

BULLETIN
OF THE
ILLINOIS STATE LABORATORY
OF
NATURAL HISTORY

URBANA, ILLINOIS, U. S. A.

VOLUME XI
1915, 1917, 1918

CONTRIBUTIONS TO THE NATURAL HISTORY SURVEY OF ILLINOIS
MADE UNDER THE DIRECTION OF

STEPHEN A. FORBES

1918



SCHNEPP & BARNES, STATE PRINTERS
SPRINGFIELD, ILL.

1918.

8040—600

Volumes

Include one set of covers and ads.

1/2 Goat

Lib. Buck 2

Cloth

1/2 Duck

1/2 Pig

Light Brown

Dark Brown

Black

Dark Blue

Dark Green

Red

Maroon

Tan

Olive

Light Green

Light Blue

Light Drab

Yellow

See Sample Back

10M Je. 16

Bulletin
Illinois State
Laboratory of
Natural History

11
1915-18

UNIV. OF
ILLINOIS
LIBRARY

PAGE

3-32

3-17

3

3

8

9

10

12

14

15

16

17-31

17

18

21

31-32

33-280

33

35-40

I. General description of the region.....	35
II. The ecological stations.....	38
Description of the prairie habitats and animals.....	40-56
I. Prairie area north of Charleston, Station I.....	40
1. Colony of swamp grasses (<i>Spartina</i> and <i>Elymus</i>), Station I, a.....	41
2. Colony of wild rye (<i>Elymus virginicus submuticus</i>), Station I, c.....	43
3. Wet area of swamp milkweed (<i>Asclepias incarnata</i>), Station I, d.....	44
4. Cone-flower and rosin-weed colony, Station I, e.....	48
5. Colony of blue stem (<i>Andropogon</i>) and drop-seed (<i>Sporobolus</i>), bordered by swamp milkweed, Station 1, g.....	49
6. Supplementary collections from Station I.....	52

	PAGE
II. Prairie area near Loxa, Illinois, Station II.....	52
III. Prairie area east of Charleston, Station III.....	55
Description of the forest habitats and animals.....	56-66
1. The Bates woods, Station IV.....	56
2. The upland oak-hickory forest, Station IV, <i>a</i>	57
3. Embarras valley and ravine slopes, forested by the oak-hickory association, Station IV, <i>b</i>	59
4. Lowland or "second bottom," red oak-elm-sugar-maple-woodland association, Station IV, <i>c</i>	62
5. Supplementary collections from the Bates woods, Station IV....	65
6. Small temporary stream in the south ravine, Station IV, <i>a</i>	65
General characteristics of the gross environment.....	66-102
1. Topography and soils of the State.....	66
2. Climatic conditions.....	67
3. Climatic centers of influence.....	69
4. Relative humidity and evaporating power of the air.....	71
5. Temperature relations in the open and in forests.....	83
6. Soil moisture and its relation to vegetation.....	86
7. Ventilation of land habitats.....	88
8. The tree trunk as a habitat.....	91
9. Prairie and Forest vegetation and animal life.....	91
10. Sources and rôle of water used by prairie and forest animals..	98
Animal associations of the prairie and the forest.....	102-158
I. Introduction.....	102
II. The prairie association.....	103
1. Swamp prairie association.....	103
2. The cottonwood community.....	105
3. Swamp-grass association.....	107
4. Low prairie association.....	108
5. Upland prairie association.....	109
6. The <i>Solidago</i> community.....	109
7. Dry prairie grass association.....	111
8. A milkweed community.....	112
III. Relation of prairie animals to their environment.....	113
1. The black soil prairie community.....	114
2. The prairie vegetation community.....	117
3. Interrelations within the prairie association.....	119
IV. The forest associations.....	122
1. Introduction.....	122
2. Dry upland (<i>Quercus</i> and <i>Carya</i>) forest association.....	124
3. Artificial glade community in lowland forest.....	125
4. Humid lowland (hard maple and red oak) forest association.....	126
5. Animal association of a temporary stream.....	127

V. Relation of the deciduous forest invertebrates to their environment	PAGE 128
1. Forest soil community.....	129
2. The forest fungus community.....	135
3. The forest undergrowth community.....	138
4. The forest crown community.....	139
5. The tree-trunk community.....	142
6. The decaying wood community.....	148
7. Interrelations within the forest association.....	157
Ecologically annotated list:—	
I. Prairie invertebrates	158-201
II. Forest invertebrates	201-238
Bibliography	239-264
Index	265-280
ARTICLE III. THE VERTEBRATE LIFE OF CERTAIN PRAIRIE AND FOREST REGIONS NEAR CHARLESTON, ILLINOIS. BY T. L. HANKINSON. (16 PLATES) SEPTEMBER, 1915.....	
281-303	
Introduction	281
The prairie area, Station I.....	282
Amphibians and reptiles.....	284
Birds	284
Mammals	288
Relations of the prairie vertebrates to their environment.....	289
The forest area, Station II.....	291
Fish, amphibians, and reptiles.....	293
Birds	294
Mammals	297
Supplementary list of birds.....	298
Relation of the woodland vertebrates to their environment.....	299
Summary and conclusions.....	301
ARTICLE IV. SOME ADDITIONAL RECORDS OF CHIRONOMIDÆ FOR ILLINOIS AND NOTES ON OTHER ILLINOIS DIPTERA. BY JOHN R. MALLOCH. (5 PLATES) DECEMBER, 1915.....	
305-363	
Notes on blood-sucking Ceratopogoninæ.....	306-309
Additions to list of Illinois Chironomidæ:—	
Ceratopogonidæ	310
Tanypinæ	317
Descriptions of males of Ceratopogoninæ previously unknown.....	317-319
Immature stages of some Illinois Diptera (Sciariidæ and Mycetophilidæ) and biological notes.....	319-324
Predaceous and Parasite Orthorrhapha.....	324-342
Key to pupæ.....	325
Bombyliidæ	327

	PAGE
Therevidae	334
Mydidae	336
Asilidae	337
Cyrtidae	341
Phytophagous and other Cyclorrhapha.....	342-352
Syrphidae	342
Ephyridae	345
Drosophilidae	346
Agromyzidae	348
Descriptions of new Illinois Diptera:.....	352-363
Phoridae	353
Anthomyiidae	356
Geomyzidae	357
Agromyzidae	359
Chloropidae	360

ARTICLE V. PHYLLOPHAGA HARRIS (LACHNOSTERNA HOPE): A REVISION OF THE SYNONYMY, AND ONE NEW NAME. BY ROBERT D. GLASGOW, PH.D. FEBRUARY, 1916.....		365-377
Synonymy of the Phyllophaga of the United States and Canada.....		370
Alphabetical list of foregoing names.....		374
<i>Phyllophaga forbesi</i> , n. sp.....		378

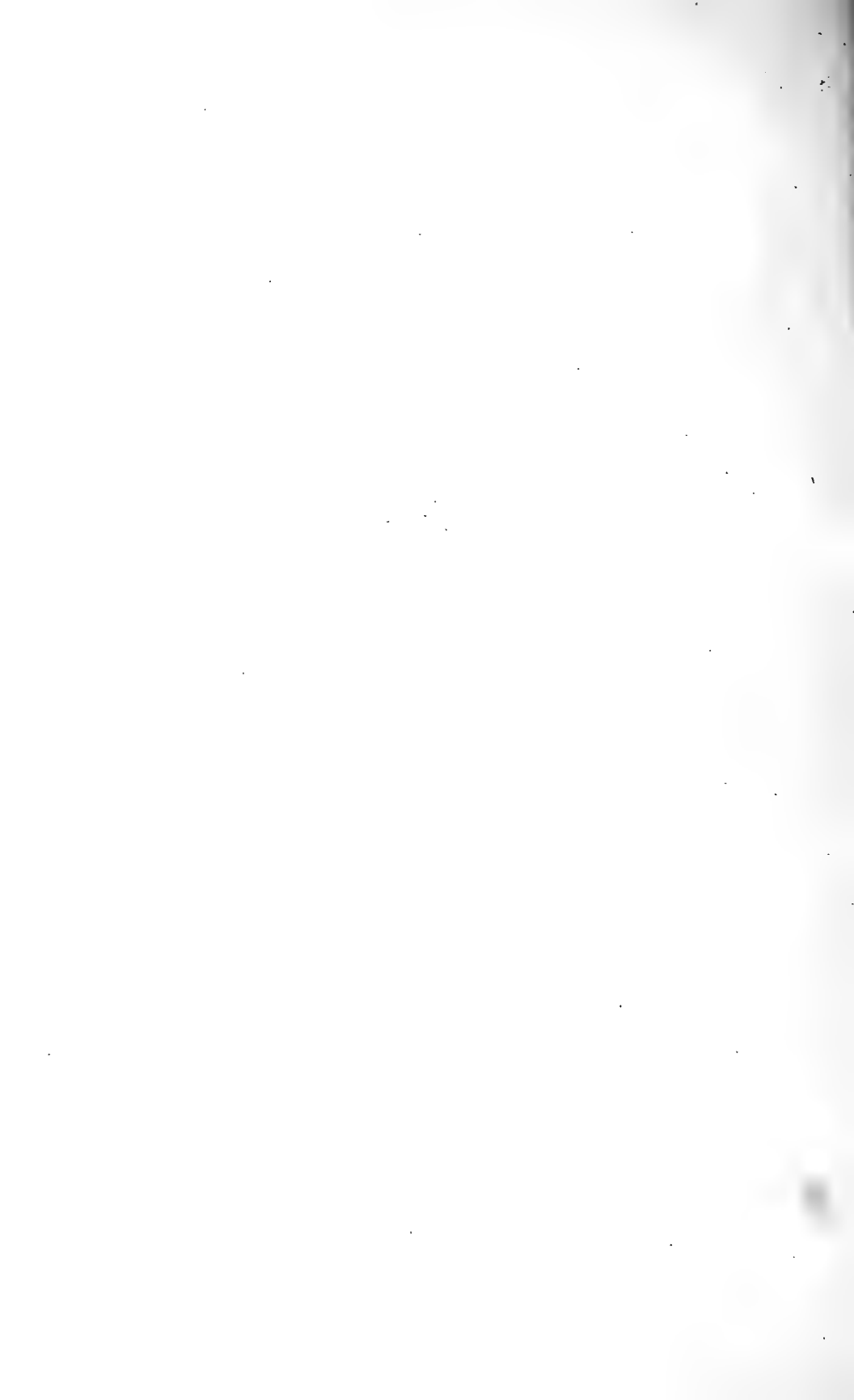
ARTICLE VI. AN EXPERIMENTAL STUDY OF THE EFFECTS OF GAS WASTE UPON FISHES, WITH ESPECIAL REFERENCE TO STREAM POLLUTION. BY VICTOR E. SHELFORD, PH.D. (1 FIGURE, 4 CHARTS) MARCH, 1917.....		381-412
I. Introduction		381
II. Statement of the fish and gas-waste problem.....		381
III. Material and methods.....		382-388
1. The character of University of Illinois water.....		383
2. Treatment for keeping fishes alive.....		384
3. Difficulties to be guarded against in fish experiments....		385
4. Fishes used		387
IV. Gas waste—its character and constituents.....		388
V. Toxicity of waste.....		389-394
1. Methods of experimenting.....		390
2. Toxicity of waste and tar.....		391
3. Toxicity of illuminating gas and constituent gas-mixtures.		392
4. Reactions of fishes to waste.....		392
VI. The toxicity of illuminating gas waste constituents.....		394
VII. General discussion		406
1. Toxicity and size		406
2. Toxicity and species		408

	PAGE
3. Fish reactions to polluting substances.....	408
4. Treatment of by-products of the manufacture of coal gas..	409
VIII. Summary	409
IX. Acknowledgments	410
X. Literature consulted.....	410
ARTICLE VII. SOME EDIBLE AND POISONOUS MUSHROOMS. BY	
WALTER B. McDOUGALL, PH.D. (2 FIGURES, 59 PLATES) NOVEM-	
BER, 1917	
	413-555
Introduction	413
Mushrooms and toadstools.....	414
The mushroom plant.....	414
Life history and development.....	414
Structure	417
Spore production and liberation.....	417
Other types of mushrooms.....	419
The ecology of mushrooms.....	420
Dissemination	420
Gravity	421
Air	421
Heat	421
Light	422
Substratum	422
Water	422
Parasites and saprophytes.....	423
Mycorrhizas	424
Animal relations	425
Diseases	427
Fairy rings	427
Luminosity	427
Mushroom-growing	429
Food value of mushrooms.....	430
Poisonous properties of mushrooms.....	430
Collecting wild mushrooms.....	431
Preparation of mushrooms for the table.....	433
Classification of mushrooms.....	435
Use of the key.....	436
Key to genera of gill fungi.....	437
Descriptions and illustrations of species.....	440-552
Reference to literature.....	554
Index to described or briefly characterized species.....	555

ARTICLE VIII. THE REACTIONS AND RESISTANCE OF FISHES TO CARBON DIOXIDE AND CARBON MONOXIDE. BY MORRIS M. WELLS, PH.D. (1 FIGURE, 1 CHART) MAY, 1918.....	PAGE 557-571
Introduction	557
Properties of the gases.....	559
Methods and materials.....	559
General resistance of fishes.....	565
Summary	568
Bibliography	569
ARTICLE IX. EQUIPMENT FOR MAINTAINING A FLOW OF OXYGEN-FREE WATER, AND FOR CONTROLLING GAS CON- TENT. BY VICTOR E. SHELFORD, PH.D. (1 FIGURE) MAY, 1918.	573-575
ARTICLE X. A COLLECTING BOTTLE ESPECIALLY ADAPTED FOR THE QUANTITATIVE AND QUALITATIVE DETERMINA- TION OF DISSOLVED GASES, PARTICULARLY VERY SMALL QUANTITIES OF OXYGEN. BY EDWIN B. POWERS, M. A. (1 FIGURE) MAY, 1918.....	577-578

ERRATA AND ADDENDA.

- Page 50, second column, line 13 from bottom, for *Danais archippus* read *Anosia plexippus*; line 8 from bottom, for *mellifica* read *mellifera*.
- Page 51, line 11 from bottom, for *Danais* read *Anosia*.
- Page 159, at right of diagram, for *Bracon agrilli* read *Bracon agrili*.
- Page 289, second column, last line but one, for *Scalops* read *Scalopus*.
- Page 294, line 3, for *catesbeana* read *catesbiana*.
- Pages 327 and 330, line 12, for *oreus* read *oreas*.
- Page 347, line 4, for *Cecidomyidæ* read *Cecidomyiidae*.
- Page 356, line 7, for *Anthomyidæ* read *Anthomyiidae*.
- Page 368, line 18, dele second word.
- Page 373, after line 10 insert as follows: 53a, *subpruinosa* Casey, 1884, p. 38.
- Page 375, after *submucida* Le Conte, 48, insert *subpruinosa* Casey, 53a.
- Page 377, after line 7, insert as follows:—
1884. Casey, Thomas L.
Contributions to the Descriptive and Systematic Coleopterology of
North America. Part I.
- Page 379, line 11 from bottom, for *sensu lata* read *sensu lato*.
- Page 382, line 12, for VII read VIII.
- Page 408, line 2, for *the next article in* read *Article VIII of*.
- Page 410, line 6 from bottom, for = $\frac{1}{2}$ read '11.
- Page 412, line 7, for 31 read 30.
- Page 421, line 17 from bottom, insert *it* before *grows*.



BULLETIN
OF THE
ILLINOIS STATE LABORATORY
OF
NATURAL HISTORY

URBANA, ILLINOIS, U. S. A.

STEPHEN A. FORBES, PH.D., L.L.D.,
DIRECTOR

VOL. XI.

JULY, 1915

ARTICLE I.

AN OUTLINE OF THE RELATIONS OF ANIMALS
TO THEIR INLAND ENVIRONMENTS

BY

CHARLES C. ADAMS, PH.D.

CONTENTS

	PAGE
The dynamic relations of animals.....	1-17
1. Introductory note	1
2. The relations of animals to their environment.....	1
3. Optima and limiting factors.....	8
4. Determination of dynamic status.....	9
5. Animal responses	5
6. The interrelations of animals	12
7. Ecological units for study	14
8. The animal association	15
9. Associational succession	16
The dynamic relations of the environment	17-31
1. Introductory	17
2. The dynamic and genetic standpoint	18
3. Dynamic and genetic classification of environments.....	21
References to literature	31-32

ARTICLE I.—*An Outline of the Relations of Animals to their Inland Environments.* BY CHARLES C. ADAMS, PH.D.

THE DYNAMIC RELATIONS OF ANIMALS

I. INTRODUCTORY NOTE

As creatures of habit, the attitude of mind with which we approach a scientific problem has much influence upon what we see in it or get from it. Although the essence of life is activity—the response of the changing organism to its changing environment—yet this dynamic conception of animal relations, *and all that it implies*, has not become as prevalent a mental habit among biologists as one might expect. While some naturalists view the animal from a more or less dynamic standpoint, they do not include a similar conception of the relation of an animal to its environment. Still others view the environment more or less dynamically but do not extend this conception to the animal, and thus both of these conceptions lack completeness and are not thoroughgoing and consistent. The study of activities, or in other words the study of processes, has made great progress in the allied sciences, much to their advantage, and undoubtedly the prevalence of similar conceptions will lead to similar advances in biology.

In the present brief paper I have attempted to discuss only certain phases of the problem with the idea of emphasizing the general principles involved, and in the hope that it may aid in making these conceptions of more practical value in investigation, and also facilitate an understanding of the discussion contained in a report on the invertebrates of the Charleston (Illinois) region, to appear in a subsequent paper of this volume of the Laboratory Bulletin.

2. THE RELATIONS OF ANIMALS TO THEIR ENVIRONMENT

The study of animal ecology may be taken up from many sides and in many ways. One of the most interesting and fundamental of these is that which considers the *dependence* of the animal upon its environment, and at the same time orients it in the gamut of energies and substances. Many phases of this discussion, though elementary and for this reason easily overlooked, are yet of fundamental importance. Every boy who has kept pets in confinement, and who has had the re-

sponsibility of caring for them, and every one who has cared for domestic animals, knows what constant attention must be given to keep them supplied with food, water, shelter, and other "necessities of life." And who can overlook the fact that it requires attention to maintain his own physical health? In the laboratory this dependence upon the environment is readily tested experimentally by any method of isolation which will prevent an animal from securing any "vital necessity": as air—when sealed in a vessel; or food—when locked up without it; or a favorable temperature. No animal can survive such isolation from its normal environment. Every student of animals in nature must also realize that similar supplies and conditions determine and control the existence and welfare of all *wild* animals. The animal is not self-sustaining, but requires a constant intake of energy and substance from its environment. Chemical methods will readily show the source from which the materials composing the animal body have been derived. The ash came from the soil or rock, and shows the animal's dependence upon the solid earth; the liquids came from the water of the earth and constitute from fifty to ninety-five per cent. of the bulk of the animal's body, showing that a relatively large quantity of this substance is essential to all living animals; the abundant gaseous element was derived from the atmosphere, to which it will again return. The substance composing the animal body is thus derived mainly from the water and the air rather than from the relatively inert and stable earth. It will be profitable for us to imagine these proportions so changed that the solids instead of the relatively mobile liquids and gases form the principal mass of the body, keeping in mind meanwhile the slow rate of chemical change in solids compared with the change in substances in a finely divided condition, such as liquids and gases. If the solids predominated, the rate of the chemical change, upon which the active life of animals depends, would be greatly retarded, and animals, including man, would be stolid beyond comprehension. Furthermore, we must not overlook the fact that animals are not maintained solely by substance, because substances are also carriers of energy, substance and energy never being separated. The living animal is not a *producer*: it can make neither substance nor energy, nor is it a kind of energy; it is solely a *transformer*, a chemical engine which changes the form of substance and chemical energy and produces new combinations from the old. The living plant transforms energy and inorganic substance, from the air, water, and earth, into complex chemical compounds, and thus concentrates powerful chemical energy in such a form that the animal, by a further change, is able to set it free and to utilize it. Sugar, starch, and gluten are familiar examples

of this "tablet" or "cartridge" form of chemical energy which animals explode or set free and then use in maintenance. During this transformation, in which chemical energy is set free, waste products—inert chemical substances—are formed which if not eliminated from the animal system will prevent its operation, just as ashes if not removed will check a furnace. Respiration aids in the removal of carbonic acid gas—a waste product—from the body, but we often forget that the chemical energy derived from the oxygen is an important feature in respiration. By another process the liquid and the solid waste is removed. Thus gases, liquids, and solids are taken into the body and later returned to the environment in a different chemical condition, thus completing a cycle of transformation. That the animal body is so largely made up of solutions and gaseous substances is an important factor in its relatively unstable chemical condition, a condition of *unstable equilibrium*, which determines the active and dynamic character of the animal. Since, then, chemical activity is one of the essential characteristics of a living organism, its influence forms one of the main problems of the zoologist when studying the changes in animal activities; their orderly sequence and the laws which govern them.

On account of the fact that the animal is a chemical engine, it is able to use chemical energy to the fullest extent. If we assume a hierarchy in the forms of energy, chemical energy seems to belong to the upper class; for though some forms of energy are not readily transformed into chemical energy, chemical energy can be transformed into *all others*. As a result the animal, being a chemical engine, has, as it were, an "inside track" to the main sources of energy, and thus by transformation is able to utilize chemical energy to form light, as in the firefly, or electricity, as in the electric eel; and other forms of energy useful to the animal are similarly derived. This study of the activities of living animals, as contrasted with the study of dead ones, is a phase of the general science of energetics, a science which furnishes the basis for the correlation of many diverse branches of knowledge.

The activities and transformations within the animal body show us very clearly how an animal is dependent upon environmental conditions. The animal transforms air, water, and rock, and all animal habitats and environments must contain these elements. In nature these are combined in a multitude of ways. The interrelations of these fundamental environmental units have been strikingly expressed by Powell ('95: 22-23) as follows:

"The envelopes of air, water, and rock are so distinct that they can be clearly distinguished; and yet, when they are carefully studied, it is

discovered that every one encroaches upon the territory of the others, not only by interaction, but also by interpenetration. It has already been shown that the water penetrates deep into the rock. Every spring that falls from the hillside gives proof that the rocks above its level hold water, which they yield slowly as a perennial supply; and the innumerable hills of the continents and islands have their innumerable springs. Every well proves that there is water below; every artesian fountain shows the existence of underground waters; and every boring in the crust of the earth, and every excavation in underground mining, discovers the presence of water.

“Wherever water flows, air flows with it, and all natural waters are permeated with air.

“The aqueous envelope is everywhere permeated with rock, which it holds in solution or suspension, and there is no natural water absolutely pure. The sea is full of salt. Salt lakes are more than full of salt, and so they must throw it upon the bottom; and the waters hold lime and many other substances. Not a drop of pure water can be found in the sea; not a drop can be found in a lake; not a drop of pure water can be found in any river, creek, brook, or spring; and not a drop of pure water can be found underground: it is all mixed to some degree with rock.

“All natural waters are aerated. No drop of water unmixed with rock and air can be found, except by the process of artificial purification.

“But surely there is pure air? Nay, not so. There is no natural air unmixed with rock and water. All the air that circulates above the land and sea, within the ken of man, and all the air which circulates underground, is mixed with rock and water.

“Pure air is invisible: it will not reflect light; it is transparent, but will not convey light. Light is conveyed through the atmosphere by ether, and is reflected and refracted by rock and water; and it seems to be largely affected in this manner by rock. If the ambient air of the earth were pure, there would be no color in the sky, no rainbow in the heavens, no gray, no purple, no crimson, no gold, in the clouds. All these are due largely to the dust in the air. The purple cloud is painted with dust, and the sapphire sky is adamant on wings.

“Land plants live on underground waters: were there no subterranean circulation of water, there would be no land plants. Fishes live on under-water air: were there no circulation of subaqueous air, there would be no fishes in the sea. The clouds are formed by particles of dust in the air, which gather the vapor: were there no dust in the air, there would be no clouds; were there no clouds, there would be no rain.”

Up to this point we have considered mainly the processes of maintenance of the animal body, but there are other processes as well which must be called to mind, such as growth, development, multiplication, and behavior. Physiologically considered, none of these activities are essentially different from the fundamental phases of metabolism and all are dependent upon it; they are special forms of the transformation of substances and energy within the animal. As the individual animal grows and develops in its life cycle, its metabolism, form, and behavior change in an orderly manner, and this transformation is in the main a continuous process like the other transformations of matter and energy. The changes which take place during ontogeny are often greater than the differences which exist between very distantly related adults, and these differences result in very different rôles which the animal often plays in the economy of nature.

Comparable to the responses of the animal to its environment, and indeed essentially of the same kind, are the responses of any part of an animal to all its other parts, the entire organism, in this case, being considered as a unit. The environment of an internal parasite is formed by the body of its host, and in a similar sense the different parts of the body are parts of the environment of the other parts. The different parts of the animal body are what they are on account of three conditions. The first is determined by its relative position and responses as a member of a series of successive generations. In this way the hereditary potentialities are determined. Ecologically considered heredity may be regarded both as the response of individuals (unicellular) and germs to the conditions of life, and as the mutual responses of different germs to one another. The crossing and intermingling of germinal elements is as truly a response as are other forms of activity. Secondly, there is considerable evidence which indicates that *at some stage* in the development of an animal any part is potentially capable of developing into any other part. The character of development, then, is conditioned by the character of the cell-environment—its relative position, and all that implies with regard to environment. A fragment of a regenerating animal develops differently according to its position, and this is a response to its relative position in the cell community. Thirdly, the development of an animal is conditioned by its external environment. The external conditions influence animals by changing their internal activities. The internal changes modify the cell community and change development. In this manner every part of the animal is influenced by the conditions of its existence.

The processes of metabolism are continuous as long as life lasts. Thus, as an animal respire there is a gaseous exchange, from the

earliest stages of its existence until its maturity and death. Eggs respire as surely as larvæ and adults, and the chemical, physical, and physiological changes within them vary with their growth and development. Some of these changes are primarily dependent on the orderly course of development during the life cycle, and are therefore irreversible processes, because no higher animal which is mature may reverse its development and become young again. At different stages of development different enzymes and hormones appear which modify the physiological conditions of growth, development, and behavior. Environmental changes, persistent and uniform, or periodic in character, tend to modify and alter these internal processes, and are an additional source of change, which is particularly shown in behavior.

It is interesting to observe in this connection that certain factors are important as they *hasten* or *retard* other processes. Thus enzymes hasten chemical changes which without them would take place at a very slow rate, and they set free much energy in a relatively short time. Temperature is another hastener of chemical reaction. Not only is it a condition which sets limitations on the chemical reaction in animals, but it also influences their optimum, and with increasing temperature chemical changes take place within the animal irrespective of the control of the animal, except in the warm-blooded animals, where a mechanism exists which regulates, within certain limits, temperature conditions.

3. OPTIMA AND LIMITING FACTORS

We have seen that the animal is dependent upon its environment for both substance and energy. If, therefore, the environment does not contain, in available form, both substance and energy, animals will not be able to live in it permanently, although with energy stored in their bodies they may be able to make more or less prolonged and successful invasions into such an environment. The optimum is the most favorable condition for any function. We may consider optima corresponding to units of different rank: a single cell or tissue in action, an organ or system of organs, the animal as a whole, a taxonomic unit—and so on, to an animal community or association. There are, then, many kinds of optima, and the study of the conditions which produce them is a complex subject. The optima for different functions may differ much; for example, that for growth is often different from that for reproduction, and the optima may also change greatly with the development of the animal. Optima, therefore, are not fixed conditions, even though they do represent a condition of physiological *relative equilibrium*. The amount or intensity of substance and energy which produces an optimum is limited above by the maximum and below by the minimum. Thus departures from the optimum, toward an

increase or a decrease, are departures *from* the most favorable conditions toward less favorable conditions, and hence toward limiting conditions. This form of expression is mainly that of the laboratory; it is desirable therefore, in addition, to express it in terms of the normal habitat. In nature we look upon the optimum as that complex of habitat factors which is the most favorable, and departure in any direction from this optimum intensity is in the direction of a less favorable degree of intensity or into unfavorable conditions. From this standpoint *any unfavorable condition is a limiting factor* and may retard, hasten, or prevent vital and ecological activities. Optima are thus almost ideal conditions, and are probably realized in nature only to a limited degree; in other words only approximately. Here also, as in the laboratory, they represent a condition of *relative equilibrium*. The laws of the transformation and development of optima are of great ecological importance, as I pointed out several years ago ('04). In field study probably the most valuable criterion to be used in the recognition of ecological optima is the normal relative abundance and influence of animals in their breeding environment.

In the preceding discussion no special emphasis has been placed upon the time element, or the rate at which changes may take place. Natural environments are complexes, in the composition of which several factors are involved. This being true, it is desirable to recall the fact that the *rate of change* is determined by the pace of the slowest factor, or, as Blackman ('05: 289) has expressed it: "When a process is conditioned as to its rapidity by a number of separate factors, the rate of the process is limited by the pace of the 'slowest' factor." This is a general law and applies to all changes, internal as well as environmental.

In closing this section, I wish to call attention to another conclusion of the English plant physiologists Blackman and Smith. They state ('11) that from experimental study of the assimilation of water plants, the conception of the optima is untenable, and that the phenomena are better explained as the result of "interacting limiting factors than by the conception of optima" (p. 412). This principle is formulated as follows (p. 397): "When several factors are possibly controlling a function, a small increase or decrease of the factor that is limiting, and of that factor only, will bring about an alternation of the magnitude of the functional activity." It will be of much importance to test the application of this idea to animal responses.

4. DETERMINATION OF DYNAMIC STATUS

In any study of the energetics of organisms it is desirable to have clearly in mind one of the fundamental conceptions of this science—

the dynamic status. The law of conservation of energy teaches us that energy can not be destroyed; that it is transformed only, and thus undergoes a cycle of changes. The animal or an animal community, as a unit and as an agent or transformer, is constantly transforming energy, setting it free. In this sense it originates, but not at a uniform rate. At one time much energy may be transformed, and at another very little. When a great amount of energy is being set free, when the animal or community is exerting much influence, we may look upon it as producing pressure or strain. A condition of stress is not a permanent one, because the pressure tends to cause such changes as will equalize or relieve this condition. This is considered as the process of adjustment to strain, and is called Bancroft's law ('11). An animal in an unfavorable condition is stimulated, its normal activities are interfered with, and a physiological condition of stress is produced which lasts until by repeated responses or "trials" the animal escapes stimulation or succumbs and a relative equilibrium is established. An area may become overpopulated and consequently there may be established a condition of stress, which results in an adjustment by a reduction (through many causes) in the excess of population and a restoration of the normal, or a condition of relative equilibrium. From these examples it may be seen that the *dynamic status* means the condition of a *unit* or system with regard to its *degree of relative equilibrium*. The cycle of change may be considered to begin at any point. I have taken as the initial stage of the cycle the condition of *stress* or *pressure*, and have indicated how this condition tends to change in response to pressure, bringing about the *process* of adjustment to strain, and leading to the *condition* of adjustment to strain, or that of relative equilibrium. The activity of the agent produces the condition of stress, the process of adjustment to the strain follows, and this leads to the product—the establishment of the condition of adjustment or of relative equilibrium.

These conceptions are very suggestive when applied to various phases of organic activity, and aid greatly in utilizing the dynamic conceptions which are in constant use in many of the physical sciences. But we can not assume that these ideas will take definite form unless the student makes some special effort to master the principles involved.

5. ANIMAL RESPONSES

The general character of the changes within the animal, which result in the transformations of energy and substance, or the process of metabolism in its broadest sense, is the basis of all animal responses. It is well known that growth, development, and behavior are condi-

tioned by certain metabolic processes, the rate of which are further conditioned by the presence of certain substances, as enzymes (from liver, etc.), and internal secretions (from thyroid, testes, adrenals, etc.). The influence of certain physiological conditions or processes is thus well known to affect the behavior of animals. The changes of instinct through the removal of the testes or ovaries, may be cited as examples of this influence. An animal whose metabolic processes have reached a certain stage is said to be satiated; later it is in the condition of incipient hunger; and still later, in the physiological condition of intense hunger. These internal changes cause the animal to react very differently to any food which is in its immediate vicinity. These changes in physiological conditions are strictly comparable to the change which an animal passes through in its ontogeny; to the life cycle of an insect, for example, in which the physiological conditions and behavior of a caterpillar are very different from those of the pupa and of the adult or moth. One of the higher animals, a dog, for instance, will undergo internal changes which will completely alter its responses at the sight of an old rival or enemy. Such considerations as those just cited show clearly that extensive internal physiological changes take place in animals, and that while some of them are very gradual others are exceedingly rapid. These internal conditions or changes have been well characterized by Jennings ('06: 289) as follows: "The 'physiological state' is evidently to be looked upon as a dynamic condition, not as a static one. It is a certain way in which bodily processes are taking place, and tends directly to the production of some change. In this respect the 'law of dynamogenesis,' propounded for ideas of movement in man, applies to it directly (Baldwin, '97: 167); ideas must indeed be considered so far as their objective accompaniments are concerned, as certain physiological states in higher organisms. The changes toward which the physiological state tends are of two kinds. First, the physiological state (like the idea) tends to produce movement. This movement often results in such a change of conditions as destroys the physiological state under consideration. But in case it does not, then the second tendency of the physiological state shows itself. It tends to resolve itself into another and different state."

I may thus summarize the relation of metabolic processes to physiological conditions and processes of behavior by the following table.

TABLE 1.—THE DYNAMIC RELATIONS OF ANIMAL ACTIVITIES

<i>The Animal as an Agent</i> (<i>Activity of an Agent</i>)	<i>Processes of Activity</i>	<i>Products of Activity</i>
<p>The animal as an agent transforms energy and substance by its metabolic processes. These are accompanied by physiological conditions or states; they constitute a condition of unstable equilibrium. The transformations take place as—</p> <p>(1) Continuous and irreversible processes, as development, differentiation, etc.; or are—</p> <p>(2) Periodic or rhythmic processes, as digestion sexual activity, etc.</p>	<p>This unstable internal condition tends towards change, resulting in—</p> <p>(1) New conditions;</p> <p>(2) Movement;</p> <p>(3) The processes of behavior: trial, experiment, investigation, etc.</p>	<p>New states. Movement. Response. Regulation. Adjustment. Relative equilibrium. Learning. Orientation. Data. Concepts. Explanation. Theory. Hypotheses. Ideals.</p>
<p>Changes in the internal conditions are produced also by external stimuli.</p>		

The responses of animals to the conditions in which they live are of a composite character. Certain responses, such as the chirping response of a coot within the egg, are inherited and are relatively automatic in character; others are greatly modified by experience, as when an animal "learns," or forms a habit by repeated responses.

The responses of animals to the conditions of existence are the basis for any study of their relations, not only to other members of their own species, but to all elements, living or otherwise, of their complete environment. It is from this standpoint that animals must be considered in estimating their place in the economy of nature; that is, in estimating how they influence one another in an association of animals living together in the same habitat, and in judging of their relation to the succession of animal communities, and even to man himself.

6. THE INTERRELATIONS OF ANIMALS

"A group or association of animals or plants is like a single organism in the fact that it brings to bear upon the outer world only the surplus of forces remaining after all conflicts interior to itself have been adjusted. Whatever expenditure of energy is necessary to maintain the existing internal balance amounts to so much power locked up, and rendered unavailable for external use."—S. A. FORBES.

We have now seen the dependence of the animal upon its environment, as this forms the basis for an understanding of conditions involved in the problem of *maintenance* or the upkeep of the animal. The optimum conditions for prolonged maintenance produce the vital

and ecological optima. These conditions imply more than mere maintenance; they mean as well, a degree of favorable conditions which permits the animal to exert an influence or stress upon its environment. As Forbes has said, if all the energy available to the animal is utilized internally there will be nothing left to influence the environment. Metabolic changes show that large amounts of energy and substance are used in maintenance. Under optimum conditions even greater amounts must exist. An animal must not only be able to maintain itself against other kinds of animals but even against its own kind, for the overproduction of its own race will be practically self-destructive. A good example of this kind of influence is seen in the hordes of lemmings which migrate, even into the sea, when overproduction becomes extreme.

The vital and ecological optima are thus to be looked upon as internally balanced, but externally, not as a state of balance or poise, but as a condition in which the animal is exerting stress, pressure, or influence upon its environment, instead of being passive or inert. A group of animals living together in any given condition such as an association, is an assemblage of interacting organisms. The active, free-moving animals collide with each other, with other kinds of animals, especially the relatively sedentary kinds, and with their environment of plants and the inorganic factors. The relatively sedentary animals are correspondingly bombarded by all elements of their environment. The association, as a whole, is thus in a continuous process of bombardment and response from every possible angle, and just as the individual animal is stimulated and responds, so all the members of any association are stimulated and respond in a similar manner. It is by this form of activity that animals not only maintain themselves but exert a radiating influence.

It will assist in realizing the constant pressure exerted by animals if we compare their activity to the flow of a stream. The pressure exerted by the stream may be realized if by a dam or similar means the current is resisted. Think for a moment of the amount of energy which would be transformed in an effort to prevent animals (or plants) from taking possession of a *favorable* habitat. Imagine an area 10 feet square and think of the effort it would require to prevent animals permanently from invading and establishing themselves in this habitat if no barriers were interposed, and if the means of destruction of the invaders were not so drastic that they materially changed the character of the habitat. Increase the size of the area and the difficulties will increase in geometrical ratio, and the utter futility of such an undertaking will soon be realized. The spreading processes of the gypsy moth in Massachusetts, and of the San Jose scale and the cotton

boll weevil, show us in terms of human experience something of the energy expended by these radiating animal activities even when there are strong human economic inducements against such invasions.

When a balanced condition, or relative equilibrium, in nature is referred to, we must not assume that all balances are alike, for some are disturbed with little effort and others are exceedingly difficult to change. This distinction is an important one. Once the balance is disturbed, the process of readjustment begins. This is a phase of the balancing of a complex of forces. Just what stages this process will pass through will depend, to an important degree, upon the extent of the disturbance. Slight disturbances are taking place all the time and grade imperceptibly into the normal process of maintenance, as when a tree dies in the forest and its neighbors or suppressed trees expand and take possession of the vacancy thus formed. Disturbances of a greater degree, on the other hand, may only be adjusted by a long cumulative process. This change can progress no faster than the rate at which its slowest member can advance. Thus a forest association of animals may be destroyed by a fire so severe that all the litter and humus of the forest floor is burned. The animals which live in the moist humic layer as a habitat, such as many land snails, diplopods, and certain insects, can not maintain themselves upon a mineral soil, rock, or clay. As such a forest area becomes reforested, these animals can only find the optimum conditions when the slow process of humus formation reaches a *certain degree of cumulative development*. Under such circumstances this later stage must be preceded by *antecedent processes*, and restoration of the balance is long delayed. Some adjustments take place so quickly that little can be learned of the stages through which they pass. There are, however, many slow processes which afford an abundance of time for study; in fact some are too slow to study during a lifetime. The processes which are moderately slow are often particularly illuminating because all stages are frequently so well preserved that comparison is a very useful method of study; the slowness of a process has a certain resolving power, as it were, recalling the influence of a prism upon a beam of white light, which reveals many characteristics obscure to direct vision. A study of the processes of adjustment among animals is a study of an important phase of the problem of maintenance. The continued process of response will, if circumstances permit, lead to a condition of relative adjustment, or to a balancing among all the factors in operation.

7. ECOLOGICAL UNITS FOR STUDY

In the study of animal responses many different units are available, and a brief consideration of these will aid in an understanding of

the methods which are useful. Because the animal body has been found to be composed of a single cell or a multitude of cells, a common belief has grown up that the cell is the natural unit for study. This opinion seems to be due to overlooking the fact that there is just as much reason for considering the *whole animal* as the unit. The unicellular animals are *whole animals* as truly as they are cells, and in multicellular animals the activity of single cells means little independently of the animal as a whole. It thus seems that ecologically at least the smallest valuable unit for study is the *individual animal*. The responses of the individual, as a kind of animal, to its condition of existence form the basis for what may be called *individual ecology*. Animals which are related by descent from common ancestors, as a community of social animals (e. g., an ant colony), or taxonomic units, such as genera, families, orders, etc. (e. g., fish, birds, catfishes, and salamanders), are also units which may be studied ecologically. Some of these hereditary units are, ecologically, fairly homogeneous, as, for instance, when a taxonomic unit is equally distinct ecologically: e. g., the woodpeckers with their arboreal habits. In other cases the taxonomic unit contains animals of great ecological diversity, as in the case of beetles, which possess almost unlimited ecological diversity, including littoral, aquatic, subterranean, and arboreal habitats, and parasitic, herbivorous, and predaceous habits. The study of ecology, upon the basis of such a unit, may be called *aggregate ecology*. Still another unit is available, based upon the animals which live together in a given combination of environmental conditions, as in a pond, on the shore of the sea, in a cave, within the bodies of animals, on the floor of the forest, or in the tree tops, etc. The animals found living together in such conditions form an *animal association* or a social community, and the study of the responses of such a community is the province of *associational ecology*.

8. THE ANIMAL ASSOCIATION

In the study of the animal association as a unit, we consider it as an agent, whose modes of activity, or responses, are of primary interest. We desire to know the kinds of animals which compose the community, the optimum and limiting influences which control its activity, the character of its responses, and the orderly sequence of changes in the environment to which it is responding.

The maintenance of an association depends upon the maintenance of the individual members which compose it, just as the maintenance of the entire animal depends upon the activities of the cells. There is the same basis for speaking of the responses of the association as there

is for speaking of the responses of the individual. The association can continue to exist indefinitely only in such environments as possess, in available form, substance and energy for its individual members. The activities of the individuals transform energy and substance, producing growth, development, multiplication, and behavior. The persistence of an association in a given habitat brings about the formation of certain waste products, which if not changed or transformed at a certain rate, or transported from the environment in some way, tend to limit the optimum activity of the individuals and of the association. In the association, as in the individual, there must be an internal relative balance before there can be such a surplus of energy that the association can radiate or exert outward stress or pressure. An association which is only maintaining itself is not at an optimum, for in this latter condition there is a surplus of energy, and the activity, rate of multiplication, and favorable development under normal conditions are favorable to the extension of the association. The pressure which such an association exerts is shown by the progressive extension of its range of influence. By the active movements of the animals, by the activity of the environment, or by both together, they tend to invade other habitats and areas, and in such of these as afford favorable conditions they tend to survive and extend the area of the association. From the standpoint of the association the behavior of these active pioneering animals corresponds to the trial activities in the behavior of the individual animal. These activities are not different in kind from those which are involved in normal maintenance. They are those which form the initial stages in the establishment and extension of the association in a new locality or the re-establishment in an old one, and thus lead to a sequence or succession of associations. Ecological succession thus consists in an orderly sequence or series of associations which occur successively and form a genetic series.

9. ASSOCIATIONAL SUCCESSION

A succession of associations takes place either through the transformation of older ones, or through the origin of a new one on a surface which has been newly formed and has had no population. A favorable habitat without a population of animals is comparable in some respects to a vacuum; it exists as a condition of unstable equilibrium which tends to change toward a more stable state. The active life of animals tends to lead them into all possible habitats, and where they find the conditions favorable for existence they tend to survive and thus bring about the establishment of an association. Each association, like the individual animal, has a certain amount of unity and

tends to maintain or perpetuate itself. But the stability of associations is only relative, and some are much more stable than others. Naturally the unstable ones are those which show succession most readily. Thus if we destroy a few trees in a hardwood forest and produce a glade, a large number of the characteristic animals of the dense forest will disappear and be replaced by animals which normally frequent open places; then in a few years sprout-growth and young and suppressed trees will change the conditions so much that the kind of forest animals which were eliminated for a time will begin to return; and when the new growth is replaced by the mature forest the animals of the mature forest will return and a new equilibrium will be formed. In such a forested region the glade is to be looked upon as an unstable condition, which through a succession of associations will later arrive at a relatively stable condition, which is able to perpetuate itself indefinitely under existing conditions. Such an association is considered a *climax*, or the culmination of a series of successions under existing conditions. The succession of associations leading to a climax represents the process of adjustment to the conditions of stress, and the climax represents a condition of relative equilibrium. Climax associations are large units, and are the resultants of certain climatic, geological, physiographic, and biological conditions.

THE DYNAMIC RELATIONS OF THE ENVIRONMENT

I. INTRODUCTORY

In the preceding section we have seen that to understand animals we must consider them as active living agents which are constantly changing and responding to their environment. That the environment of animals should also be studied as an *actively changing medium* has not been as clearly recognized by students of plants and animals as one might anticipate from its importance. Some students feel that the study and understanding of the environment is not a part of zoology, or at least not an essential part. Furthermore, to some of these students at least, the environment seems largely chaotic, a confused unwieldy mass with no evident favorable point of attack. This view is quite natural to those who have had no training and practical experience in recognizing the "orderly sequence" or laws of environmental changes, and particularly to those who do not feel that environmental relations are an essential part of their subject. By many such students the environment is viewed in a manner comparable to the prevailing chaotic views on weather before meteorology became a science, or on taxonomy before Linnaeus, or on geology before Lyell. If one has serious doubts on this point, he need only turn to the standard treatises

on zoology and search for a comprehensive and adequate recognition and utilization of the orderly and regulatory character of the environment as an essential part of the subject.

The fallacy of this position has been well expressed as follows by Brooks ('99): "I shall try to show that life is response to the order of nature. . . . But if it be admitted, it follows that biology is the study of response, and that the study of that order of nature to which response is made is as well within its province as the study of the living organism which responds, for all the knowledge we can get of both these aspects of nature is needed as a preparation for the study of that relation between them which constitute life." Later he says: "But if we stop there, neglecting the relation of the living being to its environment, our study is not biology or the science of life." No one seems to have attempted to refute this; naturally an easier path is followed—to ignore it. Perhaps up to the time of the present generation there has been some excuse for this confusion; but now the responsibility does not rest upon students of the physical and vegetational environment but upon students of animals, because the former students have arranged their scientific data in a manner which clearly shows the orderly lawful sequence of changes in environmental activities. This should form the basis for a study of the corresponding series of changes which take place within the animal, and also be the basis for a study of the reciprocal responses taking place between the animal and the environment.

In this section an outline will be given of some of the most important phases of environmental changes in inland areas viewed as lawful and orderly, particularly those changes which influence animal habits.

2. THE DYNAMIC AND GENETIC STANDPOINT

Since Lyell taught the scientific world that a study of processes now in operation is the key to an understanding of the present as well as of the past, the *process* method has been slowly but inevitably penetrating to the utmost subdivisions of inquiry. With the progressive appreciation and use of this method its efficiency has been increased. Its progress has been the most rapid where the principles of its application have been most clearly understood. As models become known in each field of work others will find the method much easier to apply, and for this reason it is desirable that such examples become fairly numerous and wide-spread.

In the application of the process method to an imperfectly understood subject, and particularly to a complex one, it is desirable to consider the subject as a *unit* or entity. This unit may then be regarded as an agent whose process of activity is to be studied, for the activity

of an agent gives us a process. Thus an organism, a plant society, or an animal community is a very complex unit or agent, which largely through chemical energy, under conditions of a normal environment, responds in an orderly sequence or changes. The environment changes, the internal conditions of the animal change, and so do the corresponding responses on the part of the animal. When all of these changes are studied as *orderly processes* we are able to see the advantage of this method of study. It is desirable to investigate all phases of animal responses in this manner, such as growth, development, heredity, etc., in order to determine the causes and conditions of this orderly sequence. As a rule our recognition of the *orderly sequence* or laws of action or succession precedes our knowledge of the causes and conditions of the sequence. This order of sequence is thus of fundamental importance and must be recognized before it can be investigated or explained. This method of studying the activity of agents, the character of their processes, constitutes the dynamic standpoint.

When the dynamic relations of an agent have been investigated, the orderly sequence of its responses established, and the causes and conditions of its activity determined, it is then possible to explain fully the origin or genesis of its activities. The *genetic method* is the study of origins in *terms of the processes involved*, and therefore the classification of facts genetically implies a knowledge of the processes involved in their origin. There are thus many degrees or stages in the development of a genetic classification, the first step of which is to determine the orderly sequence of changes. In a certain sense, in its broadest application, the process method is universal and includes the genetic, but until their mutual relations become clearly recognized and are generally understood both should be emphasized.

Particular attention should be called to the fact that the activity of an agent results in a process, and processes give us the *laws of change*. Many processes are reversible; that is a process may go forward in one direction and then become reversed and proceed in the opposite direction. Other processes are non-reversible, and operate in only one direction, being in a sense orthogenetic, as in the later stages of the ontogenetic process.

Let us summarize the main characteristics and principles involved in the dynamic and genetic method. They have been well expressed by Keyes ('98), and for my purpose are arranged as follows:

"A truly genetic scheme for the classification of natural phenomena thus always has prominently presented its underlying principle of cause and effect. . . . To begin with, an adequate scheme should be based directly upon . . . agencies. . . . All products must find accurate expression in terms of *the agencies*. . . . The primary groupings

of the . . . processes must be based, therefore, upon the manner in which these agencies affect the . . . materials. . . . Constructive and destructive agencies can be recognized only when the phenomena are made the basis for the scheme. Processes are merely operative. If coupled with products at all, in classification, all must be regarded as formative or constructive. The product's destruction, its loss of identity, is wholly immaterial. The action of agencies is merely to produce constant change."

Van Hise ('04) has formulated other principles of the process method as follows:

"The agent is the substance containing energy which it expends in doing work upon other substances. The substance upon which work is done may thereby receive energy, and thus become an agent which does work upon other substances; and so on indefinitely. Indeed, the rule is that one process follows another in the sequence of events, until the energy concerned becomes so dispersed as to be no longer traceable. Theoretically this goes on indefinitely. . . . We have seen that the action of one or more agents through the exertion of force and the expenditure of energy upon one or more substances is a geological process. It is rare indeed, if it ever happens, that a single agent works through a single force upon a single substance. . . . If geology is to be simplified, the processes must be analyzed and classified in terms of energies, agents, and results. Each of the classes of energy and agent should be taken up, and the different kinds of work done by it discussed. . . . The general work of each of the agents and the results accomplished should be similarly considered. Not only so, but the work of the different forms that each of the agents takes should be separately treated. Thus, besides considering the work of water generally, the work which it does both running and standing must be treated. The first involves the work of streams; the second, the work of lakes and oceans. This involves the treatment of streams as entities. . . . The treatment of the agents will be more satisfactory in proportion as the work done by each of the forms of each of the agents is explained under physical and chemical principles in the terms of energy."

Viewed from this standpoint it is remarkable how many of our current zoological conceptions are essentially static, and how confused are our conceptions of the process method. Physiology is supposed to be devoted solely to processes, yet physiologists use the terms anabolism and katabolism, constructive and destructive influences, and, likewise, zoologists frequently use the expressions "the friends" or "the enemies" of animals—a dual terminology which has a certain

utility but which exists mainly on account of the static conceptions of organic relations.

The dynamic or process concept is a difficult one to attain, and to apply in all cases, as any one will soon learn if he strives to do this consistently; and yet as a scientific ideal there can be no doubt that it has the same superiority over the older static methods and point of view that an explanation has over an empirical description.

3. DYNAMIC AND GENETIC CLASSIFICATION OF ENVIRONMENTS

In the natural history sciences we have two main sorts of classifications of phenomena, those which we call "natural" and those which we call "artificial." Natural classifications are those in which the basal criteria are of *origin*, the method of processes or genesis. A classification of lakes upon the basis of the *processes which operated in their origin*—crustal movements of the earth, the meanders of streams, the work of an ice-sheet, volcanic activity, etc.—would at the same time furnish an *explanation of them in terms of their origin*. Artificial classifications are those in which the criteria are arbitrarily chosen. Any character may be made the basis for an artificial classification. Thus lakes may be classified upon the basis of their size, depth, color of the water, distance from cities, number of boats upon them, etc., but such classification would not furnish the basis for a *scientific explanation of lakes*. The artificial is often useful or convenient for a special purpose; the genetic is illuminating from the standpoint of *scientific interpretation*. This method may be applied to any kind of environment, physical, physical and biological combined, or solely biological. To the degree that the environment is dominated by the physical conditions the laws of physical change and physical genesis will preponderate in the origin of such environments, and corresponding relations apply to biological environments.

The dependence of the genetic method upon causes and conditions makes it impossible to divorce it from the local conditions. This is at once the strength and weakness of this method, for it is particular, and generalized averages mean little because origins are different under different conditions; this is the key to *individuality*. Thus streams viewed as stages in the progressive transformation of a liquid medium for life, may be formed in many diverse ways, and for this reason the general principles of the method of genesis may be expressed most simply in an *ideal case*. Genetic series are *unending*, they extend into the past and will continue in the future. The point of departure for study must therefore be arbitrarily chosen, and the more nearly a natural basis can be approximated the simpler its application becomes.

For this reason a cycle will be followed here which begins with a condition of *stress*, advances through the *process of adjustment to strain*, and reaches a *condition of relative equilibrium*. The starting point in such a cycle we will consider as the *original conditions*, and the later activities as the derived ones. The original conditions we will assume to be an uplifted undulating plain, composed of relatively homogeneous materials, in a humid climate, and covered by a varied vegetation including trees. The elevated condition of the land produces a condition of *unstable equilibrium* or *stress* for the rain falling upon its surface; and, furthermore, the vegetation will tend to spread over the entire surface, and thus exert a certain pressure also. These original conditions are, therefore, unstable and destined to change, and mutually to influence and regulate one another.

If we now imagine the rain "turned on" under such conditions, what are the main processes which will operate? The rain falling in a depression will be supplemented by that which drains from the elevations; thus, through the *agency* of running water, a standing water habitat will have its origin. With this concentration of water will come also a burden of debris from the upland; and in this way the "constructive" and "destructive" processes will begin at the same time. Plants will invade such a depression and add their remains. Some of the depressions will overflow and the outflowing streams will cut down the outlet to progressively lower levels, and ultimately drain the basin. On the other hand, inwash and organic debris may together accumulate at such a rate as to raise the level of the basin above ground water and thus transform the conditions to that of land. The progressive stages of the *process of degradation* thus favor the transformation of the depression and a progressive formation of lakes, which are converted into ponds and swamps and ultimately, with drainage, to dry land. For depressions we thus get a genetic series which we may call the lake, pond, and swamp series. This does not classify the depression series according to size, depth, character of water, etc., as in an artificial classification, but in the *order of their development or genesis* through the *agency* of running water. Accompanying this *sequence* there are of course changes in size, depth, etc., but these are subordinated in the classification to the *developmental sequence centering about the process of the degradation of the land by the agency of running water*. This is therefore a classification of environments, not on the basis of the product, as it might appear from calling it a depression or standing-water series, but upon the *basis of the activity or processes of the dominant agent*.

We will assume that all the lakes, ponds, and swamps, due to the original relief of the land, become drained and constructively con-

verted into streams or dry land. Let us consider the streams, particularly those which did not develop from the lake, pond, and swamp series, in order to consider them in their simpler conditions of development.

The first shower on the new land surface, or the beginning of a cycle, forms an extensive ramification of small streamlets, their dendritic branches flowing down all slopes. With the confluence of the smaller branches the progressively larger trunks are formed, and with their increase in volume, cutting progresses; but all traces of this stream itself tend to vanish soon after the shower is over, although some water may linger in pools in the deeper depressions. These conditions form an *initial stage* in the development of the activity of running water as an animal habitat. These temporary streams are rain waters intermingled with dust from the air and soil from the ground. Since, viewed chemically, such waters have not existed as a liquid long enough to dissolve much gaseous and solid material, they represent a relatively original condition, or an initial stage in the chemical development of the stream as a medium for living animals. Again and again these showers are repeated, and where there is a slight variation in the hardness of the substratum small pools are formed on the softer materials, where erosion is more rapid. In these pools it is possible for some aquatic or amphibious animals, of marked powers of dispersal, to become lodged, or even entrapped, as in the case of animals which migrate up the stream during its temporary flow; such pools, in fact, may be reached even by individuals from the ground water.

Finally these temporary streams cut down to ground-water level and become permanent. Such a stream then, in addition to the fresh rain-water which it receives with each shower, has a permanent supply of ground water. This water, having filtered through the soil, contains both gas, particularly CO_2 , and minerals, and thus as a solution differs much from rain water. The composition of ground water varies much with the chemical differences of the substratum. Such water generally contains enough substance in solution to be a favorable medium for plant growth, such as algæ—aquatic pioneers which are comparable to the lichens in their invasion upon bare rock. But the temporary flow of water is still dominant, and will remain so until the supply of permanent ground water is of such a volume that, having a good current, it rushes over the obstacles in its path; then a permanent brook has been evolved, and a permanent rapid-water habitat has originated.

As the erosion of the stream advances, organic debris not only multiplies indigenously in the water, but it is also washed and blown in, and through its decay the composition of the water is changed.

particularly in the amount of CO_2 present. This gas causes the water to take into solution a greater amount of lime; and at the same time the agitation to which it is subjected while dashing over obstacles or flowing over falls increases the amount of oxygen present, a process further aided by the oxygen set free in it by water plants. Carbonic acid, moreover, is set free by the rapids and falls. It is thus very evident that the chemical processes are undergoing an important development as the stream progresses, since there are going on both the process of gaseous equilibrium with the air, and an increase of the solids in solution. The stream is progressively becoming a more favorable or enriched culture medium for organisms. The rapidly flowing water which characterizes the brook is the predominant physical feature of this environment, the stretches of relatively quiet water which form the pools, between the more rapidly flowing parts, anticipating the kind of conditions which are destined to increase with the transformation of the brook conditions into those of a creek. With the progress of development in drainage a brook is progressively transformed by the processes of erosion into a creek. Here the rapid-water conditions are more nearly equaled by a corresponding enlargement of the pool or the quieter stretches of water, where the finer sediments are deposited and the animals dwelling on the surface film or in the mud and sand, find suitable conditions. The falls and rapids which characterize the brook are exceptional in the creek, but may linger where the rate of change has been very slow on account of the resistance of the substratum. The alternation of rapid and slower water, which characterizes the creek stage, with the preponderance of the relatively rapidly flowing water, is gradually transformed into that of a river, where the water flows at a slower rate and rapids and falls have as a rule become extinct, and where a condition of relative chemical equilibrium has also been reached. Here the burden of coarse debris is at a minimum, and the surface, sides, and bottom of the stream, have become differentiated as relatively distinct habitats. With progressive approach toward baselevel all conditions of the environment tend to become more stable and equalized until the stream erodes to tide level, becomes brackish and finally as salt as the sea itself, and reaches an equilibrium determined by the dominant animal environment upon the earth—that of the sea.

We have now outlined the developmental sequence of wet depressions, the lake-pond-swamp series, and the running water, the brook-creek-river series, these two series including the main inland animal environments in a liquid medium in a humid climate. We have yet to consider the animal environments of land animals proper, those which live in the gaseous medium of air. The complexity of conditions upon

land is much greater than that in water, either fresh or salt. In other words the land habitats are the most complex on earth. For simplicity in handling this involved problem, an ideal series will also be followed, and instead of attempting to discuss all the principles involved, only such will be mentioned as may be illustrated by a single example. This will serve to show the application of the method. We shall consider the process of degradation of the land, such as might be developed during a topographic cycle of erosion, and as applied to a snow-capped conical mountain in a temperate humid region.

Let us consider the series of processes which operate upon such a mountain. The snow and rain which fall upon it are in unstable equilibrium, the snow creeps or plunges down the slopes, and the water flows down. In the zone of ice and snow physical and mechanical changes preponderate; but at lower altitudes, with the melting of the snow and ice, on account of the higher temperature, chemical changes become more prominent and supplement the mechanical work of running water. Here, also, plants and animals become an important factor in modifying the processes of change by hastening or retarding the processes of degradation. We thus see that on different parts of a mountain there are important modifications in the processes of degradation. The same general processes which operate to form lakes, ponds, swamps, brooks, creeks, and rivers, are also at the same time producing changes in the land habitats. The entire surface of such a mountain is undergoing change, but because of the concentration of degradative progress near its base, particularly on account of the concentration of the drainage there, ravines and valleys develop here more rapidly and converge toward the main divide, the mountain top. As these ravines and valleys enlarge, the mountain is lowered; and ultimately all is reduced to a plain, and to baselevel. The condition of stress which existed upon the slopes of such a mountain as degradation progressed, became relatively adjusted *at that place*, but where the degraded materials were deposited a stress was *becoming cumulative*, and it is this ever changing adjustment of stresses which makes natural processes unending.

With the degradation of the mountain, progressively higher zones are lowered; the snow cap disappears; the region above the tree limit, and later the lower parts, are spread over a large area, and the mountainous character is largely gone. In this manner and at the same time as the land is degraded to a lowland by running water, in the water itself a series of habitats is developing, and thus *all the environment is being transformed, along relatively distinct but mutually interdependent lines, toward the same general direction or condition*—a rela-

tive equilibrium resulting from the balancing of all stresses near sea level.

In the preceding discussion no emphasis has been placed on the fact that degradation of the land is only a part of a large cycle of activity, and that the deposition of the degraded materials may be a cause of so much stress as to initiate an elevation of the land. If the heavy soluble materials from the land are washed into the sea and only lighter materials remain behind, the increased stress resulting between the sea and the land will tend to elevate the lighter areas until an equilibrium is established between the heavy sea and the lighter land; therefore, some crustal movements, at least, may be complementary phases of the degradation of the land. The elevations and depressions of the surface of the land with regard to the sea level may thus initiate new cycles of transformation in all environments. These processes do not need amplification here, although they should be noted; but this lack of amplification does not imply a minor influence of this factor. Still another cycle may be initiated by the processes of vulcanism, a factor the influence of which is easily overlooked in large parts of the world but in others is very prominent. Only one more comprehensive physical factor will be mentioned; that due to alterations in the atmosphere—climatic changes. Although the temperate humid climate has been made the basis for the preceding discussion, it must be remembered not only that there are other kinds of climates, but that these undergo transformation or changes from such extremes as the cold arctic deserts on the one hand, to the dry hot deserts on the other. Within this great amplitude of climatic possibility is found one of the greatest causes both of complexity in land environment and of many local differences in the transformation of habitats.

To simplify this sketch of the operation of the physical features of the environment the organic factors have been neglected, and these should now be considered. On account of the ultimate dependence of animals for food upon vegetation, many intimate relations exist between plants and animals; furthermore, in addition to the food relations there are many other important ones, such as the physical and chemical influence of the vegetation upon the soil, its influence upon the temperature and humidity of the air and on light; and, finally, there is qualification of these influences by the different kinds of vegetation. A vegetational cover of grass has a very different effect from one of shrubs or a forest cover; conifers and hard-wood forests differ in effect also; and the succession of plant societies varies, not only with different kinds of vegetation but also in different climates, and with different physiographic conditions. As Cowles ('11) has shown, there are several cycles or series of successions of vegetation. Many of

these changes are dependent upon physical conditions which are equally potent in their influence upon animals. Thus physical and vegetational changes in combination influence animals directly and indirectly, and in the conditions due to this fact we find the basis for the important control which vegetation exerts upon animals.

Animals themselves form an important part of their own environment, not only in their relation to their own kind, as mates or as progeny, but also as members of an animal community whose members must adjust their activities to one another through symbiotic, competitive, or predatory relations. If any animal becomes abnormally abundant, that is, more numerous than the conditions can support, this number in itself becomes a weakness, through the positive attraction of the organisms (plant and animal) which are able to prey upon it, and soon the normal abundance is restored. For example, in a coniferous forest, bark-beetles (*Scolytoidea*) may increase to such an extent that the forest is largely destroyed, and a succession is produced in the vegetation as the conifers are replaced by a growth of aspen and birch. As a result of this destruction of the kind of food and habitat essential for the next generation of beetles, a proper habitat is lacking, and the restoration of the normal number of beetles is hastened. This same example also shows how one kind of animal may influence the character of a whole community by its control over the vegetation.

The influence of man must be looked on from the same standpoint as one views the activity of any other animal; as that of a member of an animal community. He hastens and retards the changes in his environment as do other animals. In general his early methods are predatory; he reaps where he does not sow; but later the milder competitive and symbiotic relations and the constructive or productive aspect become more prominent. Civilization is an attempt to make the environment "to order," but as yet man has not learned how to produce a permanent "optimum" along the lines of an ecological community. As has already been said, to understand man we should view him as an integral part of an ecological community, as one member of a biotic community of plants and animals, or at least of an animal community which includes all animals that are influenced by man—and not consider him, as some students do, as a distinct entity with little regard to his animal and plant associates.

The main features of the preceding discussion may be summarized as in the following table.

TABLE 2.—THE GENESIS AND FORMATION OF INLAND HABITATS IN A HUMID CLIMATE AND THE DYNAMIC STATUS OF THE PROCESSES

Dynamic status.	Phases in the formation of inland environments.			
I. Unstable equilibrium—condition of stress or pressure	<i>Original conditions</i> ; elevated land area, or new land surface, or beginning of new cycle.			
II. Process of adjustment to stress or strain.	Process of <i>formation of habitats</i> ; all habitats are <i>constructive</i> .			
<p>(The following are examples of the major processes):</p> <ol style="list-style-type: none"> 1. The processes of degradation of the land. 2. The processes of adjustment to climate. 3. The process of the establishment of biotic (plant or animal) dominance. 	Biotic sequence in all habitats and all series, as a <i>part</i> of the animal environment.	Sequence of standing water series (depression series); reversible series.	Sequence of land habitats, elevation series; reversible process.	Sequence of stream habitats, depression series; partly reversible.
	Initial phase	Lake	Upland	Temporary stream
	Intermediate phase	Pond	Lowland	Brook
	Dominant phase	Swamp	Baseleveled plain	River
III. Relative equilibrium.	<i>Derived conditions</i> ; lowland area, old land surface (baseleveled to the marine environment), end of a cycle, or dominance; under relatively stable conditions.			

The preceding discussion is based upon the conditions of a humid climate, but the semi-arid and the arid climates should also be touched on. In time, as ecological studies are extended to all kinds of land areas, it will be possible to formulate all of the general principles of the origin or process of development of land habitats; but at present vast areas of the land have never been observed by a zoologist from a modern ecological standpoint. Most of the ecological studies of animals have been carried on in a humid climate, only slight attention having been given to the ecological relations existing in an arid climate, and still less to those in alpine and polar regions. After the humid regions have been better studied, the arid regions will probably be the next to be carefully investigated. The plant ecologists, by their studies in these regions, have already furnished important facts preparing the way for the animal ecologist, because they investigate both the physical and vegetational conditions upon the prairies and plains of the West. If the regions of progressively increasing aridity are examined, there will be found to be a corresponding series of changes in the animal habitats. The standing-water series of habitats found in such a series, in contrast with those of humid regions with fresh-water lakes, ponds, and swamps in addition to the temporary fresh waters, are alkaline and salt waters, and we find an extensive series ranging from Great Salt Lake, Salton Sea, and Devil's Lake, to strong briny pools and alkaline mud flats. These are, of course, as capable of a genetic treatment as are the corresponding fresh-water bodies of humid areas. The stream series is also present in the arid region, but it exists under conditions quite different from those in humid areas. The through-flowing streams are *relatively* independent of local conditions because their main supply of water is from the mountain; but they are nevertheless much modified by the character and amount of the burden which they carry during the time of high water, and they tend to become clogged at low water stages. The chemical composition of such waters is quite different from that of regions continually leached by rains. The small streams flowing from the mountains, whose diminishing volume does not allow them to traverse the arid regions, succumb, and disappear in the dry earth—examples of a second degree of dominance of the desert or plains. But the truly characteristic streams of the arid regions are those primarily dependent upon the desert conditions. Such streams are well within the arid regions and are dominated wholly by them. They are solely of a temporary character, and correspond to the initial stage of stream development, the temporary stream, in a humid climate. In an arid climate, however, development does not proceed beyond this early stage, and the degradation and

baseleveling of the land is due to the combined influence of water and the wind.

On land, the movements of the soil by the wind, as in the sand-dune regions of true deserts, show us a characteristic condition; in a more humid climate, however, the dunes would tend to become anchored by vegetation. Other soils than sand are also blown about. The extreme of dry desert conditions must be looked upon as the ultimate or climax condition, a condition of relative equilibrium, under present climatic conditions, for certain regions. A slight departure from these extreme conditions is seen in such localities as receive most abundant showers during the growing season for vegetation. These are able to influence the development of the drainage only in a minor way, but they moisten a shallow surface layer of soil and permit the growth of short grasses, such as the buffalo-grass (Schantz, '11:40). Very recently another important source of water in the arid regions has come to be recognized. This, McGee has shown to be the subsurface or artesian waters which come up from below; and this is an important supplementary source of moisture in extensive areas in the arid West (McGee, '13), where the evaporation is large. It is not unlikely that even in humid regions where the soils are very sandy, as upon the Coastal Plain, and where the strata dip in such a manner as to favor an underflow of water, this supply may be of considerable importance to the biota. With a greater rainfall during the growing season, permitting a relative humidity greater than on the short-grass area of the plains, a deeper-rooted vegetational cover gives us the long prairie grasses of the eastern prairie.

As soon as the physical conditions permit a growth of vegetation this material becomes an environmental factor which reflexly modifies the physical conditions of the air, the soil, and the animal habitat. This is shown to a marked degree in the humid area of the southeastern United States, where the rainfall, greater than that on the arid plains and prairies, favors the development of a forest cover. Such a forest not only tends to retard evaporation but also acts as a sponge and by its vegetable debris and loose soil retards the run-off. In this manner not only are land habitats influenced, but this conservation of moisture tends to prolong the duration of temporary streams, and to stabilize the flow of permanent ones; and, further, through the same influence, the ground-water level declines slowly, and bodies of standing water are also influenced. Thus all the more important habitats are to some degree regulated and made more stable by a forest cover.

The foregoing discussion and examples, selected from the activities of animals and changes in their environments, are varied enough to

show how diverse are the applications of the process method to investigation. The general idea is easily grasped, but to make the dynamic method a regular habitual procedure in investigation is truly difficult, so difficult, indeed, that there is reasonable ground for doubting if this method can be mastered without a practical application of it to a concrete problem, at the same time giving special attention to the method of procedure.

REFERENCES TO LITERATURE

Adams, C. C.

'04. On the analogy between the departure from optimum vital conditions and departure from geographical life centers. *Science*, n. s., 19: 210-211.

'13. Guide to the study of animal ecology. 183 pp. New York. (This book contains numerous references to the literature bearing upon the subject of this article.)

Bancroft, W. D.

'11. A universal law. *Science*, n. s., 23: 159-179.

Blackman, F. F.

'05. Optima and limiting factors. *Ann. Bot.* 19: 281-295.

Blackman, F. F. and Smith, A. M.

'11. Experimental researches on vegetable assimilation and respiration. IX. On assimilation in submerged water-plants, and its relation to the concentration of carbon dioxide and other factors. *Proc. Royal Society, B.*, 83: 389-412, 1910.

Brooks, W. K.

'99. The foundations of zoology. 339 pp. New York.

Cowles, H. C.

'11. The causes of vegetative cycles. *Bot. Gaz.*, 51: 161-183; also, *Ann. Assoc. Amer. Geogr.*, 1: 1-20. 1912.

Jennings, H. S.

'06. Behavior of the lower organisms. 366 pp. New York.

Keyes, C. R.

'98. The genetic classification of geological phenomena. Journ. Geol., 6: 809-815.

McGee, W. J.

'13. Field records relating to subsoil water. U. S. Dept. Agr., Bur. Soils, Bull. 93. 40 pp.

Powell, J. W.

'95. Physiographic processes. Nat. Geogr. Monographs, 1: 1-32.

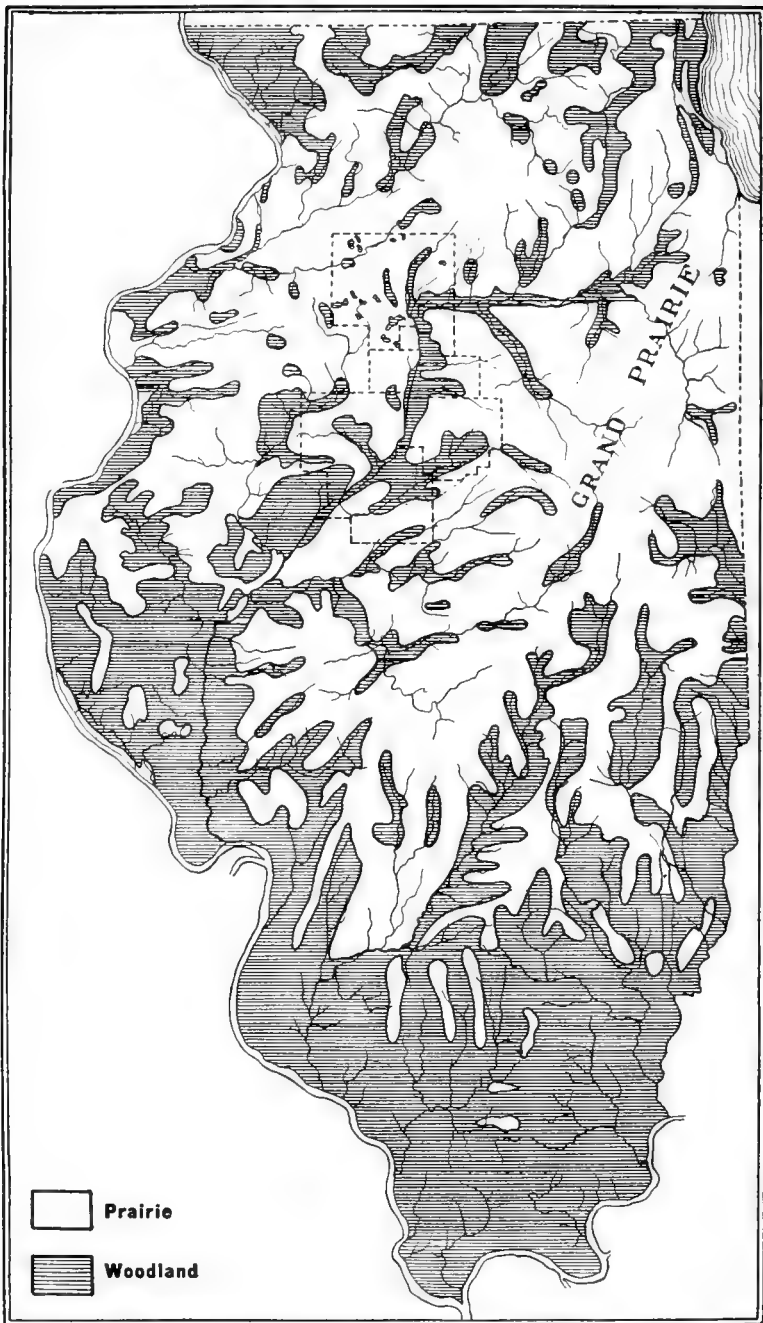
Schantz, H. L.

'11. Natural vegetation as an indicator of the capabilities of land for crop production in the Great Plains area. U. S. Dept. Agr., Bur. Plant Industry, Bull. No. 201. 100 pp.

Van Hise, C. R.

'04. The problems of geology. Journ. Geol., 12: 589-616.

The New York State College of Forestry, Syracuse, N. Y.



ORIGINAL FOREST AND PRAIRIE AREA IN ILLINOIS
(AFTER BRENDEL AND BARROWS)

BULLETIN
OF THE
ILLINOIS STATE LABORATORY
OF
NATURAL HISTORY

URBANA, ILLINOIS, U. S. A.

STEPHEN A. FORBES, PH.D., L.L.D.,
DIRECTOR

VOL. XI.

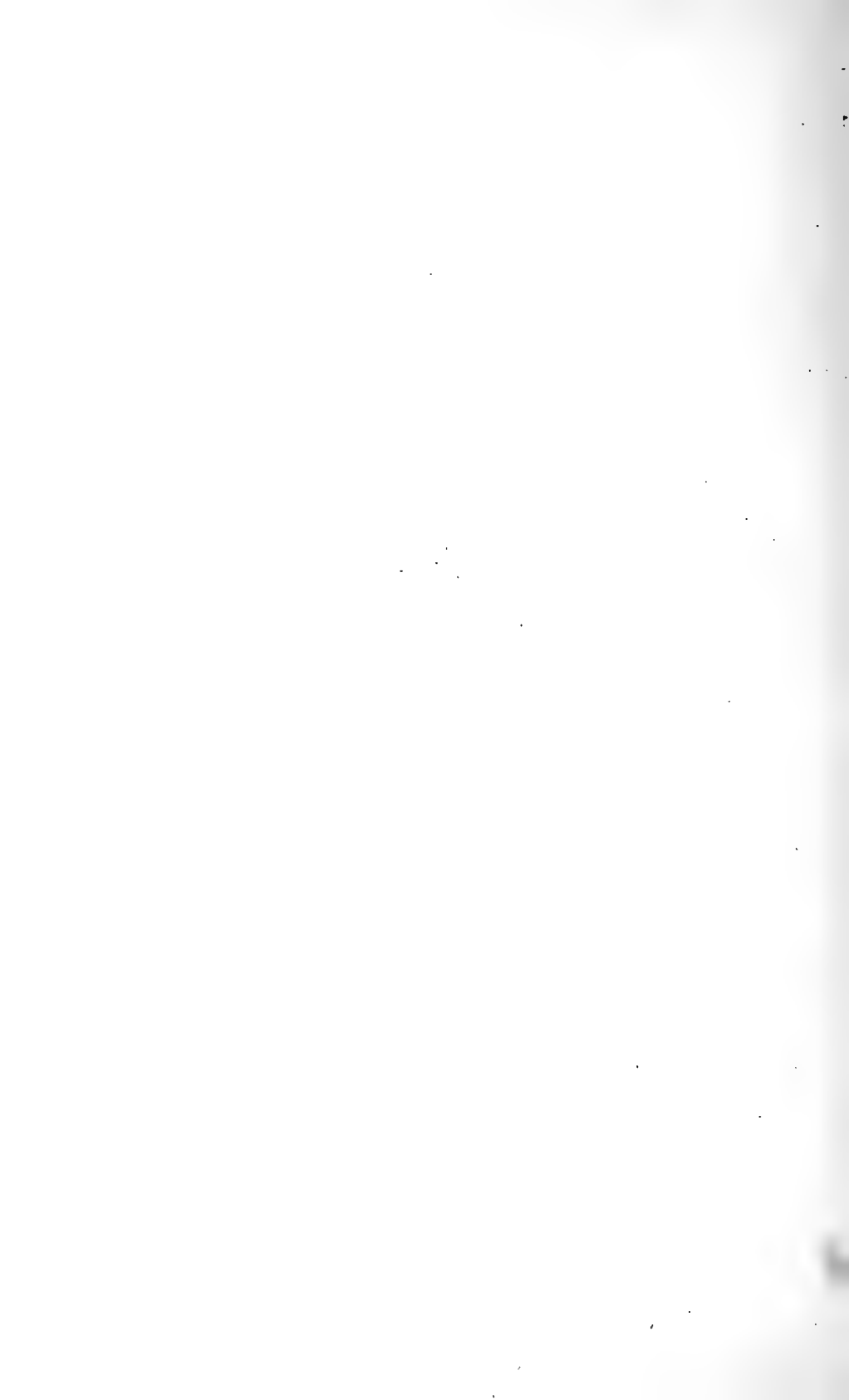
SEPTEMBER, 1915

ARTICLE II.

AN ECOLOGICAL STUDY OF PRAIRIE AND FOREST
INVERTEBRATES

BY

CHARLES C. ADAMS, PH.D.



CONTENTS

	PAGE
Introductory	33
General description of the region and location of the ecological stations.....	35
I. General description of the region.....	35
II. The ecological stations.....	38
Description of the prairie habitats and animals.....	40-56
I. Prairie area north of Charleston, Station I.....	40
1. Colony of swamp grasses (<i>Spartina</i> and <i>Elymus</i>), Station I, <i>a</i> ..	41
2. Colony of wild rye, <i>Elymus virginicus submuticus</i> , Station I, <i>c</i> ..	43
3. Wet area of swamp milkweed (<i>Asclepias incarnata</i>), Station I, <i>d</i>	44
4. Cone-flower and rosin-weed colony, Station I, <i>e</i>	48
5. Colony of blue stem (<i>Andropogon</i>) and drop-seed (<i>Sporobolus</i>), bordered by swamp milkweed, Station I, <i>g</i>	49
6. Supplementary collections from Station I.....	52
II. Prairie area near Loxa, Illinois, Station II.....	52
III. Prairie area east of Charleston, Station III.....	55
Description of the forest habitats and animals.....	56-66
1. The Bates woods, Station IV.....	56
2. The upland oak-hickory forest, Station IV, <i>a</i>	57
3. Embarras valley and ravine slopes, forested by the oak-hickory association, Station IV, <i>b</i>	59
4. Lowland or "second bottom," red oak-elm-sugar maple wood- land association, Station IV, <i>c</i>	62
5. Supplementary collections from the Bates woods, Station IV....	65
6. Small temporary stream in the south ravine, Station IV, <i>d</i>	65
General characteristics of the gross environment.....	66-102
1. Topography and soils of the State.....	66
2. Climatic conditions	67
3. Climatic centers of influence	69
4. Relative humidity and evaporating power of the air.....	71
5. Temperature relations in the open and in forests.....	83
6. Soil moisture and its relation to vegetation.....	86
7. Ventilation of land habitats.....	88
8. The tree trunk as a habitat.....	91
9. Prairie and forest vegetation and animal life.....	91
10. Sources and rôle of water used by prairie and forest animals....	98
Animal associations of the prairie and the forest.....	102-158
I. Introduction	102
II. The prairie association.....	103
1. Swamp prairie association.....	103
2. The cottonwood community.....	105
3. Swamp-grass association.....	107
4. Low prairie association.....	108
5. Upland prairie association.....	109
6. The <i>Solidago</i> community.....	109
7. Dry prairie grass association.....	111
8. A milkweed community.....	112
III. Relation of prairie animals to their environment.....	113
1. The black soil prairie community.....	114
2. The prairie vegetation community.....	117
4. Interrelations within the prairie association.....	119

	PAGE
IV. The forest associations.....	122
1. Introduction	122
2. Dry upland (<i>Quercus</i> and <i>Carya</i>) forest association.....	124
3. Artificial glade community in lowland forest.....	125
4. Humid lowland (hard maple and red oak) forest association....	126
5. Animal association of a temporary stream.....	127
V. Relation of the deciduous forest invertebrates to their environment....	128
1. Forest soil community.....	129
2. The forest fungus community.....	135
3. The forest undergrowth community.....	138
4. The forest crown community.....	139
5. The tree-trunk community.....	142
6. The decaying wood community.....	148
7. Interrelations within the forest association.....	157
Ecologically annotated list:—	
I. Prairie invertebrates.....	158-201
II. Forest invertebrates.....	201-238
Bibliography	239-264

INTRODUCTORY

In four generations a true wilderness has been transformed into the present prosperous State of Illinois. This transformation has been so complete that in many parts of the state nearly all of the plant and animal life of the original prairie and forest has been completely exterminated. Between the degree of change which has taken place in any given area and the suitability of that area for agriculture there has been an almost direct relation. Fortunately, however, for the preservation of prairie and forest animals, the state is not homogeneous, some areas being too hilly, rocky, or sandy for prosperous agriculture.

The character and mode of transformation which has taken place in the past is instructive in several particulars because it serves to guide our anticipations as to the future of our fauna. The forested southern part of the state (see frontispiece) was first invaded by trappers and hunters, who began the extermination of the larger animals. These invaders were in turn followed by others who, with the round of the season, were hunters or farmers, and continued this exterminating process, particularly in the clearings, which began to replace the forest. These pioneers, men of little wealth, possessed a combination of mental and economic habits which was the result of life in a forested country, and naturally they settled in those places most like their former homes—within the forest or near the forest margin. From these settlements they looked out upon the prairies as vast wastes to be dreaded and avoided. As a result of this attitude toward the prairies, it required some time, even a new generation, some economic pressure, and a change of habits before the prairies were settled. Meanwhile the northern part of the state was yet a wilderness; but through the influence of the Great Lakes, as a route of communication with the populous East, a rapid invasion of settlers set in from that direction. Though these settlers also came from a wooded country, they were more wealthy, settled upon a very fertile soil which was favorably located with regard to eastward communication, and they therefore progressed more rapidly than the less favored, more isolated southern invaders on the poorer soil; consequently they spread from the forest

to the prairie more rapidly than did the settlers in the South. There thus developed two active centers of influence, each of which transformed the primeval conditions in the same manner and in the same direction toward an environment suitable for man.

The forests and the upland prairie were first changed. Then the fertile wet prairie was drained, so that today it has largely become either the hilly and rocky areas that survive as forests or the low periodically flooded tracts, and the undesirable sand areas which similarly preserve patches of sand prairie. All the changes are more rapid and complete upon fertile soil than upon the poorer soils in the southern part of the state.

Such considerations as these will aid one in estimating the probable rate of future changes in different parts of the state, and will serve to show in what parts there is urgent need of local studies if ecological records are to be made before extinction of some forms is complete.

A study has been made with the idea of reporting upon representative patches of prairie and forest in a manner which would aid others in making similar local studies, and would at the same time preserve some records of the present condition of the prairie and forest. When this work was planned, we had no general or comprehensive discussion of the conditions of life upon the prairie and in the forest. For this reason a general summary of these conditions and a sketch of the general principles involved are given, so that the reader may gain some conception of the relation of the local problems to those of a broader and more general character.

A section for this report was prepared giving general directions for making such local studies, but later it was decided to publish this separately, in somewhat extended form, as a "Guide to the Study of Animal Ecology."* This volume should be regarded as intimately related to this paper, and this report should at the same time be considered as a concrete example of the procedure suggested in that "Guide" for ecological surveys. It will be observed that the study of the Charleston area here referred to has been conducted in much the same way as was my cooperative study of Isle Royale, Lake Superior, entitled "An Ecological Survey of Isle Royale, Lake Superior" ('09), although certain aspects have been elaborated here which, for lack of time, were not treated there. The time devoted to the study of the Charleston area was also limited, but in the preparation of the report upon it use has been made of many years' experience and a general knowledge of the prairie and forest. Without such a background

*The Macmillan Co. 1913.

much greater caution would have been necessary in discussing many phases of the problem.

ACKNOWLEDGMENTS

The study of the Charleston area was carried out with the cooperation of the Illinois State Laboratory of Natural History, through its director, Prof. Stephen A. Forbes, and with the further cooperation of Professors E. N. Transeau and T. L. Hankinson, of the Eastern Illinois State Normal School, located at Charleston. Personally I am indebted to Professor Forbes for the opportunity of taking part in this study as the State Laboratory representative, and for the aid he has given in the illustration of the report. To Professor Transeau I am particularly indebted for the plant determinations, for lists of the plants, and for evaporation data. To Professor Hankinson I am under especial obligation for many specimens, which materially added to my lists, and for a large number of photographs. I am indebted likewise to my associates in this study for their hearty cooperation throughout the progress of the work.

For the determination of entomological specimens I am indebted primarily to Mr. C. A. Hart, Systematic Entomologist of the State Laboratory of Natural History, who named most of the insects collected. For the names of certain flies I am indebted to Mr. J. R. Malloch, of this Laboratory. Others who have determined specimens are as follows: N. Banks (*Phalangida*), J. H. Emerton (spiders), R. V. Chamberlain (myriapods), F. C. Baker (*Mollusca*), Dr. W. T. M. Forbes (lepidopterous larvæ), Dr. M. C. Tanquary (ants), Dr. M. T. Cook (plant galls), J. J. Davis (*Aphididæ*), and Dr. A. E. Ortmann (crawfishes collected by T. L. Hankinson). I am indebted to the U. S. Geological Survey for photographs. Acknowledgments for illustrations are made under text figures and in explanations of plates.

GENERAL DESCRIPTION OF THE REGION AND LOCATION OF THE ECOLOGICAL STATIONS

I. GENERAL DESCRIPTION OF THE REGION

The town of Charleston, Coles county, Illinois, in the vicinity of which these ecologic studies were made, is situated on the Shelbyville moraine which bounds the southern extension of the older Wisconsin ice-sheet. To the south of this moraine lie the poorer soils which characterize so much of southern Illinois; to the north, upon the older Wisconsin drift, are some of the most productive soils found in the upper

Mississippi Valley. The economic, sociologic, political, and historical significance of the difference in the soils of these regions is fundamental to any adequate understanding of man's response to his ecological environment within this area. Some of the results of this difference have long been known, but it is only in recent years that their general bearing has been adequately interpreted in terms of the environment. Hubbard ('04) was the first, I believe, to show the significance of this difference in soils and its influence upon local economic problems. That such an important influence should affect one animal (man) and not others seems very doubtful, and yet in only one other case do we know that the lower animals respond to this ecologic influence. Forbes ('07b) has shown that certain kinds of fish found in streams on the fertile soils are wanting in streams on the poorer soil. To what degree the land fauna and the native vegetation respond to this distinction is not known, as this subject has not been investigated except agriculturally. Here, then, is a factor in the physical surroundings which should be reckoned with in any comprehensive study of the biotic environment. In this portion of the state, on account of the differences in the soil, the physical environment is probably more favorable to certain organisms and less favorable to others, and consequently, to a certain degree, the environment selects, or favors, some organisms. Through their activities and through other agencies of dispersal, the animals along the borders between the two soil types transgress these boundaries, and are therefore forced to respond to the new conditions and to adjust themselves, if possible.

But the soil is not the only environmental influence which has produced an unstable zone or tension line in this area. A second factor is the difference in the vegetation—the difference between the forest and the prairie. In all probability, Coles county was at one time all prairie, but the Kaskaskia and Embarras rivers, as they cut their valleys through the moraine and developed their bottoms, have led forests within the morainic border from farther south. The forests about Charleston have extended from the Wabash River bottoms. On account of the southerly flow of the Embarras through this county, the forest and prairie tension line is about at right angles to that produced by the differences in the soil. The forests have tended to spread east and west from the streams and to encroach upon the prairie, and thus to restrict its area more and more. The fundamental significance of the tension between the forest and the prairie has long been known within the state. It influenced its economic, social, political, and historic development as much as any other single factor during its early settlement. And just as Hubbard ('04) has shown the influence of soil upon man

within the state, so also has Barrows ('10) shown the influence of the forests and prairie upon the state's development. While the influence of the soil upon the animal life of the state is not so well known or established, the influence of prairie and forest upon the animals is universally recognized, even though the subject has been given relatively little study by naturalists.

A third leading agency is the influence of man, who has transformed the prairie and forest to make his own habitat. There are thus recognized in the Charleston region three primary environmental influences: *first*, the relative fertility of the soil (this depending on the geological history); *second*, the kind of vegetable covering, whether prairie or forest (this probably depending largely on climatic conditions); and *third*, the agency of man. The general background of the Charleston region, then, ecologically considered, depends on the combined influence of five primary and secondary agencies, four of which we may call natural and one artificial. All these are different in kind and so independent that they tend toward different equilibria or different systems of unity. Two of these are due to differences in the soil, two others to the character of the vegetation (whether prairie or forest), and the fifth, or artificial one, is due to man. Though the present report does not undertake to include all the problems centered here, as any complete study would, it is desirable to see the relation of our special study to the general problems of the region as a whole.

The undulating plain about Charleston, formed as a terminal moraine, is broken along the small streams by ravines, which have cut a few hundred feet below the general level of the region as they approached the larger drainage lines. The main drainage feature is the Embarras River, which flows southwest about two to three miles east of Charleston, in a narrow valley partly cut in rock. The wooded areas are mainly near the streams; the remainder of the area is under intensive cultivation.

During the preliminary examination of the region, which was made to aid in selecting representative areas for study, it soon became evident that the only samples of prairie which could give any adequate idea of the original conditions were those found along the different railway rights-of-way. Other situations, vastly inferior to these and yet a valuable aid in the determination of the original boundaries of the prairies, were the small patches or strips along the country roads. Most of the patches of prairie along the railway tracks represent the "black soil" type of prairie, which is extensively developed in this part of the state upon the "brown silt loam" soil" (see Hopkins and Pettit, '08: 224-231). Much of the region studied was originally wet prairie

(which has since been drained), but some of the higher ground, formed by the undulation of the surface and surrounded by the black soil, is lighter in color and is well drained. Thus in the black soil areas there are both wet and well-drained tracts, and corresponding differences in the habitats.

The originally wooded and the present wooded areas east of Charleston, in the vicinity of the Embarras River, are in a region quite different from the prairie both in topography and in soil. Here the relief is much more pronounced, on account of both the proximity of the river and the greater development of the drainage lines, which have cut a few hundred feet below the general level of the country. The tributary valleys and ravines are numerous and steep-sided, and in general are wooded, the density varying with the amount of clearing done. Most of the soil of the wooded areas and along the bluffs is distinctly lighter in color than that of the black soil prairie, and is presumably "gray silt loam" (Hopkins and Pettit, '08: 238-242), though along the flood-plain and the river bottom the soils are mixed in character.

II. THE ECOLOGICAL STATIONS

In the study of an area or an animal association of any considerable size two methods are available. One is to examine as much of the area as is possible and secure data from a very wide range of conditions. This method is useful in obtaining the general or broad features of a region or an association, though to a corresponding degree it must ignore local influences and details, and by it most of the previous studies upon prairie animals have been made. It seemed, therefore, that in the present study a somewhat more intensive method was desirable, particularly in view of the fact that the extinction of prairie and forest is rapidly progressing. The method followed was to examine a large area in order to select a representative sample, and upon the basis of this sample to make as intensive a study as time and circumstances would permit. This method has the advantage of making it possible to preserve at least some record of the *local details*; and at the same time, to the degree that the selected area is a true sample, it also gives the results a much wider application.

The prairie samples examined were all along the rights-of-way, and the forest was a second-growth woods on the bottoms and bluff of the Embarras River, on a farm belonging, at that time, to Mr. J. I. Bates. Practically all of the observations here reported upon were made during August, 1910. The forest is a modified one, but it appears to have been cut over so gradually that its continuity as a forest habitat was not completely interrupted, although the cutting has prob-

ably seriously influenced many animals, particularly those which frequent mature forests, abounding in dead and dying trees and with an abundance of logs upon the ground in all stages of decay. Such conditions are the cumulative product of a fully mature climax forest. Of course the conditions have also been influenced by the extinction, or reduction in the number, of the original vertebrate population of the forest.

The different localities or regions examined are, for brevity and precision, indicated by Roman numerals; the particular minor conditions, situations, or habitats, by italic letters. An effort has been made to indicate the location of the place studied with enough precision to enable students to re-examine the habitats at any future time (Pl. I). The photographs which accompany this report may also aid in locating the places studied. Had similar photographic records been made fifty years ago, they would have been of much value and interest to us in this study, in much the same way as fifty years hence this report will form a part of the very limited record of the conditions found at the present time.

List of Ecological Stations, Charleston, Illinois, August, 1910

- Station I. Prairie along the right-of-way of the Toledo, St. Louis and Western, or "Clover Leaf" R. R., between one and two miles north of Charleston: Section 2, Township 12 N., Range 9 E., and S. 35, T. 13 N., R. 9 E. (Pl. I.)
- a. Cord or Slough Grass (*Spartina*) and Wild Rye (*Elymus*) Association. At mile-post marked "Toledo 318 miles and St. Louis 133 miles": S. 2, T. 12 N., R. 9 E.
 - b. Couch Grass (*Agropyron smithii*) Association. The distance of two telegraph poles north of Station I, a, and west of the railway track: S. 2, T. 12 E., R. 9 E.
 - c. Wild Rye (*Elymus*) Association. East and north of the "Yard Limits" sign: S. 2, T. 12 N., R. 9 E. (Pl. II, Fig. 1.)
 - d. Swamp Milkweed (*Asclepias incarnata*) Association. North of first east-and-west cross-road north of Charleston; east of railway track: S. 35, T. 13 N., R. 9 E. A wet area. (Pl. II, Fig. 2; Pl. III, Fig. 1.)
 - e. Cone-flower (*Lepachys pinnata*) and Rosin-weed (*Silphium terebinthinaceum*) Association. Just north of the preceding Station; east of railway track: S. 35, T. 13 N., R. 9 E. (Pl. V.)
 - f. Couch Grass (*Agropyron smithii*) Association. West of railway track: S. 35, T. 13 N., R. 9 E. Moist area.
 - g. Prairie Grass (*Andropogon furcatus* and *A. virginicus* and *Sporobolus cryptandrus*) Association, bordered by Swamp Milkweed (*Asclepias incarnata*) and Mountain Mint (*Pycnanthemum flex-*

uosum). This formed the north boundary of the area studied: S. 35, T. 13 N., R. 9 E. (Pl. III, Fig. 2; Pl. IV, Fig. 1 and 2.)

Station II. Prairie area west of Loxa, Illinois. Right-of-way along the Cleveland, Cincinnati, Chicago and St. Louis, or "Big Four," R. R.: Sections 10 and 11, Township 12 N., Range 8 E.

- a. From one half mile west of Loxa west to near Anderson Road, to telegraph pole No. 12330: S. 11, T. 12 N., R. 8 E. (Pl. VI. and VII.)
- b. Prairie at Shea's: S. 17, T. 12 N., R. 8 E.
- c. Cord Grass (*Spartina*) Association. East of Shea's: S. 17, T. 12 N., R. 8 E.

Station III. Prairie east of Charleston. Right of way along the C. C. C. & St. L. R. R.: S. 12, T. 12 N., R. 9 E.; S. 5, 6, and 7, T. 12 N., R. 10 E.

- a. Rosin-weed (*Silphium terebinthinaceum*) Association. Just west of the place where the Ashmore Road crosses the Big Four track; about one mile east of Charleston: S. 12, T. 12 N., R. 9 E.
- b. Blue Stem (*Andropogon*) and Rosin-weed (*Silphium terebinthinaceum*) Association. Three fourths of a mile east of the crossing of the Ashmore Road and the Big Four track: S. 6 and 5, T. 12 N., R. 10 E. An area which grades from prairie into transitional forest conditions. (Pl. VIII and IX.)

Station IV. Bates Woods. On the east bluffs and bottom of the Embarras River, north of where the Cleveland, Cincinnati, Chicago and St. Louis, or Big Four, R. R. crosses the river. On the farm of J. I. Bates: S. 5, T. 12 N., R. 10 E. (Pl. X, Fig. 1; Pl. XI, XII, and XIII.)

- a. Upland Oak-Hickory Association (*Quercus alba* and *Q. velutina*, and *Carya alba*, *C. glabra*, and *C. ovata*.) Second-growth forest. (Pl. XII and XIII.)
- b. Embarras Valley and Ravine Slopes, with Oak-Hickory Association.
- c. Red Oak (*Quercus rubra*), Elm (*Ulmus americana*), and Sugar Maple (*Acer saccharum*) Association. Lowland or "second bottom," Embarras Valley. (Pl. XIV; XV; and XVI, Fig. 1 and 2.)
- d. Small streamlet in South Ravine. This formed the southern border of the area examined. A temporary stream. (Pl. XVII, Fig. 1 and 2.)

DESCRIPTION OF THE PRAIRIE HABITATS AND ANIMALS

I. PRAIRIE AREA NORTH OF CHARLESTON, STATION I

This area includes patches or islands of prairie vegetation occurring along the right-of-way of the Toledo, St. Louis and West-

ern, or "Clover Leaf," Railway, north of Charleston. The southern border began just beyond the area of numerous side tracks and extended north of the first east and west cross-road for a distance of about one mile, to the place where the right-of-way is much narrowed and fenced off for cultivation. This is a strip of land through the level black soil area, which was originally composed of dry and wet prairie. The higher portions have a lighter colored soil, and the lower parts have the black and often wet soil which characterized the original swamp or wet prairie. The railway embankment and the side drainage ditches have favored the perpetuation of patches or strips of these wet habitats; the excavations for the road-bed, on the other hand, have accelerated drainage of the higher grounds. The soil taken from these cuts and heaped up on the sides of the tracks reinforces the surface relief noticeably in a region which is so nearly level. Through the depressions fillings have been made in building the railway embankment, and as a result the drainage has been interfered with in some places.

The disturbances brought about by railway construction and maintenance have greatly modified the original conditions, so that the prairie vegetation persists usually only in very irregular areas, sometimes reaching a maximum length equal to the combined distance between three or four consecutive telegraph poles—these poles are generally about 200 feet apart. In breadth the area is usually less than the space between the ditch bordering and parallel to the road-bed or embankment and the adjacent fence which bounds the right-of-way, or about 40 feet. This entire right-of-way is about 100 feet wide. In addition to these changes in the physical conditions, a large number of weeds not native to the prairie have been introduced, opportunities for this introduction being favorable, as railways traverse the entire area. In general, attention was devoted solely to the areas or colonies of prairie vegetation and their associated invertebrate animals, the areas of non-prairie vegetation being ignored, not as unworthy of study, but because the vanishing prairie colonies required all the time available.

1. *Colony of Swamp Grasses (Spartina and Elymus), Station I, a*

This colony of slough grass (*Spartina michauxiana*) and wild rye (*Elymus*) is located a short distance north of the "Clover Leaf" switch tracks and just south of the telegraph pole marked "Toledo 318 miles and St. Louis 133 miles." The length of this colony was about 40 paces.

During August, 1910, it was dry, but probably in the spring and early summer, rains make this area a habitat for swamp grasses.

Though it was an almost pure stand of slough grass, with this were mixed a few plants of wild rye (*Elymus virginicus submuticus* and *E. canadensis*). These grasses reach a height of about four feet. The ground was very hard and dry, and there were large cracks in it.

A single collection of animals was made here, No. 179.

Common Names	Scientific Names
Common Garden Spider	<i>Argiope aurantia</i>
Ambush Spider	<i>Misumena aleatoria</i>
Differential Grasshopper, adult and nymphs	<i>Melanoplus differentialis</i>
Red-legged Grasshopper, adult and nymphs	<i>Melanoplus femur-rubrum</i>
Texan Katydid	<i>Scudderia texensis</i>
Meadow Grasshopper	<i>Orchelimum vulgare</i> , adult, and nymphs of <i>vulgare</i> or <i>glaberrimum</i> .
Dorsal-striped Grasshopper	<i>Xiphidium strictum</i>
Black-horned Meadow Cricket	<i>Æcanthus nigricornis</i>
Four-spotted White Cricket	<i>Æcanthus quadripunctatus</i>
Ground-beetle	<i>Leptotrachelus dorsalis</i>
Sciomyzid fly	<i>Tetanocera plumosa</i>

The basic food-supply in such a habitat is of course the grasses, and this fact fully accounts for the presence of large numbers of individuals which feed upon grasses, as do the *Orthoptera* in general. But the *Orthoptera* listed are not exclusively vegetable feeders, for Forbes ('05: 147) has shown that *Xiphidium strictum* feeds mainly upon insects, chiefly plant-lice, as well as upon vegetable tissues, including fungi and pollen; *Orchelimum vulgare* (p. 144), largely upon plant-lice and other insects; and *Æcanthus quadripunctatus* (p. 220), upon plant tissues, pollen, fungi, and plant-lice. These observations were based upon a study of the contents of the digestive tract. The food of the sciomyzid fly is unknown. The garden spider lives exclusively upon animal food; and being abundant, it must exert considerable influence upon other small animals. It not only destroys animals for its food, but many others are ensnared in its web and thus killed. In one of the webs I found a large differential grasshopper. The rank growth of vegetation furnishes the necessary support for the webs of this spider.

Some of the insects, as *Melanoplus differentialis* and *M. femur-rubrum*, oviposit in the soil, but others—*Scudderia texensis*, *Xiphidium strictum*, *Orchelimum vulgare*, and *Æcanthus*—deposit their

eggs in stems of plants or under the leaf-sheaths of grasses (Forbes, '05: 143, 145, 148, 216). The mode of oviposition in these *Orthoptera* raises the question whether or not they are able to pass their complete life cycle within this habitat. Are the species which oviposit in the soil able to endure submergence during the wet season of the year, or must they each year re-invade this habitat from the more favorable adjacent regions? The sciomyzid fly is a regular inhabitant of such situations, for an allied species, *Tetanocera pictipes* Loew, has been found by Needham ('01: 580) to be aquatic, breeding on colonies of bur reed (*Sparganium*), and Shelford ('13a: 188, 284) also finds *plumosa* in wet places.

The flower spider, *Misumena*, captures its prey direct, frequenting flowers where its prey comes to sip nectar,

With more perfect drainage the character of this habitat would change; a more varied growth of vegetation would probably develop; and the relative abundance of the various kinds of animals would also change. The present imperfect drainage is more favorable to the accumulation of vegetable debris than if the habitat was connected with a stream which could float it away. The periodical drying hastens decay, and the deep cracks in the soil become burial places for various kinds of organic debris.

2. Colony of Wild Rye, *Elymus virginicus submuticus*, Station I, c*

Wild rye is a swamp grass. This colony was located about half a mile north of the colony of slough grass (Station I, a) and about 222 feet south of the first east and west cross-road north of Charleston. For a general view of this grassy habitat see Figure 1, Plate II. In length this habitat extends about one third the distance between two consecutive telegraph poles, or about 65 feet. The conditions of the habitat are in general similar to those in the colony of *Spartina*. The black soil was very dry and much cracked when examined, late in August. Though a few plants of *Asclepias sullivantii* grew here among the grass, it was a dense, almost pure stand of wild rye, which reached a height of about three and a half feet.

Only a very few collections were made here, and these were for the sole purpose of determining the general composition of the association.

These collections, Nos. 153, 180, and 181, were as follows:

*Animals were not studied at Station I, b, and therefore the location will not be discussed here.

Common Garden Spider	<i>Argiope aurantia</i>	No. 153
Differential Grasshopper	<i>Melanoplus differentialis</i>	—
Red-legged Grasshopper	<i>Melanoplus femur-rubrum</i>	No. 180
Dorsal-striped Grasshopper	<i>Xiphidium strictum</i>	No. 180
Meadow Grasshopper	<i>Orchelimum vulgare</i> , adult, and nymphs of <i>vulgare</i> or <i>glaberrimum</i>	No. 180
Texan Katydid	<i>Scudderia texensis</i>	No. 181

These are all abundant species. *O. vulgare*, by its persistent fiddling, is noticeable in all such grass spots during hot sunny weather. A live differential grasshopper was found in the web of the garden spider. A comparison of the two colonies of swamp grasses, *Spartina* and *Elymus*, will probably help to give one a general idea of the kind of invertebrates which were abundant in the original swamp-grass area of this vicinity. It will be noticed that grass and grass eaters are the dominant species, and that upon these a smaller number of predaceous animals depend. The characteristic species are the *Orthoptera* and the garden spider. This spider, on account of its predaceous habits, is able to live in a great variety of open situations, but does not normally live in dense woodlands.

3. Wet Area of Swamp Milkweed (*Asclepias incarnata*), Station I, d

This colony of swamp milkweed was about one eighth of a mile north of the east and west cross-road. This flat, poorly drained black-soil area, about 80 feet long, was wet throughout August, crawfish holes being abundant (Pl. IIIA, fig. 2; Pl. IIIB, figs. 1, 2). To the east, beyond the boundary fence, in the adjoining corn field, stood a pool of water surrounded by a zone of yellowish weakened corn, visited occasionally by a few shore birds. Along the east side of the newly formed railway embankment (Pl. III, fig. 1) is a shallow trench containing water and a growth of young willows (*Salix*) and cottonwoods (*Populus deltoides*), also blue flags (*Iris versicolor*), bulrush (*Scirpus*), and sedge (*Carex*). The characteristic plants over this area were the abundant swamp milkweed (*Asclepias incarnata*, Pl. IIIA, fig. 1) and *Bidens*. A few plants of water horehound (*Lycopus*) and dogbane (*Apocynum medium*) were present, and many individuals of a low plant with a winged stem (*Lythrum alatum*).

The collections (Nos. 1, 12, 13, 14, 15, 18, 32, 37, 45, 156, and 157) of animals taken here were as follows:

Pond snail	<i>Galba umbilicata</i>	18
Prairie Crawfish	<i>Cambarus gracilis</i>	—
Garden Spider	<i>Argiope aurantia</i>	—
Ambush Spider	<i>Misumena aleatoria</i>	157
Chigger	<i>Trombidium</i> sp.	—
Nine-spot Dragon-fly	<i>Libellula pulchella</i>	—
Stink-bug	<i>Euschistus variolarius</i>	12
Small Milkweed-bug	<i>Lygaeus kalmii</i>	12
Large Milkweed-bug	<i>Oncopeltus fasciatus</i>	1
Ambush Bug	<i>Phymata fasciata</i>	12
Tarnished Plant-bug	<i>Lygus pratensis</i>	12
Soldier-beetle	<i>Chauliognathus pennsylvanicus</i>	156
Black Flower-beetle	<i>Euphoria sepulchralis</i>	156
Four-eyed Milkweed-beetle	<i>Tetraopes tetraophthalmus</i>	12
Milkweed-beetle	<i>Tetraopes femoratus</i> (?)	1
Leaf-beetle	<i>Diabrotica atripennis</i>	1
Dogbane Beetle	<i>Chrysochus auratus</i>	14
Celery Butterfly	<i>Papilio polyxenes</i>	15, 45
Philodice Butterfly	<i>Eurymus philodice</i>	12
Idalia Butterfly	<i>Argynnis idalia</i>	33
Milkweed Butterfly	<i>Anosia plexippus</i>	—
Honeysuckle Sphinx	<i>Hemaris diffinis</i>	32
Giant Mosquito	<i>Psorophora ciliata</i>	13
Giant Fly	<i>Mydas clavatus</i>	12
Honey-bee	<i>Apis mellifera</i>	—
Pennsylvania Bumblebee	<i>Bombus pennsylvanicus</i>	155
Bumblebee	<i>Bombus fraternus</i>	12
Bumblebee	<i>Bombus separatus</i>	12, 157
Carpenter-bee	<i>Xylocopa virginica</i>	1, 156
Rusty Digger-wasp	<i>Chlorion ichneumoneum</i>	12

The soft, wet, black soil contained large numbers of crawfish holes, and from several of them T. L. Hankinson dug specimens of *Cambarus gracilis*. Frogs (*Rana*) were seen but none were secured. A Carolina rail was flushed from the ditch along the track, and on the margins of the water in the adjacent corn field Mr. Hankinson recognized some shore birds. The dragon-fly *Libellula pulchella* was abundant on the wing and resting on the vegetation, and two examples were found in the webs of *Argiope aurantia*. No nymphs were found, but doubtless eggs were laid by some of the numerous adults. It was interesting to observe the fresh burrows of the crawfish which had traversed the fresh firm yellow clay of the recently reinforced railway embank-

ment (shown in Pl. II, fig. 2) and appeared upon its surface. The occurrence here of a small snail, *Galba umbilicata*, is of interest. A very large species of mosquito with conspicuously banded legs, *Psorophora ciliata*, was found here. Though these aquatics and the ground forms did not receive much attention, they are representative of wet places.

The presence of certain plants in this habitat has determined the occurrence of several species of animals. Thus the dogbane *Apocynum medium* accounts for the brilliantly colored leaf-beetle *Chrysochus auratus*, which feeds upon its leaves and roots. But the most conspicuous feature of this habitat in August is the variety of insects which are attracted by the flowers of the swamp milkweed. These flowers may be regarded as so much insect pasture. A few butterflies were observed, *Papilio polyxenes* being found in an *Argiope* web; and on the flowers of the swamp milkweed were *Papilio cresphontes*, *Eurytnus philodice*, *Argynnis idalia*, *Anosia plexippus*, and the honeysuckle sphinx (*Hemaris diffinis*). Among the most abundant *Hymenoptera* were the honey-bee (*Apis mellifera*) and the common rusty digger-wasp (*Chlorion ichneumoncum*). Others were the carpenter-bee (*Xylocopa virginica*) and the bumblebees *Bombus fraternus* and *separatus*. On the flowers of the thistle (*Cirsium*) near this station, *Bombus pennsylvanicus* was also taken. The giant fly (*Mydas clavatus*) was taken on the flowers of the swamp milkweed. Beetles from these flowers were the spotted milkweed-beetles (*Tetraopes tetraophthalmus* and *femoratus*?) the flower-beetle *Euphoria sepulchralis*, and, late in August, great numbers of the soldier-beetle *Chauliognathus pennsylvanicus*. The *Hemiptera* found are equally characteristic, and include both of the common milkweed-bugs (*Oncopeltus fasciatus* and *Lygaeus kalmii*) and *Lygus pratensis*. Still other insects were present on the milkweeds, preying not upon the plant, but upon its guests. These were the ambush bug (*Phymata fasciata*) and the ambush spider (*Misumena aleatoria*), the latter being captured with a large bumblebee (*Bombus separatus*) in its grasp. It is thus quite evident that this milkweed has an important controlling influence upon the insects of this habitat at this season. Another abundant animal was the chigger, a larval mite of the genus *Trombidium*, which is brushed from the vegetation by one's arms and legs. These irritating pests were so abundant that to work with comfort in this region it was necessary to powder one's clothes and body with flowers of sulphur. These young six-legged mites are supposed to prey upon insects, as do the adults. According to Chittenden ('06 : 4) chiggers are most abundant in damp places and forest margins, and among shrubs, grass,

and herbage. The adults are known to eat plant-lice, small caterpillars, and grasshoppers' eggs. This mite is thus an important predaceous member of the association. The dragon-flies are well known to feed upon small insects, which they capture on the wing, and on account of their abundance they are influential insects here.

An examination of the list of animals secured at this station shows that there is considerable diversity in the conditions under which their breeding takes place. Indeed the breeding habits and places are almost as diverse as are the feeding relations. Thus the snail *Galba* breeds in the water; and the crawfish, *Cambarus gracilis*, lives as a burrower except for a brief period in spring, when it is found in streams. It is distinctly a subterranean species. The garden spider, in the fall, leaves its eggs in its web. The life history of the ambush spider is not known. It seems probable that the sexes meet upon flowers, and as the flowers fade they migrate to fresh ones—a response which Hancock has observed ('11 : 182-186) in the allied species *Misumena vatia*. The ambush bug, when found on flowers, is in a large number of cases copulating, but where the eggs are laid and the young developed is unknown to me. Though this bug also must migrate with the fading of the flowers, after the habit of *Misumena*, it is winged and does not have to go "on foot" as the spider probably does. When disturbed these bugs do not as a rule seek to escape by flight, and it is not unlikely that they often crawl from one flower to another when the distance is short. The soldier-beetle is similar to the ambush bug in its propensity to copulate on flowers. The milkweed beetles and the dogbane beetle are commonly seen copulating upon the leaves and stems of the plants on which they live. The larva of the milkweed beetles bore into the roots and stems of plants; the dogbane beetle has similar habits. Of the butterflies, *Anosia* was observed copulating on the willows, one sex with the wings spread, the fore ones overlapping in part the hinder pair, the other sex with the wings folded together vertically, the heads of the insects being turned in opposite directions. The eggs of the mosquito are laid near the surface of the water. The honey-bee and bumblebees are social, and the breeding and care of the young are quite different from those of the other animals found in this habitat. *Xylocopa* cuts the nest for its brood in solid wood, and seems rather foreign upon the prairie, although posts and ties are now to be found there. The rusty digger-wasp provisions its nest, which is dug in the ground, with various grasshoppers; upon these the egg is laid and the young larva feeds. This wasp probably did not breed in this moist habitat. The wet substratum here is probably unfavorable for the breeding of those *Orthoptera* which deposit their eggs in the soil.

4. Cone-flower and Rosin-weed Colony, Station I, e

This station was continuous with and just north of the swamp milkweed area (Station I, d) just described. The surface of the ground sloped gently upward toward the north, but none of it was free from crawfish holes, and the ground-water level was not far below. The soil is very dark in color.

The general appearance of this habitat is shown in Plate V. The large-leaved plants are *Silphium terebinthinaceum*, and the heads of the numerous cone-flowers (*Lepachys pinnata*) show as black points in the picture. The cone-flower was the dominant plant at this time. There were a few scattered plants of *Silphium integrifolium* and of wild lettuce (*Lactuca canadensis*). At the time the collecting was done in this area *Silphium* was not in blossom, and all the flower-collecting was from *Lepachys*.

The collections of animals taken here (Nos. 8, 40, and 158) are as follows:

Crawfish	<i>Cambarus</i> sp. (Burrows observed)	
Garden Spider	<i>Argiope aurantia</i>	40
Sordid Grasshopper	<i>Ecoptolophus sordidus</i>	158
Differential Grasshopper	<i>Melanoplus differentialis</i>	40
Red-legged Grasshopper	<i>Melanoplus femur-rubrum</i>	40
Texan Katydid	<i>Scudderia texensis</i>	40
Dorsal-striped Grasshopper	<i>Xiphidium strictum</i>	40
Black-horned Meadow Cricket	<i>Ecanthus nigricornis</i>	40
Membracid bug	<i>Campylenchia curvata</i>	40
Jassid	<i>Platymetopius frontalis</i>	40
Lygæid	<i>Ligyrocoris sylvestris</i>	40
Ambush Bug	<i>Phymata fasciata</i>	40
Chrysomelid beetle	<i>Nodonota convexa</i>	40
Southern Corn Root-worm Beetle	<i>Diabrotica 12-punctata</i>	40
Robber-fly	<i>Asilidæ</i>	—
Trypetid fly	<i>Euaresta æqualis</i>	40
Eucerid bee	<i>Melissodes bimaculata</i>	8
Eucerid bee	<i>Melissodes obliqua</i>	8
Nomadid bee	<i>Epeolus concolor</i>	8
Social wasp	<i>Polistes</i> sp.	—

Collection No. 40 was made by sweeping the vegetation with an insect net. No. 8 is a collection made from the flowers of *Lepachys pinnata*. The nest of *Polistes* was across the railway track from this station. The abundance of *Melissodes obliqua* and of the pretty

Epeolus concolor on the flowers of *Lepachys* indicates the attractive power of this plant. The coarser plants furnish support for the webs of *Argiope*; the flowers serve as drinking cups in which *Phymata* lies in ambush; and the varied vegetation affords food for the numerous *Orthoptera*. The proximity of ground-water accounts for the presence of *Cambarus*, and an adjacent corn field explains the presence of *Diabrotica*. A robber-fly (*Asilidæ*) was seen but not captured. It is interesting to see *Melissodes obliqua* as it hurries round and round the heads of cone-flowers and sweeps up the great masses of yellow pollen. The hind pair of legs, when loaded with pollen, have nearly the bulk of the abdomen. Robertson ('94; 468) says that this is the most abundant visitor to the cone-flower, and more abundant on this flower than on any other.

It is probable that the conditions within this habitat were suitable for the breeding of most of the species listed. *Euaresia æqualis* has been bred from the seed pods of the cocklebur (*Xanthium*) and probably came from the adjacent corn field. It is most likely on flowers that the strepsipterid parasitic insects find many of their hosts (Pierce '09 b: 116). These insects are found on the following prairie insects: *Polistes*, *Odynerus*, *Chlorion ichneumoncum*, *C. pennsylvanicum*, and *C. atratum*. Robertson ('10) records many important observations on the hosts of Illinois *Strepsiptera*.

5. Colony of Blue Stem (*Andropogon*) and Drop-seed (*Sporobolus*), bordered by Swamp Milkweed, Station I, g*

This colony formed the extreme northern part of the prairie area examined along the "Clover Leaf" track. It extended along the track for a distance of about 200 feet. The area is level black soil prairie. Its general appearance and location are indicated in Figure 2, Plate II, and in Figure 2, Plate III, photographs taken at the time of our study, and in Figure 2, Plate IV, a photograph taken by T. L. Hankinson April 23, 1911. This latter view clearly shows the character of the drainage during the spring wet season. During the late summer, the dry season, the ditch along the railway track concentrates the drainage so that a colony of swamp milkweed (*Asclepias incarnata*) and small willows flourish in it. Upon the well-drained part of this area there is a rather rich growth of *Andropogon furcatus*, *A. virginicus*, and *Sporobolus cryptandrus*, and many plants of the dogbane *Apocynum medium* and a few plants of *Asclepias sullivantii*. This was the largest and best colony of the upland prairie grasses seen along the Clover Leaf tracks; and yet when it is compared with the patches of such

*No collections were made at Station I, f.

grass east of Charleston (Station III) it is a meager colony. Just south of this grassy colony was a large one of the mountain mint, *Pycnanthemum flexuosum*. This is shown in Figure 1, Plate IV.

The collections of animals (Nos. 1, 2, 3, 4, 6, 7, 19, 28a, 36, 39, 44, 157, and 159) are as follows:

Pond snail	<i>Physa gyrina</i>	19
Crawfish	<i>Cambarus</i> sp.	—
Harvest-man	<i>Liobunum politum?</i>	7
Garden Spider	<i>Argiope aurantia</i>	6, 39
Ambush Spider	<i>Misumena aleatoria</i>	6, 157, 159
Red-tailed Dragon-fly	<i>Sympetrum rubicundulum</i>	7
Nine-spot Dragon-fly	<i>Libellula pulchella</i>	—
Prairie Ant-lion	<i>Brachynemurus abdominalis</i>	36
Lace-wing Fly	<i>Chrysopa oculata</i>	44
Grasshopper	<i>Syrbula admirabilis</i>	3
Sordid Grasshopper	<i>Encoptolophus sordidus</i>	44
Differential Grasshopper	<i>Melanoplus differentialis</i>	39
Red-legged Grasshopper	<i>Melanoplus femur-rubrum</i>	3, 39
Texan Katydid	<i>Scudderia texensis</i>	2, 44
Meadow Grasshopper	<i>Orchelimum vulgare</i>	—, 3
Cone-nosed Katydid	<i>Conocephalus</i> sp.	159
Four-spotted White Cricket	<i>Cecanthus 4-punctatus</i>	3
Stink-bug	<i>Euschistus variolarius</i>	39
Small Milkweed-bug	<i>Lygaeus kalmii</i>	1, 6
Large Milkweed-bug	<i>Oncopeltus fasciatus</i>	1
Rapacious Soldier-bug	<i>Sinea diadema</i>	6
Ambush Bug	<i>Phymata fasciata</i>	1
Four-eyed Milkweed Beetle	<i>Tetraopes tetraophthalmus</i>	1
Rhipiphorid beetle	<i>Rhipiphorus dimidiatus</i>	6
Bill-bug	<i>Sphenophorus venatus</i>	39
Milkweed Butterfly	<i>Danais archippus</i>	—
Giant Mosquito	<i>Psorophora ciliata</i>	44
Mycetophilid fly	<i>Sciara</i> sp.	6
Giant Bee-fly	<i>Exoprosopa fasciata</i>	6
Vertebrate Robber-fly	<i>Promachus vertebratus</i>	39, 44
Honey-bee	<i>Apis mellifica</i>	1
Bumblebee	<i>Bombus fraternus</i>	1
Bumblebee	<i>Bombus separatus</i>	1
Eucerid bee	<i>Melissodes bimaculata</i>	6
Nomadid bee	<i>Epeolus concolor</i>	6
Leaf-cutting bee	<i>Megachile mendica</i>	1
Rusty Digger-wasp	<i>Chlorion ichneumoneum</i>	1
Myzinid wasp	<i>Myzine sexcincta</i>	1, 6

Physa and *Cambarus* were found among the milkweeds on account of the wet ground, and the presence of the giant mosquito was probably due to the same condition. The majority of the other animals were attracted to this habitat by the milkweed, particularly by its flowers. Among these were the milkweed bugs and beetles, the milkweed butterfly, the honey-bee, and the rusty digger-wasp. The dense growth of the milkweeds does not appear to be so favorable to the garden spider as is the more open and irregular growth of vegetation elsewhere. The ambush spider frequented the milkweed flowers for prey and also the flower masses of the mountain mint, on which it was in active competition with the ambush bug and the rapacious soldier-bug, which have similar food habits. The mountain mint, whose flowers are frequented by the predaceous animals just mentioned, is also visited by rhipiphorid beetles, the bee-fly (*Exoprosopa fasciata*), the bees *Melissodes bimaculata* and *Epeolus concolor*, and the myzinid wasp *Myzine sexcincta*. The prairie grasses were frequented by a large variety of *Orthoptera*, which showed a decided preference for them, their abundance being evident in the list. The wide-ranging predators and parasites, such as *Liobunum*, *Libellula*, *Sympetrum*, *Chrysopa*, *Brachynemurus*, *Promachus*, *Chlorion*, and *Myzine*, probably forage over extensive areas compared with the relatively sedentary kinds, such as *Misumena*, *Argiope*, *Phymata*, and *Sinea*. *Phymata* was captured on a milkweed flower with a honey-bee; *Promachus vertebratus* was taken on a grass stem with a stink-bug (*Euschistus variolarius*); and *Misumena alcatoria* was taken with a large, nearly mature female nymph of *Conocephalus*.

The conditions which permit an animal to breed in a habitat have an important influence upon the character of its population. It is evident that many of the animals taken do not breed here. Some of the relatively sedentary kinds, such as *Physa*, *Cambarus*, and *Argiope*, and probably *Misumena*, do not cover long distances. Good examples of the wider ranging forms are *Sympetrum*, *Libellula*, *Danais*, *Promachus*, *Apis*, *Bombus*, and *Chlorion*. Several of the animals, as the snails, crawfish, and the dragon-flies, require an aquatic habitat. *Chrysopa* places its eggs among colonies of plant-lice, and *Brachynemurus* probably spends its larval life in dry or sandy places, feeding upon ants and other small insects, as do other ant-lions. Several of the *Orthoptera* deposit their eggs in the soil; and some of the locustids, among grasses and herbaceous stems. Others are found copulating upon the plants on which the young feed, as *Tetraopes*, *Chrysochus*, *Lygæus*, and *Oncopeltus*; and still others copulate in the flowers mainly, as *Phymata*. It is probable that on the flowers some of the para-

sitic species find their hosts, as Pierce ('04) has shown to be the case in the rhipiphorid genus *Myodites*. *Rhipiphorus* is probably parasitic.

6. Supplementary Collections from Station I

In addition to the specimens given in the preceding lists for Station I there are others, general collections from this area, which should be listed for this prairie. For details concerning each species of the following consult the annotated list.

Garden Spider	<i>Argiope aurantia</i>	26
Ambush Spider	<i>Misumena aleatoria</i>	31
Chigger	<i>Trombidium</i> sp.	—
Dorsal-striped Grasshopper	<i>Xiphidium strictum</i>	35
Coreid bug	<i>Harmostes reflexulus</i>	27
Ambush Bug	<i>Phymata fasciata</i>	24, 26, 43
Ladybird	<i>Hippodamia parenthesis</i>	Hankinson
Leaf-beetle	<i>Trirhabda tomentosa</i>	Hankinson
Four-eyed Milkweed Beetle	<i>Tetraopes 4-ophthalmus</i>	35
Old-fashioned Potato Beetle	<i>Epicauta vittata</i>	Hankinson
Margined Blister-beetle	<i>Epicauta marginata</i>	Hankinson
Black Blister-beetle	<i>Epicauta pennsylvanica</i>	26, 152
Snout-beetle	<i>Centrinus penicellus</i>	41
Snout-beetle	<i>Centrinus scutellum-album</i>	Hankinson
Giant Bee-fly	<i>Exoprosopa fasciata</i>	24, 31
American Syrphid	<i>Syrphus americanus</i>	11
Tachinid fly	<i>Trichopoda ruficauda</i>	38
Bumblebee	<i>Bombus separatus</i>	22
False Bumblebee	<i>Psithyrus variabilis</i>	22
Eucerid bee	<i>Melissodes obliqua</i>	24, 48
Short Leaf-cutting Bee	<i>Megachile brevis</i>	Hankinson
Halictid bee	<i>Halictus fasciatus</i>	26
Halictid bee	<i>Halictus virescens</i>	23
Stizid wasp	<i>Stizus brevipennis</i>	35, Hankinson
Rusty Digger-wasp	<i>Chlorion ichneumonenum</i>	6
Harris Digger-wasp	<i>Chlorion harrisi</i>	24
Digger-wasp	<i>Ammophila nigricans</i>	24
Solitary wasp	<i>Odynerus vagus</i>	46

II. PRAIRIE AREA NEAR LOXA, ILLINOIS, STATION II

This station includes patches of prairie along the Cleveland, Cincinnati, Chicago and St. Louis (Big Four) railroad right-of-way between Charleston and Mattoon, Ill., and about one mile west of

the small station of Loxa. Along this track the telegraph-pole numbers were used in locating our substations. This is a rather level black soil area, originally poorly drained and wet, but now considerably modified by the ditching and grading occasioned by railway construction and maintenance. The changes have been similar to those on the prairie north of Charleston, but the ditching has been a few feet deeper and the embankment is higher. The most abundant and characteristic kinds of vegetation are the tall prairie grasses—blue stem (*Andropogon furcatus*), drop-seed (*Sporobolus cryptandrus*), and beard grass (*Andropogon virginicus*)—a rosin-weed (*Silphium laciniatum*), the flowering spurge (*Euphorbia corollata*), wild lettuce (*Lactuca canadensis*), rattlesnake-master (*Eryngium yuccifolium*), and beggar-ticks (*Desmodium*). Many other kinds of plants were also present. The general appearance of this habitat is shown in plates VI and VII.

Our collections from this prairie (Nos. 47–57 and 176–178) are as follows:

Garden Spider	<i>Argiope aurantia</i>	49, 179
Ambush Spider	<i>Misumena aleatoria</i>	47, 178
Sordid Grasshopper	<i>Encoptolophus sordidus</i>	48
Two-lined Grasshopper	<i>Melanoplus bivittatus</i>	55
Differential Grasshopper	<i>Melanoplus differentialis</i>	48
Meadow Grasshopper	<i>Orchelimum vulgare</i>	178
Lance-tailed Grasshopper	<i>Xiphidium attenuatum</i>	48
Dorsal-striped Grasshopper	<i>Xiphidium strictum</i>	48, 50, 57
Stink-bug	<i>Euschistus variolarius</i>	50, 52, 178
Ambush Bug	<i>Phymata fasciata</i>	48, 52, 54, 55, 57, 178
Dusky Leaf-bug	<i>Adelphocoris rapidus</i>	55
Soldier-beetle	<i>Chauliognathus pennsylvanicus</i>	178
Southern Corn Root-worm	<i>Diabrotica 12-punctata</i>	55
Margined Blister-beetle	<i>Epicauta marginata</i>	48
Black Blister-beetle	<i>Epicauta pennsylvanica</i>	48, 178
Rhipiphorid beetle	<i>Rhipiphorus dimidiatus</i>	52
Rhipiphorid beetle	<i>Rhipiphorus limbatus</i>	178
Snout-beetle	<i>Rhynchites œneus</i>	48
Thoe Butterfly	<i>Chrysophanes thoe</i>	55
Dogbane Caterpillar	<i>Ammalo cglenensis</i> or <i>tenera</i>	53
Giant Bee-fly	<i>Exoprosopa fasciata</i>	47, 57, 176
Robber-fly	<i>Deromyia</i> sp.	51
Vertebrated Robber-fly	<i>Promachus vertebratus</i>	56
Corn Syrphid	<i>Mesogramma politum</i>	177
Syrphid fly	<i>Allograpta obliqua</i>	177

Tachinid fly	<i>Cistogaster immaculata</i>	55
Pennsylvania Bumblebee	<i>Bombus pennsylvanicus</i>	50, 52, 55, 176
False Bumblebee	<i>Psithyrus variabilis</i>	176
Eucerid bee	<i>Melissodes bimaculata</i>	48
Nomadid bee	<i>Epeolus concolor</i>	48, 52
Halictid bee	<i>Halictus obscurus</i>	55
Halictid bee	<i>Halictus fasciatus</i>	48, 52
Black Digger-wasp	<i>Chlorion atratum</i>	55
Pennsylvania Digger-wasp	<i>Chlorion pennsylvanicum</i>	55
Myzinid wasp	<i>Myzine sexcincta</i>	52, 55
Ant	<i>Formica pallide-fulva schaufussi</i> <i>incerta</i>	52

The general conditions of this prairie appear to have been less disturbed than at Station I; at least the prairie vegetation is more extensive and uniform. The change in the vegetation is apparently greater than the change in the kinds of animals. Their feeding and breeding relations appear to be much like those at the prairie stations previously discussed.

In the flowers of the cup-leaved rosin-weed (*Silphium integrifolium*) was found a giant bee-fly (*Exoprosopa fasciata*) which had been captured by the ambush spider (*Misumena alcatorea*), and on webs in colonies of this same plant the garden spider (*Argiope aurantia*) was observed, with a grasshopper (*Melanoplus differentialis*) entangled in the web. From the flowers of this *Silphium* the following insects were taken: *Epicauta marginata* and *E. pennsylvanica*, *Rhynchites aeneus*, *Phymata fasciata*, *Encoptolophus sordidus*, *Melanoplus differentialis* (nymph), *Xiphidium strictum* (adult and nymph), *X. attenuatum*, *Melissodes bimaculata* and *obliqua*, *Epeolus concolor*, and *Halictus fasciatus*. The margined blister-beetle (*Epicauta marginata*) was found both upon the flowers and the leaves of the plant. On the flowers of the purple prairie clover (*Petalostemum purpureum*), *Bombus pennsylvanicus*, *Xiphidium strictum*, and *Euschistus variolarius* were taken. Collection 176 was taken from the flowers of *Liatris scariosa*, and Nos. 55 and 178 from the flowers of *Eryngium yuccifolium*.

Swarms of the small corn syrphid, *Mesogramma politum*, were present, on one day settling by dozens on my hands and clothes, where they were easily grasped by the wing. It had been a warm day, and this swarming was in the sunshine at about 4:30 p. m. The flies came from a large corn field a few feet away.

III. PRAIRIE AREA EAST OF CHARLESTON, STATION III

This prairie area is about two miles east of Charleston along the "Big Four" railway track. There were two colonies here. One, substation *a*, was on low black-soil prairie just west of the first north and south road crossing the railway track east of Charleston. This was largely a colony of the large-leaved rosin-weed, *Silphium terebinthinaceum*. The second colony, substation *b*, was a mile and a half directly east of substation *a*, and half a mile east of the second north and south road east of Charleston.

Substation or "station" *a* was originally far out upon the black soil prairie; *b*, on the other hand, is of special interest because it was originally wooded, has been cleared and maintained as a railroad right-of-way, and contains today, therefore, a practically unique mixture of forest and prairie plants and animals, with the prairie kinds dominating. The soil, lighter in color than the black soil prairie, is representative of the wooded regions. This colony has every appearance of a cleared forest area invaded by prairie organisms.

The animals at station *a* were not studied, and the only record is that of the black blister-beetle, *Epicauta pennsylvanica* (No. 119), which was abundant on the flowers of *Silphium terebinthinaceum*.

At station *b* excavation was necessary to lower the road-bed, and upon the disturbed soil thus thrown up along the track the prairie vegetation had become established. The general appearance of this region is shown in plates VIII and IX. Here grew large quantities of rosin-weed (*Silphium terebinthinaceum*) and blue stem (*Andropogon*); in places upon high ground, indeed, this prairie grass was dominant. Associated with it was the flowering spurge, *Euphorbia corollata*, as seen in Plate VIII. The forest near by is shown in the background. This same forest and grass area is shown in the background and middle of Plate IX, and in the foreground of the same picture is shown the mixture of prairie and forest plants. Here are hickory sprouts, crab-apple, grape, sumac, and smilax, intermingled with *Silphium*, blue stem, and *Lactuca canadensis*. Not all of these appear in the photograph, but they were present in some parts of the colony.

The collections here (Nos. 58-62 and 175) are as follows:

Leather-colored Grasshopper	<i>Schistocera alutacea</i>	59
Black-horned Meadow Cricket	<i>Ecanthus nigricornis</i>	62
Meadow Grasshopper	<i>Orchelimum vulgare</i>	175
Soldier-beetle	<i>Chauliognathus pennsylvanicus</i>	175
Spotted Grape-beetle	<i>Pelidnota punctata</i>	58
Black Blister-beetle	<i>Epicauta pennsylvanica</i>	

(Sta. III, *a*) 119

Cabbage Butterfly	<i>Pontia rapæ</i>	61
Vertebrated Robber-fly	<i>Promachus vertebratus</i>	62
Pennsylvania Bumblebee	<i>Bombus pennsylvanicus</i>	175
Impatient Bumblebee	<i>Bombus impatiens</i>	175
Bumblebee	<i>Bombus auricomus</i>	175
(Rose-gall)	<i>Rhodites nebulosus</i>	60

No animals were taken here which were dependent upon the sumac, hickory, crab-apple, or smilax. *Pelidnota* lives upon the grape, and grapes are primarily woodland or forest-margin rather than prairie plants. *Schistocerca* is also probably a marginal species. On the flowers of *Silphium terebinthinaceum* were taken *Orchelimum vulgare*, *Chauliognathus pennsylvanicus*, and *Bombus pennsylvanicus*, *auricomus*, and *impatiens*.

The persistence of woodland vegetation in this locality, in spite of the repeated mowings and burnings, shows that it has much vigor, and would, if undisturbed, in a few years shade out the prairie vegetation and restore the dominance of the forest. With such a change in the vegetation there would of course be a corresponding change in the animals.

DESCRIPTION OF THE FOREST HABITATS AND ANIMALS

1. *The Bates Woods, Station IV*

The Bates woodland area is located about three and a half miles northeast of Charleston on the farm that was owned by Mr. J. I. Bates, and consists of about 160 acres. It includes a bottom-land area near the Embarras River, and extends up the valley slope on to the upland. It is isolated from the trees bordering the river (Pl. X, fig. 1) by a narrow clearing, and from those on the northeast, north, and northwest by another clearing (Pl. XI); on the south and southwest it is continuous with partially cleared areas, which extend south to the Big Four railway track.

The river bottom-land is undulating and rises rather gradually toward the base of the bluffs. The bluff line is irregular on account of the ravines which have been etched in it, the largest of which forms the southern boundary of the region examined. The upland is relatively level. The soils on the bottom are darker colored, except in places near the base of the bluff, and at the mouths of the ravines where the upland soil has been washed down. The upland soil is presumably the "light gray silt loam" of the State Soil Survey (Moultrie County Soils, Ill. Exper. Sta. Soil Rep., 1911, No. 2, p. 23). All of

the area examined was well drained, and all was forested. The region is not homogeneous physically or in its vegetation, and for this reason the area is divided into substations in order that the influences of the local conditions within the forest might be preserved, and their individuality recognized.

2. *The Upland Oak-Hickory Forest, Station IV, a*

The general appearance of this forest is shown in plates XII and XIII. This is an open second-growth forest composed of oaks and hickories—such as white oak (*Quercus alba*), black oak (*Q. velutina*), shag-bark hickory (*Carya ovata*), bitternut (*C. cordiformis*), pignut (*C. glabra*), and scattered individual trees of red oak (*Q. rubra*), walnut (*Juglans nigra*), and mulberry (*Morus rubra*). The shrubs are sassafras (*Sassafras variifolium*), sumac (*Rhus glabra*), Virginia creeper (*Psedera quinquefolia*), poison ivy (*Rhus toxicodendron*), rose (*Rosa*), raspberry (*Rubus*), moonseed (*Menispermum canadense*), and tree seedlings. The average diameter of the largest trees is 8–10 inches. Most of the small growth consists of the sprouts from stumps, and many of these are 2–3 inches in diameter. The forest crown is not complete, and as a consequence there are more or less open patches in which most of the herbaceous growth is found, such as horse mint (*Monarda bradburiana*), pennyroyal (*Hedeoma pulegioides*), everlasting (*Antennaria plantaginifolia*), tick-trefoil (*Desmodium nudiflorum*), and other, less abundant kinds. Even a plant quite characteristic of the prairie, the dogbane *Apocynum*, was found here in one of the open glades.

The forest floor has an unequal covering of dead leaves, largely oak, most of which lie in the low vegetation and in slight depressions. Occasionally there is but little cover and the light-colored soil is exposed. There are few stumps and logs in this part of the forest, and no thick layer of vegetable mold, so that one would not expect to find any animals which normally frequent moist soil and vegetable debris. As this is a second-growth forest it lacks the conditions which abound in an original growth, where are old, dead and decaying trees, and numerous decaying logs and stumps. In this respect the woods is not fully representative of an original upland forest on well-drained bluff land.

The relative evaporating power of the air of this substation was 54 per cent. of that of the standard instrument in the open garden at the Normal School, a fact which indicates a relative evaporation comparable to that of the ordinary black-soil prairie; in producing this condition, the glade-like, open character of this forest is undoubtedly an important factor.

The characteristics of this habitat may be summed up as follows: upland, open, relatively dry second-growth oak-hickory forest, with little undergrowth of shrubs and herbs, and with a small amount of litter and humus; soil dry and firm; and few decaying stumps and tree trunks.

The collections of animals made here (Nos. 64-67, 69, 71, 74-83, 88, 91-93, 102, 103, 107, 109, 118, 120-123, 127, 135, 136, 142, 145, 147, 150, 151, 162, 163, 166, 169, 170, 171, and 183) are as follows:

Land snail	<i>Polygyra albolabris</i>	91
Predaceous snail	<i>Circinaria concava</i>	71
Land snail	<i>Zonitoides arborea</i>	71
Carolina slug	<i>Philomycus carolinensis</i>	71
Land snail	<i>Pyramidula perspectiva</i>	71, 88
Harvest-spider	<i>Liobunum vittatum</i>	82, 123
Harvest-spider	<i>Liobunum ventricosum</i>	123b
Stout Harvest-spider	<i>Liobunum grande</i>	82
Island Spider	<i>Epeira insularis</i>	70
White-triangle Spider	<i>Epeira verrucosa</i>	70
Rugose Spider	<i>Acrosoma rugosa</i>	70, 147
Ground Spider	<i>Lycosa</i> sp.	142, 150
White Ant	<i>Termes flavipes</i>	72, 76, 79
Ant-lion	<i>Myrmeleonidæ</i> (Forest border)	183
Dog-day Harvest-fly	<i>Cicada linnei</i>	162
Periodical Cicada	<i>Tibicen septendecim</i>	—
Forest Walking-stick	<i>Diapheromera femorata</i>	64, 93
Grouse Locust	<i>Tettigidea lateralis</i>	109
Short-winged Grouse Locust	<i>Tettigidea parvipennis</i>	122
Green Short-winged Grasshopper	<i>Dichromorpha viridis</i>	67, 92, 93, 121, 123
Sprinkled Grasshopper	<i>Chlocaltis conspersa</i>	67, 93, 122
Boll's Grasshopper	<i>Spharagemon bolli</i>	67, 150
Lesser Grasshopper	<i>Melanoplus atlantis</i>	67
Acridiid grasshopper	<i>Melanoplus amplexens</i>	67
Acridiid grasshopper	<i>Melanoplus obovatipennis</i>	93
Forked Katydid	<i>Scudderia furcata</i>	109
Angle-winged Katydid	<i>Microcentrum laurifolium</i>	135
Common Katydid	<i>Cyrtophyllus perspicillatus</i>	145
Meadow Grasshopper	<i>Orchelimum cuticularc</i>	67, 93
Meadow Grasshopper	<i>Xiphidium nemorale</i>	93, 103
Striped Cricket	<i>Nemobius fasciatus</i>	67, 93, 122
Spotted Cricket	<i>Nemobius maculatus</i>	122
Woodland Cricket	<i>Apithus agitator</i>	93

Woodland Tiger-beetle	<i>Cicindela unipunctata</i>	136
Caterpillar-hunter	<i>Calosoma scrutator</i>	64
Carabid beetle	<i>Galerita janus</i>	171
Ladybird	<i>Coccinellidæ</i>	81
Splendid Dung-beetle	<i>Geotrupes splendidus</i>	120
Dogbane Beetle	<i>Chrysochus auratus</i>	103
Tenebrionid larva	<i>Meracantha contracta</i>	83
Philenor Butterfly	<i>Papilio philenor</i>	69, 166
Turnus Butterfly	<i>Papilio turnus</i>	—
Troilus Butterfly	<i>Papilio troilus</i>	163
Sphingid larva	<i>Cressonia juglandis</i>	102
Arctiid moth	<i>Halisidota tessellaris</i>	168
Notodontid moth	<i>Datana angusii</i>	65, 162
Notodontid moth	<i>Nadata gibbosa</i>	169
Notodontid moth	<i>Heterocampa guttivitta?</i>	127
Geometrid moth	<i>Eustroma diversilineata</i>	163
Gelechiid moth	<i>Ypsolophus ligulellus?</i>	76, 78, Hankinson
(Cecidomyiid gall)	<i>Cecidomyia holotricha</i>	107, 170
(Cecidomyiid gall)	<i>Cecidomyia tubicola</i>	107
(Cecidomyiid gall)	<i>Cecidomyia caryæcola</i>	107, 170
Syrphid fly	<i>Chrysotoxum ventricosum</i>	163
Corn Syrphid	<i>Mesogramma politum</i>	76, 78, Hankinson
Vespa-like Syrphid	<i>Milesia ornata</i>	103
Pigeon Tremex	<i>Tremex columba</i>	66
(Oak Bullet-gall)	<i>Holcaspis globulus</i>	170
(White Oak Club-gall)	<i>Andricus clavula</i>	170
(Oak Wool-gall)	<i>Andricus lana</i>	170
Formicid ant	<i>Cremastogaster lineolata</i>	118
Formicid ant	<i>Aphænogaster fulva</i>	74-80
Formicid ant	<i>Formica fusca subsericea</i>	163
Mutillid ant	<i>Sphærophthalma</i>	151
Short Caterpillar-wasp	<i>Ammophila abbreviata</i>	127

3. Embarras Valley and Ravine Slopes, forested by the Oak-Hickory Association, Station IV, b

This station included the slope of the valley from the river bottom (Station IV, c) to the upland forest (Station IV, a) and the side of the south ravine, the bottom of which forms Station IV, d. This substation is not as homogeneous physically as the upland or lowland forest, because the part along the south ravine is relatively open, is well drained, and has a south exposure, and the southeast slope to the low-

land forest on the other hand, is well wooded and shaded, and much more humid. The substation also has a considerable amount of litter, leaves, and humus. This region may be considered as transitional between the upland and lowland forest, but it represents, not one but two transitional stages, the south slope approaching the upland forest type, and the southeast slope approaching that of the lowland forest. Thus, if one walked from the upland forest down the slope of the south ravine, and eastward to the southeast valley slope to the bottomland forest, he would traverse all the main degrees of conditions found at Station IV.

The forest cover consists primarily of the following trees: white oak (*Quercus alba*), black oak (*Q. velutina*), walnut (*Juglans nigra*), pignut (*Carya glabra*), and, in smaller numbers, mulberry (*Morus rubra*), red oak (*Quercus rubra*), shag-bark hickory (*Carya ovata*), bitternut (*C. cordiformis*); and of the following shrubs: redbud (*Cercis canadensis*), sassafras (*Sassafras variifolium*), moonseed (*Menispermum canadense*), five-leaved ivy (*Pseodera quinquefolia*), grape (*Vitis cinerea*), prickly ash (*Zanthoxylum americanum*), and sumac (*Rhus glabra*), the latter growing in large colonies on the open south ravine-slope. On the more moist and shaded southeast slope lived the clearweed (*Pilea pumila*), a plant quite characteristic of moist deep-shaded woods. Thus sumac and clearweed may be considered as index plants to the physical conditions in different parts of these two slopes, one shaded and the other rather open.

The atmometer, located on the upper part of the south ravine slope, gave a relative humidity of 31 per cent. of the standard in the garden of the Normal School. It will be recalled that in the upland forest (Station IV, *a*) the atmometer gave 54 per cent., the comparison showing how much less the evaporating power of the air is on the south ravine slope than it is in the upland forest. The relative evaporation was not determined for the southeast slopes, but the presence of *Pilea* clearly indicates that it is less than on the south ravine slope, where the instrument was located. On the lower parts of the valley slope, where this substation grades into the lowland, the layers of dead matted leaves and humus reached to a considerable depth, and looked as if they had been pressed down by drifting snows. Such places were found to contain very few animals.

This habitat is characterized by a sloping surface, by relative openness on the ravine side and dense shade on the valley slope, by relatively humid air, by second-growth forest somewhat transitional between that of the uplands (Station IV, *a*) and the river bottoms (Station IV, *c*), by a relatively large amount of shrubbery, by considerable

humus and litter, by moist soil, and by more logs and stumps than are in the upland forest.

The collections of animals made at this substation (Nos. 68, 84, 85, 87, 89, 90, 94, 100, 104, 105, 106, 108, 110, 111, 124, 125, 131, 132, 133, 140, 149, 161, 164, 165, 166, and 168) are as follows:

Land snail	<i>Polygyra clausa</i>	164
Land snail	<i>Vitrea indentata</i>	140, 164
Land snail	<i>Vitrea rhoadsi</i>	164
Land snail	<i>Zonitoides arborea</i>	84
Carolina Slug	<i>Philomycus carolinensis</i>	89, 125
Land snail	<i>Pyramidula perspectiva</i>	84, 164
Milliped	<i>Cleidogona caesioannulata</i>	140
Milliped	<i>Polydesmus</i> sp.	125
Stout Harvest-spider	<i>Liobunum grande</i>	111
White Ant	<i>Termes flavipes</i>	125
Woodland Cockroach	<i>Ischnoptera</i> sp.	140
Green Short-winged Grasshopper	<i>Dichromorpha viridis</i>	110
Boll's Grasshopper	<i>Spharagemon bolli</i>	133
Scudder's Grasshopper	<i>Melanoplus scudderi</i>	124
Woodland Cricket	<i>Apithes agitator</i>	124
Caterpillar-hunter	<i>Calosoma scrutator</i>	100, 149
Wireworm	<i>Melanotus</i> sp.	125
Horned Passalus	<i>Passalus cornutus</i>	85
Tenebrionid larva	<i>Meracantha contracta</i>	140
Troilus Butterfly	<i>Papilio troilus</i>	161
Philenor Butterfly	<i>Papilio philenor</i>	166
Lycænid butterfly	<i>Everes comyntas</i>	161
American Silkworm	<i>Telea polyphemus</i>	163
Hickory Horned-devil	<i>Citheronia regalis</i>	68, 108
Arctiid caterpillar	<i>Halisidota tessellaris</i>	163, 168
Rotten-log Caterpillar	<i>Scolecocampa liburna</i>	125
Notodontid	<i>Datana angusii</i>	104
Notodontid larva	<i>Nadata gibbosa</i>	94
Geometrid	<i>Caberodes confusaria</i>	161
Slug Caterpillar	<i>Cochlidion</i> or <i>Lithacodes</i>	165
Pigeon Tremex	<i>Tremex columba</i>	132
(Acorn Plum-gall)	<i>Amphibolips prunus</i>	131
Old-fashioned Ant	<i>Stigmatomma pallipes</i>	140
Tennessee Ant	<i>Aphanogaster tennesseensis</i>	87
Formicid ant	<i>Myrmica rubra scabrinodis</i> <i>schneckii</i>	140

Carpenter-ant	<i>Camponotus herculeanus penn-</i>	
	<i>sylvanicus</i>	84, 85
Rusty Carpenter-ant	<i>Camponotus herculeanus penn-</i>	
	<i>sylvanicus ferrugineus</i>	90
Short Caterpillar-wasp	<i>Ammophila abbreviata</i>	124

4. Lowland or "Second Bottom," Red Oak-Elm-Sugar Maple Woodland Association, Station IV, c

This station includes the part of the forest located upon the upper or higher part of the river bottom. This area is sometimes called the "second bottom" because it is above the present flood-plain. The general position of the forest is shown in Figure 1, Plate X. The fringe of willows along the river bank is shown at *a*; the flood-plain area is cleared at *b*; the substation forest is at *c*; and part of the forest of the valley slope is seen at *d*. Other views of this station are shown in plates XIV, XV, and XVI (figures 1 and 2). The general slope is toward the river; minor inequalities are due to the action of the temporary streams which are etching into the uplands and depositing their burdens of debris at the mouths of the ravines. Soil, leaves, and other organic debris are washed from the upland, the ravines, and the valley slopes, and are deposited upon the bottoms, forming low alluvial fans, which have been built up in successive layers or sorted again and again as the temporary streams have wandered over the surface of the fan on account of the overloading and deposition which filled up their channels. In this manner the soil in general is not only supplied with moisture, drained from the upland, but the various soils are both mixed as successive layers of organic debris are buried by storms and also mulched by the large amount of this debris which is washed and blown to the lowland. No springs were found upon the southeast valley slope, but in the south ravine pools of water were present during August, 1910, when my observations were made.

The forest, characterized by hard maple (*Acer saccharum*), red oak (*Quercus rubra*), and elm (*Ulmus americana*), forms a dense canopy which shuts out the light and winds, thus conserving the moisture which falls and drains into it, and making conditions very favorable to a rich mesophytic hardwood forest. That the relative humidity is high is shown by the moisture found in the humus of the forest floor, and, further, not only by the presence of clearweed (*Pilea pumila*) and the nettle *Laportea canadensis*, which characterize such moist shady woods, but also by the presence of the scorpion-flies (*Bit-tacus*). These organisms are permanent residents where such condi-

ditions prevail, and their presence is as clearly indicative of certain physical conditions as that of aquatic animals would be indicative of other physical conditions. In addition to these evidences we have the readings of our atmometer, which showed the evaporating power of the air to be 26 per cent. of the standard in the garden at the Normal School. This shows that the relative evaporation is very low, and that conditions for the preservation of the moisture which falls and drains into this area are very favorable. The general character of this forest is shown in plates XIV, XV, and XVI, Figure 1.

The vegetational cover on the lowland is quite different in its composition from that on the upland. This is shown mainly by the presence of the elm (*Ulmus americana*), hard maple (*Acer saccharum*), and red oak (*Quercus rubra*), and secondarily, by the presence, in smaller numbers, of the black cherry (*Prunus serotina*), slippery elm (*Ulmus fulva*), shingle oak (*Quercus imbricaria*), and the Kentucky coffee-tree (*Gymnocladus dioica*). Other trees present are walnut (*Juglans nigra*), mulberry (*Morus rubra*), and bitternut (*Carya cordiformis*). The shrubs and vines are gooseberry (*Ribes cynosbati*), prickly ash (*Zanthoxylum americanum*), redbud (*Cercis canadensis*), buck-brush (*Symphoricarpos orbiculatus*), green brier (*Smilax*), five-leaved ivy (*Psedera quinquefolia*), moonseed (*Menispermum canadense*), bittersweet (*Celastrus scandens*), and grape (*Vitis cinerea*). The characteristic herbaceous vegetation is nettle (*Laportea canadensis*), clearweed (*Pilea pumila*), bellflower (*Campanula americana*), Indian tobacco (*Lobelia inflata*), tick trefoil (*Desmodium grandiflorum*), *Actinomeris alternifolia*, maiden hair fern (*Adiantum pedatum*), beech fern (*Phegopteris hexagonoptera*), the rattlesnake fern (*Botrychium virginianum*), and *Galium circæzans* and *G. trifolium*.

Although the forest is generally dense and therefore deeply shaded, there are some places which are comparatively open. Attention, however was devoted mainly to the denser parts. At one place, near the base of the eastern slope of the valley, a few trees had been cut within a few years, and in this glade the conditions and plants and animals were different from those in the dense forest. (See Pl. XVI, figs. 1 and 2.)

This habitat may be characterized as follows: lowland densely covered by sugar maple-red oak forest (climax mesophytic); very humid air; a moist soil; relatively few shrubs; herbaceous plants—nettles and clearweed—characteristic of damp, shady, rich woods; and considerable litter and humus in places.

The collections of animals made here (Nos. 113, 114, 116, 117, 137-139, 141, 143, 144, 173, 182, and 184) are as follows, the italicized numbers designating collections from the glade:

Predaceous Snail	<i>Circinaria concava</i>	113
Land snail	<i>Vitrea indentata</i>	113
Slug eggs	<i>Philomycus</i> (?) eggs	114
Alternate Snail	<i>Pyramidula alternata</i>	173
Milliped	<i>Callipus lactarius</i>	113
Ambush Spider	<i>Misumena aleatoria</i>	184
Tent Epeirid	<i>Epeira domiciliorum</i>	131, 173
Three-lined Epeirid	<i>Epeira trivittata</i>	138
Spined Spider	<i>Acrosoma spinea</i>	138, 172
Rugose Spider	<i>Acrosoma rugosa</i>	172
Ground Spider	<i>Lycosa scutulata</i>	144
Cherry-leaf Gall-mite	<i>Acarus serotinae</i>	116
Clear-winged Scorpion-fly	<i>Bittacus stigmaterus</i>	141
Leaf-hopper	<i>Aulacizes irrorata</i>	117, 143
Pentatomid	<i>Hymenarcys nervosa</i>	113
Coreid	<i>Acanthocerus galeator</i>	182
Spined Stilt-bug	<i>Jalysus spinosus</i>	117
Short-winged Grasshopper	<i>Dichromorpha viridis</i>	117, 143
Acridiid grasshopper	<i>Melanoplus amplexens</i>	117, 143
Acridiid grasshopper	<i>Melanoplus gracilis</i>	143
Scudder's Grasshopper	<i>Melanoplus scudderi</i>	117
Round-winged Katydid	<i>Amblycorypha rotundifolia</i>	117, 143
Nebraska Cone-nose	<i>Conocephalus nebrascensis</i>	117
Meadow Grasshopper	<i>Orchelimum cuticulare</i>	143
Meadow Grasshopper	<i>Orchelimum glaberrimum</i>	117, 143
Meadow Grasshopper	<i>Xiphidium nemorale</i>	117, 143
Striped Cricket	<i>Nemobius fasciatus</i>	143
Elaterid larva	<i>Corymbites</i> sp.	113
Elaterid	<i>Asaphes memnonius</i>	113
Black-tipped Calopteron	<i>Calopteron terminale</i>	173
Reticulate Calopteron	<i>Calopteron reticulatum</i>	143
Horned Fungus-beetle	<i>Boletotherus bifurcus</i>	173
Common Skipper	<i>Epargyreus tityrus</i>	173
Imperial Moth (larva)	<i>Basilona imperialis</i>	106
Noctuid moth	<i>Autographa precatioris</i>	143
Asilid fly	<i>Deromyia discolor</i>	117
Vespa-like syrphid	<i>Milesia ornata</i>	143, 184
Long-sting	<i>Thalessa lunator</i>	143
Black Longtail	<i>Pelecinus polyturator</i>	117, 143
Cocoon Ant	<i>Tapinoma sessile</i>	139

5. *Supplementary Collections from the Bates Woods, Station IV*

Tent Epeirid	<i>Epeira domiciliorum</i>	167
White-triangle Spider	<i>Epeira verrucosa</i>	126
Spined Spider	<i>Acrosoma spinea</i>	148
Rugose Spider	<i>Acrosoma rugosa</i>	126
Mealy Flata	<i>Ormenis pruinoso</i>	Hankinson
Leaf-hopper	<i>Gypona pectoralis</i>	Hankinson
Pentatomid bug	<i>Euschistus fissilis</i>	124
Pentatomid bug	<i>Mormidea lugens</i>	Hankinson
Tarnished Plant-bug	<i>Lygus pratensis</i>	Hankinson
Coreid bug	<i>Alydus quinquespinosus</i>	Hankinson
Coreid bug	<i>Acanthoceros galeator</i>	Hankinson
Rapacious Soldier-bug	<i>Sinea diadema</i>	Hankinson
Acridiid grasshopper	<i>Melanoplus obovati-pennis</i>	124
Pennsylvania Firefly	<i>Photuris pennsylvanica</i>	Hankinson
Margined Soldier-beetle	<i>Chauliognathus marginatus</i>	Hankinson
Soldier-beetle	<i>Telephorus</i> sp.	Hankinson
Chrysomelid beetle	<i>Cryptocephalus mutabilis</i>	Hankinson
Clubbed Tortoise-beetle	<i>Coptocycla clavata</i>	Hankinson
Portlandia Butterfly	<i>Enodia portlandia</i>	63
Eurytus Butterfly	<i>Cissia eurytus</i>	Hankinson
Gelechiid-moth	<i>Ypsolophus ligulellus</i>	Hankinson
(Hairy Midge-gall)	<i>Cecidomyia holotricha</i>	(Near collection No. 96)
Corn Syrphid Fly	<i>Mesogramma politum</i>	Hankinson
(Horned-knot Oak-gall)	<i>Andricus cornigerus</i>	(Near 96)
(Oak Wool-gall)	<i>Andricus lana</i>	(Near 96)
Ichneumon Wasp	<i>Trogus obsidianator</i>	Hankinson
Formicid ant	<i>Aphaenogaster fulva</i>	125
Rusty Carpenter-ant	<i>Camponotus herculeanus pennsylvanicus ferrugineus</i>	97
Spider Wasp	<i>Psammochares aethiops</i>	Hankinson

6. *Small Temporary Stream in the South Ravine, Station IV, d*

This small temporary stream in a ravine formed the southern boundary of the area examined (Pl. XVII, figs. 1 and 2). At the season of our examination it was a series of small disconnected pools. Very little attention was devoted to the collection and study of its life. Most of the collections were secured by T. L. Hankinson. A few aquatic animals were collected here. In a small pool were taken numerous specimens of the creek chub (*Semotilus atromaculatus*), and one stone-

roller (*Campostoma anomalum*). Frogs, toads, and salamanders were also taken in the vicinity by Mr. Hankinson, who dug from their burrows specimens of *Cambarus diogenes*, and also secured *immunis* and *propinquus*. On the surface of the pools were numerous specimens of a water-strider, *Gerris remigis*. The forest cover is undoubtedly an important factor in the preservation of such pools, as it controls the evaporating power of the air.

Mr. Hankinson tells me that during the summer of 1912 this temporary stream was completely dry, and that no fish have been taken from it since the earlier collection mentioned above. From the mouth of the ravine across the bottom to the river it is only a few hundred feet, and in time of heavy or prolonged rains these pools are in direct communication with the river. Such a stream is an excellent example of an early stage in the development of the stream habitat, and shows its precarious character, and the liability to frequent extermination of these pioneer aquatic animals which invade it in its early stages. This applies particularly to those animals which have no method of tiding over dry periods. On the other hand, those animals which live in the pools, those parts of temporary streams which persist longest between showers, have better chances of survival, particularly burrowing animals, like the crawfish and its associates. It seems probable that crawfish burrows harbor a varied population; not only the crawfish leeches (*Branchiobdellidæ*) but also the eggs of certain *Corixidæ* (Forbes, '76: 4-5; '78, p. 820; Abbott, '12) may almost cover the body of some crawfishes. By means of this burrow ground-water is reached, and a subterranean pool is formed. For the elaboration of the stream series see Adams ('01) and Shelford ('11 and 13a).

This temporary stream shows how, by the process of erosion, the upland forest area is changed into ravine slopes, and, later, even into the bed of a temporary stream. Thus progresses the endless transformation of the habitat.

GENERAL CHARACTERISTICS OF THE GROSS ENVIRONMENT

1. *Topography and Soils of the State*

Illinois lies at the bottom of a large basin. This is indicated in part by the fact that so many large rivers flow toward it. The mean elevation of the state is about 600 feet, and about a third of it lies between 600 and 700 feet above sea-level. Except Kentucky, the bordering states are from 200 to 500 feet higher. Iowa and Wisconsin are considerably higher, so that winds from the north and northwest

reach the state coming down grade. Taken as a whole the land surface is a tilted plain sloping from the extreme northern part—where a few elevations exceed a thousand feet—toward the south, bowed in the central part by a broad crescentic undulation caused by a glacial moraine, and then declining gradually to the lowland north of the Ozark Ridge, near the extreme southern part of the state. This east and west ridge occasionally exceeds 1,000 feet, but its average height is between 700 and 800 feet. It is very narrow, only about 10 miles in average width, and rises about 300 feet above the surrounding lowland (Leverett, '96, '99). South of this ridge lie the bottoms of the Ohio River. The largest river within the state is the Illinois.

The soils of the state are largely of glacial origin. Even the unglaciated extreme northwestern part and the Ozark Ridge region have a surface layer of wind-blown loess. In some places considerable sand was assorted by glacial water, forming extensive tracts of sandy soil, and locally dune areas are active. Along the larger streams there are extensive strips of swamp and bottom-land soils. The remaining soils, which characterize most of the state, were either produced mainly by the Iowan or Illinoian ice-sheets, as in the case of the relatively poorer soils, or by the Wisconsin sheet, which formed the foundation for the better soil. The dark-colored prairie soils are due to organic debris. Coffey ('12:42) has said: "Whether this accumulation of humus is due to lime alone or to the lack of leaching, of which its presence is an indication, has not been definitely determined. Neither do we know whether it is due to chemical or bacteriological action; most probably the latter, an alkaline medium being necessary for the growth of those bacteria or other microorganism which cause this form of decomposition."*

2. Climatic Conditions

The climatic features of a region are generally conceded to have a fundamental influence upon its life. The controlling influences upon climate are elevation above sea-level, latitude, relation to large bodies of water—generally the sea—and the prevailing winds. The elevation and relief of Illinois have but a slight influence. In latitude Illinois is practically bisected by the parallel $39\frac{1}{2}^{\circ}$ in the north temperate zone. This position influences the seasons and the amount of heat received from the sun. The sea is far distant, but the Great Lakes are near by, and proximity to the interior of a large continent

*Consult Hopkins and Pettit ('08) and the County Soil Reports of the State Soil Survey for a detailed account of the chemical conditions of Illinois soils. The bacterial, algal, and animal population have hardly been noticed by students of Illinois soils.

brings the state within that influence. And, finally, it lies in the zone of the prevailing westerly winds, and directly across the path of one of the main storm tracks, along which travel in rapid alternation the highs and lows which cause rapid changes of temperature, wind, and precipitation, and thus produce the extremely variable weather conditions.

The state is 385 miles long, and as latitude has much influence upon climate, the climate of Illinois differs considerably in the extreme north and south. This is clearly shown in the average annual temperature, which in the northern part is 48.9° F., in the central part is 52.70°, and in the southern part is 55.9° (Mosier, '03). These averages probably closely approximate the soil temperatures for these regions. The average date of the last killing frost in the northern part is April 29; in the central part, April 22; and in the southern part, April 12. The average date of the first killing frost for the northern part is October 9, central part, October 11, and the southern part is October 18 (Henry). The growing season for vegetation in the northern half of the state averages from 150 to 175 days and for the southern half from 175 to 200 days (Whitson and Baker, 12:28). The precipitation shows similar differences, increasing from north to south. The annual average for the northern part is 33.48 inches, increasing to 38.01 in the central and to 42.10 inches in the southern part (Mosier, '03:62). Mosier has shown that the Ozark Ridge, with an average elevation of about 800 feet, condenses the moisture on its south slope so that it has a precipitation of 7.15 inches more than do the counties just north of the ridge. This same humid area appears to extend up the Wabash Valley to Crawford county, and gives the valley counties a rainfall 3 inches in excess of the adjacent counties to the west. The average annual rainfall for the state is 37.39 inches—nearly one third of it during April, May, and June, and if July is included, more than half. The heaviest precipitation, 8.23 inches, is in May and June.

As previously mentioned, the state lies in the zone of prevailing westerly winds and across the path of storms. These have a dominant influence upon the direction of the winds. In the northern part of the state, they are, by a slight advantage, southerly—a tendency which progressively increases toward the south, for in the central part the southerly winds reach 55 per cent., and in the southern part 62 per cent. During the winter the northwest winds predominate throughout the state, to a marked degree in the central part, where they reach 60 per cent., and where also the velocity is greatest, reaching an average of 10.3 miles an hour. The velocity of the wind for the entire

state is highest during spring. During the summer, the southwest winds predominate in the northern and central parts, and in the southern part 82 per cent. of the winds are southerly. The velocity of the wind is least during the summer, and the greatest stagnation occurs in August. During autumn there is a falling off of the southerly winds and an increased velocity as winter conditions develop. The transition in the fall is in marked contrast with the vigor of the spring transition. The cooler seasons are more strongly influenced by northerly winds, and the warmer seasons by southerly winds.

3. *Climatic Centers of Influence*

In the preceding section the *average* conditions of temperature, precipitation, and the direction and velocity of the winds have been summarized, but little effort was made to indicate the mode of operation of the determining factors which produce and maintain these average conditions. It is often true that the main factors which explain the conditions seen in some restricted locality can not be found within it because the local sample is only a very small part of a much larger problem. Thus no one attempts to find an explanation of the through-flowing upper Mississippi system within the state of Illinois; a larger unit of study is necessary. The region examined must extend to the headwaters. So, also, with most of the climatic features of Illinois; their approximate sources must be sought elsewhere. Let us therefore consider some of the broader features which influence the climate of North America, particularly that of the eastern part.

The climates of the world have been divided into two main kinds, depending primarily upon the controlling influence of temperature. This is due to the relative specific heat of land and water, that of water being about four times that of land. The sea, which covers three fourths of the earth's surface, is thus an immense reservoir of heat, which is taken up and given off slowly, at a rate one fourth that of the land. It is therefore relatively equable. The northern hemisphere contains the largest amount of land, and is therefore less under the control of the sea than the southern hemisphere; yet the sea's influence is very powerful, particularly near the shore. The large land masses, on the other hand, on account of their lower specific heat, receive and give off heat more rapidly to the air above. For this reason the temperature changes, as between day and night or summer and winter, are much more rapid and much more extreme over land than over the sea. A climate dominated by the equable sea is oceanic; that dominated by the changeable lands is continental. Illinois lies far

from the sea and is therefore strongly influenced by continental conditions. To what degree is the marine influence shown?

Meteorologists (cf. Fassig, '99) have come to look upon the large areas of permanent high and low barometric pressure as among the most important factors in climatic control. There are five of these powerful "centers of action" which influence our North American climate (Fig. 1), and four of these are at sea. A pair of *lows* are in the far north, one in the north Pacific near Alaska, the other in the

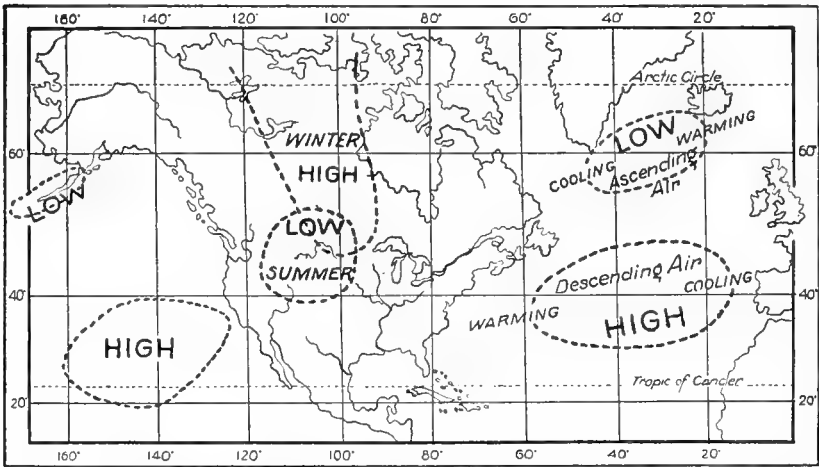


FIG. 1. Diagram showing the positions of the relatively stable areas of high and low barometric pressure, and indicating their influences upon the evaporating power of the air and upon the climate in general.

north Atlantic south of Greenland. A pair of *highs* are farther south, one in the Pacific between California and the Hawaiian Islands, and the other centering in the Atlantic near the Azores. The highs and lows in each ocean seem to be paired and to have some reciprocal relation. The fifth center of action is upon the land. It is a *high* barometric area in the Mackenzie basin of Canada, where it becomes a powerful center of influence through winter and spring, but with the progress of summer conditions weakens, and through the accumulation of continental heat becomes converted into a *low*; thus there is a complete seasonal inversion on the continent.

These large highs and lows, although relatively permanent, are continually changing in intensity and position. The *highs* are regions of descending, diverging, warming, and drying air, producing clearing and clear air on their western side, but the reverse on their eastern side.

The *lows* are regions of ascending, converging, cooling air, with increasing moisture and clouds on their western side, but are the reverse on their eastern side (Moore, '10: 153). These same characteristics apply to the small highs and lows which we are accustomed to see on the daily weather maps.

If, now, we consider these large centers of action, such consideration will do much toward giving us a graphic idea of our climate. During the winter, because of the small amount of heat received in the Mackenzie basin, the temperature becomes very low, and a powerful high barometric area is formed; then the descending air blowing from the *eastern* part of this high, or from small highs originating from the larger one, produce the cold winters and cold waves in winter which characterize the northeastern United States. If, however, the Atlantic high wanders on the eastern coast of the United States in winter, the *western* part of this high, with its descending, diverging, warming, and drying air, produces a mild winter. The climate of the eastern United States is thus, in the cold season, under the alternate invasion of these two powerful centers of action. During the warm season the continental winter high is replaced by a low, due to the accumulating warm continental temperatures which thus have produced an inversion or seasonal overturning. But the Atlantic high is permanent and exerts its influence continuously. If the *western* part of this high encroaches upon the eastern United States during the summer, with its descending, drying, and clear air, it may produce drouth, this depending, of course, on its degree of development. The continental low of summer, with the drying influence of its *eastern* side, has a similar tendency. *Thus the character of the summer is determined, to an important degree, by the interplay and relative balance between these two warming and drying centers.* The activity of these centers has a powerful influence upon the moisture-bearing winds, which influence humidity and evaporation in Illinois, and in the eastern United States.

4. *Relative Humidity and Evaporating Power of the Air*

We are now in a position to examine the facts of relative humidity and the relative evaporating power of the air in the eastern United States. The relative aridity on the plains east of the Rocky Mountains is due primarily to the removal of moisture from the prevailing westerlies in their passage from the Pacific over the various western mountain ranges which extend across their path, combined with the excessive summer heating of the continental mass. Here, then, is the influence of the continental summer low. Farther east the Atlantic high tends to supplement the continental low and to cause the Gulf

winds to bring moisture inland,* and the Great Lakes region adds its quota.

In the storm-track zone, where stagnation of the air is due largely to the balance existing between the continental low and the oceanic high, the aridity of the plains extends the farthest east, and as an arid peninsula it crosses Illinois, giving during August a relative humidity to the prairie area of 60–70 per cent. of saturation (Johnson, '07). The reality of the arid peninsula across Illinois is further shown by the rainfall-evaporation ratios computed and mapped by Transeau ('05). These ratios were determined by dividing the mean annual rainfall at each place by the total mean annual evaporation. These mapped percentages show that the prairie region is closely bounded by the region with an evaporation ratio of between 60 and 70 per cent. of the rainfall received. These conditions furnish a general background or perspective for a profitable consideration of the local and more detailed studies which have been made of the relative evaporating power of the air in different plant and animal habitats.

For our purpose it is not necessary to consider the history of methods of measuring relative evaporation. This measurement may be made by evaporating water in open pans or by the porous porcelain-cup method. Such cups have been devised by several students, but a modified form of the Livingston atmometer has been mainly used by plant ecologists, and this was the kind we used at Charleston. Transeau ('08) was the first to use such an instrument and to show its value in studying the relation of intensity of evaporation to plant societies. His work on Long Island, N. Y., showed very clearly that evaporation in open places was much greater than in dense forests. These observations were enough to show that evaporation is a factor related to the physical conditions of life upon the prairie and in the forest, and therefore in our cooperative study of the Charleston area in 1910 relative evaporation was made a special feature in the study of representative environments, in order to determine its relation to both the plants and the animals. So far as is known this is the only study yet made in which these determinations have been recorded from the same places where the animals have been studied. Since our data were secured, several papers have been published on relative evaporation in different sorts of habitats in this state and in northern Indiana by plant ecologists Fuller ('11, '12a, '12b), McNutt and Fuller ('12), Fuller, Locke,

*Zon ('13) has recently asserted that the moisture from the sea does not make a single overland flight inland, but rather is largely precipitated near the sea, is evaporated and carried farther inland, is precipitated again, and this process repeated again and again, so that its inland flight is a vertical revolving cycle of precipitation and evaporation. If this contention is valid, evaporation from the land is a much more important climatic factor than it is usually thought to be.

and McNutt ('14), Sherff ('12, '13a, '13b), and Gleason and Gates ('12). Shelford ('12, '13a, '13b, '14a), utilizing the evaporation data of the plant ecologists, has applied the same to animal associations also, and he has further tested some of these ideas experimentally in the laboratory. In Ohio, Dachnowski ('11) and Dickey ('09) have made records of data obtained by the use of the porous cup, and in Iowa Shimek ('10, '11) has used the open-pan method. Mention should also be made of Yapp's observations ('09) on a marsh in England. A very important summary of evaporation records, in the open and in forests, is given by Harrington ('93). The effect of wind-breaks upon evaporation has been studied by Bates ('11) and Card ('97). Finally, mention should be made of Hesselman's studies of relative humidity in forest glades in Sweden ('04).

Our records from the Charleston region will be given first, and then their significance will be discussed. The unglazed porcelain cups, with a water reservoir, were placed so that the tops of the cups were about six inches above the soil in the habitats examined, and at weekly intervals the water loss was measured. The instruments were in operation simultaneously, so that the results are comparable. The standard instrument was located in the open exposed garden of the Eastern Illinois Normal School at Charleston, which was considered as unity, or 100 per cent. For further details as to the conditions where the atmometers were located consult the description of the stations and the photographs.

An examination of the diagram (Fig. 2) will show that although based upon a limited amount of data (for less than a month, from

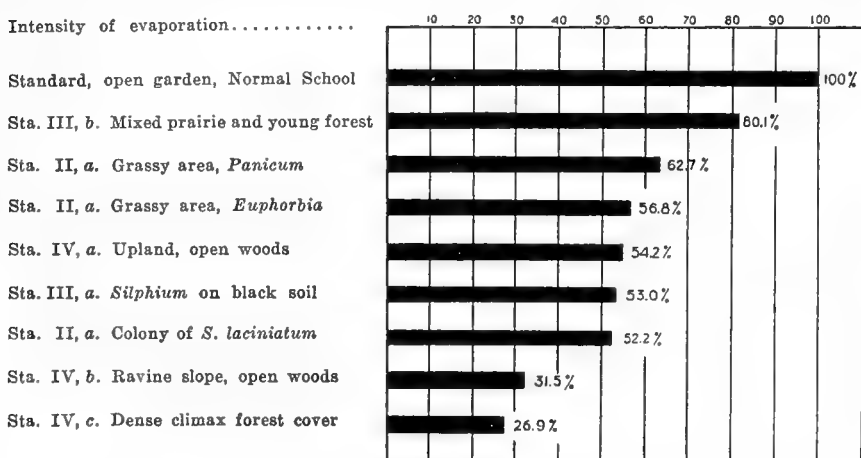


FIG. 2. Diagram of the relative evaporation in different prairie and forest habitats, showing the great reduction in evaporation with the development of a closed forest canopy of a climax forest; Charleston, Illinois.

August 19 to September 22) the facts are in harmony with similar studies elsewhere covering a much longer period, so that there is valid reason for confidence in them. The standard instrument was located, as already mentioned, in an open, exposed cultivated garden, where the intensity of evaporation was very high. The black soil prairie areas, Stations II and III, *a*, have an average of 56.1 per cent.—a condition much like that in the grassy-Euphorbia prairie at Loxa (Station II, *a*)—or a little more than half that of the standard instrument. The dry upland area of mixed prairie and young forest, on gray silt loam (Station III, *b*), has an intensity of 80 per cent. This is in the region of the most extensive grassy prairie about Charleston; the general appearance of the region is shown in Plate XIII. A surprising feature of the table is the evaporation in the open-crowned upland oak-hickory woods (Station IV, *a*). In this forest perhaps two thirds to three fourths of the ground was shaded, and it was very well drained. The evaporation here reached 54.2 per cent., being very near that of the average of the black soil prairie (56.1 per cent.). I had anticipated much less evaporation than on the prairie, a position more intermediate between the prairie and the lowland forest, or about 42 per cent. (cf. Harvey, '14:95). The ravine slope (Station IV, *b*), although somewhat open, has 31.5 per cent.—a very low rate of evaporation—and is remarkably close to that of the densely crowned lowland forest (Station IV, *c*), at 26.9 per cent. The decline, however, in the intensity of evaporation with the degree of completeness of the for-

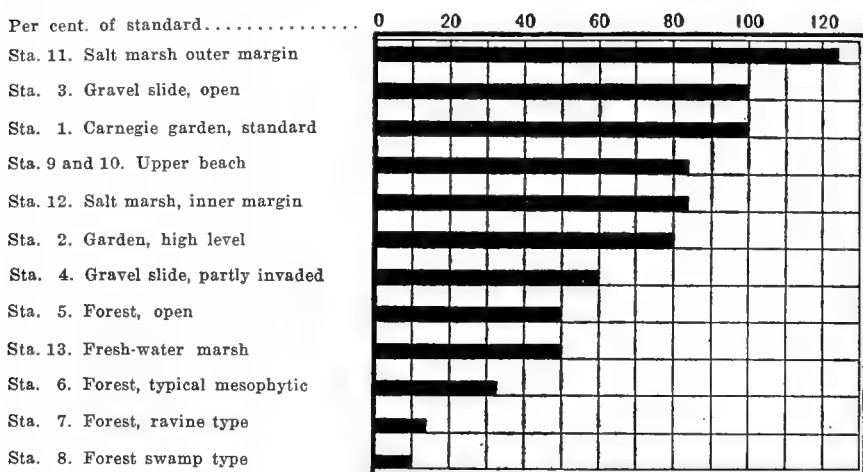


FIG. 3. Diagram of the relative intensity of evaporation in the lowest stratum of different kinds of habitats, Long Island, N. Y. (After Transeau.)

est crown, is strikingly shown in passing from the open upland woods, at 54.2 per cent., to the ravine slope at 31.5 per cent., and on to the lowland forest at 26.9 per cent.

A comparison of these results with those secured by Transeau ('08) on Long Island, is instructive. His standard instrument was also in an open garden (Fig. 3), comparable with the Charleston standard. A gravel slide, partly invaded by plants, had an evaporation of 60 per cent., comparable with the open prairie at Charleston; the open forest, 50 per cent., comparable with the upland open Bates woods at 54.2 per cent.; and the mesophytic forest, 33 per cent., comparable with the ravine and lowland places in the Bates woods at 31.5 and 26.9 per cent. respectively.

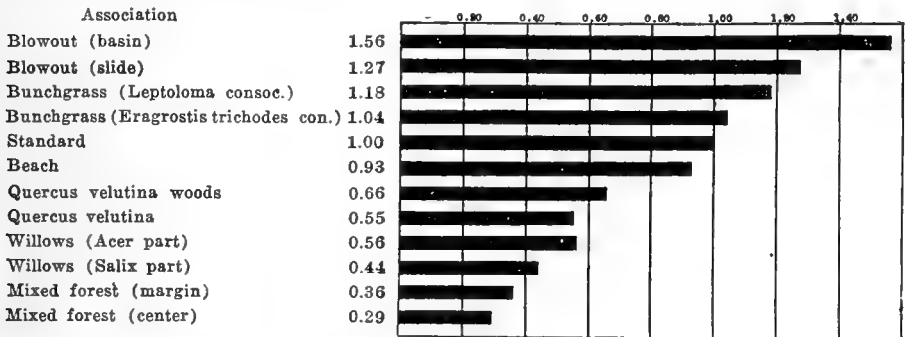


FIG. 4. Relative intensity of evaporation in different kinds of habitats on sandy soil, Havana, Illinois. (After Gleason and Gates.)

Another series of relative evaporation observations was made by Gleason and Gates ('12) on sandy soils at Havana, Illinois. As their methods were similar to those used at Charleston, useful comparisons may again be made. The standard instrument was in an open area comparable to the garden at Charleston. An examination of Figure 4, summarizing the results of their study, shows that upon the grass-covered sand prairie (bunch-grass) the evaporation was about 110 per cent., that in open black oak (*Q. velutina*) woods (on sand) it was about 60 per cent., and that in a denser hickory-black-oak-hackberry mixed forest (somewhat open) it was about 31 per cent. There is thus a close general correspondence between the conditions at Havana and Charleston, although the evaporation upon sand prairie appears to be relatively much greater than upon the black-soil prairie.

Fuller ('11) and McNutt and Fuller ('12) have made comparative studies in different kinds of forest in northern Illinois and in northern

Indiana. Their results are combined and summarized in Figure 5. This diagram shows the relative evaporation near the surface of the soil, the standard of comparison being the evaporation in a maple-beech climax forest, where evaporation is relatively low. The average daily amount, in c.c., shows that there is a progressive increase in evaporation as follows: 8.1 c.c. in a maple-beech forest, 9.35 c.c. in the oak-hickory upland forest, 10.3 c.c. in an oak dune forest, 11.3 c.c. in a pine dune forest, and an increase to 21.1 c.c., on the cottonwood dunes. This expressed on a percentage basis is, in inverse order, respectively 260 per cent. in the cottonwoods, 140 per cent. in the pines, 127 per cent. in the oak dunes, 115 per cent. in the oak-hickory forest, and 100 per cent. in the maple-beech forest.

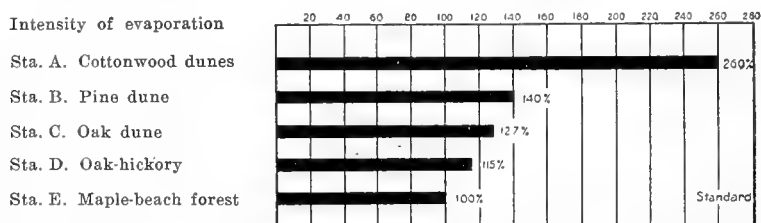


FIG. 5. Diagram showing the relative rate of evaporation in different kinds of forest in northern Illinois and Indiana. [Data from Fuller ('11) and McNutt and Fuller ('12).]

Shimek ('10, '11) has made valuable observations on the relative rate of evaporation on the prairie of western Iowa. He used the open-pan method in four representative habitats. His results show very clearly that the rate of evaporation is much greater in exposed places than where there is shelter from the sun and wind. I have put his data in a form comparable with those which have just been discussed (Fig. 6), and have made the cleared field area, Station 4, the standard of comparison, as it more nearly approaches the standard used at Charleston and by others. Station 3 is on a high bluff, exposed to the

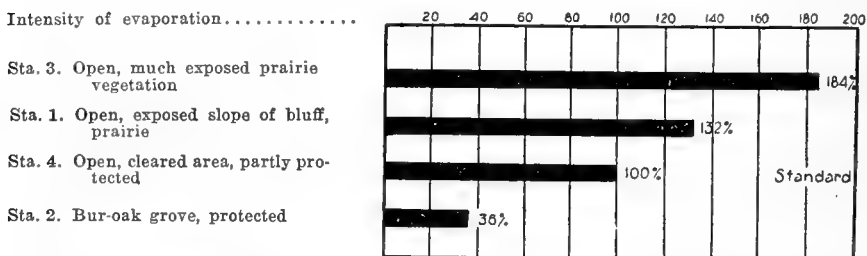


FIG. 6. Diagram of relative evaporation in prairie and forest habitats, in western Iowa. (Data from Shimek.)

west and south winds, and, as might be expected, it has an excessive evaporation—184 per cent. Station 1, also covered by prairie vegetation, and exposed to west and southwest winds but sheltered from winds from the south and southeast, also shows a very high evaporation—132 per cent. Station 4, which was made the standard, had been cleared of forest, and was an open place protected by a ridge. Station 2 was apparently a dense grove composed of bur oak, basswood, elm, and ash, with considerable undergrowth. Here the rate of evaporation dropped considerably—to 36 per cent. The general character of this forest calls to mind the denser oak forests on sand at Havana, Illinois. An important feature of these observations is that they were made far out upon the “prairie”, bordering the plains, most other studies on relative evaporation having been made much farther east.

In Ohio, Dachnowski ('11) and Dickey ('09) have recorded the relative evaporation of the air, using a campus lawn as unity. In the central grass-like area of a cranberry bog the evaporation was 69.2 per cent., and in the marginal maple-alder forest it was 51.2 per cent.

Harrington ('93:96-102), in summarizing European studies on the relative evaporation (with a water-surface as standard) in the open and in German forests shows that the “annual evaporation in the woods is 44 per cent. of that in the fields.” Compared with evaporation in the open, that under deciduous trees is 41 per cent., and that under conifers is 45 per cent.—a difference most marked in the summer. Ebermeyer's Austrian observations (l. c. :99) show that the “evaporation from a bare soil wet is about the same as that from a water surface,” both in the open and in the forest. A saturated soil under forest litter gives an evaporation of only 13 per cent. of that of a free-water surface in the open. Harrington (l. c. : 100) concludes that “About seven-eighths of the evaporation from the forest is cut off by the woods and litter together.” Sherff ('13a, '13b) has shown that in the Skokie Marsh, north of Chicago, the absolute amount of evaporation near the soil was less at the center of a *Phragmites* swamp than at its margin (Fig. 7), that a swamp meadow

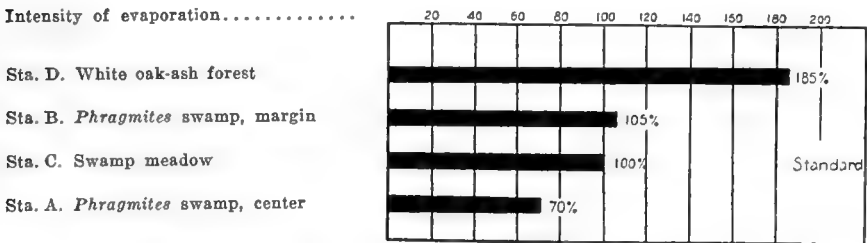


FIG. 7. Diagram of relative evaporation in Skokie Marsh area, near Chicago, at 10 inches (25 cm.) above the soil. Recalculated. (Adapted from Sherff.)

was in an intermediate position, and that in an adjacent white oak-ash forest evaporation was about twice as much as in the swamp meadow. Sherff used as standard the forest (D). This gave him for the center of the swamp (A) 38 per cent., for the swamp meadow (C) 54 per cent., and for the outer swamp margin (B) 105 per cent. In Figure 7, I have used his swamp meadow as 100 per cent., and by recalculation this gives the forest (D) 185 per cent., for the swamp margin (B) 105 per cent., and for the center of the swamp (A) 70 per cent. These figures indicate a concentric arrangement of the conditions of evaporation about the swamp.

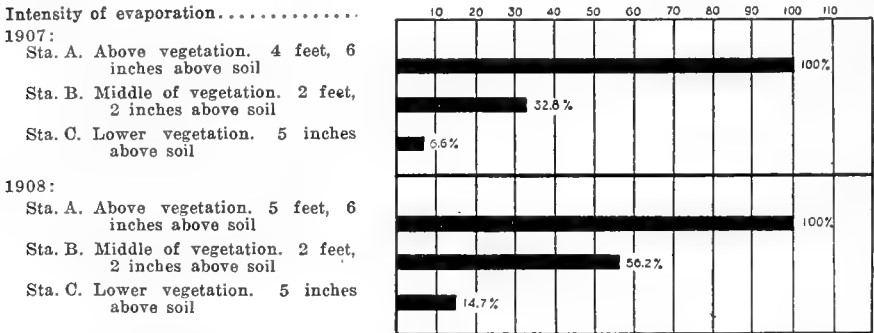


FIG. 8. Diagram showing the relative evaporation at different vertical levels in a marsh in England, the evaporation in the lower layers of the vegetation being much greater than in the upper strata or in the air above it. (Data from Yapp.)

Thus far, attention has been devoted solely to the horizontal differences in evaporation. There are also important vertical ones, varying above the surface of the substratum. Important observations on this subject have been made, by a porous-cup method, in an open grassy marsh in England, by Yapp ('09). The vegetation grew to a height of two to five feet. From his data the accompanying diagrams (Figs. 8, 8a) have been prepared. This shows that when the standard was made the rate of evaporation above the general level of the vegetation, within the grass layer evaporation was reduced from about one half (Sta. B, 1908, 56.2 per cent.) to one third (Sta. B, 1907, 32.8 per cent.) at 2 feet 2 inches above the soil; and that at 5 inches above the soil it was reduced to between one fourteenth (Sta. C, 1907, 6.6) and one seventh (Sta. C, 1908, 14.7) of that above the vegetation. Yapp (l. c.: 298) concludes from his studies that "In general, the results of the evaporation experiments show that the lower strata of the vegetation possess an atmosphere which is continually very much

more humid than that of the upper strata, and farther, that the higher and denser the vegetation the greater these differences are." This is shown in Fig. 8a.

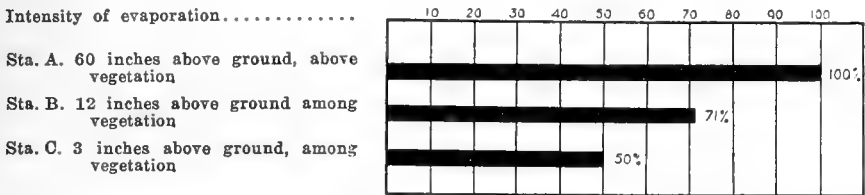


FIG. 8a. Diagram showing the relative evaporation at different vertical levels in a marsh in England, the evaporation in the lower layers of the vegetation being much greater than in the upper strata or in the air above it. (Data from Yapp.)

In America only a few records have been made on vertical gradients in evaporation, two of these in marsh areas, one in Ohio by Dachnowski ('11), and the other near Chicago by Sherff ('13a, '13b). The Ohio observations, made upon a small island in a lake, in a cranberry-sphagnum bog, show that the rate of evaporation above the vegetation is much greater than among it, and that this diminishes as the soil is approached, these results agreeing with those obtained by Yapp. Sherff's observations were made in Skokie Marsh, north of Chicago, and show that the relative evaporation also varies with different kinds of swamp vegetation. From his data a diagram has been made (Fig. 9) in which the rate of evaporation in the upper part of the reeds

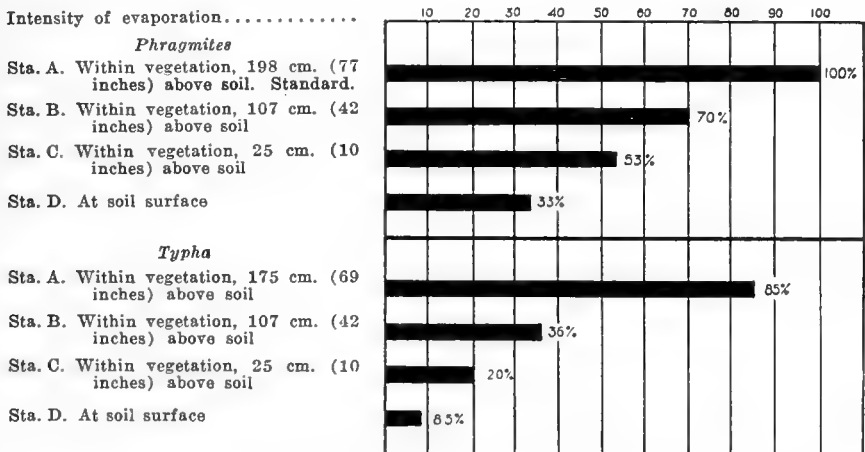


FIG. 9. Diagram of relative evaporation at different vertical levels above the soil within the vegetation of Skokie Marsh. (Adapted from Sherff.)

(*Phragmites*) at 77 inches is taken as 100 per cent. or the standard. Lower down, at 42 inches, the rate is 70 per cent., at 10 inches, 53 per cent., and at the surface, 33 per cent. Among the cattails (*Typha*), in the upper part of the vegetation, at 69 inches evaporation was 85 per cent.; at 42 inches it was 36 per cent.; at 10 inches, 20 per cent.; and at the surface, 8.5 per cent. These results show that at successively lower levels in the vegetation the rate of evaporation is greatly reduced. They tend also to confirm the results of Yapp and Dachnowski. It seems, then, fair to conclude that the rate of evaporation above the swamp vegetation increases rapidly with downward progression, and probably with upward progression also. A vegetable layer, comparable to the mulching of straw used by gardeners, thus acts as a powerful conserver of moisture. There are great differences within a few vertical feet in the open; what is the condition within the forest?

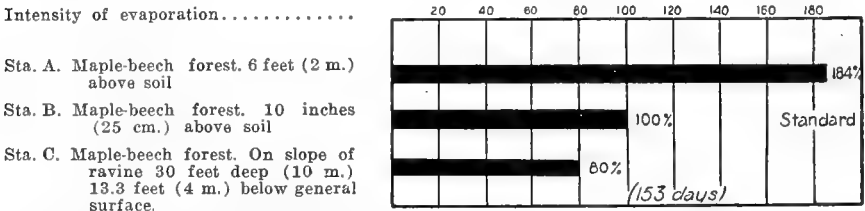


FIG. 10. Diagram showing the relative evaporation in a beech-maple woods, six feet above the soil (A), near the surface of the soil (B), and in a ravine (C). [Adapted from Fuller ('12).]

The character of vertical differences in evaporation within the forest has not been given as much attention as the similar changes in the open; but attention has already been called to the moisture-conserving effect of a forest litter, the evaporating rate in one instance being only 13 per cent. when compared with that from a water surface in the open. McNutt and Fuller ('12) have shown that grazing in an oak-hickory forest changed the average daily rate of evaporation for 189 days from 9.89 c.c., in the ungrazed forest, to 12.74 c.c., in the grazed forest, at Palos Park, Ill. There are thus, within the forest, changes in evaporation with differences both in the ground cover and in the litter on the forest floor which correspond to the change in the vegetation in open places.

Vertical differences in evaporation have been tested in a maple-beech-forest in northern Indiana by Fuller ('12b), who used the porous-cup method. His results have been summarized in Figure 10. This diagram shows that the evaporation at six feet above the surface is nearly twice as much as that at 10 inches above the surface, and

that in a ravine, 13.3 feet (4 m.) below, it was 80 per cent. of that 10 inches above the surface. The relative seasonal activity from May to November is shown in Figure 11. This diagram shows that after the leaves appear the highest evaporation takes place in July. This is probably the critical season for some animals.

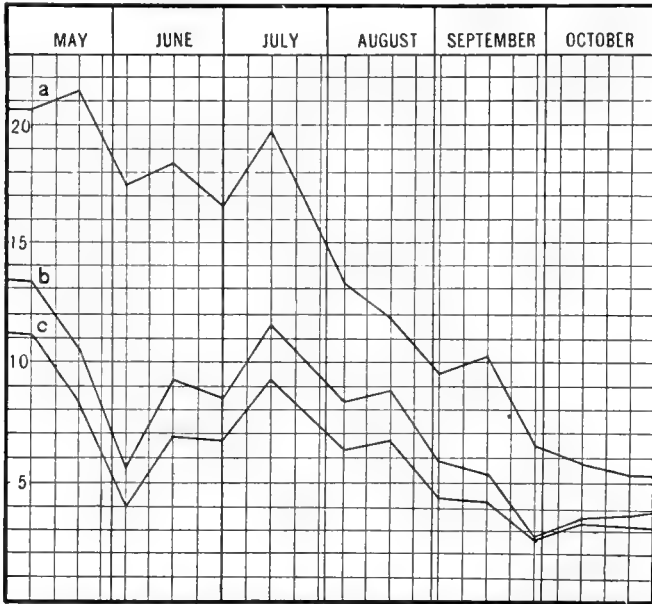


FIG. 11. Diagram showing the average daily rate of evaporation in beech-maple forest, six feet above soil (a), near the surface of soil (b), and in a ravine (c). (From Fuller.)

In the forest, Libernau (Harrington, '93: 34) found that the "relative humidity increases and decreases with the absolute humidity, whereas it is known in general, and also at the Station in the open country, that these two climatic elements are inverse. This is accounted for by the fact that the forest is a source of atmospheric aqueous vapor as well as of cooling." (L. c. : 104: "The absolute humidity decreases in the forest from the soil upwards. The rate of decrease is usually the greatest under the trees and the least at the level of the foliage. The rate above the trees is intermediate between the other two. This rate is least in the late hours of the night, when it may be zero. It increases with the increase of the temperature of the air, becoming greatest in the midday hours, when, under exceptionally favorable circumstances, it may make a difference of 10 per cent.

or even more. Occasionally, in high winds, the absolute humidity is greater over the trees. Over the field station the daily progress of absolute humidity was about the same as in the forest, but the maximum difference was only about half as great. The absolute humidity in and above the forest is greater than that over the open fields, and there is some trace of an increase of this difference to the time of maximum."

A greater relative humidity has been found over evergreen trees than over deciduous trees, which is slight (l. c. : 104), but the psychrometer was close to the evergreens and farther above the deciduous ones.

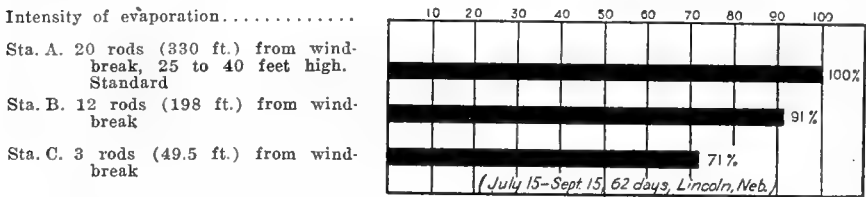


FIG. 12. Diagram showing relative retardation of evaporation by a windbreak, Lincoln, Nebraska. [Adapted from Card ('97).]

The border of the Illinois forest and prairie was characterized by tongues and isolated groves of forest and by glades. The forest had the same kind of influence as windbreaks upon the leeward areas and glades, and therefore the influence of windbreaks upon the evaporating power of the air is of interest. Card ('97) made a valuable study of this series of problems at Lincoln, Nebraska. The influence of windbreaks upon evaporation is summarized in Figure 12. This diagram shows that leeward of a close windbreak ranging from 25 to 40 feet in height, the rate of evaporation in terms of the standard (A), which was 330 feet leeward, was 91 per cent. at a distance of 198 feet (B), and 71 per cent. at 49.5 feet (C), thus showing a marked reduction with proximity to the windbreak. These observations covered 62 days.

Nearer to Illinois, similar though very limited observations were made in central Wisconsin by King ('95) which agree with Card's on the retardation of evaporation by windbreaks. His results are shown graphically in Figure 13.

Recently Bates ('11) has made an elaborate study of the effects of windbreaks upon light, soil, moisture, velocity of wind, evaporation, humidity, and temperature. His results confirm those just given and give additional facts which, however, with one exception, will not be mentioned. The paper itself should be consulted. This investigation by Bates shows that in proportion to the perfection of the windbreak

a quiet, stagnant air strip is formed to the leeward, and that this favors excessive heating during clear days and low temperatures on clear nights. Years ago Harrington ('93: 119) suggested this idea and called attention to the close relation existing between the leeward conditions of windbreaks and forest glades. The glade climate is more rigorous, or extreme, than that upon plains (l. c.: 19, 84-88, 119). Such a climate is thus a bit more "continental" during the spring, sum-

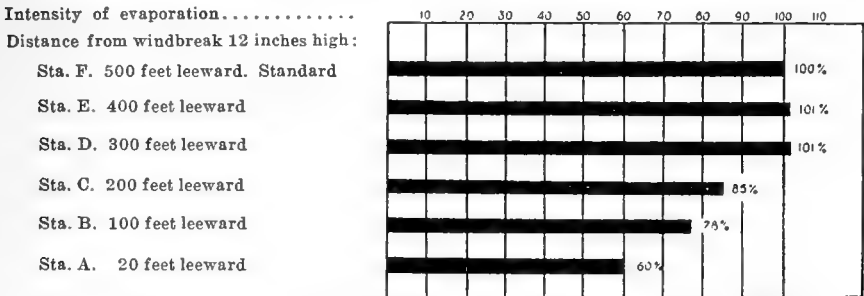


FIG. 13. Diagram showing the relative evaporation, May 31, at different distances leeward of a windbreak, Almond, Wis. [Adapted from King ('95).]

mer, and autumn. These glades are very hot in the early afternoon and cool on clear nights, and the air is relatively stagnant; as Harrington says, it is "lee for winds from all directions." The center of a dense forest may thus possess physical conditions quite different from those of the glade forest margin or in the open. Beginning with the relatively stable conditions within a forest toward its margin, the diurnal temperature variations are much more extreme (Harrington, l. c.: 89) "to a distance of a score or so of rods where it reaches a maximum. The amplitude is greater in glades. Hence the extremes of temperature are exaggerated just outside the forest." The annual soil temperatures of a glade are intermediate between that of the forest and the plain. The forest margin is thus seen to possess many of the characteristics of the glade, for its climate is somewhat more extreme than that in the open, far from the forest.

5. *Temperature Relations in the Open and in Forests*

The temperature relations in open and forested regions are often very different. The density of the vegetable covering in the open and in the forests varies much and may have considerable influence upon animals. Yapp ('09) observed that the marsh vegetation in England

caused marked vertical differences in temperature in the vegetational stratum. He summarizes these results as follows (p. 309): "The temperature results show that the highest layers of the vegetation possess a greater diurnal range of temperature than either the free air above or the lower layers of the vegetation. Regularly, especially in clear weather, both the higher day and the lowest night temperatures were recorded in this position."

Dachnowski ('12: 292-297) studied the temperature conditions in a cranberry bog substratum in central Ohio. He found that at a time when ice formed from 8 to 15 inches thick on the adjacent lake, in the bog it was only 3 to 5 inches thick, and there were small patches where it did not form at all. At a depth of 3 inches in the peat the temperature ranged from 33° to 77° F. (.5°-25.0° C.). In the bordering maple-alder zone, at 3 inches depth it ranged from 33° to 72° F. (.5°-22.0° C.). His observations indicate that the temperature relations within the maple-alder zone are more stable than those in the open central area.

Cox ('10) has also shown that the character of the vegetation in Wisconsin cranberry bogs has much influence upon temperature relations in this habitat.

It seems very probable that similar conditions hold over prairie vegetation, but I do not know of any observations on this point. We are all familiar with the common practice of gardeners of using a mulch of straw to retard temperature changes under it; prairie vegetation must have a similar influence. (Cf. Bouyoucos, '13: 160.)

The relative air temperatures within and without the forest show a distinct tendency to reduce the maxima and minima, and to *lower* the mean annual temperature. Harrington ('93: 53) concludes, therefore, that "*the forest moderates (by reducing the extremes) and cools (by reducing the maxima more than the minima) the temperature of the air within it. The moderating influence is decidedly greater than the cooling effect.*" These effects are not uniform, but are much more marked in the summer, and Harrington further says: "The cooling effect tends to disappear in winter. The moderating effect is the most important one and it is the most characteristic" (p. 56).

The temperature relations within the forest crown show that in general the effects are similar to those found at an elevation of about 5 feet. The maxima are lowered, the minima are elevated, and there is a cooling effect. The differences are most pronounced during the summer, and the temperatures are intermediate in position between those at the five-foot level and those in the open (l. c.: 66). At a height of 24 feet, deciduous trees showed a marked summer cooling

effect, while evergreens showed much less, though they are much more uniform for 9 months of the year. Again, he says: "In summer the average gradient under trees is about $+2^{\circ}$; that is, it grows warmer as we ascend at the rate of two degrees per 100 feet (31 m.). Outside in the general average it grows colder by about a quarter of a degree." This warmer air above the cooler in the forest favors its stability or relative stagnation, although as a whole the forest air is cooler and heavier than the surrounding air and tends to flow outward. The forest thus tends to produce a miniature or incipient barometric high. In conclusion Harrington (p. 72) states that "The surface of the surface of the forest is, meteorologically, much like the surface of the meadow or cornfield. The isothermal surface above it in sunshine is a surface of maximum temperature, as is the surface of a meadow or cornfield. From this surface the temperature decreases in both directions." In the case of a beech forest the warm diurnal layer above the forest crown was only 6.5 feet thick (p. 34).

The conditions above the forest are thus representative of the atmospheric conditions above dense vegetation in general, and are in perfect harmony with Yapp's observations upon the temperature above a marsh ('09: 309), quoted on a previous page, to the effect that temperature changes are extreme here, and greater than in the free air above or in the lower layers among the vegetation. *The forest is thus to be considered as a thick layer of vegetation in its influence upon meteorological conditions.* The conditions above the forest, therefore, exemplify a general law.

In general terms, the temperature of the soil below the zone of seasonal influence is that of the mean annual temperature for a given locality. The surface zone, however, varies with the season. Harrington ('93) has summarized the German observations on the relative soil temperatures in the open and in the forest. In the following quotation the minus sign indicates a forest temperature less than a corresponding observation in the open. These temperatures were taken about 5 feet above the soil. He says (p. 43): "The average of the seventeen stations (representing about two hundred years of observations) should give us good and significant results. It shows for the surface— $2^{\circ}.59$, for a depth of 6 inches (152 mm.)— $1^{\circ}.87$, and for a depth of 4 feet (1.22 m.)— $2^{\circ}.02$. The influence of the forest on the soil, then, is a cooling one, on the average, and for central Europe the cooling amounts to about two and a half degrees for the surface. The cooling is due to several causes: The first is the shade; the foliage, trunks, branches, and twigs cut off much of the sun's heat, absorb and utilize it in vegetative processes, or in evaporation, or reflect it away into space. Thus the surface soil in the forest receives

less heat than the surface of the fields. The same screen acts, however, in the reverse direction by preventing radiation to the sky, thus retaining more of the heat than do the open fields. The balance of these two processes, it seems from observation, is in favor of the first and the average result is a cooling one. . . . The differences of temperature at the depth of 6 inches (152 mm.) are more than half a degree less than at the surface. In this is to be seen the specific effect of the forest litter; it adds a covering to that possessed by the surface, so that while the deeper layer is cooled as much by the protection from the sun's rays as is the surface, it is not cooled so much by radiation of heat to the sky. Its temperature is, consequently, relatively higher, and approximates somewhat more the field temperatures."

"The forest soil is warmer than that of the open fields in winter, but cooler in the other seasons, and the total cooling is much greater than the warming one. . . . The forest, therefore, not only cools the soil, but also moderates the extremes of temperature" (p. 46).

The character of the forest, whether evergreen or deciduous, influences the temperature conditions of the soil, as is seen by a comparison of these conditions in the forest and in the open. The two kinds of forest are much alike in winter; during the spring the soil warms up more rapidly under conifers. Temperature variations are slightly greater under deciduous trees.

6. *Soil Moisture and its Relation to Vegetation*

The moisture in the soil is derived largely from precipitation, but part of it, in some localities, comes directly from the adjacent deeper soils or rocks, and thus only indirectly from precipitation. As Illinois lies at the bottom of a large basin, there must be some subsurface flow from the adjacent higher regions, but to what extent is not known. McGee ('13a: 177) estimates that the general ground-water level—the level at which the soil becomes saturated—has, since settlement, declined 10.6 feet in Illinois. This decline is not limited to drained regions but is a general condition. In addition to these changes of level there are seasonal fluctuations. Sherff ('13a: 583) observed in Skokie Marsh that the water-table was at or above the surface in May, then declined until early September, and then rose rapidly to the surface by the middle of October. The wet prairie at Charleston has undergone just such changes as these; the ground-water level has been lowered and there are marked seasonal changes.

Harvey ('14) has recently shown that the soil of *Eryngium-Silphium* prairie at Chicago contains a large amount of water during

April and until late in May; that the moisture falls and is low during July and August, with a mean of 24 per cent. of saturation for these months; but that in October the soil is again at or near the point of saturation.

The blanket of humid air which accumulates under a cover of vegetation, retards evaporation and conserves soil moisture. The denser the vegetation the more marked is its influence. The litter—the organic debris in an early stage of decomposition—on the forest floor has the same tendency, and has even a greater water capacity than the soil itself. On the other hand, a forest is a powerful desiccator; as Zon ('13:71) has recently put it: "A soil with a living vegetative cover loses moisture, both through direct evaporation and absorption by its vegetation, much faster than bare, moist soil and still more than a free water surface. The more developed the vegetative cover the faster is the moisture extracted from the soil and given off into the air. The forest in this respect is the greatest desiccator of water in the ground." This drying effect is shown particularly near the surface of the soil, where roots are abundant and where drouth is so marked that it may prevent the growth of young plants here (cf. Zon and Graves, '11:17-18).

Warming ('09:45) says: "It may be noted that, according to Ototozky, the level of ground-water invariably sinks in the vicinity of forest, and always lies higher in an adjoining steppe than in a forest; forest consumes water."

McNutt and Fuller ('12) have made a study of the amount of soil moisture at 3 inches (7.5 cm.) and at 10 inches (25 cm.) below the surface in an oak-hickory forest, at Palos Park, Illinois. They found that the percentage of water to the dry weight of the soil at the 3-inch level averaged 18.9 per cent. and at 10 inches was 12.5 per cent. of the dry weight of the soil. The greater moisture near the surface is due to the humus present in this layer. The grazed part of the forest possessed less soil moisture, and shows the conserving effect of vegetation. (Cf. also Fuller '14.)

The artificial control of soil moisture is well shown by the effect of windbreaks. Card ('97) studied the moisture content of the soil to leeward of a windbreak and found that in general there is a "decrease in the per cent. of water as the distance from the windbreak increases." As the physical conditions leeward of windbreaks are similar in many respects to those in forest glades and forest margins, it is very probable that the conditions of soil moisture also will be very similar in these places.

7. *Ventilation of Land Habitats*

The preceding account of the temperature, humidity, and evaporating conditions in various habitats forms a necessary basis for an understanding of the processes of ventilation or atmospheric change in land habitats. The differences in pressure due to the different densities of cool and warm air and to the friction and retardation of moving air currents, determine to an important degree the composition of the air in many habitats. In such an unstable medium as air, changes take place very rapidly through diffusion, and through this constant process of adjustment there is a tendency to level off all local differences. These are naturally best preserved where diffusion currents are least developed—in the most stagnant or stable atmospheric conditions; therefore any factor which retards an air current and produces eddies, or slow diffusion, will favor local differentiation of the air.

We have seen that any vegetable cover retards air currents, so that the air within the vegetation becomes different from the faster moving air above it. The accumulation of humidity at different levels above the soil within the vegetation, clearly shows this. The denser the vegetation the more completely are the lower strata shut off and, to a corresponding degree, stagnant and subject to the local conditions. Two factors have an important influence upon these conditions: the character of the cover itself, and the character of the substratum. If both of these are mineral rather than organic, in general comparatively little local influence is to be expected, although in some localities CO_2 escapes from the earth and on account of its density may linger in depressions and thus kill animals (Mearns '03). Generally, however, the organic materials are of most importance both as a cover and as a substratum, and are often the source of carbon dioxide. Living vegetation may also add oxygen to such stagnant air, but the main source of it is the free air itself. The forest litter, on account of its imperfect stage of decay, consumes oxygen and gives off carbon dioxide; in the humus below it, shut off even more from free access to air, the carbon dioxide is relatively more abundant and the oxygen relatively less so or absent; and in the deeper mineral soil the amount of carbon dioxide is relatively less on account of the absence of organic debris, and a small amount of oxygen is present.

The aeration of the soil is influenced to a large degree by its porosity; the looser it is, the freer the circulation. Buckingham ('04) has shown that "the speed of diffusion of air and carbonic acid through these soils was not greatly dependent upon texture and structure, but was determined in the main by the porosity of the soil. . . . the

rate of diffusion was approximately proportional to the square of the porosity the escape of carbonic acid from the soil and its replacement by oxygen take place by diffusion, and are determined by the conditions which affect diffusion, and are sensibly independent of the variations of the outside barometric pressure."

In the upper, better ventilated, moist, neutral or alkaline layers of vegetable debris decomposition is brought about mainly by the agency of fungi; but in the deeper, poorly ventilated acid layers, lacking oxygen, bacteria are the active agents (cf. Transeau, '05, '06). The higher the temperature the more rapid the circulation, and on this account ventilation in the open is relatively more rapid than in the cooler woodlands. The black soil prairies are thus favorable to a higher temperature and better ventilation. Dry soil, according to Hilgard ('06: 279) contains from 35 to 50 per cent. its volume of air, and in moist or wet soils this space is replaced by water. Thus the conditions which influence the amount of water present have a very important influence upon aeration. As water is drained from the soil, air takes its place; so drainage and the flow of water through the soil facilitate ventilation. The part of the soil containing air is thus above the water-table; and as this level fluctuates with the season and from year to year the lower boundary of this stratum is migratory. Hilgard states that cultivated garden soil contains much more air than uncultivated forest soil. Warming ('09: 43) says that the "production of acid humus in the forest leads to an exclusion of the air." If lime is present, such an acid condition can not arise.

While the source of oxygen in the soil is the air, the reverse is the case with carbon dioxide. The surface layers of the soil, among dense vegetation, constitute an area of concentration of carbon dioxide. Because this is more soluble than other gases, it is found in rain water, according to Geikie, in a proportion 30 to 40 times greater than in the air. Rains thus assist in the concentration of carbon dioxide in the soil. This concentration is well shown by the following table by Baussungault and Lewy (Van Hise, '04: 474).

Character of soil air	CO ₂ in 10,000 parts by weight
1. Sandy subsoil of forest	38
2. Loamy subsoil of forest	124
3. Surface soil of forest	130
4. Surface soil of vineyard	146
5. Pasture soil	270
6. Rich in humus	543

The amount of carbonic acid in the atmosphere is by weight about 4.5 parts in 10,000. The amount in the air is, as Van Hise says, "insignificant in comparison with the amount in soils in regions of luxuriant vegetation. In such regions the carbon dioxide is from thirty to more than one hundred times more abundant than in the atmosphere." This carbonic acid in the presence of bases, sodium, potassium, calcium, and magnesium compounds, forms carbonates and bicarbonates. This is the process of carbonation—one of the most important processes of change in surface soils.

In view of the dominance of CO_2 in soils we may anticipate that many of the animals living in them possess some of the characteristics of the plants, bacteria, fungi, etc., which are active in such soils. The anaerobic forms live without free oxygen; others live only where oxygen is present. The animals which thrive in the soil are likely to be those which tolerate a large amount of CO_2 and are able to use a relatively small amount of oxygen, at least for considerable intervals, as when the soil is wet during prolonged rains. This is a subject to which reference will be made later.

The air is the main source of oxygen, and from the air it diffuses into the soil; thus the process of equilibration is constantly in progress. Carbonic acid, also present in the air, is washed down by rain and concentrated in the soil, where it is increased by the decay of organic debris and by respiring animals to such an extent that it exists under pressure and diffuses into the air, thus contributing to the air. In the soil, then, the process of *decarbonization* is of great importance to animal life, and must not be neglected. The optimum soil habitat is therefore determined, to a very important degree, by the proper ratio or balance between the amount of available oxygen and the amount of carbon dioxide which can be endured without injury. The excessive accumulation of carbon dioxide, an animal waste product, is comparable to the accumulation of plant toxins which may increase in the soil to such a degree as to inhibit plant growth. Such substances must be removed from the soil, or changed in it to harmless compounds, or plants and animals can not continue to live in certain places. I have used the term ventilation to cover both the oxygenation and decarbonization of land habitats, and the same principles are applicable to life in fresh-water habitats.

We have just seen how atmospheric ventilation favors the removal of certain injurious waste products from the air and soil. In addition to gaseous waste products there are also liquids and solid kinds which may be equally harmful in a habitat. These are known to exist in confined liquids, as in aquaria (Colton, '08; Woodruff, '12), where they

interfere with the welfare of the animals present, and it is probable that they also exist in soils. The older naturalists elaborated the idea that if organisms were not such active agents in the destruction or transformation of plant and animal bodies such remains would soon encumber the earth. Thus organisms themselves are among the most active agents in influencing directly and indirectly the ventilation of animal habitats.

8. *The Tree Trunk as a Habitat*

A living tree trunk is composed of wood, sap (moisture), and bark, all of which are relatively poor conductors of heat. When the trunks are cooled, as in winter, they are slow in warming, not only because of poor conduction but also because of the slow circulation of sap, which is derived from the cool ground-water. As the season progresses, the trunks warm up, this process being retarded in part by the shade and the cool forest conditions; and in the fall, radiation of the heat accumulated also takes place slowly. The tree trunk therefore changes its temperature slowly, as does the soil. The animals which live within wood thus live in a relatively cool and stable environment. In living trees the humidity is relatively high, as it may also be in fallen, decaying logs. Relatively dry logs, before progress of decay, on the other hand, form a relatively dry and uniform habitat. (Cf. on the temperature of trees: Harrington, '93, pp. 72-75; Packard, '90, p. 23; and Jones, Edson, and Morse, '03, pp. 97-100.)

9. *Prairie and Forest Vegetation and Animal Life*

The dependence of animals upon plants for food is one of the most fundamental animal relations. It is a world-wide relation, but its mode of operations varies greatly in different environments. For example, many years ago, Brooks gave us a graphic picture of the rôle of marine vegetation in the economy of marine animals. In the sea there are no forests or grasslands, and no corresponding animals associated with these conditions, as on land; but in the sea great numbers of minute plants float, and upon these feed an immense number of small crustaceans and other small animals. These small creatures occur in such large numbers that at times the sea is a sort of gruel which sedentary and stationary kinds may appropriate by simply allowing the sea to flow into their mouths. The food here circulates in their environmental medium, as plant foods do in the soil and air. This condition has made it possible for vast numbers of plant-like animals to grow over the sea floor as plants do over rocks and plains. The living meadows of animals thus furnish pasture for a host of preda-

ceous kinds; and upon these still others prey, so that flesh-eating animals make up the most conspicuous classes of marine animals. Quite otherwise are the conditions on land, where no air current carries food to the hungry mouths of animals. Plants with roots in the soil and stems in the air are able, however, to secure their food from the circulating medium, but being themselves fixed, they are easy prey to animals—both the sedentary kinds, which live in or upon the plant tissues, and the active wandering kinds, which forage over large areas. The predaceous animals, either by active mind or body, must secure their food from the plant-feeding kinds. The great expanses of grassland and forest tend to be devastated by a vast army of animals which far outnumber the predaceous kinds. The conditions of life, therefore, found upon grassland areas, like the prairie, and in the forest, are to the farthest possible extent removed from those found in the sea. This, then, is one of the most fundamental contrasts in the conditions of existence encountered by animals.

These considerations naturally raise the question to what extent and in what particular manner does land vegetation influence animal life? Does a change in the vegetation as great as that between the forest and the prairie have a marked influence upon animals? In the Charleston region we have just such a difference in the vegetation.

Many years ago Bates pointed out repeatedly in his "The Naturalist on the River Amazons" that the animals of that densely forested region were to a marked degree distinctly arboreal and "adapted" to a forest life. In most densely forested regions like conditions probably prevail, and to a corresponding degree open lands harbor animals equally characteristic and as truly terrestrial in habits. The contrast between the conditions of life in the open and in the forest is one of the most fundamental environmental conditions upon land. The significance of this contrast seems to have been realized only in part. The prairies or grasslands are representative of only one kind of open; they are caused by many kinds of factors limiting the extension of forests. Open places are formed by lakes, ponds, and swamps; by the avenues through forests formed by different kinds of streams, as brooks, creeks, and rivers; by the small amount of soil on rock surfaces; and by still other kinds of limiting influences, such as the sea, severe climate, and altitude. Among almost all of the major taxonomic groups of land animals is seen the independent origin and preservation of animals suited for life in the forest; this clearly points to the extensive influence and antiquity of this environment. The same is true of animals living in the open. But to assume that it is solely the kinds of forest trees serving as *food* for animals, or the corresponding kinds of vegetation in the open, which determines whether

an animal lives in the open or in the forest, would be unwarranted in the light of the preceding discussion of the effect of vegetation upon air temperatures, winds, humidity, relative evaporating power of the air, and corresponding changes in the soil. Animal life is most abundant in a narrow vertical layer above the earth's surface, by far the most of it is within a few inches or feet of the surface; and above the level of the forest-crown it diminishes with great rapidity. Below the surface of the soil the same general law holds; most of the ground animals are within the first few inches of soil, only a small number extending a few feet below the surface, and those found at greater depths being indeed very few. The rate of decline is many times more rapid below the surface than it is above it. There is, then, above and below the surface a rapid and progressive attenuation of the favorable conditions for animals and plants, and the animals do not establish thriving communities far from those physical conditions which are also favorable to vegetation. Animals are dependent upon plants for food, but both are dependent upon a certain complex of physical conditions near the surface of the earth.

It is well to recall at this point how the influence of the climate and the vegetation exemplify certain general laws which operate in all habitats. The differentiation of habitats upon the earth is primarily due to temperature and the specific heat relations of the earth, which result in the several media—gases, liquids, and solids. With a higher temperature all would be gas, and with a lower one all would be solidified. The present intermediate conditions, therefore, permit the present differentiation. These media are further differentiated by temperature about as follows: Since the source of solar energy, heat, and light, and the oxygen supply, *are above the surface* of the earth, the vertical attenuation of these influences is one of the most striking peculiarities of animal habitats, both in water (where the causes have long been recognized) and upon land. Any covering of the earth, even the surface layer of vegetation, soil and water, tends to shut off heat, light, and oxygen. At the same time such a layer tends to shut in those influences which originate primarily in or below it. Thus carbonic acid originating under the cover, by organic decay, breathing animals, or bacteria, or washed in by the rain, tends to be shut in. Furthermore, heat once reaching here, either in water or on land, tends toward slow radiation. Thus we may look upon the surface layer as a partition which is under pressure from both sides, and through which constant interchange is in progress, as the process of dynamic equilibrium operates.

This attenuation of intensities, above and below the surface, produces vertical layers of relatively equal strength or pressure. Thus the attenuation of temperature in gases (air) and in liquids (water) causes different densities in air and in water which modify to an important degree the physical and chemical conditions in these media. This results in their stratification: when the heavier layers are below, stability is the tendency; and when the reverse order obtains, a change takes place toward the stable condition. With stratification, flowage tends to occur within the strata, and to be horizontal rather than vertical; additional pressure is therefore necessary to cause the vertical currents or circulation under such conditions. This is why carbonic acid accumulates in the soil and in small deep lakes abounding in organic debris, this accumulation being largely due, in both cases, to the slow rate of exchange caused by the stratification produced by differences in density. This same relative stagnation is a primary factor in the vertical differences in the relative evaporating power of the air within a vegetable layer of the prairie or the forest. Though on the prairie the vegetational layer is generally but a few inches or a few feet thick, in the forest it is about eighty feet, or more, thick; and the forest thus influences atmospheric conditions solely as a *thick* layer of vegetation.

Differences, then, in the character, structure, or composition of the surface of the substratum are of fundamental importance in understanding its relative influence upon animals. Primarily these differences are due to temperature, secondarily to temperature in combination with moisture; and they result in the relative humidity and the relative evaporating power of the air. The most important difference in the surface layer in the Charleston region is that of prairie and forest, and therefore the main features of these habitats will now be summarized. It should not be overlooked that conditions on the prairie are likely to be quite representative of open places in general, though they will probably be somewhat unrepresentative in the case of open places having wet or extremely dry substrata. It is also true that the conditions produced by the forest are comparable, in some degree, with those due to the influence of an elevation.

SUMMARY OF ENVIRONMENTAL FEATURES OF THE PRAIRIE AND THE DECIDUOUS FOREST
—TEMPERATURE, HUMIDITY, AND EVAPORATION—DURING THE GROWING SEASON

Above the Vegetation

Prairie

In sun, maximum heated stratum.
Cooler above and below this stratum.
Absolute humidity less than in or over forest.

Forest

Above crown, in sun, maximum heated stratum. A thin layer. Cooler above and below this stratum.
Absolute humidity greater than in the open.

Among the Vegetation

Prairie

Temperature lower and higher than in the forest—more extreme.
Temperature lower toward the soil, and warmer than in the forest.
Absolute humidity progressively increases toward the soil.
Relative evaporation decreases toward the soil; greater than in the forest.

Forest

Temperature moderated—not as low or as high as on the prairie.
Temperature lower toward the soil, and cooler than in the open.
Absolute humidity progressively increases toward the soil.
Relative evaporation decreases toward the soil; less than in the open.

In the Soil

Prairie

Temperature averaging warmer than forest, warmer near surface in summer, and cooler in winter. Warmer in sun and cooler at night than in forest.
Temperature progressively more stable downward. Soil moisture increases downward.

Forest

Temperature cooler on the average and in summer, and warmer in winter, near the surface, than in the open. Cooler in sun and warmer at night than in the open.
Temperature progressively more stable downward. Soil moisture, below the surface layer, increases downward.

The conditions on the prairie and in the forest may be graphically shown as in the following diagrams, Figure 14 showing the temperature relations, and Figure 15 showing the relative evaporating power of the air.

CLIMAX FOREST

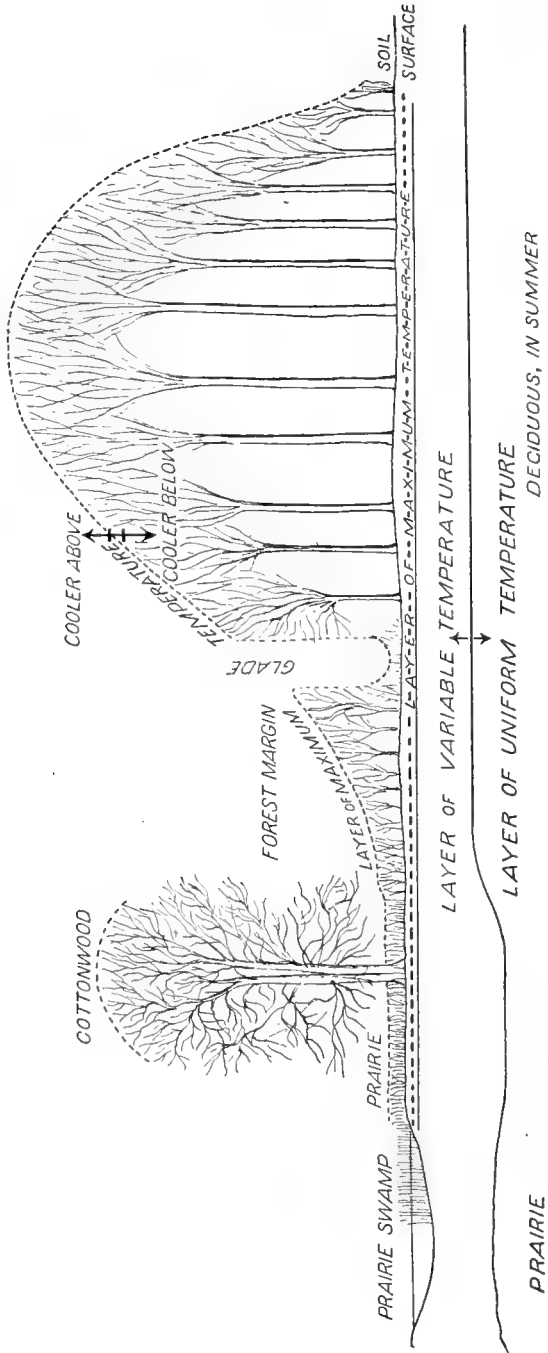


FIG. 14. Diagram showing temperature relations of prairie and forest as influenced by vegetation.

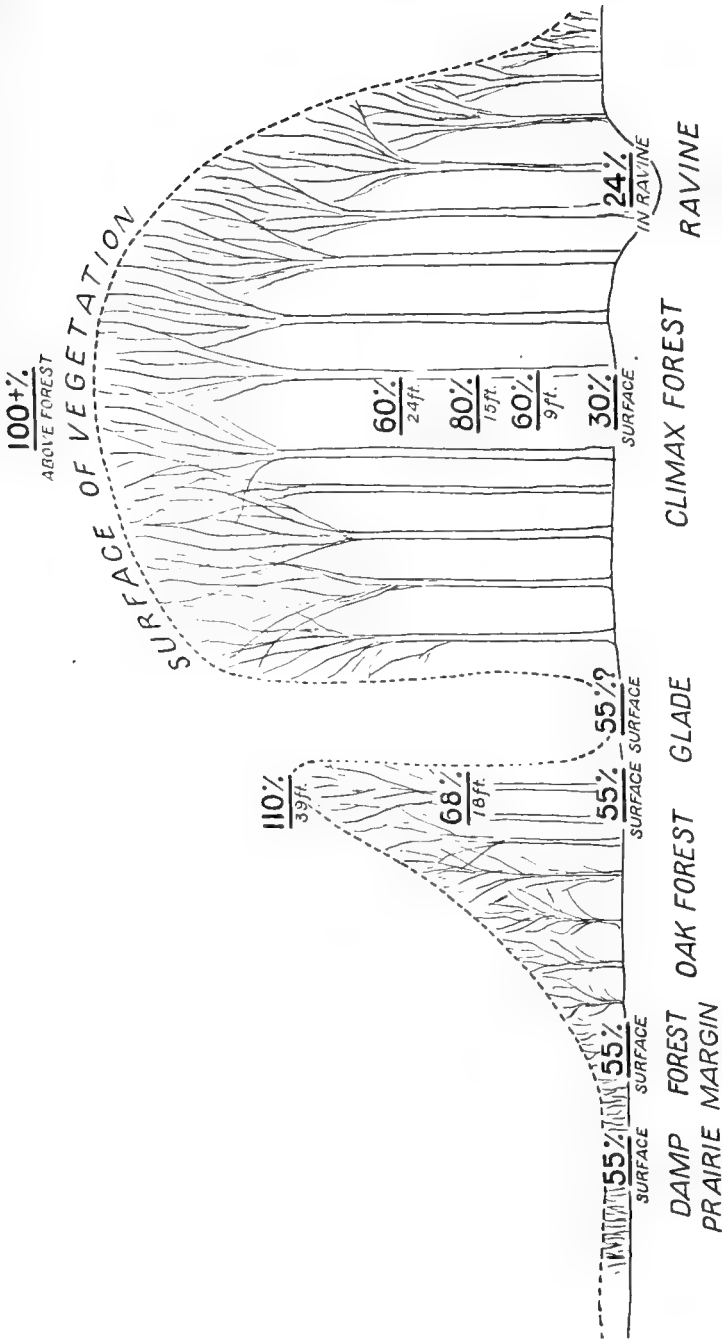


Fig. 15. Diagram showing relative evaporating power of air as influenced by prairie and forest vegetation.

10. *Sources and Rôle of Water used by
Prairie and Forest Animals*

The bodies of animals contain a very large proportion of water—from 60 to 95 per cent. Growing animals in particular require water in relatively large amounts. Practically all foods gain entrance into the body in aqueous solutions, and are transported by water to all parts; and by the same means, the waste products, with the exception of the excretion of carbonic acid, are removed. The methods by which aquatic animals secure water are relatively simple, because they live in a liquid medium; but the conditions upon land are quite different. Here osmotic pressure does not operate as in water, and the air varies from saturation to a very dry condition. This dryness tends to cause strong evaporation from animals living in such a medium, and a proper balance between intake and water-loss is one of the most potent influences in the life of land animals. In this relation lies the importance of the sources of water available to them. These sources are as follows: with the food, by drinking, from the atmosphere, and by metabolism. The loss is by excretion and evaporation, the relative humidity and the evaporating power of the air being, therefore, important considerations. The loss of water is retarded in many ways. Some animals possess a relatively impermeable skin, or a covering, as hair or feathers, which retards air currents and evaporation through the skin, just as a cover of vegetation retards soil evaporation. Other animals conserve their moisture by modes of behavior, being active mainly during the cooler night, thus escaping the excessive evaporation of the heated day; and still others live in burrows in the soil, where the humidity is higher than in the air. Many animals can live only where the air is humid. There is thus an almost endless series of conditions relating animals to the supply and loss of water.

On account of the herbivorous food habits of so many animals a large number secure much water with the juicy vegetation eaten, and others from nectar or from the sap drawn or escaping from plants. The predaceous animals secure a large amount of water from the fluids of the animals they devour or the juices sucked from their bodies, as in the case of certain *Hemiptera* and some parasites. In addition to the fluids derived from plants and animals, many animals also drink water, some in small amounts and others in large quantities. Innumerable observations have been made by naturalists on the drinking habits of animals, but I know of no general discussion of this subject, and particularly of none from the standpoint of the variation of their behavior in this respect in different environments. But the sources of water mentioned are not the only ones available to animals, although

they are the most obvious, and familiar to us. An important additional source is that formed within the body of the animal by the processes of respiration and dehydration; this is metabolic water. The relation of this source to others and to water-loss has recently been summarized in an important paper by Babcock ('12: 87, 88, 89-90, 91, 160, 161, 171-172, 174-175, 175-176, 181). The following quotations from this paper will serve to give a concise statement of the general principles involved in this important process. He says (pp. 87-88): "There are, however, particular stages in the life history of both plants and animals in which metabolic water is sufficient for all purposes for considerable periods of time. . . . This is also true in the case of hibernating animals that receive no water from external sources for several months, although water is constantly lost through respiration and the various excretions. In addition many varieties of insects such as the clothes moths, the grain weevils, the dry wood borers, etc., are capable of subsisting, during all stages of development, upon air-dried food materials containing less than ten per cent water; in these cases, nearly all of the water required is metabolic. . . . Many organisms also, when deprived of free oxygen, are capable of maintaining for a short time, certain of the respiratory functions, and deriving energy from food material and from tissues by breaking up the molecular structure into new forms of a lower order. This is known as intramolecular respiration, and like direct respiration, results in the production of both water and carbon dioxide." (Pp. 89-90): "The substances oxidized by both plants and animals, to supply vital energy, consist of carbohydrates, fats, and proteins. All of these substances contain hydrogen, and their complete oxidation produces a quantity of water equal to nine times the weight of hydrogen present in the original substances. . . . Most of the the fats yield more than their weight of water, while proteins, when completely oxidized, give from 60 to 65 per cent of water. . . . Animals, however, are unable to utilize the final products of protein metabolism which are in most cases poisonous and must be removed from the tissues by excretion in various forms, the principal of which are urea, uric acid, and ammonia. . . . The amount of metabolic water formed by oxidation during any period is proportional to the rate of respiration. . . . (Page 91): "With parasitic plants, and with animals, which derive all of their organic nutrients from chlorophyl producing plants, imbibed water is not so essential to life; with these the chief function of imbibed water is to aid in the removal of waste products, the metabolic water being in most cases sufficient for transferring nutrients and for replacing the ordinary losses incurred by respiration and evaporation." . . . (Page 160): "Another and more im-

portant difference is the inability of animals to resynthesize the organic waste products of respiration into substances that may be again utilized as nutrients. . . . This is especially the case with the soluble products arising from protein metabolism. With most animals these nitrogenous products are excreted in solution through the kidneys, chiefly as urea, but birds, reptiles, and all insects excrete most of the nitrogenous waste matter as uric acid, or its ammonia salt, which being practically insoluble in the body fluids, is voided in a solid condition." (Page 61): "The need for water is much less for animals that excrete uric acid than for those that excrete urea, since uric acid, being practically insoluble in the the body fluids, is not so poisonous as urea and is voided solid with a minnum loss of water. Many animals that excrete uric acid instead of urea never have access to water and subsist in every stage of their development upon air dried food which usually contains less than 10 per cent water. The most striking illustrations of this kind are found among insects such as the clothes moths, the grain weevils, the dry wood borers, the bee moths, etc. The larvæ of these insects contain a high per cent of water, and the mature forms, in spite of the development of wings which are relatively dry, rarely contain less than 50 per cent of water." (Pp. 171-172): "Serpents and other reptiles that live in arid regions and rarely if ever have access to water, except that contained in their food, are said by Vauquelin to excrete all of the waste nitrogen as salts of uric acid. The same is true of birds that live on desert islands where only salt water is available. It is essential that animals of these types should produce as much metabolic water as possible from the assimilated food, and the waste of water through the excretions should be reduced to a minimum. Since the food is largely protein both of these ends are attained by the excretion of uric acid which, as already stated, contains the least hydrogen of any nitrogenous substance excreted by animals so that the maximum amount of metabolic water has been derived from the food consumed." (Pp. 174-175): "There are many animals that are able to go long periods without having access to water except that contained in their food, in which water usually amounts to less than 20 per cent of total weight, and the metabolic water derived from oxidation of organic nutrients. A notable example of this is the prairie dog which thrives in semi-arid regions. These small animals feed upon the native herbage which for months at a time is as dry as hay. It has been surmised that the burrows in which they live extend to underground water courses, but this does not seem likely since in many of these regions wells must be sunk hundreds of feet before water is reached. It is more probable that they depend chiefly upon metabolic water. They feed mostly at night when the temperature is low and

during the hottest hours of day remain in their burrows where the air is more nearly saturated with moisture and evaporation is relatively small." (Pp. 175-176): "An application of these principles would undoubtedly serve to prolong life, when suitable water for drinking is not available. In such cases the food should consist of carbohydrates and fats. Proteins should not be used. . . . The water required for preventing uremic poisoning under these conditions is small and if the relative humidity of the surrounding air is high enough to prevent rapid evaporation of water from the body, the metabolic water arising from the oxidation of nutrients may be ample for the purpose." (Page 181): "Metabolic water derived from the oxidation of organic nutrients would probably be sufficient for all animal needs were it not for the elimination of poisonous substances resulting from protein degeneration."

The preceding quotation brings out very clearly the harmful effects of an accumulation of uric acid upon the animal. This is only a special case illustrating a general law, for except water the main end products of metabolism are *acid*. There is thus a constant tendency for acid to accumulate, as Henderson ('13a: 158-159; see also '13b) has said: "This tendency toward acidity of reaction and the accumulation of acid in the body is one of the inevitable characteristics of metabolism; the constant resistance of the organism one of the fundamental regulatory processes. Now it comes about through the carbonate equilibrium that the stronger acids, as soon as they are formed, and wherever they are formed, normally find an ample supply of bicarbonates at their disposal, and accordingly react as follows The free carbonic acid then passes out through the lungs, and the salt is excreted in the urine."

Recently Shelford ('13b, see also '14a) has summarized the physiological effects of water-loss by evaporation and other methods. It is probable that the carbonic acid excretion is retarded by drying, and that by this means irritability may be increased.

It is not simply loss of water, but loss beyond certain limits that interferes with the life of animals. Thus loss is not an unmixed evil, because, in addition to removing excretions, evaporation is an important factor in the control of temperature within the bodies of animals. Loss of water also tends to concentrate the body fluids, and when this loss brings about a relatively dry condition, such tissues are in a condition which is favorable for the endurance of relatively extreme low or high temperature (Davenport, '97: 256-258), and even dryness (see references, Adams, '13: 98-99). This is a reason why it is difficult to distinguish, in nature, between the effects of aridity and temperature extremes, and hence arise the puzzling interpretations of con-

tinental climates. These extreme conditions are characteristic of many habitats.

It is readily seen how the general principles just summarized apply to the land animals of the prairie. Many of these are active during the day, live in the bare exposed places, or near the level of the vegetation, where evaporation is greatest and water-loss is correspondingly large, and feed upon the dry haylike vegetation. Others remain among the humid layers of the vegetation or in the moist soil, and feed upon juicy plants and other moist food. Predaceous and parasitic animals, deriving their moisture from their prey, occupy both the dry and humid situations. These are representative cases, between which there are a large number of intergradations.

In the forest, where evaporation is more retarded than in the open, a large number of animals live in the forest crown, at the forest margin, in glades, and in wood, of all degrees of dryness, and eat food varying similarly from juicy leaves to dry wood. On the other hand, some live in moist logs, among damp humus, or in the soil, and feed upon dripping fungi or soggy wood. Many of these animals possess little resistance to drying.

The optimum for prairie and forest animals thus involves a dynamic balance between the intake of water and its loss by evaporation and excretion.

ANIMAL ASSOCIATIONS OF THE PRAIRIE AND THE FOREST

I. INTRODUCTION

In an earlier chapter of this paper the habitats and animals found at the different stations were discussed, and in the preceding section the general characteristics of the physical and vegetational environment of the prairie and forest have been described and summarized. We are now in a better position to consider the relations of the invertebrates, not only to their physical environment, but also to the vegetation, and, furthermore the relations which these animals bear to one another. We wish also to consider both the prairie and the forest as separate units, and to see how the animals are related to their physical and biological environment. As previously stated, the special localities studied were described by stations both to give a precise and concrete idea of the prairie and its animals, as now existing in a limited area, and also to preserve as much of the local color as the data would permit. I wish now to reexamine these animals from another standpoint, that of the animal association as a unit. The prairie as a whole

is not homogeneous from this point of view; it is a mosaic composed of a number of minor social communities. Each of these smaller units, however, is fairly homogeneous throughout.

Our present knowledge of these minor associations is imperfect, and for this reason they are arranged in an order approximating that which we might reasonably expect to be produced if the initial stage were made to begin with a poorly or imperfectly drained area and to advance progressively with corresponding vegetational changes, toward a more perfect condition of drainage. Upon the prairie a perfect series would include every stage from lakes, ponds, and swamps to well-drained dry prairie. But cultivation and drainage have obliterated so much, that now only very imperfect remnants exist in the vicinity of Charleston. Although the sequence followed therefore does not include all stages of the process it is approximately genetic.

There are three essential features in every animal association, or community; certain physical conditions; certain kinds of vegetation, which also modify the physical conditions; and representative kinds of animals. Occasionally an effort is made to divorce these, to separate organisms from their normal habitat, but such an effort is deceptive, for no organism can live for any considerable period without a normal environment.

I have not attempted to treat these associations with equal fullness. In the sections devoted to the description of the stations it was possible in some cases, on account of the uniform character of a station, to describe the animal association rather fully. In such instances the detailed account is not repeated. In other cases I have elaborated the community relations more fully here than elsewhere. The descriptions of the stations and the associations, and the annotated lists, are intended to be mutually supplementary.

II. THE PRAIRIE ASSOCIATIONS

1. *Swamp Prairie Association*

The swamp prairie community lives in a habitat characterized by shallow water, which stands approximately throughout the growing season of the vegetation. The soil is black, and rich in vegetable debris. The characteristic plants are bulrush (*Scirpus*), flags (*Iris*), swamp milkweed (*Asclepias incarnata*), beggar-ticks (*Bidens*), and young growths both of willow (*Salix*) and cottonwood (*Populus deltoides*). The abundant growth of vegetation and the wet soil are conditions favorable for the production and accumulation of organic debris, which tends to fill the depressions and to supplement the inwash

from the surrounding slopes. At the same time, burrowing animals, particularly the crawfish, also bury debris and work over the soil. In the Charleston area this community was developed at Station I, *d*, and in part at I, *g*.

The representative animals of this community are those living in the water, such as the prairie crawfish, *Cambarus gracilis* (Pl. XXXVI), the snail *Galba umbilicata*, and such insects as the nine-spot dragon-fly, *Libellula pulchella* (Pl. XXXVIII, fig. 2), and the giant mosquito, *Psorophora ciliata*, whose immature stages are spent in the water. In addition to these are other representative species whose presence is, to an important degree, conditioned by the presence of certain kinds of vegetation—such species, for example, as those which feed upon the dogbane (*Apocynum*), the brilliantly colored beetle *Chrysochus auratus*; upon milkweed, the milkweed bugs *Lygaeus kalmii* and *Oncopeltus fasciatus* (Pl. XL, figs. 1 and 3), and the milkweed beetle *Tetraopes*; and, finally, the rather varied series of flower visitors feeding upon pollen or nectar, such as the soldier-beetle (*Chauliognathus pennsylvanicus*), *Euphoria sepulchralis*, and several species of butterflies, moths, bees and wasps, including the honey-bee, bumblebees, and carpenter-bee (*Xylocopa virginica*), and the common rusty digger-wasp (*Chlorion ichneumoneum*). Visiting the same flowers, but of predaceous habit, were found the ambush spider (*Misumena alectoria*) and the ambush bug (*Phymata fasciata*). Small insects were preyed upon by the dragon-flies (*Libellula pulchella*), and the dragon-flies in turn were entangled in the webs of the garden spider (*Argiope aurantia*).

No animals were taken on the flags, but Needham ('00) has made an important study of the population inhabiting flags at Lake Forest, Illinois, and shows that it is an extensive one. He gives an excellent example showing how the injury by one insect paves the way for a train or succession of others. For example: the ortolid fly *Chatopsis aenea* Wied. (Pl. XVIII, fig. 1), bores into the stem of the buds and causes them to decay (Cf. Forbes, '05, p. 164; Walton, Ent. News, Vol. 19, p. 298. 1908). This condition affords a favorable habitat for a pomace-fly (*Drosophila phalerata* Meig.*), an oscinid (*Oscinis coxendix* Fitch, Plate XVIII, figures 3 and 4), a beetle, parasitic *Hymenoptera*, and, after the decaying buds were overgrown by fungus threads, the bibionid fly *Scatopse pulicaria* Loew. This paper by Needham is one of the very few in which the population of a plant has been studied as a biotic community. Forbes ('90, pp. 68-69; 02, p. 444) has shown that snout-beetles (*Sphenophorus ochreus* Lec., Plate

*Mr. J. R. Malloch informs me that *D. phalerata* is not an American species.

XVIII, figures 5, 6, and 7) breed in root-bulbs of *Scirpus*, and that these beetles eat the leaves of *Phragmites*. Webster ('90, pp 52-55) observed these beetles feeding on the leaves of *Scirpus* and the larvæ feeding on its roots. I have found great numbers of these beetles cast up on the beach of Lake Michigan. Evidently they breed in the swamps about the lake, fall into it when on the wing, and are washed ashore.

2. The Cottonwood Community

Ordinarily we are accustomed to think of the prairie as treeless, and yet one large tree was relatively abundant upon the original prairie of Illinois, particularly upon wet prairie, or, when pools were present, even upon the uplands. This was the cottonwood, *Populus deltoides*. These trees were often important landmarks when isolated; and today the large trees or their stumps are important guides in determining the former extent of the prairie. In the region studied there were no large mature cottonwoods, although saplings were present, but north of Charleston in the adjacent fields mature trees were found. They grow normally at the margins of wet places, as about prairie ponds and swamps, or along the small ill-defined moist sags and small prairie brooks. This tree is usually solitary or in irregular scattered rows when along streams, and does not, as a rule, form clumps or groves. This relatively isolated habit may be a factor in the comparatively small number of invertebrates which are associated with it, or at least in the amount of serious injury which they do to these trees upon the prairie. Many of the larger trees are mutilated, or even destroyed by lightning (Cf. Plummer, '12), and such injury favors entrance of insects on account of the rupturing of the thick bark.

The galls on the leaves and twigs of the trees often attract attention. A large irregular gall on the ends of the twigs becomes conspicuous in winter. This is formed by the vagabond gall-louse, *Pemphigus oestlundi* Ckll. (Pl. XIX, fig. 1) (*vagabundus* Walsh, Ent. News, Vol. 17, p. 34. 1906). I have found these galls abundant upon the prairie at Bloomington, Ill. At this same locality I found a large bullet-like gall at the junction of the petiole and the leaf—that of *Pemphigus populicaulis* Fitch (Pl. XIX, fig. 2), and at Urbana, Ill., on other large prairie cottonwoods, a somewhat similar gall, on the side of the petioles, caused by *P. populi-transversus* Riley (Pl. XIX, fig. 3). I have also taken large caterpillars of the genus *Apatela* on leaves of cottonwood, and September 3, at Urbana, upon its cultivated form, the Carolina poplar, *A. populi* Riley (Pl. XX, fig. 6). These caterpillars have bodies covered by yellow hair penciled with black. At dusk swarms of May-beetles (*Lachnosterna*) can be seen and heard feeding

among the leaves of the cottonwood and the Carolina poplar. It is noteworthy that I have made these observations at Urbana, Illinois, upon cottonwoods growing upon what was originally prairie.

Forbes ('07a) has shown, as the result of extensive collections of May-beetles from trees, that they have a decided preference for Carolina poplar (p. 456) and willow. This same paper also contains important observations on the nocturnal flights to and from the forest, from the normal habitat of the grubs, and from the daytime abode of the beetles in the open fields. Wolcott ('14) has recently emphasized the point that the grubs live only in open places in proximity to woodland where the beetles can secure food. These observations show very clearly that May-beetles are animals primarily of the *prairie* or forest margin, and probably lived upon the original prairie, scattered, where cottonwoods or willows grew. A glance at the map of the prairie and forest (frontispiece) shows that the marginal area was very extensive, and must have furnished an optimum habitat for these beetles. This is a good illustration of the fact that the cottonwood exerted an influence upon the prairie far beyond its shadow.

In some localities another beetle (*Melasma scripta* Fabr.) feeds upon the leaves of the cottonwood, and may become a serious pest to poplars and willows, but I have not seen this species abundant on isolated mature trees upon the prairie. I have taken these beetles (July 2) under cottonwoods at Bloomington, Ill. Packard ('90, pp. 426-474) has published a list of the insects known to feed upon *Populus*.

Willows (*Salix*) are frequently associated with the cottonwoods upon the prairie, but, in marked contrast with these, they generally grow in colonies and are eaten by a great variety of insects. Packard ('90, pp. 557-600) lists 186 species of insects on them, and Chittenden ('04, p. 63) extends the number to 380 species. Of course in any given locality the number of species found will be relatively small, and the number is further limited by the environmental conditions—whether the land is upland or low and flooded. The degree of proximity of willows and cottonwood is likely to influence the relative abundance of the insects feeding upon these trees, since a large number of insects which feed upon willow also feed upon the cottonwood. Colonies of willow are thus likely to become sources of infestation for the cottonwood; this relation, however, is a mutual one. Walsh ('64) and Heindel ('05) have published very interesting studies of the community life of the insect galls on Illinois willows. Cockerell ('97, pp. 770-771) has listed the scale insects found upon willows and poplars.

3. Swamp-grass Association

The prairie swamp-grasses, slough grass (*Spartina*), and wild rye (*Elymus*) were growing in relatively pure stands or colonies in depressions which were dry in the late summer. The prolonged wetness of the habitat and the dominance of the few kinds of grasses are characteristic features of the environment of this association. These conditions were found at Station I, *a* and *c*, north of Charleston. As these stations were rather homogeneous and have already been discussed somewhat fully, only a summary will be given here.

On account of the grassy vegetation the abundance of *Orthoptera* is not surprising. Representative species are *Melanoplus differentialis*, *M. femur-rubrum*, *Scudderia texensis*, *Orchelimum vulgare*, *Xiphidium strictum*, *Æcanthus nigricornis*, and *Æ. quadripunctatus*. Other representative animals are *Argiope aurantia* and the swamp fly *Tetanocera plumosa*. The list of species is probably very incomplete; during the wet season there are undoubtedly a number of aquatic; furthermore, there are still other species which feed upon *Spartina* and *Elymus*, particularly some *Hemiptera*, and stem-inhabiting *Hymenoptera*, and certain *Diptera*. Thus Webster ('03a, pp. 10-13, 26, 32, 38) has recorded a number of chalcids of the genus *Isosoma* which live in the stems of *Elymus virginicus* and *canadensis*. In this same paper he discusses their parasitic and predaceous enemies (pp. 22, 27, 33). A fly also breeds in *Elymus*, the greater wheat stem-maggot, *Meromyza americana* Fitch (Pl. XX, figs. 1-5), as recorded by Fletcher (l. c., p. 48). This species is of economic importance, having spread from grasses to the cultivated grains. It has been studied in Illinois by Forbes ('84). He found a fly parasite of this species, and Webster reports a mite preying on it. Webster (l. c., p. 53) reports another fly, *Oscinis carbonaria* Loew, bred from *Elymus* by Fletcher.

In another paper Webster ('03b) has published a list of insects inhabiting the stems of *E. canadensis* and *virginicus*. Osborn and Ball ('97b, pp. 619, 622; '97a) have discussed the life histories of certain grass-feeding *Jassidæ* which feed upon *Elymus*. Osborn ('92, p. 129) records a plant-louse, *Myzocallis*, from *Elymus canadensis* in Iowa, and a species of leaf-hopper has been recorded by Osborn and Ball ('97b, p. 615) from *Spartina*. On the same plant, Osborn and Serrine ('94, p. 897) record a plant-louse on the roots. In a list of the plant-lice of the world and their food plants Patch ('12) lists a few from *Spartina*. This same list includes (pp. 191-206) many grasses and the associated aphids, those on *Elymus* on page 196.

4. Low Prairie Association

The moist black soil prairie, a degree removed from the wet or swamp condition, with ground water in the spring relatively near the surface, is fairly well characterized by the rosin-weed (*Silphium*), particularly *S. terebinthinaceum*. Other plants likely to be associated with *S. terebinthinaceum* are *Silphium laciniatum* and *S. integrifolium*, *Eryngium yuccifolium*, *Lepachys pinnata*, and, to a less degree, *Lactuca canadensis*.

In the Charleston area this condition is represented by Station I, *a*, north of the town, and Station III, *a*, and in part *b*, east of the town. The proximity of ground water is shown at Station I, *e*, by the presence of crawfish burrows, probably those of *Cambarus gracilis*. At Station III the proximity of water was also evident where *S. terebinthinaceum* was most abundant in the railway ditches. Such perennial plants are indicative of the physical conditions for a period of years, and are thus a fairly reliable index of average conditions—much more so than the annuals.

It is difficult to decide which kinds of animals are characteristic of this kind of prairie. Provisionally I am inclined to consider the following as being so: *Cambarus gracilis*; *Argiope aurantia*; the grasshoppers *Encoptolophus sordidus*, *Melanoplus differentialis*, *M. femurrubrum*, *Scudderia texensis*, and *Xiphidium strictum*; *Cæcanthus nigricornis*; *Phymata fasciata*; and asilids. The presence of *Lepachys* was clearly an important factor in determining the presence of *Melissodes obliqua* and *Epeolus concolor*. At Station III, *b*, east of Charleston, *Epicauta pennsylvanica* and *Bombus pennsylvanicus*, *auricomus*, and *impatiens* were taken on the flowers of *Silphium terebinthinaceum*.

Robertson ('94, pp. 463-464; '96b, pp. 176-177) has published lists of insect visitors to the flowers of *Silphium* and *Lepachys* ('94, pp. 468-469), at Carlinville, Ill. Recently Shelford ('13a, p. 298) has published a long list of animals inhabiting *Silphium* prairie near Chicago. Forbes ('90, p. 75) has reported the snout-beetle *Rhynchites hirtus* Fabr. as feeding upon *Silphium integrifolium*.

In a colony of prairie vegetation at Seymour, Ill., which included much *Silphium* and *Eryngium*, the following insects were taken October 7 from the ball-like flower clusters of *Eryngium yuccifolium*: the bugs *Lygæus kalmii*, *Thyanta custator* Fabr., *Euschistus variolarius*, and *Trichopepla semivittata* Say (No. 539, C. C. A.), the last named in large numbers, the nymphs in several sizes as well as the adults, a fact which suggests that both may hibernate upon the prairie. Robertson ('89, pp. 455-456) has summarized his collections of insects from *Eryngium* and on *Euphorbia corollata* ('96a, pp. 74-75).

Upon remnants of prairie vegetation growing at Urbana, Illinois, I have found several kinds of insects centered about a wild lettuce, *Lactuca canadensis*. Upon the upper, tender parts of this plant, the plant-louse *Macrosiphum rudbeckiæ* Fitch, thrives late in the fall, in very large numbers. Some seasons nearly every plant is infested. The lice become so abundant upon these tender parts that the entire stem for a distance of a few inches is completely covered. They migrate upward with the growth of the stem and keep on the fresh, tender parts. Among the plant-lice, and running about on the stem of the plant, attending ants abound; eggs, larvæ, and adults of lace-wing flies (*Chrysopa*) also abound; and several species of coccinellids, syrphid larvæ, and a variety of small parasitic *Hymenoptera* are present.

5. Upland Prairie Association

The well-drained prairie, a degree removed from the permanently moist prairie, is fairly well represented by the physical and biological conditions in which *Euphorbia corollata*, *Apocynum medium*, and *Lactuca canadensis*, are the representative plants. The plant ecologist would consider the conditions favorable to mesophytic plants. In the Charleston region these conditions are approximated at Station II, where drainage has doubtless changed the area from a somewhat moist, to its present well-drained, condition.

Representative animals of this community are as follows: *Argiope aurantia*, *Misumena alcatoria*, *Encoptolophus sordidus*, *Melanoplus bivittatus*, *M. differentialis*, *Orchelimum vulgare*, *Xiphidium strictum*, *Euschistus variolarius*, *Phymata fasciata*, *Chauliognathus pennsylvanicus*, *Epicauta marginata* and *E. pennsylvanica*, *Rhipiphorus dimidiatus* and *R. limbatus*, *Ammalo*, *Exoprosopa fasciata*, *Promachus vertebratus*, *Bombus pennsylvanicus*, and *Mysine sexcincta*.

On dry prairie at Mayview, Ill., September 26, I found the plant-louse *Aphis asclepiadis* Fitch on the leaves and stems of the dogbane (*Apocynum*) and the lice attended by the ant *Formica fusca* L. A beetle, *Languria mozardi* Latr., whose larva is a stem-borer, inhabits *Lactuca canadensis*. Its life history and habits have been discussed by Folsom ('09, pp. 178-184).

6. The *Solidago* Community

A common community in the late summer and early fall is centered about the goldenrod (*Solidago*). This plant was not abundant or in blossom at any of the stations studied in detail, but it grew in small widely scattered colonies or clumps. Observations were made in two

colonies, north of Charleston, both west of Station I, *a*, and I, *g*. The collections made (Nos. 20, 26, 42, 43) are as follows:

Ambush Bug	<i>Phymata fasciata</i>	20, 26
Stink-bug	<i>Euschistus variolarius</i>	26
Black Blister-beetle	<i>Epicauta pennsylvanica</i>	26
Noctuid moth	<i>Spragueia leo</i>	20, 26
Conopid fly	<i>Physocephala sagittaria</i>	26
Empidid fly	<i>Empis clausa</i>	43
Halictid bee	<i>Halictus fasciatus</i>	26
Myzinid wasp	<i>Myzine sexcincta</i>	20, 26
Ant	<i>Formica fusca subsericea</i>	20

It is important to know that these collections from *Solidago* were made just as the flowers were beginning to blossom. Collections a few weeks later would probably have given many more kinds. It should be noted, too, that all these plants were far out upon the prairie and far from woodlands—a factor which may influence to some extent the kinds of visitors. As a rule the lists which have been published state little or nothing at all as to the conditions in which the plants were growing. If this factor is neglected, the presence of some visitors remains puzzling. Thus on some goldenrods the locust beetle, *Cyllene robinia*, is abundant; but this is conditioned in part by the proximity of the yellow locust, which is absent on the Charleston prairie.

Phymata was found copulating upon the flower, and with an empidid fly, *Empis clausa* (No. 43), in its grasp. Two kinds of galls formed by insects were found on this plant: one formed by the fly *Cecidomyia solidaginis* (No. 43), which forms a rosette of leaves; and the other the spindle-like stem-gall, formed by a small caterpillar, *Gnorimoschema gallsolidaginis* (No. 7462 Hankinson). September 20 the moth *Scepsis fulvicollis* Hübn. was found in goldenrod flowers near Station I, *a*. Its larva feeds on grass. A large noctuid larva, *Cucullia asteroides* Guen., was found in a mass of flowers. As the day was cloudy and cool, *Scepsis* was resting or sleeping on the flower masses, as were also the black wasp *Chlorion atratum* Lep., and *Polistes*—both the light form *variatus* Cress., and the darker one, *pallipes* Lep. On October 23, 1893, I found the curculionid *Centrinophus helvinus* Casey (det. H. F. Wickham) on goldenrod at Bloomington, Ill.

Needham ('98, pp. 29–40) has given a good popular account of the insects associated with goldenrod, and Riley ('93, pp. 85–87) has published an extensive list and given a number of observations on their food habits.

Pierce ('04, pp. 173-188) has published a long list of bees found visiting *Solidago* in Nebraska. He also mentions the following beetles: *Chauliognathus pennsylvanicus*, *Nemognatha immaculata* and *N. sparsa*, *Zonitis bilineata*, *Epicauta pennsylvanica*, and *Myodites solidaginis* Pierce. *Myodites* is a rhipiphorid beetle which appears to lay its eggs upon *Solidago*. Here the larva develops, and from here, by attaching itself to different flower visitors, it is carried to their nests. The nesting sites are often populated by several kinds of insects, a social community, and thus the larva is thought to be carried in close proximity to the bee *Epinomia*, upon which it is parasitic. This bee does not visit *Solidago*, but frequents the sunflower (*Helianthus*), and thus is only infested at the nest (see also Canadian Entomologist, Vol. XXIV, 1902, p. 394). This is a good example of the complex relations existing among the animals of the prairie. Robertson ('94, p. 455) found *Myodites fasciatus* Say on *Solidago* at Carlinville, Ill., and he also lists (l. c. pp. 454-458) many species of insects which he found on different species of goldenrod. As *Epinomia* is not known from Illinois it is probable that some other bee is host for *Myodites*.

7. Dry Prairie Grass Association

The dry prairie grass association includes those animals which live on the driest of the black soil prairie among the tall prairie grasses *Andropogon* and *Sporobolus*. Upon the original prairie this was probably a relatively stable habitat.

About Charleston these grassy habitats occupied only very small areas north of the town, at Station I, *g* (in part), and Station III, *b* (in part).

Representative animals of this community are the following: *Argiope aurantia*, *Brachynemurus abdominalis*, *Chrysopa oculata*, *Syrbula admirabilis*, *Encoptolophus sordidus*, *Melanoplus differentialis*, *M. femur-rubrum*, *Scudderia texensis*, *Orchelimum vulgare*, *Conocephalus*, *Æcanthus nigricornis* and *Æ. 4-punctatus*, *Euschistus variolarius*, *Sinea diadema*, *Phymata fasciata*, *Chauliognathus pennsylvanicus*, *Tetraopes tetraophthalmus*, *Rhipiphorus dimidiatus*, *Exoprosopa fasciata*, *Promachus vertebratus*, *Bombus pennsylvanicus*, *auricomus*, *impatiens*, *fraternus*, and *separatus*, *Melissodes bimaculata*, and *Myzine sexincta*.

Probably a number of insects breed in the roots and stems of *Andropogon* and *Sporobolus*, but none were secured.

Although *Elymus* has contributed many insect pests to cultivated grains, it seems that *Andropogon* has not, if we except the chinch-bug (*Blissus leucopterus* Say). This insect was not related to *Andropo-*

gon as *Isosoma* is to *Elymus*, but this and other prairie grasses which grow in bunches or stools evidently formed the optimum hibernating quarters of these pests when they lived upon the original prairie (Fitch, '56, p. 283; Marlatt, '94a; Schwarz, '05) and upon the seashore. Osborn and Ball ('97a and '97b) have listed several grass-feeding *Jassida* from *Andropogon* and *Sporobolus*. Osborn and Sirrine ('94, p. 897) found a plant-louse on the roots of *Andropogon*, and Patch ('12, p. 191) lists *Schizoneura corni* Fabr. on *A. furcatus*.

8. A Milkweed Community

Bordering the gravelly ballast along the rails north of Charleston at Station I (Pl. II, fig. 2) may be seen a large-leaved plant, the common milkweed (*Asclepias syriaca*). This plant flourishes along the track in many places, and wherever it was found there tended to appear a small but very well-defined animal community. To determine the composition of this social community, a few collections were made at various points within Station I. That this milkweed is the hub of this microcosm is clearly shown by the fact that no similar association was found grouped around any other plant in the area, not even about the other milkweeds, *A. sullivantii*, or *A. incarnata*. The collections are numbered as follows: Nos. 27-30, 33, 34, and 154.

The terminal young and tender leaves of the plant are often densely covered with the plant-louse *Aphis asclepiadis* Fitch (Nos. 28, 29), and these lice are attended by the workers of the ant *Formica fusca subsericea* Say (Nos. 30, 154). On another plant no plant-lice are recorded, but upon it were found their common enemy, the nine-spotted ladybird, *Coccinella 9-notata*; two species of ants (*Formica pallide-fulva schaufussi incerta*, and *Myrmica rubra scabrinodis sabuleti*); besides, running about on the leaves, the pretty, metallic, long-legged flies *Psilopus siphon* (No. 27). They run with a singular rapid glide, stop suddenly for a moment, and then continue their rapid pace. Certain flies of this family are said to be predaceous, but I have never seen *Psilopus* capture any small animal. On the same plant just mentioned a small bug, *Harmostes reflexulus*, was also taken; and in the flowers of this plant were hundreds of a small dark-colored empidid fly, *Empis clausa* (No. 27). Two other animals were found on this plant; *Zonitis bilineata* Say (No. 33), and a jumping spider (attid), which had in its jaws what appeared to be the remains of the beetle *Diabrotica 12-punctata* (No. 34). Contrary to my usual experience, these plants did not abound with milkweed beetles (*Tetraopes*) or with the common milkweed bugs (*Lygaeus kalmii* and *Oncopeltus fasciatus*), which are usually numerous. The proximity of the fragrant

blossom of *Asclepias incarnata* may explain this paucity at this time and place. The milkweed butterfly, *Anosia plexippus*, is of course a member of this community.

W. Hamilton Gibson ('00, pp. 227-237) has discussed, in a very interesting manner, the relations of this plant to its insect pollinators, and calls attention to the variety of insects which are entrapped and killed by its flowers. He also points out that the dogbane (*Apocynum*) has a similar habit.

Robertson, our leading American authority on the relations of flowers and insects, has published extensive lists of the flower visitors, not only of *A. syriaca* (*cornuti*) but of other Illinois milkweeds (Bot. Gaz., Vol. XI, pp. 262-269; Vol. XII, pp. 207-216, 244-250; and Trans. St. Louis Acad. Sci., Vol. V, No. 3, pp. 569-577).

III. RELATION OF PRAIRIE ANIMALS TO THEIR ENVIRONMENT

The relation of prairie animals to the major features of their physical and biotic environment presents several facts of unusual interest. On account of the relatively heavy precipitation during June, the slight topographic relief of the region, and its imperfect drainage, unusually large areas of the original black soil prairie are wet or swampy. Certain animals are able to tide over this early, unfavorable wet-summer period because they are not fully roused from their winter inactivity; others, in their immature stages of development, require less food than later; still others survive by migration to the drier uplands. At the same time, other animals, preferring moist or wet habitats, flourish, and then decline in numbers as the season advances. Toward August, on account of the eastward migration of the continental peninsula of aridity and intense evaporation, those animals whose activity is retarded by the earlier wet season find the conditions progressively more favorable, and thrive and grow accordingly. This is the acme of the season for dry-prairie animals, and great numbers of slowly maturing composite plants now make the landscape yellow with their flowers. The *Orthoptera* are now mature, and when flushed, or, when not flushed, by their sounds, are noticeable. That these conditions cause these animals to thrive, is only too evident during exceptionally dry seasons, when the ordinary August drouth begins in July and extends into September.

In the conditions just indicated, the imperfect drainage, the wet season followed by the dry, we are touching closely upon the real causes of the prairie. Yet to me it seems fruitless to search for *the* cause of the Illinois prairie; the causes are probably multiple. In the midst of the Great Plains, the "short grass country" the causes of grass-land

may be relatively few, because the dominating conditions are so thoroughly established and extreme. But near the eastern margin of this dominance, upon the prairies—the “long grass country”—the number of limiting factors increases greatly, and even a relatively trivial local influence is able to overcome the slight momentum which this dominance possesses. In Illinois, then, the causes of the prairie biota, mentioning only the larger groups of influences, seem to be as follows: *a*, a sandy character of the soil, resulting in sand prairie; *b*, loam and good drainage, resulting in black soil prairie; *c*, very imperfect drainage, resulting in wet prairie. A shallow soil underlaid by rock might also produce prairie, but I have not seen any large area of this kind in Illinois.

We have, then, in the wetness and the dryness of the prairie two of the important controlling influences upon the prairie associations. On the prairie aquatic animals may thrive, particularly those which develop early and mature rapidly, and possess some power to resist or tide over the dry season, either as adults of non-aquatic habits by estivation, or in some resistant immature stage. We can see how aquatic animals, in this manner, are capable of enduring these extreme conditions and remain numerous upon the prairie. Where crawfish holes are abundant, many small aquatic animals are able to utilize them and thus escape drying. Crawfish holes should be examined during dry seasons with this idea in mind. On the other hand, the prairie is inhabited by many animals which can not endure much moisture, and live best in conditions of moderate or extreme dryness. These are the kinds which find their optimum during the driest part of the season, and in very dry years. When there is an abundance of moisture, some of these, for example the chinch-bug, are particularly susceptible to disease. The maximum development of this arid type as seen on the Illinois sand prairie has been studied by Hart ('07); more recently by one of my students, Vestal ('13b, '14); and about Chicago and northern Indiana by Shelford ('13a). An examination of the lists of sand invertebrates given by Hart (l. c., pp. 230-257) and Vestal ('13b, pp. 14-60), in comparison with those for the black soil prairie at Charleston, will show many differences, not only in kinds but also in their relative abundance. Some allowance must also be made for the fact that the animals of the black soil prairie are not as fully preserved as those of the sand areas.

1. *The Black Soil Prairie Community*

The soil population of both sand and black soil prairie has never received thorough study, although observations from the sand areas

have been recorded by Hart, and his observations amplified by Vestal. In the black soil area many observations have been made by Forbes ('94) on the life histories and habits of certain species of economic importance, particularly those injuring corn and grasses in the soil. In his studies are included many insects, such as elaterid larvæ, aphids, ants, and white-grubs. The physical conditions of life here yet await careful investigation.

A very large number of the animals living on and above the surface of the soil spend a part of their lives within it. Thus among the *Orthoptera*, the acridiids lay their eggs in the soil—this is probably true of most of the beetles; and even the parasitic animals often spend most of their life in the soil with their hosts. This is true also of the wasps and a great number of hibernating animals, and of a large number of grass-inhabiting, and other, *Lepidoptera*. Such characteristic flies as the asilids and bombyliids spend much of their life in the soil, as do many other flies, at least during their pupal period. It is very probable that upon the original prairie a large number of noctuid and crambid moths and tipulid and elaterid larvæ inhabited the prairie sod, and with them, of course, were associated their enemies—predaceous beetles, and parasitic flies and *Hymenoptera*. For an account of grass-feeding crambids Felt ('94) and Fernald ('96) should be consulted.

The stage of development, structure, and behavior of soil-inhabiting animals are often quite different from those living above the surface. Some kinds, as pupæ or adults, have spines or setæ, which enable them to wriggle in the soil, as, for example, do the pupal asilids or the adults of *Myzine* and *Tiphia*. Locomotion in such a dense medium is attended by many difficulties, and it is not surprising that animals living here have peculiarities of structure and behavior, and that a large number are relatively sedentary.

In the discussion of the ventilation of habitats, attention was called to the fact that soil-inhabiting animals probably possessed considerable resistance to an abundance of CO_2 and to a lack of oxygen. We are all familiar with the abundance of earthworms, *Lumbricus* and its allies, crawling upon the surface and entrapped upon our walks and pavements after prolonged rains. In these cases the saturation of the soil has driven out the air. Apparently the earthworms are relatively less resistant to the lack of oxygen than many other soil animals, for they come to the surface in a much more marked degree. Since earthworms live in burrows, have an easy route to the surface, and are possessed of good powers of locomotion, they contrast strikingly with many other sedentary soil animals. Bunge ('88, p. 566) found that earthworms were able to survive one day in an oxygen-free liquid.

Cameron ('13, p. 190) speaks of the resistance to drowning of elaterid larvæ as follows: "I myself have kept specimens of the larvæ of *Agriotes lineatus*, our commonest wireworm, in water for as long as six days without their being drowned, but those which were thus treated for a period of seven or eight days did not generally recover from the deleterious effects of immersion. Leather-jackets and surface caterpillars submitted to the same treatment succumbed in a much shorter time, one to two days for the caterpillars, depending on their state of development—much shorter time than this for very young forms—and from one to three days in the case of leather-jackets, the latter being in all cases fully mature."

Dr. R. D. Glasgow informs me that it is probable that the soil-inhabiting white-grubs, *Lachnosterna*, may be able to close their spiracles when the soil is saturated and thus resist drowning, as in the case of the European *Melolontha* (Cf. Henneguy, '04, p. 105; Packard, '98, p. 442). With this closure of the spiracles there is probably correlated a power to resist a lack of oxygen and an excess of CO₂. In any case, this is a subject worthy of experimental investigation. Cameron ('13, pp. 197-199) has called attention to the marked resistance to a lack of oxygen found in muscid (dipterous) larvæ; they endure submersion for long periods and recover rapidly. He says (l. c., p. 198): "A faculty of resistance and power of adaptability to adverse circumstances is of peculiar advantage to the insect inhabitants of the soil, which, owing to the varying climates and atmospheric conditions, are often subjected to the most severe extremes of heat and cold, wet and drouth. The more sluggish maggots of *Diptera* have a greater plasticity than the active larvæ of predaceous *Coleoptera*. On considering these two orders by themselves, amongst *Diptera* the larvæ of *Muscidæ* have a greater power of resistance generally than the larvæ of Nematocerous and Brachypterous families, whilst among *Coleoptera* the grubs of *Rhynchophora* are not so easily affected as those of *Carabidæ* and *Staphylinidæ* and other active families. This is just what we might expect, seeing that nature, which has deprived Dipterous maggots and Weevil grubs of legs that they might readily escape danger, has compensated them to some extent by endowing them with a greater power of resistance to adverse conditions."

Upon the black soil prairie the snout-beetles *Sphenophorus* abounded in the roots of swamp plants, where they were particularly liable to submersion with varying rainfall. It is, however, possible that this resistance may be entirely independent of the footless condition.

The optimum soil conditions for insects have thus been summarized by Cameron ('13, p. 198) as follows: "Soils that are of a light and open texture are, as we have already seen, the ones most frequented by soil insects, all other conditions, such as those of food, being

equal. A porous subsoil is also conducive to the well-being of insect life, in that the rain can quickly penetrate, and, as it passes through, air is drawn into the more superficial layers in order to take its place. Hence a reason why soil insects are only rarely found in the deeper subsoil; for the increased amount of moisture, together with the decrease in aeration, is decidedly detrimental to their activities."

The density, moisture, solutions, and ventilation of the soil, its fresh and decaying vegetation, make conditions possible both for a population consisting of vegetable feeders and, preying largely upon them, a series of predaceous and parasitic associates.

It is desirable that the prairie ground fauna should be made the object of special investigation, particularly from the standpoint of soil solutions, moisture content, ventilation, humus content, and the influence of the living vegetation. For this reason several papers are here mentioned which will be valuable in such a study. Diem ('03) has made an elaborate quantitative study of the ground fauna of the Alps. He studied a variety of conditions, including pasture, meadows, and coniferous forest soils. He describes his methods of study and gives many references to the literature. Other papers which should be studied in this connection are by Dendy ('95), Cameron ('13), Motter ('98), and particularly those by Holdhaus ('10, '11a, '11b). Banta's ('07) paper on cave animals will also prove valuable because of the close relation of cave animals to those living in the smaller openings in ordinary soil.

Near the soil surface, among the stools of grass and on the ground, vegetable litter is most abundant, and humidity is high, evaporation slow, and the temperature lower and also more equable than higher up. It is in this layer that a vast number of animals hibernate, and in it also many, active at night, are hidden during the day. In this layer live the animals which feed largely on organic debris. Bumblebees often build their nests at this level, or in depressions in the ground. Some of our species of *Bombus* may nest deep in the soil and ventilate the nest by vibrating their wings, as do certain European species (Sladen, '12, pp. 47-49). This is a very interesting response to a subterranean life and merits investigation.

2. *The Prairie Vegetation Community*

Above the surface of the soil, among the vegetation, quite another environment exists. This varies greatly not only with the character of the substratum but also with the character and density of the prairie vegetation. The fertility of the black soil, and the rapidity with which it is occupied by vegetation, makes areas of bare soil of short duration.

The prevailing condition is therefore one of dense vegetation. I know of no detailed study of the amount of life which develops in this layer of prairie vegetation. For this reason certain observations made in meadows and pastures are of interest. McAttee ('07) examined a grassy meadow and the surface of the soil for bird food, and a corresponding area of four square feet of a forest floor. He concluded that the population in a meadow is much more dense than that in a forest. This conclusion, however, is not valid, as Banks ('07) has pointed out, because the two areas are not strictly comparable ecologically. In the meadow life is concentrated near the surface; in the forest it is largely in the trees and not on the forest floor. Clearly the ecologically comparable areas of the open and the forest are their subsurface soils, the surface soil and the layer of vegetation, and the space above the vegetational layer. As previously pointed out in this paper, the forest should be looked upon as a very thick layer of vegetation. Another estimate of the population of pasture vegetation has been made by Osborn ('90, pp. 20-23). This is a rough estimate, but it shows that there were about one million *Jassida* present per acre. He further estimated that the amount of vegetation per acre eaten by insects amounted to about one half of that eaten by a cow. This example aids one in understanding how it was possible for the insects of the original prairie to influence the amount of food available for the buffalo, particularly during dry seasons when there was limited grass growth, and when grasshoppers thrived in large numbers. In this layer of vegetation, in addition to the general feeders, eating almost any kind of vegetation, there is a rather extensive population which has a restricted diet, feeding upon a single food plant, or on only a few species. There are a number of cases where, though an insect has several food plants, all, or nearly all, belong to the *same plant association*, and often have much the same geographic range. A good example of this among prairie animals is the case of the plant-louse *Macrosiphum rudbeckiae* Fitch, which lives on a variety of prairie plants; as *Vernonia*, *Solidago*, *Bidens*, *Ambrosia*, *Cirsium*, *Silphium*, and *Lactuca* (Cf. Hunter, '01, p. 116). The beetle *Chrysochus* and the bugs *Lygaeus kalmii* and *Onopeltus fasciatus* are often found on *Asclepias* and *Apocynum*; *Aphis asclepiadis* lives on *Asclepias* and on *Euphorbia*. Though pollen- and nectar-feeding insects often forage over many kinds of plants, some of them have clearly defined preferences, almost amounting to limitation to a single food plant. Thus the bee *Melissodes obliqua* seeks pollen largely from *Lepachys pinnata*, and the Pennsylvania soldier-beetle, though very abundant on flowers, is not numerous in corn fields even when pollen is excessively abundant.

Many kinds of insects are recorded as "sleeping" among rank growths of vegetation and on flowers. In such places on cloudy or cool days, late in the evening or in the early morning, insects are found at rest and in a sluggish or torpid condition. The cause of this behavior is not known. They may be "sleeping," or they may only have been trapped there by a lowering of the temperature, as at sundown, when their activity slowed down and they came to a rest on the last flower visited. In this connection it should be recalled that it is near the general level of the surface of the vegetation that the most extreme temperatures are found,—the most warmth in the sun and the greatest coolness at night. This is the main zone also of flowers visited by insects.

In this same layer of vegetation is found the usual grouping of vegetable feeders, scavengers, predators, and parasites. As the nectar-drinkers visit the flowers, certain predators spring upon them, just as the large members of the cat family seize their prey at the margins of streams and lakes when the herbivores come to drink. Other predaceous insects such as the wasps, robber-flies and dragon-flies, live active lives and seek their prey on the wing.

Above the general surface of the prairie vegetation no invertebrates live permanently, unless the parasites, external and internal, of the swifts and swallows can be so considered. Winged forms frequent this region during flights in which they find food and mates. Spiders, by their cottony "balloons," utilize the winds and are thus transported. All of these are transients, and not permanent inhabitants of the open area.

3. *Interrelations within the Prairie Association*

In concluding this discussion of the conditions of life on the prairie, we may profitably consider some parts of the network of interrelations which bind together the animals and the environment. As the kinds of animals and the number of factors involved are so numerous, only a few selected animals will be considered. In this choice I have not limited myself solely to the kinds taken at Charleston, but have utilized common and well known prairie animals. As representatives of the soil-inhabiting forms the white-grubs and May-beetles (*Lachnosteria*) and the corn-field ant (*Lasius niger americanus*) have been chosen; as representatives of those which live above the surface and mainly among the vegetation the differential grasshopper and *Bombus* have been chosen; and as representatives of the active predators and parasites, *Promachus*, *Chlorion*, *Tiphia*, and the parasitic fungi *Empusa* and *Cordyceps*. Statement of the available supply of water

and oxygen, the temperature, etc., is omitted for simplicity, not because these matters are unimportant. Some of the main features of these interrelations are summarized in the following diagram, Figure 16. This shows that the white-grubs living in the soil and devouring the roots of plants are preyed upon in turn by an aggressive fungus (*Cordyceps*) and by a wasp (*Tiphia*)—an external parasite; and that *Tiphia* is parasitized in turn by *Exoprosopa* and by the larva of the small beetle *Rhipiphorus*. The adult May-beetles feed upon the leaves of trees, and although many show a decided preference for trees living in the open, as the cottonwood and willows, others feed largely upon forest trees. Thus the prairie animals exert a direct influence upon the forest community as well as upon the prairie. The differential grasshopper feeds upon the vegetation, and jumps or flies into the webs of *Argiope*, where it may be killed even if it should not be eaten. The eggs which this grasshopper lays in the soil are devoured by the larvæ of *Chauliognathus* and *Epicauta*, and the adults are killed by the fungus *Empusa*, or mutilated by the mite *Trombidium*—an external parasite (Pl. XXI, figs. 1 and 2). The rusty digger-wasp, *Chlorion ichneumoneum*, feeds upon the nectar and pollen of flowers, and provisions its burrows in the ground for its larva with grasshoppers (*Orchelimum*); this larva, again, is probably devoured by the small parasitic fly *Mctopia*. The larvæ of the soldier-beetle *Chauliognathus* are predaceous, and eat other larvæ; thus they influence many species; the adults frequent flowers as pollen-feeders. Although *Epicauta* devours eggs of grasshoppers during its larval stage it feeds upon vegetation in the adult stage. The larvæ of *Bombus* live upon nectar and pollen supplied them by the female or worker, and the adult is also a nectar- and pollen-feeder, *Bombus* thus being solely sustained by vegetation. They are preyed upon by a host of predaceous enemies, as *Phymata* and *Promachus*; and parasites, including the flies *Frontina*, *Brachycoma*, probably *Conops*, and the false bumblebee (*Psithyrus*); their nests, moreover, form a habitation for a great variety of insects, mites, and other animals too numerous to be put in the diagram. These bees, then, on account of their large size, their large colonies, and the large amount of concentrated food which they amass at the nest, combine to make themselves attractive to a great number of animals, and become the hub of a busy microcosm, an extensive community of mutually interrelated kinds.

The root-louse of grass, *Schizoneura panicola* Thos. (Forbes, '94, pp. 85-93), through the attention of several kinds of ants, *Lasius niger americanus* Emery, *L. flavus* De G., *L. interjectus* Mayr, and *Formica schaufussi* Mayr, is cared for from the egg to the adult stage; these ants keep the plant-lice on fresh roots from which they suck their food.

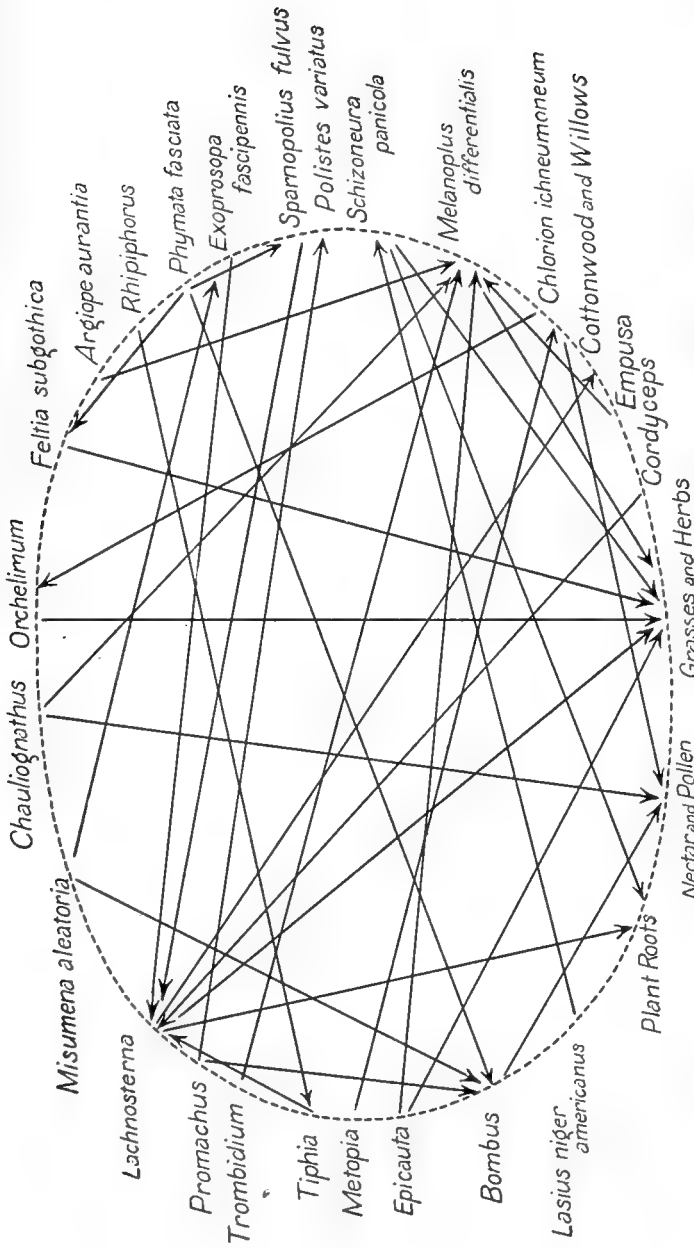


Fig. 16. Diagram showing the complex network of interrelations among prairie invertebrates, as shown by their food relations. The arrows point toward the food of the animal.

In return the ants secure honeydew and wax from the lice. A closely related aphid, *Schizoneura corni* Fabr. lives from "September until June on the dogwood (*Cornus*), and from June until September on the roots of certain grasses" (Forbes, l. c., p. 89). This insect, upon the original prairie, was probably an inhabitant of the forest margin, or lived near moist places where dogwoods abounded. (This point should be determined at some favorable locality.) In such a complex, interwoven community as that of the prairie it is immaterial where one takes up the thread of relations, for if followed carefully without interruption it will lead one about, from one animal to another successively, until the intimate life of every animal and plant in the community has been reached, and influenced to some extent. Thus the animals living in the soil, at the surface, and among the vegetation are bound together, not only by their changes of habitats, as when a subterranean maggot matures and becomes a flower fly, but also by their movements, as when an active wasp or grasshopper burrows in the soil, so that there is a complex interpenetration of relations which extends to all depths, to all horizontal relations, and binds together the entire social community.

In this discussion only the invertebrates have been considered, but this phase of the subject should not be concluded without emphasizing the fact that all the organisms of a region form a single biotic community, each member of which is related to all the others and to the physical environment.

IV. THE FOREST ASSOCIATIONS

I. Introduction

In a study of forest animals their relation to the physical and vegetational environment must be kept constantly in mind, in order that their progressive changes may be clearly understood. If the woodland animals and associations are considered broadly, it is possible to study the progressive transformation of the habitats and associations by agencies which erode the land and thus develop the drainage, and to combine with this a study of the successive changes in the vegetation (including vegetable products). In the Charleston region this transformation includes the progressive invasion of the prairie by the forest. From this standpoint it is also possible to arrange the forest associations in a genetic series.

There is little doubt that this entire region was once treeless or prairie, that in time the forest invaded it, mainly or almost exclusively along the streams. Even at the time of settlement the forests had not spread far from the larger streams; but by normal forest extension and

drainage development the prairie was encroached upon and restricted. The trees farthest from the streams, speaking in general terms, may be looked upon as the pioneer guard of the extending forest. Such trees are oaks and hickories of various kinds, which are hardy and able to live on wet, acid, or very dry soils, as, for example, the shingle oak (*Quercus imbricaria*) and post oak (*Q. michauxii*=*minor*). In the Charleston area all such forest remnants are so closely pastured that they were not studied; therefore our series is incomplete. The upland forest in the Bates woods (Station IV, *a*) may be considered somewhat representative of a *second* stage in forest development. This, however, is not a primeval condition, but one which has been modified by man; for example, the mature trees have been removed. It is, however, clearly an oak-hickory forest.

A *third* stage in forest development is found upon the bottom, nearer the river, the most favorable habitat for tree growth in the region, where the red oak (*Quercus rubra*) and hard maple (*Acer saccharum*) form a dense, humid shady forest—a climax mesophytic forest. With these changes in the vegetation there have been corresponding changes in the physical environment. The relatively open oak-hickory forests are dry, both in the air and in the ground; they are well lighted; they are warmer and cooler relatively; and they have soil which contains less litter and humus. Fallen trees and stumps decay more slowly on account of the dry environment. As the open woods become closed by the development of a dense forest crown, these conditions are changed in important ways: the woods become progressively darker, more stable in temperature, more humid in air and soil; the litter and humus increase; and all wood decays more rapidly both on account of the moisture, fungi, etc., and the activity of animals. The earlier stages in forest development result in the combination of glade and grove—*islands of open, and islands of trees*—but with the extension of the forest by its encroachment upon the glades the forest crown becomes complete and continuous, and a climax forest has become established. These relations show what kind of factors must be considered in striving to group forest habitats in a developmental series.

The forest associations are here considered in the same sequence as that given in the description of the forest stations, and for this reason the discussion will be brief, being mainly intended to give a uniform treatment to all the animal communities studied about Charleston. A more general discussion of the ecological relations of our common forest invertebrates follows.

2. Dry Upland (*Quercus* and *Carya*) Forest Association

The upland oak-hickory forest community is upon high well-drained land. It is bordered by a ravine and a valley, so that the precipitation drains away rapidly. The soil, in contrast with that of the black soil prairie, is a gray loam, containing little organic debris. Through clearing, the woods have become relatively open, so that the sunny spots are rather numerous. The characteristic vegetation consists of oaks and hickories, such as white oak (*Quercus alba*), black oak (*Q. velutina*), shag-bark hickory (*Carya ovata*), pignut (*C. glabra*); and of rose, raspberry, sassafras (*Sassafras variifolium*), sumac (*Rhus glabra*), young trees, horsemint (*Monarda*) everlasting (*Antennaria*) and tick-trefoil (*Desmodium*). The conditions are those of Station IV, *a*, the upland Bates woods, and the open ravine slopes, IV, *b*.

Representative animals of this community, including numerous ground-inhabiting *Orthoptera*—many of the acridiids being short-winged forms—are *Dichromorpha viridis*, *Chloealetis conspersa*, *Spharagemon bolli*, *Melanoplus atlanis*, *amplectens*, *obovatifemnis*, and *scudderi*, *Scudderia furcata*, *Microcentrum laurifolium*, *Orchelimum cuticulare*, *Xiphidium nemorale*, *Nemobius fasciatus* and *maculatus*, *Apithus agitator*, *Cicindela unipunctata*, *Calosoma scrutator*, *Chrysochus auratus* (on dogbane in an open area), *Myrmeleomida*, and *Sphacrophthalma*. Several species of butterflies were seen on the wing in the sunny openings. A number of cecidomyid and cynipid galls on oaks and hickories are more characteristic of the upland forest than of the lowland forest on account of paucity or absence of white and black oaks and hickories upon the bottoms. Other upland plants determine in a similar manner the presence of other animals.

As a forest develops, upon what has previously been a treeless tract, and as wood therefore becomes an available animal habitat, a very complex factor is added to the environment. Not only is a log food for certain animals, but also, if it lies upon the ground, it affords conditions favorable for still others. It tends to conserve moisture under it, and as it decays and disintegrates, fungi grow upon and in it; hence other food is produced for animals which are not eaters of wood. As decay progresses, furthermore, the log itself readily absorbs and retains moisture, thus giving to some animals within it a habitat with atmospheric conditions of relatively high humidity, in which land mollusks, diplopods, etc., thrive. Such conditions furnish an important factor in the extensive range of certain animals throughout several kinds of forest; for though the kinds of trees may change, nevertheless

when once the log habitat is developed certain animals are able to persist. Nor is the log the only factor of this character in the forest; the moist soil, abounding in vegetable debris, has a similar influence; and besides, when once a dense canopy is developed the retarded evaporation and the shade, with the accompanying reduction in heat rays, have a marked influence. The presence of logs and vegetable debris upon the forest floor determines to a very important degree the presence of the land mollusks, diplopods, *Termes*, *Galerita janus*, and *Meracantha contracta*; it determines, upon the slopes (Station IV, *b*), the presence of *Ischnoptera*, *Melanotus*, *Passalus cornutus*, and *Scolecocampa liburna*.; and it probably determines, too, many of the ants on the upland and on the forest slopes. Among the forest shrubby growth and tree trunks *Epeira verrucosa* and *Acrosoma rugosa* (and probably *spinca*) spread their webs and appear to thrive only in deep shady woods. A large number of butterflies and moths feed upon the foliage of forest trees, being thus distinctly arboreal, as are also *Cicada* (nymph, subterranean), *Diapheromera*, *Calosoma scrutator* (predaceous), *Tremex columba* (and its parasite *Thalessa lunator*), and *Cyrtophyllus perspicillatus*. *Geotrupes splendidus* is a ground scavenger. The presence of *Ammophila abbreviata* is due to the presence of numerous caterpillars on the foliage.

3. Artificial Glade Community in Lowland Forest

In the dense humid lowland forest of the Bates woods (Station IV, *c*) a small open area has been formed by cutting; an artificial glade, as contrasted with a natural open forest. This may be considered an experimental glade. Although it is on the river bottom and completely surrounded by a dense forest community, it is clearly not related to that community, but rather to the open upland forest, and for this reason is here interposed between the discussion of the upland and lowland associations.

The glade was about 25 feet in diameter; only on the north side, where the sun had the best access, had brush (sassafras) made much progress in closing the borders of this open area. It was therefore in direct communication with the dense surrounding lowland forest. Such a small glade permitted direct sunlight on the ground only during the middle hours of the day, and it was during this time that animal life was most active. On account of the dense shade of the surrounding forest there was little undergrowth, but in parts of the glade there was a dense growth which covered the ground. It was composed of grasses, large masses or colonies of *Eupatorium caelestinum* in flower, *Actinomeris alternifolia*, with wood nettle (*Laportea cana-*

densis), and clearweed (*Pilea pumila*) surviving as relics of the lowland forest vegetation.

Representative animals of this community are the following: *Misumena aleatoria*, *Lycosa scutulata*, *Epeira domiciliorum*, *Aulacizes irrorata*, *Jalysus spinosus*, *Dichromorpha viridis*, *Melanoplus amplectens*, *gracilis*, and *scudderi*, *Amblycorypha rotundifolia*, *Conocephalus nebrascensis*, *Orchelimum cuticulare* and *glaberrimum*, *Xiphidium nemorale*, *Nemobius fasciatus*, *Acanthocerus galeator*, *Autographa precatationis*, *Epargyreus tityrus* (larva on sassafras), *Deromyia discolor*, *Milesia ornata*, and, apparently as wanderers from the forest, *Calopteron reticulatum*, *Thalessa lunator*, and *Pelecinus polyturator*.

4. Humid Lowland (Hard Maple and Red Oak) Forest Association

This lowland forest community is upon a well-drained but moist slope of the valley of the Embarras River. The soil is damp, and contains a large amount of vegetable debris. The forest canopy is complete, and the forest is relatively dark. Representative trees are the hard maple (*Acer saccharum*), red oak (*Quercus rubra*), and the elm (*Ulmus americana*); the herbaceous plants are nettle (*Laportea canadensis*) and the clearweed (*Pilea pumila*).

Representative animals are the various forest mollusks, *Epeira trivittata*, *Acrosoma spinea* and *rugosa*, *Acarus serotina*, *Bittacus stigmaterus* (and probably *strigosus* and *apicalis*), *Asophes memnonius*, *Calopteron terminale*, probably *Thalessa lunator*, *Pelecinus polyturator*, and *Tapinoma sessile* and other ants. *Boletotherus bifurcus* is dependent upon the shelf-fungus *Polyporus*, which grows most abundantly on decaying stumps and logs in moist woods. The species of *Bittacus* are as representative of shady, moist woods as are the nettle *Laportea* and the clearweed (*Pilea*). Such an insect as *Bittacus* might live in the park-like groves of an open forest, but its optimum habitat is in the dense climax forest. Perhaps the most striking contrast between the open and closed shady forest is due to the absence of numerous *Orthoptera* which are generally abundant in open grassy places. That these forms are able to thrive on the bottoms when the proper conditions are present is seen by their abundance in the glade in the lowland forest. In the uplands also, *Papilio* and *Polygonia* frequent the open spaces, but in the shady lowland forest the slow, low-flying *Enodia* and *Cissia* are the characteristic butterflies seen on wing.

[5. *Animal Association of a Temporary Stream*]

The prairie animal communities were arranged in an order to aid in looking upon the prairie habitats as so many different degrees or stages in the progress of drainage development, this being a dominant physical environmental factor upon the prairie. Similarly, the forest communities are easily arranged in a developmental sequence dependent upon the combined influence of the progress of erosion and drainage and the advance of forest upon the prairie. Thus the prairie and forest are given an orderly sequence, and the only remaining important habitat, in the region examined, is that of the stream series.

Very little time was devoted to the study of the stream animals, and mention of it is made here mainly because of this opportunity to show the harmony and continuity of treatment which it is possible to give to all the habitats and communities of a limited forested region.

This small temporary stream formed the southern boundary of the area which was studied in the Bates woods. It formed Station IV, *e*, and is an early stage in stream development. To understand just what this means it is necessary to consider the processes which have been in operation and which have reached the present stage of stream development. This stream flows in a steep-sided ravine cut in the unconsolidated glacial deposits which form the sides of the Embarras valley, a ravine between 75 and 100 feet deep when it enters the valley, which narrows rapidly, turns to the northwest, and soon ascends to the surface of the upland oak-hickory forest. The upper parts and head end of the ravine are dry, except during rains and soon after; but the lower part may retain water in the basins for a number of days after rains.

The same conditions which we now find at the head of this ravine once existed at the edge of the valley. That is, at one time there was no ravine in this region. As the rainfall from the uplands flowed over the edge of the valley it started a small gully; this, once formed, became the trail for waters of other rains, each shower tending to cut the ravine deeper and wider and to advance it into the upland. This process has continued until now the head of the ravine has cut back about one half of a mile. The unconsolidated debris is not composed of homogeneous materials, and has therefore been washed away more rapidly at some places than at others. In this manner pools have formed where less resistant materials were, and between these pools, over more resistant gravel or stone, miniature cascades or rapids have been formed, the tendency thus being towards an alternation of pools and cascades. In these pools Mr. T. L. Hankinson took a number of vertebrates, and upon the surface of the pools were many water-striders, *Gerris remigis*. From the burrows along the margin of the

stream Mr. Hankinson secured *Cambarus diogenes*. Thus by the growth of this ravine a new community is developing at this place—that of a temporary stream.

In time such a stream will cut down to ground-water level, the pools will become permanent, and a constant current will be maintained between the pools, and a permanent stream will become established. The manner in which this ravine and stream grow, at the expense of the upland forest, is an indication of how the upland forest may be changed and by degrees become converted into a lowland forest and even into an aquatic habitat.

V. RELATION OF THE DECIDUOUS FOREST INVERTEBRATES TO THEIR ENVIRONMENT

We have seen that the forest should be looked upon as a thick layer of vegetation in its effect upon the physical conditions which influence animal life. This thick layer is of relatively slow growth, and in its early stage it is composed of shrubs and young trees. But “as the vertical extent of the forest increases and the forest crown migrates upward, the intervening trunk, bark and branch habitat . . . enlarges and the leaf-eating inhabitants of the forest crown rise upward. This crown fauna retains or rather continues some of the characteristics found at the marginal zone, with which it retains direct continuity” (Adams, '09, p. 162). In addition to this vertical upward migration of the forest crown, the forest also tends to spread laterally, by arms or peninsulas of forest, which expand upon the open, or by the excentric growth of groves, which in time fuse and form a continuous forest. The original forest margin and adjacent prairie was characterized by “groves”, as they were commonly called by the early settlers, and also by more or less open woods or “oak openings,” which are the homologs of the open oak forests yet found on the Illinois sand areas. This interdigitation of forest and prairie produced peninsulas of forest extending into the prairie, peninsulas of prairie extending into the forest, islands of prairie surrounded by forest, and islands of forest surrounded by prairie. Where the forest was advancing, the open places or glades are to be considered as prairie relics; and when the prairie was for any reason encroaching on the forest the forest is to be considered the relic. The glade and the grove are thus comparable communities, and are to be considered as relics or pioneers according to the direction of advance of the local association. The development of adequate drainage and all that is associated with this process, the character of the soil, the extension or retreat of the forest, the changes in composition of the forest, and the kinds of

animals composing the communities are the dominating influences in the woodland environments. In the Charleston area the soils are loam, and therefore sand need not be considered. The forests are of two main types, the oak-hickory of the uplands and the red oak-maple of the lowland. At present the forests are declining; in fact, the lowland Bates forest has been converted into a corn field since these studies were made.

The kinds of animals present in the woods are strikingly different from those of the prairie, as is seen almost at a glance, and as is quite clear by a comparison of the annotated lists of the prairie and forest animals. Prolonged study will probably serve to enhance this difference. A small number are found both in the forest and upon the prairie, but this is the marked exception. Furthermore, the open oak-hickory woods, and the glade-like clearing which furnishes an open habitat within the woods, contained a vast majority of the animals found common to the prairie and the forest. These animals are to be looked upon as pioneers (or relics) of the prairie, and are not to be confused with the dense forest inhabitants. On a previous page attention was called to the vast importance of the marked discontinuity which exists between the kinds of animals living in the open and in the forest. This distinction is so marked as to merit comparison with the contrast existing between land and fresh-water animals. Possibly *on land* it ranks second only to this in its fundamental character. When the same kind of animal lives both in the open and in the forest, it often behaves differently in the two situations. It is significant that it required more than a generation for the southern woodland human pioneers of Illinois to change their behavior sufficiently for life on the prairie. Undoubtedly there are many examples of just such changes in behavior.

I. *Forest Soil Community*

The animals of our woodland soils have not been specially investigated. Many observations on the life histories of soil invertebrates have been recorded, but not as much is known of them as of prairie soil animals because of the smaller numbers which attack cultivated crops. Undoubtedly the native underground inhabitants of raspberries, currants, blackberries, and other wild shrubs have continued to thrive on the cultivated kinds (see Webster '93 for a paper on raspberry and blackberry insects), and the same is true of the crab-apples and the haws. Few subterranean animals, however, inhabiting these shrubs and trees of the forest have been studied in detail, with the notable exception of the periodical cicada. It is very probable that a number of animals which lived in the prairie soil continue to do so in

the forest glades; and many ground-inhabiting *Orthoptera* in the forest oviposit in the soil as do their congeners on the prairie. On Isle Royale, Michigan, I found that the carabid beetles which lived in the openings were likely to extend into the coniferous forest in the humus layer, which corresponds to this habitat in the open, and this is probably true to some degree in Illinois forests.

In the denser forest, in marked contrast with the prairie, there is generally a large amount of litter on the forest floor. The prairie soils are dark, but the surface contains a relatively smaller amount of organic materials comparable to forest litter. In the forest, however, though the sub-surface soil is relatively light in color, the surface contains much fresh and partially decayed organic debris.

McAtee ('07) has made a careful count of all the invertebrates found upon an area of four square feet of the forest floor, at or near the surface. This is the only quantitative study made of our forest soil animals known to me. His observations were made during the hibernating season.

Representative plant-feeding ground animals are the two cicadas *linnei* and *septendecim*, which suck sap from the roots of trees. Their underground enemies seem to be largely mites. The arboreal habit of the adults subjects them to many enemies. The periodical cicada, as the result of subterranean life, in the moist soil, displays little resistance to drying, and when exposed to the air soon shrivels, as shown by Marlatt ('07, p. 123). When conditions in the soil are unfavorable (l. c., p. 96) as the period of emergence approaches, some individuals respond by building a mud tube, similar to the crawfish chimneys, which are closed with a plug of mud. That saturated ground seems to be an unfavorable condition at this stage suggests that resistance to the lack of oxygen decreases as the insect matures. Most of the nymphs of this species live within less than two feet of the surface, though some rather inconclusive observations indicate that the nymphs have a wonderful resistance to submergence, as is shown by the following quotation from Marlatt ('07, p. 125): "A curious feature in connection with the underground life of this insect is the apparent ability to survive without injury in soil which may have been flooded for a considerable period. Doctor Smith records a case of this kind where a gentleman in Louisiana in January, 1818, built a milldam, thus overflowing some land. In March of the following year the water was drawn off and 'in removing a hard bed of pipe clay that had been covered with water all of this time some 6 feet deep the locusts were found in a fine healthy state, ready to make their appearance above ground, that being the regular year of their appearance.' Another case almost exactly similar is reported by Mr.

Barlow. In this instance the building of a dam resulted in the submerging of the ground about an oak tree during several months of every summer, ultimately resulting in the death of the tree. This went on for several years, until the dam was washed away in a freshet, when digging beneath the tree led to the discovery of the cicada larvæ in apparently healthy condition from 12 to 18 inches below the natural surface of the ground. In both of these instances the ground may have been nearly impervious, so that the water did not reach the insects nor entirely kill all of the root growth in the submerged soil."

The roots of plants, and particularly those of trees, penetrate rather deeply into the soil, but finally die, leaving a large amount of organic substance in the soil. As the large roots decay, animals are able through the tunnels made to penetrate rather deeply and to find organic food, in the shape of wood and fungi. Motter ('98, p. 225) performed an interesting experiment which shows that wood buried three feet below the surface and dug up after two or three months contained spiders, mites, *Thysanura*, psocids, a beetle, and flies. Although this wood was buried in a cemetery, it is not unlikely that woodland soils commonly have such a fauna. Davenport ('03, pp. 22-23) has tabulated the habitats of many *Collembola* and shows that many species live in damp soil, in sand, under bark, under stones, in caves, etc.—conditions corresponding to the soil habitat. These insects are very sensitive to moisture, and some are able to resist submergence in sea water from twelve to sixteen hours per day. Davenport says (page 17): "During all but about six to eight hours of the day these air-breathers are below the surface of the sand, during which time they must take in relatively little oxygen." During certain seasons, when the soil is saturated, such resistance must be of great value to its possessor. I know of no extensive observations or experiments on the resistance of these soil animals to carbonic acid, to the lack of oxygen, or to various combinations of these conditions.

That the soil conditions in glades and forests are different has already been pointed out. We have below a good example of the response of a forest animal to an artificial glade or clearing. A number of observations have also been made on the hastened rate of emergence of the periodical cicada where the soil has been abnormally warm, as in a hothouse (Schwarz, '90a, p. 230), or where the ground has been warmed by flues (Marlatt, '07, p. 90), or where a forest has been burned, and possibly the heat from the fire in combination with its greater absorption of heat after the fire, has caused the cicadas to emerge (Marlatt, '07, p. 94). In a forest glade, made by clearing, Schwarz ('90a) found the cicadas emerging when none were found in the surrounding woods. Concerning this discovery he remarks:

"Now, a clearing made in the midst of a dense forest forms a natural hothouse, the soil receiving much more warmth on such places than in the shady woods. We should thus not wonder to see the Cicada appear earlier on such cleared spaces than in the woods." There is therefore reason to expect the season to be more advanced in glades than in the surrounding woods.

The peculiar fossorial fore legs of the cicada nymphs are marked structural features associated with the subterranean habitat. Very naturally, too, cleaning reactions are correlated with such a burrower, whose legs become begrimed with the soil.

Near the surface of the soil the variety of animal life is greatly increased. Not only forms which inhabit the soil regularly are present, but many live here for short periods as adults or during some immature stage. It is not possible to draw a sharp line between the soil community, the humus layer community, and the community of the decayed and solid wood for these reasons: the slightly decomposed organic debris on the surface is progressively renewed by leaves, stems, branches, and animal remains, and is transformed below into the humus layer; this also grades upward by all degrees, through decaying wood into solid wood, and on to the living trees. The acidity of leaves during the early stages of decay and their alkalinity at an advanced stage is a fact of great importance, as has been shown by Coville ('14). This suggests the paucity or absence of animals in dense matted layers of decaying leaves.

In considering the animals that live on or near the surface of the soil in Bates woods, certain species seem more characteristic of rather bare mineral soils, others are more representative of open oak-hickory woods, and still others are representative of much humus. The acridiid locusts found in these woods, such as *Chlocaltis conspersa* and *Melanoplus amplectens*, are woodland rather than prairie in their haunts, and are commonly found near the bare soil and oviposit in it. Here live the woodland cricket *Apithus*, the tiger-beetle *Cicindela unipunctata*, the scavenger *Geotrupes splendidus*, the mutillid ant *Sphacrophthalma*, the wasp *Psammochares athiops* and *Lycosa*; and *Ammophila abbreviata* buries its eggs here in the soil.

Among the loose litter harvest spiders (*Liobunum*) were found running about, although they are not confined to these conditions, for, like *Calosoma scrutator*, they climb trees. The crickets *Nemobius* found here seem to avoid bare soil. The larva of the beetle *Merantha contracta* was found among decaying leaves.

The animals living in the humus layer of the soil, and in the much advanced stages of decayed wood, are not wholly identical, because in the humus layer roots of living plants and fungi are so often available

for food. On the other hand, many of the inhabitants of decayed logs, as snails and slugs, use the log as a retreat and sally forth at night and during moist weather to devour vegetation. Rotten wood also contains many fungi affording fresh, living plant tissue.

Representative animals of the forest litter, especially of its humus layer, appear to be certain millipeds, as *Callipus* and *Cleidogona*. Cook ('11b, p. 451) has said of them: "Nearly all the members of the group have essentially the same habits and live in clearly similar environments. They pass their lives buried in the humus layer of the soil or among the dead leaves or other decaying vegetable matter that furnishes them food." Elsewhere he says ('11c, p. 625): "In nature at large the millipeds have a share in the beneficial work of reducing dead plant material to humus. Prussic acid and other corrosive secretions may aid in the precipitation of colloidal substances in the humus, in addition to the protection that they give by rendering the millipeds distasteful to birds and other animals that otherwise might feed upon them. The precipitation of colloids enables the millipeds to keep their bodies clean and protects them against the clogging of their spiracles." Diem ('03, pp. 383-386) gives a good summary of the habits and foods of certain European diplopods. I am inclined to consider the layer of litter as the habitat of the immature panorpid *Bittacus*, of which three species were found in the Bates woods. The adults fly about among the low vegetation much after the manner of the *Tipulidæ*, with which they are easily confused when on the wing. It is probable that the larva of *Panorpa confusa* West. has habits similar to those of *Bittacus*. I have taken the adult of this species but once—at Bloomington, Illinois, August 23, 1892, in dense damp woods. The larvæ of *Panorpa* are predaceous, and this is probably true of *Bittacus*. The ant *Stigmatomma pallipes* is another representative of this community (cf. Wheeler, '05, p. 373), as are probably also a number of tipulid larvæ.

The animals of the humus layer appear to live much more active lives than those deeper in the soil. This activity in itself allows them a chance to secure the necessary supply of oxygen, which tends to be deficient among the decaying vegetation; at the same time, moreover, their movements must aid in the ventilation of the soil. It is of interest to observe that millipeds abound in a habitat relatively deficient in oxygen, abounding in carbonic acid, and are producers of prussic acid (HCN), whose physiologic effect is to inhibit oxidation and nutrition. Roth (Diem, '03, p. 385) submerged some diplopods in water from six to eight hours and they survived. (For the marked resistance of geophiloids, see Ent. News, 24: 121.) In nature they must often meet with such conditions in the soil. One of the most abundant kinds

of myriapods in the debris on the forest floor is *Spiroboldus marginatus* Say, taken in Urbana, Ill., in the Brownfield woods October 15, 18, and May 23 (many specimens), and in the Cottonwood forest October 8 and 13; at White Heath, Ill., May 26; at Riverside, Ill., August 23; at Tonica, Ill., in September; and at Bloomington, Ill. This is the common large brown diplopod, our largest myriapod. Another large and abundant species is *Fontaria virginiensis* Dru. This is largely brown dorsally, with marginal triangular yellow spots, yellow below. A chilopod, *Bothropolys multidentatus* Newp., was taken in the Brownfield woods October 18; and in woods at Monticello, Ill., in June (M. Waddell), with *Otocryptops sexspinosus* Say. In the Brownfield woods it was taken October 15 and 18; and here also *Polydesmus serratus* Say was taken May 23. *Callipus lactarius* Say was taken in the Cottonwood forest previously mentioned, October 8 from decayed logs, and in the Brownfield woods October 15, associated with *Scytonotus granulatus* Say and the chilopod *Lithobius voracior* Chamb. (No. 491, C. C. A.). These predaceous kinds must be considered important members of the humus and rotten-log communities, and are somewhat comparable to the predaceous clerid beetles upon the living tree trunks in their influence upon the community. They are, however, very sensitive to moisture and live in a humid atmosphere among damp debris. Shelford ('13b) has shown that *Fontaria corrugata* Wood is very sensitive to moisture. *Myriapoda* are infested by a number of gregarine parasites (Ellis, '13, pp. 287-288).

The following statement by Coville ('14, p. 337) is of much interest: "The importance of myriapods, however, as contributing to the formation of leafmold has not been adequately recognized. In the canyon of the Potomac River, above Washington, on the steeper talus slopes, especially those facing northward, the formation of alkaline leafmold is in active progress. . . . Here during all the warm weather the fallen leaves of the mixed hardwood forest are occupied by an army of myriapods, the largest and most abundant being a species known as *Spiroboldus marginatus*. . . . On one occasion a thousand were picked up by Mr. H. S. Barber on an area 10 by 100 feet, without disturbing the leaves. On another occasion an area 4 by 20 feet yielded 320 of these myriapods, the leaf litter in this area being carefully searched. Everywhere are evidences of the activity of these animals in the deposits of ground-up leaves and rotten wood. Careful measurements of the work of the animals in captivity show that the excrement of the adults amounts to about half a cubic centimeter each per day. It is estimated on the basis of the moist weight of the material that these animals are contributing each

year to the formation of leafmold at the rate of more than 2 tons per acre."

The burrows of earthworms aid in the ventilation of the soil and in carrying down into it vegetable debris, as Darwin long ago observed. In the blackened decayed leaves at Urbana, Ill., on November 18, I found enchytraeid worms abundant, and in the adjacent soil, below a decayed log, a *Diplocardia* (No. 547, C. C. A.).

In the Brownfield woods at Urbana, among the dead leaves and in logs during the cool season hibernating females of the white-faced hornet, *Vespa maculata* Linn. (Pl. XXI, fig. 3) are often found. Females were taken from among leaves or in decayed wood October 8, and 12 (in rotten wood), October 15 (No. 491, C. C. A.), and November 9. The Bloomington records of hibernating females are April 23 and October 18. In such situations two ichneumons have been taken in the Brownfield woods: *Hoplismenus morulus* Say on November 14, and *Ichneumon cincticornis* Cress., November 9; also the two ground-beetles *Anisodactylus interstitialis* Say and *Lebia grandis* Hentz (Pl. XXI, fig. 4) on October 18; and *Ceuthophilus* sp., *Lebia grandis*, *Galerita janus*, the larva of *Meracantha contracta*, and the large black predaceous bug *Melanolestes picipes* H. S. (Pl. XXII, figs. 1 and 2) October 12, under bark and under logs. *Melanolestes* was also found in the Cottonwood forest November 14, with the "slender-necked bug," *Myodochia serripes* Oliv. (Pl. XXII, fig. 3). These examples show how during the hibernating season many animals are to be expected here which at other seasons live in other habitats. *Vespa* is arboreal, as shown by the large nests seen in these woods.

Baker ('11, p. 149) has listed many mollusks found under fallen logs and under bark in the forest of southern Michigan. As various scavengers thrive in this zone, eating not only the vegetable debris, but also the animals which die in it or fall upon it, the digestive peculiarities of these animals are in part a response to the conditions of this habitat. The animal carcasses which fall to the ground are comparable to the similar slowly falling remains which tend to accumulate upon the bottom of bodies of standing water. The student of this community will find of interest Dendy's ('95) paper on animals in the soil, under stones and bark.

2. The Forest Fungus Community

Many fungi grow up through the humus layer and are food for a great number of animals. Still other fungi grow only on and in wood. I will not now attempt to emphasize this difference. The fleshy fungi are very short-lived at the surface, and soon decay or are devoured by various animals. A large number, if not most, of our land *Mollusca*

devour them. On a stump in the upland Bates woods *Zonitoides arborea*, *Pyramidula perspectiva*, and *Philomycus carolinensis* were found upon a felt-like growth of fungi; it is to be remembered, too, that with the other snails lives the snail *Circinaria* which preys upon them. At the time the Bates woods was examined, it was rather dry, so that fungi were not abundant. No millipeds were found on fungi, but Cook ('11b, p. 625) states that "The mouth parts of millipeds are not adapted for biting or chewing, but are equipped with minute scrapers and combs for collecting soft, decaying materials. Dead or dying tissues are preferred. The only living plants that are regularly eaten by millipeds are the fleshy fungi. Some of the native millipeds in the vicinity of Washington, District of Columbia, feed to a considerable extent upon the local species of *Amanita*, *Russula*, and *Lactarius*. Damage is sometimes done to other plants when millipeds gain access to wounded surfaces of roots or cuttings." A horned fungus beetle, *Boletotherus bifurcus*, living on *Polyporus* on stumps, was found in the Bates woods.

At Urbana, Ill., in a dense maple-basswood forest (Brownfield) November 14 I took a very large number of the small mycetophagid beetle *Triphyllus humeralis* Kby. (No. 545, C. C. A.) on a shelf-fungus, *Polyporus tomentosus* Fries, growing on a much decayed log. On the under side of this same kind of fungus numerous tipulid flies were found, some individuals evidently ovipositing. These were determined by Mr. J. R. Malloch as belonging to the genus *Trichocera*. These are flies which thrive in the far north, as in Greenland. One species, *brumalis* Fitch (Lintner's Second Report, p. 243) is found common in forests in the winter season, and even when the temperature is below freezing they are on wing. Such northern forms are likely to be active in winter or vernal farther south. On another shelf-fungus, *Dacalia* sp. taken at Urbana, Ill., I found numerous specimens of *Arrhenoplita bicornis* Oliv. (Pl. XXIII, fig. 2). This is a small greenish tenebrionid in which the males have two large horns on the head. I have the following woodland fungus-beetles taken at Bloomington, Illinois: *Endomychida*—*Aphorista vittata* Fabr., April 14 (A. B. Wolcott); *Erotylida*—*Tritoma thoracica* Say, June 23 (on fungi) and July 26; *T. biguttata* Say (Sept. 21), *Megalodacne fasciata* Fabr., March 7 (A. B. Wolcott); *Nitidulida*—*Phenolia grossa* Fabr. (July 26), *Pallodes pallidus* Beauv., July 2 (on gilled fungus); *Mycetophagida*—*Mycetophagus bipustulatus* Mels. (April 27), *M. punctatus* Say April 18, and June 23 (on fungi); *Tenebrionida*—*Platydemus ruficornis* Sturm. March 13 and June 23 (on fungi), *Diaperis maculata* Oliv. (*hydri* Fabr.) (Pl. XXIII, fig. 1) July 26; *Melandryida*—*Eustrophus bicolor* Say, June 23 (on fungi), and *E. tomentosus* Say,

June 23 (on fungi). In the Brownfield woods at Urbana, Ill., *Penthe obliquata* Fabr. and *P. pimelia* Fabr. were taken under logs October 15 (No. 491, C. C. A.). Ulke ('02, p. 53) says. "*Penthe*, on fungi growing on logs and stumps." *Cratoparis lunatus* Fabr. (*Anthrribidæ*) was taken April 5 and 23, Bloomington, Ill., and August at Havana, Illinois. Figures of some of these fungus-beetles are given in Felt's report ('06, pp. 494-498).

The general animal population of fungi is so extensive, including mites, sow-bugs, myriapods, and mollusks, in addition to insects, that no attempt will be made to summarize it here. The student of Illinois fungus animals will find Moffat's paper ('09) on the *Hymenomycetes* of the Chicago region very helpful. (Cf. von Schrenk and Spaulding, '09.) A few references to zoological papers will aid the student who wishes to give more attention to this interesting and increasingly important economic subject, and a short list follows.

Busck ('02). Mushroom pests.

Hubbard ('92). Insects in *Polyporus volkatus* Peck; and ('97) on the ambrosia beetles.

Johannsen ('10-'12). Mycetophilidæ.

Malloch ('12). Phoridæ in fungi.

Popenoe ('12). Mushroom pests.

Patch ('12). Aphids on fungi, page 179.

Ulke ('02). Notes on food habits of fungus-beetles, of which there are many families, including *Silphidæ*, *Staphylinidæ*, *Endomychidæ*, *Erotylidæ*, *Mycetophagidæ*, *Nitidulidæ*, *Scarabæidæ*, *Tenebrionidæ*, *Melandryidæ*, *Scolytidæ*, etc.

Jäger ('74, I, pp. 245-246) and Möller ('67, pp. 59-60) have given short lists of the German fungus insects.

The subject of fungus insects can not be dismissed without special mention of the ambrosia beetles of the family *Scolytidæ*. These small beetles have been studied by Hubbard ('97), who showed that they rear fungi in their tunnels in wood, these fungi furnishing nourishment to the larvæ and beetles. Each beetle seems to grow its own kind of fungus. They belong to the following genera: *Platypus*, *Xyleborus*, *Corthylus*, *Monarthrum*, *Xyloterus*, and *Gnathotrichus*. The beetles of the genus *Corthylus* live in a variety of hardwood trees, including maple, sassafras, dogwood, etc., and attack living trees. The ambrosia beetles are thus dependent upon fungi growing in the trees. They furnish a very striking example of a mutually dependent association relationship. Hopkins ('99, '93a, '93b) has published much valuable data on the life history, habitats, and enemies of these beetles. A study of them as a biotic community would be very interesting and

valuable, since such a good foundation has already been built by Hubbard and Hopkins.

3. *The Forest Undergrowth Community*

Above the soil, in the layer of herbaceous and shrubby vegetation in the Bates woods, lives a considerably different assemblage of animals from that in the soil. Running about over this vegetation, or resting on it, are found the harvest-spiders, and in webs spread between trees and shrubs are found *Epeira insularis* and *verrucosa*, and *Acrosoma spinea* and *rugosa*.

In the Cottonwood forest at Urbana, cutting has made rather open spaces so that there is considerable undergrowth, including much spice bush (*Benzoin*); among these bushes two spiders thrive, *Epeira insularis* Hentz and *E. domiciliorum* Hentz. The leaf-footed bug, *Lepidoglossus oppositus* Say (Pl. XXII, fig. 4) also abounded on these plants. *Insularis* is also in the Brownfield woods. The jumping spider *Phidippus audax* Hentz, and *Acrosoma rugosa* were also taken in the Cottonwood forest. In a dense shady flood-plain forest at Muncie, Illinois, *Acrosoma rugosa* and *Epeira verrucosa* and *labyrinthica* were taken August 3. The harvest-spiders *Liobunum* are largely animal scavengers, but the true spiders are of course strictly predaceous. The location of the spider-webs, near the ground, attests the flight of insects upon which they depend for food. The numerous snails feed to a large degree upon the herbaceous plants of this lower layer, as do plant-feeding *Hemiptera* and the grass-eating *Lepidoptera*, including the woodland butterflies *Enodia* and *Cissia*, other *Lepidoptera*, and *Eucres*, *Autographa*, *Polygonia*, and, possibly the katydid *Amblycorypha*. In the shrub layer *Epeira domiciliorum*, folded among leaves, is a characteristic animal. It seems to thrive best in more open woods than those in which *Acrosoma* abounds. Nettles (*Laportea*) and clearweed (*Pilea*) were not searched for animals, but were undoubtedly inhabited by a number of kinds. The same is true of the shrubs. Young trees in this layer appear less liable to attack by gall-producing insects than larger trees are.

The following insects feed upon woodland shrubs, and were taken at Bloomington: *Cerambycidae*—*Liopus alpha* Say, June 18 (bred from sumac by Felt, '06, p. 482), and taken by me on elm during June; *Liopus fascicularis* Harr. (*xanthoxyli* Shimer), June, recorded as from prickly ash, *Zanthoxylum* (Packard, '90, p. 659); and *Molorchus bimaculatus* Say, copulating April 17, reported from dogwood, redbud, twigs of maple and hickory, (l. c., '90, p. 293, 424). The curculionid *Conotrachelus seniculus* Lec., was taken October 10, 1891, from the inside of a very ripe papaw at Bloomington; another

specimen was captured during August at Havana, Ill. Felt ('06, p. 582) records *seniculus* as from hickory and butternut. *Attelabus rhois* Boh. was taken July 4, on hazelnut, at Bloomington. It is recorded from sumac, dogwood, alder, and oak.

For lists of *Coccidæ* living on woodland (and other) shrubs see Cockerell ('97).

4. *The Forest Crown Community*

Instead of next turning to the animals of decayed wood on the forest floor, I wish to begin at the other end of a series, with the animals of the *living tree*, and then to follow an order which passes progressively through enfeebled, dying, fermenting, seasoned, and solid wood to all stages of its decay. The decay of a fallen trunk commonly begins with the sap-wood, thus loosening the bark, and extends inward until the whole becomes soft or is changed to brown powdered wood, which gradually changes to humus. This is a series of progressive humification, and, speaking in general terms, follows the course through which all forests tend to pass; although fire, flood, and animals, including man, divert much wood from such a fate.

To investigate such a series fully is far beyond the scope of the Charleston studies, and yet our material, supplemented to some degree, may serve at least to outline one. The difficulties of studying the animals of the forest crown are serious, and so far as known to me no comprehensive work on this community has been done in this country. Many members of it have been studied individually, but the animals have not been studied as a community. About the woodland insects a vast fund of facts has been accumulated in the study of the economic problems of shade, fruit, and forest trees; furthermore, investigations have shown that among the invertebrates insects have a controlling or dominating influence in the forest. But the relations of the other forest invertebrates to the forest crown have received very little attention from our students.

The animals of the forest crown, and particularly those of the foliage, are more exposed to changes of temperature, moisture, wind, and evaporation than those below the crown and protected by it. Within the crown there are, in fact, an upper, exposed part, and the lower, protected part. Many of the animals of the forest crown live relatively free from the influence of the substratum, as other animals in the open water are similarly free from the influence of the bottom. Others divide their time, part of it being spent in or on the earth, and a part of it in the trees. Conditions of poor ventilation, darkness, density of medium, relative stability, excess of moisture, and corresponding conditions in the soil, are here replaced by conditions of

good ventilation, intense light, and changing and a relatively dry medium. The problems involved in these conditions vary accordingly.

The relative scarcity of mollusks and myriapods in trees is in marked contrast with their abundance in habitats in proximity to the soil. In the Bates woods the cherry-leaf gall-mite, *Acarus*, is arboreal, but spiders are almost entirely absent. The walking-stick, *Diapheromera*, is arboreal in part, but its eggs fall to the earth and hatch there. The Severins ('10) have shown that the emergence of walking-sticks from the eggs is influenced to a very marked degree by moisture, dryness being distinctly injurious and moisture favorable. The molting of the young animals seems similarly dependent upon moisture, and may be prevented by keeping them in a "well-aerated breeding-cage" (Severins, '11c). This is another clear case of a forest animal sensitive to moisture. To the fact that there is greater moisture near the soil are therefore related the egg-laying habits and the development of the immature insect, a development in marked contrast with that of the strictly arboreal katydids. Of the katydids, *Microcentrum* and *Cyrtophyllus* are distinctly arboreal throughout life, as the eggs are attached to the twigs, and they are relatively independent of the ground. Curiously the Bates woods specimen of *Cyrtophyllus* was taken among low sprouts. *Amblycorypha*, however, lives near the ground. The cicadas are distinctly arboreal during the imago stage. The larvæ of *Papilio turnus* and *cresphontes*, *Epargyreus tityrus*, *Cressonia juglandis* (and parasite), *Telea*, *Cithronia*, *Basilona*, *Halisidota*, *Datana*, *Nadata*, *Heterocampa*, *Eustroma*, *Ypsolophus*, and the slug caterpillar are all arboreal. Many of these pupate on the branches or among the leaves and do not descend to the earth. The sphingid *Cressonia*, however, pupates in the soil. There is a marked tendency for the *Lepidoptera* to be completely arboreal. Even noctuid caterpillars such as *Peridroma saucia* and its allies, which live during the day on the ground, climb trees at night (Packard, '90, p. 173; Slingerland, '95). Many of the gall-flies are limited to certain kinds of trees and are arboreal, as, for example, the several species of *Cecidomyia* found in the Bates woods. The same is true of certain cynipid gall-makers, such as *Holcaspis*, *Amphibolips*, and *Andricus*. It will be seen that the above-listed kinds are largely defoliators and leaf-gall producers. *Ammophila* is a predator. *Trogus* and the small hymenopters (cocoons) on *Cressonia* are parasitic.

Among the animals which live for a considerable part of their lives in or on the soil and a part in the trees, are the two cicadas, *Calosoma*, *Cressonia*, *Ammophila*, and certain ants, although no special observations were made to learn to what degree the ants patrolled the

trees. The relatively large number of caterpillars present suggests that in this woods they were attended by a large number of parasitic flies and parasitic *Hymenoptera* in addition to predaceous insects. The twig-pruners, *Elaphidion*, are referred to here because they belong to the crown community for at least a part of their lives. For a summary of our knowledge of these beetles reference should be made to Chittenden ('98 and '10,) and to Forbes ('11, pp. 50-53), who gives a summary of their injury to oaks and hickories in Illinois. The oak pruner, *Elaphidion villosum* Fabr. (Pl. XXIII, figs. 3 and 4) was taken by me at Bloomington July 3. It is injurious to hickory, maple, and other trees. The normal duration of the life cycle appears to be one year, but in dry wood this period may be prolonged to four or more years (Hamilton, '87; Chittenden, '10, p. 5)—another example of the prolongation of life in dry wood. Mr. W. P. Flint informs me that *Oncideres cingulatus* Say is a common Illinois beetle, which girdles hickory branches, and that in the dead fallen branch its larva develops. It is reported from hickory and basswood by Hopkins ('93b: 198.)

Additional defoliators of trees taken at Bloomington include *Macrobasis unicolor* Kby. (Pl. XXIV, fig. 2), taken June 27 on the Kentucky coffee-tree, *Gymnocladus*. Other specimens were taken June 4 and 12. Hamilton (Can. Ent., Vol. 21, p. 103) also records this as defoliating locust. The larva of the curculionid *Conotrachelus elegans* Say, taken September 5, is recorded as feeding on the leaves of hickory. The imbricated snout-beetle, *Epicærus imbricatus* Say (Pl. XXIII, fig. 1), was taken June 4, and, copulating, June 27, at Bloomington. It has been recorded feeding upon the leaves of wild cherry, plum, gooseberry, etc.

The nut-weevils may be properly considered as members of the crown population. Of these *Balaninus nasicus* Say was taken August 1 (on papaw) at Bloomington, and during September at Chicago. This is recorded as from acorns, hazelnuts, and hickory-nuts. *Balaninus uniformis* Lec. was taken August 20, 21, and September 21 at Bloomington. This, too, is recorded as from acorns, as also is *B. caryæ* Horn, taken August 27. Miss Murtfeldt ('94) has observed *B. reniformis* ovipositing in acorns and has described the process. This weevil is associated and in competition with the acorn codling-caterpillar, *Melissopus latiferreana* Walsm. These two insects pave the way for a small caterpillar of the genus *Gelechia*, and for a second caterpillar, the larva of the acorn moth, *Blastobasis glandulella* Riley, which feeds on the refuse within the acorn, and is thus a scavenger. The debris of the predecessors is an essential for the one that follows. Hamilton ('90) has given a good account of

the habits of *Balaninus* (Cf. Chittenden, '08). On a previous page mention is made of the habit of the May-beetles (*Lachnosterna*) defoliating oaks.

The invertebrate animals of the forest crown are largely insects, and for this reason some of the treatises on forest insects, and on certain families of *Lepidoptera*, make excellent manuals for this assemblage. Thus Packard's "Forest Insects" ('90) and his monographs on the arboreal bombycine moths ('95; '05; '14) are very essential. In his "Forest Insects" the various kinds of insects are grouped according to the kind of tree and the part of the tree which they inhabit, and thus one can readily find what is given concerning those living upon or in the foliage, buds, fruits, twigs, etc. A somewhat similar arrangement is found in Felt's "Insects Affecting Park and Woodland Trees" ('05, '06). The crown community varies with the kind of trees composing it, as many kinds feed upon a relatively small number of food plants, on allied kinds of plants, or on those of members of the same plant association. The herbivorous species are influenced in variety and abundance by the kind of vegetation; their predaceous and parasitic associates, however, are only indirectly influenced in this manner.

5. *The Tree-Trunk Community*

In an earlier section attention was called to the equable conditions in tree trunks, and to the available moisture in the food of wood-eating insects. The outer growing part of the tree contains the greatest amount of water, insoluble starch, soluble sugar, and other food materials; the heart-wood, on the other hand, is dead and contains only a small amount of water (see Roth, '95, p. 29). In view of these relations it is but natural that the outer parts of living trunks should be subject to attack by more animals than are the drier and less nourishing inner parts. We should expect that young animals would thrive best in the layers of the outer, moister wood, not only on account of the softer wood being less difficult to chew, but also on account of its greater nutriment and the larger supply of water in these layers. The inner parts are thus protected not only by the outer layers, but also by the general inability of many animals to digest dry wood. Many of the insects which live in wood, particularly in dry wood, require several years to attain maturity. This gradual rate of development seems to be due in part to the slowness with which metabolic water is produced by the growing larvæ. There are many cases recorded in which developing larvæ have apparently been delayed in maturing for many years by living indoors and in dry wood. Weismann ('91, p. 48) has published an interesting case of *Buprestis splen-*

dens which emerged from a desk which had been in use for thirty years. He suggests that such prolonged lives are a kind of starvation sleep analogous to winter sleep. McNeil ('86) records that the beetle *Eburia quadrigeminata* (Pl. XXVIII, fig. 5) emerged from a doorstep in a house which had been built nineteen or twenty years, and Packard ('90, pp. 687-688) records the emergence of the wood-boring beetle *Monohammus confusor* Kby., which came out of a piece of pine furniture which had been in use "for fully fifteen years." Felt ('05, p. 267) states that instances are recorded of *Chion cinctus* (Pl. XXVIII, fig. 2) emerging from wood several years after the furniture had been manufactured. The prolongation of the life cycle of *Elaphidion villosum* (Pl. XXIII, figs. 3 and 4) in dry wood is another case bearing upon this point. Other similar cases are known which show that larval life is greatly prolonged in dry wood, or that the adult in such conditions lives for many years. In such cases it is not known just when the adult transformed.

Animals which live in living bark and living wood are in some cases, with regard to moisture and to air, subject to peculiar conditions brought about by the sap of the tree. In the case of hardwoods the sap is watery, and in conifers the pitch or turpentine is gummy and easily mires feeble insects, or suffocates them. Why is it that in hardwoods, such as maple and box elder, all wood- and bark-boring insects are not flooded in their burrows and drowned by the flow of sap in the spring? I do not know how many factors are involved in this problem. The gummy exudation on peach and cherry trees is evidence of the influence of insects upon the flow of sap. Where sap flows from trees many insects, particularly flies and *Lepidoptera*, are attracted to and feed upon this fluid. Felt and Joutel ('04, p. 17) state that the grubs of some members of the beetle genus *Saperda* feed upon the sap, but they do not give the evidence for their opinion.

In the coniferous trees the flow of pitch has a marked influence upon the bark-inhabiting scolytids. Hopkins ('99, pp. 404) says of the pair of *Dendroctonus frontalis*, which work together to establish the brood, that "In this operation in healthy living bark filled with turpentine, it is necessary for one of the beetles to move back and forth in the burrow continually in order to keep it open and push back and dispose of the borings and inflowing turpentine. . . . From the time they penetrate the outer layer of living bark there must necessarily be an incessant struggle with the sticky, resinous mass which is constantly flowing into the burrow and threatening to overcome them." The larva of another bark-beetle, *D. terebrans*, is able to live in this sap. Thus Hopkins (l. c., p. 418) says: "This social brood chamber is often extended down towards or even into the bark of the

roots in such a manner as to hold the turpentine flowing into it. Thus the larvæ are often completely submerged in the viscid substance, which does not appear to interfere with their progress." There are thus marked differences in these beetles in their response to sap. As a result of utilization of the knowledge of this difference, the larvæ sensitive to an excess of sap may be killed in trees by diverting a large amount of it into the infested bark. This plan was proposed and practised by Robert on conifers as quoted by Packard ('90, pp. 29-30); and by Hopkins ('99, p. 391) for the elm. By "cutting narrow strips of bark from the trunks of infested elms, the Scolytids were either killed or driven out by the increased vigor of the tree and the greater flow of sap which it is well known will result from this treatment."

The trunk of a tree is of such a substantial nature that it can not be destroyed at once by animals. Such durability furnishes an opportunity to see how one kind of insect prepares the way for attack by others, as is shown by the following examples. The elm borer, *Saperda tridentata* Oliv. (Pl. XXIV, figs. 3 and 4), invades weakened trees, and it is followed (Felt, '05, p. 70) by the weevils *Magdalis armicollis* Say (Pl. XXV, figs. 1 and 2) and *M. barbata* Say, *Neoclytus erythrocephalus* Fabr., and, as a parasite of *Saperda*, *Melanobracon simplex* Cress., and *Bracon agrili* Ashm., which is a parasite of *Neoclytus* (l. c., p. 73). Four other insects have been found associated with *Magdalis barbata* (l. c., p. 74). *Xylotrechus colonus* Fabr. (Pl. XXVIII, fig. 6) appears to be able to kill hickory, and from such wood many insects have been reared by Felt ('05, p. 261). Felt and Joutel ('04, p. 18) state that in hickories dying from injury by *Scolytus quadrispinosus* Say (Pl. XXV, fig. 3) the beetle *Saperda discoidea* Fabr. follows, living under the bark.

The absence of woodland *Cerambycidae*, *Scolytidae*, and *Buprestidae* in the Charleston collections eliminates the most important and largest variety of insect inhabitants of tree trunks.* In addition to the beetles which invade trunks, the large boring caterpillar, *Prioxystus robinia* (cf. Packard '90, p. 53), and the horntail larva, *Tremex columba*, are able to do much injury. The caterpillar can

*I visited the Bates woods on June 8, 1914, and found a number of insects in a recently cleared part of the upland area about a stump of a black oak (*Q. velutina*). Running about in the sun on the top of the stump was *Chrysobothris femorata* Fabr., near the stump was a cerambycid, *Stenosphenus notatus* Oliv., and on the bark, shaded by a vigorous growth of suckers, were the cockroach *Ischnoptera inaequalis* Sauss.-Zehnt., the tenebrionid beetle *Meracantha contracta* Beauv., and the otiorhynchid *Pandeletejus hilaris* Hbst. About the base of the stump was a large funnel-shaped spider-web beneath which and in its meshes were remains of the following insects: *Chion einctus* (cerambycid), *Meracantha contracta*, *Chrysobothris femorata* (several specimens), an *Agrilus*, *Passalus cornutus*, and *Lachnosterna*.

kill living trees, but the horntail generally follows injury of some kind. Within the tree trunk there is not the safety from enemies which one might anticipate. A large number of wood-inhabiting immature insects are footless, and have relatively small powers of locomotion. Their burrows are relatively small, so that when an enemy once gains admission it can easily secure the owner. Tree trunks infested with horntails often have a large number of females of *Thallessa* on them. I have caught them literally by the handful in such places. Many other parasitic *Hymenoptera* are easily taken upon trees infested by boring larvæ if watched carefully during the warm parts of the day. Schwarz ('82) has called attention to a number of beetles which live in the burrows of wood-boring insects. These burrows may be invaded, not only while yet inhabited by their makers, but also after their abandonment. To find an insect in a burrow is therefore not proof that the insect made it. A predaceous larva which is reported to destroy bark- and wood-boring larvæ is *Alaus oculatus* L. (Pl. XVI, figs. 1, 2, and 4). I have taken this larva in the woods at White Heath, Ill., May 26, and the beetle at Savanna, Ill., May 30. The beetle was taken at Bloomington, Ill., March 23 (A. B. Wolcott); in its hibernating cell in a rotten log in the Cottonwood forest October 8 (No. 489, C. C. A.); and—an immature larva—in the Brownfield woods May 23, Urbana, Ill. Both the larva and the beetle hibernate in logs. Hopkins ('04, p. 42) says of the larva: "As a larva [it] preys upon numerous species of bark and wood-boring insects in deciduous trees." Currie ('05, p. 102) says: "The larvæ prey upon and do much toward preventing the increase of several of the destructive flat-headed borers (*Buprestidæ*) in deciduous trees." Snyder ('10, p. 8) reports the larva of *Alaus* sp. "especially injurious" to decayed poles, and Lugger ('99, p. 130) states that they live largely upon insects found in decayed wood. Evidently the food habits of these larvæ need investigation. Probably other predaceous elaterid and trogositid larvæ live in our trees. Other predaceous beetles on trees are the following, taken at Bloomington: *Chariessa pilosa* Forst., July 3, *Clerus quadriguttatus* Oliv. (Pl. XXVI, fig. 3) June 15, and *Cymatodera balteata* Lec., July and August 17. Hopkins ('93b, p. 187) reports that *Chariessa pilosa* (Pl. XXVI, fig. 6) is found under bark of walnut, and was taken in a dead grape-vine, and reports also that it is predaceous. Felt ('06, p. 504) figures this species and reports it on trees infested with borers.

The locust borer, *Cyllene robinia* Forst. (Pl. XXVII, figs. 1 and 2), is a common insect in many localities, and the beetle is frequently taken upon *Solidago* in the fall. The beetle was taken at Bloomington.

ton September 14 and October 2 (A. B. Wolcott), and on the prairie at St. Joseph, Ill., on flowers, September 26 (No. 310, C. C. A.). Hopkins ('06, p. 8) has shown that although the larvæ begin development only in living wood, they are able to complete it in dry dead wood, but in this case such conditions hasten development.

The apple borer *Saperda candida* Fabr. (Pl. XXVI, fig. 4) was taken in the woods at Bloomington July 4. In the original forests it probably bored in the wild crab apples and the haws (*Crataegus*). *S. tridentata* Oliv., the elm borer, was also taken at Bloomington. This is a serious pest to elms, and paves the way for *Magdalis* and *Neoclytus*. Mr. W. P. Flint informs me that *Saperda vestita* Say is common throughout the state in the live bark of linden, and that *Sinoxylon basilaris* Say lives mainly in weakened trees and in living wood. He also tells me that *Goes debilis* Lec., *G. tigrina* DeG., and *G. pulverulentus* Hald., live in a variety of living trees.

The flat-headed apple-tree borer, *Chrysobothris femorata* Fabr. (Pl. XXVI, fig. 5), is known to attack the bark of enfeebled trees and logs and stumps of oak, hickory, maple, basswood, and apple (Hopkins, '93b, p. 183). The beetles were taken June 13, 25, 30, and August 11, at Bloomington. *Leptostylus aculiferus* Say (Pl. XXVIII, fig. 1) was taken April 17 in the same locality. Hopkins ('93b, p. 196) reports this insect infesting dying and dead maple- and apple-trees. The larvæ mine in the inner bark. Beutenmüller ('96, p. 79) states that it breeds under the bark of oak. The curculionid *Cryptorhynchus parochus* Hbst., is reported by Hopkins ('04, p. 34) to mine as a larva in "the inner bark and sapwood of weakened and recently dead walnut." It is also reported from butternut. Thirteen specimens of this species were taken at Bloomington April 17. The larvæ of *Romaleum atomarium* Dru. live in stumps and logs of recently dead oak (Hopkins, '04, p. 36), and are reported also from hackberry. The beetles were taken July 25 and August 8 at Bloomington. *Romaleum rufulum* Hald. was taken at Charleston June 17. This is reported from oak. The larvæ of *Chion cinctus* Dru. (Pl. XXVIII, fig. 2) are reported by Hopkins ('04, p. 36) to "mine the inner bark and bore into the wood of trunk and branches of dying and recently dead hickory, chestnut, oak, etc." This beetle was taken at Urbana, and at Bloomington July 12. The larvæ probably continue to live in the seasoned wood, as the beetles are recorded as emerging from dry wood some years after furniture or lumber was manufactured.

Certain species of insects live mainly in dead, though solid and seasoned, wood, before decay causes any important changes; some begin work in the living wood and continue in the dead wood; and

others begin in dead wood and continue there after it begins to decay. Among the beetles which live in dead wood the hickory borer, *Cyllene caryæ* Gahan (*pictus* Auct.) is representative. This beetle closely resembles the locust borer, but it appears in the spring and early summer, rather than in the fall as does *robinia*. I have taken *caryæ* at Bloomington April 20, 30, May 20, and June 20, and at Urbana May 16. The larvæ bore in dead branches and small trees of hickory and mulberry, according to Hopkins ('93b, p. 194). *Xylo-trechus colonus* Fabr. (Pl. XXVIII, fig. 6) lives in the bark and wood of dying and dead timber of oak, hickory, elm, and ash (Hopkins, '93, p. 194). My Bloomington records of it are May 9, June 14, 25, and July 1 and 20. *Eburia quadrigeminata* Say (Pl. XXVIII, fig. 5) is a borer in ash and honey-locust (Packard, '90, pp. 541-542), and has been taken on beech and elm (Hopkins, '93b, p. 193) and in hickory. Bloomington records of it are July, August 1 (on papaw), and August 28. Elsewhere mention has been made of its long life in dry wood. *Elaphidion mucronatum* Fabr. has been recorded by Chittenden ('98, p. 42) as emerging from dry wood as follows: "There is a divisional note on its having bred February 8, 1889, from a piece of dogwood (*Cornus*) which had been stored in a carpenter shop some years to be used for hammer handles. The larvæ had worked principally under the bark where they produced large and irregular channels, entering, when nearly full grown, the solid wood, in which they transformed." It also lives in healthy living wood. The larvæ of *Arhopalus fulminans* Fabr. is reported to live in the inner bark and sap-wood of oak. This was taken during May at Bloomington, and *Dicerca lurida* Linn., a hickory borer, was taken at Chicago August 8 and at Bloomington June 13.

The oak pruner, *Elaphidion villosum* Fabr. girdles hickory branches, which fall to the ground. From seasoned wood thus formed Hamilton ('87) reared from branches one half to one inch in diameter, the following beetles: "*Clytanthus ruricola* and *albofasciatus*, *Neoclytus luscus* and *erythrocephalus*, *Stenosphenus notatus*, etc." Such seasoned wood is particularly liable to attack, according to Hopkins ('09, p. 66), by beetles of the family *Lyctida* (cf. Kraus and Hopkins, '11). In such wood, too, white ants (*Termes*) and carpenter-ants (*Camponotus*) will make extensive excavations. The northern brentid, *Eupsalis minuta* Dru., (Pl. XXVIII, figs. 3 and 4) occasionally lives in living weakened trees, but is generally in dead wood. Hopkins ('93b, p. 207) records it as from oak, elm, and beech, and Packard ('90, p. 69) as from white oak. I have taken it at Bloomington June 15, 25 (copulating), and July 2. *Neoclytus luscus* Fabr., a hickory and ash borer, was taken

there October 15. The larvæ of *Neoclytus erythrocephalus* Fabr. (Pl. XXVIII, fig. 4) are associated in dead elms with *Magdalis* (Packard, '90, p. 228; Felt, '05, p. 70), and appear to follow injury by *Saperda tridentata*. In hickory, *Neoclytus* has been found associated with *Xylotrechus colonus* Fabr., *Chrysobothris femorata* Fabr., *Catogenus rufus* Fabr., and *Tremex* and *Thalessa* (Felt, '05, p. 261). The cucujid *Catogenus rufus* was taken at Springfield July 20 by A. B. Wolcott. *Liopus variegatus* Hald., taken at Bloomington June 11 and July 22, is reported under the bark and from several kinds of trees. The cerambycid *Smodicum cucujiforme* Say is also reported from under bark, and was taken July 6 at Bloomington. *Calloides nobilis* Say, reported from oak stumps and hickory, was taken at Chicago in June. From oak also *Purpuricenus humeralis* Fabr. is reported. This was taken at Chicago, and June 9 at Bloomington. The rare lymexylid, *Lymexylon sericeum* Harr., "a borer in old oak wood," was taken at Bloomington July 2. The larva of the flat-headed borer *Dicerca divaricata* Say bores in the dead and rotten wood of maple, cherry, etc. The beetles were taken May 9 and June 3 at Bloomington. Other wood borers whose records for Bloomington should be given, are as follows: *Leptura proxima* Say, a maple borer, June 13; *Dorcaschema wildii* Uhler, an Osage-orange and mulberry borer, June 19; *Criocephalus obsoletus* Rand, July 14; and *Oberea tripunctata* Swed., whose larvæ breed in twigs of cottonwood and blackberry, June 13 (Blatchley, '10, p. 1092).

6. *The Decaying Wood Community*

Thoroughly dry wood, or that submerged in water and thus shut away from the air, remains sound for an indefinite period. In the decay of wood, a certain amount of moisture, air, a favorable temperature, fungi, and insects, are the main agents and conditions. The fungi growing on wood remove the starch, sugar, and other food materials, or they may dissolve the wood itself. This process of course changes the character of the wood so that animals able to derive sustenance from the solid wood now find it unsuitable for their purpose; and still other kinds, on the other hand, unable to eat the solid wood, are now able to feed upon the softened product.

The rate of decay of trees varies greatly. The yellow locust (*Robinia*) red cedar (*Juniperus*), mulberry (*Morus*), and hardy catalpa (*Catalpa*) are very resistant. This catalpa is reported by von Schrenk ('02, p. 50) to serve as a railway tie for eighteen years and remain sound; as fence posts it has served from twenty-three to thirty-eight years. Large stumps of white oak and walnut are also very durable.

On the other hand, cottonwood (*Populus*), basswood (*Tilia*), and silver maple (*Acer saccharinum*) decay rather rapidly. I have found little definite information on the rate of decay of our trees. The most definite information I have found concerning the durability of wood in contact with the soil is in a study of fence posts by Crumley ('10). He shows that heartwood is particularly liable to decay (l. c., pp. 613-614). He gives (pp. 634-635) the following scale of durability, beginning with the most durable; Osage orange, yellow locust, red cedar (woodland grown), mulberry, white cedar, catalpa, chestnut, oak, and black ash. The following have poor durability: honey-locust, sassafras, black walnut (young trees; old trees are durable), butternut, and elm. Red cedar growing "in the open is about the same as oak in durability." These observations aid in giving some idea of the relative rate of decay of logs and stumps in contact with the soil. In the West, Knapp ('12, p. 7) has shown that the upper part of the bole of fire-killed Douglas fir "deteriorates more rapidly than the lower part because of the larger proportion of sapwood. . . . *Down timber* is less subject to insect attacks than standing timber but decays more rapidly." Hopkins ('09, p. 128) publishes a photograph of an Engelmann spruce forest, at an elevation of 10,000 feet on Pike's Peak, which was killed about 1853-56, about fifty years previously; there were, however, still preserved on the trunks, the markings of the beetles which killed the trees. The rate of decay in warm moist regions is relatively more rapid than that in cool and dry regions.

As wood decays it loses the characteristics which distinguish the living and solid trees. For this reason we anticipate that animals showing a preference for different kinds of trees are more characteristic of the living and sound wood, and decline in numbers as disintegration progresses, being replaced by the kinds which live in and upon decaying wood. There is thus with the decay of wood a progressive increase in the kinds of animals characteristic of humus. This is true in general terms, for certain animals even show a preference for certain kinds of decayed wood, while others are general feeders upon almost any kind of such wood. Hamilton ('85, p. 48) has observed that "*Cucujus clavipes* feeds on locust, maple, sycamore, wild cherry, hickory, white oak, elm; *Clinidium sculptile* on spruce, hemlock, tamarack, black oak, hickory, chestnut, ash, gum, poplar, birch; *Synchroa punctata* on all species of oak, hickory, apple, cherry, mulberry, Osage orange, chestnut; *Dendroides canadensis* on nearly everything."

The decay of wood begins when moisture and fungi are able to gain entrance, as at some point of injury—an insect burrow, a

broken branch, a fire scar near the soil, etc.—and spreads from such source. The time of year, and the method by which a tree is killed will often have an important influence upon the kind of invasion by animals. A tree which is killed and remains standing is not so liable to rapid decay as one which lies upon the ground and becomes moist. It is readily seen that there are a vast number of causes which operate to produce all degrees of decaying wood. A fallen hardwood trunk and its stump are liable to begin decaying at the sap-wood layer, just under the bark. The bark loosens; and moisture, fungi, and animals mutually hasten each others' activities, and the processes of disintegration. Under such bark, in the Bates woods, were found the following: queens of the carpenter-ants (*Camponotus*) establishing their colonies; the flat-bodied larvæ of *Pyrochroa*; the large Carolina slug (*Philomycus*); the beetle *Passalus cornutus*; white ants (*Termes flavipes*); the rotten-log caterpillar (*Scolecocampa liburna*); the snails *Zonitoides arborea* and *Pyramidula perspectiva*; *Polydesmus*, *Galerita janus*, and a *Melanotus* larva. These are fairly representative kinds of animals of the log community at this stage of development. It will be noted that the ants, the white ants, and *Galerita* are predaceous, but that the remainder are probably sustained largely by rotten wood, herbaceous plants, and fungi. With the progressive radiate (when beginning within) or convergent (when beginning without) growth of decay this animal community migrates into the log or stump as its favorable habitat increases in area and thickness. When this process has made considerable advance and the log has become soft, the animals which began at the surface or within are able to penetrate the entire log. This may be considered an intermediate stage in the transformation of the log to humus. This biotic community, composed of fungi and animals, commonly begins its work at the surface (most frequently, in the case of fallen trees, on the under side where the log touches the ground) and moves progressively inward, transforming the log as it goes. In its wake there follows a *later stage of the transformation*—the dark-colored humus layer, composed of decayed wood, the dead bodies of animals, and their excrement. The large number of years involved in such a transformation makes it possible for many kinds of animals to find this sort of habitat,—just as old artificial ponds are more fully stocked with animals than newly excavated ones. Slowly developing animals are thus able to live here, the conditions prevailing being at the other extreme from those suited to a life in the ephemeral fungi.

As a fallen or standing trunk dries out, particularly upon the upper surface, if fallen, the bark often curls, cracks, and loosens from the wood. In such a situation in the Cottonwood forest at Urbana,

the spider *Corirachne versicolor* Keys. was taken by me March 23. At times such places are relatively dry, and in them I have frequently found, in large numbers, the tenebrionid beetle *Nyctobates pennsylvanica* DeG. This species was taken at Bloomington March 9 and June 15. A similar-appearing relative, with enlarged femora, *Merinus laevis* Oliv., was taken June 15 and July 29. When *Nyctobates* is placed in a corked vial it proceeds to chew the cork (which is about of the firmness of the bark and wood in which it lives) and makes a fine sawdust. *Nyctobates* was taken by me November 18 under loose dry bark of the sugar maple (*Acer saccharum*) in the Cottonwood forest (No. 549, C.C.A.). The March and November records of this species clearly indicate that the beetle hibernates in the wood. *Scotobates calcaratus* Fabr. and *Xylopinus saperdioides* Oliv. are other tenebrionids which live under bark. I have taken *Scotobates* at Bloomington June 29 and July 2, and *Xylopinus* June 29, July 2 and 26. The cucujid beetle *Brontes dubius* Fabr. was taken at Bloomington March 9, April 5, July 25, 26, and September 21, and *Cucujus clavipes* Fabr. (Pl. XXVIII, fig. 8), whose larvæ Smith reports to be predatory, was taken March 6. Hopkins ('93b, p. 177) reports both of these beetles from the bark of dead deciduous trees. Townsend ('86, p. 66) reports both under the bark of decayed basswood, and Packard ('90, p. 223) records *clavipes* from under oak bark. Another common beetle, a spondylid, *Parandra brunnea* Fabr. (Pl. XXIX, figs. 1, 2, and 5), I have taken from decayed wood at Bloomington. The larvæ, pupæ, and beetles were found in rotten wood July 23, and the beetles also on July 25, 26, and August 6. Hart ('11, p. 68) calls this the heart-wood borer on account of its methods of boring in this part of several kinds of deciduous trees. It burrows largely in rotten, and, also, according to Mr. W. P. Flint, in sound, walnut heart-wood. In recent years Snyder ('11, p. 4) reports much injury by it to telephone poles. He says: "The insect attacks poles that are perfectly sound, but will work where the wood is decayed; it will not, however, work in wood that is 'sobby' (wet rot), or in very 'doty' (punky) wood." As this injury is near the ground, the invasion is probably begun in rotten wood by the young larva and extended later into the firm wood. This same author ('10, pp. 7-8) lists several other insects associated in poles with *Parandra*. Clearly this beetle is an inhabitant of wood in the early stages of decay. It apparently does not kill trees, nor remain to the last in the log with *Passalus*, but occupies an intermediate position. This is a representative of a class of insects whose ecology has been rather slighted in the past because of the economic conditions which permitted the neglect of insects which were not supposed to be of much importance.

But with increased economic efficiency this class of insects which hasten the decay of wood will receive more attention. Mr. W. P. Flint informs me that in the southern part of Illinois the white ants (*Termes flavipes*) and the ant *Cremastogaster lineolata* are very active in decaying wood. Other inhabitants of damp rotten wood, logs, and roots, are the larvæ of the large scarabæid *Xyloryctes satyrus* Fabr. I have taken them at Urbana, Ill., October 1, 12, and 15 in the Brownfield woods, and in the Cottonwood forest October 8. Smith ('10, p. 321) reports the larva feeding in the roots of ash, and Walsh (Proc. Boston Soc. Nat. Hist., Vol. 9, p. 287. 1863), from the roots of grass. *Osmoderma scabra* Beauv. (Pl. XXIX, fig. 4) was taken at Bloomington, Ill., July 26, and *O. eremicola* Knoch (Pl. XXIX, fig. 3) in June at Bloomington, and at Springfield, Ill., in July by A. B. Wolcott. The larvæ of both these species are known to live in decaying wood; the adults are found under the bark, and according to Packard ('90, p. 283) in heart-wood. *Prionus imbricornis* L. (Pl. XXIX, fig. 6) lives under bark and in decaying wood. One individual was taken at Bloomington July 22. *Orthosoma brunneum* Forst., another species with larval habits similar to *Prionus*, was taken at the same place during July. It lives in a great variety of decaying wood. The larvæ of the common rose flower-beetle, *Trichius piger* Fabr. (Pl. XXIX, fig. 7), taken by me June 16, 18, 19, 22, 25, and July 7, and at Savanna, Ill., May 30, live, according to Smith ('10, p. 322), in "old oak stumps." The larvæ of *Lucanus dama* Thunb. (Pl. XXXI, figs. 1 and 2) live in decaying wood. The beetle was taken June 30, in July, and August 1 under wood. The beetles of *Dorcus parallelus* Say were taken May 12, July 25, and August 6. *Ceruchus piceus* Web. was taken April 5, and one taken July 25 was covered with white fungus threads. The larva of *Dorcus* and *Ceruchus* feed mainly or solely in rotten wood. On Plate XXX the larva of *Meracantha contracta* is seen in its burrow in decayed wood. These insects from decayed wood are among the most common of woodland insects.

In concluding this part on insects of rotten wood the following papers should be mentioned, which will be of assistance to one pursuing this subject: Townsend ('86), on beetles in decaying basswood; Packard ('90, pp. 222-223), on insects of decaying oak, (l. c., pp. 283-284) in decaying elm, (p. 424) in decaying maple, and (p. 612) in hackberry; Felt ('06, pp. 484-494) on insects in decaying wood and bark of deciduous trees; and Shelford ('13a, pp. 245-247) on insects of decaying beech. Dury (Ent. News, Vol. 19, pp. 388-389, 1908) states that he took over three hundred species of beetles

from a much decayed log; unfortunately, however, he does not publish the list.

Some of the animals which invade the log in its earliest stages of decay continue to hold possession throughout the transformation. Thus *Passalus* arrives early, as soon as the bark begins to loosen, and remains to a late stage in the process—when the log or stump can easily be kicked to pieces. The rotten log caterpillar *Scolecocampa* has a somewhat similar history in the log. When a log reaches such a condition that it looks like brown meal, and is nearly level with the surface of the ground, it may during the summer become so dry that it affords a favorable haunt for myrmeleonid larvæ; probably the ant-lion of *Myrmeleon immaculatus* DeG., a woodland species.

In the foregoing manner the tree trunk decays and naturally sinks lower and lower, the woody fibers disappear, the debris becomes darker in color, the autumn leaves, twigs, and other litter of the forest gradually add layer to layer, and finally the remains of the log become blended with the humus of the forest floor. Thus is completed one of the most important cycles of transformation to be found in the forest habitat. The following diagram, Figure 17, has been prepared to show the general train or succession of insects corresponding to these changes in the conditions in trees.

It will simplify this discussion of changes in the animal associations, caused either by changes in the character of the forest trees or by changes in the woodland vegetable products, to state concisely the main general factors involved in these changes. To explain zoological facts it is often necessary to utilize the products of the allied sciences, and the student may even be forced to make some investigations for himself in these fields, because these sciences may not have especially treated his specific problems. All relations become of zoological significance, however, when they bear upon a zoological problem. The major group of causes or processes which operate in such a way as to initiate changes in forests may be grouped provisionally as follows.

1. Geological and physiographic processes: crustal movements of the earth, as earthquakes; the wearing down or erosion of the land, as the mowing down of forests by landslides.

2. Climatic processes: wind storms, tornadoes, ice and sleet storms, etc., which injure trees and destroy forests; lightning and fires,—in brief, any climatic factor which is able to injure or kill trees.

3. The processes of competition and succession of forest vegetation; based upon plant activities, as when an oak-hickory forest is followed by a red oak-hard maple forest, or when fungi kill trees. These causes are largely botanical problems.

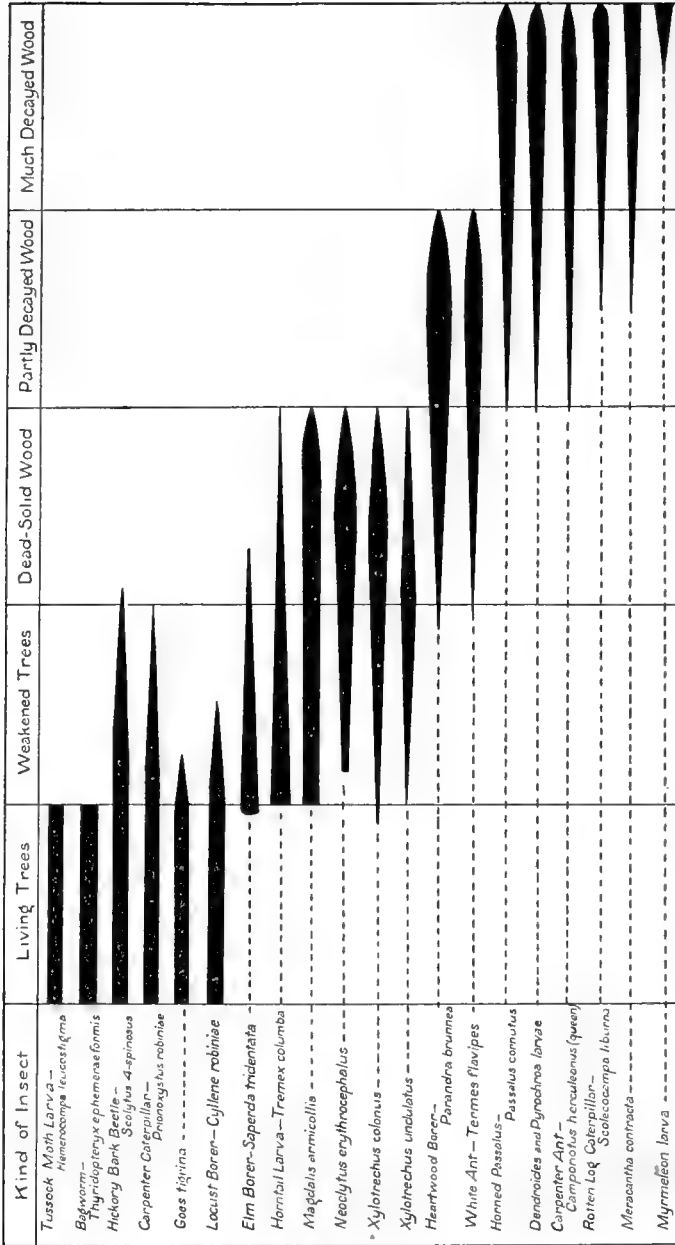


Fig. 17. Diagram showing the succession of insects living on or in trees, from the living tree—through the stages of weakened trees, dead but not solid wood, partly decayed wood—to thoroughly decayed wood. The preferences are distinctly marked. (See p. 153.)

4. Destruction of trees by animals: the processes of defoliation, borings in branches, bark, trunk, or roots, and the girdling of trees. Fires started by man, depending on the degree of destruction, cause new cycles of succession. Both beavers and man build dams, flood areas, and thus kill trees.

5. Combinations of physical and organic processes; the flooding of river bottoms by driftwood rafts which become converted into dams and thus submerge large areas.

Since it is most usual for these causes to act, not singly but in various combinations, and since they also vary greatly in their degrees of influence, their operation is extremely complex. The drowning of the forests along the Mississippi River through the sinking of the land by the New Madrid earthquake, is a good example, showing how a large tract of forest may be killed and much dead and decayed wood formed, as has been shown by Fuller ('12)—(Plate XXXII). Tarr and Martin ('12) have shown how destructive to forests the earthquakes are in Alaska. The influence of the New Madrid earthquake upon animal life has not been investigated, but it is not too late even today, after more than one hundred years, to make important studies on this subject. On the other hand, the processes of erosion operate more continuously than the periodic earthquakes, and tend to degrade the land, lower the water-level, and to change the habitats in swamp and other forests.

The results of climatic influences are seen in the amount of injury done by sleet, which, weighing down the branches, breaks many of them and leaves the fractured stubs as favorable points for attack by fungi and insects. Webb ('09) has shown that when a tornado passed through Mississippi and Louisiana the felled pine forests were from one to three miles wide. Practically all of this timber became infested with the larvæ of *Monohammus titillator* Fabr. After a severe frost in Florida the dead wood of the orange-trees became infested by wood-boring larvæ, which spread from this wood to the enfeebled living wood, as Hubbard (Howard, '95) observed. Lightning (Plummer, '12) kills and maims many trees, producing dead wood, and through fires started in the same manner much more damage is done. Hopkins ('09) considers that much of the injury attributed to fire is primarily due to insects which made the dead and dry fuel for the destructive fire work.

That competition among trees weakens some of them is well known. This weakening makes them more susceptible to attack by fungi and insects. In a forest where the shade-enduring trees can shade out all competitors, the shrubs and trees which are intolerant show just such a lack of resistance. As an example of this process

the following case may be cited: Mr. W. P. Flint informs me that he has observed that shaded, suppressed white oaks in southern Illinois are much more heavily infested by the bark-louse *Aspidiotus obscurus* Comstock, and by the beetle *Phymatodes varius* Say than are the vigorous trees.

Trees may be injured and killed by animals in many ways, as by defoliating them, boring in the twigs, trunk, or roots, and by the destruction of the bark and sap-wood of the trunk. Of injuries caused by insects the work of defoliators of hardwoods is one of the most conspicuous kinds. Repeated defoliation of elms by the elm leaf-beetle *Galerucella luteola* Müll. will, according to Felt ('05, p. 61), so weaken a tree that *Tremex columba* finds suitable food in its diseased and dying substance. With *Tremex* present its parasite *Thalassa* also arrives. The maple borer, *Plagionotus speciosus* Say, may also weaken a tree and pave the way for *Tremex* and *Thalassa*. A study of the after effects of the prominent defoliators of shade and forest trees, such as the fall web-worm (*Hyphantria cunea*), the white-marked tussock-moth (*Hemerocampa leucostigma*, Plate XXXI, figs. 3, 4 and 5), the bag-worm (*Thyridopteryx ephemeraformis*), the larch saw-fly (*Nematus erichsonii*), the gypsy moth (*Porthetria dispar*), and the brown-tailed moth (*Euproctis chrysorrhæa*), would doubtless throw much light upon the details of successions caused by insects. I have not been able to learn that this subject has been studied carefully in this country. Such injuries are clearly not limited to hardwoods, for many similar observations have been made in coniferous forests. Hewitt ('12, p. 20) has listed some of the beetles which follow the defoliation of larches by the larch saw-fly. Hopkins ('01, pp. 26-27) found that the spruces of New England were being killed by the bark-beetle *Dendroctonus piccaperda* Hopkins; that following the damage done came other beetles, such as *Polygraphus rufipennis* Kby., which attacks the weakened tops of the trees, following the attack of its predecessors on the trunk or base; and that also, following *Dendroctonus*, came *Tetropium cinnamopterum* Kby., which mines in the dead trees. The yellow pines of the West are killed by the bark-beetle *Dendroctonus ponderosa*, and this is followed by many kinds of insects which live on the decaying bark and wood, as Hopkins ('02, pp. 10-16) has shown. He also states ('09, p. 68) that in the Appalachian Mountains *Dendroctonus frontalis* Zimm. killed a large part of the trees in an area "aggregating over 75,000 square miles." Such examples of multiple attack show the complexity of the causes influencing forest life. When the great amount of influence which insects are able to exert and do exert upon forests is considered, the question is raised as to what may be their

influence in determining the *kind of trees* that compose what the plant ecologists (Cowles and others) consider the climax forest of eastern North America—the maple-beech forest. It has long been known (Packard, '90, p. 515) that the beech has remarkably few insect enemies, perhaps about fifty species being recorded. Its associate, the hard maple (*Acer saccharum*), has many more, and the oaks and hickories, which are largely absent from the climax forest and characterize the changing stages preceding the climax, are preyed upon by more insects than any other of our trees, their number possibly equaling the sum total of all the other forest-tree insects.

A good example of the combined influence of physical and organic factors is seen in the huge rafts of driftwood which have accumulated in the Red River of Louisiana and Arkansas (Veatch, '06)—(Pls. XXX and XXXIV)—on such an extensive scale that hundreds of acres of the bottoms were flooded and the forests killed, producing vast quantities of dead and decaying wood. With the opening of the drainage canal, connecting Lake Michigan with the Illinois River, the bottoms were so flooded that willows, maples, cottonwoods, etc., on the lowest ground were killed along the river for many miles, and presented a view similar to that shown on Plate XXXV. In this manner vast quantities of dead and decaying wood have been made available as food and habitat for wood-inhabiting invertebrates.

7. *Interrelations within the Forest Association*

The dependence of the animal upon the physical and organic environment is primarily a phase of the problem of maintenance. In the forest these relations are so intricate, and involve the lives of so many kinds of animals, that a forest, like the prairie, must be looked upon as a mosaic composed of a vast number of smaller animal, or biotic communities, each one not only interrelated at many angles within itself, but similarly connected with the other communities of the forest. Walsh ('64, pp. 549–550) has given us a graphic account, not of the forest as a whole but of one of its smallest units—those which he found clustered about the galls of willow trees, the willow leaf-gall community. He says:

“Nothing gives us a better idea of the prodigious exuberance of Insect Life, and of the manner in which one insect is often dependent upon another for its very existence, than to count up the species which haunt, either habitually or occasionally, one of these Willow-galls, and live either upon the substance of the gall itself or upon the bodies of other insects that live upon the substance of the gall. In the single gall *S* [*alicis*]. *brassicoides* n. sp. there dwell the *Cecidomyia* which

is the maker of the gall—four inquiline Cecidomyia—an inquiline saw-fly (*Hymenoptera*)—five distinct species of Microlepidoptera, some feeding on the external leaves of the gall, and some burrowing into the heart of the cabbage, but scarcely ever penetrating into the central cell, so as to destroy the larva that provides them with food and lodging—two or three Coleoptera—a Psocus (*Pseudoneuroptera*)—a Heteropterous insect found in several other willow-galls—an Aphis which is also found on the leaves of the willow, but peculiarly affects this gall—and preying on the Aphides the larva of a Chrysopa (*Neuroptera*) and the larva of a Syrphide (*Diptera*)—besides four or five species of Chalcididæ, one Braconide Ichneumon (*Hymenoptera*) and one Tachinide (*Diptera*), which prey on the Cecidomyia and the Microlepidoptera—making altogether about two dozen distinct species and representing every one of the eight Orders. . . . If this one little gall and the insect that produces it were swept out of existence, how the whole world of insects would be compelled to resort for food to other sources, thereby grievously disarranging the due balance of Insect Life! How many others would probably perish from off the face of the earth, or be greatly reduced in numbers! Yet to the eye of the common observer this gall is nothing but an unmeaning mass of leaves, of the origin and history of which he knows nothing and cares nothing!"

With this conception of a community in mind it is only necessary to refer to the following diagram (Fig. 18) to see how immaterial it is as to where one begins to take up this thread of interrelations, for sooner or later every animal and plant in the association will have to be passed in review and its influence recognized as a response to its conditions of life.

ECOLOGICALLY ANNOTATED LIST

I. PRAIRIE INVERTEBRATES

An exhaustive study of the animal ecology of a region or an association must be based upon a thorough investigation of the ecological relations of the individual animals composing it. An *ideal* annotated list in an ecological paper should, therefore, include for each species a complete account of its life history, its behavior, its physiology, and the structural features which would in any way contribute to an understanding of the response of the animal to its organic and inorganic environment. At present we have no such knowledge of the animals of any locality or of any complex association of animals.

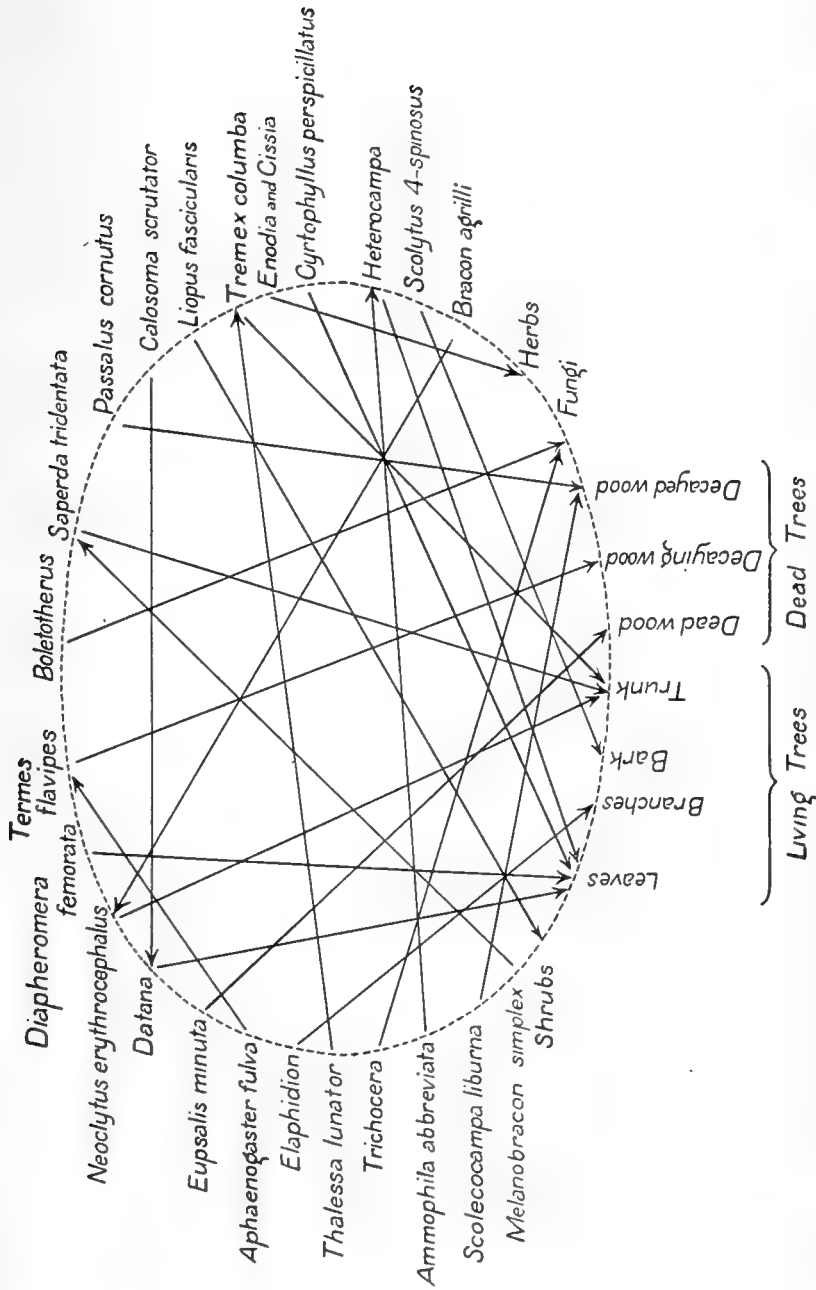


FIG. 18. Diagram showing the complex network of interrelations among forest invertebrates, as shown by their food relations. The arrows point toward the food of the animal.

In a preliminary study, like the present one, it is desirable to record rather fully the observations made in the region studied, because we have so few descriptions of the conditions of life on our prairies. An effort has been made to give for each species the date of observation or collection, the locality or "station" where found, observations on habits and life history, and the field numbers of the specimens secured. These numbers illustrate how observations may be accumulated, upon a large number of individuals, without the observer's being familiar with them, or even knowing their scientific names.

It is really surprising how little is recorded about some of the commonest animals of the prairie and forest in zoological literature. Other animals, particularly those of economic importance, are treated rather fully, but generally with little relation to their natural environment. In this list it has been considered desirable not to give an extended account of each kind of animal, but to refer to some of the most important literature concerning it, so that one may gain some general idea of the ecological potentialities of each kind of animal.

MOLLUSCA

PHYSIDÆ

Physa gyrina Say.

Three half-grown young and an adult shell were taken among swamp milkweed, *Asclepias incarnata* (Sta. I, *g*), Aug. 11 (No. 19). All show distinct varices; the last one formed on the adult shell is very distinct. These scars mark a period of rest or slow growth which was probably due to hibernation or the drying-up of the swamp. *Physa*, as a rule, can not endure such extreme desiccation as can *Lymnaea*, and to that degree is indicative of a more permanent water supply. Our specimens were all dead, but some of them so recently that fly maggots came from them.

LYMNÆIDÆ

Galba umbilicata (C. B. Adams).

A single specimen of this small snail was taken among swamp milkweeds (Sta. I, *d*) Aug. 11 (No. 18). Mr. F. C. Baker, who determined the specimen, writes me that this is the first record of this species for Illinois. Baker remarks ('11, p. 240) that this species is "abundant in still water in sheltered borders of rivers, in small brooks, ditches, and streams, and in shallow overflows. Clings to dead leaves or other submerged debris, or crawls over the muddy

bottom of its habitat, in shallow water. Associated with *Galba obrussa*, *Aplexa hypnorum*, and the small planorbes (Baker). In ditches and brooks in pastures (True). Common in damp places and in ditches along roads where water collects only in rainy weather (Nylander)."

Our specimen was taken where the water was very shallow (only a few inches deep) and overgrown with vegetation. This species appears to be a strictly shallow-water marginal form, and has considerable power of enduring desiccation.

CRUSTACEA

ASTACIDÆ

Cambarus gracilis Bundy. Burrowing Prairie Crawfish. (Pl. XXXVI.)

The prairie crawfish was abundant at Sta. I, *d*, on the wet parts of the prairie. T. L. Hankinson dug some specimens from their holes, which proved to be of this species. Specimens were captured Apr. 23, 1911, and Aug. 9, 1910 (No. 7442).

Crawfish burrows were observed to traverse the dense yellow clay with which the railway embankment had been built over a swampy place at Sta. I, *d*. Burrows were also observed at Sta. I, *e*, among the colony of *Silphium terebinthinaceum* and *Lepachys pinnata*, and also at Station I, *g*.

I have found the characteristic claw of this species on wet prairie along the railway track at Mayview, Ill. At this time, September 26, 1912, burrows with fresh earth were numerous, far from any stream. (No. 482, C. C. A.)

Cambarus diogenes Girard. Diogenes Crawfish.

Crawfish of this species were taken by T. L. Hankinson at Sta. I, *d* (No. 8047A). The presence of this chimney builder at this station suggests that the numerous chimneys shown in Figure 2, Plate IIIB are in part the work of this species though they are in part also the work of *gracilis*.

ARACHNIDA

PHALANGIIDA

PHALANGIIDÆ

Liobunum politum Weed. Polished Harvest-spider. (Pl. XXXVII, fig. 3.)

Two small phalangiids, both probably of this species, were found under moist wood upon the prairie (Sta. I, *g*) Aug. 8. Concerning

these specimens, Mr. Nathan Banks writes me that they are "young, not fully colored, but probably *Liobunum politum* Weed."

Weed ('91) reports that this rather rare species occurs in fields and forests, and is seldom found about buildings. He has found it among river driftwood, and says ('92a, p. 267): "It sometimes occurs under boards in fields, and is often swept from grass and low herbage." When disturbed it emits, as do others of its family, a liquid with a pungent odor. Weed ('91) has made some observations on its breeding habits. He notes that in confinement it ate plant-lice.

L. formosum Wood was taken by me upon the lodged driftwood of a small brook on the border of a forest at White Heath, Ill., May 4, 1911. (No. 505, C.C.A.) This species, according to Weed ('89, p. 92), hibernates as an adult.

ARANEIDA

EPEIRIDÆ

Argiope aurantia Lucas (= *riparia* Hentz). Common Garden Spider.
(Pl. XXXVII, figs. 1 and 2.)

This is very abundant, and the most conspicuous spider on the prairie. Found among the prairie grasses (Sta. I, *g*) Aug. 8 and 12 (Nos. 6 and 39); in its web among goldenrod, *Solidago* (Sta. I), Aug. 12 (No. 26); among the swamp grasses (Sta. I, *a*) Aug. 28 (No. 179); and among *Elymus* (Sta. I, *c*) Aug. 24 (No. 153); from sweepings made in the colony of *Lepachys pinnata* (Sta. I, *e*) Aug. 12 (No. 40); and on the Loxa prairie (Sta. II) Aug. 13 (No. 49), Aug. 27 (No. 178), and Aug. 28 (No. 179); in an open area in the upland Bates woods (Sta. IV, *a*) Aug. 17 (No. 93); and in an open glade in the lowland forest (Sta. IV, *c*) Aug. 22 (No. 143). In its webs in the swamp-milkweed colony (Sta. I, *d*) Aug. 9 the large dragon-fly *Libellula pulchella* Drury was found entrapped; a grasshopper, *Melanoplus differentialis* Thomas, was also found entrapped (Sta. I, *a*) Aug. 28 (No. 179); and a large butterfly, *Papilio polyxenes* Fabr., was discovered (Sta. I, *d*) Aug. 12 (No. 45).

The openness of an area rather than its prairie character appears to determine the habitat of this spider. This is evidenced by its presence in open spaces within the forest. It flourishes in gardens for similar reasons. Years ago I found this species very abundant in the late summer and fall at Bloomington, Ill., in an asparagus bed, after the plants had been allowed to grow up and form a rank mass

of vegetation. This species has received considerable study. McCook ('90) and Porter ('06) record many observations on this species. Howard ('92b) has discussed its hymenopterous parasites and those of some other spiders.

No specimens of *Argiope transversa* Emerton, the transversely black-and-yellow-banded relative of *aurantia*, were observed at Charleston, although they are fairly abundant in colonies of prairie vegetation near Urbana, e. g. at Mayview, Ill., Sept. 26, and on Nov. 26, 1911. I have seen this species only among colonies of prairie vegetation along railway rights-of-way.

THOMISIDÆ

Misumena alcatoria Hentz. Ambush Spider.

This crab-like flower spider was abundant upon flowers: on the mountain mint, *Pycnanthemum flexuosum* (Sta. I, *g*), Aug. 8 (No. 6); on the mint, (Sta. I) with a giant bee-fly, *Exoprosopa fasciata* Macq., Aug. 12 (No. 31); on the Loxa prairie (Sta. II) with the same kind of fly, Aug. 13 (No. 47); on the prairie (Sta. I, *g*) on the flower of the swamp milkweed, *Asclepias incarnata*, Aug. 24 (No. 157) with a male bumblebee, *Bombus separatus* Cress.; on *Andropogon* (Sta. I, *g*) with a large immature female of *Conocephalus*, Aug. 24 (No. 159); on the Loxa prairie (Sta. II) on flowers of *Eryngium yuccifolium*, Aug. 27 (No. 178); in the colony of *Elymus* (Sta. I, *a*) Aug. 28 (No. 179); and in the open glade of the lowland Bates woods (Sta. IV, *c*) on the flowers of *Eupatorium calcestinum*, with a very large syrphid fly, *Milesia ornata* Fabr. (= *virginicensis* Drury), Aug. 26 (No. 184). These insects captured by the spiders vary from about five to ten times the size of their captor. There is considerable variation of color in this series of spiders.

It would be well worth while for some one to make a special study of this spider, and give us an account of its methods of capturing food and finding fresh flowers, with a full account of its life history. McCook ('90, Vol. 2, pp. 367-369) gives some information about the habits of an allied species of spider, but the account is meager. Some observations on the breeding habits of this species have been made by Montgomery ('09, p. 562); and Pearse ('11) has recently published the results of an interesting study of the relation between the color of these spiders and the color of the flowers they frequent. He concludes that although this spider may change its color slowly (from yellow to white), it does not do so with rapidity or in such a way as to match its surroundings, and, further, that it does not seek an environment or a flower colored like itself.

He finds, however, that on *white* flowers, *white* spiders occur generally, that on *yellow* flowers, *yellow* spiders occur, and also that upon flowers of colors other than white and yellow, such as purple, pink, and blue (p. 93), white spiders predominate.

ATTIDÆ

Phidippus sp.

This jumping spider was taken Aug. 12 (No. 34) on the common milkweed, *Asclepias syriaca*, along the railway tracks (near Sta. I, a), and when captured had in its jaws fragments of what seemed to be *Diabrotica 12-punctata* Oliv.; but as the fragments were lost during the process of capture, this determination was not made certain.

ACARINA

TROMBIDIIDÆ

Trombidium sp. Harvest-mites. Chiggers. (Pl. XXI, figs. 1 and 2.)

These are the immature six-legged stage of a mite or mites which when mature have eight legs. The young are parasitic on insects (Banks, Proc. U. S. Nat. Mus., Vol. 28, pp. 31-32, 1904); the adults prey upon plant-lice and caterpillars; one species also eats locusts' eggs.

These mites were very abundant on the prairie north of Charleston (Sta. I), and became such a pest that relief had to be sought in a liberal application of flowers of sulphur to our legs and arms, as is recommended by Chittenden ('06).

INSECTA

ODONATA

LIBELLULIDÆ

Sympetrum rubicundulum Say. Red-tailed Dragon-fly.

This dragon-fly was taken in the prairie grass zone (Sta. I, g) Aug. 8 (No. 4.) It is one of our commonest kinds. The nymphs live in small bodies of standing water. The adults forage for small insects in open places, along hedge rows, and in open forest glades. For the habitats of dragon-fly nymphs, reference should be made to Needham (Bull. 68, N. Y. State Mus., p. 275, 1903). Williamson ('00, pp. 235-236) has observed robber-flies carrying this species, and has found this and other species of dragon-flies in the webs of the spider *Argiope*.

Libellula pulchella Drury. Nine-spot Dragon-fly. (Pl. XXXVIII, fig. 2.)

Individuals were abundant in both colonies of swamp milkweeds (Sta. I, *d* and *g*) and several were seen entrapped in webs of *Argiope aurantia* (Sta. I, *d*) Aug. 9. This is one of the most abundant of our large dragon-flies. It frequents small bodies of water and sluggish pond-like streams. Williamson has taken it also in the webs of *Argiope*. This large powerful insect is able to do considerable damage to a spider-web and then make its escape. Among the milkweeds (Sta. I, *d*) an individual was seen by T. L. Hankinson to escape from a web. This dragon-fly, like most of its kind, captures small insects on wing; one kind, however, is reported to have dug a cricket out of the ground (Psyche, Vol. V, p. 364. 1890).

NEUROPTERA

MYRMELEONIDÆ

Brachynemurus abdominalis Say. Adult Ant-lion.

A single specimen was taken along the railway track north of Charleston (near Sta. I, *g*) Aug. 12 (No. 36). This is a species which frequents dry habitats. The larva is unknown, but is probably predaceous—as other ant-lion larvæ are and as the adult is supposed to be.

Two adult females were taken July 19 and 20, 1907, at Cincinnati, Ohio, in my room, to which they were attracted by the electric light. Another female was taken Aug. 8, 1901, at Gate City, Virginia (near Big Moccasin Gap). Determined by R. P. Currie.

CHRYSOPIDÆ

Chrysopa oculata Say. Lacewing. (Pl. XXXVIII, fig. 1.)

A single specimen of this insect was taken among prairie grasses (Sta. I, *g*) Aug. 12 (No. 44). The larvæ feed upon plant-lice, and the adults are also considered predaceous. Howard (Proc. Ent. Soc., Wash., Vol. 2, pp. 123–125. 1893) has given a list of their numerous hymenopterous parasites. Mr. T. L. Hankinson captured one also (Sta. I) July 3, 1911 (No. 7665). Fitch ('56) published many observations on the members of this genus; and Marlatt ('94a) has written on the life history of this species.

ORTHOPTERA

ACRIDIDÆ

Syrbula admirabilis Uhler.

One specimen of this grasshopper was found in the tall prairie grasses blue-stem *Andropogon* and *Panicum* (Sta. I, *g*) Aug. 8 (No. 3). Morse ('04, p. 29) says this species frequents "open country" and is "common in upland fields amid *Andropogon* and other coarse grasses."

Encoptolophus sordidus Burm. Sordid Grasshopper. (Pl. XXXIX, fig. 1.)

One nymph of this species was taken in the prairie-grass colony north of Charleston (Station I, *g*) Aug. 12 (No. 44); another (No. 158) on Aug. 24 in the colony of *Lepachys pinnata* (Sta. I, *e*); and an adult (No. 48) Aug. 13 at Loxa (Sta. II, *a*) from the flowers of *Silphium integrifolium*.

This is a species characteristic of dry open places, where the vegetation is low. The peculiar snapping sound made by the male when on wing is quite characteristic. (Cf. Hancock, '11, pp. 372-373.)

Dissosteira carolina Linn. Carolina Grasshopper. (Pl. XXXIX, fig. 4.)

A very reddish specimen of this species was taken in a cleared bottom forest at River View Park, about three miles southeast of Charleston, Aug. 19 (No. 95). Many specimens were observed in the pasture above the "Rocks," on the Embarras River about three miles east of Charleston. These individuals exhibited to a marked degree the hovering, undulating flight which is so characteristic of this species during the hot days of summer and early autumn. Townsend (Proc. Ent. Soc. Wash., Vol. 1, pp. 266-267. 1890) has made interesting observations on this habit, and finds that it is mostly the males which participate in this courting ceremony, as he considers it. There appears to be more or less of a gathering of individuals when one of the locusts performs. There were perhaps half a dozen performing in the colony observed at the "Rocks." Townsend (Can. Ent., Vol. 16, pp. 167-168. 1884) has considered this flight as related to breeding. Some one might study this subject with profit, and determine its meaning. Poulton's paper "On the Courtship of certain Acridiidae" (Trans. Ent. Soc. London, 1896, Pt. II, pp. 233-252) might prove helpful in this connection.

This species seems to have been influenced by man to a marked degree. Its original habitat appears to have been natural bare spots,

such as sandy beaches, banks of streams, sand-bars, and burned areas. In a humid forested area such places are usually in isolated patches, or in more or less continuous strips as along shores; but since the activities of man produce large cleared areas and bare spots, such as roads, railways, and gardens, the favorable area of habitat for this species has been vastly increased. Consult Hancock ('11, pp. 340-347) for observations on the habits of this species.

Schistocerca alutacea Harr. Leather-colored Grasshopper. (Pl. XXXIX, fig. 3.)

One specimen of this large grasshopper was taken east of Charleston, on the prairie which grades into the forest (Sta. III, *a*) Aug. 15 (No. 59). Morse ('04, p. 39) and Hart ('06, p. 79) recognize that this species lives among a rank growth of vegetation and brush. In general the local conditions are open or transitional, and may be compared to those of a shrubby forest margin, and not to those of the distant open prairie or to conditions within the forest. (Cf. Hancock, '11, pp. 366-370.)

Melanoplus bivittatus Say. Two-striped Grasshopper. (Pl. XL, fig. 3.)

This grasshopper was taken from flowers of the rattlesnake-master, *Eryngium yuccifolium*, on the prairie at Loxa (Sta. II), Aug. 13 (No. 55). It is a little surprising that it was so rare this season on the prairie areas examined, as it is usually a common species. Hancock ('11, pp. 356-359) has discussed this grasshopper.

Melanoplus differentialis Thomas. Differential Grasshopper. (Pl. XXXIX, fig. 5, and Pl. XL, fig. 1.)

This species was generally common in open areas, especially on the prairie, but was also found in open places in the forest. It was very abundant in the colonies of swamp prairie grasses, *Spartina* and *Elymus* (Sta. I, *a*), Aug. 28 (No. 179); in the upland prairie grasses, as *Andropogon* and *Panicum* (Sta. I, *g*), Aug. 12 (No. 39); and in colonies of *Lepachys* (Sta. I, *e*) Aug. 12 (No. 40); also at Loxa on *Silphium integrifolium* (Sta. II, *a*) Aug. 13 (No. 48).

This must be considered as one of the most common and characteristic of prairie animals. Notwithstanding the destruction of the original prairie, its habitat has been perpetuated, particularly upon waste and neglected areas, such as fence rows, roadsides, railway rights-of-way, and vacant city lots.

Melanoplus femur-rubrum DeG. Red-legged Grasshopper. (Pl. XXXIX, fig. 2.)

This species also is one of the most common and generally distributed insects upon open areas. It was found among the prairie grasses *Andropogon* and *Sporobolus* (Sta. I, *g*) Aug. 8 and 12 (Nos. 3 and 39); in the *Lepachys* colony (Sta. I, *e*) Aug. 12 (No. 40); and in *Elymus* and *Spartina* (Sta. I, *a* and *c*) Aug. 24 and 28 (Nos. 153, 179, and 180). As Hart ('06, p. 81) has remarked, it is common in cultivated areas. Cultivation appears to be distinctly favorable to it; *differentialis*, on the other hand, seems to thrive best in waste places.

LOCUSTIDÆ

Scudderia texensis Sauss.-Pict. Texan Katydid.

This is the common and characteristic katydid of the prairie areas. It was found (Sta. I, *g*) among the tall swamp milkweeds Aug. 8 (No. 2); in the tall blue-stem *Andropogon* and in *Panicum* Aug. 12 (No. 44); in the *Lepachys* colony (Sta. I, *e*) Aug. 12 (No. 40); and among the swamp prairie grasses *Spartina* and *Elymus* (Sta. I, *a* and *c*) Aug. 28 (Nos. 179 and 180). Consult Hancock, '11, pp. 330-331, for the life history of this species.

Conocephalus sp., nymph.

A large female nymph was secured on blue-stem *Andropogon* (Sta. I, *g*) Aug. 24 (No. 159), having been captured by a crab-spider, *Misumena aleatoria* Hentz.

Orchelimum vulgare Harr. Common Meadow Grasshopper. (Pl. XL, figs. 2 and 4.)

This grasshopper was taken east of Charleston on the flowers of broad-leaved rosin-weed, *Silphium terebinthinaceum* (Sta. III), Aug. 26 (No. 175); on the Loxa prairie (Sta. II) Aug. 27; on the flowers of rattlesnake-master, *Eryngium yuccifolium* (No. 178); and on the prairie north of Charleston from the colony of wild rye, *Elymus* (Sta. I, *a*), Aug. 28 (No. 179). A squeaking individual (No. 180) captured here confirmed observations made in other places—particularly in the tall prairie grasses *Andropogon* and *Sporobolus* (Sta. I, *g*), where the first specimen (No. 3) was taken Aug. 8. Nymphs, very probably of this species, were also in the prairie grasses *Andropogon* and *Sporobolus* (Sta. I, *g*) Aug. 8 (No. 3); and Aug. 28 (Nos. 179 and 180) in the swamp grasses *Elymus* and *Spartina* (Sta. I, *a, c*). This species is preeminently a tall-grass frequenter, whose penetrating *zeeing* during the sunny hours serves to locate grass plots and low, rank weedy growths.

Blatchley ('03, p. 384) has observed the species feeding on small moths, and once saw an individual on goldenrod eating a soldier-beetle, *Chauliognathus pennsylvanicus* DeG. Forbes ('05, p. 144) reports that its food consists mainly of plant-lice, and leaves of grass, fungus spores, and pollen. It is thus evident that it eats both animal and vegetable food.

Xiphidium attenuatum Scudd. Lance-tailed Grasshopper. (Pl. XL, fig. 7.)

On the prairie at Loxa (Sta. II), on flowers of the arrow-leaved rosin-weed, *Silphium integrifolium*, a single individual of this species was found Aug. 13 (No. 48).

According to Blatchley ('03, pp. 380-381) it frequents the coarse vegetation bordering wet places. He also states that the eggs are placed between the stems and leaves of "tall rank grasses."

Xiphidium strictum Scudd. Dorsal-striped Grasshopper. (Pl. XL, fig. 6.)

This prairie species was taken on prairie clover, *Petalostemum* (Sta. I, b), Aug. 11 (No. 21); in sweepings among the cone-flower, *Lepachys pinnata* (Sta. I, c), Aug. 20 (No. 40); on the mountain mint *Pycnanthemum flexuosum* (Sta. I) Aug. 12 (No. 35); on *P. flexuosum* or *P. pilosum* (Sta. II) Aug. 13 (No. 57); among the swamp grasses *Elymus* and *Spartina* (Sta. I, a and c) Aug. 28 (Nos. 179, 180); on the Loxa prairie on *Silphium integrifolium* (Sta. II) Aug. 13 (No. 48); and on purple prairie clover, *Petalostemum purpureum* (Sta. II), Aug. 13 (No. 50).

Forbes ('05, p. 147) gives its food as plant-lice, fungi, pollen and, larvæly, other vegetable tissues. He also states that it frequents the "drier slopes in woods and weedy grounds" (p. 148).

GRYLLIDÆ

Æcanthus nigricornis Walk. Black-horned Meadow Cricket. (Pl. XL, fig. 5, Pl. XLI, figs. 1 and 2.)

This prairie cricket was taken in sweepings from the cone-flower (*Lepachys pinnata*) colony (Sta. I, e) Aug. 12 (No. 40); on the transitional prairie east of Charleston (Sta. III, b) Aug. 15 (No. 62); and from the swamp cord-grass, *Spartina* (Sta. I, a), Aug. 28 (No. 179).

Blatchley ('03, p. 451) says: "In August and September, nearly every stalk of goldenrod and wild sunflower along roadsides, in open fields or in fence corners, will have from one to a half dozen of these insects upon its flowers or branches. It is also especially abundant

upon the tall weeds and bushes along the borders of lakes and ponds, and in sloughs and damp ravines."

Blatchley (l. c., p. 452) made some incomplete observations on the peculiar courting habits of this species, a subject which has been elaborated by Hancock ('05). Hancock also describes the method of oviposition. The female first gnaws the plant stem; then bores a hole and deposits an egg; and next, again gnaws the stem. The eggs are laid in stems of blackberry, goldenrod, and horseweed (*Leptilon*).

Houghton (Ent. News, Vol. 15, pp. 57-61. 1904) has published interesting observations on the carnivorous habits of nymphs of *Æ. niveus* DeG. Cf. Parrott and Fulton, '14.

Ashmead (Insect Life, Vol. 7, 241. 1894) reports that *Æ. nigricornis* (*fasciatus*) is preyed upon by the wasp *Chlorion harrisi* Fernald (*Isodontia philadelphica* St. Farg.).

Æcanthus quadripunctatus Beut. Four-spotted White Cricket.

This prairie species was found among the tall prairie grasses blue-stem *Andropogon* and *Panicum* (Sta. I, g) Aug. 8 (No. 3); and among the colony of cord grass, *Spartina* (Sta. I, a), Aug. 28 (No. 179).

Blatchley ('03, p. 453) reports it on "shrubby and weeds in fence-rows and gardens; and along roadsides." This indicates how a prairie species adjusts itself to the conditions produced by man. Parrott (Journ. Econom. Ent., Vol. 4, pp. 216-218. 1911) gives figures of the eggs of this species and describes its method of oviposition in raspberry stems.

HEMIPTERA

CICADIDÆ

Cicada dorsata Say. Prairie Cicada.

Although this species was not taken at Charleston, a single specimen (No. 185) was captured at Vera, Fayette county, Ill., September 1, on a giant stool of blue-stem *Andropogon*. Osborn (Proc. Iowa Acad. Sci., Vol. 3, p. 194. 1896) reported one specimen from Iowa; Woodworth, (*Psyche*, Vol. 5, p. 68. 1888) says: "On the prairies, Illinois to Texas"; and MacGillivray (*Can. Ent.*, Vol. 33, p. 81. 1901) adds Missouri, Colorado, and New Mexico.

MEMBRACIDÆ

Campylenchia curvata Fabr.

This bug was taken in sweepings made in the colony of cone-flower, *Lepachys pinnata* (Sta. I, e), Aug. 12 (No. 40).

JASSIDÆ

Platymetopius frontalis Van D.

This leaf-hopper was taken in sweepings in the cone-flower colony (Sta. I, *e*) Aug. 12 (No. 40).

APHIDIDÆ

Microparsus variabilis Patch.

This plant-louse infests the leaves of the Canadian tick-trefoil, *Desmodium canadense*, and causes the leaves to curl. Quite a colony of these plants found infested (near Sta. I, *f*) Aug. 24, were stunted and deformed by these plant-lice (No. 160). Consult Patch (Ent. News, Vol. 20, pp. 337-341. 1909) for a description of the insect and a plate showing the injury which it causes; also Williams (Univ. Studies, Univ. Neb., Vol. 10, p. 76, 1910) and Davis (*ibid.*, Vol. 11, p. 28. 1912).

Aphis asclepiadis Fitch. Milkweed Plant-louse.

Plant-lice of this species were abundant upon the younger terminal leaves of the common milkweed, *Asclepias syriaca*, along the railway track north of Charleston (Sta. I) Aug. 12 (Nos. 28, 29, and 154). Associated with them were workers of the ants *Formica fusca* Linn. var. *subsericea* Say (Nos. 28, 29, and 154) and *Formica fusca* Linn. (No. 28). On a milkweed plant which lacked the plant-lice were found associated another ant, *Formica pallide-fulva* Latr., subsp. *schaufussi* Mayr, var. *incerta* Emery, and the metallic-colored fly *Psilopus siphon* Say.

At Urbana, Ill., a very abundant plant-louse on wild lettuce, *Lactuca canadensis*, is *Macrosiphum rudbeckiae* Fitch (det. by J. J. Davis). The upper, tender branches of these plants are in the fall covered with vast numbers of these lice, both wingless and winged. That this species feeds upon a number of other prairie plants is a point of much interest because of their distinctly prairie character. It is reported from *Vernonia*, *Solidago*, *Bidens*, *Ambrosia*, *Cirsium*, *Silphium*, and *Cacalia* (Thomas, Eighth Rep. State Ent. Ill., p. 190. 1879).

PENTATOMIDÆ

Euschistus variolarius Beauv. (Pl. XLI, fig. 3.)

This common plant-sucking bug was taken on flowers of the swamp milkweed, *Asclepias incarnata* (Sta. I, *d*), Aug. 9 (No. 12); from the blue-stem *Andropogon* colony (Sta. I, *g*), where a large robber-fly, *Promachus vertebratus*, was taken astride a grass stem with one of these bugs in its grasp Aug. 12 (No. 39); at Station

I by T. L. Hankinson, July 3, 1911 (No. 7665); on the Loxa prairie (Sta. II), with insects from flowers of the purple prairie clover, *Petalostemum purpureum*, Aug. 13 (No. 50); and on flowers of the mountain mint *Pycnanthemum pilosum* or *P. flexuosum* (Sta. II), Aug. 13 (No. 52). Consult Forbes ('05, pp. 195, 261) for a summary of its life history, and references to literature. It feeds upon a great variety of plants (Olsen, in Journ. N. Y. Ent. Soc., Vol. 20, p. 53. 1912) and on soft-bodied insects.

Stiretrus anchorago Fabr. (Pl. XLI, fig. 5.)

This highly colored bug was taken, Aug. 23 (No. 146), not upon the prairie proper but at the margin of the Bates woods (near Sta. IV, a), where the clearing had been so complete that only sprouts and young trees occurred, associated with many plants which frequent open, sunny places, such as ironweed (*Vernonia*) and *Pycnanthemum pilosum*.

This bug sometimes feeds upon the larvæ of the imported asparagus beetle, *Crioceris asparagi* (Chittenden, Circ. No. 102, Bur. Ent., U. S. Dept. Agr., p. 6. 1908). This circular contains figures of the nymph and adult. Olsen reports it as feeding upon caterpillars and beetle larvæ and on the plants *Asclepias* and *Rhus* (Jour. N. Y. Ent. Soc., Vol. 20, pp. 55, 56. 1912).

THYREOCORIDÆ

Thyreocoris pulicarius Germ. Flea Negro-bug. (Pl. XLII, fig. 2.)

This negro-bug was taken on the flowers of goldenrod, *Solidago* (near Sta. I, a), Aug. 12 (No. 26). Forbes and Hart ('00, p. 100) state that this insect abounds on *Bidens*, a plant which grew in great abundance near the goldenrod referred to. Taken (Sta. I) by T. L. Hankinson July 3, 1911 (No. 7665).

LYGÆIDÆ

Ligyrocoris sylvestris Linn.

This insect was taken while sweeping vegetation in the cone-flower (*Lepachys*) colony (Sta. I, e) Aug. 12 (No. 40).

Lygus kalmii Stål. Small Milkweed Bug. (Pl. XLII, fig. 1.)

This is one of the commonest insects found upon milkweeds of the prairie. Specimens were taken on the flowers of the swamp milkweed, *Asclepias incarnata* (Sta. I, g), Aug. 8 (No. 1); on flowers of the mountain mint, *Pycnanthemum flexuosum* (Sta. I, g), Aug. 8 (No. 6); and on swamp milkweeds (Sta. I, d) Aug. 9 (No. 12).

This is another common insect about which very little is known. Its food plants and life history are worthy of study. I have taken this species from Mar. 20 (adult, 1894) to Nov. 4 (adult, 1893) at Bloomington, Ill.; at Havana, Ill., during August; and at Chicago June 8 (1902). That it probably hibernates in the adult stage is shown by the fact that I captured an adult as early as Mar. 22 at Urbana, Ill. This bug, like the squash-bug (*Anasa*), may have an active migratory period in the fall, and only those individuals survive the winter which happen to be in favorable places when the cold weather sets in. I have captured this bug in the dense Brown-field woods (Urbana), where it was crawling on a log Oct. 12 (No. 312, C.C.A.). Hart ('07, p. 237) records it from *Asclepias cornuti* (= *A. syriaca*) at Havana in the sand area, and also from Teheran, Illinois.

Oncopeltus fasciatus Dall. Large Milkweed Bug. (Pl. XLII, fig. 3.)

This large red plant-bug I took but once—on flowers of the swamp milkweed, *Asclepias incarnata* (Sta. I, *g*), Aug. 8 (No. 1); T. L. Hankinson, however, captured another specimen (Sta. I) July 3, 1911 (No. 7665).

I have found it in years past abundant on prairie colonies of milkweed at Bloomington, Ill., from June into September, and at Havana and Chicago during August. On Sept. 26, at Mayview, Ill., along the railway among prairie plants this plant-bug was found on dogbane (*Apocynum*). A pale yellow color may replace the red.

COREIDÆ

Harmostes reflexulus Say.

This bug was found in flowers of *Asclepias syriaca* along the railway track (Sta. I) Aug. 12 (No. 27).

REDUVIIDÆ

Sinea diadema Fabr. Rapacious Soldier-bug. (Pl. XLI, fig. 4.)

One specimen of this bug was taken from the flowers of the mountain mint, *Pycnanthemum flexuosum*, in the prairie grass colony (Sta. I, *g*), Aug. 8 (No. 6). I took it at St. Joseph, Ill., in a colony of prairie vegetation along the railway track Sept. 26, 1911 (No. 495, C.C.A.).

This bug preys upon caterpillars and many other insects. The little we know of its life history has been recorded by Ashmead ('95, *Insect Life*, Vol. 7, p. 321); its predaceous habits, however, have attracted considerable attention from economic entomologists. For

numerous references to this phase see Caudell, Jour. N. Y. Ent. Soc., 1901, Vol. 9, p. 3. The young feed upon plant-lice.

PHYMATIDÆ

Phymata fasciata Gray (*zvolffi* Stål). Ambush or Stinging Bug.
(Pl. XLII, fig. 4.)

This is one of the most abundant and characteristic of prairie insects. It was taken from the flowers of the swamp milkweed, *Asclepias incarnata* (Sta. I, g), Aug. 8 (No. 1); among the same flowers, at Station I, d, Aug. 9; on goldenrod, *Solidago* (near Sta. I, a), Aug. 11 (No. 20); and again on goldenrod (Station I) Aug. 12 (No. 43), *in copula*, and with an empidid fly in its clasp; on flower of mountain mint, *Pycnanthemum flexuosum* (Sta. I), Aug. 11 (No. 24); from goldenrod (Sta. I) Aug. 12 (No. 26); in sweepings from the colony of *Lepachys pinnata* (Sta. I, e) Aug. 12 (No. 40); from the flowers of the mountain mint, *P. flexuosum*, on the Loxa prairie (Sta. II) Aug. 13, with a large bee-fly, *Exoprosopa fasciata*, in its clutches (No. 57); on the following flowers (Sta. II) Aug. 13—rosinweed, *Silphium integrifolium* (No. 48), mountain mint *Pycnanthemum pilosum* and *P. flexuosum* (No. 52), Culver's-root, *Veronica virginica* (No. 54), and rattlesnake-master, *Eryngium yuccifolium* (No. 55); in the partly cleared area north of Bates woods (Sta. IV) in flowers of the mountain mint *P. pilosum* Aug. 23 (No. 146); and on the Loxa prairie, at telegraph pole No. 12323 (Sta. II), on the flowers of rattlesnake-master Aug. 27 (No. 178).

At Mayview, Ill., in a colony of prairie vegetation, one specimen was taken by Miss Ruth Glasgow with the butterfly *Pontia protodice* Sept. 26, 1912; a second had captured a dusky plant-bug, *Adelphocoris rapidus* Say. At the same time and place Miss Grace Glasgow took from a flower another bug with the bee-fly *Sparnophilus fulvus* Wied. This fly is parasitic on white-grubs, *Lachnosterna* (Forbes, '08, p. 161). Among prairie vegetation at St. Joseph, Ill., Sept. 26, 1911, I took from a flower an ambush bug with a large cutworm moth, *Feltia subgothica* Haw. (No. 302, C.C.A.). (Pl. XLIII, figs. 1 and 2.)

Packard ('73, p. 211) records that *Phymata fasciata* had been observed feeding upon plant-lice on linden trees in Boston, and Walsh (Amer. Ent., Vol. 1, p. 141. 1869) states that it feeds habitually upon bees and wasps, and shows skill in avoiding their sting. Cook (Bee-keeper's Guide, ninth ed., pp. 323-324, 1883) reports that it destroys plant-lice, caterpillars, beetles, butterflies, moths, bees, and

wasps. The ambush bug and the ambush spider (*Misumena alcatoria* Hentz) are in active competition upon flowers for much the same kind of food.

MIRIDÆ

Adelphocoris rapidus Say. Dusky Leaf-bug. (Pl. XLII, figs. 5 and 6.)

This leaf-bug was taken from the flowers of the rattlesnake-master, *Eryngium yuccifolium* (Sta. II, a), Aug. 13 (No. 55). It was taken in a colony of prairie vegetation at Mayview, Ill., Sept. 26, 1912, by Miss Ruth Glasgow, who found it captured by *Phymata fasciata*. It feeds upon a large variety of plants.

Lygus pratensis Linn. Tarnished Plant-bug. (Pl. XLIII, figs. 3 and 4.)

This common plant-bug was taken, copulating, from the flowers of the swamp milkweed, *Asclepias incarnata* (Sta. I, d), Aug. 9 (No. 12). It is a common fruit and garden pest. Consult Forbes ('05, pp. 119, 263) for figures of this species and references to its life history and habits, and Crosby and Fernald ('14) for a very full account of this species.

COLEOPTERA

CARABIDÆ

Leptotrachelus dorsalis Fabr.

This ground-beetle was taken in the *Spartina* colony on the prairie north of Charleston (Sta. I, a) Aug. 28 (No. 179). It is supposed to be predaceous. Its life history is not known to the writer. Blatchley ('10, p. 138) records it as from "low herbs in open woods", and Webster ('03b, p. 22) states that the larva of this beetle destroys the larvæ of *Isosoma grande* Riley in wheat fields.

Although no special effort was made to secure members of this family of beetles from the prairie, where they must abound, it is surprising that some members of the genus *Harpalus* were not so abundant as to demand attention. More attention to the ground fauna and less to that found on vegetation would doubtless have given other results. Generally in this family the food habits are predaceous, but there are exceptions, and these include kinds which frequent open places. On September 25, 1900, the writer found specimens of *Harpalus caliginosus* Fabr. feeding on the flowers or seeds of ragweed, *Ambrosia*, which grew in a neglected field along Holston River near Rogersville, Tenn., and at Rockford, Tenn., on Sept. 25, 1901, similar observations were made upon *Harpalus pennsylvanicus* DeG. Many years ago Webster ('80, p. 164) made similar observations on this species, and also found it eating wheat, timo-

thy seeds, the prairie grass *Panicum crusgalli* Linn., and even a small beetle, *Ips 4-guttatus* Fabr. He also observed *H. caliginosus* feeding upon seeds of ragweed, *Ambrosia artemisiifolia*. (See Forbes—'80, pp. 156-157 and '83a, pp. 45-46—for further observations upon the food habits of the beetles of this genus.) Clarkson (Can. Ent., Vol. 17, p. 107, 1885) observed *caliginosus* feeding upon ragweed on Long Island; and Hamilton (Can. Ent., Vol. 20, p. 62, 1888) records similar observations for this beetle and for *pennsylvanicus*. Both species are reported to injure strawberries. Coquillett (Insect Life, Vol. 7, p. 228, 1894) observed *caliginosus* feeding upon a grasshopper.

COCCINELLIDÆ

Hippodamia parenthesis Say. Parenthetical Ladybird.

This insect was taken only by T. L. Hankinson (Sta. I) July 3, 1911 (No. 7665).

Coccinella novemnotata Hbst. Nine-spotted Ladybird. (Pl. XLIV, fig. 2).

This insect was taken on the common milkweed, *Asclepias syriaca*, (Sta. I) Aug. 12 (No. 27). This species is another example of one of the commonest insects to which so little attention has been given that we really have no full account of its life history and ecology. Many scattered observations have been made, but none are extensive. Forbes examined the stomach contents of five specimens and found that they had eaten plant-lice, fungus spores, and a few lichen spores ('80, pp. 157-159, and '83a, pp. 53-54).

LAMPYRIDÆ

Chauliognathus pennsylvanicus DeG. Soldier-beetle. (Pl. XLIII, figs. 5 and 6.)

This is one of the most abundant beetles found on flowers in late summer and fall, particularly upon goldenrods (*Solidago*), and other composites. The first specimens were taken in a cleared area, with much sprout growth and open patches, where the mountain mint *Pycnanthemum pilosum* abounded, (near Sta. IV, a), Aug. 23 (No. 146). On the following day they were first found on the prairie—copulating as usual—on the flowers of the swamp milkweed, *Asclepias incarnata* (Sta. I, d), Aug. 24 (No. 156.)

They were taken from the flowers of the broad-leaved rosinweed, *Silphium terebinthinaceum*, on the prairie east of Charleston (Sta. III, b) Aug. 26 (No. 175), and on the Loxa prairie (Sta. II,

Pole No. 12323) on the flowers of the rattlesnake-master, *Eryngium yuccifolium*, Aug. 27 (No. 178).

According to Riley (Second Rep. U. S. Ent. Comm., p. 261. 1880) the eggs of this species are deposited on the ground in irregular bunches. He quotes Hubbard, who says that the larvæ huddled together when ready to moult, and that afterwards they became very active. The insect passes the winter as a nearly mature larva, and matures about August. The larvæ are known to eat beetle larvæ and caterpillars; the adults feed upon nectar and pollen.

SCARABÆIDÆ

Euphoria sepulchralis Fabr. Black Flower-beetle. (Pl. XLIV, fig. 4.)

Only two specimens of this beetle were taken: one on the flowers of the swamp milkweed, *Asclepias incarnata* (Sta. I, *d*), Aug. 24 (No. 156); the other from the flowers of *Pycnanthemum pilosum* in the cleared area bordering the upland Bates woods (Sta. IV, *a*) Aug. 23 (No. 146). Blatchley ('10, p. 997) reports it at sap, on various flowers, and especially on goldenrod; and Webster has found it eating into kernels of corn (Insect Life, Vol. 3, p. 159).

E. inda (Pl. XLIV, fig. 3) has been observed by Wheeler ('10a, p. 384) to fly to an ants' nest and bury itself; he suggests that it may live in such nests. Schwarz ('90b, p. 245) considers the *inda* larvæ abundant at Washington in nests of *Formica integra*. For the life history of this beetle see Chittenden (Bull. 19, N. S., Bur. Ent., U. S. Dept. Agr., pp. 67-74. 1899).

Pelidnota punctata Linn. Spotted Grape Beetle. (Pl. XLIII, fig. 5.)

Only one specimen of this beetle was taken. It was found upon a prairie containing some forest relics, on a grape leaf (Sta. III, *b*) Aug. 15 (No. 58). This insect is a forest or forest-margin insect; as is indicated by the fact that the larva feeds upon the decaying roots and stumps of oak and hickory. The adult devours leaves of the grape and of the Virginia creeper (Cf. Riley, Third Rep. Insects Mo., p. 78).

CERAMBYCIDÆ

Tetraopes tetraophthalmus Forst. Four-eyed Milkweed Beetle.

This is one of the commonest insects in the prairie parts of Illinois. Nevertheless, though almost every schoolboy who ever made a collection of insects has it in his collection, very little is known of its habits or life history.

At Charleston it was taken Aug. 8 on flowers of the swamp milkweed, *Asclepias incarnata*, at Sta. I, *g* (No. 1) and at Sta. I, *d* (No. 12); on the flowers of the mountain mint *Pycnanthemum virginianum* (Sta. I) Aug. 12 (No. 35); and T. L. Hankinson took the beetle (Sta. I) July 3, 1911 (No. 7665).

Robertson (Trans. St. Louis Acad. Sci. Vol. 5, p. 572. 1891) states that this beetle and *Epicauta vittata* Fabr. gnaw the flowers of the swamp milkweed; and in the same volume (p. 574) reports that the rose-breasted grosbeak (*Habia ludoviciana*) cleared these beetles from *A. syriaca* in his yard. Beutenmüller (Jour. N. Y. Ent. Soc., Vol. 4, p. 81. 1896) says that the larva bores into the roots and lower parts of the stems of *Asclepias*, and suggests that the other species have similar habits.

Tetraopes femoratus Lec. (?) Milkweed Beetle.

A peculiar individual (No. 1) was taken Aug. 8 on the swamp milkweed *Asclepias incarnata* (Sta. I, *d*). Mr. C. A. Hart, who determined the specimen, remarks that it "is very remarkable—thorax of *femoratus*, antennæ and pattern nearest to *4-ophthalmus*."

CHRYSOMELIDÆ

Cryptocephalus venustus Fabr.

This leaf-beetle was taken from the flowers of prairie clover, *Petalostemum* (Sta. I, *b*), Aug. 11 (No. 21). Blatchley ('10, p. 1123) states that it is found on the flowers of *Erigeron* in timothy fields, on ironweed, and on wild sweet potato. Chittenden ('92, p. 263) has observed the var. *simplex* Hald. on ragweed, *Ambrosia trifida*, "dodging around the stem after the manner of a squirrel or lizard on a tree-trunk. . . . The insect is a polyphagous leaf-eater."

Chrysochus auratus Fabr. Dogbane Beetle.

Only two specimens of this usually common metallic-green beetle were seen and secured. One (No. 14) was taken Aug. 9 on the dogbane or Indian hemp, *Apocynum medium*, growing among the swamp milkweeds, *Asclepias incarnata* (Sta. I, *d*); and the other on dogbane in the upland part of Bates woods (Sta. IV, *a*), Aug. 20, 1910 (No. 103). Later, July 3, 1911, T. L. Hankinson (Sta. I) also secured this beetle (No. 7665). The food plant was abundant, but the beetles appeared to be exceptionally rare. This is another widely recognized but really little known insect. It is also found on the leaves of milkweeds. Zabriskie (Jour. N. Y. Ent. Soc., Vol. 3, p. 192. 1895) describes the egg-capsules of this species, which he found early in July on fence posts, near plants of the spreading dogbane,

Apocynum androsæmifolium, and especially upon the under surface of the leaves of this plant. A single egg is deposited within a conical black mass, which is probably the excrement of the beetle. To this note Beutenmüller adds that "the larvæ, after hatching drop to the ground and live on the roots of the plant."

With so much of a clue, the complete life history of this species ought to be worked out without much difficulty. Forbes once reported this species injuring potato (Lintner, Fourth Report on the Injurious and other Insects of the State of New York, p. 142).

Nodonota convexa Say.

This small leaf-beetle was taken in sweepings of vegetation in a colony of the cone-flower, *Lepachys pinnata* (Sta. I, e), Aug. 12 (No. 40). Blatchley ('10, p. 1149) states that it occurs in low places on ragweed, *Ambrosia trifida*. This cone-flower colony was on rather low land containing crawfish holes.

Trirhabda tomentosa Linn.

This insect was taken at Station I by T. L. Hankinson July 3, 1911 (No. 7665). It is common on *Solidago*. Schwarz (Am. Nat., Vol. 17, p. 1289. 1883) reports it as a defoliator of prickly ash (*Zanthoxylum*).

Diabrotica 12-punctata Oliv. Southern Corn Root-worm. (Pl. XLV, fig. 3).

This common corn pest was taken in sweepings of the vegetation in a colony of *Lepachys pinnata* (Sta. I, e) Aug. 12 (No. 40), and T. L. Hankinson captured it (Sta. I) July 3, 1911 (No. 7665). A few feet away was a large corn field. It was also taken on the flowers of *Eryngium yuccifolium* on the prairie at Loxa (Sta. II) Aug. 13 (No. 55). Here also a field of corn stood only a few feet away.

Diabrotica longicornis Say. Western Corn Root-worm. (Pl. XLV, fig. 1.)

This beetle was found upon the flower-masses of the mountain mint *Pycnanthemum pilosum*, growing in a forest clearing (near Sta. IV, a) Aug. 23 (No. 146). It feeds upon the silk and pollen of corn, and probably on the corresponding parts of other plants.

Diabrotica atripennis Say.

One specimen of this beetle was taken on the flowers of the swamp milkweed, *Asclepias incarnata* (Sta. I, d), Aug. 8 (No. 1). Very little appears to be recorded on this species except that it feeds upon the pollen and silk of corn, the pollen of composites, and the blossoms of beans (Forbes, '05, p. 189).

MELOIDÆ

Zonitis bilineata Say. Two-lined Blister-beetle. (Pl. XLIV, fig. 1.)

This beetle was taken on the apical leaves of the common milkweed, *Asclepias syriaca* (Sta. I), Aug. 12 (No. 33). Blatchley ('10, p. 1356) records it as from the flowers of the wild rose.

Epicauta vittata Fabr. Old-fashioned Potato Beetle or Striped Blister-beetle. (Pl. XLV, fig. 5.)

Several specimens were taken by T. L. Hankinson at Station I July 3, 1911 (No. 7665).

Epicauta marginata Lec. Margined Blister-beetle. (Pl. XLV, fig. 2.)

This beetle was taken at Station I by T. L. Hankinson only—July 3, 1911 (No. 7665); it was taken also from the leaves of the rosin-weed, *Silphium integrifolium*, on the Loxa prairie (Sta. II) Aug. 13 (No. 48); from an open ravine in Bates woods (Sta. IV, *b*) Aug. 22 (No. 124); and in the lowland glade (Sta. IV, *c*) Aug. 22 (No. 143). For accounts of the common Illinois species of blister-beetles see Forbes and Hart ('00, pp. 487-490, and Forbes, '05, pp. 111-114).

Epicauta pennsylvanica DeG. Black Blister-beetle.

This beetle was collected from flowers of goldenrod, *Solidago* (Sta. I, *a*), Aug. 12 (No. 26); on the Loxa prairie (Sta. II) from flowers of the rosin-weed, *Silphium integrifolium*, Aug. 13 (No. 48); on flowers of *Silphium terebinthinaceum* (Sta. III *a*), Aug. 20 (No. 119); in the cleared margin of Bates woods (near Sta. IV, *a*), on flowers of *Pycnanthemum pilosum* Aug. 23 (No. 146); again on goldenrod, *Solidago* (near Sta. I, *a*), Aug. 24 (No. 152); and from the Loxa prairie on flowers of rattlesnake-master, *Eryngium yuccifolium*, (Sta. II, *a*) Aug. 27 (No. 178).

The larvæ of this and some other species of blister-beetles prey upon locusts' eggs. (Cf. Riley, First Rep. U. S. Ent. Comm., p. 293. 1878.) The beetle lays its own eggs in the vicinity of the locusts' eggs.

RHIPIPHORIDÆ

Rhipiphorus dimidiatus Fabr.

Five specimens of this mordellid-looking little beetle were taken on flowers of the mountain mint *Pycnanthemum flexuosum* (Sta. I, *g*) Aug. 8 (No. 6); and three specimens on flowers of the mountain mints *P. flexuosum* and *P. pilosum* on the Loxa prairie (Sta. II) Aug. 13 (No. 52). Blatchley ('10, p. 1366) reports it as from the flowers of *P. linifolium* Pursh.

These small beetles are black except the basal two-thirds of the elytra, which are pale yellow. The larvæ are parasitic on wasps, as has been shown by Chapman for the European species *paradoxus* (Ann. Mag. Nat. Hist., Ser. 4, Vol. 5, p. 191, and Vol. 6, p. 314. 1870). The larvæ undergo a very peculiar metamorphosis which is related to their parasitic habit. It is desirable that the life histories of the American species should be studied.

Ashmead (Psyche, Vol. 7, p. 77. 1894) reared this beetle from the cells of the wasp *Eumenes fraterna* Say. Riley (Sixth Rep. Ins. Mo., p. 125. 1874) states that he bred *Rhipiphorus pectinatus* Fabr., var. *ventralis* Fabr., from the cocoons of the wasp (*Tiphia*) which preys upon the grubs of *Lachnosterna*. Melander and Brues ('03, p. 26) found another member of the same family of beetles, *Myodites fasciatus* Say, on wing over nests of *Halictus*. Pierce ('04) has made a valuable study of the ecology of *Myodites solidaginis*, giving particular attention to its host, a bee (*Epinomia triangulifera* Vachal). Pierce (l. c., p. 185) states that the tiger-beetle *Cicindcla punctulata* Fabr. is an active enemy of *Epinomia* and *Myodites*. I have found this a very abundant beetle in open sunny places on bare ground, as, for example, along a footpath through a timothy meadow at Bloomington, Ill. Such situations are the favorite haunts of many burrowing *Hymenoptera*.

Rhipiphorus limbatus Fabr.

A single specimen was taken on the flower of the rattlesnake-master, *Eryngium yuccifolium*, on the Loxa prairie (Sta. II, a) Aug. 27 (No. 178). This species is yellow, with black elytra, and a large black spot on the dorsum of the prothorax. Blatchley ('10, p. 1367) reports it from various composites. Robertson (Trans. St. Louis Acad. Sci., Vol. 6, pp. 106, 107. 1892) reports this beetle from Carlinville, Ill., on the flowers of several species of *Pycnanthemum*, and (idem, Vol. 5, p. 571) he also records it from milkweeds (*Asclepias*).

RHYNCHITIDÆ

Rhynchites æneus Boh.

This snout-beetle was taken on the prairie west of Loxa from flowers of the rosin-weed, *Silphium integrifolium* (Sta. II), Aug. 13 (No. 48). It has been taken from other flowers (Pierce, '07, p. 251).

CALANDRIDÆ

Sphenophorus venatus Say (*placidus* Say). (Pl. XLV, fig. 4.)

This "bill-bug" was taken from the colony of tall blue-stem *Andropogon* and foxtail, *Panicum* (Sta. I, g), Aug. 12 (No. 39).

Forbes ('03—22d Rep. State Ent. Ill.—p. 8) gives a summary of what is known of this species. It is a corn pest, has been found widely dispersed in Illinois, and hibernates as an adult beetle. A tachinid fly has been bred from the larva of *S. robustus* Horn. (Coquillett, '97, p. 18.)

CURCULIONIDÆ

Centrinus penicellus Hbst.

This snout-beetle was taken on the flowers of goldenrod, *Solidago* (near Sta. I, a), Aug. 12 (No. 26); another specimen was taken from Sullivant's milkweed, *Asclepias sullivantii* (Sta. I), Aug. 12 (No. 41). Forbes and Hart ('00, p. 493) state that it has been taken in the "latter part of July and August." It injures beet leaves, but its early life history is not known.

Centrinus scutellum-album Say.

This beetle was taken at Station I, July 3, 1911, by T. L. Hankinson (No. 7665). It has been taken from a number of flowers in which it fed upon pollen (Pierce, '07, p. 284). The larva of *Centrinus picumnus* Hbst. has been found injuring *Setaria* (Webster, in *Insect Life*, Vol. I, p. 374. 1889).

LEPIDOPTERA

PAPILIONIDÆ

Papilio polyxenes Fabr. Celery Butterfly.

This common butterfly was taken on wing along the railway track near the swamp milkweed (*Asclepias incarnata*) colony (Sta. I, d) Aug. 9 (No. 15), and from a web of the common garden spider *Argiope aurantia*, among these milkweeds (No. 45). Chittenden (*Bull. 82, Bur. Ent. U. S. Dept. Agr., pp. 20-24. 1909*) gives a brief account of this common species which feeds upon umbellifers. It was very abundant on parsley in the J. I. Bates garden (near Sta. IV, a) Aug. 26 (No. 174).

PIERIDÆ

Pontia rapæ Linn. Cabbage Butterfly. (Pl. XLVI, fig. 1.)

A mutilated specimen of this butterfly, which had been captured by a robber-fly, was secured by E. N. Transeau (Sta. III, b, Aug. 15; No. 61).

Eurymus philodice Godart.

This butterfly was taken on the flowers of *Pycnanthemum pilosum* in a cleared area bordering the Bates woods (near Sta. IV, a)

Aug. 23 (No. 146); and on flowers of the swamp milkweed, *A. incarnata* (Sta. I, *d*), Aug. 9 (No. 12).

NYPHALIDÆ

Argynnis idalia Drury. Idalia Butterfly.

This species was taken from the flowers of the swamp milkweed, *A. incarnata* (Sta. I, *d*), Aug. 12 (No. 37).

Anosia plexippus L. Milkweed Butterfly. (Pl. XLVI, fig. 3.)

This common butterfly was abundant upon the prairie at Station I. It was observed copulating on willows at Sta. I, *d*, Aug. 9, and when on wing was able to carry its mate, whose wings were folded. It was observed on flowers of the thistle *Cirsium discolor* at Station I (No. 155).

LYCENIDÆ

Chrysophanus thoe Boisd. & Lec. Thoe Butterfly.

This butterfly was taken on flowers of the rattlesnake-master, *Eryngium yuccifolium*, on the Loxa prairie (Sta. II) Aug. 13 (No. 55).

The caterpillar feeds upon smartweeds (*Polygonum*) and dock (*Rumex*), and also upon prickly ash, *Zanthoxylum*.

SPHINGIDÆ

Hemaris diffinis Boisd. Honeysuckle Sphinx.

This hawk-moth was taken upon flowers of the swamp milkweed, *A. incarnata* (Sta. I, *d*), Aug. 12 (No. 32), and by T. L. Hankinson July 3, 1911, at Station I (No. 7655). This moth flies during bright daylight. The caterpillar lives on bush honeysuckle, snowberry, and feverwort.

ARCTIDÆ

Ammalo eglensis Clem. or *tenera* Hübn.

This caterpillar was taken on dogbane, *Apocynum medium*, on the Loxa prairie (Sta. II) Aug. 13 (No. 53).

Eglensis is reported to feed upon *Asclepias tuberosa* and *Apocynum*.

NOCTUIDÆ

Rhodophora gauræ Sm. and Abb.

This interesting larva was not taken at Charleston, but on the prairie near Vera, Fayette county, Ill., on *Gaura bicnmsis* Sept. 1 (No. 186). This specimen was determined by W. T. M. Forbes. It

is of interest that this larva, which is recorded from the "Southern and Southwestern States" and Colorado, was found on the prairie of Illinois. It is another example illustrating the southwestern and western affinities and origin of many elements in the prairie fauna. Mr. C. A. Hart informs me that he took the moth at a light Sept. 10 and 17, 1909, at Urbana, and that it was taken at Pekin, Ill., in August.

Spragueia leo Guen.

This little moth was taken once on the flowers of *Solidago* (near Sta. I, *a*) Aug. 11 (No. 20); again, in a similar situation, Aug. 12 (No. 26); and a third time in the cleared area near the Bates woods on the flowers of *Pycnanthemum pilosum* (Sta. IV, *a*) Aug. 23 (No. 146, two specimens).

GELECHIIDÆ

Gnorimoschema gallæsolidaginis Riley. (Caterpillar Gall) (Pl. XLVI, fig. 4.)

This common gall was taken by T. L. Hankinson on *Solidago* at Sta. I, Aug. 8, 1910 (No. 7462).

Cf. Riley (First Rep. Ins. Mo., pp. 173-175. 1869) and Busck (Proc. U. S. Nat. Mus., Vol. 25, pp. 824-825. 1903).

DIPTERA

CECIDOMYIIDÆ

Cecidomyia solidaginis Loew. (Goldenrod Bunch Gall.) (Pl. XLVI, fig. 5.)

This gall was taken on *Solidago* Aug. 12 at Sta. I (No. 42), and by T. L. Hankinson at Sta. I, on Aug. 8, 1910 (No. 7462). This gall forms a rosette or terminal bunch of leaves on *Solidago*.

Cecidomyia sp.

A willow cone-gall was found Sept. 13 by T. L. Hankinson on willows at Sta. I. (Cf. Heindel, '05.)

CULICIDÆ

Psorophora ciliata Fabr. Giant Mosquito or Gallinipper.

This is our largest species of mosquito. It was taken among the swamp milkweeds, *Asclepias incarnata* (Sta. I, *d*), Aug. 10 (No. 13); and in the prairie grass colony (Sta. I, *g*) Aug. 12 (No. 44). Both of these places were near moist or wet areas. Individuals were not abundant, although the species is particularly adapted to living where the moisture is variable. Morgan and Dupree (Bull. 40, Div.

Ent., U. S. Dept. Agr., p. 91. 1903) have concluded that all the eggs do not hatch with the first rain after their deposition, but that hatching is completed with the alternation of wet and dry weather.

MYCETOPHILIDÆ

Eugnoriste occidentalis Coq.

A single specimen of this small fly was taken on the flowers of *Solidago* (Sta. I) Aug. 12 (No. 26). The specimen was determined by J. R. Malloch. It had been previously recorded from goldenrod flowers by Aldrich ('05, p. 148).

Sciara sp.

These small flies were taken from the flowers of the mountain mint, *Pycnanthemum flexuosum* (Sta. I, g), Aug. 8 (No. 6).

BOMBYLIDÆ

Exoprosopa fasciata Macq. Giant Bee-fly.

This was one of the most abundant and characteristic insects of the prairies and cleared areas, and belongs in the same class as the red milkweed beetle (*Tetraopes*) and the milkweed bug, *Lygæus kalmii*. It was taken from flower masses of the mountain mint *Pycnanthemum flexuosum* (Sta. I, g) Aug. 8 (No. 6); on the flowers of *Verbena stricta* Vent. (near Sta. I, a) Aug. 11 (No. 23); again from *P. flexuosum* (Sta. I) Aug. 11 (No. 24); and on the flowers of *Liatris scariosa* (Sta. 11, a) Aug. 27 (No. 176). Two specimens had been captured by the flower spider *Misumena alcatoria* Hentz: one on flowers of the rosin-weed, *Silphium integrifolium* (Sta. II), Aug. 13 (No. 47), the other on flowers of the mountain mint *Pycnanthemum flexuosum* (Sta. I) Aug. 12 (No. 31); and a third was captured by the ambush bug, *Phymata fasciata* Gray, on the flowers of the mountain mint (Station II) Aug. 13 (No. 57).

This was a very common species on the prairie patches at Bloomington, Ill., July 26 to Aug. 23, and in pastures abounding in *Verbena* at Kappa, Ill., and Havana, Ill., in August. Graenicher ('10, pp. 94-95) has listed several species of flowers from which this fly has been taken. It is probable that it preys upon some wasps, since a related species, *E. fascipennis* Say, has been bred from the cocoons of the white-grub wasp, *Tiphia* (Forbes, '08, p. 160).

Systæchus vulgaris Loew.

In the cleared area bordering the Bates woods, on flowers of the mountain mint *Pycnanthemum pilosum* (near Sta. IV, a), a specimen

of this bee-fly was taken Aug. 23 (No. 146). Graenicher ('10, p. 93) has listed a variety of plants visited by this fly.

The habits of this species appear not to be known, but the larvæ of an allied species, *S. oreas* O. S., preys upon the eggs of grasshoppers (Riley, Second Rep. U. S. Ent. Comm., pp. 262-268. 1880). Sheldford ('13c) has found that *Spogostylum anale* Say is a parasite on the larva of *Cicindela*. A related fly, *Sparnopolius fulvus*, is parasitic on the grubs of *Lachnosterna* (Forbes, '08, p. 161). Holmes ('13) has shown the relation of light to the hovering flight of *Bombylius*.

MYDAIDÆ

Mydas clavatus Drury. Giant fly.

A single specimen of this giant fly was taken on flowers of the swamp milkweed, *Asclepias incarnata* (Station I, d), Aug. 9 (No. 12). I have taken this species at Chicago during July, and at Bloomington, Ill., on June 29.

Harris (Insects Injurious to Vegetation, p. 607. 1869) describes briefly the larva and pupa; and Washburn (Tenth Ann. Rep. State Ent. Minn., Pl. II, fig. 15. 1905) gives a colored figure of the species.

The larvæ of this family live in decaying wood and prey upon insects, and the adults are also predaceous (Hubbard '85, p. 175).

Howard (Insect Book, p. 136) states that the larva of *Mydas fulvipes* Walsh "lives in decaying sycamore trees and is probably predatory on other insects living in such locations." He also states that the adults are predaceous.

ASILIDÆ

Deromyia sp.

This robber-fly was taken on the Loxa prairie (Sta. II) Aug. 13 (No. 51).

The larvæ of some members of this family feed upon rhubarb roots (Harris, Ins. Inj. to Vegetation, p. 605. 1869), and others, as *Erax bastardi*, are known to prey upon the eggs of grasshoppers (Riley, First Rep. U. S. Ent. Comm., pp. 303-304, 317. 1878). Adults of several species of robber-flies feed upon grasshoppers; others kill bees (Riley, Sec. Rep. Ins. Mo., pp. 121-124. 1870).

Promachus vertebratus Say. Vertebrated Robber-fly. (Pl. XLVI, fig. 6.)

This is an abundant fly upon the prairie. A specimen was taken on the Loxa prairie (Sta. II) Aug. 13 (No. 56); and on the prairie east of Charleston (Sta. III, b) Aug. 15 (No. 62). Here a robber-fly was seen with a cabbage butterfly, *Pontia rapæ* (No. 61); since the

fly escaped, however, the species is not known. Another was found astride a grass stem (Sta. I, *g*) with the stink-bug *Euschistus variolarius* grasped in its legs Aug. 12 (No. 39). Aug. 12, among the prairie grasses (Sta. I, *g*), a pair of these flies was taken copulating (No. 44). Walsh (Am. Ent., Vol. I, pp. 140-141. 1869) states that *Asilus* preys upon *Polistes* and *Bombus*, which it grasps by the head-end, to keep out of the reach of the sting, from the bodies of which it sucks the juices. It handles a harmless grasshopper very differently.

I have observed a large species of robber-fly at Havana, Ill., which hung suspended from grass while devouring its prey; and Aldrich (Proc. Ent. Soc. Wash., Vol. 2, p. 147. 1893) observed a robber-fly suspended by its fore feet, apparently asleep, holding a large beetle. Cook (Bee-keepers' Guide, ninth ed., pp. 317-321. 1883) has seen a species of robber-fly capture a tiger-beetle, *Cicindela*; many of these flies furthermore prey upon the honey-bee. The introduction of this bee into the prairie association must have had considerable influence upon flower-frequenting insects, and especially upon the predaceous kinds.

The capture of the cabbage butterfly by an asilid is another observation which Cook has recorded for *Proctacanthus milberti* Macq. (*Asilus missouriensis* Riley). He says (l. c. p. 318): "It has been observed to kill cabbage butterflies by scores." Wallis (Can. Ent., Vol. 45, p. 135. 1913) observed this fly capturing *Cicindela*. Punnett (Spolia Zeylanica, Vol. 7, pp. 13-15. 1910) has recently shown that in Ceylon robber-flies are important enemies of large butterflies. *Proctacanthus milberti* has been observed to prey upon locusts (Riley, First U. S. Ent. Comm., p. 317. 1878). For an elaborate account of the food and feeding habits of this family see Poulton, ('07).

As very little is known of the breeding habits of the American species, the observations of Hubbard on the oviposition of *Mallophora orcina* Wied. (Second Rep. U. S. Ent. Comm., p. 262. 1880) are of interest. He saw a female of this Florida species bury its abdomen in the ground, where it deposited five or six eggs at a depth of half to two thirds of an inch. The eggs hatched in a week. *Erax lateralis* Macq. has been recorded as predaceous upon May-beetle larvæ (Titus, in Bull. 54, Bur. Ent., U. S. Dept. Agr., pp. 15-16). Titus gives figures of the larva and pupa.

DOLICHOPODIDÆ

Psilopus siphon Say. Metallic Milkweed Fly. (Pl. XLVI, fig. 2.)

This pretty metallic-colored fly, observed by almost every field student or collector, is one of our commonest insects. It runs rapidly

over the upper surface of the leaves of the common milkweed, *Asclepias syriaca*, and is so nimble that it requires a little care to catch it. A large number of the flies were secured from the common milkweed along the railway track (Sta. I) Aug. 12 (No. 27), and also on the milkweeds infested with the plant-louse *Aphis asclepiadis* Fitch. Although some species of *Dolichopodidae* are said to be predaceous, I have never seen this species attack any insect.

The peculiar breeding habits of some of the members of this family have been described by Aldrich (Am. Nat., Vol. 28, p. 35-37. 1894).

SYRPHIDÆ

Syrphus americanus Wied. (Pl. XLVII, figs. 3, 4, and 5.)

This fly was taken along the railway track (Sta. I) Aug. 9 (No. 11). Its hum when on wing sounded much like that of the small yellow-jacket, *Vespa*. Metcalf ('13, p. 55) found it feeding on aphids infesting *Phragmites*.

Certain syrphid larvæ prey upon plant-lice, and the adults are abundant on flowers, especially unbellifers, feeding on their nectar. For good accounts of both larvæ and adults consult Williston (Bull. 31, U. S. Nat. Mus., pp. 269-272. 1886) and Metcalf ('13).

Mesogramma politum Say. Corn Syrphid. (Pl. XLVII, figs. 1 and 2.)

This syrphid was found in great numbers on the Loxa prairie (Sta. II) Aug. 27 (No. 177).

The larvæ are pollen feeders, as has been shown by an examination of the contents of the alimentary canal (cf. Riley and Howard, Insect Life, Vol. 1, p. 6). Also consult Forbes ('05, p. 162), who figures the species. Upon the original prairie the species probably fed on the pollen of various grasses or other plants.

Allograpta obliqua Say. (Pl. XLVII, figs. 6 and 7.)

This insect was taken on the Loxa prairie (Sta. II) in company with great numbers of *Mesogramma politum* Say, Aug. 27 (No. 177). For figures of the larva, pupa, and adult see Washburn (Tenth Ann. Rep. State Ent. Minn., p. 101. 1905) and Metcalf ('13, p. 58). It feeds upon aphids.

CONOPIDÆ

Physocephala sagittaria Say.

This insect was taken on the flowers of goldenrod, *Solidago* (Sta. I), Aug. 12 (No. 26). Also taken on a small-flowered aster at Urbana. Ill., Oct. 8. The larvæ of this family are parasitic on other insects. There is a figure of an allied species on Plate XLVIII, figure 1.

TACHINIDÆ

Cistogaster immaculata Macq.

A single specimen of this fly was taken on the flower of rattlesnake-master, *Eryngium yuccifolium* (Sta. II) Aug. 13 (No. 55).

The larva is parasitic on lepidopterous larvæ (Townsend, Psyche, Vol. 6, p. 466. 193); and has been bred from the army-worm, *Leucania unipuncta* Haw. Two undetermined species of tachinids were taken by T. L. Hankinson (Sta. I) July 3, 1911 (No. 7665).

Trichopoda ruficauda V. d. W.

A single specimen of this fly was taken along the railway track (Sta. I) Aug. 12 (No. 38).

An allied species, *T. pennipes* Fabr., has been bred from the squash-bug (Cook, Rep. Mich. State Board Agr., pp. 151-152. 1889), and another, *plumipes* Fabr., has been bred from a grasshopper, *Dissosteira venusta* Stål (Coquillett, '97, p. 21).

SCIOMYZIDÆ

Tetanocera plumosa Loew. (Pl. XLVIII, fig. 2.)

Taken in a colony of *Spartina* (Sta. I, a) Aug. 28 (No. 179). This species is figured by Washburn (Tenth Ann. Rep. State Ent. Minn., p. 121. 1905). The larvæ of this family are aquatic. Needham (Bull. 47, N. Y. State Mus., pp. 580-581, 592, Pl. 14. 1901) describes and figures *T. pictipes* Loew. (Cf. Shelford, '13a.)

TRYPETIDÆ

Euaresta æqualis Loew.

This insect was taken in sweepings among a colony of the cone-flower, *Lepachys pinnata* (Sta. I, c), Aug. 12 (No. 40). Marlatt (Ent. News, Vol. 1, p. 168) records the rearing of this fly from the seed-pod of the cocklebur (*Xanthium*).

EMPIDIDÆ

Empis clausa Coq.

A specimen of this fly was taken from a pair of copulating ambush bugs, *Phymata fasciata*, on the flowers of *Solidago* (Sta. I) Aug. 12 (No. 43), and great numbers, so many that they darkened the flowers on which they rested, were seen upon *Asclepias syriaca* (Sta. I) Aug. 12 (No. 27). The specimen was determined by J. R. Malloch.

McAtee (Ent. News, Vol. 20, pp. 359-361. 1909) gives an account of the habits of *Empididæ*, and Schwarz (Proc. Ent. Soc. Wash., Vol. 20, pp. 146-147. 1893) states that one kind captures small flies, and

suspended by its foreleg, eats its prey. This position when eating is a curious habit, independently acquired by several predaceous insects, as *Bittacus*, *Vespa*, and certain *Asilidæ*.

Mr. Malloch has called my attention to British observations made upon the peculiar habits of these flies. Thus Howlett ('07) has shown that the male supplies the female with an insect for food during copulation. These observations have been confirmed by Hamm ('08). Poulton ('07) discusses the food habits of these flies in much detail.

HYMENOPTERA

CYNIPIDÆ

Rhodites nebulosus Bassett. (Rose Gall.)

This gall was taken on a wild rose, *Rosa*, in the mixed forest and prairie colony east of Charleston (Sta. III, *b*) Aug. 15 (No. 60).

BRACONIDÆ

An undetermined species was taken from the flowers of *Pycnanthemum pilosum* in the cleared area with sprout growth bordering the Bates woods (near Sta. IV, *a*) Aug. 23 (No. 146).

FORMICIDÆ

Myrmica rubra Linn., subsp. *scabrinodis* Nyl., var. *sabuleti* Meinert.

This ant was found upon the prairie on flowers of the common milkweed, *Asclepias syriaca* (Sta. I), Aug. 12 (No. 27). It was associated with *Formica fusca subsericea* Say and *Formica pallide-fulva schaufussi incerta* Emery.

Wheeler ('05, pp. 374, 384) regards this as one of the heath ants, which "inhabit rather poor, sandy or gravelly soil exposed to the sun and covered with a sparse growth of weeds or grasses It nests in sandy or gravelly sunny places such as open pastures, roadsides, etc." These requirements are admirably met by the conditions along the gravelly and sandy road-bed of the railway where the milkweeds flourish.

Formica fusca Linn., var. *subsericea* Say.

This ant was found on flowers of the goldenrod, *Solidago* (near Sta. I, *c*), Aug. 11 (No. 20); on leaves of the common milkweed (*Asclepias syriaca*) infested with the plant-louse *Aphis asclepiadis* Fitch (Sta. I) Aug. 12 (No. 30) and again Aug. 24 (No. 154); and in the upland Bates woods (Sta. IV, *a*) Aug. 26 (No. 163).

According to Wheeler ('10a, p. 458) this ant is enslaved by *Formica sanguinea* Latr. and the following subspecies: *aserva* Forel, *rubi-*

cunda Emery, *submuda* Emery, *subintegra* Emery, and *puberula* Emery. Wheeler has seen *Formica sanguinea* "plunder a *subsericea* nest nearly every day for a week or a fortnight." In raiding a nest the ants carry off the larvæ and pupæ to their own nests, to serve as slaves when matured.

Wheeler (l. c., p. 374) states that *subsericea* may live in a great variety of situations—an unusual trait, but indicated in our collecting by its presence in both forest and prairie.

Formica pallide-fulva Latr., subsp. *schaufussi* Mayr, var. *incerta* Emery.

This common reddish ant was taken on the prairie from flowers of the common milkweed, *Asclepias syriaca* (Sta. I), Aug. 12 (No. 27); and on the Loxa prairie from flowers of the mountain mint *Pycnanthemum pilosum* or *P. flexuosum* (Sta. II) Aug. 13 (No. 52).

This ant was associated on the milkweeds with *Myrmica rubra* Linn., subsp. *scabrinodis* Nyl., var. *sabuleti* Meinert, and *Formica fusca subsericea* Emery.

Wheeler ('05, pp. 373, 374) lists this species as frequenting glades, "open sunny woods, clearings, or borders of woods," and further adds that the glade and field faunas are not separated by a sharp line, for "*Formica schaufussi*, for example, seems to occur indifferently in either station." That open patches in woods or glades often contain ants which also frequent open places, is thus in harmony with a general rule for this association, not only in the case of animals but also of plants, so that it applies to the entire biota of such situations.

Wheeler ('10a, p. 393) lists a small wingless cricket, *Myrmecophila pergandei*, as living with *Formica pallide-fulva*. These lick the surfaces of the ants, and seem to feed upon the products of the dry bath.

Wheeler says ('05, p. 400) that the food of *schaufussi* appears to be "largely of the excrement of Aphides and the carcasses of insects."

Wheeler ('04, pp. 347-348) states that the nests are usually found under a stone, and that *Formica difficilis* Emery var. *consocians* Wheeler is a temporary parasite upon *incerta*, but "only during the incipient stages of colony formation" (p. 358). This is a temporary parasitism of one colony upon another, during which the parasite multiplies and becomes strong enough, at the expense of its host, to establish a new independent colony. This is what Wheeler calls a "temporary social parasite, a true cuckoo ant, which sponges on another species only so long as necessary in order to gain a successful start in life." Schwarz ('90b, p. 247) records several species of beetles as living with *schaufussi*. Not only does this species suffer from temporary ant-parasites, but it may be enslaved by some form of Amazon-

ant, as *Polyergus lucidus* (Wheeler, '10a, p. 482; Tanquary, '11, p. 302).

MUTILLIDÆ

Sphacrophthalma sp. Velvet Ant.

This wasp was taken on the bare footpath at the margin of the Bates upland woods (near Sta. IV, a) Aug. 23 (No. 151). It is probably parasitic in the nests of bees.

MYZINIDÆ

Myzine sexcincta Fabr.

This black-and-yellow-banded wasp was very abundant on flowers. It was taken Aug. 8 (Sta. I, g) on flowers of *Asclepias incarnata* (No. 1) and from *Pycnanthemum flexuosum* (No. 6); from the flowers of goldenrod, *Solidago* (near Sta. I, a), Aug. 11 and 12 (Nos. 20 and 26); by T. L. Hankinson (Sta. I) July 3, 1911 (No. 7665); on flowers of *Pycnanthemum* (Sta. II) Aug. 13 (No. 52); and from the flowers of *Eryngium yuccifolium* (Sta. II) Aug. 13 (No. 55); and from the cleared area bordering Bates woods (Sta. IV, a) Aug. 23 (No. 146).

Packard (Guide to the Study of Insects, 8th ed. p. 177. 1883) states that this wasp flies "low over hot sandy places." This is one of the species found by Banks (Jour. N. Y. Ent. Soc., Vol. 10, p. 210, 1902) to sleep in grass, and by Brues (idem, Vol. 11, p. 229. 1903) resting during the day and night upon plants.

SCOLIIDÆ

Scolia bicincta Fabr.

This hirsute black wasp, with two yellow transverse dorsal bands on the abdomen, is represented in our series by four specimens. Three of these were taken on flowers of *Pycnanthemum pilosum* from the clearing bordering the upland portion of the Bates woods (near Sta. IV, a) Aug. 23 (No. 146); the others, from an open space in the upland forest (Sta. IV, a) Aug. 26 (No. 163). I have also taken this species at Bloomington, Ill., Aug. 23, 1892, and Aug. 25, 1896.

Packard (Guide to the Study of Insects, 8th ed., p. 176. 1883) states that in Europe *Scolia bicincta* burrows sixteen inches in sand banks, and that it probably stores its nest with grasshoppers. Riley (First Rep. U. S. Ent. Comm., p. 319. 1878) states that species of *Scolia* are known to have the habit of stinging grasshoppers and digging nests, provisioning these with grasshoppers, on which they lay eggs as does the wasp *Chlorion cyaneum* Dahlb. (*C. cæruleum* Drury). (Cf. with Kohl, Ann. des K. K. naturhist. Hofmuseums, Bd.

5, pp. 121-122. 1890.) Forbes ('08, pp. 157-160) has found that *Tiphia* is parasitic upon the grub of the May-beetles (*Lachnosterna*). The wasp crawls into the ground in search of the larva, stings it, and lays its eggs upon it. It is not unlikely that *Scolia* has similar habits.

The sleeping habits of *bicincta* and some other *Hymenoptera* have been described by Banks (Journ. N. Y. Ent. Soc., vol. 10, pp. 127-130. 1902), Brues (idem, Vol. 11, pp. 228-230. 1903), and Bradley (Ann. Ent. Soc. Amer., Vol. 1, pp. 127-130).

Scolia tricincta Fabr.

One specimen was taken—in the clearing bordering the Bates woods on flowers of *Pycnanthemum pilosum* (Sta. IV, a) Aug. 23 (No. 146).

EUMENIDÆ

Odynerus vagus Sauss. Potter Mud-wasp.

An oval mud nest, about 18 mm. long and 10 mm. in diameter, was found on a stem of dogbane, *Apocynum medium* (Sta. I), Aug. 12 (No. 46). The nest was placed in a vial; and later, a single wasp of the above species came from an opening which was made at the point where the mud cell was formerly attached to the plant.

This is a predatory wasp, which stores its nest with caterpillars (Peckhams, in "Wasps, Social and Solitary," pp. 94-95. 1905).

VESPIDÆ

Polistes—probably *variatus* Cress.

A small nest was observed in a grassy area near Station I, e, but was not secured. The adults feed the young with caterpillars and nectar. See Enteman (Pop. Sci. Monthly, Vol. 61, pp. 339-351. 1902) for an excellent account of the habits and life history of these social wasps.

That these wasps will build their nests in an open area is of interest, because the nests are so commonly found under eaves and on the under side of roofs—situations which were originally lacking on the prairie.

As Walsh stated, the social wasps do not store up food, because "they feed their larvæ personally from day to day."

PSAMMOCHARIDÆ

Priocnemoides unifasciatus Say (*Priocnemis*). Spider Wasp.

This wasp was taken in the cleared area bordering the Bates woods, on flowers of *Pycnanthemum pilosum* (near Sta. IV, a) Aug. 23 (No. 146).

A specimen was taken Aug. 21 at Bloomington, Ill. The yellow wings and antennæ, and yellow subapical wing spot on the smoky wings make this a conspicuous species. The family name *Pompilidæ* was formerly used for these wasps.

SPHECIDÆ

Ammophila nigricans Dahlb.

A single specimen was taken from the flowers of *Pycnanthemum flexuosum* (Sta. I) Aug. 11 (No. 24).

This is a very common Illinois species. I have taken it at Bloomington from June 22 to September 9, at Havana during August, and at Chicago, August 19 and 28. A specimen taken August 2 at Bloomington, Ill., was digging in the ground when captured.

Chlorion ichneumoncum Linn. (*Sphex ichneumonca* Fabr.). Rusty Digger-wasp. (Pl. L, fig. 1.)

This insect, abundant on flowers of the swamp milkweed, *Asclepias incarnata*, August 8, was taken on them at Sta. I, *g*, Aug. 8 (No. 1) and at Sta. I, *d*, Aug. 9 (No. 12); and on the mountain mint *Pycnanthemum flexuosum* (Sta. I) Aug. 8 (No. 6). It was also taken by T. L. Hankinson July 3, 1911 (No. 7665).

This is a very common insect on flowers in central Illinois. I have found it abundant at Chicago during August; at Bloomington, Ill., from June 24 to Oct. 1; at Mayview on Sept. 26 in a colony of prairie vegetation.

Packard (Guide to the Study of Insects, pp. 167-168. 1870) tells how these wasps dig holes four to six inches deep in gravel walks, and after capturing long-horned grasshoppers, *Orchelimum vulgare* or *O. gracile*, and stinging and paralyzing them, proceed to bury them. The egg is deposited on the locust before the soil is scraped in. (Cf. Walsh, Am. Ent., Vol. 1, p. 126. 1869). For an excellent account of the habits of this species consult the Peckhams, "Instincts and Habits of the Solitary Wasps" (1898). See Fernald ('06) for the recent synonymy.

Chlorion pennsylvanicum Linn. Pennsylvania Digger-wasp.

This wasp was taken on the flowers of *Eryngium yuccifolium* (Sta. II) Aug. 13 (No. 55). On Aug. 8, 1893, I captured a specimen at Chicago. (Cf. Fernald, '06, p. 405.)

Chlorion harrisi H. T. Fernald (*Isodontia philadelphica* Auct.). Harris's Digger-wasp.

One specimen of this wasp was taken on flowers of the mountain mint *Pycnanthemum flexuosum* (Sta. I) Aug. 11 (No. 24).

I have also taken this species at Bloomington, Ill., Aug. 21 and Sept. 7 and 11.

This wasp has been known in North Carolina to build its nests in the funnel-like bases of the leaves of the pitcher-plant *Sarracenia flava* (Jones, Ent. News, Vol. 15, p. 17 and Pl. III. 1904), and provisions its nest with *Æcanthus*. Ashmead (Insect Life, Vol. 7, p. 241. 1894) states that it "preys upon the cricket *Æcanthus fasciatus* Fitch."

Chlorion atratum Lepeletier (*Priononyx atrata* St. Farg. and *Sphex brunneipes* Cress.). Black Digger-wasp.

This species was taken from the flowers of *Eryngium yuccifolium* (Sta. II) Aug. 13 (No. 55). I have also taken it at Havana, Ill., during August, and at Bloomington, Ill., on September 3, 5, and 12.

In a colony of prairie vegetation near St. Joseph, Ill., when out with a class on an ecological excursion, Sept. 26, 1911, I made some interesting observations on this wasp. Along the Big Four railway track between Mayview and St. Joseph, Ill., fresh sand and gravel had very recently been placed upon the road-bed. In this fresh sand we observed a large black wasp, *Chlorion atratum*, digging. The wasp was about two thirds of her length in the hole when first observed, and when captured later she was more than her length in the hole. She would scratch out the sand so that it fell near the mouth of the hole, and then come out and, standing over the pile, she would scrape it far out of the way by rapid movements of her legs. Every now and then she would come out of the hole with gravel in her jaws; several of such samples were preserved. As the sand was loose the gravel was of course not firmly imbedded. Of the small stones carried out five of the largest range from one fourth to one half an inch in diameter. In bulk each of these is larger than the thorax of the wasp. Four small flies were seen to hover about the hole; some which alighted on small stones near by were captured by a member of the party and proved to be small tachinids (No. 309, C.C.A.), which Mr. J. R. Malloch determined to be *Metopia leucocephala* Rossi. (Cf. Coquillett, '97, p. 127.) Mr. Malloch also called my attention to recorded observations on other tachinid flies which inhabit the burrows of *Hymenoptera* in Great Britain, and are parasitic in habit (Malloch, '09). Hamm ('09b) has described how one of these flies, *Setulia grisea* Mg., follows the females of *Cerceris* as she provisions her burrow with weevils. They were observed to enter and to come out of the burrow. Melander and Brues ('03, pp. 9, 20) state that *M. leucocephala* infests the bee *Halictus* by choosing "the moment when the incoming bee pauses at her threshold quickly and quietly to oviposit on her pollen mass and thus infect her offspring." This fly has been reported to be

viviparous. Cf. Aldrich ('05, p. 476). The Peckhams ('98, p. 37) observed a small fly at the burrows of *Chlorion ichneumoncum*. Brues (Jour. N. Y. Ent. Soc., Vol. 11, p. 228, 1903) has observed this species near Chicago sleeping in sweet clover. (See also Bradley, in Ann. Ent. Soc. Amer., Vol. 1, pp. 127-130, 1908.)

For the habits of this species see the Peckhams, "Instincts and Habits of the Solitary Wasps," pp. 171-173. This species provisions its nest with the Carolina locust, *Dissosteira carolina*. Coquillett (Insect Life, Vol. 7, p. 228, 1894) says that this species shows a preference for *Melanoplus femur-rubrum* DeG. in provisioning its nest.

STIZIDÆ

Stizus brevipennis Walsh. Digger-wasp.

A single specimen of this large wasp was taken on flowers of *Pycnanthemum flexuosum* (Sta. I) Aug. 12 (No. 35); another was taken by T. L. Hankinson (Sta. I) July 3, 1911 (No. 7665).

Walsh (Am. Ent., Vol. 1, p. 162, 1869) found this species on flowers of the wild parsnip at Rock Island, Ill. An allied wasp, *Sphæcius speciosus* Drury, preys upon the cicada or dog-day harvest-fly, *Cicada pruinoso*, on which it lays its egg and upon which its larva feeds. Consult Riley (Insect Life, Vol. 4, pp. 248-252, 1891) for an excellent account of this wasp. As Walsh infers, *brevipennis* and *speciosus* probably have similar habits. A tachinid fly, *Senotainia trilineata* V. d. W., has been bred from the nest of *speciosus* (Coquillett, '97, p. 20).

HALICTIDÆ

Halictus obscurus Rob.

A single specimen was taken—on the Loxa prairie from the flowers of *Eryngium yuccifolium* (Sta. II) Aug. 13 (No. 55).

Halictus fasciatus Nyl.

This bee was taken Aug. 13 on the Loxa prairie (Sta. II) from the flowers of *Silphium integrifolium* (No. 48) and from those of *Pycnanthemum flexuosum* or *P. pilosum* (No. 52); and on goldenrod, *Solidago* (Sta. I), Aug. 12 (No. 26).

Halictus virescens Fabr.

A single male of this small bee, with metallic green head and thorax, was taken on flowers of verbena (Sta. I) Aug. 11 (No. 23).

NOMADIDÆ

Epeolus concolor Rob.

This species was taken on the heads of the cone-flower, *Lepachys pinnata* (Sta. I, c), Aug. 8 (No. 8); very abundantly from flowers of

the mountain mint *Pycnanthemum flexuosum* (Sta. I, *g*) Aug. 8 (No. 6); from flowers of *Silphium integrifolium* (Sta. II) Aug. 13 (No. 48); and from flowers of *Pycnanthemum flexuosum* or *pilosum* (Sta. II) Aug. 13 (No. 52).

It is said to be "parasitic on the species of *Colletes*," but Robertson ('99, pp. 35, 37) does not accept this view, and Ashmead (*Psyche*, Vol. 7, pp. 41-42. 1894) states that *Epeolus donatus* Smith makes a nest in the ground and provisions it with a honey-paste. He describes the burrows, egg, and larva.

Robertson has published keys to the Carlinville (Ill.) species of *Epeolus* (*Can. Ent.*, Vol. 35, pp. 284-288. 1903).

EUCERIDÆ

Melissodes aurigena Cress.

A single female of this species was taken from flowers of ver-bena(near Sta. I, *b*) Aug. 11 (No. 23).

The homing behavior of this genus of bees has been studied by Turner (*Biol. Bull.*, Vol. 15, 247-258. 1908). He concludes that memory is utilized.

Melissodes bimaculata St. Farg.

This bee was taken from the heads of the cone-flower, *Lepachys pinnata* (Sta. I, *e*), Aug. 8 (No. 8); abundantly from flowers of the mountain mint *Pycnanthemum flexuosum* (Sta. I, *g*) Aug. 8 (No. 6); on the Loxa prairie on flowers of the rosin-weed, *Silphium integrifolium* (Sta. II), Aug. 13 (No. 48; and on the cleared margin of the Bates woods on flowers of the mountain mint, *P. pilosum* (Sta. IV, *a*), Aug. 22 (No. 146).

Some observations on the "sleeping habits" of this bee and of other *Hymenoptera* have been made by Banks (*Journ. N. Y. Ent. Soc.*, Vol. 10, pp. 209-214. 1902). Graenicher ('05, p. 164) has recorded observations on the habits of *M. trinodis* Rob. and also on its bee parasite *Triepeolus*. Ashmead (*Psyche*, Vol. 7, p. 25. 1894) found the burrows of *bimaculata* eight inches deep in the soil.

Melissodes desponsa Smith.

This bee was taken on the cleared margin of the Bates woods on flowers of the mountain mint *Pycnanthemum pilosum* (near Sta. IV, *a*) Aug. 22 (No. 146).

Melissodes obliqua Say.

This bee was found abundant upon flowers of the cone-flower, *Lepachys pinnata* (Sta. I, *e*), Aug. 8 (No. 8); it was taken from flowers of the white mint, *Pycnanthemum flexuosum* (Sta. I), Aug. 11 (No.

24); and a female was taken from the flowers of *Silphium integrifolium* (Sta. I) Aug. 13 (No. 48). According to Robertson (Trans. Acad. Sci. St. Louis, Vol. 6, p. 468. 1894) this bee is the most abundant bee visitor to the cone-flower, and it also shows a marked preference for this plant.

MEGACHILIDÆ

Megachile mendica Cress. Leaf-cutting Bee.

A single specimen was taken on flowers of the swamp milkweed, *Asclepias incarnata* (Sta. I, *g*), Aug. 8 (No. 1).

The habits of our leaf-cutting bees have received little attention, although the circular areas which they cut from rose leaves are a familiar sight. Putnam (Proc. Essex Inst., Vol. 4, pp. 105-107. 1864) describes the nests of *Megachile centuncularis* Linn., and Packard, one of its hymenopterous parasites (idem, pp. 133-137).

Megachile brevis Say. Short Leaf-cutting Bee.

A single female was taken by T. L. Hankinson (Sta. I) July 3, 1911 (No. 7665). This species is known to use plum leaves for its nest. Its habits have been briefly described by Reed (Sec. Rep. Ent. Soc. Ont., pp. 24-26. 1872; Can. Ent., Vol. 3, pp. 210-211. 1871). The nest is formed of a leaf which is wrapped about the disks cut from the leaves, and is not in the ground or in cavities in wood as is the case with many species. Packard (Jour. N. Y. Ent. Soc., Vol. 5, p. 109-111. 1897) describes and gives figures of the immature stages of what is possibly *M. centuncularis* Linn. See also Packard ('73), Ashmead ('92), and Howard ('92a).

Some of the species of this genus are parasitized by bees of the genera *Stelis* and *Calioxys* as has been shown by Graenicher ('05); some also are parasitized by certain flies (Howard, in Proc. Ent. Soc. Wash., Vol. 2, p. 248. 1893).

XYLOCOPIDÆ

Xylocopa virginica Drury. Carpenter-bee. (Pl. XLIX.)

Only four specimens of this bee were taken, and these were found on flowers of the swamp milkweed, *Asclepias incarnata* (Sta. I, *d*), Aug. 8 (No. 1) and 24, (No. 156).

The carpenter-bee has much the appearance of a large bumblebee. The female cuts tunnels in wood to make a nest for the young. Packard has described the larva (Journ. N. Y. Ent. Soc., Vol. 5, p. 113. 1897). The same author records observations by Angus on the boring habits of this species (Our Common Insects, pp. 21-24. 1873). He found the larva of a bee-fly, *Anthrax sinuosa* Wied., parasitic on the

larva of the carpenter-bee. Felt, ('05, Pl. 39, and '06, p. 484) has given figures of the nest and has briefly described it. The burrows are made in the seasoned lumber of houses, in telegraph poles, and in similar situations. On the prairie at Charleston, fence posts, telegraph poles, and railway ties constitute the supply of wood available for nesting purposes. It thus appears probable that this bee was not particularly abundant on the original prairie, far from the forests or cottonwoods, for such nesting habits imply a supply of wood for the burrows. The larva is said to feed upon pollen, on which the eggs are placed.

BOMBIDÆ

Bombus pennsylvanicus DeG. Pennsylvania Bumblebee.

This species was taken on the Loxa prairie from flowers of the purple prairie clover, *Petalostemum purpureum* (Sta. II), Aug. 13 (No. 50); on flowers of the mountain mint, *Pycnanthemum pilosum* or *P. flexuosum* (Sta. II) Aug. 13 (No. 52); on flowers of the rattlesnake-master, *Eryngium yuccifolium* (Sta. II), Aug. 13 (No. 553); in an open glade in the lowland forest (Sta. IV, c) Aug. 22 (No. 143); on flowers of the thistle *Cirsium discolor* (near Sta. I, d) Aug. 24 (No. 155); from the flowers of the broad-leaved rosin-weed, *Silphium terebinthinaceum* (Sta. III, b), Aug. 26 (No. 175); and on the prairie west of Loxa on the flowers of the blazing star, *Liatris scariosa* (Sta. II), Aug. 27 (No. 176).

Banks (Jour. N. Y. Ent. Soc., Vol. 10, p. 212. 1902) has recorded this species as sleeping on flowers.

The following papers on the habits and life history of the bumblebees will aid in the study of these neglected insects:

Coville, Notes on Bumble-Bees. Proc. Ent. Soc. Wash., Vol. 1, pp. 197-202. (1890)—Putnam, Notes on the Habits of some Species of Bumble Bees. Proc. Essex Inst., Vol. 4, pp. 98-104. (1864)—Packard The Humble Bees of New England and their Parasites; with notices of a new species of Anthophorabia, and a new genus of Proctotrupidæ. Proc. Essex Inst., Vol. 4, pp. 107-140. (1865)—Marlatt, An Ingenious Method of Collecting *Bombus* and *Apathus*. Proc. Ent. Soc. Wash., Vol. 1, p. 216. (1890)—Howard, The Insect Book, (1904), pp. 12-16; and Sladen, The Humble-Bee (1912). Marlatt describes the use of a jug of water in collecting bees from the nest. (This has long been the common method of destroying these bees used by country boys and farmers of central Illinois.)

A very important systematic paper, which also contains much on the life history and habits of the American *Bombidæ* has recently been published by Franklin ('13).

A tachinid fly, *Brachycoma davidsoni* Coq. (Coquillett, '97, p. 10) has been bred from a larva of *Bombus fervidus* Fabr. The larva of the syrphid fly *Volucella* lives as a scavenger in *Bombus* nests (Cf. Metcalf, '13, p. 68). The conopid flies *Physocephala* and *Conops* are parasitic on *Bombus*. A nematode parasite, *Spharularia bombi*, infests hibernating queens. It has been found in *B. pennsylvanicus*, *fervidus*, and *consimilis* (Cf. Stiles '95).

Bombus auricomus Rob.

Two males of this species were taken from flowers of the large-leaved rosin-weed, *Silphium terebinthinaceum*, on the prairie area east of Charleston (Sta. III, b), Aug. 26 (No. 175). This bumblebee was also taken by T. L. Hankinson (Sta. I) July 3, 1911 (No. 7665). (Cf. Franklin, '13, Pt. I, p. 413.)

Bombus impatiens Cress. Impatient Bumblebee.

A single female was taken from the flowers of the broad-leaved rosin-weed, *Silphium terebinthinaceum*, east of Charleston (Sta. III, b), Aug. 26 (No. 175).

Bombus fraternus Smith.

Two females of this species were taken on flowers of the swamp milkweed, *Asclepias incarnata*: one of them (No. 1) at Station I, g, Aug. 8; and the other (No. 12) at Station I, d, Aug. 9.

Bombus separatus Cress.

This species was collected from the swamp milkweed, *Asclepias incarnata*, as follows: Station I, g, Aug. 8 (No. 1); Station I, d, Aug. 9 (No. 12); Station I, d, Aug. 24 (No. 157)—the latter had been captured by the flower spider *Misumena alcatoria* Hentz; and one male from flowers of the horse mint, *Monarda* (Sta. I), Aug. 11 (No. 22).

Psithyrus variabilis Cress. False Bumblebee.

A single female was taken from the flowers of the horse mint, *Monarda* (Sta. I), Aug. 11 (No. 22); and a male was taken on the prairie west of Loxa from flowers of the blazing star, *Liatris scariosa* (Sta. II), Aug. 27 (No. 176). These bees are parasitic in the nests of *Bombus*. For an excellent account of the habits of the British species, Sladen ('12, pp. 59-72) should be consulted.

APIDÆ

Apis mellifera Linn. Honey-bee.

Workers of this species were extremely abundant on flowers of the milkweed *Asclepias incarnata* (Sta. I, and Sta. I, d, g) Aug. 8

(No. 1). Milkweed flowers play a double rôle as food and enemy. Robertson (Trans. St. Louis Acad. Sci., Vol. 5, p. 573) states that honey-bees are frequently found hanging dead from the flowers of the common milkweed, *A. syriaca*, and Gibson (Harper's Mag., Vol. 95, pp. 519-520. 1897) has found many of them entrapped by this milkweed. Bees are not the only insects captured by this insect trap, for Gibson found gnats, crane-flies, bugs, wasps, beetles, and small butterflies hanging from the flowers. He also found that the dogbane *Apocynum* thus captures moths.

II. FOREST INVERTEBRATES

MOLLUSCA

HELICIDÆ

Polygyra albolabris Say. (Pl. LI, figs. 2 and 3.)

A single adult dead shell (No. 91) of this woodland species was found in the upland forest (Sta. IV, a). It is our largest species of snail.

The natural history of our land-snails has received little attention, but is worthy of careful study. The best account of the life history and habits of this species is by Simpson ('01).

Polygyra clausa Say.

A single dead immature shell was taken under a small decayed limb on the ravine slope (Sta. IV, b) Aug. 26 (No. 164), associated with many individuals of *Pyramidula perspectiva*, and one individual each of *Vitrea indentata* and *V. rhoadsi*.

Shimek ('01, p. 200) groups this species with those which frequent "higher, more deeply shaded (often mossy and rocky) banks and slopes, sometimes in deep woods."

CIRCINARIIDÆ

Circinaria concava Say. Predaceous Snail.

A large dead shell (No. 71) and several living specimens were found in a decayed stump in the upland forest (Sta. IV, a). A young individual (No. 113), diameter 6 mm., was taken Aug. 20 among the vegetable debris washed from a ravine and deposited as a low fan in the lowland forest (Sta. IV, c). With it were associated *Vitrea indentata*, and some kind of large snail eggs (No. 114). This is a carnivorous species.

ZONITIDÆ

Vitrea indentata Say.

One specimen (No. 113) was taken Aug. 20, among a mass of drifted rotten wood and dead leaves deposited at the mouth of a ravine in the lowland forest (Sta. IV, *c*), in company with a young specimen of the carnivorous *Circinaria concava*; and another (No. 140), on Aug. 22, under leaves at the base of a ravine slope (Sta. IV, *b*), in woods so dense that there was very little herbaceous vegetation, but a thick ground cover of leaves and vegetable mold. The interesting ant *Stigmatomma pallipes*, *Myrmica rubra scabrinodis schencki*, and the larva of *Meracantha contracta* were found here. Specimens were also taken Aug. 26 (No. 164) under a small decayed limb on the ravine slope (Sta. IV, *b*) in company with *Vitrea rhoadsi*, *Polygyra clausa*, and *Pyramidula perspectiva*.

Vitrea rhoadsi Pilsbry.

This snail was taken under a small damp decayed limb on a wooded ravine slope (Sta. IV, *b*) in company with *V. indentata*, *Pyramidula perspectiva*, and *Polygyra clausa* (No. 64). Mr. F. C. Baker informs me that this species has not previously been recorded from Illinois.

Zonitoides arborea Say.

This snail was taken on a fungus which was growing on a decayed stump in the upland forest (Sta. IV, *a*) Aug. 17 (No. 71), in company with the mollusks *Pyramidula perspectiva*, *Circinaria concava*, and *Philomycus carolinensis*, the ant *Aphanogaster fulva*, and the white ant *Termes flavipes*. Also taken from a moist rotting stump, on the slope of the valley (Sta. IV, *b*), Aug. 17 (No. 84), in company with the snail *P. perspectiva*, the slug *P. carolinensis*, newly established colonies of the ant *Camponotus herculeanus pennsylvanicus*, and the beetle *Passalus cornutus*.

This snail appears to be mainly a species of the woodland, where it occurs under decaying wood and vegetable debris.

Motter ('98, p. 219) records this species from an old grave. This suggests a subterranean habit. (Cf. Baker, '11, p. 155.)

PHILOMYCIDÆ

Philomycus carolinensis Bosc. Carolina Slug.

Several young specimens of this slug (No. 71), about 5 mm. long when contracted in alcohol, were found (Sta. IV, *a*) Aug. 17 in the upland forest on a well rotted stump overgrown in part by a felt-like fungous growth. The finding of these young slugs and the finding

elsewhere in the forest of eggs, possibly of this species (Nos. 86 and 114), is of special interest. On the forested ravine slope (Sta. IV, *b*) in another decaying stump, in which the bark was loosened and the sap-wood quite decayed, soft, large examples of this slug were found in abundance Aug. 17 (No. 89). They were associated with newly established colonies of the carpenter-ant *Camponotus herculeanus pennsylvanicus*, and the horned Passalus, *Passalus cornutus* (No. 85). The association of these three species is not an accident, but indicates clearly a certain stage in the decay of a log or stump which is favorable to their development. Another colony was found under the bark of an oak stump (Sta. IV, *b*) in which the sap-wood had decayed, but the remainder of which was solid though discolored. A very large individual and several young slugs ranging in length from about half an inch to an inch and a half were found in a cavity under the bark Aug. 22 (No. 125).

A batch of eggs, found with specimens No. 89, and presumably of this species, was taken Aug. 17 (No. 86). These eggs, pearl-like translucent spheres, twenty-two in number, were in a small cluster. The other lot of eggs (No. 114) was taken Aug. 20 among dead leaves and rotten-wood drift at the mouth of a ravine in the lowland forest (Sta. IV, *c*), where *Vitrea indentata* was taken (No. 113). The large size of these eggs, which even when shriveled in alcohol are over 2 mm. in diameter, the paucity of other large pulmonates throughout these woods, the abundance of *Philomycus*, and the presence of small young at this season are indicative that the eggs belong to this slug.

Little seems to be recorded concerning the life history of this species or its habits. An individual kept by Binney (Bull. 28, U. S. Nat. Mus., pp. 243-244. 1885) deposited thirty eggs June 30. These hatched July 10 and grew very rapidly. Baker ('02, p. 203) states that it ascends trees to a "height of over fifty feet, and is most frequently found under bark which has become 'started'." He also states that it is "solitary in habit." My own observations of this species confirm his statement as to its preference for wood in which the sap-wood has decayed, but I have often found several specimens in close proximity, as was the case with specimens No. 89.

ENDODONTIDÆ

Pyramidula alternata Say. Alternate Snail.

A single dead shell (No. 173) of this common species in forests, was taken at the mouth of a ravine in the lowland forest (Sta. IV, *c*).

This is generally a woodland species. At Mackinaw Dells, along

the Mackinaw bottoms in Woodford county, Ill., I have found large numbers late in the fall hibernating in hollow trees about five feet above the ground. A very large colony—perhaps several hundred specimens—was once found some little distance from woods along a moist railway embankment south of Bloomington, Ill. Baker ('02, p. 208) states that the eggs, from twenty to eighty, are laid early in June and hatch in about thirty days.

Pyramidula perspectiva Say.

The decayed stump in the upland forest (Sta. IV, *a*) which was overgrown with a layer of fungus (see under *P. carolinensis*) contained Aug. 17, a very large number of young and adults of this species (No. 71). The shell is distinguished by the large open umbilicus, which leaves the upper whorls exposed.

This is the most abundant mollusk in the forest. It was found associated with *Circinaria concava*, *Zonitoides arborea*, and *Philomycus carolinensis*. In small cavities in the wood encrusted with the fungus, large numbers of *P. perspectiva* were found crowded together. Apparently this snail fed upon the fungus, the moist surface possibly adding attractiveness. In this stump was a large nest of the ant *Aphanogaster fulva* (No. 79) and one of white ants, *Termes flavipes* (No. 72). *P. perspectiva* was also taken from a decaying stump on the wooded ravine slope (Sta. IV, *b*) Aug. 17 (No. 84) in association with *Zonitoides arborea*, *Philomycus carolinensis*, the ant *Camponotus herculeanus pennsylvanicus*, and the beetle *Passalus cornutus*; under decayed logs in the upland oak forest (Sta. IV, *a*) Aug. 17 (No. 88); and under a small much-decayed limb on the wooded ravine slope (Sta. IV, *b*) Aug. 26 (No. 164) in company with *Polygyra clausa*, *Vitrea indentata*, and *Vitrea rhoadsi*.

Shimek ('01, pp. 200, 202) says that this species is common on shaded banks, under decaying logs, and lists it with those which frequent "higher, more deeply shaded (often mossy and rocky) banks and slopes, sometimes in deep woods."

CRUSTACEA

ASTACIDÆ

Cambarus diogenes Girard. Diogenes Crawfish.

This crawfish was taken Aug. 17, 1911, in the south ravine (Sta. IV, *d*), where Mr. Hankinson also took it in 1910 in the following situations: from a pool in the stream Aug. 17; from burrows, with chimneys, in the bed of the stream, Aug. 20; and from under flat stones in the bed of this stream, three specimens, Aug. 22.

For detailed accounts of the ecological relations of this species see Ortmann ('06) and Harris ('03).

Cambarus propinquus Girard. Neighborhood Crawfish.

This species also was taken from a small pool in the south ravine (Sta. IV, *d*), Aug. 20, 1910, by Hankinson.

Consult Ortmann ('06) and Harris ('03).

Cambarus immumis Hagen. Immune Crawfish.

This species was taken from pools in the temporary stream (Sta. IV, *d*) by Hankinson Aug. 17 and 20, 1910.

Consult Harris ('03).

MYRIAPODA

LYSIOPETALIDÆ

Callipus lactarius Say.

This myriapod was taken among dead leaves and rotten wood in the forest bottom at the mouth of a ravine (Sta. IV, *c*) Aug. 20 (No. 113).

There is hardly a more neglected group of animals in Illinois than the *Myriapoda*. The ecological relations of our American myriapods offer a virgin field for study. A few observations upon the habitat of the humus-inhabiting Texas species have been made by Cook ('11a, pp. 147-150).

CRASPEDOSOMIDÆ

Cleidogona casioannulata Wood.

This myriapod was taken under damp leaves on the lower slopes of the lowland forest (Sta. IV, *b*) Aug. 22 (No. 140), associated with the old-fashioned ant, *Stigmatomma pallipes*.

POLYDESMIDÆ

Polydesmus sp.

This myriapod was taken under the bark of an oak stump in the early stages of decay—all sap-wood being honeycombed; the remainder solid though discolored—(Sta. IV, *b*) Aug. 22 (No. 125), associated with *Philomycus carolinensis*.

ARACHNIDA

PHALANGIIDA

PHALANGIIDÆ

Liobunum vittatum Say. Striped Harvest-spider.

One female was taken in the upland Bates forest, while running about on the dry leaves lying around a decayed stump (Sta. IV, *a*)

Aug. 17 (No. 82), and two males were found in the same forest Aug. 22 (No. 123).

Weed ('89, p. 87) states that this species is very abundant on rocky ledges in parts of southern Illinois. He is of the opinion that the winter is passed in the egg stage, and maturity is reached in July. The young prefer grass, low vegetation, and piles of rubbish, but when mature are found in a "great variety of situations," as in the corn fields of the prairie parts of Illinois, in grasslands, among brush, and in the forest ('92c, p. 1006).

Liobunum ventricosum Wood. (Pl. LI, fig. 1.)

Three specimens of this "daddy-long-legs" were taken in the upland Bates forest (Sta. IV, a) Aug. 22 (No. 123b)

The young of this species hibernate, and maturity is reached early in June (Weed, '92b, p. 264). This is exceptional, as most species of this group pass the winter in the egg stage. The food of daddy-long-legs consists mainly of dead insects (Weed, '89, p. 80).

Liobunum grande Say. Stout Harvest-spider.

This stout-bodied and short-legged species was found running about on dry leaves in the upland forest (Sta. IV, a) Aug. 17 (No. 82); and in a damp ravine (Sta. IV, b) Aug. 20 (No. 111).

Consult Weed ('92b and '93) for descriptions and figures of this species. Very little appears to be recorded about it.

ARANEIDA

EPEIRIDÆ

Epeira insularis Hentz. Island Epeirid. (Pl. LII, figs. 1, 2, and 3.)

This spider was taken from a web stretched between trees in the upland forest (Sta. IV, a), Aug. 16 (No. 70).

McCook ('89, Vol. 1, pp. 117, 118, 273, 330, 337; '90, Vol. 2, pp. 20, 86-87, 208, 214, 289, 441, 453) records a number of interesting observations on this spider. The Peckhams ('87) give an account of their observations on its senses.

Epeira domiciliorum Hentz. Tent Epeirid.

This spider was taken at the margin of the low, damp forest (Sta. IV, c) Aug. 22 (No. 137); from the margin of a large web among the branches of trees in the upland forest (Sta. IV, a) Aug. 26 (No. 167); and, on the same date, from the glade in the lowland forest (Sta. IV, c), folded in a sassafras leaf (No. 173).

I have found the species at the margin of its webs, in a leafy tent, in dense woodlands near Urbana, Ill., in the Brownfield woods Oct.

18, and in the Cottonwood forest Oct. 13. It was abundant among the leaves of a shrub—the spice-bush (*Benzoin*).

McCook ('89, Vol. 1, pp 78–79, 116, 255, 288, 339, and '90, Vol. 2, pp. 86–88, 224, 334) records many observations on the habits of this species, and, more recently, Porter ('06) has studied an allied species.

Epeira trivittata Keys. Three-lined Spider. (Pl. LIII, figs. 1 and 2.)

A single specimen was taken on a web in the lowland forest (Sta. IV, c) Aug. 22 (No. 138).

Epeira verrucosa Hentz. White-triangle Spider. (Pl. LIII, figs. 3 and 4.)

This species was taken from webs stretched between trees in the forest (Sta. IV) Aug. 16 (No. 70); and again at the same Station Aug. 22 (No. 126). The individuals taken were always at the center of their webs.

The peculiar whitish, leaf-like triangular area on the dorsal surface of the abdomen is a striking peculiarity of this species. It is associated in habitat with *Acrosoma spinca* Hentz, and *A. rugosa* Hentz.

Acrosoma spinca Hentz. Spined Spider. (Pl. LIV, figs. 1–5.)

From webs connecting trees in the damp lowland forest (Sta. IV, c) this spider was taken Aug. 22 (No. 138) and Aug. 26 (No. 172); and another individual (No. 148) was taken Aug. 23 (Sta. IV) from a small web on a low sassafras shrub within two feet of the ground. It feigned death when placed in a vial, the hind legs being closely applied to the abdomen, the others being folded against the cephalothorax. The two large posterior spines on the abdomen of this species make it conspicuous.

This is a representative forest-inhabiting species; its web and those of *rugosa*, generally placed at about the height of a man's head, are often so abundant, at least during August, as to be bothersome when one after another is swept from the trees by one's face. Because of the tension of these threads few persons care to have them accumulate on the face.

McCook ('89, Vol. 1, pp. 126–127) has recorded observations on this species.

Acrosoma rugosa Hentz. (*gracile* Walck.). Rugose Spider.

This spider was taken from webs connecting trees and shrubs in the upland forest (Sta. IV, a) Aug. 16 (No. 70) and Aug. 22 (No. 126); on a web in the forest (Sta. IV) Aug. 23 (No. 147), with the apex of the ventral abdominal cone turned uppermost at the cen-

ter of the web; and from webs in the shady lowland forest (Sta. IV, *c*) Aug. 26 (No. 172).

Montgomery ('03, pp. 119-120 and '09) has made observations on the breeding habits of this species, and McCook ('89, Vol. 1, pp. 64, 73, 125-127, 254, 338, and '90, Vol. 2, pp. 285, 289, 375) describes its webs and gives observations on its habits.

LYCOSIDÆ

Lycosa scutulata Hentz.

A single immature specimen was taken from the low vegetation in an open glade in the lowland part of the Bates woods (Sta. IV, *c*) Aug. 22 (No. 144).

For the breeding habits of this species see Montgomery ('03, pp. 72-76).

Lycosa sp.; young.

This spider was taken in the upland woods (Sta. IV, *a*), running upon the ground, Aug. 23 (No. 150). Another undetermined species was taken in the pathway entering the upland forest from the cleared area (Sta. IV, *a*). This spider was dug from a burrow about two inches deep, in the solid clay of the pathway, Aug. 22 (No. 142).

ACARINA

ERIOPHYIDÆ

Acarus serotina Beut. Cherry-leaf Gall-mite. (Pl. LV, fig. 1.)

This small mite was taken in the lowland portion of the Bates woods (Sta. IV, *c*) Aug. 20 (No. 116). It forms a gall on the upper side of the leaves of the wild cherry, *Prunus serotina*.

INSECTA

PLATYPTERA

TERMITIDÆ

Termes flavipes Koll. White Ant. Termite. (Pl. LV, fig. 2.)

A small well-decayed stump in the upland forest (Sta. IV, *a*) was found Aug. 17 to contain a colony of these termites in large numbers—mainly workers but also some soldiers (Nos. 72, 79). In close proximity was a colony of the ant *Aphaenogaster fulva*. Some of these ants (Nos. 74-76) were observed to pick up termites and carry them away as they do their own young when a nest is disturbed. *A.*

fulva is known to relish the termites as food. A second colony of termites (No. 125) was found Aug. 22 under the bark of an oak stump (Sta. IV, *b*), in the early stages of decay, when the sap-wood was becoming honeycombed but the remainder of the wood was still solid. The caterpillar *Scolecocampa liburna* was found in the same stump.

As white ants feed mainly upon woody and other vegetable materials, they are active agents in hastening the decay and destruction of such substances, mainly in forested areas but also upon the prairie.

Two species have long been confused under the name of *flavipes*, and as the newly recognized one, *virginicus* Bks., may occur in extreme southern Illinois, reference is made to it. (See Banks, Ent. News, Vol. 18, pp. 392-393. 1907).

NEUROPTERA

MYRMELEONIDÆ

An ant-lion was taken from its inverted funnel in the dust along the path through the cleared area to the forest (near Sta. IV, *a*) Aug. 29 (No. 183).

Although ant-lions are common in many localities and widely dispersed, little is really known of the ecology of the American species. These insects reach their greatest abundance and diversity in the arid regions of the west and southwest. In the eastern forested area they are of much more local occurrence and are generally found in the dust, particularly in sheltered places—as under an overhanging cliff or even under the porches of houses, where the desirable protection from rain is afforded; or, often, in the woods, in the powdery dust that marks the final stages in the decay of a log. The log as an animal habitat has an interesting life history and a corresponding succession of animals. On the decay of the sap-wood, *Camponotus* and *Philomyces* are among the early invaders of the log; the ant-lion, present in its dust, is one of the latest. It should be noted that these isolated, dry, dusty places are the situations in the humid area which most nearly approach the conditions which on the plains, and particularly on the desert, are of nearly continuous geographic extent.

MECAPTERA

PANORPIDÆ

Bittacus stigmaterus Say. Clear-winged Scorpion-fly.

The damp, shady lowland forest, with a ground cover composed of nettles (*Laportea canadensis*) and clearweed (*Pilea pumila*),

would seem to furnish an ideal habitat for the genus *Bittacus*, but only two specimens, a male and a female, were taken (Sta. IV, c) Aug. 22 (No. 141).

The young and adults of this genus are predaceous. Brauer and Felt have described the habits of some of the adults. They capture small flies and other insects with their legs as they hang suspended. The use of the legs for suspension and for the manipulation of their food recalls somewhat similar methods used by other predaceous insects, such as robber-flies (*Asilidæ*) and hornets (*Vespa*). *Bittacus* may copulate while thus suspended and eating, as described and figured by Brauer. Either the first or second, or both pairs of legs may be used for suspension.

The larvæ are caterpillar-like, but in the case of our American species none of them are known. The European species are predaceous, and live upon the ground. According to Brauer a certain amount of drying seems necessary to the hatching of the eggs. Some species have been taken at light, where they preyed upon the congregated insects. (See Hine, '01, p. 260, and Bull. No. 7, n. s., Div. Ent., U. S. Dept. Agr., p. 86. 1897.) Papers by Brauer ('53, '55, '62, '63, '71), Felt ('95), and others by Hine ('98, '01), will be of the greatest assistance to a student of this neglected group of insects.

Bittacus strigosus Hag. Spotted Crane-like Scorpion-fly.

This species was taken but once—June 28, 1911, by T. L. Hankinson in the Bates woods (No. 7678). It was abundant south of Bloomington Aug. 22, 1895, where *B. stigmaterus* Say was also taken July 16, 1896. These species are characteristic of dense woods.

Bittacus apicalis Uhler. Brown-tipped Scorpion-fly.

This insect was taken June 28, 1911, in the Bates woods by T. L. Hankinson (No. 7678). I have found this species very abundant in dense shady woods south of Bloomington, Ill. The brown tips of the wings make it easily identifiable.

ORTHOPTERA

BLATTIDÆ

Ischnoptera sp.

This cockroach was found under leaves on the lower slopes of a ravine (Sta. IV, b) leading to the lowland Aug. 22 (No. 140). Hancock ('11, pp. 416-418) discusses the habits and habitat of *I. pennsylvanica* (Pl. LVI, figs. 4 and 5.)

PHASMIDÆ

Diapheromera femorata Say. Forest Walking-stick. (Pl. LVI, fig. 6.)

These insects were abundant in the upland forest (Sta. IV, *a*); the following observations were made on them. A fuscous male (No. 64) was taken Aug. 16 crawling on hickory. When disturbed it fell to the ground and remained quiet. A female was taken at the base of a tree in a resting position with the antennæ closely applied and stretched forward. On August 17 a nymph was taken in an open area; Aug. 20 (No. 103), a large gray female; a copulating pair (No. 134), in which the female was gray and the male fuscous; and, finally, a small immature male (No. 163) in the before-mentioned resting position, on hickory.

On the ravine slope (Sta. IV, *b*), memoranda are as follows: Aug. 22 (No. 124a) three fuscous males, and a large gray female in the resting position, and (No. 132), in copulation, a fuscous male and a green female, the latter lacking the hind pair of legs. A green, nearly mature nymph was taken in a wood-lot adjacent to the Bates area Aug. 28 (No. 99). A large fuscous male was taken east of Charleston on the Embarrass River at the "Rocks" Aug. 10 (No. 17).

This walking-stick is distinctly a forest-inhabiting insect, but we have another, *Bacunculus blatchleyi* Caud., which frequents the prairie, though it was not found about Charleston. Occasionally *femorata* becomes of economic importance. Riley (Rep. U. S. Dept. Agr., 1878, pp. 241-245) studied its life history and habits and found that some predaceous bugs prey upon it. The Severins (Jour. Economic Ent., Vol. 3, pp. 479-481. 1910) have shown experimentally that the hatching of the eggs is facilitated by moisture. T. L. Hankinson found a phasmid nymph, about an inch long, June 28, 1911, in the woods (No. 7678).

The behavior of our species is worthy of more attention than it has received. In such a study, reference should be made to a suggestive paper by Stockard on the "Habits, Reactions and Mating Instinct of the 'Walking-Stick' *Aplopus Mayeri*" (Pub. No. 103, Carnegie Institution, pp. 43-59. 1908); or, if the color changes are studied, Schleip's paper on "Der Farbenwechsel von *Dixippus morosus* (Phasmidae)" (Zool. Jahrb. Bd. 30, Abt. Allgem. Zool. u. Physiol., pp. 45-132. 1910) should be consulted. Cf. Caudell, Proc. U. S. Nat. Mus., Vol. 26, pp. 863-885, 1903.

ACRIDIDÆ

Tettigidea lateralis Say. (Pl. LVII, fig. 3.)

A grouse locust was found in the dry upland forest (Sta. IV, *a*) on the ground Aug. 20 (No. 109).

Morse ('04, p. 16) states that this species has a preference for "wet meadows and swales."

Tettigidea parvipennis Morse. Short-winged Grouse Locust.

A single specimen was secured in the upland forest (Sta. IV, a) on dry leaves Aug. 22 (No. 122).

Hancock ('02, p. 149) found this species very abundant in moist, dense woods.

Dichromorpha viridis Scudd. Short-winged Grasshopper. (Pl. LVII, fig. 7.)

A green short-winged female was taken from the tall prairie grass (*Andropogon* and *Sporobolus*) colony (Sta. I, g) Aug. 12 (No. 39). The following were taken from the upland forest (Sta. IV, a): Aug. 16 (No. 67) on dry leaves, a nymph, a long-winged male, and three short-winged females; Aug. 17 (No. 92) in an open space, a copulating pair, both of which were brown and short-winged, and a brown short-winged female (No. 93); Aug. 22 two more copulating pairs, one (No. 121) brown short-winged forms, the other (No. 122) green short-winged individuals. In a glade in the lowland forest where grasses, *Eupatorium caelestinum*, and young sasfras abounded (Sta. IV, c), a nymph, a brown short-winged female, and three males, two brown and one green, were taken Aug. 20 (No. 117), and on Aug. 22 a green female nymph and green and brown short-winged males (No. 143); and on the slopes of the valley (Sta. IV, b) a green short-winged female was secured Aug. 20 (No. 110).

On account of the disparity in the size of the sexes—the males being much smaller than the females—it is possible for copulating females to jump about and carry the males with them, the pair No. 121 affording an example.

According to Morse ('04, p. 19, 32) this is a forest and thicket species which also frequents "tangled herbaceous growths whenever found." In New England it frequents "grass fields on wet soil, near the margins of ponds and streams; in the South and Central States it is more commonly found in rank herbage along ditches and streams, and in the edge of moist woodlands. Its haunts are thus intermediate in character between those of a campestral and sylvan species, and so likewise are the structural adaptations presented by it, a very large proportion of the females being brachypterous."

It will be noted that the Charleston series is mainly from the forest area, only one individual coming from the true (moist) prairie; also that the forest, even the upland part, is in close proximity to a

humid lowland forest tract. Hancock ('11, pp. 297, 392-394) has discussed the habitat of this species.

Chlocaltis conspersa Harr. Sprinkled Grasshopper. (Pl. LVII, fig. 6.)

This locust was taken from the ground, mainly among leaves, in the upland forest (Sta. IV, *a*) Aug. 16 (No. 67); in sunny open places Aug. 17 (No. 93); and along a path through the forest among dry leaves Aug. 22 (No. 122).

Morse ('04, p. 19) considers this a forest, forest-margin, and thicket species, and Hart ('06, p. 75) says it frequents "open woods on ground encumbered with leaves, branches, and bushes." Consult Scudder (Final Report upon the Geology of New Hampshire, Vol. 1, pp. 371-372. 1874) for an account of the egg-laying habits of this species; also Hancock ('11, pp. 347-351) for its habits.

Spharagemon bolli Scudd. Boll's Grasshopper. (Pl. LVII, fig. 4.)

A male of this species was taken on the ground on leaves in the upland forest (Sta. IV, *a*) Aug. 16 (No. 67); a dead female was found clinging to the tip of a plant stem on the most open part of the slope (Sta. IV, *b*) from the upland forest to the lowland Aug. 22 (No. 133); and a female was taken among leaves on the ground in the upland forest (Sta. IV, *a*) Aug. 23 (No. 150). T. L. Hankinson found an adult and a nymph in the Bates woods June 28, 1911 (No. 7678). (Cf. Hancock, '11, pp. 362-364.)

The positive heliotropism or negative geotropic response shown in diseased grasshoppers is of interest. It may be caused either by a fungous or bacterial disease. (Cf. Gillette, Bull. No. 6, n. s., Div. Ent. U. S. Dept. Agr., pp. 89-93. 1896.)

Morse ('04, p. 15) considers this an exceptional ground-inhabiting or geophilous species since it is "an inhabitant of xerophytic forests as well as of open fields, and in the Southern States is found quite as often in the forest as on the open plain."

Melanoplus differentialis Thomas. Differential Grasshopper.

Consult the list of prairie invertebrates, p. 167.

Melanoplus atlantis Riley. Lesser Grasshopper. (Pl. LVII, fig. 8.)

A single specimen was taken on the ground in the upland forest (Sta. IV, *a*) Aug. 16 (No. 67). The open character of parts of this dry forest affords favorable conditions for this species.

Morse ('04, pp. 19, 42) considers this a characteristic species of open country, but "likely to be found anywhere." Hancock ('11, pp. 415-416) has described the habitat of this species.

Melanoplus amplectens Scudd.

This locust and nymphs doubtfully regarded as of the same species were taken from the ground, mainly among leaves, in the upland forest (Sta. IV, *a*) Aug. 16 (No. 67); other collections are as follows: in the glade in the lowland forest (Sta. IV, *c*) Aug. 20 (No. 117); on the open ravine slope (Sta. IV, *b*) Aug. 22, a male (No. 124a); and on the same date, in the glade of the lowland forest (Sta. IV, *c*), a nymph and an adult female (No. 143).

This is the largest of the short-winged locusts in the forest, and an abundant species. Morse ('04, pp. 19, 50, Pl. 7) described its haunts as in thickets, forest margins, open forests, and occasionally in grassy clearings and fields.

Melanoplus gracilis Bruner.

Two males were found Aug. 20 in a glade in the lowland forest (Sta. IV, *c*) where there was a luxuriant cover of vegetation, and nettles and *Eupatorium caelestinum* abounded; and Aug. 22, in the same location, one female was found (No. 143).

The wings are very rudimentary in this species. Hart ('06, p. 82) describes its habitat as follows: "On tall grasses and weeds in ravines and about marshes, masses of wild vines along railroads, weedy growths in the beds of small streams, and in like situations." These conditions are found in open areas with an abundance of vegetation.

Melanoplus obovatipennis Blatch.

This small species, similar to *scudderi*, was found in the upland forest (Sta. IV, *a*) Aug. 17 (No. 93). A nymph taken Aug. 22 from the forest (Sta. IV) is doubtfully regarded as of this species (No. 124).

Hart ('06, p. 81) gives the habitat of this species as "High wooded hillsides throughout Illinois." Blatchley ('03, p. 308) states that it frequents "for the most part, high, dry, open woods, especially those in which beech and oak trees predominate." He further states that in a dry season it may be found associated with *Dichromorpha viridis* and *Truxalis brevicornis* "among the reeds and tall rank grasses near the borders of marshes."

Melanoplus scudderi Uhl. Scudder's Grasshopper.

A single female was found in the open glade in the lowland forest (Sta. IV, *c*) Aug. 20 (No. 117); and a nymph taken Aug. 22 from the open ravine slope (Sta. IV, *b*) is doubtfully referred to this species (No. 124).

Hart ('06, p. 81) describes the habitat of this grasshopper as "open woods and thickets, and along rail fences and roadsides." Species which now characterize our open, partly cleared woodlands, in the primeval forest probably frequented forest margins, bluffs, and the borders of streams, or open patches in woods where a tree had fallen, and similar situations. With a thinning out of the forest (up to a certain degree) their habitat is increased in area, but when by clearing the woods disappear, their habitat vanishes.

LOCUSTIDÆ

Scudderia furcata Bruner. Forked Katydid. (Pl. LVII, fig. 5.)

One female was taken in an open area in the upland forest on low shrubs (Sta. IV, a) Aug. 20 (No. 109). Another specimen was taken near Vera, Fayette county, Ill., on a finely developed colony of prairie vegetation among *Andropogon*, Sept. 1 (No. 185).

Blatchley ('03, p. 349) states that it is "most frequently seen on the low bushes and trees about the margin of thickets and along fence rows, but in the prairie country north [in Indiana] it frequents coarse grasses and weeds."

Amblycorypha rotundifolia Scudd. Round-winged Katydid. (Pl. LVII, fig. 2.)

A single female of this species was taken in the glade in the lowland forest (Sta. IV, c) Aug. 20 (No. 117); and also a freshly emerged female (No. 143). Blatchley ('03, p. 352) states that this is "more of a terrestrial species than *oblongifolia*, being often seen on the ground, or on clumps of tall grass and weeds which grow in damp ravines." Hart ('06, p. 84) says that this species is found "On grasses and weeds in damp ground."

Microcentrum laurifolium Linn. Angle-winged Katydid. (Pl. LVII, figs. 1 and 2.)

Males were found on hickory sprouts at the cleared margin of the upland forest (near Sta. IV, a) Aug. 22 (No. 135). They were chirping loudly, in the early afternoon, on sprouts less than two feet high.

Cyrtophyllus perspicillatus Linn. Common Katydid. (Pl. LVIII, fig. 1.)

One male was taken in the partly cleared area bordering the forest (near Sta. IV, a) Aug. 23 (No. 145). Here, among stump sprouts of hickory, oak, and young sassafras, about two to three feet high, stood this male stridulating in the sun at 2:30 p. m., but the note did not seem exactly normal, that is, as when heard at night.

This species is so distinctly arboreal and nocturnal that I was surprised to find it stridulating during the day, and so near the ground. I have camped for days in a grove where these insects made a great din at night, but found none on the low vegetation or on the ground (as at Kappa, Ill). Years ago a large colony flourished in Franklin Park at Bloomington, Ill.

Conocephalus nebrascensis Bruner. Nebraska Cone-nose.

A female was taken in the glade in the damp lowland forest (Sta. IV, c) Aug. 20 (No. 117).

The female of this species has been observed to oviposit "between the stem and root-leaves of *Andropogon*", a typical prairie plant, but little appears to be recorded of its habitat. A large nymph of this genus, and probably of this species (No. 159), was taken on the prairie grass *Andropogon* (Sta. I, g) Aug. 24. It had been captured by the crab-spider *Misumena aleatoria* Hentz (No. 159).

Orchelimum cuticulare Redt.

A specimen was taken in the upland forest (Sta. IV, a) Aug. 16 (No. 67); another, from the open areas of the upland forest (Sta. IV, a) Aug. 17 (No. 93); and a third, from the glade in the damp lowland forest (Sta. IV, c) Aug. 22 (No. 143). All of these were males.

Orchelimum glaberrimum Burm.

This insect was found in abundance in the glade in the lowland forest (Sta. IV, c) Aug. 20 (No. 117), and a nymph was taken in the same place Aug. 22 (No. 143).

The abundance of this species in this damp area, with its profusion of low vegetation, indicates that the conditions were favorable.

Xiphidium nemorale Scudd.

Nymphs and adults were found in the glade in the lowland forest (Sta. IV, c) Aug. 20 (No. 117) and Aug. 22 (No. 143); in the openings in the upland forest (Sta. IV, a) Aug. 17 (No. 93), and Aug. 20 (No. 103).

Blatchley ('03, p. 374) states that it abounds along the "borders of dry, upland woods, fence rows, and roadsides, where it delights to rest on the low shrubs, blackberry bushes, or coarse weeds usually growing in such localities."

GRYLLIDÆ

Nemobius fasciatus DeG. Striped Cricket. (Pl. LVIII, fig. 6.)

Nymphs of this species were found in the upland forest on the

ground (Sta. IV, *a*) Aug. 16 (No. 67); in the upland forest area also, in an open place, was found a short-winged male Aug. 17 (No. 93); along a path in the upland forest, among dry leaves, a short-winged female was taken Aug. 22 (No. 122); and an abundance of short-winged males and females, and nymphs (No. 143) were found Aug. 22 in the glade in the lowland forest (Sta. IV, *c*).

This small cricket is generally abundant among the litter on the forest floor.

Nemobius maculatus Blatch. Spotted Cricket.

A nymph was taken in the upland forest (Sta. IV, *a*) among leaves Aug. 22 (No. 122).

Blatchley ('03, p. 425) states "It is found in low open woods, usually in the vicinity of or beneath logs"; Hart, ('06, p. 89) states that it is found "About logs and dead wood in sparse woods and near streams."

Apithus agitator Uhl. Woodland Cricket.

A nymph was taken from the open area in the upland forest (Sta. IV, *a*) Aug. 17 (No. 93); another from an open ravine slope (Sta. IV, *b*) Aug. 22 (No. 124). No adults were secured.

Blatchley ('03, pp. 458-459) records this species as from forests, noting its preference for prickly ash. It is also recorded as from grape-vines and dense shrubbery. The females deposit eggs in the twigs of the white elm, *Ulmus americana* Linn.

HEMIPTERA

CICADIDÆ

Cicada linnei Grossb. (*Cicada tibicen* L.). Dog-day Harvest-fly.
Pl. LV, fig. 5.)

This insect was found at the cleared margin of the upland forest (near Sta. IV, *a*) on low hickory sprouts Aug. 26 (No. 162).

It is said to require two years to mature. T. L. Hankinson reports that *Tibicen septendecim* L. (Pl. LV, figs. 3 and 4) was found about Charleston in 1907, and branches scarred by the ovipositing females were observed in the Bates forest (Sta. IV, *a*).

Felt ('05, pp. 237-238) describes the emergence of the adult *Tibicen* from the nymph skin. For the recent synonymy see Smith and Grossbeck (Ent. News, Vol. 18, pp. 116-129, 1907).

FULGORIDÆ

Ormenis pruinosa Say (?). Mealy Flata. (Pl. LVI, figs. 1 and 2.)

This insect was taken by T. L. Hankinson June 28, 1911, in the

Bates woods (No. 7678). It appears to feed upon a large variety of trees, shrubs, and herbaceous plants. Its normal habitat is probably in open woods or the forest margin. Swezey ('04, pp. 8-9) gives full references to the life history of this insect and a list of the food plants.

TETTIGONIELLIDÆ

Aulacizes irrorata Fabr. (Pl. LVI, fig. 3.)

A few specimens were taken, the collection data being as follows: from an open glade in the lowland forest (Sta. IV, c) Aug. 20 (No. 117); and from the smaller branches of sassafras bushes (Sta. IV, c) Aug. 22 (No. 143).

This insect is often taken on grapes, and in the South on cotton. Sanderson (Bull. 57, Bur. Ent., U. S. Dept. Agr., p. 58. 1906) describes briefly the egg-laying habits and figures the adult insect.

Gypona pectoralis Spangb.

This species was taken June 28, 1911, in the Bates woods (Sta. IV) by T. L. Hankinson (No. 7678).

PENTATOMIDÆ

Euschistus fissilis Uhl.

This bug was taken in Bates forest (Sta. IV) Aug. 22 (No. 124). It has been known to feed upon wheat (Webster, Rep. U. S. Dept. Agr., 1885, p. 317). It also feeds upon corn, and on the moth *Aletia*. It is parasitized by the proctotrypid *Trissolcus euschisti* Ashm. (Olsen, in Journ. N. Y. Ent. Soc., Vol. 20, p. 52. 1912).

Mormidea lugens Fabr.

A nymph of this bug was taken by T. L. Hankinson in the Bates woods (Sta. IV) June 28, 1911 (No. 7678).

Hymenarcys nervosa Say.

This insect was taken on the ground from among dead leaves and decayed wood which had drifted to the mouth of a ravine in the lowland forest (Sta. IV, c) Aug. 20 (No. 113). In the South this insect feeds upon cotton.

MIRIDÆ

Lygus pratensis Linn. Tarnished Plant-bug.

This bug was taken in the Bates woods (Sta. IV) June 28, 1911, by T. L. Hankinson (No. 7678). See prairie list, page 175.

COREIDÆ

Alydus quinquespinosus Say.

This bug was taken by T. L. Hankinson June 28, 1911, in the Bates woods (No. 7678), and July 10 (No. 7693) on the undergrowth in the woods (Sta. IV).

Acanthocerus galeator (*Euthoatha*) Fabr. (Pl. LVI, fig. 8.)

Six large nymphs of this plant-bug were taken on the apical part of a tall herb, *Actinomeris alternifolia* Linn., growing in the open glade of the lowland forest (Sta. IV, c; Pl. XIV) Aug. 29 (No. 182).

This bug has been reported to suck the juice from the plum, and it injures the tender parts of orange plants. Hubbard (Insects Affecting the Orange, U. S. Dept. Agr., Div. Ent., p. 163. 1885) gives figures of the adult insect and describes briefly the eggs and young. Forbes and Hart ('00, p. 445) have summarized the little that is known of this insect.

Jalysus spinosus Say. Spined Stilt-bug. (Pl. LVI, fig. 7.)

This bug was found Aug. 20 in the open glade of the lowland forest (Sta. IV, c), where there was a luxuriant growth of herbaceous vegetation (No. 117). It was also taken (Sta. IV) by T. L. Hankinson June 28, 1911 (No. 7678). Luggar reports it from oak woods. It feeds upon plants.

GERRIDÆ

Gerris remigis Say. Water-strider. (Pl. L, fig. 2.)

This water-strider was abundant in the pools of the small temporary stream in the ravine bordering the southern part of the Bates woods (Sta. IV, d) Aug. 22 (No. 129).

It is an important enemy of mosquito larvæ.

REDUVIIDÆ

Sinea diadema Fabr. Rapacious Soldier-bug.

A nymph of this predaceous bug was captured by T. L. Hankinson in the Bates woods (Sta. IV) June 28, 1911 (No. 7678). See list of prairie animals, page 173.

COLEOPTERA

CICINDELIDÆ

Cicindela unipunctata Fabr. Woodland Tiger-beetle.

One specimen of this tiger-beetle was taken along the path through the cleared area as it entered the forest (Sta. IV, a) Aug. 22 (No. 136).

Tiger-beetles are generally most abundant in open places, but this beetle seems to be a woodland species like the brilliantly colored *C. sexguttata* Fabr. Wickham ('99, pp. 210-211) records *unipunctata* from wooded areas. It is rare and difficult to catch, and is said to be nocturnal in habit.

CARABIDÆ

Calosoma scrutator Fabr. Caterpillar-hunter.

This common arboreal beetle was taken Aug. 16 (No. 64) in the upland Bates wood (Sta. IV, *a*), where it attracted attention by the rustling sound it made in crawling among the dry leaves on the ground. Specimens of these beetles I could easily secure by remaining quiet and listening for this rustling of the leaves. One specimen was seen to crawl up the trunk of a small oak-tree, three or four inches in diameter, for about seven feet. Another individual I took from my neck. It may have fallen upon me from a tree, but more probably it climbed upon me as it does a tree. In woods adjacent to the Bates forest, a caterpillar-hunter (No. 97) was found Aug. 20 with what appeared to be the damp cast skin of some large bombycid larva, which was also claimed by an ant, *Camponotus herculeanus* Linn., subsp. *pennsylvanicus* DeG., var. *ferrugineus* Fabr. On the ravine slope (Sta. IV, *b*) Aug. 20 T. L. Hankinson captured one of these beetles (No. 100) with a caterpillar about an inch long, which it had partly mangled in the thoracic region with its formidable jaws. On the upper slopes of the ravine (Sta. IV, *b*) Aug. 23 another beetle (No. 149) was found on the ground under a hickory tree, eating a *Datana* larva. Along this same rather open forested slope another individual was observed to run from the ground up the trunk of a small white oak (six or seven inches in diameter) for three or four feet, and then to return to the ground. The climbing individuals observed took a relatively straight course up the trunk, making no effort to climb in a spiral direction, and made the descent head foremost.

At Bloomington, Ill., while picking cherries I have taken the beetle in trees. Although the arboreal habit is evidently very well developed in this species, it is also very much at home on the ground. The rapidity and apparent ease with which it ran over dry oak leaves in the upland Bates woods surprised me.

The active foraging habits of this beetle are well shown by Herman's observations (Journ. Cincinnati Soc. Nat. Hist., Vol. 21, p. 80. 1910) on its killing nestlings of the cardinal grosbeak (*Cardinalis cardinalis*) in bushes three feet from the ground. Harris (In-

sects Injurious to Vegetation, p. 470. 1869) states that it preys upon canker-worms, both on the ground and by ascending trees.

Galerita janus Fabr.

A specimen was found under the bark of a decaying log in the upland Bates forest (Sta. IV, *a*) Aug. 23 (No. 171). This common beetle is frequently found in such situations, and seems to have a preference for relatively damp places. I have taken the adult as early as March 23 under bark of logs in the sap-wood stage of decay at Urbana, Ill., where it was found associated with single dealated females of *Camponotus herculeanus pennsylvanicus*, *Passalus cornutus*, pyrochroid larvæ, the caterpillar *Scolecocampa liburna*, and the slug *Philomycus carolinensis*.

This species is a fairly common one. I found it abundant at Bloomington, Ill., where it was taken April 15, May 1, and June 22.

The larva has been described by Hubbard (*Psyche*, Vol. 1, pp. 49-52. 1875).

COCCINELLIDÆ

A species of lady-beetle was found upon a fungus growing on a stump in the upland forest (Sta. IV, *a*) Aug. 17 (No. 81). Associated with the beetle on the fungus were large numbers of the snail *Pyramidula perspectiva*.

ELATERIDÆ

Melanotus sp.

A larva belonging to this genus (No. 125) was found Aug. 22 under the bark of a decaying stump (Sta. IV, *b*) in which the sap-wood was destroyed, the remainder being sound though discolored. It was associated with the slug *Philomycus carolinensis* and the caterpillar *Scolecocampa liburna*.

Corymbites sp.

A larva belonging to this genus (No. 113) was found in drifted leaves and dead wood at the mouth of a ravine in the lowland forest (Sta. IV, *c*).

Asaphes memnonius Hbst.

This click-beetle was taken at the mouth of a ravine in the lowland forest (Sta. IV, *c*) Aug. 20 (No. 113) in drift composed of dead leaves and rotten wood.

LAMPYRIDÆ

Calopteron terminale Say. Black-tipped Calopteron.

This interesting beetle was taken in the damp lowland forest (Sta. IV, *c*) Aug. 26 (No. 173).

This species has been mentioned as an instance of mimicry because of its resemblance in shape and color-pattern to the syntomid moth *Lycomorpha pholus* Drury. Both are found in damp shady woods.

Calopteron reticulatum Fabr. Reticulate Calopteron. (Pl. LVIII, fig. 4.)

A single specimen was taken—in the glade in the lowland forest (Sta. IV, c) Aug. 22 (No. 143).

The larva and pupa of this species are described by Coquillett (Can. Ent., Vol. 15, pp. 97-98. 1883). July 10 he found a pupa "suspended by the hind end of its body beneath a log."

Photuris pennsylvanica DeG. Pennsylvania Firefly. (Pl. LVIII, fig. 3.)

This large firefly was taken June 28, 1911, in the Bates woods (Sta. IV) by T. L. Hankinson (No. 7678).

McDermott ('10, '11) Knab ('05), and Mast ('12) should be consulted for discussions on the natural history and ecology of our fireflies. McDermott gives many observations on *P. pennsylvanica*.

Chauliognathus marginatus Fabr. Margined Soldier-beetle.

This predaceous beetle was taken June 28, 1911, in the Bates woods (Sta. IV) by T. L. Hankinson (No. 7678). (Cf. Lintner, Fourth Rep. Injurious and other Ins. N. Y., 1888, pp. 74-88.) This is a predaceous species in the larval stage, feeding on immature insects. The adults feed on pollen (Riley, in Fifth Rep. Ins. Mo., p. 154. 1873).

Telephorus sp.

This was taken June 28, 1911, in the Bates woods (Sta. IV) by T. L. Hankinson (No. 7678). See *T. bilineatus*, Pl. XLIV, fig. 1.

LUCANIDÆ

Passalus cornutus Fabr. Horned Passalus. (Pl. LVIII, fig. 5.)

This common woodland beetle was found under the bark of a decaying stump on the slope of a ravine (Sta. IV, b) Aug. 17 (No. 85). One specimen, with a chestnut thorax and yellowish wings, had just shed the pupal skin. Another, a fully matured specimen, carried a large colony of mites. Ewing (Univ. Studies, Univ. Ill., Vol. 3, p. 24. 1909) states that nymphs of uropod mites are often attached to insects for transportation. It has generally been assumed that they are parasitic.

This *Passalus* seems to be one of the most common insects found in decaying logs and stumps. I have found it very abundant at

Bloomington, Ill. The beetles evidently hibernate, for I have taken them at Urbana, Ill., as late as October 18, and as early in the spring as March 23.

This beetle invades logs and stumps as soon as the sap-wood begins to be well decayed, and evidently advances into the log with the progress of decay. As it invades logs in the sap-wood stage of decay, it is often associated with *newly founded* colonies of the ant *Camponotus herculeanus pennsylvanicus*, pyrochroid larvæ, the slug *Philomycus carolinensis*, and the caterpillar *Scolecocampa liburna*. For physiological studies of *cornutus* see Schafer (Mich. Agr. Coll. Exper. Sta., Tech. Bull. No. 11. 1911).

SCARABÆIDÆ

Geotrupes splendidus Fabr. Splendid Dung-beetle.

This dung-beetle was dug from a hole, an inch or so below the surface, in the hard clay of the pathway near the margin of the forest bordering the cleared area (Sta. IV, *a*) Aug. 22 (No. 120). As cattle and horses were pastured in this forest, its presence is readily accounted for.

Pelidnota punctata Linn. Spotted Grape Beetle.

Only one specimen of this beetle was taken. It was found on a grape leaf (Sta. III, *b*) Aug. 15 (No. 58). This insect is primarily a forest or forest-margin insect. The larva feeds upon the decaying roots and stumps of oak and hickory. The adult devours leaves of the grape and of the Virginia creeper.

Many undetermined scarabæid larvæ were found in a much-decayed stump in the ravine near the small temporary stream (near Sta. IV, *d*) Aug. 22 (No. 130).

CHRYSOMELIDÆ

Chrysochus auratus Fabr. Dogbane Beetle.

This characteristic species of the prairie (No. 103) was taken Aug. 20 in an open place in the upland oak-hickory forest (Sta. IV, *a*) on the dogbane *Apocynum medium*. See list of prairie invertebrates, p. 178.

Cryptocephalus mutabilis Mels.

This leaf-beetle was taken June 28, 1911, in the Bates woods (Sta. IV) by T. L. Hankinson (No. 7678). It has been reported on *Ceanothus*, *Viburnum*, hazel, and oak by J. B. Smith. Evidently this is a woodland beetle.

Coptocyclus clavata Fabr. Clubbed Tortoise-beetle.

This leaf-beetle was taken in the south ravine of the Bates woods (Sta. IV, *b*) by T. L. Hankinson June 28, 1911 (No. 7678). It is known to injure the potato, tomato, eggplant, and bittersweet. The larvæ and adults feed upon the same kinds of plants (Lintner, Sixth Rep. Injurious and other Ins. N. Y., pp. 126-127. 1890).

TENEBRIONIDÆ

Boletotherus bifurcus Fabr. Horned Fungus-beetle. (Pl. LIX, figs. 1, 2, and 3.)

This curious-looking beetle was found on the shelf-fungus *Polyporus* in the lowland forest (Sta. IV, *c*) Aug. 26 (No. 173).

I have found this species very abundant near Bloomington, Ill., where at times it was difficult to find an example of *Polyporus* which was not thoroughly honeycombed by the larvæ of these beetles. A single shelf has been found to contain several beetles. They were generally discovered within galleries excavated within the fungus. On July 11 in such a shelf I found larvæ and pupæ in abundance. Other dates of capture are June 3 and July 6. Riley and Howard (Insect Life, Vol. 3, p. 335. 1891) also report it from *Polyporus*. Figures of the larva and pupa are given by Packard ('83, p. 474) and descriptions by Gissler (On coleopterous larvæ of the family *Tenebrionidæ*, Bull. Brooklyn Ent. Soc., Vol. 1, pp. 85-88. 1878).

Meracantha contracta Beauv.

Larvæ of this beetle were taken under dry leaves in the upland forest (Sta. IV, *a*) Aug. 17 (No. 83); and others from under damp leaves at the base of the wooded slopes of a ravine leading to the lowland forest (Sta. IV, *b*) Aug. 22 (No. 140). The latter larvæ were associated with the ant *Stigmatomma pallipes*. These larvæ are often confused with wireworms (*Elateridæ*).

I found the beetles occasionally in the forest at Bloomington, Ill., June 13; and Aug. 1 on the papaw.

I have a specimen of this larva, in very rotten wood, showing the sinuous larval boring (Pl. XXX), from the Brownfield woods, Urbana, Ill. (March 9; collector, D. M. Brumfiel). Wickham has described and figured the larva (Journ. N. Y. Ent. Soc., Vol. 4, pp. 119-121. 1896).

PYROCHROIDÆ

Pyrochroa sp.

A single specimen of a larva belonging to the above family was taken August 22 (No. 130) in the ravine (Sta. IV, *b*) from under

the bark of a decaying stump, in company with numerous scarabæid larvæ. These larvæ are very characteristic animals—under bark when decay has loosened it from the sap-wood. The accompanying figure (Pl. LIX, fig. 4) shows the general appearance of this larva and of an adult beetle. I found *Dendroides canadensis* Latr. fairly abundant at Bloomington, Ill., July 25. Larvæ belonging to this family have been taken in the Brownfield woods, Urbana, Ill., under the bark of decaying trees. It is a representative animal species in this habitat.

See Moody (Psyche, Vol. 3, p. 76. 1880) for descriptions of pyrochroid larvæ.

LEPIDOPTERA

PAPILIONIDÆ

Papilio philenor Linn. Philenor Butterfly. (Pl. LIX, fig. 5.)

The caterpillar was found crawling upon the ground in the upland forest (Sta. IV, *a*) Aug. 16 (No. 69). Aug. 26 a larva (No. 166) which had attached itself to the stem of a prickly ash (Sta. IV, *b*), was just entering upon the pupal stage, but had not yet cast the larval skin.

The larva feeds upon Dutchman's pipe, *Aristolochia*—a plant which was not observed in the forest.

Papilio turnus Linn. Turnus Butterfly.

The butterfly was observed on wing Aug. 16 in the open glades of the upland forest (Sta. IV, *a*).

The larva feeds upon *Prunus* and *Liriodendron*.

Papilio cresphontes Cram. Cresphontes Butterfly.

The butterfly was observed in the open spaces of the upland forest on wing Aug. 16.

The larva feeds upon *Zanthoxylum*, *Ptelea*, *Dictamnus*, *Citrus*, etc.

Papilio troilus Linn. Troilus Butterfly.

The butterfly was taken, on wing, from the open slope of the south ravine (Sta. IV, *b*) Aug. 22 (No. 161); and in the upland forest (Sta. IV, *a*) Aug. 26 (No. 163).

The larva feeds upon sassafras and *Laurus*.

NYMPHALIDÆ

Polygonia interrogationis Fabr.

The butterfly was taken in the open glade in the lowland forest (Sta. IV, *c*) Aug. 20 (No. 117).

The larva feeds upon *Humulus*, *Ulmus*, and *Urtica*.

AGAPETIDÆ

Enodia portlandia Fabr. Portlandia Butterfly.

This woodland butterfly was taken in the Bates woods (Sta. IV) Aug. 15 (No. 63) and on June 28, 1911 (No. 7678), by T. L. Hankinson.

The larva feeds upon grasses. Fiske ('01, pp. 33-34) gives a good description of the haunts of this species. Years ago I found it abundant near Bloomington (Orendorf Springs), Ill., in dense, damp, shady woods. It is as characteristic of shade as most species are of sunshine.

Cissia curytus Fabr. Eurytus Butterfly.

This is also a woodland butterfly. It was taken in the Bates woods by T. L. Hankinson June 28, 1911 (No. 7678). The larva feeds upon grass.

LYCÆNIDÆ

Everes comyntas Gdt.

This small blue butterfly was taken on the open upper slopes of the wooded south ravine in the Bates forest (Sta. IV, *b*) Aug. 22 (No. 161).

The larva feeds upon red clover and *Desmodium*.

HESPERIDÆ

Epargyreus tityrus Fabr. Common Skipper.

This caterpillar was found in the open glade in the lowland forest (Sta. IV, *c*), folded within a leaf of sassafras, Aug. 26 (No. 173).

I have taken this butterfly many times at Bloomington, Ill.; and have found the larvæ folded in leaves of the yellow locust, *Robinia*, upon which they had evidently been feeding.

SPHINGIDÆ

Cressomia juglandis Sm. and Abb.

This caterpillar was taken on low branches of the shell-bark hickory, *Carya ovata*, in the upland forest (Sta. IV, *a*) Aug. 20 (No. 102).

The larva feeds upon walnut, ironwood, and hickory. Our specimens bore a large number of cocoons of a hymenopterous parasite. When handled, this larva makes a peculiar squeaking sound (Bull. 54, Bur. Ent., U. S. Dept. Agr., p. 80. 1905).

SATURNIIDÆ

Telea polyphemus Cramer. American Silkworm. (Pl. LIX, fig. 6.)

This caterpillar was taken on the ground, under hickories and white oaks on the forested slopes to the valley (Sta. IV, *b*) Aug. 26 (No. 163).

The larva feeds upon walnut, basswood, elm, maple, cherry, etc.

CERATOCAMPIDÆ

Citheronia regalis Fabr. Royal Walnut Moth; Hickory Horned-devil (larval name). (Pl. LX, figs. 1 and 2.)

This larva was found on the valley slope (Sta. IV, *b*) on sumac Aug. 16 (No. 68); and on walnut Aug. 20 (No. 108). This last specimen was apparently fully mature.

The food plants of the larva are butternut, hickory, sycamore, ash, and lilac. See Packard ('05, p. 130) for many figures and a full description of this species.

Basilona imperialis Drury. Imperial Moth. (Pl. LXI, Fig. 1).

The larva of this species was found on the leaves of sassafras on the forested slope to the lowland forest (Sta. IV, *b*) Aug. 20 (No. 106). It feeds upon a large number of forest trees including oak, maple, wild cherry, walnut, hickory, and several conifers.

See Packard ('05, p. 125) for figures and full descriptions of this species.

ARCTIIDÆ

Halisidota tessellaris Sm. and Abb. (Pl. LXI, fig. 4.)

These caterpillars were taken on hickory on the wooded slope to the lowland (Sta. IV, *b*) Aug. 26 (No. 163); and, again, abundantly (No. 168), in the upland forest (Sta. IV, *a*) on climbing buckwheat, *Polygonum convolvulus*, which was entwined about a young walnut or butternut. The yellow hairs and the tufts give this caterpillar a striking appearance.

I have found moths of this species abundant at Bloomington, Ill.

The food plants are recorded as maple, oak, hazel, and buttonwood. Though larvæ were abundant upon leaves of the climbing buckwheat, I did not observe them there eating it.

NOCTUIDÆ

Autographa precatationis Guen.

The moth was taken in the open glade in the lowland forest (Sta. IV, *c*) Aug. 22 (No. 143).

The larva feeds upon plantain, burdock, and dandelion.

Scolecocampa liburna Geyer. Rotten-log Caterpillar.

A single caterpillar (No. 125) was taken Aug. 22 upon the slope of a wooded ravine (Sta. IV, *b*) under the bark of a stump in an early stage of decay—the sap-wood honeycombed, but the remainder solid though discolored. The larva, with its characteristic excrement, was found in a cell excavated in the rotten sap-wood.

This is another species of animal which invades wood in the sap-wood stage of decay and is so often associated with *Philomyces carolinensis*, *Passalus cornutus*, and newly established colonies of *Camponotus herculeanus pennsylvanicus*. The larva winters in logs, as is evidenced by the fact that I found it in such situations late in fall and early in spring (March 23) at Urbana, Ill. The large quantity of excrement often indicates the approximate location of the larva. This larva has been described by Edwards and Elliot (*Papilio*, Vol. 3, p. 134. 1883). It has been found in chestnut, oak, and other kinds of decaying logs. The moth is recorded in July. The pileated woodpecker, *Phlaeotomus pileatus*, has been known to eat this caterpillar (Beal, in Bull. 37, Biol. Surv., U. S. Dept. Agr., p. 34. 1911). Smith (Ann. Rep. N. Jersey State Mus., 1909, p. 471. 1910) states that the larva is found in "decaying cherry, hickory, oak and chestnut stumps."

NOTODONTIDÆ

Datana angusii G. and R.

The caterpillar of this species was found on the valley slope (Sta. IV. *b*) on bitternut hickory, *Carya microcarpa*, Aug. 20 (No. 104); in the upland forest (Sta. IV, *a*) on hickory Aug. 16 (No. 65); and at the margin of this forest Aug. 26 (No. 162).

The food plants of the larva are walnut, hickory, linden, and birch. Packard ('95, pp. 110-111) describes and gives figures of the larva and adult.

Nadata gibbosa Sm. and Abb. (Pl. LXI, fig. 2.)

This larva was taken on white oak, *Quercus alba*, in a forested ravine (Sta. IV, *b*) Aug. 19 (No. 94); on leaves of the white oak, upon which it had been feeding, in the upland forest (Sta. IV, *a*) Aug. 26 (No. 169).

Packard ('95, pp. 142-146) gives figures of this species and lists as food plants, oak, birch, and sugar plum. It is also reported on maple.

Heterocampa guttivitta Walk (?). (Pl. LXI, figs. 3 and 5.)

This larva (No. 127) was captured Aug. 22 by a digger-wasp, *Anmophila abbreviata* Fabr. which was found dragging it along the ground in the upland forest (Sta. IV, *a*). See Packard

('95, pp. 230-235) for an account of this forest-inhabiting larva.

The larva of *guttivitta* is known to feed upon red maple, oak, and viburnum.

GEOMETRIDÆ

Eustroma diversilineata Hübn. (Pl. LXII, fig. 1.)

This span-worm moth was taken in the upland forest (Sta. IV, *a*) Aug. 26 (No. 163).

Packard (Monogr. Geometrid Moths, p. 128. 1876) states that the larva feeds upon grape and *Psedera*. These are mainly forest plants, and this is probably a woodland species.

Caberodes confusaria Hübn.

This moth was taken near the upper slope of the south ravine in open woods (Sta. IV, *b*) Aug. 22 (No. 161).

The larva feeds upon *Trifolium*.

COCHLIDIDÆ

Cochlidion or *Lithacodes* sp. Slug Caterpillar.

This curious larva was found on a stump on the wooded ravine slope (Sta. IV, *b*) Aug. 26 (No. 165).

GELECHIDÆ

Ypsolophus ligulellus Hübn. (?)

These small moths were taken in the upland woods (Sta. IV, *a*) by T. L. Hankinson June 28, 1911 (No. 7678). The larva is reported on apple, pear, and plum.

DIPTERA

CECIDOMYIDÆ

Cecidomyia holotricha O. S. (Hairy Midge-gall.)

Abundant on the under side of hickory leaves (near Sta. IV) Aug. 20 (No. 96); and on leaves of *Carya ovata* in the upland forest (Sta. IV, *a*) Aug. 26 (Nos. 107 and 170). These brownish, hairy galls may cover large areas on the under side of some leaves. See Cook '05, p. 840, or Beutenmüller '04, p. 112.

Cecidomyia tubicola O. S. (Hickory Tube-gall.)

Immature galls (No. 107) were found Aug. 20 in the upland Bates woods (Sta. IV, *a*) on the lower side of leaves of *Carya ovata*.

Cccidomyia caryæcola O. S. (Hickory Seed-gall.)

This gall was taken on *Carya ovata* leaves in the upland forest (Sta. IV, a) Aug. 20 (No. 107); and Aug. 26 (No. 170). Many galls are formed on hickory and other trees by plant-lice (Cf. Pergande, '02).

ASILIDÆ

Deromyia discolor Loew.

This robber-fly was taken in an open area in the lowland forest (Sta. IV, c) Aug. 20 (No. 117). Williston (Kingsley's Standard Natural History, Vol. 2, pp. 418-419. 1884) states that most robber-flies "rest upon the ground, and fly up when disturbed, with a quick buzzing sound only to alight again a short distance ahead. All their food, which consists wholly of other insects, is caught upon the wing Other flies and *Hymenoptera* are usually their food, but flying beetles, especially *Cicindelidæ*, are often caught, and they have even been known to seize and carry off large dragonflies. Not only will they feed upon other *Asilidæ*, but the female frequently resents the caresses of her mate by eating him up, especially if he is foolish enough to put himself in her power. In an instance the writer observed, a female seized a pair of her own species, and thrusting her proboscis into the thorax of the male, carried them both off together. The larvæ live chiefly under ground or in rotten wood, especially in places infested with grubs of beetles upon which they will feed. The young larvæ will bore their way completely within beetle larvæ and remain enclosed until they have consumed them. Many, however, are found where they evidently feed upon rootlets or other vegetable substances. They undergo their transformations in the ground. The pupæ have the head provided with tubercles, and on the abdominal segments there are also spiny protuberances and transverse rows of bristles, which aid the insects to reach the surface when they are ready to escape as flies." Marlatt (Proc. Ent. Soc. Wash., Vol. 2, p. 82. 1893) observed *D. discolor* preying upon wasps of the genus *Vespa*. By seizing the head of the wasp it avoids being stung.

Deromyia umbrinus Loew.

A specimen of this large robber-fly was taken in the south ravine (Sta. IV, d) by T. L. Hankinson, with the eucerid bee *Melissodes perplexa* Cresson in its grip, Aug. 22, 1910 (No. 7530).

SYRPHIDÆ

Chrysotoxum ventricosum Loew.

This wasp-like fly was found resting on a leaf in the upland forest (Sta. IV, a) Aug. 26 (No. 163).

Mesogramma politum Say. Corn Syrphid.

This fly was taken by T. L. Hankinson in the Bates woods (Sta. IV) June 28, 1911 (No. 7678). See the prairie list, p. 188.

Milesia ornata Fabr. Vespa-like Syrphid.

This beautiful large syrphid was taken on dogbane in an open space in the upland forest (Sta. IV, a) Aug. 20 (No. 103); in the open glade in the lowland forest (Sta. IV, c) Aug. 22 (No. 143); and on Aug. 26 (No. 184) on the flowers of *Eupatorium caelestinum* in the clutches of the flower spider *Misumena alcatoria* Hentz. It was also taken in the Bates woods by T. L. Hankinson June 28, 1911 (No. 7678). Metcalf ('13, p. 73) quotes Verrall as follows concerning the subfamily *Milesiinae*: "What little is known about the metamorphosis shows that many species live in rotten wood or about the sap flowing from injured tree trunks."

HYMENOPTERA

SIRICIDÆ

Tremex columba Linn. Horntail; Pigeon Tremex.

This species was taken on wing in the upland forest (Sta. IV, a) Aug. 16 (No. 66); and on the open slope of a ravine (Sta. IV, b) Aug. 22 (No. 132).

The larva bores in the trunks of trees, as oak, elm, sycamore, and maple. Consult Packard ('90, pp. 379-381) for a description and figure of the larva. The long-sting, *Thalessa lunator*, is an external parasite upon this larva (see Riley, '88). I have taken normally colored females at Bloomington, Ill., July 25, Sept. 29, and Oct. 8. Two abnormally colored individuals were taken in September, one of them almost, and the other (taken Sept. 29) completely lacking the usual black markings. A female was taken at Milmine, Ill., in October. Consult Bradley ('13) for a key to the varieties of this species of *Tremex*.

An interesting feature in the ecological relations of this species is the fact that it appears to frequent only weakened, diseased, and dying trees, and these, not as a primary invader, but as a trailer, following insects which have done previous injury to the trees. Felt ('05, p. 61) shows that in New York successive attacks of the

elm leaf-beetle, or injury by the sugar maple borer *Plagionotus speciosus* Say, prepare the way for the horntail larva. Ecologically considered, the leaf-beetle and the borer initiate a succession of insect invasions into the tree trunk; *Tremex* follows, with its parasite *Thalassa*; and these in turn lead the way for still others; thus a succession of insects is produced.

CYNIPIDÆ

Holcaspis globulus Fitch. (Oak Bullet Gall.)

This gall was taken on white oak, *Quercus alba*, in the upland forest (Sta. IV, a) Aug. 26 (No. 170).

Consult Cook ('05) and Beutenmüller ('04) for figures and descriptions of various kinds of galls mentioned in this list.

Amphibolips confluens Harr. (Oak-apple or May-apple Gall.)

These galls were abundant upon the forest floor in the upland Bates woods (Sta. IV, a) during August (No. 101). The galls grow upon the leaves of several species of oaks (*Quercus*).

Amphibolips prunus Walsh. (Acorn Plum Gall.) (Pl. LXII, fig. 2.)

A single specimen of this gall was found on the slope of the south ravine in Bates woods (Sta. IV, b) Aug. 22 (No. 131). Another specimen came from the woods northeast of the Bates woods Aug. 20 (No. 96). It grows upon acorn cups.

Andricus clavula Bass. (White Oak Club Gall.) (Pl. LXII, fig. 5.)

This gall, formed in the terminal bud, was common on white oak, *Quercus alba*, in the upland Bates woods (Sta. IV, a) Aug. 26 (No. 170).

Andricus cornigerus O. S. (Horned Knot Oak Gall.) (Pl. LXII, fig. 3.)

This gall occurred in very large numbers on the branches of shingle oak, *Quercus imbricaria*, in a forest just northeast of the Bates woods, Aug. 20 (No. 96). The galls are old and apparently decaying.

Andricus lana Fitch. (Oak Wool Gall.) (Pl. LXII, fig. 4.)

Two examples of this gall were found on leaves of white oak, *Quercus alba*: one was taken near the Bates woods (Sta. IV) Aug. 20 (No. 96), and the other was found in the Bates woods (Sta. IV, a) on the petiole of a leaf, Aug. 26 (No. 170).

Andricus seminator Harr. (Oak Seed-gall.) (Pl. LXIII, fig. 1.)

A single specimen of this gall was found upon *Quercus alba* (Sta. IV, a) Aug. 20 (No. 101). The cotton-like masses of this

gall are conspicuous. They may be tinged with red; when dry they become brownish.

ICHNEUMONIDÆ

Thalessa lunator Fabr. Lunate Long-sting.

A female ichneumon of this species was found on a tree trunk in the open glade in the lowland forest (Sta. IV, *c*) Aug. 22 (No. 143).

The larva feeds, as an external parasite, upon the larva of the horntail, *Tremex columba*, which was also found in the Bates woods (Sta. IV). I found *T. lunator*, both males and females, abundant on shade trees at Bloomington, Ill., October 1, 1892, and also took it July 26, 1895. Riley ('88) gives an excellent account of this species accompanied by figures of the immature stages, and that of its host as well.

Trogus obsidianator Brullé.

This black ichneumon with fulvous antennæ was taken in the Bates woods (Sta. IV) June 28, 1911, by T. L. Hankinson (No. 7678). This wasp is known to be parasitic upon the larva of *Papilio polyxenes* Fabr. (*P. asterias*—Insect Life, Vol. 1, p. 161) and upon the caterpillar of *Pyrrharctia isabella* (?). This species has been taken in central Illinois during June and July (Weed, Psyche, Vol. 5, p. 52). (See also Riley, in Amer. Ent., Vol. 3, p. 134. 1880.)

PELECINIDÆ

Pelecinius polyturator Drury. Black Longtail. (Pl. LXIII, fig. 2.)

This remarkable looking insect was found in the glade of the lowland forest (Sta. IV, *c*) Aug. 20 (No. 117) and Aug. 22 (No. 143). Other females were seen in this forest.

I have also taken this species at Bloomington, Ill. At Evanston, Ill., during July, 1910, this species was very abundant upon some damp lawns. I have counted four or five females in sight at once. They were often found upon blue-grass sod. The male of this species is considered very rare. The only one which I ever captured was taken July 29, 1910, at Evanston, Ill. The larva is parasitic upon the grub of the May-beetle, *Lachnosterna* (Forbes, Eighteenth Rep. State Ent. Ill., p. 124. 1894). It may also prey upon other scarabæid larvæ inhabiting woodlands.

FORMICIDÆ

Stigmatomma pallipes Hald. Old-fashioned Ant.

A single wingless queen and four pupæ (No. 140) were taken Aug. 22 near the base of a ravine slope (Sta. IV, *b*) in dense shaded

woods, almost devoid of herbaceous vegetation, but with a thick layer of leaves, and other vegetable debris.

Wheeler (Biol. Bull., Vol. 2, pp. 56-69. 1901) considers this a rather rare ant, although widely distributed over eastern North America. It is subterranean in habit, and "does not come to the surface even at night." Contrary to the habits of most ants this primitive species has retained the carnivorous habits of the ancestral forms, and the young are fed on fragments of insects. They do not feed one another, or the larvæ by regurgitation, as do the specialized species of ants. They thus furnish us a glimpse at the ancient history of ants. Wheeler ('05, pp 374-375) states that this species occurs only in "rich, rather damp woods, under stones, leaf mould, or more rarely under or in rotten logs."

A worker of *Myrmica rubra* Linn., subsp. *scabrinodis* Nyl., var. *schencki* Emery (No. 140) was taken from the same patch of leaves.

Cremastogaster lineolata Say. (Pl. LXII, fig. 6.)

This ant was taken only once—in the upland part of the Bates woods (Sta. IV, a) Aug. 20 (No. 118). Large numbers of the ants were found in an oak-apple gall (*Amphibolips confluens* Harr.) lying on the forest floor. When I picked up the gall, many ants came out and ran over my hand, biting vigorously.

This is essentially a ground and forest-inhabiting ant, which forms nests in the soil, under stones, and in logs, stumps, etc. It has the peculiar instinct to make a sort of temporary nest out of debris to cover the aphids and coccids which it attends (Wheeler, Bull. Am. Mus. Nat. Hist., Vol. 22, pp. 1-18. 1906).

Several carnivorous staphylinid beetles of the genus *Myrmedonia* have been taken in the nests of these ants (Wheeler, '10a, p. 382; Schwarz, '90b, p. 247).

Aphanogaster fulva Roger.

A well-rotted stump in the upland Bates woods (Sta. IV, a) was found Aug. 17 to contain a moist, felt-like layer of some fungous growth, and on this was a large colony of snails (No. 71). In an adjacent part of this stump was a small colony of white ants, *Termes flacipes* Koll. (No. 72). A colony of ants which was in close proximity to the white ants, proved to be *A. fulva* Roger. As the galleries were exposed by cutting up the stump, these ants were seen to pick up the termites and carry them away, just as they do their own young on similar occasions. Five pairs—the ant and the termite which it carried—were preserved (Nos. 74-76, and 78-79). One of the termites lacks a head. All of them were workers. Larvæ and naked pupæ (No. 79) were abundant in this nest, and workers (No. 80) were abundant about the stump. On Aug. 22 another

colony of this ant (No. 125) was found under the bark of a decaying oak stump (Sta. IV) in which the sap-wood was honeycombed, but the remainder solid, though discolored.

Forel (Psyche, Vol. 9, p. 237. 1901) remarks that *Aphanogaster* is "very fond of termites, and when one uncovers and scatters about a nest of termites in a wood, they hasten to feast on the succulent morsels." These observations suggest the possible fate of the captured termites; none of the ants were seen to eat them, however. In the absence of observations, the missing head mentioned above may be variously accounted for.

This habit of carrying off termites has been observed in other species of ants. Forbes (19th Rep. State Ent. Ill., p. 198. 1896) reports that near Carterville, Mason county, Ill., Mr. John Marten observed *Formica schaufussi* (= *Formica pallide-fulva* Linn., subsp. *schaufussi* Mayr) to pick up and carry away the living termites when its nest under a log in which termites abounded, was disturbed, and McCook (Proc. Acad. Nat. Sci. Phila., 1879, p. 155) has observed similar behavior in the case of the mound-building ant, *Formica exsectoides* Forel.

The histerid beetle *Heterius blanchardi* Schwarz has been found in nests of this ant (Wheeler, '10a, pp. 388, 389); and European observers have seen ants carrying and rolling them about. Consult also Schwarz ('90b, 247) for a list of beetles found with this ant.

Wheeler ('10a, p. 206) lists *A. fulva* as a glade species which in the forests utilizes logs and branches as substitutes for stones. (See Wheeler, '05, pp. 372-373.)

Aphanogaster tennesseensis Mayr. Tennessee Ant.

A colony of this ant (No. 87) was taken Aug. 17 from a decaying stump, situated on the slope (Sta. IV, b) from the upland forest to the lowland on the river bottom.

According to Wheeler (Bull. Am. Mus. Nat. Hist., Vol. 20, 1904, p. 362, and Vol. 21, 1905, p. 373) this species normally nests in dead wood in rather open forests. He holds the opinion that the queen of this species can not rear her own brood, and thus establish a new colony, but must utilize a small or weak colony of the allied species *A. fulva* Roger, which lives under stones. Thus the new colonies are started under stones; later, when they become numerous, they are found in rotten wood. This, Wheeler concludes, indicates that they "migrate away from the *fulva* workers." Tanquary ('11) has performed some interesting experiments which show that queens of *tennesseensis* are adopted by colonies of other ants, a result which seems to confirm Wheeler's anticipation.

Schwarz ('90b, p. 247) records two beetles found with this ant.

Formica fusca Linn., var. *subsericea* Say.

This ant was taken in the upland Bates woods (Sta. IV, a) Aug. 26 (No. 163). See the list of prairie invertebrates, p. 190.

Myrmica rubra Linn., subsp. *scabrinodis* Nyl., var. *schencki* Emery.

This ant (No. 140) was found Aug. 22 under leaves in a small ravine on a shady slope (Sta. IV, b) from the upland forest to the valley bottoms. The soil under these leaves had been thoroughly tunneled by small mammals during the preceding winter, but recently the leaves had not been disturbed. The soil was a mixture of sand, clay, and vegetable debris, was moist, and contained few kinds of animals. A single ant of this variety (No. 140) was taken while collecting specimens of *Stigmatomma pallipes*.

This species is listed by Wheeler (Bull. Am. Mus. Nat. Hist., Vol. 21, p. 373. 1905) as a field ant which prefers to nest in grassy pastures and lawns, in situations exposed to the sun. Our specimen was, therefore, found in an unusual habitat.

Tapinoma sessile Say. Coconut Ant.

This coconut ant, so called because of the odor of the workers, which has been compared to that of decayed coconuts, was found in the lowland part of the Bates woods, at the base of the slope to the bottoms (Sta. IV, c) Aug. 22 (No. 139). A large colony was found among the surface layers of dry dead leaves; from it were secured two queens, vast numbers of eggs, and also larvæ, pupæ, and workers. Wheeler ('05, pp. 373, 389) states that this ant usually nests in open sunny woods, the borders of woods, and under stones, logs, etc.

Schwarz ('90b, p. 247) records beetles as living with this ant.

Camponotus herculeanus Linn., subsp. *pennsylvanicus* DeG. Carpenter Ant.

This species was taken from under the bark of a rotting stump among a dense second-growth, on the valley slope (Sta. IV, b) between the upland and the lowland forest Aug. 17 (No. 84). This stump was in that stage of decay so often utilized by the large Carolina slug, *Philomyces carolinensis*, and the horned Passalus beetle, *Passalus cornutus*. The colony was recently founded, for the dea-ated female occupied a small cell excavated in the rotten sap-wood. This colony consisted of four pupæ and six larvæ of different sizes. Another colony was taken in the same stump, from the rotted sap-wood zone, in company with the snail *Philomyces carolinensis* and some kind of pulmonate snail eggs. This colony was in a more advanced stage than the preceding, about a dozen larvæ, seven pupæ.

and two adult workers being present, and about half a dozen eggs (No. 85).

Pricer ('08) has given an interesting account of the life history and habits of this ant in Illinois. He states (p. 197) that the food is largely the honeydew of plant-lice, but is supplemented by plant juices and dead insects. He found a small staphylinid beetle, *Xenodusa cava*, abundant in the nests.

I have found *pennsylvanicus* abundant at Bloomington, Ill., and represented as follows: by a male June 29; by a winged female in June; and by dealated females June 29 and July 2 and 25.

McCook ('83) has given an interesting account of the founding of colonies of this ant. See also Wheeler, '06b, pp. 38-39, Plate VIII, and '10b, pp. 335-338, for further information concerning it.

Camponotus herculeanus Linn., subsp. *pennsylvanicus* DeG., var. *ferrugineus* Fabr.

This variety was taken a short distance to the northeast of the Bates woods (Sta. IV) Aug. 20 (No. 97). Here the large ground-beetle *Calosoma scrutator* was found running on the ground with what appeared to be a bunch of greenish moss; a large reddish ant also struggled for possession of the prize. Upon closer examination it was found that the skin of some large lepidopterous larva was the object desired. This skin, recently shed or moistened by a recent rain, was a prize for both *ferrugineus* and *Calosoma*.

A dead wingless *ferrugineus*, covered with a fungus growth, was found in a small cell excavated in the rotten wood of a decaying log on the ravine slope (Sta. IV, b) Aug. 17 (No. 90). Apparently this female had died before her colony developed. (See Pricer, '08; Wheeler '10b, pp. 338-339.)

I have found this form abundant at Bloomington, Ill. Winged females were taken July 26, dealated ones on July 25 and 26, and males June 29, and July 9 and 25. On July 21, 1892, several males were taken at night, being attracted to a lamp located near a small brook.

A very large colony, numbering thousands of individuals, was found May 26, under a well-decayed log, in a forest at White Heath, Ill. It contained winged males, females, and workers. The winged forms were present in vast numbers. The far-advanced condition of decay of the log was in marked contrast with that in which the initial colonies are usually found. During the years of development of such a large colony the progress of decay will naturally make some changes in the habitat; reciprocally the ants will doubtless tend to monopolize the logs to the exclusion of some other animals, and

also facilitate the decay of the log by their activities. There is an "orderly sequence" of changes in the developing colony, and a similar orderly sequence of changes in the log habitat.

An ant colony in its development clearly illustrates the transformation from the individual to the associational phase of ecological relations. Beginning with the fertilized female and her progeny, the colony develops in size and in the division of labor among its members; until, finally, by the possible addition of slaves, commensals, parasites, and even predaceous enemies, the colony or association is built up in an orderly sequence, and the organisms adjust themselves to one another and to the environment in general.

MUTILLIDÆ

Sphicrophthalma sp. Velvet Ant.

This stinging, wingless velvet ant was taken at the margin of the forest near the cleared area (Sta. IV, *a*) Aug. 23 (No. 151).

PSAMMOCHARIDÆ

Psammochares æthiops Cress. (*Pompilus* Fabr.)

This large black wasp was taken by T. L. Hankinson July 10, 1911, in the Bates woods (No. 7693). It probably stores its nest with spiders.

SPHECIDÆ

Ammophila abbreviata Fabr. Short Caterpillar Wasp.

This wasp was taken on the open ravine slope (Sta. IV, *b*) Aug. 22 (No. 124). One example (No. 127) was running on the ground in the upland forest (Sta. IV, *a*) with a quiescent bombycine caterpillar—probably *Heterocampa guttivitta* Walk.—in its grip.

I took this species of wasp at Bloomington, Ill., July 26. Its copulating habits have been recorded, with figures, by Turner ('02).

BIBLIOGRAPHY

Abbott, J. F.

- '12. An unusual symbiotic relation between a water bug and a crayfish. *Am. Nat.*, 46: 553-556.

Adams, C. C.

- '01. Baseleveling and its faunal significance, with illustrations from southeastern United States. *Am., Nat.*, 35: 839-852.
- '09. The Coleoptera of Isle Royale, Lake Superior, and their relation to the North American centers of dispersal. *Ann. Rep. Mich. Geol. Surv.*, 1908, pp. 157-215.
- '13. Guide to the study of animal ecology. VII+183 pp. New York.
- '15. An outline of the relations of animals to their inland environments. *Bull. Ill. State Lab. Nat. Hist.* 11: 1-32.

Aldrich, J. M.

- '05. A catalogue of North American Diptera. *Smithsonian Miscel. Coll.*, 46: No. 1444. 680 pp.

Ashmead, W. H.

- '92. Notes on the genus *Melittobia*. *Proc. Ent. Soc. Wash.*, 2: 228-232.

Babcock, S. M.

- '12. Metabolic water; its production and rôle in vital phenomena. *Research Bull. Wis. Agr. Exper. Sta.*, No. 22: 87-181.

Baker, F. C.

- '02. The Mollusca of the Chicago area. Part II. The Gastropoda. *Bull. Chicago Acad. Sci.*, No. 3, Part 11: 137-410.
- '11. The Lymnæidæ of North and Middle America, recent and fossil. *Special Pub. Chicago Acad. Sci.*, No. 3. 539 pp.

Baker, H. B.

- '11. Mollusca. *Ann. Rep. Bd. Mich. Geol. and Biol. Surv.*, 1910, pp. 121-176.

Banks, N.

- '04. A treatise on the Acarina, or mites. Proc. U. S. Nat. Mus., 28: 1-114. (No. 1382)
'07. A "census of four square feet." Science, n. s., 26: 637.

Banta, A. M.

- '07. The fauna of Mayfield's Cave. Carnegie Inst. Pub. No. 67. 114 pp.

Barrows, H. H.

- '10. Geography of the middle Illinois valley. Bull. Ill. Geol. Surv., No. 15. 128 pp.

Bates, C. G.

- '11. Windbreaks: their influence and value. U. S. Dept. Agr., Forest Serv., Bull. 86. 100 pp.

Beutenmüller, W.

- '96. Food-habits of North American Cerambycidae. Journ. N. Y. Ent. Soc., 4: 73-81.
'04. The insect-galls of the vicinity of New York City. Am. Mus. Journ., 4: 89-124.
'09a. The species of *Holcaspis* and their galls. Bull. Am. Mus. Nat. Hist., 26: 29-45.
'09b. The species of *Amphibolips* and their galls. Bull. Am. Mus. Nat. Hist., 26: 47-66.

Binney, W. G.

- '85. A manual of American land shells. Bull. U. S. Nat. Mus., No. 28. 528 pp.

Blatchley, W. S.

- '03. The Orthoptera of Indiana. 26th Ann. Rep. [Ind.] Dept. Geol. and Nat. Resources, 1901, pp. 123-471.
'10. An illustrated descriptive catalogue of the Coleoptera or beetles (exclusive of the Rhynchophora) known to occur in Indiana. Bull. No. 1, [Ind.] Dept. Geol. and Nat. Resources. Also published by Nature Pub. Co., Indianapolis. 1386 pp.

Bouyoucos, G. J.

- '13. An investigation of soil temperature and some of the most important factors influencing it. Mich. Agr. Exper. Sta., Tech. Bull. No. 17, pp. 1-196.

Bradley, J. C.

- '13. The Siricidæ of North America. Journ. Ent. and Zool., 5: 1-30.

Brauer, F.

- '53. [Habits of imago of *Bittacus tipularius* F.] Verhandl. zool.-bot. Vereins in Wien, 3: 151.
- '55. Beiträge zur Kenntniss des inneren Baues und der Verwandlung der Neuropteren. Verhandl. der zool.-bot. Vereins in Wien, 5: 701-726.
- '63. Beiträge zur Kenntniss der Panorpiden-Larven. Verhandl. k. k. zool.-bot. Gesellsch., 13: 307-324.
- '71. Beiträge zur Kenntniss der Lebensweise und Verwandlung der Neuropteren. (Micromus variegatus Fabr., Panorpa communis L., Bittacus italicus Klg. und Bittacus Hagenii Brau.) Verhandl. k. k. zool.-bot. Gesellsch. in Wien, 21: 107-166.

Briggs, L. J., and Belz, J. O.

- '11. Dry farming in relation to rainfall and evaporation. U. S. Dept. Agr., Bur. Plant Industry, Bull. No. 188. 71 pp.

Buckingham, E.

- '04. Contributions to our knowledge of the aeration of soils. U. S. Dept. Agr., Bur. Soils, Bull. No. 25. 52 pp.

Bunge, G.

- '88. Ueber das Sauerstoffbedürfniss der Schlammbewohner. Zeit. für Physiol. Chemie, 12: 565-567.

Busck, A.

- '02. Notes on enemies of mushrooms and on experiments with remedies. U. S. Dept. Agr., Div. Ent., Bull. No. 38, n. s., pp. 32-35.

Cameron, A. E.

- '13. General survey of the insect fauna of the soil within a limited area near Manchester [England]: a consideration of the relationships between soil insects and the physical conditions of their habitat. Journ. Econ. Biol., 8: 159-204.

Card, F. W.

- '97. Windbreaks. Bull. Neb. Agr. Exper. Sta., 9, No. 48: 69-96.

Caudell, A. N.

- '01. The genus *Sinea* of Amyot and Serville. Journ. N. Y. Ent. Soc., 9: 1-11.

Chittenden, F. H.

- '92. Notes on the food habits of some species of Chrysomelidæ. Proc. Ent. Soc. Wash., 2: 261-267.
- '98. Twig pruners and allied species. U. S. Dept. Agr., Div. Ent., Bull. No. 18, n. s., pp. 35-43.
- '02. The leaf-mining locust beetle, with notes on related species. U. S. Dept. Agr., Div. Ent., Bull. No. 38, n. s., pp. 70-89.
- '04. Insects injurious to basket willow. U. S. Dept. Agr., Bur. Forestry, Bull. No. 46: 63-80.
- '06. Harvest mites, or "chiggers." Circ. No. 77, Bur. Ent., U. S. Dept. Agr. 6 pp.
- '08. The nut weevils. Circ. No. 99, Bur. Ent., U. S. Dept. Agr. 15 pp.
- '10. The oak pruner. Circ. No. 130, Bur. Ent., U. S. Dept. Agr. 7 pp.

Cockerell, T. D. A.

- '97. The food plants of scale insects (Coccidæ). Proc. U. S. Nat. Mus., 19: 725-785. (No. 1122)

Coffey, G. N.

- '12. A study of the soils of the United States. U. S. Dept. Agr., Bur. Soils, Bull. No. 85. 114 pp.

Colton, H. S.

- '08. Some effects of environment on the growth of *Lymnæa columella* Say. Proc. Acad. Nat. Sci. Phil., 1908, pp. 410-448.

Cook, M. T.

- '05. The insect galls of Indiana. Twenty-ninth Ann. Rep. [Ind.] Dept. Geol. and Nat. Resources, 1904, pp. 801-867.

Cook, O. F.

- '11a. Notes on the distribution of millipeds in southern Texas, with descriptions of new genera and species from Texas, Arizona, Mexico and Costa Rica. Proc. U. S. Nat. Mus., 40: 147-167. (No. 1810)

- '11b. New tropical millipeds of the order Merocheta, with an example of kinetic evolution. Proc. U. S. Nat. Mus., 40: 451-473. (No. 1831)
- '11c. The hothouse milliped as a new genus. Proc. U. S. Nat. Mus., 40: 625-631. (No. 1842)
- Coquillett, D. W.
- '97. Revision of the Tachinidæ of America north of Mexico. U. S. Dept. Agr., Div. Ent., Tech. Ser. No. 7. 154 pp.
- Coville, F. V.
- '14. The formation of leafmold. Smithsonian Report for 1913, pp. 333-343.
- Cowles, H. C.
- '11. The causes of vegetative cycles. Bot. Gaz., 51: 161-183.
- Cox, H. J.
- '10. Forest and temperature conditions in the cranberry marshes of Wisconsin. U. S. Dept. Agr., Weather Bur., Bull. T. 121 pp.
- Crosby, C. R., and Leonard, M. D.
- '14. The tarnished plant-bug. Cornell Agr. Exper. Sta., Bull. No. 346: 463-526.
- Crumley, J. J.
- '10. The relative durability of post timbers. Bull. Ohio Agr. Exper. Sta., No. 219: 605-640.
- Currie, R. P.
- '05. Catalogue of the exhibit of economic entomology at the Lewis and Clark Centennial Exposition, Portland, Oregon, 1905. U. S. Dept. Agr., Bur. Ent., Bull. No. 53. 127 pp.
- Dachnowski, A.
- '11. The vegetation of Cranberry Island (Ohio) and its relations to the substratum, temperature, and evaporation. Parts I and II. Bot. Gaz., 52: 1-33; 126-150.
- '12. Peat deposits of Ohio: their origin, formation and uses. Bull. Geol. Surv. Ohio, ser. 4, No. 16. 424 pp. Columbus, O.
- Davenport, C. B.
- '97. Experimental morphology. Part I. Effect of chemical and physical agents upon protoplasm. 280 pp. New York.

- '03. The Collembola of Cold Spring beach with special reference to the movements of the Poduridæ. Cold Spring Harbor Monogr., II. 32 pp.
- Davis, J. J.
- '12. Williams' "The Aphididæ of Nebraska"; a critical review. Univ. Studies, Univ. Nebr., 11: 253-290.
- '13. The Cyrus Thomas collection of Aphididæ, and a tabulation of species mentioned and described in his publications. Bull. Ill. State Lab. Nat. Hist., 10: 97-121.
- Dendy, A.
- '95. The cryptozoic fauna of Australasia. [Pub.] Austral. Assn. Adv. Sci., 1895. 21 pp.
- Dickey, M. G.
- '09. Evaporation in a bog habitat. Ohio Nat., 10: 17-35.
- Diem, K.
- '03. Untersuchungen über die Bodenfauna in den Alpen. Jahrb. der St. Gallischen Naturwiss. Gesellsch. f. das Vereinsjahr 1901-1902, pp. 234-414.
- Ellis, M. M.
- '13. A descriptive list of the cephaline Gregarines of the New World. Trans. Am. Micr. Soc., 32: 259-296.
- Emerton, J. H.
- '02. The common spiders of the United States. 225 pp. Boston.
- Enteman, M. M.
- '02. Some observations on the behavior of the social wasps. Pop. Sci. Monthly, 61: 339-351.
- Ewing, H. E.
- '09. A systematic and biological study of the Acarina of Illinois. Univ. Studies, Univ. Ill., 3: 359-472.
- Fassig, O. L.
- '99. Types of March weather in the United States. Am. Journ. Sci. (4) 8: 320-340.
- Felt, E. P.
- '94. On certain grass-eating insects. A synopsis of the species of Crambus of the Ithaca fauna. Bull. Cornell Univ. Agr. Exper. Sta., No. 64: 47-102.

- '95. The scorpion-flies. Tenth Rep. N. Y. State Ent., pp. 463-480.
- '05, '06. Insects affecting park and woodland trees. Mem. 8, N. Y. State Mus.: Vol. I ('05), 459 pp.; Vol. II ('06), 877 pp.
- '11. Summary of food habits of American gall midges. Ann. Ent. Soc. Amer., 4: 55-62.
- Felt, E. P., and Joutel, L. H.
- '04. Monograph of the genus *Saperda*. Bull. N. Y. State Mus., No. 74. 86 pp.
- Fernald, C. H.
- '96. The Crambidae of North America. 81 pp. Mass. Agr. Coll.
- Fernald, H. T.
- '06. The digger-wasps of North America and the West Indies belonging to the subfamily Chlorioninæ. Proc. U. S. Nat. Mus., 31: 291-423.
- Fiske, W. F.
- '01. An annotated catalogue of the butterflies of New Hampshire. Tech. Bull. N. H. Agr. Exper. Sta., No. 1. 80 pp.
- Fitch, A.
- '56. First and second report on the noxious, beneficial and other insects of the State of New York. 327 pp. Albany.
- Fletcher, J.
- '91. Report of the entomologist and botanist. Reports on the experimental farms of the Dominion of Canada for 1890, pp. 154-188.
- Flint, W. P., and Sanders, G. E.
- '12. Note on a parasite of white-grubs. Journ. Econ. Ent. 5: 490.
- Folsom, J. W.
- '09. The insect pests of clover and alfalfa. Bull. Ill. Agr. Exper. Sta., No. 134: 113-197; Twenty-fifth Rep. State Ent. Ill., pp. 41-124.
- Forbes, S. A.
- '76. List of Illinois Crustacea. Bull. Ill. State Lab. Nat. Hist., 1, No. 1: 1-25.

- '78. Breeding habits of *Corixa*. *Am. Nat.*, 12:820.
- '80. Notes on insectivorous Coleoptera. *Bull. Ill. State Lab. Nat. Hist.*, Vol. I, No. 3, pp. 153-160; reprint (1903), pp. 167-176.
- '83a. The food relations of the Carabidæ and Coccinellidæ. *Bull. Ill. State Lab. Nat. Hist.*, Vol. I, No. 6, pp. 33-64; reprint (1912), pp. 33-60.
- '83b. The food relations of predaceous beetles. *Twelfth Rep. State Ent. Ill.*, 1882, pp. 105-122. Also in *Trans. Ill. Dept. Agr. for 1882*, Vol. 20.
- '84. The wheat bulb-worm. *Thirteenth Rep. State Ent. Ill.*, 1883, pp. 13-29. Also in *Trans. Ill. Dept. Agr. for 1883*, Vol. 21.
- '90. Sixteenth report of the state entomologist on the noxious and beneficial insects of the State of Illinois. Also in *Trans. Ill. Dept. Agr. for 1888*, Vol. 26, pp. 1-104.
- '94. A monograph of insect injuries to Indian corn. Part I. *Eighteenth Rep. State Ent. Ill.* XI+171 pp. Also in *Trans. Ill. Dept. Agr. for 1893*, Vol. 31, pp.
- '02. The corn bill-bugs in Illinois. *Bull. Ill. Agr. Exper. Sta.*, No. 79:435-461. Also (1903) in *22d Rep. State Ent. Ill.*, pp. 1-26.
- '04. The more important insect injuries to Indian corn. *Bull. Ill. Agr. Exper. Sta.*, No. 95:329-399.
- '05. A monograph of insect injuries to Indian corn. Part II. *Twenty-third Rep. State Ent. Ill.* 273 pp.
- '07a. On the life history, habits, and economic relations of the white-grubs and May-beetles (*Lachnosterna*). *Bull. Ill. Agr. Exper. Sta.*, No. 116:447-480. Also (1908) in *24th Rep. State Ent. Ill.*, pp. 135-168.
- '07b. On the local distribution of certain Illinois fishes: an essay in statistical ecology. *Bull. Ill. State Lab. Nat. Hist.*, 7:273-303.
- '11. Some important insects of Illinois shade trees and shrubs. *Bull. Ill. Agr. Exper. Sta.*, No. 151:463-529; *26th Rep. State Ent. Ill.*, pp. 1-61.
- '12. What is the matter with the elms in Illinois? *Bull. Ill. Agr. Exper. Sta.*, No. 154:1-22; *27th Rep. State Ent. Ill.*, pp. 1-20.

Forbes, S. A., and Hart, C. A.

- '00. The economic entomology of the sugar beet. Bull. Ill. Agr. Exper. Sta., No. 60: 397-532; 21st Rep. State Ent. Ill., pp. 49-175.

Fox, H.

- '14. Data on the Orthopteran faunistics of eastern Pennsylvania and Southern New Jersey. Proc. Acad. Nat. Sci. Phila., 1914. pp. 441-534.

Franklin, H. J.

- '13-'14. The Bombidæ of the New World. Parts I and II. Trans. Am. Ent. Soc., 38: 177-486; 39: 73-200.

Fuller, G. D.

- '11. Evaporation and plant succession. Bot. Gaz., 52: 193-208.
'12a. Evaporation and plant succession on the sand dunes of Lake Michigan. Trans. Ill. Acad. Sci., 4: 119-125.
'12b. Evaporation and the stratification of vegetation. Bot. Gaz., 54: 424-426.
'14. Evaporation and soil moisture in relation to the succession of plant associations. Bot. Gaz., 58: 193-234.

Fuller, G. D., Locke, J. R., and McNutt, W.

- '14. The stratification of atmospheric humidity in the forest. Trans. Ill. Acad. Sci., 1913, 6: 100-102.

Fuller, M. L.

- '12. The New Madrid Earthquake. Bull. No. 494, U. S. Geol. Surv. 119 pp.

Gibson, W. H.

- '00. My studio neighbours. 245 pp. New York.

Gleason, H. A., and Gates, F. C.

- '12. A comparison of the rates of evaporation in certain associations in central Illinois. Bot. Gaz., 53: 478-491.

Graenicher, S.

- '05. Some observations on the life history and habits of parasitic bees. Bull. Wis. Nat. Hist. Soc., 3: 153-167.
'06. A contribution to our knowledge of the visual memory of bees. Bull. Wis. Nat. Hist. Soc., 4: 135-142.
'10. The bee-flies (Bombyliidæ) in their relations to flowers. Bull. Wis. Nat. Hist. Soc., 8: 91-101.

Hamilton, J.

- '85. Short notes on Coleoptera. *Can. Ent.*, 17: 45-48.
- '87. *Elaphidion villosum* Fab. *Can. Ent.* 19: 141-145.
- '90. *Balaninus*—its food habits. *Can. Ent.*, 22: 1-8.

Hamm, A. H.

- '08. Observations on *Empis livida*, L. *Ent. Mo. Mag.* (2), 19: 181-184.
- '09a. Observations on *Empis opaca*, F. *Ent. Mo. Mag.* (2), 20: 132-134.
- '09b. *Setulia grisea*, Mg., and *Cerceris arenaria*, Linn., in the New Forest. *Ent. Mo. Mag.* (2), 20: 273-274.

Hancock, J. L.

- '02. *The Tettigidæ of North America.* 176 pp. Chicago.
- '05. The habits of the striped meadow cricket (*Æcanthus fasciatus* Fitch). *Am. Nat.*, 39: 1-11.
- '11. *Nature sketches in temperate America.* 451 pp. Chicago.

Harrington, M. W.

- '93. Review of forest meteorological observations: a study preliminary to the discussion of the relation of forests to climate. U. S. Dept. Agr., Forestry Div., Bull. No. 7: 23-122.

Harris, J. A.

- '03. An ecological catalogue of the crayfishes belonging to the genus *Cambarus*. *Kan. Univ. Sci. Bull.*, 2: 51-187.

Hart, C. A.

- '06. Descriptive synopsis of insect collections for distribution to Illinois high schools. II. Orthoptera. Pages 67-92. Illinois State Laboratory of Natural History, Urbana.
- '07. Zoological studies in the sand regions of the Illinois and Mississippi river valleys. *Bull. Ill. State Lab. Nat. Hist.*, 7: 195-267.
- '11. Miscellaneous economic insects. Twenty-sixth Rep. State Ent. Ill., pp. 668-98.

Harvey, E. M.

- '14. Evaporation and soil moisture on the prairies of Illinois. *Trans. Ill. Acad. Sci.*, 1913, 6: 92-99.

Heindel, R. L.

- '05. Ecology of the willow cone gall. *Am. Nat.*, 39: 859-873.

Henderson, L. J.

'13a. The fitness of the environment. An inquiry into the biological significance of the properties of matter. 317 pp. New York.

'13b. The regulation of neutrality in the animal body. *Science*, n. s., 37: 389-395.

Henneguy, L. F.

'04. Les Insectes: Morphologie—Reproduction, Embryogénie. 804 pp. Paris.

Herman, W. C.

'10. A new bird enemy. *Journ. Cincinnati Soc. Nat. Hist.*, 21: 80.

Hesselman, H.

'04. Zur Kenntniss des Pflanzenlebens schwedischer Laubwiesen. Beihefte zum Bot. Centralbl., Bd. 17, Jahrg. 1904, pp. 311-460.

Hewitt, C. G.

'12. The large larch sawfly [*Nematus erichsonii*], with an account of its parasites, other natural enemies and means of control. *Can. Dept. Agr., Div. Ent., Bull. No. 10*, sec. revise. 42 pp.

Hine, J. S.

'98. The North American species of the genus *Bittacus*. *Journ. Columbus Hort. Soc.*, XIII. 12 pp.

'01. A review of the Panorpidæ north of Mexico. *Bull. Sci. Lab. Denison Univ.*, 11: 241-264.

Hilgard, E. W.

'06. Soils, their formation, properties, composition, and relations to climate and plant growth in the humid and arid regions. 593 pp. New York.

Holdaus, K.

'10. Die Siebetechnik zum Aufsammeln der Terricolfauna (nebst Bemerkungen über die Oekologie der im Erdboden lebenden Tierwelt). *Zeit. f. wiss. Insektenbiol.*, 6: 1-4; 44-57.

'11a. Ueber die Abhängigkeit der Fauna vom Gestein. *Verhandl. des. VIII. Internat. Zool.-Kong. zu Graz, 1910*, pp. 726-745.

- '11b. Ueber die Abhängigkeit der Fauna vom Gestein. *Mém. 1^{er} Cong. Internat. d'Ent., Bruxelles, 1910, 2: 321-344.*
- Holmes, S. J.
'13. Note on the orientation of *Bombilius* to light. *Science, n. s., 38: 230.*
- Hopkins, A. D.
'93a. Catalogue of West Virginia Scolytidæ and their enemies. *Bull. W. Va. Agr. Exper. Sta., No. 31: 121-168.*
'93b. Catalogue of West Virginia forest and shade tree insects. *Bull. W. Va. Agr. Exper. Sta., No. 32: 171-251.*
'99. Report on investigations to determine the cause of unhealthy conditions of the spruce and pine from 1880-1893. *Bull. W. Va. Agr. Exper. Sta., No. 56: 197-461.*
'01. Insect enemies of the spruce in the Northeast. *U. S. Dept. Agr., Div. Ent., Bull. No. 28, n. s. 48 pp.*
'02. Insect enemies of the pine in the Black Hills Forest Reserve. An account of results of special investigations, with recommendations for preventing losses. *U. S. Dept. Agr., Div. Ent., Bull. No. 32, n. s. 24 pp.*
'04. Catalogue of exhibits of insect enemies of forests and forest products at the Louisiana Purchase Exposition, St. Louis, Mo., 1904. *U. S. Dept. Agr., Div. Ent., Bull. No. 48. 56 pp.*
'06. The locust borer. *U. S. Dept. Agr., Bur. Ent., Bull. No. 58, Pt. I. 16 pp.*
'09. Barkbeetles of the genus *Dendroctonus*. *U. S. Dept. Agr., Bur. Ent., Bull. No. 83, Pt. I. 169 pp.*
- Hopkins, C. G., Mosier, J. G., Pettit, J. H., and Readhimer, J. E.
'11. Moultrie county soils. *Soil Rep. No. 2, Ill. Agr. Exper. Sta., pp. 3-38.*
- Hopkins, C. G., and Pettit, J. H.
'08. The fertility of Illinois soils. *Bull. Ill. Agr. Exper. Sta., No. 123: 187-294.*
- Howard, L. O.
'91. The parasites of the Hemerobiinæ. *Proc. Ent. Soc. Wash., 2: 123-124.*
'92a. The Habits of *Melittobia*. *Proc. Ent. Soc. Wash., 2: 244-248.*
'92b. The hymenopterous parasites of spiders. *Proc. Ent. Soc. Wash., 2: 290-302.*

'95. A secondary effect of the Florida freeze. U. S. Dept. Agr., Div. Ent., Insect Life, 7: 413.

'05. A jumping gall. U. S. Dept. Agr., Bur. Ent., Bull. No. 54: 81.

Howlett, M.

'07. Note on the coupling of *Empis borealis*. Ent. Mo. Mag. (2), 18: 229-232.

Hubbard, G. D.

'04. A case of geographic influence upon human affairs. Bull. Am. Geogr. Soc., 36: 1-13.

Hubbard, H. G.

'85. Insects affecting the orange. U. S. Dept. Agr., Div. Ent. 227 pp.

'92. The inhabitants of a fungus. Can. Ent., 24: 250-255.

'97. The ambrosia beetles of the United States. U. S. Dept. Agr., Div. Ent., Bull. No. 7, n. s., pp. 9-30.

Hunter, W. D.

'01. The Aphididæ of North America. Bull. Iowa Agr. Exper. Sta., No. 60: 63-138.

Jackson, C. F.

'08. A synopsis of the genus Pemphigus, with notes on their enemies, importance, life history and geographical distribution. Proc. Columbus Hort. Soc., 22: 160-218.

Jäger, G.

'74. Deutschlands Thierwelt nach ihren Standorten eingetheilt, Bd. I. 400 pp. Stuttgart.

Johannsen, O. A.

'09-'12. The fungus gnats of North America. Parts I-IV. Bull. Me. Agr. Exper. Sta.: Pt. I (1909), No. 172, pp. 209-276; Pt. II (1910), No. 180, pp. 125-192; Pt. III (1912), No. 196, pp. 249-328; Pt. IV (1912), No. 200, pp. 57-146.

Johnson, K. S.

'07. Mean monthly and annual relative humidity charts of the United States. Rep. S. African Assn. Adv. Sci., 1906, pp. 161-168.

Jones, C. H., Edson, A. W., and Morse, W. J.

- '03. The Maple sap flow. Bull. Vt. Agr. Exper. Sta., No. 103: 43-184.

King, F. H.

- '95. Destructive effect of winds on sandy soils and light sandy loams, with methods of prevention. Eleventh Ann. Rep. Wis. Agr. Exper. Sta., pp. 292-326.

Knab, F.

- '05. Observations on Lampyridæ. Can. Ent., 37: 238-239.

Knapp, J. B.

- '12. Fire-killed Douglas fir: a study of its rate of deterioration, usability, and strength. U. S. Dept. Agr., Forest Service, Bull. 112. 18 pp.

Kraus, E. J., and Hopkins, A. D.

- '11. A revision of the powder-post beetles of the family Lyctidæ of the United States and Europe. Appendix: Notes on habits and distribution with lists of described species. U. S. Dept. Agr., Bur. Ent., Tech. Ser. No. 20, Pt. III, pp. 111-138.

Leverett, F.

- '96. The water resources of Illinois. Ann. Rep. U. S. Geol. Surv., 1895-96, Pt. II, pp. 1-155.
'99. The Illinois glacial lobe. Monogr. U. S. Geol. Surv., Vol. 38. 817 pp.

Livingston, B. E.

- '06. The relation of desert plants to soil moisture and to evaporation. Carnegie Inst. Pub., No. 50. 78 pp.

Lugger, O.

- '99. Beetles (Coleoptera) injurious to fruit-producing plants. Bull. Minn. Agr. Exper. Sta., No. 66: 85-332.
'00. Bugs injurious to our cultivated plants. Bull. Minn. Agr. Exper. Sta., No. 69: 1-259; Sixth Ann. Rep. Entomol. Minn. Exper. Sta., 1900. 259 pp.

McAtee, W. L.

- '07. Census of four square feet. Science, n. s., 26: 447-449.

McCook, H. C.

- '83. How a carpenter ant queen finds a formicary. Proc. Acad. Nat. Sci. Phil., 1883, pp. 303-307.

'89, '90, '93. American spiders and their spinningwork. Vol. I (1889), 369 pp.; Vol. II (1890), 479 pp.; Vol. III (1893), 284 pp. and atlas. Philadelphia.

McDermott, F. A.

'10. A note on the light-emission of some American Lampyridæ. *Can. Ent.*, 42: 357-363.

'11. Some further observations on the light-emission of American Lampyridæ: The photogenic function as a mating adaptation in the Photinini. *Can. Ent.*, 43: 399-406.

McGee, W J

'13a. Wells and subsoil water. U. S. Dept. Agr., Bur. Soils, Bull. No. 92. 185 pp.

'13b. Field records relating to subsoil water. U. S. Dept. Agr., Bur. Soils, Bull. No. 93. 40 pp.

McNeil, J.

'86. A remarkable case of longevity in a longicorn beetle (*Eburia quadrigeminata*). *Am. Nat.*, 20: 1055-1057.

M'Nutt, W., and Fuller, G. D.

'12. The range of evaporation and soil moisture in the oak-hickory forest association of Illinois. *Trans. Ill. Acad. Sci.*, 5: 127-137.

Malloch, J. R.

'09. *Miltogramma Germari*, Mg., and *Amaurosoma flavipes*, Fln., from Oxfordshire. *Ent. Mo. Mag.* (2), 20: 105-106.

'12. The insects of the dipterous family Phoridae in the United States National Museum. *Proc. U. S. Nat. Mus.*, 43: 411-529. (No. 1938).

Marlatt, C. L.

'94a. The hibernation of the chinch-bug. U. S. Dept. Agr., Div. Ent., *Insect Life*, 7: 232-234.

'94b. The pear-tree Psylla in Maryland. U. S. Dept. Agr., Div. Ent., *Insect Life*, 7: 175-185.

'07. The periodical cicada. U. S. Dept. Agr., Bur. Ent., Bull. No. 71. 181 pp.

Mast, S. O.

'12. Behavior of fire-flies (*Photinus pyralis*) with special reference to the problem of orientation. *Journ. Animal Behav.*, 2: 256-272.

- Mearns, E. A.
'03. Feathers beside the Styx. *The Condor*, 5: 36-38.
- Melander, A. L.
'04. Destructive beetles: a note on landscape gardening. *Ent. News*, 15: 19-20.
- Melander, A. L., and Brues, C. T.
'03. Guests and parasites of the burrowing bee *Halictus*. *Biol. Bull.*, 5: 1-27.
- Metcalf, C. L.
'13. The Syrphidae of Ohio. A biologic, economic, and systematic study of the family in the state. *Bull. Ohio State Univ.*, 17: No. 31. 122 pp.
- Möller, L.
'67. Die Abhängigkeit der Insekten von ihrer Umgebung. 107 pp. Leipzig.
- Moffatt, W. S.
'09. The higher fungi of the Chicago region. Pt. I.—The Hymenomycetes. *Bull. Chicago Acad. Sci.*, No. 7, Pt. I. 156 pp.
- Montgomery, T. H., Jr.
'03. Studies on the habits of spiders, particularly those of the mating period. *Proc. Acad. Nat. Sci. Phil.*, 1903, pp. 50-149.
'09. Further studies on the activities of araneads, II. *Proc. Acad. Nat. Sci. Phil.*, 55: 548-569.
- Moore, W. L.
'10. Descriptive meteorology. 344 pp. New York.
- Morgan, H. A., and Dupree, J. W.
'03. Development and hibernation of mosquitoes. U. S. Dept. Agr., Div. Ent., *Bull. No. 40*, n. s., pp. 88-92.
- Morse, A. P.
'04. Researches on North American Acridiidae. Carnegie Institution, Pub. No. 18. 55 pp.
- Mosier, J. G.
'03. Climate of Illinois. *Bull. Ill. Agr. Exper. Sta.*, No. 6: 45-76.

Motter, M. G.

- '98. A contribution to the study of the fauna of the grave. A study of one hundred and fifty disinterments, with some additional experimental observations. *Journ. N. Y. Ent. Soc.*, 6: 201-231.

Murtfeldt, M. E.

- '94. Acorn insects, primary and secondary. *U. S. Dept. Agr., Div. Ent., Insect Life*, 6: 318-324.

Needham, J. G.

- '98. *Outdoor studies: a reading book of nature study.* 90 pp. New York.
- '00. The fruiting of the blue flag (*Iris versicolor* L.). *Am. Nat.*, 34: 361-386.

Needham, J. G., and Betten, C.

- '01. Aquatic insects in the Adirondacks. *Bull. N. Y. State Mus.*, No. 47: 383-612.

Ortmann, A. E.

- '06. The crawfishes of the State of Pennsylvania. *Mem. Carnegie Mus.*, 2: 343-523.

Osborn, H.

- '90. Report on insects of the season in Iowa. *U. S. Dept. Agr., Div. Ent., Bull. No. 22*: 18-41.
- '92. Catalogue of the Hemiptera of Iowa. *Proc. Iowa Acad. Sci.*, Vol. I, Pt. II, pp. 120-131.

Osborn, H., and Ball, E. D.

- '97a. Contributions to the hemipterous fauna of Iowa. *Proc. Iowa Acad. Sci.*, 4: 172-234.
- '97b. Studies of the life histories of grass-feeding Jassidae. *Bull. Iowa Agr. Exper. Sta.*, No. 34: 612-640.

Osborn, H., and Serrine, F. A.

- '94. Notes on injurious insects. *Bull. Iowa Agr. Exper. Sta.*, No. 23: 881-905.

Osten-Sacken, C. R.

- '82. Ueber das Betragen des californischen flügellosen Bittacus (*B. apterus* MacLachl.). *Wiener Ent. Zeit.*, I Jahrg., pp. 123-124.

Parrott, P. J., and Fulton, B. B.

- '14. Tree crickets injurious to orchard and garden fruits. N. Y. Agr. Exp. Sta. Bull., No. 388, pp. 417-461. Geneva.

Packard, A. S., Jr.

- '73. Our common insects. 225 pp. Salem, Mass.
- '83. Guide for the study of insects. Eighth ed. 715 pp. New York.
- '90. Insects injurious to forest and shade trees. Fifth Rep. U. S. Ent. Comm. U. S. Dept. Agr. 957 pp.
- '95, '05, '14. Monograph of the Bombycine moths of North America, including their transformations and origin of the larval markings and armature:—
- Part I. ('95) Family I.—Notodontidæ. Mem. Nat. Acad. Sci., Vol. VII. 291 pp.
- Part II. ('05) Family Ceratocampidæ, subfamily Ceratocampinæ. Mem. Nat. Acad. Sci., Vol. IX. 149 pp.
- Part III. ('14) Families Ceratocampidæ (exclusive of Ceratocampinæ), Saturniidæ, Hemileucidæ and Brahmæidæ. Edited by T. D. A. Cockerell. Mem. Nat. Acad. Sci., Vol. XII. 516 pp.
- '98. A text-book of entomology. 729 pp. New York.

Patch, E.

- '12. Food plant catalogue of the Aphidæ of the world. Part I. Bull. Me. Agr. Exper. Sta., No. 202, pp. 179-214.

Pearse, A. S.

- '11. The influence of different color environments on the behavior of certain arthropods. Journ. Animal Behav., 1: 79-110.

Peckham, G. W. and E. G.

- '87. Some observations on the mental powers of spiders. Journ. Morph., 1: 383-419.
- '98. On the instincts and habits of the solitary wasps. Bull. Wis. Geol. and Nat. Hist. Surv., No. 2. 245 pp.
- '05. Wasps, social and solitary. 311 pp. Boston.

Pergande, Theo.

- '02. North American Phylloxerinae affecting Hicoria (Carya) and other trees. Proc. Davenport Acad. Sci., 9: 185-273.

Pierce, W. D.

- '04. Some hypermetamorphic beetles and their hymenopterous hosts. Univ. Studies, Univ. Neb., 4: 153-190.
- '07. On the biologies of the Rhynchophora of North America. Ann. Rep. Neb. Bd. Agr., 1906-07, pp. 249-319.
- '09a. Studies of North American weevils. Proc. U. S. Nat. Mus., 37: 325-364. (No. 1708).
- '09b. A monographic revision of the twisted winged insects comprising the order Strepsiptera Kirby. Bull. U. S. Nat. Mus., No. 66. 232 pp.

Plummer, F. G.

- '12. Lightning in relation to forest fires. U. S. Dept. Agr., Forest Service, Bull. 111. 39 pp.

Popenoe, C. H.

- '12. Insects injurious to mushrooms. Circ. No. 155, U. S. Dept. Agr., Bur. Ent. 10 pp.

Porter, J. P.

- '06. The habits, instincts and mental powers of spiders, genera Argiope and Epeira. Am. Journ. Psychol., 17: 306-357.

Poulton, E. B.

- '07. Predaceous insects and their prey. Trans. Ent. Soc. Lond., 1906, Pt. III, pp. 323-409.

Pricer, J. L.

- '08. The life history of the carpenter ant. Biol. Bull., 14: 177-218.

Riley, C. V.

- '72. Fourth annual report on the noxious, beneficial, and other insects of the State of Missouri. 145 pp. Jefferson City, Mo.
- '74. Sixth annual report on the noxious, beneficial, and other insects of the State of Missouri. 169 pp. Jefferson City, Mo.
- '88. The habits of *Thalessa* and *Tremex*. U. S. Dept. Agr., Div. Ent., Insect Life, 1: 168-179.
- '93. Catalogue of the exhibit of economic entomology at the World's Columbian Exposition, Chicago, Ill., 1893. U. S. Dept. Agr., Div. Ent., Bull. No. 31. 121 pp.

Robertson, C.

- '89. Flowers and insects: Umbelliferæ. Trans. Acad. Sci. St. Louis, 5: 449-460.

- '91. Flowers and insects, Asclepiadaceæ to Scrophulariaceæ. Trans. Acad. Sci. St. Louis, 5: 569-598.
- '92. Flowers and insects—Labiataæ. Trans. Acad. Sci. St. Louis, 6: 101-131.
- '94. Flowers and insects—Rosaceæ and Compositæ. Trans. Acad. Sci. St. Louis, 6: 435-480.
- '96a. Flowers and insects. XV. Bot. Gaz., 21: 72-81.
- '96b. Flowers and insects. Contributions to an account of the ecological relations of the entomophilous flora and the anthophilous insect fauna of the neighborhood of Carlinville, Illinois. Trans. Acad. Sci. St. Louis, 7: 151-179.
- '99. Flowers and insects. XIX. Bot. Gaz., 28: 27-45.
- '10. Hosts of Strepsiptera. Can. Ent., 42: 323-330.

Roth, F.

- '95. Timber: An elementary discussion of the characteristics and properties of wood. U. S. Dept. Agr., Div. Forestry, Bull. No. 10. 88 pp.

Ruthven, A. G.

- '08. The faunal affinities of the prairie region of central North America. Am. Nat., 42: 388-393.

Schantz, H. L.

- '11. Natural vegetation as an indicator of the capabilities of land for crop production in the Great Plains area. U. S. Dept. Agr., Bur. Plant Industry, Bull. No. 201. 100 pp.

Schrenk, H. v.

- '02. The diseases of the hardy catalpa. U. S. Dept. Agr., Bur. Forestry, Bull. No. 37, pp. 49-58.

Schrenk, H. v., and Spaulding, P.

- '09. Diseases of deciduous forest trees. U. S. Dept. Agr., Bur. Plant Industry, Bull. No. 149. 73 pp.

Schwarz, E. A.

- '82. Wood-boring Coleoptera. Am. Nat., 16: 823-824.
- '90a. Notes on *Cicada septendecim* in 1889. Proc. Ent. Soc. Wash., 1: 230-231.
- '90b. Myrmecophilous Coleoptera found in temperate North America. Proc. Ent. Soc. Wash., 1: 237-247.
- '05. The home of the chinch bug. U. S. Dept. Agr., Div. Ent., Insect Life, 7: 420-422.

Scudder, S. H.

- '01. Index to North American Orthoptera. Alphabetical index to North American Orthoptera described in the eighteenth and nineteenth centuries. Occasional Papers, Bost. Soc. Nat. Hist., VI. 436 pp.

Severin, H. P., and Severin, H. C.

- '10. The effect of moisture and dryness on the emergence from the egg of the walking-stick, *Diapheromera femorata* Say. Journ. Econ. Ent., 3: 479-481.
- '11a. The life-history of the walking-stick, *Diapheromera femorata* Say. Journ. Econ. Ent., 4: 307-320.
- '11b. The mechanism in the hatching of the walking-stick, *Diapheromera femorata* Say. Ann. Ent. Soc. Amer., 4: 187-190.
- '11c. A few suggestions on the care of the eggs and the rearing of the walking-stick, *Diapheromera femorata* Say. Psyche, 18: 121-123.

Shelford, V. E.

- '11. Ecological succession. I. Stream fishes and the method of physiographic analysis. Biol. Bull., 21: 9-35.
- '12. Ecological succession. IV. Vegetation and the control of land animal communities. Biol. Bull., 23: 59-99.
- '13a. Animal communities in temperate America as illustrated in the Chicago region. Bull. Geogr. Soc. Chicago, No. 5. 362 pp.
- '13b. The reactions of certain animals to gradients of evaporating power of air. A study in experimental ecology. Biol. Bull., 25: 79-120.
- '13c. The life-history of a bee-fly (*Spogostylum anale* Say) parasite of the larva of a tiger beetle (*Cicindela scutellaris* Say var. *lecontei* Hald.). Ann. Ent. Soc. Amer., 6: 213-225.
- '14. The significance of evaporation in animal geography. Ann. Assoc. Amer. Geogr., 3: 29-42.
- '14a. Modification of the behavior of land animals by contact with air of high evaporating power. Journ. Animal Behav., 4: 31-49.

Sherff, E. E.

- '12. The vegetation of Skokie Marsh, with special reference to subterranean organs and their interrelationships. Bot. Gaz., 53: 415-435.

'13a. Vegetation of Skokie Marsh. Bull. Ill. State Lab. Nat. Hist., 9: 575-614.

'13b. Evaporation conditions at Skokie Marsh. Plant World, 16: 154-160.

Shimek, B.

'01. The loess of Iowa City and vicinity. Bull. Lab. Nat. Hist. State Univ. Iowa, 5: 195-212.

'10. Geology of Harrison and Monona counties. Ann. Rep. Iowa Geol. Surv., 1909, 20: 271-485.

'11. The prairies. Bull. Lab. Nat. Hist., State Univ. Iowa, 6: 169-240.

Simpson, G. B.

'01. Anatomy and physiology of *Polygyra albolabris* and *Limax maximus* and embryology of *Limax maximus*. Bull. N. Y. State Mus., 8, No. 40: 241-314.

Sladen, F. W. L.

'12. The humble-bee: its life-history and how to domesticate it, with descriptions of all the British species of *Bombus* and *Psithyrus*. 283 pp. London.

Slingerland, M. V.

'95. Climbing cutworms in Western New York. Bull. Cornell Univ. Agr. Exper. Sta., No. 104: 555-600.

Smith, J. B.

'00. The rôle of insects in the forest. Ann. Rep. State Geol. N. J., 1899, pp. 205-232.

'10. The insects of New Jersey. Ann. Rep. N. J. State Mus., 1909, pp. 14-888.

Snyder, T. E.

'10. Damage to chestnut telephone and telegraph poles by wood-boring insects. U. S. Dept. Agr., Bur. Ent., Bull. No. 94, Pt. I. 12 pp.

'11. Damage to telephone and telegraph poles by wood-boring insects. Circ. No. 134, Bur. Ent., U. S. Dept. Agr. 6 pp.

Stiles, C. W.

'95. *Spherularia bombi* in America. Ent. News, 6: 248-250.

Swaine, J. M.

- '09. Catalogue of the described Scolytidæ of America, north of Mexico. Bull. N. Y. State Mus., No. 134, App. B, pp. 76-159.

Swezey, O. H.

- '04. A preliminary catalogue of the described species of the family Fulgoridæ of North America north of Mexico. Ohio Dept. Agr., Div. Nurs. and Orch. Inspec., Bull. No. 3. 48 pp.

Tanquary, M. C.

- '11. Experiments on the adoption of Lasius, Formica and Polyergus queens by colonies of alien species. Biol. Bull., 20: 281-308.

Tarr, R. S., and Martin, L.

- '12. The earthquakes at Yakutat Bay, Alaska, in September, 1899. U. S. Geol. Surv., Professional Paper 69. 135 pp.

Thomas, C.

- '79. Eighth report of the state entomologist on the noxious and beneficial insects of the State of Illinois. [Report on Aphididæ.] 212 pp.

Townsend, C. H. T.

- '86. Coleoptera found in dead trunks of *Tilia americana* L. in October. Can. Ent., 18: 65-68.
'90. Further note on *Dissosteira* (*Ædipoda*) *carolina*. Proc. Ent. Soc. Wash., 1: 266-267.

Transeau, E. N.

- '05. Forest centers of eastern America. Am. Nat., 39: 875-889.
'05, '06. The bogs and bog flora of the Huron River valley. Bot. Gaz., 40: 351-375, 418-448; 41: 17-42.
'08. The relation of plant societies to evaporation. Bot. Gaz., 45: 217-231.

Turner, C. H.

- '02. The copulation of *Ammophila abbreviata*. Psyche, 19: 137.

Ulke, H.

- '02. A list of the beetles of the District of Columbia. Proc. U. S. Nat. Mus., 25: 1-57. (No. 1275.)

Van Hise, C. R.

- '04. A treatise on metamorphism. U. S. Geol. Surv. Monogr., Vol. 47. 1286 pp.

Veatch, A. C.

- '06. Geology and underground water resources of northern Louisiana and southern Arkansas. U. S. Geol. Surv., Professional Paper No. 46. 422 pp.

Vestal, A. G.

- '13a. Local distribution of grasshoppers in relation to plant associations. Biol. Bull., 25: 141-180.
'13b. An associational study of Illinois sand prairie. Bull. Ill. State Lab. Nat. Hist., 10: 1-96.
'14. Internal relations of terrestrial associations. Am. Nat., 48: 413-445.

Walsh, B. D.

- '64. On the insects, coleopterous, hymenopterous and dipterous, inhabiting the galls of certain species of willow. Proc. Ent. Soc. Phil., 3: 543-644.

Warming, E.

- '09. Oecology of plants: an introduction to the study of plant communities. 422 pp. Oxford [Eng.].

Webb, J. L.

- '09. The southern pine sawyer. U. S. Dept. Agr., Bur. Ent., Bull. No. 58, Pt. IV, pp. 41-56.

Webster, F. M.

- '80. Notes upon the food of predaceous beetles. Bull. Ill. State Lab. Nat. Hist., Vol. I, No. 3, pp. 149-152; reprint (1903), pp. 162-166.
'90. Report of observations upon insects affecting grains. U. S. Dept. Agr., Div. Ent., Bull. No. 22: 42-72.
'93. Insects affecting the blackberry and raspberry. Bull. Ohio Agr. Exper. Sta., No. 45: 151-217.
'03a. Some insect inhabitants of the stems of *Elymus canadensis*. U. S. Dept. Agr., Div. Ent., Bull. No. 40, n. s., pp. 92-93.
'03b. Some insects attacking the stems of growing wheat, rye, barley, and oats, with methods of prevention and suppression. U. S. Dept. Agr., Div. Ent., Bull. 42. 62 pp.

Weed, C. M.

- '89. A descriptive catalogue of the Phalangiinæ of Illinois. Bull. Ill. State Lab. Nat. Hist., 3: 79-97.
- '91. The polished harvest spider. Am. Nat., 25: 295-297.
- '92a. Descriptions of new or little-known North American harvest-spiders (Phalangiidæ). Trans. Am. Ent. Soc., 19: 187-194.
- '92b. A preliminary synopsis of the harvest-spiders (Phalangiidæ) of New Hampshire. Trans. Am. Ent. Soc., 19: 261-272.
- '92c. The striped harvest-spider: a study in variation. Am. Nat., 26: 999-1008.
- '93. A descriptive catalogue of the harvest-spiders (Phalangiidæ) of Ohio. Proc. U. S. Nat. Mus., 16: 543-563. (No. 950)

Weismann, A.

- '91. The duration of life. Essays upon heredity and kindred problems, 1: 3-66. Oxford, Eng.

Wheeler, W. M.

- '00. The habits of *Ponera* and *Stigmatomma*. Biol. Bull., 2: 43-69.
- '04. A new type of social parasitism among ants. Bull. Am. Mus. Nat. Hist., 20: 347-375.
- '05. An annotated list of the ants of New Jersey. Bull. Am. Mus. Nat. Hist., 21: 371-403.
- '06a. The habits of the tent-building ant (*Crematogaster lineolata* Say). Bull. Am. Mus. Nat. Hist., 22: 1-18.
- '06b. On the founding of colonies by queen ants, with special reference to the parasitic slave-making species. Bull. Am. Mus. Nat. Hist., 22: 33-105.
- '10a. Ants, their structure, development and behavior. 663 pp. New York.
- '10b. The North American ants of the genus *Camponotus* Mayr. Ann. N. Y. Acad. Sci., 20: 295-354.

Whitson, A. R., and Baker, O. E.

- '12. The climate of Wisconsin and its relation to agriculture. Bull. Wis. Agr. Exper. Sta., No. 223. 65 pp.

Wickham, H. F.

- '96. Description of the larvæ of some heteromorous and rhyngophorous beetles. Journ. N. Y. Ent. Soc., 4: 118-124.

- '99. The habits of American Cicindelidæ. Proc. Davenport Acad. Nat. Sci., 7: 206-228.
- Williams, T. A.
- '10. The Aphididæ of Nebraska. Univ. Studies, Univ. Neb., 10: 85-175.
- Williamson, E. B.
- '00. The dragonflies of Indiana. Twenty-fourth Ann. Rep. [Ind.] Dept. Geol. and Nat. Resources, 1899, pp. 233-333; (index) 1003-1011.
- Wolcott, G. N.
- '14. Notes on the life history and ecology of *Tiphia inornata* Say. Journ. Econ. Ent., 7: 382-389.
- Woodruff, L. L.
- '12. A summary of the results of certain physiological studies on a pedigreed race of *Paramecium*. Biochem. Bull., 1: 396-412.
- Yapp, R. H.
- '09. On stratification in the vegetation of a marsh, and its relation to evaporation and temperature. Ann. Bot. 23: 275-319.
- Zon, R.
- '13. The relation of forests in the Atlantic plain to the humidity of the central states and prairie region. Science, n. s., 38: 63-75.
- Zon, R., and Graves, H. S.
- '11. Light in relation to tree growth. U. S. Dept. Agr., Forest Service, Bull. No. 92. 59 pp.

INDEX

A

- Acanthocerus galeator*, 64, 65, 126.
Acarina, 164, 208.
Acarus serotinae, 126, 140, 208.
Acer saccharinum, 149.
 saccharum, 42, 62, 63, 123, 126, 151, 157.
Acorn codling-caterpillar, 141.
 moth, 141.
 plum gall, 61, 232.
Acorns, 141.
Acridiidae, 115, 166, 211.
Aerosoma, 138.
 gracile, 207.
 rugosa, 58, 64, 65, 125, 126, 138, 207.
 spinea, 64, 65, 125, 126, 138, 207.
Actinomeris alternifolia, 63, 125, 219.
Adelphocoris rapidus, 53, 174, 175.
Adiantum pedatum, 63.
Agapetidae, 226.
Agrilus, 144.
Agriotes lineatus, 116.
Agropyron smithii, 39.
Alaus, 145.
 oculatus, 145.
Alder, 77, 84, 139.
Aletia, 218.
Allograpta obliqua, 53, 188.
Alydus quinquespinosus, 65, 219.
Amanita, 136.
Amazon-ant, 191.
Amblycorypha, 138, 140.
 oblongifolia, 215.
 rotundifolia, 64, 126, 215.
Ambrosia, 118, 171.
 artemisiifolia, 176.
 beetles, 137.
 trifida, 178, 179.
Ambush bug, 45, 46, 48, 50, 52, 53, 104, 174, 185, 189.
Ammalo, 109.
 eglenensis, 53, 183.
 tenera, 53, 183.
Ammophila, 140.
 abbreviata, 59, 62, 125, 132, 159, 228, 238.
 nigricans, 52, 194.
 Amphibolips, 140.
 confluens, 232, 234.
 prunus, 61, 232.
Andricus, 140.
 clavula, 59, 232.
 cornigerus, 65, 232.
 lana, 59, 65, 232.
 seminator, 232.
Andropogon, 40, 49, 55, 111, 160, 163, 167, 168, 169, 170, 171, 181, 212, 215, 216.
 furcatus, 39, 49, 53, 112.
 virginicus, 39, 49, 53.
Anisodactylus interstitialis, 135.
Anosia plexippus, 45, 46, 47, 50, 51, 113, 183.
Ant, Amazon-, 191.
 carpenter-, 62, 147, 150, 154, 203, 236.
 cocconut, 64, 236.
 corn-field, 119.
 -lion, 58, 165, 209.
 prairie, 50.
 old-fashioned, 61, 233.
 rusty carpenter-, 62, 65.
 Tennessee, 61, 235.
 velvet, 192, 238.
 white, 58, 61, 147, 150, 152, 154, 202, 204, 208, 234.
Antennaria, 124.
 plantaginifolia, 57.
Anthrax sinuosa, 198.
Ants, 35, 125, 140, 171, 177.
Apatela, 105.
 populi, 105.
Aphænogaster, 235.
 fulva, 59, 65, 159, 202, 204, 208, 234, 235.
 tennesseensis, 61, 235.
Aphididae, 35, 171.
Aphids, 137, 188, 234.
Aphis, 158.
 asclepiadis, 109, 112, 118, 171, 188, 190.
Aphorista vittata, 136.
Apidæ, 200.
Apis mellifera, 45, 46, 47, 50, 51, 200.

- Apithus, 132.
 agitator, 58, 61, 124, 217.
 Aplexa hypnorum, 161.
 Aplopus mayeri, 211.
 Apocynum, 104, 109, 113, 118, 173,
 183, 201.
 androsæmifolium, 179.
 medium, 44, 45, 49, 57, 109, 178,
 183, 193, 223.
 Apple, 146, 149, 229.
 Arachnida, 161, 205.
 Araneida, 162, 206.
 Arctiidæ, 183, 227.
 Argiope, 120, 164, 165.
 aurantia, 42, 44, 45, 46, 47, 48, 49,
 50, 51, 52, 53, 54, 104, 107, 108,
 109, 111, 121, 162, 165, 182.
 riparia, 162.
 transversa, 163.
 Argynnis idalia, 45, 146, 183.
 Arhopalus fulminans, 147.
 Aristolochia, 225.
 Army-worm, 189.
 Arrhenoplitæ bicornis, 136.
 Artemisia, 175.
 Asaphes memnonius, 64, 126, 221.
 Asclepias, 118, 172, 178, 181.
 cornuti, 113, 173.
 incarnata, 39, 44, 49, 103, 112, 113,
 160, 163, 171, 172, 173, 174, 175,
 176, 177, 178, 179, 182, 183, 184,
 186, 192, 194, 198, 200.
 sullivantii, 43, 49, 112, 182.
 syriaca, 112, 164, 171, 173, 176, 178,
 180, 188, 189, 190, 191, 201.
 tuberosa, 183.
 Ash, 77, 78, 147, 149, 152, 227.
 black, 149.
 prickly, 60, 63, 138, 179, 183, 217,
 225.
 Asilidæ, 48, 49, 108, 115, 186, 190,
 210, 230.
 Asilus, 187.
 missouriensis, 187.
 Asparagus beetle, imported, 172.
 Aspidiotus obscurus, 156.
 Astacidæ, 161, 204.
 Aster, 188.
 Attelabus rhois, 139.
 Attidæ, 164.
 Aulacizes irrorata, 64, 126, 218.
 Autographa, 138.
 precaionis, 64, 126, 227.
- B
- Bacteria, 89, 90.
 Bacunculæ blatchleyi, 211.
 Bag-worm, 154, 156.
 Balaninus, 142.
 caryæ, 141.
 nasicus, 141.
 reniformis, 141.
 uniformis, 141.
 Bark-beetle, hickory, 154.
 Basilona, 140.
 imperialis, 64, 227.
 Basswood or linden, 77, 136, 141, 146,
 149, 151, 152, 174, 227, 228.
 Beans, 179.
 Beard grass, 53.
 Bee, carpenter-, 45, 46, 104, 198, 199.
 -fly, giant, 50, 52, 53, 185.
 honey-, 45, 46, 50, 51, 104, 187, 200.
 leaf-cutting, 50, 198.
 moths, 100.
 short leaf-cutting, 52, 198.
 Beech, 76, 80, 85, 147, 152, 157, 214.
 Bees, 186, 192.
 Beet, 182.
 Beggar-ticks, 53, 103.
 Bellflower, 63.
 Benzoin, 138, 207.
 Bidens, 44, 103, 118, 171, 172.
 Bill-bugs, 50.
 Birch, 149, 228.
 Birds, 100.
 Bittacus, 62, 126, 133, 190.
 apicalis, 126, 210.
 stigmaterus, 64, 126, 209, 210.
 strigosus, 126, 210.
 Bitternut, 57, 60, 63, 228.
 Bittersweet, 63, 224.
 Blackberry, 129, 148, 170, 216.
 Blastobasis glandulella, 141.
 Blattidæ, 210.
 Blazing star, 199, 200.
 Blissus leucopterus, 111.
 Blister-beetle, black, 52, 53, 55, 180.
 marginated, 52, 53, 180.
 striped, 180.
 two-lined, 180.
 Blister-beetles, 180.
 Blue flag, 44, 103.
 stem, 40, 53, 55, 166, 168, 169, 170,
 171, 181.
 Boletotherus, 159.
 bifurcus, 64, 126, 136, 224.
 Bombidæ, 199.
 Bombus, 47, 51, 117, 119, 120, 121,
 187, 200.
 auricomus, 56, 108, 111, 200.
 consimilis, 200.
 fervidus, 200.
 fraternus, 45, 46, 50, 111, 200.

Bombus—*continued*.

- impatiens, 56, 108, 111, 200.
- pennsylvanicus, 45, 46, 54, 56, 108, 109, 111, 199.
- separatus, 45, 46, 50, 52, 111, 163, 200.
- Bombycid**, 220.
- Bombyliidæ**, 115, 185.
- Bombylius**, 186.
- Borer**, elm, 146, 154.
 - flat-headed apple-tree, 146.
 - heartwood, 154.
 - hickory, 147.
 - locust, 145, 154.
 - sugar-maple, 232.
- Borers**, wood, 99, 100.
- Bothriopolys multidentatus**, 134.
- Botrychium virginianum**, 63.
- Box elder**, 143.
- Brachycoma**, 120.
 - davidsoni, 200.
- Brachynemurus abdominalis**, 50, 51, 111, 165.
- Bracon agrili**, 144, 159.
- Braconidæ**, 158, 190.
- Branchiobdellidæ**, 66.
- Brenthid**, northern, 147.
- Brontes dubius**, 151.
- Brown-tailed moth**, 156.
- Buck-brush**, 63.
- Buckwheat**, climbing, 227.
- Buffalo**, 118.
- Bug**, ambush, 45, 46, 48, 50, 52, 53, 104, 174, 185, 189.
 - chinch, 111, 114.
 - fllea negro-, 172.
 - leaf-footed, 138.
 - milkweed, see milkweed bug.
 - plant-, see plant-bug.
 - slender-necked, 135.
 - squash-, 189.
 - stinging, 174.
 - stink-, 50, 51, 187.
- Bulrush**, 44, 103.
- Bumblebee**, false, 52, 54, 120, 200.
 - impatient, 56, 200.
 - Pennsylvania, 45, 54, 56, 199.
- Bumblebees**, 47, 117.
- Buprestidæ**, 144, 145.
- Buprestis splendens**, 142.
- Burdock**, 227.
- Bush honeysuckle**, 183.
- Butterflies**, 187.
- Butterfly**, cabbage, 56, 182, 186.
 - celery, 45, 182.
 - cresphontes, 225.
 - eurytus, 65, 226.
 - idalia, 45, 183.

Butterfly—*continued*.

- milkweed, 45, 50, 183.
- philenor, 59, 61, 225.
- philodice, 45.
- portlandia, 65, 226.
- thoe, 53, 183.
- troilus, 59, 61, 225.
- turnus, 59, 225.
- Butternut**, 139, 146, 149, 227.
- Buttonwood**, 227.

C

- Caberodes confusaria**, 61, 229.
- Cacalia**, 171.
- Calandridæ**, 181.
- Callipus**, 133.
 - lactarius, 64, 134, 205.
- Calloides nobilis**, 148.
- Calopteron**, black-tipped, 64, 221.
 - reticulate, 64, 222.
 - reticulatum, 64, 126, 222.
 - terminale, 64, 126, 221.
- Calosoma**, 140.
 - scrutator, 59, 61, 124, 125, 132, 159, 220, 237.
- Cambarus**, 48, 50, 51.
 - diogenes, 66, 128, 161, 204.
 - gracilis, 45, 47, 48, 104, 108, 161.
- immunis**, 66, 205.
 - propinquus, 66, 205.
- Campanula americana**, 63.
- Camponotus**, 147, 150, 209.
 - herculeanus, 154.
 - pennsylvanicus, 62, 202, 204, 221, 223, 228, 236.
 - ferrugineus, 62, 65, 220, 237.
- Campostoma anomalum**, 66.
- Campylenchia curvata**, 48, 170.
- Cankerworms**, 221.
- Carabidæ**, 116, 130, 175, 221.
- Cardinalis cardinalis**, 220.
- Carex**, 44.
- Carya**, 124.
 - alba, 40.
 - cordiformis, 57, 60, 63.
 - glabra, 40, 57, 60.
 - microcarpa, 228.
 - ovata, 40, 57, 60, 124, 229, 230.
- Catalpa**, 148.
 - hardy, 148.
- Caterpillar-hunter**, 59, 61, 220.
 - carpenter, 154.
 - gall, 184.
 - rotten-log, 61, 150, 153, 154, 228.
 - slug, 61, 140, 229.
 - wasp, short, 59, 62, 238.
- Caterpillars**, 164, 193.

- Catogenus rufus, 148.
 Cattails, 80.
 Ceanothus, 223.
 Cecidomyia, 140, 157, 158, 184.
 caryæcola, 59, 230.
 holotricha, 59, 65, 229.
 salicis-brassicoides, 157.
 solidaginis, 110, 184.
 tubicola, 59, 229.
 Cecidomyiidae, 124, 184, 229.
 Cedar, red, 148.
 white, 149.
 Celastrus scandens, 63.
 Centrinophus helvinus, 110.
 Centrinus penicellus, 52, 182.
 picumnus, 182.
 scutellum-album, 52, 182.
 Cerambycidae, 144, 177.
 Ceratocampidae, 227.
 Cerceris, 195.
 Cercis canadensis, 60, 63.
 Ceruchus piceus, 152.
 Ceuthophilus, 135.
 Chætopsis ænea, 104.
 Chalcididae, 158.
 Chariessa pilosa, 145.
 Chauliognathus, 120, 121.
 marginatus, 65, 222.
 pennsylvanicus, 45, 46, 47, 51, 53,
 55, 56, 104, 109, 111, 169, 176.
 Cherry, 143, 148, 149, 227, 228.
 black, 63.
 wild, 141, 149, 208, 227.
 Chestnut, 146, 149, 228.
 Chiggers, 45, 46, 52, 164.
 Chinch-bug, 111, 114.
 Chion einetus, 143, 144, 146.
 Chloeahtis conspersa, 58, 124, 132,
 213.
 Chlorion, 119.
 atratum, 49, 54, 110, 195.
 æruleum, 192.
 cyaneum, 192.
 harrisi, 52, 170, 194.
 ichneumoneum, 45, 46, 47, 49, 50,
 51, 52, 104, 120, 121, 194, 196.
 pennsylvanicum, 49, 54, 194.
 Chrysobothris femorata, 144, 146,
 148.
 Chrysochus, 118.
 auratus, 45, 46, 47, 51, 59, 104, 124,
 178, 223.
 Chrysomelidae, 178, 223.
 Chrysopa, 109, 158.
 oculata, 50, 51, 111, 165.
 Chrysophanus thoe, 53, 183.
 Chrysopidae, 165.
 Chrysotoxum ventricosum, 59, 231.
 Chub, creek, 65.
 Cicada, 125.
 dog-day, 58, 196, 217.
 dorsata, 170.
 linnei, 58, 130, 217.
 periodical, 58, 129, 130, 131, 132.
 prairie, 170.
 pruinosa, 196.
 tibicen, 217.
 Cicadas, 140.
 Cicadidae, 170, 217.
 Cicindela, 186, 187.
 punctulata, 181.
 sexguttata, 220.
 unipunctata, 59, 124, 132, 219.
 Cicindelidae, 219, 230.
 Circinaria concava, 58, 64, 136, 201,
 202, 204.
 Circinariidae, 201.
 Cirsium, 46, 118, 171.
 discolor, 183, 199.
 Cissia eurytus, 65, 126, 138, 159, 226.
 Cistogaster immaculata, 54, 189.
 Citheronia, 140.
 regalis, 61, 227.
 Citrus, 225.
 Clearweed, 60, 62, 63, 126, 138, 209.
 Cleidogona, 133.
 caesiannulata, 61, 205.
 Cleridae, 134.
 Clerus quadriguttatus, 145.
 Click-beetle, 221.
 Clinidium sculptile, 149.
 Clover, prairie, 169, 178.
 purple prairie, 54, 169, 172, 199.
 red, 226.
 sweet, 196.
 Clytanthus albofasciatus, 147.
 ruricola, 147.
 Coccidae, 139, 234.
 Coccinella novemnotata, 112, 176.
 Coccinellidae, 59, 176, 221.
 Cochlidiidae, 229.
 Cochlidion, 61, 229.
 Cocklebur, 49, 189.
 Cockroach, 210.
 woodland, 61.
 Cælixys, 198.
 Coffee-tree, Kentucky, 63, 141.
 Coleoptera, 116, 158, 175, 219.
 Collembola, 131.
 Colletes, 197.
 Cone-flower, 39, 48, 49, 169, 170, 172,
 179, 189, 196, 197, 198.
 Cone-nose, Nebraska, 64, 116.
 Conifers, 86, 143, 144, 227.

Conocephalus, 50, 51, 111, 163, 168.
 nebrascensis, 64, 126, 216.
Conopidæ, 188.
Conops, 120, 200.
Conotrachelus elegans, 141.
 seniculus, 138.
Coptocycla clavata, 65, 224.
Cord grass, 39, 40, 167, 170.
Cordyceps, 119, 120, 121.
Coreidæ, 173, 219.
Corirachne versicolor, 151.
Corixidæ, 66.
Corn, 85, 177, 179, 182, 218.
 root-worm, southern, 48, 53, 179.
 western, 179.
Cornus, 122, 147.
Corthylus, 137.
Corymbites, 64, 221.
Cotton, 218.
Cottonwood, 76, 103, 105, 106, 120,
 121, 148, 149, 157.
Couch grass, 39.
Crab-apple, 55, 56, 129, 146.
Crab-spider, see *Spider*, ambush,
 crab-, or flower.
Crambidæ, 115.
Cranberry, 77, 79, 84.
Crane-flies, 201.
Craspedosomidæ, 205.
Cratægus, 146.
Cratoparis lunatus, 137.
Crawfish, 35, 44, 66, 108, 114, 179.
 burrowing prairie or prairie, 45,
 104, 161.
 Diogenes, 161, 204.
 immune, 205.
 leeches, 66.
 neighborhood, 205.
 prairie or burrowing prairie, 45,
 104, 161.
Creek chub, 65.
Cremastogaster lineolata, 59, 152,
 234.
Cressonia juglandis, 59, 140, 226.
Cricket, 165.
 black-horned meadow, 42, 48, 55,
 169.
 four-spotted white, 42, 50, 170.
 spotted, 58, 217.
 striped, 58, 64, 216.
 woodland, 58, 61, 132, 217.
Crioccephalus obsoletus, 148.
Crioceris asparagi, 172.
Crustacea, 91, 162, 204.
Cryptocephalus mutabilis, 223.
 venustus, 178.
 simplex, 178.

Cryptorhynchus parochus, 146.
Cucujus clavipes, 149, 151.
Cucullia asteroides, 110.
Culicidæ, 184.
Culver's root, 174.
Curculionidæ, 182.
Currant, 129.
Cyllene caryæ, 147.
 pictus, 147.
 robinia, 110, 145, 147, 154.
Cymatodera balteata, 145.
Cynipidæ, 124, 190, 232.
Cyrtophyllus perspicillatus, 58, 125,
 140, 159, 215.

D

Daddy-long-legs, 206.
Dædalia, 136.
Dandelion, 227.
Datana, 140, 159, 220.
 angusii, 59, 61, 228.
Dendroctonus frontalis, 143, 156.
 piceaperda, 156.
 ponderosa, 156.
 terebrans, 143.
Dendroides, 154.
 canadensis, 149, 225.
Deromyia, 53, 186.
 discolor, 64, 126, 230.
 umbrinus, 230.
Desmodium, 53, 124, 226.
 canadense, 171.
 grandiflorum, 63.
 nudiflorum, 57.
Diabrotica atripennis, 45, 179.
 12-punctata, 48, 49, 53, 112, 164,
 179.
 longicornis, 179.
Diaperis hydni, 136.
 maculata, 136.
Diaperomera femorata, 58, 125, 140,
 159, 211.
Dicerea divaricata, 148.
 lurida, 147.
Dichromorpha viridis, 58, 61, 64, 124,
 126, 212, 214.
Dictamnus, 225.
Digger-wasp, 52, 228.
 black, 54, 194.
 Harris's, 52, 194.
 Pennsylvania, 54, 194.
 rusty, 45, 46, 50, 52, 104, 120, 194.
Diplocardia, 135.
Diplopods, 124, 125, 133.
Diptera, 116, 184, 229.

Dissosteira carolina, 166, 196.
 venusta, 189.
 Dixippus morosus, 211.
 Dock, 183.
 Dogbane, 44, 49, 57, 104, 109, 113,
 124, 173, 178, 183, 193, 201, 223,
 231.
 beetle, 45, 59, 178, 223.
 spreading, 178.
 Dogwood, 122, 137, 138, 139, 147.
 Dolichopodidæ, 187, 188.
 Doreaschema wildii, 148.
 Doreus parallelus, 152.
 Dragon-flies, 47, 119, 164, 165, 230.
 Dragon-fly, nine-spot, 45, 50, 104, 165.
 red-tailed, 50, 164.
 Drop-seed, 49, 53.
 Drosophila phalerata, 104.
 Dung-beetle, splendid, 59.
 Dutchman's pipe, 225.

E

Earthworms, 115, 135.
 Eburia quadrigeminata, 143, 147.
 Eggplant, 224.
 Elaphidion, 141, 159.
 mucronatum, 147.
 villosum, 141, 143, 147.
 Elateridæ, 115, 145, 221, 224.
 Elm, 40, 62, 63, 77, 126, 138, 144, 147,
 148, 149, 152, 227, 231.
 slippery, 63.
 white, 40, 62, 217.
 Elymus, 39, 41, 44, 107, 111, 162, 163,
 167, 168, 169.
 canadensis, 42, 109.
 virginicus, 107.
 submuticus, 42, 43.
 Empididæ, 174, 189.
 Empis clausa, 110, 112, 189.
 Empusa, 119, 120, 121.
 Enchytræids, 135.
 Encoptolophus sordidus, 48, 50, 53,
 54, 108, 109, 111, 166.
 Endodontidæ, 203.
 Enodia portlandia, 65, 126, 138, 159,
 226.
 Epargyreus tityrus, 64, 126, 140, 226.
 Epeira domiciliorum, 64, 65, 126, 138,
 206.
 insularis, 58, 138, 206.
 labyrinthica, 138.
 trivittata, 64, 126, 207.
 verrucosa, 58, 65, 125, 138, 207.
 Epeirid, island, 58, 206.
 tent, 64, 65, 206.
 three-lined, 64.

Epeiridæ, 162, 206.
 Epeolus concolor, 48, 49, 50, 51, 54,
 108, 196.
 donatus, 197.
 Epicærus imbricatus, 141.
 Epicauta, 120.
 marginata, 52, 53, 54, 109, 180.
 pennsylvanica, 52, 53, 54, 55, 108,
 109, 110, 111, 180.
 vittata, 52, 178, 180.
 Epinomia, 111, 181.
 triangulifera, 181.
 Erax bastardi, 186.
 lateralis, 187.
 Erigeron, 178.
 Eriophyidæ, 208.
 Eryngium yuceifolium, 53, 54, 86,
 108, 163, 167, 168, 174, 175, 177,
 179, 180, 181, 183, 189, 192, 194,
 195, 196, 199.
 Euaresta æqualis, 48, 49, 189.
 Euceridæ, 197.
 Eugnoriste occidentalis, 185.
 Eumenes fraterna, 181.
 Eumenidæ, 193.
 Eupatorium cælestinum, 125, 163,
 212, 214, 231.
 Euphorbia, 74, 118.
 corollata, 53, 55, 108, 109.
 Euphoria inda, 177.
 sepulchralis, 45, 46, 104, 177.
 Euproctis chrysorrhæa, 156.
 Eupsalis minuta, 147, 159.
 Eurymus philodice, 45, 46, 182.
 Euschistus fissilis, 65, 218.
 variolarius, 45, 50, 51, 53, 54, 108,
 109, 110, 111, 171, 187.
 Eustroma, 140.
 diversilineata, 59, 229.
 Eustrophus bicolor, 136.
 tomentosus, 136.
 Euthotha galeator, 219.
 Everes comyntas, 61, 138, 226.
 Evergreens, 82, 85.
 Everlasting, 57, 124.
 Exoprosopa, 120.
 fasciata, 50, 51, 52, 53, 54, 109, 111,
 163, 174, 185.
 fascipennis, 121, 185.

F

Feltia subgothica, 121, 174.
 Fern, beech, 63.
 maidenhair, 63.
 rattlesnake, 63.
 Feverwort, 183.
 Fir, Douglas, 149.

Firefly, Pennsylvania, 65, 222.
 Flag, blue, 44, 103, 104.
 Flower-beetle, black, 45, 46, 177.
 rose, 152.
 Fontaria corrugata, 134.
 virginiensis, 134.
 Formica difficilis consocians, 191.
 exsectoides, 235.
 fusca, 109, 171.
 subsericea, 59, 110, 112, 171, 190,
 191, 236.
 integra, 177.
 pallide-fulva schaufussi, 235.
 pallide-fulva schaufussi incerta,
 54, 112, 171, 190, 191.
 sanguinea, 190, 191.
 aserva, 190.
 puberula, 191.
 rubicunda, 190.
 subintegra, 191.
 subnuda, 191.
 schaufussi, 120, 191, 235.
 Formicidæ, 190, 233.
 Foxtail, 181.
 Frogs, 45, 66.
 Frontina, 120.
 Fulgoridæ, 217.
 Fungi, 102, 135, 137, 149, 159, 221.
 shelf, 224.
 Fungus-beetle, horned, 64, 224.
 Fungus-beetles, 137.

G

Galba obrussa, 161.
 umbilicata, 45, 46, 47, 104, 160.
 Galerita janus, 59, 125, 135, 150, 221.
 Galerucella luteola, 156.
 Galium circæzans, 63.
 trifolium, 63.
 Gall, acorn plum-, 61, 232.
 caterpillar, 184.
 -flies, 140.
 goldenrod bunch, 184.
 hairy midge, 65, 229.
 hickory seed-, 230.
 hickory tube-, 229.
 horned knot oak-, 232.
 -insects, 106.
 -louse, vagabond, 105.
 -mite, cherry-leaf, 64, 208.
 oak-apple or May-apple, 232, 234.
 oak bullet, 59, 232.
 oak seed-, 232.
 oak wool-, 59, 65, 232.
 rose, 56, 190.
 white oak club-, 59, 232.
 willow cone-, 184.
 willow leaf-, 158.

Gallinipper, 184.
 Galls, 35.
 Gaura biennis, 183.
 Gelechia, 141.
 Gelechiidæ, 184, 229.
 Geometridæ, 229.
 Geophiloids, 133.
 Geotrupes splendidus, 59, 125, 132,
 223.
 Gerridæ, 219.
 Gerris remigis, 66, 127, 219.
 Giant fly, 45, 46, 186.
 Gnathotrichus, 137.
 Gnorimoschema gallæsolidaginis, 110,
 184.
 Goes debilis, 146.
 pulverulentus, 146.
 tigrina, 146, 154.
 Goldenrod, 109, 110, 111, 162, 169,
 170, 172, 174, 176, 177, 180, 182,
 185, 188, 190, 192, 196.
 bunch gall, 184.
 Gooseberry, 63, 141.
 Grape, 55, 56, 60, 63, 145, 177, 217,
 218, 223, 229.
 -beetle, spotted, 55, 177, 223.
 Grass, 42, 43, 51, 74, 78, 121, 152,
 162, 166, 173, 212, 226.
 beard, 53.
 cord, 39, 40, 169, 170.
 couch, 39.
 -root-louse, 120.
 slough, 39, 41, 42, 107.
 Grasshopper, Boll's, 58, 61, 213.
 Carolina, 166, 196.
 common meadow, 42, 44, 50, 53, 55,
 58, 168.
 differential, 42, 44, 48, 50, 53, 119,
 167, 213.
 dorsal-striped, 42, 44, 48, 52, 53,
 169.
 lance-tailed, 53, 169.
 leather-colored, 55, 167.
 lesser, 58, 213.
 red-legged, 42, 44, 48, 50, 168.
 Seudder's, 61, 64, 214.
 short-winged, 58, 61, 64, 212.
 sordid, 48, 50, 53, 166.
 sprinkled, 58, 213.
 two-striped or two-lined, 53, 167.
 Grasshoppers or locusts, 47, 164, 180,
 186, 187, 192, 213.
 Green brier, 63.
 Gregarina, 134.
 Grosbeak, rose-breasted, 178.
 Grouse-locust, short-winged, 58, 212.
 Grouse-locusts, 211.

Gryllidæ, 169, 216.
 Gum, 149.
 Gymnocladus, 141.
 dioica, 63.
 Gypona pectoralis, 65, 218.
 Gypsy moth, 156.

H

Habia ludoviciana, 178.
 Hackberry, 75, 146, 152.
 Halictidæ, 196.
 Halictus, 181, 195.
 fasciatus, 52, 54, 110, 196.
 obscurus, 54, 196.
 virescens, 52, 196.
 Halisidota, 140.
 tessellaris, 59, 61, 227.
 Harmostes reflexulus, 52, 112, 173.
 Harpalus, 175.
 caliginosus, 175.
 pennsylvanicus, 175.
 Harvest-fly, dog-day, 58, 196, 217.
 Harvest-mites, 164.
 Harvest-spider, polished, 161.
 stout, 58, 61, 206.
 striped, 205.
 Harvest-spiders, 132, 138.
 Haw, 129, 146.
 Hazel, 139, 141, 223, 227.
 Hedeoma pulegioides, 57.
 Helianthus, 111.
 Helicidæ, 201.
 Hemaris diffinis, 45, 46, 183.
 Hemerocampa leucostigma, 154, 156.
 Hemiptera, 98, 138, 170, 217.
 Hemlock, 149.
 Hesperiidæ, 226.
 Heterius blanchardi, 235.
 Heterocampa, 140, 159.
 guttivitta, 59, 228, 238.
 Heteroptera, 158.
 Hickory, 40, 55, 56, 57, 58, 59, 74, 75,
 76, 80, 87, 123, 124, 129, 138, 139,
 141, 144, 146, 147, 148, 149, 157,
 177, 211, 215, 217, 223, 226, 227,
 228, 229, 230.
 bark-beetle, 154.
 bitternut, 57, 60, 63, 228.
 -borer, 147.
 horned-devil, 61, 227.
 pignut, 57, 60, 124.
 seed-gall, 230.
 shagbark, 57, 60, 124.
 shell-bark, 226.
 tube-gall, 229.

Hippodamia parenthesis, 52, 176.
 Holcaspis, 140.
 globulus, 59, 232.
 Honey-bee, 45, 46, 50, 51, 104, 187,
 200.
 -locust, 147, 149.
 Honeysuckle, bush, 183.
 Hoplisemenus morulus, 135.
 Hornet, white-faced, 135.
 Hornets, 210.
 Horntail, 144, 154, 231, 233.
 Horsemint, 57, 124, 200, 201.
 Horseweed, 170.
 Humulus, 225.
 Hymenarcys nervosa, 64, 218.
 Hymenomycetes, 137.
 Hymenoptera, 115, 190, 231.
 parasitic, 104, 109, 140, 141, 145,
 163, 165, 198, 226.
 Hyphantria cunea, 156.

I

Ichneumon cincticornis, 135.
 Ichneumonidæ, 233.
 Imperial moth, 64, 227.
 Indian hemp, 178.
 tobacco, 63.
 Insecta, 100, 164, 208.
 Ips 4-guttatus, 176.
 Iris, 103.
 versicolor, 44.
 Ironweed, 172, 178.
 Ironwood, 226.
 Ischnoptera, 61, 125, 210.
 inæqualis, 144.
 pennsylvanica, 210.
 Isodontia philadelphica, 170, 194.
 Isosoma, 107.
 grande, 175.
 Ivy, five-leaved, or Virginia creeper,
 57, 60, 63, 177, 223.
 poison, 57.

J

Jalysus spinosus, 64, 126, 219.
 Jassidæ, 107, 112, 118, 171.
 Juglans nigra, 57, 60, 63.
 Juniperus, 148.

K

Katydid, angle-winged, 58, 215.
 common, 58, 215.
 cone-nosed, 50.
 forked, 58, 215.
 round-winged, 64, 215.
 Texan, 42, 44, 48, 50, 168.

Katydid, 140.

Kentucky coffee-tree, 63, 141.

L

Lacewing, 150, 165.

Lachnosterna, 105, 116, 121, 142, 144,

174, 181, 186, 193, 233.

Lactarius, 136.

Lactuca, 118.

canadensis, 48, 53, 55, 108, 109,

171.

Ladybird or lady-beetle, 52, 59, 221.

nine-spotted, 112, 176.

parenthetical, 176.

Lampyridæ, 176, 221.

Languria mozardi, 109.

Laporteæ canadensis, 62, 63, 125, 126,

138, 209.

Larch, 156.

Lasius flavus, 120.

interjectus, 120.

niger americanus, 119, 120, 121.

Laurus, 225.

Leaf-beetle, elm, 156, 232.

Leaf-bug, dusky, 53, 175.

Leaf-cutting bee, 50, 52, 198.

Leaf-footed bug, 138.

Leather-jackets, 116.

Lebia grandis, 135.

Lepachys, 108.

pinnata, 39, 48, 49, 108, 118, 161,

162, 166, 167, 168, 169, 170, 172,

174, 179, 189, 196, 197.

Lepidoptera, 115, 138, 140, 182, 225.

Lepidopterous larvæ, 35, 47.

Leptilon, 170.

Leptoglossus oppositus, 138.

Leptostylus aculiferus, 146.

Leptotrachelus dorsalis, 42, 175.

Leptura proxima, 148.

Lettuce, wild, 48, 53, 109, 171.

Leucania unipuncta, 189.

Liatrix scariosa, 54, 185, 199, 200.

Libellula pulchella, 45, 50, 51, 104,

162, 165.

Libellulidæ, 164.

Ligyrocoris sylvestris, 48, 172.

Lilac, 227.

Linden or basswood, 77, 136, 141, 146,

149, 151, 152, 174, 227, 228.

Liobunum, 132, 138.

grande, 58, 61, 206.

politum, 50, 51, 161.

ventricosum, 58, 206.

vittatum, 58, 205.

Liopus alpha, 138.

fascicularis, 138, 159.

variegatus, 148.

xanthoxyli, 138.

Liriodendron, 225.

Lithacodes, 61.

Lithobius voracior, 134.

Lobelia inflata, 63.

Locust, 141, 149.

borer, 145, 154.

Carolina, 166, 196.

grouse-, see grouse-locust.

honey-, 147, 149.

yellow, 110, 148, 226.

Locustidæ, 51, 168, 215.

Locusts or grasshoppers, 47, 164, 180,

186, 187, 192, 213.

Long-sting, lunate, 64, 231, 233.

Long-tail, black, 64, 233.

Lucanidæ, 222.

Lucanus dama, 152.

Lumbricus, 115.

Lycænidæ, 183, 226.

Lycomorpha pholus, 222.

Lycopus, 44.

Lycosa, 58, 132, 208.

scutulata, 64, 126, 208.

Lycosidæ, 208.

Lyetidæ, 147.

Lygæidæ, 172.

Lygæus kalmii, 45, 46, 50, 51, 104,

108, 112, 118, 172, 185.

Lygus pratensis, 45, 46, 65, 175, 218.

Lymexylon sericeum, 148.

Lymnæa, 160.

Lymnæidæ, 160.

Lysiopetalidæ, 205.

Lythrum alatum, 44.

M

Macrobasis unicolor, 141.

Macrosiphum rubbeckiæ, 109, 118,

171.

Magdalis, 146, 148.

armicollis, 144, 154.

barbita, 144.

Mallophora oreina, 187.

Maple, 76, 77, 80, 84, 129, 136, 137,

138, 141, 143, 146, 148, 149, 152,

157, 227, 228, 231.

hard or sugar, 40, 62, 63, 123, 126,

151, 157.

red, 229.

silver, 149.

May-beetles, 106, 119, 142, 187, 193,

233.

- Meadow cricket, black-horned, 42, 48, 55, 169.
 -grasshopper, common, 42, 44, 50, 53, 55, 58, 168.
- Mealy flata, 65, 217.
- Mecaptera, 209.
- Megachile brevis, 52, 198.
 centuncularis, 198.
 mendica, 50, 198.
- Megachilidæ, 198.
- Megalodaene fasciata, 136.
- Melanobracon simplex, 144, 159.
- Melanolestes picipes, 135.
- Melanoplus amplectens, 58, 64, 124, 126, 132.
 atlans, 58, 124, 213.
 bivittatus, 53, 109, 167.
 differentialis, 42, 43, 48, 50, 53, 54, 107, 108, 109, 111, 121, 162, 167, 168, 213.
 femur-rubrum, 42, 43, 48, 50, 107, 108, 111, 168, 196.
 gracilis, 64, 126, 214.
 obovatipennis, 58, 65, 124, 214.
 scudderi, 61, 64, 124, 126, 214.
- Melanotus, 61, 125, 150, 221.
- Melasoma scripta, 106.
- Melissodes aurigenia, 197.
 bimaculata, 48, 50, 51, 54, 111, 197.
 desponsa, 197.
 obliqua, 48, 49, 52, 54, 108, 118, 197.
 perplexa, 230.
 trinodis, 197.
- Melissopus latiferreana, 141.
- Meloidæ, 180.
- Melolontha, 116.
- Membracidæ, 170.
- Menispermum canadense, 57, 60, 63.
- Meracantha contracta, 59, 61, 125, 132, 135, 144, 152, 154, 202, 224.
- Merinus lævis, 151.
- Meromyza americana, 107.
- Mesogramma politum, 53, 54, 59, 65, 188.
- Metopia, 120, 121.
 leucocephala, 195.
- Microcentrum, 140.
 laurifolium, 58, 124, 215.
- Microlepidoptera, 158.
- Microparsus variabilis, 171.
- Midge-gall, hairy, 65, 229.
- Milesia ornata, 59, 64, 126, 163, 231.
 virginensis, 163.
- Milesiinae, 231.
- Milkweed, 104, 112, 113, 172, 173, 178, 181.
- Milkweed—*continued*.
 beetle, 46, 104, 185.
 four-eyed, 45, 50, 52, 177.
 bug, small, 45, 50, 104, 172, 185.
 large, 45, 50, 104, 173.
 bugs, 104.
 common, 112, 164, 171, 176, 180, 188, 190, 191, 201.
 -fly, metallic, 187.
 Sullivant's, 182.
 swamp, 39, 44, 46, 49, 51, 103, 160, 162, 163, 165, 168, 171, 172, 173, 174, 175, 176, 177, 178, 179, 182, 183, 184, 186, 194, 198, 200.
- Millipeds, 133, 136.
- Mint, 163.
 horse-, 57, 124, 200, 201.
 mountain or white, 39, 50, 51, 163, 169, 172, 173, 174, 176, 178, 179, 180, 185, 191, 194, 197, 199.
- Miridae, 175, 218.
- Misumena aleatoria, 42, 43, 45, 46, 47, 50, 51, 52, 53, 54, 64, 104, 109, 121, 126, 163, 168, 175, 185, 200, 216, 231.
 vatia, 47.
- Mites, 120, 130, 131, 137.
 uropod, 222.
- Mollusca, 35, 124, 125, 126, 135, 137, 140, 160, 201.
- Molorehus bimaculatus, 138.
- Monarda bradburiana, 57, 124, 200.
- Monarthrum, 137.
- Monohammus confusor, 143.
 titillator, 155.
- Moonseed, 57, 60, 63.
- Mormidea lugens, 65, 218.
- Morus, 148.
 rubra, 57, 60, 63.
- Mosquito, giant, 45, 50, 51, 104, 184.
- Mosquitoes, 219.
- Moth, acorn, 141.
 brown-tailed, 156.
 gypsy, 156.
 imperial, 64, 227.
 royal walnut, 227.
- Moths, 169.
 clothes, 99, 100.
- Mud-wasp, potter, 193.
- Mulberry, 57, 60, 63, 147, 148, 149.
- Muscidæ, 116.
- Mushrooms, 137.
- Mutillidæ, 192, 238.
- Mycetophagus bipustulatus, 136.
 punctatus, 136.
- Mycetophilidæ, 137, 185.

Mydaidæ, 186.
 Mydas clavatus, 45, 46, 186.
 fulvipes, 186.
 Myodites, 52, 181.
 fasciatus, 111, 181.
 solidaginis, 111, 181.
 Myodocha serripes, 135.
 Myriapoda, 35, 134, 137, 140, 205.
 Myrmecophila pergandei, 191.
 Myrmedonia, 234.
 Myrmeleon, 154.
 immaculatus, 153.
 Myrmeleonidæ, 58, 124, 153, 165, 209.
 Myrmica rubra scabrinodis sabuleti,
 112, 190, 191.
 rubra scabrinodis schencki, 61,
 202, 234, 236.
 Myzine, 115.
 sexcineta, 50, 51, 54, 109, 110, 111,
 192.
 Myzinidæ, 192.
 Myzocallis, 107.

N

Nadata gibbosa, 59, 61, 140, 228.
 Negro-bug, flea, 172.
 Nematus erichsonii, 156.
 Nemobius, 132.
 fasciatus, 58, 64, 124, 126, 216.
 maculatus, 58, 124, 217.
 Nemognatha immaculata, 111.
 sparsa, 111.
 Neoclytus, 146, 148.
 erythrocephalus, 144, 147, 148, 154,
 159.
 luscus, 147.
 Nettle, wood, 62, 63, 125, 126, 138,
 209, 214.
 Neuroptera, 165, 209.
 Noctuidæ, 115, 183, 227.
 Nodonota convexa, 48, 179.
 Nomadidæ, 196.
 Notodontidæ, 228.
 Nut-weevils, 141.
 Nyctobates pennsylvanicus, 151.
 Nymphalidæ, 183, 225.

O

Oak, 40, 57, 58, 59, 74, 76, 77, 80, 87,
 123, 124, 128, 139, 141, 142, 146,
 147, 148, 149, 151, 152, 157, 177,
 203, 205, 214, 215, 219, 220, 223,
 227, 228, 229, 231, 232.
 -apple gall, 232, 234.
 black, 57, 60, 75, 144, 149.
 bur, 77.

Oak—continued.

 post, 123.
 -pruner, 141, 147.
 red, 40, 57, 60, 62, 63, 123, 126, 129.
 shingle, 63, 123, 232.
 white, 57, 60, 78, 124, 147, 148, 156,
 227, 228, 232.
 Oberea tripunctata, 148.
 Odonata, 164.
 Odynerus, 49.
 vagus, 52, 193.
 Oecanthus, 42, 195.
 fasciatus, 195.
 nigricornis, 42, 48, 55, 107, 108,
 111, 169.
 niveus, 170.
 quadripunctatus, 42, 50, 107, 111,
 170.
 Oncideres cingulatus, 141.
 Oncopeltus fasciatus, 45, 46, 50, 51,
 104, 112, 118, 173.
 Orange, 155, 219.
 Orchelimum, 120, 121.
 cuticulare, 58, 64, 124, 126, 216.
 glaberrimum, 42, 44, 64, 126, 216.
 gracile, 194.
 vulgare, 42, 44, 50, 53, 55, 56, 107,
 109, 111, 168, 194.
 Ormenis pruinosa, 65, 217.
 Orthoptera, 42, 43, 44, 47, 49, 51, 107,
 113, 124, 126, 130, 166, 210.
 Orthosoma brunneum, 152.
 Osage orange, 148, 149.
 Oscinis carbonaria, 107.
 coxendix, 104.
 Osmoderma eremicola, 152.
 scabra, 152.
 Otocryptops sexspinosus, 134.

P

Pallodes pallidus, 136.
 Pandeletejus hilaris, 144.
 Panicum, 166, 167, 168, 170, 181.
 crus-galli, 176.
 Panorpa, 133.
 confusa, 133.
 Panorpidæ, 209.
 Papaw, 138, 141, 147, 224.
 Papilio, 126.
 asterias, 233.
 cresphontes, 46, 140, 225.
 philenor, 59, 61, 225.
 polyxenes, 45, 46, 162, 182, 233.
 troilus, 59, 61, 225.
 turnus, 59, 140, 225.
 Papilionidæ, 182, 225.
 Parandra brunnea, 151, 154.

- Parsley, 182.
 Parsnip, wild, 196.
 Passalus cornutus, 125, 144, 150, 151,
 153, 154, 159, 202, 203, 204, 221,
 222, 223, 236.
 horned, 61, 154, 203, 222, 236.
 Peach, 143.
 Pear, 229.
 Pelecinidæ, 233.
 Pelecinus polyturator, 64, 126, 233.
 Pelidnota punctata, 55, 56, 177, 223.
 Pemphigus oestlundii, 105.
 populicaulis, 105.
 populi-transversus, 105.
 vagabundus, 105.
 Pennyroyal, 57.
 Pentatomidæ, 171, 218.
 Penthe obliquata, 137.
 pimelia, 137.
 Peridroma saucia, 140.
 Petalostemum, 169, 178.
 purpureum, 54, 169, 172, 199.
 Phalangiida, 35, 161, 205.
 Phalangiidæ, 161, 205.
 Phasmidæ, 211.
 Phegopteris hexagonoptera, 63.
 Phenolia grossa, 136.
 Phidippus, 164.
 audax, 138.
 Philomycidæ, 202.
 Philomycus carolinensis, 58, 61, 64,
 136, 150, 202, 204, 205, 209, 221,
 228, 236.
 Phlæotomus pileatus, 228.
 Phorida, 137.
 Photuris pennsylvanica, 65, 222.
 Phragmites, 77, 80, 105, 188.
 Phymata, 120.
 fasciata, 45, 46, 47, 48, 49, 50, 51,
 52, 53, 54, 104, 108, 109, 110, 111,
 121, 174, 175, 185, 189.
 wolffi, 174.
 Phymatidæ, 174.
 Phymatodes varius, 156.
 Physa gyrina, 50, 51, 160.
 Physidæ, 160.
 Physocephala, 200.
 sagittaria, 110, 188.
 Pieridæ, 182.
 Pigeon tremex, 59, 61, 231.
 Pignut, 57, 60, 124.
 Pilea pumila, 60, 62, 63, 126, 138, 209.
 Pine, 76, 143, 155.
 yellow, 156.
 Pitcher-plant, 195.
 Plagionotus speciosus, 156, 232.
 Planorbis, 161.
 Plantain, 227.
 Plant-bug, dusky, 174.
 tarnished, 45, 65, 175, 218.
 Plant-lice, 47, 51, 107, 162, 164, 165,
 169, 174, 176, 188, 230.
 Plant-louse, milkweed, 171. See
 Aphis asclepiadis.
 Platydemia ruficornis, 136.
 Platymetopius frontalis, 48, 171.
 Platyptera, 208.
 Platypus, 137.
 Plum, 141, 198, 219, 229.
 sugar, 228.
 Polistes, 48, 49, 187.
 pallipes, 110.
 variatus, 110, 121, 193.
 Polydesmidæ, 205.
 Polydesmus, 61, 150, 205.
 serratus, 134.
 Polyergus lucidus, 192.
 Polygonia, 126, 138.
 interrogationis, 225.
 Polygonum, 183.
 convolvulus, 227.
 Polygraphus rufipennis, 156.
 Polygyra albolabris, 58, 201.
 clausa, 61, 201, 202, 204.
 Polyporus, 126, 136, 224.
 tomentosus, 136.
 volvatus, 137.
 Pompilidæ, 194.
 Pompilus æthiops, 238.
 Pontia protodice, 174.
 rapæ, 56, 182, 186.
 Poplar, 106, 149.
 Carolina, 105, 106.
 Populus, 106.
 deltoides, 44, 103, 105, 149.
 Porthetria dispar, 156.
 Potato, 179, 224.
 -beetle, old-fashioned, 52, 180.
 wild sweet, 178.
 Prairie-dog, 100.
 Prickly ash, 60, 63, 138, 179, 183, 217,
 225.
 Prioenemoides unifasciatus, 193.
 Prioenemus unifasciatus, 193.
 Priononyx atrata, 195.
 Prionoxystus robinæ, 144, 154.
 Prionus imbricornis, 152.
 Proctacanthus milberti, 187.
 Promachus, 119, 120, 121.
 vertebratus, 50, 51, 53, 56, 109,
 111, 171, 186.
 Prunus, 225.
 serotina, 208.
 Psammochares æthiops, 65, 132, 238.

Psammocharidæ, 193, 238.
Psedera, 229.
 quinquefolia, 57, 60, 63.
Psilopus siphon, 112, 171, 187.
Psithyrus, 120.
 variabilis, 52, 54, 200.
Psocids, 131.
Psocus, 158.
Psorophora ciliata, 45, 46, 47, 50, 104,
 184.
Ptelea, 225.
Pulmonates, 236.
Purpuricenus humeralis, 148.
Pycnanthemum, 181, 192.
 flexuosum, 39, 50, 163, 169, 172,
 173, 174, 180, 185, 191, 192, 193,
 194, 196, 197, 199.
 linifolium, 180.
 pilosum, 169, 172, 174, 176, 177, 179,
 180, 182, 184, 185, 190, 191, 192,
 193, 196, 197, 199.
 virginianum, 178.
Pyramidula alternata, 64, 203.
 perspectiva, 58, 61, 136, 150, 201,
 202, 204, 221.
Pyrochroa, 150, 154, 224.
Pyrochroidæ, 221, 223, 224.
Pyrrharctia isabella, 233.

Q

Quercus, 124, 232.
 alba, 40, 57, 60, 124, 228, 232.
 imbricaria, 63, 123, 232.
 michauxii, 123.
 minor, 123.
 rubra, 40, 57, 60, 62, 63, 123, 126.
 velutina, 40, 57, 60, 75, 124, 144.

R

Ragweed, 175, 178, 179.
Rail, Carolina, 45.
Rana, 45.
Raspberry, 57, 124, 129, 170.
Rattlesnake-master, 53, 167, 168, 174,
 175, 177, 180, 181, 183, 189, 199.
Redbud, 60, 63, 138.
Reduviidæ, 173, 219.
Reptiles, 100.
Rhipiphoridæ, 180.
Rhipiphorus, 120, 121.
 dimidiatus, 50, 51, 52, 53, 109, 111,
 180.
 limbatus, 53, 109, 181.
 paradoxus, 181.
 pectinatus ventralis, 181.

Rhodites nebulosus, 56, 190.
Rhodophora gauræ, 183.
Rhubarb, 186.
Rhus, 172.
 glabra, 57, 60, 124.
 toxicodendron, 57.
Rhynchites æneus, 53, 54, 181.
 hirtus, 108.
Rhynchitidæ, 181.
Rhynchophora, 116.
Ribes cynosbati, 63.
Robber-fly, vertebrated, 50, 53, 56,
 171, 186.
Robber-flies, 49, 119, 164, 182, 186,
 187, 210, 230.
Robinia, 148, 226.
Romaleum atomarium, 146.
 rufulum, 146.
Root-louse, grass, 120.
Rosa, 57, 190.
Rose, 57, 124, 198.
 wild, 180, 190.
Rose-breasted grosbeak, 178.
Rosin-weed, 39, 40, 48, 53, 108, 174,
 180, 181, 185, 197.
 arrow-leaved, 169.
 broad- or large-leaved, 55, 168, 176,
 199, 200.
 cup-leaved, 54.
Rotten-log caterpillar, 61, 150, 153,
 154, 228.
Rubus, 57.
Rumex, 183.
Russula, 136.
Rye, *wild*, 39, 41, 42, 43, 107, 168.

S

Salamanders, 66.
Salix, 44, 103, 106.
Saperda, 143.
 candida, 146.
 discoidea, 144.
 tridentata, 144, 146, 148, 154, 159.
 vestita, 146.
Sarracenia flava, 195.
Sassafras, 57, 60, 124, 125, 126, 127,
 149, 212, 215, 218, 225, 226, 227.
 variifolium, 57, 60, 124.
Saturniidæ, 227.
Saw-fly, 158.
 larch, 156.
Scale insects, 106.
Scarabæidæ, 177, 223, 225, 233.
Scatopse pulicaria, 104.
Scepsis fulvicollis, 110.
Schistocerca alutacea, 55, 56, 167.

- Schizoneura corni*, 112, 122.
 panicola, 120, 121.
Seiara, 50, 185.
Sciomyzida, 42, 43, 189.
Scirpus, 44, 103, 105.
Scolecocampa liburna, 125, 150, 153,
 154, 159, 209, 221, 223, 228.
Scolia, 192.
 bicineta, 192.
 tricincta, 193.
Scoliidae, 192.
Scolytidae, 137, 144.
Scolytus quadrispinosus, 144, 154,
 159.
Scorpion flies, 62.
Scorpion-fly, brown-tipped, 210.
 clear-winged, 64, 209.
 spotted crane-like, 210.
Scotobates calcaratus, 151.
Seudderia texensis, 42, 44, 48, 50,
 107, 108, 111, 168.
Scytonotus granulatus, 134.
Sedge, 44.
Semotilus atromaculatus, 65.
Senotainia trilineata, 196.
Serpents, 100.
Setaria, 182.
Setulia grisea, 195.
Shelf-fungus, 224.
Silkworm, American, 61, 227.
Silphium, 86, 108, 118, 171.
 integrifolium, 48, 54, 108, 166, 167,
 169, 174, 180, 181, 185, 196, 197,
 198.
 laciniatum, 53, 108.
 terebinthinaceum, 39, 40, 48, 55,
 56, 108, 161, 168, 176, 180, 199,
 200.
Sinea diadema, 50, 51, 65, 111, 173,
 219.
Sinoxylon basilare, 146.
Siricidae, 231.
Skipper, common, 64, 226.
Slug, Carolina, 58, 61, 150, 202, 236.
 caterpillar, 61, 140, 229.
Slugs, 133.
Smartweed, 183.
Smilax, 55, 56, 63.
Smodicum cucujiforme, 148.
Snail, alternate, 64, 203.
 predaceous, 58, 64, 201.
Snails, 133, 138, 160.
Snout-beetle, imbricated, 141.
Snowberry, 183.
Soldier-beetle, 45, 46, 53, 55, 104,
 169, 176.
 margined, 65, 222.
Soldier-beetle—*continued*.
 Pennsylvania, 45, 46, 53, 55, 104,
 118, 169, 176.
 beetles, 120.
 -bug, rapacious, 50, 51, 65, 173,
 219.
Solidago, 109, 110, 111, 118, 145, 162,
 171, 172, 174, 176, 179, 180, 182,
 184, 185, 188, 189, 190, 192, 196.
Sow-bugs, 137.
Span-worm, 229.
Sparganium, 43.
Sparnopolius fulvus, 121, 174, 186.
Spartina, 39, 40, 41, 43, 44, 107, 167,
 168, 169, 170, 175, 189:
 michauxiana, 41.
Sphærophthalma, 59, 124, 132, 192,
 238.
Sphærolaria bombi, 200.
Sphagnum, 79.
Spharagemon bolli, 58, 61, 124, 213.
Sphecidae, 194, 238.
Sphecius speciosus, 196.
Sphenophorus, 116.
 ochreus, 104.
 placidus, 181.
 robustus, 182.
 venatus, 181.
Sphex brunneipes, 195.
 ichneumonea, 194.
Sphingidae, 183, 226.
Sphinx, honeysuckle, 45, 46, 183.
Spice-bush, 138, 207.
Spider, ambush, crab-, or flower, 42,
 43, 45, 46, 50, 51, 52, 53, 64, 104,
 163, 168, 175, 200, 216, 231.
 common garden, 42, 44, 45, 48, 50,
 52, 53, 104, 162, 182.
 ground, 58, 64.
 harvest-, see harvest-spider.
 island, 58.
 jumping, 112, 138, 164.
 rugose, 58, 64, 65, 207.
 spined, 64, 65, 207.
 three-lined, 207.
 wasp, 65, 193.
 white-triangle, 58, 65, 207.
Spiders, 119, 131, 138, 140, 238.
Spirobolus marginatus, 134.
Spogostylum anale, 186.
Sporobolus, 49, 111, 112, 168, 212.
 cryptandrus, 39, 49, 53.
Spragueia leo, 110, 184.
Spruce, 149, 156.
 Engelmann, 149.
Spurge, flowering, 53, 55.
Squash-bug, 189.

Staphylinidæ, 116.
 Stelis, 198.
 Stenosphenus notatus, 144, 147.
 Stigmatomma pallipes, 61, 133, 202,
 205, 224, 233, 236.
 Stilt-bug, spined, 64, 219.
 Stink-bug, 50, 51, 187.
 Stiretrus anchorago, 172.
 Stizidæ, 199.
 Stizus brevipennis, 52, 196.
 Stone-roller, 66.
 Strawberry, 176.
 Strepsiptera, 49.
 Sumac, 55, 56, 57, 60, 124, 138, 139,
 227.
 Sunflower, 111.
 wild, 169.
 Sweet potato, wild, 178.
 Sycamore, 149, 186, 227, 231.
 Sympetrum rubicundulum, 50, 51,
 164.
 Symphoricarpos orbiculatus, 63.
 Synchroa punctata, 149.
 Syrbulæ admirabilis, 50, 111, 166.
 Syrphid, American, 52.
 corn, 53, 59, 65, 188.
 Vespa-like, 59, 64, 231.
 Syrphidæ, 158, 188, 231.
 Syrphus americanus, 52, 188, 231.
 Systæchus oreas, 186.
 vulgaris, 185.

T

Tachinidæ, 158, 182, 189, 195.
 Tamarack, 149.
 Tapinoma sessile, 64, 126, 236.
 Telea, 140.
 polyphemus, 61, 227.
 Telephorus, 65, 222.
 bilineatus, 222.
 Tenebrionidæ, 224.
 Termes, 125, 147.
 flavipes, 58, 61, 150, 152, 154, 159,
 202, 204, 208, 234.
 virginicus, 209.
 Termites, 208, 234.
 Termitidæ, 208.
 Tetanocera pictipes, 43, 189.
 plumosa, 42, 43, 107, 189.
 Tetraopes, 104, 112, 185.
 femoratus, 45, 46, 47, 178.
 tetraophthalmus, 45, 46, 47, 50, 51,
 52, 111, 177, 178.
 Tetropium cinnamopterum, 156.
 Tettigidea lateralis, 58, 211.
 parvipennis, 58, 212.
 Tettigoniellidæ, 218.

Thalesa, 145, 148, 156.
 lunator, 125, 126, 159, 231, 232, 233.
 Thistle, 199.
 Thomisidæ, 163.
 Thyanta custator, 108.
 Thyreocoridae, 172.
 Thyreocorpus pulicarius, 172.
 Thyridopteryx ephemeræformis, 152,
 154.
 Thysanura, 131.
 Tibicen septendecim, 58, 130, 217.
 Tick-trefoil, 57, 63, 124.
 Canadian, 171.
 Tiger-beetle, woodland, 59, 219.
 Tiger beetles, 132, 187, 220.
 Tilia, 149.
 Timothy, 175, 178.
 Tiphia, 115, 119, 120, 121, 181, 185,
 193.
 Tipulidæ, 115, 133.
 Toads, 66.
 Tomato, 224.
 Tortoise-beetle, clubbed, 65, 224.
 Tremex columba, 59, 61, 125, 144,
 148, 154, 156, 159, 231, 233.
 Trichius piger, 152.
 Trichocera, 136, 159.
 brumalis, 136.
 Trichopepla semivittata, 108.
 Trichopoda pennipes, 189.
 plumipes, 189.
 ruficauda, 52, 189.
 Triepeolus, 197.
 Trifolium, 229.
 Triphyllus humeralis, 136.
 Trirhabda tomentosa, 52, 179.
 Trissolcus eusehisti, 218.
 Tritoma biguttata, 136.
 thoracica, 136.
 Trogositids, 145.
 Trogus, 140.
 obsidianator, 65, 233.
 Trombidiidæ, 164.
 Trombidium, 45, 46, 52, 120, 121, 164.
 Truxalis brevicornis, 214.
 Trypetidæ, 189.
 Twig-pruners, 141.
 Tussock-moth, white-marked, 154,
 156.
 Typha, 80.

U

Ulmus, 225.
 americana, 40, 62, 63, 126, 217.
 fulva, 63.
 Umbellifers, 182, 188.
 Uropod mites, 222.
 Urtica, 225.

V

- Verbena, 185, 196, 197.
 stricta, 185.
 Vernonia, 118, 171, 172.
 Veronica virginica, 174.
 Vespa, 135, 190, 210, 230.
 maculata, 135.
 Vespidae, 193.
 Viburnum, 223, 229.
 Virginia creeper or five-leaved ivy, 57,
 60, 63, 177, 223.
 Vitis cinerea, 60, 63.
 Vitrea indentata, 61, 64, 201, 202,
 203, 204.
 rhoadsi, 61, 201, 202, 204.
 Volucella, 200.

W

- Walking-stick, forest, 58, 140, 211.
 Walnut, 57, 60, 63, 145, 146, 148, 151,
 226, 227, 228.
 black, 149.
 moth, royal, 227.
 Wasp, digger-, see digger-wasp.
 potter mud-, 193.
 solitary, 52.
 spider, 65, 193.
 white-grub, 185.
 Wasps, 119, 181, 185.
 Water horehound, 44.
 -strider, 66, 127, 219.
 Web-worm, fall, 156.
 Weevils, 195.
 grain, 99, 100.
 nut-, 141.
 Wheat, 175, 218.
 -stem maggot, greater, 107.

- White ant, 58, 61, 147, 150, 152, 154,
 202, 204, 208, 234.
 -grubs, 116, 119.
 Willow, 44, 47, 49, 103, 106, 120, 121,
 157, 158.
 Wireworms, 224.
 Woodpecker, pileated, 228.

X

- Xanthium, 49, 189.
 Xenodusa cava, 237.
 Xiphidium attenuatum, 53, 54, 169.
 nemorale, 58, 64, 124, 126, 216.
 strictum, 42, 44, 48, 52, 53, 54, 107,
 108, 109, 169.
 Xyleborus, 137.
 Xylocopa virginica, 45, 46, 47, 104,
 198.
 Xylocopidae, 198.
 Xylopinus saperdioides, 151.
 Xyloryctes satyrus, 152.
 Xyloterus, 137.
 Xylotrechus colonus, 144, 147, 148,
 154.
 undulatus, 154.

Y

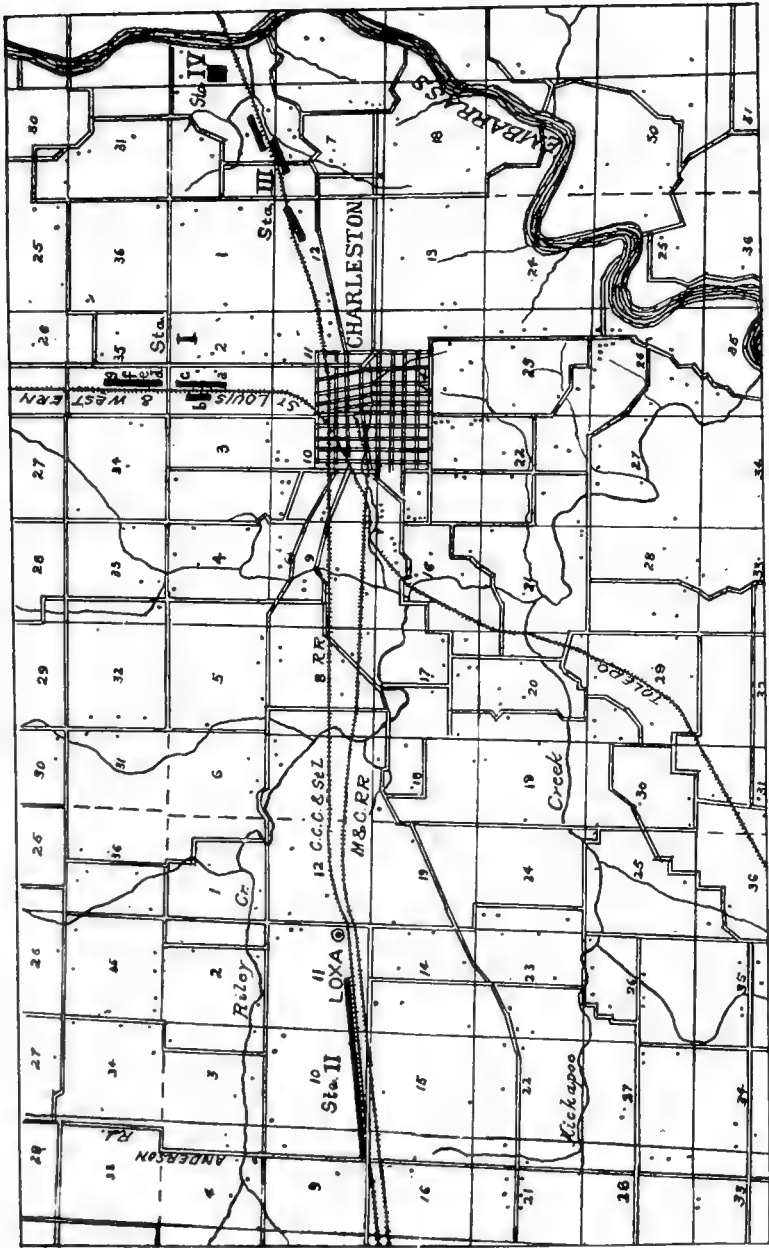
- Ypsolophus, 140.
 ligulellus, 59, 65, 229.

Z

- Zanthoxylum, 60, 63, 138, 179, 183,
 225.
 Zonitidae, 202.
 Zonitis bilineata, 111, 112, 180.
 Zonitoides arborea, 58, 61, 136, 150,
 202, 204.



PLATE I



Map showing location of the ecological stations.



PLATE II



Fig. 1. Colony of swamp grass (*Elymus virginicus*), Station I, c.



Fig. 2. General view, to the right of the railway track, from Station I, d, toward I, g. On the bare foreground are plants of *Asclepias syriaca*. (Photograph, T. L. Hankinson.)

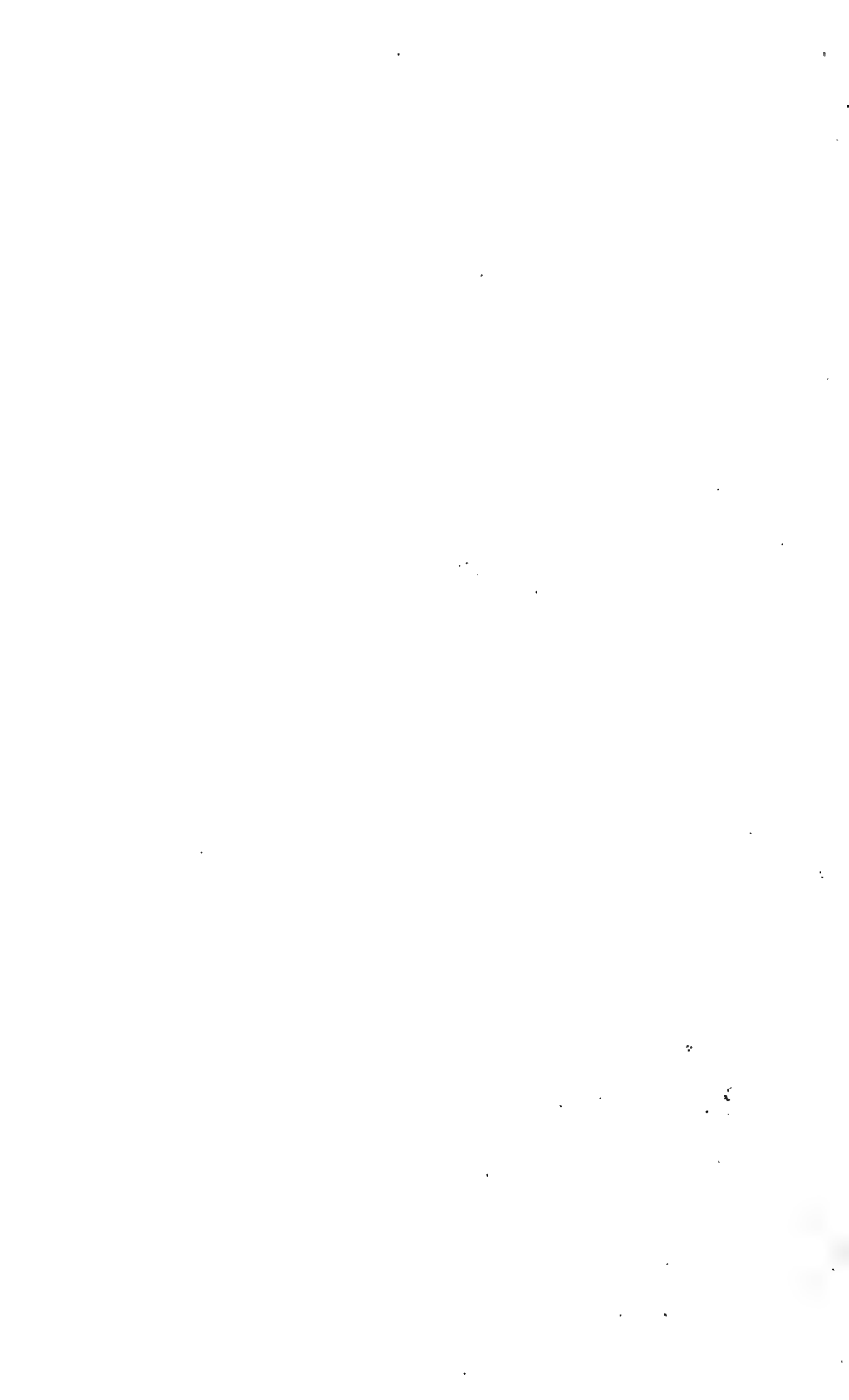


PLATE III



Fig. 1. Swampy area with colony of swamp milkweed (*Asclepias incarnata*), Station I, d. (Photograph, T. L. Hankinson.)



Fig. 2. General view of Station I, g, a colony of swamp milkweed (*Asclepias incarnata*) in a ditch parallel to the rails, and of blue stem (*Andropogon*) and drop-seed (*Sporobolus*). Photograph, T. L. Hankinson.)

PLATE IIIA



Fig. 1. Flowers of the swamp milkweed (*Asclepias incarnata*) at Station I, d. These were the favorite haunts of many flower-visiting insects. (Photograph, T. L. Hankinson.)



Fig. 2. Crawfish chimney at Station I, d, Charleston, Ill. Probably formed by *Cambarus gracilis* or *diogenes*. (Photograph by T. L. Hankinson.)

PLATE IIIB



Fig. 1. Crawfish chimney at Station I, Charleston, Ill. Probably formed by *Cambarus gracilis* or *diogenes*. (Photograph by T. L. Hankinson.)



Fig. 2. General view at Station I, d, showing numerous crawfish chimneys, probably formed by *Cambarus gracilis* or *diogenes*. (Photograph by T. L. Hankinson.)

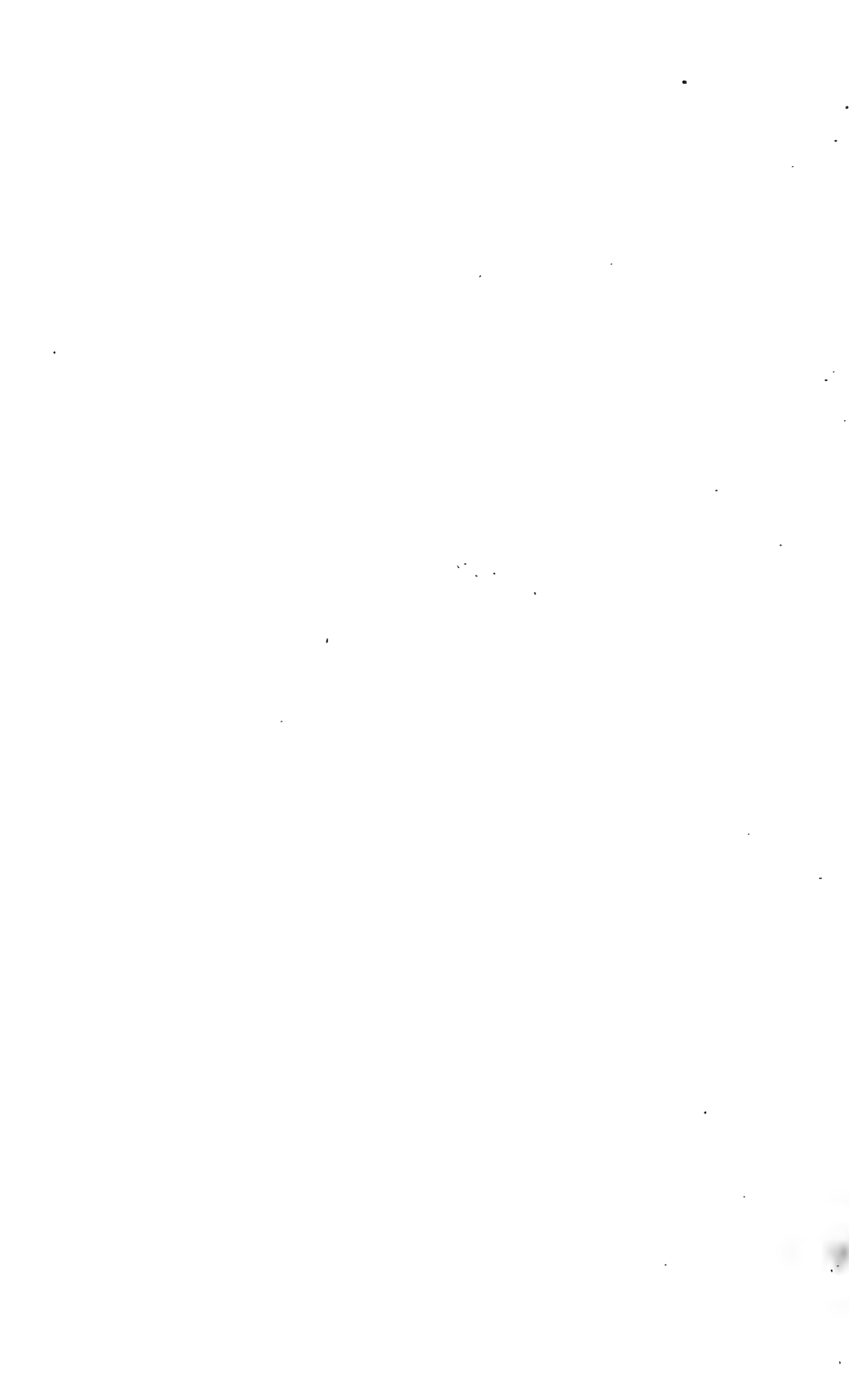


PLATE IV



Fig. 1. Colony of mountain mint (*Pycnanthemum flexuosum*) at Station I, g. The large upturned leaves are those of *Asclepias sullivantii*. (Photograph by T. L. Hankinson.)



General view of Station I, g, April 23, 1911, showing the submerged condition. (Photograph by T. L. Hankinson.)

PLATE V



General view of Station I, e, showing a colony of *Lepachys pinnata* (the black dots on the flower heads) and rosinweed (*Silphium terebinthinaceum*) and *Lactuca canadensis*. (Photograph, T. L. Hankinson.)

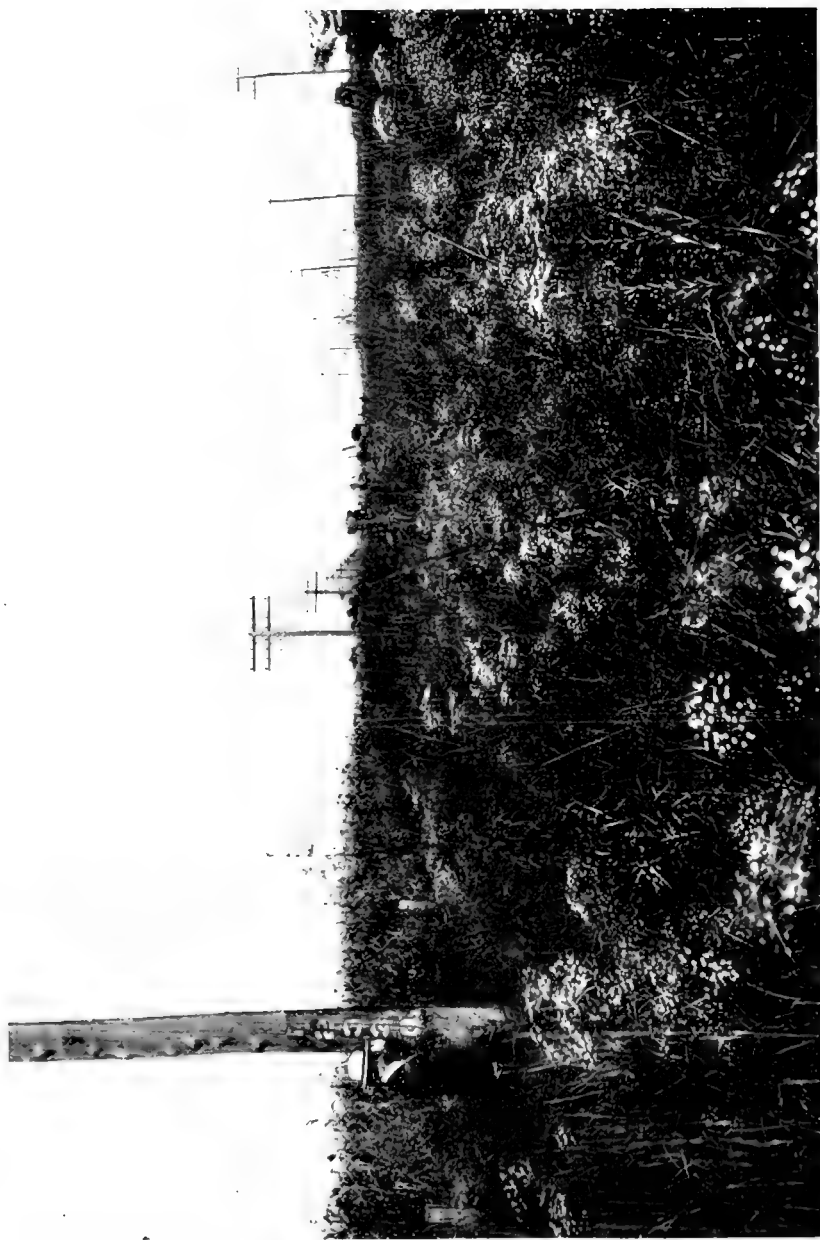
PLATE VI



General view of the black-soil prairie at Loxa, Ill., Station II, a. (Photograph, T. L. Hankinson.)

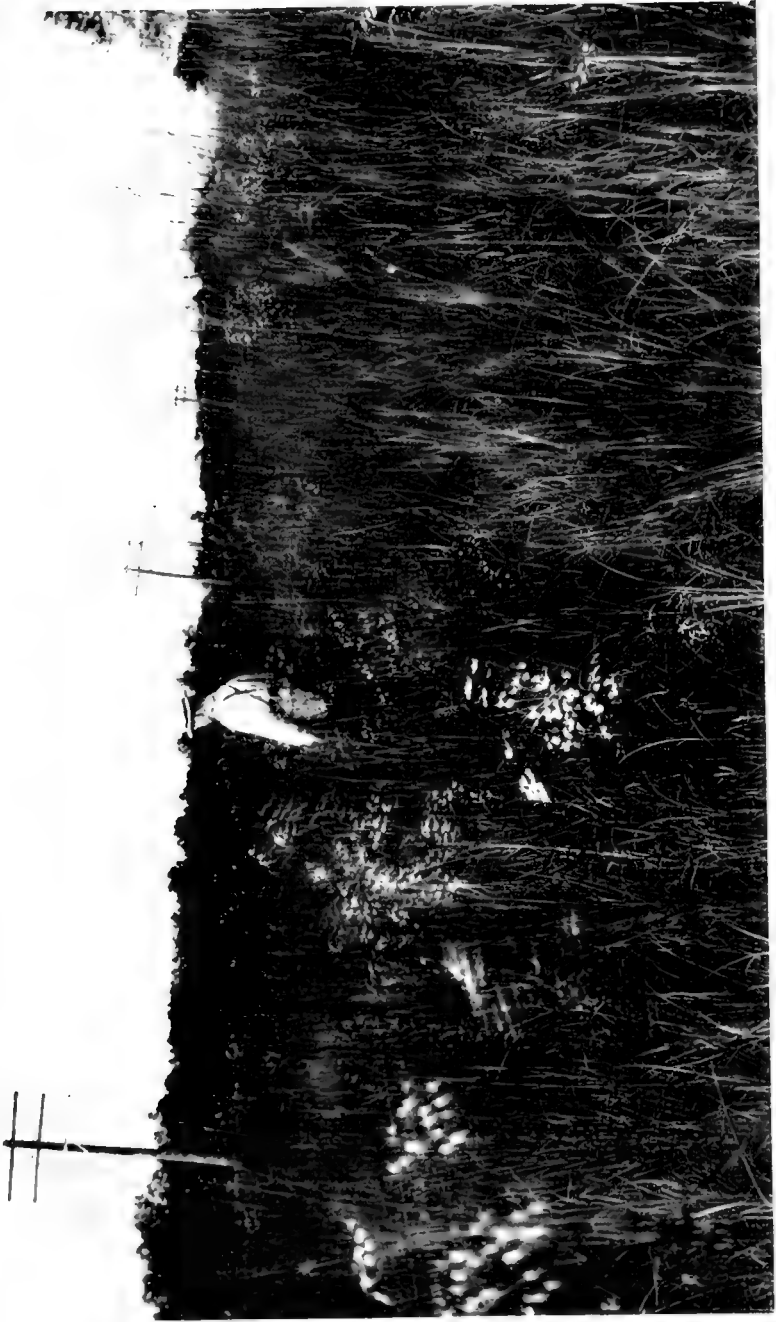


PLATE VII



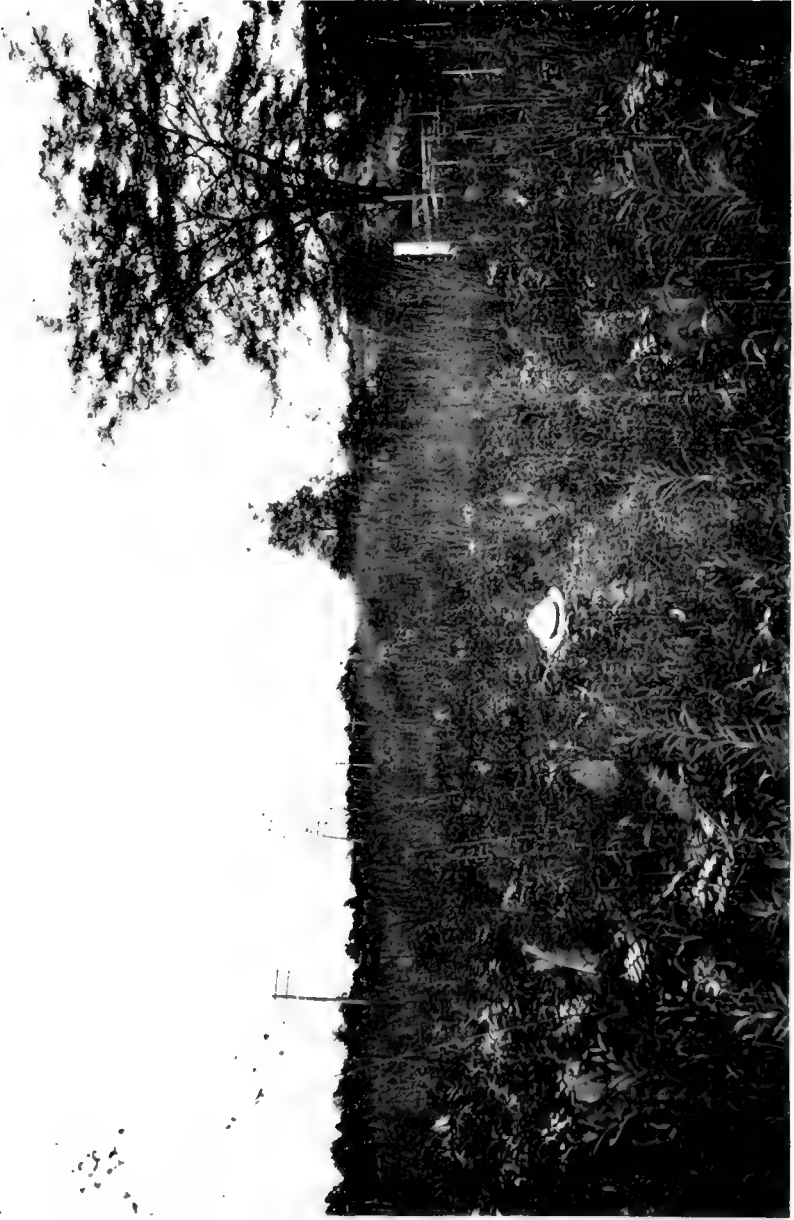
Another view of the Loxa prairie, Station II, *a*, showing a different kind of vegetation. (Photograph, T. L. Hankinson.)

PLATE VIII



Prairie-grass area east of Charleston, Station III, *b*. The grass is *Amblyopogon* and the white flowers are *Euphorbia*. (Photograph, T. L. Hankinson.)

PLATE IX



Area east of Charleston with mixture of prairie and forest vegetation. Station III, *b*. (Photograph, T. L. Hankinson.)

PLATE X



Fig. 1. General view of the Bates woods, Station IV, looking to the south, August, 1910. (Photograph, C. C. Adams.)



Fig. 2. General view of the same area after clearing. June 8, 1914. (Photograph, T. L. Hankinson.)

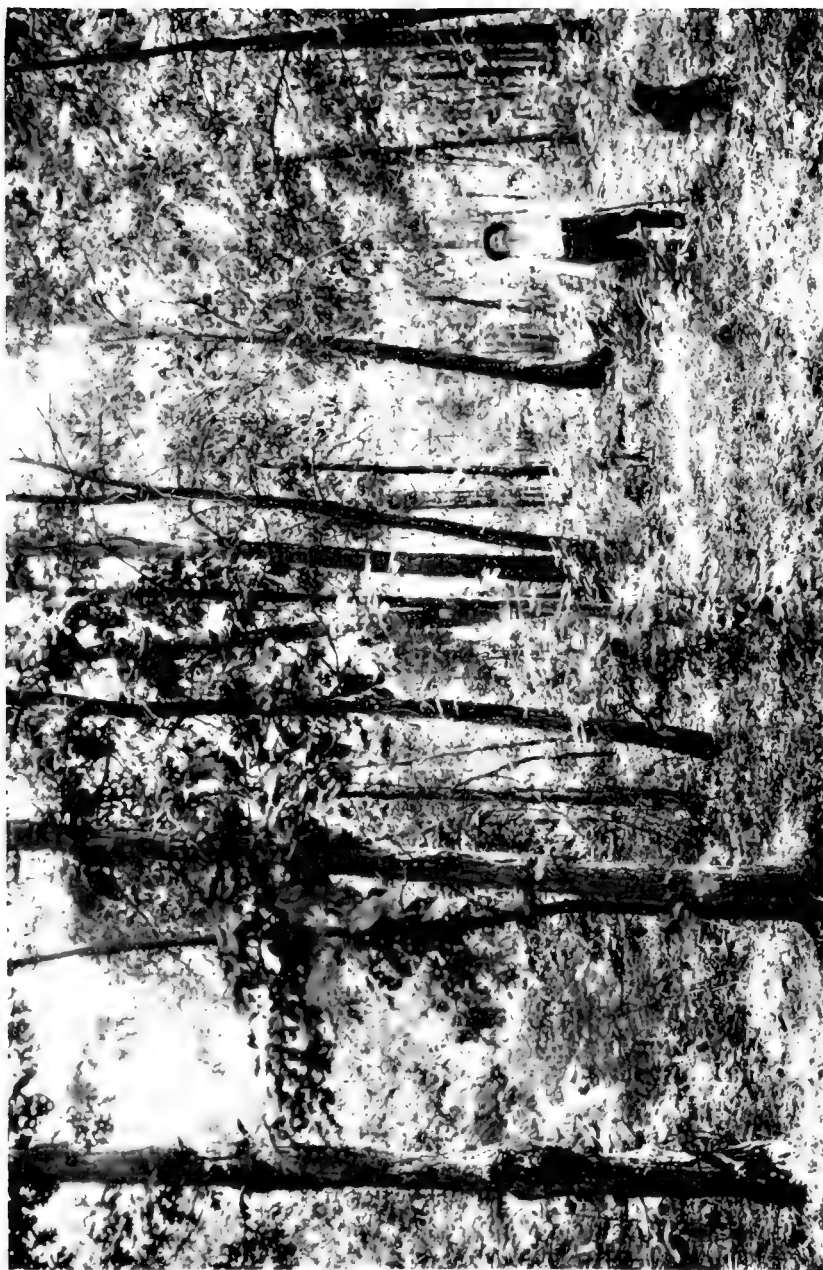


PLATE XI



The cleared area bordering the upland part of the Bates woods, adjacent to Station IV. *a.* (Photograph, T. L. Hankinson.)

PLATE XII



The upland area of the Bates woods, Station IV, *a*: a white oak-hickory forest, showing the undergrowth in the more open places.
(Photograph, T. L. Haukinson.)

PLATE XIII



The upland area of the Bates woods, Station IV, *a*, showing the small amount of undergrowth in the more densely shaded parts. (Photograph, T. L. Hankinson.)

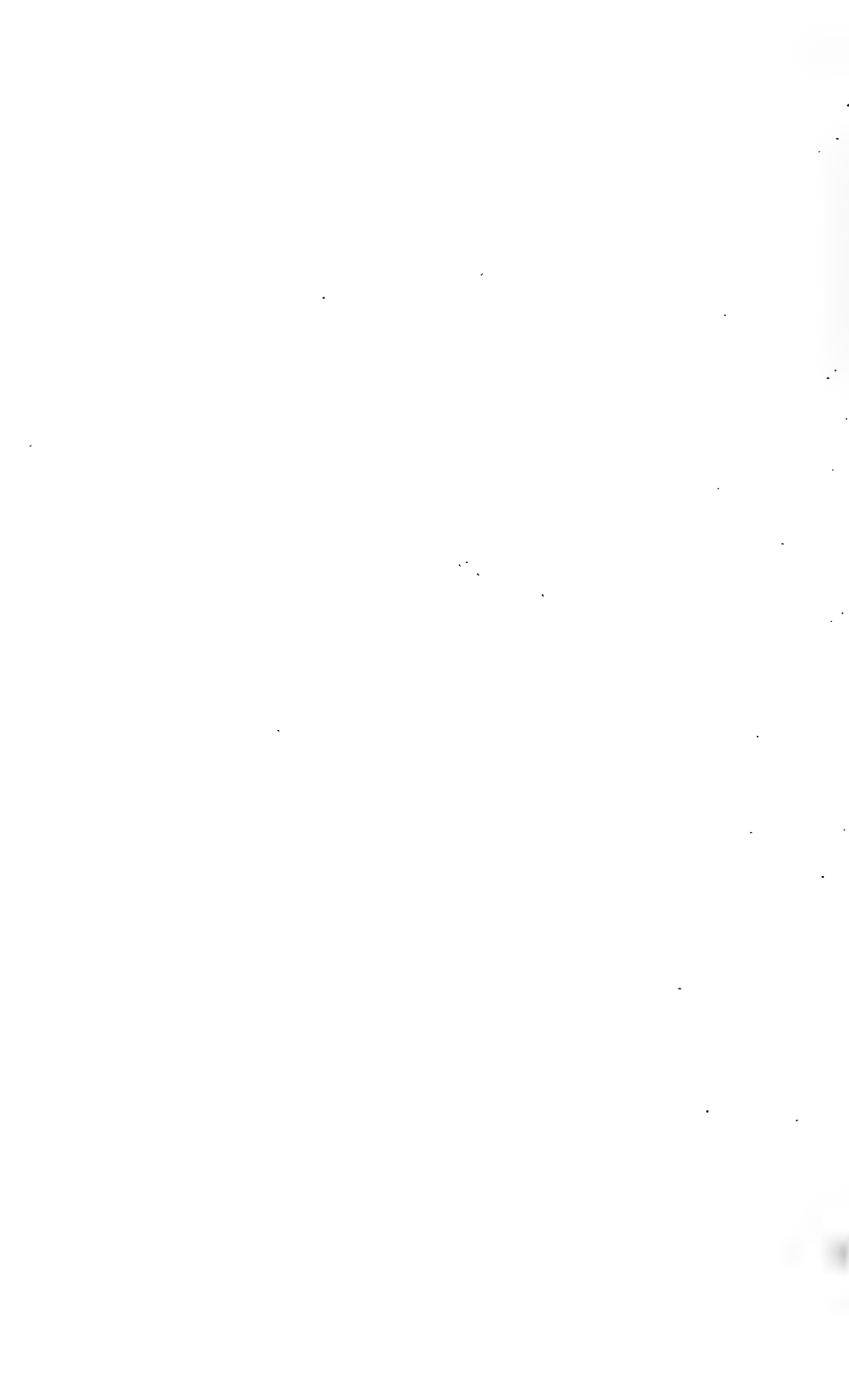


PLATE XIV



The lowland forest of the Bates woods, Station IV, c, looking into the forest from a small clearing or glade. (Photograph, T. L. Hankinson.)

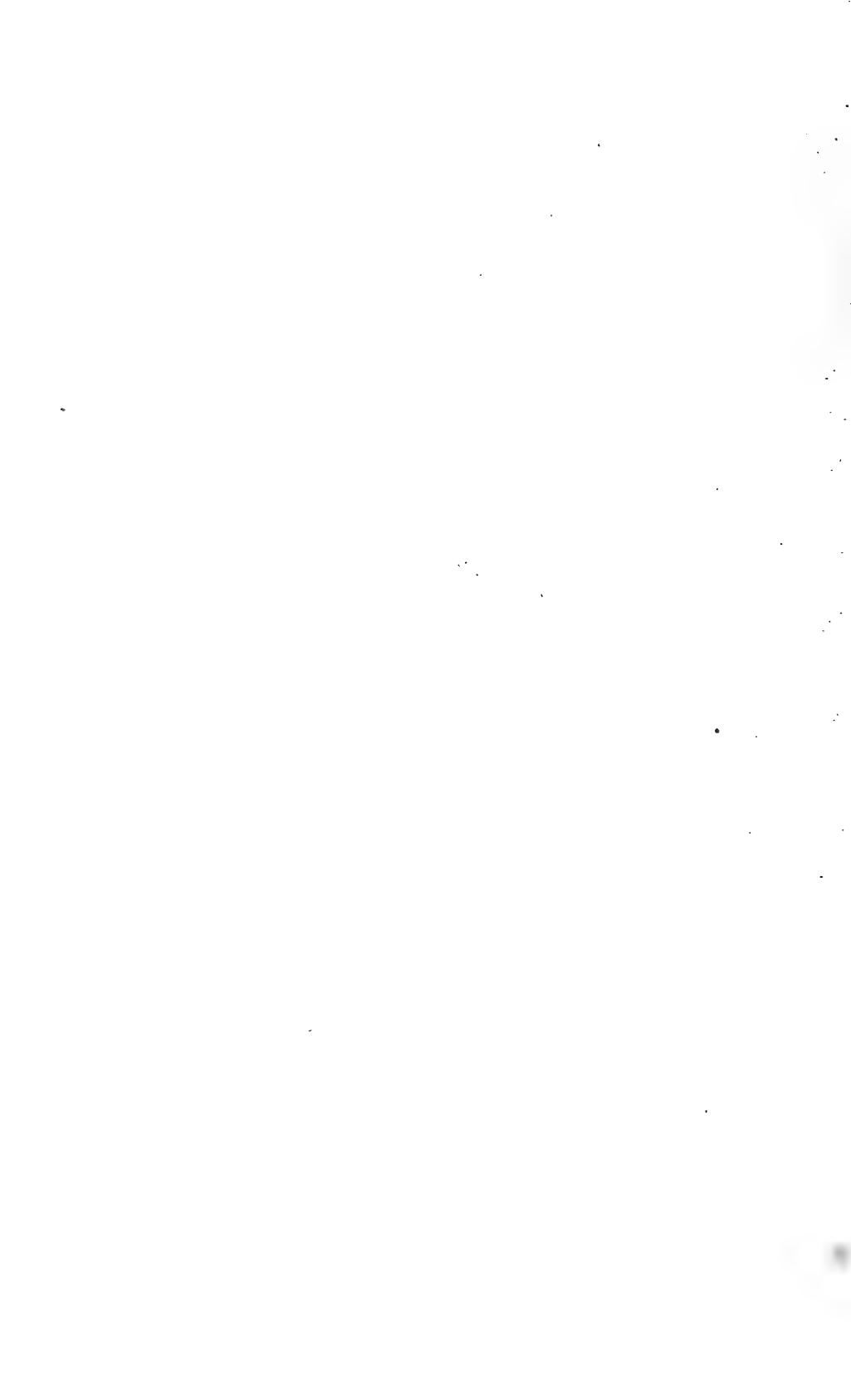


PLATE XV



Lowland maple-basswood forest of the Bates woods, Station IV, . . . Interior view, showing absence of shrubbery. (Photograph, T. L. Hankinson.)



PLATE XVI



Fig. 1. Margin of the artificial glade in the lowland forest of Bates woods, Station IV, c. The ground cover is largely clearweed (*Pilea*). (Photograph, C. C. Adams.)



Fig. 2. Detail of vegetation in and at the margin of the artificial glade in the lowland Bates forest, Station IV, c. See Plate XIV for another view of the glade. (Photograph, C. C. Adams.)

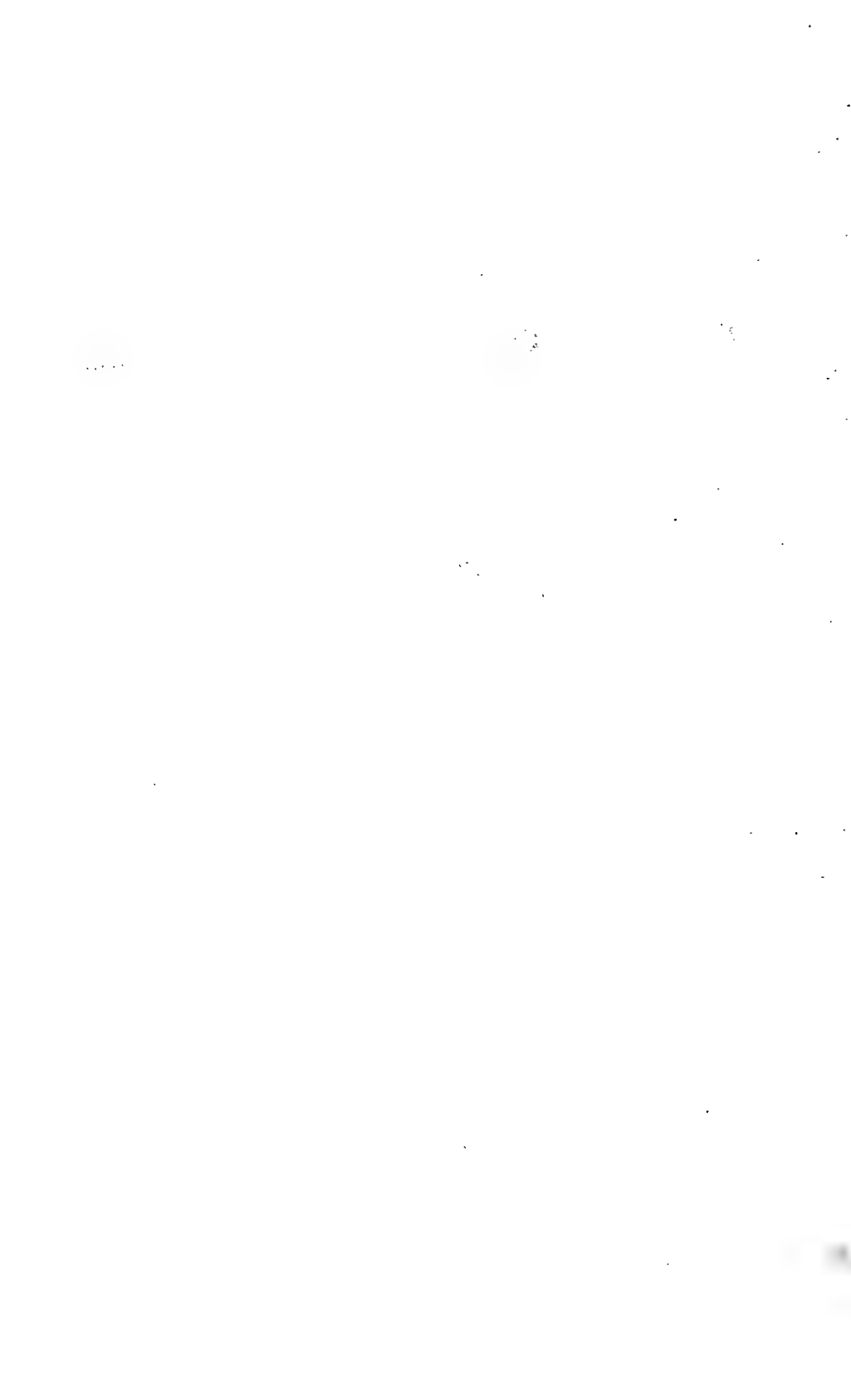


PLATE XVII



Fig. 1. General view of the ravine with temporary stream, which bounded the Bates woods on the south, Station IV, *d.* (Photograph, T. L. Hankinson.)

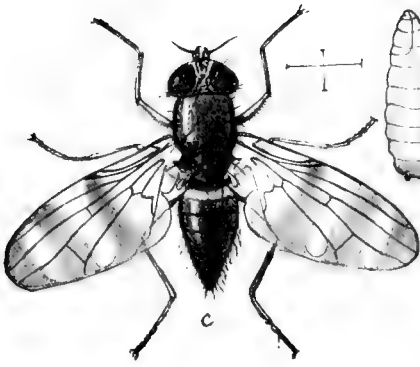


Fig. 2. A pool in the temporary stream in the south ravine, Bates woods, Station IV, *d.* (Photograph, T. L. Hankinson.)

PLATE XVIII

- Fig. 1. Stalk-maggot, *Chatopsis aenea*; *a*, larva, *b*, puparium; *c*, adult. Enlarged as indicated. (Howard, Ins. Life.)
- Fig. 2. Frit-fly, *Oscinis coxendix*, puparium. Enlarged. (Washburn, Rep. State Ent. Minn.)
- Fig. 3. The same, larva. Enlarged. (Washburn, l. c.)
- Fig. 4. The same, adult. Enlarged. (Washburn, l. c.)
- Fig. 5. Bill-bug, *Sphenophorus ochreus*, dorsal view. Enlarged $2\frac{1}{3}$ times.
- Fig. 6. The same, side view. Enlarged $2\frac{1}{3}$ times.
- Fig. 7. The same, larva, side view. Enlarged.

PLATE XVIII



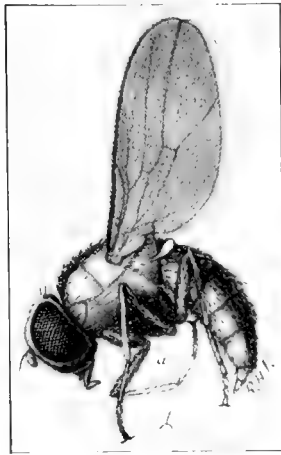
1



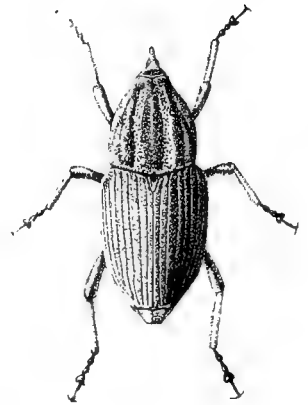
2



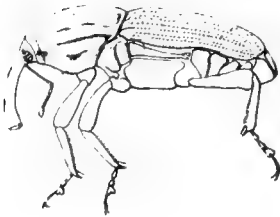
3



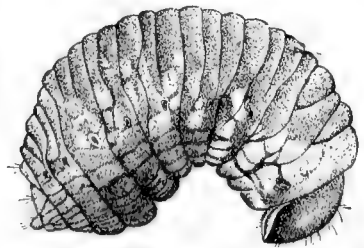
4



5



6



7

PLATE XIX

- Fig. 1. Gall on *Populus* caused by *Pemphigus oestlundii*. (Cook, Rep. Ind. Dept. Geol. and Nat. Res.)
- Fig. 2. Poplar Leaf Gall-louse, *Pemphigus populicaulis*, and its gall: *a*, incipient gall on under side of leaf; *b*, gall from the upper side of the leaf; *c*, mature gall, showing aperture; *d* and *e*, incipient double galls; *f*, wingless female; *g*, winged insect—*f* and *g* enlarged as indicated. (Riley, Amer. Ent.)
- Fig. 3. Poplar transverse gall and louse, *Pemphigus populi-transversus*: *a*, gall on *Populus* leaf; *b*, gall showing aperture; *c*, winged female louse; *d*, antenna of winged female. Enlarged as indicated. (Riley.)

PLATE XIX

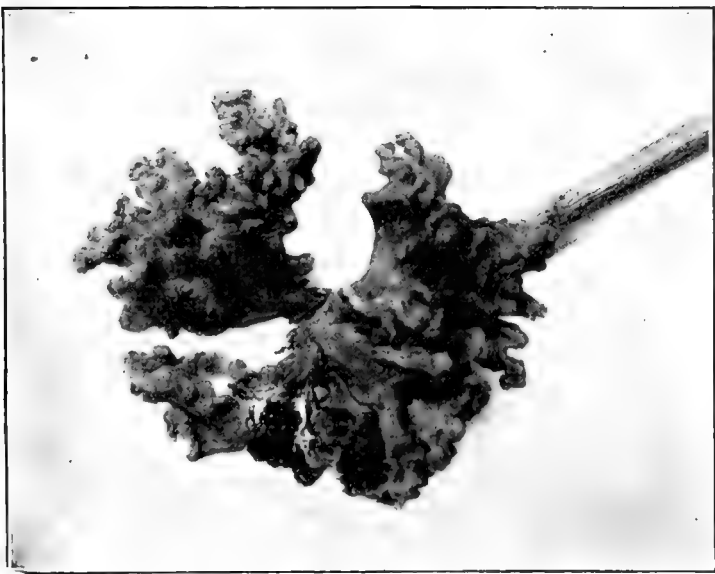
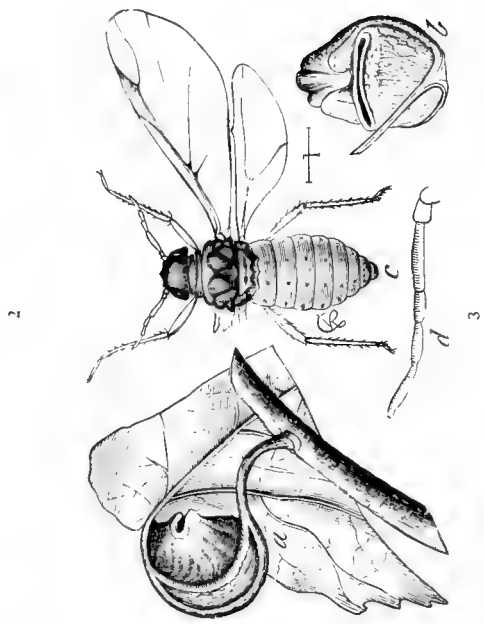
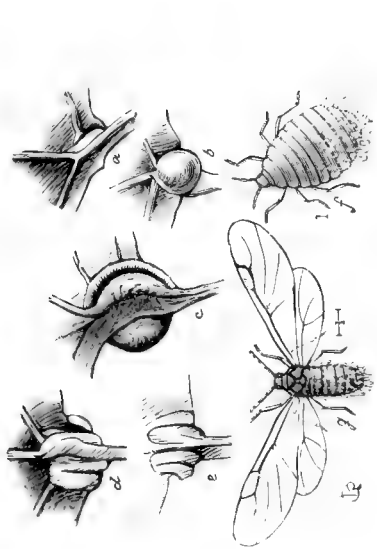
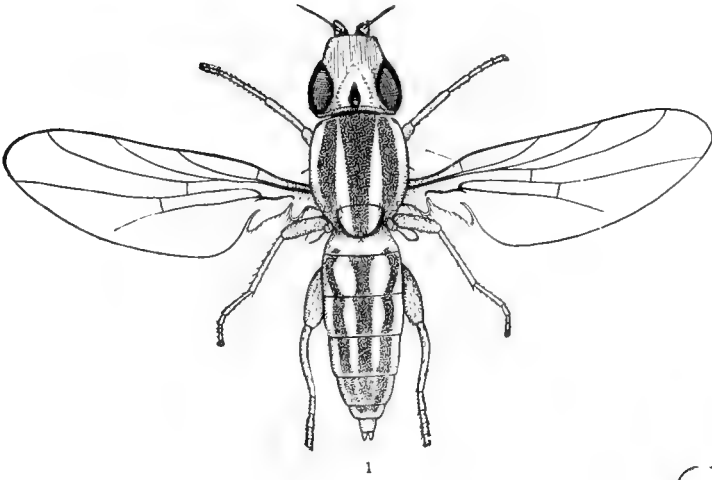


PLATE XX

- Fig. 1. The Wheat Bulb Worm, *Meromyza americana*, adult fly. Magnified twelve diameters.
- Fig. 2. Larva of same. Magnified sixteen diameters.
- Fig. 3. Work of larva (*a*), larva (*b*), and pupa (*c*) of same. (Riley, Rep. State Ent. Mo.)
- Fig. 4. Pupa of same, dorsal view.
- Fig. 5. Pupa of same enclosed in puparium. Magnified thirty diameters.
- Fig. 6. Cottonwood Dagger Caterpillar, *Apatela populi*. (Riley, Rep. State Ent. Mo.)

PLATE XX



2



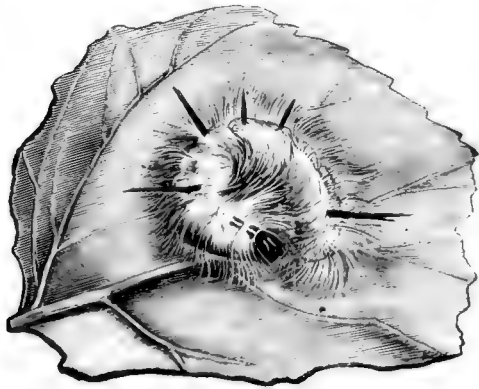
3



4



5

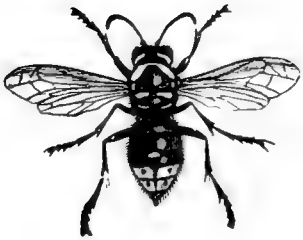
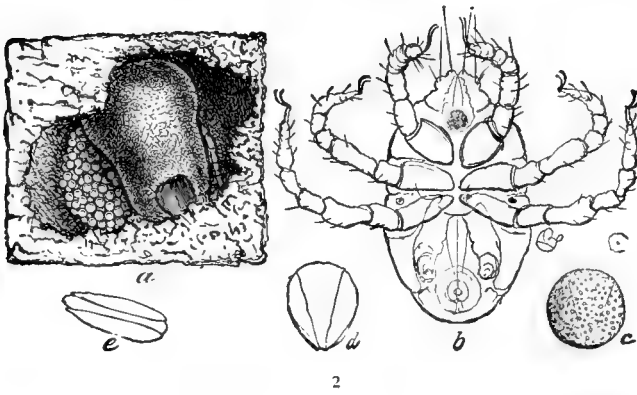
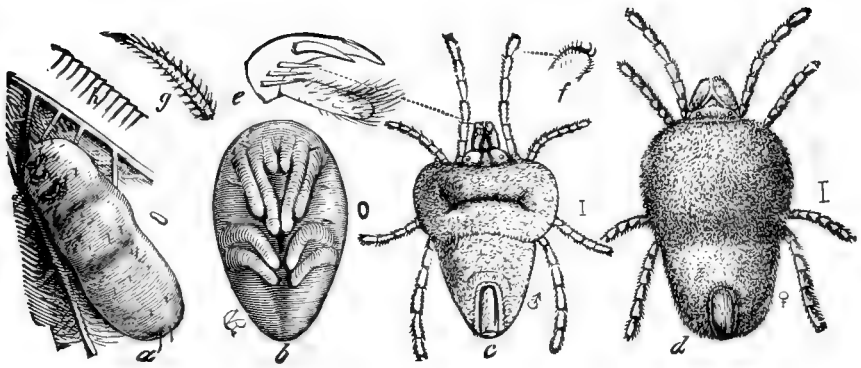


6

PLATE XXI

- Fig. 1. Red Locust-mite, *Trombidium locustarum*: *a*, mature larva on wing of locust; *b*, pupa; *c*, adult male; *d*, adult female; *e*, pupal claw and thumb; *f*, pedal claw; *g*, one of the barbed hairs; *h*, striations on the larval skin; *c* and *d* enlarged as indicated. (Riley, Rep. U. S. Ent. Comm.)
- Fig. 2. The same: *a*, female with her eggs; *b*, newly hatched larva (natural size indicated by dot within the circle); *e*, egg; *d* and *e*, empty egg-shells. (Riley, l.c.)
- Fig. 3. White-faced Hornet, *Vespa maculata*. (J. B. Smith, Ins. of N. J.)
- Fig. 4. Ground-beetle, *Lebia grandis*. (After Felt, Mem. N. Y. State Mus.)

PLATE XXI



3

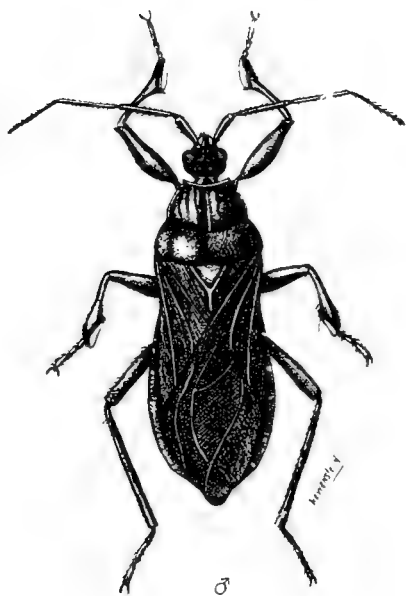


4

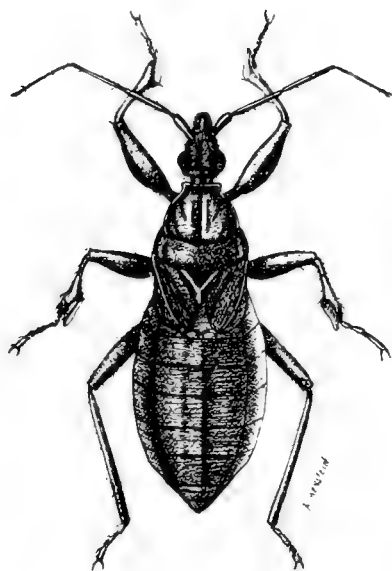
PLATE XXII

- Fig. 1. Black Pirate, *Melanolestes picipes*, male. Enlarged. (Lugger, Rep. Ent. Minn. Exp. Sta.)
- Fig. 2. The same, female. Enlarged. (Lugger, l. c.)
- Fig. 3. *Myodocha serripes*. Enlarged. (Lugger, l. c.)
- Fig. 4. Leaf-footed Bug, *Leptoglossus oppositus*. (Chittenden, Bull. Bur. Ent. U. S. Dept. Agr.)

PLATE XXII



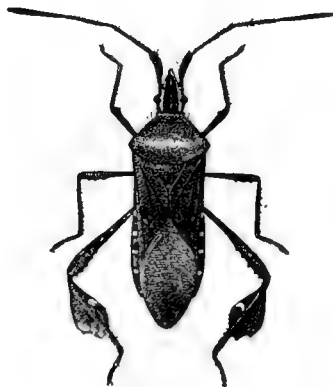
1



2



3

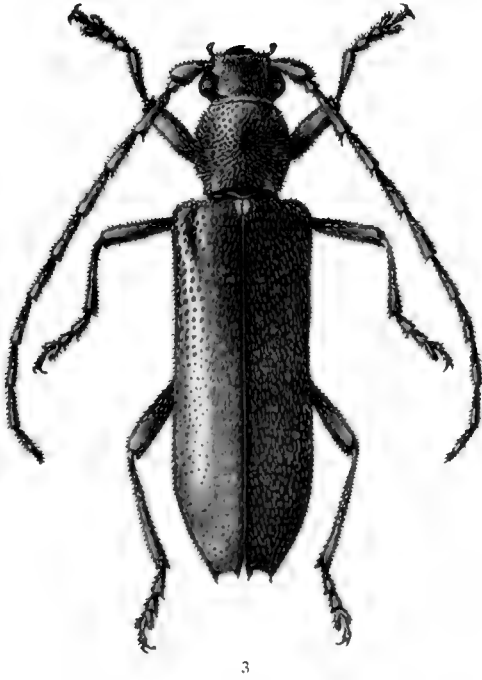
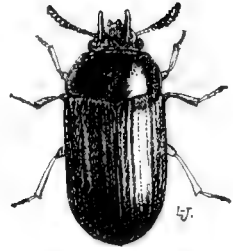
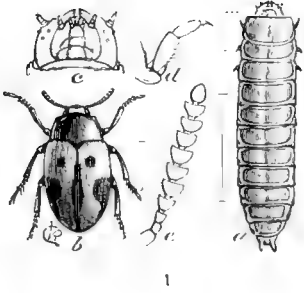


4

PLATE XXIII

- Fig. 1. *Diaperis maculata*: *a*, larva; *b*, beetle; *c*, head of larva; *d*, leg of larva; *e*, antenna of beetle. (Riley.)
- Fig. 2. Green Horned Fungus-beetle, *Arrhenophita bicornis*. Enlarged.
(After Felt, Mem. N. Y. State Mus.)
- Fig. 3. Twig-pruner, *Elaphidion villosum*, beetle. Enlarged.
- Fig. 4. The same, larva. Enlarged.

PLATE XXIII



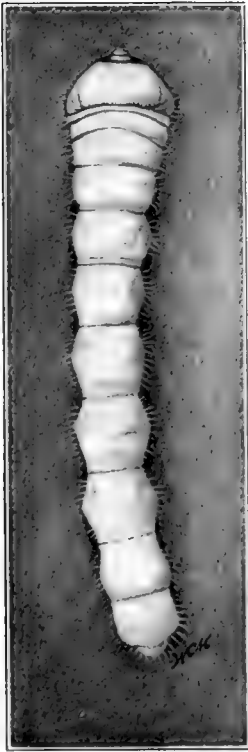
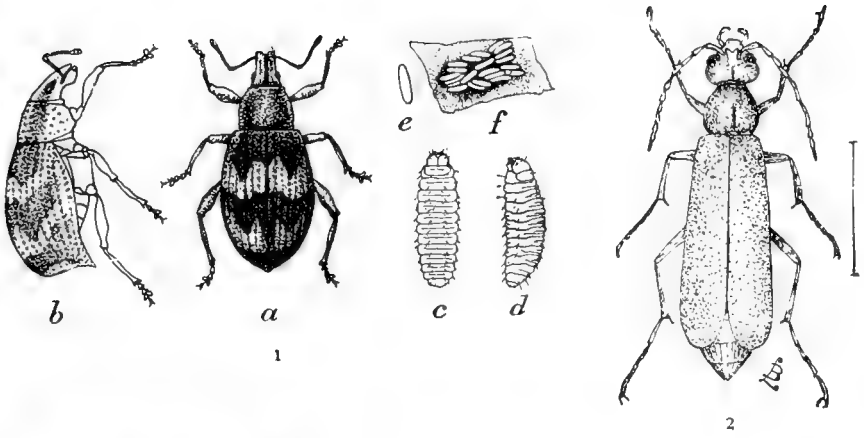
3

4

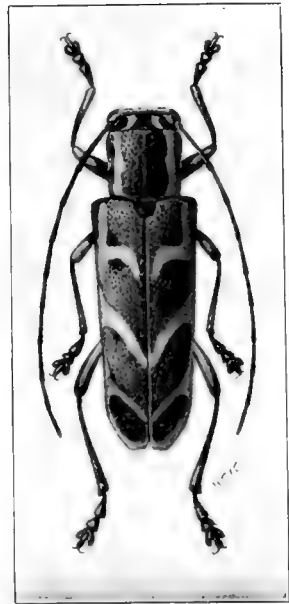
PLATE XXIV

- Fig. 1. Imbricated Snout-beetle, *Epicarus imbricatus*: *a*, dorsal view of beetle; *b*, side view of same; *c*, larva, dorsal view; *d*, side view of same; *e* and *f*, egg and egg mass. (Chittenden, Bull. Bur. Ent. U. S. Dept. Agr.)
- Fig. 2. Gray Blister-beetle, *Macrobasis unicolor*. Enlarged as indicated. (Bruner, Bull. Nebr. Exp. Sta.)
- Fig. 3. The Elm Borer, *Saperda tridentata*, larva. Enlarged.
- Fig. 4. The same, beetle. Enlarged.

PLATE XXIV



3

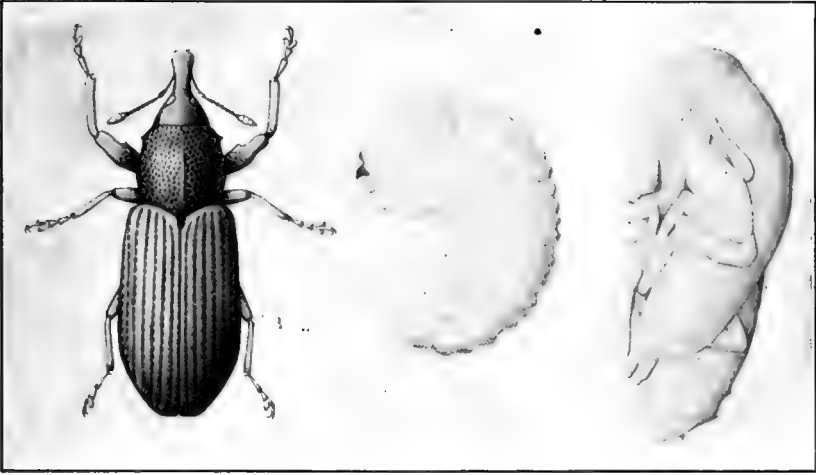


4

PLATE XXV

- Fig. 1. Reddish Elm Snout-beetle, *Magdalis armicollis*: beetle, larva, and pupa. Enlarged eight diameters.
- Fig. 2. Burrow showing egg of *Magdalis armicollis*. Enlarged three diameters.
- Fig. 3. Hickory Bark-beetle, *Scolytus 4-spinosus*: 1 and 2, work; 3, beetle, enlarged and natural size; 4, larva, side view, enlarged and natural size; 5, pupa, ventral view, enlarged as indicated; 6, *Magdalis armicollis*, punctuation of elytra. (Riley, Rep. State Ent. Mo.)

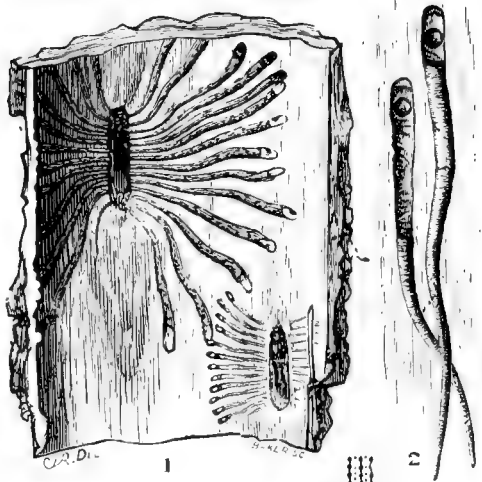
PLATE XXV



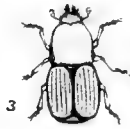
1



2



1



3



4



3



6



5



1



2

PLATE XXVI

- Fig. 1. Larva of Eyed Elater, *Alaus oculatus*.
Fig. 2. Beetle of same. (After Harris, Ins. Inj. Veg.)
Fig. 3. Clerid beetle, *Clerus quadriguttatus*. Enlarged. (After Felt, Mem. N. Y. State Mus.)
Fig. 4. Larva of Eyed Elater, *Alaus oculatus*, oblique view, to show apex of abdomen.
Fig. 5. Flat-headed Apple-tree borer, *Chrysobothris femorata*: *a*, larva; *b*, beetle; *c*, head of male beetle; *d*, ventral view of pupa. (Chittenden, Circ. Bur. Ent. U. S. Dept. Agr.)
Fig. 6. Clerid beetle, *Chariessa pilosa* (enlarged), with antenna of female. (After Felt, Mem. N. Y. State Mus.)
Fig. 7. Round-headed Apple-tree Borer, *Saperda candida*: *a*, larva, side view; *b*, larva, dorsal view; *c*, beetle; *d*, pupa. (Chittenden, Circ. Bur. Ent. U. S. Dept. Agr.)

PLATE XXVI

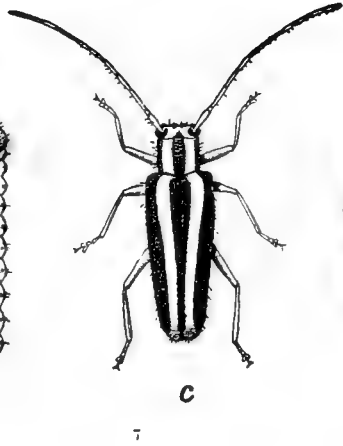
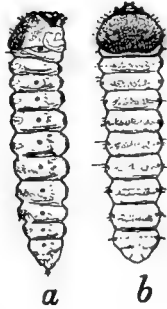
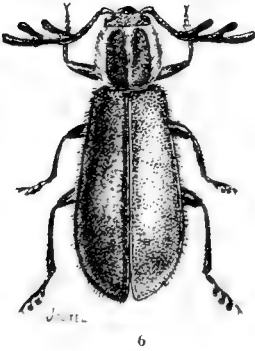
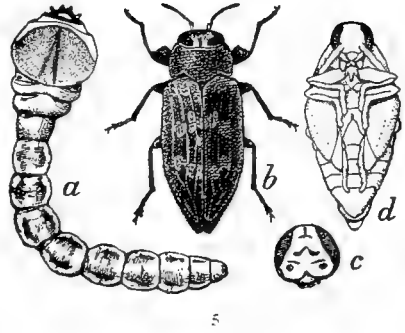
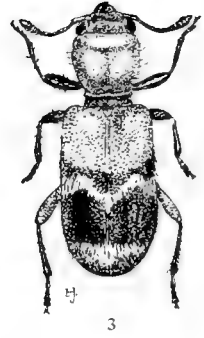
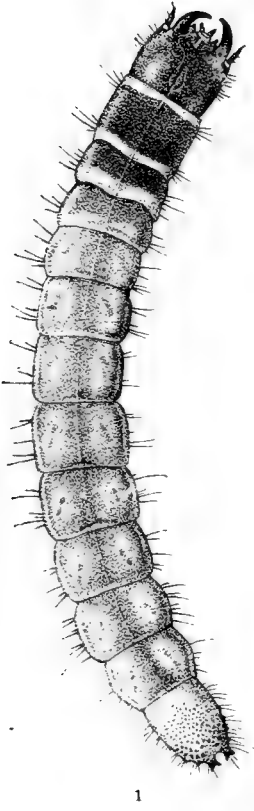
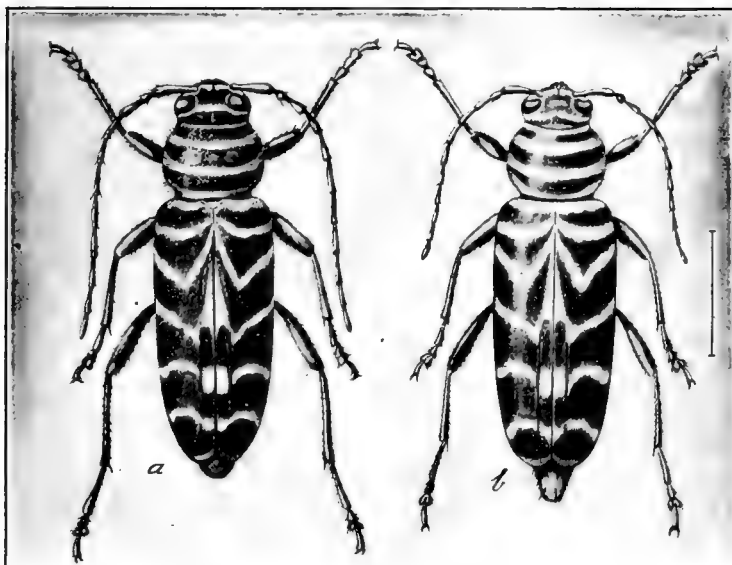


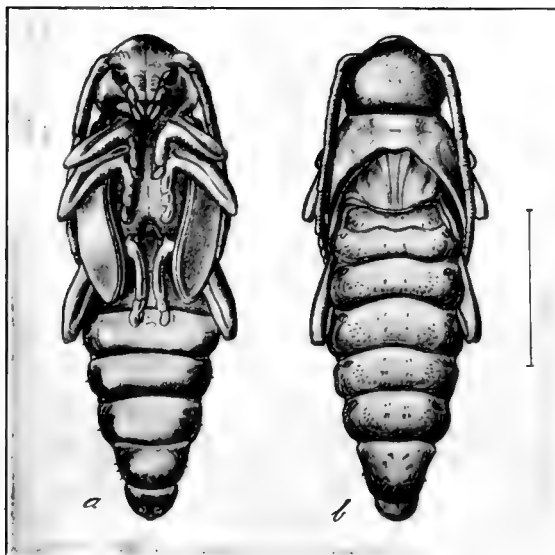
PLATE XXVII

- Fig. 1. Locust-borer, *Cyllene robiniae*, adult: *a*, male; *b*, female. Enlarged as indicated. (Hopkins, Bull. Bur. Ent. U. S. Dept. Agr.)
- Fig. 2. The same, pupa: *a*, ventral end; *b*, dorsal view. Enlarged as indicated. (Hopkins, l. c.)

PLATE XXVII



1



2

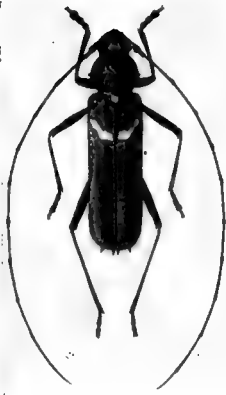
PLATE XXVIII

- Fig. 1. Cerambycid beetle, *Leptostylus aculiferus*. (Blatchley, Coleopt. of Ind.)
- Fig. 2. Banded Hickory Borer, *Chion cinctus*, adult.
- Fig. 3. Northern Brentian, *Eupsalis minuta*, male. (After Felt, Mem. N. Y. State Mus.)
- Fig. 4. The same, female. (After Felt, l. c.)
- Fig. 5. Twin-spotted Eburia, *Eburia 4-geminata*. (Blatchley, Coleopt. of Ind.)
- Fig. 6. Rustic Borer, *Xylotrechus colonus*, adult. Enlarged.
- Fig. 7. Cerambycid beetle, *Necolytus erythrocephalus*. Enlarged.
- Fig. 8. Red Cucujid, *Cucujus clavipes*: *a*, larva; *b*, beetle; *c*, apex of larval abdomen (enlarged); *d*, head of larva; *e*, side view of apex of larval abdomen. Larva and beetle enlarged as indicated. (Riley.)

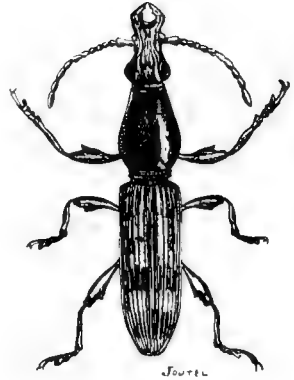
PLATE XXVIII



1



2



Journe

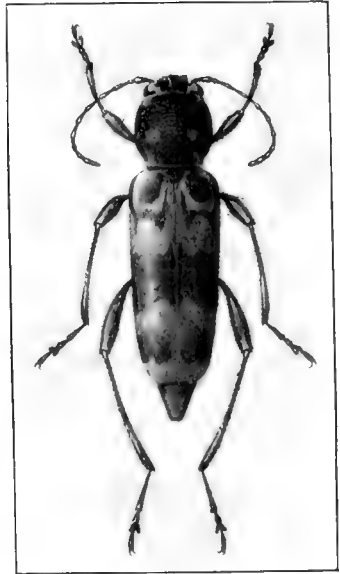
3



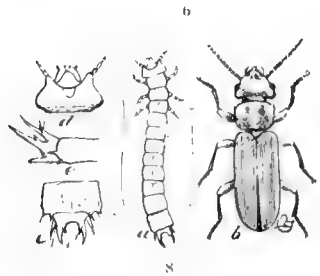
4



5



7



b

x

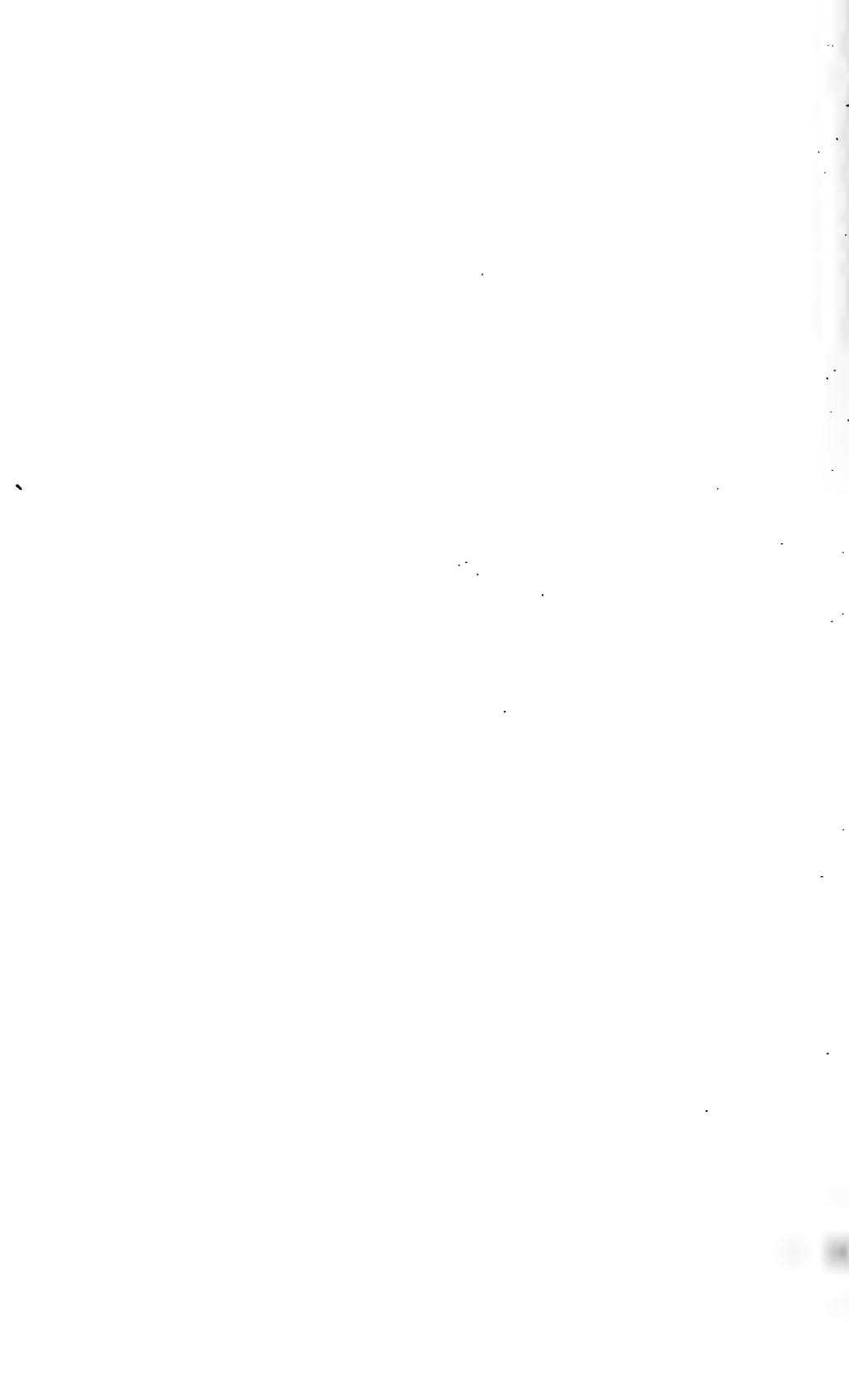
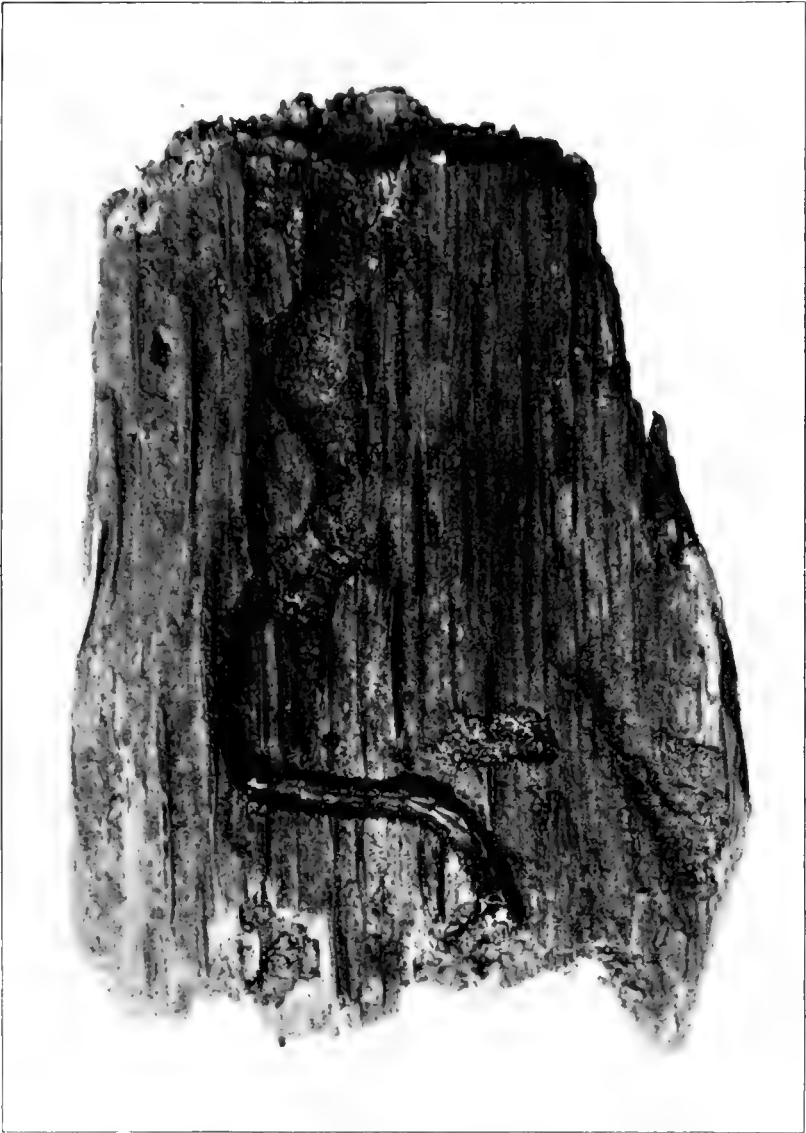


PLATE XXX

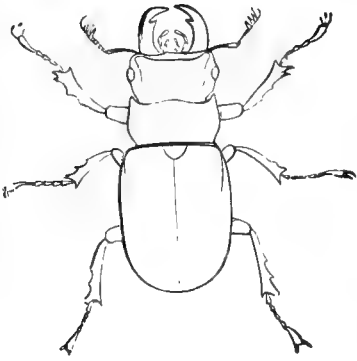


Larva of the beetle *Meracantha contracta* in its burrow in much-decayed wood. (Photograph, P. A. Glenn.)

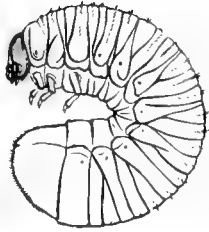
PLATE XXXI

- Fig. 1. Pinching Bug, *Lucanus dama*. (Packard, Guide to Study of Ins.)
- Fig. 2. The same: cocoon and side view of larva. (Packard, l. c.)
- Fig. 3. White-marked Tussock-moth, *Hemerocampa leucostigma*, larva.
- Fig. 4. The same, male moth.
- Fig. 5. The same: wingless female moth and egg masses. (Britton, Rep. State Ent. Conn.)

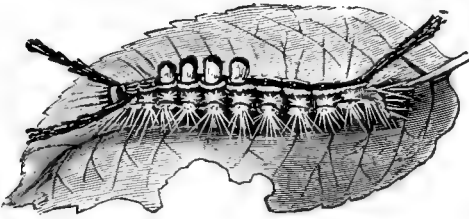
PLATE XXXI



1



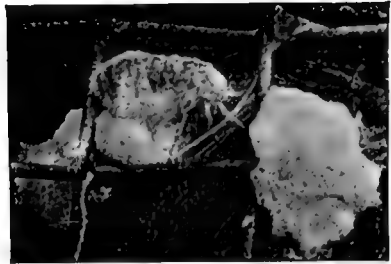
2



3



4



5



PLATE XXXII



View of dead timber, much of it hardwood, Reelfoot Lake, Tenn., killed by submergence caused by the sinking of the land during the New Madrid earthquake in 1811 (cf. Fuller '12). (Photograph loaned by U. S. Geol. Survey.)



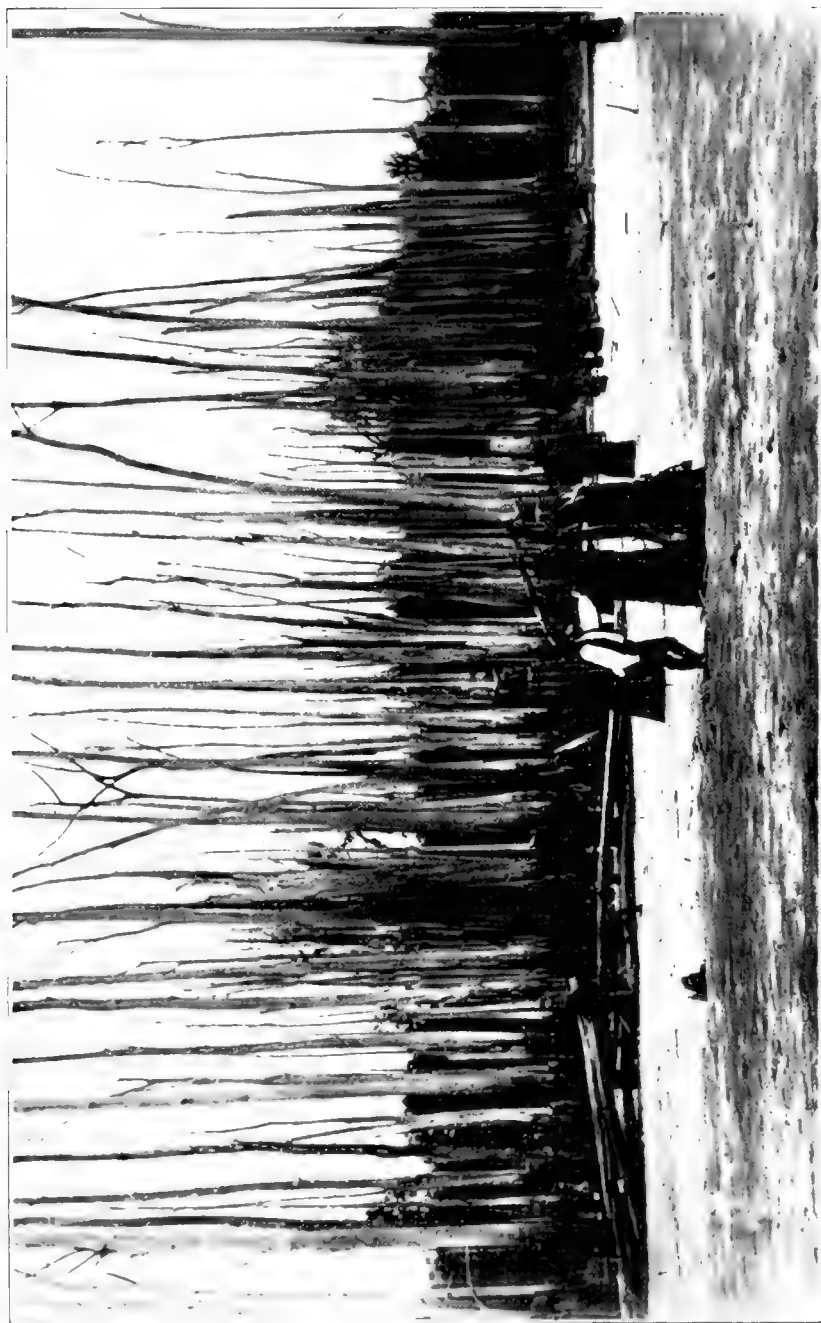
PLATE XXXIII



The great Red River raft, Louisiana. Such rafts formed temporary lakes which killed trees as shown in Plate XXXIV. (Photograph loaned by U. S. Geol. Survey.)



PLATE XXXIV



Timber killed by flooding in a temporary lake, formed by a raft jam, Bossier Parish, La. (Photograph loaned by U. S. Geol. Survey.)



PLATE XXXV



Trees killed along the shores of the Illinois River by the permanent rise caused by water from Lake Michigan. Near the upper end of Quiver Lake, Havana, Ill., August, 1909. (Photograph, C. C. Adams.)



PLATE XXXVI



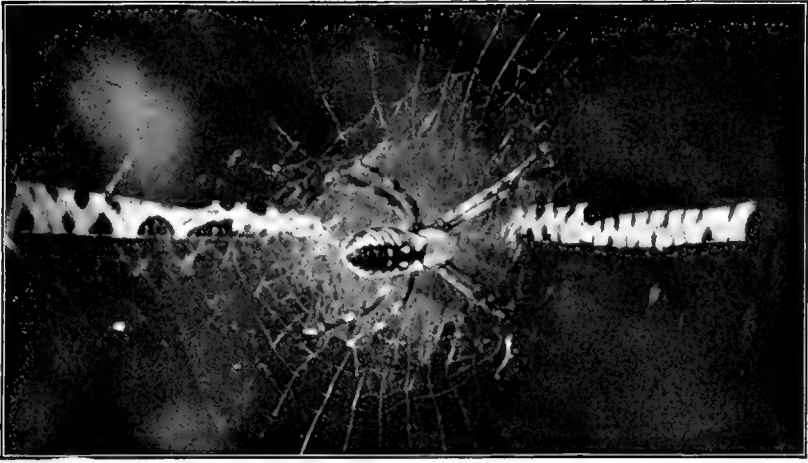
Prairie Crawfish, *Cambarus gracilis*: male (left), female (right), young (below). (Photograph loaned by Nellie Rietz Taylor.)

PLATE XXXVII

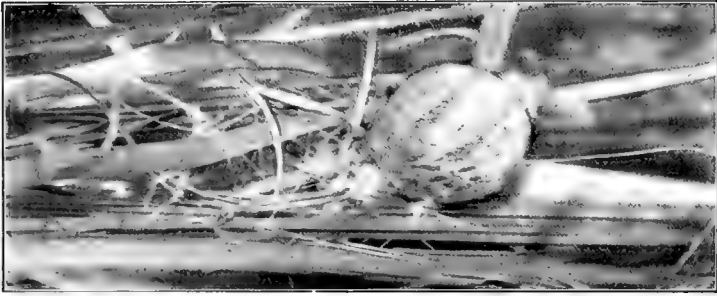
Prairie Species

- Fig. 1. Female Garden Spider, *Argiope aurantia*, in the middle of its web. Natural size. (Emerton, Common Spiders.)
- Fig. 2. Egg cocoon of same in marsh grass. Natural size. (Emerton, l.e.)
- Fig. 3. Polished Harvest-spider, *Liobunum politum*, male. Natural size. (Weed, Proc. U. S. Nat. Mus.)

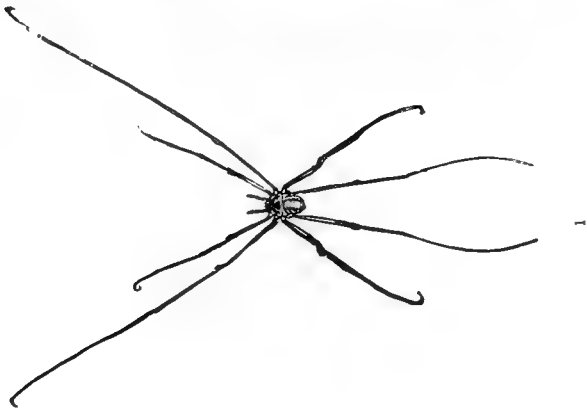
PLATE XXXVII



3



2



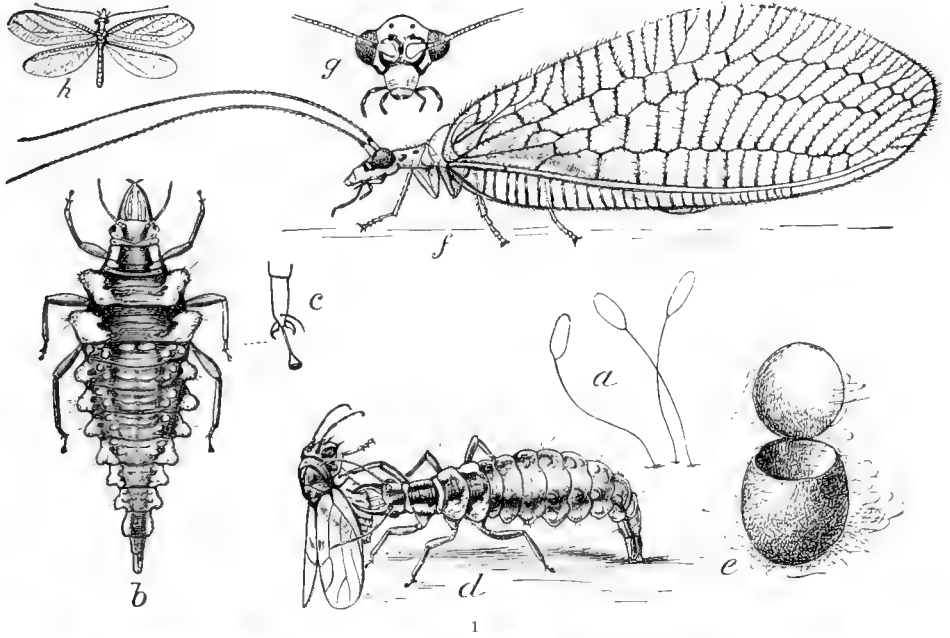
1

PLATE XXXVIII

Prairie Species

- Fig. 1. Lacewing, *Chrysopa oculata*: *a*, egg; *b*, larva; *c*, tarsus of larva; *d*, larva feeding upon an insect; *e*, egg-shell; *f*, adult lacewing; *g*, head of adult; *h*, adult, natural size. (Chittenden, Bur. Ent. U. S. Dept. Agr.)
- Fig. 2. Nine-spot Dragon-fly, *Libellula pulchella*, resting on swamp plants at Station I, *d*. (Photograph, T. L. Hankinson.)

PLATE XXXVIII



1



2

PLATE XXXIX

Prairie Species

- Fig. 1. Sordid Grasshopper, *Encoptolophus sordidus*, male. (Lugger, Rep. Ent. Minn. Exp. Sta.)
- Fig. 2. Red-legged Grasshopper, *Melanoplus femur-rubrum*. (Riley.)
- Fig. 3. Leather-colored Grasshopper, *Schistocerca alutacea*. (Lugger, l. c.)
- Fig. 4. Carolina Grasshopper, *Dissosteira carolina*. (Lugger, l. c.)
- Fig. 5. Differential Grasshopper, *Melanoplus differentialis*, male. (Lugger, l. c.)

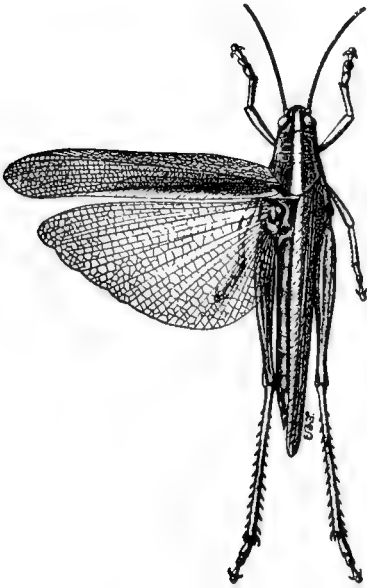
PLATE XXXIX



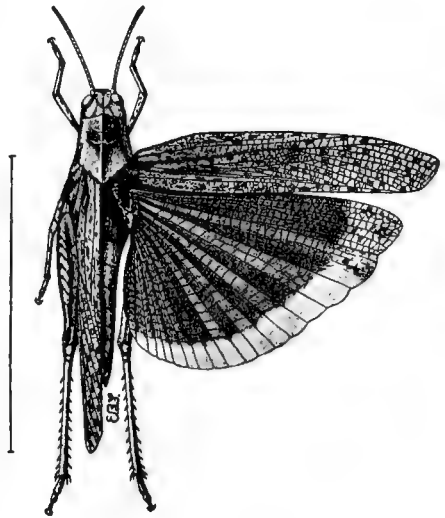
1



2



3



4



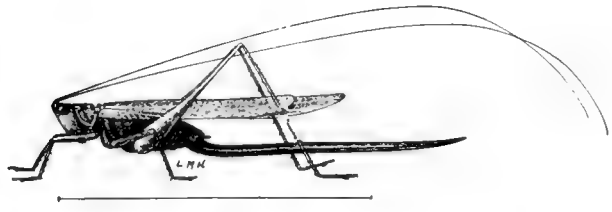
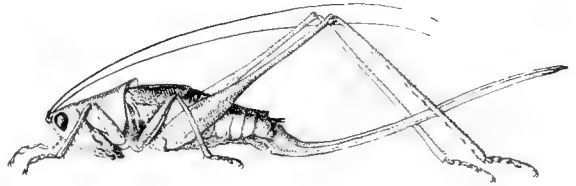
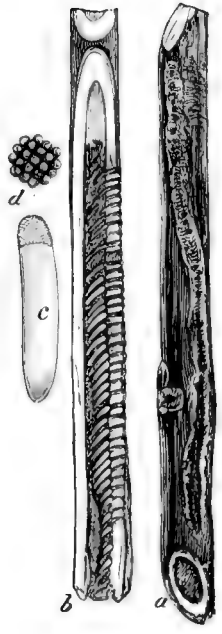
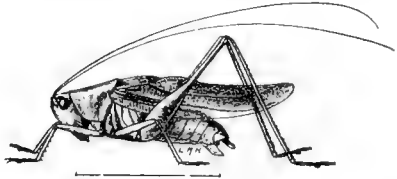
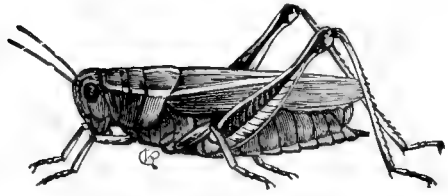
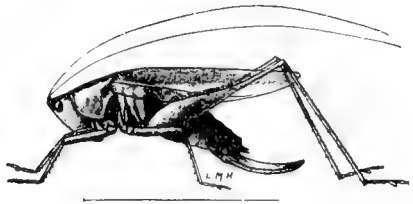
5

PLATE XL

Prairie Species

- Fig. 1. Differential Grasshopper, *Melanoplus differentialis*, female. (Riley.)
- Fig. 2. Common Meadow Grasshopper, *Orchelimum vulgare*, female. Enlarged as indicated. (Lugger, Rep. Ent. Minn. Exp. Sta.)
- Fig. 3. Two-striped Grasshopper, *Melanoplus bivittatus*, female. (Riley.)
- Fig. 4. Common Meadow Grasshopper, *Orchelimum vulgare*, male. Enlarged as indicated. (Lugger, l. c.)
- Fig. 5. Meadow Cricket, *Æcanthus*, eggs and punctures: *a*, stem showing punctures; *b*, twig split to show eggs; *c*, a single egg; *d*, cap of egg enlarged. (Riley, Rep. State Ent. Mo.)
- Fig. 6. Dorsal-striped Grasshopper, *Xiphidium strictum*, female.
- Fig. 7. Lance-tail Grasshopper, *Xiphidium attenuatum*, female. Enlarged as indicated. (Lugger, l. c.)

PLATE XL



5

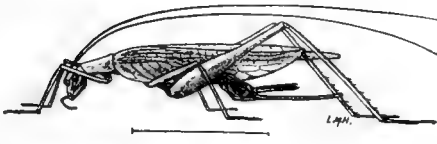
7

PLATE XLI

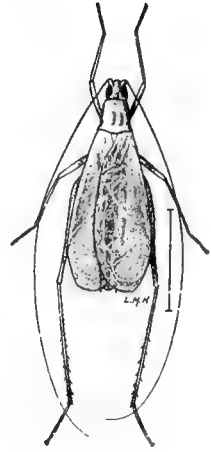
Prairie Species

- Fig. 1. Black-horned Meadow Cricket, *Æcanthus nigricornis*, female, enlarged as indicated (Lugger, Rep. Ent. Minn. Exp. Sta.); and basal joints of antennæ of *Æ. nigricornis* (left) and *quadripunctatus* (right) (after Hart, Ent. News).
- Fig. 2. The same, male. (Lugger, Rep. Ent. Minn. Exp. Sta.)
- Fig. 3. Stink-bug, *Euschistus variolarius*.
- Fig. 4. Rapacious Soldier-bug, *Sinea diadema*. Enlarged as indicated. (Riley, Rep. State Ent. Mo.)
- Fig. 5. *Stiretrus anchorago*: a, adult; b, nymph. (Riley, Bur. Ent. U. S. Dept. Agr.)

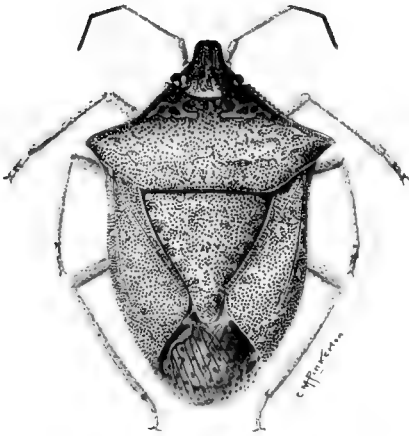
PLATE XLI



1



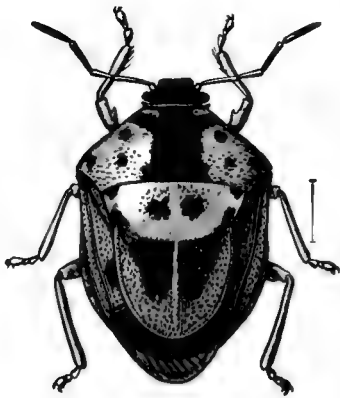
2



3



4



a



b

5

PLATE XLIII

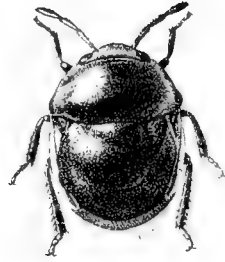
Prairie Species

- Fig. 1. Small Milkweed Bug, *Lygaeus kalmii*. Enlarged.
Fig. 2. Flea Negro-bug, *Thyreocoris pulicarius*. Enlarged.
Fig. 3. Large Milkweed Bug, *Oncopeltus fasciatus*. (Uhler, Standard Nat. Hist.)
Fig. 4. Ambush Bug, *Phymata fasciata*: *a*, dorsal view; *b*, side view; *c*, front clasping leg; *d*, sucking beak. (Riley, Bur. Ent. U. S. Dept. Agr.)
Fig. 5. Dusky Leaf-bug, *Adelphocoris rapidus*, nymph.
Fig. 6. The same, adult.

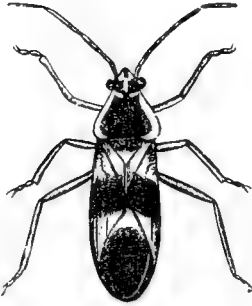
PLATE XLII



1



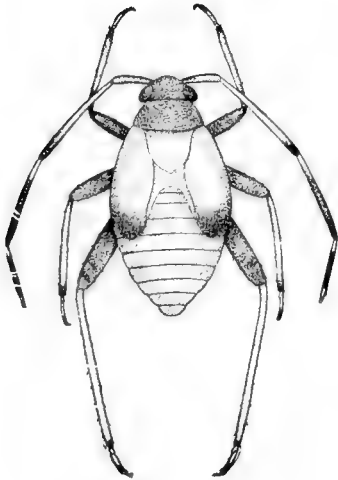
2



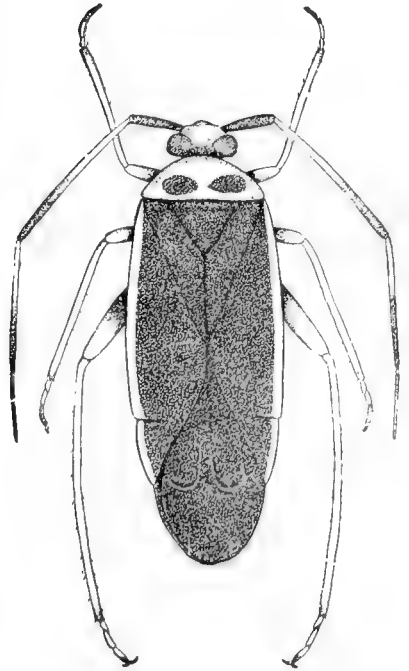
3



4



5



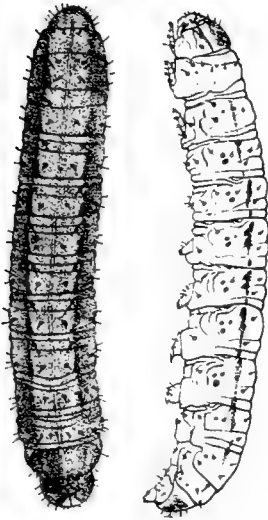
6

PLATE XLIII

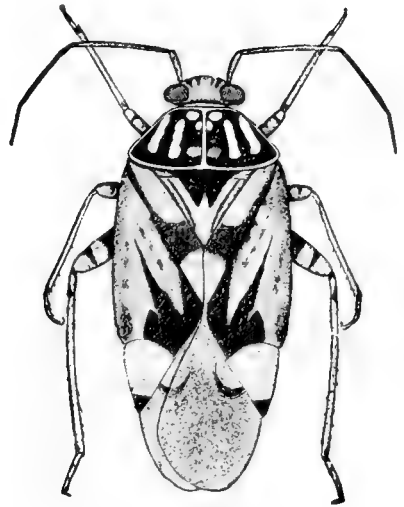
Prairie Species

- Fig. 1. Dingy Cutworm, *Feltia subgöthica*, dorsal and lateral views.
Fig. 2. Moth of same, with wings spread and with wings folded. (Riley, Rep. State Ent. Mo.)
Fig. 3. Tarnished Plant-bug, *Lygus pratensis*.
Fig. 4. Nymph of same.
Fig. 5. Pennsylvania Soldier-beetle, *Chauliognathus pennsylvanicus*:
 a, larva; *b*, head of larva (enlarged); *c*, *d*, *e*, *f*, *g*, and *h*,
 structural details of larva. (Riley, Rep. State Ent. Mo.)
Fig. 6. Adult of same. (Riley, l. c.)

PLATE XLIII



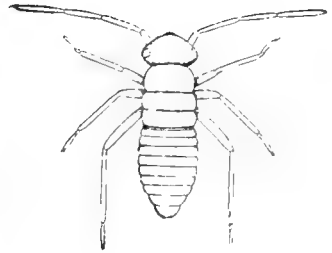
1



3



2



4



5



6

PLATE XLIV

Prairie Species

- Fig. 1. Two-lined Soldier-beetle, *Telephorus bilineatus*: *a*, larva; *b*, head of larva; *c*, beetle. (Riley, Rep. State Ent. Mo.)
- Fig. 2. Nine-spotted Ladybird, *Coccinella novemnotata*. (After Felt, Mem. N. Y. State Mus.)
- Fig. 3. Indian Cetonia, *Euphoria inda*: *a*, beetle; *b*, egg; *c*, young larva; *d*, mature larva; *e*, pupa. About twice natural size. (Chittenden, Bull. Bur. Ent. U. S. Dept. Agr.)
- Fig. 4. Black Flower-beetle, *Euphoria sepulchralis*. Enlarged.
- Fig. 5. Spotted Grape Beetle, *Pelidnota punctata*: *a*, larva; *b*, pupa in its cell; *c*, beetle; *d*, tip of larval abdomen; *e*, antenna of larva; *f*, leg of larva. (Riley, Rep. State Ent. Mo.)

PLATE XLIV

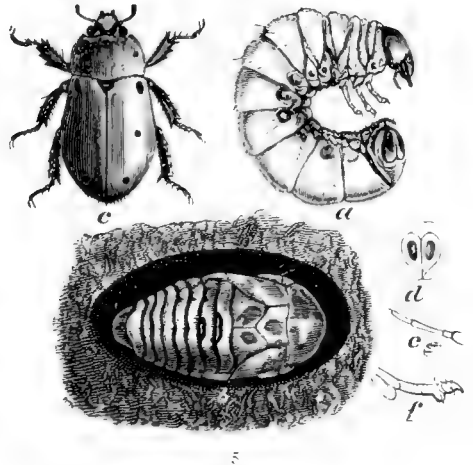
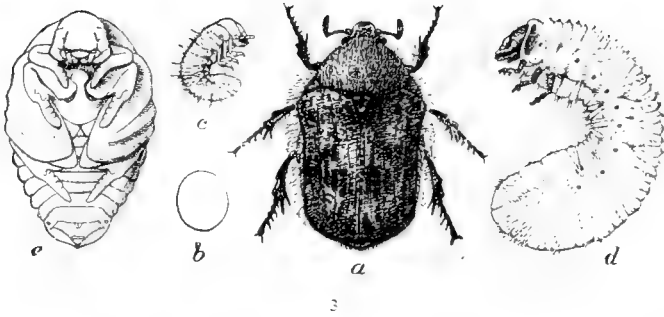
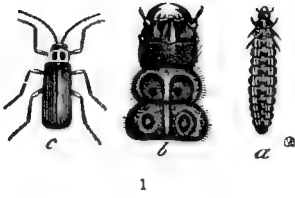
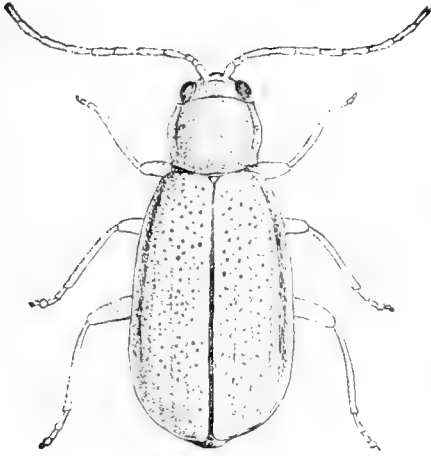


PLATE XLV

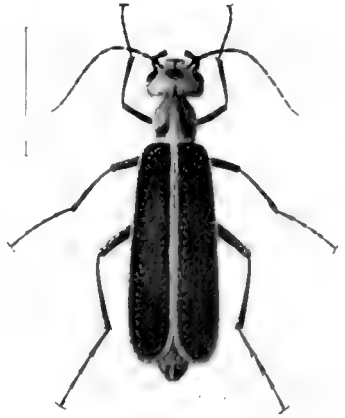
Prairie Species

- Fig. 1. Western Corn Root-worm beetle, *Diabrotica longicornis*. Enlarged.
- Fig. 2. Margined Blister-beetle, *Epicauta marginata*.
- Fig. 3. Southern Corn Root-worm beetle, *Diabrotica 12-punctata*. Enlarged.
- Fig. 4. Bill-bug, *Sphenophorus venatus*.
- Fig. 5. Striped Blister-beetle, *Epicauta vittata*: *a*, female beetle; *b*, eggs; *c*, young (triangulin) larva; *d*, second or caraboid stage; *e*, contracted scarabæoid stage, natural size; *f*, scarabæoid stage; *g*, coarctate larva, or winter stage. (Hittenden, Bull. Bur. Ent. U. S. Dept. Agr.; *b-g*, after Riley, Trans. St. Louis Acad. Sci.)

PLATE XLV



1



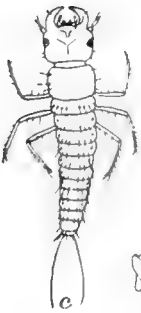
2



3



4



e



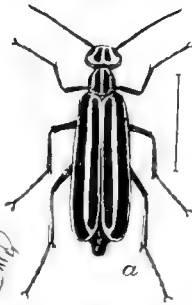
b



d



e



a



f



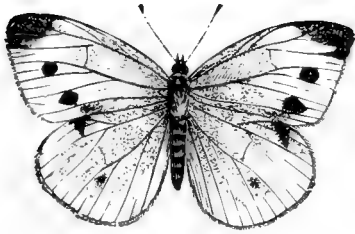
g

PLATE XLVI

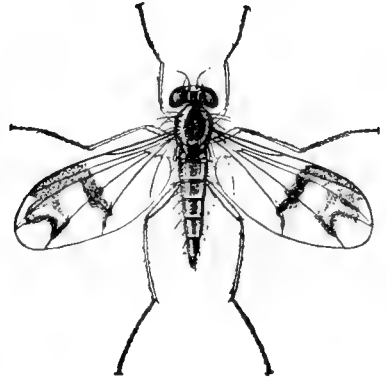
Prairie Species

- Fig. 1. Cabbage-worm Butterfly, *Pontia rapae*, female. (Riley, Rep. State Ent. Mo.)
- Fig. 2. Metallic Milkweed Fly, *Psilopus siphæ*, male. Enlarged. (Washburn, Rep. State Ent. Minn.)
- Fig. 3. Milkweed Butterfly larva, *Anosia plecippus*. (Riley, Rep. State Ent. Mo.)
- Fig. 4. Caterpillar Gall, *Gnorimoschema gallsolidaginis*. (Cook, Rep. Ind. Dept. Geol. and Nat. Res.)
- Fig. 5. Goldenrod Bunch Gall, formed by the midge *Cecidomyia solidaginis*. (Beutenmüller, Amer. Mus. Journ.)
- Fig. 6. Vertebrated Robber-fly, *Promachus vertebratus*, male. (Washburn, Rep. State Ent. Minn.)

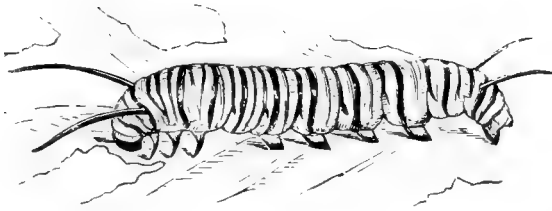
PLATE XLVI



1



2



3



4



5

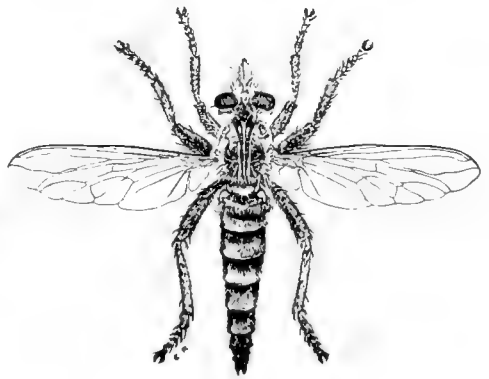
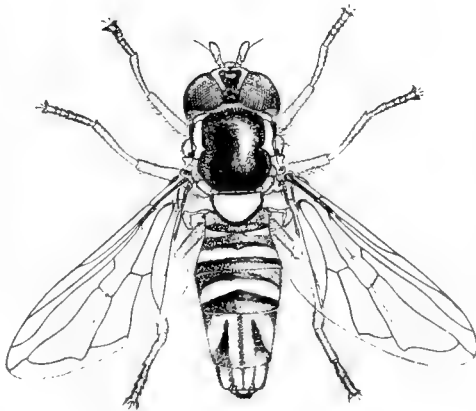
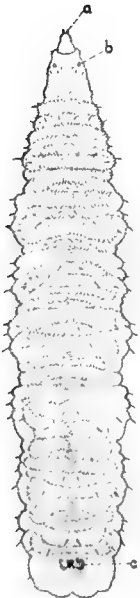
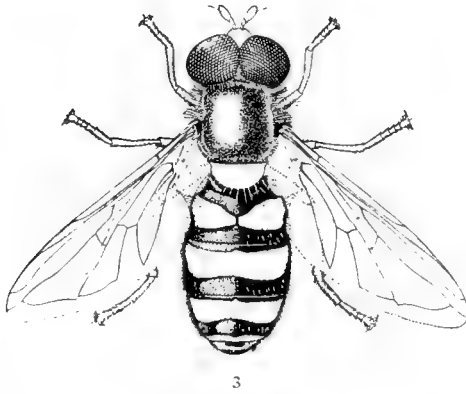
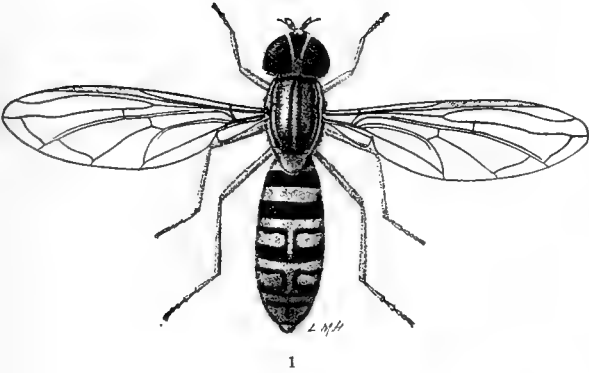


PLATE XLVII

Prairie Species

- Fig. 1. Corn Syrphid Fly, *Mesogramma politum*. Enlarged.
Fig. 2. Larva of same. Enlarged. (Sanderson, Rep. Del. Exp. Sta.)
Fig. 3. Syrphid fly, *Syrphus americanus*. (Metcalf, Bull. Ohio Biol. Surv.)
Fig. 4. Puparium of same. (Metcalf, l. c.)
Fig. 5. Larva of same. (Metcalf, l. c.)
Fig. 6. Syrphid fly, *Allograpta obliqua*. (Metcalf, l. c.)
Fig. 7. Larva of same. (Metcalf, l. c.)

PLATE XLVII



5

6

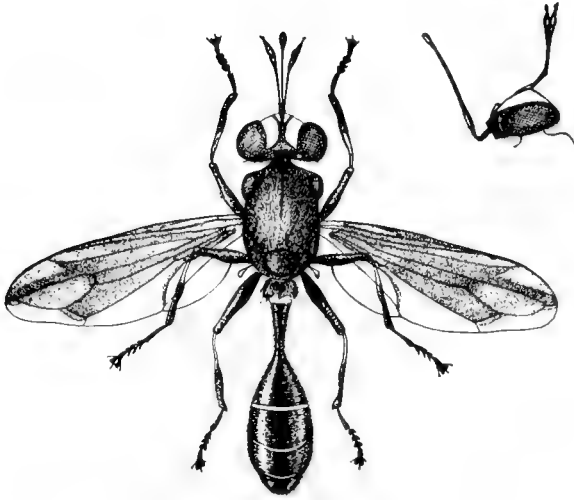
7

PLATE XLVIII

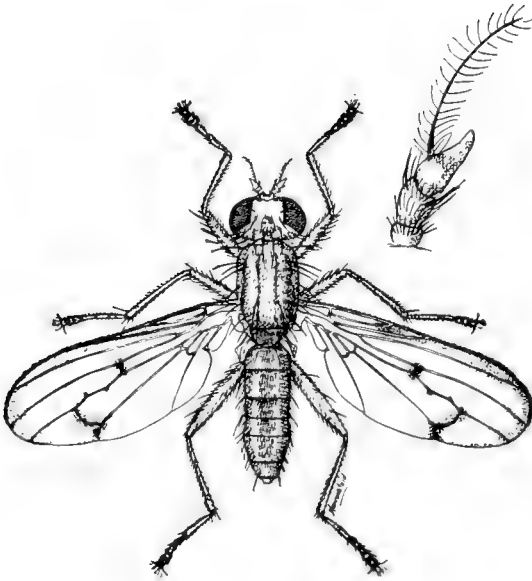
Prairie Species

- Fig. 1. Conopid fly, *Physocephala tibialis*, and side view of head.
(Washburn, Rep. State Ent. Minn.)
- Fig. 2. Sciomyzid fly, *Tetanocera plumosa*, and profile of antenna.
(After Washburn, l. c.)

PLATE XLVIII



1



2

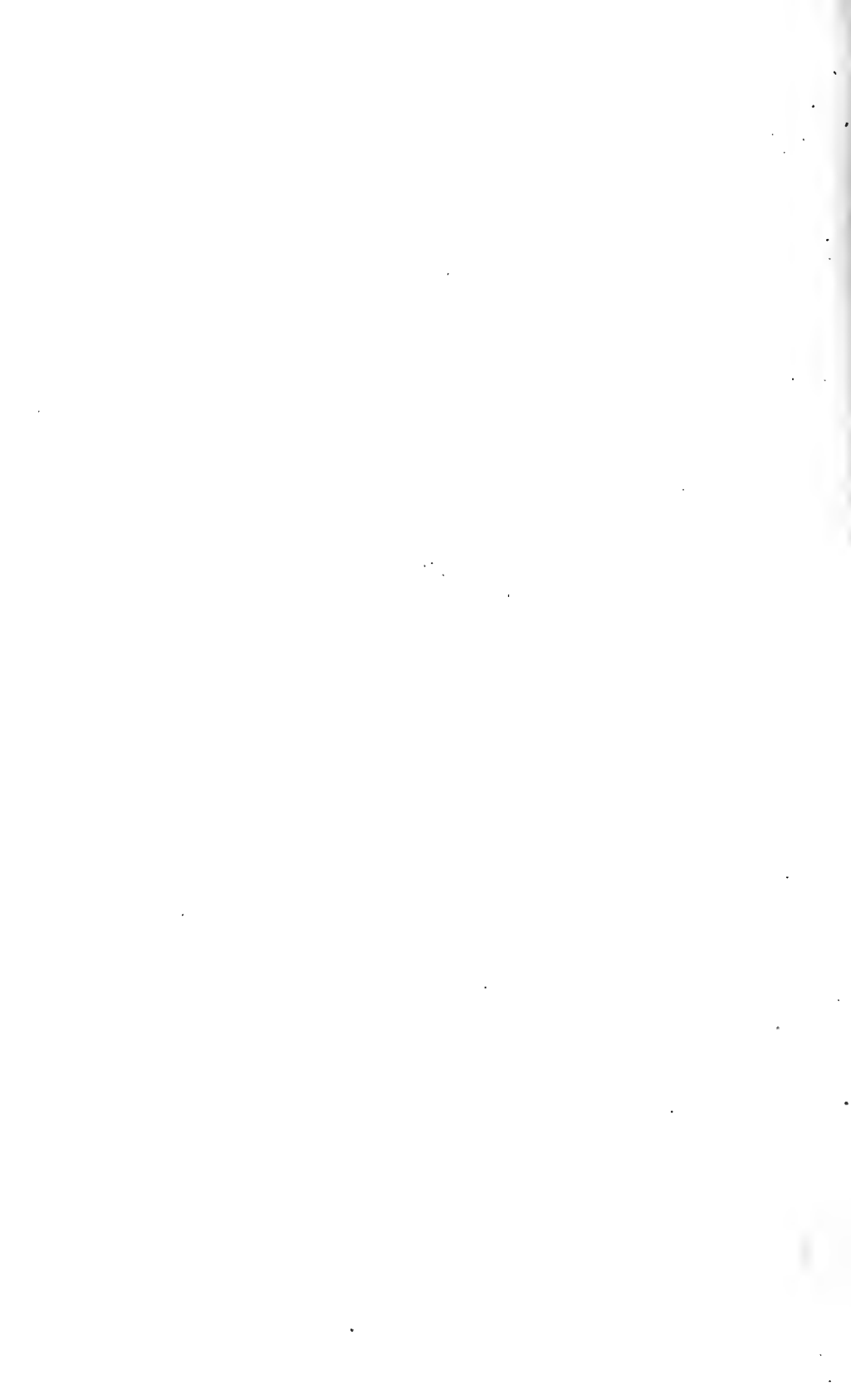
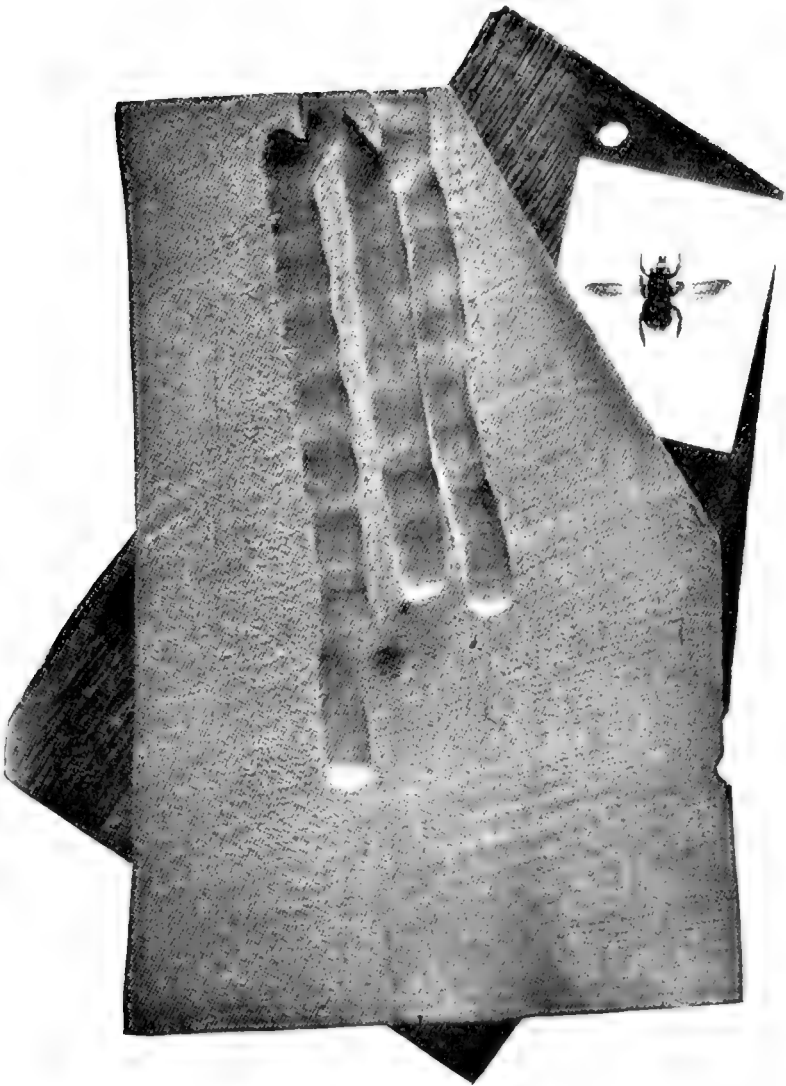


PLATE XLIX



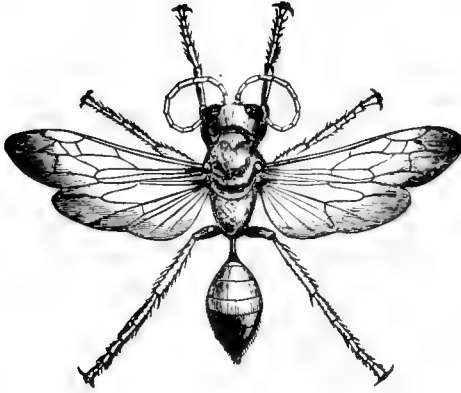
Carpenter-bee, *Xylocopa virginica*: the bee and its tunnels in wood. (After Felt Mem. N. Y. State Mus.)

PLATE L

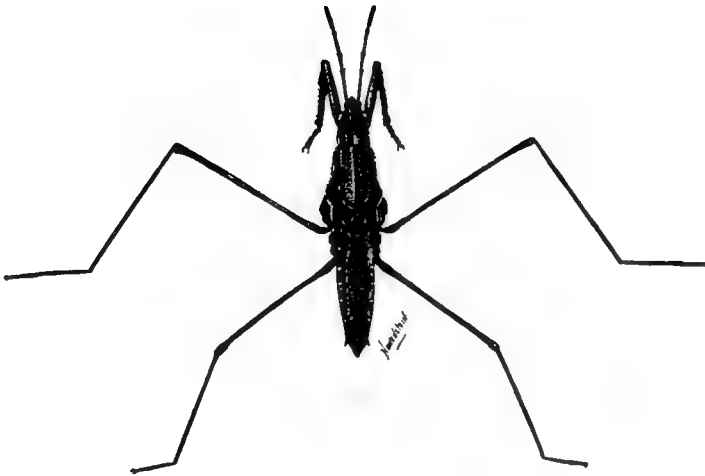
Prairie Species

- Fig. 1. Rusty Digger-wasp, *Chlorion ichneumoneum*. (J. B. Smith, Ins. of N. J.)
- Fig. 2. Water-strider, *Gerris remigis*. (Lugger, Rep. Ent. Minn. Exp. Sta.)

PLATE L



1



2

PLATE LI

Forest Species

- Fig. 1. Harvest-spider, *Liobunum ventricosum*. (Weed, Proc. U. S. Nat. Mus.)
- Fig. 2. Forest Snail, *Polygyra albolabris*, dorsal view. (Simpson.)
- Fig. 3. The same, lateral view. (Simpson.)

PLATE LI

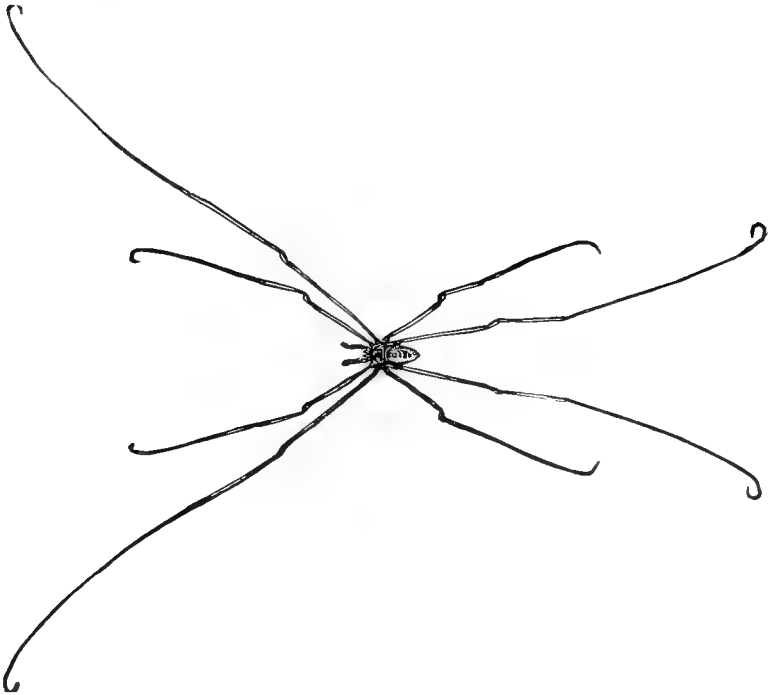


PLATE LII

Forest Species

- Fig. 1. Island Epeirid, *Epeira insularis*, male. (Emerton, Common Spiders.)
- Fig. 2. The same, female. Twice enlarged. (Emerton, l. c.)
- Fig. 3. Web of *Epeira insularis*, with nest above, among leaves. One third natural size. (Emerton, l. c.)

PLATE LII

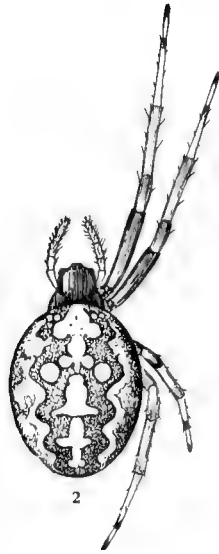
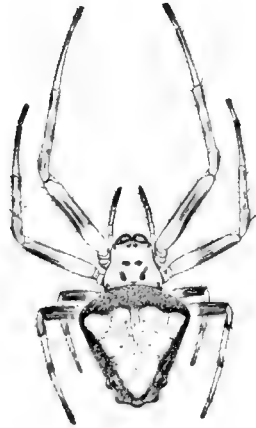
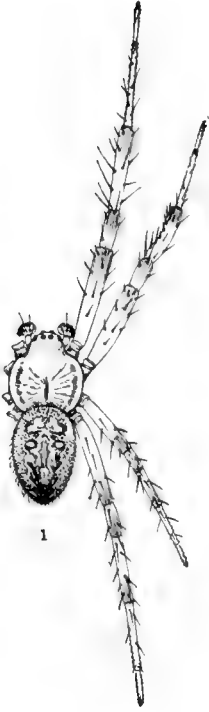


PLATE LIII

Forest Species

- Fig. 1. Three-lined Epeirid, *Epeira trivittata*, male. Enlarged four times. (Emerton, Common Spiders.)
- Fig. 2. The same, female. Enlarged four times. (Emerton, l. c.)
- Fig. 3. White-triangle Spider, *Epeira verrucosa*, male. Enlarged twice. (Emerton, l. c.)
- Fig. 4. The same, female. Enlarged twice. (Emerton, l. c.)

PLATE LIII



3

4

PLATE LIV

Forest Species

- Fig. 1. Rugose Spider, *Acrosoma rugosa*, female. Enlarged four times.
(Emerton, Common Spiders.)
- Fig. 2. Lycosid spider, *Lycosa scutulata*, female. Twice enlarged.
(Emerton, l. c.)
- Fig. 3. Spined Spider, *Acrosoma spinea*, male. Enlarged four times.
(Emerton, l. c.)
- Fig. 4. The same, female. Enlarged four times. (Emerton, l. c.)
- Fig. 5. Web of Spined Spider, *Acrosoma spinea*. (Emerton, l. c.)

PLATE LIV



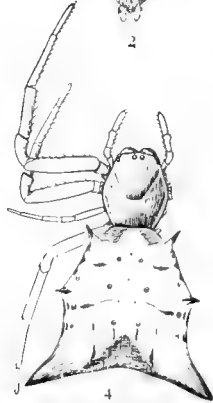
1



2



3



4



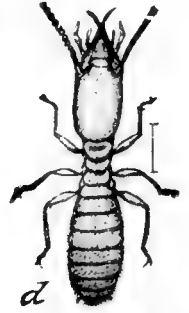
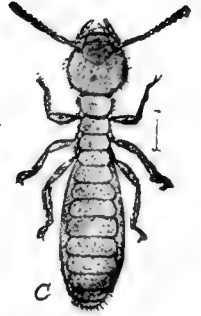
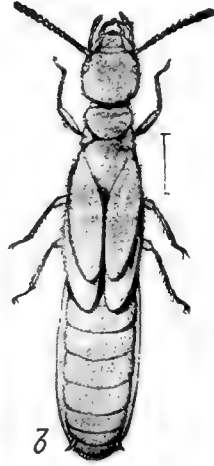
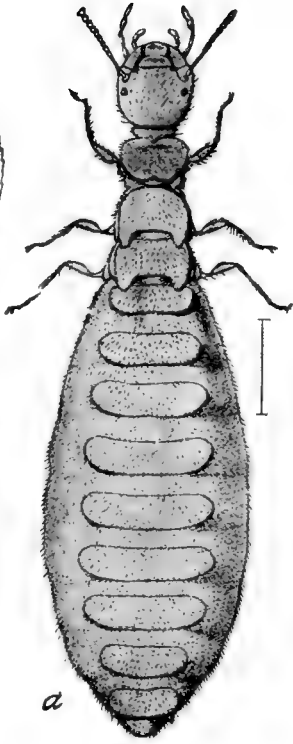
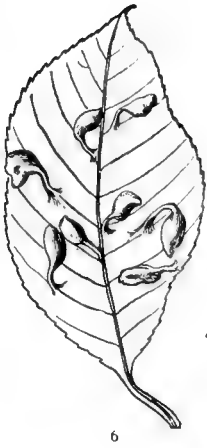
5

PLATE LV

Forest Species

- Fig. 1. Galls of Cherry-leaf Gall-mite, *Acarus serotinus*. (Beutenmüller, Bull. Amer. Mus. Nat. Hist.)
- Fig. 2. White Ant, *Termes flavipes*: *a*, queen; *b*, young of winged female; *c*, worker; *d*, soldier. All enlarged as indicated. (After Marlatt, Bull. Bur. Ent. U. S. Dept. Agr.)
- Fig. 3. Periodical Cicada, *Tibicen septendecim*. Young nymph, newly hatched. Greatly enlarged. (Lugger, Rep. Ent. Minn. Exp. Sta.)
- Fig. 4. The same: *A*, male, typical form (natural size); *c*, *d*, genital hooks of same (enlarged); *g*, sounding apparatus; *B*, male of small form (*cassinii*), natural size; *e*, *f*, genital hooks (enlarged). (Lugger, l. c.)
- Fig. 5. Dog-day Harvest-fly, *Cicada linnei*, male. (Lugger, l. c.)

PLATE LV



3

2

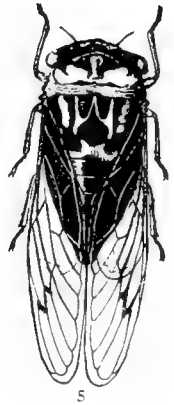
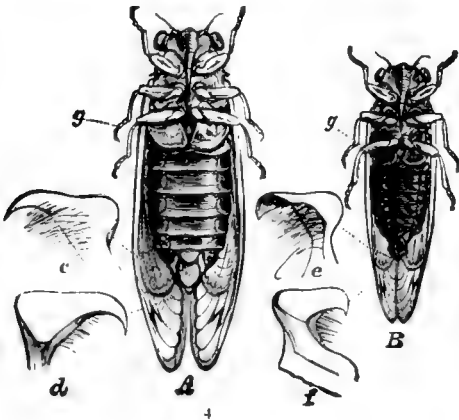


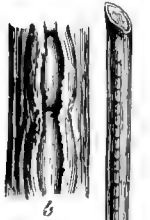
PLATE LVI
Forest Species

- Fig. 1. Mealy Flata, *Ormenis pruinosa*. Enlarged as indicated. (Riley, Rep. State Ent. Mo.)
- Fig. 2. Eggs of same: *a*, form and arrangement of the eggs; *b*, insertion in twig; *c*, row of eggs in twig. Enlarged. (Riley, l. c.)
- Fig. 3. Leaf-hopper, *Aulacizes irrorata*. Much enlarged. (Sanderson, Bull. Bur. Ent. U. S. Dept. Agr.)
- Fig. 4. Pennsylvania Cockroach, *Ischnoptera pennsylvanica*, male. Enlarged as indicated. (Blatchley, Rep. Ind. Dept. Geol. and Nat. Res.)
- Fig. 5. The same, female. (Blatchley, l. c.)
- Fig. 6. Forest Walking-stick, *Diaperomera femorata*, male. (Lugger, Rep. Ent. Minn. Exp. Sta.)
- Fig. 7. Spined Stilt-bug, *Jalysus spinosus*. (Lugger, l. c.)
- Fig. 8. Plant-bug, *Acanthocerus galeator*.

PLATE LVI



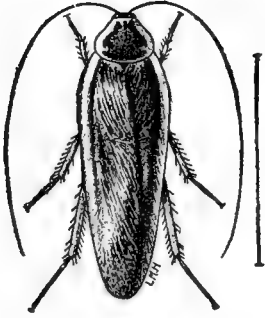
1



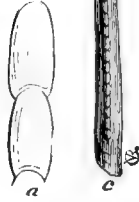
b



3



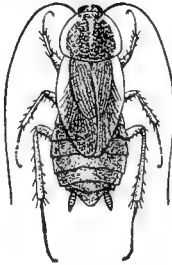
4



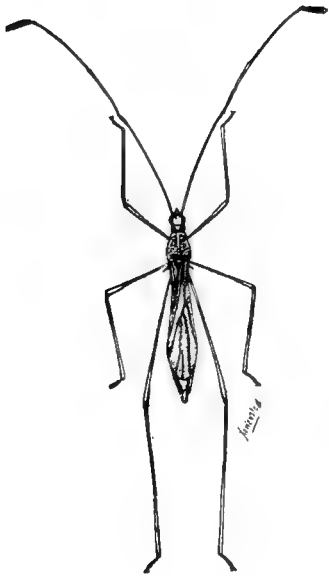
a

c

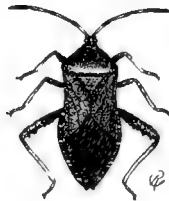
2



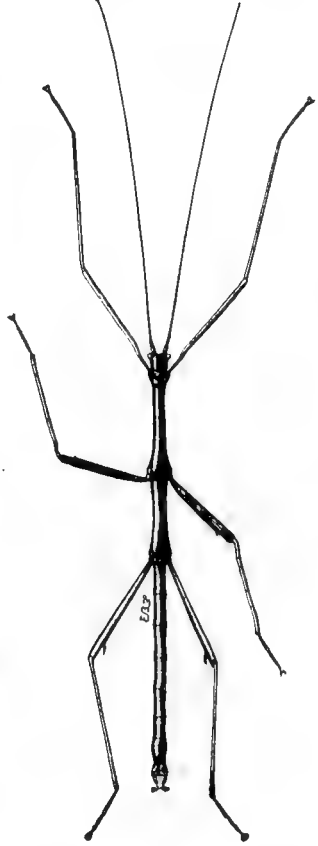
5



7



6



8

PLATE LVII

Forest Species

- Fig. 1. Common Katydid, *Cyrtophyllus perspicillatus*, male. (Lugger, Rep. Ent. Minn. Exp. Sta.)
- Fig. 2. Round-winged Katydid, *Amblycorypha rotundifolia*; *b*, apex of ovipositor (enlarged). (Riley, Rep. State Ent. Mo.)
- Fig. 3. Grouse Locust, *Tettigidea lateralis*. Enlarged as indicated. (Lugger, Rep. Ent. Minn. Exp. Sta.)
- Fig. 4. Boll's Grasshopper, *Spharagemon bolli*, male. Enlarged as indicated. (Lugger, l. c.)
- Fig. 5. Forked Katydid, *Scudderia furcata*, male. (Lugger, l. c.)
- Fig. 6. Sprinkled Grasshopper, *Chlocaltis conspersa*, female. (Lugger, l. c.)
- Fig. 7. Short-winged Grasshopper, *Dichromorpha viridis*. Enlarged as indicated. (Lugger, l. c.)
- Fig. 8. Lesser Grasshopper, *Melanoplus atlaxia*, female. Enlarged as indicated. (Lugger, l. c.)

PLATE LVII

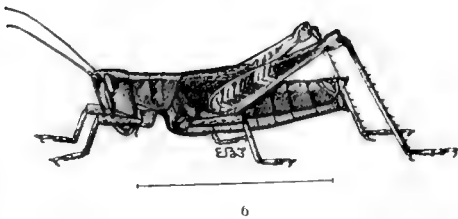
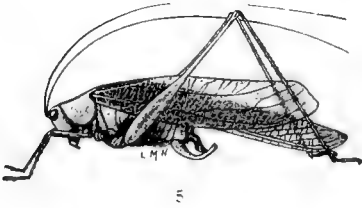
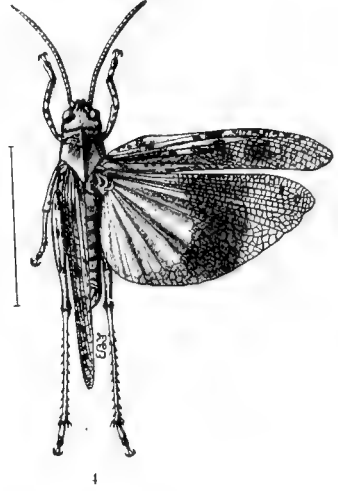
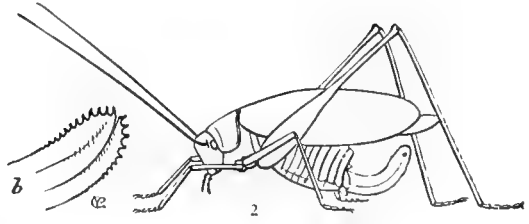
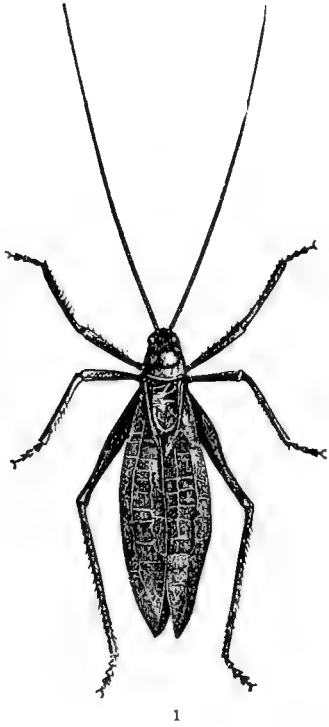
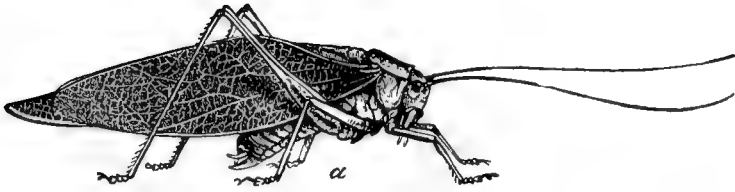


PLATE LVIII

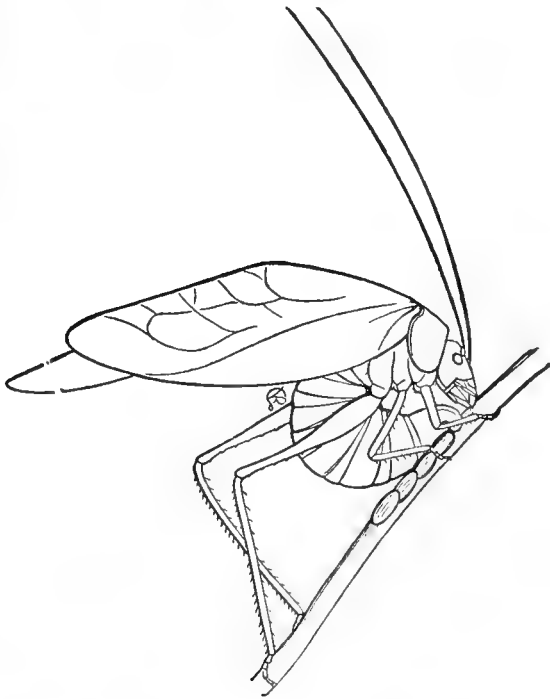
Forest Species

- Fig. 1. Angle-winged Katydid, *Microcentrum laurifolium*, male.
(Riley, Rep. State Ent. Mo.)
- Fig. 2. Female of same, ovipositing. (Riley, i. c.)
- Fig. 3. Firefly, *Photuris pennsylvanica*: *a*, larva (enlarged as indicated); *b*, leg of larva (enlarged); *c*, beetle. (J. B. Smith, Ins. of N. J.)
- Fig. 4. Reticulate Calopteron, *Calopteron reticulatum*. (Blatchley, Coleopt. of Ind.)
- Fig. 5. Horned Passalus, *Passalus cornutus*: *a*, larva; *b*, pupa, from side; *c*, beetle; *d*, ventral view of legs; *e*, rudimentary hind leg of larva. (Riley, Rep. State Ent. Mo.)
- Fig. 6. Striped Cricket, *Nemobius fasciatus*, form *vittatus*, female.
(Lugger, Rep. Ent. Minn. Exp. Sta.)

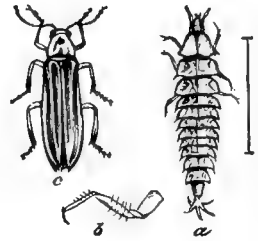
PLATE LVIII



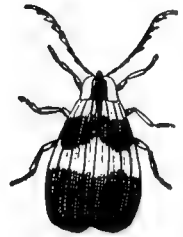
1



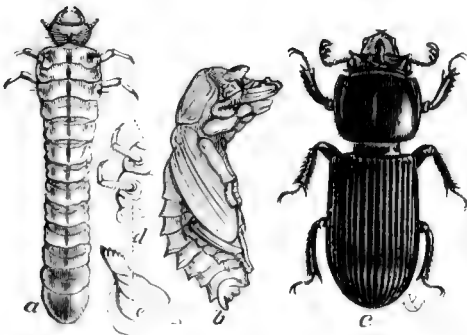
2



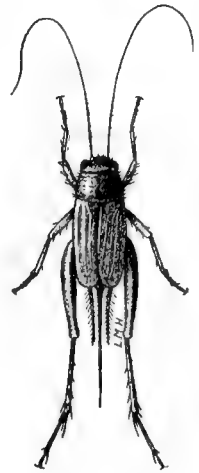
3



4



5



6

PLATE LIX

Forest Species

- Fig. 1. Horned Fungus-beetle, *Boletotherus bifurcus*. Dorsal view of male (enlarged). (After Felt, Mem. N. Y. State Mus.)
- Fig. 2. The same, dorsal view of female (enlarged). (After Felt, l. c.)
- Fig. 3. The same, side view of male (enlarged). (After Felt, l. c.)
- Fig. 4. *Dendroides canadensis*: *a*, larva (enlarged as indicated); *b*, pupa (enlarged as indicated); *c*, female beetle (enlarged as indicated); *d*, enlarged anal fork of larva; *f*, antenna of male (enlarged). (Le Baron, Rep. State Ent. Ill.)
- Fig. 5. *Papilio philenor*, caterpillar. (Riley, Rep. State Ent. Mo.)
- Fig. 6. American Silkworm Moth, *Telea polyphemus*. (After Felt, Mem. N. Y. State Mus.)

PLATE LIN

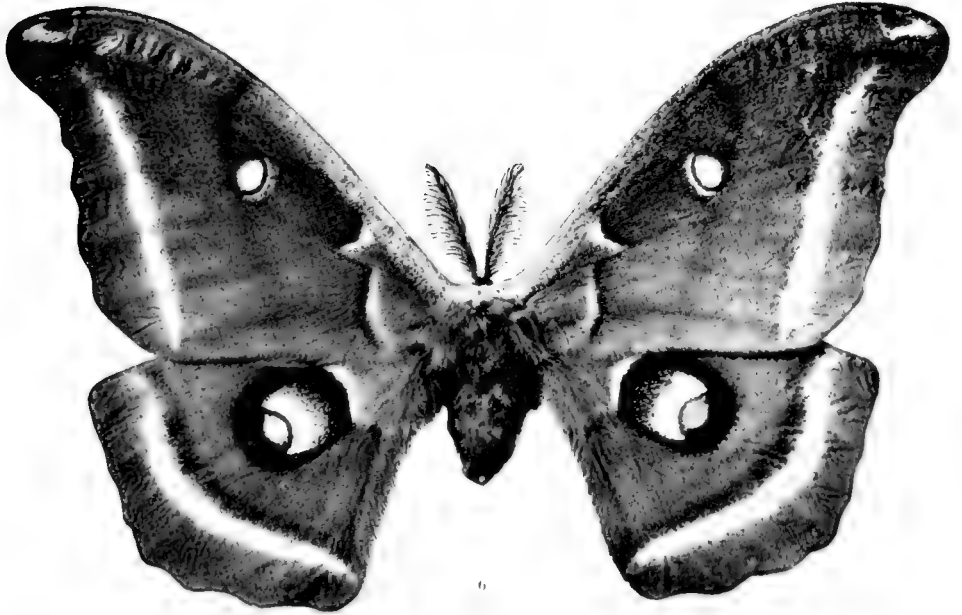
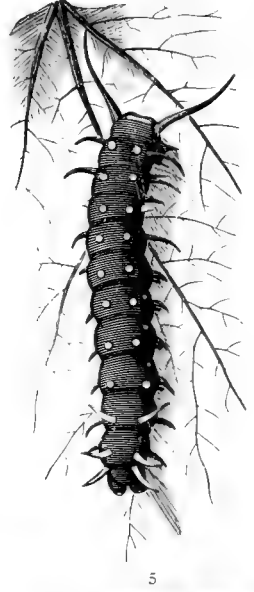
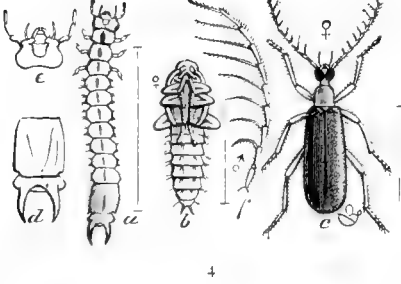
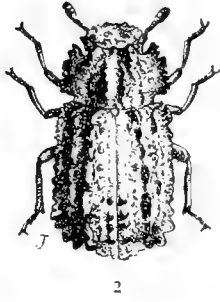
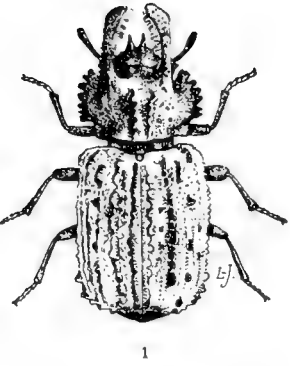


PLATE LX

Forest Species

- Fig. 1. Hickory Horned-devil, the larva of *Citheronia regalis*. (After Packard, Mem. Nat. Acad. Sei.)
- Fig. 2. Royal Walnut Moth, *Citheronia regalis*. (After Felt, Mem. N. Y. State Mus.)

PLATE LX



1



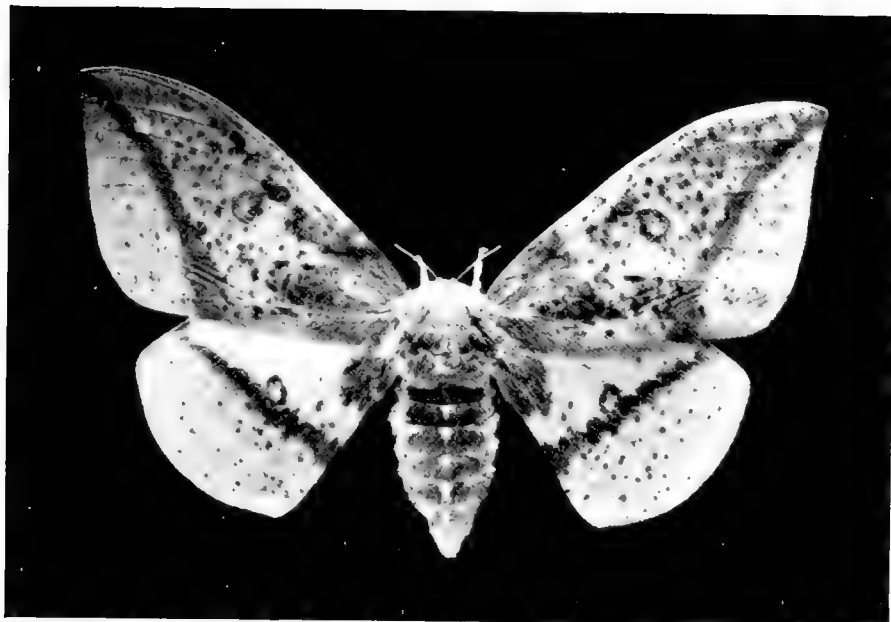
2

PLATE LXI

Forest Species

- Fig. 1. Imperial Moth, *Basilona imperialis*. (After Felt, Mem. N. Y. State Mus.)
- Fig. 2. *Nadata gibbosa*, moth. (After Packard, Mem. Nat. Acad. Sci.)
- Fig. 3. *Heterocampa guttivitta*, male moth. (After Packard, Mem. Nat. Acad. Sci.)
- Fig. 4. *Halisidota tessellaris*, moth.
- Fig. 5. *Heterocampa guttivitta*, female moth. (After Packard, Mem. Nat. Acad. Sci.)

PLATE LXI



1



2



3



4



5

PLATE LXII

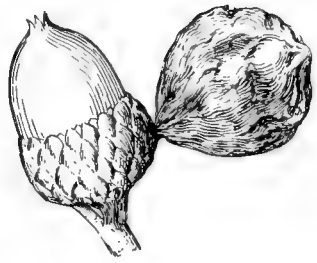
Forest Species

- Fig. 1. Spanworm moth, *Eustroma diversilineata*.
Fig. 2. Acorn Plum-gall, *Amphibolips prunus*. (Beutenmüller, Amer. Mus. Journ.)
Fig. 3. Horned Knot Oak-gall, *Andricus cornigerus*. (Beutenmüller, Bull. Am. Mus. Nat. Hist.)
Fig. 4. Oak Wool-gall, *Andricus lana*. (Beutenmüller, l. c.)
Fig. 5. White Oak Club-gall, *Andricus clavula*. (Beutenmüller, l. c.)
Fig. 6. Ant. *Cremastogaster lineolata*, worker.

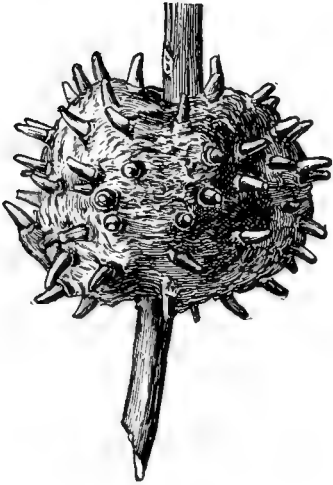
PLATE LXII



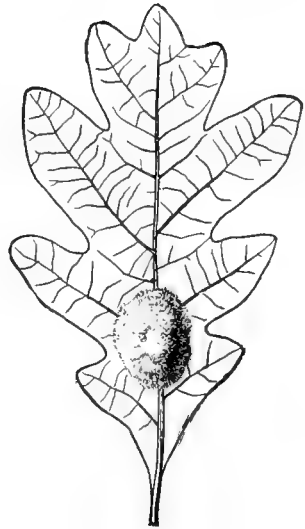
1



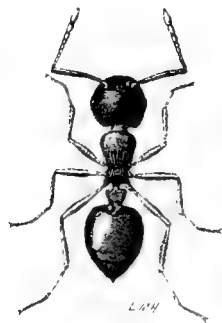
2



3



4



5

PLATE LXIII

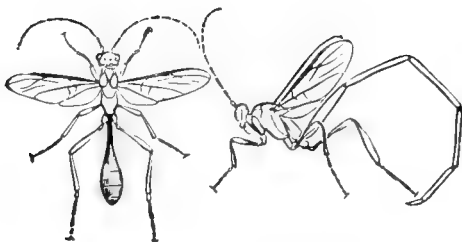
Forest Species.

- Fig. 1. Oak Seed-gall, *Andricus seminator*. (Cook, Rep. Ind. Dept. Geol. and Nat. Res.)
- Fig. 2. Black Longtail, *Pelecinus polyturator*: *a*, male; *b*, female. (J. B. Smith, Ins. of N. J.)

PLATE LXIII



1



2

BULLETIN
OF THE
ILLINOIS STATE LABORATORY
OF
NATURAL HISTORY

URBANA, ILLINOIS, U. S. A.

STEPHEN A. FORBES, PH. D., LL. D.,
DIRECTOR

VOL. XI.

SEPTEMBER, 1915

ARTICLE III.

THE VERTEBRATE LIFE OF CERTAIN PRAIRIE AND FOREST
REGIONS NEAR CHARLESTON, ILLINOIS

BY

T. L. HANKINSON

CONTENTS

	PAGE
Introduction	281
The prairie area, Station I.....	282
Amphibians and reptiles.....	284
Birds	284
Mammals	288
Relation of the prairie vertebrates to their environment.....	289
The forest area, Station II.....	291
Fish, amphibians and reptiles	293
Birds	294
Mammals	297
Supplementary list of birds	298
Supplementary list of mammals	299
Relation of the woodland vertebrates to their environment	299
Summary and conclusions	301

ARTICLE III.—*The Vertebrate Life of certain Prairie and Forest Regions near Charleston, Illinois.* BY T. L. HANKINSON.

INTRODUCTION

During August, 1910, a study was made of the biological conditions of a piece of prairie and a piece of woodland near Charleston, Coles County, Illinois, by Mr. Charles C. Adams, of the University of Illinois, who studied the invertebrates; by Mr. E. N. Transeau, of the Eastern Illinois State Normal School, at Charleston, who studied the plants; and by the writer, who gave particular attention to the vertebrate life. Embodied in this paper are the notes taken at this time on the vertebrates, together with other notes on vertebrates taken during occasional visits to the places since then.

The two areas chosen for the work here reported are located as follows. The prairie, in section 35, township 13 N., range 9 E., is a bit of right-of-way of the Toledo, St. Louis and Western Railroad, about two miles north of the center of the city of Charleston, extending some sixteen hundred feet along the east side of the track, just north of the east and west wagon-road which here crosses the railroad. This place will be frequently referred to in this paper as Station I. The woodland, chiefly in section 5, township 12 N., range 10 E., is about three and a half miles northeast of the center of Charleston and covers about one hundred and sixty acres of the farm owned by Mr. J. I. Bates. We called this Bates woods—Station II of this paper. These two areas are shown on the map, Plate LXIV.

In selecting areas for special study, an attempt was made to get those as little disturbed by man as possible and representing at the same time the two prevailing types of country about Charleston, namely, *forest* and *prairie*. Such conditions are hard to find in a region so extensively cultivated as Coles County. In a part of the country of this character the most extensive representations of original prairie features are usually along railway rights-of-way. This fact governed us in the selection of Station I as representative prairie. As representative forest, Bates woods (Station II) was chosen, because it seemed less disturbed than any other piece of forest available for study.

To one or the other of these stations almost daily visits were made during August, 1910. The writer's data were obtained chiefly by watching animals. It was possible to identify most of the birds positively without shooting them. Binocular field-glasses constituted the most useful instrument for the work. For small mammals, furthermore, considerable trapping was done. The results of the efforts to find vertebrates, made by the writer and by his co-workers (incidentally—while doing their special parts of the field work), were on the whole disappointing. Yet the methods seemed little at fault, for they were of a well-tested kind. It is very evident that vertebrates were not present in any considerable numbers, either as individuals or species, in either of the regions. Hence this contribution on the vertebrate life of the two areas is unimportant as compared with the other parts of the report on the life of this region.

The writer is under considerable obligation to Mr. C. B. Cory for naming a few birds and mammals for him; to Mr. A. G. Ruthven for naming amphibians and reptiles; and to his collaborators in the field, Mr. E. N. Transeau and Mr. C. C. Adams, both of whom gave him information and other help in doing the work on vertebrates.

THE PRAIRIE AREA, STATION I

The prairie region studied, lies, as before stated, along the Toledo, St. Louis and Western Railroad (known as the Clover Leaf Road). It is approximately sixteen hundred feet long by forty feet in width. A line of telegraph poles, placed two hundred feet apart and supporting five wires, runs the length of it. Plates LXV, LXVI, and LXVII, Fig. 1, will give one a general idea of the place.

The surface of the area is uneven. Near its middle is a marked depression, a few hundred feet in length and with a bottom five or six feet below the railroad-track bed. This is a west extension of a large piece of low ground comprising eight or nine acres of the field just east of the area studied. Commonly the ground here is wet, and it may be covered with water, forming a pool with its west margin at Station I. Marsh conditions may also develop here, which probably resemble those that were prevalent in the large prairie marshes or sloughs that existed in much of the region north of Charleston before the days of ditching and tile drains. This low, commonly wet area will be referred to in this paper as Substation *d*. The main part of the low region in the field east of the station is sometimes a large mud flat with black soil, which on drying becomes much cracked. Plate LXV, Fig. 2; Plate LXVI, Fig. 1; Plate LXVII, Fig. 2; Plate LXVIII; Plate LXIX, Fig. 1; and Plate LXXI,

Fig. 1,—all show parts of this low-ground area under different conditions and from different points of view.

On both north and south sides of Substation *d*, the ground is high and level, but at the north end of Station I the ground is low but without conspicuous marsh conditions. Early in the spring, however, there are shallow pools here. Plate LXVI, Fig. 2, and Plate LXVII, Fig. 1 show the south portion of the station, and Fig. 1, Plate LXXII, shows the north part.

The whole area has a black, stiff, clay soil, except for a narrow, artificial ridge of gravel near the track in places; indeed, the natural topography appears to have been little disturbed by the railway construction work, which began about 1880. The ground of the station is almost entirely covered with vegetation, chiefly herbaceous in character. There is a large willow (*Salix*) patch at Substation *d* and a smaller one near the north end of the station. Saplings of cottonwood (*Populus deltoides*) are scattered over parts of the region, and small cherry-trees are numerous about the south end. In August, 1910, conspicuous herbs on the high ground were goldenrod (*Solidago*), rosin-weed (*Silphium*), cone-flower (*Lepachys pinnata*), mountain mint (*Pycnanthemum virginianum*), and flowering spurge (*Euphorbia corollata*); and there were also a number of grasses and sedges, that in some cases formed tall, thick growths. On the low ground, swamp milkweed (*Asclepias incarnata*), rushes (*Scirpus*), flags (*Iris*), and the tall reed grass were prominent.

The fields adjoining Station I are cultivated. They were planted with Indian corn during the period of observation, but in 1913 a large piece of broom-corn lay adjacent to the north half of the station. Figure 1, Plate LXX, shows a part of this. Because attempts to grow Indian corn on the piece of low ground where there is often much water have been almost failures, this has been a nearly open area with a few sickly corn plants here and there and with many weeds. (See Plate LXVIII, Fig. 2.) Along the road just south of the station and running at right angles to it is a row of cherry trees and a few Osage orange trees. (See Plate LXVI, Fig. 2, and Plate LXX, Fig. 2.) The field some six hundred feet east of the north part of the station surrounds a piece of uncultivated land covering between two and three acres. It is a small swamp with standing water a good part of the time—one of the few bits of undrained prairie lowland left in the region about Charleston, and undoubtedly a remnant of a much larger prairie slough. Vegetation is so abundant here that the swamp looks like a compact bush patch with a few cottonwood trees at its middle, and with a broad zone of grass, sedge, and other low herbs forming its border. Figure 1, Plate LXX,

shows this bit of swamp; it can also be seen in the far background just to the right of the foremost telegraph pole in Figure 1, Plate LXXI. A short distance south of this little swamp, out in the field, is a large, isolated, naked, and burnt dead stub of a tree, forming a conspicuous landmark (Plate LXXI, Fig. 2).

Vertebrates were not numerous at Station I, and at few times were there so many as to constitute a conspicuous feature of the area, the kinds present being usually represented by merely a few individuals. Only thirty-five species were found at the station or in its immediate vicinity. A list of these, with brief notes of their occurrence, follows.

AMPHIBIANS AND REPTILES

Chorophilus nigrilus (Le Conte). Swamp Tree-frog.

Conspicuous by its call in early spring about the temporary pond at Substation *d* and about the small shallow pools at the north end of the station (Pl. LXXII, Fig. 1). Eggs of the species were found at this place April 23, 1911.

Rana pipiens Shreber. Common Frog.

A few specimens were seen in early spring about the low ground at Substation *d*, and in the pools here in early spring where they undoubtedly breed. Eggs were found in the temporary pools at the north end of the station (Pl. LXXII, Fig. 1). A large example of this species was found in the stomach of a garter snake (see below) November 24, 1913. The frog, its hind legs included, was about eight inches long.

Thamnophis sirtalis (Linn.). Garter Snake.

Two of these snakes were taken by the writer; one of them small (March 30, 1913), and one large, measuring twenty-nine inches in length (November 24, 1913). This large snake is the one that ate the leopard frog spoken of above. It is shown in Figure 2, Plate LXXII, as it appeared before it was captured.

BIRDS

Butorides virescens virescens (Linn.). Little Green Heron.

One was seen, resting on the fence between the right-of-way and the corn field, July 31, 1912.

Rallus elegans Aud. King Rail.

One was flushed from the high grass of the low ground of Substation *d* on August 1, 1912, and another on May 18, 1913.

Porzana carolina (Linn.). Sora Rail.

Frequently flushed during the field work in August, 1910, from the grass-covered low ground of Substation *d*.

Totanus flavipes (Gmel.)? Lesser Yellowlegs.

One was seen at the mud flat in the field east of the station in August, 1910. It is possible that this may have been the greater yellowlegs, *Totanus melanoleucus* (Gmel.).

Helodromas solitarius solitarius (Wils.). Solitary Sandpiper.

Common about the mud flat of the field east of the station in August, 1910.

Oxyechus vociferus vociferus (Linn.). Killdeer.

Common about the pools and mud flats whenever these existed.

Colinus virginianus virginianus (Linn.). Bob-white.

Two of these birds were flushed from the right of way July 3, 1911. A small covey flew up from the broom-corn stubble just east of the station on November 4, 1913.

Zenaidura macroura carolinensis (Linn.). Mourning Dove.

Frequently seen resting on the telegraph wire over the station and occasionally seen on the ground.

Circus hudsonius (Linn.). Marsh Hawk.

One was seen flying over the fields near the station in August, 1910. It is common in the prairie region north of Charleston.

Falco sparverius sparverius Linn. Sparrow Hawk.

One was seen resting on a telegraph pole at the station, July 3, 1911. They are common along the Clover Leaf right-of-way.

Melanerpes erythrocephalus (Linn.). Red-headed Woodpecker.

One was seen about the telegraph poles of the station August 8, 1910. Also seen about the cottonwoods of the small swamp east of the station.

Colaptes auratus luteus Bangs. Flicker.

Common about corn fields, and frequently seen on fences bordering those in the vicinity of the station. A nest was found in the small swamp east of the station in May, 1914.

Tyrannus tyrannus (Linn.). Kingbird.

Frequently seen on the wires. On August 8, 1910, one was seen chasing a marsh hawk near the station. Kingbirds were noted in the small swamp east of the station.

Cyanocitta cristata cristata (Linn.). Blue Jay.

A few were seen about the wild cherry-trees along the road just south of the station.

Corvus brachyrhynchos brachyrhynchos Brehm. American Crow.

Often seen flying over the station and in the adjacent corn fields. A few were noted on the railroad track at the station in July, 1911.

Agelaius phœniceus phœniceus (Linn.). Red-winged Blackbird.

The most often seen bird at the station and the only one actually found nesting there. On May 18, 1913, a nest with three eggs was found about two feet above the marshy ground of substation *d*, in some rushes (*Scirpus robustus*) to which the nest was attached (Pl. LXIX, Fig. 2). Seven red-winged blackbirds' nests were located by the writer on May 21, 1914, in the thick willows of the willow zone of the small swamp east of the station (Pl. LXX, Fig. 1). They were placed five to eight feet up in the willows, and five that were examined internally contained eggs, one to four in number.

Quiscalus quiscula œneus Ridgw. Bronzed Grackle or Crow Blackbird.

Abundant; often in large flocks about the corn fields in the region around the station in late summer and early fall. A number were seen feeding on the ground at the station April 23, 1911, and July 31, 1912. On May 21, 1914, a dozen or more of these blackbirds were seen following a harrow in the field east of the station—undoubtedly after grubworms that were being turned up here in large numbers; the writer, in fact, saw a bird pick one up.

Sturnella magna magna (Linn.). Meadowlark.

Not common at the station or in its immediate vicinity, though a few were seen resting on the wires. Meadowlarks are most common in the Charleston region in grassy meadows, and comparatively few are seen about cultivated fields like those in the neighborhood of Station I. They seem to avoid railway rights-of-way. The writer, however, found a nest of the species with four eggs within a dozen feet of the Clover Leaf track on a grassy part of the right-of-way, some ten miles north of Charleston, on May 1, 1914.

Passer domesticus domesticus (Linn.). English Sparrow.

Common at the south end of Station I, about the fences, trees, shrubs, and overhead wires.

Astragalinus tristis tristis (Linn.). Goldfinch.

Common at the station and its vicinity in the fall when weed seeds were common; they were not seen here at other seasons.

Spizella monticola monticola (Gmel.). Tree Sparrow.

Common about the broom-corn near the station and in the small swamp east of it, during the fall of 1913 and winter of 1913-14. They probably visited the station at times where conditions were favorable for them.

Melospiza melodia melodia (Wils.). Song Sparrow.

A few of these birds were seen at the station and sometimes they were heard singing there.

Passerina cyanea (Linn.). Indigo Bunting.

Seen at the station August 11, 1910; a male was on a telegraph wire.

Hirundo erythrogaster (Bodd.). Barn Swallow.

Seen flying about the station in August, 1910.

Lanius ludovicianus migrans Palmer. Migrant Shrike.

Shrikes were frequently seen at the station, resting on the wires or tops of telegraph poles, where they appeared to be watching for prey below. One was seen to drop down from the wire and capture a monarch butterfly. In the winter shrikes are sometimes seen at other places along the Clover Leaf Railroad; and in all probability they visited the station then. One specimen obtained in August, 1910, was *L. ludovicianus migrans*. The writer is not certain that all the shrikes seen belonged to the subspecies *migrans*; some may have been loggerhead shrikes, *Lanius ludovicianus hudsonius* Linn.

Dendroica coronata (Linn.). Myrtle Warbler.

Occasionally seen in fall about the bushy and weedy roadside near the south end of the station.

Geothlypis trichas trichas (Linn.). Maryland Yellow-throat.

A male yellow-throat was seen, and heard singing about the willow patch of the low ground in the summer of 1911 and in May, 1913. A nest was probably present, although the writer was unable to find it.

Toxostoma rufum (Linn.). Brown Thrasher.

Not a regular inhabitant of the station; only one seen (April 23, 1911), and this was on the fence.

Planesticus migratorius migratorius (Linn.). Robin.

Common at the south end of the station; many seen at times resting on the wires. Probably attracted by the wild cherries near this place.

MAMMALS

Mus musculus (Linn.). House Mouse.

One was caught in a trap set on the low ground (Substation *d*), in a patch of swamp milkweed.

Peromyscus maniculatus bairdi (Hoy and Kennicott). White-footed Prairie Mouse.

Caught on the high ground in a patch of wild sunflowers, in a mouse trap baited with apple.

Sylvilagus floridanus mearnsi (Allen). Common Rabbit.

Rabbits were very common here during the spring and summer of 1913. They would frequently jump up from their resting places in the herbage of the low ground. Many were present in the fields about the station. The animal is abundant in the prairie region north of Charleston.

Blarina parva (Say). Small Short-tailed Shrew.

One was found drowned in an old well at the edge of the small piece of swamp just east of the station, on March 16, 1914.

Besides the vertebrates just listed, a number of others certainly inhabit the piece of right-of-way, and the above record probably includes only a small fraction of those actually present. Some species of birds that were probably overlooked are the Wilson's snipe, and one or more kinds of wild ducks. The former has been flushed in places about Charleston similar to Substation *d*; and on October 30, 1911, the writer saw, from a train, a wild duck fly up from the pool which has its west margin at this station. Hunters say that ducks visit this place in spring and autumn whenever water is present there.

Little was learned concerning the kinds of mammals at Station I. A number of burrows on the high ground of the station appeared to be gopher burrows. From Mr. F. E. Wood's published notes on the mammals of Champaign County*—a county less than twenty miles north of Coles County—and from data on these forms obtained from the writer's observations about Charleston, it appears that the following belong to the fauna of the piece of prairie under consideration, either as occasional visitors or as permanent inhabitants.

*A Study of the Mammals of Champaign County, Illinois. Bull. Ill. State Lab. Nat. Hist., Vol. VIII, Article V (1910), pages 501-613.

Common Names	Scientific Names
Striped Gopher	<i>Citellus tridecemlineatus</i> (Mitchill)
Gray Gopher	<i>Citellus franklini</i> (Sabine)
Prairie Meadow-mouse	<i>Microtus austerus</i> (Le Conte)
Skunk	<i>Mephitis mesomelas avia</i> (Bangs)
Weasel	<i>Putorius noveboracensis</i> Emmons
Short-tailed Shrew	<i>Blarina brevicauda</i> Say
Common Mole	<i>Scalops aquaticus machrinus</i> (Rafinesque)

RELATION OF THE PRAIRIE VERTEBRATES TO THEIR ENVIRONMENT

The influences that seemed to be the most important in determining the character of the vertebrate fauna of Station I were its size, its topography, its climatic conditions, its vegetation, its invertebrates, the interactions of the vertebrates themselves, and certain features in the country surrounding the station.

The small size of the area studied was undoubtedly an important factor in giving the place a small vertebrate fauna. Any favorable feature for a particular species in the way of food, shelter, nesting place, and so on, could not be extensive enough to attract many individuals of the species.

The topography was of such a character that a diversity of conditions, chiefly hydrographic and vegetal, were brought about. A varied fauna was thus produced, with some animals that were strictly aquatic and others that were entirely terrestrial.

The weather has a marked effect on the vertebrate life. In winter little activity is manifest, though a few roving winter birds may search about the dead but standing herbs for seeds; shrikes and sparrow-hawks may rest on the wires; and a few rabbits may hide in the dead, ground vegetation. In spring the wet weather, that usually comes, causes the forming of pools where amphibians breed. In different summers the amount and frequency of rainfall differs greatly. In 1910 and in 1912, small pools or areas of wet ground were present most of the time, and aquatic or partly aquatic animals were prominent through the season; but in the summers of 1911 and 1913, dry weather prevailed, and water animals, except crawfish in burrows, seemed to be entirely absent. The appearance and slow disappearance of the pools, especially of the large pool, bring about a succession of animal habitats—pond changing to mud flat and the latter to low, dry, cracked ground with scant vegetation. Each of these has

its characteristic animal community. Figure 2, Plate LXVII and Plate LXVIII show conditions in this series. Autumn weather has been very diverse in character since the observations began. In November, 1913, very unusual conditions, like those of early spring, prevailed. The air was warm and balmy; the fields were green; and flying insects were much in evidence. At this time, November 24, 1913, a garter snake was captured on the high ground at the station. It was very active, and it had just swallowed a large leopard frog.

The plant life of this prairie area is probably the most important factor in determining its vertebrates, since it not only furnishes them food, in the shape of seeds, fruits, roots, leaves, and insects, but also affords them shelter, seclusion, and concealment while they are resting, feeding, and nesting. A few instances of these latter uses of plants to vertebrates were observed: rabbits were found hiding among the plants; a king rail concealed itself so effectively in a small patch of rushes that much searching did not reveal it; a red-winged blackbird's nest was attached to rush leaves, which not only supported the nest but concealed it (Pl. LXIX, Fig. 2).

Vertebrates were in all probability attracted to the station by insects and other invertebrates which furnish them food, yet meager data on this point was obtained, for few were seen feeding. A shrike caught a monarch butterfly while being watched by the writer, and a shrike which was killed contained many insect fragments, chiefly of grasshoppers and other *Orthoptera*. Bronzed grackles were seen searching for grubworms behind a harrow that was being used in the field just east of Station I, May 21, 1914. In fact, most of the birds seen at the station were well-known insect eaters.

Vertebrates have a marked influence on each other, and their interactions have much to do with the character of the vertebrate fauna at Station I. Few facts concerning these interrelations could be obtained, however, because of the meagerness of the field work done. A kingbird was seen chasing a marsh hawk over the fields near the station; a red-winged blackbird appeared to be trying to drive away a sparrow-hawk that was about the telegraph poles at the station; and, as previously stated, a garter snake was found, which had swallowed a large frog. Shrikes and sparrow-hawks seen along the railroad here and elsewhere in winter are in all probability hunting for mice. Man produces at this station a marked effect on the vertebrates of a lower order than himself. During the hunting season, hunters were often seen at the station or near it looking for rabbits, bob-whites, or ducks; and judging from the many empty shot-shells found lying on the ground, some game is found by gun-

ners here. Railway workmen cut the weeds and shrubbery and sometimes burn over the region in the fall. Trains passing also disturb the animal life. On the other hand, the telegraph line constitutes a very attractive feature for birds. Eight of the twenty-nine species of birds that were seen at or near the station were noted only on the wires and poles, which appeared to be the one feature of the place to bring them there, and a majority of all the individual birds noted were upon the poles or wires.

The vertebrate life of Station I is influenced considerably by the nature of the region about it. From neighboring corn fields, where they fed, blackbirds would come and gather in large numbers on the telegraph wires; and birds attracted to roadside cherry-trees near the south end of the station also used wires near by as a resting place. Beneath the wires and along fences in the neighborhood of this row of trees many small cherry-trees had sprung up, in all probability from cherry-stones dropped by the birds (Pl. LXVII, Fig. 1, and Pl. LXX, Fig. 2). In the former figure there are no trees visible under the wire, those formerly there having been cut away by railroad employees, but there are cherry-trees visible along the fence. Were it not for the destructive activities of man, the south part of the station would soon develop into a small cherry thicket, having its origin in cherry-stones dropped there by the birds. A tall naked stub in the field a few hundred feet east of the middle of the station was a kind of headquarters for woodpeckers, ten nesting-holes being counted in it (Pl. LXXI, Fig. 2).

The small piece of swamp a short distance east of the station may have been responsible for the presence, at the station, of red-winged blackbirds, the green heron, and the rails. All of these birds frequent such places in the Charleston region, and red-winged blackbirds nest there in considerable numbers. A green heron's nest was found in a little swamp similar to this one but some two miles northwest of it. A flicker's nest was found in this swamp May 21, 1914.

THE FOREST AREA, STATION II

As stated above, the piece of woods studied is about three and a half miles northeast of Charleston, perhaps a quarter of a mile north of the Big Four railroad and a few rods west of the Embarras River.

The topography of the woods is much varied. A part of the woods is on the west slope of the Embarras valley, and other portions are on the high ground and on the low ground adjacent to this slope; besides, two rather complex ravine systems cut up the woods considerably. There are, then, four rather distinct kinds of region in

the woods: (1) high, comparatively level ground; (2) low, river-bottom woods; (3) slopes; and (4) ravine bottoms. A small, temporary stream is in the south ravine. At the time that our field work was started, trees covered the region quite evenly except in a few small glades and about the west margin, where, over a few acres, considerable wood-cutting had been done. There was much diversity in the height of trees, and a number of kinds were present.

On the upland were chiefly oaks (*Quercus*) and hickories (*Carya*), but walnut (*Juglans*), mulberry (*Morus rubra*), and sumac (*Rhus glabra*) were also present, as well as other species. On the river bottom were maples (*Acer*), elms (*Ulmus*), red oak (*Quercus rubra*), wild cherry (*Prunus serotina*), coffee-tree (*Gymnocladus dioica*), walnut, mulberry, bitternut hickory (*Carya cordiformis*), and redbud (*Cercis canadensis*). Climbing plants, notably wild grape (*Vitis cinerea*), were common, especially in the low woods. Undergrowth was unequally developed; in the upland woods in some places the ground had little else than dead leaves and fallen twigs upon it (see Pl. LXXIII), while in other places, there were many bushes (Pl. LXXIV). Herbage was scant on the forest floor in the upland woods but formed an abundant growth in the bottom woods (see Pl. LXXV).

The little stream, which runs in an easterly direction, taking a tortuous course through the south part of the woods, is an important animal habitat; and it brings to the station a number of aquatic vertebrates. For a good part of its course in the woods, it flows through a ravine (Pl. LXXVI). In the southeast corner of the woods, however, it passes through a piece of low and level ground where it is less shaded, and its banks have rank herbage. Farther up stream, in the thicker woods, the banks have little low vegetation on them and are covered chiefly with dead leaves, brush or other forest debris. Figure 1, Plate LXXVII, shows a part of the stream in the lower, southeast corner of Bates woods. Throughout its course, the stream is a series of clear, shallow pools connected by narrow rills trickling over deposits of sand and gravel in the stream bed. In the lower part of its course, east of Bates woods and on the river flood-plain, the bed of the stream is ordinarily dry. Aquatic plants, except some algæ (chiefly *Spirogyra*, *Oscillatoria*, and diatoms) were absent. Water-striders (*Gerris*) and small crawfish (*Cambarus*) were the only invertebrates noted in conspicuous numbers by the writer.

The country about Bates woods, which was an important factor in determining the nature of its fauna, is rough and hilly. It was, for the most part, originally forested, but now it is largely cleared

and cultivated. Corn is the prevailing crop grown upon it. Plate LXXVII, Figure 2, and Plate LXXIX show features of the country about the woods.

Birds were the most conspicuous of the vertebrates of Bates woods, but they appeared to have a decided preference for the margin of the upland woods at the time (August, 1910) when most of the field work was done. Plate LXXVIII is typical of the upland woodland margin where most of the birds were found.

Many vertebrates besides birds were undoubtedly present in the woods, but few notes were obtained on them. Two species of fish, represented by only a few individuals, were in the stream, and some amphibians were found at this place. Only one species of reptile was found, the box-turtle. Mammals seemed scarce, and much trapping brought scanty results. The almost complete absence of squirrels in woods which have food and shelter in abundance for them, is due, as I was told, to certain gunners.

An annotated list of the vertebrates found by the writer in Bates woods follows.

FISH, AMPHIBIANS AND REPTILES

Campostoma anomalum (Rafinesque).. Stone-roller.

A small example, two and a half inches long, was caught in the ravine stream in August, 1910.

Semotilus atromaculatus (Mitchill). Horned Dace.

Small specimens, one to nearly two inches long, were present in small numbers in a few of the shallow pools in the lower part of the south ravine woods during August, 1910. They were in the deepest of the few shallow pools here. When disturbed they would hide under stones or under the bank. Freshets following hard rains in August, 1910, seemed to clean these and other fish out of the stream, for none have been found in it since.

An examination of the intestinal contents of a few of these little dace, revealed various objects, but chiefly insect fragments, including parts of beetles, gnat larvæ, and ants. Copepods and green alga filaments were also present. These dace were seen trying to capture grasshoppers and other insects that had fallen on the water surface.

Desmognathus fusca Rafinesque. Dusky Salamander.

Larvæ of this species were frequently found in the shallow, stony-bottomed pools of the stream, where it flowed through the deeper and well-shaded part of the ravine in the woods.

Bufo americanus Le Conte. Common Toad.

A few small toads were noted along the bank of the lower, less-shaded part of the creek in the woods.

Hyla versicolor Le Conte. Common Tree-toad.

One specimen was taken in Bates woods by Mr. Adams.

Rana catesbeana (Shaw). Bullfrog.

A large specimen was taken in the pool close to the fence in the lower part of the stream in the woods. The pool is shown in Figure 1, Plate LXXVII. In the stomach of this frog were remains of grasshoppers, ground-beetles, snails, and crawfish (*Cambarus diogenes*).

Terrapene carolina (Linn.). Box-turtle.

Two box-turtles were found on the north slope of the south ravine by Mr. Adams. One was too small to be identified with certainty, but the other was undoubtedly this species.

BIRDS

Butorides virescens virescens (Linn.). Little Green Heron.

Common along the Embarras River near Bates woods; also frequently seen about some small ponds in a piece of woods continuous with Bates woods.

Cathartes aura septentrionalis Wied. Turkey Vulture.

Birds of this species were seen flying low over the woods in August, 1910. They are common in the Charleston region, especially along the Embarras bottoms.

Accipiter cooperi (Bonap.)? Cooper's Hawk.

A hawk that resembled this species flew from the trees in the south ravine on April 4, 1914.

Coccyzus americanus americanus (Linn.). Yellow-billed Cuckoo.

Common about the upland woods; none seen in the low, bottom woods.

Ceryle alcyon (Linn.). Belted Kingfisher.

Common about the "Big Four ponds" just south of Bates woods, which are in a piece of woods similar to Bates woods.

Dryobates villosus villosus (Linn.). Hairy Woodpecker.

One specimen was seen in the upland woods April 4, 1914.

Dryobates pubescens medianus (Swains.). Downy Woodpecker.

Common in both high and low woods but most often seen in the latter.

Centurus carolinus (Linn.). Red-bellied Woodpecker.

Often seen in the upland woods in August, where it was frequently noisy.

Sphyrapicus varius varius (Linn.). Yellow-bellied Sapsucker.

This species was noted in April, 1914, about the few trees which remain of the upland woods.

Colaptes auratus luteus Bangs. Northern Flicker.

Common about the margins of the upland woods in August, 1910. It appeared to limit itself strictly to regions of this character and to avoid the thick interior woods.

Archilochus colubris (Linn.). Ruby-throated Hummingbird.

Seen resting in the foliage region of the upland woods in August, 1910.

Myiarchus crinitus (Linn.). Crested Flycatcher.

Common in the woods on both high and low ground, confining itself mostly to the "upper story" of the woods, that is, the foliage region.

Myriochanes virens (Linn.). Wood Pewee.

Common; frequently heard; chiefly in the upland woods.

Empidonax virescens (Vieill.). Acadian Flycatcher.

Common in the upland woods.

Cyanocitta cristata cristata (Linn.). Blue Jay.

Very common; busy feeding on acorns. Few calls were uttered, and the presence of the bird was usually revealed by the oft-repeated noise of dropping acorns in some particular part of the woods.

Corvus brachyrhynchos brachyrhynchos Brehm. American Crow.

Uncommon, though a few were noted.

Astragalinus tristis tristis (Linn.). Goldfinch.

Very common and singing about the tops of the high trees along the south edge of the woods in August, 1910.

Zonotrichia albicollis (Gmel.). White-throated Sparrow.

Common in Bates woods in late spring and early fall during migrations.

Spizella pusilla pusilla (Wils.). Field Sparrow.

Abundant in the bushy growth near the upland woods, to the edge of which it frequently went. Plate LXXVIII shows a typical habitat.

Junco hyemalis hyemalis (Linn.). Slate-colored Junco.

Seen in August, 1910, along the east edge of the low woods. Abundant and singing on April 4, 1914, in the remnant of the upland woods.

Melospiza melodia melodia (Wils.). Song Sparrow.

A few individuals were noted. Uncommon.

Pipilo erythrophthalmus erythrophthalmus (Linn.). Towhee.

A few specimens were seen in the low woods.

Cardinalis cardinalis cardinalis (Linn.). Cardinal.

Often heard in various parts of the woods both low and high; a few were seen.

Zamelodia ludoviciana (Linn.). Rose-breasted Grosbeak.

One specimen was noted in the low woods in August, 1910. Probably more common than it seemed to be, on account of its silence at this time of year.

Passerina cyanea (Linn.). Indigo Bunting.

Common and singing almost constantly during the August days in the shrubby growth on the upland near the woods. None seen or heard in the woods.

Piranga erythromelas Vieill. Scarlet Tanager.

A few individuals were noted in the interior of the woods.

Piranga rubra rubra (Linn.). Summer Tanager.

A few specimens were seen and heard about the edges of the woods.

Sciurus sp. Water-thrush.

A water-thrush was seen in the south ravine on May 24, 1911. A good enough view could not be obtained to determine the species.

Icteria virens virens (Linn.). Yellow-breasted Chat.

A few individuals were noted in the woods.

Mniotilta varia (Linn.). Black and White Warbler.

Several birds of this species were seen in the upland woods during August, 1910.

Setophaga ruticilla (Linn.). Redstart.

A few individuals were seen; probably common.

Thryothorus ludovicianus ludovicianus (Lath.). Carolina Wren.

One specimen was found in the low forest.

Baeolophus bicolor (Linn.) Tufted Titmouse.

Common in the woods at all seasons. Lives chiefly in the foliage region, but comes frequently to the undergrowth, and is often seen on the ground.

Penthestes atricapillus atricapillus (Linn.). Chickadee.

Common in the woods; seen chiefly in the upland woods.

Polioptila carulea carulea (Linn.). Blue-grey Gnatcatcher.

A few specimens were noted in August, 1910.

Planesticus migratorius migratorius (Linn.). Robin.

A few robins were seen in the woods. They did not appear to be common.

Sialia sialis sialis (Linn.). Bluebird.

Common in April, 1914, about the few trees left standing after the removal of most of the upland woods.

MAMMALS

Tamias striatus (Linn.)? Chipmunk.

One chipmunk was seen in the remnant of the upland woods in June, 1914. Since Wood records the subspecies *hysteri* in Champaign County, it is possible that this may be *T. striatus hysteri* (Richardson).

Sciurus niger rufiventer (Geoffroy)? Fox Squirrel.

A squirrel that was in all probability this species, but which may possibly have been a gray squirrel, was seen in the upland woods in August, 1910.

The foregoing list includes all the vertebrates seen by the writer in Bates woods during the field trips made to the region. It certainly comes far from including all those that were in the woods since the field studies were started in August, 1910. Most of the writer's observations were made in late summer, when birds are seen with difficulty because of their comparative silence. Poor success was obtained in making mammal collections, although methods were used that the writer has employed with considerable success in places similar to Bates woods. It is very probable that mammals are actually scarce there.

It is remarkable that no examples of the common rabbit (*Sylvilagus floridanus mearnsi*) were found, for the species is very abundantly represented about Charleston in both wooded and prairie regions. Another notable fact is that no snakes were observed, for they are frequently though not commonly found in other woodlands about Charleston.

Other vertebrates that in all probability belong to the Bates woods' fauna, according to the writer's observations in similar woodlands about Charleston and according to reliable testimony, are given in the list below. Still other species may live in the woods or visit it oc-

asionally, but their occurrence can not be so clearly vouched for as those in the following list.

SUPPLEMENTARY LIST OF BIRDS

Common Names	Scientific Names
Black-crowned Night Heron	<i>Nycticorax nycticorax navius</i> (Bodd.)
Bob-white	<i>Colinus virginianus virginianus</i> (Linn.)
Sharp-shinned Hawk	<i>Accipiter velox</i> (Wils.)
Red-tailed Hawk	<i>Buteo borealis borealis</i> (Gmel.)
Red-shouldered Hawk	<i>Buteo lineatus lineatus</i> (Gmel.)
Sparrow Hawk	<i>Falco sparverius sparverius</i> Linn.
Barred Owl	<i>Strix varia varia</i> Barton.
Screech Owl	<i>Otus asio asio</i> (Linn.)
Great Horned Owl	<i>Bubo virginianus virginianus</i> (Gmel.)
Black-billed Cuckoo	<i>Coccyzus erythrophthalmus</i> (Wils.)
Red-headed Woodpecker	<i>Melanerpes erythrocephalus</i> (Linn.)
Whippoorwill	<i>Antrostomus vociferus vociferus</i> (Wils.)
Kingbird	<i>Tyrannus tyrannus</i> (Linn.)
Cowbird	<i>Molothrus ater ater</i> (Bodd.)
Baltimore Oriole	<i>Icterus galbula</i> (Linn.)
Bronzed Grackle	<i>Quiscalus quiscula œneus</i> Ridgw.
Purple Finch	<i>Carpodacus purpureus purpureus</i> (Gmel.)
Lark Sparrow	<i>Chondestes grammacus grammacus</i> (Say)
White-crowned Sparrow	<i>Zonotrichia leucophrys leucophrys</i> (Forst.)
Tree Sparrow	<i>Spizella monticola monticola</i> (Gmel.)
Fox Sparrow	<i>Passerella iliaca iliaca</i> (Merr.)
Cedar Waxwing	<i>Bombycilla cedrorum</i> Vieill.
Myrtle Warbler	<i>Dendroica coronata</i> (Linn.)
Catbird	<i>Dumetella carolinensis</i> (Linn.)
Brown Thrasher	<i>Toxostoma rufum</i> (Linn.)
Brown Creeper	<i>Certhia familiaris americana</i> (Bonap.)

Golden-crowned Kinglet	<i>Regulus satrapa satrapa</i> Licht.
Ruby-crowned Kinglet	<i>Regulus calendula calendula</i> (Linn.)
Wood Thrush	<i>Hylocichla mustelina</i> (Gmel.)
Hermit Thrush	<i>Hylocichla guttata pallasii</i> (Cab.)

SUPPLEMENTARY LIST OF MAMMALS

Opossum	<i>Didelphys virginiana</i> Kerr.
Fox Squirrel	<i>Sciurus niger rufiventer</i> (Geofroy)
Gray Squirrel	<i>Sciurus carolinensis</i> Gmel.
Chipmunk	<i>Tamias striatus hysteri</i> (Richardson)
Flying Squirrel	<i>Sciuropterus volans</i> (Linn.)
House Mouse	<i>Mus musculus</i> Linn.
Mole Mouse	<i>Microtus pinetorum scalopsoides</i> (Aud. and Bach.)
Muskrat	<i>Fiber zibethicus</i> (Linn.)
Common Rabbit	<i>Sylvilagus floridanus mearnsi</i> (Allen)
Raccoon	<i>Procyon lotor</i> (Linn.)
Skunk	<i>Mephitis mesomelas avia</i> (Bangs)
Weasel	<i>Putorius noveboracensis</i> Emmons
Smaller Shrew	<i>Blarina parva</i> (Say)
Common Mole	<i>Scalopus aquaticus machrinus</i> (Rafinesque)

RELATION OF THE WOODLAND VERTEBRATES
TO THEIR ENVIRONMENT

The principal factors that influence the vertebrates of Bates woods are similar to those which are influential in determining the character of the vertebrates of the prairie area (Station I): vegetation, topography of the region, climatic conditions, invertebrates, the vertebrates themselves, and the surrounding region.

The vegetation of the woods affects vertebrates directly by giving them places of concealment from their enemies and shelter from the elements, and also by furnishing them with food to a certain extent. The food thus provided by the plants of Bates woods is chiefly fruit. There are many plants there that bear fruits known to be acceptable to birds, important among which are the following: mulberry, sassafras, poison-ivy, smilax, blackberry, sumac, wild grape, wild cherry, June-berry, pokeberry, woodbine, flowering dogwood, bayberry, and

oaks of various kinds. Meager data were obtained on the feeding of birds upon fruit, for it was very difficult to see them eating on account of the foliage and their wariness; furthermore, fruit-eating birds were not present in numbers proportionate to the amount of fruit there for them. This illustrates a condition very conspicuous in the Charleston region generally—plenty of bird food but few birds to avail themselves of it. The marked decrease in numbers of wild native birds about Charleston during some ten years of the writer's observations in the region, is undoubtedly due to other causes than to a scarcity of food. Blue jays and tufted titmice were seen in Bates woods pecking acorns or carrying them.

The environmental conditions in the woods were diversified by the character of the topography. There were marked differences in the fauna of the upland and lowland woods; some birds preferred one to the other. The ravine with the small stream also had certain vertebrates not found elsewhere in the woods.

Some observations were made on the effect of climatic conditions on the vertebrates of the woods. The temperature of the air and water in the woods, and the amount of moisture in the air are features that undoubtedly affect the vertebrate life, directly or indirectly, by determining the character of food, shelter, and other environmental features present. These factors are the chief ones in bringing about the marked seasonal differences in faunal conditions and in giving rise to a variety of animal habitats and hence to a variety of forms ranging from strictly aquatic animals to those living in arid situations. Some animals were found that live continually in the shade; others were found that are attracted by bright sunlight. A dynamic climatic feature was noticed in August, 1910, when a hard rain produced such a torrent in the creek that the few fish in it were seemingly all carried out of it, not again to return. Thus in a few hours a rain produced a marked and apparently permanent faunal change.

The invertebrates had a powerful effect on the vertebrate life of Bates woods, being food for the majority of the vertebrates found there. Some insectivorous birds common in Bates woods are the yellow-billed cuckoo, downy woodpecker, red-bellied woodpecker, crested flycatcher, wood pewee, Acadian flycatcher, red-eyed vireo, and tufted titmouse. The large bullfrog captured in the stream had been eating small crawfish. Grasshopper fragments were found in the stomach of a small toad caught along the stream.

Little information was obtained concerning the influence of the species of vertebrates on each other. A few hawks were noted, which undoubtedly prey upon other vertebrates in the woods, yet none were seen hunting there. Vertebrates may also affect each other through

competition for food, yet so much food was present in the form of insects and fruit, that this was probably an unimportant factor. Man has done much to change the character of the vertebrate life of the woods. Hunters frequently visit the place with the result that game (squirrels, rabbits, bob-whites) has become very scarce there. During the last two years, furthermore, man has almost destroyed this as a habitat for wood-loving animals by timber-cutting. A little of the upland woods is left and most of that on the Embarras slope; practically all of the lowland woods is removed. Plate LXXIX shows some of the conditions as they now (1914) are. The timber in the lower part of the south ravine has not been much disturbed. Here, in the spring of 1914, many maples (*Acer saccharum*) were tapped for sap.

Insufficient data were obtained concerning the effect of the surrounding region upon the vertebrate life of Bates woods. All the species found there live normally in woodland regions. Though birds undoubtedly carry fruits and seeds of the plants in the woods to the more open region about it, thus tending to extend the wooded area, nevertheless the counteracting operations of man prevent their doing much in this way.

SUMMARY AND CONCLUSIONS

When a careful search in a very typical part of central Illinois for regions with features like those of the original prairies and forests reveals no better places than the piece of Clover Leaf right-of-way (Station I) and the small piece of woods (Station II), and when we note that both of these have become so modified since our work began in 1910 that they are no longer of special interest, biologically, we are once more made aware of the importance of studying any remnants of wild uncultivated Illinois land, or any areas having conditions similar to these, in order that we may have a few facts, at least, concerning the history of our interesting fauna.

Station I, although it appeared to have more primitive conditions than any other piece of ground near Charleston, had a vertebrate fauna very different from that of the old, uncultivated prairies, according to the little information available concerning the life of the latter. Some idea of this prairie life is given by C. E. Wilson, who, in writing of the prairies of Coles County,* tells of the buffalo that used to live there and the great number of prairie wolves that did much damage during the period of the early settlement of the county.

*History of Coles County, Illinois, in Historical Encyclopedia of Illinois. Munsell Publishing Co., Chicago. 1906.

He writes of the wild fowl coming each spring to the prairie ponds "in countless thousands", a number of them remaining to breed. Prairie chickens were numerous, as well as some other prairie vertebrates that are now very scarce. Snakes, including rattlesnakes, were very prevalent. In all probability the latter are now exterminated on the prairies in the part of Illinois which includes Charleston.

Robert Ridgway gives an interesting account of the bird life of a piece of prairie near Olney, some forty miles south of Charleston.* Ninety-five species were observed by him. Some of these not now existing about Charleston, unless in very small numbers, are Henslow's bunting, black terns, marsh wrens (both species), ravens, swallow-tailed kites, and blue kites. His description makes it very evident that no bit of uncultivated prairie-land like the one of this study can at present have a bird fauna of the same aspect as that of the prairies as they used to be in this part of the country.

The vertebrate fauna of Station I was of a composite nature in that it was made up of aquatic, semi-aquatic, woodland, and prairie forms. It was somewhat surprising to find the prairie forms comparatively scarce. For example, the prairie birds (those that feed and breed in the open field) were for the most part absent at Station I. Examples of these, scarce or absent at Station I but common in the Charleston region, are the meadowlark, horned lark, grasshopper sparrow, savanna sparrow, dickcissel, bobolink, upland plover, and pectoral sandpiper.

The piece of right-of-way appeared to be visited by birds somewhat incidentally in going to and from places more attractive to them in the neighborhood,—the corn fields, the bit of swamp, and the row of cherry trees. The feature of the right-of-way that brought most of the birds there seemed to be the telegraph wires, for these formed perches and convenient lookouts. Furthermore, whenever standing water, another attractive feature, appeared at the station, aquatic forms were quick to visit it.

The abundance of varied herbage, with its edible fruits, seeds, and many insect associates, did not appear to be an important factor in determining the character of the vertebrate life of Station I. This was probably due to disturbing features at the place, to its small area, and to better feeding-grounds near by.

Bates woods (Station II) was a very desirable piece of woods for our study because of its primitive state and the fact that it presented three kinds of forest conditions, each with a rather distinct fauna.

*Prairie Birds of Southern Illinois, *American Naturalist*, 1873, pages 197-203.

These were (1) wooded upland, (2) low, wooded, bottom-land, and (3) a wooded ravine with a small stream.

There was an apparent scarcity here of reptile and mammal life that could not be fully accounted for.

Birds, at least in late summer, preferred the upland to the low-land woods, and the margins, especially when bushy, to the interior.

Food for birds and squirrels was abundant in Bates woods, enough to support many more of these creatures than were present. Competition for food, thus, was in all probability, an unimportant factor in determining the character of the vertebrate fauna.

Game animals were scarce in the woods, undoubtedly because of excessive hunting.

The vertebrate fauna of Bates woods has undergone decided changes, due to environmental transformations brought about chiefly by man. Wilson in his "History of Coles County", mentions the following vertebrates, now absent, which used to be in the wooded part of the county: panther, wildcat, black timber wolf, large gray wolf, bear, deer, badger, wild turkey, wild pigeon, Carolina parakeet, and ruffed grouse.

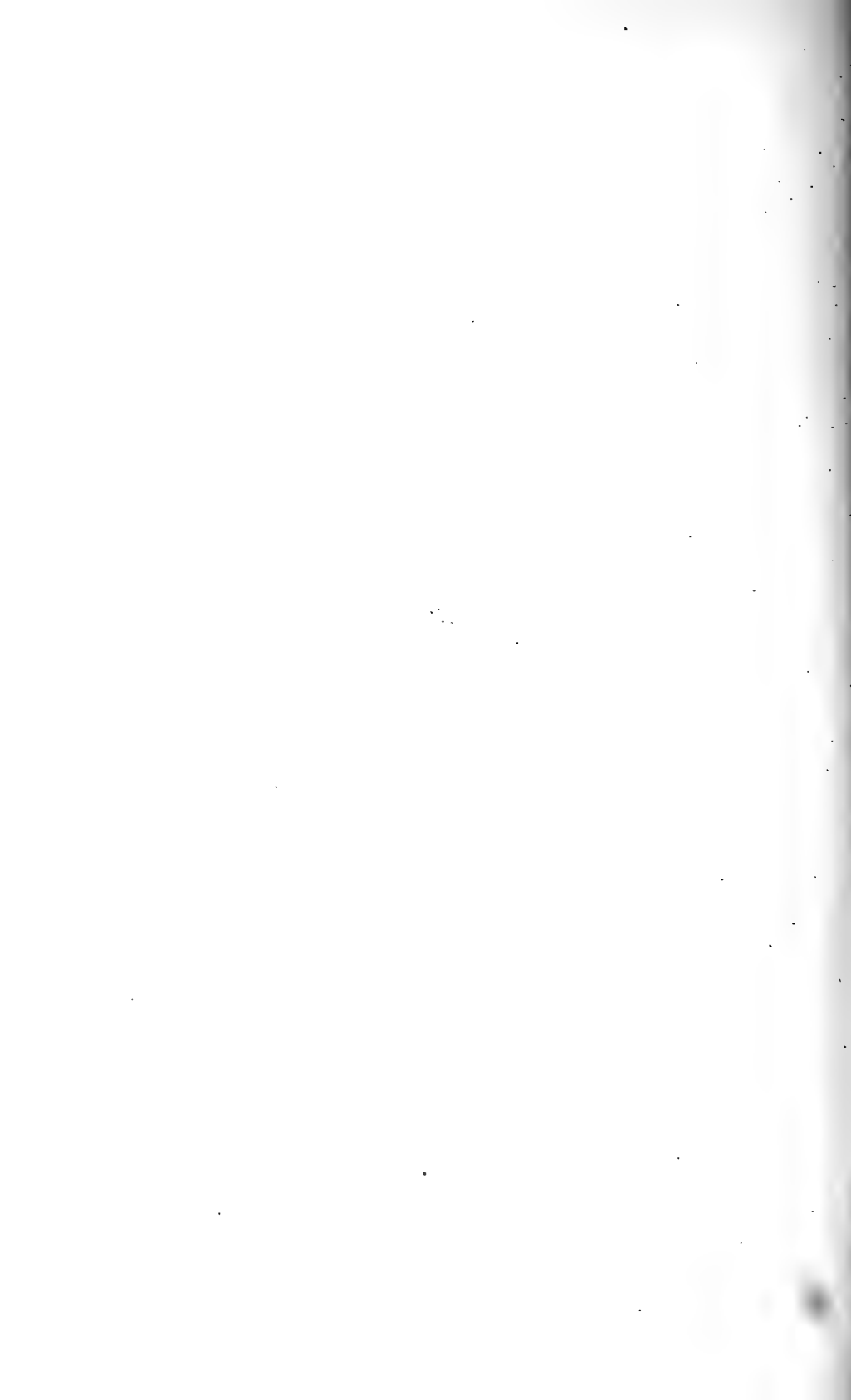
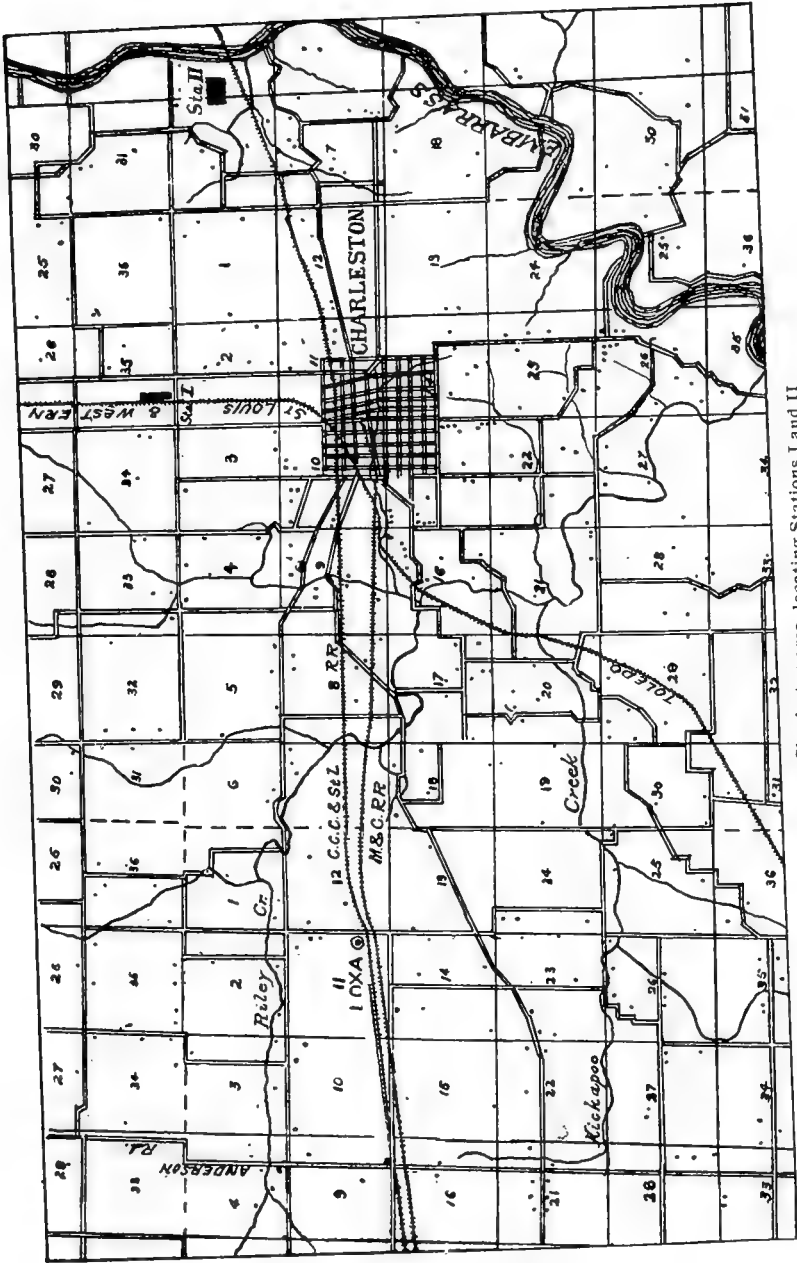


PLATE LXIV



Map of the Charleston area, locating Stations I and II

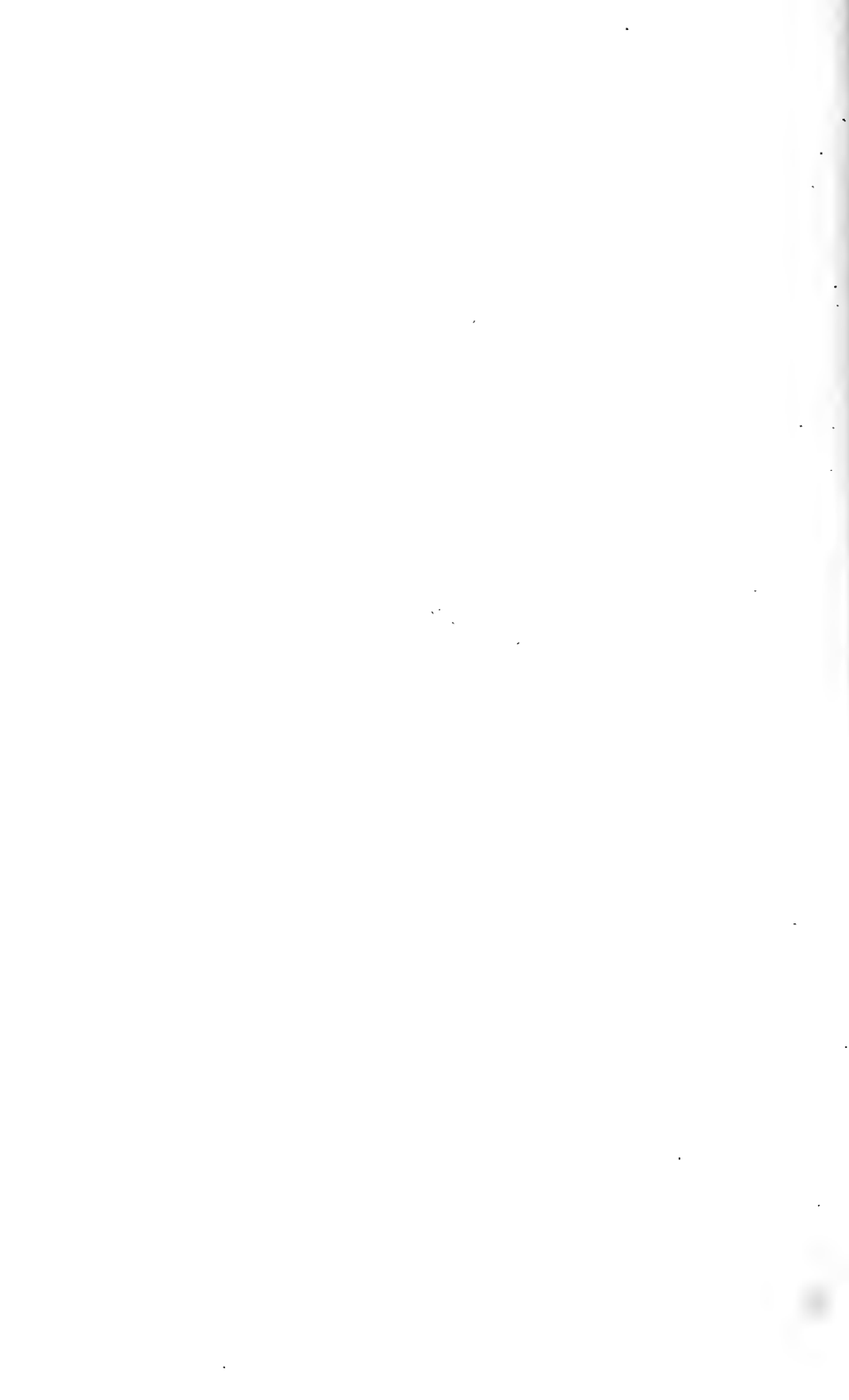


PLATE LXV



Fig. 1. Station I. Looking northeast over the north portion of the station.

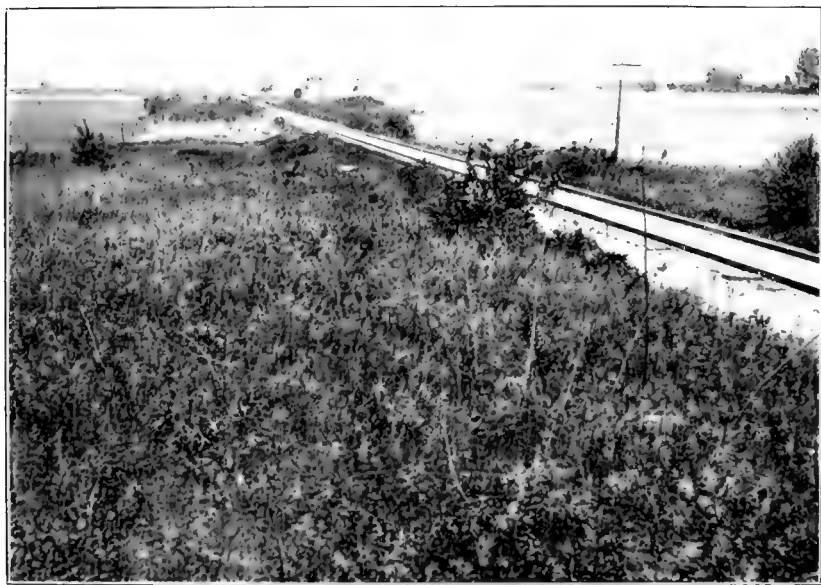


Fig. 2. Station I. Looking northeast over most of the station from the south end of it.



PLATE LXVI



Fig. 1. Station I. Looking south, showing in the foreground the low-ground region, substation *d*, in November, 1913.



Fig. 2. Station I. Looking south over the high-ground region south of substation *d*, November, 1913.

PLATE LXVII



Fig. 1. Station I. Looking northeast over the south portion, showing wild cherry-trees along the fence. January, 1914.

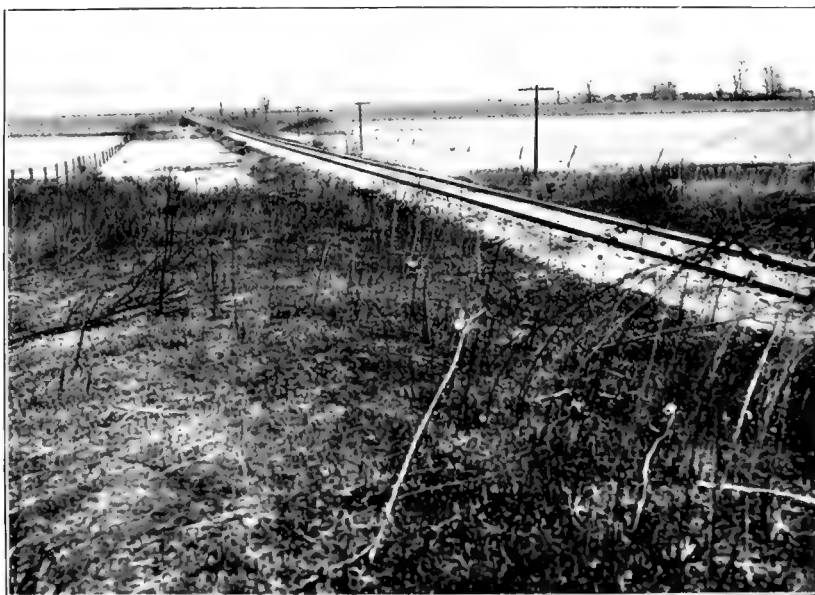


Fig. 2. Station I. Looking northeast over most of the station, showing flooded condition of the low-ground region in March, 1913.

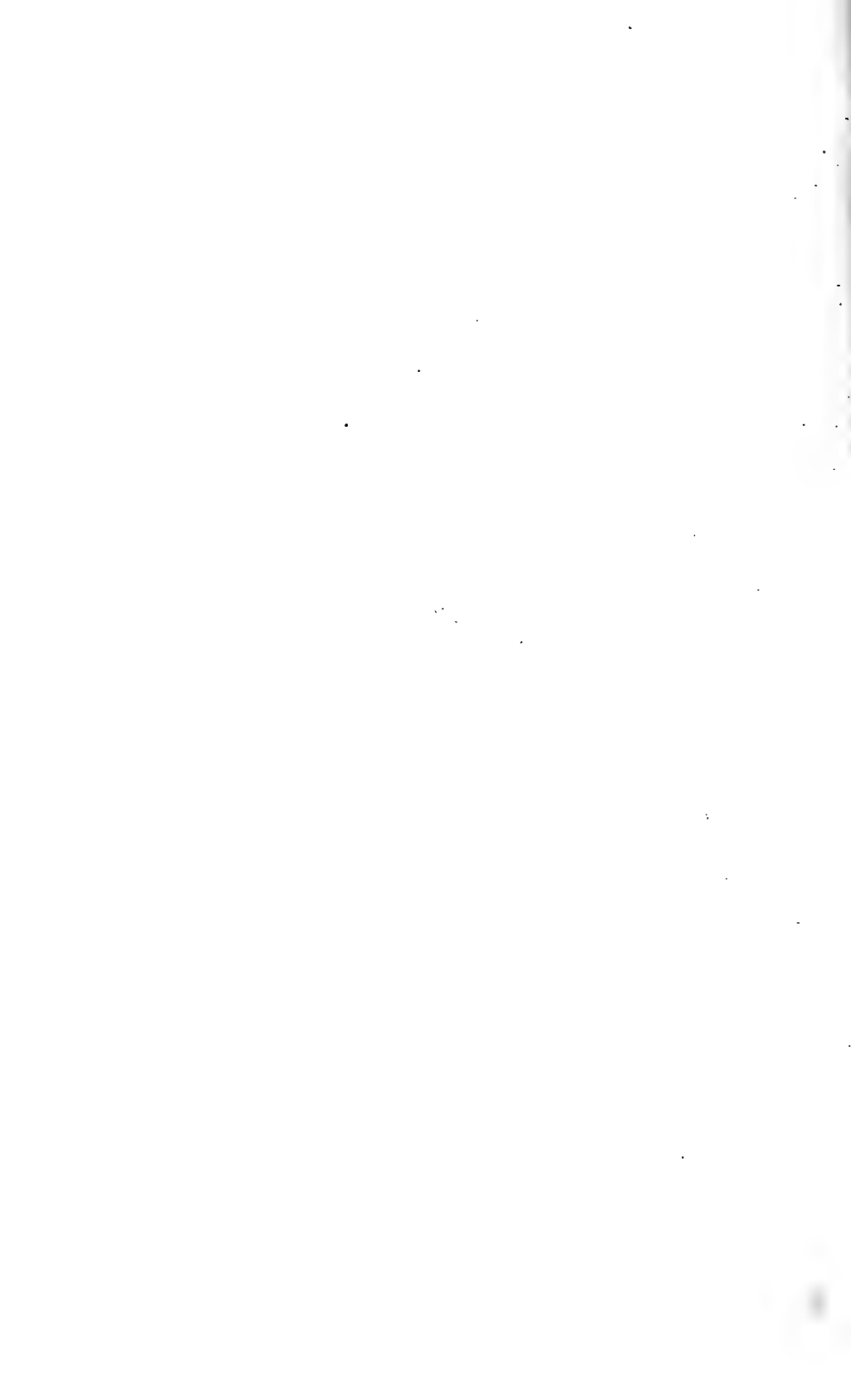


PLATE LXVIII



Fig. 1. Station I. Looking east from the railway track across the flooded field adjacent to the station on the east. March, 1913.



Fig. 2. Border of a recent mud flat at the edge of the piece of right-of-way, Station I. August, 1913.



PLATE LXIX



Fig. 1. Station I. Looking southeast over the milkweed patch of the low ground, substation *d*, August, 1910.



Fig. 2. Station I Looking west toward the railway-track bed, showing willows, rushes, and other plants forming nesting habitat of the red-winged blackbird (nest close to the handkerchief). May, 1913.

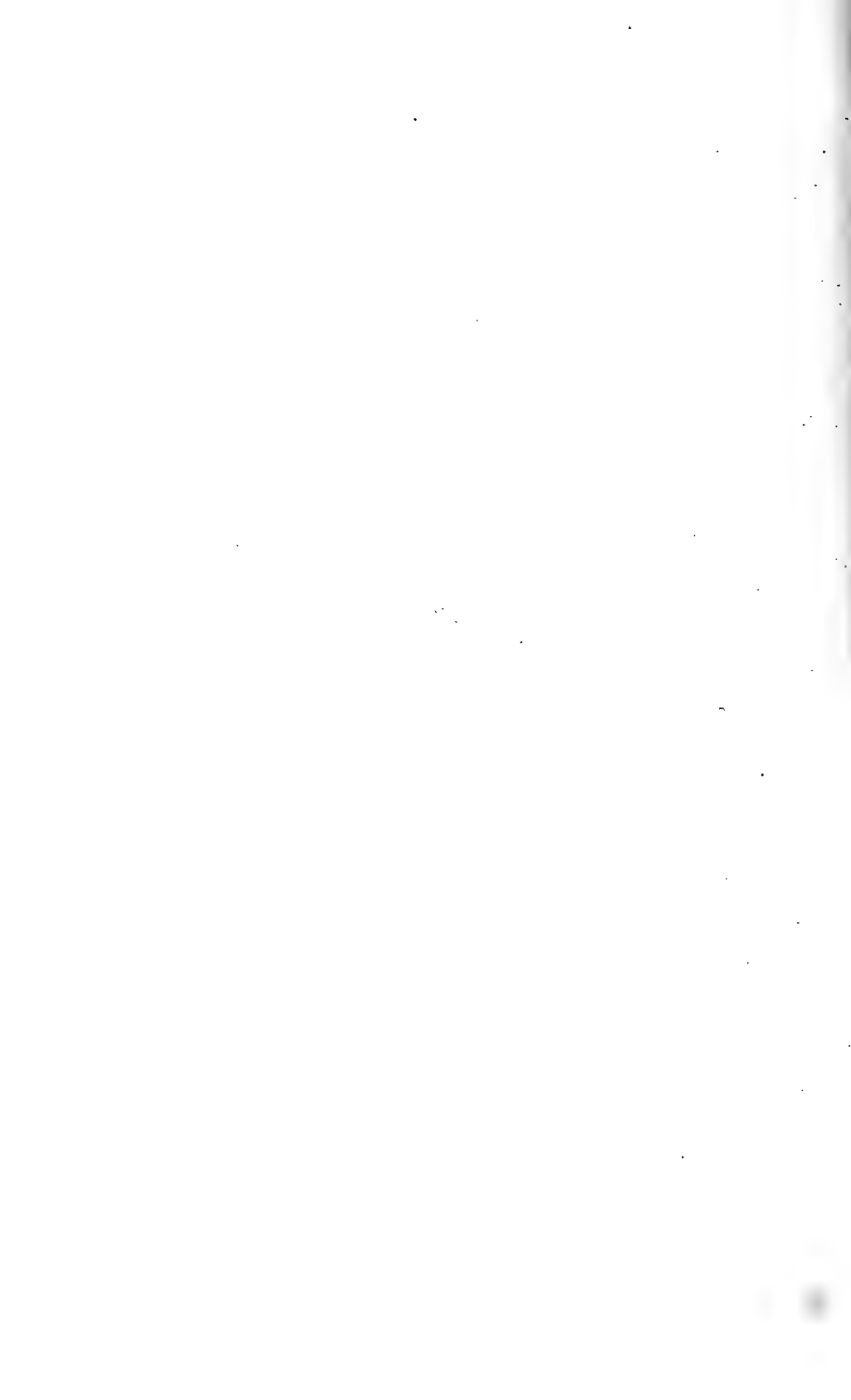


PLATE LXX



Fig. 1 Small swamp east of Station I, a short distance in the field. Broom-corn stubble in the foreground. January, 1914.



Fig. 2. Row of wild cherry-trees (some Osage orange trees intermixed) along the road just south of Station I. January, 1914.

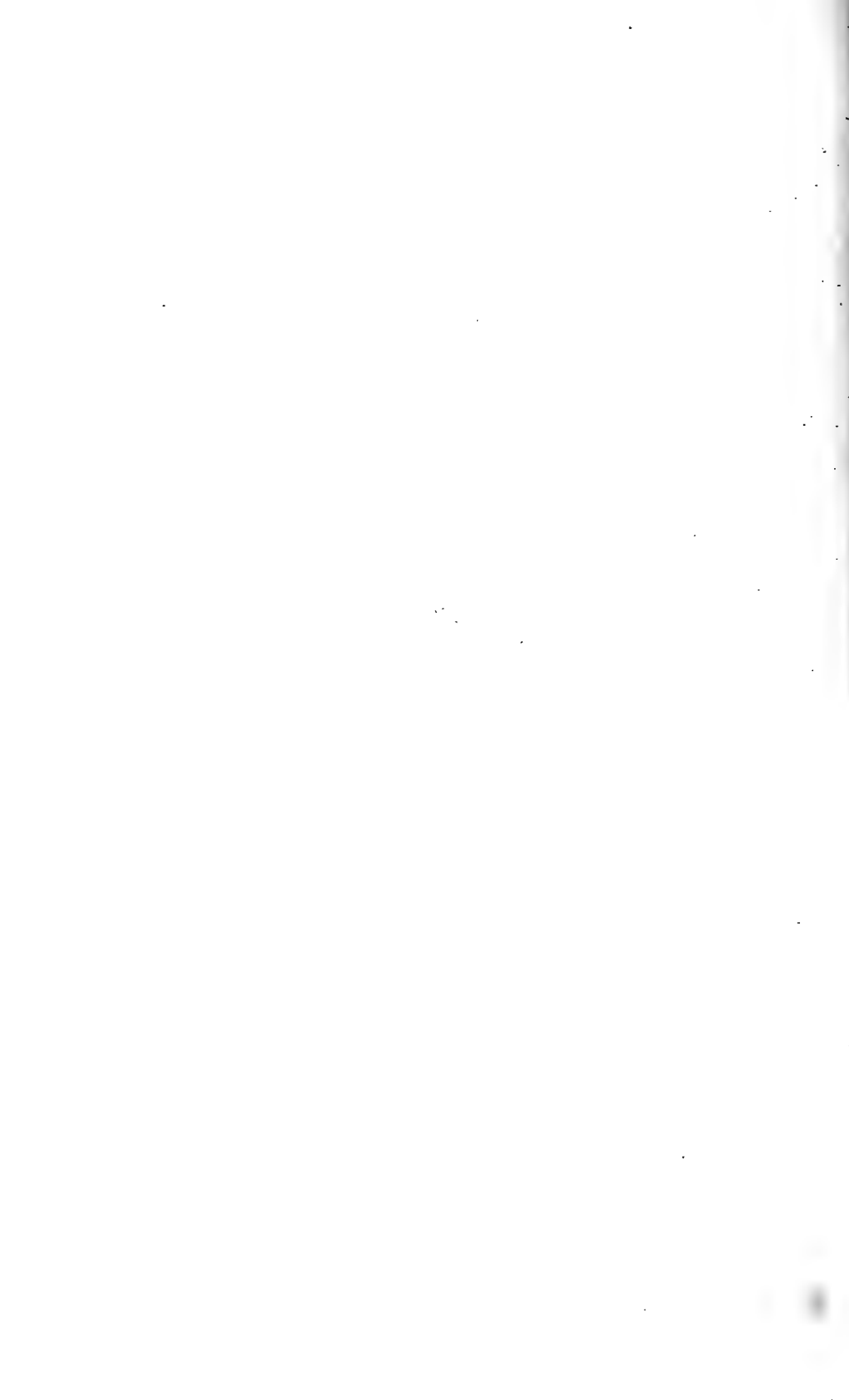


PLATE LXXI



Fig. 1. Station I, substation *d*, looking northeast, November, 1913. Small swamp shown to the right, on the horizon line.



Fig. 2. Dead tree, east of Station I, in field. January, 1914.

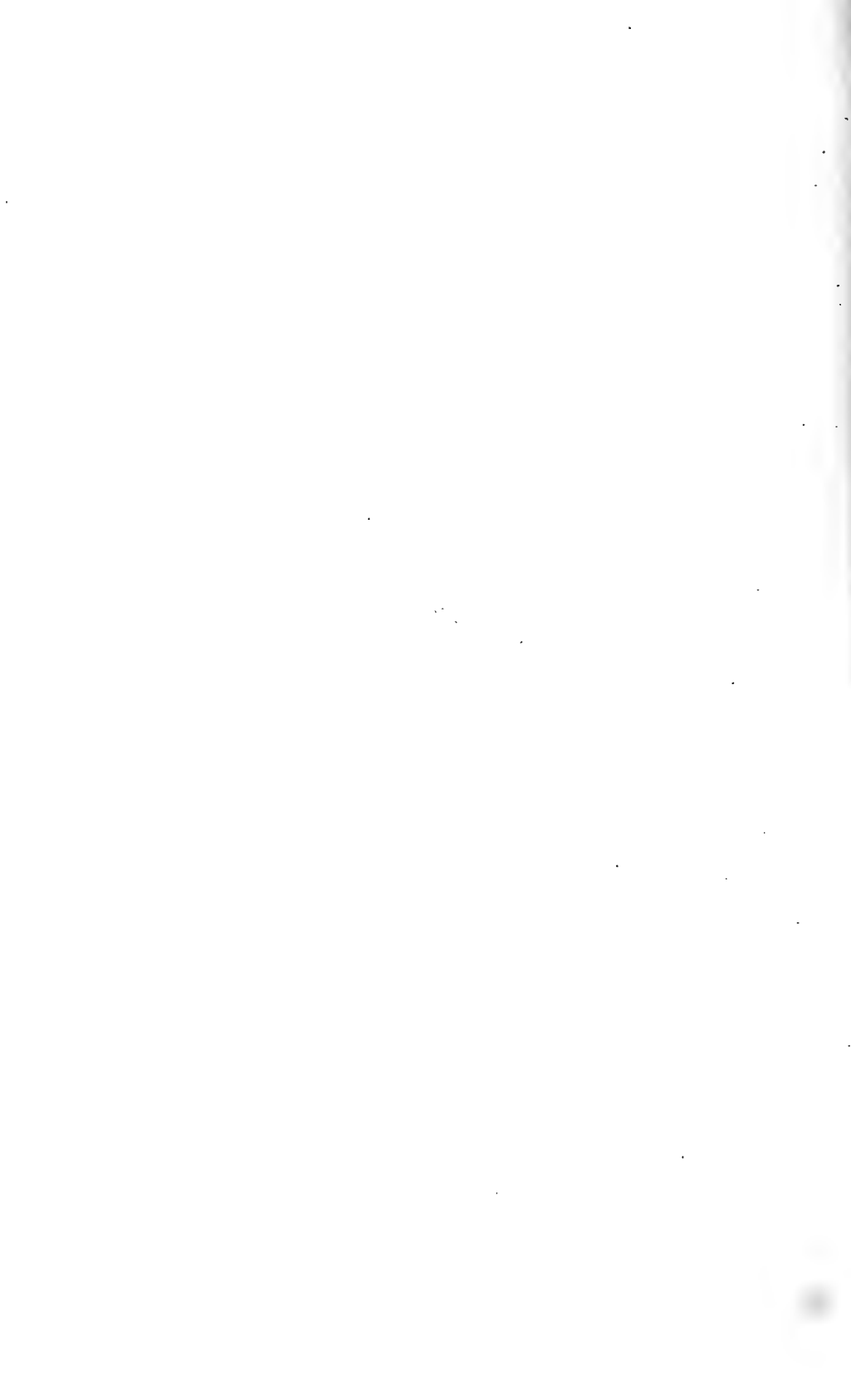


PLATE LXXII



Fig. 1. Station I. Small temporary pool at the north end of the station in April, 1911. Looking northeast.



Fig. 2. Garter snake, *Thamnophis sirtalis*, at Station I. November 24, 1913.

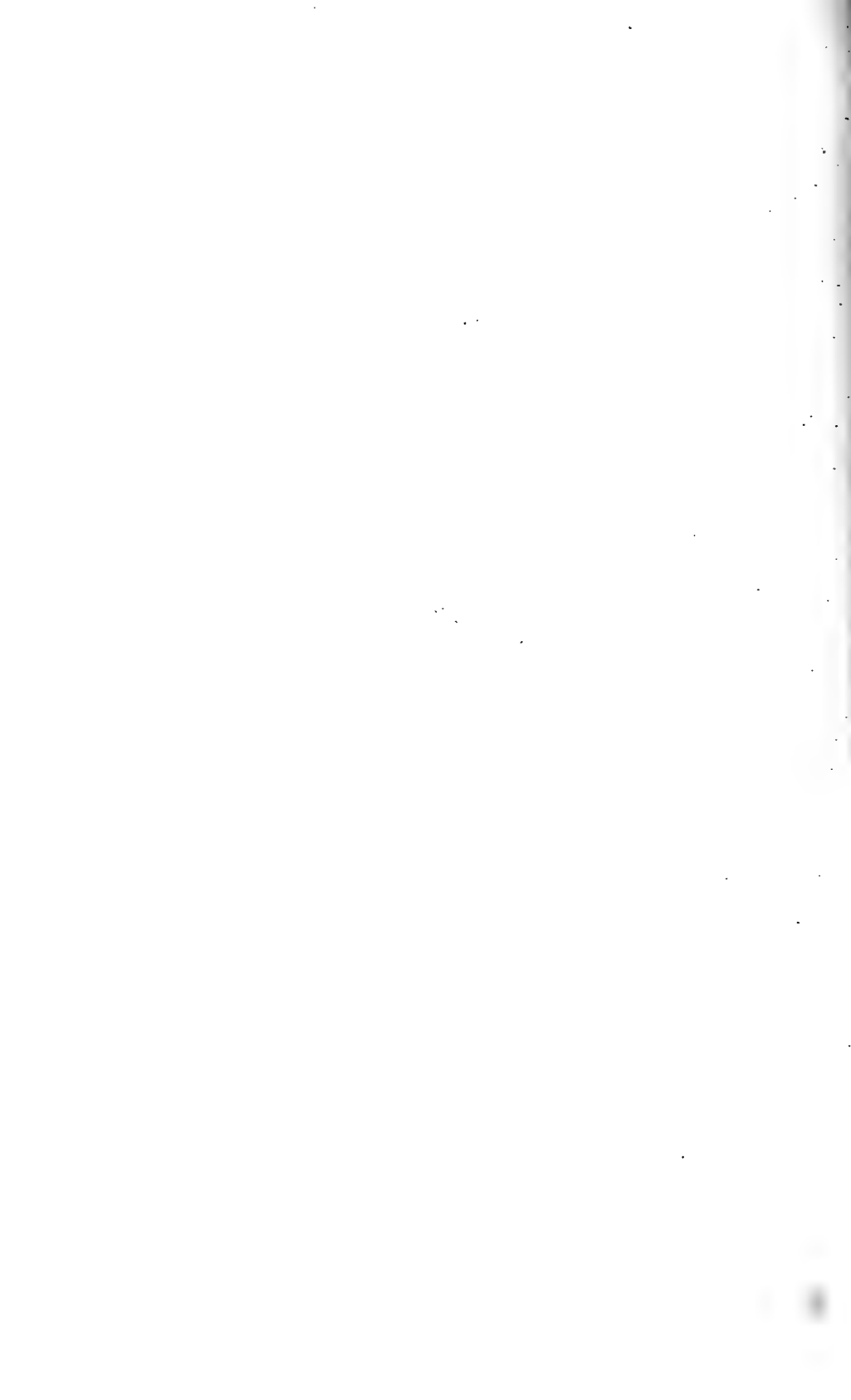


PLATE LXXIII



Station II. Interior of upland woods, showing type of forest with scant undergrowth. August, 1910.

PLATE LXXIV



Station II. Interior of portion of upland woods, typical of that with shrubby undergrowth. August, 1910.

PLATE LXXV



Station II. Interior of lowland woods.

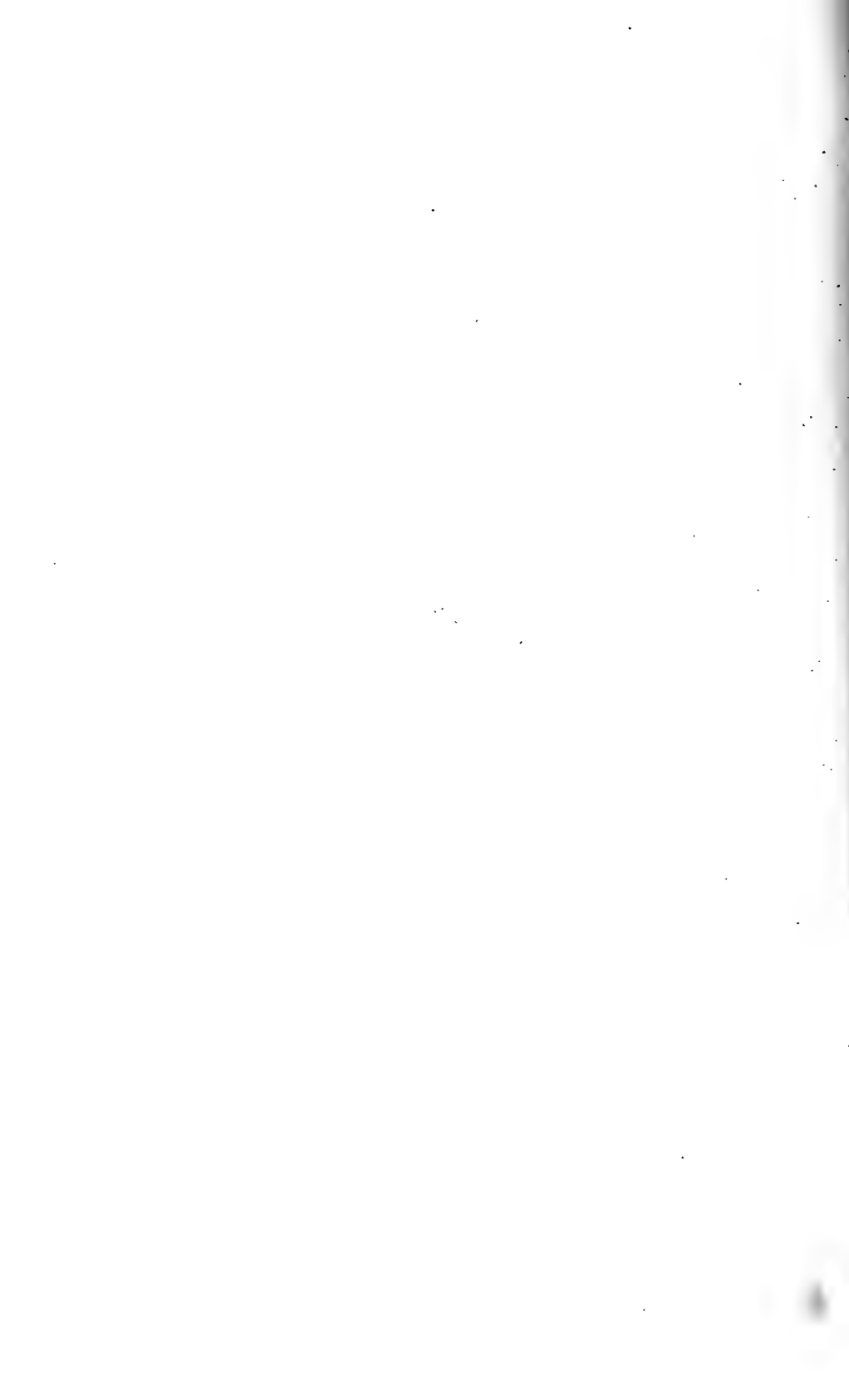


PLATE LXXVI



Fig 1. Station II. South ravine of woods. Looking northwest, up the ravine. April, 1914.



Fig. 2. Station II. Lower part of south ravine of woods. Looking west, up the ravine. August, 1912.

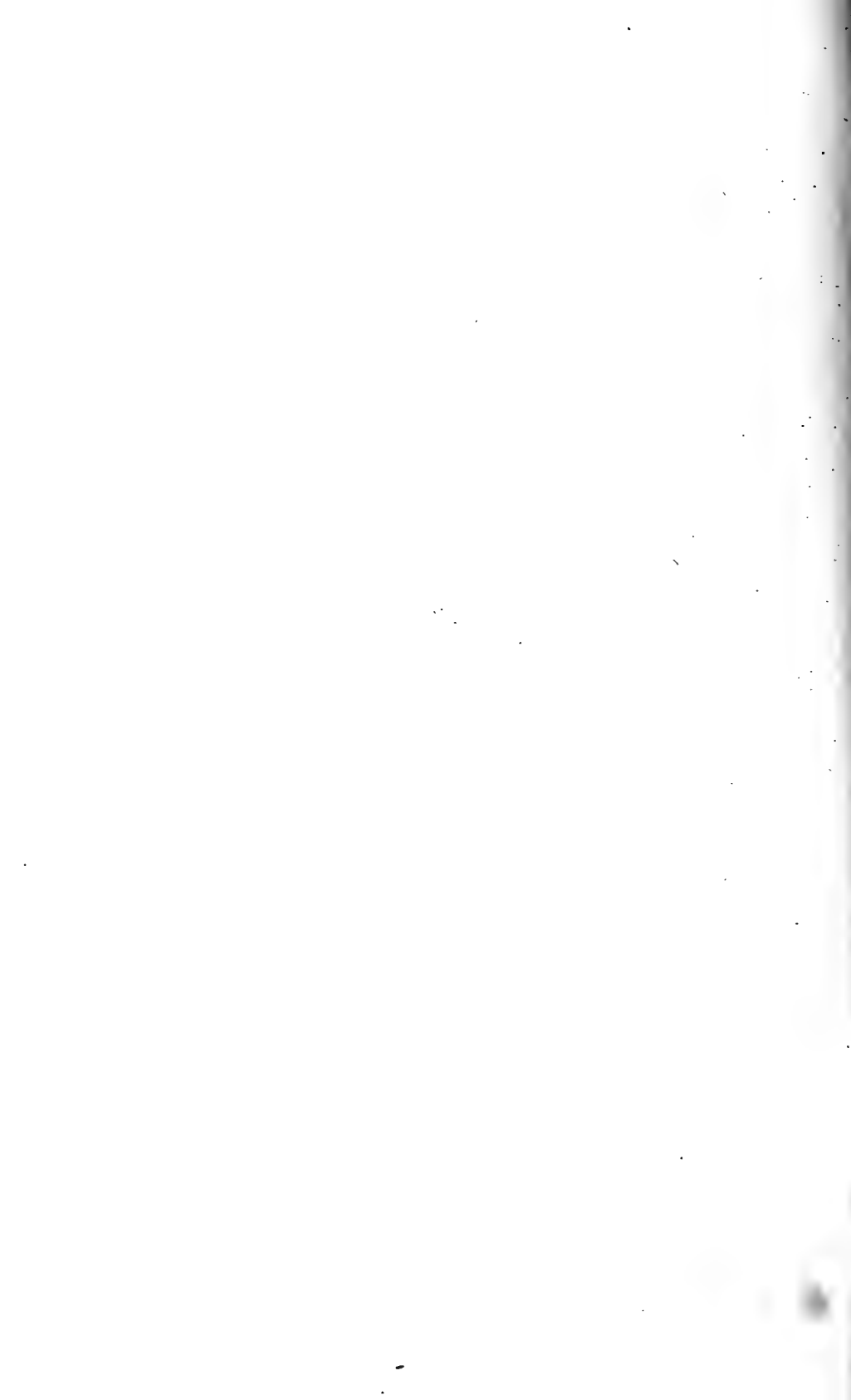


PLATE LXXVII



Fig. 1. Station II. Lower part of woodland stream just below the ravine. Looking southwest, up stream. August, 1910.

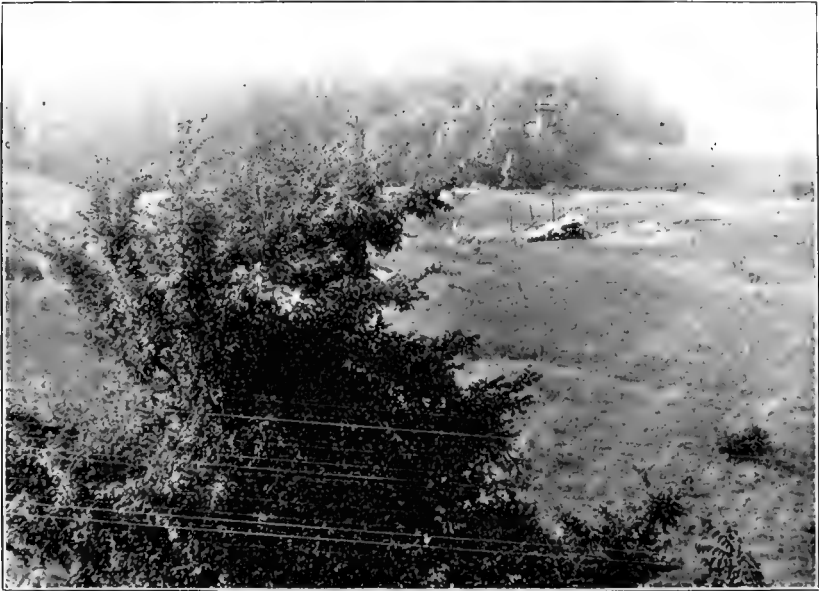


Fig. 2. Station II. Bates woods, looking north from the Big Four railroad track.

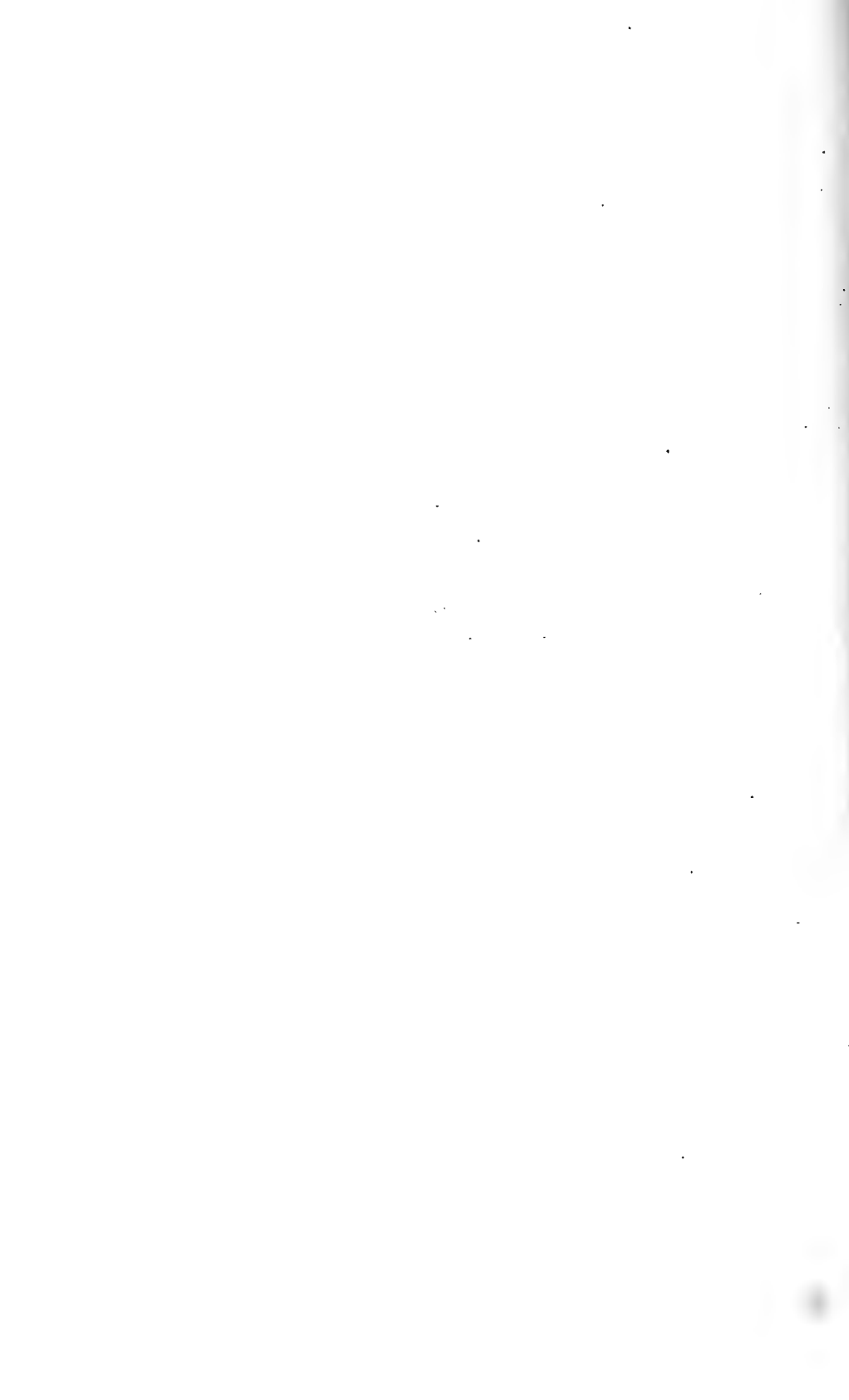
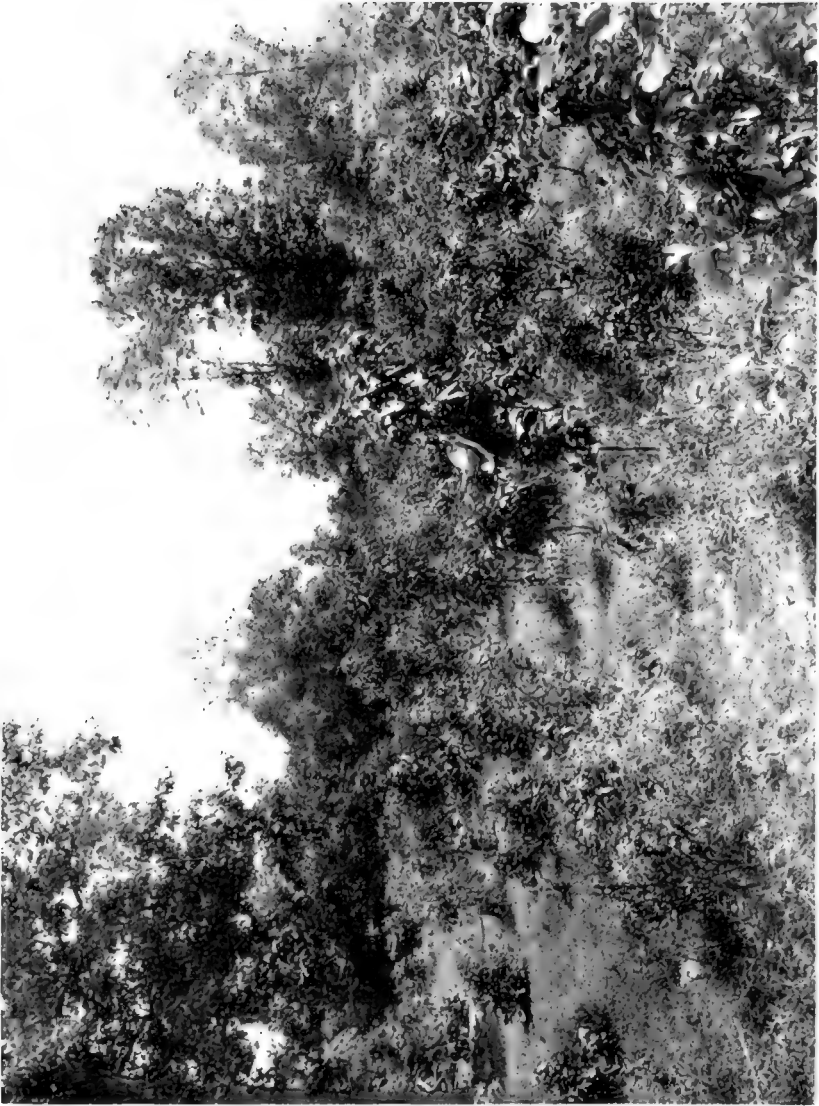


PLATE LXXVIII



Station II. West margin of upland Bates woods. August, 1910. Typical of region of most abundant bird life.

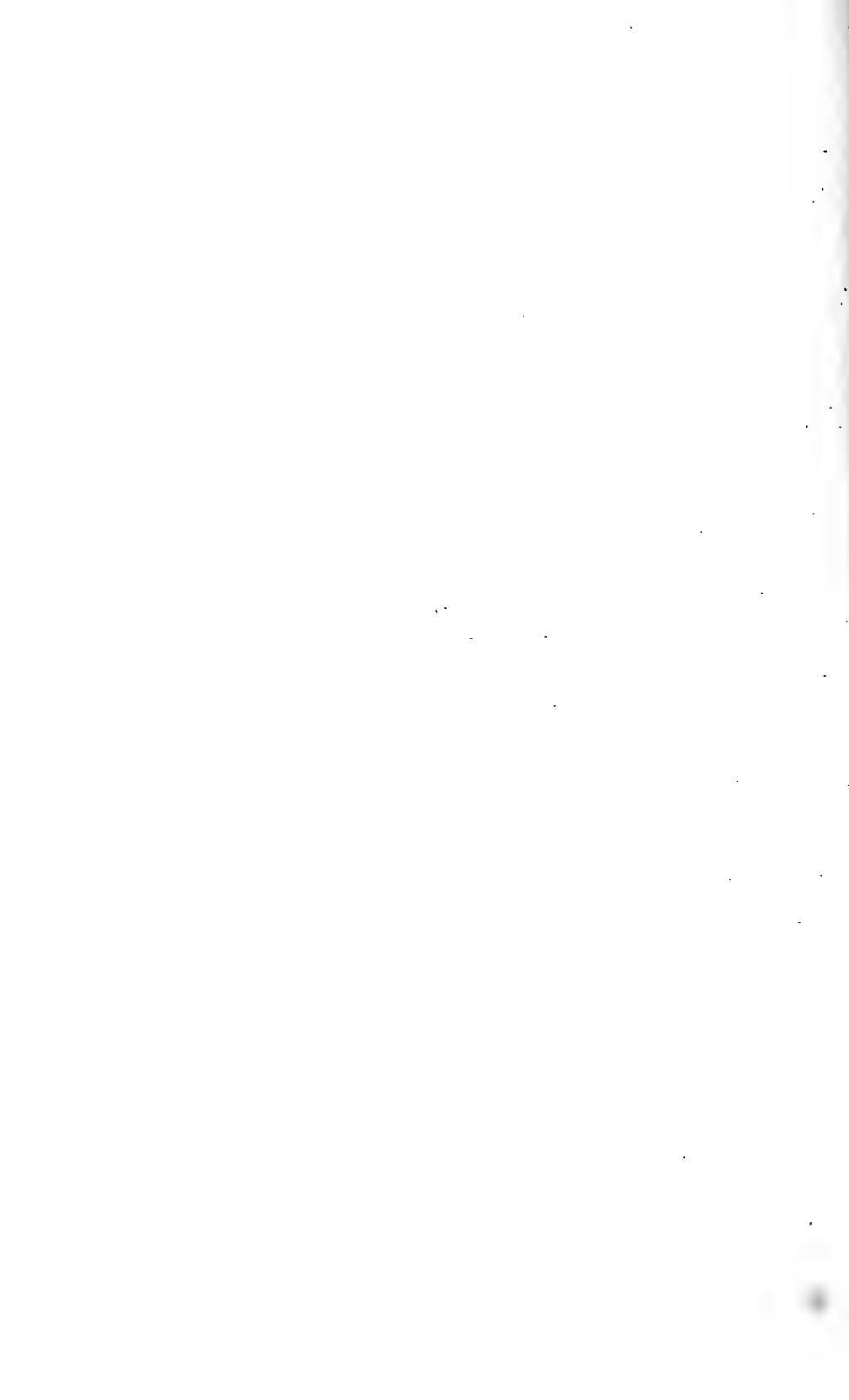


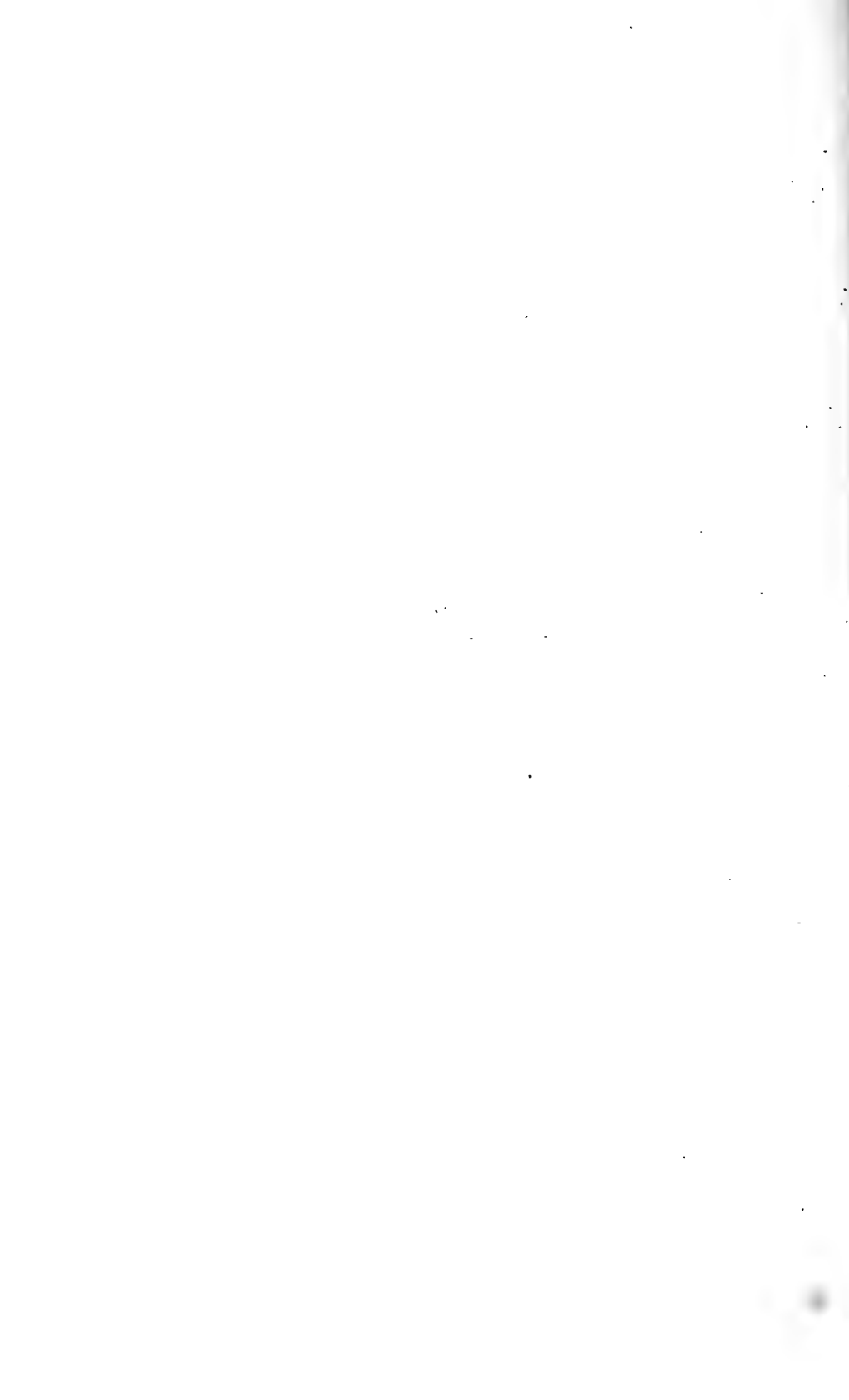
PLATE LXXIX



Fig. 1. Station II. Bates woods, looking southeast, showing remnant of upland woods and stump-field with a few scattered trees where the lowland woods stood. Taken June, 1914.



Fig. 2. Station II. River region northeast of Bates woods, and corn field and potato patch (in foreground) where the lowland woods stood. Taken September, 1913.



BULLETIN
OF THE
ILLINOIS STATE LABORATORY
OF
NATURAL HISTORY

URBANA, ILLINOIS, U. S. A.

STEPHEN A. FORBES, PH.D., LL.D.,
DIRECTOR

VOL. XI.

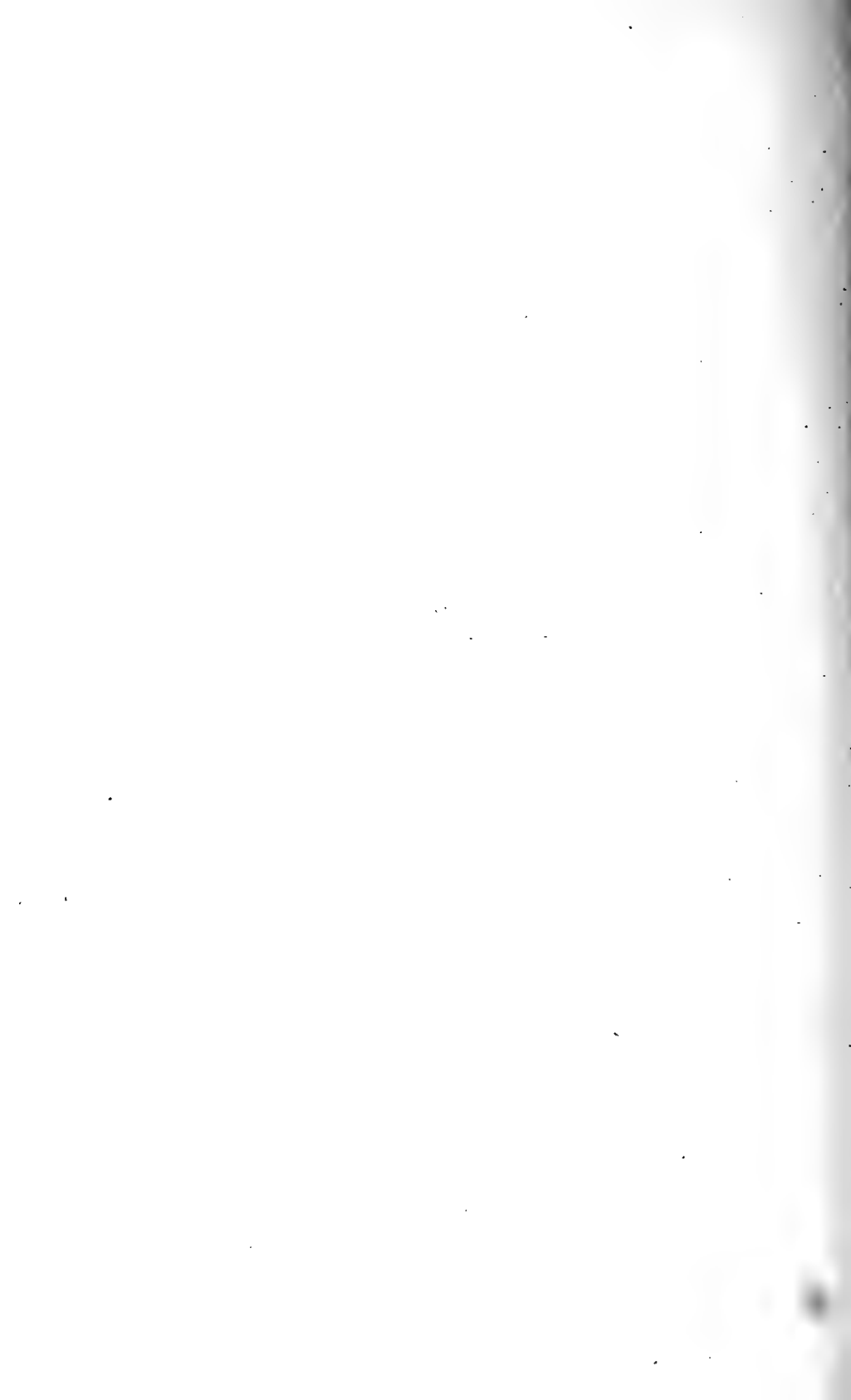
DECEMBER, 1915

ARTICLE IV.

SOME ADDITIONAL RECORDS OF CHIRONOMIDÆ FOR ILLINOIS
AND NOTES ON OTHER ILLINOIS DIPTERA

BY

JOHN R. MALLOCH .



CONTENTS

	PAGE
Notes on blood-sucking <i>Ceratopogoninae</i>	306-309
<i>Culicoides guttipennis</i> Coquillett	306
<i>Culicoides stellifer</i> Coquillett	307
<i>Culicoides sanguisugus</i> Coquillett	307
<i>Culicoides hamatopotus</i> Malloch	308
<i>Culicoides biguttatus</i> Coquillett	308
<i>Pseudoculicoides griseus</i> Coquillett	309
<i>Ceratopogon peregrinus</i> Johannsen.....	309
Additions to list of Illinois <i>Chironomida</i>	310-317
<i>Ceratopogoninae</i> :—	
<i>Neoceratopogon</i> , n. gen.	310
<i>Neoceratopogon bellus</i> Coquillett	310
<i>Forcipomyia elegantula</i> , n. sp.	311
<i>Euforcipomyia</i> , n. gen.	312
Key to species	313
<i>Euforcipomyia hirtipennis</i> , n. sp.	313
<i>Euforcipomyia longitarsis</i> , n. sp.	314
<i>Euforcipomyia fuscicornis</i> Coquillett	314
<i>Johannsenomyia albibasis</i> , n. sp.	315
<i>Probezzia infuscata</i> , n. sp.	316
<i>Tanyptinae</i> :—	
<i>Tanyptus carneus</i> Fabricius	317
Descriptions of males of <i>Ceratopogoninae</i> previously unknown.....	317-319
<i>Johannsenomyia argentata</i> Loew	317
<i>Probezzia pallida</i> Malloch	318
Immature stages of some Illinois <i>Diptera</i> , and biological notes.....	319-324
<i>Sciariidae</i> :—	
<i>Sciara</i> sp.?	320
<i>Mycetophilidae</i> :—	
<i>Mycetobia divergens</i> Walker	321
Predaceous and Parasitic <i>Orthorrhapha</i>	324-342
Key to pupæ	325
<i>Bombyliidae</i>	327
<i>Spogostylum anale</i> Say	328
<i>Ezoprosopa fasciata</i> Macquart?	329
<i>Ezoprosopa fascipennis</i> Say	330
<i>Sparnopolius fulvus</i> Wiedemann.....	331
<i>Anthrax lateralis</i> Say	332
<i>Anthrax hypomelas</i> Macquart	334
<i>Therevidae</i> :—	
<i>Psilocephala hamorrhoidalis</i> Macquart	334
<i>Mydaidae</i> :—	
<i>Mydas clavatus</i> Drury	336
<i>Asilidae</i> :—	
<i>Promachus vertebratus</i> Say	337
<i>Deromyia winthemi</i> Wiedemann	338
<i>Proctacanthus milberti</i> Macquart?	339
<i>Asilus notatus</i> Wiedemann	340
<i>Cyrtidae</i>	341
<i>Oncodes costatus</i> Loew	341

	PAGE
Phytophagous and other <i>Cyclorrhapha</i>	342-352
<i>Syrphidæ</i>	342
<i>Tropidia quadrata</i> Say	343
<i>Brachypalpus frontosus</i> Loew	343
<i>Ceria willistoni</i> Kahl	344
<i>Ephydridæ</i> :—	
<i>Hydrellia scapularis</i> Loew	345
<i>Drosophilidæ</i>	346
<i>Drosophila (Scaptomyza) adusta</i> Loew	347
<i>Drosophila dimidiata</i> Loew	348
<i>Agromyzidæ</i>	348
<i>Agromyza pruni</i> Grossebacher	349
<i>Agromyza tiliæ</i> Couden	351
<i>Agromyza angulata</i> Loew	351
Descriptions of New Illinois <i>Diptera</i>	352-363
<i>Phoridæ</i> :—	
<i>Platyphora flavofemorata</i> , n. sp.	353
<i>Anihomyidæ</i> :—	
<i>Pogonomysia flavinervis</i> , n. sp.	356
<i>Geomyzidæ</i> :—	
<i>Aphaniosoma quadrivittatum</i> , n. sp.	357
<i>Agromyzidæ</i> :—	
<i>Agromyza aprilina</i> , n. sp.	359
<i>Chloropidæ</i> :—	
<i>Gaurax</i> Loew	360
Key to species	360
<i>Gaurax flavidulus</i> , n. sp.	361
<i>Gaurax pallidipes</i> , n. sp.	362
<i>Gaurax interruptus</i> , n. sp.	363

ARTICLE IV.—*Some Additional Records of Chironomidae for Illinois and Notes on other Illinois Diptera.* BY J. R. MALLOCH.

In a previous paper, Article 6 of Volume X of this Bulletin, I indicated that despite the fact that our state list of species of *Chironomidae* is larger than any list yet published for any other state in the Union it could not be considered as a complete list of all the species occurring in Illinois. The greater portion of the material upon which the previous paper was based consisted of species collected by Mr. C. A. Hart and the writer during 1914, and containing, as it did, but a small series of collections from a number of scattered localities it could not be expected to include all of our species. Being aware of this fact and desirous of obtaining as many species as possible, the writer during the present year has devoted most of his spare time to collecting in the vicinity of White Heath, on the Sangamon River, with a view to completing the series of *Ceratopogoninae* in the collection in so far as that particular locality is concerned. No material from this part of the Sangamon River was contained in that previously studied, though many of the species were obtained near Monticello, which is but a few miles down river from this point.

An attempt was also made to discover what species attacked man and at what particular time and in what situations. The writer endured considerable discomfort in his investigations, as mosquitoes were very numerous and bit very severely upon every occasion that he visited the river. In addition to the mosquitoes the writer had upon one occasion the experience of being bitten by the nymph of a capsid. It is not possible at present to determine the species of this insect beyond the fact that it is certainly not *Lygus pratensis*—a species which I have seen in the act of biting at Chain Bridge, Va., and which is recognized as having that proclivity.

Another source of annoyance was provided by the females of a small black bee (*Halictus* sp.), which persistently settled upon the bare arms, evidently attracted by the perspiration. On two days this species occurred in fair numbers and was very annoying, settling on the arms and being with difficulty brushed off. Judging from the actions of the insects they were sucking up the small particles of perspiration.

The worst discomfort experienced during 1915 at White Heath was that provided by "chiggers" (*Trombidium* sp.), which were in abundance—an unusual occurrence in this part of the state.

As the collection of *Chironomidae* was but an incident in a rather overcrowded program, I found it impossible to do any work on the early stages of the aquatic forms, and the additional data obtained refer only to the habits of the imagines and to certain species which are either new to science or are not included in my previous paper.

NOTES ON BLOOD-SUCKING CERATOPOGONINÆ

In my previous paper I listed as blood-sucking species, *Culicoides variipennis*, *C. sanguisuga*, *C. hæmatopotus*, and *C. guttipennis*, the first two biting both man and cattle, the third biting man, and the last biting a horse. Before listing my records for this year it may be of interest to mention those given by Pratt in 1907 for this group*.

He lists six species as blood-sucking, viz., *Ceratopogon guttipennis*, *C. sanguisuga*, *C. stellifer*, *C. variipennis*, *C. cinctus*, and *C. unicolor*. All of these species were described by Coquillett, who placed them in the genus *Ceratopogon* (sens. lat.). All but *unicolor* belong to *Culicoides*. The generic position of *unicolor* is uncertain. It will be seen from a comparison of the two lists that four species recorded by Pratt are also in the Illinois list. This year, I have been able to find several additional biting species.

CULICOIDES GUTTIPENNIS Coquillett†

In 1914 I did not succeed in obtaining specimens of this species attacking man, although well aware that it was considered as one of the most persistent biters in the genus. This year, however, upon different dates, I have obtained a large number of specimens in the act of biting. I found that by exposing the bare arm and settling quietly down by the side of the river I could readily obtain any number of specimens of this species. The exposed part, however, was not most subject to attack, as the insects appeared to settle much more readily upon the clothes, especially upon the legs, and almost invariably made their way up between the legs, or, when one was in a sitting posture, directed their efforts towards the under surface and particularly at the back of the knee if the leg were drawn up. It is obvious, of course, that in

*"Notes on 'Punkies,'" Some Miscellaneous Results of the Work of the Bureau of Entomology—IX, Bull. 64, Part III, Bur. Ent., U. S. Dept. Agr. pp. 23-28.

†Citation to original publication is given only when species is not included in my previous paper.

attacking cattle the most vulnerable portions are best calculated to yield the best results to these small insects with their rather short mouth-parts, and that the most vulnerable parts are those near the upper extremities of the legs. I have found in the case of *Simuliidæ*, or black flies, that while they may be found upon almost any part of the body of a cow or horse they are more often found on the under surface of the body close to the leg or, in the case of the horse particularly, inside the ear—the most vulnerable spots.

The blood-sucking species of *Ceratopogoninæ* are mostly crepuscular in habit, and in most cases I found that during May and June the greatest numbers occurred after five o'clock in the afternoon, continuing active until 8 p. m. at least, this being the latest hour that it was possible for me to make observations. From experience at other times and in other localities I know, however, that the insects bite as late as 10 p. m. The earliest hour at which I found *guttipennis* biting was 1 p. m. On this occasion the sun was shining, but an hour or so later a short thunder storm occurred, the weather conditions very probably being responsible for the unusual occurrence of the species.

When in the act of biting it was not always easy to capture this species in a cyanide vial, as the insects were very readily disturbed, which is not the case with the smaller species, *biguttatus* and *sanguisugus*.

May 9, only one specimen was taken; on May 15 but two; while on May 30, thirty-five specimens were collected, all in the act of biting. On the first two dates *biguttatus* was the commonest species. On various dates in June and July *guttipennis* was found to occur commonly, but no large collection was made.

In my paper previously referred to I stated that the early stages of *guttipennis* were undescribed. Lest there should be any misunderstanding on this point it may be pertinent to indicate that meaningless figures of the larva and pupa accompanied by absolutely inadequate descriptions are given by Pratt in his paper referred to on a previous page.

CULICOIDES STELLIFER Coquillett

Two specimens of this species were taken in the act of biting the writer, August 8, 1915, on bank of Sangamon River, near White Heath.

CULICOIDES SANGUISUGUS Coquillett

This species is found commonly in Urbana, large numbers of both sexes being taken on windows of stores in the city after the lights are turned on. I have also taken many specimens on the inner side of win-

dows of the Natural History Building of the University of Illinois, especially in the basement on windows close to the outer doors. Only three specimens of the species were taken in the act of biting on the dates that collections were made at White Heath, two of these being taken at the Sangamon River May 30, and the other at the railroad station in the town over a mile from the river. It appears from the rate of occurrence of this species in our collections that *sanguisugus* is more common in towns than *guttipennis* or *varipennis*.

CULICOIDES HÆMATOPOTUS Malloch

This species occurred along with *guttipennis* but in smaller numbers. It was taken biting on May 6, 9, and 30, and June 6. Some specimens were taken on windows of the Natural History Building also. Its biting habits are similar to those of *guttipennis*. The bite of both is less severe than that of *varipennis*.

CULICOIDES BIGUTTATUS Coquillett

Ceratopogon biguttatus Coquillett, Proc. U. S. Nat. Mus., Vol. 23, p. 604.

This species is an addition to the Illinois list, the only specimens I had when I wrote my previous paper being from Virginia.

As an aid to the identification of the species it is necessary to indicate that in my key to the Illinois species* *biguttatus* will run down to No. 6. To include it, it is necessary to change the wording to read as follows:

- 6. Spots on wings indistinct; mesonotum without well-defined markings6a
- Spots on wing rounded, clearly defined; mesonotum with well-defined brown markings.....7
- 6a. Wings with only 2 clear spots, one over cross vein and the other at apex of third.....*biguttatus*.
- Wings with several ill-defined clear marks in the posterior and anal cells along wing margin in addition to those over cross vein and at apex of third.....*sanguisugus*.

Coquillett originally described *biguttatus* from specimens obtained in the District of Columbia. In Illinois the species occurred on the same dates as *guttipennis* and at the same place. The largest number taken biting on any one day was thirteen on May 15. This species attaches itself more firmly to the skin than does *guttipennis* and can be taken much more easily by inverting the cyanide vial over it when in

*Bull. Ill. State Lab. Nat. Hist., Vol. 10, Art. 6, p. 296.

the act of biting. In some cases the specimen succumbed to the fumes without relaxing its hold and had to be pried off. I took a single female on a window in the Natural History Building at Urbana July 25, 1915.

PSEUDOCULICOIDES GRISEUS Coquillett

Ceratopogon griseus Coquillett, Proc. U. S. Nat. Mus., Vol. 23, 1901, p. 602.

A single specimen of this species was taken biting, on the bank of Sangamon River near White Heath on May 9.

I have a suspicion that the species which I described as *P. major** may be synonymous with *griseus*, but desire to obtain further material before definitely deciding, as I am of the opinion that there are several closely allied species in this genus, the differentiation of which will require careful study of a large amount of material.

There is no previous record of *griseus* biting man.

CERATOPOGON PEREGRINUS Johannsen

July 7, while collecting on tree trunks and limbs after a period of rain, I discovered a dead worm lodged on a branch of a cypress tree, its location and condition indicating that it had been dropped by a bird. When first seen there were several specimens of *Ceratopogon peregrinus* engaged in feeding upon it in company with a species of *Aphiocheta* and a female of *Lonchaea polita* Say. This occurred about noon, and about a dozen specimens in all were taken. One specimen that had just arrived and had only begun to feed, had the abdomen normal in size, but those that had been feeding for some time had the abdomen greatly distended. It was observed that all the specimens were females, and in one case the insect was seen inserting its proboscis in the minute drops of moisture on the leaves.

This species is very common both indoors and outdoors throughout the locality collected over, but no records of feeding habits other than the above have been obtained. An attempt was made to ascertain if the species would bite man by confining the females on the bare skin of the arm, but although this method has proven successful with some *Simuliidae* that are not particularly prone to that habit it was unsuccessful with *peregrinus*. It may be of interest to mention that attempts to persuade several species of *Forcipomyia* to bite by allowing them to settle on the hands and arm and also by confining them on the skin by inverting a vessel over them, proved failures. I have not discovered any species of this genus attacking man or cattle.

*Loc. cit., p. 311.

ADDITIONS TO LIST OF ILLINOIS CHIRONOMIDÆ

Several of the species which were taken this year are new to science; others are new to the state list; while in some cases the males of known species are described herein for the first time, and in one instance the female is thus dealt with. In all instances care has been taken to indicate the characters by means of which the additions to our list may be separated from those already recorded by the writer. In considering the number of additions to the Illinois list it is necessary to include *Culicoides biguttatus* previously mentioned.

CERATOPOGONINÆ

NEOCERATOPOGON, n. gen.

This genus is erected for the reception of *Ceratopogon bellus* Coquillett, a species unknown to me when my previous paper was written.

Generic characters: male.—Eyes narrowly separated above; antennæ elongate, plumose, apical 3 joints much longer than the preceding flagellar joints; legs slender; third hind tarsal joint short, slightly longer than fourth, the latter obcordate and with the third very slightly longer than fifth; claws small, slender, simple, subequal; empodium indistinguishable; wings with distinct hairs as in *Ceratopogon*; first and third veins fused, not connected by a cross vein as in *Ceratopogon*; media petiolate.

Female.—Eyes narrowly separated above; antennæ elongate, basal flagellar joints elongate, not nearly transverse as in *Ceratopogon*, apical five joints distinctly longer than preceding joints; tarsal claws unequal in size, the inner twice as long as the outer.

Type of genus, *Ceratopogon bellus* Coquillett.

NEOCERATOPOGON BELLUS Coquillett

Ceratopogon bellus Coquillett, Proc. U. S. Nat. Mus., Vol. 25, 1902, p. 87. ♂

Female.—Yellowish white, opaque. Face brownish; upper part of head covered with white pruinescence; antennæ elongate and mouth parts brownish or yellowish. Disc of mesonotum covered with whitish pruinescence; a small brown spot at base of each discal hair; scutellum whitish, a black or brown streak on center; postnotum yellow. Abdomen yellowish or white above, fuscous on venter. Legs white, marked with fuscous or brown as follows: entire coxæ and trochanters, a broad median band on all femora and a very narrow one at apices; a narrow band near base on all tibiæ, a broad median band on fore pair,

a narrow one beyond middle on mid pair, a narrow one before and another beyond middle on hind pair, and the apices of all pairs, apices of tarsal joints, and whole of basal joint of hind tarsi. Wings with 8 small deep black spots as follows: on cross vein (sometimes paired), at apex of third vein, below middle of petiole of cubitus, near base of posterior branch of media and near apices of each branch of that vein and of cubitus. Halteres whitish, knob with a black spot.

Antennæ about 1.5 as long as head and thorax combined. Thoracic dorsum and scutellum with sparse rather long hairs. Legs slender; basal joint of hind tarsi slightly shorter than the remaining joints combined.

Male.—Agrees with the female in color.

Hypopygium large, projecting apical portion of lateral arm slender, curved.

Length, 1–1.5 mm.

Illinois locality, Urbana, July 5–7, 1915, several females at rest on cypress tree on university campus, one in Natural History Building, and one male on cypress tree; one female August 27, on cypress tree (J. R. Malloch).

This genus will run down to the second section of caption 3 in the key to genera of *Ceratopogonina* in my paper, and may be separated from *Ceratopogon*, the genus there included, by the fusion of the first and third veins of the wing, the absence of empodia, and the unequal tarsal claws in the female.

The early stages are unknown.

FORCIPOMYIA ELEGANTULA, n. sp.

Female.—Pale yellow, marked with deep black. Head yellow, upper portion of back of head and the antennal flagellum fuscous, eyes black. Mesonotum slightly shining, with 3 glossy black vittæ, the median one bifid posteriorly and ending slightly beyond middle of disc, the lateral pair abbreviated and conspicuously broadened anteriorly, not extending to posterior margin; pleuræ with 3 shining black spots, one between fore and mid coxæ, directly above it, the upper extremity of which does not reach upper margin of pleuræ, and a third below wing base; scutellum and postnotum glossy black. Abdomen slightly shining, dorsum with anterior half of segments 2–5 and the whole of segment 6 blackened; venter yellow, blackened at apex. Legs whitish yellow, apical fourth of hind femora deep black. Wings grayish, surface hairs fuscous with the exception of a rather large patch over the apex of the third vein which is yellowish white. Hal-

teres pale yellow. Hairs on body and legs yellow, lanceolate hairs on the latter fuscous.

Eyes distinctly separated above; antennal flagellum with basal joints moniliform, sensory hairs of moderate length, thicker than the ordinary surface hairs. Mesonotum and scutellum with rather numerous long hairs. Legs with conspicuous hairs, all tibiæ with a dorsal series of lanceolate upright scales; basal joint of hind tarsi one fifth shorter than second; empodia distinct. Third vein ends at middle of wing.

Male.—Agrees in color with female.

The legs are devoid of the lanceolate hairs; the apical 4 antennal joints are elongated; the hypopygium is large and very similar to that of *specularis*; in other respects similar to female.

Length, .75 mm.

Type locality, Urbana, Ill., June 28, and August 5, 1915, taken on window in basement of Natural History Building, University of Illinois, by the writer. Allotype, August 12, 1915; same situation.

The type specimen has a large mite about two thirds as long as the abdomen, firmly attached to it near the base.

The female of this species will run down to caption 3 in my key to the Illinois species of this genus (p. 312), but may be readily separated from both species therein by the difference in coloration, and from *cilipes* by the possession of lanceolate scales on the fore tibiæ. The male can be separated from all others in my preceding paper by the yellow thorax with its conspicuous glossy black vittæ.

One female had a number of extruded eggs attached to the apex of abdomen. They are white, about three times as long as thick, slightly rounded at the extremities, and slightly curved in outline. They are closely attached to each other on their longer sides.

EUFORCIPOMYIA, n. gen.

Distinguished from *Forcipomyia* by having the basal joint of hind tarsi much longer than the second, and from *Pseudoculicoides* by the different structure of the antennæ, which is similar to that of *Forcipomyia*. In *Pseudoculicoides* the antenna of the female has the flagellar joints very appreciably constricted at apices, especially the apical 5, while in *Forcipomyia* and the present genus the joints are but slightly constricted and for a very short distance, never having a conical appearance as in *Pseudoculicoides*.

The wings are densely haired, but the hairs are slender and rather upright, more resembling those on the wings of *Pseudoculicoides* than on *Forcipomyia*. The first vein runs close to the third and is con-

nected with it by a cross vein and the media is petiolate. Empodia distinct.

Type of genus, *Euforcipomyia hirtipennis*, n. sp.

KEY TO SPECIES

1. Basal joint of hind tarsus not twice as long as second (22:15)....
..... *hirtipennis*.
- Basal joint of hind tarsus at least twice as long as second.....2
2. The short joints of antennal flagellum longer than broad, distinctly narrowed at bases, the segmentation very distinct; basal joint of hind tarsus twice as long as second (40:20).....*longitarsis*.
- The short joints of antennal flagellum broader than long, closely fused, the segmentation indistinct; basal joint of hind tarsus about 2.5 times as long as second (37:15).....*fusicornis*.

EUFORCIPOMYIA HIRTIPENNIS, n. sp.

Female.—Black, shining; abdomen more brownish, subopaque. Antennæ and mouth parts brownish. Legs yellow. Wings slightly grayish, covered with brown hairs. Halteres yellow. Hairs throughout on body and legs yellow.

Eyes slightly separated; antenna longer than head and thorax combined, the divisions between joints distinct throughout, basal 9 flagellar joints subequal in length, distinctly but not greatly longer than broad, hairs of moderate length, sensory organs longer than length of joints, slightly curved, apical 5 joints elongated, stout, their combined lengths less than that of basal 9, apex of last joint produced in the form of a short thorn. Thorax with long and rather sparse slender hairs, those on margin of scutellum very long. Abdomen with sparse short hairs. Legs of moderate strength; hind tibia and hind tarsus subequal in length; basal joint of hind tarsi about 1.5 as long as second (22:15); third joint slightly shorter than fourth, fourth and fifth subequal; claws small, subequal, simple; empodium as long as claws, fringed; surfaces of femora and tibiæ with numerous long hairs. Third vein ending a little beyond middle of wing, first ending one third from apex of third, connected with the latter by a cross vein at its middle; media with very short petiole, base of posterior branch indistinct; surface of wing with numerous microscopic upright hairs in addition to the long subdepressed hairs.

Length, .5 mm.

Type locality, Urbana, Ill., June 30, 1915, taken by the writer on the windows of the basement of the Natural History Building.

Nothing is known of the early stages or of the habits of the imago.

EUFORCIPOMYIA LONGITARSIS, n. sp.

Female.—Fuscous. Mesonotum shining; pleuræ reddish brown. Legs testaceous or yellowish. Hairs on body and legs yellow; on wings brown.

Eyes contiguous; antenna about as long as head and thorax together, basal joints of flagellum longer than broad, narrowed at bases and more distinctly so at apices, apical 5 joints elongated; palpi 5-jointed. Mesonotum with pale decumbent hairs, those on lateral and posterior margins very long; scutellar hairs numerous, long and conspicuous. Abdomen with pale yellow hairs, those near the posterior lateral angles very long. Legs of moderate strength, with numerous slender hairs, those on dorsal surface of tibiæ very long; hind tibia about three fourths as long as hind tarsus; basal joint of hind tarsi twice as long as second, proportions of the first three joints, 40, 20, 15; empodium as long as claws. Wings densely haired throughout their entire surface; costa ending slightly before middle of wing; first and third veins almost fused basally, the former ending about two fifths from apex of latter; cubitus forking slightly beyond apex of third vein.

Length, .75 mm.

Type locality, Urbana, Ill., August 24, 1915, on basement window in Natural History Building, University of Illinois (J. R. Malloch). Early stages and habits of adult unknown.

EUFORCIPOMYIA FUSICORNIS Coquillett

Ceratopogon fusicornis Coquillett, Jour. N. Y. Ent. Soc., Vol. 23, 1905, p. 63.

Female.—Differs from *hirtipennis* in having the mesonotum with distinct brownish pruinescence, the antennæ almost black, and the legs brownish.

Eyes distinctly separated above; antenna not longer than head and thorax combined, basal joints of flagellum very distinctly shorter than broad, rather closely fused; apical five joints elongated. Mesonotum with sparse subdepressed golden hairs and a few longer upright ones intermixed. Legs of moderate strength; basal joint of hind tarsi about two and a half times as long as second (37:15), third distinctly shorter than second, fourth shorter than fifth; claws small, simple, equal; empodia as long as claws, fringed. Third vein ending distinctly beyond middle of wing, first slightly beyond middle of third, third and first almost fused; otherwise wings as in *hirtipennis*.

Length, .5 mm.

Type locality, Florida. I have seen a specimen from Beltsville, Md., July 4, 1915 (W. L. McAtee), which was taken attacking *Chauliodes* sp.

This species resembles rather closely some species of *Ceratopogon* but differs noticeably in possessing the long surface hairs in addition to the short upright ones on the wings. Several species of *Forcipomyia* have been recorded as attacking insects, and in the present paper I record a species of *Ceratopogon* feeding upon a worm.

Fusicornis has not been taken in Illinois and is added here for convenience of reference.

JOHANNSENYOMYIA ALBIBASIS, n. sp.

Female.—Glossy black. Head black, face yellow, palpi pale yellow, proboscis reddish yellow. Thorax entirely glossy black, without pruinescence and with inconspicuous dark hairs which are very sparse on center of mesonotum. Abdomen shining, black apically, the basal 2 or 3 segments whitish. Legs yellowish white, blackened narrowly on fore knees and apices of fore and mid tibiæ, broadly on apices of mid and hind femora and hind tibiæ, the latter sometimes with dark suffusion to near base, apical joint of all tarsi black. Wings clear, veins of the basal half very pale, darker from middle to apex. Halteres yellowish, knob black.

Eyes distinctly separated above, antenna slightly longer than head and thorax together, second joint not much swollen, basal eight joints of flagellum distinctly longer than broad, apical five joints much more elongated than preceding joints. Legs slender, without spines or setulose hairs; fifth tarsal joint on all legs with 4 or 5 pairs of rather long ventral spines; tarsal claws long, subequal, each with short subbasal tooth. Wings of moderate width; third vein ends about one fifth from apex; first ends at two fifths from base of third, its last section distinctly shorter than the preceding one; media forks before cross vein; cubitus slightly beyond cross vein.

Male.—Differs from the female in having the antennæ yellowish, with dark plumes; the coxæ brownish, and the fore knees more noticeably blackened; the third vein ending slightly over three fourths from base of wing; the fifth tarsal joint without ventral spines; the tarsal claws much smaller and without the subbasal tooth.

Length: female, 2.5 mm.; male, 2 mm.

Type locality, White Heath, Ill., May 8–30, 1915 (J. R. Malloch).

This species will in the case of the female run down to section 13 in my key to the species of this genus in my recently published paper on the Chironomidæ of Illinois*, but is readily separated from the two species there given by the color. The male will run down to section-8 in the same key, but may also be separated from the two species with dark halteres by the color as well as several structural characters.

The species was very common at rest on the under side of leaves of trees and bushes bordering the Sangamon River. The male bears a striking resemblance to that of *Probezzia pallida* which occurred along with it.

PROBEZZIA INFUSCATA, n. sp.

Female.—Head black, face, proboscis, and palpi brownish yellow; basal half of antennæ pale yellow, apical half fuscous. Thorax glossy black, without any traces of pruinescence. Abdomen white or creamy, apical half infuscated except the 2 apical segments, which are whitish. Legs yellow, mid and hind coxæ fuscous, apical two fifths of femora, entire tibiæ, and apical two tarsal joints of all legs black. Wings, including the veins, whitish on basal half, apical half slightly infuscated, the veins blackish. Halteres brown, knobs black. Antennal hairs pale; thoracic setulæ black.

Eyes distinctly separated; second antennal joint rather small; basal flagellar joint nearly twice as long as second, all flagellar joints conspicuously longer than their diameter, entire length of antenna about one and a half times as long as head and thorax combined. Thoracic dorsum smooth, setulæ short and sparse; scutellar bristles short. Abdomen stout, without noticeable hairs. Legs slender, femora slightly swollen on apical third; tibiæ with rather noticeable setulose hairs; fourth tarsal joint of all legs obcordate; fifth joint with two series of ventral bristles; claws of moderate size, subequal, each with short subbasal tooth. Third vein ending slightly before apex of wing, first at two fifths from base of third; cubitus forking slightly proximad of cross vein.

Male.—Agrees with the female in color except that the abdomen is blackened from the base of third segment to apex with the exception of the hypopygium, which is yellowish. The wings are also less noticeably infuscated. The antennal plumes are yellowish white.

The second antennal joint is considerably larger than in the female and black in color. The fifth tarsal joint has no spines on the ventral surface; the claws are smaller and have no subbasal tooth. The third vein ends at five sixths the wing length, the first beyond middle of third, and cubitus forks under the cross vein.

*Bull. Ill. State Lab. Nat. Hist., Art. 6, Vol. 10, May, 1915.

Length: female, 4.5 mm.; male, 3-3.5 mm.

Type locality, White Heath, Ill., on bank of Sangamon River, May 9, 16, and 30, 1915 (J. R. Malloch).

The female of this species will run down to section 8 in my key to the species of *Probezzia* in the paper previously mentioned, and may be separated from *albiventris*, the only other described species with black halteres, by the infuscated abdomen, differently colored legs, and infuscated wings. The male will run down to section 14, and is readily separated from the species included therein by the dark halteres. The male of *albiventris* is not known, but must closely resemble that of *infuscata*.

The early stages and the habits of the imago are unknown.

TANYPINÆ

TANYPUS CARNEUS Fabricius

The only Illinois records I had of this species when I wrote my paper was that of a larva from the Illinois River. On June 18, 1915, I took a male imago on a window in the basement of the Natural History Building of the University of Illinois, at Urbana, which agrees with the description of the species in almost all respects, the only departure being in the color of the abdomen, which has a broad dark brown anterior band on all segments but the fourth, the latter being entirely whitish yellow. Single examples of the female were taken on July 21 and August 13. I have no doubt as to the identity of the species.

DESCRIPTIONS OF MALES OF CERATOPOGONINÆ PREVIOUSLY UNKNOWN

JOHANNSENYOMYIA ARGENTATA Loew

Male.—Glossy black. Head black, basal portion of flagellum of antennæ and their plumes fuscous, the latter with a whitish luster when viewed from certain angles; mouth parts brownish. Mesonotum without distinct pruinescence. Abdomen in some specimens with a faint hoary pruinescence when viewed from behind. Legs yellowish, mid and hind coxæ, apices of fore femora narrowly, of mid femora broadly, and almost the whole of hind femora, blackened, as also are the bases and apices of fore and mid tibiæ, the entire hind tibiæ, the apices of the basal four tarsal joints, and the whole of the fifth joint of all legs. Wings slightly grayish, radius and basal portion of upper fork of media blacker than other veins. Halteres black.

Eyes distinctly separated above; antennæ extending to beyond middle of abdomen. Hypopygium small, recurved, apical portion of lateral arm short and stout. Legs slender; fifth tarsal joint of hind legs with 2-3 pairs of ventral thorns, the other legs unarmed; tarsal claws short, subequal, with short basal tooth. Third vein ending at about four fifths the wing length, first slightly before middle of third.

Length, 2.5 mm.

Locality, White Heath, Ill., May 30, and July 11, 1915, on bank of Sangamon River (J. R. Malloch). I have also taken females of this species at White Heath June 26 and July 11, and Mr. Hart took it at St. Joseph June 27, 1915, neither of these localities being included in my previous paper.

The male of this species was unknown when I wrote my paper on the family, and this is the first published description of that sex. In my key to the genus it will run down to section 13; and from both the species contained therein it may be separated by the long antennæ and by its having only the hind tarsi with the fifth joint spined ventrally.

PROBEZZIA PALLIDA Malloch

Male.—Head brownish, eyes black, antennæ yellowish, plumes pale yellow, mouth parts almost white. Thorax varying from dark brown to deep black, shining. Abdomen white, apical half black or brown, hypopygium yellow. Legs almost white, last tarsal joint black. Wings white, veins pale yellow. Halteres yellow.

Eyes separated above; antenna longer than head and thorax combined. Mesonotum with four longitudinal rows of rather strong upright setulose hairs. Hypopygium rather large, not recurved, apical portion of lateral arm shorter than basal, strong and stout, clawlike. Legs of normal strength; fifth tarsal joint unarmed; claws small, subequal, simple. Third vein ending about four fifths from base of wing, first slightly before middle of third.

Length, 1.5 mm.

* Locality, White Heath, Ill., May 9 and 16, 1915 (J. R. Malloch). A large series of this sex was taken on the under side of leaves of bushes and trees on the bank of the Sangamon River on the last-named date. The day was very windy, and the insects were resting on the sheltered side of the plants. I took two females also at White Heath on May 16, one of them from a spider's web; it was still alive when taken.

The male of *pallida* will run down to section 10 in my key to the species of this genus. It may be separated from all the species therein

by the fact that the legs are whitish and the fifth joint of all tarsi deep black. The other six species all have a greater proportion of the legs blackened.

I had a slight doubt about the identity of this sex as the male of *pallida* when I wrote the description, but since then I have examined a series of both sexes which were reared by Mr. R. A. Muttkowski from larvæ obtained in Wisconsin, and find that despite the unusual difference in color it is undoubtedly the male of *pallida*. I understand from Mr. Muttkowski that he is preparing descriptions of the early stages of this and several other species for publication.

IMMATURE STAGES OF SOME ILLINOIS DIPTERA, AND BIOLOGICAL NOTES

Not infrequently larvæ or pupæ of *Diptera* are submitted to the office of the State Entomologist for identification, and quite often it has been impossible for those in charge of this branch of the work to give names for the species involved. The immature stages of *Diptera* are comparatively little known, and very often entomologists who have succeeded in rearing species from either the larval or pupal stage neglect to make descriptions that will serve to identify the species in those stages upon any subsequent occasion; or the written description or figures are so inaccurate or vague that they serve only to give a general idea of the appearance of the species. It is the purpose of the present writer to describe in detail a number of species which have been reared by members of the office staff here or by himself, and to figure the principal features of each so that it may be possible for students to recognize the species when occasion arises.

Of the species described herein, *Psilocephala hæmorrhoidalis* Macquart is predaceous on wireworms, while the species of *Asilidæ* and *Mydaidæ* are also predaceous upon subterranean larvæ, and are of considerable economic importance. The species of *Mydaidæ* is predaceous upon larvæ which burrow in rotten tree-stumps. The species of *Bombyliidæ* dealt with are parasites, those of *Anthrax* being recorded as internal parasites upon *Lepidoptera*; *Exoprosopa fascipennis* is parasitic upon *Tiphia* spp., which are themselves parasitic in larvæ of *Lachnosterna* spp.; *Spogostylum anale* and *Sparnopolius fulvus* are ectoparasitic upon larvæ of *Cincindela* and *Lachnosterna* respectively. The habits of *Exoprosopa fasciata* are not known to me, while no record is available that indicates whether *fascipennis* is an internal or external parasite. The species of *Mycetophilidæ* described, *Mycetobia divergens*, has been recorded as attacking the trunks of fruit trees, but

it certainly does not do so unless there is an injury, and then it feeds, not upon the wood but upon the exuding sap and attendant fungus. The genus is of interest, however, because it is an exception to the general rule in *Mycetophilidæ* in respect to its respiratory system. A description of the larva and pupa of a species of *Sciara* is given herein which serves to show the differences between the peripneustic and amphipneustic types of larvæ.

SCIARIDÆ

SCIARA sp. ?

Larva.—Length, 7–8 mm. White, semitransparent; head glossy black; alimentary canal showing brownish on about two thirds of its length; ventral view of head as in Figure 1, Plate LXXX; mandibles (Fig. 8) showing but slightly above maxillary lobe; antennæ in the form of a circular clear area, not protuberant; median dorsal sclerite with 14 small round clear spots arranged as in Figure 10, Plate LXXX; hypopharynx as in same figure. First ganglion enclosed in head; two tracheal trunks emanating from each side of head, connected at prothoracic spiracle (Fig. 3), there being beyond that point only one main trunk on each side; in addition to the prothoracic spiracle 9 other spiracles are present on the succeeding segments (Fig. 2), the first and last of which appear to be closed; body without surface hairs.

Pupa (Pl. LXXX, Fig. 4).—Length, 3–5 mm. Whitish or slightly yellowish. Entire body without hairs, the usual pair on upper margin of head almost indistinguishable. Prothoracic respiratory organ rounded, not raised, stigmatiform. Abdominal segments 1–7 with distinct spiracles, apical 2 without spiracles.

A number of larvæ of this species were sent here for identification from Danville, Ill., at the end of July, 1915, with the information that they had been found traveling over a path in a ropelike mass. Unfortunately an attempt to rear the species failed, so that it is not possible to give a specific identification. It is, however, evident that it is the same species recorded by Felt as occurring at Franklin, N. Y.*

The occurrence of so-called "snakeworms" in their peculiar ropelike processions has been recorded at different times by several entomologists in America, and they have been known as occurring in Europe for many years. Various causes have been assigned as responsible for the larvæ's migrating *en masse*; but the most probable cause is that of heavy or continued rain penetrating their habitat in the earth

*Sixteenth Rep. State Ent. N. Y., 1901, p. 992.

and forcing them to get to the surface in much the same manner as earthworms. Whether we have a number of species in America that are addicted to this habit, or only one, remains to be discovered. Most of the species of the family feed upon decaying vegetable matter.

MYCETOPHILIDÆ

MYCETOBIA DIVERGENS Walker

Mycetobia divergens Walker, Ins. Saund., Diptera, Pt. 1, 1856, p. 418.

Mycetophila persica Riley, Prairie Farmer, June 15, 1867, Vol. 35 (n. s., 5), No. 19, p. 397.

Mycetobia sordida Packard, Guide to Study of Insects, 1869, p. 388.

Mycetobia marginalis Adams, Kans. Univ. Sci. Bull., Vol. 2, No. 2, 1903, p. 21

Larva (Pl. LXXX, Fig. 12).—Length, 9–11 mm. White, semi-transparent. Head brownish, eye-spots black, surrounded by paler color. Thoracic segments with brown markings of variable extent and depth, pattern on dorsum generally as in figure; laterally the pale markings are generally in the form of an irregular vertical stripe on middle of segments and a pale posterior margin, those on prothoracic segment being usually connected on upper portions, whereas on the other two segments they are separated throughout their length; the pale markings of the lateral areas are continued over the ventral surface for a short distance, and there are also two wedge-shaped pale marks extending from the posterior margin of each segment which are usually short on the prothoracic segment and much longer and broader on the other two segments. Abdomen without brown marks.

Head about 1.5 as long as broad, tapering slightly anteriorly; labrum protruding, its ventral surface densely covered with fine downwardly directed hairs; mandibles as in Figure 11; labial plate as in Figure 13; maxillæ stout, of moderate length, with short papillæ; surface of head with a few short hairs. Prothoracic respiratory organs (Figs. 5 and 6) slightly raised above level of segment, their margins rugose; trachea connected by a stout transverse trunk at division of first and second thoracic segments; immediately behind the spiracular opening is a strong branch which is subdivided near its base, one of the divisions being directed forward, entering the head, the other directed backward; abdomen without spiracles, the lateral tracheal branches bifurcate, without the normal terminal connection with the outer wall of abdomen; apices of the two main parallel tracheal trunks slightly projecting beyond surface of last segment in life, retracted in dead specimens, their apical margins with a number of weak radiating hairs.

Pupa (Pl. LXXX, Fig. 7).—Length, 5–7 mm. Pale yellowish brown, opaque. Head with two short hairs on upper anterior margin. Prothoracic respiratory organs short and stout, situated well forward. Integument of entire pupa with microscopic reticulations. Thorax with numerous short hairs or spinules arranged as shown in figure. Abdomen with numerous stout spinules or small thorns as shown in figure, the dorsal arrangement of which is as shown in Figure 9, as is also the apical armature of abdomen; spiracles not distinguishable.

Larvæ of this species were abundant on tree trunks, where through injury the sap was exuding, at Urbana, in July, August, and September, 1915. Many imagines were reared from larvæ obtained from the trunk of a mulberry tree, and on the campus of the University of Illinois there were several elm trees on which the larvæ were common. In the case of all trees upon which I found the species it is noteworthy that there was a fungous growth over the surface where the exudation occurred, and in this the larvæ moved with considerable facility. They bear a striking resemblance to the larvæ of aquatic *Ceratopogonina* and progress by the same serpentine motion as do those larvæ. The larval skin is not generally entirely freed from the pupa at transformation, the apical half of the pupal abdomen being enclosed in it, the head of the larva lying close to the ventral surface of the abdomen. The pupa, just before the emergence of the imago, makes its appearance at the surface of the matter in which it is buried, having been previously visible only through the presence of the small respiratory organs, which generally pierce the upper layer of the covering. I found that the pupæ when removed from their normal position in the semi-liquid matter can regain that position by means of a rotary motion of the body, entering, tail first, until all but the apices of the thoracic respiratory organs are enveloped. Under natural conditions they pupate under the loose bark and possibly in this way cause very slight injury.

No damage is done to the trees by the presence of the larvæ so far as I can discover, and they are present only in those trees where an injury causes an exudation of sap. It is not impossible that they may have an irritating effect upon the wound other than that suggested above, but I doubt it. They feed upon the liquid exudation and not upon the fiber of the tree, and I reared many examples after the larvæ had been removed from the trees for over a month, their only food being that provided by the fungous matter collected along with them. I have observed that the first cold weather, not frost, proves fatal to most of the larvæ.

Of parasites I found only a small worm which moved freely about in the interior of the body of the larva. In form this resembles a

nematode, but having had so far no opportunity of submitting it to an authority on the group I can not present any definite information as to its identity.

The following observations regarding the family status of the genus may be of interest to students of the *Nemocera*.

The genus *Mycetobia* presents in the larval stage what, judging from our present very meager knowledge of the family, is a departure from the normal mycetophilid respiratory system in having no lateral abdominal spiracles. In fact the lateral tracheal branches simply fork and have no terminal extension which would seem to indicate the recent possession of abdominal spiracles. This is not, to my mind, incompatible with their position in this family, though there are some writers who may differ from me upon this point,—e. g. Osten Sacken, who considered that the genus does not belong to the *Mycetophilidæ* because of the closed spiracles. In this connection it seems necessary to mention a recent paper dealing in an arbitrary manner with the classification of this group.* In the paper referred to there is a summary of facts deduced from the writings of investigators, principally Brauer, unsupported by any other data in possession of the compiler, by means of which the latter endeavors to outline what he considers to be a natural classification of the families in the group. I have the conviction that a natural classification can only be arrived at by a careful consideration of the characters possessed by all stages taken in conjunction with their mode of life. It is impossible, to my mind, to arrive at a decision as to the importance of certain organs as a means of classification unless we know how the species live, what is the importance of the organs in the habitat, and, finally, to what extent a departure from a certain mode of life may affect one set of organs in comparison with others that seem to be of less fundamental significance. That we may, and do, find species in a family with certain organs functional which in others are vestigial or even absent, is not sufficient reason for the separation of such species into different families, and though the respiratory system is of more importance probably than any other one character, I consider that it is absurd to lay down any rule of classification based upon that one character, which is admittedly variable in most groups of insects, especially in view of the fact that we are unacquainted with probably ninety-five per cent. of the species included, in so far as their larval stages are concerned.

Another, and most reprehensible attitude is that taken by the writer previously referred to when he discounts the evidence brought for-

*The *Nemocera* not a Natural Group of Diptera. Ann. Ent. Soc. Amer., Vol. 8, 1915, p. 93.

ward by some investigators that *Mycetobia pallipes* has an amphipneustic larva with the statement that although he has not seen the larva he nevertheless believes "that the supposed difference rests upon an error of observation." Thus the careful work of real investigators is ignominiously thrust aside because this writer considers that the facts given, not being in conformity with his ideas and consonant with his unwarranted deductions, are necessarily erroneous. Psychological classifications are not reliable; and while they are at time interesting reading the real factors in classification must first be more fully investigated before any safe ground for deductions as to relationships of families is provided. Notwithstanding the absence of functional abdominal spiracles, we may with an easy mind retain *Mycetobia* in the *Mycetophilidae*, and it is not improbable that further investigation will prove that it is not the only genus which presents such a departure from what is now considered the normal condition in the family. In fact, the European species *Polylepta leptogaster* Winnertz has been proven by Schmitz to be a departure in a more remarkable manner than is the present species.*

It is not necessary that I should deal with this paper here, but as it appeared three years before the note on classification which has been referred to, and as the genus *Polylepta* occurs in North America it is obvious that mention of it at least is not out of place in the present connection.

PREDACEOUS AND PARASITIC ORTHORRHAPHA

(*Bombyliidae*, *Mydidae*, *Asilidae*, *Therewidae*, and *Cyrtidae*)

It may seem a little presumptuous to formulate a method for the separation of the next seven genera dealt with upon the slender basis afforded by the species available to me, but it is not improbable that the characters which separate these may be found serviceable in the separation of others as yet unknown to me, and a key is given herewith which sets forth the structural differences observed that are considered as probably of generic value. It is essential to a better understanding of generic relations, not only of the genera here dealt with but of all genera in the so-called *Nemocera*, that a knowledge of the early stages be obtained. It is also necessary that entomologists who may be in possession of materials or data, or may later have either, should place whatever they have upon record as an aid to the elucidation of the problems connected with the classification of the group, it

*Biologisch-anatomische Untersuchungen an einer höhlenbewohnenden *Mycetophiliden*larve, *Polylepta leptogaster* Winn. Naturhistorisch Genootschap in Limburg. Jaarboek, 1912, 4th Note.

being absolutely impossible for any one man, or even for a few men, to cover all the ground in a satisfactory manner.

The key presented herewith is based upon species in the collection of this Laboratory with one exception, and gives a synopsis of the characters which I have used in separating them. There are in the series examples of the following families: *Bombyliidæ*, *Mydaidæ*, *Asilidæ*, and *Therevidæ*. The pupæ of all these families, as far as I am aware, bear a strong resemblance to those of *Tabanidæ*, but the pupæ of the latter differ noticeably, as far as I have seen, in having no long thornlike cephalic processes, the protuberances being short and not heavily chitinized. The use of the cephalic armature by the *Asilidæ* and their allies in digging their way out of the ground necessitates that those organs be strong, as the species often must burrow through rather hard dry soil, while the *Tabanidæ*, being for the most part species which live in water or in moist situations, do not require such powerful organs to assist in their emergence from their pupal habitat. The abdomen in all the species included in the key is armed upon each segment with a median transverse series of thorns, or hairs and thorns in alternation. This feature is somewhat similar to that presented by the pupæ of the *Tabanidæ*, but the apical segment differs considerably in the two groups, while the species of *Tabanus* have usually the transverse thorns or hairs in a double row, the anterior one consisting of shorter and stronger thorns than the posterior one.

The pupæ of the only two species of *Cyrtidæ* that I have seen, one of which is described in the present paper, differ very considerably from those of the group included in the key, and also from the *Tabanidæ*, in having the head and abdomen without thorns or bristles, and the abdominal spiracles reduced in number, there being not more than five pairs.

KEY TO PUPÆ

1. Head with but two thorns, abdominal spiracles conspicuously elevated, thornlike *Psilocephala hamorrhoidalis* (p. 334).
- Head with more than 2 thorns, abdominal spiracles reniform, not conspicuously elevated 2
2. Dorsal abdominal segments with a transverse series of short flattened thorns on middle of each segment, and alternating long, slender, slightly curled hairs; sometimes the short thorns are bent upward at right angles at bases and apices* (*Bombyliidæ*) 3

*In all cases that I have seen these short thorns have the appearance of being attached to the abdomen, rather than of being a part of it as is the case in the other pupæ dealt with here.

- Dorsal abdominal segments without long slender curled hairs, the transverse series consisting of strongly chitinized thorns which alternate in size.....8
3. The short stout thorns on abdominal segments 2 to 4 bent upward at right angles at bases and apices; armature of head consisting of a lunate series of 4 strong thorns on upper margin the bases of which are contiguous, and 2 shorter, downwardly directed thorns on middle near lower margin.....*Spogostylum anale* (p. 328).
- The short stout thorns on abdominal segments either bent up at apices only and the armature of head not as above, or if the short thorns are bent up both at bases and apices the head armature consists of 8 thorns.....4
4. Upper pair of cephalic thorns slender, widely separated at base...5
- Upper pair of cephalic thorns very stout, contiguous at base.....*(Anthrax)* 7
5. The short abdominal thorns bent upward at right angles at bases and apices.....*Exoprosopa fasciata?* (p. 329).
- The short abdominal thorns not bent up at base, only so at apices..... 6
6. Lateral pair of cephalic thorns contiguous at base, the lower one without basal protuberance or hairs.....*Exoprosopa fascipennis* (p. 330).
- Lateral pair of cephalic thorns rather widely separated at base, the lower one with a short wartlike protuberance at base on under side which has upon it 2 or 3 hairs.....*Sparnopolius fulvus* (p. 331).
7. Upper pair of cephalic thorns simple, without a small tooth at base on outer side; viewed laterally the middle one of the 3 caudal thorns on each side is much smaller than the lower one, sometimes indistinguishable.....*Anthrax hypomelas* (p. 334).
- Upper pair of cephalic thorns each with a small tooth on outer side at base; viewed laterally the middle one of the 3 caudal thorns on each side is about as large as the lower one.....*Anthrax lateralis* (p. 332).
8. Upper pair of cephalic thorns directed outward and slightly upward; apices of wing sheaths extending beyond apices of sheaths of middle legs.....*Mydas clavatus* (p. 336).
- Upper pair of cephalic thorns directed forward and slightly downward; apices of wing sheaths not extending beyond apices of sheaths of middle legs.....*(Asilidæ)* 9
9. Prothoracic spiracle merely a rugose area, without well-defined reniform portion; abdominal spiracles very large.....*Promachus vertebratus* (p. 337).
- Prothoracic spiracles rugose, but with a well-defined reniform area which is distinctly elevated.....10
10. Apices of sheaths of fore legs extending very distinctly caudad of apices of wing sheaths.....*Deromyia winthemi* (p. 338).

- Apices of sheaths of fore legs not extending to apices of wing sheaths 11
- 11. Middle of wing sheath with a small distinctly raised area; apical abdominal segment truncate, the upper pair of thorns directed upward.....*Proctacanthus milberti* (p. 339).
- Middle of wing sheath without raised area; apical abdominal segment not truncate, the upper pair of thorns directed backward and slightly curved downward.....*Asilus notatus* (p. 340).

I have not included any species in the key of which I have not examined specimens, preferring not to use descriptions which I might misinterpret. I have, however, indicated in the text characters which appear to be available for the separation of *Systachus oreus* from *Exoprosopa fasciata* and *Aphabantus mus* from *Sparnopolius fulvus*.

Erax lateralis Macquart has been recorded by Titus as predaceous upon *Ligyris* spp.* Unfortunately the figures and descriptions of the larva and pupa given by him are too vague to permit my discovering their distinctive generic characters.

BOMBYLIIDÆ

Many species of this family have been reared both in North America and in Europe, and the larvæ have been found to be predaceous or parasitic in all cases put upon record. Williston gives a summary of their larval habits†. *Aphabantus* and *Systachus* are predaceous on egg-masses of the locust *Caloptenus spretus*. *Anthrax* is recorded as parasitic upon three genera of *Hymenoptera*—*Megachile*, *Osmia*, and *Odynerus*—and three genera of *Lepidoptera*—*Mamestra*, *Noctua*, and *Agrotis*; *Spogostylum* upon four genera of *Hymenoptera*—*Pelopaw*, *Megachile*, *Cemonus*, and *Osmia*—and two genera of *Coleoptera*—*Cicindela* and *Calicodoma*; *Bombylius* upon the hymenopterous genera *Andrena* and *Colletes*; *Toxophora* upon the hymenopteran *Eumenes*; and *Systopus* on the lepidopteran *Limacodes*; while *Callostoma* is predaceous on the egg-masses of the locust *Caloptenus italica*.

Vassiliew, in a short note on the biology of some European species of *Anthrax*, records the occurrence of *morio* Linn. and *velutina* Fall. as secondary parasites of *Masycera sylvatica* Fall., a tachinid parasite of *Dendrolinus pini* Linn.‡

*Some Miscellaneous Results of the Work of the Bureau of Entomology. Bull. 53, Bur. Ent., U. S. Dept. Agr., 1905, p. 15.

†Manual of North American Diptera, p. 213. 1908.

‡Beitrag zur Biologie der Gattung Anthrax Scop. (Fam. Bombyliidae.), Zeitschr. für Wiss. Insektenbiol., Bd. 1, Heft 4, p. 174. 1905.

SPOGOSTYLUM ANALE Say

Anthrax anale Say, Jour. Acad. Nat. Sci. Phil., Vol. 3, 1823, p. 45.

Larva.—Length, 12–14 mm. White. Head small and inconspicuous (Pl. LXXXIII, Fig. 1), retracted within the first thoracic segment to the point marked X in figure; mandibles strong, slightly serrated on latero-ventral surfaces, curved downward; dorsal surface of head with 5 strong hairs arranged as in figure. Thoracic and abdominal segments with strongly defined incisions between them; prothoracic spiracle large; abdomen without noticeable spiracles (in preserved examples); apical abdominal segment conspicuously attenuated, produced in the form of a short point; no surface hairs on abdomen or thorax.

Pupa.—Length, 12 mm. Testaceous. Head with the upper armature consisting of 4 strong thorns in a crescentic series, their bases connected, and 2 smaller downwardly directed thorns near ventral surface on median line as shown in Figure 9, Plate LXXXIII; 6 long hairs on head, 4 at bases of upper thorns and 2 at bases of the median pair. Thorax with 4 long hairs, 2 above base of wing-sheath and 2 closely placed ones about midway between them and the dorso-median line in transverse line with them; prothoracic spiracle distinct. First abdominal segment with a transverse series of long closely placed slightly curled hairs anterior to middle from a little distance on each side of median line to a point more than midway to spiracle, the series broadly interrupted in the middle, and this area without the short bristles present in *Anthrax* and *Exoprosopa*; posterior to the spiracle on first segment are about 6 remarkably long hairs directed outward and slightly forward; segments 2 to 4 with the transverse armature consisting of long hairs alternating with short bristles, the apices and bases of the latter bent upward at right angles (Fig. 2); armature of segments 5 to 8 consisting of long hairs, the series except on segment 8 usually with short, straight, alternating bristles; spiracles small but distinct on segments 1 to 7; apical segment with 2 slender slightly curved thorns (Pl. LXXXIII, Figs. 8 and 10); armature of segments posterior to spiracles consisting of very long hairs, that of ventral segments of transverse series of moderately long hairs which are discontinued on middle of segments.

The larvæ and pupæ from which the foregoing descriptions are drawn, are those obtained by Dr. V. E. Shelford near Chicago, and which were used by him as a basis for his paper on the species.* Dr.

*The Life-history of a Bee-fly (*Spogostylum anale* Say) Parasite of the Larva of a Tiger Beetle (*Cicindela scutellaris* Say var. *lecontei* Hald.). Ann. Ent. Soc. Amer., Vol. 6, No. 2, 1913, p. 213.

Shelford kindly permitted me to use his material. The species is ectoparasitic.

The species is represented in the collection here by imagines from the following Illinois localities: Pekin, Quincy, Algonquin, Cedar Lake, Clay City, Grafton, Thebes, and Mt. Carmel. There is also a specimen from St. Louis, Mo. The dates of occurrence are in August with the exception of the example from Mt. Carmel, which is given as having been taken June 10 or 11—a rather unusual date if correct. Dr. Shelford gives a summary of localities for the species in his paper from data obtained from dipterologists.

EXOPROSOPA FASCIATA Macquart ?

Exoprosopa fasciata Macquart, Dipt. Exot., Vol. 2, Pt. 1, 1838, p. 51.

Pupa.—Length, 20 mm. Testaceous yellow, thorns and wing sheaths dark brown. Head with 8 strong thorns; upper median pair widely separated at base; lateral view of head as in Figure 6, Plate LXXXIII; lateral pair of thorns slender and elongated; 2 strong hairs at base of each of the upper thorns, one above the base of each of the lower median pair and slightly laterad of them, and one close to suture between head and thorax, slightly above level of lower thorns. Thorax with the usual 4 hairs, a widely placed pair above wing base and another pair closely placed midway between wing base and dorso-median line and distinctly caudad of the posterior one of the former pair; wing sheath with a distinct, bifid, wartlike protuberance close to costal margin near base; apices of middle leg-sheaths projecting distinctly beyond apices of wing sheaths; prothoracic spiracle with well-defined rugose reniform area. Abdominal segments 2 to 6 with the bases and apices of the short thorns of the transverse series turned up at right angles (Pl. LXXXIII, Fig. 3); first segment with a transverse series of long curled hairs which does not extend over the median line and is discontinued about two thirds of the distance to spiracle; posterior to the spiracle is a series of about 8 long hairs which are distinctly shorter than those of the segment above; spiracles of moderate size, margins rugose; apical segment as in Figures 4 and 11.

The pupal exuvium from which the foregoing description was drawn was found in a garden in Urbana by Miss E. Mosher, August, 1914. There is little doubt about the identity of the species, although the imago was not directly associated with the specimen, for the large size and dark-colored wings, coupled with the fact that *fasciata* is the only common species that agrees in these respects occurring at this time here, make it very probable that the identification is correct.

The species is represented in the collection here by imagines from the following Illinois localities: Lake County, Algonquin, Waterman, Milan, Bloomington, Normal, Pekin, Forest City, Havana, Campaign, Urbana, Meredosia, Camp Point, Belleville, Dubois, Grand Tower, Alto Pass, and Metropolis, the dates of collection ranging from July 12 to August 31. The species is a very common one and probably occurs throughout the entire state. There is also in the collection one specimen from New Harmony, Ind., taken September 2, and one from Delaware Co., Pa. I have taken the species at White Heath, Ill., on two species of *Monarda* and on *Helianthus* in August.

The pupa which I have associated with this species bears a striking similarity to that figured by Riley for *Systachus orcus*, differing however in the dark color of the wing cases and in their being comparatively shorter, not extending to the apex of the second abdominal segment, whereas in *Systachus orcus* they extend to apex of third. There is also an evident distinction in the structure of the dorsum of the apical segment.

EXOPROSOPA FASCIPENNIS Say

Anthrax fascipennis Say, Keating's Narrative of an Expedition to the Source of St. Peter's River, etc., Appendix, p. 373. 1824.

Pupa (Pl. LXXXI, Fig. 4).—Length, 16 mm. Pale testaceous, slightly shining, thorns on head black-brown. Upper pair of cephalic thorns directed forward and very slightly downward, widely separated at base, parallel; below the level of these thorns on each side, on a raised base, are two stout thorns, the inner one long and directed almost straight forward, the outer much shorter, slightly curved, and directed outward; on each side of median line of lower margin of front is a stout thorn, the bases of the thorns connected (Pl. LXXXI, Fig. 5); in addition to the thorns there are 6 long slender hairs on the head capsule, as shown in the figure, visible from in front, and one on each side close to the suture between head and thorax, located near base of the sheath containing mouth parts. Thorax with a pair of closely placed hairs on disc on each side of median line, and a pair more widely placed, above base of wing; wing sheath with a sharp tubercle about one third from base, near costal margin. First abdominal segment with a transverse series of 5 or 6 short, thick thorns occupying the central portion of anterior margin, and 6 long curved hairs on each side of these in continuation of the transverse series which extends over midway from median line to spiracle; posterior to spiracle are about 7 long hairs; segments 2 to 7 with a regular transverse median series of flattened thorns, as shown in Figures 1 and 2; Plate LXXXI; on segments 2 and

3 there are no alternating slender hairs between the median 6 or 8 thorns and the hairs are rather weak when present; on segment 4 these hairs are not present between the median 4 thorns; on the other segments, 5 to 7, they are present on the whole series; segment 8 has about 6 short stout thorns in the transverse series between which, except in the case of the central pair, there are alternating long hairs; lateral aspect of pupa as shown in Figure 4; apical segment of abdomen with a parallel pair of stout upwardly and backwardly directed thorns which are broad at base and have each a small subbasal tooth.

The pupal exuvium from which the above description was drawn is that of a specimen reared from *Tiphia* sp. collected at Elliott, Ill., April 27, 1906, and which emerged July 17, 1906. There are in the collection of this Laboratory a large number of specimens of exuvia of pupæ that were obtained at Elliott and Mackinaw, Ill., the imagines emerging on various dates between July 17 and August 8. Some which produced imagines of the parasites were collected September 30. This species is a hyperparasite affecting *Tiphia* species which are parasitic upon *Lachnosterna* species.

The species is generally distributed throughout the state, occurring from the beginning of July till the end of September. Imagines are in the laboratory collection from the following Illinois localities: Algonquin, Savanna, Havana, Pekin, Urbana, Champaign, Normal, Albion, Carlinville, Clay City, Bridgewater, Williams Mountain, Herod, Grand Tower, Alto Pass, Teheran, and Metropolis. There is also a specimen from Westville, N. J.

SPARNOLIUS FULVUS Wiedemann

Bombylius fulvus, Wiedemann, Dipt. Exot., 1821, p. 172.

Bombylius l'herminieri Macquart, Dipt. Exot., Vol. 2, Pt. 1, 1841, p. 103.

Bombylius brevisrostris Macquart, l. c.

Sparnopolius fulvus (Wiedemann) Loew, Neue Beitr., Vol. 3, 1855, p. 43.

Pupa.—Length 11–12 mm. Yellowish testaceous, slightly shining. Surface smooth. Head with upper pair of thorns widely separated at base; lateral pair separated by about as great a distance as the length of the lower thorn, the base of the latter with a slight tubercle on lower surface upon which there are two hairs (Pl. LXXXIII, Fig. 7); the pair of thorns on median line of lower portion of head of moderate size, directed downward, and rather widely separated basally; the normal 8 cephalic hairs present. Prothoracic spiracle rather small, distinctly elevated, its apex with narrow rugose rim; mesothorax with 3 hairs, 2 above the base of wing sheath and one midway between that

point and median line, slightly caudad of the posterior one of the preceding pair; in front of wing base is a slight gibbosity which has no elevated thornlike points; wing sheath without a raised area on surface; apices of sheaths of mid tarsi extending to base of last joint of hind pair and distinctly beyond apices of wing sheaths; apices of sheaths of fore tarsi extending to apices of wing sheaths. First abdominal segment with about 6 widely placed weak hairs in a transverse row near anterior margin; segments 2 to 8 each with a transverse series of short stout bristles with alternating slender and, in comparison with other species, short hairs, the bristles on all segments turned upward at apices, most distinctly so on segments 3 to 5; spiracles small but very distinct, similar to that of prothorax, present on segments 1 to 7; posterior to the spiracle on each segment there are 3 moderately long hairs; apical segment as in Figure 5, Plate LXXXIII; ventral segments each with a transverse pair of rather long slender hairs on each side near middle, the one farthest from lateral margin about midway between that point and median line, the other midway between it and the lateral margin.

The specimens from which the foregoing description was drawn are those mentioned by Dr. Forbes in his Thirteenth Report* as having been reared from larvæ of *Lachnosterna*, upon which they are ectoparasitic.

Imagines are in the collection here from the following Illinois localities: Effingham, Neoga, Urbana, and Algonquin, the dates of occurrence being in August and September.

In Riley's figure of *Aphæbantus mus* the apices of the wing sheaths do not extend beyond the apex of the second tarsal joint, the wing sheath has a small protuberance about one third from base near the costa, and there are more than 2 hairs on each side of each ventral segment.

ANTHRAX LATERALIS Say

Anthrax lateralis Say, Jour. Acad. Nat. Sci. Phil., Vol. 3, 1823, p. 42.

Pupa.—Length, 14 mm. Testaceous yellow, shining. General habitus similar to that of *Exoprosopa fascipennis*. Head with the pair of strong upper thorns contiguous at base, their upper surfaces with a flattened area (Pl. LXXXI, Figs 16, 17, and 21); below these thorns on each side is a slightly swollen area upon which is a single small tubercle; on the median line considerably below the level of the lateral tubercles is a pair of small sharp points, best seen when viewed

*Twenty-fourth Report of the State Entomologist on the Noxious and Beneficial Insects of the State of Illinois, 1908, p. 161.

from the side (Pl. LXXXI, Fig. 16), near the bases of which is a single long hair on each side; on each side near base of the upper pair of large thorns is a single long hair and another above base of each thorn. Thorax and wing sheaths without tubercles; the pair of hairs above wing base present, the discal hair indistinguishable. Abdomen with spiracles very small; first segment with about 6 short, stout brown thorns on median sixth slightly beyond base, and on each side of these but slightly more cephalad a closely placed series of about 20 long, slender curled hairs, reaching about two thirds of the distance from median line to spiracle; posterior to the spiracle are about 6 long hairs; segments 2 to 7 with a transverse median comblike series of stout brown thorns, interspersed with long slender hairs at about every fourth or fifth one (Pl. LXXXI, Figs. 3 and 8); eighth segment with a pair of closely placed thorns on each side of the median line, between each pair of which is a single slender hair (Fig. 19); apex of abdomen with 3 thorns on each side (Fig. 19); post-spiracular hairs 8-9 in number; each ventral segment with 6-8 hairs on each side of median line in a transverse series.

The pupal exuvium from which this description was drawn is that of a specimen that was reared from a larva parasitic in a pupa of a noctuid moth which was obtained at the Devil's Hole near Havana, Ill., June 8, 1905, the parasite emerging July 1, 1905.

Imagines in the laboratory collection are from the following Illinois localities: Algonquin, Savanna, Milo, Urbana, Champaign, Long Lake, and Kappa. There is also a specimen in the collection from Jamesburg, N. J., and one from San Bernardino, Cal. The dates of occurrence range from June 10 to August 11.

No other specimens in the collection bear any records of life history.

Anthrax alternata Say has been reared from an undetermined noctuid larva* by Gillette, and recorded by Riley and Howard. In the same paper *Anthrax hypomelas* Macquart is recorded as having been reared from a pupa of *Agrotis herilis* by Webster, and *A. molitor* Loew from a pupa of a noctuid resembling *Taniocampa rufula*. Zetterstedt, in 1842, stated that the group to which *lateralis* belongs, deposits eggs upon lepidopterous larvæ. Glover, in the Agricultural Report for 1866, mentions that "an *Anthrax* has been bred from the chrysalis of a moth."†

*Insect Life, Vol. 2, 1890, p. 353.

†Loc cit., p. 354.

ANTHRAX HYPOMELAS Macquart

Anthrax hypomelas Macquart, Dipt. Exot., Vol. 2, Pt. 1, 1838, p. 76.

Pupa.—Length, 14 mm. Pale testaceous, slightly shining; thorns on head and on abdomen dark brown. Upper pair of cephalic thorns contiguous for two thirds of their length (Pl. LXXXI, Fig. 22), lateral thorn flattened, simple, the pair on median line near lower margin contiguous, a small fine hair on each side of the latter pair, a longer hair on each side of the upper pair of thorns and another above the base of each thorn (Fig. 20). Thorax without protuberances; a pair of small fine hairs above the base of wing cases, and another pair on each side of median line about middle of thorax. Abdomen similar to that of *A. lateralis*, differing only in having apical armature as in Figure 18, the median tooth having more the appearance of a small process on base of upper one than of a separate tooth, or occasionally almost indistinguishable.

As mentioned under the previous species, *hypomelas* has been recorded by Riley and Howard, but the figure given in the paper is not clear enough in detail to permit of its specific characters being recognized although the general habitus is unmistakable.

The specimens of *hypomelas* pupæ that I have seen include one, without label data, obtained from the Ohio Agricultural Experiment Station, Wooster, Ohio, with the statement that it had been reared at Wooster in 1907, and two in this Laboratory.

The pupal exuvia last referred to are those of specimens reared from *Feltia jaculifera* at Urbana, Ill. The larvæ of the moth were obtained June 8, 1901, and the parasites emerged September 14 of that year from the pupæ of the host.

Specimens of the imago are in the collection here from the following localities: Havana, Ill., September 5, 1905; Urbana, Ill., September 21, 1890 (C. A. Hart); Grand Forks, N. Dak., July and August, 1890, (Miss M. J. Snyder); and Westville, N. J., September 9, 1901.

THEREVIDÆ

PSILOCEPHALA HÆMORRHOIDALIS Macquart

Thereva hæmorrhoidalis Macquart, Dipt. Exot., Vol. 2, Pt. 1, 1841, p. 26.

Larva. (Pl. LXXXI, Fig. 10).—Length, 22 mm. White. Head brown, black on posterior margin of dorsal surface. Dorsal sclerite with a long slightly curved hair on each side one third from posterior margin; dorsal and ventral sclerites separated laterally by a rather broad membranous stripe, near the anterior extremity of which is a

very long hair directed downward and curving slightly forward, and about the middle there is a similar hair, as shown in Figure 9. Internally there are 2 strong rods connected with the mandibles, and attached to the posterior margin of the dorsal sclerite is a strong rod, dilated posteriorly, which runs to the posterior margin of the first thoracic segment internally. Thoracic segments each with a long curved hair near the middle on sides, prothoracic respiratory organ short, located close to posterior margin of segment. Abdomen with segments as in Figure 10, the pattern shown being probably caused by the spines of the pupa showing through; surface without hairs except on last segment, where there are 2 pairs, one on the dorsum and the other on the venter; apex bifid (Fig. 10, *a*).

Pupa. (Pl. LXXXI, Figs. 11 and 12).—Length, 9 mm. Yellowish white. Surface of integument of body slightly wrinkled. Head and thorax in lateral aspect as in Figure 15, thorn on wing base remarkably long and slender. Thoracic respiratory organ tubelike, the abdominal spiracles almost identical with it in form, their apices presenting to the eye the appearance of small rounded openings. Apex of abdomen with 2 long curved spines directed slightly upward (Fig. 13).

This species was found by D. K. McMillan, the field assistant of this office for northern Illinois, commonly in truck gardens infested with wireworms, upon which it feeds in the larval stage. I have seen the larvæ occasionally in wheat fields, and the adult is represented in the laboratory collection from the following localities: Algonquin, June to August (Nason); Havana, August 18, 1904 (Hart and Brown); Piper City, July 27, 1888 (Marten); Grand Tower, August 25, 1889 (Hart); Urbana, July 21, 1899 (Hart), and June 14, 1915, on flowers of wild parsnip (Hart and Malloch); Champaign, July 14, 1899 (Hart); McHenry, July 31, 1884 (Webster); Philo, June 3, 1887, from pupa found in sod corn (Hart); West Union, May 24, 1884; Waterman, July 27, 1883 (Webster); Monticello, June 28, 1914 (Hart and Malloch),—all in Illinois; Jamesburg, N. J., July 4, 1893.

The larvæ of this family are recognizable by the peculiar subdivision of the abdominal segments, as shown in the figure (10) herewith, which gives them the appearance of having 20 segments. In some other families there is a similar subdivision, for example in *Mycetophilidæ* (see *Mycetobia*, Pl. LXXX, Fig. 12), but the subdivision is of a different character, the short portion of the segments being appreciably shorter than the anterior portion is in *Psiloccephala*. This species and probably allied species are no doubt of considerable eco-

nomic importance as enemies of wireworms, and it seems strange that nothing has been published in America regarding this habit.

In Europe several species have been reared, and all are credited with being predaceous enemies of insects in the larval stage. A fairly complete summary of the European investigations has been given by Lundbeck in "Diptera Danica", Part 2 (1908), p. 137. In this paper mention is made of the fact that occasionally the larvæ of *Therevidæ* may devour their own kind—a fact that comes within the knowledge of the present writer from his experience in rearing *Psilocephala*, the reason for the cannibalism being the lack of other food.

MYDAIDÆ

MYDAS CLAVATUS Drury

Musca clavatus Drury, Illustrations of Natural History, Vol. 1, p. 103, 1770.

Pupa (Pl. LXXXII, Fig. 9).—Length, 36 mm. Reddish brown, subopaque. Surface of head and thorax coarsely rugose, that of abdomen rather finely and regularly rugose. Thorns of head rugose to apices, lateral cephalic thorn as in Figure 16. Front of head as in Figure 10; lateral aspect as in Figure 15. Thorax with a bifid humeral tubercle, the one on wing-base with a single flattened thornlike process. First abdominal segment with the thorns (Fig. 21) directed forward and located close to anterior margin, succeeding segments with the thorns rather smaller, directed backward, and located caudad of the transverse median line of the segments, the portion of each segment caudad of the thorns declivitous and honeycombed, the anterior portion irregularly rugose; apical segment with 2 slightly curved processes which are a little upcurved (Fig. 8); spiracles as in Figure 23.

The specimen from which the above description was drawn, was obtained at White Heath, Ill., May 26, 1910, as a larva in a rotten tree-stump, the adult emerged July 18, 1910 (A. G. Vestal). The writer obtained a pupa under a rotten tree-stump at Kinderhook, Ill., in June, 1914. The laboratory collection contains imagines from the following Illinois localities: Urbana, July 4, 1914 (Malloch) and August 3, 1909 (Hart); Champaign, August 13, 1892 (Hucke); Albion, July 12, 1888 (Marten); Havana, July 13, 1897 (Hart and Brown); Alto Pass, August 27, 1889 (Hart); Pinkstaff, July 1, 1911 (Glenn); Monticello, July 2, 1914 (Hart and Malloch); Muncie, July 5, 1914 (Hart and Malloch); and Bloomington, July 26, 1895.

The specimens taken at Muncie were mostly captured on flowers of milkweed, several being taken with the fingers—a proceeding which generally results in the captor's discovering that the insect can pinch

rather severely with the hind femora and tibiæ. So far I have failed to find the larva, no opportunity offering to search for it, but from the fact that many imagines were found on cut-over land where the old tree-stumps remained, upon which the insects often settled, I believe that larvæ must be common in the various localities where I have seen the imagines.

The larva has been recorded as feeding upon the larvæ of insects in old tree-stumps, and the imago has also been recorded as predaceous. I am unable to confirm the last record, as all the specimens taken by both Mr. Hart and myself were upon flowers or at rest upon tree-stumps. It is not impossible that the species is predaceous, but from personal observation and an examination of the mouth parts, which differ essentially from those of *Proctacanthus* and allied forms, I infer that if it is predaceous it is rarely so and must be only in cases where the prey is soft-bodied. It is necessary that exact observations be made to determine the facts of the case, negative evidence such as I am in possession of being inconclusive.

ASILIDÆ

PROMACHUS VERTEBRATUS Say

Asilus vertebratus Say, Jour. Acad. Nat. Sci. Phil., Vol. 3, 1823, p. 47.

Larva (Pl. LXXXII, Fig. 12).—Length, averaging 40 mm. (preserved specimens). White, head and spiracles brown. Head with 10 long hairs, 5 ventral and 5 dorsal, as shown in Figures 24 and 25; mandibles opposed, long and stout; maxillary palpi of moderate size; antennæ very small. Each thoracic segment with 2 hairs, one on each side on ventral surface; prothoracic respiratory organ located near posterior margin on side; anal respiratory organs (Fig. 13) located in a depression on portion anterior to last segment (8th abdominal segment?), the latter with 8 long hairs, 4 ventral and 4 dorsal (Figs. 11 and 14).

The larva here described is without doubt that of *vertebratus*, although no direct connection has been established between it and the imago. There is in the collection, however, a poorly preserved specimen that agrees in all particulars with the above, which is one of several specimens obtained by J. J. Davis, the others being reared and producing imagines of *vertebratus*. The larva is found not uncommonly in spring where ploughing is being done.

Pupa.—Length, 27 mm. Yellowish brown, head and thorax shining, abdomen subopaque. Head similar to that of *Asilus notatus* (Pl.

LXXXI, Figs. 6 and 7), lateral cephalic thorns as in Figure 4, Plate LXXXII. Thorax differs from that of *notatus* in having near the base of the wing sheath, in longitudinal line with the bifid tubercle at base of posterior leg sheath (Fig. 5), a sharp-pointed tubercle, and midway from base to apex of wing case, on its median line, 2 small wartlike protuberances on a common base. Abdominal spiracles c-shaped, very similar to those of *Mydas clavatus*, the open side directed cephalad; the abdominal armature (Fig. 20) similar to that of *Asilus notatus*, differing noticeably only on the apical two segments, the penultimate segment in *vertebratus* having strong thorns on dorsum as on other segments, while in *notatus* there are only hairs similar to those of the ventral segments; the difference in the apical segments of the two species is shown in Figure 14, Plate LXXXI, and Figure 2, Plate LXXXII.

The pupa from which the above description was drawn resulted from a larva obtained at Havana, Ill., April 24, 1905, and the imago emerged July 24, 1905.

The larva is predaceous, feeding upon the larvæ of *Lachnosterna*, and the species is distributed throughout the entire state, though not very common in most localities.

DEROMYIA WINTHEMI Wiedemann

Dasyopogon winthemi Wiedemann, Dipt. Exot., 1821, p. 223.

Diogmites misellus Loew, Berl. Ent. Zeitschr., 1866, p. 22.

Deromyia winthemi Van der Wulp, Tijdsch. v. Ent., Vol. 25, 1883, p. 93.

Pupa.—Length, 20–25 mm. Brownish yellow, distinctly shining; thorns dark brown. Upper pair of cephalic thorns directed forward and curved slightly downward, distance between them distinctly greater than that between them and upper one of the 3 lateral thorns; lateral thorns as in Figure 16, Plate LXXX, the lower one without basal projection. Prothoracic spiracle reniform apically, distinctly elevated; a distinct wartlike swelling on disc of thorax just above wing base; the pair of thorns in front of wing base on lateral margin of disc of thorax very long, curved backward at their middle (Fig. 14); wing cases without central protuberances, their apices in vertical line with second abdominal spiracle and much proximad of apices of sheaths of fore legs. Abdomen with transverse rugæ except on portion of first segment anterior to the transverse series of thorns, where the rugæ are longitudinal; armature of abdomen rather variable, normally as follows: first segment with a transverse series of stout thorns near anterior margin, which are broadest at middle, stand up-

right, and are slightly bent caudad near apices, several of the thorns being occasionally bifid apically; segments 2 to 7 each with a median transverse series of thorns which alternate in size, the shorter ones being generally stouter and very often bifid on middle portion of series; eighth segment with a much weaker transverse series than the others; posterior to the spiracle on first segment is a series of from 6 to 8 long hairlike bristles; spiracles conspicuous, raised, reniform; armature of ventral segments consisting of a transverse series of weak closely placed hair-like bristles at apical third of each segment except the eighth, which has a series on each side at middle extending from lateral margin halfway to median line; ventral surface without rugæ, apical segment as in Figure 15.

The foregoing description was drawn from specimens found by W. P. Flint, of the State Entomologist's office, in a garden at Springfield, Ill., August 6-8, 1915. One specimen of each sex was reared.

Imagines of this species are in the collection here from Grand Tower, Murphysboro, and St. Francisville, the dates ranging from July 25 to August 2. I took a single specimen on the south campus of the University here August 28, 1915.

PROCTACANTHUS MILBERTI Macquart ?

Proctacanthus milberti Macquart, Dipt. Exot., Vol. 1, Pt. 2, 1838, p. 124.

Pupa.—Length, 25 mm. Pale yellowish brown. Armature of head similar to that of *Promachus vertebratus*, differing in having the pair of anterior, forwardly directed thorns smaller and more widely separated at base and the lateral trifid process without distinct angle on base of lower thorn (Pl. LXXXII, Fig. 6). The pair of thorns at base of posterior leg sheath (Pl. LXXXII, Fig. 7) are longer and more slender than in *vertebratus*; the tubercle on base of wing sheath is absent, and a single wart is present on the swelling on middle of the sheath. First abdominal segment with a transverse series of long slender spines, about 18 in number, which are directed slightly forward, their points slightly recurved, the series occupying two thirds of the length on each side between the median line and the spiracle; between some of the long spines there is sometimes a smaller spine; posterior to the first spiracle are about 7 long hairs (Fig. 22)—3 in *Asilus notatus* and *Promachus vertebratus*; segments 2 to 7 each with a transverse median series of long slender spines alternating with shorter stout thorns which are single, bifid, or paired (Fig. 19); eighth segment with a transverse series of spines which are of irregular sizes and unevenly arranged; apical segment with a long slender upwardly

directed spine on each posterior dorso-lateral angle, and a small wart-like process about midway between the base of that and the ventral line (Figs. 1 and 3).

The specimens from which the above description was drawn are two empty pupa skins obtained by Mr. Hart at Beach, Ill., August 24, 1906. It is not certain that the pupa is that of *milberti*, as the species was not reared, but imagines were obtained at the same time and place, and as this was the only species of such large size that was found I assume that the pupa very probably belongs to it.

The species is very probably predaceous in the larval stage upon larvæ of burrowing insects.

Illinois localities represented by material in laboratory collection: Jonesboro, Beach, Havana, Forest City, Jacksonville, Alto Pass, Grafton, Grand Tower, Dubois, Oakville, Edgewood, Metropolis, Albion, Carbondale, and Litchfield. Dates of occurrence range from August 8 to September 23.

ASILUS NOTATUS Wiedemann

Asilus notatus Wiedemann, Auss. Zweifl. Ins., Vol. 1, 1828, p. 451.

Pupa (Pl. LXXXI, Fig. 7).—Length, 12 mm. Brownish yellow, slightly shining. Head distinctly shining, integument without distinct wrinkles; a pair of strong thornlike projections on anterior cephalic surface (Fig. 6) which are rather irregularly longitudinally rugose at base, smooth and highly polished at apices; on each side of the head, almost in vertical line with these thorns and located on the latero-ventral region there is a tridentate process of a similar nature to the thorns (Pl. LXXXII, Fig. 18), the posterior one having a slight scale-like process near its base. Thorax with faint indications of wrinkling on the surface and 3 wartlike projections on each side (as shown in Pl. LXXXI, Fig. 7), the lower one, at base of sheath of posterior leg, having 2 distinct sharp thorns at the apex (Pl. LXXXII, Fig. 17). Abdomen with surface of all segments wrinkled; first segment with 10 long upright brown thorns (Pl. LXXXI, Fig. 7), the apices of which are directed slightly backward, near the anterior margin on dorsum, the distance from the central one to the outer one being about equal to the distance from the latter to the spiracle; posterior to the spiracle are 3 long fine hairs, otherwise the segment is bare; second to sixth segments each with a transverse median row of stout brown thorns alternating large and small in size, extending from median line midway to spiracle on each side, being replaced at this point by a series of long fine hairs which are carried below the level of the spiracles and almost join the ventral series; seventh segment with the dorsal series located nearer to

the posterior margin than on the other segments, the bristles of almost an equal size, otherwise as preceding segments; eighth segment without dorsal thorns, only the long hairs present on lateral region; apical segment as in Figure 14, Plate LXXXI; ventral segments each with a transverse row of long rather irregular hairs near the posterior margin except in the case of the eighth, which has the series on the transverse median line.

This description is taken from a specimen obtained by the writer on the bank of the Sangamon River near White Heath, May, 1915. It was found in rather sandy soil at a depth of about 6 inches. The specimen which emerged is a male. The imagines were remarkably common in the forestry belonging to the University of Illinois, at Urbana, on June 20, 1915. The larva, which is predaceous, was not obtained. The species is common and generally distributed throughout the state, being probably our commonest species of the genus.

CYRTIDÆ

Unfortunately I have of this family but a single pupal exuvium of one species, and that is in rather poor condition. It proves, however, to be quite different structurally from exuvia in the preceding group, having neither strong hairs nor thorns on any part of head, thorax, or abdomen, thus differing markedly from those herein described and from the *Tabanidæ*, the latter having armature on the abdomen very similar to the asilid group.

It is unfortunate that in the case of the only reared specimen available here no record is given of the circumstances under which the pupa was obtained. Species of allied genera have been found to be parasitic in spiders, or to feed upon their eggs. Mr. J. L. King has obtained the larva and pupa of a species of *Pterodontia* in Ohio. The pupa differs from that of *Oncodes* in possessing only 3 pairs of raised abdominal spiracles.

ONCODES COSTATUS LOEW

Oncodes costatus Loew, Berl. Ent. Zeitschr., 1869, p. 165.

Pupa.—Length, 5 mm. White, shining. Head small, without discoverable protuberances or hairs (poorly preserved). Thorax with a wartlike protuberance on each side of disc anteriorly, indicating the location of the openings of the prothoracic respiratory organs. Abdomen with a wartlike protuberance on spiracular areas of segments 1 to 4, segment 5 without protuberance, the spiracle distinguishable, remaining segments without distinct spiracle; apex of abdomen blunt, last segment slightly protuberant but without armature of any kind,

as is the entire abdomen except for the spiracular protuberances (Pl. LXXXI, Fig. 23).

A single specimen of the pupal exuvium of this species is in the collection here. It is unfortunately in rather poor condition, being impaled upon the pin which bears the imago. The locality is Urbana, Ill., June 25, 1904 (Hart and Kegley). Additional Illinois localities (for imagines) are as follows: Carbondale, May 30, 1904, jarred from an apple tree at night (Taylor), and Odin, June 2, 1909, a large series on dead twigs of elm, and one without data, June 23, 1909, from same locality (Hart).

There is a considerable difference in the color of some of the specimens, some having the humeri and scutellum yellowish while others have those parts quite dark, almost like disc of thorax. I am not at all certain that we have as many species in North America as the listed names indicate, as color, which has been exclusively used as a specific separation, appears to be quite unreliable.

PHYTOPHAGOUS AND OTHER CYCLORRHAPHA

SYRPHIDÆ

In this paper I describe the larva and puparium of one species of *Syrphidæ* and the puparia of two others. Two of these have been previously described by other writers, but very briefly.

Metcalf has described and figured the early stages of ten species of *Syrphidæ* from Ohio, one of which is not determined specifically*. All of the named species described in his paper occur in Illinois. It is opportune to notice the occurrence in this state of a parasite of *Allograpta obliqua* Say, which did not occur in connection with Metcalf's work on that species in Ohio. This species belongs to the chalcid genus *Bothriothorax*, and is at present undescribed, according to A. A. Girault to whom the species was submitted. Four examples of each sex of the parasite were reared by the writer from a single larva. The parasites completed their metamorphoses within their host, emerging through a single exit-hole in its skin. This does not coincide with Hubbard's observation on the chalcid parasites of *Baccha babista* quoted by Metcalf†, which emerged through a number of holes in the puparium. Metcalf reared the ichneumonid *Bassus lactatorius* Fabricius, from *Allograpta obliqua*. The chalcid *Bothriothorax peculiaris* Howard, has been recorded by Smith as a parasite of syrphid puparia.

*Syrphidæ of Ohio, Bull. 1, Ohio Biol. Surv., published as No. 31, Vol. 17, Ohio State Univ. Bull. 1913.

†Loc. cit., p. 51.

TROPIDIA QUADRATA Say

Xylota quadrata Say, Am. Entom., Vol. 1, Pl. VIII; Compl. Works, Vol. 1, p. 14.

Puparium (Pl. LXXXIII, Fig. 17).—Length, 9 mm. Testaceous yellow. Entire body opaque, covered with very short closely placed pale hairs. Lower part of the lidlike anterior portion with 8 small blackish thorns, 4 in a semicircle close to the lower extremity, 2 slightly higher placed, about midway between median line and lateral suture, and 2 close to suture, about midway between lower extremity and the median cross-suture; 2 strong thorns on each ventro-lateral margin close to anterior margin of pupa; anterior respiratory organ (Fig. 18) covered with small glossy knoblike swellings. Posterior extremity with 3 thorns close to ventro-lateral margin; posterior respiratory organ as shown in Figure 19, Plate LXXXIII.

The pupal exuvium from which the above description was drawn, is that of a male which bears the number 13549. The puparium was found floating in the water at Flag Lake, near Havana, Ill., August 3, 1895. Several were found on August 3 and 5, but only one imago emerged (August 14). Two specimens, evidently newly pupated, were found by Mr. Hart in a *Sagittaria* belt which had but recently become inundated.

Imagines in the collection here are from the following localities: Algonquin, Chicago, Champaign, and Urbana, the dates ranging from May 25 to July 17. There are also 2 specimens in the collection from Westville, N. J., taken August 16.

The early stages of the members of this genus have not previously been described, and the larval habits are unrecorded.

BRACHYPALPUS FRONTOSUS Loew

Brachypalpus frontosus Loew, Berl. Ent. Zeitschr., 1872, p. 83.

Larva (Pl. LXXXIII, Fig. 12).—Length, 17 mm. White, with the prothoracic thorns and setulæ dark brown, anal respiratory organ pale brown. Surface of entire body with closely placed, stout, small, pale hairs. Front view of head and prothorax as in Figure 14; antennæ of moderate size, apices with two circular sensory organs; anterior margin of prothorax with 3–4 transverse rows of blackish thornlike processes which are recurved apically, the upper or posterior one strongest; prothorax with a strong outwardly directed, backwardly curved thorn on each side and a small respiratory organ slightly nearer to median line; each segment with 10 slight carinæ, 4 on dorsum, one on each dorso-lateral angle, one on middle of each lateral surface, and one on each ventro-lateral angle, each carina with a group of hairs at

middle of each segment, the bases of the hairs being generally fused; hairs on remainder of surface shorter than those on carinæ, and occasionally pairs are fused on lateral surfaces; ventral surface with 7 pairs of conspicuous pseudopods, all of which are armed on apices of posterior surfaces with about 4 series of short blackish recurved thorns, the apical row being strongest; apex of abdomen as in Figure 12.

Puparium (Pl. LXXXIII, Fig. 13).—Length of body 11 mm., caudal process, 5 mm. Yellowish brown, slightly shining. Surface as in larva except that the hairs are less conspicuous, the carinæ are indistinguishable, and the rugæ are much more numerous, as shown in Figure 13. The head is entirely retracted and the prothoracic thorns and respiratory organs are brought almost to the antero-ventral margin (Fig. 15); the pair of pupal respiratory processes, so conspicuous in *Tropidia quadrata*, are represented by slight callosities of the surface which are barely distinguishable; ventral pseudopods much less conspicuous than in larva; apical process distinctly broader than high.

The material from which the foregoing descriptions were drawn, was obtained near Urbana, Ill., under bark on a rotten tree-stump. The specimens reared are recorded as pupating March 5 and emerging March 19 and 21.

Imagines in the laboratory collection are from the following Illinois localities: Algonquin, Carlinville, and Urbana, the last-mentioned taken on April 20; the others without dates.

The only previous American record of the larval habits that I know of is that by Keen.*

I know of no previous description of the larva; the pupa has been very briefly described by Parker.†

CERIA WILLISTONI Kahl

Ceria willistonii Kahl, Kans. Univ. Quart., Vol. 6, 1897, p. 141.

Puparium (Pl. LXXXIII, Fig. 16).—Length of body 10 mm., apical process 4 mm. Yellowish white, mottled with brown or blackish, opaque. (Anterior portion with respiratory organs missing.) Surface covered with microscopic pale hairs. Dorsum with a median longitudinal series of paired wartlike tubercles extending nearly to apex, 6 pairs in all; apices of tubercles with a few short setulose hairs; dorso-lateral margin with a single longitudinal series of 6 wartlike tubercles, each of which is slightly caudad of the corresponding sub-

*Can. Ent., Vol. 16, 1884, p. 147.

†Proc. Ent. Soc. Wash., Vol. 17, 1915, p. 147.

median one, and is similarly armed at apex; between the submedian and dorso-lateral warts is a longitudinal series of much smaller ones in direct line with the others, and on the upper margin of lateral area is a similar series of small warts, the whole forming a diagonal series on each side of the 6 segments; medio-lateral line with a pair of small warts on middle of each segment, the anterior one of each pair white, with a conspicuous small brown spot ventrad of it, and located almost vertically midway between the warts of the series dorsad of it; on the ventro-lateral line is a single wart on each segment, located in direct vertical line between the pair in medio-lateral series; ventral segments 1 to 4 each with a small slightly raised circular area on each side of the median line, each area being crowned with numerous dark brown setulose hairs; the remaining segments somewhat flattened and slightly fused, without the well-defined circular areas of the anterior 4, though still discernible, and without the setulose hairs; apical 2 segments each with a transverse series of 4 thornlike processes, 2 on the marginal and 2 on the submarginal line; apical process about 7 times as long as thick, shining brown, transversely oval in cross-section.

The pupal exuvium from which the above description was drawn, is that of a male. The pupa was obtained in a wood at Urbana, Ill., May 12, 1888, by Mr. Hart, and the imago emerged 3 days later.

Banks records the species from Falls Church, Va., where he obtained the pupa on oak bark about the middle of March, the imago emerging March 27. He has briefly described the puparium,* and states that the larvæ of *Ceria* are said to feed in flowing sap of trees. No data on the food habits are on file in this Laboratory.

C. willistoni has been given by some authors as a synonym of *C. signifer* Loew. The puparium of *signifer* is briefly described by C. W. Johnson.† It was found by Dr. Skinner near Bala, Pa., on an oak leaf. It is not possible to decide from the description whether it is identical with that here described.

The localities from which *signifer* has been recorded include Mexico, Florida, and Texas; *willistoni* was described from Kansas.

EPHYDRIDÆ

HYDRELLIA SCAPULARIS Loew

Hydrellia scapularis Loew, Mon. N. Amer. Dipt., Vol. 1, 1862, p. 153.

Larva.—Not preserved, the following characters being ascertained from an examination of the puparium. Anterior and posterior mar-

*Ent. News, Vol. 4, 1893, p. 91.

†Proc. Ent. Soc. Wash., Vol. 5, 1903, p. 310.

gins of dorsal segments except the apical 3 with numerous short setulæ which are irregularly arranged; ventral segments with similar setulæ, which are arranged in distinct transverse series which extend well on to the disc of the segments; antepenultimate segment with a large transverse patch of these setulæ on disc (Pl. LXXXIII, Fig. 16).

Puparium (Pl. LXXXIV, Fig. 13).—Length, 4 mm. Yellowish brown. Anterior respiratory organs absent. Segments with similar armature to that of larva. Apical segment armed with 2 sharp processes which pierce the outer membrane of the leaf in which the puparium is enclosed, and connected with these processes, which are evidently the posterior spiracles, are 2 tracheæ which run forward and presumably connect with the pupal envelope, although the point of connection is not discernible in the specimen before me.

The above description was drawn from specimens obtained by Mr. Hart and the writer at Grand Tower in April, 1914. The larvæ were mining the leaves of a species of *Panicum* growing in a small stream, many of the mines being below the water level.

Two specimens of a hymenopterous parasite were reared, both males. One specimen was submitted to Mr. A. B. Gahan, who identified it as *Gyrocampa*, n. sp. He considered it inadvisable to describe a new species from the male only.

Scapularis is generally distributed throughout the state. There is a previous record of the larva mining leaves of *Hordeum* by Webster and Parks.* Several European species of the genus have been recorded as phytophagous, but so far this is the only North American species on record.

DROSOPHILIDÆ

The imagines of many species of *Drosophila* are numerous throughout Illinois during the greater portion of the year, and may be seen in large numbers on the inside of windows of fruit-stores and delicatessen stores, as well as in cafés and restaurants, where they are readily detected, flying over various foods, by their slow and steady flight. The principal food of the larvæ consists of decaying vegetable matter, exuding sap on trees, and fungi. A few species are found mining leaves of cruciferous plants, and several attack injured fruit.

I am unable to indicate characters for distinguishing the larvæ of the family from allied acalypterates because of the paucity of my material. The larvæ vary very considerably within the genus *Drosophila* as at present limited, and the puparia vary even more in structure; in fact there is more difference between the pupæ of certain species of

*Jour. Agr. Research, Vol. 1, 1913, p. 84.

Drosophila than there is between the pupæ of different genera in some other families.

One species that I have reared has a larva that is capable of jumping much as do the larvæ of most *Cecidomyidæ*. One specimen covered a distance of over 5 inches at a single leap. I expect to deal with this and other species of the family in a subsequent paper.

DROSOPHILA (SCAPTOMYZA) ADUSTA LOEW

Drosophila adusta Loew, Berl. Ent. Zeitschr., 1862, p. 231.

Puparium (Pl. LXXXIV, Fig. 1).—Length, 1.5 mm. Reddish brown. Cephalic extremity with two long tapering respiratory processes, the trachea of which may be seen traversing the area of the sunken or flattened portion of puparium. Ventral surfaces of abdominal segments with numerous very minute setulæ, arranged in rather irregular transverse series. Caudal projections whitish, rounded apically and with weak apical hairs. Dorsal surface of abdominal segments armed with setulæ similar to those of ventral surface.

The specimen from which the foregoing description was drawn, was obtained from sap exuding from a mulberry tree at Urbana, Ill., July 3, 1915. It was unrecognized in the larval stage, but the pupa was readily separated from the other species before the adult emerged.

Chittenden has recorded this species, as *Scaptomyza adusta*, mining leaves of cabbage, etc.*.

The habits of the species of this group (*Scaptomyza*) are but imperfectly known, but it seems strange that the same species should be in the larval stage both a leaf-miner and a frequenter of sap of the nature in which I found it. I have seen a very large series of *Scaptomyza*, reared by Mr. A. B. Gahan, at College Park, Md., from cruciferous plants, cabbage and turnip, which led me to conclude when I examined them that the species *flavcola* and *graminum* were synonymous, the series presenting all gradations of thoracic coloration from unicolorous ferruginous to ferruginous with a brown central vitta, and from unicolorous grayish to gray with a dark brown central vitta. It is also worthy of note that in the specimens with unicolorous thorax the setulose discal hairs were arranged rather regularly over the entire surface, whereas in those with the vittate thorax the setulæ were arranged in a single longitudinal series along the margins of the central vitta, and the area beyond these was almost or entirely devoid of setulæ. To arrive at a definite decision as to the distinctness of the forms it would be requisite to rear a series from the eggs.

*Bull. 33, n. s., Div. Ent. Dept. Agr., 1902, p. 76.

DROSOPHILA DIMIDIATA Loew

Drosophila dimidiata Loew, Berl. Ent. Zeitschr., 1862, p. 230.

Puparium.—Length, 2 mm. Pale reddish yellow, slightly shining. General habitus similar to that of *Drosophila adusta*. Anterior respiratory organs about three times as long as their diameter, terminating in numerous fine hairs (Pl. LXXXIV, Fig. 5). Surface of abdomen with the usual transverse bands of short setulæ; apex of abdomen with a scalelike projection as shown in Figures 6 and 7, Plate LXXXIV; above the base of the apical pair of respiratory processes is a pair of small tubercles; cephalad of the scalelike process the surface of the abdomen is broken by 2 or 3 narrow but deep depressions.

The exuvia from which the above description was drawn are those of adults reared from larvæ obtained by Mr. Hart and the writer at Havana, Ill., November 16, 1913. The larvæ were found feeding in fungus on the trunk of a fallen decaying tree on the bank of the Illinois River. The imagines emerged November 21, 1913.

This species was originally described from imagines obtained in Illinois by Le Baron. Aldrich in his "Catalogue of North American Diptera", 1905, gives only the original locality. It is one of the commonest species at Urbana, occurring on windows in the Natural History Building, and on fungi on the campus of the University during the summer. Professor Aldrich informs me that he has taken the species at Lafayette, Ind.

AGROMYZIDÆ

The larval habits of the species contained in the genus *Agromyza* are similar in that all those known are phytophagous, but they differ in the point of attack which they select, some mining in leaves, and others in the roots or in the stem. All so far reported are internal feeders, and several are of economic importance, two of the latter class recently discovered being *Agromyza pruinosa* Coquillett—mining the cambium layer of birch—and *A. pruni* Grossenbacher, mining the cambium of *Prunus*. The last-named species I describe in the present paper. It has not been taken in this state, but almost certainly occurs here. As the original description is very brief and not readily accessible to entomologists I take the opportunity of re-describing it from material kindly supplied me by Mr. Grossenbacher, who reared the species.

There are a large number of very closely allied species in the genus *Agromyza*, and much careful work upon the early stages and food habits is necessary before we shall be able to decide just how many dis-

tinct species we have in North America. In this branch of the work there is a splendid opening for original and valuable investigation.

AGROMYZA PRUNI Grossenbacher

Agromyza pruni Grossenbacher, Bull. Torrey Bot. Club, Vol. 42, 1915, p. 235.

Larva, full-grown (Pl. LXXXIV, Fig. 8).—Length, 11–13 mm. White, semitransparent, mouth hooks black. Prothoracic segment longer than succeeding one, head parts retracted within prothorax (Pl. LXXXIV, Fig. 9), prothoracic respiratory organs indistinguishable except in one larva which had evidently been near the point of pupating. First abdominal segment longer than the two preceding thoracic segments together and shorter than second abdominal; segments 2 to 5 subequal in length; 6 shorter than 5; 7 and 8 together about equal to 6; integument of thoracic segments with numerous microscopic punctiform marks which are only visible under a very high magnification; abdominal segments with microscopic setulæ at the incisions, on their anterior margins, those on segments 1 to 5 consisting of one or two series which, like those of the apical segments, do not extend entirely round the body; segment 6 with 3 or 4 series, segment 7 with 6 or 7, apical segment with 8–9; anal respiratory organs rather conspicuous, ending in 3 short branches.

Puparium (Pl. LXXXIV, Fig. 10).—Length, 5 mm. Testaceous, slightly shining. Anterior respiratory organs very small. Abdominal segmentation not deep; segments with weak transverse rugæ; anal ventral orifice marked by a black spot; anal respiratory organs small, but slightly protruded.

Imago: male and female.—Black. Head black, anterior portion of frons, the antennæ, and palpi brown. Legs black, fore tibiæ and tarsi and apices of mid and hind tarsi yellowish (alcoholic specimens).

Frons over one third the head-width; orbits differentiated, each about one fourth the width of center stripe; 5 pairs of orbital bristles present, their length decreasing anteriorly; antennæ of moderate size, third joint rounded apically, pilosity short, arista slender, almost bare, the entire length about equal to that of frons; face concave; cheek narrow, about one sixth as high as eye, marginal bristles of moderate strength, not numerous, vibrissa well differentiated; eye nearly twice as high as long; palpi of moderate size. Mesonotum with 4 pairs of dorso-central bristles, the two anterior pairs reduced in size, the foremost pair well in front of suture; the pair of bristles between the posterior pair of dorso-centrals half as long as the latter; disc with numerous short setulæ. Abdomen stout; male hypopygium small, very much

like that of *parvicornis*; female ovipositor very conspicuous, as long as preceding segment of abdomen, of almost equal diameter throughout its length; surface with short hairs (Pl. LXXXIV, Fig. 11). Legs of moderate strength; mid-tibial bristles small. Wings of moderate width; costa to slightly beyond apex of third vein; inner cross-vein below end of first vein; outer cross-vein less than its own length from inner, slightly bent, its upper extremity nearer apex of wing than its lower; last section of fourth vein about 10 times as long as preceding section; last section of fifth about $1\frac{1}{2}$ times as long as preceding section.

Length, 3.5-4 mm.

The life history of this species has been dealt with by its describer in the bulletin cited under the species name in the present paper, it being an elaboration of his report upon the same species in a previous paper.*

The three species of *Agromyza* known to cause medullary spots in wood of trees are *carbonaria* Zetterstedt, a European species; *pruinosa* Coquillett, occurring in the cambium of river birch; and the present species, found in the cambium of *Prunus avium* and *domestica*. In Grossenbacher's first paper above cited he states that *Crataegus* is also attacked, while *Salix* is not. In his last paper he makes mention only of the species of *Prunus*, and gives his agromyzid a name that leads me to infer that he considers it as a *Prunus*-infesting species exclusively.

I have recorded *Agromyza pruinosa* from Illinois†, and it is very probable that *A. pruni* occurs in suitable localities. Up to the present I have been unable to devote time to a search for the species.

I have drawn the larva and puparium of *Agromyza parvicornis* Loew (Pl. LXXXIV, Figs. 14 and 15) to show the normal reduction in size due to the induration of the larval skin in pupation in *Agromyza*.

The imago of *pruni* will run down to section 16 in my key to the North American species of this genus‡ if the frons is considered as partly reddish, the cross veins being close together. It is readily separated from both of the species in that section by its robust build and the possession of 4 pairs of dorso-central bristles. The species has much the same appearance as *pruinosa*, but differs in venation, etc., while the food plant and larval and pupal characters are quite enough to separate them specifically. The difference in venation will separate it from *aprilina*.

*Medullary spots: a contribution to the life history of some cambium miners. Tech. Bull. 15, N. Y. Agr. Exper. Sta., pp. 47-65. 1910.

†Can. Ent., Vol. 47, 1915, p. 15.

‡Ann. Ent. Soc. Amer., Vol. 6, 1913, p. 271.

AGROMYZA TILLÆ Couden

Agromyza tillæ Couden, Proc. Ent. Soc. Wash., Vol. 9, 1908, p. 34.

Puparium.—Length, 2.5 mm. Yellowish white, shining. Segments poorly defined but distinguishable; surface without hairs or protuberance except the anterior and anal respiratory organs. Anterior respiratory organs of moderate length (Pl. LXXXIV, Fig. 18), located on dorsum of first segment, separated from each other by less distance than the length of one of the organs. Anal respiratory organs shorter and comparatively stouter than anterior pair (Pl. LXXXIV, Fig. 19); anal orifice distinct, a few fine irregular reticulated lines on dorsum cephalad of the orifice.

The puparium from which the above description is drawn is one of a lot collected by J. J. Davis at Chicago October 6, 1908, the imagines emerging May 24, 1909. The species makes galls on twigs of linden trees. Besides these specimens there are several in the collection here which were reared by Marten several years ago at Urbana. The galls, "at base of leaf petioles of basswood", were obtained September 27, 1891, and the imagines emerged May 2, 1892. Originally figured and described from Missouri, and recorded as making galls on linden. I subsequently recorded the species from Veitch, Va., and doubtfully from Delaware County, Pa.*

AGROMYZA ANGULATA Loew

Agromyza angulata Loew, Berl. Ent. Zeitschr., 1869, p. 47.

Larva.—Length, 1.75 mm. Pale greenish or whitish. Segments laterally conspicuously swollen, the incisions between them deep, so that viewed from above the whole larva presents a somewhat monili-form appearance; viewed from the side the larva is not so thick as across the dorsum and the segments present a more even surface with little indication of swellings or constrictions. Mouth parts black and of moderate size; armature consisting of 4 hooks, one at apex, a transverse pair slightly caudad of it, followed by another one at the lower posterior angle of the anterior face. Prothoracic respiratory organs very small and inconspicuous (Pl. LXXXIV, Fig. 2). Segments throughout with microscopic wartlike processes, which are rather widely separated on the surfaces of the swollen portions; apex of abdomen as in Figure 3, Plate LXXXIV.

Puparium (Pl. LXXXIV, Fig. 12).—Length, 1.25 mm. Glossy black, with purple or violaceous reflections, especially in the depres-

*Ann. Ent. Soc. Amer., Vol. 6, 1913, p. 327

sions and on the posterior 3 segments. Surface with similar processes to those of the larva, but almost indistinguishable because of the ground-color. Prothoracic respiratory organs very small. Depressions on body very deep, those on dorsum very conspicuous, slightly crescentic in shape. Apex of abdomen similar to that of larva except that in hardening the projecting portions are contracted considerably and are less clearly distinguishable.

Reared from leaves of *Setaria glauca*, the larvæ occurring in the apical 6 inches of the leaf, usually 4 or more in each mine. In company with another species *angulata* was found to be present on vacant lots both in Urbana and Champaign in July and August, 1915, their work showing up readily because of the conspicuous whitening of the tips of the affected leaves. *Angulata* has previously been recorded as attacking timothy grass*, and it will also feed on wheat. A summary of investigations of the habits and life history of this species, with figures of the imago and puparium, are given by Webster and Parks.†

DESCRIPTIONS OF NEW ILLINOIS DIPTERA

In the course of the year it frequently happens that specimens are taken in general collections, or in connection with other work, which belong to undescribed species. Often these species are of economic importance, and usually they are small forms which are readily overlooked in the field. It is considered necessary in the interests of students of the represented order to place the occurrence of such species upon record; to give adequate descriptions of them; and to indicate their relationships with already described species. Isolated descriptions of new species unless very full are often useless for the purpose of identification because of their inadequate nature or the omission of the essential characters by means of which the species of the genus are separated. Many species have been described by writers who were unacquainted with congeneric species, and because of this ignorance they either did not compare their so-called new species with those already described, or they compared it with some species to which it bore but a faint resemblance. The present writer in all cases compares the new species he describes with the forms most closely related, not because he presumes to set an example but because he considers it his duty to do so.

*Malloch.—A Revision of the species in *Agromyza* Fallén, and *Cerodontha* Rondani, Ann. Ent. Soc. Amer., Vol. 6, No. 3, 1913, p. 304.

†The Serpentine Leaf-miner, Jour. Agr. Research, Vol. 1, No. 1, Oct. 10, 1913, pp. 83-84.

PHORIDÆ

PLATYPHORA FLAVOFEMORATA, n. sp.

Male.—Black. Head black, frons highly polished; antennæ fulvous, third joint brown at apex, arista black; palpi fulvous. Thorax glossy black, upper portion of pleuræ, especially posteriorly, brownish; scutellum dull black, the surface shagreened. Abdomen black, distinctly shining throughout, surface with very faint indications of pruinescence. Legs yellow, mid and hind coxæ infuscated at bases; all tibiæ infuscated, the depth of the infuscation increasing from near base to apices; tarsi fuscous. Wings clear, thick veins fuscous. Halteres yellow, apices of stems and the knobs black.

Frons about 1.5 as wide as its length at center, the length slightly less at eye margin than at center, surface with numerous short decumbent hairs, those at vertex slightly longer than those on disc; distance between the posterior ocelli about twice that between either of these and the median one; basal antennal joint rather elongate; third joint about 1.5 as long as broad, rounded at apex; arista subapical, bare, very slender, basal joint very short, slightly swollen; cheeks with 4–5 forwardly and slightly downwardly directed bristles; palpi very small, armed with several stout apical setulæ. Mesonotum broader than long, disc with short hairs and without dorso-central macrochætæ, scutellum about twice as broad as its length at center, margin with a number of decumbent setulose hairs which lie along the edge and give it the appearance of having a rim; disc distinctly shagreened. Abdomen with second segment longer than either of the 3 following segments, 6th longer than 4+5, its lateral surfaces with short hairs; surfaces of abdominal segments minutely shagreened; hypopygium small, surface of dorsal plate shagreened. Legs stout; fore coxæ stout, over two thirds as long as fore femora, their anterior surfaces with setulose hairs which become longer and stronger towards apices of coxæ; fore tibia about two thirds as long as femur, and distinctly longer than basal joint of tarsi (17:10); fore tarsi dilated, especially the basal joint, which is distinctly wider at apex than is the tibia; second tarsal joint appreciably longer than third; mid tibiæ with 2–3 apical setulæ, hind tibiæ with short decumbent setulæ on ventral surfaces, so arranged that they appear like irregular longitudinal rugæ; apices with 2–3 short setulæ and one longer bristle; mid and hind tarsi slender, basal joint of each with a few short downwardly directed setulæ on ventral surfaces. Costa extending to middle of wing; third vein swollen, thicker than costal vein excepting apical part of latter, setulose throughout; second vein distinct, setulose; first vein swollen at apex, extending be-

yond base of second; costal setulæ about equal to diameter of costal vein; veins 4 and 5 very distinctly divergent at apices; greatest distance from vein 7 to margin of wing equal to greatest distance from vein 4 to margin.

Female.—Reddish yellow. Eyes black; frons with a slight pearly iridescence, antennæ and palpi concolorous with head. Thorax similar in color to upper part of head. Abdomen dorsally darker than thorax, becoming dark brown or fuscous at apex, the iridescence very distinct, especially at base; ventral surface opaque black except at extreme base. Legs reddish yellow, the short setulose hairs on tibiæ and tarsi giving them a slight fuscous color.

Ocelli indistinguishable; width of frons less than twice its length at center, anterior outline convex; eyes very small, each about one tenth the width of frons seen from above; surface of frons with sparse microscopic hairs; antennæ smaller than in the male, shape similar; arista with very slight pale pubescence; palpi almost as large as third antennal joint, with apical setulæ as in male; cheek with 2 distinct groups of setulæ, one extending from middle to eye margin and consisting of 3 strong setulæ and several weak hairs, the other located on mouth margin and consisting of 3 strong setulæ. Mesothorax slightly over 1.5 as broad as long; disc with very weak setulæ, lateral margins more strongly setulose; posterior outline slightly emarginate; appearance of dorsum as in Figure 17, Plate LXXXIV. Abdomen with 6 distinct segments, undifferentiated from thorax except by the transverse suture, its dorsal level and lateral margins similar to those of thorax; fourth segment slightly elongated, its posterior margin broadly and slightly concave; surfaces of all segments with weak setulæ. Legs rather short and stout; fore tarsi short and distinctly dilated, basal joint as long as next two together and less than half as long as tibia; armature of legs as in male except that the mid tibiæ have a long apical spur. Wings and halteres absent.

Length: male, 1.7 mm.; female, 1 mm.

Type locality, White Heath, Ill., August 22, 1915—a pair taken *in copula* on a sandy bank along the Illinois Central Railroad between White Heath and the Sangamon River by the writer.

The male of this species bears a strong resemblance to *coloradensis* Brues*, differing noticeably however in wing venation, which in *flavo-femorata* is similar to that of *eurynota*, which Brues described at the same time. In separating the males of the three North American species the following key will be found useful.

*Psyche, Vol. 21, 1914, p. 79.

1. Veins 4 and 5 almost parallel apically *coloradensis*.
- Veins 4 and 5 very distinctly divergent apically 2
2. Legs and antennæ black; scutellum polished; basal joint of fore tarsi almost as long as fore tibiæ *eurynota*.
- Legs and antennæ yellowish, more or less infuscated apically; scutellum subopaque, shagreened, basal joint of fore tarsi not two thirds as long as fore tibiæ *flavofemorata*.

The genus *Platyphora* was described by Verrall in 1877 with the genotype *lubbocki* Verrall, a myrmecophilous species found in Britain*. Nothing was known of the female of the species for a number of years. In 1890 Meinert described the genus *Ænigmatias*† with the genotype *blattoides* Meinert. Mik suggested in 1898‡ that *Ænigmatias* was the female of *Platyphora*. The most definite statement concerning the relations of the genera is that published by Donisthorpe.§ In this paper it is stated definitely that the genera are synonymous, *Platyphora* being simply the winged male and *Ænigmatias* the apterous female of the same genus. This decision was arrived at from data obtained in connection with observations made on ants' nests in which the species of *Platyphora* occur. I am not aware of any copulating record having been made prior to that in the present paper, the decision as to the specific identity of the European species resting upon the fact that only males of *Platyphora* and only females of *Ænigmatias* were obtainable, and that both occurred in the immature stages in the same nests. The record now published confirms the previous one by Donisthorpe, if such confirmation were required.

Coquillett described as a male a female discovered in Arizona.|| This species, *schwarzi* Coquillett, is very similar to *flavofemorata*, and a comparison of the foregoing description with Coquillett's type will be necessary to discover specific differences, although his description seems to indicate that the two are distinct. It is pertinent to indicate here that the females of neither of the species described by Brues are known.

In the case of *flavofemorata* the species was found on a sandy bank where there were numerous ants' nests. The male was running about fairly rapidly, and it was only after I had inverted a cyanide bottle over it that I discovered the attached female. The latter was carried apparently curled forward under the abdomen of the male and was

*Jour. Linn. Soc. Lond., Zool., Vol. 13, 1877, p. 259.

†Entom. Meddel., Vol. 2, 1890, p. 213.

‡Wien Ent. Zeit., Vol. 17, 1898, p. 204.

§Ent. Rec., Vol. 26, 1914, p. 276.

||Can. Ent., Vol. 35, 1903, p. 21.

quite invisible from above on account of the rather large wings of the male, which were folded closely over the abdomen. It is quite possible that it is by this means that the females find their way from one nest to another, as they are themselves not well adapted to do so.

Coquillett's species is recorded as occurring in a situation where no ants' nests were within easy reach.

ANTHOMYIDÆ

POGONOMYIA FLAVINERVIS, n. sp.

Male.—Glossy black. Frontal and facial orbits slightly brownish, covered with dense silvery pilosity. Thorax with slight, but distinct, grayish pruinescence, which when viewed from in front gives the disc the appearance of being trivittate anteriorly. Abdomen when viewed from behind distinctly gray pruinescent on sides, leaving only a rather narrow dorso-central black line which is more or less interrupted at apex of each segment. Legs black. Wings slightly tinged with yellow, all veins yellow, costa with black setulose hairs. Calyptre whitish, margins yellowish. Halteres brown, knobs dark brown.

Eyes distinctly separated, orbits each about as wide as central stripe at narrowest part of frons; frons at narrowest part as wide as distance between outer margins of the posterior ocelli; the strong pair of vertical macrochætæ much more conspicuous than the postocular bristles; arista short-haired; head otherwise similar to that of *alpicola*. Thorax with the macrochætæ and hairs as in *alpicola* but much weaker. Abdomen rather narrow and distinctly tapering apically, the macrochætæ and hairs much less conspicuous than in *alpicola*. Legs with the armature much as in *alpicola*; mid femora with the antero-ventral surface armed with a series of 8–9 bristles, which begins before middle and extends to apex, the longest bristle being slightly beyond the middle of the series; postero-ventral surface with a series of 8–9 longer and more hairlike bristles extending from base to a point about one third from apex, the bristles increasing in length from base to apex of series; hind femora with the series of bristles on antero-ventral surfaces much less numerous than in *alpicola*; postero-ventral surface with a single long slender bristle about one third from apex (two smaller and weaker ones in *alpicola*); hind tibiæ with armature like that of *alpicola* except that the bristles are distinctly weaker. Wing venation similar to that of *alpicola*.

Female.—Agrees in color with the male except that the abdomen is almost entirely glossy black.

Eyes separated by slightly less than one third the head-width, orbits each about half as wide as central stripe at its narrowest point; decussate frontal bristles slender. Abdomen much broader than in male. Legs stouter than in male; mid femora with a stout bristle about one fourth from base on the antero-ventral surface which is appreciably shorter than the diameter of the femur (in *alpicola* this bristle is more slender and much longer than the diameter of the femur). Third and fourth wing-veins slightly convergent apically.

Length, 5.5–7 mm.

Type locality, Algonquin (Nason).

The type series consists of one male and three females, two bearing Algonquin labels (one with the date May 24, 1895), and two labeled N. Ill., one of the latter also bearing Stein's label "*Pogonomyia* n. sp.", and presumably the species referred to by him in *Berliner Entomologische Zeitschrift**. Subsequently Stein referred to the species a specimen from Wisconsin, but as he had only seen females he did not describe the species.

The foregoing description should serve to separate *alpicola* Rondani, and *flavinervis*. I have not seen *aterrima* Van der Wulp, which was described from Mexico, but it must be very similar to *alpicola* if not identical with it. I have both sexes of *alpicola* from Moscow, Idaho, May 22, 1913 (J. M. Aldrich).

GEOMYZIDÆ

APHANIOSOMA QUADRIVITTATUM, n. sp.

Female.—Opaque yellow. Head yellow with the exception of a small spot surrounding the ocelli and a small area round the connection between the head and thorax, which are black; eyes iridescent green in life. Mesonotum with four blackish gray vittæ, the center pair indistinctly connected with a similarly colored spot on center of anterior margin at connection of head and thorax, lateral pair discontinued at humeri, posteriorly all four vittæ being discontinued slightly beyond middle of disc, the lateral pair slightly exceeding the median pair in length; lower portion of sternopleura slightly darkened; postnotum blackened on lower half. Abdomen pale yellow, each segment with a conspicuous blackish brown cross-band on basal portion which is broad on median line and narrows towards each lateral margin. Legs yellow. Wings clear, veins yellow. Halteres yellow. Bristles on head and thorax black, surface hairs yellow.

*Vol. 42, 1897, p. 170.

Head slightly higher than long; face concave in center; upper half of back of head concave; post-vertical bristles very weak, cruciate; frons in profile slightly buccate, viewed from above nearly one half the width of head, slightly narrowed anteriorly; orbit not differentiated from center stripe; two distinct orbital bristles present on each side which are slightly reclinate and of moderate size; anterior to the lower one is a short setula; ocellar bristles forwardly directed, divergent; surface of center stripe with numerous short setulose hairs; antennæ rather small, third joint rounded, arista almost as long as frons, bare; cheeks with numerous rather distinct hairs and 2-3 stronger bristles along mouth margin anteriorly; cheek at middle half as high as eye, the latter slightly longer than high. Mesonotum with 2 pairs of widely separated dorso-central bristles, the anterior pair much weaker than the posterior and preceded by a closely placed series of short setulæ which extend along the inner margin of the lateral vittæ almost to anterior margin of disc; acrostichals two-rowed anteriorly, irregularly four-rowed posteriorly; no bristles between posterior dorso-centrals; scutellum slightly flattened on disc, 4 subequal marginal bristles present, the posterior pair located on margin very close to base. Abdomen slightly elongated, pointed at apex. Legs rather slender; tibiæ without preapical bristle. Wings narrow, auxiliary vein complete but indistinct; costa unbroken, first division one fifth as long as second; second vein distinctly arcuate, the cell between it and third vein conspicuously narrowed apically; inner cross-vein about as far beyond apex of first as it is in front of outer cross-vein; outer cross-vein short, not much longer than inner; last section of fourth vein four times as long as penultimate; last section of fifth, one and a half times as long as penultimate.

Length, 2 mm.

Type locality, Urbana, Ill., June 19 to July 9, 1915; on window in Natural History Building, University of Illinois (J. R. Malloch).

The range of variation in color in this species includes forms in which the back of the head is entirely gray, and the dorsum of thorax and abdomen almost entirely blackish gray.

The genus *Aphamiosoma* was described by Becker in 1903*, who distinguished it from *Chyromyia* by the concave occiput, the latter genus having the occiput convex. The characters of the two genera are very similar, but the shape of the head should readily separate them. The Egyptian species, *approximatum* Becker, differs from the above species in having the disc of the mesonotum opaque gray dusted and the pleuræ with gray spots. It is also considerably smaller—.5-.75 mm.

*Aegyptische Dipteren. Mitt. Zool. Mus. Berlin, II Bd., 3 Hft.

AGROMYZIDÆ

AGROMYZA APRILINA, n. sp.

Female.—Glossy black. Frons opaque black, orbits and ocellar triangle glossy; lunula yellowish; face and cheeks opaque, slightly dusted with grayish pruinescence; antennæ, palpi, and proboscis black. Thorax highly polished without trace of pruinescence; scutellum as disc of mesonotum. Abdomen as thorax, with a slight metallic blue sheen towards apex. Legs entirely black. Squamæ and fringes whitish. Halteres yellow, knobs white.

Head in profile as in Figure 4, Plate LXXXIV, frons over one third the head-width, parallel-sided, orbits narrow, each about one fifth as wide as center stripe, five moderately strong orbital bristles present, which decrease slightly in strength towards anterior margin, orbits otherwise bare; frontal triangle distinct, rather broad and short, not extending midway to anterior margin; antennæ of average size, third joint distinctly, but not greatly, longer than broad; arista swollen at base, bare, its length exceeding that of anterior width of frons by about one fourth; face and cheeks as shown in figure of profile. Mesonotum with 4 pairs of dorso-central bristles, which decrease in size anteriorly, the foremost pair being but little stronger than the strong discal hairs of which there are about 6 irregular rows between the anterior dorso-centrals; the pair of bristles between the posterior pair of dorso-centrals distinct. Abdomen elongate, discal hairs numerous and rather strong; ovipositor stout and of moderate length. Legs normal in length and in form; mid tibiæ with the posterior pair of bristles distinct. Costa extending slightly beyond third vein; outer cross-vein slightly beyond middle of wing and a little more than its own length from inner; inner cross-vein beyond end of first vein and two fifths from apex of discal cell; last section of fourth vein four times as long as penultimate section; last section of fifth five sixths as long as penultimate; auxiliary vein complete; sixth vein extending nearly to wing margin.

Male.—Agrees with the female in color.

Differs from the female in the case of one specimen in having the outer cross-vein at one seventh of the distance from inner cross-vein to wing margin.

Length: female, 3–3.5 mm.; male, 2.5 mm.

Type locality, Cottonwood grove, Urbana, Ill., April 16–20, 1915 (J. R. Malloch).

In the key to the species of *Agromyza* in my paper in the Annals of the Entomological Society of America this species will run down

to caption 15. Including *subnigripes* (= *nigripes* Schiner *nec* Meigen) there are four species occurring in North America that fall here; they may be separated thus:

- a. Squamæ gray, fringes brown.....*subnigripes* Malloch.
- Squamæ and fringes whitish.....aa
- aa. Cross veins separated by about the length of outer cross-vein.....
.....*aprilina*, n. sp.
- Cross veins separated by about twice the length of outer cross-
vein.....aaa
- aaa. Arista almost bare; occiput not projecting on upper half.....
.....*abbreviata* Malloch.
- Arista distinctly pubescent; occiput projecting on upper half.....
.....*kincaidi* Malloch.

CHLOROPIDÆ

GAURAX Loew

I recently described two new species of the genus *Gaurax* and published a synoptic key to the North American species*. Since sending that paper in for publication I have found three species which are evidently undescribed, and in presenting descriptions of these I feel that it becomes necessary to publish an enlarged synopsis of the species so that students may the more readily recognize the new forms.

I have not found any of the early stages of the species; most of the imagines occurring on tree-trunks and limbs. Several examples of *dorsalis* Loew were taken on windows of the basement in the Natural History Building of the University of Illinois.

In the case of the specimens of *montanus* Coquillett which I took here the apices of the hind femora are slightly brownish, a character possessed by the type also, though omitted in the original description.

KEY TO SPECIES.

1. Wings not entirely hyaline, either with a black spot at apex of second vein, or with a distinct dark mark or infuscation on disc....2
- Wings entirely hyaline.....7
2. Wings with a small black spot at apex of second vein (Toronto, Can.)
.....*pseudostigma* Johnson.
- Wings with a much greater portion blackened.....3
3. Thorax and scutellum entirely yellow; a large black mark occupying the area of the wings from middle of second vein between costa and third vein and a small portion of the apex of the cell posterior to third (Ill.).....*flavidulus*, n. sp.

*Proc. Ent. Soc. Wash., Vol. 17, 1915, p. 159.

- Thorax with at least black discal marks; wings marked otherwise than as above.....4
4. Thorax and scutellum black.....5
- Ground color of thorax yellow, disc with black marks, scutellum yellow.....6
5. Setulose hairs on frons and cheeks black; wings with very distinct infuscation, which extends to base and is most distinct in cell bounded by first vein and costa; legs entirely yellow (Ill.).....
.....*pallidipes*, n. sp.
- Setulose hairs on frons and cheeks yellow; wings with rather indistinct infuscation, which does not extend to base; legs yellow, hind femora and tibiæ largely black (Ill.).....*fumipennis* Malloch.
6. Sides of mesonotum near anterior angles with a white spot (Ill.)...
.....*splendidus* Malloch.
- Sides of mesonotum without a white spot (Mass.).....
.....*obscuripennis* Johnson.
7. Thorax and scutellum glossy black; apical half of hind femora black, the remainder of legs yellow (La.).....*pilosulus* Becker.
- Either disc of mesonotum or the scutellum yellow; legs not as above.....8
8. Halteres yellow.....9
- Halteres black.....11
9. Scutellum black, disc of mesonotum yellow, with a posteriorly tridentate black mark which covers almost the entire disc (Pa., Ill., N. H.).....*dorsalis* Loew.
- Scutellum yellow, with brownish marks upon the disc.....10
10. Disc of mesonotum with 3 confluent black vittæ, forming a large discal mark, rarely narrowly separated; scutellum with a basal black mark on each side (N. H.).....*ephippium* Zetterstedt.
- Disc of mesonotum with 3 black spots, the rudiments of the normal vittæ, beyond middle; scutellum with a large brownish mark on disc (Ill.).....*interruptus*, n. sp.
11. Legs entirely yellow or with only a faint brownish mark at apices of hind femora (N. H., Vt., Ill.).....*montanus* Coquillett.
- Legs with distinct, deep black marks.....12
12. Thorax glossy black, lower half of pleuræ and the scutellum yellow (Ill.).....*apicalis* Malloch.
- Thorax and scutellum yellow, disc of the former with black marks (Pa.).....*festivus* Loew.

GAURAX FLAVIDULUS, n. sp.

Male.—Yellow, subopaque. Head yellow, ocellar region, inner upper mouth-margin, and back of head black. Thorax yellow, a black central spot on pleuræ and a similarly colored transverse one on middle of postnotum. Abdomen yellow, infuscated on sides of first seg-

ment and entire dorsum of other segments; venter yellowish. Legs yellow, mid and hind tibiæ with a brownish black spotlike mark on dorsal surfaces near base. Wings with a large black mark covering the entire area anterior to third vein from middle of second to apex of third and extending slightly posterior to third near its apex; veins black. Halteres yellow. Setulose hairs on head and thorax black, the weak hairs pale yellow.

Frons over one third the head-width, triangle poorly defined; antennæ small, third joint rounded apically, slightly pilose; arista short-haired; cheek linear; eyes sparsely haired. Surface of mesonotum with weak hairs; apical pair of scutellar bristles distinctly stronger than basal. Abdomen rather slender; hypopygium of moderate size, recurved. Legs normal. Third costal division of wing about three fourths as long as second; veins 3 and 4 parallel, the latter ending in wing tip.

Length, 1 mm.

Type locality, Urbana, Ill., July 4, 1915, at rest on cypress limb (J. R. Malloch).

Differs from any described species of the genus in the wing markings.

GAURAX PALLIDIPES, n. sp.

Male.—Black, shining. Head yellowish brown; frons opaque black-brown, triangle glossy black; antennæ brownish; arista fuscous; palpi dusky yellow; back of head black. Thorax and abdomen shining black, the latter slightly yellowish at base. Legs entirely yellow. Wings with a very distinct infuscation on anterior basal half, which fades out before apex of third vein; veins black. Halteres yellow, knob black. Hairs and bristles on head black; bristles on thorax yellow; hairs on thorax and abdomen white.

Head short and broad; frons one half the width of head, triangle well defined and very large, filling almost the entire frons; lateral and vertical setulæ strong; antennæ large, third joint very hairy; arista slender, short-haired; marginal hairs on cheek strong; eyes very distinctly haired. Mesonotum rather densely covered with long white hairs; scutellum with similar hairs and 4 marginal bristles, the apical pair strongest. Abdomen short and broad. Legs of moderate strength. Third costal division of wing two thirds as long as second; veins 3 and 4 parallel, the latter ending in wing tip.

Length, 1.5 mm.

Type locality, Urbana, Ill., July 4, 1915, at rest on cypress limb (J. R. Malloch).

Differs from *fumipennis* Malloch in having the legs entirely yellow and the infuscation of the wings carried to the base.

GAURAX INTERRUPTUS, n. sp.

Female.—Ochreous yellow, slightly shining. Head yellow, ocellar region, inner upper mouth-margin, and back of head black, arista brownish. Mesonotum with the three vittæ faintly indicated anteriorly, black on posterior third from transverse median line of disc midway to posterior margin; pleuræ with a large glossy black central spot and the upper margin narrowly black; scutellum brownish black except the margin; postnotum yellow above, black below. Abdomen black dorsally, segments paler on anterior margins, venter yellow. Legs yellow. Wings hyaline, veins grayish. Halteres yellow, knobs white. Bristles on head and thorax black, hairs yellowish.

Frons opaque, over one third the width of head, surface with numerous setulose hairs, those on vertex, lateral margins, and a pair on center of anterior margin strong; antennæ rather small, arista short-haired; eyes sparsely haired; triangle poorly defined. Mesonotum with less noticeable surface hairs than in most species of the genus; scutellum with short discal hairs and 4 marginal bristles, the apical pair strong. Abdomen and legs normal. Third costal division of wing about four fifths as long as second; veins 3 and 4 subparallel, the latter ending in wing tip.

Length, 1 mm.

Type locality, Urbana, Ill., July 5, 1915, at rest on cypress tree trunk (J. R. Malloch).

This species is separable from *ehippium* by the interrupted thoracic vittæ, and the discal spot on scutellum.

Urbana, Illinois, December 3, 1915.

PLATE LXXX

Larval and Pupal Details of Sciara, Mycetobia, and Deromyia

- Fig. 1. *Sciara* sp., larva, ventral view of head: *a*, antenna; *lab*, labium; *mx*, maxillæ; *lb*, labrum; *m*, mandible.
- Fig. 2. The same, abdominal trachea and spiracle of larva.
- Fig. 3. The same, prothoracic trachea and spiracle of larva.
- Fig. 4. The same, latero-ventral view of pupa.
- Fig. 5. *Mycetobia divergens*, prothoracic spiracle of larva.
- Fig. 6. The same, portion of head and prothorax showing trachea and spiracle of larva.
- Fig. 7. *Mycetobia divergens*, lateral view of pupa.
- Fig. 8. *Sciara* sp., mandible of larva.
- Fig. 9. *Mycetobia divergens*, dorsal view of apical segments of pupa.
- Fig. 10. *Sciara* sp., clypeus and hypopharynx of larva.
- Fig. 11. *Mycetobia divergens*, mandible of larva.
- Fig. 12. The same, dorsal view of larva.
- Fig. 13. The same, labial plate of larva.
- Fig. 14. *Deromyia winthemi*, thorns at base of wing of pupa.
- Fig. 15. The same, lateral view of eighth and ninth segments of abdomen of pupa.
- Fig. 16. The same, side view of lateral cephalic thorns of pupa.

PLATE LXXXI

*Larval and Pupal Details of Bombyliidae, Asilidae,
Therevidae, and Cyrtidae*

- Fig. 1. *Exoprosopa fascipennis*, pupal abdominal dorsal bristles, dorsal view.
- Fig. 2. The same, lateral view.
- Fig. 3. *Anthrax lateralis*, pupal abdominal dorsal bristles, lateral view.
- Fig. 4. *Exoprosopa fascipennis*, lateral view of pupa.
- Fig. 5. The same, front view of head of pupa.
- Fig. 6. *Asilus notatus*, lateral view of head and thorax of pupa.
- Fig. 7. The same, dorsal view of pupa.
- Fig. 8. *Anthrax lateralis*, pupal abdominal dorsal bristles, dorsal view.
- Fig. 9. *Psilocephala hamorrhoidalis*, larval head, lateral view: *a*, antenna; *m*, mandible; *pr*, posterior rods.
- Fig. 10. The same, lateral view of larva: *sp*, prothoracic spiracle; 1-6, abdominal segments one to six; *a*, dorsal view of apex of abdomen.
- Fig. 11. *Psilocephala hamorrhoidalis*, ventral view of pupa.
- Fig. 12. The same, dorsal view.
- Fig. 13. The same, lateral view of apex of abdomen of pupa.
- Fig. 14. *Asilus notatus*, lateral view of apex of abdomen of pupa.
- Fig. 15. *Psilocephala hamorrhoidalis*, lateral view of head and thorax of pupa.
- Fig. 16. *Anthrax lateralis*, lateral view of head of pupa.
- Fig. 17. The same, front view of head of pupa.
- Fig. 18. *Anthrax hypomeles*, lateral view of apical segments of abdomen of pupa.
- Fig. 19. *Anthrax lateralis*, same as above.
- Fig. 20. *Anthrax hypomeles*, lateral view of head of pupa.
- Fig. 21. *Anthrax lateralis*, dorsal view of head of pupa.
- Fig. 22. *Anthrax hypomeles*, same as above.
- Fig. 23. *Oncodes costatus*, lateral view of abdomen of pupa.

PLATE LXXXI

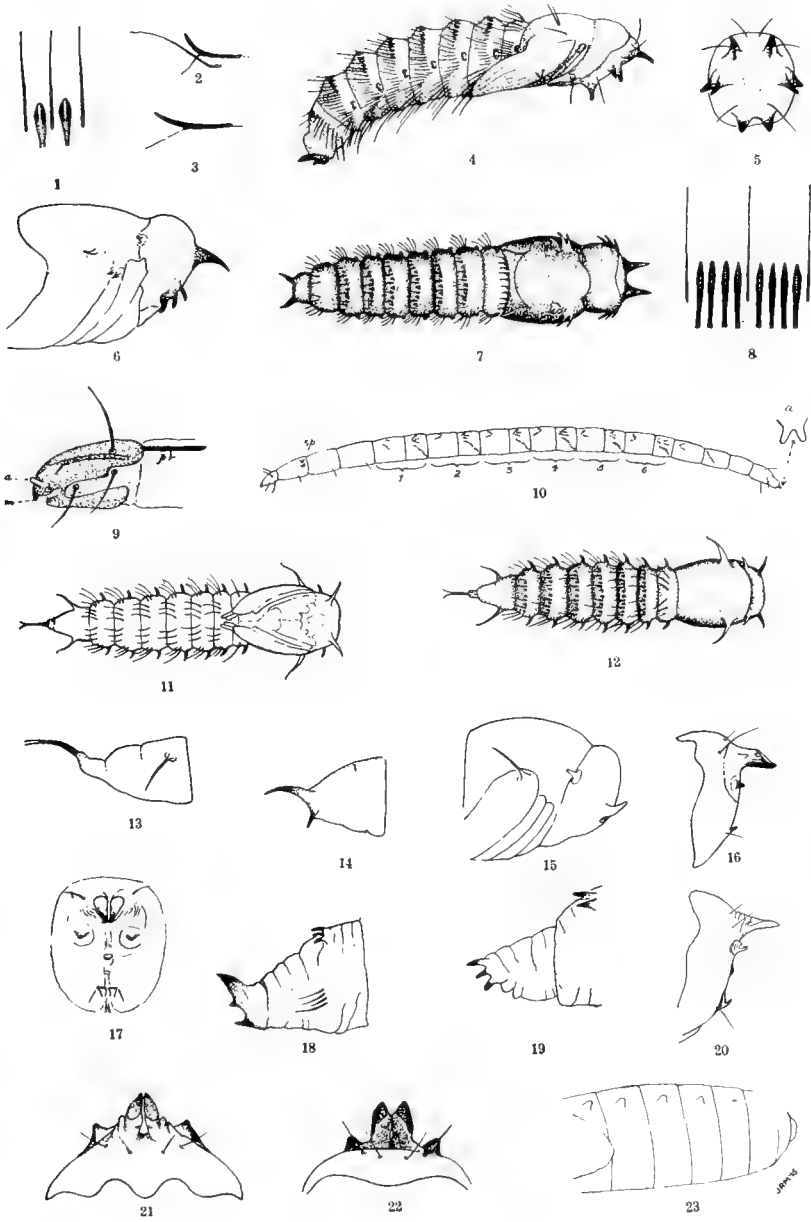


PLATE LXXXII

Larval and Pupal Details of Asilidæ and Mydæidæ

- Fig. 1. *Proctacanthus milberti*, ninth abdominal segment of pupa.
Fig. 2. *Promachus vertebratus*, seventh, eighth, and ninth abdominal segments of pupa.
Fig. 3. *Proctacanthus milberti*, end view of ninth segment of abdomen of pupa.
Fig. 4. *Promachus vertebratus*, side view of lateral cephalic thorn of pupa.
Fig. 5. The same, thorns at base of wing-case of pupa.
Fig. 6. *Proctacanthus milberti*, side view of lateral cephalic thorns of pupa.
Fig. 7. The same, thorns at base of wing-case of pupa.
Fig. 8. *Mydas clavatus*, dorsal view of apex of abdomen of pupa.
Fig. 9. The same, lateral view of pupa.
Fig. 10. The same, front view of head of pupa.
Fig. 11. *Promachus vertebratus*, ventral view of apex of abdomen of larva.
Fig. 12. The same, lateral view of larva.
Fig. 13. The same, posterior spiracle of larva.
Fig. 14. The same, dorsal view of apex of abdomen of larva.
Fig. 15. *Mydas clavatus*, lateral view of head of pupa.
Fig. 16. The same, side view of lateral cephalic thorn of pupa.
Fig. 17. *Asilus notatus*, thorn at base of wing-case of pupa.
Fig. 18. The same, side view of lateral cephalic thorn of pupa.
Fig. 19. *Proctacanthus milberti*, dorsal abdominal thorns of pupa.
Fig. 20. *Promachus vertebratus*, same as above.
Fig. 21. *Mydas clavatus*, same as above.
Fig. 22. *Proctacanthus milberti*, spiracular area of first abdominal segment of pupa.
Fig. 23. *Mydas clavatus*, abdominal spiracle of pupa.
Fig. 24. *Promachus vertebratus*, dorsal view of head of larva.
Fig. 25. The same, ventral view of head of larva.

PLATE LXXXII

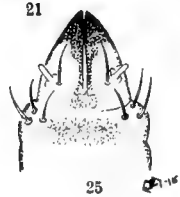
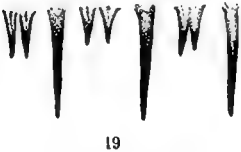
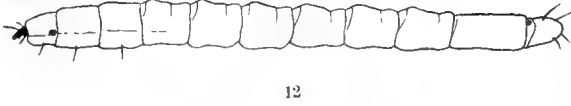
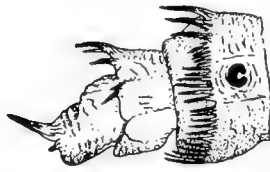
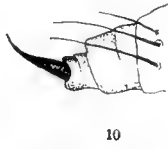
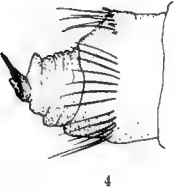
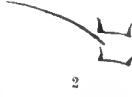
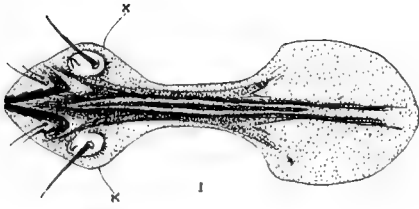


PLATE LXXXIII

Larval and Pupal Details of Bombyliidae and Syrphidae

- Fig. 1. *Spogostylum anale*, dorsal view of head of larva. Retracted within prothoracic segment to point marked X.
- Fig. 2. *Spogostylum anale*, dorsal abdominal bristles of pupa.
- Fig. 3. *Exoprosopa fasciata*, same as above.
- Fig. 4. The same, lateral view of apex of abdomen of pupa.
- Fig. 5. *Sparnopolius fulvus*, same as above.
- Fig. 6. *Exoprosopa fasciata*, lateral view of head of pupa.
- Fig. 7. *Sparnopolius fulvus*, same as above.
- Fig. 8. *Spogostylum anale*, dorsal view of apex of abdomen of pupa.
- Fig. 9. The same, lateral view of head of pupa.
- Fig. 10. The same, lateral view of apex of abdomen of pupa.
- Fig. 11. *Exoprosopa fasciata*, dorsal view of apex of abdomen of pupa.
- Fig. 12. *Brachypalpus frontosus*, dorsal view of larva.
- Fig. 13. *Brachypalpus frontosus*, lateral view of puparium.
- Fig. 14. *Brachypalpus frontosus*, front view of head and prothorax of larva.
- Fig. 15. *Brachypalpus frontosus*, puparium, front view of lower margin of cephalic extremity, showing the remarkable change in position of the prothoracic thorns.
- Fig. 16. *Ceria willistoni*, lateral view of puparium, anterior portion missing.
- Fig. 17. *Tropidia quadrata*, lateral view of puparium.
- Fig. 18. The same, anterior respiratory organ of puparium.
- Fig. 19. The same, dorsal view of apex of abdomen of puparium.

PLATE LXXXIII



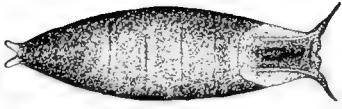
19

PLATE LXXXIV

Larval, Pupal, and Imaginal Details of Diptera

- Fig. 1. *Drosophila adusta*, dorsal view of puparium.
Fig. 2. *Agromyza angulata*, prothoracic respiratory organ of larva.
Fig. 3. The same, dorsal view of apex of abdomen of larva.
Fig. 4. *Agromyza aprilina*, lateral view of head of imago.
Fig. 5. *Drosophila dimidiata*, dorsal view of cephalic end of puparium.
Fig. 6. The same, dorsal view of apex of abdomen of puparium.
Fig. 7. The same, lateral view of apex of abdomen of puparium.
Fig. 8. *Agromyza pruni*, lateral view of larva.
Fig. 9. The same, lateral view of head parts of larva, more enlarged.
Fig. 10. *Agromyza pruni*, puparium, lateral view with dorsal and ventral views of apex of abdomen. The larva and puparium are drawn to the same scale and show the remarkable reduction in size due to the induration of the larval skin.
Fig. 11. *Agromyza pruni*, dorsal view of apex of abdomen of female of imago.
Fig. 12. *Agromyza angulata*, lateral view of puparium.
Fig. 13. *Hydrellia scapularis*, dorsal view of puparium, showing enclosed imago.
Fig. 14. *Agromyza parvicornis*, lateral view of larva.
Fig. 15. *Agromyza parvicornis*, puparium, lateral view and enlarged view of apex of abdomen. Drawn to same scale to show comparative reduction in size in pupal stage.
Fig. 16. *Hydrellia scapularis*, antepenultimate ventral segment of larva.
Fig. 17. *Platyphora flavofemorata*, imago, dorsal view of head and thorax: *h*, head; *sp*, spiracle; *pr*, prothorax; *m*, mesothorax; *ol*, overlapping portion of mesothorax; *pn*, postnotum.
Fig. 18. *Agromyza tiliae*, prothoracic respiratory organ of puparium.
Fig. 19. The same, ventral view of apex of abdomen of puparium.

PLATE LXXXIV



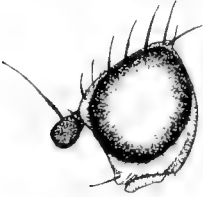
1



2



3



4



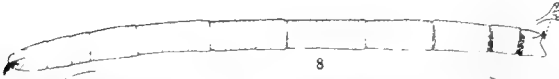
5



6



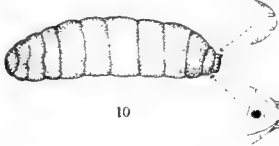
7



8



9



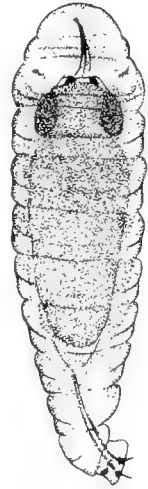
10



11



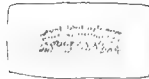
12



13



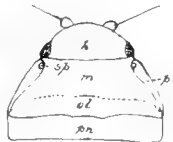
14



16



15



17



18



19

ARTICLE V.—*Phyllophaga* Harris (*Lachnosterna* Hope): *A Revision of the Synonymy, and one New Name.* BY ROBERT D. GLASGOW, PH.D.

In few genera of equal economic importance has greater confusion existed, either in collections or in the published work on the group, than in the assemblage of species known to American and English entomologists as *Lachnosterna* Hope, and to European entomologists as *Ancylonycha* Dejean.

Some years ago the writer turned to this group hoping to make it the basis for a study of some of the problems relating to the origin or source, the diversification, and the dispersal of animal forms in North America. The group offers material that is unsurpassed for such a study. It has a wide distribution, and comprises a great number of species which are relatively sedentary, of large size, and usually abundant wherever they occur. Moreover, it includes a large and compact series of species which are peculiar to the region selected for study.

It appeared very early, however, that sufficient data were not yet available to warrant such a treatment of the group. Exhaustive collections had been made in too few localities, particularly in too few localities that have a critical significance for the group, and the determinations in the published lists, based usually upon external characters alone, were too frequently inaccurate to make even the existing records available for the proposed studies.

The work of Dr. George H. Horn (1887) on *Phyllophaga* is more complete and more nearly monographic in nature than that of any other author; yet Dr. Horn says of the group: "It is not surprising that attention has not been given to the species as the literature at present available does not give great assistance, and *in my own case* there was *almost equal difficulty* in arriving at a correct determination of the species *with the types for comparison* along with the literature." And again, Dr. Horn says: "*Lachnosterna* is certainly one of the most difficult genera in our fauna.".*

*Italics by present author.

Shortly after the publication of Horn's "Revision," which was based upon external characters alone, a notable contribution to our knowledge of *Phyllophaga* was made by John B. Smith (1889), who demonstrated the great taxonomic value of the genital characters in the group, and published a series of figures showing these characters for the various species. Smith's figures have been immensely useful to entomologists who have used these characters, but unfortunately, they were designed to supplement Horn's work rather than for independent use, and were published without any accompanying synoptic tables. For this reason they are available only indirectly, through the index, for verifying determinations based upon external characters made first from Horn's tables, and they have not been used as generally as they should have been.

Smith's work was based upon that of Horn, and made no advance in nomenclatural accuracy such as the use of the genital characters had made possible, for, as Smith states in his introduction, he had no opportunity to verify by reference to the types Horn's determinations of the species described by earlier authors. The insufficiency of the external characters when used alone, makes it no reflection upon the thoroughness of Horn's work to say that these determinations were not always correct, and, indeed, Dr. Horn's statements quoted above show that he freely admitted such a possibility himself.

Since our present unsatisfactory knowledge of *Phyllophaga* is due primarily to the lack of means for the ready and accurate determination of the species, the writer determined, as the first step toward the accomplishment of his original purpose, to make a thorough systematic study of the group, and to prepare tables and figures such that collectors anywhere may make accurate determinations of their species with ease and certainty. In this way it is hoped so to encourage the study of the group that local lists may multiply rapidly and accurate data increase, until the group may serve, possibly in a few years, as a basis for the biological generalizations to which it promises to lend itself so effectively.

Because of the more urgent need for such a treatment of the "May beetles" of that region, and because it was desired to stimulate collecting there as early as possible, the species of the United States and Canada were taken up first; but it is hoped to extend the work as rapidly as circumstances may permit, to include the entire range of the group.

This preliminary paper is designed to indicate the progress of the work, and to present at once the changes in synonymy that a thorough study of the types has shown to be necessary.

All of the types of North American species known still to be in existence have been located, and as far as possible all determinations have been verified by studies of the genital characters in the actual type specimens. The writer has personally dissected and remounted all of the type specimens of this group in American museums, and has carefully studied and sketched the genital characters in these types. The Burmeister types, which belong to the museum of the University at Halle, were sent by Dr. Otto Taschenberg to the University of Illinois, to be remounted and studied by the writer; while the remaining types in foreign museums were remounted by members of the respective museum staffs, and carefully prepared drawings of the genital structures sent to the University of Illinois for use in the present studies.

Of the types not yet known to the writer, either directly or through drawings of the genital characters prepared for these studies, those of the earlier authors apparently have been lost, while those of the more recent authors are in private collections that have not yet been conveniently accessible. The species of the latter group, however, are all well known to the writer, while, fortunately, those of the first group usually are so strongly marked in one way or another as to leave little doubt that they have been correctly identified.

It is needless to say that the results reported here would have been impossible but for the uniform courtesy, the hearty encouragement, and the ready assistance that have been experienced from the beginning of these studies. Permission to dissect priceless type specimens has everywhere been freely granted, and numerous collectors have generously coöperated in the work. Full acknowledgments will be made in a later paper, but it would be out of place to present even these preliminary results without naming the men who primarily have made this work possible.

Preeminent among these, the writer deems it an honor, as it is a pleasure, to acknowledge his profound indebtedness to Dr. S. A. Forbes. Dr. Forbes generously placed at his disposal all of the collections of "May beetles" (over 100,000 specimens) and all of the data relating to the group which belong to the Office of the Illinois State Entomologist and to the Illinois State Laboratory of Natural History; through a special commission for the State Entomologist's Office, Dr. Forbes made it possible for the writer to visit all of the American museums where types of *Phyllophaga* are deposited, and he lent his influence to aid in securing the privilege of making dissections of these type specimens; and, finally, while in Europe, after

the meeting at London of the Second International Entomological Congress, Dr. Forbes visited the museums at London, Paris, and Berlin, where he personally made arrangements to have all of the types of North American *Phyllophaga* at these institutions dissected, and drawings of the genital structures prepared for these studies—an arrangement that was later extended by correspondence to include all of these types known to be in foreign museums. Indeed, the results accomplished thus far have been possible only through the continued interest and encouragement and material assistance with which Dr. Forbes has followed each step of the work; and any credit that may be due for these results belongs to Dr. Forbes quite as much as to the writer.

Special acknowledgments are due to Dr. Otto Taschenberg, of the University at Halle, who, as stated before, generously sent the Burmeister types all the way to America, in order that they might be examined directly for these studies.

For directing the dissection of type specimens under their charge and for the preparation of drawings of the genital structures for these studies, the writer is deeply indebted to Mr. Charles J. Gahan, of the British Museum of Natural History, to M. Pierre Lesne, of the Muséum d'Histoire Naturelle de Paris, to Dr. Richard Heymons, of Berlin University, to Dr. Karl Brandt, of the University at Kiel, and to Dr. B. Y. Sjoestedt, of the Naturhistoriska Riksmuseum at Stockholm.

The Graduate School of the University of Illinois has made liberal grants of money for the purchase of collections and to defray the cost of the drawings made from the types in foreign museums.

The late Dr. John B. Smith generously placed his private collection of "May beetles" unreservedly at the writer's disposal, with instructions to use the material it contained in any way that might advance the work.

For the privilege of dissecting type specimens, for the loan of valuable material, and for innumerable courtesies, the writer is deeply indebted also, to Dr. L. O. Howard; to Mr. J. C. Crawford, Mr. E. A. Schwarz, and Mr. H. S. Barber, of the United States National Museum; to Dr. Henry Skinner and Mr. E. T. Cresson, Jr., of the Museum of the Academy of Natural Sciences of Philadelphia; to Mr. Charles Schaeffer, of the Museum of the Brooklyn Institute of Arts and Sciences; and to Mr. Samuel Henshaw, of the Museum of Comparative Zoology at Harvard University.

Special acknowledgments are due to Mr. E. A. Schwarz, Mr.

H. S. Barber, and Mr. Samuel Henshaw for assistance in locating obscure references and references in rare and relatively inaccessible publications, and to Mr. A. N. Caudell, for assistance in solving many of the difficult nomenclatural problems encountered in the course of the work.

And, finally, the writer wishes to acknowledge his particular indebtedness to Mr. E. A. Schwarz, for many invaluable suggestions and data relating to *Phyllophaga*, drawn from a wealth of entomological knowledge and experience that is probably unsurpassed.

The name *Phyllophaga* was proposed by Thaddeus W. Harris in 1826, in the following words: "The genus *Melolontha* as constituted by Fabricius contains a vast number of species, differing greatly in external appearance, and somewhat in modes of life. Fabricius describes 149 species, and Schoenherr, after separating those which constitute the modern genera *Anisonyx*, *Glaphyrus*, *Amphicoma*, *Rutela*, and *Hoplia*, enumerates 226 species of *Melolontha*, to which additions are constantly making from the discovery of new species. Hence the genus requires further subdivision. The bases of these subgenera have been pointed out by Latreille, Knoch, and Schoenherr, and some have already been established. I would restrict the name of *Melolontha* to those species which have more than three lamellæ to the club of the antennæ, like the *vulgaris* of Europe, and of which we have an indigenous example in the *M. decimlineata* of Say (*M. occidentalis* Herbst?). Our common species *quercina*, *hirsuta*, *hirticula*, *balia*, and some others might receive the generic name *Phyllophaga*.* *M. vespertina*, *sericea*, and *iricolor* would form another subgenus which might be called *Stilbolema*, unless they are included in *Serica* MacLeay, or *Omaloplia* of Megerle; the characters of their genera I have not seen. *M. pilosicollis*, *longitarsa*, and *moesta* of Knoch and Say should each constitute a subgenus. The latter (with *M. sordida* and *frondicola* Say?) belongs to Kirby's genus *Apogonia*. From the singular manner in which the nails are divided at tip, I would call the *linearis* of Schoenherr *Dichelonyx*." (Massachusetts Agricultural Journal and Repository, Vol. X (1826), p. 6, note.)

Of the other two names referred to at the beginning of this article, *Ancylonycha* Dejean was first used in 1833 (Catalogue des Coléoptères de la collection de M. le Comte Dejean), while *Lachnosterna* Hope was not coined until 1837 (Hope, The Coleopterist's Manual, containing the Lamellicorn Beetles of Linnæus and Fabricius).

Le Conte was familiar with all three of these names, but he rejected both *Phyllophaga* Harris and *Ancylonycha* Dejean, and adopted

*Italics by present author.

Lachnosterna Hope, because neither of the earlier names was supported by a technical description that would indicate the limits of the genus.

The name *Phyllophaga* is adopted by the writer on the ground that its validity was fully established by its publication in connection with a series of valid specific names—a position that is fully endorsed by Messrs. Caudell and Banks, and by many other entomologists to whom the question has been submitted—and in the absence of a designated genotype, the species *hirticula* Knoch is here proposed as the type of the genus.

The name *Phyllophaga* has been proposed several times for genera in widely diverse groups of animals, but the earliest use of this name known to the writer, aside from its use by Harris as cited above, is that of Robineau-Desvoidy, who, in 1830, proposed this name for a genus of *Diptera*.

The status of the various names that have been proposed for new genera to be formed at the expense of *Phyllophaga*, but which were all suppressed by Horn, will be reserved for discussion in a later paper, since any consideration of these names would involve interpretations of relationship that would be out of place here.

In several instances in the following list, names indicated as synonyms represent geographic races or varieties; but it has seemed best not to attempt to indicate the status of such names until they may be discussed more fully than would be possible here.

In this list two exclamation points before a name indicate that the writer has personally studied the genital characters in the type specimen, while a single exclamation point before a name indicates that, although the writer has not seen the type specimen himself, the type has been dissected, and drawings of the genital characters prepared for these studies.

SYNONYMY OF THE PHYLLOPHAGA OF THE UNITED STATES AND CANADA*

1. ! *fervida* Fabricius, 1781, p. 36.
! *quercina* Knoch, 1801, p. 74.
!! *arcuata* Smith, 1888, p. 183.
2. ! *tristis* Fabricius, 1781, p. 39.
! *pilosicollis* Knoch, 1801, p. 85.
3. *crenulata* Froelich, 1792, p. 94.
georgicana Gyllenhal, 1817, p. 77.

*The arrangement is chronological.

4. *fusca* Froelich, 1792, p. 99.
! *fervens* Gyllenhal, 1817, p. 74.
5. ! *quercus* Knoch, 1801, p. 72.
6. ! *ilicis* Knoch, 1801, p. 75.
 porcina Hentz, 1830, p. 256.
 !! *fimbriata* Burmeister, 1855, p. 326.
 !! *ciliata* Le Conte, 1856, p. 253.
7. ! *micans* Knoch, 1801, p. 77.
8. ! *hirsuta* Knoch, 1801, p. 78.
9. ! *hirticula* Knoch, 1801, p. 79.
10. *knochii* Schoenherr and Gyllenhal, 1817, p. 75.
11. *longitarsa* Say, 1824, p. 241.
12. *lanceolata* Say, 1824, p. 242.
13. *balia* Say, 1825, p. 194.
 !! *comata* Burmeister, 1855, p. 337.
14. *ephilida* Say, 1825, p. 196.
 !! *burmeisteri* Le Conte, 1856, p. 242.
15. ! *drakii* Kirby, 1837, p. 133.
 !! *consimilis* Le Conte, 1850, p. 226.
 !! *grandis* Smith, 1888, p. 181.
16. !! *fraterna* Harris, 1842, p. 29.
 !! *cognata* Burmeister, 1855, p. 323.
17. !! *pruinina* Le Conte, 1856, p. 251.
 pruinosa || Melsheimer, 1846, p. 139.
18. *rugosa* Melsheimer, 1846, p. 140.
19. !! *anxia* Le Conte, (March,) 1850, p. 226.
 ! *brevicollis* Blanchard, (April 25,) 1850, p. 132.
 ! *puncticollis* Blanchard, (April 25,) 1850, p. 133.
 !! *cephalica* Le Conte, 1856, p. 245.
 ! *uninotata* Walker, 1866, p. 323.
 !! *dubia* Smith, 1888, p. 183.
 !! *insperata* Smith, 1889, p. 93.
 !! *alpina* Linell, 1897, p. 726.
20. !! *futilis* Le Conte, 1850, p. 226.
 !! *gibbosa* Burmeister, 1855, p. 324.
 !! *decidua* Le Conte, 1856, p. 246.
 !! *serricornis* Le Conte, 1856, p. 247.
21. ! *profunda* Blanchard, 1850, p. 132.
 !! *biimpresca* Smith, 1889, p. 97.
 !! *grandior* Linell, 1897, p. 727.
22. ! *uniformis* Blanchard, 1850, p. 133.
 carolina Fall, 1912, p. 43.

23. ! *crassissima* Blanchard, 1850, p. 133.
 !! *obesa* Le Conte, 1856, p. 251.
 !! *robusta* Le Conte, 1856, p. 257.
 !! *generosa* Horn, 1887, p. 222.
24. *glaberrima* Blanchard, 1850, p. 136.
25. ! *diffinis* Blanchard, 1850, p. 138.
 !! *comans* Burmeister, 1855, p. 358.
 !! *sororia* Le Conte, 1856, p. 246.
 !! *rufiola* Le Conte, 1856, p. 256.
26. !! *cribrosa* Le Conte, 1854, p. 231.
 !! *ventricosa* Le Conte, 1854, p. 440.
27. !! *aqualis* Le Conte, 1854, p. 440.
28. !! *forsteri* Burmeister, 1855, p. 325.
 !! *semicibrata* Le Conte, 1856, p. 247.
 !! *lugubris* Le Conte, 1856, p. 248.
 !! *lutescens* Le Conte, 1856, p. 249.
 !! *politula* Horn, 1887, p. 248.
 !! *nova* Smith, 1889, p. 95.
29. !! *albina* Burmeister, 1855, p. 328.
30. *crinita* Burmeister, 1855, p. 359.
 !! *glabripennis* Le Conte, 1856, p. 260.
31. !! *prununculina* Burmeister, 1855, p. 360.
 !! *cerasina* Le Conte, 1856, p. 241.
32. !! *gracilis* Burmeister, 1855, p. 361.
 !! *volvula* Le Conte, 1856, p. 235.
 !! *inana* Le Conte, 1856, p. 242.
33. !! *dispar* Burmeister, 1855, p. 361.
 !! *boops* Horn, 1887, p. 284.
34. !! *farcta* Le Conte, 1856, p. 238.
35. !! *torta* Le Conte, 1856, p. 239.
36. !! *frontalis* Le Conte, 1856, p. 239.
37. !! *latifrons* Le Conte, 1856, p. 241.
38. !! *congrua* Le Conte, 1856, p. 243.
39. !! *corrosa* Le Conte, 1856, p. 249.
 !! *affinis* Le Conte, 1856, p. 252.
40. !! *calceata* Le Conte, 1856, p. 250.
41. !! *marginalis* Le Conte, 1856, p. 250.
42. !! *subtonsa* Le Conte, 1856, p. 254.
43. !! *vilifrons* Le Conte, 1856, p. 255.
 !! *hirticeps* Le Conte, 1856, p. 255.
44. !! *mitida* Le Conte, 1856, p. 256.
 !! *limula* Horn, 1887, p. 264.
 !! *innominata* Smith, 1889, p. 98.

45. !! *clypeata* Horn, 1887, p. 145.
 !! *integra* || Le Conte, 1856, p. 258.
46. !! *parvidens* Le Conte, 1856, p. 259.
47. !! *rubiginosa* Le Conte, 1856, p. 259.
48. !! *submucida* Le Conte, 1856, p. 260.
49. !! *glabricula* Le Conte, 1856, p. 260.
50. !! *debilis* Le Conte, 1856, p. 262.
51. !! *errans* Le Conte, 1860, p. 283.
52. !! *maculicollis* Le Conte, 1863, p. 76.
53. !! *nitidula* Le Conte, 1863, p. 77.
54. !! *clemens* Horn, 1887, p. 144.
55. !! *hamata* Horn, 1887, p. 220.
56. !! *prætermissa* Horn, 1887, p. 223.
 !! *definita* Smith, 1888, p. 501.
57. !! *hirtiventris* Horn, 1887, p. 231.
58. !! *postrema* Horn, 1887, p. 233.
59. !! *inversa* Horn, 1887, p. 241.
60. !! *bipartita* Horn, 1887, p. 242.
61. !! *vchemens* Horn, 1887, p. 244.
62. !! *barda* Horn, 1887, p. 248.
63. !! *spretata* Horn, 1887, p. 250.
64. !! *infidelis* Horn, 1887, p. 253.
65. !! *luctuosa* Horn, 1887, p. 254.
66. !! *scitula* Horn, 1887, p. 256.
67. !! *implicita* Horn, 1887, p. 262.
 !! *minor* Linell, 1897, p. 728.
68. !! *delata* Horn, 1887, p. 267.
69. !! *æmula* Horn, 1887, p. 271.
70. !! *arcta* Horn, 1887, p. 271.
71. !! *vetula* Horn, 1887, p. 274.
72. !! *fucata* Horn, 1887, p. 278.
73. !! *exorata* Horn, 1887, p. 278.
74. !! *ignava* Horn, 1887, p. 280.
75. !! *inepta* Horn, 1887, p. 282.
76. !! *affabilis* Horn, 1887, p. 283.
77. !! *ecostata* Horn, 1887, p. 284.
78. !! *lenis* Horn, 1887, p. 287.
79. !! *heterodoxa* Horn, 1887, p. 289.
80. !! *tusa* Horn, 1887, p. 290.
81. !! *ulkei* Smith, 1889, p. 94.
82. !! *quadrata* Smith, 1889, p. 94.
83. !! *hornii* Smith, 1889, p. 95.

84. !! *longispina* Smith, 1889, p. 97.
 85. !! *antennata* Smith, 1889, p. 99.
 86. !! *elongata* Linell, 1897, p. 725.
 87. !! *parva* Linell, 1897, p. 726.
 88. !! *rugosoides* Linell, 1897, p. 728.
 89. !! *karlsioei* Linell, 1898, p. 400.
 90. *epigæa* Wickham, 1903, p. 71.
 91. !! *arkansana* Schaeffer, 1906, p. 257.
 lenta Fall, 1908, p. 162.
 92. !! *pygidialis* Schaeffer, 1906, p. 257.
 93. !! *latidens* Schaeffer, 1906, p. 258.
 94. *lobata* Fall, 1908, p. 163.
 95. !! *georgiana* Schaeffer, 1909, p. 382.

ALPHABETICAL LIST OF FOREGOING NAMES

	NO.		NO.
<i>amula</i> Horn	69.	<i>congrua</i> Le Conte.....	38.
<i>aqualis</i> Le Conte.....	27.	<i>consimilis</i> Le Conte.....	15.
<i>affabilis</i> Horn	76.	<i>corrosa</i> Le Conte.....	39.
<i>affinis</i> Le Conte.....	39.	<i>crassissima</i> Blanchard	23.
<i>albina</i> Burmeister	29.	<i>crenulata</i> Froelich	3.
<i>alpina</i> Linell	19.	<i>cribrosa</i> Le Conte.....	26.
<i>antennata</i> Smith	85.	<i>crinita</i> Burmeister	30.
<i>anxia</i> Le Conte.....	19.	<i>debilis</i> Le Conte.....	50.
<i>arcta</i> Horn	70.	<i>decidua</i> Le Conte.....	20.
<i>arcuata</i> Smith	1.	<i>definita</i> Smith	56.
<i>arkansana</i> Schaeffer	91.	<i>delata</i> Horn	68.
<i>balia</i> Say	13.	<i>diffinis</i> Blanchard	25.
<i>barda</i> Horn	62.	<i>dispar</i> Burmeister	33.
<i>biimpresa</i> Smith	21.	<i>drakii</i> Kirby	15.
<i>bipartita</i> Horn	60.	<i>dubia</i> Smith	19.
<i>boops</i> Horn	33.	<i>ecostata</i> Horn	77.
<i>brevicollis</i> Blanchard	19.	<i>elongata</i> Linell	86.
<i>burmeisteri</i> Le Conte.....	14.	<i>ephilida</i> Say	14.
<i>calceata</i> Le Conte.....	40.	<i>epigæa</i> Wickham	90.
<i>carolina</i> Fall	22.	<i>errans</i> Le Conte.....	51.
<i>cerasina</i> Le Conte.....	31.	<i>exorata</i> Horn	73.
<i>cephalica</i> Le Conte.....	19.	<i>farcta</i> Le Conte.....	34.
<i>ciliata</i> Le Conte	6.	<i>fervens</i> Gyllenhal	4.
<i>clemens</i> Horn	54.	<i>fervida</i> Fabricius	1.
<i>clypeata</i> Horn	45.	<i>fimbriata</i> Burmeister	6.
<i>cognata</i> Burmeister	16.	<i>forsteri</i> Burmeister	28.
<i>comata</i> Burmeister	13.	<i>fraterna</i> Harris	16.
<i>comans</i> Burmeister	25.	<i>frontalis</i> Le Conte.....	36.

	NO.		NO.
<i>fucata</i> Horn	72.	<i>marginalis</i> Le Conte	41.
<i>fusca</i> Froelich	4.	<i>micans</i> Knoch	7.
<i>futilis</i> Le Conte	20.	<i>minor</i> Linell	67.
<i>generosa</i> Horn	23.	<i>nitida</i> Le Conte	44.
<i>georgiana</i> Schaeffer	95.	<i>nitidula</i> Le Conte	53.
<i>georgicana</i> Gyllenhal	3.	<i>nova</i> Smith	28.
<i>gibbosa</i> Burmeister	20.	<i>obesa</i> Le Conte	23.
<i>glaberrima</i> Blanchard	24.	<i>parva</i> Linell	87.
<i>glabricula</i> Le Conte	49.	<i>parvidens</i> Le Conte	46.
<i>glabripennis</i> Le Conte	30.	<i>pilosicollis</i> Knoch	2.
<i>gracilis</i> Burmeister	32.	<i>politula</i> Horn	28.
<i>grandior</i> Linell	21.	<i>porcina</i> Hentz	6.
<i>grandis</i> Smith	15.	<i>postrema</i> Horn	58.
<i>hamata</i> Horn	55.	<i>prætermissa</i> Horn	56.
<i>heterodoxa</i> Horn	79.	<i>profunda</i> Blanchard	21.
<i>hirsuta</i> Knoch	8.	<i>pruinosa</i> Melsheimer	17.
<i>hirticeps</i> Le Conte	43.	<i>prunina</i> Le Conte	17.
<i>hirticula</i> Knoch	9.	<i>prununculina</i> Burmeister	31.
<i>hirtiventris</i> Horn	57.	<i>puncticollis</i> Blanchard	19.
<i>hornii</i> Smith	83.	<i>pygidialis</i> Schaeffer	92.
<i>ignava</i> Horn	74.	<i>quadrata</i> Smith	82.
<i>ilicis</i> Knoch	6.	<i>quercina</i> Knoch	1.
<i>implicita</i> Horn	67.	<i>quercus</i> Knoch	5.
<i>inana</i> Le Conte	32.	<i>robusta</i> Le Conte	23.
<i>inapta</i> Horn	75.	<i>rubiginosa</i> Le Conte	47.
<i>infidelis</i> Horn	64.	<i>rufiola</i> Le Conte	25.
<i>innominata</i> Smith	44.	<i>rugosa</i> Melsheimer	18.
<i>insperata</i> Smith	19.	<i>rugosoides</i> Linell	88.
<i>integra</i> Le Conte	45.	<i>scitula</i> Horn	66.
<i>inversa</i> Horn	59.	<i>semicibrata</i> Le Conte	28.
<i>karlsioei</i> Linell	89.	<i>serricornis</i> Le Conte	20.
<i>knochii</i> Schoenherr and Gyllenhal	10.	<i>sororia</i> Le Conte	25.
<i>lanceolata</i> Say	12.	<i>spretta</i> Horn	63.
<i>latidens</i> Schaeffer	93.	<i>submucida</i> Le Conte	48.
<i>latifrons</i> Le Conte	37.	<i>subtonsa</i> Le Conte	42.
<i>lenis</i> Horn	78.	<i>torta</i> Le Conte	35.
<i>lenta</i> Fall	91.	<i>tristis</i> Fabricius	2.
<i>limula</i> Horn	44.	<i>tusa</i> Horn	80.
<i>lobata</i> Fall	94.	<i>ulkei</i> Smith	81.
<i>longispina</i> Smith	84.	<i>uniformis</i> Blanchard	22.
<i>longitarsa</i> Say	11.	<i>uninotata</i> Walker	19.
<i>luctuosa</i> Horn	65.	<i>vehemens</i> Horn	61.
<i>lugubris</i> Le Conte	28.	<i>ventricosa</i> Le Conte	26.
<i>lutescens</i> Le Conte	28.	<i>vetula</i> Horn	71.
<i>maculicollis</i> Le Conte	52.	<i>vilifrons</i> Le Conte	43.
		<i>volvula</i> Le Conte	32.

A LIST OF THE PUBLICATIONS CONTAINING ORIGINAL DESCRIPTIONS
OF PHYLLOPHAGA OF THE UNITED STATES AND CANADA

1781. Fabricius, Johann Christian.
Species Insectorum, Tomus I.
1792. Froelich, Jos. Aloys.
Der Naturforscher, Stueck 26, pp. 68-165.
1801. Knoch, August Wilhelm.
Neue Beytraege zur Insectenkunde, Theil 1.
1817. Gyllenhal, Leonhard.
Synonymia Insectorum (Schoenherr), Band 1, Theil 3, Appendix.
1817. Schoenherr, Carl Johan, and Gyllenhal, Leonhard.
Synonymia Insectorum (Schoenherr), Band 1, Theil 3, Appendix.
1824. Say, Thomas.
Journ. Acad. Nat. Sci. Phil., Vol. 3, Part 2, pp. 238-282.
1825. Say, Thomas.
Journ. Acad. Nat. Sci. Phil., Vol. 5, Part 1, pp. 160-204.
1830. Hentz, Nicholas Marcel.
Trans. Am. Phil. Soc., Vol. 3, N.S., pp. 253-258.
1837. Kirby, William.
Fauna Boreali-Americana (Richardson, J.), Part 4, The Insects.
1842. Harris, Thaddeus William.
Insects Injurious to Vegetation, 1st edition.
1846. Melsheimer, Frederick Ernst.
Proc. Acad. Nat. Sci. Phil., Vol. 2, 1844-45, pp. 134-160.
1850. Le Conte, John L.
Lake Superior, its Physical Character, Vegetation, and Animals (Agassiz), pp. 201-242.
1850. Blanchard, Émile.
Catalogue de la Collection Entomologique du Museum d'Histoire Naturelle de Paris (Milne-Edwards, M.), Tome I.
1854. Le Conte, John L.
Proc. Acad. Nat. Sci. Phil., Vol. 6, 1852, pp. 226-235.
1854. Le Conte, John L.
Proc. Acad. Nat. Sci. Phil., Vol. 6, 1852, pp. 439-448.
1855. Burmeister, Hermann.
Handbuch der Entomologie, Band 4, Abth. 2.
1856. Le Conte, John L.
Journ. Acad. Nat. Sci. Phil., Ser. 2, Vol. 3, pp. 225-288.

1860. Le Conte, John L.
Proc. Acad. Nat. Sci. Phil., 1859, pp. 281-293.
1863. Le Conte, John L.
New Species of North American Coleoptera, Part I.
1866. Walker, Francis.
The Naturalist in Vancouver Island and British Columbia,
Vol. 2.
1887. Horn, George H.
Entomologica Americana, Vol. 3, Nov. 1887, pp. 141-145.
1887. Horn, George H.
Trans. Am. Ent. Soc., Vol. 14, Dec. 1887, pp. 209-296.
1888. Smith, John B.
Insect Life, Vol. 1, Dec. 1888, pp. 180-185.
1889. Smith, John B.
Entomologica Americana, Vol. 5, May, 1889, pp. 93-99.
1889. Smith, John B.
Proc. U. S. Nat. Mus., Vol. 11, 1888, pp. 481-525.
1897. Linell, Martin L.
Proc. U. S. Nat. Mus., Vol. 18, 1896, pp. 721-731.
1898. Linell, Martin L.
Proc. U. S. Nat. Mus. Vol. 19, 1897, pp. 393-401.
1903. Wickham, H. F.
Can. Ent., Vol. 35, March, 1903, pp. 67-74.
1906. Schaeffer, Charles.
Trans. Am. Ent. Soc., Vol. 32, pp. 249-266.
1908. Fall, H. C.
Entomological News, Vol. 19, April, 1908, pp. 159-164.
1909. Schaeffer, Charles.
Science Bulletin, Brooklyn Institute Museum, Vol. 1, No. 15.
1912. Fall, H. C.
Can. Ent., Vol. 44, Feb. 1912, pp. 40-48.

This occasion is taken to propose a much needed name for an undescribed species that is abundant in southern Illinois in midsummer; so abundant that it ranks high among the species of *Phyllophaga* whose numbers give them marked economic importance. The writer takes pleasure in naming this important Illinois species after his instructor and friend, Dr. S. A. Forbes. The name proposed seems peculiarly appropriate in view of the notable contributions made by Dr. Forbes to our knowledge of the biological and economic relations of the species of *Phyllophaga* that occur in Illinois.

PHYLLOPHAGA FORBESI, n. sp.

Moderately elongate, subcylindrical, rufotestaceous, moderately shining. Clypeus broadly emarginate, moderately reflexed; both clypeus and front rather coarsely and very closely punctate. Prothorax one half broader than long; sides arcuate, nearly parallel posteriorly, narrowed in front, margins entire; surface much less closely punctate than front, with an indistinct fovea on each side in front of middle. Elytra more closely and deeply punctate than prothorax, discal costae feeble. Pygidium of male broader than long, surface irregularly wrinkled, vaguely punctate; of female, smoother, less vaguely punctate, nearly as long as broad. Metasternum closely and finely punctate, hairs short and sparse. Abdomen finely, faintly, and sparsely punctate, nearly smooth at middle. Claws strong, slightly intramedian in male, median in female. Hind tarsi similar in both sexes.

Length 14–17 mm.

Male.—Antennæ 10-jointed, club a little shorter than the stem. Abdomen broadly concave, penultimate segment feebly emarginate at middle, with a roughened space in front of the faint emargination; last segment deeply emarginate, with an obtuse or rounded cusp at each side of the emargination, the middle of the segment abruptly depressed, the depressed area but little roughened, and with a distinct transverse ridge at posterior margin. Fixed spur of hind tibiæ short and narrow, outer spur long and slender.

Female.—Club of antennæ much shorter than the funiculus. Spurs of hind tibiæ slender.

Many specimens. Abundant in southern Illinois in late June, July, and early August.

This species is very nearly allied to *ephilida* Say and *uniformis* Blanchard (*carolina* Fall). It resembles both of these species in all of the more obvious characters, and is rather common in collections in the *ephilida* series. It may be assumed that specimens bearing an Illinois label, and properly placed in the *ephilida* series, are of this species; since *ephilida* Say does not occur in Illinois.

While this species is not easily separated from *ephilida* by the external characters alone, the genital characters of the two species are strikingly different. The male genital structures are symmetrical in both species. In the apical portion of these structures, however, in *ephilida* the ventral margins are entire, the ventro-distal angles are produced to form elongate, rounded lobes, and there is a very characteristic pair of long, slender, curved processes that arise from the dorso-lateral margins of the distal opening and extend distad, in a general

ventro-mesal direction; while in the species here described, the slender, curved processes of *ephilida* apparently have no counterpart, the rounded, ventro-distal lobes are broad and not elongate as in *ephilida*, and in this species, there is a pair of broad, angulate lobes not present in *ephilida*, which are apparently developed from the ventral margins, and which bear each a short, straight, slender process, which extends directly mesad from its point of origin. The females of this species are readily separated from those of *ephilida* and *uniformis* by the pubic process. This structure has approximately the same length and the same general form in these three species, but in the Illinois species it is broader than in either of the other two.

The foregoing will serve to indicate the general plan of the writer's work on *Phyllophaga*, and will make immediately available some of the results already obtained. It is hoped that the names given here will be useful to those who contemplate publishing on the group before the completed synopsis may appear.

The writer is now prepared to give determinations of any "May beetle" material from the United States and Canada, and will be glad to do anything in his power to encourage greater activity in the study of the group. He will gladly determine and report promptly on any collections that may be submitted to him if mounted with the genital structures exposed. Unmounted material, however, or mounted collections that do not have the genital structures exposed, can be accepted only with the understanding that they will be determined as leisure from other duties may permit the time-consuming manipulation that such material requires.

A large series of exotic species of *Phyllophaga*, *sensu lato*, is now being worked over. This series belongs to the United States National Museum, and includes species from the West Indies, Mexico, Central America, South America, Eastern and Southern Asia, and islands of the Pacific and Indian Oceans. It is hoped that studies of this material will suggest a grouping of the North American species that will represent natural relationships more successfully than might be possible from a study of the North American species alone.

Any criticisms or suggestions from other workers that may contribute to the completeness, or the thoroughness, or the usability of the forthcoming paper will be welcome.

Issued Feb. 4, 1916.

ERRATA

Page 373, after line 10, insert 53a, *subpruinosa* Casey, 1884, p. 38.

Page 375, after *submucida* Le Conte, 48, insert *subpruinosa* Casey, 53a.

Page 377, after line 7, insert 1884. Casey, Thomas L. Contributions to the Descriptive and Systematic Coleopterology of North



BULLETIN
OF THE
ILLINOIS STATE LABORATORY
OF
NATURAL HISTORY

URBANA, ILLINOIS, U. S. A.

STEPHEN A. FORBES, PH D., L. L. D.,
DIRECTOR

VOL. XI.

MARCH, 1917

ARTICLE VI.

AN EXPERIMENTAL STUDY OF THE EFFECTS OF
GAS WASTE UPON FISHES, WITH ESPECIAL
REFERENCE TO STREAM POLLUTION

BY

VICTOR E. SHELFORD, PH. D.

CONTENTS

	PAGE
I. Introduction	381
II. Statement of Fish and Gas-waste Pollution Problem.	381
III. Material and Methods.	383
1. Character of University of Illinois Water.	383
2. Treatment for keeping Fishes Alive.	384
3. Difficulties to be Guarded against in Fish Experiments.	385
4. Fishes used	387
IV. Gas Waste—Its Character and Constituents.	388
V. Toxicity of Waste.	389
1. Methods of Experimenting	390
2. Toxicity of Waste and Tar.	391
3. Toxicity of Illuminating Gas and Constituent Gas-mixtures.	392
4. Reactions of Fishes to Waste.	392
VI. Toxicity of Illuminating Gas Waste Constituents.	394
VII. General Discussion	406
VIII. Summary	409
IX. Acknowledgments	410
X. Literature Consulted	410

ARTICLE VI.—*An Experimental Study of the Effects of Gas Waste upon Fishes, with Especial Reference to Stream Pollution.*
BY VICTOR E. SHELFORD.

I. INTRODUCTION.

The products of destructive distillation of coal include an innumerable series of substances representing most of the important groups of organic compounds ranging from gases to solids. In the manufacture of illuminating gas all these substances are thrown into streams in varying amounts, depending upon the manner of treating by-products. The gases and volatile products are in solution in water used in washing the gas, and are often introduced into waterways. By-products, except the heavy tars, are often thrown away. This is especially true in the case of the smaller plants where the quantity is insufficient to make the further treatment of it profitable. Thus in many plants only the heavy tars are saved, the gas liquor drip from the mains and holders being dumped into waterways without the removal of even ammonia. The immense commercial value of these wasted products has been more generally appreciated since the outbreak of the European war, which cut off the large supply of foreign dyes and important organic compounds and increased the demand for such products as may be used in the manufacture of explosives. The value of these wasted products should be sufficient to prevent their wastage, but their injurious effect upon fishes and other life of streams generally is itself sufficient to justify the prohibition of pollution by this means.

II. STATEMENT OF THE FISH AND GAS-WASTE POLLUTION PROBLEM.

The gas waste problem is concerned with the effects upon fishes of the gas liquor untreated, the effect after the removal of the heavy tar, the effect of tar, the effect of gas-washing water, and that of lime, etc. from the purifiers. It is the purpose of this paper to show that essentially all the products of the distillation of coal are very toxic to fishes, some of the most toxic being those which are commonly regarded as "insoluble" in water. From the standpoint of fishes the waste problem is concerned with the reactions of fishes when encountering the pol-

luted waters. The reactions of fishes to the results of contamination with natural organic matter, such as decomposing bodies of plants and animals, are generally advantageous, as the fish turn away from the polluted area. The result of this investigation shows that in the case of gas wastes the reactions are usually disadvantageous,—the fishes swim into the polluting substances without recognizing them or turning back from them even when their toxicity is such as to cause death within a short period. The detrimental character of gas wastes is thus increased many fold.

The toxicity of waste differs for different species of fish and is greatest for the more valuable fishes as indicated by Dr. Wells' work (Article VII of this volume). It will be shown to be generally greater for the smaller and younger fishes. The writer's investigations will show that this rule holds good down to the youngest fry studied. Sollmann ('06) found some evidence that the eggs and newly hatched embryos of marine *Fundulus* are more resistant to poisons than the adults. He however seems to question his results in this respect because of the long exposure in the poison solutions and small quantity of the solution in proportion to the size and total oxygen demand and excretory output of the adult fish. Child's work with phenyl urethane which was done after long experience in the use of such poisons showed that in marine *Fundulus* the resistance declined rapidly from a maximum in the two-cell stage of the egg, to the time of hatching. In *Tautogolabris* the resistance fell from a survival time of 675 minutes soon after fertilization to 15 minutes at the time the heart began to beat and rose to 20 minutes at the time of hatching, when the experiments were discontinued. The resistance of the eggs and embryos of fresh water fishes has not been studied and compared with that of the adults, but there is every evidence that the rule reported here will hold good throughout the age and size series beginning about the time of hatching. The most sensitive period must be determined before the minimum fatal quantity can be established with any certainty. For this reason no attempt has herein been made to determine the minimum which will prove fatal to the fishes studied. Dr. Wells has found that the resistance of some fishes to various factors varies greatly with the time of year. The lowest point comes between the middle of June and the last of July when such fishes as the cyprinids can hardly be taken from the water before death sets in. From this time the resistance slowly rises until September. Then the rise becomes more rapid and reaches its highest point in March and April, when all the fishes are exceedingly resistant. With the onset of the breeding season the resistance falls, though whether or not it con-

tinues to fall until the period is well passed has not been determined. The effects on the breeding operations while of paramount importance have not been touched in this investigation. In this work no experiments were performed between June 8 and Aug. 18.

In the course of the investigation the working out of the toxicity of the different compounds has been rendered essential, first because of their general occurrence as by-products and secondly because various methods of treatment remove some compounds and not others. This toxicity is further of interest in connection with the effects of these compounds as drugs and poisons. The recent use of gold fishes, frogs, etc. as means of standardizing drugs, such as digitalis, renders these data of interest to the pharmacist and legal toxicologist. The timed killing of upwards of 1,500 fishes has, it is hoped, made clear some facts and methods which may be useful in the study of these problems with domesticated species such as gold fish.

III. MATERIAL AND METHODS.

The character of the water used is of much importance in the study of toxicity of polluting substances. The loss of oxygen and accumulation of waste matter in standing water renders experiments conducted with it open to criticism and necessitates the use of a short period to death in comparatively high concentrations of the drugs as a criterion in determining relative toxicity. It further necessitates the running of control experiments in running water. Experiments in running water are usually necessary in the case of gases. Toxicity is frequently different in distilled water and tap water.

I. THE CHARACTER OF UNIVERSITY OF ILLINOIS WATER, AND OTHER WATER PROBLEMS.

The water supply of the University comes from deep wells and the salts are nearly all present in the form of carbonates instead of a mixture of carbonates, chlorides, and sulphates as is the case in waters where fish normally occur. It also contains about twice as much magnesium and calcium and eight times as much iron as is commonly present in such waters. As it comes from the tap the university water contains no oxygen and about 18cc. per liter of carbon dioxide. The lack of oxygen alone makes it unsuitable for fishes, and the presence of so much carbon dioxide renders it wholly unfit for them. Fishes die in it quickly. The mortality among fishes brought in from streams was very great when this water was used in aquaria in which they were kept.

2. TREATMENT FOR KEEPING FISHES ALIVE.

Treatment A

The water in this case was boiled in an apparatus (Fig. 1) which continuously boils and cools it, being run through at the rate of 500 cc. per minute. This removed all of the readily precipitable iron and the excess of magnesium and calcium, thus reducing the total solids to about what one commonly finds in the average stream; but the water so treated still differed from stream water in that the salts present were nearly all carbonates, instead of a mixture of carbonates, chlorides, and sulphates, and decidedly alkaline. The water was aerated after boiling. The mortality became markedly less among fishes when they were first brought in, but on the whole it was not less than in water which received Treatment B.

Treatment B

In this treatment the water was aerated in an aerating device, so as to give air saturation. This removed nearly all the free carbon dioxide and rendered the water alkaline. In this the fishes lived fairly well but became very sluggish, so that they were not suitable for behavior experiments.

Treatment C

Thinking that the above sluggishness might be due to the absence of sulphates and the presence of carbonates only, a small quantity of sulphuric acid was added to the water. This rendered it acid by displacing some of the carbonic acid in the carbonates with the sulphate radical. This treatment proved beneficial, but the requisite manipulation was cumbersome.

Treatment D

For this treatment aerated water and direct tap water were run, half and half, into the aquaria. This rendered the fishes active and suitable for behavior experiments and the difficulties of manipulation were reduced. Later a less complete aeration in the aerating device shown in figure 1 was found to give equivalent results, and fishes lived unusually well for months without attention. In this the water was treated by running down twelve feet of incline at a rate of about two liters per minute. It then usually contained sufficient oxygen to support fishes and from 1-3 cc. of free CO₂ per liter, and had lost much of its iron and a little of its excess magnesium and calcium.

3. DIFFICULTIES TO BE GUARDED AGAINST IN FISH EXPERIMENTS.

a. *Character of Water.*

At the beginning of the work Dr. Wells ('15 and '15a) undertook a careful study of the relation of fishes to salts, acids, and alkalies. In general he found that carbonates do not have detrimental effects upon fishes when the water is acid. He further found many minor complications in connection with different salts which occur in some waters but none of these occurred in the water used. His findings relative to acidity, alkalinity, etc. are of general application and may be summarized as follows:

Water which is consistently slightly alkaline lessens the activity of fishes and the mortality is high. N/100 alkalinity, KOH, (56 pts. per m.) kills them in a few hours.

Neutral water also seems to be toxic to the fishes, and they become less and less active until death may occur.

An optimum acidity is obvious. 2-6 cc. of CO_2 per liter, (4-12 pts. per m.) seems to be the proper acid concentration for many fresh water fishes. Higher concentrations prove fatal very soon, though fishes will live for some time in 10-20 cc. per liter (20-40 pts. per m.) of carbon dioxide. N/10,000 H_2SO_4 , (4.9 pts. per m.) is fatal in a day or so, but N/20,000 H_2SO_4 , (2.4 pts. per m.) seems to be near their optimum as they live in this concentration for a long time.

Fishes react very definitely to exceedingly small concentrations of hydrogen and hydroxyl ions. Fresh-water fishes in a gradient which is slightly acid at one end and neutral near the middle and slightly alkaline at the other end will spend most of their time in the acid end, turning back from the alkaline end at a point just on the *acid side* of neutrality. The concentration here when tested shows that they turn back when the acid concentration falls below N/12,000 carbonic acid (3.5 pts. per m.).

In a gradient where the fishes may select between alkalinity and neutrality they avoid the neutral water to some extent and spend the greater part of the time in slightly alkaline water.

b. *Quantity of Water.*

In the aquaria suckers, small-mouthed and large-mouthed black bass died frequently when the flow of water was small and the depth in the aquaria more than 6 inches. This was probably due to insufficient oxygen. When the amount of water in the aquaria was small and the flow sluggish as was the case when the water was 2 or 3 inches

deep the greatest mortality was among the darters and the minnows (*Notropis* and *Pimephales*). These died in numbers in the aquaria, no darters at all being kept alive. After a number of trials a series of experiments was performed to demonstrate the cause of the death of the fishes (darters, *Etheostoma coeruleum*, and minnows, *Pimephales notatus*). The procedure was as follows:

Twenty-two 5 in. x 8 in. battery jars were set in a water bath,—the tank into which and out of which tap water flowed,—ready for filling with water modified variously, by boiling, aeration, and the addition of various substances as shown in Table I. Minnows and darters were given separate jars.

The following table shows the results.

TABLE I
AVERAGE LIFE UP TO TEN DAYS.
Two individuals in each condition except where otherwise stated.

750 cc. H ₂ O	Darters	Minnows
	Days alive	Days alive
Boiled alkaline	8	10
Boiled acid	5	8
Aerated,—alkaline to neutral	2½	10
Aerated acid	6	6 smaller died first
Iron precipitate, aerated	10	10
Iron precipitate, not aerated	6	10
Creek water, standing	10	omitted
Creek water, aerated	6 (6 fish)	6
Creek water, standing	1½ (8 fish)	..
Direct tap water	1/48	1/48

These experiments should be repeated but were sufficient to indicate the proper precaution as to quantity of water and rate of flow. As they stand they indicate that the addition of sulphuric acid in the quantity given does not improve living conditions in the boiled water for either darters or minnows. In the case of the aerated water the results are contradictory. Iron sediment does not seem to be a factor causing death. The number of fish to a given amount of water appears very important, and indicates that the losses were in part due to an insufficient flow through the aquaria. The fishes evidently add some waste products to the water which are of a non-gaseous character and thus are not removed. It appears that there should be about *one liter of water for each gram of fish* in the case of the two species studied. Less is doubtless sufficient for many species though it was thought best to use 4 liters of H₂O in which to kill a 4–6 gram sunfish in a bottle.

c. *The Transportation of Fishes.*

In collecting fishes for such experimental work they may be secured and brought to the laboratory in numbers if only a very small quantity of water is used. In general it is best to allow the dorsal fins of sunfish, basses, crappies, and suckers to protrude from the water. Minnows on the other hand, live best in about 3 inches of water. In this way many fishes may be safely brought in without the usual labor of carrying a quantity of water.

4. FISHES USED.

The fishes used in this experiment belong to the species mentioned below.

<i>Common name</i>	<i>Scientific name</i>	<i>Abundance</i>
Orange-spotted sunfish	<i>Lepomis humilis</i> Gir.	Abundant
Blue-spotted sunfish	<i>Lepomis cyanellus</i> Raf.	Common
Blue-gill	<i>Lepomis pallidus</i> Mit.	Common
Long-eared sunfish	<i>Lepomis megalotis</i> Raf.	Common
Rock bass	<i>Ambloplites rupestris</i> Raf.	Common
Small-mouthed black bass	<i>Micropterus dolomieu</i> Lac.	Common
Large-mouthed black bass	<i>Micropterus salmoides</i> Lac.	Common
Blunt-nosed minnow	<i>Pimephales notatus</i> Raf.	Very common
Steel-colored minnow	<i>Notropis whipplii</i> Gir.	Abundant
Common shiner	<i>Notropis cornutus</i> Mit.	Abundant
Golden shiner	<i>Abramis crysoleuca</i> Mit.	Abundant
Common sucker	<i>Catostomus commersonii</i> Lac.	Common
Bullheads	<i>Ameiurus nebulosus</i> LeS.	Common
Brook silverside	<i>Labidesthes sicculus</i> Cope	Occasional
Rainbow darter	<i>Etheostoma coeruleum</i> St.	Common

The small sunfish, *Lepomis humilis*, was used as a standard fish. It is only about 4" long when adult, is widely distributed in Illinois and without value as a food fish. A sufficient number of other fishes were studied to make its relative sensitiveness clear, and minnows and one of the basses were nearly always used in reaction experiments. Minnows were used also to show toxicity.

The condition of individual fishes is also a matter of importance. In a few cases fishes with obvious external protozoan parasites were killed in coal-tar products, and in every case they died sooner than the

normal fish. Thus in detailed work it is important to open and examine all fishes dying sooner than other fish of the same size.

When fishes are brought into the laboratory they do not ordinarily take food and are often not well-fed or in a semi-starved state when the experiments are performed. Wells found that in the case of salts the resistance to adverse conditions is slightly increased by starvation. To test this, fishes were kept in the aquaria from May 15 to Aug. 23. All died but six; those which died being their only source of food. On Aug. 23 fishes recently caught were compared with the starved ones. The starved fishes were from 3 to 3½ inches long (7-9 cm.) and had an average weight of 7.6 gm. while fishes of this length collected from the streams weighed twice as much. In the fresh waste the starved fish died somewhat sooner on the average though the time of some individuals of about the same length as the well-fed individuals was almost the same as the latter. In aerated waste the starved fishes lived longest. On account of the small number (six) of starved fishes available the experiment could not be carried out on a large enough scale to establish significant averages but there was nothing to indicate that any important differences existed.

IV. GAS-WASTE—ITS CHARACTER AND CONSTITUENTS.

The waste of the Champaign gas plant consists of what is known as the "drip", which accumulates in the bottom of the holders and in the pipes leading to and from them, also in the mains throughout the town. It consists of water with illuminating gases and other coal products in solution. On the surface of this water a light tar floats, while some heavy tar may rest at the bottom.

The waste is pumped from the inlet and outlet of the holder onto the ground beside the tank, and is alleged to flow into the Boneyard Creek in wet weather. The light tar is used by the gas-works people for paint, for which purpose it appears to have some value. It dries hard and rather quickly. The heavy tar is removed but as is the usual case with small plants, everything else is thrown away.

Coal-tar is an excessively complex mixture of chemical compounds many of which occur in its distillation between naphthalene on the one hand and anthracene on the other. It contains nitrogenous compounds, chiefly of a basic nature. The usual constituents of the waste and tar varies with the coal used, the temperature and the method of washing and testing the gases etc. during the process of manufacture and the amount of water gas added.

These constituents may be classified and described as follows (Lunge '00).

A. *Nitrogenized Compounds.*

Of this group ammonia and its salts are of constant occurrence. The volume of ammonia in the drip from the Champaign holder inlet is usually about 200% of the volume of liquid. The salts are abundant in all parts of an ordinary plant. Such well known compounds as ethylamine, aniline, pyridine, and quinoline belong to this group.

B. *Sulphuretted Compounds.*

To this group belong such well known compounds as hydrogen sulphide, sulphur dioxide and carbon bisulphide, and the less well known liquid thiophene, which is common as an impurity in benzene. All are very poisonous.

C. *Oxygenized Compounds.*

In this group are included such well known substances as acetone, acetic and benzoic acids, and phenol and the cresols.

D. *Hydrocarbons.*

To this group belong the solids phenanthrene, anthracene, naphthalene, and the volatile liquids, xylene, toluene, benzene, etc. The gases are numerous, including acetylene, ethylene, and methane.

E. *Carbon Oxides.*

These are the two well known gases carbon dioxide and monoxide.

Gas waste from plants which remove only the heavy tar may be regarded as containing all of these compounds. The dissolved gases of course escape into the air but are held in great quantity and given off slowly from the tarry materials.

V. TOXICITY OF WASTES FROM THE CHAMPAIGN PLANT.

The toxicity of different samples differs greatly, some samples being ten or twelve times as toxic as others. This depends upon the interval since the main was pumped and whether it comes from the inlet or the outlet to the holder. Attempts were made to determine the toxicity of waste by means of indicators and acid. There appears to be no relation between the amount of normal acid required to produce a red color with methyl orange and toxicity to fish. The same difficulty was encountered when normal alkali was used. Likewise

the amount of iodine absorbed appeared to bear no definite relation to toxicity. It is probably best to determine the toxicity of waste with fishes rather than by chemical means.

I. METHODS OF EXPERIMENTING WITH WASTE.

a. *Standing water.*

Battery jars 5 inches in diameter and 8 inches deep are filled to a depth of 4 inches (10 cm.) with waste diluted for use. This gave 2,000 cc. of liquid with 113 sq. cm. of exposed surface and gave conditions under which one or two fishes would live for days. This method simulated in a general way the conditions in polluted standing water. The period of toxicity determination being one or two hours the method was free from serious objections.

b. *Running Water Method.*

A bottle with a very wide neck, holding a liter is fitted with a rubber stopper in which are three holes (M. Fig. 1). A 12 liter aspirator bottle (Fig. 1 W) with stopper tubulature is closed at the bottom aperture and filled with waste about ten times as strong as is required for the experiment at hand. One part of the diluted waste is run into the bottle through one opening in the three holed rubber stopper, while 9 parts of water are introduced through another. The water flows from this bottle into a larger bottle holding about three liters, in which the fishes were confined. The flows were set with pinch cocks on rubber tubing and adjusted from time to time. The flows used varied from time to time but usually were between 100 to 300 cc. per minute. The object was to secure definite concentrations rather than definite flows, as all that is necessary is to change the water often and simulate the conditions in running streams. The temperature of such experiments was usually 17°C.

c. *Bottle method.*

For determining the exact toxicity of any sample of waste when unexposed to the air it is necessary to proceed in an entirely different way. A bottle with a wide mouth, holding a little more than four liters, is supplied with a close fitting rubber stopper. It is first filled with water to the four liter mark scratched on the outside. A definite amount of waste is then run in from a burette or Mohr's pipette. The bottle is then shaken until all of the substance is in solution. The free air space, which should not exceed 2% of the volume of the

water, serves when the bottle is laid on its side to show any undissolved substance lighter than the water, thus making the method later applicable to the light slightly soluble constituents of waste. The temperature of such experiments was usually 20°C.

2. TOXICITY OF WASTE AND TAR.

The toxicity of waste from the Champaign plant varies so that a general statement as to the toxicity can hardly be made. In general the greater the amount of tar the more toxic the waste. The most toxic sample contained much tar. Eight hundredths of a cc. of the waste was introduced from a Mohr pipette into four liters of water in a four liter bottle. The water was shaken until all the waste had gone into solution excepting a slight tarry film on the sides of the bottle near the surface of the water. It is impossible to say how much of the substance actually went into solution, but assuming that half of it did, it may be safely said that ten to twenty parts per million of this waste killed a 4-5 gram *Lepomis humilis* in an hour, while twice that amount killed such fishes in from ten to thirty-five minutes. Another sample with less tar killed fishes of the same size in five hours when 1,000 parts per million were present.

A small amount of tar was rubbed on the sides of several full grown *Lepomis humilis* and the fishes left in open aquaria; all died in from one to nineteen hours.

A small amount of tar was rubbed in the mouths and on the sides of several suckers and orange-spotted sunfishes in open aquaria. All died in from one to nineteen hours. Marsh ('07) found tar very toxic to perch and bass.

Aerating and boiling removed toxic constituents of the waste. For example, a sample of waste was treated as follows:

1. Fresh waste was added to 99 times its volume of aerated water as quickly as possible, and the small space above the water in the large bottle was filled with illuminating gas.

2. Some of the same waste was aerated by pouring from one beaker to another for three minutes. This was added to 99 parts of water and corked.

3. Some of the same waste was boiled vigorously for several minutes, until all odor of ammonia was removed, and added to 99 parts of aerated water.

The effect of these treatments is illustrated by the following experiment which is one of many. A liter of each of the three kinds of waste was put into each of three battery jars and 4-5 gm. orange-spotted sunfishes placed in them. They survived as follows:

	Fresh	Aerated	Boiled
The fishes lived. . .	23 minutes	81 minutes	150 minutes

These samples of waste were kept in loosely stoppered bottles for nearly a year and still showed differences of lesser magnitude.

The fractional distillation of tar yields various different substances. One of these distilled off at 260°-290°C., which gives heavy constituents only, was supplied by the Department of Chemistry and proved very toxic.

1000 pts. per million (by volume), not all in sol.,	killed various fishes in	5-10 min.
250 " " " " " " " " " "	" " " " " "	10-20 "
125 " " " " " " " " " "	" " " " " "	25-40 "
90 " " " " " " " " " "	" <i>Lepomis humilis</i> "	40-60 "
70 " " " " " " " " " "	" " " " " "	55-60 "

Since apparently not more than half of these amounts went into solution and tarry film adhered to the bottle, the heavier parts of the tar are very toxic and remain so for long periods.

3. TOXICITY OF ILLUMINATING GAS AND CONSTITUENT GAS-MIXTURES.

As shown by Marsh ('07), illuminating gas is very toxic to fishes. It is difficult to determine how much gas is required to produce fatal results in a sufficiently short time as the constituent gases go into solution with different rapidity and the constituents in a given sample of dissolved gas are difficult to determine, so that no attempt was made to analyze them. The illuminating gas was introduced from an inverted bottle (U) as shown in figure 1. The gas was led into a bottle by displacing water and the bottle stoppered with a two hole rubber stopper wired in place and containing one tube reaching to the bottom and another passing through the cork only. A valve leaking by drops was attached to the short arm and the water thus forced into the bottle, drop by drop. The gas was accordingly forced into the cooling and solution coils of the apparatus, much of it going into solution, but a quantity passing through to the mixing bottle and collecting, where it was allowed to escape from time to time.

A mixture of ethylene 30 cc. per liter, carbon monoxide approximately 6 cc. per liter and sulphur dioxide about 33 cc. per liter killed the standard fish in 15 minutes.

4. REACTIONS OF FISHES TO WASTE.

Much of the danger to fishes from pollution of streams, especially where the pollution is local, is determined by the reactions of the fishes

to the polluting substances. Fishes turn away from dangerous substances which are normally found in their usual environment, but with strange and unusual substances such as are thrown into streams by gas-works and other industrial plants, they frequently enter and follow up to points where the concentrations are fatal, or fail to recognize the dangerous substance at all and often stay in it until they are intoxicated and finally die there. (Chart II, graphs 8-11; Chart V, graph 60.)

Conditions and Methods of Study.

The experiments were performed in a gradient tank (N), figure 1. The tank used in these experiments was 122.3 cm. long, 15 cm. wide, 13 cm. deep. The front wall was of plate glass and a plate glass top was used at times. Water of two kinds, normal and polluted, was used in the experiments. One kind was allowed to flow into one end at a definite rate and another kind into the other end at the same rate. It flowed out at the middle at the top and at the bottom so that the two kinds of water met at the center. The outflow at the center did not of course prevent the mixing of the two kinds of water and thus the middle section, equal to one half or one third of the tank was a gradient between two kinds of water. The water entered both ends at the same rate (usually 600 cc. per minute) through tees the cross-bars of which contained a number of small holes. The cross-bars of the tees were at the center of the ends of the tank behind screens. The drain openings were located at the center near the top and in the bottom. The outer openings of the drain tubes were at the level of the water in the tank. We found no evidence that fishes reacted to the slight current produced by the water flowing in at the ends and drifting toward the center and out through the drains. Since each half of the tank held about 9 liters, it required 15 minutes to fill it or to replace all of the water in one of the halves. The tank was enclosed under a dark hood. Two electric lights were fixed in the rear and above the center of the two halves, i.e., above a point midway between the screen partition and the center drain. The light was 15-20 cm. above the surface of the water which was 13 cm. deep. The experiments were observed through openings in the hood above the lights or through the glass side late at night. Fishes do not usually note objects separated from them by a light.

Water differing as little as possible from that in which the fishes usually live was used for control readings. Controls were observed and conditions in the two ends of these were the same either because the water introduced at the two ends was alike or because no water

was run into either end (standing water). In the controls (Chart I) the fishes usually swam from end to end in a rather symmetrical fashion, and thus comparing these movements with those occurring when the fishes encountered differences in water, we are able to determine the reactions of the fishes to the differences.

When the differences between the solutes at the two ends of the tank were not great we found by chemical tests that the central portion of the tank was a gradient between the characteristic waters introduced at the two ends. Usually the end thirds were essentially like the inflowing water. When the difference in concentration was great the region of the gradient was proportionally longer and the ends with the inflowing concentrations correspondingly shorter. When the difference in concentration was very great the entire tank was gradient. For an experiment a fish was placed in a dish containing enough water to barely cover it and set above the tank. When all was in readiness the fish was liberated in the center of the tank. Marks on the sides divided the tank into thirds. The fish nearly always swims back and forth, apparently exploring the tank. The movements of the fish were recorded graphically as shown in Chart I.

For this purpose sheets of ruled paper were used. Four vertical double rulings corresponded to the thirds and two ends of the tank. Distance from right to left was taken to represent the length of the tank, vertical distance to represent time and the graphs drawn to scale. The width of the tank was ignored. The graphs on the following pages are copies of the originals. The experiments were conducted with water at about 17°C.

Before or after the experiment, the headings of the sheets were filled with data regarding the kind, size, and previous history of the fish, the conditions in the tank, concentration of the solutes and other significant data. The fish was observed continuously for twenty or more minutes. Fishes are positive to waste in all concentrations tried.

Fishes are positive or indefinite to illuminating gas, and to combinations of the most important illuminating gas constituents in both acid water with 2-3 cc. of oxygen per liter and in alkaline water at oxygen saturation (Chart II, graphs 11 and 12; Chart V, graphs 53 and 54).

VI. THE TOXICITY OF ILLUMINATING GAS WASTE CONSTITUENTS.

The following table shows the relative toxicity of the chief constituents of gas-waste arranged according to the outline on p. 389. On the pages following it are given occurrence of the substance, the method of work, physiological effect, and the reactions of fishes. The

experiments were performed in the kind of water in which the fish had been living, containing about 3 cc. per liter of oxygen and 4-6 cc. per liter of CO_2 . Some experiments were carried on in running water, some in jars exposed to the air, as described on page 390, and in case of volatile substances the amount required to kill a standard fish in an hour was determined in a corked four-liter bottle as described on the same page.

TABLE II

SHOWING THE RELATIVE TOXICITY OF VARIOUS PRODUCTS ASSOCIATED WITH THE MANUFACTURE OF COAL GAS. THE TOXICITIES ARE BASED ON THE AMOUNT OF THE SUBSTANCE REQUIRED TO KILL IN ONE HOUR A SMALL SUNFISH (*LEPOMIS HUMILIS*) WEIGHING 4-6 GRAMS.

The values given are approximately correct within the limits stated. Temperature 20° C except in the case of gases where it was 16-17° C.

Substance		Solid, gm. per l., Liquid, cc. per l., or Gas, cc. per l.	Parts per Million	Remarks	
A. Nitrogenized Compounds.					
Ammonia.....	NH_3	Gas	8,000-10,000 cc.	7-8	Spasms common
Ammonium Carbonate....	$(\text{NH}_4)_2\text{CO}_3$	Solid	0.600-0.800 gm.	600-800	" "
Ammonium Chloride.....	NH_4Cl	Solid	0.700-0.800 gm.	700-800	
Ammonium Sulphate.....	$(\text{NH}_4)_2\text{SO}_4$	Solid	0.420-0.500 gm.	420-500	
Ammonium Sulphocyanate	$(\text{NH}_4)\text{NCS}$	Solid	0.280-0.300 gm.	280-300	
Ammonium Ferrocyanide.	$(\text{NH}_4)_4$ $\text{Fe}(\text{CN})_6$	Solid	0.150-0.200 gm.	150-200	
Ethylamine.....	$\text{NH}_2(\text{C}_2\text{H}_5)$	Liquid	400-800	Not accurately determined
Aniline.....	$\text{C}_6\text{H}_7\text{N}$	Liquid	1.000-1.100 cc.	1020-1122	
Pyridine.....	$\text{C}_5\text{H}_5\text{N}$	Liquid	1.500-1.600 cc.	1477-1576	
Quinoline.....	$\text{C}_8\text{H}_7\text{N}$	Liquid	0.048-0.052 cc.	52-56	Paralyzes; death point determined by mechanical stimulation
Isoquinoline.....	$\text{C}_8\text{H}_7\text{N}$	Liquid	0.060 cc.	65	
Pyrrol.....	$\text{C}_4\text{H}_5\text{N}$	Liquid	Not studied; unavailable
B. Sulphuretted Compounds					
Hydrogen Sulphide.....	H_2S	Gas	3.250-3.500 cc.	4.9-5.3	
Sulphur Dioxide.....	SO_2	Gas	5.500-6.600 cc.	16-19	
Carbon Bisulphide.....	CS_2	Liquid	0.090-0.100 cc.	100-127	Larger fishes die first
Thiophene.....	$\text{C}_4\text{H}_4\text{S}$	Liquid	0.025 cc.	27	
C. Oxygenized Compounds					
Acetone.....	$\text{C}_3\text{H}_8\text{O}$	Liquid	18,000-19,000 cc.	14,250- 15,050	
Benzoic Acid.....	$\text{C}_7\text{H}_6\text{O}_2$	Solid	0.550-0.570 gm.	550-570	
Phenol (Carbolic Acid)..	$\text{C}_6\text{H}_6\text{O}$	Solid	0.07-0.075 gm.	70-75	
Orthocresol.....	$\text{C}_7\text{H}_8\text{O}$	Solid	0.055-0.065 gm.	55-65	
Paracresol.....	$\text{C}_7\text{H}_8\text{O}$	Solid	0.080-0.090 gm.	80-90	
Metacresol.....	$\text{C}_7\text{H}_8\text{O}$	Liquid	0.120-0.130 cc.		

TABLE II—Continued

Substance		Solid, gm. per l., Liquid, cc. per l., or Gas, cc. per l.	Parts per Million	Remarks	
D. Hydrocarbons					
Phenanthrene.....	$C_{14}H_{10}$	Solid	0.001-0.002 gm.	1-2	Rated "insoluble"
Anthracene.....	$C_{14}H_{10}$	Solid	Only slightly toxic†
Naphthalene.....	$C_{10}H_8$	Solid	0.004-0.005 gm.	4-5	Rated "insoluble"
Xylene.....	C_8H_{10}	Liquid	0.055-0.056 cc.	47-48	Rated "insoluble"
Toluene.....	C_7H_8	Liquid	0.070-0.080 cc.	61-65	Rated "insoluble"
Benzene.....	C_6H_6	Liquid	0.040-0.042 cc.	35-37	Rated "insoluble"
Acetylene.....	C_2H_2	Gas	Sat. sol.	No deaths
Amylene.....	C_8H_{10}	Liquid	1.000-1.250 cc.	655-693	
Ethylene.....	C_2H_4	Gas	18.00-20.00 cc.	22-25	
Methane.....	CH_4	Gas	Not toxic—only one Labidesthes sicculus died
E. Carbon Oxides					
Carbon Monoxide.....	CO	Gas	16.00 cc.	75	
Carbon Dioxide.....	CO ₂	Gas	See Wells' Art.
F. Mixtures					
Tar Acid.....		Liquid	0.07 cc.	70	Pts. per million by volume
Illuminating Gas.....		Gas	Amount not deter- mined
Waste.....		Liquid	0.020-0.040 cc.	20-40	Amount not deter- mined
Waste.....		Liquid	0.002 cc.	2	To kill in 24 hours
Boiled Waste.....		Liquid	Toxicity less than aerated
Aerated Waste.....		Liquid	Toxicity less than unboiled
Tar.....		Liquid	Rubbed on fishes, kills in 18 hrs.

Ammonia.

The amount of ammonia in gas-waste from which it has not been commercially removed is great. Champaign-Urbana Gas-works' waste pumped from the holder intake showed about 200% volume in waste not containing tar and 400% volume in waste containing a small amount of tar. No ammonia is recovered at this plant. The intake and outlet are pumped out daily, or two or three times per week. This waste is pumped onto the ground and finds its way into a small stream.

A solution approximately half normal (8.517 gm. per l.) was made and dilutions of this were made up quickly in 500 cc. of distilled water in 750 cc. wide-mouthed glass-stoppered bottles. Fishes were quickly dropped in and after they had died and the time to death was noted the solution was titrated with a standard acid and litmus indicator. When the killing concentration was determined approximately a solution was made up and the results verified in the 4-liter bottle.

In man ammonia causes comatose conditions or delirium and dyspnoea, death coming very suddenly (Witthaus and Becker). In frogs and mammals it causes increased reflex irritability which may be followed by tetanic convulsions (Cushny). When first placed in ammonia solution which will produce death in an hour or less, fishes are often much stimulated, the head often floating lower than the rest of the body. Erratic movements follow after a time and the fish usually turns over in convulsion and remains comparatively still with peculiar twitchings of the tail and fins until death. Ammonia is less toxic in distilled water than in water with carbonates. Five parts per million is fatal to fishes. Weigelt found that 0.1% solution killed tench in 45 minutes.

Fishes do not ordinarily turn back when they encounter ammonia, but swim into it without giving any of the avoiding reactions which characterize the movements of fishes with reference to such environmental substances as carbon dioxide. The reaction is usually indefinite or indifferent (Shelford and Allee, Wells). *Pimephales* was positive to it in alkaline water; *Lepomis humilis*, *Notropis* and *Abramis crysoleuca* were positive to fatal concentrations in acid and in alkaline water (4-6 cc. per l. of CO₂). Wells found that in very strong concentrations the fish selected a point in the gradient tank near the centre and avoided both ends but the concentration of ammonia in the part of the tank selected was such as to cause the death of the fishes in a short time (Chart II, graphs 14 and 15; Chart V, graph 55).

Ammonium carbonate.

It is present in quantity in liquors from all parts of the manufacturing plant, most abundantly from the last condenser and washers. A solution of 20 gm. per liter was prepared and its actual strength determined by titrating with standard hydrochloric acid and methyl orange indicator. Its general effects are similar to ammonia. Erratic movement occurs oftener than in the case of ammonia. Fishes are usually positive to strong concentrations, e. g., 1 gm. per liter, but they do not act with precision as in the case of other alkalies (Chart II, graph 16).

Ammonium chloride.

It is abundant in the liquor from all parts of an ordinary plant (Lunge 3d ed., 741).

A solution was made by dissolving 8 gm. per liter of water. The solution was tested by adding a definite quantity of NaOH to a known amount of the solution and boiling until the vapor did not turn litmus blue. The remaining free alkali was titrated with standard acid and

methyl orange indicator. It tends to paralyze the terminations of the motor nerves of the frog. In the case of fishes, it shows no important differences from ammonia. Reactions are usually positive to strong concentrations and negative to weak ones (Chart II, graph 17).

Ammonium sulphate.

It is present in waste in small quantities. A solution was made and tested as in the case of ammonium chloride. It is much less toxic than the carbonate. Its toxicity is greatest in the presence of carbonates (Wells '15). When all the carbonates have been transformed into sulphates it becomes less toxic. Fishes are positive in reaction to fatal concentrations and negative to weak concentrations (Chart II, graph 18).

Ammonium sulphocyanate.

It occurs in some quantities in first condensers and washers. A solution was made by weighing out the salt and dissolving it in distilled water. The strength of the solution was determined by adding a strong alkali and distilling off the ammonia into standard acid and titrating with standard alkali. It is much more toxic than the chloride. The fish showed no striking symptoms. Fishes are positive to fatal concentrations (Chart II, graphs 19 and 20).

Ammonium ferrocyanide.

It occurs in small quantities in liquor from last condensers. The general method of experimentation and determination was the same as in the case of ammonium sulphocyanate. The physiological effects are not striking on the fishes. Fishes are positive to fatal concentrations (Chart III, graph 21).

Ethylamine.

Five grams of Kahlbaum's hermetically sealed product was broken into two liters of water but with an obvious loss. Dilutions from this were made and tested. Its effect appears to be in a general way like that of ammonia. Fishes were positive in a single experiment (Chart III, graph 22).

Aniline.

A sample of Kahlbaum's, slightly brown, was used, the proper dilutions being made by adding a small quantity from a burette to 4 liters

of water. In man it causes prostration, giddiness, vomiting, and neuralgic pains. In fish it produces anesthesia. There is a considerable stimulation at first, quickly followed by trembling of the fins and some erratic movements. The fishes turn upon their sides in two minutes. They may live for hours, with their fins and gills moving slightly. Five cc. per liter of water in the open battery jar killed fishes after the mixture had been standing three days. Fishes are indefinite or positive to the concentration used (.08-.12 cc. per liter) (Chart III, graph 23).

Pyridine.

It occurs in coal-tars, crude benzene, toluene, etc. In man it causes paralysis of the motor centers and nerves, and movements become weak and unsteady. Death follows from a failure of respiration (U.S.D.). The effects on fishes are similar to those of many other substances. Heavy respiration is usually noted early and they usually die with opercles and mouth closed probably through failure of respiratory movements. Fishes are positive or indefinite in all cases studied (Chart III, graph 24).

Quinoline.

It occurs in coal-tar. It is a powerful antipyretic but causes general collapse. In .025 cc. per liter of water fish usually turn on their sides in 10-15 minutes and continue to move their fins and gills for many hours. In strong concentrations fishes are very quickly paralyzed and there is some difficulty in determining when they die, as movements of the mouth and opercles cease long before death occurs. If the fish are removed and handled roughly life may be detected by a general body movement.

A solution of it turns pink on standing and its toxicity gradually falls off on exposure to air. A solution which killed fishes in 2 minutes Nov. 1, killed them in 1 hour Nov. 13 and after several days on Dec. 10.

Fishes are usually negative in reaction to both fatal and more dilute solutions, though the standard fish was positive in two cases (Chart III, graph 25).

Isoquinoline.

Its toxic effect differs but little from quinoline. The reactions of fishes are strikingly different, being usually positive instead of uniformly negative as in the case of quinoline (Chart III, graph 26).

Pyrrol.

This compound was not studied as none could be obtained.

Hydrogen sulphide.

This gas occurs in illuminating gas and in solution in waste. It occurs also in the decomposition of organic matter in water and forms an important part of the gas generated in connection with sewage contamination. It occurs in small quantity at the bottom of lakes (Birge and Juday, '11) but is a very important gas in salt lakes especially those with a thermocline and in thermocline arms of the sea. Marine organisms thus often encounter it, fresh water organisms only in small quantities. For experimental purposes it was generated in a Kipp generator of large size by the action of hydrochloric acid on iron sulphide. The generator afforded sufficient pressure to force it through the mixing bottle direct. It was determined with standard iodine. Fifty cc. were drawn from the mixing bottle with a 50 cc. pipette and introduced into an Erlenmeyer flask as quickly as possible and N/100 iodine quickly added until a brown color was obtained. The mixture was then carefully titrated with N/100 sodium thiosulphate which had been corrected until it was essentially the equivalent of the iodine, and the amount of thiosulphate used was deducted from the amount of iodine put into the flask. When greater accuracy was desired the determination was repeated, iodine was placed in the flask and the 50 cc. of H₂S water added to the excess of iodine beneath the surface and contact with the air essentially prevented. These determinations should be made with great care as slight differences in manipulation gave very variable results in the fish-killing experiments, with concentration which differed only in the error caused by slightly different exposures to the air in rapid manipulation.

When much diluted it produces nausea, pain in the head, and great general weakness, followed by coma. In concentrated solutions it produces loss of consciousness very quickly. In fishes the symptoms do not appear more quickly than in the case in solutions of other substances. It is more toxic when accompanied by little oxygen. Two cc. per liter are fatal to fishes. Water in a battery jar exposed to the air with 4 cc. per liter at the beginning killed fishes in 18-24 hours; meanwhile the concentration fell to less than two cc. per liter and the life of the fishes was prolonged by access to the surface. Hardy species of fish live in 1-1.8 cc. per liter without apparent injury. Weigelt found weak solutions fatal to tench.

Fishes are often positive to a weak concentration which would produce death in a few days, but are negative to strong concentrations as

a rule. When in solution the gas forms a very weak acid which would tend to cause fishes to react positively especially in alkaline water. The negative reactions are less definite than to carbon dioxide and other stimuli often encountered in natural environments of the fishes (Chart III, graphs 27 and 28).

Sulphur dioxide.

This gas was determined in the Champaign waste which showed in sample without tar 13.84 cc. per liter and sample with tar 56.21 cc. per liter. For the experimental work a tank of Kahlbaum's compressed gas was obtained from the University of Illinois chemical store room and the tank was attached to the gas introducer direct.

It is very irritating to the mucous membrane and the respiratory tract. It is generated in the burning of sulphur and its characteristic odor is familiar. In the case of fishes, gulping or other similar movements indicates its irritating character. Their respiration is usually heavy and they swim around in an intoxicated state for some time before death. A strong solution killed fishes after standing in a battery jar for over two weeks. Weigelt found that 0.0005% solution killed trout in a little more than one hour.

Fishes are usually negative to higher concentrations from 10 to 500 cc. per liter which produce death in a few minutes, but are quite generally positive to concentrations which are fatal in an hour (Chart III, graphs 29 and 30).

Carbon bisulphide.

It occurs commonly in crude benzene, and in the tars and other residuals. Known quantities were dissolved in 4 liters of water. It is a powerful poison to man, the vapor producing hysterical neurosis and the liquid taken internally produces unconsciousness quickly. In the case of fishes the symptoms are not markedly different from those caused by a number of other substances; they appear to become intoxicated rather slowly.

In .05 cc. per liter of water fishes were intoxicated but recovered after an hour and a half. The experiment was performed in a closed bottle so that evaporation could hardly be responsible. It is possible that the substance was absorbed or rendered harmless by some tissue such as fat.

Two species of sunfish were tried in the gradient tank and both were positive to fatal concentration while the minnow (*Pimephales*) was negative (Chart III, graph 29 and 30).

Thiophene.

It occurs as an impurity in commercial benzene. It is not particularly poisonous to man. In a one hour fatal concentration fishes are intoxicated showing signs of stimulation and some staggering after about 20 minutes. These symptoms were followed by intoxication. Sunfishes, basses and minnows were all positive to fatal concentrations (Chart III, graphs 33 and 34).

Acetone.

It occurs in connection with benzene (Lunge 3d ed, pp. 176). For the fish experiments it was added to the water and the final experiments performed in a four-liter bottle. It is only slightly poisonous to man and least toxic to fishes of the compounds studied. Fishes of various sorts are positive to it, particularly to the weaker concentrations (Chart IV, graph 35).

Benzoic acid.

It occurs as a residual in the manufacture of phenol, and in coal tar "oils". It is less toxic than most other coal tar products. It appears to be only slightly poisonous to man. The dry powder was weighed and dissolved in water. Fishes of various sorts are negative to it (Chart IV, graph 36).

Phenols and the Cresols.

According to Witthaus and Becker, 5% solution of any of these coagulates protein, narcotizes partially and finally paralyzes the nervous system. It occurs in coal-tar and in gas-liquor and is one of the sources of the toxicity of wastes. For the work on fishes the solid crystals were melted, one cc. was accurately measured, and added to a liter of water, and dilutions made from this solution, which was kept tightly corked.

Phenol is a powerful irritant, producing stupor and shallow irregular breathing in man when taken in small quantities. Larger quantities are rapidly fatal. Strong concentrations such as 1 cc. per liter are very rapidly fatal to fishes, but solutions of $\frac{1}{2}$ to $\frac{3}{4}$ this amount kill standard fishes only after one hour or more. In such solutions the fishes make a few erratic movements, turn on their sides and remain for a long period with faint respiratory movements and slight swimming movements of the fins. Fishes dying in it are characterized by a gaping condition of the gills which is common if

not general among fishes dying in waste. This is probably due to the irritating character of the substance. The toxicity of the water containing it is retained for several weeks, depending on the concentration at the beginning. Sixty-five parts per million will still produce fatal results after a month's exposure in the battery jars. Weigelt killed a tench in a 0.05% solution in 15 hours. Hofer ('99) obtained results which more nearly resemble mine.

Several species of fish which were tried in the gradient tank gave positive reactions to concentrations which would kill them in two or three hours (in both acid and alkaline water). Orange-spotted sunfish are indifferent to very weak concentrations (Chart IV, graph 37; Chart V, graph 57).

Cresols.

Orthocresol is less caustic than phenol but was found to be more poisonous to fishes. Fishes of various sorts were negative or indefinite to concentrations about twice that required to kill them in an hour, but were sometimes positive to weaker fatal concentrations (Chart IV, graph 38).

Paracresol is a little less toxic than phenol. A solution which killed small fishes in 20 minutes, killed similar fishes in less than 12 hours after 2 months exposure to air in a 5x8 battery jar. Fishes were uniformly positive or indifferent in both strong concentrations and very weak ones (Chart IV, graph 39; Chart V, graph 56).

Metacresol is least toxic of the four representatives of the group. The erratic convulsive movements often occur when intoxication sets in. Various fishes are variable in their reaction to fatal concentrations, but commonly when negative at the beginning of the experiment the protective reaction breaks down due to the paralyzing of the sensory nerve endings (Chart IV, graph 40).

Phenanthrene.

It is found in the last fractions of the distillation of coal tar "oils".

For the experiments on fishes a quantity of it was placed in a five gallon bottle of tap-water and warmed and shaken from time to time during several days. This solution was used for most of the fish experiments. In December, 1915, two liters of distilled water were placed in each of three bottles. Phenanthrene was added to one to make 100 mg. per liter, to another to make 5 mg. per liter, and to the third to make 2.5 mg. per liter. These were allowed to stand with occasional shaking till August, 1916. At this time there were still

crystals in the 100 mg. and 5 mg. bottles but none in the 2.5 mg. bottle. The water in the bottle containing 5 mg. per liter killed fishes in a somewhat longer time than the tap water solution but since the fishes available were larger and many substances are commonly less toxic in distilled water, the experiments were taken to indicate the approximate toxicity given in the table. One half gram of phenanthrene and one cc. of quinoline in two liters of water exposed to air proved fatal a month after being placed in solution.

Fishes are usually positive or indefinite to saturated solutions of phenanthrene (Chart IV, graph 41).

Anthracene appeared not to be toxic to fishes.

Naphthalene.

Ordinary tar contains 5–10% of naphthalene. It is commonly said to be insoluble, but evidently about 5 parts per million may be dissolved. The experiment of adding definite quantities to distilled water was conducted in the same manner as in the case of phenanthrene; no crystals were left in the bottle with 5 milligrams per liter.

In man it causes delirious intoxication. There are no violent symptoms in fishes; they are gradually intoxicated, turn on their sides and die without special symptoms or erratic movements.

It is very much more toxic in tap water containing much carbonate than in distilled water. Most fishes die in about half the time in saturated tap water as in distilled. Fishes are usually positive to naphthalene (Chart IV, graph 43, and Chart V, graph 58) but occasionally negative (Chart IV, graph 42).

Xylenc.

It is present in coal-tar distillates. The experiments with fishes were performed in the four-liter bottle, which was laid on its side after the xylene was added and shaken until the surface film of the exposed portion was free from droplets of the substance.

It is more toxic to man than benzene or toluene. To fishes it is more toxic than toluene and less toxic than benzene. Fishes are gradually intoxicated in less than 50 parts per million, frequently making erratic movements, jumping up in the gradient tank, etc. They usually lie on their sides until death ensues. In nearly every case fishes are positive to it. Two species of sunfish were positive to it and remained in the stronger solution until intoxicated (Chart IV, graph 44).

Toluene.

It occurs in coal-tar and has almost the same effect upon fishes as xylene, but is a little less toxic. The reactions of fishes were almost invariably positive to fatal concentrations (Chart IV, graph 45; Chart V, graph 59).

Benzene.

Benzene occurs in coal-tar and is more toxic to fishes than either toluene or xylene. In man it causes convulsions, rapid respiration, coma and lowered temperature. In the case of fishes it intoxicates them rapidly. There is considerable erratic movement and death ensues much as in the case of toluene or xylene. Fishes are commonly negative or indifferent to benzene, their reactions to it thus differing from the reactions to the other substances. They often jump out of the gradient tank (Chart IV, graphs 46 and 47).

Acetylene.

It occurs in illuminating gas but is only slightly poisonous to man. A nearly saturated solution in running water anesthetized fishes but they recovered as soon as the amount was reduced. Fishes are usually positive to it.

Ethylene.

A determination of samples of Champaign waste showed 200-300 cc. per liter in solution. The ethylene used was made by heating ethyl alcohol and sulphuric acid and washing in alkali and water. Fishes are anesthetized, lose equilibrium gradually, and die without violent symptoms.

18 cc. per liter of ethylene (18 pts. per million), in running water, oxygen at saturation, kills 3-4 gram orange-spotted sunfish in one hour.

30 cc. per liter (30 pts. per million), and oxygen 2.25 cc. kills 3 gram orange-spotted sunfish in 24 minutes; 3 grams *Notropis* in 14 minutes; 3 gram *Pimephales* in 30 minutes.

In standing water exposed to the air in battery jars, such water killed fishes as follows:

TABLE III

Hours of exposure to the air	Fish species	Weight	Time to death
0-2	Orange-spotted sunfish	4 grams	53 minutes
0-2	Pimephales	1.8 "	16-30 "
2-4	Orange-spotted sunfish	4.2 "	90 "
2-4	Pimephales	1.4 "	22 "
4-6	Pimephales	1.3 "	38-45 "
19-24	Orange-spotted sunfish*	4.0 "
19-24	Pimephales	1.3 "	100 "

* Affected but did not die.

In nearly all the experiments tried the fishes were positive in reaction to ethylene, often being overcome in the gradient, and even dying without showing any avoidance of the ethylene water. 2, 30, and 60 cc. per liter (2, 30, and 60 pts. per million) were tried with similar results; the only suggestion of a negative reaction came in the lowest concentration (Chart V, graph 50).

Amylene.

It occurs in coal-tar but only in small quantities. Amylene was once used as an anesthetic but was found to be dangerous. It acts as an anesthetic on fishes. Various fishes are positive to it in all concentrations tried (Chart V, graphs 48 and 49).

Methane.

Methane is one of the most abundant constituents of illuminating gas. It was made by the action of soda lime on sodium acetate and washed in water. Crocker found that methane made that way was not toxic to plants while other methods yielded toxic products.

It is not toxic to man and no toxic effects were noted for fishes except in the case of a single specimen of *Labidesthes sicculus*.

VII. GENERAL DISCUSSION.

I. TOXICITY AND SIZE.

One of the very important questions arising in connection with the toxicity of substances to fish is the relation of age and size of the fishes to their resistance to the substance. In general, with the majority of compounds studied the largest fishes survived longest. While

this is true, there is, however, much variation, and some of the largest fishes died first.

A number of compounds show still further irregularity and in the cresols the larger fishes are very often first to die. In carbon bisulphide this appears to be the rule with the concentrations studied. In the case of naphthalene the larger fishes usually die first. Xylene, benzene, and toluene show considerable variation in this respect though the results with a given concentration and given weight of fish are particularly constant.

TABLE IV

Showing typical results of killing Lepomis humilis in various compounds. In sulphur dioxide the smaller fishes die first. In xylene there is some variation and in carbon bisulphide the larger appear to die first as a rule.

Compound	Concentration	Weight	Time to death in minutes
Sulphur dioxide	11cc. per l.	1.5 gm.	13
		4.3 gm.	15
		6.0 gm.	20
	37cc. per l.	3.0 gm.	8
		4.0 gm.	14
		9.4 gm.	25
Xylene	$\frac{1}{4}$ saturated Running water	4.1 gm.	30
		6.0 gm.	35
		8.3 gm.	alive at 60
	$\frac{1}{8}$ saturated Running water	2.0 gm.	90
		6.2 gm.	98
		17.0 gm.	80
Carbon bisulphide	.065 cc. per l.	7.5 gm.	25
		4.0 gm.	80

In the case of carbon dioxide and low oxygen, Wells ('13), found that the results of dividing the time to death by the weight of the fishes, secured as the time to kill a gram of fish, not a constant but a value which increased rather regularly in most cases, as the size of the fish decreased. In the case of the coal-tar products there is much more irregularity than in the case of the conditions studied by Wells.

Since the smallest individuals of given species usually die quickest the importance of contamination is greatest in connection with the younger stages. The effect upon the development of eggs is likely to be great. Gortner and Banta found that various phenolic compounds killed the eggs of frogs and other amphibians in concentration as low as 50 parts per million. The critical point for further study is in connection with the most sensitive stage. This is the weakest link in the life-history chain, and represents its strength. *It is the stage on which minimum fatal concentration must be worked out.*

2. TOXICITY AND SPECIES.

This is best determined with the use of low oxygen and carbon dioxide and the data presented by Dr. Wells in the next article in this volume shows such differences based largely on his experiments along this line. In a general way the relative resistance of the different species to coal-tar products is similar to that given in his table. According to our general experience with the orange-spotted sunfish it should be rated at 12 in Dr. Wells' table. There are, however, some outstanding exceptions. To the coal-tar products suckers are generally about as resistant as the orange-spotted sunfish, and while in most substances the green sunfish is more resistant than the orange-spotted, it is less resistant to some of the phenolic compounds.

3. FISH REACTIONS TO POLLUTING SUBSTANCES.

The study of the behavior of fishes with reference to polluting substances is a departure from the usual method of study of such relations. The graphs on the charts show that fishes are as a rule indefinite or positive to the substances which are not regularly encountered in their environments. In other words they swim into the poisonous solution without detecting it and turning back as they do in the case of low oxygen and much carbon dioxide. They may go directly into it without noting it, and after being for a brief time in the solution they very generally avoid the pure water which is identical with that in which they have been living for months even though the solution chosen caused death. In some cases fishes at the beginning tend to avoid the modified water, but soon, usually after a brief contact with the solution, begin to turn back from the pure water, having very quickly formed a preference or "habit" which keeps them in the poisonous solution. Peculiarities of *behavior* occur in some cases with reference to particular concentrations.

The behavior results are of the greatest significance to the pollution question for since fishes are positive to fatal concentrations of the vast majority of organic compounds introduced into streams by gas-works, the tendency must be for them to enter rather than avoid the portions of streams so contaminated, making the loss very much greater than it would otherwise be. The peculiarities of the reactions to the various poisons is suggestive of a possibility of investigating the physiological effects of habit-forming drugs. It is possible that detailed study of these reactions might show why habit-forming drugs produce a demand for more of the same drug, when several small quantities have been taken.

4. TREATMENT OF BY-PRODUCTS OF THE MANUFACTURE OF COAL-GAS.

The great toxicity of nearly all the representatives of the chief groups of compounds occurring as by-products of the manufacture of coal-gas render it inadvisable to permit the pollution of streams with any of these compounds. Attention is especially directed to the fact that the compounds commonly reckoned as insoluble in water by industrial chemists are among the most deadly. Further it must be noted that the volatile and gaseous products such as ethylene, carbon monoxide, benzene, xylene, etc., which doubtless go into solution in the water which is used for washing gases during manufacture, and which are least likely to be suspected of being detrimental, are among the most poisonous compounds and probably the most universally thrown into streams. Marsh ('07) has shown further that effluent from an ammonia sludge-bed, lime and iron oxide from purifiers and residuals from water-gas are very toxic.

In general the experiments leave no doubt but that earnest effort should be made to prevent the introduction of anything whatsoever in the way of coal-gas products into stream and bodies of water. No matter what method of treating the wastes may be devised the general toxicity of the entire series of compounds makes it certain that much damage will result from pollution with the residues of any form of treatment. In general however the damage to fishes will be greatest in connection with the smaller plants which ordinarily save only the heavy tar or at most tar and ammonia. If the government cannot compel gas manufacturers to make their valuable but poisonous by-products into something useful, it can at least make such an industry advisable by preventing the addition of these waste materials to streams, and if necessary conduct investigations into methods for the profitable disposal of the entire series of these by-products.

VIII. SUMMARY.

1. Illuminating gas, gas-liquor, and thirty-one out of thirty-four representatives of the chief groups of compounds found in gas and gas-liquor are very toxic to fishes. From one to fifteen hundred parts per million are fatal to an orange-spotted sunfish in one hour. (P. 391.)

2. As a rule the smaller fishes are more readily affected than the larger, down to the smallest fry studied; the minimum amount of the various substances required to kill fishes must be established by using the most sensitive stages, which are probably the smallest fry. (P. 407.)

3. Fishes usually react positively to the compounds and mixtures studied; i.e., enter the polluted water from the pure water readily and turn back into the polluted water when pure water is encountered. The danger to fishes is increased greatly thereby. Fishes often develop a "preference" for the polluted water after a number of trials of both kinds. (P. 397.)

4. On account of the extreme toxicity of gases such as CO and ethylene, and of benzene and other volatile matter, water which has been in contact with gases should not be introduced into streams. (See Article VII, also pp. 395 and 409.)

5. Various types of manufacturing and by-product recovering plants, while they remove different substances do not leave a harmless residue; on account of the fact that the very toxic substances such as carbon monoxide, benzene, and naphthalene differ widely in their properties, residues from all such plants will be almost certain to be toxic. (P. 395.)

6. The results thus far obtained may throw some light on the poisonous effect of the various compounds from the pharmaceutical standpoint, and may be of assistance in the matter of standardization of drugs with fishes.

IX. ACKNOWLEDGMENTS.

The writer is indebted to the State Water Survey for analyses of water made at the beginning of his work. He is further much indebted to various members of the Department of Chemistry of the University of Illinois, particularly to Dr. C. G. Derick, now of the Research Laboratory of the Schoellkopf Aniline and Chemical Works, Inc., Dr. H. J. Broderson, and Dr. G. D. Beal, for extended advice and suitable chemicals.

X. LITERATURE CONSULTED.

Beacall, T., Seibert, F. M., and Robertson, I. W.

'15. Dyestuffs and coal-tar products, their chemistry, manufacture, and application. Crosby Lockwood and Son, London.

Birge, E. A., and Juday, Chancey.

'04. The inland lakes of Wisconsin. The dissolved gases of the water and their biological significance. Bull. Wis. Geol. and Nat. Hist. Surv., No. XXII; Sci. Ser., No. 7.

Burrell, Geo., and others.

'14. Relative effects of carbon monoxid on small animals. Dept. Interior, Bur. Mines, Tech. Paper No. 62.

- Child, C. M.
'15. Senescence and rejuvenescence. Univ. of Chicago Press, Chicago.
- Cushny, A. R.
'01. Textbook of pharmacology and therapeutics. Lea Brothers and Co., Phila.
- Fränkel, S.
'06. Die Arzneimittel-Synthese—etc. Julius Springer, Berlin.
- Giacosa, Piero.
'04. Sul compartamento dell'ossido di carbonio nell'organismo. Atti R. Accad. Sci. Torino, 39:421-428. Abstract, Jour. Chem. Soc. Abs. Papers, Vol. 86, Pt. II, p. 429*.
- Gortner, R. A., and Banta, A. M.
'14. Notes on the toxicity of dilute solutions of certain phenolic compounds as indicated by their effect on amphibian eggs and embryos—etc. Biochem. Bull., 3: 357-368.
- König, J.
'99. Verunreinigung der Gewässer.
- König, J., and Hasenbäumer, J.
'02. Einfluss von schwefliger Säure auf Pflanzen und Fische. Fühling's landw. Zeit., 51:853-856; 893-895. Abstracts: Bied. Centr., 1903, 32:535-536; Jour. Chem. Soc. Abs. Papers, Vol. 84, Pt. II, p. 748*.
- Lederer, A.
'13. Some observations on the formation of hydrogen sulphide in sewage. Am. Jour. Pub. Health, 3: 552-561.
- Lunge, G.
'00. Coal-tar and ammonia, ed. 3. Gurney and Jackson, London.
- Marsh, M. C.
'07. The effect of some industrial wastes on fishes. U. S. Geol. Surv., Water Supply and Irrigation Paper, No. 192: 337-348.
- May, Percy.
'11. The chemistry of synthetic drugs. Longmans, Green and Co., London.
- Phelps, E. B.
'09. The pollution of streams by sulphite pulp waste: a study of possible remedies. U. S. Geol. Surv., Water-Supply Paper

*Only this abstract consulted.

226. (Contains list of Survey publications on stream pollution.)
- Shelford, V. E., and Allee, W. C.
- '13. The reactions of fishes to gradients of dissolved atmospheric gases. *Jour. Exper. Zool.*, 14: 207-266.
- '14. Rapid modification of the behavior of fishes by contact with modified water. *Jour. An. Behav.*, 4: 1-31.
- Shelford, V. E., and Powers, E. B.
- '15. An experimental study of the movements of herring and other marine fishes. *Biol. Bull.*, 28: 315-334.
- Sollmann, T.
- '06. The effects of a series of poisons on adult and embryonic funduli. *Am. Jour. Physiol.*, 16: 1-46.
- Weigelt, C.
- '03. L'assainissement et le Repeuplement des Rivières. Mémoires couronnés et autres mémoires de l'Acad. Roy. de Belgique, T. LXIV. (Translation from the German.)
- Wells, M. M.
- '13. The resistance of fishes to different concentrations and combinations of oxygen and carbon dioxide. *Biol. Bull.*, 25: 323-347.
- '15. Reactions and resistance of fishes in their natural environment to acidity, alkalinity and neutrality. *Biol. Bull.*, 29: 221-257.
- '15a. The reaction and resistance of fishes in their natural environment to salts. *Jour. Exper. Zool.*, 19: 243-283.
- White, G. F., and Thomas, Adrian.
- '12. Studies on the absorption of metallic salts by fish in their natural habitat. I. Absorption of copper by *Fundulus heteroclitus*. *Jour. Biol. Chem.*, 11: 381-386.
- Witthaus, R. A., and Becker, T. C.
- '11. Medical jurisprudence, forensic medicine, and toxicology, ed. 2. Wm. Wood and Co., New York.
- Wood, H. C., Remington, J. P., and Sadtler, S. P.
- '07. The Dispensatory of the United States of America, 19th ed. Lippincott and Co., Phila.

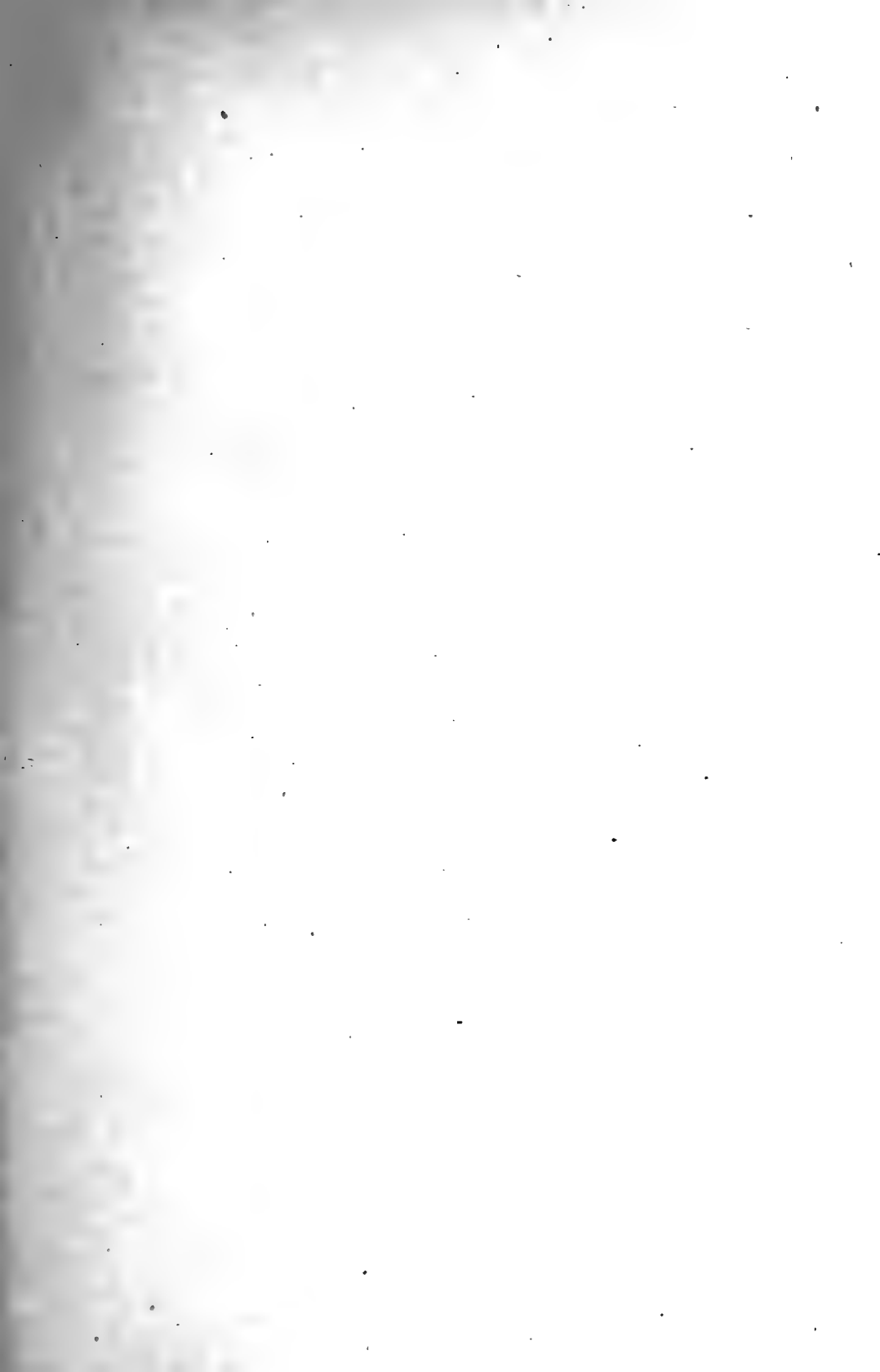


FIGURE 1.

This figure shows the boiling and aerating device used in the experiments.

The various parts are arranged alphabetically beginning with the water supply of the water boiler, at the right side. Parts A to L on the right side make up the boiling device. The entire apparatus was built above a drain-table. Aa was the water supply pipe. Water could be passed through this directly to the float valve (Fv) or through the coil B which is a gas heater, into pipe C and thence through the float valve (Fv). From the float valve it could be passed directly into the lower tank J through G or upward through the calibrated valve F which could be set for any desired flow and into the upper boiling tank H from which it flowed into I and then J. With all these different means of introducing water into the delivery tank J any desired amount of heating or exposure to air within limits could be secured. In the tanks H, I, and J the water could be heated or boiled with gas. The apparatus would deliver about 200 cc. per minute free from oxygen and with no free carbon dioxide (decidedly alkaline to phenolphthalein). From J the water passed through the tees at k and k₁ through the three way valve (3 Wv) and through seventy-five feet of block-tin pipe to the outlets L. The gas introducer (V) could be inserted into the pipe between the two coolers and any desired gas introduced at that point. For many of the experiments with gases water was run through all three of the boilers, which usually gave from 2-3 cc. of oxygen per liter and about 5 cc. of free carbon dioxide. This is about the condition of a somewhat polluted water.

At times however this method gave very low oxygen content for some reason not obvious, and accordingly the aerating device which gave water rarely less than two and one half to three cubic centimeters per liter of oxygen and 4-5 cc. of carbon dioxide were used. In this device the water at the left end of the drain-table was brought up through a float valve (Fv) which delivered water to the corrugated incline (O) of the aerating device. From this incline the water flowed to the settling box (P) below, where most of the precipitated iron settled out. From this it flowed into the storage and withdrawal tank R. From here the water was carried downward through S and through the gas introducer (V) and through T and through the lower sixty feet of block-tin pipe in the lower cooler.

Gases were introduced under pressure as shown in the case of the bottle U. A number of valves which can be noted in the figure made possible the use of water from various sources.

The gradient tank is shown below (N), the shading representing the distribution of solutes introduced at the right. In some cases solutes were run in from the aspirator bottle (W) which was kept at water temperature by a jet of water direct from the supply pipe. In such cases the solute was added to the mixing bottle into which water was flowing.

FIG. 1.

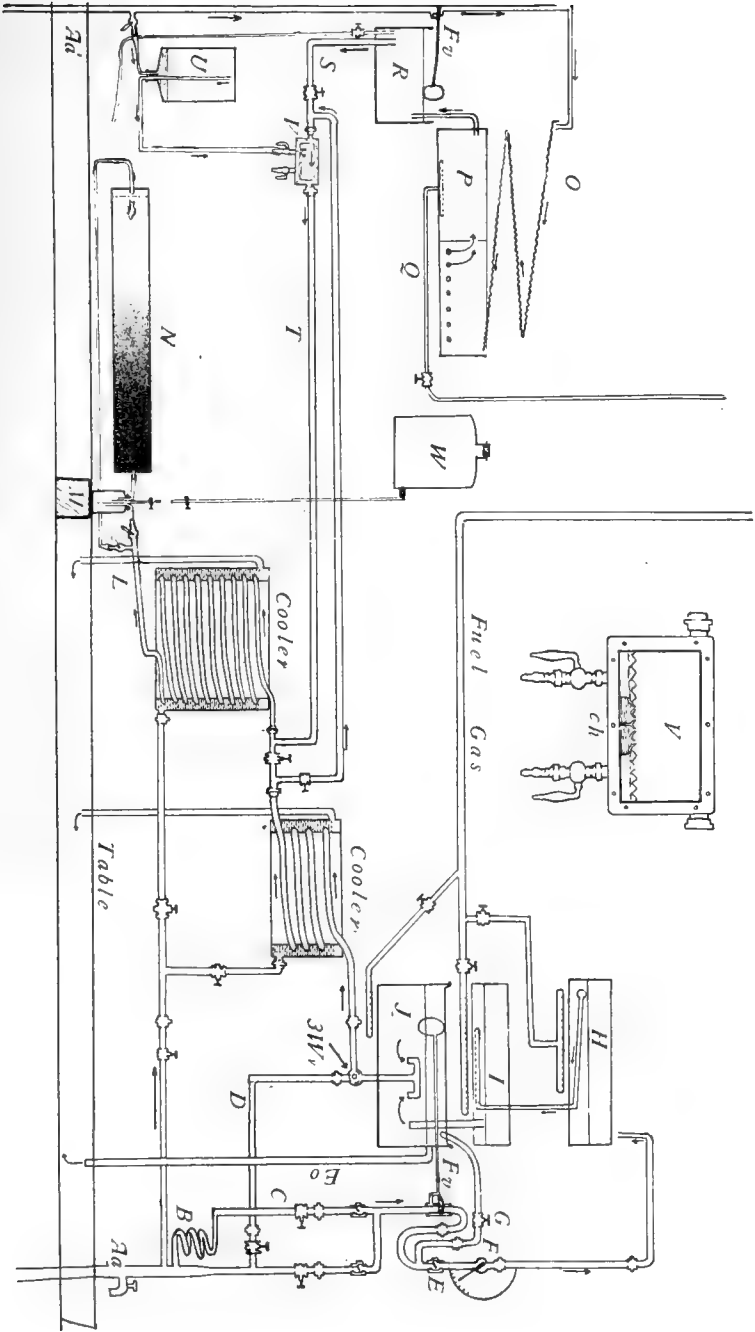


CHART I.

The graphs on this chart show the movements of fishes in the gradient tank when no contaminating substance has been added at the end, and the water is therefore of equal purity throughout. Graphs 1-5 have been previously published.

The gradient tank is shown in Figure 1, N, on preceding page. This is a diagram of a longitudinal section of the tank. The left hand end was used for the introduction of water such as the fishes were taken from and the right hand end was used for the introduction of water to which the substance being tested had been added. The water was introduced through a number of small openings in pipes which extended crosswise at each end of the tank, midway between top and bottom. The water flowed out at the center from both top and bottom. This gave pure water at the left hand end and usually in the case of dissolved solids and liquids, throughout about one third of the tank while the approximate full concentration of the polluting substance extended throughout the right hand third. The central third contained a mixture in which the concentration of the substance added at the right decreased from right to left. The central portion of the tank was accordingly a gradient between the two kinds of water introduced into the ends. The fishes introduced into the tank usually swim from end to end. The record of the movements of the fish was made by tracing their longitudinal movements in the tank on paper with reference to a time scale. Thus in Graph 1 the fish passed from the center to the left end and back to the right end during the first minute.

Graph 1 shows the longitudinal movements of a river chub made up as a composite of a number of such graphs to show that on the whole no more time was spent in one end of the tank than in the other.

Graph 2 shows the movements of two individuals of the green sunfish. Where the broken line appears, the two were moving separately. It will be noted that fishes made long stays in the ends but usually moved back and forth nearly always without turning back at the center.

Graph 3 shows the movements of a golden shiner in a uniform tank. It will be noted that the fish rarely turns around except at the end.

Graph 4 shows the movements of a specimen of *Notropis*. There was little activity and the fish turned back at the center once.

Graph 5 shows the movements of a specimen of rock bass.

Graph 6 shows the movements of a specimen of the orange-spotted sunfish. This species often turned before reaching the end of the tank but the number of turnings in the central third were the same from each direction.

Graph 7 shows the movements of a long-eared sunfish. It sometimes turned near the center, but about the same number of times from each end.

CHART I.

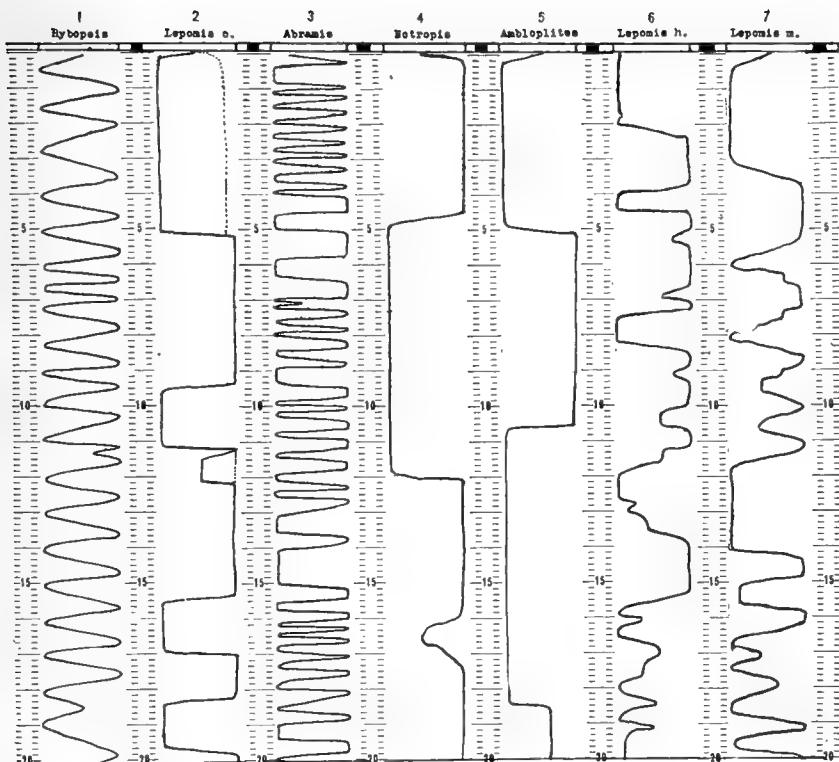


CHART II.

The relations of tank length to time scale is the same as in Chart I. In the case of this and all the charts which follow, the polluting substance was introduced into the right hand end of the gradient tank and is accordingly shown at the right side of the graphs. The vertical broken lines are intended to indicate the location of thirds of the tank length. The solid black area at the right between the two lines at the head of each graph is intended to show the part of the tank in which the polluted water is full strength and the narrowing of this black area from right to left in the middle third is intended to indicate the region of principal gradient. The unpolluted water contained about 5 cc. CO₂ per liter. X indicates that the fish became intoxicated; the arrow that it was driven.

Graph 8 shows the positive reaction of an orange-spotted sunfish to 1 part of weak waste to 25 parts of water. The fishes avoided the normal water and remained most of the time in the high concentration and gradient.

Graph 9 shows the reaction of the golden shiner to waste, 1 part in 100 of water, which killed the standard fish in a little more than one hour. In this case the fish avoided the unpolluted water and did not enter it at all until driven as indicated by the arrow.

Graph 10 shows the reaction of an orange-spotted sunfish to the same solution as was used in the case of graph 8. In this case the fish was negative, showing that there is some variation in the reaction.

Graph 11 shows the reaction of a minnow (*Pimephales*), indicated by the broken line. The fish was negative for a time but became intoxicated after a little more than two minutes and then remained positive after being driven into the strongest solution.

Graph 12 shows the reaction of an orange-spotted sunfish to illuminating gas. There was little activity and one fish remained in the clear water while the other remained in the polluted water during the period of observation. The amount of illuminating gas was not determined; much more was forced into the water than would go into solution in the pipe of the lower cooler (Fig. 1, preceding Chart I).

Graph 13 shows the reaction of a large-mouthed black bass to illuminating gas under the same conditions as in graph 12. The fish was driven into the stronger solution of gas and reacted positively thereafter.

Graph 14 shows the reaction of the golden shiner to a solution of ammonia which would prove fatal in a short time. The fish on the whole remained most of the time in the part of the tank containing a somewhat diluted solution but gave no avoiding reactions.

Graph 15 shows the positive reaction of a minnow (*Notropis*) to ammonia solution under the same conditions as graph 14. In this case the fish was clearly positive.

Graph 16 shows the positive reaction of two individuals of *Notropis* to a solution of approximately one gram per liter of NH₂(CO), which kills such fishes in less than an hour.

Graph 17 shows a decidedly positive reaction of a rock bass to approximately 1 gram per liter of ammonium chloride. The experiment continued for 10 minutes after the portion shown without change of result.

Graph 18 shows the reaction of a rock bass to 0.7 gram of ammonium sulphate per liter. The fish rested in the polluted water throughout the greater part of the time and turned back when a decreased concentration was encountered.

Graph 19 shows the reaction of a minnow (*Pimephales*) to approximately 0.25 gram of ammonium sulphocyanate (sulphocyanide) per liter. The fish moved back and forth actively and turned back regularly from a pure water.

Graph 20 shows the reaction of a full-grown rock bass to the same concentration as in Graph 19. The fish was driven into the pure water at the end of seven minutes but soon returned to the polluted portion.

CHART II.

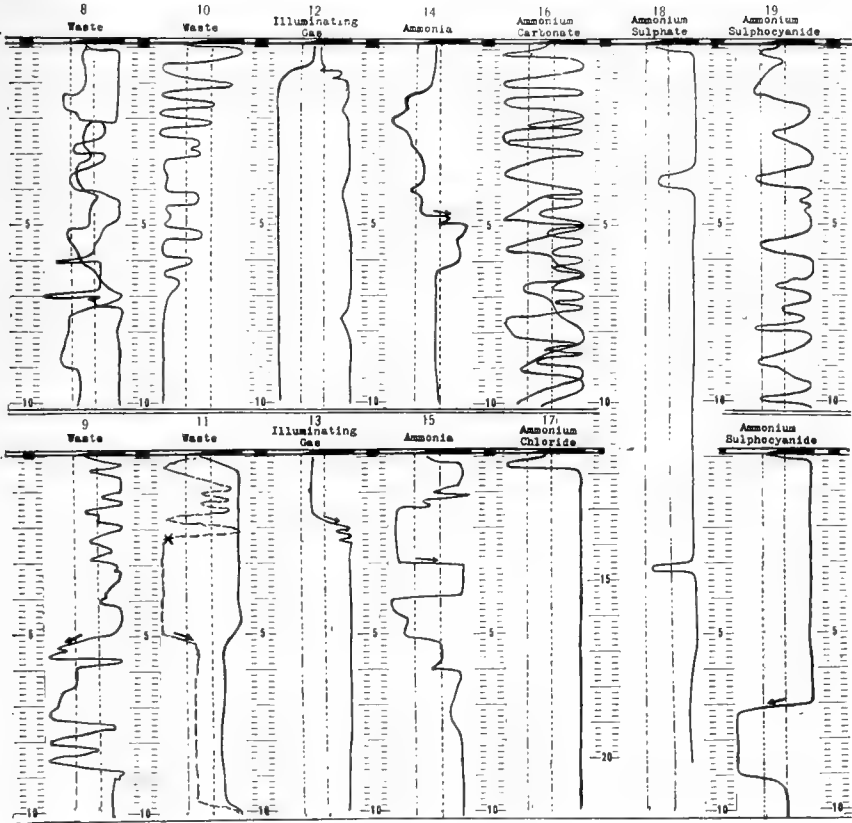


CHART III.

Graph 21 shows the reaction of a minnow (*Notropis*) to approximately 0.25 gram of ammonium ferrocyanide per liter. The fish was active and swam back and forth turning back from the pure water repeatedly.

Graph 22 shows a slight preference on the part of an orange-spotted sunfish for water containing ethylamine.

Graph 23 shows the indifference of two orange-spotted sunfishes to about one-tenth cc. of aniline per liter.

Graph 24 shows the marked activity of two individuals of *Notropis* in a pyridine gradient and their repeated avoidance of the pure water throughout the experiment.

Graph 25 shows the marked negative reaction of the minnow (*Pimephales*) and long-eared sunfish to 0.16 cc. of quinoline per liter.

Graph 26 shows a marked negative reaction of a minnow (*Notropis*) to a weak solution of isoquinoline. In the case of both quinoline and isoquinoline the fishes were active and turned back from the polluted water; the rule for the former, and the exception for the latter.

Graph 27 shows the negative reaction of a minnow (*Pimephales*) to water containing 8 cc. per liter of hydrogen sulphide. The fish became intoxicated at the end of five minutes as indicated by the X in the graph.

Graph 28 shows the positive reaction of a full-grown rock bass to two cc. per liter of hydrogen sulphide. The pure water was encountered repeatedly and repeatedly avoided.

Graph 29 shows the reaction of two orange-spotted sunfishes to approximately 500 cc. of sulphur dioxide per liter. The fishes spent the greater part of the time in the central part of the tank.

Graph 30 shows the positive reaction of two orange-spotted sunfishes to 5 cc. of sulphur dioxide per liter.

Graph 31 shows the positive reaction of a long-eared sunfish to water containing less than 1 cc. per liter of carbon disulphide.

Graph 32 shows the reaction of a minnow (*Pimephales*) under the same conditions as graph 31. The fish was positive during the first seven minutes and negative during the last three.

Graph 33 shows the positive reaction of a rock bass to a fatal concentration of thiophene.

Graph 34 shows an equally positive reaction of a long-eared sunfish.

CHART III.

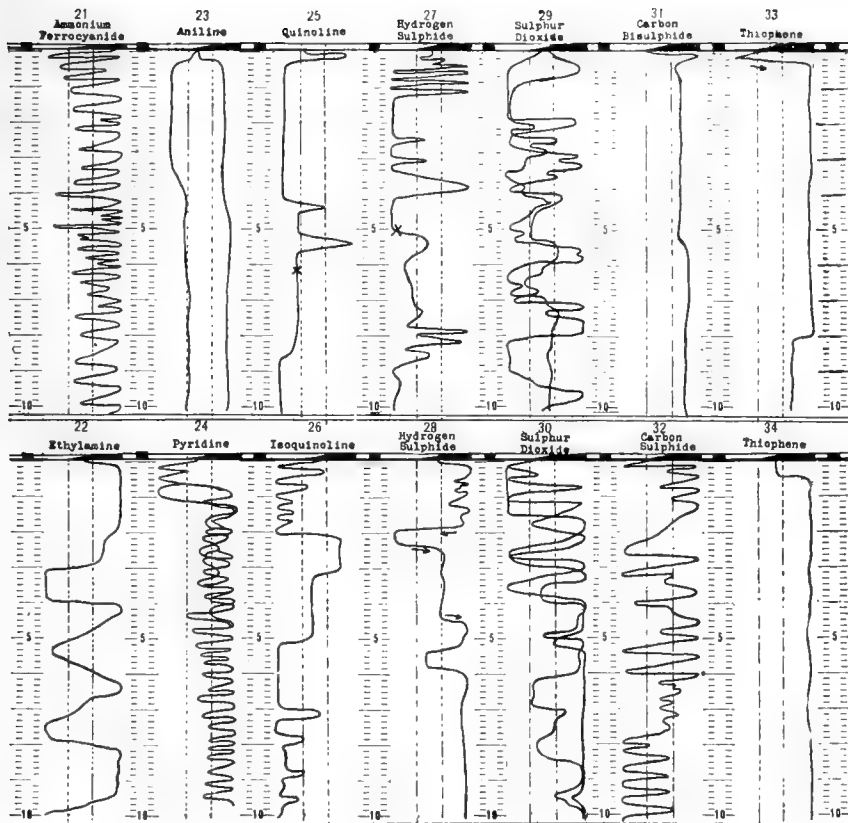


CHART IV.

Graph 35 shows the positive reaction of two minnows (*Pimephales*) to water containing $2\frac{1}{2}$ cc. per liter of acetone. The fishes turned back repeatedly from the pure water.

Graph 36 shows the decidedly negative reaction of a minnow (*Pimephales*) to water containing a fatal concentration of benzoic acid.

Graph 37 shows the reaction of a green sunfish to water containing 0.5 cc. per liter of phenol. The fish was markedly positive to the phenol during the first ten minutes, when the activity increased, probably due to its irritating effects. The greater part of the time was spent in the phenol however.

Graph 38 shows the reaction of a full-grown rock bass to approximately 0.1 cc. per liter of orthocresol, which would prove fatal to the fish in an hour or more. When the fish entered the polluted water the first time it did not recognize it at all. It gave no avoiding reaction. Later it moved toward the weaker solution and turned back again into the stronger solution. After becoming partially intoxicated, it moved into the pure water but returned to the fatal solution again and was completely overcome there.

Graph 39 shows the reaction of an orange-spotted sunfish to 0.3 cc. paracresol per liter—about three times as much as is required to kill one of the fishes in one hour. It is to be noted in particular that the fish after trying the pure water twice, gradually avoided it more and more until it finally came to rest in the strongest solution of paracresol.

Graph 40 shows the reaction of two orange-spotted sunfishes to 0.12 cc. of metacresol, sufficient to kill them in an hour. One fish was negative and the other positive. The fish which happened to enter the polluted water at first became intoxicated and remained positive thereafter. Fishes are often negative to metacresol.

Graph 41 shows the reaction of an adult rock bass to a saturated solution of phenanthrene. Fishes are often indefinite to this substance.

Graph 42 shows the negative reaction of an adult rock bass to a saturated solution of naphthalene.

Graph 43 shows the positive reaction of an individual orange-spotted sunfish to a saturated solution of naphthalene. Fishes are generally positive to this deadly substance.

Graph 44 shows the reaction of an adult rock bass to a mixture of pure water 3 parts and water saturated with xylene 1 part. The fish was decidedly positive and was soon intoxicated.

Graph 45 shows the reaction of a minnow (*Notropis*) to water containing approximately 0.08 cc. per liter of toluene. The fish is decidedly positive, though this concentration would kill it in less than an hour.

Graph 46 shows the reaction of two orange-spotted sunfishes to 0.04 cc. of benzene per liter—sufficient to kill them in an hour. In this experiment the fishes avoided the pure water and finally came to rest in the center.

Graph 47 shows the reaction of an orange-spotted sunfish and a rock bass to a slightly weaker concentration of benzene than was used in the case of graph 46. In this case the fishes both finally avoided the polluted water.

CHART IV.

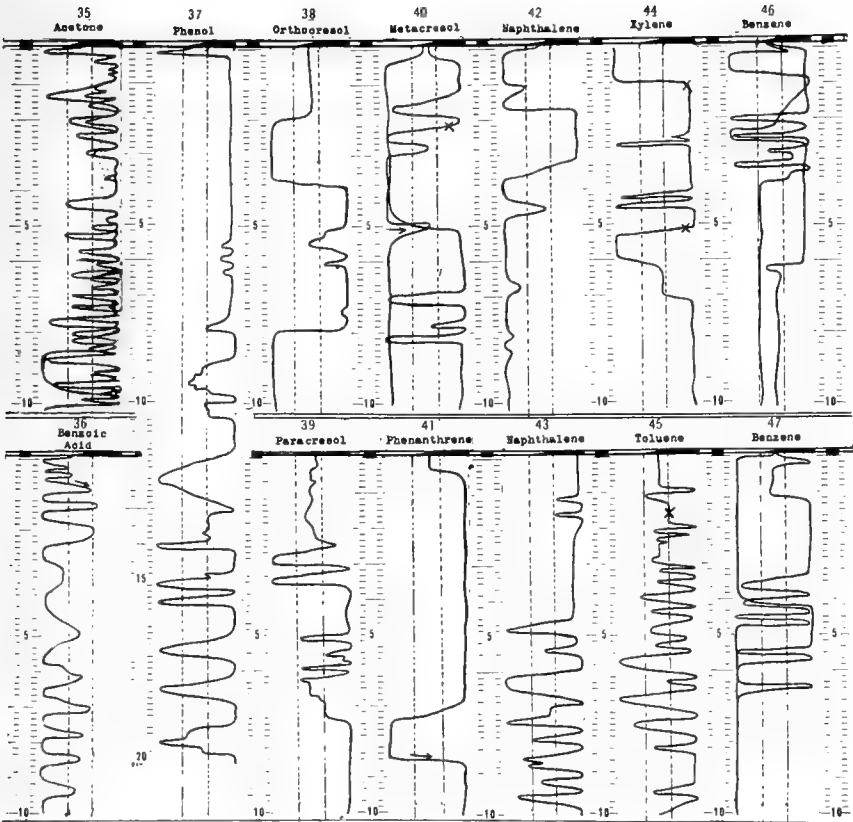


CHART V.

Graph 48 shows the positive reaction of an orange-spotted sunfish to 0.22 cc. of amylen. Reactions to this drug are usually positive.

Graph 49 shows the positive reaction of two minnows (*Notropis*) to amylen in which they appear to have selected an optimum concentration, near the center.

Graph 50 shows the reaction of a large-mouthed black bass to water containing 34.4 cc. of ethylene per liter. It is clearly positive, though this concentration would kill the fish in less than an hour.

Graph 51 shows the reaction of a minnow (*Notropis*) to water containing about ten cc. per liter of acetylene. The reaction is clearly positive though the gas is not fatal.

Graph 52 shows the reaction of an orange-spotted sunfish to about ten cc. of acetylene per liter; the reaction is clearly positive.

Graph 53 shows the reaction of three orange-spotted sunfishes to a mixture of carbon monoxide (1.4 cc. per liter) and ethylene (9.6 cc. of ethylene).

Graph 54 shows the reaction of two suckers to the same solution as in graph 53.

Graph 55 shows the reaction of an individual (*Abramis*) to ammonia in alkaline water. The fish was positive, as in acid water.

Graph 56 shows the reaction of a large-mouthed black bass to paracresol in alkaline water. The general result is the same as in acid water.

Graph 57 shows the reaction of an orange-spotted sunfish to orthocresol in alkaline water. The fish was positive, as in the acid water.

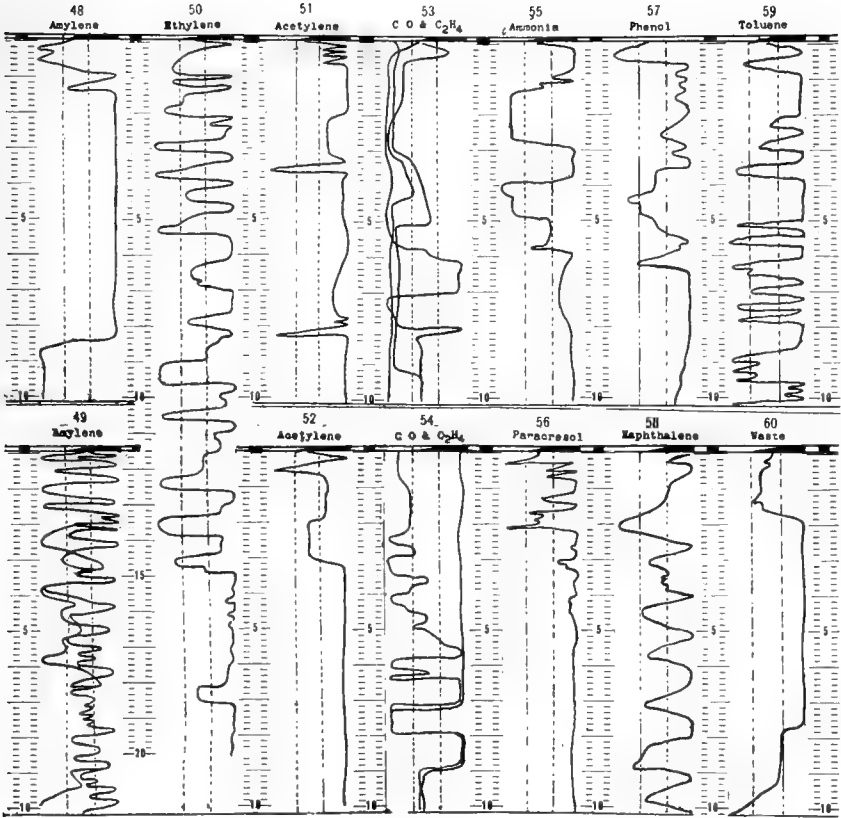
Graph 57 shows the reaction of an orange-spotted sunfish to phenol in alkaline water. This and other fishes are positive, as in acid water.

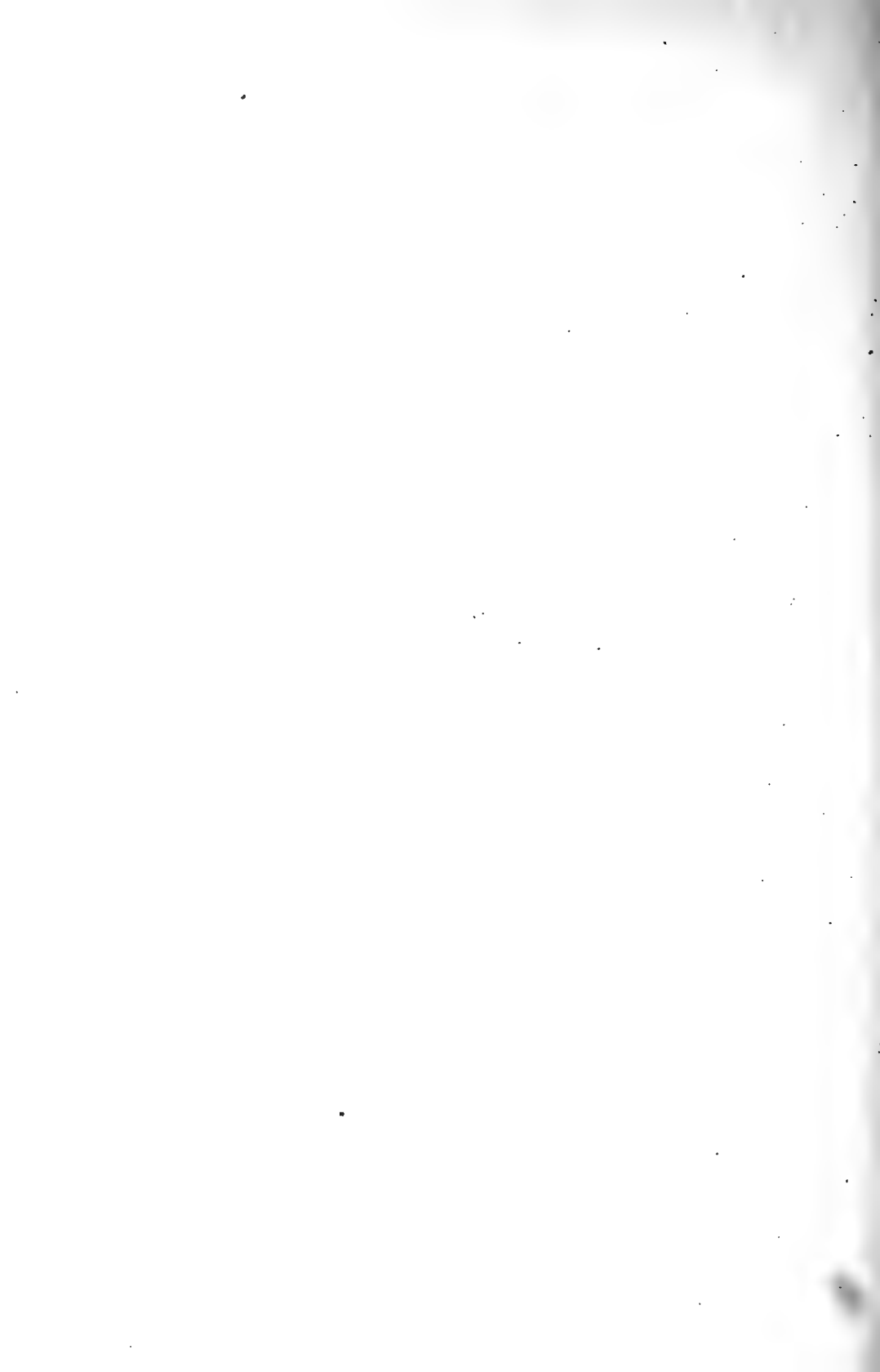
Graph 58 shows the positive reaction of an orange-spotted sunfish to naphthalene in alkaline water.

Graph 59 shows the positive reaction of a large-mouthed black bass to toluene in alkaline water.

Graph 60 shows the positive reaction of a blue-gill to gas waste in alkaline water.

CHART V.





BULLETIN
OF THE
ILLINOIS STATE LABORATORY
OF
NATURAL HISTORY

URBANA, ILLINOIS, U. S. A.

STEPHEN A. FORBES, PH. D., L. L. D.,
DIRECTOR

VOL. XI.

NOVEMBER, 1917

ARTICLE VII.

SOME EDIBLE AND POISONOUS MUSHROOMS

BY

WALTER B. McDOUGALL, PH. D.

CONTENTS

	PAGE
Introduction	413
Mushrooms and toadstools	414
The mushroom plant	414
Life history and development	414
Structure of a mushroom	417
Spore production and liberation	417
Other types of mushrooms	419
The ecology of mushrooms	420
Dissemination	420
Gravity	421
Air	421
Heat	421
Light	422
Substratum	422
Water	422
Parasites and saprophytes	423
Mycorrhizas	424
Animal relations	425
Diseases	427
Fairy rings	427
Luminosity	427
Mushroom growing	429
Food value of mushrooms	430
Poisonous properties of mushrooms	430
Collecting wild mushrooms	431
The preparation of mushrooms for the table	433
The classification of mushrooms	435
Use of the key	436
Key to genera of gill fungi	437
Descriptions of species	440
References	554
Index to	555

ARTICLE VII.—*Some Edible and Poisonous Mushrooms.* By
WALTER B. McDOUGALL, PH.D.

INTRODUCTION

The interest in wild mushrooms and the number of people who collect wild mushrooms for the table are increasing rapidly. Numerous inquiries are received by the botany department of the University of Illinois each season concerning the identification and edibility of various species. At the same time, whenever there is a good mushroom season, the newspapers report an increasing number of cases of mushroom poisoning. These facts indicate the great desirability of a wider dissemination of the knowledge necessary to distinguish intelligently the common edible and poisonous mushrooms. It was with these facts in mind that it was decided to prepare, for the people of the state, photographs and descriptions of a limited number of species, in the hope that it might help our friends to make use of the abundance of excellent food material that annually goes to waste in the fields and woods, without risking their lives in the act.

The majority of the species included here were collected in Champaign county in the vicinity of Urbana. Aid received from the State Laboratory of Natural History, however, has enabled me to do some collecting in Jackson, Union, and Wabash counties. I have indicated, after the description of each species, in what counties it has been collected. The fact that a species has not been collected in a certain place, however, does not indicate that it does not occur there, since nearly every species included is likely to be found in any part of the state, as well as in adjoining states.

Some of the photographs are natural size; others are somewhat reduced. In nearly every photograph there is a scale which will enable one to see at a glance the relative size of the objects. The scale used is ruled according to the metric system, and the figures on it, therefore, indicate centimeters and not inches. Those who are not familiar with the metric system will not be inconvenienced by this if they merely remember that two and one-half centimeters very nearly equal an inch.

CONTENTS

	PAGE
Introduction	413
Mushrooms and toadstools	414
The mushroom plant	414
Life history and development	414
Structure of a mushroom	417
Spore production and liberation	417
Other types of mushrooms	419
The ecology of mushrooms	420
Dissemination	420
Gravity	421
Air	421
Heat	421
Light	422
Substratum	422
Water	422
Parasites and saprophytes	423
Mycorrhizas	424
Animal relations	425
Diseases	427
Fairy rings	427
Luminosity	427
Mushroom growing	429
Food value of mushrooms	430
Poisonous properties of mushrooms	430
Collecting wild mushrooms	431
The preparation of mushrooms for the table	433
The classification of mushrooms	435
Use of the key	436
Key to genera of gill fungi	437
Descriptions of species	440
References	554
Index to	555

ARTICLE VII.—*Some Edible and Poisonous Mushrooms.* By
WALTER B. McDOUGALL, PH.D.

INTRODUCTION

The interest in wild mushrooms and the number of people who collect wild mushrooms for the table are increasing rapidly. Numerous inquiries are received by the botany department of the University of Illinois each season concerning the identification and edibility of various species. At the same time, whenever there is a good mushroom season, the newspapers report an increasing number of cases of mushroom poisoning. These facts indicate the great desirability of a wider dissemination of the knowledge necessary to distinguish intelligently the common edible and poisonous mushrooms. It was with these facts in mind that it was decided to prepare, for the people of the state, photographs and descriptions of a limited number of species, in the hope that it might help our friends to make use of the abundance of excellent food material that annually goes to waste in the fields and woods, without risking their lives in the act.

The majority of the species included here were collected in Champaign county in the vicinity of Urbana. Aid received from the State Laboratory of Natural History, however, has enabled me to do some collecting in Jackson, Union, and Wabash counties. I have indicated, after the description of each species, in what counties it has been collected. The fact that a species has not been collected in a certain place, however, does not indicate that it does not occur there, since nearly every species included is likely to be found in any part of the state, as well as in adjoining states.

Some of the photographs are natural size; others are somewhat reduced. In nearly every photograph there is a scale which will enable one to see at a glance the relative size of the objects. The scale used is ruled according to the metric system, and the figures on it, therefore, indicate centimeters and not inches. Those who are not familiar with the metric system will not be inconvenienced by this if they merely remember that two and one-half centimeters very nearly equal an inch.

MUSHROOMS AND TOADSTOOLS

Every botanist is asked frequently how to tell a mushroom from a toadstool. As a matter of fact there is no difference between a mushroom and a toadstool. Every fungus that produces a fleshy or woody or jelly-like fruit-body which is large enough to be studied without a microscope may be called a mushroom, or it may be called a toadstool. Personally I prefer to call them mushrooms. There are hundreds of kinds of mushrooms, very many of which are edible, and many not edible, but only a few of which are poisonous. The question then should be, not how to tell a mushroom from a toadstool, but how to tell edible from poisonous mushrooms, or edible from poisonous toadstools. The answer is practically the same as it would be if the question were how to tell sweet apples from sour apples without tasting. One must learn the botanical characters of each kind, and learn them so well that he recognizes the various kinds at sight as easily as he recognizes the members of his own family. It cannot be too strongly emphasized that there is no such thing as a "rule" by which the edible kinds may be distinguished from the poisonous. It must be remembered that mushrooms are the fruits of fungus plants, and it is no more difficult to learn fifty kinds of mushrooms than it is to learn fifty kinds of trees or fifty kinds of birds. A child on being introduced to different kinds of fruits for the first time may mistake a pear for an apple, but after he has once learned them he does not make that mistake. Neither will one mistake one kind of mushroom for another after he has once learned them; but no one should eat any kind of mushroom until he has learned to recognize it at sight and to call it by name.

THE MUSHROOM PLANT

LIFE HISTORY AND DEVELOPMENT

The vegetative part of the mushroom plant, in most cases, grows entirely within the substratum or material on which it lives. This material may be the soil, or rotten wood, or the bark or wood of a living tree, depending on the kind of mushroom. This vegetative part of the plant consists of a network of branched threadlike structures called hyphae, the whole mass of hyphae taken together being called the mycelium. The spawn which can be purchased from seedsmen consists of this mycelium mixed with the soil and manure in which the plant grew.

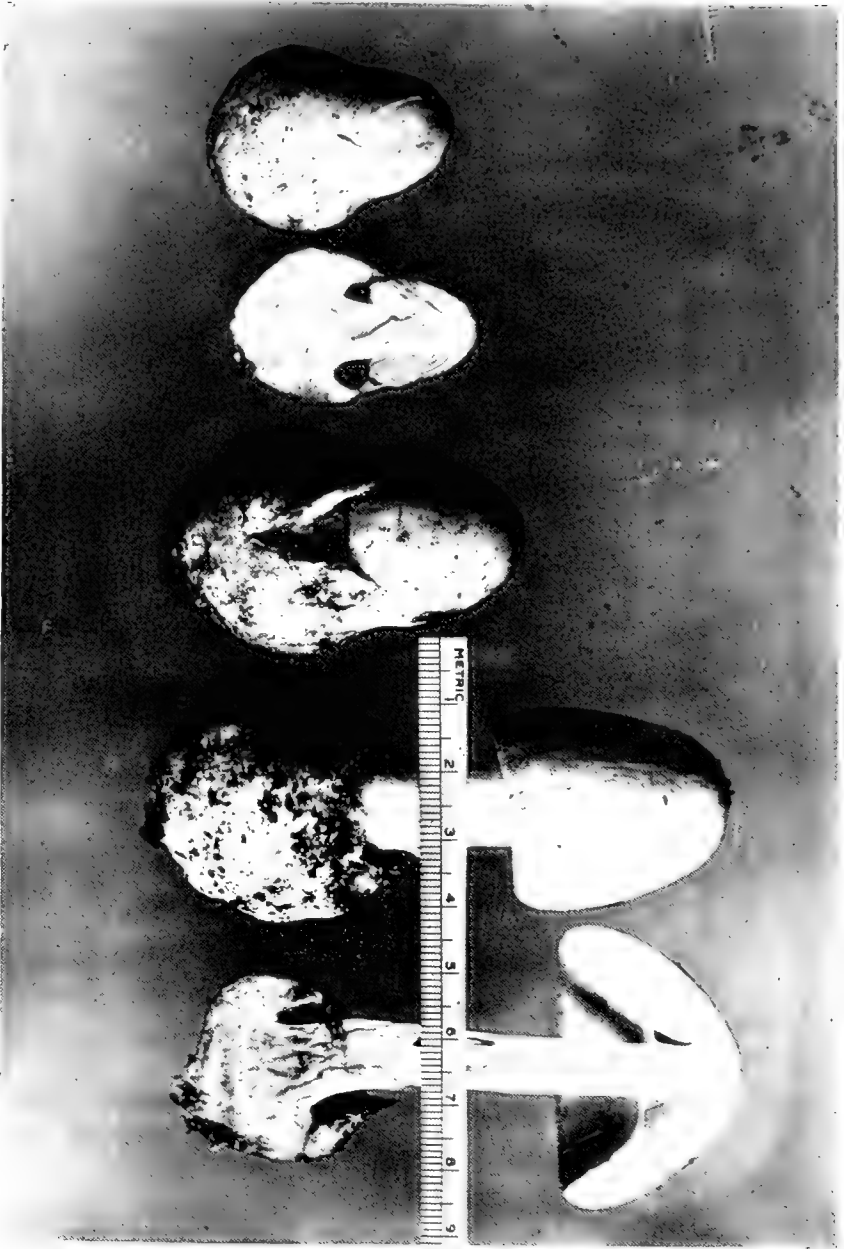
The life history of the fungus plant begins, not in a seed, but in a spore. A single spore is usually too small to be seen with the naked eye, and consists of a tiny bit of living protoplasm enclosed within a

membrane or wall as an egg is enclosed in its shell. The spore is very light and may float about in the air for a very long time, or may be carried by the wind for many miles. When, however, it chanced to fall upon a suitable substratum, which is sufficiently moist and warm, it germinates, that is, a little threadlike hypha grows out from one side and into the substratum, and there it continues to grow and branch and forms the mycelium or plant body.

The mycelium sometimes grows quite rapidly, but sometimes rather slowly, and it may take weeks or months or even years for it to mature sufficiently to be ready to produce fruit. When it has matured and the conditions for fruiting are suitable, if it happens to be a fungus that produces umbrella-shaped mushrooms, little knots or knobs appear, here and there, on the threads of the mycelium. These are very small at first but they gradually enlarge and finally become large enough so that they begin to project above the surface of the soil or other substratum. These structures are developing fruit-bodies or mushrooms, and in this very young stage they are spoken of as "buttons" or button stages. If we were to cut one of these buttons in two, lengthwise, we would find that it is already a little umbrella, but the umbrella is closed and is entirely covered with a membrane or veil which is called the outer or universal veil. Page 416 shows several stages in the development of one of these buttons into a mushroom. The species shown there is *Amanita verna*, "the destroying angel", a very pretty but deadly-poison plant. It will be seen from the photograph that as the button grows the outer veil, after being stretched to its limit, is broken. In this species it splits at the top and remains at the base of the stem as a cup-like structure, sometimes called the "death-cup", but more properly called the volva. The great majority of mushrooms, however, do not have a volva, because the outer veil is torn loose at the bottom and remains wholly or in part on the top of the mushroom, or is so thin and delicate that it disappears entirely, and no trace of it can be seen.

There is a second veil, called the inner veil, which extends from the outer edge of the top part of the mushroom to near the upper end of the stem. When the umbrella opens up, this veil is stretched to its limit and finally gives way. In the case of *Amanita verna*, and a large number of other species, it is always torn loose at its outer edge and remains on the stem, forming a ring around the stem. In some species, however, it tears loose from the stem and clings to the outer edge of the umbrella, and in a very large number of species it is so delicate that it very quickly shrivels away and is rarely seen at all. The fate of these two veils, as the mushroom develops, is very important, as we shall see later, in the classification of mushrooms.

Amanita verná, showing development from the button stage to the mature mushroom.



STRUCTURE

Let us now examine a little more closely the structure of a mature mushroom of the umbrella type. We find that it consists of a stem, or stipe, and an expanded portion which is called the cap, or pileus. If our mushroom happens to be an *Amanita* it will have also a cup-like structure, or volva, at the base of the stem, and a ring, or annulus, farther up on the stem. There are some kinds of mushrooms which have a volva but no ring, others which have a ring but no volva, and many which have no ring and no volva. Also the character of these structures, when present, differs greatly in different kinds of mushrooms. The ring may be very large and thick and conspicuous, or very small, delicate, and inconspicuous. Again, the volva, in some cases, is not at all cup-like, but clings to the base of the stem like a close sheath, or it may be broken up and appear as patches on the lower end of the stem.

We see also that on the under side of the cap there are numerous thin, bladeliike structures which extend from the stem to the margin of the cap. These are called the gills or lamellae.

If, now, we should cut a very thin slice from any part of the stem or cap and examine it with a strong magnifying-glass or a microscope, we should find that it is made up of a large number of threadlike hyphae similar to those that compose the mycelium, but that they are crowded so close together that they form a compact body.

The spores of the mushroom are produced on the sides of the gills. An examination of the surface of one of the gills under sufficient magnification would show us that certain of the hyphae which end there are modified into club-shaped structures, each club having four tiny projections at its end. At the end of each of these little projections a spore is borne. The club-shaped structure on which the spores are produced is called a basidium, and all fungi which produce their spores on basidia are called Basidiomycetes. (See Fig. 1.) Usually also there are present on the surface of the gills larger and longer club-shaped bodies called cystidia. These project much farther than the basidia and, at least in some kinds of mushrooms, serve to prevent the gills from getting too close together, and thus insure for the spores sufficient room to develop and be liberated.

SPORE PRODUCTION AND LIBERATION

The spores, as we said, are produced on structures called basidia. These basidia are microscopic in size, so that there is room for a very large number on each gill, and, since each basidium usually produces four spores, the spores are produced in very great numbers.

According to Professor Buller, of the University of Manitoba, a single large specimen of the cultivated mushroom, or meadow mushroom, *Agaricus campestris*, may produce as many as 1,800,000,000 spores, while a large shaggy-mane mushroom has been estimated to produce 5,240,000,000 spores. But some other kinds of mushrooms do even better, since a single giant puffball may produce as many as 7,000,000,000,000 spores. Of course such a production allows for an immense waste, and it is probable that not more than one in 20,000,000, and perhaps much fewer than that, ever succeeds in growing.

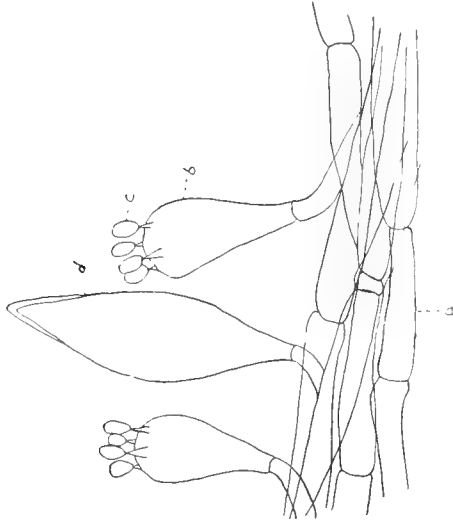


FIG. 1. Cross-section of a very small portion of a gill, showing hyphae, *a*; basidia, *b*; spores, *c*; and a cystidium, *d*. Greatly enlarged.

When the spores are mature they are discharged forcibly from the basidia. They are projected outward at right angles to the surface of the gill for a distance equal to something less than one-half the distance between two adjacent gills. This gives them a clear pathway to fall downward.

Certain kinds of mushrooms have a special means of making sure of the proper liberation of their spores. In the shaggy-mane mushroom (page 479), for instance, and in others belonging to the same group, the gills are very close together, but at maturity they deliquesce or dissolve into an inky fluid. This is in no sense comparable to the dissolving of chemical substances, but is a process of auto-digestion (self-digestion). The spores on these gills mature in a very definite order, beginning at the lower ends of the gills and ripening progressively upward. As the cap begins to open up and becomes bell-shaped, the lower ends of the gills are slightly separated from each other.

There the spores mature and fall, and at once auto-digestion sets in and removes the now useless parts of the gills, thus leaving a clear path for the fall of the spores from higher up. This continues until all the spores have fallen and the gills have entirely dissolved.

OTHER TYPES OF MUSHROOMS

So far we have been talking only of the umbrella type of mushroom. There are, however, a number of other types of fungi that are just as truly mushrooms and among which there are some valuable edible kinds. The oyster mushroom, *Pleurotus ostreatus* (page 529), for instance, has gills, but instead of being umbrella-like it is shelf-like and is attached at one side to the wood on which it grows. There are also a large number of shelf-like mushrooms which do not have gills at all, but, instead, we find on the under side of the shelf a large number of little pores or tubes. The spores are produced on the inner surface of these tubes. They are produced on basidia, just as in the gill fungi, so that if one were to examine the inner surface of one of the tubes, sufficiently magnified, it would look very much like the surface of a gill. Many of these pore fungi are woody or leathery and tough, and therefore not good to eat, but a few of them are fleshy and tender and very good. There are also a large number of fungi that are umbrella-shaped but have pores instead of gills. These are mostly fleshy and tender, some of them being edible and some of them poisonous.

There are a number of other groups of mushrooms that produce their spores on basidia. Among these are the hedgehog fungi (page 543) and the club fungi (page 541). The hedgehog fungi are so called because they bear many spinelike branches on the surface of which the spores are produced. These spines always hang downward, no matter in what position the fungus is growing, and this fact serves to distinguish the hedgehog fungi from the club fungi, since in the latter the branches always project upward.

Still another important group of mushrooms is the puffball group (page 545). These are particularly safe for beginners to use on the table since there are no poisonous ones among them. The larger kinds are all excellent if used while they are still pure white all the way through. They must always be cut in two and examined before using, however, since if one has begun to darken inside, although it will not be poisonous, it will be very bitter and will spoil a whole dishful. The spores of a puffball are produced on basidia that are scattered through the greater part of the interior of the mushroom, and when they are mature they can easily be "puffed" out by pressing on the sides of the puffball.

All of the groups of the mushrooms so far mentioned produce their spores on basidia and are, therefore, Basidiomycetes. There is another very large group of fungi, which includes a few mushrooms, which produces its spores in a very different way. This is the group of sac fungi or Ascomycetes, so called because their spores are produced within little sac-like structures. A great majority of the sac fungi have very small fruit bodies and grow as parasites on other plants. These are very important and very interesting as the causes of plant diseases, but they are not mushrooms. A familiar example of a mushroom belonging to this group is the morel (page 547), the sponge-like mushroom which is collected for the table by so many people in early spring. If we were to cut a very thin slice at right angles to the surface of a morel and examine it with a microscope we should find a large number of little elongated sacs, each one containing eight spores. These sacs are scattered thickly over the whole surface of the cap. There are several other types of mushrooms belonging to the sac-fungi group, some of them edible and a few of them slightly poisonous. The "truffles", which are so highly prized in certain European countries, are sac fungi.

THE ECOLOGY OF MUSHROOMS

By the ecology of plants we mean their relations to the environment in which they live. No fungus can ever go through its entire life history wholly independent of other living or dead organisms, nor without being greatly affected by heat, light, water, character of soil or other substratum, etc. The study of these various interrelations is not only extremely interesting but is necessary to a proper understanding of the life of mushrooms.

Dissemination.—An important ecological consideration is that of the methods by which the spores are scattered. As we have said, the spores are discharged forcibly, but in the case of the gill fungi, it is merely to get them away from the gill so that they can fall freely, and they need to be scattered by some external means. This is in most cases done by the wind. The spores of a mushroom are exceedingly light and the slightest air-current is enough to carry them away. For this reason very few of the spores fall below or near the fruit body that produces them. Practically all of them are caught up by air currents before they reach the ground, even in the case of short-stemmed mushrooms, and they may be carried by the wind for many miles. This is undoubtedly the most important means of spore dissemination. Spores often stick to the bodies of slugs, and other small animals that feed upon the mushrooms, and are disseminated in that way, but that is a method of minor importance.

There is another method of dissemination that may be of considerable importance. Since the spores are produced in such great numbers they must become scattered over the vegetation nearly everywhere, and herbivorous animals must eat them by the thousands. Certain kinds of mushrooms grow only on dung and it has been proven that in some of these, at least, the spores are not able to germinate until they have passed through the alimentary canal of some animal. The animal, therefore, by eating the spores, not only prepares them for germination but deposits them in a place suitable for their growth. An interesting case of this type of dissemination is found in a little fungus called *Pilobolus*. *Pilobolus* is too small to be called a mushroom but it is a very interesting plant. It grows only on dung, and when its spores are mature it hurls them with such force that they are thrown clear off from the dung pile and on to the surrounding grass. These spores can never grow on the grass, but, if they are eaten by some herbivorous animal along with the grass, they are much more certain to be deposited in a favorable place for growth than if they were simply blown about by the wind.

Gravity.—The force of gravity and its effect on plants is practically the same all over the surface of the earth. For this reason it is of more interest from a physiological than from an ecological point of view. But it will be of interest to note here, in passing, the importance of the way in which it affects mushrooms. It is the force of gravity which causes the stems of flowering plants to grow upward and the roots to grow downward. Likewise it causes the umbrella type of mushroom to grow upright and with its cap horizontal. If the mushroom encounters an obstacle as it comes up, or if grows from the side of a tree or stump, the stem always curves in such a way as to bring the cap into a horizontal position. The significance of this fact is that if the cap is not horizontal, so that the gills are vertical, the spores, when they fall, will strike against the sides of the gills, and when they do that they always stick fast and never fall off. So sensitive are the gills themselves to the force of gravity that if a cap is laid on a table with one side raised higher than the other by an object placed under it, the gills will gradually move in such a way as to bring themselves into as nearly a vertical position as possible.

Air.—The composition of the atmosphere, that is, the relative amounts of the different gases, and the dust particles in it, is of considerable importance to some kinds of plants, but ordinarily it is not of any great importance in connection with mushrooms.

Heat.—A certain amount of heat is necessary for the growth of any plant. There are very few kinds of mushrooms that ever grow at all during the winter. There are many kinds, however, that are

found only in early spring, others that occur only during the warmer part of the summer, and still others that grow only in autumn, while there are some that occur throughout the growing season. Also, there are many species that are found only in the warm countries of the tropics, while others occur only in temperate or colder regions. However, it is very difficult to say whether these differences are due primarily to heat or not. There are so many causes acting on plants at the same time that it is often impossible to single them out without performing control-experiments, and we are very apt to ascribe certain effects to heat when they really are due primarily to other causes. The differences between spring and summer or spring and autumn mushrooms are probably not due primarily to temperature, though the differences between tropical and cold-climate species may be.

Light.—Light is not nearly so important to mushrooms as it is to green plants. In fact most fungi grow better in the dark than in the light. There are, however, many species that grow only in the shade of other plants, while others grow only in open sunny places. The difference in the amount of light is probably not the only reason for this, but, in some cases, it may be the principal one. Many kinds of mushrooms, too, grow very well in the dark but cannot produce perfect fruit-bodies unless they have light. The fact that fungi can grow in the dark makes it possible for them to flourish in places where no other plants can exist. In underground caves, mines, etc., certain kinds of fungi are practically the only plant life.

Substratum.—The material on which a fungus grows, whether it be soil, wood, bark, dead leaves, or other substance, is spoken of as the substratum. There is scarcely any kind of substratum that is not suitable for some kinds of fungi, but many of the mushrooms are limited to very definite kinds of substratum. There are a number of species, for instance, that grow only on dung; others that are found only on leaf-mold or rich humus in woods; while still others prefer the soil of pastures, lawns, etc. There are many kinds, too, that occur only on wood, and, of these some are quite cosmopolitan and grow on various kinds of wood, while others are found only on the wood of a particular kind of tree. A number of mushrooms spend their lives as parasites on other living plants, but these will be spoken of again later.

Water.—As is the case with nearly all plants, water is one of the most important factors affecting the life of mushrooms. Plants are often separated into three groups based on the relative amount of water necessary for their successful growth. Those plants that can get along with a very small amount of water are called xerophytes, while those that require a very large amount are called hydrophytes, and those

that flourish best when supplied with a medium amount of water are called mesophytes.

We are apt to think of all fungi as requiring a great deal of water for their best development. That is true of a large number of fungi but by no means of all. The great majority of mushrooms are mesophytes, while others, especially some of the shelving forms that grow on wood, are pronounced xerophytes. Practically all of these require an abundance of water for the development of their fruit bodies but they do not flourish in a soil that is continuously saturated with water. For this reason one often finds that in a wood of which part is very low land and part higher land many more kinds of mushrooms are found on the higher land than on the low land. Nevertheless in the case of most mushrooms no fruit bodies are developed except during rainy weather so that a wet season is always a good mushroom season. Although some of the smaller mushrooms do literally "spring up overnight", the most of those that are large enough to be worth collecting for the table require at least two or three days for their development. During a dry season, therefore, a single rain is not likely to bring us a good crop of mushrooms. It must be followed within one or two days by a second or third in order to complete the development of those fruit bodies that were started by the first shower, and the very best time for mushrooms is when it rains a little every day or two.

Parasites and Saprophytes.—Plants which are green, or have green parts, such as grasses, trees, etc., make little if any use of ready-formed foods. They manufacture their own foods from the carbon dioxide of the air, water, and mineral salts obtained from the soil. But plants which have no "leaf green", as the fungi, cannot do this. Such plants may live upon, and get their food from, other living plants or animals, in which case they are called parasites, or they may live on the dead remains of plants and animals, and are then called saprophytes.

A considerable number of our mushrooms are quite destructive parasites. The heart-rots of forest trees are in most cases due to the growth of the mycelium of certain shelving mushrooms. There are also a few kinds, such as *Armillaria mellea* (page 489), which are parasitic on the roots of trees, and sometimes kill the trees which they attack. Many of the umbrella type of mushroom, as well as some puffballs, are more or less harmless parasites on the roots of trees and other plants, causing the production of structures known as mycorrhizas. These will be discussed presently. There are also a number of mushrooms that are parasitic on other mushrooms. The commonest of these, perhaps, is *Stropharia epimyces* (page 495), which is a parasite on the shaggy-mane (page 479) and the inky-cap (page 481) mushrooms. This plant never grows independently on the ground

and it has never been found on any other than these two mushrooms. It is probable that some time in the past it grew on the ground side by side with, and in competition with, the shaggy-mane and inky-cap, but in some way it gained the mastery over its "tender and tasty neighbors" and forced them to supply it with food, but by doing so it has made itself entirely dependent upon them. There are a few other species that grow as parasites on other mushrooms, but they are not often found.

Many of the wood-destroying mushrooms are parasitic for a part of their life and saprophytic during the remainder. That is, they start their life history in a living tree, but after the tree has been killed they continue to live upon it. These fungi are often spoken of as wound parasites, because the only way they can ever get a start in a tree is through a wound, caused by the breaking off of a limb or by other means. No tree would ever become affected with a heart-rot if it were never wounded or if its wounds were always properly taken care of, and one of the main objects of modern tree-surgery is to prevent mushroom spores from getting into the wounds of trees to grow and produce diseases.

There are also some wood-destroying fungi that live only saprophytically. *Lentinus lepideus*, for instance, is an umbrella-shaped mushroom which is very fond of growing on railroad ties. It used to cause a great deal of damage until the railroad men learned how to treat their ties with chemical preservatives which make them unfit for mushroom food. The umbrella-shaped mushrooms as a group have always been considered as pure saprophytes. Certainly very many of them are, but it is probable that many more than was formerly thought are at least partly parasitic.

Mycorrhizas.—Remarkably interesting structures from an ecological point of view are the so-called mycorrhizas. A mycorrhiza is a combination of root and fungus, that is, it is a root with a fungus either growing inside of it (endotrophic mycorrhiza) or growing on the outside and entirely covering it with a coat of mycelium (ectotrophic mycorrhiza). Only the very smallest rootlets can form mycorrhizas, because they are attacked by the fungus very soon after the rootlet is produced and the rootlet is always killed within a year, so that the mycorrhizas are never more than a year old.

In the case of those mycorrhizas in which the fungus is inside of the root, the fungus is usually parasitic on the root for a time and has very much the best of the bargain. Later on, however, the fungus gets tired of the struggle and the root gradually gets the upper hand and finally succeeds in digesting and devouring the fungus. Some of our forest trees, especially the maples, have this type of mycorrhiza

as also have many other plants, such as the orchids. Indeed, many of the orchids have become entirely dependent upon the mycorrhizal fungi. In some orchids the seeds will not germinate except in the presence of the proper fungus, while in others the seeds will germinate but the seedlings never grow beyond a certain stage unless they become associated with the fungus. The kinds of fungi that cause this type of mycorrhiza is in most cases not known, because their fruit bodies have not been seen. Only a few of those associated with the orchids have been identified and in no case were they found to be mushrooms.

The other type of mycorrhiza (ectotrophic), in which the mycelium of the fungus is mostly on the outside of the root, is found on many of our forest trees, such as ash, hickory, beech, linden, etc., as well as on many shrubs and herbaceous plants. These mycorrhizas were until recently not very well understood. They were first described about thirty years ago and for a long time after that it was thought that they were of great importance to the plants on which they occur, in that they helped to absorb from the soil certain materials which the plants would otherwise be unable to get. It is now believed, however, that they are of no benefit in any way to the plants on which they occur. The fungus is merely a parasite on the root. Ordinarily these parasites are quite harmless to a tree because only a small percentage of its roots are affected, and it really does not suffer any more than it would if we were to cut off a few of its roots or pull off a few of its leaves.

It seems likely, therefore, that these mycorrhizas are of much more importance in the life of the fungi which cause them than they are to the plants on which they are found. It is now known that most if not all of the ectotrophic mycorrhizas are caused by mushrooms. It is probable that very many of our late summer and fall mushrooms, especially those which grow in the woods, are capable of forming mycorrhizas on the roots of trees. The fruit bodies of these mushrooms are usually produced soon after the mycelium becomes attached to the roots, and it is possible that the fungi have great need of the particular kind of food that they get from the roots for the development of the fruit bodies.

Any one can observe these mycorrhizas by digging up some of the roots of trees growing in the woods in the fall of the year. They appear as little clusters of short, stubby root-branches, usually white or whitish, but sometimes colored—brown, yellow, red, etc.

Animal Relations.—We have already spoken of the ways in which animals aid in the scattering of mushroom spores. There are a number of other ways in which animals affect the life of mushrooms. Chief

among these perhaps is the destruction of the fruit bodies. Many animals feed upon mushrooms. Sheep, for instance, are very fond of certain kinds, especially the larger puffballs. Rabbits, also, make use of these delicacies whenever they get a chance, and it is said that turtles are quite fond of varying their diet by eating mushrooms. Slugs habitually feed upon various kinds of mushrooms, as likewise do crickets.

But the greatest amount of destruction is brought about by still smaller animals. Maggots, which are the young of small flies or gnats, are sometimes very destructive in beds of cultivated mushrooms. The eggs of these insects are usually laid just at the top of the stem where it is attached to the cap. They hatch in about three days, and at once bore into the mushroom and riddle it in a short time. Seven to ten days later they burrow into the ground, and after spending from four to seven days there they emerge as adult gnats, and each one lays about one thousand eggs for the next generation. So abundant are these gnats that in hot weather there are certain kinds of wild mushrooms that become infested so quickly that it is almost impossible to collect any that are fit to eat.

Mushroom mites are sometimes troublesome. These little insects are closely related to the cheese mites and they multiply even more rapidly. It is very difficult for mushroom-growers to get rid of them because they cling to the bodies of flying insects and are thus carried from place to place.

A very interesting interrelation of mushrooms and animals is found in certain tropical countries. Occasionally while one is walking through a tropical forest he sees in front of him a distinct green line which seems to be in motion. Closer examination shows this to be composed of a large number of ants marching single file and each one carrying over his back a piece of green leaf. These are leaf-cutting ants, or "umbrella ants" as they are sometimes called because of their habit of carrying pieces of leaves over their backs. They have made a visit to some tree and are now returning to their nest for the purpose of making a garden. The pieces of leaves will be chewed to a pulp and then spread out over a place that has been thoroughly cleaned off. On this they will plant the mycelium of a mushroom and in a few days they will have an excellent mushroom garden. These ants take good care of their garden, weeding out undesirable fungi, and in return they obtain an abundant supply of food. The mushroom which they cultivate is called *Rozites gongylophora* and is one of the umbrella type of gill fungi. Usually, however, the ants do not allow it to produce fruit bodies. Years of cultivation has caused the fungus to produce abnormal outgrowths—little, upright, club-shaped bodies—

on its mycelium, and these are what the ants eat. Whenever the mushroom is allowed to fruit it is necessary to clean off the garden and start over again.

Diseases.—There are not very many diseases of mushrooms other than those due to animals. One, which is sometimes quite serious among cultivated mushrooms, is called the mycogone disease. It is due to one of the sac-fungus parasites, and causes the mushrooms to become deformed and unfit for market. A similar disease attacks a number of wild mushrooms.

A very peculiar and interesting disease is found on *Lentinus tigrinus* (page 428), a gill fungus which grows on rotten wood. It is due to a parasitic mold which grows over the gill-surface to such an extent that the gills, usually, are entirely hidden. So common are the diseased forms of this mushroom that it was formerly thought to be a perfectly normal condition. Recently, however, in some unpublished studies by one of my students, Miss Esther Young, it has been shown that it is a disease due to a species of mold belonging to the genus *Sporotrichum*.

Quite recently a disease of cultivated mushrooms due to a species of bacterium has been reported.

Fairy rings.—Certain mushrooms are often found growing in definite rings a few feet to twenty or more feet in diameter. These have been known as fairy rings because long ago it was believed that when the fairies danced around in circles during the night a mushroom sprang up in each place where a fairy stepped. The cause of the rings is that the mycelium which starts from a spore grows out in all directions forming a circular patch of mycelium but as it grows it produces certain toxic substances which in time kill the older portions of the plant. Each year the mycelium advances a little and produces a crop of mushrooms so that the fairy ring increases in size from year to year. Such fairy rings are commonly formed by *Marasmius orcales*, *Agaricus silvicola* (page 473) and *Lepiota Morgani* (page 459), and sometimes by the giant puffball.

Luminosity.—The phenomenon of luminosity in living beings has been observed for a long time, though it is still not well understood. The fireflies that flit about just after sundown of a summer's evening are well known to every one. The light emitted by them is of short duration. Among the fungi there are certain species that emit light continuously, under proper conditions, for days or weeks. Most conspicuous among these is *Clitocybe illudens* (page 513), an orange-colored mushroom that grows in clusters about old stumps. The gill-surface of this mushroom is nearly always luminous, as can be ob-

PLATE LXXXVI



Lentinus tigrinus diseased by *Sporotrichum*, a parasitic mold.

served after dark or by taking the fruit bodies into a dark room. The mycelium of this plant is also luminescent, so that broken pieces of wood containing the mycelium often glow. The mycelium of *Armillaria mellea* (page 489) often causes rotten wood to glow in the same way.

Recently a Japanese species of *Pleurotus*, the genus to which our oyster mushroom (page 529) belongs, has been reported as luminous. Only the gill-surface glows, but it is said that several of the fruit-bodies together can emit enough light to enable one to read by it.

MUSHROOM-GROWING

Mushrooms have been grown for market in European countries, especially in France and England, for a very long time. In more recent years they have been grown on an increasingly large scale in this country, so that now one can purchase mushrooms in the market at any time at prices usually ranging from fifty cents to one dollar a pound. These are grown mostly in specially constructed mushroom-houses or in greenhouses, but any one who has a well ventilated cellar may grow mushrooms provided he can control the temperature to a certain extent. The temperature should be kept between 50° and 60° F. If it gets colder than this the spawn will not grow, while if it gets much warmer the spawn or the growing crop will mold.

In making up mushroom beds well-cured manure from a horse stable should be used. The manure must be cured without allowing it to dry out or burn, but, also, it must not become too wet. When it is placed in the bed it should be quite damp but not wet, and should be evenly distributed and packed rather firmly to a depth of about six to ten inches. After allowing several days for the temperature to become adjusted the bed will be ready to receive the spawn.

Spawn, which consists of the mycelium of a mushroom mixed with the substratum in which it grew, can be purchased from seed-houses in brick form. Each brick should be broken into eight or ten pieces and the pieces planted about a foot apart in the manure, being covered to a depth of one or two inches. From one to two weeks after planting the spawn will be seen to be growing and spreading. The bed should then be covered with about an inch of well-sifted, moist, light garden-soil.

The amount of moisture present is very important. The air surrounding the beds ought to be nearly saturated with moisture constantly, and for this reason the beds must be protected from drafts which would blow the moisture away. If the manure had the proper amount of moisture in it when it was put in, the beds probably will not need watering for several weeks. They must be watched closely

however, and when they begin to dry up water should be applied in a fine spray on and around the beds.

The first crop of mushrooms may be expected in about one and one-half or two months after spawning, and one should be able to pick some every day or two for two or three months. They should be picked before the inner veil breaks and sent to market immediately. When all precautions have been taken, however, there may be "crop failures" due to the presence of mushroom mites, which may destroy the mycelium as fast as it grows from the spawn, or to animal or plant parasites. When a bed has ceased to produce, the material of which it is made up must be entirely cleaned out and the bed remade with new material.

FOOD VALUE OF MUSHROOMS

The value of mushrooms as articles of food lies chiefly in their flavors. If we were to measure their food-value by the amount of energy that can be obtained from them, they would not rank very high. On that basis the food-value of the cultivated mushroom is just about the same as that of cabbage, less than one-half that of potatoes, or about one-twelfth that of wheat flour. Oysters have a food-value considerably less than that of potatoes but nevertheless most of us enjoy oysters because of their flavor, and most of us can enjoy mushrooms as soon as we learn a few species so that we can eat them without fearing that they will end our earthly existence. The market price of mushrooms is prohibitive to the great mass of people, but there are tons of excellent wild species which are allowed to decay in the woods and fields every year. These will furnish variety and flavor to the daily menus of thousands of families, at a cost only of the time taken to collect them, as soon as people have learned to distinguish them one from another.

POISONOUS PROPERTIES OF MUSHROOMS

The genus *Amanita* is by far the most dangerous group of mushrooms. *Amanita verna* (page 449) and its very near relative *Amanita phalloides* have probably caused more deaths in this country than any other species. The active poison in these and closely related species is known as the Amanita toxin. Its chemical nature is not yet understood and no antidote for it is known. The clinical symptoms in poisoning by these mushrooms are practically always the same. For six to fifteen hours after the mushrooms have been eaten no discomfort is felt. The patient is then suddenly seized by a severe abdominal pain, cramp-like in character and accompanied by vomiting. Paroxysms of pain and vomiting alternate with periods of remission, and

the loss of strength is very rapid. Death usually occurs in four to six days in children and in eight to ten days in adults, but if large quantities of the fungus are eaten, death may occur within forty-eight hours. One or two specimens are often enough to cause death. There is no satisfactory method of treatment. Of course medical advice should be obtained as soon as possible and every effort made to rid the alimentary canal of the poisonous material, but the absorption of the poison takes place so rapidly that even when the first symptoms appear it may be too late to save the patient. Stimulants should be employed freely in the hope of tiding the patient over the periods of weakness, and narcotics should be used to relieve the intense pains. Atropin has no effect at all on this poison.

Another group of Amanitas, to which belongs *Amanita cothurnata* (page 451), are entirely different in their poisonous properties. They are deadly poison, but in one respect they are not so bad as the other group, for there is an antidote for the poison. The poison is an alkaloid known as muscarin, and atropin is a perfect physiological antidote for it. The clinical symptoms are quite different from those in the case of *Amanita verna*. The first signs of trouble usually appear in one to five hours. The patient shows excessive salivation and perspiration, a flow of tears, and vomiting. Mental symptoms are also present, particularly giddiness with confusion of ideas, and, sometimes, delirium and violent convulsions. Atropin should be given at once and in large doses, and at the same time the alimentary canal should be emptied of the ingested material as quickly as possible. Prompt action on the part of a competent physician should in most cases save the patient.

Other poisonous mushrooms, such as *Clitocybe illudens* (page 513) and *Lepiota Morgani* (page 459), are usually not so dangerous as the Amanitas, and a physician, if called within a reasonable time, will, as a rule, be able to effect a cure.

COLLECTING WILD MUSHROOMS

The first and most important thing, to be remembered by the person who is going to collect wild mushrooms for the table is that he must collect only such species as he is perfectly familiar with, and only such specimens as he is perfectly sure belong to one of those species. Any one who will accept a mushroom merely because the gills are pink or because the "skin" of the cap will peel off, or merely because it is growing along with a well-known species or in a place where a well-known species has previously been collected, has no business collecting for the table, for he is certain, sooner or later, to get some poisonous specimens mixed in with the good ones. But

any one who is willing to use common sense, and reject all specimens that he is not sure of, may keep his table supplied with mushrooms with absolutely no danger; with no more risk than he takes when he goes into the vegetable garden and selects carrots, beets, and radishes, but rejects the wild parsnip which may grow as a weed there.

The beginner should collect at first only three or four of the more easily distinguishable species, such as *Morchella comica* (page 547), *Coprinus comatus* (page 479), *Agaricus campestris* (page 466), and the larger puffballs. Soon he will learn to distinguish also the other species of *Coprinus* and *Agaricus*. Then gradually he will add such species as *Pleurotus ostreatus* (page 529), *Pluteus cervinus* (page 487), some of the *Lepiotas*, etc., and he will be surprised to see how soon he will have two or three dozen excellent edible species on his list.

The very best time to go mushroom-collecting, if convenient, is early in the morning, since at that time all those which have opened up during the night are fresh and free from insect infestations. The only thing that is at all essential for the work of collecting is a basket to carry the specimens in. It is well, however, to take along a garden trowel, and to get into the habit of digging up the mushrooms instead of "picking" them. This is because there are some species which even the expert cannot recognize unless he has the whole of the stem. If the mushroom is picked or broken off above ground one of the most evident earmarks for identification, the volva (page 415), may be left behind in the soil.

All mushrooms that are not perfectly fresh should be rejected. Many cases of so-called mild mushroom-poisoning have been caused by the foolish eating of specimens infested by larvae. "Tainted" mushrooms are as unwholesome as "tainted" meat. No one would expect a leg of mutton which had been exposed in the woods for two or three days during hot weather to be fit to eat. No more should be expected of mushrooms, for although many of them will keep for a considerable time when the weather is cool, in warm weather they very soon become unfit for food.

While collecting the known edible species for the table many beautiful and interesting fungi will be found which are not discussed in this article. If one becomes interested in knowing what they are he must obtain one or more of the larger books mentioned on page 554. If there are some which cannot be identified with the aid of those books then it is permissible to send specimens to a known authority for identification. When this is done the specimens should always be accompanied by a letter giving full information as to the appearance of the fresh specimen, their place and manner of growth, etc. The specimens should be wrapped in oiled paper, or groceryman's

butter-paper, placed in a box, and mailed at once. Another way, which in some cases will serve even better, is to photograph the fresh specimen and then dry it, sending both the dried specimen and a copy of the photograph with the letter.

Whoever will learn a few species of mushrooms and begin collecting them for use will receive double remuneration for his time, for he will not only obtain excellent food absolutely free, but will get also the increased healthfulness that comes from stimulating walks in the open air. For any one who has already learned to love walking in the woods and fields there is no group of organisms that can furnish a more fascinating study than these lowly plants. The variety of form, color, and beauty is practically unlimited, and he who has never made a special study of any group of organisms can hardly realize the ecstatic pleasure with which the mycologist greets the first appearance each season of his old friends among the mushrooms, or with what unbounded joy he makes the acquaintance of species, to him, new or rare.

THE PREPARATION OF MUSHROOMS FOR THE TABLE

All mushrooms should be thoroughly washed, but they should be washed quickly and in cold water only, since warm water or a prolonged soaking in water injures the flavor of many kinds. All specimens that are not perfectly fresh or that are in the least infested with insects should be thrown away. A few kinds should be peeled, but as a rule peeling removes some of the best flavored parts. The stems of most species should be removed, though if the stems are very tender there is no reason why they should not be used. Mushrooms should not be kept long in a fresh condition. If they cannot be used at once they should be partly cooked and placed in the ice box, the cooking to be finished later.

As a rule mushrooms may be used in any way that oysters are used, or they may be cooked along with oysters, meat, poultry, or vegetables, or used as flavoring for soups and sauces, or for stuffing peppers. The better-flavored species should be cooked simply and seasoned lightly, while those of poorer quality may be improved by more elaborate cooking and more thorough seasoning. A few species that are slightly bitter when raw should be parboiled.

The majority of mushrooms, perhaps, are best simply broiled or fried. To broil, the caps are placed, gills up, on a very hot broiling iron, sprinkled with pepper and salt, and a liberal piece of butter is placed on the gills. When the butter is all melted the caps are turned over for a minute or two and then served hot on toast. To fry, place the caps in very hot butter or oil, fry about three minutes, and serve

on hot buttered toast with a sauce of lemon juice, melted butter, salt, and pepper.

Some mushrooms are better baked or stewed. To bake, line the baking dish with thin slices of toast, fill with layers of mushrooms, seasoning each layer with salt, pepper, and butter, and bake for fifteen minutes or longer according to the species. To stew the tougher species, boil them in water until they are tender, then pour off most of the water, add milk and stew a few minutes longer, season with salt, pepper, and butter, thicken with flour or corn-starch, and serve hot.

The following recipes are selected from Bulletin No. 175 of the United States Department of Agriculture:—

Fried Mushrooms.—Beat the yolk of an egg with a tablespoonful of water, and season with pepper and salt. In this, dip each cap and then dip into fine cracker crumbs or corn meal. Have butter or cooking oil very hot in a frying-pan. Fry slowly on each side five minutes. A sauce can be made by thickening the butter or oil with flour and adding milk or cream. If desired, serve on toast. A smooth, thin tomato sauce is also excellent.

Mushrooms baked with Tomatoes.—In a baking dish arrange small round slices of buttered toast; upon each piece place a rather thin slice of peeled tomato, salted and peppered; upon each slice of tomato place a fine, thick mushroom, gill side up; in the center of each mushroom put a generous piece of butter, season with salt and pepper. Cover the dish and bake in a hot oven ten minutes; then uncover and bake for an additional five or ten minutes, as the mushrooms seem to require.

Peppers stuffed with Mushrooms.—Cut the stem end of the peppers and carefully remove all seeds and the white membrane; chop or break the mushrooms into small pieces, season with pepper and salt, press firmly into the peppers, and put a good-sized lump of butter on top of each. The water adhering to the mushrooms after washing will furnish sufficient moisture for their cooking. Arrange the peppers on end in a baking dish, having water, with salt, pepper, and butter, poured in to the depth of about an inch. Place the dish in a hot oven, cook covered fifteen minutes; then uncover and baste and cook for ten or fifteen minutes longer, or until the peppers are perfectly tender. An addition of chopped cooked chicken or veal to the mushrooms is a pleasing variation.

Mushrooms and Cheese.—Butter a baking dish, place in layers mushrooms broken in small pieces, bread crumbs, grated cheese, salt, pepper, and bits of butter. Continue until dish is filled, letting the top layer be a thin sprinkling of cheese. Cover and cook in oven for twenty minutes; remove cover for five minutes before serving.

Mushroom Patties.—Cut the mushrooms into small pieces, cook slowly in butter until tender, add cream or milk, pepper, and salt, and thicken with flour. Fill the reheated patty shells.

THE CLASSIFICATION OF MUSHROOMS

The true fungi, excluding bacteria and slime-molds, are usually grouped into three classes, the Phycomycetes, which includes the common molds, the Ascomycetes or sac fungi, and the Basidiomycetes. With the first of these classes we are not concerned since it does not include any fungi with fruit bodies large enough to be called mushrooms.

The second class, that of the sac fungi, includes a very large number of species that are important as the causes of plant diseases but are too small to be called mushrooms, and a relatively few species that may be called mushrooms. The only edible ones that are common in this state are the morels and some of their near relatives and a few of the larger cup-fungi (see page 553).

The third class, that of the basidia-producing fungi, is predominantly the mushroom group. The five groups of this class, to which most of our edible mushrooms belong, are the puffballs (page 545), the pore fungi (page 535), the hedgehog fungi (page 543), the club fungi (page 541), and the gill fungi. By far the greater number of both the edible and the poisonous forms are gill fungi. For this reason we need to consider a little further the way of classifying these. First, however, it will be necessary to understand the naming of mushrooms.

It will be noticed that whenever we have mentioned the scientific name of a mushroom we have used two words. This is because it is a rule among botanists that every plant shall be given a name which consists of two Latin or Greek words, or other words in Latin form, the first of which is the genus or group name and the second of which is the species or individual name. All those mushrooms that are indistinguishably the same kind are given the same individual or species name, and then all of those species that seem to be closely related are grouped together and given the same genus name. Therefore, just as there may be a number of human individuals all having the same "group" name, as Tom Jones, Sam Jones, and John Jones, so there may be a number of species of mushrooms all having the same genus name, as *Agaricus campestris*, *Agaricus arvensis*, *Agaricus silvicola*, etc. The name of the plant is usually followed by the name or initials of the person who first described the species, as *Agaricus campestris* Linn.

The various genera of gill fungi are distinguished from each other, in part, by the color of the spores. In some genera the spores are

white, in others they are pink, in others some shade of yellow or rust-color, in others purple-brown, and in still others they are black. A single spore of any mushroom is too small to be seen with the naked eye, but when a sufficient mass of them is obtained the color can readily be recognized. If the stem is removed from a fresh mushroom and the cap is placed, gills down, on a sheet of paper and covered with an inverted tumbler the spores will fall to the paper in great numbers, and within an hour or so an impression of the gill surface, consisting entirely of spores, will be formed on the paper. Such an impression is called a spore print (Fig. 2). One of the first things to do, then, when the genus of a species is in doubt, is to make a spore print to determine the color of the spores.

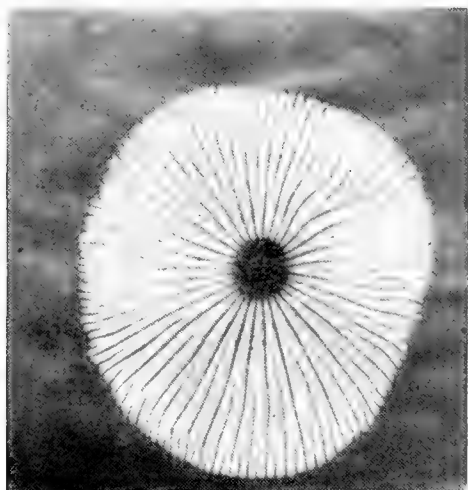


FIG. 2. Spore print of *Collybia radicata*.

USE OF THE KEY

In the key to the gill fungi on page 437 the genera are arranged in columns according to the spore color, and in the first column some other differences between genera are tabulated. Suppose now that on our first collecting trip we find a cluster of orange-colored mushrooms. We probably have seen the same kind before but we do not know its name. We at once cut the stem from one specimen and place the cap, gills down, on a piece of white paper and invert a tumbler over it. If we can spare another specimen we arrange it in the same way on a piece of black paper. Then with a specimen in hand, we turn to the key. At the beginning of the key we find, "I. Flesh vesiculose", and three

KEY TO GENERA OF GILL FUNGI

Spore color.....	White	Pink	Yellow	Purple	Black
I. Flesh vesiculose	Lactarius				
1. Juice milky	Russula.....		Russula		
2. Juice not milky.....					
II. Flesh not vesiculose					
1. Stem central					
A. Gills free					
a. Volva and ring present.....	Amanita				
b. Volva only present	Amanitopsis.	Volvaria			
c. Ring only present.....	Lepiota.....	Pluteus.....	Agaricus	Coprinus
d. Neither volva nor ring present	Pluteolus.....	Coprinus
B. Gills attached					
a. Stem fleshy					
A. Ring present	Armillaria.....	Pholiota.....	Stropharia	
B. Ring absent					
a. Gills adnate or sinuate....	Tricholoma.....	Entoloma.	Heboloma.....	Hypholoma	Panecolus
b. Gills mostly decurrent....	Cantharellus				
1. Gills much forked.....	Clitocybe.....	Flammula		
2. Gills not much forked.					
b. Stem cartilaginous					
A. Gills adnate					
a. Cap expanded	Collybia.....	Naucoria		
b. Cap conical	Mycena.....	Galera		
B. Gills decurrent	Omphalia				
2. Stem eccentric or absent.....	Pleurotus.....	Claudopus	Crepidotus		

lines below, "II. Flesh not vesiculose". We cannot determine whether the flesh is vesiculose or not without a microscope. But this fact need not worry us, for this is the only place in the key that seems to require the use of a microscope and we can easily dispense with it here. There are only two genera, *Lactarius* and *Russula*, that have vesiculose flesh. The first of these can easily be distinguished from all other genera by the presence of an abundance of juice, usually milky but sometimes colored, which exudes whenever the plant is wounded. The members of the other genus, *Russula*, are so characteristic in appearance (see page 445) that after we have collected a few of them we are not likely to mistake them for any other genus. We will remember also that the species of *Lactarius* and *Russula* are all midsummer plants, very few of them being found before July or after August.

We easily decide, therefore, that our plant does not belong to either of the above genera and we turn to the next line after "II. Flesh not vesiculose", which is "1. Stem central". Clear at the end of the key we find the corresponding "2. Stem eccentric or absent"; but we see at once that our plant has a stem which is very nearly if not exactly at the center, and we look at the next line "A. Gills free". A few lines below is the corresponding "B. Gills attached". The meaning is, free from or attached to the stem. On examining our plant we find that the gills are not free from the stem and we turn to the line following "B. Gills attached" which is "a. Stem fleshy". Further down we find the corresponding "b. Stem cartilaginous". This difference is sometimes rather difficult to determine, but if we break one of the fresh stems we find that it does not snap off like a piece of cartilage but seems to be tough, fleshy, and fibrous, and we look at the next two lines following "a. Stem fleshy". These are "A. Ring present" and "B. Ring absent". Since our plant has no ring on the stem we turn to the next two lines, "a. Gills adnate or sinuate" and "b. Gills mostly decurrent". Adnate means attached squarely against the stem, sinuate means attached to the stem and having a distinct notch at the stem-end, and decurrent means attached to the stem and extending down some distance on it. Since the gills of our plant are distinctly decurrent we turn to the next two lines, "1. Gills much forked" and "2. Gills not much forked". An examination of the gills of our plant shows that they are very seldom forked or branched, therefore the plant must belong either to the genus *Clitocybe* or the genus *Flammula*, depending on the color of the spores. Turning now to our spore print we find that the spores are white and we know that we have a *Clitocybe*. We now read over the descriptions and examine the photographs of the different species of *Clitocybe* and

easily determine that this orange-colored one is *Clitocybe illudens* and is not edible.

It must not be supposed that this key to the genera is in any sense complete. It includes all the genera represented in this article, and a few others, but in order to make it as little complex as possible a considerable number of less common genera have been left out.

THE PEPPERY LACTARIUS (EDIBLE)

Lactarius piperatus Fries

The genus name *Lactarius* is derived from the word *lac* meaning milk, and the species name *piperatus* is derived from the word *piper* meaning pepper. The name is very appropriate for this mushroom, for whenever any portion of the cap, especially the gills, is wounded, there exudes from the wound an abundance of milky juice which is very peppery to the taste.

Lactarius piperatus is usually the commonest species of the genus. It occurs on the ground in woods from July to October, and is a readily distinguished species.

The cap is at first convex, then expanded and somewhat depressed in the middle, and when fully mature it may be funnel-shaped. It is entirely white, smooth, even on the margin, and quite regular in shape. The cap is usually from 5 to 15 cm. (2 to 6 inches) broad.

The gills are very narrow and very much crowded. They are white or cream color and are attached to the stem, either adnate or decurrent. The gills are unequal in length and some of them are forked. The abundant white milk does not change color on exposure to the air. The gills, however, are sometimes spotted with yellow. The spores are white.

The stem is solid, smooth, and white. It is cylindrical or somewhat tapering downward, and from 2.5 to 5 cm. (1 to 2 inches) long. There is no ring and no volva.

Many people are afraid of this species because of its peppery taste. This quality entirely disappears with cooking, however, and the plant is perfectly harmless although it is not a general favorite with mushroom eaters. The following interesting paragraphs are quoted from McIlvaine:

"*L. piperatus* is a readily distinguished species. It is very common. In 1881, after an extensive forest fire in the West Virginia forests, I saw miles of the blackened district made white by a growth of this fungus. It was the phenomenal growth which first attracted my attention to toadstools. I collected it then in quantity and used it, with good results, as a fertilizer on impoverished ground.

"It has been eaten for many years in most countries, yet a few writers continue to warn against it. It is the representative fungus of its class—meaty, coarse, fair flavor. It is edible and is good food when one is hungry and cannot get better. It is best used as an absorbent of gravies."

Collected in Jackson and Union counties.

PLATE LXXXVII

Lactarius piperatus. Edible.



THE ORANGE-BROWN LACTARIUS (EDIBLE)

Lactarius volemus Fries

Lactarius volemus is a common and widely distributed species which often is quite abundant. It grows in damp woods from July to September, and when one specimen is found others are likely to be found near by. It grows under the same conditions and often along with *Lactarius piperatus*. The ground in the woods on the sandstone hillsides of Union and Jackson counties was fairly covered with these two species during the early part of July, 1916. This plant contains an abundance of white milky juice which flows out rapidly and falls from the plant in drops whenever the cap, gills, or stem are wounded. Unlike the milk of *Lactarius piperatus*, this is not at all bitter but is quite pleasant to the taste. It becomes quite sticky as it dries.

The cap is 5 to 12 cm. (2 to 5 inches) broad, at first convex, then expanded and plane, or with a slight elevation at the center. Old plants are sometimes depressed at the center. The surface is smooth or wrinkled. The color varies from dull orange to brown. The flesh is white, and quite thick and firm.

The gills are close together, white or sometimes yellowish, and attached squarely to the stem or slightly decurrent on it. The spores are white.

The stem is 3 to 10 cm. (1 to 4 inches) long, solid, hard, and often curved. The stem is colored like the cap but lighter. There is no ring and no volva.

This mushroom has long been known as an edible one and is considered excellent.

Collected in Jackson and Union counties.



Lactarius volvens. Edible.

THE GREEN RUSSULA (EDIBLE)

Russula virescens Fries

The green Russula occurs on the ground in the woods or sometimes in pastures or clearings that have never been plowed, but always in the vicinity of trees.

The cap is 5 to 10 cm. (2 to 4 inches) broad, at first nearly round, then convex, and finally flat. In old specimens it is often depressed in the middle. It is usually dry, rather thick and firm, but quite brittle so that it is very easily broken. The surface is green—a shade of green that reminds one of green cheese—with more or less regular, somewhat angular patches of a deeper green. The color is usually more pronounced toward the center of the cap, the center often being quite dark green and the color fading out toward the margin, which may be yellowish white. Occasionally specimens are found which have very little of the green color, this being replaced by yellowish white. In mature specimens the margin of the cap is somewhat striate. The taste of the raw flesh is mild and pleasant.

The gills are white, rather thin and narrow, and crowded. They are nearly free from the stem though usually not quite. Some of them are forked and others not, and there are usually some shorter ones intermixed with the others. The gills are very brittle, being easily broken to pieces. The spores are white.

The stem is stout and usually shorter than the diameter of the cap. It is smooth, white, and solid at first, but usually becoming spongy. There is no ring and no volva.

This mushroom usually occurs singly though several may occur very close together. It should be looked for during July and August. It is a great favorite with squirrels and slugs, and the tortoise is said also to appreciate its sweet, nutty flavor. I consider it one of the best and most delicious of edible species.

Collected in Champaign and Union counties.

PLATE LXXXIX



Russula virescens. Edible.

THE SLIGHTLY ILL-SMELLING RUSSULA (NOT EDIBLE)

Russula foetentula Peck

This mushroom usually occurs in the woods, often among fallen leaves, though I have found occasional specimens under trees on lawns. The specimens from which the accompanying photograph was made were collected among white oak trees in the "forestry", an artificial wood-lot on the campus of the University of Illinois.

This species is very easily recognized. The cap is nearly spherical at first, but when fully expanded is flat or somewhat depressed in the middle. It is rather thin, smooth but quite viscid, and conspicuously striate on the margin. The color is reddish yellow. The odor is like that of bitter almonds, and the taste is slightly bitter. The cap is 4 to 8 cm. (1.5 to 3 inches) broad.

The gills are thin and narrow and quite close together. They are attached to the stem but sometimes are very nearly free from it, and are whitish in color but not pure white. The spores are very pale yellow when collected in mass.

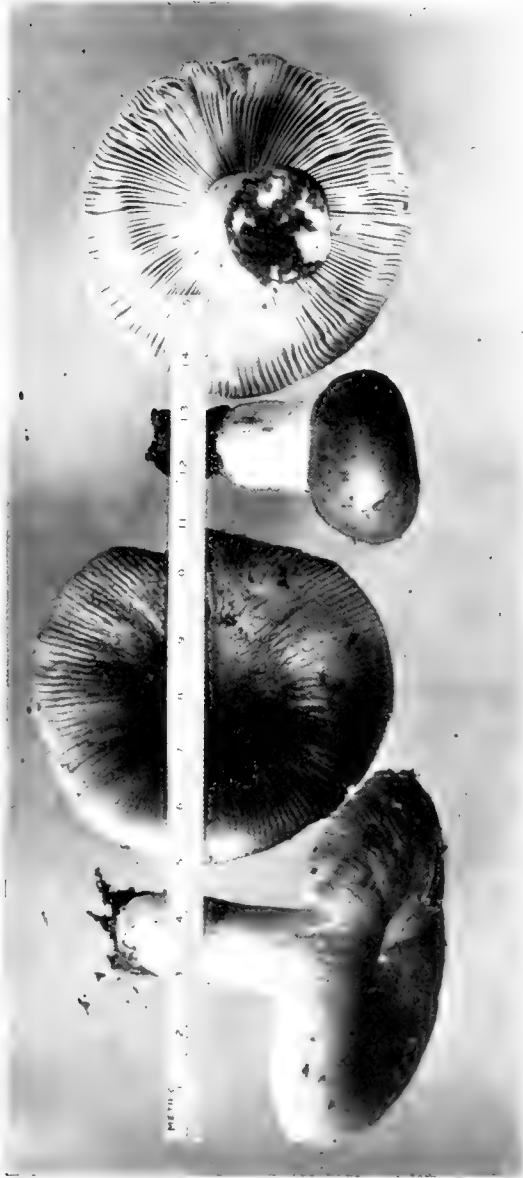
The stem is firm and smooth and often hollow. It is white or yellowish white in color but is usually stained with reddish brown spots at the base. The stem is usually from 2.5 to 5 cm. (1 to 2 inches) long. There is no ring and no volva.

R. foetentula was described by Dr. Peck in 1906 from specimens collected in New York. It seems not to have been found commonly elsewhere but it is common at Urbana and undoubtedly it occurs in other parts of the state as well. It may be looked for from the middle of June until late in August. It usually occurs singly, that is, not in dense clusters, although a considerable number of specimens may be found on a very small area.

An interesting thing about this mushroom is that it forms ectotrophic mycorrhizas (see page 424) on the roots of the white oak (*Quercus alba*). The genus *Russula* contains a large number of species all of which produce their fruit bodies during the summer, and it is probable that a number of them are capable of producing mycorrhizas. *R. foetentula*, however, is only the second one of the genus to be definitely reported as a mycorrhiza-former.

This species is not poisonous but it is not classed as edible because it has not only a disagreeable odor but a disagreeable taste as well, and would spoil the taste of any other mushrooms with which it might be cooked.

Collected in Champaign county.



Russula foetentula. Not edible.

THE SPRING AMANITA (POISONOUS)

Amanita verna Bull.

This mushroom is deadly poison. It has probably caused more deaths in this country than any other one species and possibly more than all other poisonous species together. This, together with the pure white color of the plant, has won for it the name "the destroying angel".

The whole plant is pure white. The cap is smooth, ovate at first and then expanded, and somewhat sticky when moist. It is from 2.5 to 10 cm. (1 to 4 inches) broad. The margin is smooth. The gills are free from the stem. The spores are white and very abundant.

The stem is smooth, often hollow or merely stuffed, and from 5 to 20 cm. (2 to 8 inches) long. It is usually bulbous at the base. The ring forms a broad collar high up on the stem. Nearly mature specimens are often found with the inner veil still stretched from the stem to the margin of the cap, thus completely covering the gills, but eventually it is torn away from the cap and falls loosely about the stem to form the broad collar. The volva is very conspicuous, with a prominent free edge, and hugs the bulbous base of the stem rather closely.

This very attractive appearing mushroom usually occurs in the woods and sometimes is quite common. It should be very carefully learned and as carefully avoided when collecting mushrooms for the table. It may be found throughout the season from May to November.

The active poison in this and closely related species is not well understood and no antidote for it is known. The symptoms of poisoning when specimens of this mushroom have been eaten are practically always the same. No discomfort is felt until six to fifteen hours have passed, when the patient is suddenly seized with a severe abdominal pain, cramp-like in character and accompanied by vomiting. Periods of pain and vomiting alternate with periods of remission, and loss of strength is very rapid. Death usually occurs in four to six days in children and eight to ten days in adults, but if large quantities of the fungus have been eaten death may occur within forty-eight hours. There is no satisfactory method of treatment. Medical advice should be obtained as soon as possible and every effort made to rid the alimentary canal of the poisonous material, but the absorption of the poison takes place so rapidly that even when the first symptoms appear it may be too late to save the patient. Stimulants should be employed freely in the hope of tiding the patient over the periods of weakness, and narcotics should be used to relieve the intense pain. Atropin has no effect at all on this poison and should not be depended on.

Collected in Champaign and Union counties.

Amanita phalloides, also poisonous, is closely related to *A. verna* and is very much like it except that the cap is dark colored.



Amanita verna. Poisonous.

THE BOOTED AMANITA (POISONOUS)

Amanita cothurnata Atkinson

The booted Amanita is a very pretty plant and occurs from August to October. It seems to prefer hills and highlands, or mountainous regions. The specimens from which the photograph was made were found on the higher land northeast of Crystal Lake Park, Urbana.

The pileus is fleshy but quite thin, at first nearly globose, then hemispherical to convex, and finally expanded. When specimens are very old the margin may be elevated. The pileus is usually white, though specimens may be found which are yellowish or tawny olive in the center. It is quite sticky when moist, and is covered with numerous, white, floccose scales which may wash off in heavy rains. The margin is finely striate. The pileus is from 5 to 15 cm. (2 to 6 inches) broad.

The gills are free, rounded next to the stem, and quite remote from it. They are always white. The edge of the gills is sometimes eroded or frazzly. The spores are white and very abundant.

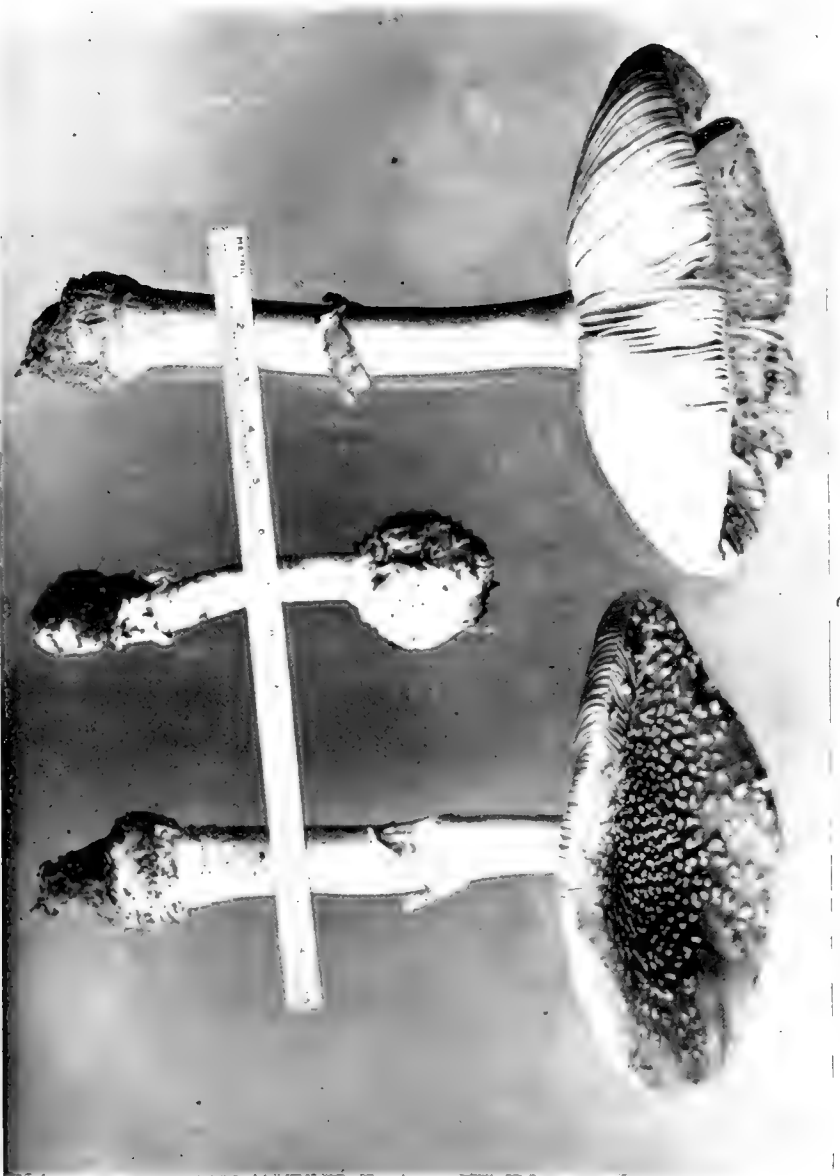
The stem is cylindrical, even, and bulbous at the base. The volva is adnate to the bulb, but just above the bulb the stem is margined by a roll of the volva, and this often looks as if it had been sewed at the top like the rolled edge of a garment. The stem is usually hollow even when quite young, and the surface is floccose, scaly, or sometimes nearly smooth. The ring is thin and membranous, and is usually a little above the middle of the stem. The stem is 5 to 15 cm. (2 to 6 inches) long.

The plant is very poisonous and sometimes occurs quite abundantly, but with the aid of the photograph and description here given, there should be no difficulty in distinguishing it from any edible species.

Atropin is a natural physiological antidote for the poison (muscarin) which occurs in this and several closely related species. When specimens of this mushroom have been eaten, the first signs of trouble are likely to appear in from one to five hours. The patient will show excessive perspiration and respiration accompanied by vomiting. Atropin should be given at once, by a physician, and in large doses, while at the same time every effort should be made to free the alimentary canal of the poisonous material. While poisoning by this mushroom is often fatal, yet it is not hopeless, and prompt action should in most cases save the patient.

Collected in Champaign county.

PLATE XCII



Amanita collyriata. Poisonous.

THE WARTED AMANITA (POISONOUS)

Amanita solitaria Bull.

Amanita solitaria is a very variable species which is widely distributed. It often occurs solitary, as its name implies, though not always. It grows sometimes in open woods, sometimes in grassy places, and the specimens from which the accompanying photograph was made grew on bare sand in the southeastern part of Kankakee county, Illinois. The forms which occur in these various habitats are so different that they have often been described as different species, but they all agree in having the stem elongated below into a root-like base and in being more or less scaly.

The cap when fully expanded is 5 to 15 cm. (2 to 6 inches) broad. In the button stage it is nearly spherical and as it opens up it becomes hemispherical, then convex, and finally nearly flat. It is usually white or nearly so. The surface is always somewhat scaly and may be very much so. The scales are sometimes large and pointed and close together, so that the cap resembles a pine cone. These large scales rub off easily and stick to the hands when the plant is handled, or they may be washed off by rains. In other plants the scales are smaller and in some cases are reduced to mere granules, or to flat patches. The flesh is white and has rather a strong odor.

The gills are white, free from the stem or attached to it by the upper angle, rather narrow, and quite close together. The spores are white.

The stem is 5 to 20 cm. (2 to 8 inches) long, sometimes enlarged toward the base, and usually rooting deep in the soil. The surface of the stem may be smooth or mealy, or scaly like the cap.

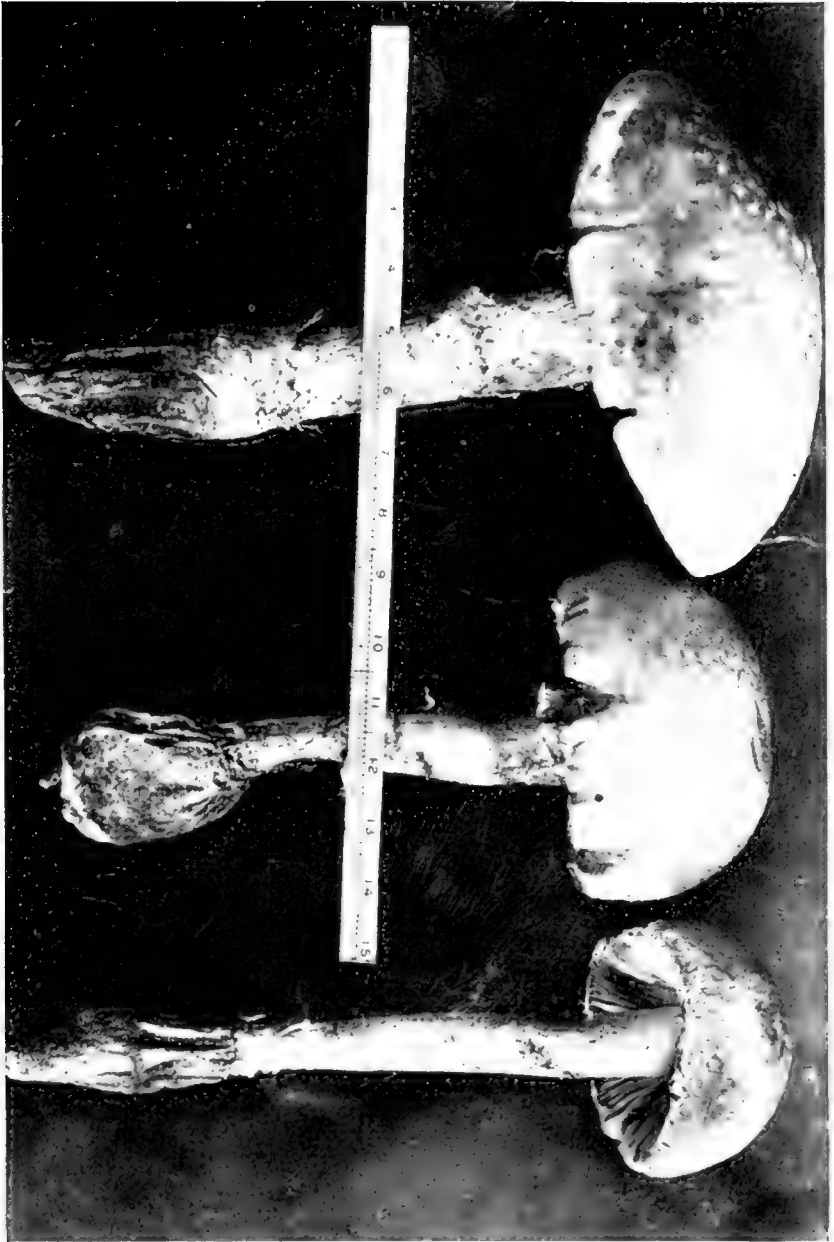
The ring is white. It is near the top of the stem and is quite fragile so that it is often much torn. Sometimes the inner veil, instead of forming a ring, is torn off from the stem and clings to the margin of the cap, or it may disappear entirely.

The volva is white and fragile so that it often breaks up and disappears.

Amanita solitaria has been reported as edible by a number of authors, but a small quantity of the deadly Amanita toxin, the same poison that is present in *Amanita verna*, has been found in this plant. For this reason it should by all means be classed as poisonous and should never be eaten.

Collected in Kankakee county.

PLATE XCIII



Amanita solitaria. Poisonous.

THE SHEATHED AMANITOPSIS (EDIBLE)

Amanitopsis vaginata (Bull.) Roz.

This mushroom occurs in the woods or in groves under trees and is quite common. Occasionally it occurs in open pastures or stubble-fields. It is edible, but there is a very poisonous species of *Amanita*, *Amanita sprata*, which looks very much like this mushroom except that the *Amanita* has a ring on the stem and the *Amanitopsis* has not. For this reason no one should eat *Amanitopsis vaginata* until he is very thoroughly familiar with it, especially since the ring of *Amanita sprata* occasionally is lost, in which case the plant looks very much like *Amanitopsis*.

The cap of *Amanitopsis vaginata* is from 3 to 8 cm. (1 to 3 inches) broad, at first bell-shaped but finally expands until it is nearly flat. The margin is thin and deeply striate, that is, it is marked by conspicuous furrows and ridges. The color of the surface may be gray, mouse-color, brown, yellowish, or white, but the flesh is always white.

The gills are white or whitish and free from the stem, and the spores are white.

The stem is cylindrical, tapering upward somewhat, but not bulbous at the base, and is from 8 to 15 cm. (3 to 6 inches) long. The stem may be smooth or covered with small scales or downy particles. Sometimes in dry weather the outer layer of the stem splits in such a way as to form large scales. The stem is either hollow or stuffed with a cottony pith. There is no ring. The volva is thin and fragile but prominent. It forms a large close sheath about the cylindrical base of the stem but is free from the stem except at the lower portion. If the plant is pulled up instead of being dug, the volva is very likely to be pulled off and remain in the ground, in which case the plant might easily be mistaken for some mushroom which lacks a volva.

Amanitopsis vaginata is a very pretty plant and some mushroom-eaters are very fond of it. The whole plant is very fragile and brittle and the flesh is thin, and since there is some danger of mistaking it for poisonous species of *Amanita* I do not recommend it. It may be found from June to November.

Collected in Champaign, Jackson, and Union counties.

PLATE XCIV



Amanitopsis vaginata. Edible.

THE SILKY VOLVARIA (EDIBLE)

Volvaria bombycina (Pers.) Fries

This beautiful mushroom is likely to be found in any locality, although usually not many specimens are found at a time. It grows on decaying wood of logs, stumps, wounded trees, etc. It occurs most frequently on maple and box-elder but occasionally it is found on oak, beech, and other trees. It may be looked for from June to October but it is more likely to be found during the latter part of this period. This is a very large and very attractive mushroom, occurring usually only one in a place, but sometimes two or more growing close together.

The cap is from 5 to 20 cm. (2 to 8 inches) broad, at first globose, then bell-shaped and finally convex. It is of a beautiful white color and the entire surface is covered with numerous silky hairs which stand out in the form of soft down. In older specimens the surface may become more or less scaly and may finally become smooth at the apex. The flesh is white and not very thick.

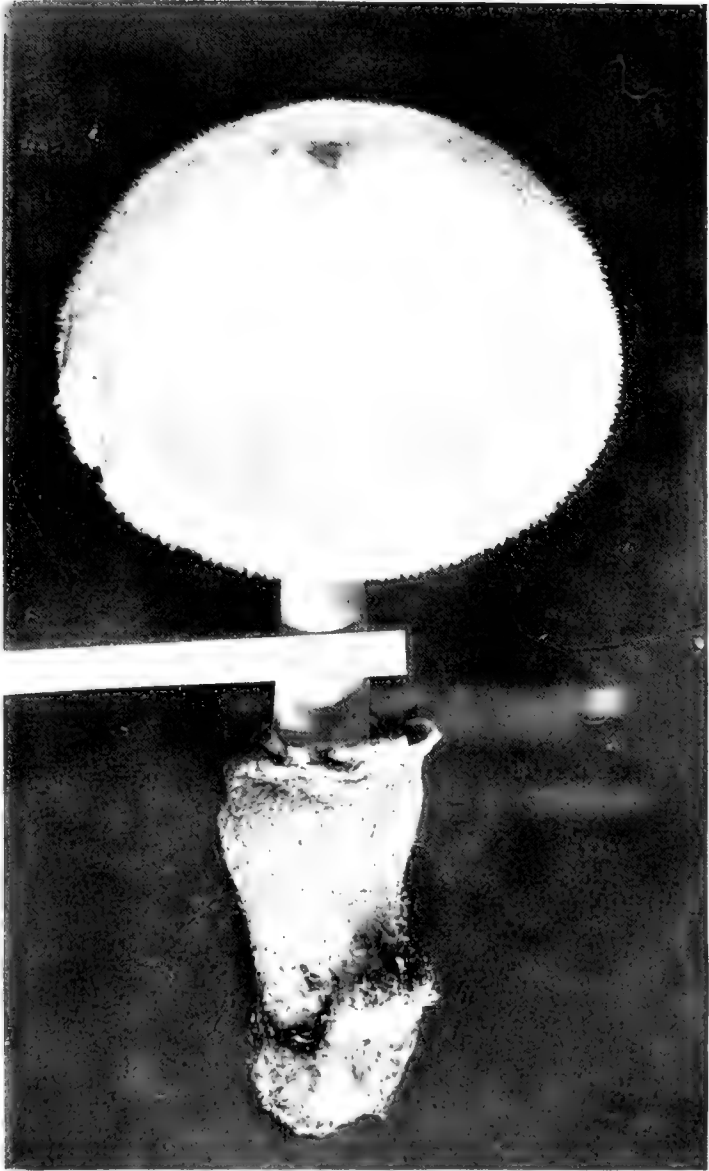
The gills are free from the stem, crowded close together, very broad along the middle, and flesh-colored. They are often toothed or ragged along the edge and do not extend quite to the margin of the cap. The spores are rosy pink in mass.

The stem is 7 to 15 cm. (3 to 6 inches) long, white in color, solid and smooth, and tapers evenly from the base to the top. When the mushroom grows on the top of a log the stem is straight, but if it grows on the side of a stump or tree-trunk the stem curves in such a way as to bring the cap into a horizontal position.

There is no ring but there is a volva. In this respect the genus *Volvaria* corresponds with the genus *Amanitopsis*, but it differs from that genus in the color of the spores. The volva is very large and thick and is usually somewhat sticky. The genus name *Volvaria*, which means a wrapper, was originally given to this plant because of the large bag-like volva.

Collected in Champaign county.

PLATE XCV



Volvaria bombycina. Edible.

THE GREEN-GILL MUSHROOM (POISONOUS)

Lepiota Morgani Peck

This is one of the largest and handsomest of mushrooms. It occurs in pastures and other open grassy places or in gardens and is sometimes quite abundant. It may be looked for from June to October, and will be found very easy to recognize. It often forms well-marked fairy rings a rod or more in diameter.

The cap is from 10 to 30 cm. (4 to 12 inches) broad; rather soft and fleshy, nearly globose at first, then expanded and sometimes depressed in the middle. The predominant color of the cap is white, but it is covered by a brownish cuticle which breaks up into scales except at the center. The flesh of both the cap and the stem is white, but when it is cut or bruised it changes to reddish and then to yellowish.

The gills are close together, quite broad, and entirely free from the stem. They are at first white, but when mature they are green. The spores are green when they are first shed but after exposure to the light for some time they gradually become yellow.

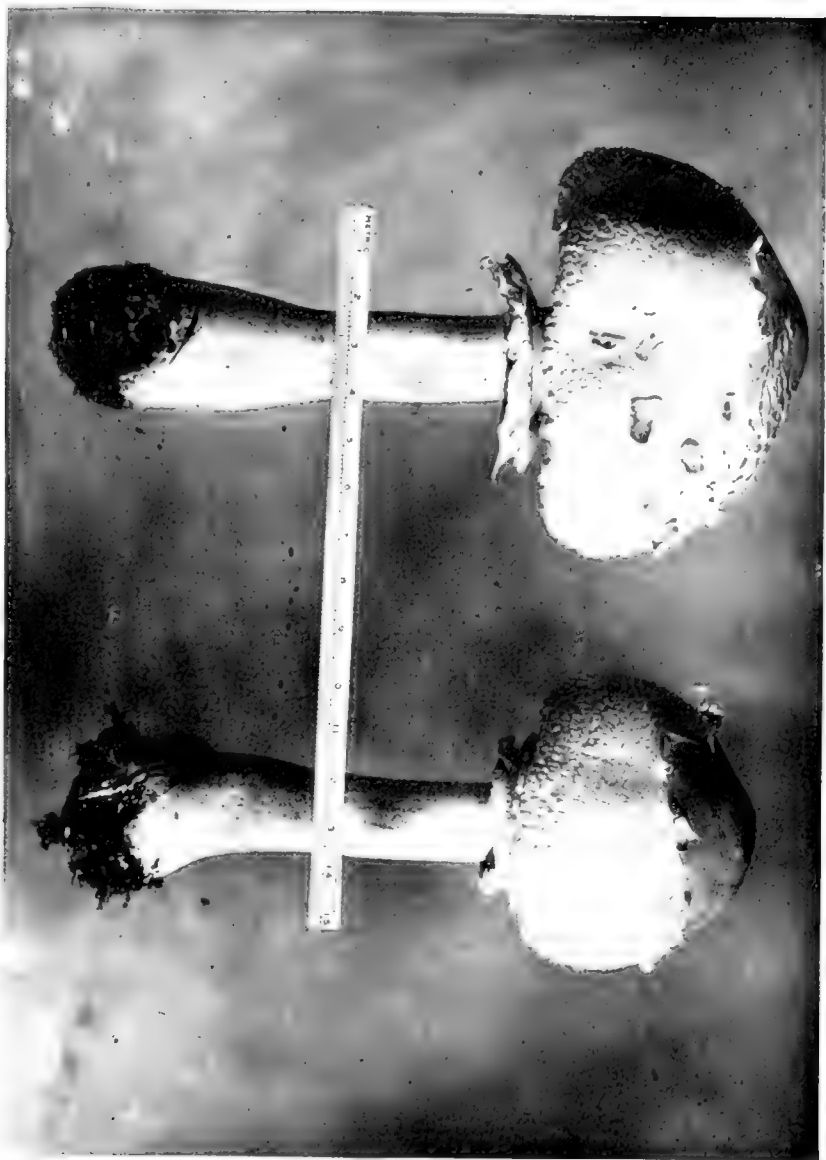
The stem is firm, cylindrical but more or less bulbous at the base, or sometimes tapering slightly upwards, and smooth. It is whitish but tinged with brown, and is from 15 to 20 cm. (6 to 8 inches) long. The ring is rather large and conspicuous and is usually movable on the stem. There is no volva.

This plant is not closely related to any other *Lepiotas*. It merely happened to be placed in this genus because there is no green-spored group and therefore no place for it. It is perhaps unfortunate that it was placed here for it has given a bad reputation to a really very dependable genus. Many people are afraid to eat any *Lepiotas* because they have heard that *Lepiota Morgani* is poisonous, but, in truth, there are no common species of *Lepiota* other than this one that are not perfectly safe, and the only shadow upon the good name of the genus has been cast by this green-spored mushroom which probably ought not to be in this genus at all.

It is said that some persons can eat *Lepiota Morgani* with perfect safety, but since it is poisonous to some it should be carefully avoided.

Collected in Champaign county.

PLATE XCVI



Lepiota Morgani. Poisonous.

THE CRESTED LEPIOTA (EDIBLE)

Lepiota cristata A. & S.

The crested *Lepiota* is a small plant, but it is common and often occurs very abundantly. It is found in the woods under trees, usually among dead leaves, and is often especially abundant along the borders of woods and in other grassy but somewhat shaded places. It occurs either in clusters or scattered, and may be looked for from May to September.

The pileus is somewhat fleshy but rather thin, at first bell-shaped or convex, then expanded and nearly plane. The surface is at first entirely dull reddish or reddish brown, but the cuticle soon breaks up into reddish or reddish brown scales, and the background of the surface is then white. The scales are often arranged in a concentric manner. They are far apart at the margin and progressively more numerous toward the center. The center of the cap remains smooth and uniformly reddish brown because it does not expand so much at this point and therefore does not crack. This gives the cap a crested appearance. The cap is from 1.5 to 4 cm. (.5 to 1.5 inches) broad.

The gills are white, and free from the stem but quite close to it. They are narrow and crowded close together. The spores are white.

The stem is whitish, slender, cylindrical, and hollow. It is usually smooth but sometimes has silky fibers on it, and is from 2.5 to 5 cm. (1 to 2 inches) long. The ring is small and white and sometimes breaks up and disappears. There is no volva. The white mycelium is often quite conspicuous and may be traced for three inches or more from the base of the stem.

This plant has a rather strong odor which is somewhat offensive; when cooked it is of good consistency and is sweet and pleasing to the taste. Although it is a very small mushroom, when it can be found in abundance it is well worth collecting.

Collected in Champaign and Wabash counties.

PLATE XCVII

Lepiota cristata. Edible.



THE GRAINY LEPIOTA (EDIBLE)

Lepiota granulosa Batsch

This is a small mushroom which occurs abundantly in the woods and in waste places during damp warm weather from August to October.

The cap is 1.5 to 6 cm. (.5 to 2.5 inches) broad, at first convex but becoming nearly plane, and sometimes has a slight elevation in the middle. The surface of the cap is made rough by numerous granular or bran-like scales and is often radiately wrinkled. The color is rusty yellow or reddish brown but becomes paler with age. The flesh is white or sometimes tinged with red.

The gills are close together, rounded at the end next to the stem, and close to the stem. They are nearly free from the stem but usually appear slightly attached to it, differing in this respect from most *Lepiotas* since it is characteristic of the genus to have the gills entirely free from the stem. The spores are white.

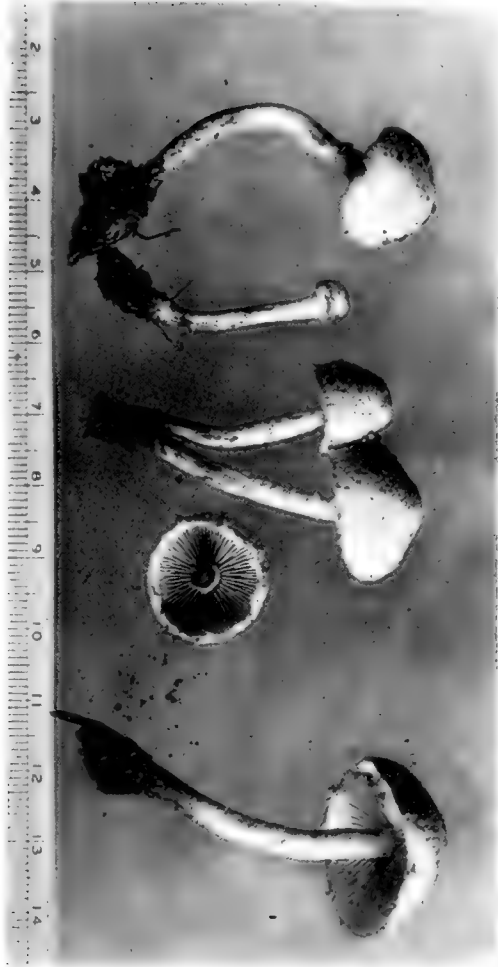
The stem is 2.5 to 6 cm. (1 to 2.5 inches) long, cylindrical or sometimes slightly thickened at the base. It is smooth and white above the ring, but below the ring it is colored and covered with granular scales like the cap. The ring is very slight, being little more than the abrupt termination of the scaly covering of the stem, and sometimes it disappears entirely. There is no volva.

There is a variety of this plant which is pure white at first, later partly turning red, and when dried becoming entirely red-tinged. There is also a variety which persistently remains pure white.

Although this is a small species a considerable number of individuals are often found on a small area, and since they are quite fleshy for their size and are of pleasing quality, they are well worth collecting when they can be found in any abundance. It is best to remove the stems and use only the caps.

Collected in Champaign county.

PLATE XCVIII



Lepiota granulosa. Edible.

THE SMOOTH LEPIOTA (EDIBLE)

Lepiota naucina Fries

This beautiful and excellent mushroom occurs in grassy places such as pastures, along roadsides, and sometimes on lawns, from June to November, but is usually most abundant during the latter part of the summer. In some years it is extremely abundant, while in others it is rather scarce. I have seen acres of ground white with it where for several years previously only occasional specimens had been found. Many people are afraid of this mushroom because of its minor resemblances to some of the poisonous Amanitas, but when one once becomes familiar with the characters and appearance of the plant there is no reason for making a mistake in collecting it.

The cap is soft but very fleshy and thick. It is at first globose, then expanded and nearly flat or with a blunt umbo or elevation in the center. The surface is smooth and snowy white or smoky white, and the flesh is thick and white. The cap is 5 to 10 cm. (2 to 4 inches) broad and usually very regular in shape.

The gills are somewhat crowded and entirely free from the stem. They are pure white or sometimes pinkish brown in very old specimens. The spores are white.

The stem is white, smooth or with fine fibers on its surface, enlarged at the base and tapering somewhat upward. It is from 5 to 10 cm. (2 to 4 inches) long. The ring is rather thin and delicate but distinct and conspicuous. It is sometimes lost in old specimens, but usually some remnants of it can be found. There is no volva.

This mushroom can be used in any way in which the common cultivated mushroom is used and will be found just as good. It probably could be cultivated for market just as profitably as is *Agaricus campestris* and its appearance is even more inviting. Its taste even when uncooked is mild and pleasant. The surface of the cap has a sort of kid-leather texture which is unmistakable when one once becomes familiar with it. Nevertheless it must be remembered that *Lepiota naucina* resembles in some respects the deadly Amanita, and one cannot exercise too great care in collecting and using only specimens that can be identified with absolute certainty.

Collected in Champaign county.

PLATE XCIX

Lepiota mucronata. Edible.



THE MEADOW MUSHROOM (EDIBLE)

Agaricus campestris Linn.

Agaricus campestris is the common "pink-gill mushroom" that is always obtainable in the market either fresh or in cans. Some people call this a mushroom and all others toadstools, erroneously thinking that this is the only one that is good to eat. It is produced in cultivation in great quantities not only in this country but in several others, especially France, Japan, and China. It is said that as many as 75 tons are annually produced in Chicago alone.

This mushroom occurs wild also, and is probably more widely known and collected for food than any other. It grows in fields and pastures and in lawns and along roadsides from July to October.

The cap is 4 to 12 cm. (1.5 to 5 inches) broad, at first somewhat globular, then round-convex, and, finally, expanded and nearly flat. The surface is at first nearly smooth but has a soft silky appearance because of numerous loose fibers. As the mushroom becomes older the surface sometimes becomes more or less scaly. The color varies from white to creamy white or light brown. The flesh is white. The margin of the cap extends somewhat beyond the ends of the gills.

The gills are close together, free from the stem, and rounded at the inner end. They are for some time hidden by the inner veil. When they are first revealed by the separation of the veil they are pink in color, but as the spores mature the gills gradually become purple-brown or blackish brown. The spores are dark brown or nearly black with a purple tinge.

The stem is 3 to 10 cm. (1 to 4 inches) long, nearly cylindrical or tapering somewhat toward the lower end, and white or whitish in color. The inner veil from which the ring is formed is white, silky, and very thin and frail. Often a part of it remains as fragments on the edge of the cap, while the ring which is formed from it on the stem is so frail that it shrivels as the mushroom matures and sometimes disappears entirely. There is no volva.

Although these mushrooms can be purchased in the market at any time at from fifty cents to one dollar a pound, any one who will take the trouble to learn the distinguishing characteristics of this and a few other species can keep his table supplied throughout the growing season at a cost only of the time it takes to collect them.

Collected in Champaign county.

PLATE C

Agaricus campestris. Edible.



THE FLAT-CAP MUSHROOM (EDIBLE)

Agaricus placomyces Peck

Agaricus placomyces occurs in lawns, parks, and the borders of woods from June to September. It is sometimes said to be associated with hemlock trees, but I find it abundantly at Urbana where hemlock does not occur, and, indeed sometimes it is not associated with any kind of tree, being found in open grassy places.

The cap is 5 to 12 cm. (2 to 5 inches) broad and rather thin. It is at first broadly ovate, then convex, and finally, when fully expanded, it is quite flat. In young specimens the surface is quite uniform brown in color, but as the cap expands the surface layer breaks up into numerous small brown scales and the ground-color then becomes white or yellowish white except at the center, where there is always a circular patch that is nearly smooth and uniformly brown.

The gills are close together and free from the stem. They are at first white but very soon become pink, and when old they are blackish brown. The spores are blackish brown with a tinge of purple.

The stem is 5 to 15 cm. (2 to 6 inches) long, rather slender, sometimes hollow, and somewhat bulbous at the base. It is white or whitish, but the bulb is sometimes tinged with yellow. The inner veil is quite interesting. It is double, that is, it consists of two layers, loosely joined together by threads. In young specimens it is found stretched from the margin of the cap to the stem. As the cap expands, the lower layer is usually torn into quite regular radiating portions. Later the upper portion is torn loose from the cap and the whole forms a broad ring on the stem. There is no volva.

This is a very pretty mushroom, and while the caps are rather thin they are of excellent flavor and can be used in any way in which the cultivated mushroom is used.

Collected in Champaign county.

PLATE CI

Agaricus placomyces. Edible.



THE FIELD OR HORSE MUSHROOM (EDIBLE)

Agaricus arvensis Schaeff.

The field mushroom, or horse mushroom, occurs in fields or pastures, or under trees on lawns, or in the borders of woods. I have found it frequently on several different lawns in the city of Urbana.

The pileus is smooth and dry, the surface sometimes more or less cracked in age, white or sometimes slightly yellowish, convex or conical, bell-shaped, and finally expanded. It is 5 to 15 cm. (2 to 6 inches) broad. It is usually quite thick and firm.

The gills are quite crowded, free from the stem, and usually broader toward the stem. When very young they are whitish, but as the spores mature they become pinkish and finally blackish brown. The spores are dark purple-brown when viewed in mass.

The stem is stout, nearly cylindrical or somewhat thickened at the base, smooth, hollow or stuffed, and 5 to 12 cm. (2 to 5 inches) long.

The ring is rather large and thick and is double, that is, it consists of two parts, the upper part being membranous, and the lower part much thicker, often yellowish, and usually split radially so that it remains as patches on the lower surface of the upper membrane. In this respect the horse mushroom resembles *A. silvicola* and *A. placomyces*, to both of which it is closely related.

When the stem is first cut there often exudes from the wound a yellowish liquid, and the whole plant usually becomes yellowish when dried.

This plant grows much larger than *Agaricus campestris*, and will be found delicious if used in any way in which that mushroom is used. It may be looked for from July to September. It sometimes occurs in large fairy rings, and sometimes is found in considerable quantities. Even if only a few specimens are found, they may be utilized very well by frying the caps quickly in a liberal supply of butter and serving on pieces of hot buttered toast.

Like many other mushrooms, *Agaricus arvensis* often seems to be partial to the vicinity of trees, though no mycorrhizal or other connection with the trees has yet been demonstrated.

Collected in Champaign county.

PLATE CII



Agaricus arvensis. Edible.

THE SYLVAN MUSHROOM (EDIBLE)

Agaricus silvicola Vitt.

Agaricus silvicola is a pretty and interesting mushroom which is very closely related to *Agaricus arvensis*, but it is not found in similar places. It occurs mostly in the woods, though it is said to occur sometimes in groves or under trees near woods. It may be looked for from July to October.

The cap is 5 to 15 cm. (2 to 6 inches) broad. It is convex and then expanded and nearly flat, but often with a broad elevation or umbo at the center. It is rather thin and brittle but quite fleshy. The surface is smooth and shining white, but sometimes tinged with yellow, and occasionally with a tinge of pink at the center. The flesh is whitish or tinged with pink.

The gills are close together, thin, tapering somewhat toward each end, entirely free from the stem and quite distant from it. The end toward the stem is somewhat rounded. The gills are at first white, but they very soon become pink and then blackish brown.

The stem is rather slender in comparison with the size of the cap and ranges from 5 to 20 cm. (4 to 8 inches) in length. It is smooth and white, except that it is often yellowish at the lower end and often becomes stained with yellow when dried. The stem is nearly cylindrical but is rather abruptly enlarged at the base into a bulb. The ring is usually thin, delicate and membranous, though sometimes it is thicker, and is easily torn, but it is broad and conspicuous and sometimes double like that of *A. arvensis* and *A. placomyces*. It is either whitish or yellowish. There is no volva.

This is a very graceful and attractive plant. It is intimately associated with trees, although no mycorrhizal or other connection with the trees has been discovered. It sometimes forms very perfect fairy rings. I have seen rings of this mushroom 15 feet or more in diameter extending around a tree in the woods, with the tree nearly at the center.

The taste of *A. silvicola* is high-flavored and spicy. It is an excellent mushroom to cook with meat and is said to be one of the best for making catsup. For those who prefer strong flavors in mushrooms, it will improve a dish of any mild-flavored species with which it is mixed.

Collected in Champaign county.

PLATE CIII



Agaricus sylvicola. Edible.

RODMAN'S MUSHROOM (EDIBLE)

Agaricus Rodmani Fries

Agaricus Rodmani is a very interesting mushroom because of its peculiar choice of a place to grow. It occurs only along the streets of cities, usually between the curbing and the walk or outside of the curbing if the street is not paved. I have found it in Urbana in perfectly bare hard soil just outside of the wagontrack on an unpaved street. More usually, however, it is found in grassy places. It is usually found during May and June though occasionally it occurs also in autumn.

The cap is at first rounded, then convex, and finally nearly plane. It is very firm and compact, thick, and heavy. The surface is smooth, or sometimes slightly cracked at the center, and white. Occasionally it becomes yellowish at the center. The flesh is white. The cap is 5 to 10 cm. (2 to 4 inches) broad.

The gills are close together and narrower than in most species of *Agaricus*. They are free from the stem but reach clear to it and are rounded at that end. When very young they are white, but they soon become pink or reddish pink and when old are blackish brown. The spores are dark purple-brown.

The stem is short, 2 to 6 cm. (1 to 2.5 inches). It is solid, nearly cylindrical, and not at all bulbous. Below the ring it is smooth and white, but above the ring it is often scurfy or covered with mealy scales.

The ring is very peculiar and characteristic. It is very thick and so completely double that it appears as two distinct rings on the stem. This is probably due to the fact that the very thick veil is at first attached to both the inner and outer surfaces of the edge of the cap and when it is broken loose from the cap it remains as a double ring on the stem. There is no volva.

The flesh of this mushroom is very firm and meaty, but it is crisp and not at all tough and its flavor is very agreeable. It is highly prized by some people who are familiar with its qualities.

Collected in Champaign county.

PLATE CIV

Agaricus Rodmani. Edible.



THE SLIGHTLY RED MUSHROOM (EDIBLE)

Agaricus subrufescens Peck

This is one of the prettiest of the large mushrooms. It occurs in woods and groves from June to September. It is said to occur also in greenhouses. According to Dr. McIlvaine it is an easy species to cultivate and has a number of advantages over *Agaricus campestris* for that purpose. It is very productive and keeps very well.

The cap is 7 to 12 cm. (3 to 5 inches) broad, at first nearly hemispherical and a single specimen growing alone is usually very perfect and regular in shape. The plant also occurs in clusters, however, and in that case the caps are somewhat irregular from mutual pressure. Later, as the cap expands, it becomes convex or somewhat flattened. The surface is covered with numerous silky hairs and minute scales. The color is light reddish brown. At the center the surface is usually smooth and a little darker in color. The flesh is white and has a flavor like that of almonds.

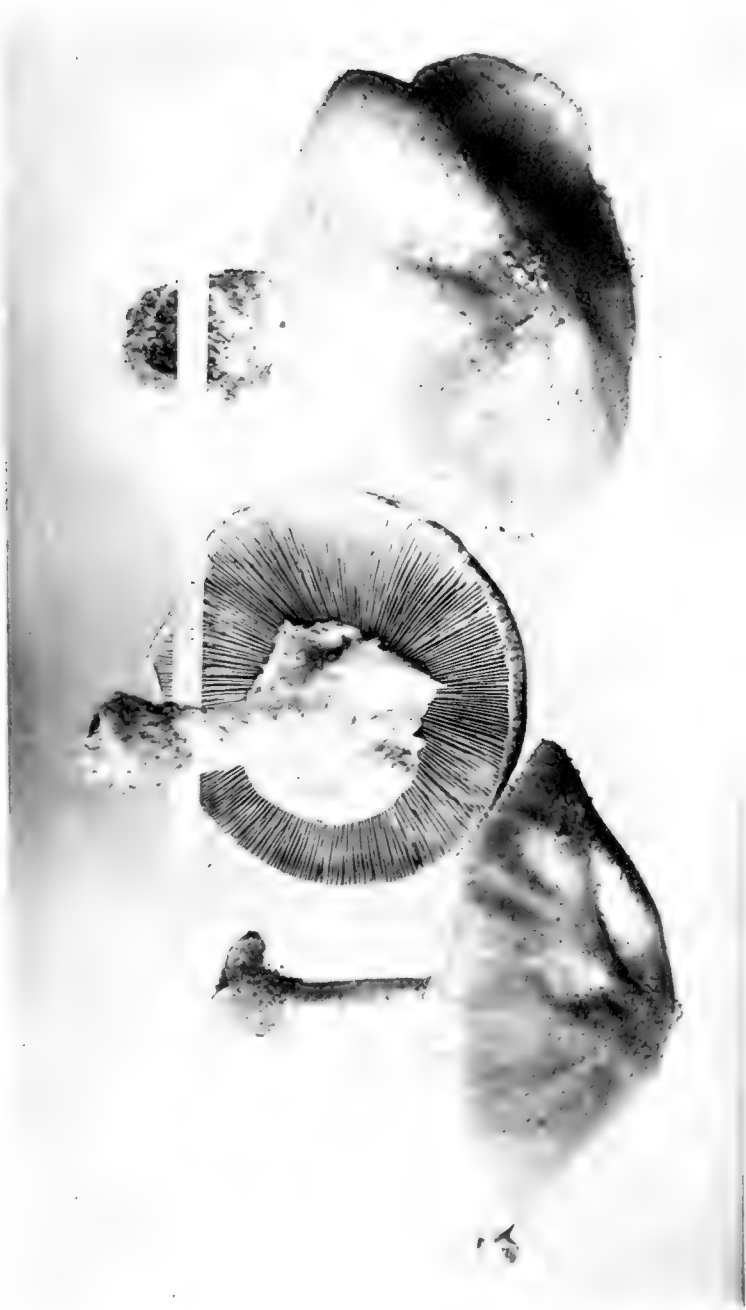
The gills are at first white, then pink, and finally blackish brown. They are entirely free from the stem.

The stem is 7 to 12 cm. (3 to 5 inches) long, white, and nearly cylindrical, but usually somewhat bulbous at the base. The stem is whitish, and somewhat scaly below the ring. The ring is thick and conspicuous, and scaly on the under side. There is no volva. The mycelium is white and often forms long root-like branches extending into the soil from the lower end of the stem.

This is considered an excellent edible species. There seems to be no doubt that the plants we have at Urbana are identical with those described by Peck from New York State. Whether they are also identical with *Agaricus silvaticus*, reported by Moffatt from the Chicago region, I am not certain.

Collected in Champaign county.

Agaricus subrufescens. Edible.



THE SHAGGY-MANE MUSHROOM (EDIBLE)

Coprinus comatus Fries

The shaggy-mane mushroom is a handsome plant which can scarcely be mistaken for anything else when one has once seen it. In fact the photograph alone is enough to identify it. It occurs in lawns, parks, and other grassy places, especially if the soil is richly manured. It grows either singly or in clusters, and may be looked for in wet, warm weather from May to late autumn. The fruit bodies grow very rapidly, so that one is likely to find a basketful waiting for him to collect them for breakfast, some morning in a place where there was not a sign of any the night before.

The cap is 5 to 15 cm. (2 to 6 inches) broad, soft-fleshy, moist, at first oblong or cylindrical and then bell-shaped, but seldom expanded. As it matures it usually splits at the margin along the lines of the gills. In very young specimens the surface is spotted with dark brown and white, due to the fact that the outer layer, which is dark brown, is torn and separated into patches or scales so that the white beneath shows between them. As the cap elongates, the brown patches become farther and farther apart, so that the mature plant is nearly all white.

The gills are broad, free from the stem, and crowded close together. They are at first white, but when the spores begin to ripen the gills become dark, then black, and finally they dissolve into an inky fluid which falls from the cap in drops. The spores are black.

The stem is sometimes very short but may be as much as 25 cm. (10 inches) long, the upper portion being concealed within the cap. It is nearly cylindrical, but usually tapers slightly upward, and is sometimes bulbous at the base. It is hollow, brittle, smooth or with some loose fibers on the surface, white or nearly so, and very easily pulled out of the cap. The ring is thin and usually movable. In mature plants it is apt to be found lying on the ground at the base of the stem or it may have disappeared altogether. There is no volva.

This is a most excellent edible species. Many people consider it much better than the cultivated mushroom. It is one of the best for stewing or for cooking with meat.

Collected in Champaign county.

PLATE CVI



Coprinus comatus. Edible.

THE INKY-CAP MUSHROOM (EDIBLE)

Coprinus atramentarius (Bull.) Fries

The inky-cap is not so pretty as the shaggy-mane, but it occurs under much the same conditions in lawns, parks, and other grassy places, especially if the soil has been richly manured. It grows either singly or in clusters, sometimes only two or three in a cluster but more often ten to twenty or more. The growth of a large cluster of these mushrooms exhibits considerable force, and will lift a very firmly sodded soil.

The cap is 3 to 10 cm. (1 to 4 inches) broad. It is at first egg-shaped or oval but it becomes expanded as it melts away into an inky fluid. The cap is soft and very tender and the surface is either smooth or scaly. The margin is usually more or less conspicuously ribbed and often is irregularly notched. The color varies from silvery gray to smoky brown.

The gills are broad and very close together. They are at first creamy white, then pinkish gray, and finally they become black and dissolve into an inky fluid. This melting away of the gills has been shown to be necessary for the liberation of the spores. The spores are black.

The stem is rather slender, 5 to 12 cm. (2 to 5 inches) long, hollow, smooth, and tapers somewhat upward. It separates from the cap very easily. The ring is rather slight, consisting only of an irregular elevation of threads near the base of the stem. Often it is washed off by rains and disappears altogether.

Although this mushroom is not so attractive as the shaggy-mane, it is more highly flavored and is considered an excellent species for stewing. Like all species of the genus *Coprinus* it is very easily digested. It should be cooked as soon as gathered, for its keeping qualities are very poor. It may be looked for after rains from May until late in the autumn.

Collected in Champaign county.

PLATE CVII



Coprinus abramentarius. Edible.

THE GLISTENING COPRINUS (EDIBLE)

Coprinus micaccus (Bull.) Fries

Coprinus micaccus may be found during wet weather from early spring until frost. It occurs at the bases of trees, stumps, posts, etc., or in grassy places where dead roots or sticks are buried in the soil. It is very common, and it is often possible to collect a basketful while walking around a city block. It usually grows in dense clusters with from ten to as many as a hundred or more in a cluster, though sometimes the plants are scattered on lawns or other grassy places.

The cap is 2 to 5 cm. (1 to 2 inches) in diameter and rather thin. It is at first ovate, then bell-shaped, and if the weather is not too damp it may become expanded, but in wet weather it is apt to dissolve into an inky fluid before becoming fully expanded. It is yellowish brown or tan in color, and the surface is marked by prominent striations extending from near the center to the margin. In young specimens the surface also bears numerous small shining scales which glisten in the light like particles of mica, and because of which the species name *micaccus* is given to the plant. In older specimens these scales are apt to disappear entirely.

The gills are narrow, crowded close together, and free from the stem. They are at first whitish, then darker, and finally black. In damp weather they dissolve into an inky fluid but in dry weather they often remain intact and become dry. The spores are black or sometimes dark brown.

The stem is 3 to 10 cm. (1 to 4 inches) long, rather slender and fragile, and hollow. It is nearly cylindrical in shape and smooth or somewhat silky on the surface. The ring is of the same type as that of *Coprinus atramentarius*, but it is very delicate and easily lost, so that it is seldom seen except in very young specimens that have not been washed by rains. There is no volva.

All species of the genus *Coprinus* are very easily digestible, and the glistening *Coprinus* has been said to be the most easily digestible mushroom that grows.

Collected in Champaign and Wabash counties.



Coprinus micaceus. Edible.

THE SPOTTED COPRINUS (EDIBLE)

Coprinus bulbosus Peck

This handsome plant occurs in the woods on and around decaying stumps and logs from May to October. It grows in large clusters and its numerous spotted caps give it a very striking appearance when one comes upon it suddenly on stepping over a rotten log or passing around a decaying stump. It is a common mushroom and often is very abundant.

The cap is 2 to 7 cm. (1 to 3 inches) broad, at first ovate, then bell-shaped, and sometimes expanded, but it usually dissolves into an inky fluid. It is fleshy but rather thin and fragile. In very young specimens the surface is uniformly brownish or straw-color, but the outer layer very soon breaks up into large, irregular scales or patches, exposing the smooth white surface of the cap and giving it the spotted appearance.

The gills are broad, crowded close together, and free from the stem. They are at first white or bluish white, then brown, and finally black, soon dissolving into an inky fluid. The spores are black.

The stem is 7 to 12 cm. (3 to 5 inches) long, nearly cylindrical, or tapering slightly upward. It is hollow and brittle, smooth, or nearly so, and white on the surface, and usually has white branching strands of mycelium extending from the base. The ring is slight like that of *Coprinus atramentarius*, to which this species is closely related. There is no volva.

Coprinus bulbosus is perhaps not quite so good as *C. atramentarius* but it is very good and well worth collecting. All coprini will be found very good if prepared in the same way as fried oysters.

Collected in Champaign county.

PLATE CIX



Coprinus ebulbosus. Edible.

THE FAWN-COLORED PLUTEUS (EDIBLE)

Pluteus cervinus Schaeff.

Pluteus cervinus is a very common and widely distributed mushroom which occurs from early spring until late autumn. It occurs on logs, stumps, etc., and also on the ground where roots or decaying wood is buried. Often successive crops are found in the same place week after week throughout the growing season. The plant is said to occur also on old sawdust piles.

The cap is 5 to 15 cm. (2 to 6 inches) broad, at first bell-shaped, then convex, and finally nearly flat. It is fleshy but quite fragile. The color and character of the surface are very variable. It is usually smooth or with only a few loose fibers, but sometimes the central portion is covered with minute hairs. In wet weather the surface is often somewhat sticky. The color varies from light brown to blackish brown, but occasionally specimens are found that are yellowish or even white. The flesh is white.

The gills are broad, close together but not greatly crowded, and free from the stem. They are at first white but become flesh-colored or pink as the spores mature. The spores are light pink.

The stem is 7 to 15 cm. (3 to 6 inches) long, solid and firm but rather brittle, and tapers slightly upward. It is usually white, with dark fibers or streaks on the surface, but sometimes it is colored like the cap. The stem is very easily removed from the cap. There is no ring and no volva. When the plant grows from the side of a stump or log the stem is apt to be curved in such a way as to bring the cap into a horizontal position.

Pluteus cervinus is one of the earliest of the larger mushrooms and is also one of the best. It is a great favorite on my own table. Fried in butter and served hot on toast it is delicious.

Collected in Champaign, Jackson, and Union counties.



Pholcus cervinus. Edible.

THE HONEY-COLORED MUSHROOM (EDIBLE)

Armillaria mellea Vahl.

Armillaria mellea is a very common and widely distributed mushroom which occurs in late summer and autumn. It grows at the bases of stumps and dead trees or from buried roots or from the living roots of trees. It is usually found in clusters, the number of individuals in each varying from a few to very many. It is a very variable species, so that the description of any one specimen is not likely to apply very well to the next specimen found, and a beginner is apt to collect a half-dozen specimens of this plant from different places and think he has as many species; yet the plant has an individuality which, when one is once familiar with it, is not likely to be mistaken in any of its forms.

The cap is 3 to 10 cm. (1 to 4 inches) broad, oval or convex at first and then nearly flat, but usually with a slight elevation in the center. The color varies from honey-color to nearly white, or it may be yellowish or reddish brown. Usually the central portion is adorned with erect, pointed, brown or black scales, while the margin is free from scales but is striate, especially in old specimens. Occasionally however, the entire cap is smooth. The flesh is white or whitish.

The gills are attached to the stem either squarely (adnate) or extending down the stem (decurrent). They are at first white, but, when older, are often stained with brown or rust-colored spots. The spores are white and very abundant.

The stem is 3 to 15 cm. (1 to 6 inches) long, and smooth or somewhat scaly. It is somewhat elastic and spongy or hollow within. The color is as variable as that of the cap, but the stem is usually somewhat darker toward the base. The ring is also very variable. It may be quite thick and persistent or very thin and membranous, and sometimes it disappears entirely. There is no volva. The mycelium often forms rope-like strands which are at first white but later become dark colored. They can usually be found by digging carefully where the fruit bodies are growing.

This mushroom is sometimes a serious parasite on the roots of trees. It is not ranked among the best of edible species because it is somewhat tough and not very high-flavored. The caps are meaty, however, and when chopped into small pieces they make good patties and croquettes. They are also useful for seasoning the gravies of various meats.

Collected in Champaign county.

PLATE CXI



Armillaria mellea. Edible.

THE HARD PHOLIOTA (EDIBLE)

Pholiota dura Bolt.

Pholiota dura occurs from May to October in pastures, lawns, parks, and other grassy places, and sometimes is quite common. The best time to look for it is during or after a few days of rainy weather.

The cap is 3 to 10 cm. (1 to 4 inches) broad. It is fleshy but firm, at first convex, then expanded and nearly flat or sometimes with an elevation at the center. The surface is at first even and smooth or nearly so, and often moist but not sticky. Later the surface becomes cracked into irregular patches. The color is whitish, though not a clear white, being tinged with yellow or tan. In mature specimens the margin is often turned upward.

The gills are attached to the stem either squarely or with a short tooth extending down the stem. They are quite broad and close together, and unequal in length, that is, short ones are interspersed among the longer ones. They are at first creamy white, then rusty brown, but with the edge often remaining white. The edge of the gills is often serrate or toothed. The spores are rusty brown in mass.

The stem is 5 to 10 cm. (2 to 4 inches) broad, rather slender, usually hollow, whitish or flesh-color, and smooth or nearly so. The stem is usually nearly straight, but sometimes in very wet weather the cap becomes too heavy for the stem and bends it over. Later, as it dries out, the response to gravity causes the stem to grow in such a way as to bring the cap into a horizontal position. If this is repeated several times, because of subsequent showers, the stem may have very peculiar crooks and curves.

In young specimens the inner veil is stretched from the stem to the margin of the cap. When it breaks it either tears away from the cap and forms a very definite ring on the stem, or it tears away from the stem and remains clinging to the margin of the cap, thus forming no ring at all. There is no volva.

Pholiota praecox, in which the surface of the cap remains smooth, is very closely related to this species. Both are good to eat.

Collected in Champaign county.

PLATE CXII



Pholiota dura. Edible.

THE SCALY PHOLIOTA (EDIBLE)

Pholiota squarrosa Bull.

This handsome and conspicuous mushroom occurs in small or large clusters on the trunks of trees, stumps, etc. or on the ground where there are buried roots or other decaying wood. It is often quite common and may be looked for from July to December, though it is usually not abundant until after the middle of August. It is easily identified and can often be seen from a considerable distance, especially in the latter part of the season after the leaves have fallen.

The cap is 3 to 12 cm. (1 to 5 inches) broad, fleshy, convex to bell-shaped and then flattened, or sometimes with the margin upturned, and usually with a prominent elevation at the center. The surface is dry, and the ground-color is yellowish or rusty but covered by numerous persistent dark brown scales. The flesh is rather thin, quite compact, and pale yellow in color.

The gills are rather narrow, close together, attached to the stem and with a tooth decurrent on the stem. They are at first yellowish or olive and later become rusty brown. The spores are rust-color.

The stem is 7 to 20 cm. (3 to 8 inches) long, nearly cylindrical but often tapering to a rather small base. The color is the same as that of the cap and the stem is clothed with scales, like those of the cap, up as far as the ring. The ring is near the top of the stem, downy and sometimes ragged, and of the same color as the scales. There is no volva.

The odor of this plant is sometimes rather disagreeable, but in some specimens it is scarcely noticeable. The taste of the young caps is sweet and mealy. As they become more mature they are less palatable, and should be used, therefore, when young. The young caps when cooked are of excellent flavor.

Collected in Champaign county.

PLATE CXIII

Pholiota squarrosa. Edible.



THE PARASITIC STROPHARIA (EDIBLE)

Stropharia epimyces (Peck) Atkinson

There is some dispute as to what is the correct name for this very interesting mushroom, but the dispute can scarcely be settled until some one makes a thorough study of the development of the fruit bodies, and for the present, therefore, the above name will serve as well as any.

This plant is usually not very common but it has occurred abundantly during the seasons of 1914 and 1915 in the vicinity of Urbana. It is of especial interest because it is parasitic on the shaggy-mane mushroom (*Coprinus comatus*). It has also been reported as occurring on the inky-cap mushroom (*Coprinus atramentarius*). The host plant is so deformed that it requires careful observation to determine to what species it belongs. It is usually irregularly top-shaped with the center deeply depressed, and the parasitic *Stropharia* grows from the bottom of this depression. It occurs either singly or in clusters, and may be looked for whenever and wherever the shaggy-mane or the inky-cap occurs.

The cap is 2 to 7 cm. (1 to 3 inches) broad, at first rounded, then convex, and finally expanded, fleshy, thin at the margin, but quite thick toward the center. The color is dirty white, sometimes becoming darker with age, and the surface is covered with numerous downy scales. Fragments of the inner veil are often found hanging to the margin of the cap.

The gills are attached to the stem but have a tendency to break away from it at maturity. They are at first gray, then dark brown. The spores are blackish with a purplish tinge.

The stem is 3 to 8 cm. (1 to 3 inches) long, fleshy, soft, and colored like the cap. The ring is near the base of the stem and is very delicate, sometimes scarcely noticeable. There is no volva.

This is an excellent edible species. The taste is exactly like that of the mushroom on which it grows. For this reason, any one who is fond of the flavor of the shaggy-mane and yet prefers his mushrooms plain-fried, may consider himself very fortunate if he finds the parasitic *Stropharia*, since the coprini are not firm enough to fry nicely while *Stropharia epimyces* is.

Collected in Champaign county.

PLATE CXIV



Stropharia epimyces. Edible.

THE SEMIGLOBOSE STROPHARIA (EDIBLE)

Stropharia semiglobata Batsch

This is a common and widely distributed mushroom. It grows on dung and on the ground on rich lawns, pastures, and other grassy places which have been recently manured, and may be looked for during wet weather from April to November. The plants are usually scattered, but sometimes grow in clusters, and occasionally two or three may be found joined together at the base.

The cap is 1 to 7 cm. (.5 to 3 inches) broad. In the smaller specimens the cap is almost perfectly hemispherical; in larger specimens it is more nearly flat. It is smooth but sticky when moist. It is rather thin at the margin but thicker and fleshy at the center, and the color is usually light yellow though occasionally it is nearly white or quite dark.

The gills are very broad and are attached squarely against the stem. They become nearly black but are sometimes more or less mottled with lighter and darker spots. The spores are blackish purple.

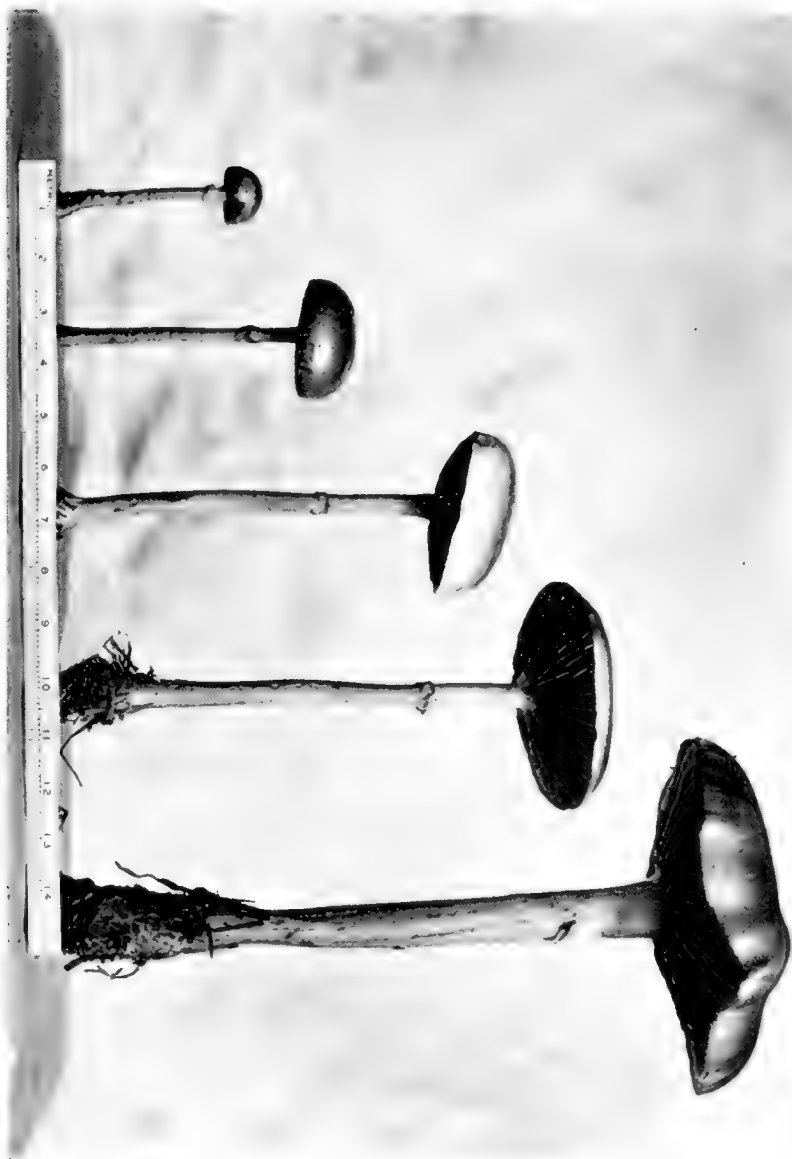
The stem is 3 to 12 cm. (1 to 5 inches) long, slender and hollow but firm, cylindrical, straight, sometimes slightly bulbous at the base, smooth, but sometimes sticky. The color is usually yellowish, but like that of the cap it varies from whitish to quite dark, and is often powdered with the dark spores. The ring is somewhat above the middle of the stem and when moist it is sticky or gummy. There is no volva.

The variation in size of this plant is quite remarkable. If one who does not know the plant were to find only the largest and the smallest specimens shown in the photograph he would scarcely think them belonging to the same species, but with the whole series before us it is easy to see that they are really all the same.

Although this mushroom has never become very popular for table use, the caps, when cooked, are really very good.

Collected in Champaign county.

Stropharia semiglobata. Edible.



THE WHITE TRICHOLOMA (EDIBLE)

Tricholoma album Schaeff.

This mushroom grows on the ground in woods, either singly or in clusters, from August to October, and is quite common.

The cap is 5 to 10 cm. (2 to 4 inches) broad, quite thick and fleshy but a little tough, and usually entirely white though sometimes tinged with yellow toward the center. It is at first convex, but becomes flat and finally depressed at the center. The surface is smooth and dry. The margin in young specimens is turned inward, but in older specimens it is straight. The flesh is white, without any decided odor, but with a slightly bitter taste.

The gills are attached to the stem and either have a distinct notch or are merely rounded at the stem end. They are somewhat crowded, quite broad, and white in color. The spores are white.

The stem is 5 to 10 cm. (2 to 4 inches) long, solid, firm, smooth, and white in color. There is no annulus and no volva.

The genus *Tricholoma* does not give us any very excellent edible species. *T. album* is perhaps as good as any of them. The bitter, unpleasant taste of the raw flesh is entirely overcome in cooking, and the plant is very good for soups or for patties.

Another species of *Tricholoma* that is likely to be found, is *T. personatum*, which is easily recognized by the lilac or violet-tinged color of the cap and stem and the violet color of the gills. It is considered better than *T. album* by some people.

Collected in Champaign county.



Tricholoma album. Edible.

THE WEeping HYPHOLOMA (EDIBLE)

Hypoholoma lacrymabundum Fries

Hypoholoma lacrymabundum may be looked for in suitable weather from July to October. It grows in wet places along ditches, under bridges, in borders of woods, and in open grassy places. The plants are sometimes scattered, but more often they grow in dense clusters of a few to many individuals. It is said to occur sometimes on decayed wood.

The cap is 2 to 8 cm. (1 to 3 inches) broad. It is at first convex, then expanded, often with a broad elevation of the central portion, and usually with irregular, radiating wrinkles. The surface is covered with silky threads or scales, which, however, are sometimes washed off by rains. The color is light or dark yellowish, darker at the center and becoming darker with age. Old specimens are often stained black where spores have fallen upon them or have been washed upon them by rains. The flesh is soft and brittle and whitish, but sometimes tinged with yellow or brown.

The gills are attached squarely against the stem and are usually notched (sinuate). They are at first whitish or light yellowish, but soon become darker and spotted with black or brown as the spores mature. The edge, however, remains whitish. In the morning or in wet weather minute drops of moisture are formed on the edges of the gills, which accounts for the common name—"The Weeping Hypoholoma". The spores are brownish purple.

The stem is 3 to 8 cm. (1 to 3 inches) long, straight or curved, colored like the cap, somewhat scaly as far as the attachment of the veil, and smooth above. The inner veil is hairy and rather delicate. It remains clinging to the margin of the cap, for the most part, and disappears with age.

Since this mushroom grows in dense clusters the caps are often made irregular from mutual pressure. The plant seems not to have been found abundantly in most regions, but it was very common at Urbana during the season of 1915. I have been unable to find any definite record of its edibility. I have eaten freely of it, however, and while I do not consider it one of the best of mushrooms, it is perfectly safe and compares very well with other species of *Hypoholoma*.

Collected in Champaign county.



Hypoholoma lacrymabundum. Edible.

THE APPENDICULATE HYPHOLOMA (EDIBLE)

Hypholoma appendiculatum Bull.

Hypholoma appendiculatum occurs from May to October in lawns, gardens, pastures, etc., and also in the woods. It is usually found in the immediate vicinity of trees or bushes, though not always. The plants grow either scattered or clustered and sometimes are very abundant.

The cap is 3 to 8 cm. (1 to 3 inches) broad. It is thin and fragile, at first convex, then expanded, and often with radiating wrinkles on the surface. The color is whitish, often yellowish toward the center, and the thin margin is sometimes tinged with purple. The margin is sometimes wavy and is often adorned with fragments of the white, woolly veil. When dry the cap is opaque, and when moist it is nearly transparent. In dry weather it often splits radially.

The gills are thin, narrow, close together, and attached to the stem. They are at first whitish but become purplish brown as the spores mature. The edges are often uneven. The spores are purple-brown.

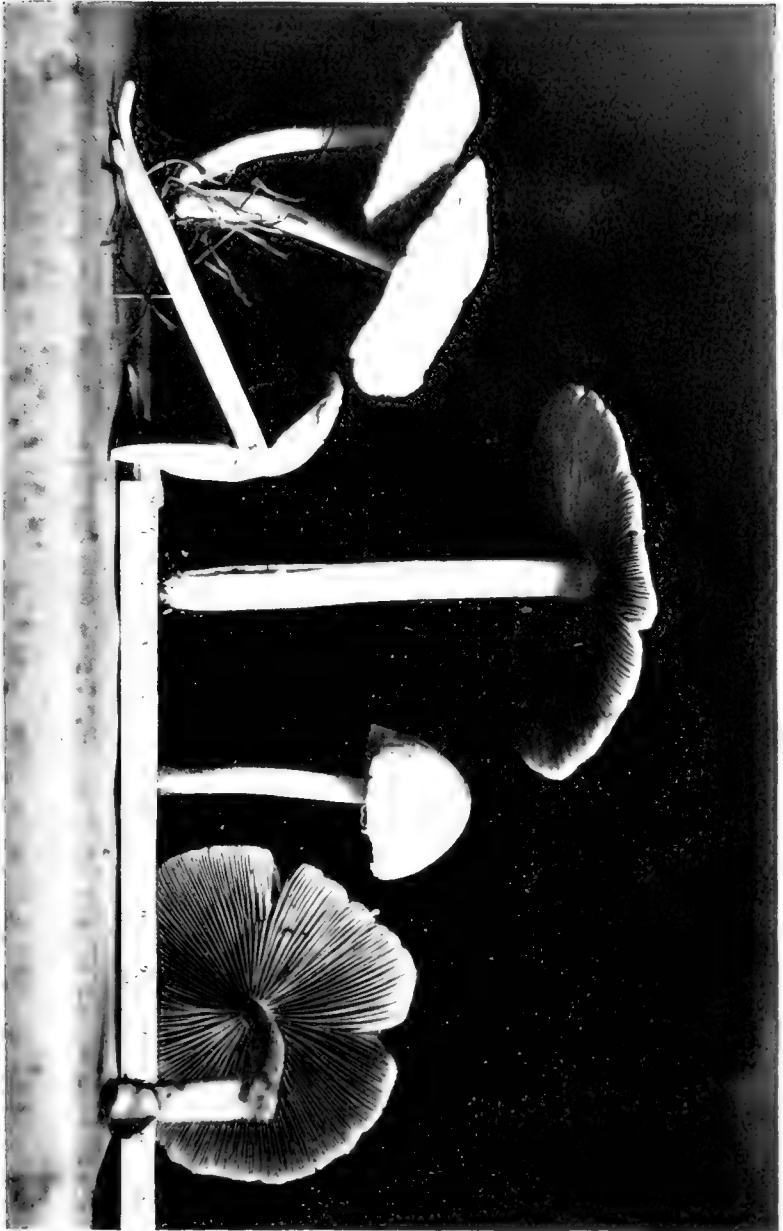
The stem is 3 to 10 cm. (1 to 4 inches) long, cylindrical, usually straight, slender, hollow, easily splitting, white, and smooth or slightly scurfy toward the top. There is no ring normally, and no volva. Sometimes, however, the veil remains partly or entirely on the stem, forming a more or less definite ring.

The plant is small but its abundance often makes up for its small size. The caps are very tender and good.

Hypholoma Candolleianum and *Hypholoma incertum* are both closely related to *H. appendiculatum* if not identical with it. It is, at least, not a serious thing to mistake one for another of these three species when collecting for the table, since all are equally good.

Collected in Champaign county.

PLATE CXVIII



Hypholoma appendiculatum. Edible.

THE EDIBLE CHANTERELLE (EDIBLE)

Cantharellus cibarius Fries

Cantharellus cibarius grows on the ground in woods from June to September. It is widely distributed and often very abundant in mid-summer of a rainy year.

The cap is 5 to 10 cm. (2 to 4 inches) broad, fleshy, rather thick, at first convex and with the margin incurved, then flat, and finally somewhat funnel-shaped. It is firm, with a smooth surface, but often quite irregular, with its margin wavy, and sometimes more or less one-sided, that is, with one side developed more than the other. The color is rich egg-yellow. The flesh is white, peppery to the taste when raw, and usually with a faint odor of apricots.

The gills are thick but so narrow that they appear like swollen veins. They are quite far apart, usually crooked, and fork or run into each other irregularly and extend down the stem somewhat (decurrent). They are colored like the cap. The spores are white or faintly yellowish.

The stem is short, firm and solid, smooth, often tapering downward, sometimes curved, and colored like the cap but usually a shade lighter. There is no ring and no volva.

This plant is highly prized everywhere as an edible species. The peppery taste of the fresh plants entirely disappears on cooking.

There is another plant, *Craterellus cantharellus*, which grows in the same situations as the edible chanterelle, often right along with it, and which very closely resembles it. The color, taste, and odor are the same. The *Craterellus* is classified in an entirely different family, however, because of the fact that it has no gills, the under side of the cap being perfectly smooth. But intermediate forms occur which are very difficult to classify, and there is some question whether the two plants are not really the same. At any rate both are equally good to eat, so that no harm can come from mistaking the one for the other. The photograph opposite this page shows both plants. The figure at the right is *Craterellus cantharellus*, the middle specimen is *Cantharellus cibarius*, while the two at the left are intermediate forms, which, however, would be called, by most collectors, *Cantharellus cibarius*.

Collected in Champaign, Jackson, and Union counties.

Cantharellus cibarius and *Craterellus cantharellus*. Edible.



THE FALSE CHANTERELLE (SLIGHTLY POISONOUS)

Cantharellus aurantiacus Fries

The false chanterelle is a common and widely distributed species which grows in the woods on the ground, or on rotten wood, from July to October. It is easily recognized by its orange-colored cap, and by the yellow gills—which are very regularly forked

The cap is 2 to 7 cm. (1 to 3 inches) broad, fleshy and soft, convex, then expanded and plane, and finally funnel-shaped. The margin is plane and even, or wavy and incurved—strongly so in young plants. The color varies from yellow to orange or even brownish, especially toward the center. The surface is smooth or slightly hairy, the hairs short and silky, especially toward the center. The flesh is slightly yellowish.

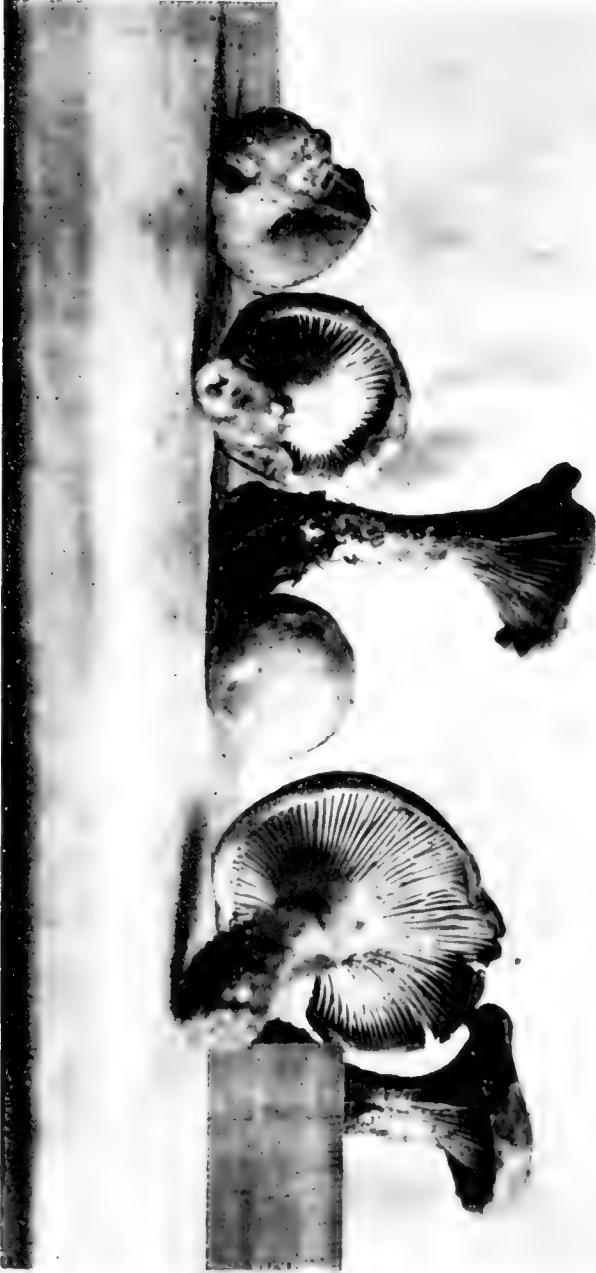
The gills are thin, blunt on the edge, close together, straight and regularly forked several times, and decurrent on the stem. The color varies from yellow to orange. The spores are white.

The stem is somewhat lighter colored than the cap. It is at first solid, then spongy and stuffed with a cottony substance, or sometimes hollow, usually tapering slightly upward, smooth, and often curved. There is no ring and no volva.

Although *Cantharellus aurantiacus* has been eaten by a number of people in this country with no evil results, yet it has generally been considered poisonous, especially in Europe, and, therefore, for the present at least, it had better be left alone.

Another species of *Cantharellus* that is apt to be found, is *C. cinnabarinus*. This is a small plant and very pretty, the whole plant being deep cinnabar-red. The gills are narrow, blunt on the edge, far apart, and branched. This species is edible.

Collected in Champaign, Jackson, and Union counties.



Cantharellus aurantiacus. Poisonous.

THE SWEET-SMELLING CLITOCYBE (EDIBLE)

Clitocybe odora Bull.

Clitocybe odora is very easy to identify because of the olive-green color and the pleasant spicy odor. It grows in grassy places in the woods or on dead leaves or twigs from August to October. The plants are either scattered or clustered.

The cap is 2 to 7 cm. (1 to 3 inches) broad, fleshy but tough, at first convex but soon becoming plane or nearly so. The flesh is quite thick and whitish, while the surface is olive-green, the color fading more or less with age. The surface is smooth and even, though the margin is often slightly downy. The cap is usually quite regular, though the margin is sometimes wavy.

The gills are broad, rather close together, and attached to the stem, either adnate or slightly decurrent. The color is white or greenish. The spores are white.

The stem is 2 to 5 cm. (1 to 2 inches) long, cylindrical or somewhat thickened at the base, solid, stuffed, or hollow. It is at first somewhat downy, but soon becomes smooth, though the base is usually covered with white filaments. The color of the stem varies from white to green. There is no ring and no volva.

The anise-like odor of this mushroom is very persistent, and the taste is very spicy. While the flavor is pleasant it is rather strong, but if a few specimens are cooked along with other plants that are not so strong in flavor, they are excellent.

When the plants are dried the green color fades, but the odor is said to persist for several years.

Collected in Champaign county.

PLATE CXXI



Clitocybe odora. Edible.

THE MANY-CAP CLITOCYBE (EDIBLE)

Clitocybe multiceps Peck

Clitocybe multiceps is common and sometimes very abundant. It grows on the ground, usually in grassy places, in clusters of from ten to as many as one hundred individuals. It may be looked for from May to October, though it is not likely to be found during midsummer.

The cap is 3 to 7 cm. (1 to 3 inches) broad. It is fleshy, although the flesh is not very thick except at the center, and very firm. It is convex, or sometimes nearly flat, and often irregular from mutual pressure. The color varies from whitish to yellowish gray or brown. The surface is smooth or sometimes slightly silky toward the center and is moist in wet weather. The flesh is white and when uncooked it has an oily taste which is somewhat disagreeable.

The gills are whitish, close together, narrow at each end, and attached to the stem either adnate or slightly decurrent. The spores are white.

The stem is 5 to 10 cm. (2 to 4 inches) long, cylindrical, or somewhat thickened at the base, firm but more or less elastic, smooth on the outside but sometimes covered with a powdered substance toward the top, and hollow or stuffed with a cottony substance within. There is no ring and no volva.

The spring clusters of this mushroom are said to be more tender and of better flavor than those appearing in autumn. Some people are very fond of the many-cap *Clitocybe* while others do not like it.

Collected in Champaign county.



Clitocybe multiceps. Edible.

THE DECEIVING CLITOCYBE (NOT EDIBLE)

Clitocybe illudens Schw.

This very beautiful mushroom grows about the bases of stumps and dead trees, or from underground roots, from July to October. It usually grows in clusters of from ten to fifty individuals and sometimes is very abundant. The deep, bright yellow color of the entire plant makes the clusters conspicuous from a considerable distance.

The cap is 7 to 20 cm. (3 to 8 inches) broad, convex or nearly plane, or sometimes somewhat funnel-shaped, but usually with a small elevation at the center. It is smooth and often quite irregular in shape. The color is bright yellow or orange-yellow. In old plants the color is sometimes brownish. The flesh is thick at the center, but thin toward the margin. It is whitish or yellow and has a strong odor and a disagreeable taste.

The gills are yellow, not crowded, narrowed toward each end, and unequally decurrent, that is, some of them extend down the stem for considerable distance and others not so far. Some of them are branched. The spores are white.

The stem is 7 to 20 cm. (3 to 8 inches) long, and tapers toward the base. It is firm, solid, smooth, and colored like the cap, or sometimes brownish toward the base. There is no ring and no volva.

It is too bad that this attractive plant is not edible, since it is often so abundant that one could easily collect several bushels. While it is not deadly poisonous, most people are made ill by eating it, and it should, therefore, be avoided.

An interesting thing about this mushroom is that it is phosphorescent, that is, when fresh specimens are placed in a dark room they emit a glowing light. For this reason the plant is sometimes called "Jack-o-lantern".

Collected in Champaign county.

Cilocybe illudens. Poisonous.



THE PURPLISH LACCARIA (EDIBLE)

Laccaria (or Clitocybe) ochropurpurea Berk.

The genus *Laccaria* is very closely related to the genus *Clitocybe*; the species of both genera were formerly placed together in the genus *Clitocybe*, but the species of *Laccaria* all have a peculiar general appearance by which one can recognize them and distinguish them from *Clitocybe* at a glance when one of them has once been learned.

The purplish *Laccaria* occurs from July to September in open grassy or bushy places and in woods. It grows either solitary or in groups and clusters, and is quite common and sometimes abundant.

The cap is 5 to 10 cm. (2 to 4 inches) broad, fleshy but firm and tough, at first nearly hemispherical or convex and with the margin curved in toward the stem, later becoming nearly plane or slightly depressed at the center. It is often very irregular. When the cap is moist the color is purplish brown, but when dry it is much lighter and gray or pale yellowish.

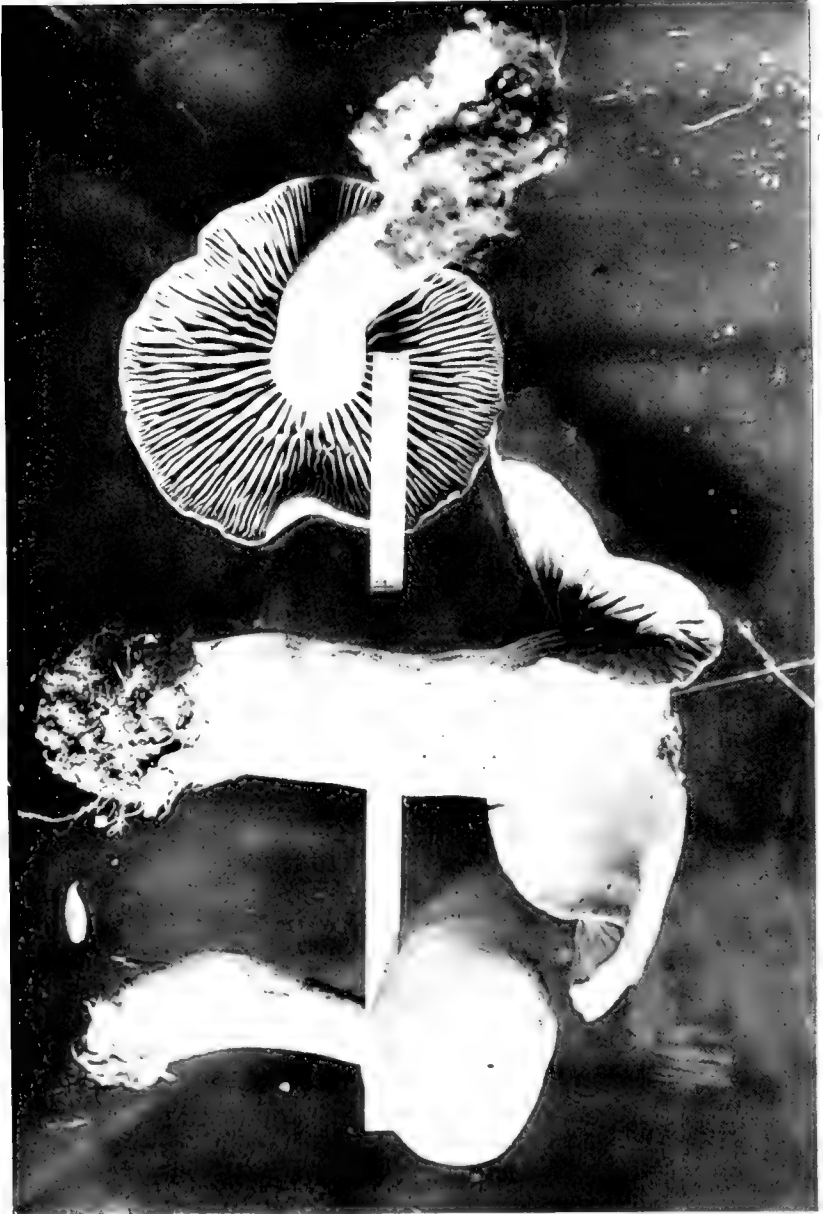
The gills are broad, thick, rather far apart, and attached to the stem, either adnate or decurrent. They are purplish in color. The spores are white, sometimes with a slight tinge of lilac or yellow when viewed in mass.

The stem is 3 to 10 cm. (1 to 4 inches) long. It is very variable, being nearly cylindrical, or thicker in the middle, or thicker at each end. It is fibrous and solid, and colored like the cap, but usually paler. There is no ring and no volva.

This mushroom is very variable in size and shape. Although it is a tough plant it cooks tender and can be used to good advantage in patties or croquettes. It is a good keeper and is not so readily attacked by insects as many other mushrooms.

There seems to be little doubt that *Laccaria ochropurpurea* forms mycorrhizas with the roots of the white oak and perhaps also with the American elm.

Collected in Champaign county.



Laccaria ochropurpurea. Edible.

THE ROOTING COLLYBIA (EDIBLE)

Collybia radicata Rehl.

Collybia radicata is a very common and widely distributed mushroom, and one that is easily recognized. It grows on the ground in woods or groves or sometimes on lawns and other grassy places. It is often found near stumps and sometimes grows upon rotten stumps or logs. It grows singly, but usually when a specimen is found a number of others will be found within a short distance. This mushroom may be found in suitable weather from May to October.

The cap is 3 to 10 cm. (1 to 4 inches) broad, fleshy but rather thin, at first convex, then flat or with the margin upturned in old plants, and sometimes with an elevation (umbo) at the center. The surface is smooth but often wrinkled, especially toward the center, and when moist it is sticky (viscid). The color varies from nearly white in some of the smaller specimens to gray or brown in larger ones. The flesh is pure white, rather thin, and tough-elastic.

The gills are snow-white, broad, unequal in length, rather far apart, and attached to the stem at the upper angle. The spores are pure white and very abundant. A very perfect spore-print can often be made from this mushroom in a few minutes.

The stem is 10 to 20 cm. (4 to 8 inches) long, colored like the cap, or sometimes paler and usually white at the upper end. It tapers gradually upward, and at the lower end it is somewhat enlarged and then tapers off into a long, slender, root-like structure in the ground. It is this character that gives the plant its specific name. The stem is firm, often twisted, and smooth but often striate or grooved.

This is a very attractive and clean-looking species. The caps, when fried, are sweet and pleasing to the taste.

Collected in Champaign, Jackson, and Union counties.



Collybia radicata. Edible.

THE BROAD-GILLED COLLYBIA (EDIBLE)

Collybia platyphylla Fries

Collybia platyphylla is a large, stout mushroom which grows from June to October on rotten logs or on the ground near rotten logs or stumps. It is found mostly in the woods but occasionally also in open pastures, especially in recently cleared fields.

The cap is 7 to 15 cm. (3 to 6 inches) broad, at first convex but soon expanded and nearly flat or with the margin upturned, fleshy, but thin and fragile. The surface appears watery when moist and usually is streaked with fine dark hairs, but the ground-color is brown or gray or sometimes nearly white. The flesh is white. The cap is sometimes quite irregular and the stem is not always exactly in the center. The thin margin is often split in various places.

The gills are very broad, as much as a half inch or more sometimes. They are soft and white, not very close together, and are attached to the stem by the upper angle. In old plants the gills are usually broken or cracked more or less. The spores are white.

The stem is 7 to 12 cm. (3 to 5 inches) long, rather soft, stuffed with a cottony substance, nearly cylindrical, more or less streaked with fibers but otherwise smooth, whitish, and sometimes slightly powdered at the upper end. There is no ring and no volva. The mycelium is very abundant and extends from the base of the stem in root-like or cord-like strands, though not at all like the root of *Collybia radicata*.

When fresh and in good condition the caps taste well, though they are not so pleasant-flavored as some other species of *Collybia*. They must be well cooked or the taste will be slightly bitter.

Collected in Champaign county.

PLATE CXXVI

Collybia platyphylla. Edible.



THE VELVET-STEMMED COLLYBIA (EDIBLE)

Collybia velutipes Curt.

Collybia velutipes is particularly interesting because it grows nearly the whole year round. It has been found in good condition in every month of the year. It grows on stumps, logs, roots in the ground, earth that has a great deal of wood material in it, and also on the trunks of living trees. It is common and plentiful, and while the heavier crop usually appears from September to November it is often abundant in the spring, and likely to be found at any time.

The cap is 3 to 8 cm. (1 to 3 inches) broad, at first convex but soon becoming plane, fleshy and moderately thick at the center but thin toward the margin, often irregular and sometimes eccentric, that is, with the stem not exactly at the center. The surface is smooth, quite sticky or viscid when moist, and somewhat striate at the margin. The color is yellow or brownish yellow, sometimes paler toward the margin. The flesh is soft and watery and slightly yellowish in color.

The gills are quite broad, and rounded at the end next to the stem. They are very nearly free from the stem but are slightly attached by the upper angle. They are not close together and are very unequal in length. The color of the gills is pale yellow or tan. The spores are white.

The stem is 3 to 8 cm. (1 to 3 inches) long, tough, often twisted, sometimes curved, hollow or stuffed with fibers. The surface of the stem is whitish when young, but soon becomes dark brown or black and densely velvety with fine black threads. This velvety covering of the stem makes the plant easy to identify. There is no ring and no volva.

Collybia velutipes sometimes grows singly or scattered and sometimes in clusters, often very dense clusters of from three or four to twenty or more individuals.

Although this mushroom is not a true parasite on living trees, it is said to do considerable damage sometimes. The mycelium grows mostly just beneath the bark, and by its continual growth it gradually pries the bark away from the wood, and may even cause the bark to fall away, leaving the trunk bare.

Although this is not one of the best mushrooms for the table it is considered excellent by some, and, because of its plentifulness, it is a valuable one to know.

Collected in Champaign county.

Collybia velutipes. Edible.



THE OAK-LOVING COLLYBIA (EDIBLE)

Collybia dryophila Bull.

Although *Collybia dryophila* is called the oak-loving Collybia it grows not only under oak trees but under most any kind of tree in the woods as well as in open places. It is a very common plant and so variable that it is very difficult to describe it in such a way as to include all its forms. It is found in suitable weather from May to October, and grows either singly or in clusters.

The cap is 3 to 8 cm. (1 to 3 inches) broad, convex or plane, or sometimes depressed in the center and with the margin upturned. The color varies from brown to bay-red or tan and usually becomes paler with age. The cap is tough, slightly fleshy but thin, and sometimes irregular in shape. The surface is normally smooth but sometimes there are abnormal outgrowths of tissue upon it. The flesh is thin and white.

The gills are very narrow, crowded close together, and very nearly free from the stem but slightly attached by the upper angle (adnexed). They are white or whitish or sometimes yellowish.

The stem is 3 to 8 cm. (1 to 3 inches) long, cylindrical or somewhat thickened at the base, firm and tough, smooth, hollow, usually colored like the cap but sometimes inclining more to reddish. There is no ring and no volva.

This is considered an excellent mushroom by some, but perhaps the greatest thing in its favor is its plentifulness. One foreign author, years ago, reported a case in which illness was caused by eating *Collybia dryophila*, but it has been eaten for years in this country and has not been known to make any one ill. It may therefore be considered perfectly safe provided it is fresh and in good condition.

Collected in Champaign county.

PLATE CXXVIII



Colymba dryophila. Edible.

THE PEAKED-CAP MYCENA (EDIBLE)

Mycena galericulata Scop.

This pretty little mushroom grows from late spring until frost on dead logs, stumps, sticks, etc., in the woods. It is common and sometimes very abundant. It usually grows in dense clusters of many individuals with the hairy bases of the stems glued together, though sometimes larger specimens are found growing singly. The plant is somewhat variable and therefore not so easily identified as some other mushrooms. The accompanying photograph is very characteristic, however, and with its aid, recognition of the plant should not be difficult.

The cap is 1 to 4 cm. (.5 to 1.5 inches) broad, at first conical or bell-shaped, then expanded and often with a prominent elevation (umbo) at the center. The surface is dry and smooth but striate (streaked with lines) from the margin to the umbo. The color is variable but is usually some shade of brown, though occasionally it is gray or whitish.

The gills are attached to the stem squarely, but with a decurrent tooth, and are connected with each other by veins. They are not close together, and the edges are either entire or toothed. The color is white or gray or flesh-colored. The spores are white.

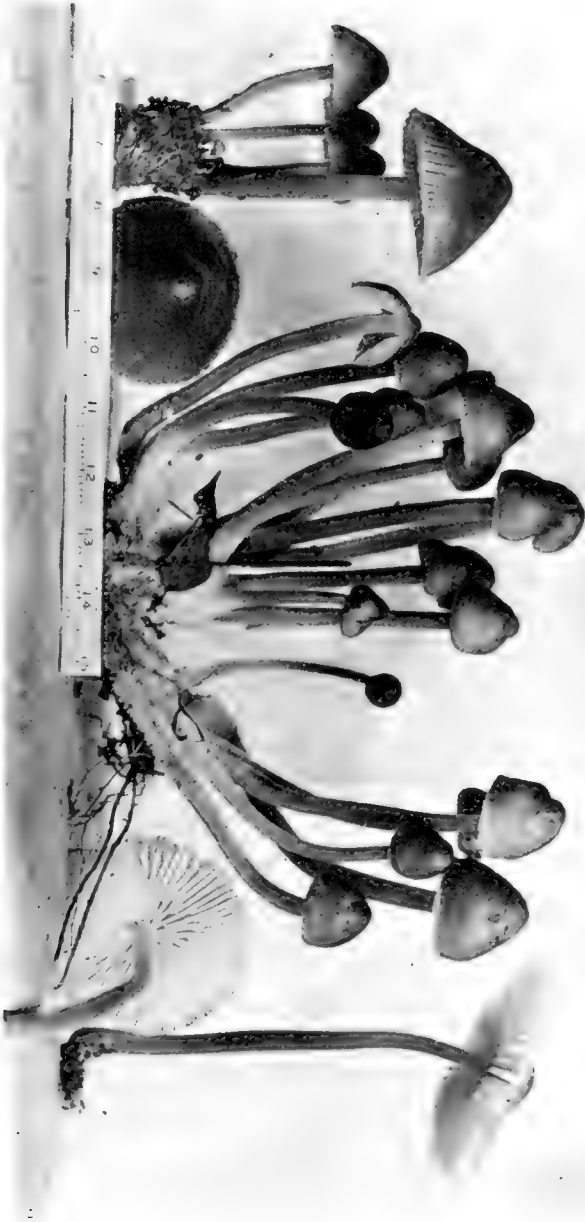
The stem is 5 to 12 cm. (2 to 5 inches) long, rigid, hollow, tough, straight or curved, slender, and with a smooth polished surface except at the base, where it is covered thickly with short white hairs.

This mushroom is especially rich in protein. When young the caps and stems may be cooked together and will be found to have a pleasing and delicate flavor. If, after washing, they are allowed to stew slowly in their own fluids for about ten minutes, and are then seasoned with pepper, salt, and butter, they are excellent.

Mycena haematopa is a common plant which has very much the same appearance and habits as *M. galericulata* but is distinguished by its blood-red juice. The edible qualities of the two species are the same.

Collected in Champaign county.

PLATE CXXIX



Mycena galericulata. Edible.

THE SLENDER GALERA. EDIBLE

Galera tenera Schaeff.

This little plant is common on lawns and pastures during wet weather from May to November. It usually grows scattered rather than clustered, and springs up quickly, so that one sometimes goes out in the morning and finds the lawn speckled with the delicate little plants.

The cap is bell-shaped and 1 to 2.5 cm. (.5 to 1 inch) high. When moist the cap is pale rust-color or brown, but as it dries off in the sun it becomes lighter colored. It is commonly smooth but occasionally one finds specimens that are covered with very fine, short, silky hairs. When the cap is damp it is usually slightly striate, the striation lines disappearing as the cap dries.

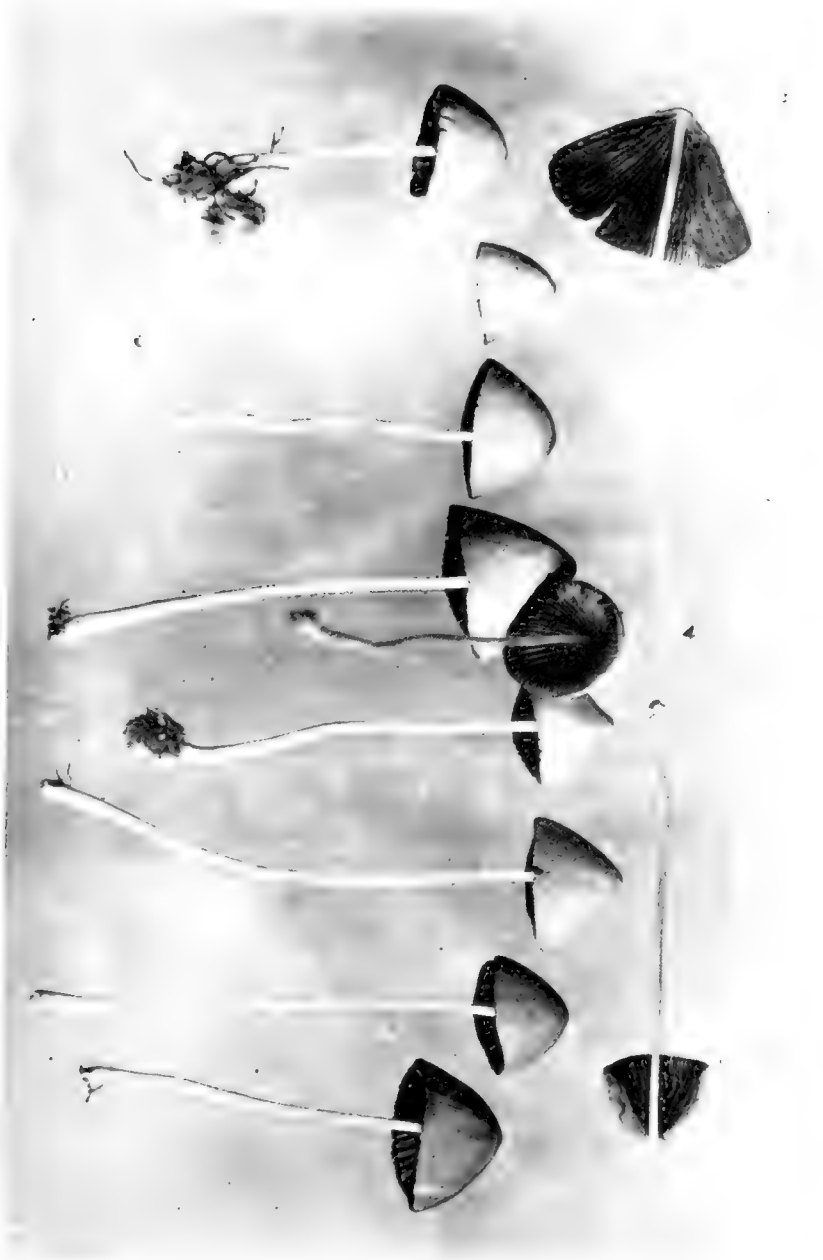
The gills are attached squarely against the stem in the top of the bell-shaped cap. They are close together, rather broad, and cinnamon-brown in color but with the edges usually whitish. The edges of the gills are sometimes more or less toothed or notched. The spores are dark rust-color.

The stem is usually 7 to 10 cm. (3 to 4 inches) long, straight, slender and fragile, hollow, and nearly the same color as the cap. It is usually somewhat shining and more or less striate toward the top. There is no ring and no volva.

This is rather a small plant to collect for the table, but sometimes its abundance makes up for its small size. The caps are tender and of good flavor. Cooked along with other mushrooms, it is a pleasing addition.

Collected in Champaign county.

PLATE CXXX



Galerina tenera. Edible.

THE OYSTER MUSHROOM (EDIBLE)

Pleurotus ostreatus Jacq.

This plant is called the oyster mushroom because the shape of the plant sometimes resembles the outline of an oyster-shell. It grows from May to December on dead trunks and branches of trees, or sometimes from wounds of living trees, usually in crowded clusters of several individuals with the caps overlapping each other. It is sometimes practically stemless, but other specimens may have a very definite stem, which, however, is always lateral, that is, at one side of the cap rather than at the center. The shape of the plant depends largely on its position. Plants growing from the upper side of a fallen log are quite different in shape from those growing from the side of the trunk or stump, since, wherever they grow, they must bring the gills into a horizontal or nearly horizontal position in order that the spores may be liberated. *Pleurotus ostreatus* is a very common and often abundant mushroom, and one that is very easy for the beginner to identify.

The cap is 5 to 20 cm. (2 to 8 inches) broad, soft and fleshy, quite thin at the margin, but thicker toward the place of attachment. It may be attached directly to the wood at one side or it may be narrowed into a short stem, and it is broadest at the outer extremity. It is usually depressed on the upper side near the place of attachment, and the margin is often incurved. The surface is moist or dry and smooth, but sometimes more or less torn into scale-like appendages. The color varies from white to gray or brown. The flesh is white.

The gills are broad, white, not much crowded, and when a stem is present they run out on it (decurrent) and narrow cut into vein-like lines which branch and connect with each other. The spores are white or pale lilac.

The stem when present is short, firm, white, usually thickened upward, and often hairy at the base. There is no ring and no volva.

This mushroom is a favorite with many mushroom-eaters, but only young plants should be used and they must be carefully and thoroughly cooked or they will be tough. When dipped in beaten egg, then in bread crumbs, and fried in very hot fat, they are excellent.

Collected in Champaign and Union counties.



Pleurotus ostracatus. Edible.

THE ELM PLEUROTUS (EDIBLE)

Pleurotus ulmarius Bull.

The elm *Pleurotus* is so called because it is often found growing on elm trees and logs. It is not confined to elms, however, but is found on many kinds of trees. At Urbana it is much more common on box-elder (ash-leaved maple) than on elm. It grows from the sides of trees, where branches have been broken off or the trees have been wounded from some other cause, from September until winter. It is more likely to be found in or near cities than in the country. This is a large plant and is easily distinguished from the oyster mushroom by its long stem, which is usually attached near the center, and by the gills, which are rounded or notched at the end next to the stem instead of decurrent. The plants usually grow singly, but several may be found on the same tree and sometimes they are more or less clustered.

The cap is 5 to 15 cm. (2 to 6 inches) broad, fleshy but firm and compact, at first convex and with the margin incurved, then flat or nearly so, always horizontal no matter what the position of the stem may be, smooth but often with the surface more or less cracked, white or whitish and sometimes tinged with red, yellow, or brown, and usually becoming darker and shining when old. The flesh is thick, firm, rather tough, and pure white.

The gills are broad, but narrower at each end, notched or rounded at the inner end, attached to the stem by the upper angle (adnexed), rather close together, white or whitish. The spores are white.

The stem is 2.5 to 10 cm. (1 to 4 inches) long, stout, solid, straight or curved according to the place of growth, more or less eccentric but often very nearly, if not quite, central, often somewhat thickened at the base, smooth, or somewhat downy with short hairs, especially at the base. The stem is white and there is no ring and no volva.

The elm *Pleurotus* has been known as an edible mushroom for a long time and is considered excellent by many people. It does not become infested with insects nearly so quickly as the oyster mushroom, and it can easily be dried and kept for winter use. Like all tree mushrooms it should be eaten when young, since old specimens are rather tough.

Although this mushroom grows on living trees, it seems to feed only on the dead portions of the bark and wood, and its growth appears to do no harm to the tree.

Collected in Champaign county.

PLATE CXXXII



Pleurotus ulmarius. Edible.

THE NEST-CAP CLAUDOPUS (EDIBLE)

Claudopus nidulans Pers.

Claudopus nidulans is a very pretty plant which grows on dead branches, tree trunks, stumps, and logs during autumn. It is widely distributed and sometimes one finds a log almost completely covered with the beautiful yellow caps. The plant is closely related to the genus *Pleurotus*, which it closely resembles but from which it differs in the color of the spores. It is usually sessile, that is, there is no stem and the cap is attached to the wood by one side like a shelf, though sometimes it is narrowed into a very short stem. The plants often grow very close together and so overlap one another.

The caps are 2 to 8 cm. (1 to 3 inches) broad, nearly round or somewhat kidney-shaped, and in young specimens the margin is rolled inward. The surface is quite hairy or downy, especially toward the margin, and is rich yellow in color.

The gills are broad, quite close together, and bright orange-yellow in color, so that the lower surface of a group of caps may be even more beautiful than the upper surface. The spores are pink.

The odor of this plant is rather strong and somewhat disagreeable, closely resembling the freshly removed intestines of swine. The flavor is mild and pleasant but the flesh is generally somewhat tough so that it must be well cooked.

Collected in Champaign county.

PLATE CXXXIII

Claudopus nidulans. Edible.

THE CONE-LIKE MUSHROOM (EDIBLE)

Strobilomyces strobilaceus Berk.

The peculiar name of this plant refers to the cone-like appearance of the cap, and the plant is very easily recognized by this character. This plant is a basidiomycete, that is, it produces its spores on the ends of club-shaped basidia, just as do the gill-bearing mushrooms, but instead of having gills on the under side of the cap it has little pores or tubes, and the basidia making up the hymenium are arranged on the inner surface of these tubes. It grows on the ground in woods from July to September.

The cap is 5 to 10 cm. (2 to 4 inches) broad, hemispherical or nearly so, dry, and very shaggy owing to numerous thick, coarse, hairy scales, of a blackish color, which project from the surface. The flesh is very interesting. It is thick and of a whitish color, but when it is cut or wounded in any way it quickly changes to red and then to black.

The layer of tubes does not separate easily from the flesh; a character which separates this plant from the genus *Boletus*. The tube layer is attached to the stem (adnate) and whitish, becoming brown or blackish in old plants. The mouths of the tubes are large in comparison with those of some other pore-mushrooms, and angular, and when they are bruised they change color just as the flesh of the cap does. The spores are dark brown or blackish when viewed in mass.

The stem is 8 to 15 cm. (3 to 6 inches) long, nearly even or sometimes tapering slightly upward, often grooved near the top, and very shaggy, having soft scales similar to those on the cap.

Before cooking this mushroom the stem should be removed, the scales cut away from the cap, and unless the tubes are very firm and fresh they, too, should be removed. The thick flesh that remains will cook well by any method. It has a rather strong taste, but is a great favorite with some people. Usually it is not very common, but occasionally one finds a troop that will make a good meal. Its appearance is so unique and its color-changes are so interesting that it is always a pleasure to find it.

Collected in Champaign and Union counties.

PLATE CXXXIV



Strobilomyces strobilaceus. Edible.

THE BRANCHED POLYPORUS (EDIBLE)

Polyporus frondosus Fries

This is one of the pore fungi which is not very common but is apt to be found in any locality, and it grows so large that a single specimen is often enough for several meals. It grows at the bases of stumps and dead trees or from their roots, and also from the roots of living trees of oak and chestnut, sometimes killing the trees which it attacks. It may be looked for from September to frost.

The whole plant is 15 to 60 cm. (6 inches to 2 feet) broad, and is very much branched, so that it appears to be made up of a large number of flattened, leaf-like caps. The separate caps are 2 to 5 cm. (1 to 2 inches) broad, irregular in shape, often curved, furrowed, etc., and gray or brownish in color. The surface is slightly hairy, the hairs very short. The tubes on the under sides of the caps are whitish, and their mouths are round and regular in young plants but become irregular in size and shape as the plant matures. The flesh is white. The stem is white and very much branched.

Young plants are tender and good when broiled or fried. Older plants must be very thoroughly cooked. It is best to stew them first and then fry or broil.

Another large Polyporus which is apt to be found, is *P. sulphureus* (Bull.) Fries, the sulphur-colored Polyporus, which is more common than *P. frondosus* and is highly prized by many people. The whole plant is sulphur-yellow, though the upper surface is usually darker, and often inclines to orange-color. It grows on living or dead trees, stumps, etc., sometimes causing a serious heart-rot of living trees. It is usually composed of several shelf-like, or fan-like caps grown together, the whole cluster becoming a foot or more across. Fresh young plants are excellent broiled, or they may be cut into small pieces and stewed slowly and thoroughly.

Collected in Champaign county.

PLATE CXXXV



Polyporus frondosus. Edible.

THE POROUS BOLETINUS (EDIBLE)

Boletinus porosus (Berk.) Peck

Boletinus porosus is another mushroom belonging to the family of pore fungi or Polyporaceae. It is seen to be separate from two closely related genera, *Boletus* and *Polyporus*, by noting the following facts. In *Boletus* the flesh is very soft and the pore-layer can easily be separated from the flesh. In *Polyporus* the flesh is tough and the pore-layer cannot easily be separated from the flesh. *Boletinus* resembles *Polyporus* in that the tube layer is not easily separable from the flesh, but it resembles *Boletus* in having very soft flesh.

Boletinus porosus grows on damp ground, in the woods and in open places, from July to September. It is often locally quite abundant, and often grows in troops, so that if one is found others are likely to be found near by.

The cap is 5 to 12 cm. (2 to 5 inches) broad, dry or moist and sticky, usually shining, smooth, and reddish-brown or yellowish-brown in color. The margin is thin, quite even, and usually turned inward. The shape of the cap is somewhat irregular and often is nearly kidney-shaped.

The pore surface is yellow. The pores are large and angular but very shallow, and are arranged more or less in radiating rows. Some of the partitions are more prominent than others, appearing somewhat like gills that branch, and are connected by cross partitions of less prominence. The spores are brownish yellow.

The stem is 2 to 7 cm. (.5 to 1.5 inches) long and is attached to one side of the cap. It is colored like the cap, into which it gradually expands, and it is prominently reticulated at the top by the decurrent walls of the tubes. The stem is quite tough.

Old plants sometimes have a disagreeable odor, but when young and fresh the odor and taste are pleasant and the plants make an excellent dish.

Collected in Champaign county.



Boletinus porosus. Edible.

THE CRESTED CLAVARIA (EDIBLE)

Clavaria cristata Pers.

This mushroom belongs to the family of club fungi or Clavariaceae. The club fungi resemble the hedgehog fungi in that the spore-bearing surface, or hymenium, covers the entire outside of the branches, but in the hedgehog fungi the branches hang downward, while in the club fungi they always project upward.

There are many kinds of club fungi, some of which are simply club-shaped and unbranched, while others are very much branched. Some are bright-colored and very beautiful. All of the branched forms are good to eat.

Clavaria cristata grows from 3 to 12 cm. (1 to 5 inches) high. It is whitish in color, and has a short, stout stem, and tufts of numerous, irregular branches which are more or less flattened toward the top. The ends of the branches are forked and divided into moose-horn-like tips. The crested *Clavaria* grows in the woods in rainy weather from June to October.

Another species that is common in the state is *Clavaria pyxidata* Pers. It closely resembles *Clavaria cristata* in general appearance but is easily distinguished by the fact that the ends of the branches are cup-shaped instead of pointed.

Either of these species is excellent for soups, stews, or patties. They should be cut up into short pieces. They remind one of noodles or macaroni. If stewed they must be cooked slowly and thoroughly or they will be tough. When fried in butter they are crisp and good.

Collected in Champaign and Wabash counties.

PLATE CXXXVII



Clavaria cristata. Edible.

THE CORAL-LIKE MUSHROOM (EDIBLE)

Hydnum coralloides Scop.

Hydnum coralloides is perhaps the most beautiful fungus that nature has produced. Elias Fries, a Swedish botanist, was the man who laid the foundation for the study of the higher fungi, and it is said that it was the great beauty of the coral-like mushroom that inspired him, while a mere boy, to determine to devote his life to a study of these plants.

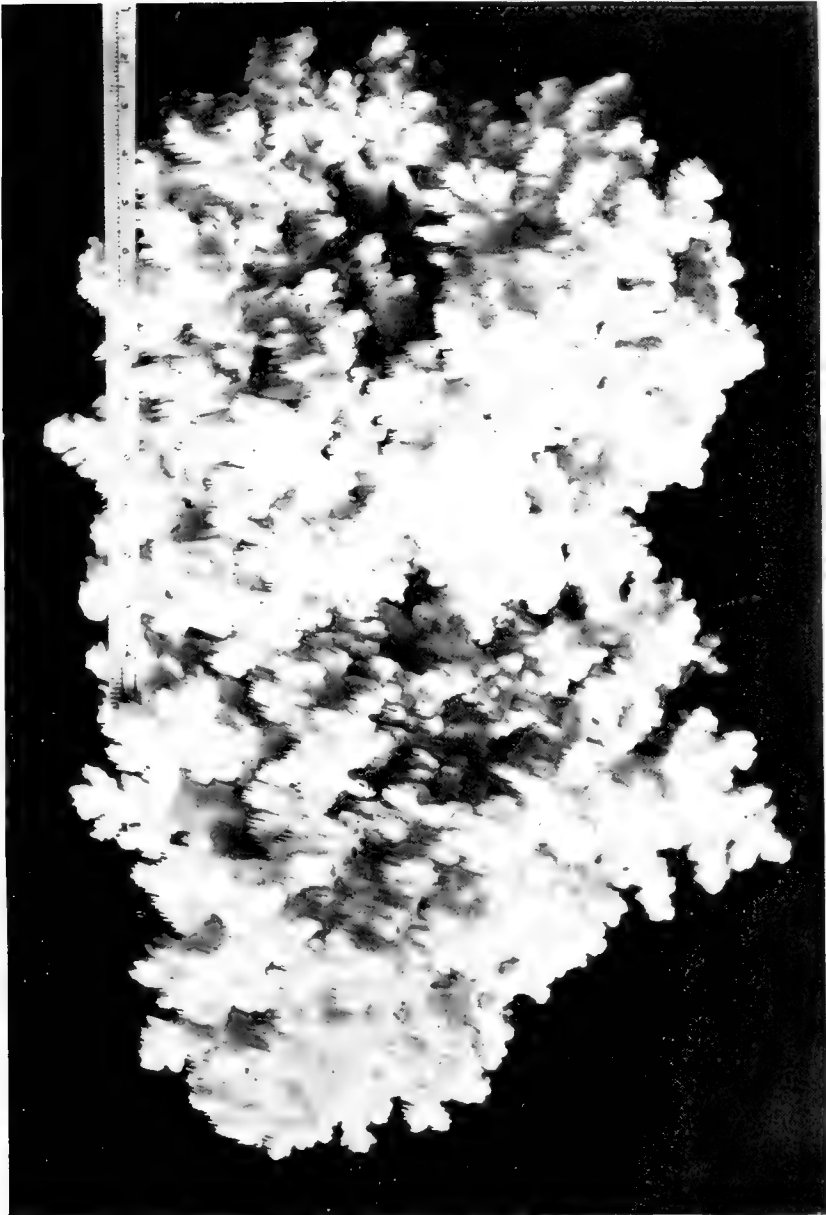
This mushroom belongs to the family Hydnaceae or hedgehog fungi, so called because the spore-bearing basidia are borne on the surface of spinelike projections which are always directed toward the earth. This character separates the hedgehog fungi from the club fungi or Clavariaceae, since, although the spore-bearing surface is similar in the two families, in the club fungi the branches always project upward, while in the hedgehog fungi they project downward.

Hydnum coralloides grows on rotten logs, branches, etc., in the woods from August to frost. The large, pure white tufts arise from a common stem which divides into many branches and then subdivides successively into long graceful shoots. The spines are scattered over the under surface of these branches and hang down for 3 to 6 mm. ($\frac{1}{8}$ to $\frac{1}{4}$ inch).

This is considered an excellent edible species. Since the Hydnums are sometimes slightly bitter it is best to boil them for just a moment and throw the water away, then stew slowly. They are excellent for croquettes.

Other species of *Hydnum* that are apt to be found, and that are just as good to eat, are *Hydnum caput-ursi* Fries, the "bear's-head Hydnum", which produces long white spines grouped at the ends of branches, the spines being much longer than those of the coral Hydnum, and *Hydnum erinaccum* Bull., the "hedgehog Hydnum", which forms a large unbranched mass with long, straight spines hanging down from its sides.

Collected in Champaign county.



Hydnum coralloides. Edible.

THE GEMMED PUFFBALL (EDIBLE)

Lycoperdon gemmatum Batsch

This little puffball is very common and is widely distributed throughout the world. It usually grows on the ground either in the woods or in open places. When young the whole plant is white both inside and out. It is usually 3 to 7 cm. (1 to 3 inches) high and 3 to 5 cm. (1 to 2 inches) broad, and is easily recognized by its shape, which is like a top, and by the erect scales, which are of two sizes, the larger ones later falling away and leaving circular scars on the surface.

There is never any danger in eating puffballs, since none of them are poisonous. They should always be cut open, however, to see that they are pure white within, since as soon as they begin to be colored they are not good. The gemmed puffball, while it is eaten in quantities by some people, is not one of the best. Some of the larger puffballs are much better.

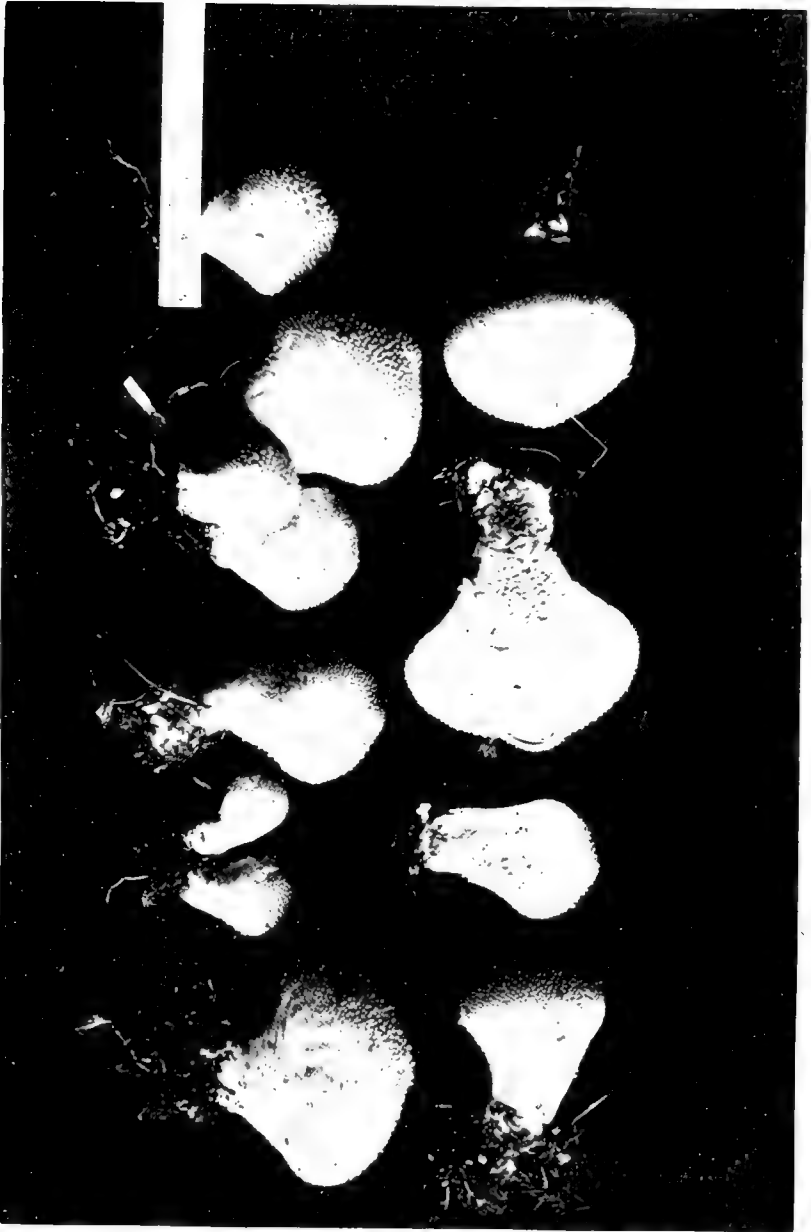
Lycoperdon cyathiforme Bosc. is a somewhat pear-shaped puffball, rounded above and tapering below to a stout base. It grows in pastures and other grassy places, or sometimes in cultivated fields, and is from 7 to 15 cm. (3 to 6 inches) in diameter. It is a most excellent mushroom for the table.

Perhaps even better than the above, but not so common, is *Calvatia gigantea* Batsch, the giant puffball. This plant is a rounded mass resting on the ground and attached by cords of mycelium. It is usually 20 to 40 cm. (8 to 16 inches) in diameter, but occasionally it gets much larger than that. It is the largest fungus known. It should be peeled, sliced, and broiled or fried.

Collected in Champaign and Union counties.

PLATE CXXXIX

Lycoperdon gemmatum. Edible.



THE COMMON MOREL (EDIBLE)

Morchella conica Pers.

The morels belong to the group of fungi known as Ascomycetes, and instead of producing their spores on the ends of club-shaped hyphae, or basidia, they produce them on the inside of little sac-like bodies called asci, (see page 420). The hymenium is composed of thousands of these sacs, or asci, placed close together, and the hymenium covers the entire outer surface of the cap.

The morels occur on the ground in early spring, from April to June. They are all edible and are very easy to recognize. The plant consists of two parts, the cap and the stem. The cap is covered with broad irregular pits separated from each other by a network of narrow ridges. The stem is usually quite thick and stout, and both the stem and cap are hollow.

Morchella conica is 5 to 15 cm. (2 to 6 inches) high and the cap is 2.5 to 5 cm. (1 to 2 inches) thick at its broadest part. The cap is elongated and more or less pointed at the upper end. The pits are arranged more or less in vertical rows. They are usually longer than broad but often are quite irregular in shape.

There are several other species closely resembling *M. conica* that are apt to be found in Illinois, but since they are all equally good to eat no harm can come from mistaking one for another of them.

The morels should always be carefully washed before cooking. Simply fried in butter they are delicious, or they may be stuffed and baked.

Collected in Champaign county.

PLATE CXL



Morchella conica. Edible.

THE HALF-FREE MOREL (EDIBLE)

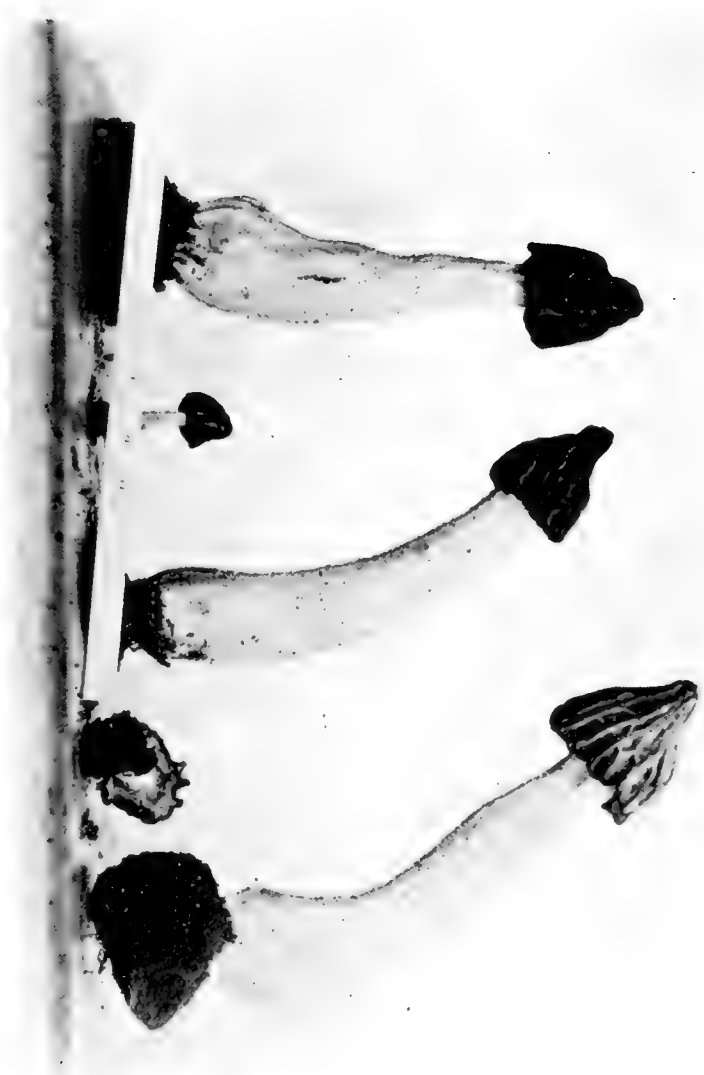
Morchella semilibera D. C.

The half-free morel is so called because the lower half of the bell-shaped cap is free from the stem. It is included here because it differs so greatly from *Morchella conica* and yet is apt to be found growing right along with that species. The cap is rarely more than 2 or 3 cm. (1 inch) long and is usually much shorter than the stem. The pits on the surface of the cap are considerably longer than broad. The cap is usually considerably pointed at the top but deformed specimens occur in which it is hemispherical and very blunt at the apex. The stem is white or whitish, usually more or less mealy, hollow, and often somewhat swollen at the base. The whole plant is 5 to 10 cm. (2 to 4 inches) high. It may be used in any way in which the other morels are used. Morels should not be gathered immediately after rains as they are then water-soaked and soon spoil.

Collected in Champaign county.

PLATE CXLI

Morchella semilibera. Edible.



THE BROWN GYROMITRA (EDIBLE)

Gyromitra brunnea Underwood

The genus *Gyromitra* is closely related to the genus *Morchella* and produces its spores in the same way, but instead of having pits on the surface of the cap, as do the morels, it has wrinkles and plaits or folds which make the cap appear more or less brain-like.

Gyromitra brunnea is a stout, fleshy plant with a distinct stem, and a broad, much-twisted, and folded cap. It grows in the woods in early spring at the same time and under the same conditions as the morels. The whole plant is 7 to 12 cm. (3 to 5 inches) high. The stem is thick, somewhat spongy, hollow but solid at the base, usually with an irregular surface, and clear white in color.

The cap is 5 to 12 cm. (2 to 4 inches) broad in the widest diameter and somewhat narrower the other way. It is attached closely to the stem in various places, and is rich chocolate-brown above and white beneath. It is tender and fragile and has a good flavor. It should be cooked in the same way as morels.

Another species which is occasionally found in the state is *Gyromitra esculenta* Fries. This is a somewhat larger plant and the brown cap is much more brain-like in appearance. Although this plant has frequently been eaten with no bad results yet it has in some way acquired a bad reputation, and, therefore, for the present at least, it had better be left alone.

Collected in Champaign county.



Gyromitra brunnea. Edible.

THE RECURVED PEZIZA (EDIBLE)

Peziza repanda Wahl.

This cup-shaped plant grows in moist woods, either on old rotten logs or on the ground, from May to October.

The cups are 3 to 10 cm. (1 to 4 inches) in diameter and grow either scattered or clustered. When very small they appear like little white knobs. These grow into hollow spheres each with an opening at the top. The sphere then expands and becomes cup-shaped or saucer-shaped and then nearly flat with the edge more or less split and wavy and sometimes drooping or curved backward. Below, the cup is narrowed into a short, stout stem which is sometimes rooting. The inner surface of the cup is pale brown or dark brown and more or less wrinkled toward the center. The outer surface is whitish.

Peziza badia Pers., the brown Peziza, is another common cup-fungus which is of good size and edible. It is not quite so large as *P. repanda* and the entire plant is brown, though somewhat darker inside than outside.

Neither of these species is considered first-class for culinary purposes, but when one cannot get better they are worth collecting. If they are to be stewed they must be cut into small pieces and cooked slowly. They are said to have more flavor when fried crisp in butter.

Collected in Champaign county.

PLATE CXLIII



Peziza repanda. Edible.

REFERENCES TO LITERATURE

The following publications have been used in the preparation of this bulletin and will be found helpful to any one who wishes to know a larger number of mushrooms than are included here.

Clements, F. C.

'10. Minnesota mushrooms. Minn. Plant Studies, No. 4.

Hard, M. E.

'08. Mushrooms, edible and otherwise.

McIlvaine, Chas., and MacAdam, R. K.

'00. One thousand American fungi.

Marshall, Nina L.

'01. The mushroom book.

Moffatt, W. S.

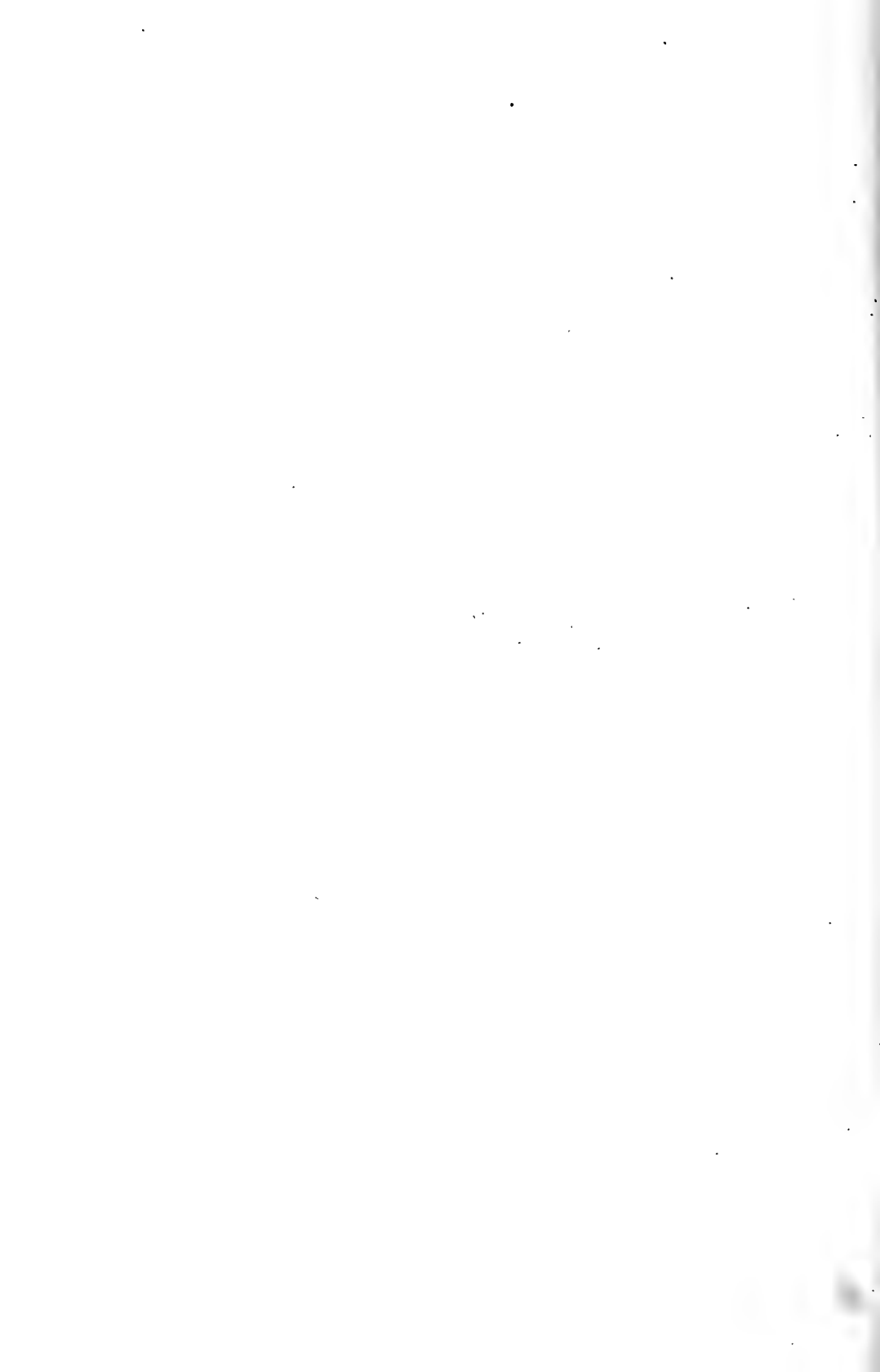
'09. The higher fungi of the Chicago region. Bull. VII, Part 1,
Nat. Hist. Surv., Chicago Acad. Sci.

Peck, C. H.

'70-'12. Reports of the State Botanist. Bulletins New York
State Education Dept.

INDEX

	PAGE		PAGE
<i>Agaricus arvensis</i>	470	<i>Hydnum cotalloides</i>	542
<i>Agaricus campestris</i>	466	<i>Hydnum erinaceum</i>	542
<i>Agaricus placomyces</i>	468	<i>Hypholoma appendiculatum</i>	502
<i>Agaricus Rodmani</i>	474	<i>Hypholoma Candollecanum</i>	502
<i>Agaricus silvicola</i>	472	<i>Hypholoma incertum</i>	502
<i>Agaricus subrufescens</i>	476	<i>Hypholoma lacrymabundum</i>	509
<i>Amanita cothurnata</i>	450	<i>Laccaria ochropurpurea</i>	514
<i>Amanita phalloides</i>	448	<i>Lactarius piperatus</i>	440
<i>Amanita solitaria</i>	452	<i>Lactarius volenus</i>	442
<i>Amanita verna</i>	448	<i>Lentinus tigrinus</i>	428
<i>Amanita verna</i> (development)	416	<i>Lepiota cristata</i>	460
<i>Amanitopsis vaginata</i>	454	<i>Lepiota granulosa</i>	462
<i>Armillaria mellea</i>	488	<i>Lepiota Morgani</i>	458
<i>Boletinus porosus</i>	538	<i>Lepiota naucina</i>	464
<i>Calvatia gigantea</i>	544	<i>Lycoperdon cyathiforme</i>	514
<i>Cantharellus aurantiacus</i>	566	<i>Lycoperdon gemmatum</i>	544
<i>Cantharellus cibarius</i>	504	<i>Morchella conica</i>	546
<i>Cantharellus cinnabarinus</i>	506	<i>Morchella semilibera</i>	548
<i>Claudopus nidulans</i>	532	<i>Myceena galericulata</i>	524
<i>Clavaria cristata</i>	540	<i>Myceena haematopa</i>	524
<i>Clavaria pyxidata</i>	540	<i>Peziza badia</i>	552
<i>Clitocybe illudens</i>	512	<i>Peziza repanda</i>	552
<i>Clitocybe multiceps</i>	510	<i>Pholiota dura</i>	490
<i>Clitocybe ochropurpurea</i>	514	<i>Pholiota praecox</i>	490
<i>Clitocybe odora</i>	508	<i>Pholiota squarrosa</i>	492
<i>Collybia dryophila</i>	522	<i>Pleurotus ostreatus</i>	528
<i>Collybia platyphylla</i>	518	<i>Pleurotus ulmarius</i>	530
<i>Collybia radicata</i>	516	<i>Pluteus cervinus</i>	486
<i>Collybia velutipes</i>	520	<i>Polyporus frondosus</i>	536
<i>Coprinus atramentarius</i>	480	<i>Polyporus sulphureus</i>	536
<i>Coprinus comatus</i>	478	<i>Russula foetentula</i>	446
<i>Coprinus ebulbosus</i>	484	<i>Russula virescens</i>	444
<i>Coprinus micaceus</i>	482	<i>Strobilomyces strobilaceus</i>	534
<i>Craterellus cantharellus</i>	504	<i>Stropharia epimyces</i>	494
<i>Galera tenera</i>	526	<i>Stropharia semiglobata</i>	496
<i>Gyromitra brunnea</i>	559	<i>Tricholoma album</i>	498
<i>Gyromitra esculenta</i>	550	<i>Tricholoma personatum</i>	498
<i>Hydnum caput-ursi</i>	542	<i>Volvaria bombycina</i>	456



BULLETIN
OF THE
ILLINOIS STATE LABORATORY
OF
NATURAL HISTORY

URBANA, ILLINOIS, U. S. A.

STEPHEN A. FORBES, PH.D., LL.D.,
DIRECTOR

VOL. XI.

MAY, 1918

ARTICLES VIII-X.

ART. VIII. THE REACTIONS AND RESISTANCE OF FISHES TO
CARBON DIOXIDE AND CARBON MONOXIDE

BY

MORRIS M. WELLS, PH.D.

ART. IX. EQUIPMENT FOR MAINTAINING A FLOW OF OXYGEN-
FREE WATER, AND FOR CONTROLLING GAS CONTENT

BY

VICTOR E. SHELFORD, PH.D.

ART. X. A COLLECTING BOTTLE ESPECIALLY ADAPTED FOR THE QUAN-
TITATIVE AND QUALITATIVE DETERMINATION OF DISSOLVED
GASES, PARTICULARLY VERY SMALL QUANTITIES OF OXYGEN

BY

EDWIN B. POWERS, M. A.



ARTICLE VIII.—*The Reactions and Resistance of Fishes to Carbon Dioxide and Carbon Monoxide.** BY MORRIS M. WELLS.

INTRODUCTION

Carbon monoxide and carbon dioxide are both present in the waste that is diverted into natural waters by many works where illuminating gas is manufactured and, since the waste as a whole is known to be exceedingly poisonous to aquatic organisms, the rôle played in its toxic action by the two gases in question was investigated at the time that the many other organic substances of which the waste is composed were studied by Shelford.† The investigation has shown that both of the gases are poisonous to fresh-water fishes even when present in the water in relatively small proportions, but the monoxide has been found to be by far the more deadly of the two.

Carbon dioxide is present normally in the natural habitats of practically all fresh-water organisms, but its toxicity does not manifest itself unless it occurs in concentrations which are high as compared with lethal concentrations of carbon monoxide. At a concentration of 10 c.c. per liter, carbon dioxide will quickly prove fatal to the more sensitive fishes; and it is doubtful if there are any fresh-water fishes that could continue to live in water where the carbon-dioxide content averaged as high as 6 c.c. per liter throughout the year. On the other hand, there is evidence that a certain small concentration of carbon dioxide, that is, a certain degree of acidity, is beneficial, if not actually essential to the continued existence of some, and perhaps many, fresh-water fishes. It would not be at all safe to assume that all fresh-water organisms require an environment whose reaction (to phenolphthalein) is slightly acid, for it is known from investigation that certain organisms, as the plankton in fresh-water lakes, seem actually to prefer alkalinity to acidity. Furthermore, there are many cases on record where fishes that normally live in water that is slightly acid from the presence of CO_2 have continued

*Contributions from the Zoological Laboratory of the University of Illinois, No. 107.

†An Experimental Study of the Effects of Gas Waste upon Fishes, with Especial Reference to Stream Pollution. By V. E. Shelford. Bull. Ill. State Lab. Nat. Hist., Vol. XI, Art. VI, pp. 381-410. 1917.

to live more or less normally in water that had become alkaline either from treatment or from the using up of the CO_2 , both free and half bound, by the algae growing in the water. However, it is still to be demonstrated that there are any species of truly fresh-water fishes that can reproduce successfully in water that is decidedly alkaline to phenolphthalein throughout the year.

It should not be concluded that, since a certain small amount of CO_2 seems to make the water more acceptable to certain fresh-water organisms, it will be well to add this gas to natural waters, for all the carbon dioxide that is necessary to organisms living in nature is produced in the natural waters by the decomposition of organic materials contained therein; and, in fact, the processes of decay often raise the concentration of carbon dioxide to a point where it is detrimental, and even fatal, to the aquatic inhabitants of the water. The addition of any substance, therefore, which will increase the amount of carbon dioxide in these waters, must be looked upon as detrimental; and it is certain that were carbon dioxide the only toxic substance contained in gas-house waste, the effect of this waste upon the aquatic organisms would still need to be regarded with suspicion, for while the more hardy organisms might survive its presence the less resistant species would be sure to fare badly, at least near the point of introduction.

Carbon monoxide—which differs from the dioxide in that the carbon atom in the monoxide is holding in combination but one oxygen atom instead of two and is, therefore, chemically speaking, unsaturated—is a well-known poisonous gas, and its frightfully deadly effect when present in the atmosphere in even exceedingly small quantities has been vividly demonstrated by many investigators. Two to three per cent. of carbon monoxide in the air breathed by a mouse will cause the death of the animal in from one to two minutes. The familiar poisonous effects of illuminating gas are largely due to the comparatively large per cent. of carbon monoxide which it contains.

The investigation of the toxic properties of the two gases in question was carried on as follows. The work with carbon dioxide as summarily presented here has been carried on since 1912, partly at the University of Chicago and partly at the University of Illinois. The carbon-monoxide investigations have all been carried on in the laboratory of the State Laboratory of Natural History at the University of Illinois, and with facilities which constitute a part of the equipment of the Vivarium. The results show that both gases are toxic to fresh-water fishes in the concentrations which would result from the introduction of gas-house wastes into natural waters, and that carbon monoxide is by far the more deadly, killing the most resistant fishes

in concentrations that would be negligible or beneficial in the case of carbon dioxide.

PROPERTIES OF THE GASES

Carbon monoxide is lighter than air, having a specific gravity of 0.967. It is odorless, tasteless, and colorless, burns with a characteristic pale blue flame, forming carbon dioxide, and is only slightly soluble in water, 23.1 c.c. dissolving in a liter at 20°C.

Carbon dioxide is heavier than air (specific gravity 1.519), is odorless, has a decidedly acid taste, is colorless at ordinary temperatures, and will not burn, since the carbon atom already holds in combination all the oxygen with which it has the power to combine. It is very soluble in water, a liter of water at ordinary temperatures holding in combination almost a liter of the gas. The carbon dioxide does not simply dissolve in the water, but unites with it to form carbonic acid ($\text{CO}_2 + \text{H}_2\text{O} = \text{H}_2\text{CO}_3$).

METHODS AND MATERIALS

Two types of experiments have been made, one to determine the resistance of the fishes to the gases in various concentrations, another to determine the reactions of the fishes to the gases in the gradient. The latter type gives the fishes an opportunity to select or reject the water containing the gas. The fishes were collected in the small streams of northern Illinois, fifteen to twenty different species having been tested more or less fully.

Resistance Experiments.—A paper (Wells, '13) has already been published which gives the detailed methods and observations concerning the resistance of fresh-water fishes to carbon dioxide. Briefly, the experiments were made as follows:—A stream of water flowing at a rate of from 500—600 c.c. per minute was passed through two experimental bottles having a capacity of seven and three liters respectively. The gas was introduced into the flow at a point far enough away to allow it to dissolve before it reached the bottles. The exact concentrations of CO_2 in the experiments was determined by titration of samples collected as the water flowed out of the experimental bottles. These determinations were made at regular intervals throughout each experiment.

The resistance experiments with carbon monoxide were made much as were those just described for carbon dioxide. The method of determining the concentration of the gas in the collected samples was that described in Hempel's "Gas Analysis".* The gas was boiled off and absorbed with a hydrochloric acid solution of cuprous chloride.

*Hempel's "Gas Analysis," 1910 edition, p. 203.

Carbon dioxide can be bought in tanks and used directly from them, but it is necessary to make the monoxide. This was done by the common method of heating oxalic acid with five to six times its weight of concentrated sulphuric acid. In the reaction both the dioxide and the monoxide are formed; the dioxide is removed by passing the gas through two wash bottles containing concentrated NaOH, and the gas remaining was also led through two wash bottles containing distilled water before it was collected in large 20-liter bottles over water. Analysis of the gas showed it to be 95 per cent. CO and 5 per cent. atmospheric gases in the proportion in which they dissolve in water from the atmosphere. These latter gases must have come out of the water over which the CO was collected. The generation of the gas and the experiments were performed with a canary bird at hand, the gas being particularly poisonous to birds.

Figure 1 illustrates the method used in introducing the CO into the water that flowed through the experimental bottles. The method may be useful wherever the introduction of small amounts of any substance, especially a volatile one, into a stream of running water is desired. It reduces the exposure to the atmosphere to a minimum, and the concentration can thus be kept relatively constant. The steps in introducing the CO were as follows:—(1) Water from J was siphoned into A, which was already full of CO. The clamp between A and B was kept closed, and thus the water in A was subjected to some pressure. After some hours the water was found to be saturated with CO. (2) B was now lowered, and the pinch clamp between A and B was loosened. The water in A now ran into B, displacing the air through the glass tube leading to the top of B. More water from J flowed into A at the same time; but if the exchange was made rather slowly, practically no mixing took place and analysis showed the water in B to be saturated or even slightly supersaturated with CO. (3) The clamp between A and B was closed, B was raised to the position shown in the figure, and the clamp between B and the burette was opened. The water now ascended in the burette till it reached the level of the water in B. (4) By opening the burette cock the saturated water was now run into the glass tee at C, where it mixed with the tap water. The rate of flow from the burette was determined by counting the drops per minute, the number of drops per c.c. having previously been determined. (5) The mixture then flowed through the experimental bottles of which D is the first. (6) Finally, as has been stated before, the actual concentration of gas in the water in the experiment was determined by analysis.

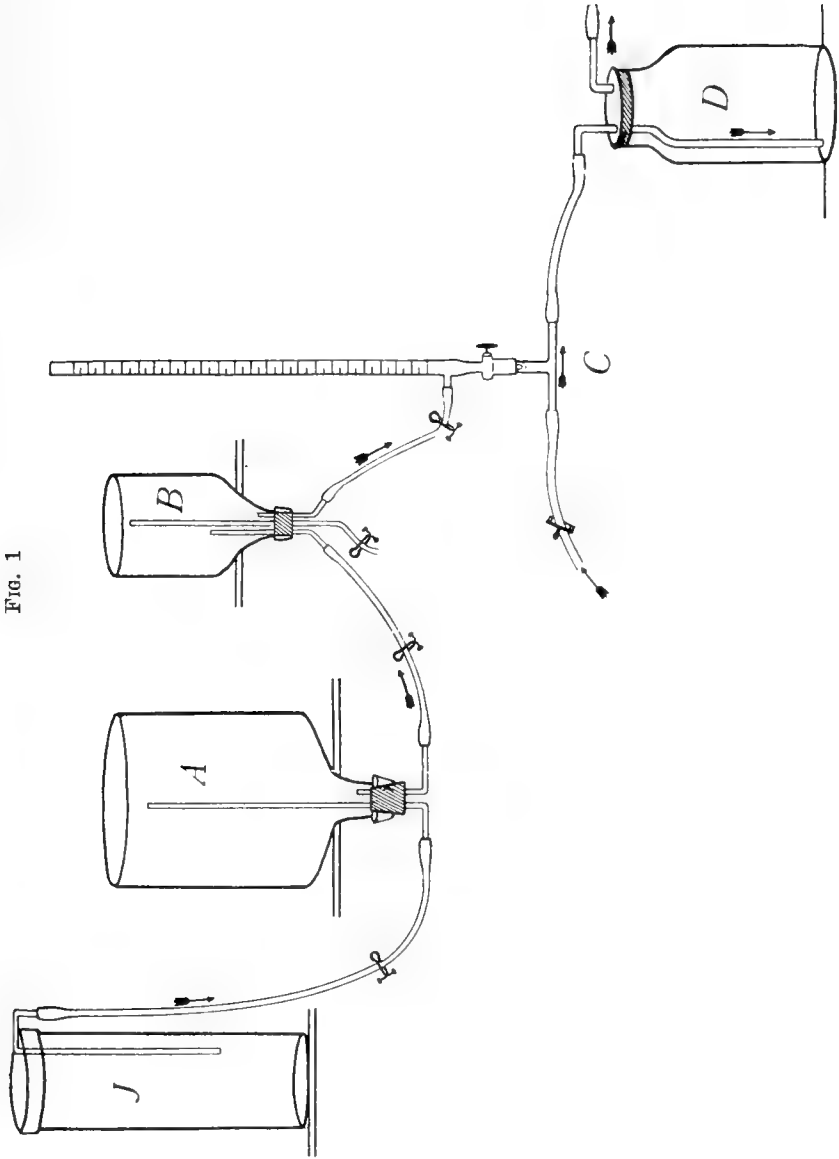


FIG. 1

The fishes were left in the experimental bottles until dead, and the time between introduction and death (dying time) is the basis of a comparison of the relative resistances of the different species. Table I is a summary of nine experiments in which four different concentrations of CO were used.

TABLE I

Showing the relative resistance of several species of fishes to different concentrations of carbon monoxide. The concentration of the CO solution which flowed through the experimental bottles is expressed in c.c. per liter.

Species of fish	Weight of fish in grams	CO 1.2 c.c. per liter	CO 3.8 c.c. per liter	CO 6 c.c. per liter	CO 11.7 c.c. per liter
<i>Moxostoma aureolum</i> (Red-horse)	10—15			28 min.	10 min.
<i>Notropis blennioides</i> (Straw-colored minnow)	2—4	1 hr.	45 min.	28 min.	
<i>Pimephales notatus</i> (Blunt-nosed minnow)	1—1.5	1 hr., 55 min.	1 hr., 20 min.		
<i>Lepomis humilis</i> (Orange-spotted sunfish)	2—6	5 hr., 40 min.	4 hr., 5 min.	1 hr., 5 min.	45 min.
<i>Lepomis cyanellus</i> (Green sunfish)	2—4	6 hr., 10 min.	5 hr., 25 min.	5 hr., 51 min.	4 hr., 5 min.
<i>Ameiurus melas</i> (Black bullhead)	20.5				9 hr., 55 min.

This table shows the high toxicity of water which contains even small amounts of carbon monoxide in solution, and that stronger concentrations are proportionately more deadly. From the results of a large number of similar experiments with CO₂ (Wells, '13) it is evident that a concentration of from 75—100 c.c. per liter of carbon dioxide is required to equal the killing effectiveness of 1 c.c. per liter of carbon monoxide.

Water which contains lethal amounts of CO₂ in solution will soon lose its toxicity if exposed to the atmosphere for a comparatively short time. The CO₂ passes into the atmosphere until there is equilibrium between the gas in the atmosphere and in the water. Since the atmosphere ordinarily contains but minute amounts of CO₂, practically all of the gas will pass from the water; a solution containing 100 c.c. CO₂ per liter will lose all but 1 to 2 c.c. per liter within two or three hours.

Normally, the atmosphere does not contain even a trace of CO, and it would appear, therefore, that water containing small quantities

of this gas would rapidly lose its toxicity when exposed in open dishes. This was found not to be the case, however, for a saturated solution of CO did not lose its toxic properties even after two weeks' exposure. A liter of the saturated solution from A (Fig. 1) was placed in each of four 5 in. \times 8 in. battery jars and the jars were set in a stream of running water to keep the temperature constant at 18° C. A liter of tap water was placed in a fifth jar and set beside the other jars. Two small fish (*Lepomis humilis*) weighing between 3.5 and 8 grams each were placed in each jar. In the CO solution the fishes died very quickly, while those in the tap water continued to swim about normally. The dead fishes were removed at once and other individuals of the same size and species (except as noted) were placed in the jars at intervals during the next two weeks. All of the fishes placed in the CO solutions died, while the control pair was normal throughout the entire time and for two weeks afterward, when they were removed.

Table II shows the procedure in one of the experiments.

TABLE II

Showing the rate at which a liter of a saturated solution of carbon monoxide loses its toxic properties when exposed to the atmosphere in a 5 \times 8 inch battery-jar. Fishes used, Lepomis humilis. Two individuals placed in the jar each time.

Time	Weight of fish in grams	Dying time	Age of solution at beginning of experiment
Nov. 22, 11:30 a. m.	4.0	16 min.	Fresh
	6.7	25 "	"
Nov. 22, 12:05 p. m.	5.4	45 min.	35 minutes
	7.3	45 "	35 "
Nov. 22, 3:34 p. m.	4.6	1 hr., 1 min.	4 hr., 4 min.
	4.8	1 " 1 "	4 " 4 "
Nov. 22, 7:58 p. m.	5.0	1 hr., 42 min.	8 hr., 28 min.
	5.3	1 " 42 "	8 " 28 "
Nov. 23	4.1	1 hr., 1 min.	1 day
	7.2	1 " 27 "	1 "
Nov. 24	3.5	4 hr., 40 min.	2 days
	4.0	5 " 15 "	2 "
Nov. 25	5.6	5 hr., 45 min.	3 days
	6.0	6 days*	3 "
Nov. 26	5.0	5 da., 8 hr.	4 days
	5.9	5 " 18 "	4 "
Dec. 5	4.0	1 hr., 30 min.	13 days

*This fish was *Lepomis cyanellus*, which is a more hardy fish than *L. humilis*.

It will be noted that the solution became less deadly as time passed, yet the fishes placed in it on the fourth day were dead on the ninth day. The explanation for the rapid death of the fish on the thirteenth day is not clear. The last of the other fishes was removed on the ninth day and the water was then not disturbed till the thirteenth day. During these four intervening days the water seems to have gained in toxicity. The tests were not carried further because the stock of fishes was nearly exhausted. The solutions in the other jars all showed the same remarkable retention of toxicity, but none of them was left undisturbed for several days and then retested, as it was not thought that such treatment would have any effect other than a further gradual diminishing of the toxicity.

It is quite evident that solutions of CO do not behave as one might expect were the gas simply in solution in the water, and it is hard to account for the tenacity with which these solutions maintain their toxicity except by supposing that the gas forms some irreversible or slowly reversible compound with the water itself, or with some substance in solution or suspension in it. In any event, it is certain that the addition of even minute amounts of CO to natural waters introduces a serious menace to the life of the organisms therein. The extremely toxic effect of very small concentrations of the gas, together with the fact that water once poisoned with it is slow to resume its normal condition, makes this gas a source of grave danger to aquatic life wherever introduced into natural waters.

Reaction Experiments.—Shelford and Allee ('14) showed that fresh-water fishes are very sensitive to carbon dioxide in a gradient and that they will turn back quite definitely from small concentrations of the gas. I have shown further (Wells, '15) that fresh-water fishes tend to select a concentration of carbon dioxide that for most species varies between 1 and 6 c.c. CO₂ per liter. Shelford ('14) has pointed out that carbon dioxide may be used as an index to the suitability of bodies of water for fishes.

To determine whether or not fishes detect carbon monoxide and react to it in a gradient, a series of thirty-five experiments was run in which ten species of fishes were tried out. The amount of CO introduced into the treated end of the gradient varied from .5 to 1 c.c. per liter. Higher concentrations were tried, but they killed the fishes so rapidly that no results could be obtained with them. With the lower concentrations some very interesting results were obtained. There was no indication upon the part of the fishes that they detected the presence of the CO with any precision, and most of the records (made by graphing the movements of the fishes to a time scale) show

a decided preference for the CO or treated water. (See Chart I) This does not mean that the fishes were overcome in this end and thus showed an apparent preference only, for the graphs show that in many cases they swam quite regularly back and forth from one end of the tank to the other but spent the greater part of the time in the CO water. In some instances they actually turned back from the tap water.

This preference for treated water over the tap water was noted in a series of experiments made later with salts, and at that time it was found that the acidity of the tap water, due to the presence in it of 18 c.c. per liter of carbon dioxide, was the cause of the negative reaction of the fishes (see Wells, '15a). When the salt experiments were made in aerated tap water in which the CO₂ was diminished to 5 c.c. per liter, normal results were obtained. In the carbon-monoxide experiments the fishes were evidently negative to the tap water because of its acidity, which, though comparatively low, was more stimulating to them than was the much more highly fatal concentration of CO. Furthermore, it would seem that the CO antagonized to some extent the action of the CO₂, for otherwise the fishes would not have shown a preference for the CO end of the gradient unless they are actually positive to CO solutions in spite of their fatal effect. That such selection of fatal environments may actually occur is not impossible, but it would not be safe so to conclude until the acid factor, referred to above, has been eliminated, and this has not yet been done. However, it is safe to say that CO in solution produces no avoiding reaction upon the part of the fishes used, and for this reason its introduction into natural waters would be doubly dangerous to fishes inhabiting them.

GENERAL RESISTANCE OF FISHES

Whether or not a particular species can persist in a given environment depends, so far as the organism is concerned, upon its ability to detect detrimental changes in the environment and to react to them, and upon its power of resisting such hurtful factors as can not be avoided by the proper reaction. These factors of reaction and resistance can never be entirely separated, but their relative importance varies widely with different species. Attached or sluggish organisms must depend to a great extent upon their powers of resistance to tide them over a period of unfavorable conditions; highly active organisms, on the other hand, may seldom find it necessary to put their resistance powers to the test, for they can move away from the disturbing conditions if these do not cover too large an area. It is

probable that the reactions of most fishes have more to do with their persistence in natural environments than does their power of resistance, for the appearance of adverse conditions in natural waters is seldom so general or so sudden that fishes can not escape, by the proper reactions, at least sufficiently for survival, and observation and experiment indicate that most fishes will so react.

Although the exact relation between reaction and resistance in organisms is not clear, as a general rule, those organisms which show but little power of resistance to adverse environmental changes are for the most part quite sensitive and quick to react to such changes, while the more resistant species frequently show little or no signs of definite reaction to the detrimental factor.

The resistance of fishes to hurtful conditions varies with the species, with age (or size and weight), with the individual (that is with physiological state), and with the season. Practically all of the fishes worked with are least resistant just after the breeding season, or in the months of June, July, and August (see Wells, '16). In September the curve of resistance begins to run up, and it continues to rise throughout the winter months, reaching its maximum in March, April, and May—that is, at the beginning of the breeding season or just before. The relative resistance of species does not seem to vary greatly with the season. Just how much species vary in their relative resistance to different harmful factors is a matter for further investigation. The work so far, however, indicates that if species 1 is more resistant than species 2 to factor *a*, it is fairly safe to conclude that it will show a greater resistance to factor *b* also. In Table III an attempt has been made to arrange the more common species of northern Illinois fishes according to their powers of resistance to detrimental environmental factors in general. Such an arrangement must at this time be considered more or less tentative because of the large number of unsolved questions concerning fish resistance in general, but the list as given will prove suggestive.

In the table the least resistant species is placed at the head of the list and given an arbitrary resistance value of 1. The succeeding species show an increasing resistance to lethal factors and their relative resistance is indicated by the figure in the middle column. The third column indicates the environments where each species is most likely to be found.

TABLE III

Indicating the relative resistance of the more common species of fishes to be taken in the waters of Northern Illinois, together with data as to the best type of ecological environment for each species. In column 2 the resistance of the least resistant species is arbitrarily taken to be unity.

Species of fish	Relative resistance	Best place to collect
<i>Labidesthes sicculus</i> (Brook silverside)	1	Small rivers and clear shallow lakes. Prefers sandy bottom
<i>Etheostoma coeruleum</i> (Rainbow darter)	2	Among the stones in the ripples of creeks and small rivers
<i>Moxostoma aureolum</i> (Red-horse)	2.3	Sandy-bottomed pools in creeks and small rivers
<i>Catostomus commersonii</i> (Common sucker)	2.4	Lake Michigan and pools in creeks and small rivers. Prefers bottoms containing some sand.
<i>Notropis atherinoides</i> (Shiner)	3.0	Common in Lake Michigan. Other larger lakes and rivers.
<i>Semotilus atromaculatus</i> (Horned dace)	4.0	The headwaters of small creeks. In vegetation along bank.
<i>Chrosomus erythrogaster</i> (Red-bellied dace)	5.0	Small clear creeks. Along with horned dace but does not go up stream as far. Often in vegetation along bank.
<i>Micropterus dolomieu</i> (Small-mouthed black bass)	5.0	Swift streams; clean bottom. Small deep lakes; cold water.
<i>Micropterus salmoides</i> (Large-mouthed black bass)	6.0	Sluggish rivers and small shallow lakes with mud bottom.
<i>Pimephales notatus</i> (Blunt-nosed minnow)	6.0	Pools, mud bottom, in creeks and small rivers.
<i>Hybopsis kentuckiensis</i> (River chub)	7.0	Creeks and small rivers. Swifter parts of pools.
<i>Notropis cornutus</i> (Common shiner)	7.0	Creeks and small rivers. Swifter parts of pools.
<i>Pomoxis annularis</i> (White crappie)	8.0	Wide distribution. Abundant in ponds, lagoons, and all sluggish water.
<i>Pomoxis sparoides</i> (Black crappie, Calico bass)	8.0	Practically same location as for white crappie.
<i>Ambloplites rupestris</i> (Rock bass)	10.0	Clean-bottomed pools with rocks. Creeks and small rivers.
<i>Perca flavescens</i> (Yellow or American perch)	10.0	Abundant in Lake Mich. Also in larger rivers but not in creeks.
<i>Lepomis cyanellus</i> (Blue-spotted sunfish)	15.0	Pools in creeks. Often with mud bottom.
<i>Ameiurus melas</i> (Black bullhead)	45.0	Ponds; pools in small creeks. Mud bottom among vegetation.

While in Table III only eighteen species of fishes are listed, the comparative resistance of other species may be estimated by comparing their resistance with that of some one of the listed species. By

placing a species of unknown resistance in an experiment with one of the species given in Table III one may obtain results that will make it possible for him to compare the resistance of the unknown species with that of any of the species listed. It should be pointed out also, that fishes of the same large taxonomic group have in general a similar power of resisting detrimental factors. Thus, the darters are a group possessing for the most part a low ability to resist untoward conditions. The minnows (Cyprinidae) are fairly resistant as a group; the sunfishes are more resistant than the minnows; and the catfishes are notably our most resistant group of fresh-water fishes. The place of an untried species in the resistance table can be reckoned more or less accurately by placing it with the listed representatives of the taxonomic group to which it belongs.

From column 3 (Table III) it will be seen that the resistance of the fishes is rather closely correlated with the type of environment which they inhabit. The more resistant species are found in ponds, shallow, muddy-bottomed lakes, or in the stagnant pools of streams. These are the fishes which one sees in aquaria. They are able to withstand increased temperature and wide fluctuation in the oxygen and carbon-dioxide content of the water, and to some extent are able to live in the presence of the excretory products of their own metabolism. The stream fishes proper can not do this, and therefore die when placed for any length of time in standing water.

SUMMARY

1. The introduction of either carbon dioxide or carbon monoxide into fish waters is certain to prove detrimental to the aquatic organisms, and especially to the fishes present in the water.
2. Both carbon dioxide and carbon monoxide are poisonous to fishes. Of the two gases, the monoxide is by far the more deadly.
3. Fishes are very sensitive to small changes in the carbon-dioxide content of the water, and tend to avoid detrimental concentrations of this gas by a very definite turning back from them. Fishes do not appear to detect the presence of carbon monoxide in the water, and will swim into concentrations of this gas that kill them in a few minutes.
4. In general, the resistance of fishes is correlated with the environment in which they are found. The more resistant species are found in ponds and shallow lakes while the least resistant fishes occur in the swift streams and in cold, deep lakes.

BIBLIOGRAPHY

Shelford, V. E.

- '14. Suggestions as to indices of the suitability of bodies of water for fishes. *Trans. Am. Fisheries Soc.*, 1914:1-14.

Shelford, V. E., and Allee, W. C.

- '14. Rapid modification of behavior of fishes by contact with modified water. *Jour. An. Behav.*, 4:1-30.

Wells, M. M.

- '13. The resistance of fishes to different concentrations and combinations of carbon dioxide and oxygen. *Biol. Bull.*, 25:323-347.

- '15. Reactions and resistance of fishes in their natural environment, to acidity, alkalinity and neutrality. *Biol. Bull.*, 29:221-257.

- '15a. The reactions and resistance of fishes in their natural environment to salts. *Jour. Exper. Zool.*, 19:243-283.

- '16. Starvation and the resistance of fishes to lack of oxygen and to KCN. *Biol. Bull.*, 31:441-452.

CHART I

Graph 1 shows the reaction of a small-mouthed black bass to water containing 35 c.c. per liter of carbon dioxide introduced at the right-hand end. The fish avoided it sharply, staying very close to the left end, where the carbon dioxide was only 3 c.c. per liter.

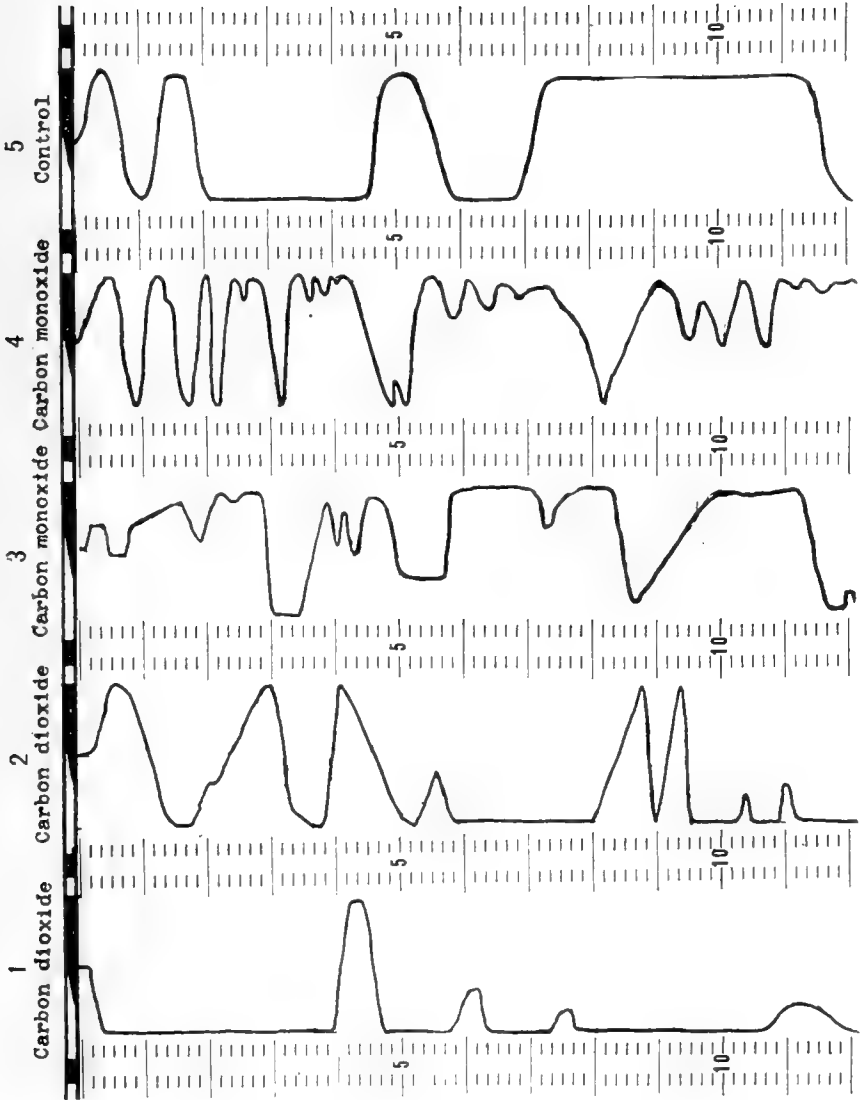
Graph 2 shows the reaction of an individual of the tadpole-cat (*Schilbeodes gyrinus*) to carbon dioxide of the same concentration as in the case of Graph 1. It will be noted that while the fish was negative to the higher concentration, more excursions were made into the higher concentration, and more time was spent there than in the case of the small-mouthed black bass. The tadpole-cat ranks with the rest of the bullhead group in having a high resistance to adverse conditions.

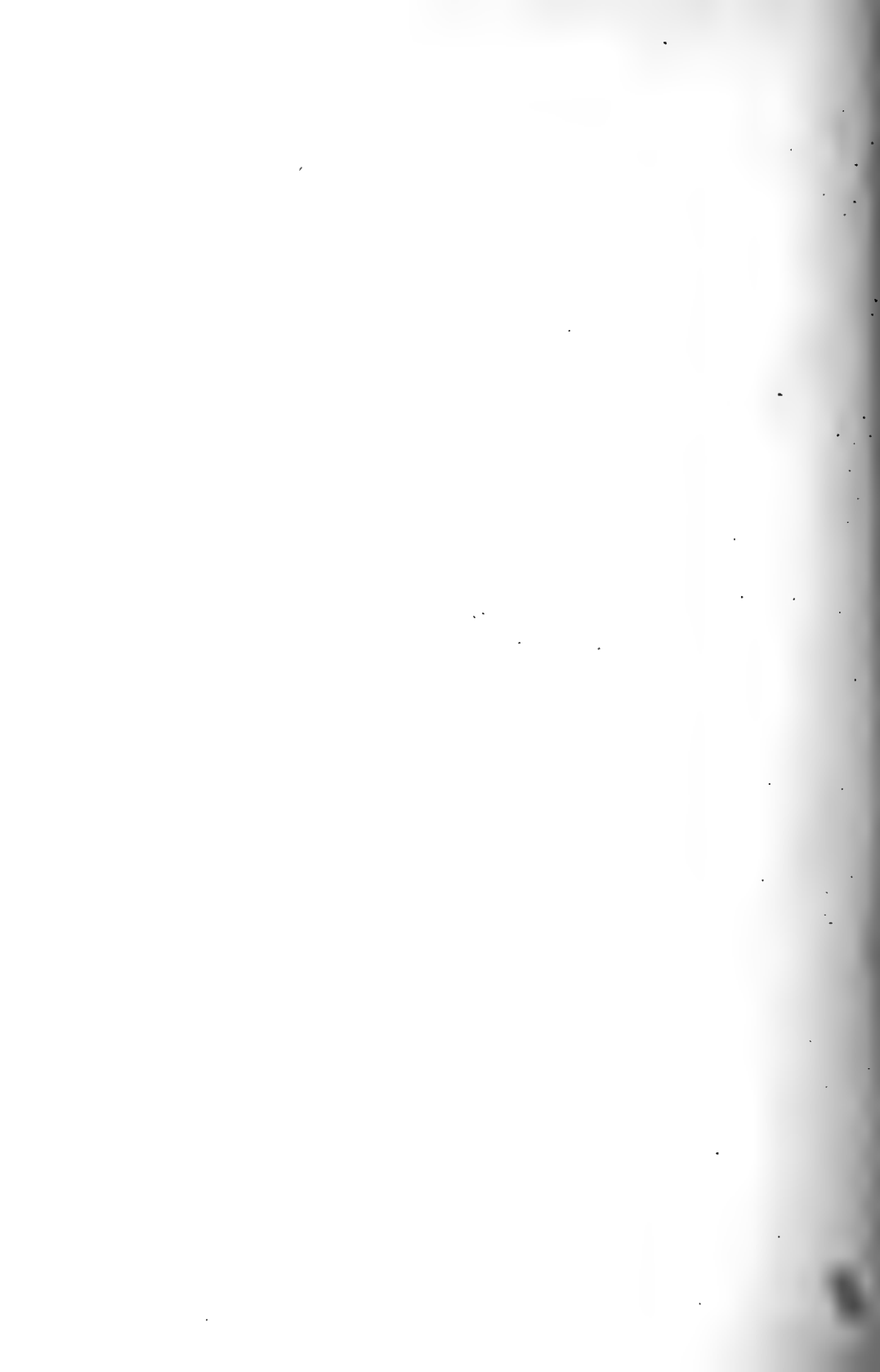
Graph 3 shows the reaction of a small-mouthed black bass to 0.5 c.c. of carbon monoxide per liter in the right-hand end of the gradient tank. The reaction is reversed as compared with that to carbon dioxide. The avoidance of the pure water is striking.

Graph 4 shows the reaction of the black bullhead to 0.5 c.c. per liter of carbon monoxide. The fish becomes slightly positive at the end of three minutes, and is increasingly so as time goes on, indicating that the preference for the monoxide increases with time.

Graph 5 shows the movement of a specimen of a black bullhead when there is no difference between the two ends of the tank.

CHART I





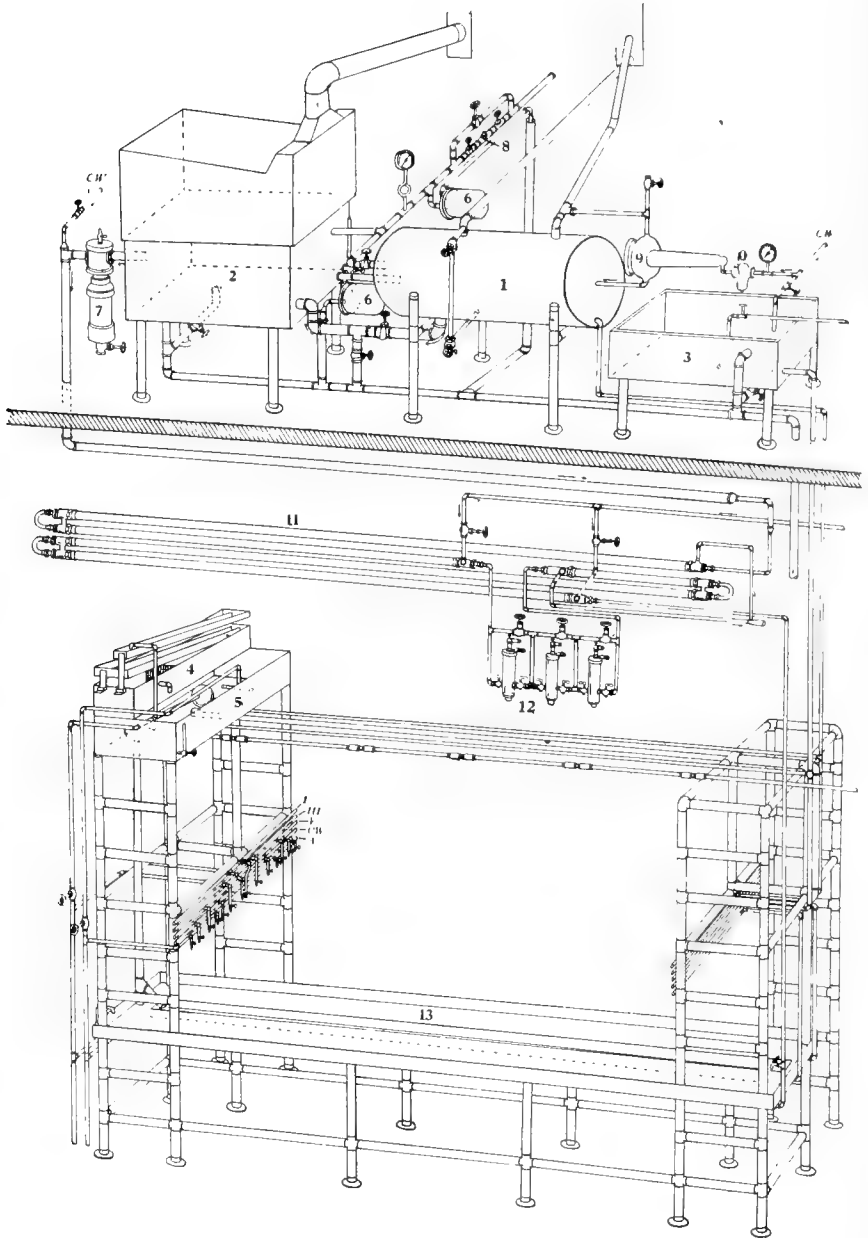
ARTICLE IX.—*Equipment for maintaining a Flow of Oxygen-free Water, and for controlling Gas Content.** BY VICTOR E. SHELFORD.

In Article VI of this volume a piece of apparatus for controlling gas content and adding gases and fluids to water is described by the present writer. His earlier work, as well as that reported by Dr. Wells in Article VIII, was done with that apparatus on a water table of temporary construction, but the table and the apparatus have both been replaced by the permanent structures herein described. The new equipment consists of a large drain-table (13), shown in the lower part of the accompanying figure, with the boilers on the floor above. The drain table is provided with double-decked towers nine feet high, for supporting bottles, tanks, etc. in the manner indicated in articles VI and VIII of this volume. Aside from possessing many advantages in the control of conditions where fluids and gases are added, the new apparatus has great advantages in the control of oxygen content, as continuous flow is insured, and with aerating troughs of various lengths almost any amount of oxygen can be obtained in running water. The other apparatus† used gas heat for boiling and could deliver not more than 100 c.c. of oxygen-free water per minute, and this amount was not certain to be free from oxygen continuously. The new piece of apparatus delivers a liter of water per minute and could probably deliver a maximum of four or five liters per minute.

It uses high pressure steam for boiling the water and delivers it with the temperature brought down to that of the water supply. We may accordingly follow the course of the water supply from the supply pipe to the exit from the cooling coil. Water is introduced into the first boiler, No. 1, from the supply pipe at the right of the upper group of apparatus. It is passed through a Schutte & Koerting 1½" strainer to an inclosed float cock, No. 9. This float cock, a stock article on the market, maintains water at a definite level in both tank

*The apparatus described in this article was developed in connection with the work on stream pollution done by the author and described in Article 6 of this volume; the new apparatus was provided by the University of Illinois in the new Vivarium Building to supersede the piece described in that article. The drawing was provided by the Department of Zoology.

†See Shelford and Allee, *Journal of Experimental Zoology*, Vol. 14, pp. 207-266. 1913.



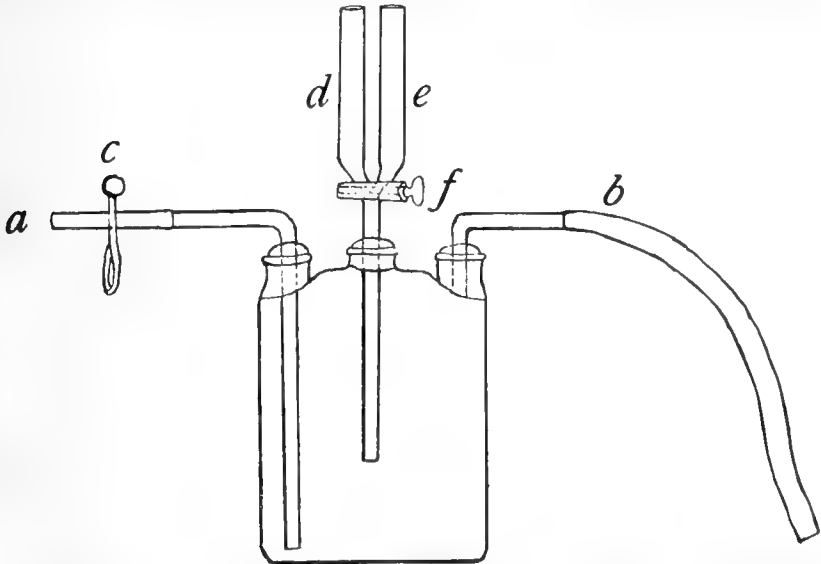
No. 1 and tank No. 2. Tank No. 1 is a water-heater containing a steam coil and vented by two large pipes connected with the flue. A large amount of steam and gas is given off from the water escape from this tank. Tank No. 1 is connected with tank No. 2 by a two-inch pipe containing a valve which makes possible the draining of one tank without draining the other. The water being withdrawn from tank No. 2, flows from No. 1 to No. 2 and is boiled for a long time in the latter, which measures $2 \times 2 \times 4$ ft. and is supplied with a six-inch vent in a large cover. The water leaves tank No. 2 at the left through a dirt trap, No. 7, and passes through the floor to the room below. The discharge line can be flushed with university water from CW. The steam used is high pressure—usually 90 pounds—but may be reduced to 25 or 30 pounds by a pressure-reducing valve, No. 8; the steam traps, No. 6, remove the condensation.

After passing through the floor the water goes through a cooler, No. 11, made from block-tin pipe (black iron return bends at the ends) placed inside $1\frac{1}{2}$ " pipes connected with each other by cooler tees, the cooling water flowing into the cooler at the point where the boiled water leaves it. In the middle of the coil are three gas introducers (12), which are modified beer air-purifiers made by Bishop, Babcock, and Becker, the gas being introduced into the chambers, through which the water flows, through blocks of basswood, thus dividing it into very small bubbles. Oxygen, carbon dioxide, and nitrogen have been introduced.

The water is delivered at the ends of a drain table. Tank No. 3 is used for securing water which is saturated with oxygen under atmospheric conditions in quantity sufficient to run through a number of bottles containing animals. Tank No. 4 is for aerating the university water-supply by running it down crimped inclines and through two chambers where the iron which is precipitated is removed. This water is stored in tank No. 5. Two tanks like Nos. 4 and 5 are provided above tank No. 3, with the controlling float-cock in No. 3, so that water may be partially aerated and delivered to No. 3, where compressed air forced into it renders it very alkaline and saturated with oxygen. The drain table is supplied with water from tanks Nos. 3 and 5 and from the university supply marked CW, and also with air (A).

ARTICLE X.—*A Collecting Bottle especially adapted for the Quantitative and Qualitative Determination of Dissolved Gases, particularly very Small Quantities of Oxygen.** BY EDWIN B. POWERS.

One of the sources of error in the Winkler method for the determination of dissolved oxygen in water, especially where the oxygen content is low, is the diffusion of oxygen into the water before and during the introduction of the chemicals. Another source of error is the mixing of the manganous chloride with the potassium iodide-alkali solution at the surface of the water, the chemicals adhering to the pipettes introducing these reagents having washed off at the top of the bottle, where they react with the oxygen present. In recent work involving the oxygen-free water apparatus described by Shelford in the preceding article of this volume, it was found especially desirable to eliminate the above sources of error. This was accomplished



*This bottle was devised primarily for the study of the oxygen requirements of crayfishes, with a view to their use as index organisms.

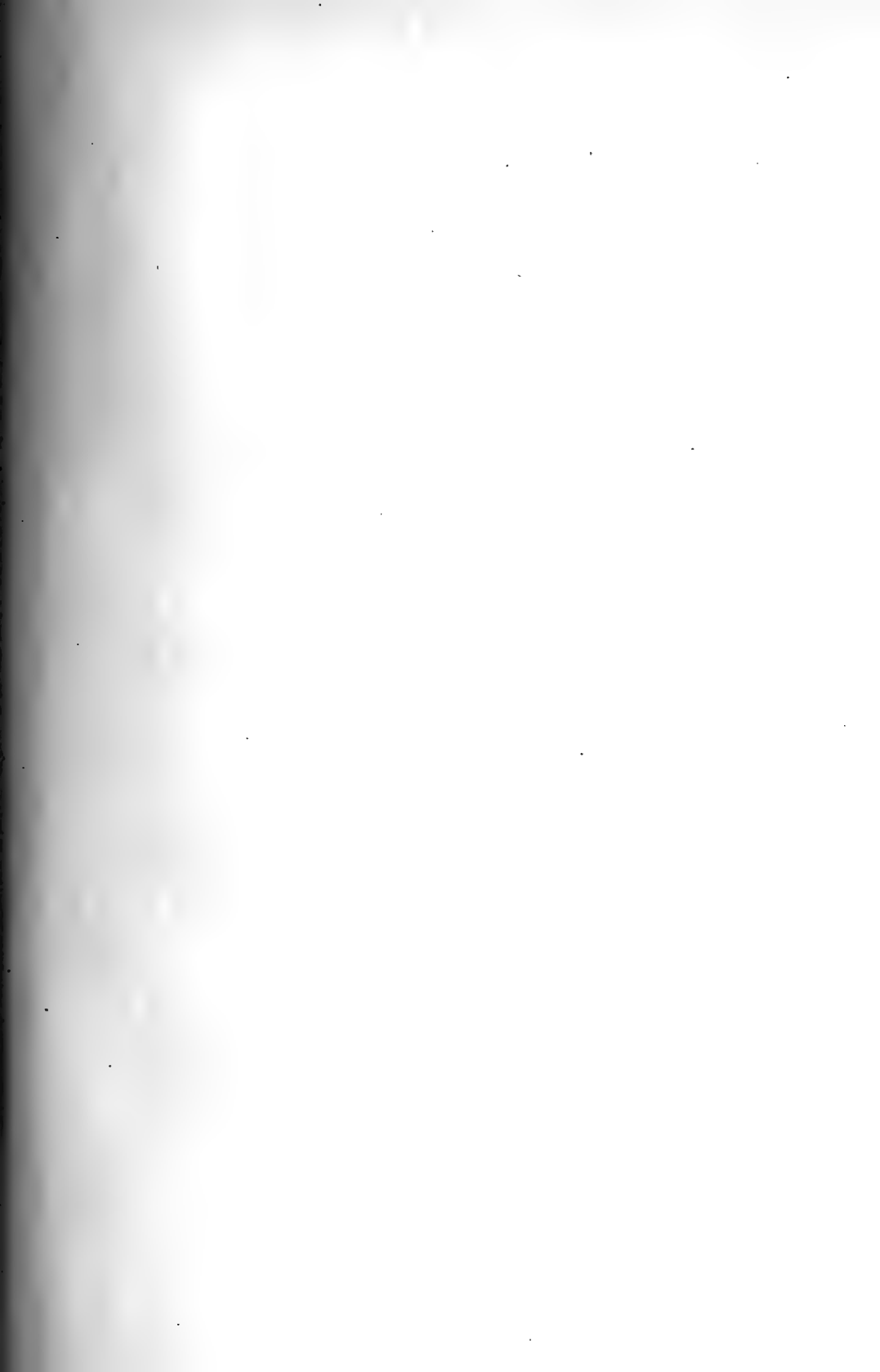
by a special bottle which allows the collecting of samples and the introduction of the chemicals without exposing the samples to air during the operation.

The apparatus shown in the accompanying figure is composed of a bottle having an inlet, *a*, at bottom and an outlet, *b*, at top. When the bottle is filled the inlet is clamped off at *c*. The manganous solution is introduced through the burette *d* and the potassium iodide-alkali solution through the burette *e*. The burettes *d* and *e* are supplied with a two-way stop-cock at *f*. The displaced water is allowed to pass out at the outlet *b*, which is kept open to equalize the pressure. The acid solution is introduced through the burette *d*, thus avoiding any action of a strong acid on the potassium iodide of the potassium iodide-alkali solution. A 200 c.c. pipette is used to draw a sample for titration, thus avoiding agitation of sample in presence of air. Correction for error due to the introduction of chemicals can be calculated from the per cent. of collection used for titration with sodium thiosulphate, and the oxygen content of the water can be calculated directly. In lieu of the simple pipette for drawing off sample of water for titration, the device described by Hyman L. Shoub* may be substituted.

A modification of this bottle is also very useful for work with hydrogen sulphide, sulphur dioxide, carbon dioxide, and other gases when exclusion from the air is essential.

I wish to thank Mr. Carl F. Miller and Mr. Paul Anders, of the Chemical Laboratory of the University of Illinois, for making this apparatus available.

*Hygienic Lab. Bull. 96, U. S. P. H. S. Aug., 1914.





INDEX.

A

- Abramis chrysoleuca*, 387, 397.
Acanthoceros galeator, 64, 65, 126.
Acarina, 164, 208.
Acarus serotinae, 64, 126, 140, 208.
Accipiter cooperi, 294.
 velox, 298.
Acer, 292.
 saccharinum, 149.
 saccharum, 42, 62, 63, 123, 126, 151, 157, 301.
Acorn codling caterpillar, 141.
 moth, 141.
 plum gall, 61, 232.
Acorns, 141.
Acridiidae, 115, 166, 211.
Acrosoma, 138.
 gracile, 207.
 rugosa, 58, 64, 65, 125, 126, 138, 207.
 spinea, 64, 65, 125, 126, 138, 207.
Actinomeris alternifolia, 63, 125, 219.
Adelphocoris rapidus, 53, 174, 175.
Adiantum pedatum, 63.
Aenigmatias, 355.
 blattoides, 355.
Agapetidae, 226.
Agaricus, 437.
 arvensis, 470, 472.
 campestris, 418, 432, 464, 466, 470, 476.
 placomycus, 468, 470, 472.
 rodmani, 474.
 silvaticus, 476.
 silvicola, 427, 470, 472.
 subrufescens, 476.
Agelaius phoeniceus phoeniceus, 286
Agrilus, 144.
Agriotes lineatus, 116.
Agromyza, 348, 359.
 abbreviata, 360.
 angulata, 351-352.
 aprilina, 350, 359-360.
 carbonaria, 350.
 kincaidi, 360.
 nigripes, 360.
 parvicornis, 350.
 pruinosa, 348, 350.
 pruni, 348, 349-350.
 tiliae, 351.
 subnigripes, 360.
Agromyzidae, 348, 359.
Agropyron smithii, 39.
Agrotis, 327.
 herilis, 333.
Alaus, 145.
 oculatus, 145.
Alder, 79, 84, 139.
Aletia, 218.
Algæ, 292, 293, 558.
Allograpta obliqua, 53, 188, 342.
Alydus quinquespinosus, 65, 219.
Amanita, 136, 417, 430, 437, 464.
 booted, 450.
 cothurnata, 431, 450.
 phalloides, 430, 448.
 solitaria, 452.
 spretta, 454.
 spring, 448.
 verna, 415, 416, 430, 431, 448, 452.
 warted, 452.
Amanitopsis, 437, 456.
 sheathed, 454.
 vaginata, 454.
Amazon-ant, 191.
Ambloplites rupestris, 387, 567.

- Amblycorypha*, 138, 140.
 oblongifolia, 215.
 rotundifolia, 64, 126, 215.
Ambrosia, 118, 171, 175.
 artemisiifolia, 176.
 beetles, 137.
 trifida, 178, 179.
Ambush bug, 45, 46, 47, 48, 50, 51, 52,
 53, 104, 110, 174, 185, 189.
 spider. See under Spider.
Ameiurus nebulosus, 387.
 melas, 561, 567. See also Bullhead,
 black.
Ammalo, 109.
 eglenensis, 53, 183.
 tenera, 53, 183.
Ammophila, 140.
 abbreviata, 59, 62, 125, 132, 159, 228,
 238.
 nigricans, 52, 194.
Amphibians, 282, 289, 293, 407.
 and reptiles, 284, 293.
Amphibolips, 140.
 confluens, 232, 234.
 prunus, 61, 232.
Amphicoma, 369.
Anasa, 173.
Ancylonycha, 365, 369.
Andrena, 327.
Andricus, 140.
 clavula, 59, 232.
 cornigerus, 65, 232.
 lana, 59, 65, 232.
 seminator, 232.
Andropogon, 40, 49, 55, 111, 160, 163,
 167, 168, 169, 170, 171, 181, 212,
 215, 216.
 furcatus, 39, 49, 53, 112.
 virginicus, 39, 49, 53.
Anisodactylus interstitialis, 135.
Anisonyx, 369.
Anosia, 51 (see Errata).
 plexippus, 45, 46, 47, 50 (see Errata),
 113, 183.
- Ant*, 54, 110.
 Amazon-, 191.
 carpenter, 62, 147, 150, 154, 203, 236.
 cocoanut, 64, 236.
 corn-field, 119.
 -lion, 58, 165, 209.
 prairie, 50.
 mound-building, 235.
 old-fashioned, 61, 233.
 rusty carpenter-, 62, 65.
 Tennessee, 61, 235.
 velvet, 192, 238.
 white, 58, 61, 147, 150, 152, 154,
 159, 202, 204, 208, 234.
Antennaria, 124.
 plantaginifolia, 57.
Anthomyiidae, 356 (see Errata).
Anthrax, 319, 326, 327, 328, 333.
 alternata, 333.
 anale, 328.
 fascipennis, 330.
 hypomelas, 326, 333, 334.
 lateralis, 326, 332-333.
 molitor, 333.
 morio, 327.
 sinuosa, 198.
 velutina, 327.
Antrostomus vociferus vociferus, 298.
Ants, 35, 125, 140, 171, 177, 293.
 leaf-cutting or umbrella, 426.
 Ants' nests, 355.
Apatela, 105.
 populi, 105.
Aphanogaster, 235.
 fulva, 59, 65, 159, 202, 204, 208,
 234, 235.
 tennesseensis, 61, 235.
Aphaniosoma, 358.
 approximatum, 358.
 quadrivittatum, 357-358.
Aphididae, 35, 137, 158, 171, 188, 234.
Aphiochæta, 309.
Aphis, 158.
 asclepiadis, 109, 112, 118, 171, 188,
 190.

- Aphæbantus**, 327.
 mus, 332.
Aphorista vittata, 136.
Apidæ, 200.
Apis mellifera, 45, 46, 47, 50 (see *Errata*), 51, 200.
Apithus, 132.
 agitator, 58, 61, 124, 217.
Aplexa hypnorum, 161.
Aplopus mayeri, 211.
Apocynum, 104, 109, 113, 118, 173, 183, 201.
 androsæmifolium, 179.
 medium, 44, 45, 49, 57, 109, 178, 183, 193, 223.
Apogonia, 369.
Apple, 146, 149, 229.
 -tree, 342.
Arachnida, 161-164, 205-208.
Araneida, 162, 206.
Archilochus colubris, 295.
Arctiidæ, 183, 227.
Argiope, 120, 164, 165.
 aurantia, 42, 44, 45, 46, 48, 49, 50, 51, 52, 53, 54, 104, 107, 108, 109, 111, 121, 162, 165, 182.
 riparia, 162.
 transversa, 163.
Argynnis idalia, 45, 46, 183.
Arhopalus fulminans, 147.
Aristolochia, 225.
Armillaria, 437.
 mellea, 423, 429, 488.
Army-worm, 189.
Arrhenoplita bicornis, 136.
Asaphes memnonius, 64, 126, 221.
Asclepias, 118, 172, 178, 181.
 cornuti, 113, 173.
 incarnata, 39, 44, 49, 103, 112, 113, 160, 163, 171, 172, 173, 174, 175, 176, 177, 178, 179, 182, 183, 184, 186, 192, 194, 198, 200, 283.
 sullivantii, 43, 49, 112, 182.
 syriaca, 112, 113, 164, 171, 173, 176, 178, 180, 188, 189, 190, 191, 201.
 tuberosa, 183.
Ascomycetes, 420, 435, 546.
 Ash, 77, 78, 147, 149, 152, 227, 425.
 black, 149.
 borer, 147.
 prickly, 60, 63, 138, 179, 183, 217, 225.
Asilidæ, 48, 49, 108, 115, 186, 190, 210, 230, 319, 324, 325, 326, 337-341.
Asilus, 187.
 missouriensis, 187.
 notatus, 327, 337, 338, 339, 340-341.
 vertebratus, 337.
Asparagus, 162.
 beetle, imported, 172.
Aspen, 27.
Aspidiotus obscurus, 156.
Astacidæ, 161, 204.
Aster, 188.
Astragalinus tristis tristis, 286, 295.
Attelabus rhois, 139.
Attidæ, 112, 164.
Aulacizes irrorata, 64, 126, 218.
Autographa, 138.
 precationis, 64, 126, 227.

B

- Baccha babista**, 342.
Bacteria, 89, 90.
Bacterium, 427.
Bacunculus blatchleyi, 211.
Badger, 303.
Bag-worm, 154, 156.
Balaninus, 142.
 caryæ, 141.
 nasicus, 141.
 reniformis, 141.
Bark-beetle, hickory, 154.
Bark-beetles, 27, 156.
Bark-louse, 156.
Basidiomycetes, 417, 420, 435.
Basilona, 140.
 imperialis, 64, 227.
Bass, 387, 391, 402.
 calico, 567.
 large-mouthed black, 385, 387, 567,
 rock, 387, 567.
 small-mouthed black, 385, 387, 567,
 570.

- Bassus lætatorius*, 342.
 Basswood, or linden, 77, 136, 141, 146,
 149, 151, 152, 174, 227, 228.
 Bayberry, 299.
 Beans, 179.
 Bear, 303.
 Beard grass, 53.
 Bee, carpenter, 45, 46, 104, 198, 199.
 -fly, 174.
 giant, 50, 52, 53, 54, 163, 174, 185.
 honey-, 45, 46, 50, 51, 104, 187, 200.
 leaf-cutting, 50, 198.
 moths, 100.
 short leaf-cutting, 52, 198.
 Beech, 76, 80, 81, 85, 147, 152, 157,
 214, 425, 456.
 Bees, 174, 186, 192.
 Beet, 182.
 Beetles, 174, 201, 235, 236, 293.
 Beggar-ticks, 53, 103.
 Bellflower, 63.
 Benzoin, 138, 207.
 Bidens, 44, 103, 118, 171, 172.
 Bill-bug, 50, 181.
 Birch, 27, 149, 228.
 river, 348, 350.
 Birds, 44, 100, 284, 287, 289, 291, 293,
 294-297, 298, 299, 300, 301, 302.
 Bittacus, 62, 126, 133, 190.
 apicalis, 126, 210.
 stigmaterus, 64, 126, 209, 210.
 strigosus, 126, 210.
 Bitternut, 57, 60, 63, 228.
 Bittersweet, 63, 224.
 Black flies, 307.
 Blackberry, 129, 148, 170, 216, 299.
 Blackbird, crow; or grackle, bronzed,
 286, 290, 298.
 red-winged, 286, 290, 291.
 Blackbirds, 291.
 Blarina brevicauda, 289.
 parva, 288, 299.
 Blastobasis glandulella, 141.
 Blattidæ, 210.
 Blazing star, 199, 200.
 Blissus leucopterus, 111.
 Blister-beedle, black, 52, 53, 55, 110,
 180.
 margined, 52, 53, 54, 180.
 striped, 180.
 two-lined, 180.
 Blister-beetles, 180.
 Bluebird, 297.
 Blue flag, 44, 103.
 -gill, 387.
 jay, 286, 295, 300.
 stem, 40, 53, 55, 166, 170, 171, 181.
 Bobolink, 302.
 Bob-white, 285, 290, 298, 301.
 Boeolophus bicolor, 296.
 Boletinus, 538.
 porosus, 538.
 porous, 538.
 Boletotherus, 159.
 bifurcus, 64, 126, 136, 224.
 Boletus, 534, 538.
 Bombidæ, 199.
 Bombus, 47, 51, 117, 119, 120, 121, 187,
 200.
 auricomus, 56, 108, 111, 200.
 consimilis, 200.
 fervidus, 200.
 fraternus, 45, 46, 50, 111, 200.
 impatiens, 56, 108, 111, 200.
 pennsylvanicus, 45, 46, 54, 56, 108,
 109, 111, 199.
 separatus, 45, 46, 50, 52, 111, 163,
 200.
 Bombycid, 220.
 Bombycilla cedrorum, 298.
 Bombyliidæ, 115, 185, 319, 324, 325,
 327-334.
 Bombylius, 186, 327.
 brevirostris, 331.
 fulvus, 331.
 l'herminieri, 331.
 Borer, apple, 146.
 ash, 147.
 elm, 146, 154.
 flat-headed apple-tree, 146.
 heartwood, 154.
 hickory, 147.

- Borer**—*continued*.
 honey-locust, 147.
 locust, 145, 147, 154.
 sugar-maple, 156, 232.
Borers, wood, 99, 100, 148.
Bothriothorax, 342.
 peculiaris, 342.
Bothropolys multidentatus, 134.
Botrychium virginianum, 63.
Box-elder, 143, 456, 530.
Box-turtle, 293, 294.
Brachycoma, 120.
 dauidsoni, 200.
Brachynemurus abdominalis, 50, 51,
 111, 165.
Brachypalpus frontosus, 343.
Bracon agrili, 144, 159 (see *Errata*).
Braconidæ, 158, 190.
Branchiobdellidæ, 66.
Brenthid, northern, 147.
Brontes dubius, 151.
Brown-tailed moth, 156.
Bubo virginianus virginianus, 298.
Buck-brush, 63.
Buckwheat, climbing, 227.
Buffalo, 118, 301.
 -grass, 30.
Bufo americana, 293.
Bug, ambush, 45, 46, 47, 48, 50, 52,
 53, 104, 174, 185, 189.
 fla negro-, 172.
 leaf-footed, 138.
 milkweed. See *Milkweed-bug*.
 plant. See *Plant-bug*.
 slender-necked, 135.
 squash, 189.
 stinging, 174.
 stink-, 50, 51, 187.
Bugs, 201.
Bullfrog, 294, 300.
Bullhead, black, 562, 567, 570.
Bullheads, 387, 570.
Bulrush, 44, 103.
Bumblebee, false, 52, 54, 120, 200.
 impatient, 56, 200.
 Pennsylvania, 45, 54, 56, 199.
Bumblebees, 45, 46, 47, 50, 52, 56, 117,
 199.
Bunting, Henslow's, 302.
 indigo, 287, 296.
Buprestidæ, 144, 145.
Buprestis splendens, 142.
Burdock, 227.
Bush honeysuckle, 183.
Buteo borealis borealis, 298.
 lineatus lineatus, 298.
Butorides virescens virescens, 284, 294.
Butterflies, 46, 125, 174, 187, 201.
Butterfly, cabbage, 56, 182, 186, 187.
 celery, 45, 182.
 crephontes, 225.
 eurytus, 65, 226.
 idalia, 45, 183.
 milkweed, 45, 50, 183.
 monarch, 290.
 philenor, 59, 61, 225.
 philodice, 45.
 portlandia, 65, 226.
 thoe, 53, 183.
 troilus, 59, 61, 225.
 turnus, 50, 225.
Butternut, 139, 146, 149, 227.
Buttonwood, 227.
- C**
- Cabbage**, 347.
Caberodes confusaria, 61, 229.
Cacalia, 171.
Calandridæ, 181.
Calicodoma, 327.
Callipus, 133.
 lactarius, 64, 134, 205.
Calloides nobilis, 148.
Callostoma, 327.
Caloptenus italicæ, 327.
 spretus, 327.
Calopteron, black-tipped, 64, 221.
 reticulate, 64, 222.
 reticulatum, 64, 126, 222.
 terminale, 64, 126, 221.
Calosoma, 140.
 scrutator, 59, 61, 124, 125, 132, 159,
 220, 237.

- Calvatia gigantea*, 544.
Cambarus, 292.
 diogenes, 66, 128, 161, 204, 294.
 gracilis, 43, 47, 104, 108, 161.
 immunis, 66, 205.
 propinquus, 66, 205.
 sp., 48, 49, 50, 51.
Campanula americana, 68.
Camponotus, 147, 150, 209.
 herculeanus, 154.
 pennsylvanicus, 62, 202, 203, 204,
 221, 223, 228, 236.
 ferrugineus, 62, 65, 220, 237.
Campostoma anomalum, 66, 293.
Campylenchia curvata, 48, 170.
 Canker-worms, 221.
Cantharellus, 437.
 aurantiacus, 506.
 cibarius, 504.
 cinnabarinus, 506.
 Capsid, 305.
 Carabidæ, 116, 130, 175, 220.
 Cardinal, 296.
Cardinalis cardinalis, 220.
 cardinalis cardinalis, 296.
Carex, 44.
Carpodacus purpureus purpureus, 298.
Carya, 124, 292.
 alba, 40.
 cordiformis, 57, 60, 63, 292.
 glabra, 40, 57, 60, 124.
 microcarpa, 228.
 ovata, 40, 57, 60, 124, 226, 229, 230.
Catalpa, 148, 149.
 hardy, 148.
Catbird, 298.
Caterpillar, carpenter, 154.
 rotten-log, 61, 150, 153, 154, 228.
 slug, 61, 140, 229.
 -gall, 184.
 -hunter, 59, 61, 220.
 wasp, short, 59, 62, 238.
Caterpillars, 125, 164, 172, 173, 174, 177,
 183, 193.
 Catfishes, 568.
Cathartes aura septentrionalis, 294.
Catogenus rufus, 148.
Catostomus commersonii, 387, 567.
 Cattails, 80.
Ceanothus, 223.
Cecidomyia, 140, 157, 158, 184.
 caryaecola, 59, 230.
 holotricha, 59, 65, 229.
 solidaginis, 110, 184.
 tubicola, 59, 229.
Cecidomyiidae, 124, 184, 229, 347 (see
 Errata).
 Cedar, red, 148, 149.
 white, 149.
Celastrus scandens, 63.
Cemonus, 327.
Centrinophus helvinus, 110.
Centrinus penicellus, 52, 182.
 picumnus, 182.
 scutellum-album, 52, 182.
Centurus carolinus, 294.
Cerambycidae, 144, 177.
Ceratocampidæ, 227.
Ceratopogon, 310, 311, 315.
 bellus, 310.
 biguttatus, 308.
 fusicornis, 314.
 griseus, 309.
 peregrinus, 309.
Ceratopogoninae, 305, 306-317, 317-
 319, 322.
Cerceris, 195.
Cercis canadensis, 60, 63, 292.
Ceria signifer, 345.
 willistoni, 344-345.
Certhia familiaris americana, 298.
Ceruchus piceus, 152.
Ceryle halcyon, 294.
Ceuthophilus sp., 135.
Chaetopsis aenea, 104.
Chalcididae, 158.
Chanterelle, edible, 504.
 false, 506.
Chariessa pilosa, 145.
 Chat, yellow-breasted, 296.
Chauliodes sp., 315.

- Chauliognathus*, 120, 121.
 marginatus, 65, 222.
 pennsylvanicus, 45, 46, 53, 55, 56,
 104, 109, 111, 169, 176.
Cherry, 143, 148, 149, 227, 228, 283,
 287, 291.
 black, 63.
 wild, 141, 149, 208, 227, 286, 292,
 299.
Chestnut, 146, 149, 228, 536.
Chickadee, 297.
Chiggers, 45, 46, 52, 164, 306.
Chinch-bug, 111, 114.
Chion cinctus, 143, 144, 146.
Chipmunk, 297, 299.
Chironomidae, 305, 319.
Chloaltis conspersa, 58, 124, 132, 213.
Chlorion, 119.
 atratum, 49, 54, 110, 195.
 caeruleum, 192.
 cyaneum, 192.
 harrisi, 52, 170, 194.
 ichneumoneum, 45, 46, 49, 50, 51, 52,
 104, 120, 121, 194, 196.
 pennsylvanicum, 49, 54, 194.
Chloropidae, 360-363.
Chondestes grammacus grammacus,
 298.
Chorophilus nigritus, 284.
Chrosomus erythrogaster, 567.
Chrysobothris femorata, 144, 146, 148.
Chrysocus, 118.
 auratus, 45, 46, 51, 59, 104, 124, 178,
 223.
Chrysomelidae, 178, 223.
Chrysopa, 109, 158.
 oculata, 50, 51, 111, 165.
Chrysophanes thoe, 53, 183.
Chrysopidae, 165.
Chrysotoxum ventricosum, 59, 231.
Chub, creek, 65.
 river, 567.
Chyromyia, 358.
Cicada, 125.
 dog-day, 58, 196, 217.
 dorsata, 170.
Cicada—*continued*.
 limnei, 58, 130, 217.
 periodical, 58, 129, 130-132.
 prairie, 170.
 pruinosa, 196.
 tibicen, 217.
Cicadas, 140.
Cicadidae, 170, 217.
Cicindela, 186, 187, 319, 327.
 scutellaris lecontei, 328.
 punctulata, 181.
 sexguttata, 220.
 unipunctata, 59, 124, 132, 219.
Cicindelidae, 219, 230.
Circinaria concava, 58, 64, 136, 201,
 202, 204.
Circinariidae, 201.
Circus hudsonius, 285.
Cirsium, 46, 118, 171.
 discolor, 183, 199.
Cissia eurytus, 65, 126, 138, 159, 226.
Cistogaster immaculata, 54, 189.
Citheronia, 140.
 regalis, 61, 227.
Citrus, 225.
Clavaria, crested, 540.
 cristata, 540.
 pyxidata, 540.
Clavariaceae, 540, 542.
Claudopus, 437.
 nest-cap, 532.
 nidulans, 532.
Clearweed, 60, 62, 63, 126, 138, 209.
Cleidogona, 133.
 caesioannulata, 61, 205.
Cleridae, 134.
Clerus quadriguttatus, 145.
Click-beetle, 221.
Clinidium sculptile, 149.
Clitellus franklini, 289.
 tridecemlineatus, 289.
Clitocybe, 437, 438, 514.
 deceiving, 512.
 illudens, 427, 431, 439, 512.
 many-cap, 510.
 multiceps, 510

- Clitocybe—continued.*
ochropurpurea, 514.
odora, 508.
 sweet-smelling, 508.
- Clover, prairie, 169, 178.
 purple prairie, 54, 169, 172, 199.
 red, 226.
 sweet, 196.
- Clyanthus albofasciatus*, 147.
 ruvicola, 147.
- Coccidae*, 139, 234.
- Coccinella novemnotata*, 112, 176.
- Coccinellidae*, 59, 176, 221.
- Coccyzus americanus americanus*, 294.
 erythrophthalmus, 298.
- Cochliidiidae*, 229.
- Cochlidion*, 61, 229.
- Cocklebur, 49, 189.
- Cockroach, 210.
 woodland, 61.
- Coelioxys*, 198.
- Coffee-tree, 292.
 Kentucky, 63, 141.
- Colaptes auratus luteus*, 285, 295.
- Coleoptera*, 116, 131, 158, 175-182, 219-225, 327.
 larvae, 172.
- Colinus virginianus virginianus*, 285, 298.
- Collembola*, 131.
- Colletes*, 197, 327.
- Collybia*, 437.
 broad-gilled, 518.
 dryophila, 522.
 oak-loving, 522.
 platyphylla, 518.
 radicata, 436, 516, 518.
 rooting, 516.
 velutipes, 520.
 velvet-stemmed, 520.
- Cone-flower*, 39, 48, 49, 169, 170, 172, 179, 189, 196, 197, 198, 283.
- Cone-nose, Nebraska, 64, 216.
- Conifers*, 26, 27, 86, 143, 144, 156, 227.
- Conocephalus*, 50, 51, 111, 163, 168.
 nebrascensis, 64, 126, 216.
- Conopidae*, 188.
- Conops*, 120, 200.
- Conotrachelus elegans*, 141.
 seniculus, 138, 139.
- Copepoda*, 293.
- Coprinus*, 437, 480, 482.
 atramentarius, 480, 482, 484, 494.
 comatus, 432, 478, 494.
 ebulbosus, 484.
 glistening, 482.
 micaceus, 482.
 spotted, 484.
- Coptocycla clavata*, 65, 224.
- Cord grass, 39, 40, 170.
- Cordyceps*, 119, 120, 121.
- Coreidae*, 173, 219.
- Corirachne versicolor*, 151.
- Corixidae*, 66.
- Corn, 177, 179, 182, 218.
 broom-, 283, 285, 287.
 Indian, 283, 285, 286, 291, 293.
 root-worm, southern, 48, 53, 179.
 western, 179.
- Cornus*, 122, 147.
- Corthylus*, 137.
- Corvus brachyrhynchus brachyrhynchus*, 286, 295.
- Corymbites* sp., 64, 221.
- Cotton, 218.
- Cottonwood, 44, 76, 103, 105, 106, 120, 121, 135, 138, 148, 149, 157, 283, 285.
- Couch grass, 39.
- Cowbird, 298.
- Crab-apple, 55, 56, 129, 146.
- Crab-spider. See Spider—ambush, crab, or flower.
- Crambidae*, 115.
- Cranberry, 77, 79, 84.
- Crane-flies, 201.
- Crappie, black, 567.
 white, 567.
- Crappies, 387.
- Craspedosomidae*, 205.
- Crataegus*, 146, 350.
- Craterellus, cantharellus*, 504.

- Cratoparis lunatus*, 137.
Crawfish, 35, 44, 48, 50, 66, 108, 114, 179, 289, 292, 294, 300.
 burrowing prairie, or prairie, 45, 104, 161.
 diogenes, 161, 204.
 immune, 205.
 neighborhood, 205.
 prairie or burrowing prairie, 45, 104, 161.
Creepers, brown, 298.
Cremastogaster lineolata, 59, 152, 234.
Crepidotus, 437.
Cressonia juglandis, 59, 140, 226.
Cricket, 165.
 black-horned meadow, 42, 48, 55, 169.
 four-spotted white, 42, 50, 170.
 spotted, 58, 217.
 striped, 58, 64, 216.
 woodland, 58, 61, 132, 217.
Crickets, 426.
Criocephalus obsoletus, 148.
Crioceris asparagi, 172.
Crow, American, 286, 295.
Crustacea, 71, 161, 204, 205.
Cryptocephalus mutabilis, 65, 223.
 venustus, 178.
 simplex, 178.
Crytorhynchus parochus, 146.
Cuckoo, black-billed, 298.
 yellow-billed, 294, 300.
Cucujus clavipes, 149, 151.
Cucullia asteroides, 110.
Culicidae, 184.
Culicoides biguttatus, 307, 308-309, 310.
 cinctus, 306.
 guttipennis, 306-307, 308.
 haematopotus, 306, 308.
 sanguisugus, 306, 307-308.
 stellifer, 306, 307.
 unicolor, 306.
 varipennis, 306.
Culver's root, 174.
Curculionidae, 182.
Currant, 129.
Cyanocitta cristata cristata, 286, 295.
Cyclorrhapha, 342-352.
Cyllene caryae, 147.
 pictus, 147.
 robiniae, 110, 145, 147, 154.
Cymatodera balteata, 145.
Cynipidae, 124, 190, 232.
Cypress, 362, 363.
Cyprinidae, 568.
Cyrtidae, 324, 325, 341-342.
Cyrtophyllus perspicillatus, 58, 125, 140, 159, 215.
- ### D
- Dace*, horned, 293, 567.
 red-bellied, 567.
Daddy-long-legs, 206.
Daedalia, 136.
Danais archippus. See *Anosia plexippus*.
Dandelion, 227.
Darter, rainbow, 387, 567.
Darters, 386, 568.
Dasygogon winthemi, 338.
Datana, 140, 159, 220.
 angusi, 59, 61, 228.
Deer, 303.
Dendroctonus frontalis, 143, 156.
 piceaperda, 156.
 ponderosa, 156.
 terebrans, 143.
Dendroica coronata, 287, 298.
Dendroides, 154.
 canadensis, 149, 225.
Dendrolinus pini, 327.
Deromyia discolor, 64, 126, 230.
 sp., 53, 186.
 umbrinus, 230.
 winthemi, 326, 338-339.
Desmodium, 53, 124, 226.
 canadense, 171.
 grandiflorum, 63.
 nudiflorum, 57.
Desmognathus fusca, 293.
Destroying angel, 415. (See also *Amanita verna*.)

- Diabrotica atripennis*, 45, 179.
 12-punctata, 48, 49, 53, 112, 164, 179.
 longicornis, 179.
Diaperis hydni, 136.
 maculata, 136.
Diapheromera femorata, 58, 125, 140,
 159, 211.
 Diatoms, 292.
Dicerca divaricata, 148.
 lurida, 147.
Dichelonyx, 369.
Dichromorpha viridis, 58, 61, 64, 124,
 126, 212, 214.
Dickcissel, 302.
Dictamnus, 225.
Didelphys virginiana, 299.
Digger-wasp, 152, 196, 228.
 black, 54, 195.
 Harris's 52, 194.
 Pennsylvania, 54, 194.
 rusty, 45, 46, 47, 50, 51, 52, 104, 120,
 194.
Diogmites misellus, 338.
Diplocardia, 135.
Diplopods, 124, 125, 133.
Diptera, 107, 116, 131, 143, 184-190,
 229-231, 305-363, 370.
Dissosteira carolina, 166, 196.
 venusta, 189.
Dixippus morosus, 211.
 Dock, 183.
Dogbane, 44, 49, 57, 104, 109, 113, 124,
 173, 178, 183, 193, 201, 223, 231.
 beetle, 45, 47, 59, 178, 223.
 caterpillar, 53.
 spreading, 178.
Dogwood, 122, 137, 138, 139, 147.
 flowering, 299.
Dolichopodidae, 187, 188.
Dorcas parallelus, 152.
Dorcaschema wildii, 148.
 Dove, mourning, 285.
Dragon-flies, 47, 119, 164, 165, 230.
Dragon-fly, nine-spot, 45, 50, 104, 165.
 red-tailed, 50, 164.
Dropseed, 49, 53.
Drosophila, 346, 347.
 adusta, 347, 348.
 dimidiata, 348.
 phalerata, 104.
Drosophilidae, 346-348.
Dryobates pubescens medianus, 294.
 villosus villosus, 294.
Ducks, wild, 288, 290.
Dung-beetle, splendid, 50, 223.
Dumetella carolinensis, 298.
Dutchman's pipe, 225.
- ### E
- Earthworms*, 115, 135.
Eburia quadrigeminata, 143, 147.
Egg-plant, 224.
Elaphidion, 141, 159.
 mucronatum, 147.
 villosum, 141, 143, 147.
Elateridae, 115, 145, 221, 224.
Elm, 40, 62, 63, 77, 126, 138, 144, 147,
 148, 149, 152, 227, 231.
 American, 514.
 borer, 144.
 slippery, 63.
 white, 217.
Elms, 292, 322, 342.
Elymus, 39, 41, 44, 107, 111, 162, 163,
 167, 168, 169.
 canadensis, 42, 107.
 virginicus, 107.
 submuticus, 42, 45.
Empididae, 174, 189.
Empidonax virescens, 295.
Empis clausa, 110, 112, 189.
Empusa, 119, 120, 121.
Enchytraeids, 135.
Encoptolophus sordidus, 48, 50, 53, 54,
 108, 109, 111, 166.
Endodontidae, 203.
Endomychidae, 136.
Enodia, 126, 138, 159.
 portlandia, 65, 226.
Entoloma, 437.
Epargyreus tityrus, 64, 126, 140, 226.

- Epeira domiciliorum*, 64, 65, 126, 138, 206.
 insularis, 58, 138, 206.
 labyrinthica, 138.
 trivittata, 64, 126, 207.
 verrucosa, 58, 65, 125, 138, 207.
Epeirid, island, 206.
 tent, 64, 65, 206.
 three-lined, 64.
Epeiridae, 162, 206.
Epeolus concolor, 48, 49, 50, 51, 54, 108, 196.
 donatus, 197.
 spp., 197.
Ephydridae, 345.
Epicaerus imbricatus, 141.
Epicauta, 120, 121.
 marginata, 52, 53, 54, 109, 180.
 pennsylvanica, 52, 53, 54, 55, 108, 109, 110, 111, 180.
 vittata, 52, 54, 178, 180.
Epinomia, 111, 181.
 triangulifera, 181.
Erax bastardi, 186.
 lateralis, 187, 327.
Erigeron, 178.
Eriophyidae, 208.
Erotylidae, 136.
Eryngium, 86.
 yuccifolium, 53, 54, 108, 163, 167, 168, 174, 175, 177, 179, 180, 181, 183, 189, 192, 194, 195, 196, 199.
Etheostoma coeruleum, 386, 387, 567.
Euaresta aequalis, 48, 49, 189.
Euceridae, 197.
Euforcipomyia, 312.
 fuscicornis, 313, 314-315.
 hirtipennis, 313, 314.
 longitarsis, 313.
Eugnoriste occidentalis, 185.
Eumenes, 327.
 fraterna, 181.
Eumenidae, 193.
Eupatorium coelestinum, 125, 163, 212, 214, 231.
Euphorbia, 73, 74, 118.
 corollata, 53, 55, 108, 109, 283.
Euphoria inda, 177.
 sepulchralis, 45, 46, 104, 177.
Euproctis chrysorrhoea, 156.
Eupsalis minuta, 147, 159.
Eurymus philodice, 45, 46, 182.
Euschistus fissilis, 65, 218.
 variolarius, 45, 50, 51, 53, 54, 108, 109, 110, 111, 171, 187.
Eustroma, 140.
 diversilineata, 59, 229.
Eustrophus bicolor, 136.
 tomentosus, 136.
Euthoetha galeator, 219.
Everes, 138.
 comyntas, 61, 226.
Evergreens, 82, 85.
Everlasting, 57, 124.
Exoprosopa, 120, 328.
 fasciata, 318, 326, 327, 329-330.
 fascipennis, 121, 185, 319, 326, 330-331, 332.
- ## F
- Falco sparverius sparverius*, 285, 298.
Feltia jaculifera, 334.
 subgothica, 121, 174.
Fern, beech, 63.
 maidenhair, 63.
 rattlesnake, 63.
Feverwort, 183.
Fiber zibethicus, 299.
Finch, purple, 298.
Fir, Douglas, 149.
Fireflies, 222.
Firefly, Pennsylvania, 65, 222.
Fishes, 293, 300, 381-412, 557, 558, 559, 562, 563, 564, 565, 566, 567, 568.
Flag, blue, 44, 103, 104.
Flags, 283.
Flammula, 437, 438.
Flicker, or northern flicker, 285, 291, 295.
Flower-beetle, black, 45, 46, 177.
 rose, 152.
Flowering spurge, 283.
Flycatcher, Acadian, 295, 300.
 crested, 295, 300.

- Fontaria corrugata*, 134.
 virginiensis, 134.
Forcipomyia, 309, 312.
 cilipes, 312.
 elegantula, 311-312.
 specularis, 312.
Formica difficilis consocians, 191.
 exsectoides, 235.
 fusca, 109, 171.
 subsericea, 59, 110, 112, 171, 190,
 191, 236.
 integra, 177.
 pallide-fulva, 191.
 schaufussi, 120, 191, 235.
 incerta, 54, 112, 171, 190, 191.
 sanguinea, 190, 191.
 aserva, 190.
 puberula, 191.
 rubicunda, 190.
 subintegra, 191.
 subnuda, 191.
Formicidae, 190, 233.
 Fowl, wild, 302.
 Foxtail, 181.
 Frog, common, or leopard, 284, 290.
 Frogs, 45, 66, 383, 398, 407.
 Frontina, 120.
Fulgoridae, 217.
Fundulus, 382.
Fungi, 90, 102, 124, 133, 135, 136, 137,
 148, 149, 159, 169, 176, 221, 320,
 322, 346, 348.
 club, 419, 435, 540, 542.
 cup, 435.
 gill, 420, 435.
 hedgehog, 419, 435, 540, 542.
 pore, 435.
 sac, 420, 435.
Fungus insects, German, 137.
 gilled, 136.
 shelf, 136, 224.
Fungus-beetle, horned, 64, 136, 224.
Fungus-beetles, 136, 137.
- G**
- Galba obrussa*, 161.
 umbilicata, 45, 46, 47, 104, 160.
Galera, 437.
 slender, 526.
 tenera, 526.
Galerita janus, 59, 125, 135, 150, 221.
Galerucella luteola, 156.
Galium circaezans, 63.
 trifolium, 63.
 Gall, acorn plum-, 232.
 caterpillar, 184.
 -flies, 140.
 goldenrod bunch, 184.
 hairy midge, 65, 229.
 hickory seed, 230.
 hickory tube, 229.
 horned knot oak- 65, 232.
 insects, 106.
 -louse, vagabond, 105.
 -mite, cherry-leaf, 64, 140, 208.
 oak-apple or May-apple, 232, 234.
 Oak bullet-, 59, 232.
 oak seed-, 232.
 oak wool-, 59, 65, 232.
 rose, 56, 190.
 white oak club-, 59, 232.
 willow cone-, 184.
 willow leaf-, 158.
Gallinipper, 184.
Galls, 35, 110, 351.
Gaura biennis, 183.
Gaurax, 360-361.
 apicalis, 361.
 dorsalis, 360, 361.
 ephippium, 361, 363.
 festivus, 361.
 flavidulus, 360, 361-362.
 fumipennis, 361, 363.
 interruptus, 361, 363.
 montanus, 360, 361.
 obscuripennis, 361.
 pallidus, 361, 362-363.
 pilosulus, 361.
 pseudostigma, 360.
 splendidus, 361.
Gelechia, 141.
Gelechiidae, 184, 229.
Geometridae, 229.

- Geomyzidae, 357.
 Geophiloids, 133.
 Geothlypis trichas trichas, 287.
 Geotrupes splendidus, 59, 125, 132, 223.
 Gerridae, 219.
 Gerris, 292.
 remigis, 66, 127, 219.
 Giant fly, 45, 46, 186.
 Glaphyrus, 369.
 Gnatcatcher, blue-gray, 297.
 Gnat larvae, 293.
 Gnathotrichus, 137.
 Gnats, 201.
 Gnorimoschema gallaesolidaginis, 110, 184.
 Goes debilis, 146.
 pulverulentus, 146.
 tigrina, 146, 154.
 Goldenrod, 109, 110, 111, 162, 169, 170, 172, 174, 176, 177, 180, 182, 185, 188, 190, 192, 196, 283.
 bunch gall, 184.
 Goldfinch, 286, 295.
 Goldfishes, 383.
 Gooseberry, 63, 141.
 Gopher, 288.
 gray, 289.
 striped, 289.
 Grackle, bronzed, or blackbird, crow, 286, 290, 298.
 Grape, 55, 56, 60, 63, 145, 177, 217, 218, 223, 229.
 -beetle, spotted, 55, 177, 223.
 wild, 292, 299.
 Grass, 42, 43, 51, 74, 78, 121, 152, 162, 166, 173, 212, 226.
 beard, 53.
 cord, 39, 40, 169, 170.
 couch, 39.
 reed, 283.
 root-louse, 120.
 slough, 39, 41, 42, 43, 107.
 Grasses, 283.
 Grasshopper, Boll's, 58, 61, 213.
 Carolina, 166, 196.
 common meadow, or meadow, 42, 44, 50, 53, 58, 64, 168.
 Grasshopper—*continued*.
 differential, 42, 44, 48, 50, 53, 119, 167, 213.
 dorsal-striped, 42, 44, 48, 52, 53, 169.
 lance-tailed, 53, 169.
 leather-colored, 55, 167.
 lesser, 58, 213.
 long-horned, 194.
 red-legged, 42, 44, 48, 50, 168.
 Scudder's, 61, 64, 214.
 short-winged, 58, 61, 64, 212.
 sordid, 48, 50, 53, 166.
 sprinkled, 58, 213.
 two-striped, or two-lined, 53, 167.
 Grasshoppers, or locusts, 47, 50, 58, 64, 65, 164, 180, 186, 187, 192, 213, 290, 293, 294, 300.
 Green brier, 63.
 Gregarina, 134.
 Grosbeak, rose-breasted, 178, 296.
 Ground-beetles, 42, 294.
 Grouse, ruffed, 303.
 Grouse-locust, 58, 211.
 short-winged, 58, 212.
 Gryllidae, 169, 216.
 Gum, 149.
 Gymnocladus, 141.
 dioica, 63, 292.
 Gypona pectoralis, 65, 218.
 Gypsy-moth, 156.
 Gyrocampa, 346.
 Gyromitra, 550.
 brown, 550.
 brunnea, 550.
 esculenta, 550.
- ## H
- Habia ludoviciana, 178.
 Hackberry, 75, 146, 152.
 Halictidae, 196.
 Halictus, 181, 195.
 fasciatus, 52, 54, 110, 196
 obscurus, 54, 196.
 sp., 305.
 virescens, 52, 196.
 Halisidota, 140.
 tessellaris, 59, 61, 227.

- Hardwoods, 26, 143.
Harmostes reflexulus, 52, 112, 173.
Harpalus, 175.
 caliginosus, 175, 176.
 pennsylvanicus, 175, 176.
 Harvest-fly, dog-day, 58, 196, 217.
 Harvest-man, 50.
 Harvest-mites, 164.
 Harvest-spider, polished, 161.
 stout, 58, 61, 206.
 striped, 205.
 Harvest-spiders, 58, 132, 138.
 Haw, 129, 146.
 Hawk, Cooper's, 294.
 marsh, 285, 290.
 -moth, 183.
 red-shouldered, 298.
 red-tailed, 298.
 sharp-shinned, 298.
 sparrow, 285, 289, 290, 298.
 Hawks, 300.
 Hazel, 139, 223, 227.
 Hazelnuts, 141.
 Heart-rots, 423, 424, 536.
Heboloma, 437.
Hedeoma pulegiodes, 57.
Helianthus, 111, 330.
 Helicidae, 201.
Helodromas solitarius solitarius, 285.
Hemaris diffnis, 45, 46, 183.
Hemerocampa leucostigma, 154, 156.
 Hemiptera, 46, 98, 107, 138, 170-175,
 217-219.
 Hemlock, 149, 468.
 Hemp, Indian, 178.
 Herbivora, 421.
 Heron, black-crowned night, 298.
 little green, 234, 291, 294.
 Hesperidae, 226.
Hetaerius blanchardi, 235.
Heterocampa, 140, 159.
 guttivitta, 59, 228, 238.
 Heteroptera, 158.
 Hickory, 40, 55, 56, 57, 58, 59, 74, 75,
 76, 80, 87, 123, 124, 129, 132, 138,
 139, 141, 144, 146, 147, 148, 149, 157,
 177, 211, 215, 217, 223, 226, 227, 228,
 229, 230, 292, 425.
Hickory—*continued*.
 bark-beetle, 154.
 bitternut, 57, 60, 63, 228, 292.
 -borer, 147.
 horned-devil, 61, 227.
 -nuts, 141.
 pignut, 57, 60, 124.
 seed-gall, 230.
 shagbark, 57, 60, 124.
 shell-bark, 226.
 tube-gall, 229.
Hippodamia parenthesis, 52, 176.
Hirundo erythrogaster, 287.
Holcaspis, 140.
 globulus, 59, 232.
 Honey-bee, 45, 46, 50, 51, 104, 187, 200,
 201.
 Honey-locust, 147, 149.
 Honeysuckle, bush, 183.
Hoplia, 369.
Hoplismenus morulus, 135.
Hordeum, 346.
 Hornet, white-faced, 135.
 Hornets, 210.
 Horntail, 144, 145, 154, 231, 233.
 Horsemint, 57, 124, 200.
 Horseweed, 170.
 Hummingbird, ruby-throated, 295.
Humulus, 225.
Hybopsis kentuckiensis, 567.
 Hydnaceae, 542.
Hydnum, bear's-head, 542.
 caput-ursi, 542.
 coralloides, 542.
 erinaceum, 542.
 hedgehog, 542.
Hydrellia scapularis, 345-346.
Hyla versicolor, 294.
Hylocichla guttata pallasii, 299.
 mustelina, 299.
Hymenarcys nervosa, 64, 218.
 Hymenomycetes, 137.
 Hymenoptera, 46, 107, 181, 190-201,
 230, 231-238, 327.
 parasitic, 104, 109, 115, 140, 141, 145,
 163, 165, 198, 226.
Hyphantria cunea, 156.

Hypholoma, 437.

- appendiculate, 502.
- appendiculatum, 502.
- candolleum, 502.
- incertum, 502.
- lacrymabundum, 500.
- weeping, 500.

I

- Ichneumon cincticornis, 135.
- Ichneumonidae, 233.
- Icteria virens virens, 296.
- Icterus galbula, 298.
- Imperial moth, 64, 227.
- Insecta, 99, 100, 119, 164-201, 208-238, 290.
- Insects, forest, 142.
 - of the trunks and decaying wood, 142-157.
 - willow-gall, 157, 158.
- Invertebrata, 119.
- Ips 4-guttata, 176.
- Iris, 103, 283.
 - versicolor, 44.
- Ironweed, 172, 178.
- Ironwood, 226.
- Ischnoptera, 61, 125, 210.
 - inaequalis, 144.
 - pennsylvanica, 210.
- Isodontia philadelphica, 170, 194.
- Isosoma, 107, 111.
 - grande, 175.
- Ivy, five-leaved, or Virginia creeper, 57, 60, 63, 177, 223.
 - poison, 57.

J

- Jack-o'-lantern, 512.
- Jalysus spinosus, 64, 126, 219.
- Jassidae, 107, 112, 118, 171.
- Johannsenomyia albibasis, 315-316.
 - argentata, 317.
- Juglans, 292.
 - nigra, 57, 60, 63.
- Junco hyemalis hyemalis, 295.
 - slate-colored, 295.
- June-berry, 299.
- Juniperus, 148.

K

- Katydid, angle-winged, 58, 215.
 - common, 58, 215.
 - cone-nosed, 50.
 - forked, 58, 215.
 - round-winged, 64, 215.
 - Texan, 42, 44, 48, 50, 168.
- Katydids, 140.
- Kentucky coffee-tree, 63, 141.
- Killdeer, 285.
- Kingbird, 285, 290, 298.
- Kingfisher, belted, 294.
- Kinglet, golden-crowned, 299.
 - ruby-crowned, 299.
- Kites, blue, 302.
 - swallow-tailed, 302.

L

- Labidesthes sicculus, 387, 406, 567.
- Laccaria, 514.
 - ochropurpurea, 514.
 - purplish, 514.
- Lacewing, 50, 109, 165.
- Lachnosterna, 105, 116, 119, 121, 142, 144, 174, 181, 186, 193, 233, 319, 331, 332, 338, 365, 369, 370.
- Lactarius, 136, 437, 438.
 - orange-brown, 442.
 - peppery, 440.
 - piperatus, 440, 442.
 - volemus, 442.
- Lactuca, 118.
 - canadensis, 48, 53, 55, 108, 109, 171.
- Ladybird or Lady-beetle, 52, 59, 221.
 - nine-spotted, 112, 176.
 - parenthetical, 176.
- Lampyridae, 176, 221.
- Languria mozardi, 109.
- Lanius ludovicianus hudsonius, 287.
 - migrans, 287.
- Laportea canadensis, 62, 63, 125, 126, 133, 209.
- Larch, 156.
- Lark, horned, 302.
- Lasius flavus, 120.
 - interjectus, 120.
 - niger americanus, 119, 120, 121.

- Laurus*, 225.
 Leaf-beetle, 45, 52.
 elm, 156, 232.
 Leaf-bug, dusky, 53, 175.
 Leaf-cutting bee, 50, 52, 198.
 Leaf-footed bug, 138.
 Leaf-hoppers, 64, 65.
 Leaf-miner, 347.
 Leather-jackets, 116.
Lebia grandis, 135.
 Leeches, crawfish, 66.
Lentinus lepidus, 424.
 tigrinus, 427, 428.
Lepachys, 108.
 pinnata, 39, 48, 49, 108, 118, 161, 162,
 166, 167, 168, 169, 170, 172, 174,
 179, 189, 196, 197, 283.
Lepidoptera, 115, 138, 140, 143, 182-184,
 225-229, 237, 319, 327, 333.
 larvae, 35, 47.
Lepiota, 437, 458, 462.
 crested, 460.
 cristata, 460.
 rainy, 462.
 granulosa, 462.
 morgani, 427, 431, 458.
 naucina, 464.
 smooth, 464.
Lepomis cyanellus, 387, 562, 563, 567.
 humilis, 387, 391, 397, 407, 562, 563.
 megalotis, 387.
 pallidus, 387.
Leptilon, 170.
Leptoglossus oppositus, 138.
Leptostylus aculiferus, 146.
Leptotrachelus dorsalis, 42, 175.
Leptura proxima, 148.
 Lettuce, wild, 48, 53, 109, 171.
Leucania unipuncta, 189.
Liatrix scariosa, 54, 185, 199, 200.
Libellula pulchella, 45, 50, 51, 104, 162,
 165.
Libellulidae, 164.
 Lichen, 176.
Ligyrocoris sylvestris, 48, 172.
Ligyris spp., 327.
Lilac, 227.
Limacodes, 327.
 Linden, or basswood, 77, 136, 141, 146,
 149, 151, 152, 174, 227, 228, 351,
 425.
Liobunum, 132, 138.
 formosum, 162.
 grande, 58, 61, 206.
 politum, 50, 51, 161.
 ventricosum, 58, 206.
 vittatum, 58, 205.
Liopus alpha, 138.
 fascicularis, 138, 159.
 variegatus, 148.
 xanthoxyli, 138.
Liriodendron, 225.
Lithacodes, 61.
Lithobius voracior, 134.
Lobelia inflata, 63.
Locust, 141, 149.
 borer, 145, 154.
 Carolina, 166, 196.
 grouse. (See Grouse-locust.)
 honey-, 147, 149.
 yellow, 110, 148, 149, 226.
Locustidae, 51, 168, 215.
 Locusts, or grasshoppers, 47, 132, 164,
 180, 186, 187, 192, 213.
Lonchaea polita, 309.
 Long-tail, black, 64, 233.
 Long-sting, lunate, 64, 231, 233.
Lucanidae, 222.
Lucanus dama, 152.
Lumbricus, 115.
Lycaenidae, 183, 226.
Lycomorpha pholus, 222.
Lycoperdon cyathiforme, 544.
 gemmatum, 544.
Lycopus, 44.
Lycosa scutulata, 64, 126, 208.
 spp., 58, 132, 208.
Lycosidae, 208.
Lyctidae, 147.
Lygaeidae, 172.
Lygaeus kalmii, 45, 46, 50, 51, 104,
 108, 112, 118, 172, 185.

- Lygus pratensis*, 305.
Lymexylon sericeum, 148.
Lymnaea, 160.
Lymnaeidae, 160.
Lysiopetalidae, 205.
Lythrum alatum, 44.
- M**
- Macrobasis unicolor*, 141.
Macrosiphum rudbeckiae, 109, 118, 171.
Magdalis, 146, 148.
 armicollis, 144, 154.
 barbita, 144.
 Maggots, 426.
Mallophaga orcina, 187.
Mamestra, 327.
 Mammals, 282, 288, 293, 297, 299, 303.
 Maple, 76, 77, 80, 81, 84, 129, 136, 137,
 138, 141, 143, 146, 148, 149, 152,
 157, 227, 228, 231.
 ash-leaved, 530. (See also box-
 elder.)
 hard, or sugar, 40, 62, 63, 123, 126,
 151, 157.
 red, 229.
 silver, 149.
 Maples, 292, 424, 456.
Marasmius oreades, 427.
Masycera sylvatica, 327.
 May-beetles, 105, 106, 119, 120, 142,
 187, 193, 233, 366, 367, 368, 379.
 Meadow cricket, black-horned, 42, 48,
 55, 169.
 grasshopper, common, 42, 44, 50, 53,
 55, 58, 168.
 Meadowlark, 286, 302.
Mealy flata, 65, 217.
Mecaptera, 209.
Megachile, 327.
 brevis, 52, 198.
 centuncularis, 198.
 mendica, 50, 198.
Megachilidae, 198.
Megalodacne fasciata, 136.
Melandryidae, 136.
Melanerpes erythrocephalus, 285, 298.
Melanobracon simplex, 144, 159.
Melolontha, 116, 369.
 balia, 369.
 decimlineata, 369.
 frondicola, 369.
 hirsuta, 369.
 hirticula, 369.
 iricolor, 369.
 linearis, 369.
 longitarsis, 369.
 moesta, 369.
 occidentalis, 369.
 pilosicollis, 369.
 quercina, 369.
 sericea, 369.
 sordida, 369.
 vespertina, 369.
 vulgaris, 369.
Melanolestes picipes, 135.
Melanoplus ampletens, 58, 64, 124,
 126, 132, 214.
 atlanis, 58, 124, 213.
 bivittatus, 53, 109, 167.
 differentialis, 42, 44, 48, 50, 53, 54,
 107, 108, 109, 111, 121, 162, 167,
 168, 213.
 femur-rubrum, 42, 44, 48, 50, 107,
 108, 111, 163, 196.
 gracilis, 64, 126, 214.
 obovatifennis, 58, 65, 124, 214.
 scudderi, 61, 64, 124, 126, 214.
Melanotus, 61, 125, 150, 221.
Melasoma scripta, 106.
Melissodes aurigenia, 197.
 bimaculata, 48, 50, 51, 54, 111, 197.
 desponsa, 197.
 obliqua, 48, 49, 52, 54, 108, 118, 197.
 perplexa, 230.
 trinodis, 107.
Melissopus latiferreana, 141.
Meloidae, 180.
Melospiza melodia melodia, 287, 296.
Membracidae, 170.
Menispermum canadense, 37, 60, 63.
Mephitis mesomelas avia, 289, 299.
Meracantha contracta, 59, 61, 125, 132,
 135, 144, 152, 154, 202, 224.

- Merinus laevis*, 151.
Meromyza americana, 107.
Mesogramma politum, 53, 54, 59, 65, 188, 231.
Metopia, 120, 121.
 leucocephala, 195.
 Mice, 290.
Microcentrum, 140.
 laurifolium, 58, 124, 215.
Microlepidoptera, 158.
Microparsus variabilis, 171.
Micropterus dolomieu, 387, 567.
 (See also Bass, small-mouthed black.)
 salmoides, 387, 567.
Microtus austerus, 289.
 pinetorum scalopsoides, 299.
 Midge-gall, hairy, 65, 229.
Milesia ornata, 59, 64, 126, 163, 231.
 virginiensis, 163.
 Milesiinae, 231.
 Milkweed, 51, 104, 112, 113, 172, 173, 178, 181, 336.
 beetle, 45, 104, 178, 185.
 four-eyed, 45, 50, 52, 177.
 beetles, 46, 47, 51.
 bug, small, 45, 50, 172, 185.
 large, 45, 50, 104, 173.
 bugs, 51, 104.
 common, 112, 164, 171, 176, 180, 188, 190, 191, 201.
 -fly, metallic, 187.
 Sullivan's, 182.
 swamp, 39, 44, 46, 49, 51, 103, 160, 162, 163, 165, 168, 171, 172, 173, 174, 175, 176, 177, 178, 179, 182, 183, 184, 186, 194, 198, 200, 283, 288.
 Millipeds, 61, 64, 133, 136.
 Minnow, blunt-nosed, 387, 401, 562, 567.
 steel-colored, 387.
 straw-colored, 562.
 Minnows, 386, 387, 402, 568.
 Mint, 163.
 horse-, 57, 124, 200.
 mountain, or white, 39, 50, 51, 163, 169, 172, 173, 174, 176, 178, 179, 180, 185, 191, 194, 197, 199, 283.
Miridae, 175, 218.
Misumena aleatoria, 42, 43, 45, 46, 50, 51, 52, 53, 54, 64, 104, 109, 121, 126, 163, 168, 175, 185, 200, 216, 231.
 vatia, 47.
 Mites, 46, 107, 120, 130, 131, 137, 222.
 mushroom, 426, 430.
 -uropod, 222.
Mniotilta varia, 296.
 Molds, 435.
 Mole, common, 289, 299.
Mollusca, 35, 124, 125, 126, 135, 137, 140, 160-161, 201-204.
Molorchus bimaculatus, 138.
Molothrus ater ater, 298.
Monarda, 124, 200, 330.
 bradburiana, 57.
Monarthrum, 137.
Monohammus confusor, 143.
 titillator, 155.
 Moonseed, 57, 60, 63.
Morchella, 550.
 conica, 432, 546, 548.
 semilibera, 548.
 Morel, common, 546.
 half-free, 548.
 Morels, 420, 435, 546, 548.
Mormidea lugens, 65, 218.
Morus, 148.
 rubra, 57, 60, 63, 292.
 Mosquito, giant, 45, 47, 50, 51, 104, 184.
 Mosquitoes, 219.
 Moth, acorn, 141.
 brown-tailed, 156.
 gypsy, 156.
 imperial, 64, 227.
 royal walnut, 227.
 Moths, 125, 169, 174, 201.
 clothes, 99, 100.
 Mouse, house, 288, 299.
 mole, 299.
 prairie meadow-, 289.
 white-footed prairie, 288.
Moxostoma aureolum, 562, 567.
 Mud-wasp, potter, 193.
Mulberry, 57, 60, 63, 147, 148, 149, 292, 299.

- Mus musculus*, 288, 299.
Musca clavatus, 336.
 Muscidae, 116.
 Mushroom, cone-like, 534.
 coral-like, 542.
 cultivated or meadow, 418, 466.
 field or horse, 470.
 flat-cap, 468.
 green-gill, 458.
 honey-colored, 488.
 inky-cap, 423, 424, 480, 494.
 oyster, 419, 528.
 pink-gill. (See Mushroom, cultivated or meadow.)
 Rodman's, 474.
 shaggy-mane, 418, 423, 424, 478, 480, 494.
 slightly red, 476.
 spawn, 429.
 sylvan, 472.
 Mushrooms, 137, 413-554.
 diseases of, 427.
 parasitic, 423, 427, 488, 494.
 puffball, 419, 423, 432, 435, 544.
 saphrophytic, 423.
 shelving, 419, 423.
 umbrella-shaped, 415, 417-419, 423, 424.
 Muskrat, 299.
 Mutillidae, 192, 238.
 Mycena, 437.
 galericulata, 524.
 haematopa, 524.
 peaked-cap, 524.
 Mycetobia, 323, 335.
 divergens, 319, 321.
 marginalis, 321.
 pallipes, 324.
 sordida, 321.
 Mycetophagus bipustulatus, 136.
 punctatus, 136.
 Mycetophila, persicae, 321.
 Mycetophilidae, 137, 185, 319, 320, 321, 323, 335.
 Mydidae, 186, 319, 324, 325, 336-337.
 Mydas clavatus, 45, 46, 186, 326, 336-337, 338.
 fulvipes, 186.
 Myiarchus crinitus, 295.
 Myodites, 52, 181.
 fasciatus, 111, 181.
 solidaginis, 111, 181.
 Myodocha serripes, 135.
 Myriapoda, 35, 134, 137, 140, 205.
 Myriochanes virens, 295.
 Myrmecophila pergandei, 191.
 Myrmedonia, 234.
 Myrmeleon, 154.
 immaculatus, 153.
 Myrmeleonidae, 58, 124, 153, 165, 209.
 Myrmica rubra scabrinodis sabuleti, 112, 190, 191.
 schneckii, 61, 202, 234, 236.
 Myzine, 115.
 sexcincta, 50, 51, 54, 109, 110, 111, 192.
 Myzinidae, 192.
 Myzocallis, 107.
- N
- Nadata, 140.
 gibbosa, 59, 61, 228.
 Naucoria, 437.
 Negro-bug, flea, 172.
 Nematode, 323.
 Nematus erichsonii, 156.
 Nemobius, 132.
 fasciatus, 58, 64, 124, 126, 216.
 maculatus, 58, 124, 217.
 Nemocera, 323, 324.
 Nemognatha immaculata, 111.
 sparsa, 111.
 Neoceratopogon, 310.
 bellus, 310.
 Neoclytus, 146, 148.
 erythrocephalus, 144, 147, 148, 154, 159.
 luscus, 147.
 Nettle, wood, 62, 63, 125, 126, 138, 209, 214.
 Neuroptera, 165, 209.
 Nitidulidae, 136.
 Noctua, 327.
 Noctuidae, 115, 183, 227, 333.

- Nodonoto convexa*, 48, 179.
 Nomadidae, 196.
 Notodontidae, 228.
Notropis, 386, 397, 405.
 atherinoides, 567.
 blennius, 562.
 cornutus, 387, 567.
 whiplii, 387.
 Nut-weevils, 141.
Nycticorax nycticorax naevius, 298.
Nyctobates pennsylvanicus, 151.
 Nymphalidae, 183, 225.
- O
- Oak, 40, 57, 58, 59, 74, 76, 77, 80, 87,
 123, 124, 128, 132, 139, 141, 142,
 146, 147, 148, 149, 151, 152, 157,
 177, 203, 205, 214, 215, 219, 220,
 223, 227, 228, 229, 231, 232, 345,
 456, 522, 536.
 -apple gall, 232, 234.
 black, 57, 60, 75, 124, 144, 149.
 bur, 77.
 post, 123.
 -pruner, 141, 147.
 red, 40, 57, 60, 62, 63, 123, 126, 129,
 292.
 shingle, 63, 123, 232.
 white, 57, 60, 78, 124, 147, 148, 149,
 156, 227, 228, 232, 446, 514.
 Oaks, 292, 300.
Oberea tripunctata, 148.
 Odonata, 164.
Odynerus, 49, 327.
 vagus, 52, 193.
Oecanthus, 42, 195.
 fasciatus, 195.
 nigricornis, 42, 48, 55, 107, 108, 111,
 169.
 niveus, 170.
 quadripunctatus, 42, 50, 107, 111, 170.
Omalopecta, 369.
Omphalia, 437.
Oncideres cingulatus, 141.
Oncodes, 341.
 costatus, 341-342.
- Oncopeltus fasciatus*, 45, 46, 50, 51,
 104, 112, 118, 173.
Opossum, 299.
Orange, 155, 219.
Orchelimum, 120, 121.
 cuticulare, 58, 64, 124, 126, 216.
 glaberrimum, 42, 44, 64, 126, 216.
 gracile, 194.
 vulgare, 42, 44, 50, 53, 55, 56, 104,
 107, 109, 111, 168, 194.
 Orchids, 425.
 Oriole, Baltimore, 298.
Ormenis pruinosa, 65, 217.
 Orthoptera, 42, 43, 44, 47, 49, 51, 107,
 113, 124, 126, 130, 166-170, 210-
 217, 290.
Orthorrhapha, 324-342.
Orthosoma brunneum, 152.
Osage orange, 148, 149, 283.
Oscillatoria, 292.
Oscinis carbonaria, 107.
 coxendix, 104.
Osmia, 327.
Osmoderma eremicola, 152.
 scabra, 152.
Otocryptops sexspinosus, 134.
Otus asio asio, 298.
 Owl, barred, 298.
 great horned, 298.
 screech, 298.
Oxyechus vociferus vociferus, 285.
- P
- Pallodes pallidus*, 136.
Pandeletejus hilaris, 144.
Paneolus, 437.
Panicum, 73, 166, 167, 168, 170, 181,
 346.
 crus-galli, 176.
Panorpa, 133.
 confusa, 133.
 Panorpidae, 209.
 Panther, 303.
Papaw, 138, 141, 147, 224.
Papilio, 126.
 asterias, 233.
 cresphontes, 46, 140, 225.

- Papilio*—*continued*.
philenor, 59, 61, 225.
polyxenes, 45, 46, 162, 182, 233.
troilus, 59, 61, 225.
turnus, 59, 140, 225.
- Papilionidae, 182, 225.
- Parandra brunnea*, 151, 154.
- Parasites of fishes, 387.
- Parokeet, Carolina, 303.
- Parsley, 182.
- Parsnip, wild, 196.
- Passalus cornutus*, 61, 125, 144, 150, 151, 153, 154, 159, 202, 203, 204, 221, 222, 228, 236.
 horned, 61, 154, 203, 222, 236.
- Passer domesticus domesticus*, 286.
- Passerella iliaca iliaca*, 298.
- Passerina cyanea*, 287, 296.
- Peach, 143.
- Pear, 229.
- Pelecinidae, 233.
- Pelecinus polyturator*, 64, 126, 233.
- Pelidnota punctata*, 55, 56, 177, 223.
- Pelopoeus*, 327.
- Pemphigus oestlundii*, 105.
populicaulis, 105.
populi-transversus, 105.
vagabundus, 105.
- Pennyroyal, 57.
- Pentatomidae, 171, 218.
- Penthe obliquata*, 137.
pimelia, 137.
- Penthestes atricapillus atricapillus*, 297.
- Perca flavescens*, 567.
- Perch, 391.
 yellow or American, 569.
- Peridroma saucia*, 140.
- Peromyscus maniculatus bairdi*, 288.
- Petalostemum*, 169, 178.
purpureum, 54, 169, 172, 199.
- Pewee, wood, 295, 300.
- Peziza badia*, 552.
 recurved, 552.
 repanda, 552.
- Phalangiida, 35, 161, 205.
- Phalangiidae, 161, 205.
- Phasmidae, 211.
- Phegopteris hexagonoptera*, 63.
- Phenolia grossa*, 136.
- Phidippus audax*, 138.
 sp., 164.
- Philomycidae, 202.
- Philomycus*, 64, 203.
canadensis, 58, 61, 136, 150, 202, 204, 205, 209, 221, 223, 228, 236.
- Phloeotomus pileatus*, 228.
- Pholiota*, 437.
dura, 490.
hard, 490.
praecox, 490.
scaly, 492.
squarrosa, 492.
- Phoridae, 137, 353.
- Photuris pennsylvanica*, 65, 222.
- Phragmites, 77, 79, 80, 105, 188.
- Phycomycetes, 435.
- Phyllophaga, 365-379.
carolina, 378.
ephillida, 378, 379.
forbesi, 378-379.
hirticula, 370.
uniformis, 378, 379.
- Phymata, 120.
fasciata, 45, 46, 48, 49, 50, 51, 52, 53, 54, 104, 108, 109, 110, 111, 121, 174, 175, 185, 189. See also Ambush-bug.
wolffi, 174.
- Phymatidae, 174.
- Phymatodes varius*, 156.
- Physa gyrina*, 50, 51, 160.
- Physidae, 160.
- Physocephala*, 200.
sagittaria, 110, 188.
- Pieridae, 182.
- Pigeon Tremex, 59, 61, 231.
 wild, 303.
- Pignut, 57, 60, 124.
- Pilea pumila*, 60, 62, 63, 126, 138, 209.
- Pilobolus*, 421.
- Pimephales, 386, 397, 401, 405, 406.
notatus, 386, 387, 562, 567.

- Pine, 143, 155.
 yellow, 156.
Pipilo erythrophthalmus erythrophthalmus, 296.
Piranga erythromelas, 296.
 rubra rubra, 296.
 Pitcher-plant, 195.
Plagionotus speciosus, 156, 232.
Planesticus migratorius migratorius, 287, 297.
 Plankton, 557.
 Planorbis, 161.
 Plantain, 227.
 Plant-bug, dusky, 174.
 tarnished, 45, 175, 218.
 Plant-lice, 42, 47, 51, 107, 112, 162, 164, 165, 169, 174, 176, 188, 230.
 Plant-louse, milkweed, 171. See also *Aphis asclepiadis*.
Platydema ruficorne, 136.
Platymetopius frontalis, 48, 171.
Platyphora, 355.
 coloradensis, 354, 355.
 eurynota, 354, 355.
 flavofemorata, 353-354, 355.
 lubbocki, 355.
 schwarzi, 355.
Platyptera, 208.
Platypus, 137.
Pleurotus, 429, 437, 532.
 elm, 530.
 ostreatus, 419, 432, 528.
 ulmarius, 530.
 Plover, upland, 302.
 Plum, 141, 198, 219, 229.
 sugar, 228.
Pluteolus, 437.
Pluteus, 437.
 cervinus, 432, 486.
 fawn-colored, 486.
Pogonomyia alpicola, 356, 357.
 aterrima, 357.
 flavinervis, 356-357.
 Poison-ivy, 299.
 Pokeberry, 299.
Polioptila caerulea caerulea, 297.
Polistes, 48, 49, 187.
 pallipes, 110.
 variatus, 110, 121, 193.
 Polydesmidae, 205.
Polydesmus, 61, 150, 205.
 serratus, 134.
Polyergus lucidus, 192.
Polygonia, 126, 138.
 interrogationis, 225.
Polygonum, 183.
 convolvulus, 227.
Polygraphus rufipennis, 156.
Polygyra albolabris, 58, 201.
 clausa, 61, 201, 202, 204.
Polylepta leptogaster, 324.
Polyporus, 126, 136, 224, 538.
 branched, 536.
 frondosus, 536.
 sulphureus, 536.
 tomentosus, 136.
 volvatus, 137.
 Pomace-fly, 104.
Pomoxis annularis, 567.
 sparoides, 567.
 Pompilidae, 194.
Pompilus, 238.
Pontia protodice, 174.
 rapae, 56, 182, 186.
 Poplar, 106, 149.
 Carolina, 105, 106.
Populus, 106, 149.
 deltoides, 44, 103, 105, 283.
Porthetria dispar, 156.
Porzana carolina, 285.
 Potato, 179, 224.
 -beetle, old-fashioned, 52, 180.
 wild sweet, 178.
 Prairie chickens, 302.
 dog, 100.
 Prickly ash, 60, 63, 138, 179, 183, 217, 225.
Prionemis unifasciatus, 193.
Prionemoides unifasciatus, 193.
Priononyx atrata, 195.
Prionoxystus robiniae, 144, 154.
Prionus imbricornis, 152.

Probezzia albiventris, 317.
 infuscata, 316.
 pallida, 316, 318-319.
Proctacanthus, 337.
 milberti, 187, 327, 339-340.
Procyon lotor, 299.
Promachus, 119, 120, 121.
 vertebratus, 50, 51, 53, 56, 109, 111,
 171, 186, 326, 337-338, 339.
 Protozoa, parasitic, 387.
Prunus, 225, 348.
 avium, 350.
 domestica, 350.
 serotina, 63, 208, 292.
Psammochares aethiops, 65, 132, 238.
Psammocharidae, 193, 238.
Psedera, 229.
 quinquefolia, 57, 60, 63.
Pseudoculicoides, 312.
 griseus, 309.
 major, 309.
Psilocephala, 335, 336.
 haemorrhoidalis, 319, 325, 334-336.
Psilopus siphon, 112, 171, 187.
Psithyrus, 120.
 variabilis, 52, 54, 200.
Psocids, 131.
Psocus, 158.
Psorophora ciliata, 45, 46, 50, 104, 184.
Ptelea, 225.
Pterodontia, 341.
Puffball, gemmed, 544.
 giant, 544.
Puffballs. See *Mushrooms, puffball*.
Pulmonates, 236.
Purpuricenus humeralis, 148.
Putorius noveboracensis, 289, 299.
Pycnanthemum, 181, 192.
 flexuosum, 39, 50, 163, 169, 172, 173,
 174, 180, 185, 191, 192, 194, 196,
 197, 199.
 linifolium, 180.
 pilosum, 169, 172, 174, 176, 177, 179,
 180, 182, 184, 185, 190, 191, 192,
 193, 196, 197, 199.
 virginianum, 178, 283.

Pyramidula alternata, 64, 203.
 perspectiva, 58, 61, 136, 150, 201, 202,
 204, 221.
Quiscalus quiscula aeneus, 286, 298.
Pyrochroidae, 221, 223, 224.
Pyrrharctia isabella, 233.

Q

Quercus, 124, 232, 292.
 alba, 40, 57, 60, 124, 228, 232, 446.
 imbricaria, 63, 123, 232.
 michauxii, 123.
 minor, 123.
 rubra, 40, 57, 60, 62, 63, 123, 126,
 292.
 velutina, 40, 57, 60, 75, 124, 144.
Quiscalus quiscula aeneus, 286, 298.

R

Rabbit, common, 288, 297, 299.
Rabbits, 289, 290, 301, 426.
Raccoon, 299.
Ragweed, 175, 176, 178, 179.
Rail, Carolina, 45.
 king, 284, 290.
 sora, 285.
Rails, 291.
Rallus elegans, 284.
Rana, 45.
 catesbiana, 294 (see *Errata*).
 pipiens, 284.
Raspberry, 57, 124, 129, 170.
Rattlesnake-master, 53, 167, 168, 174,
 175, 177, 180, 181, 183, 189, 199.
Rattlesnakes, 302.
Raven, 302.
Redbud, 60, 63, 138, 292.
Red-horse, 562, 567.
Redstart, 296.
Regulus calendula calendula, 299.
Reduviidae, 173, 219.
Regulus satrapa satrapa, 299.
Reptiles, 100, 282, 303.
 and *amphibians*, 284, 293.
Rhipiphoridae, 51, 180.

- Rhipiphorus*, 120, 121.
 dimidiatus, 50, 51, 52, 53, 109, 111, 180.
 limbatus, 53, 109, 181.
 paradoxus, 181.
 pectinatus ventralis, 181.
Rhodites nebulosus, 56, 190.
Rhodophora gaurae, 183.
 Rhubarb, 186.
Rhus, 172.
 glabra, 57, 60, 124, 292.
 toxicodendron, 57.
Rhynchites aeneus, 53, 54, 181.
 hirtus, 108.
 Rhynchitidae, 181.
Rhynchophora, 116.
Ribes cynosbati, 63.
 Robber-fly, vertebrated, 50, 53, 56, 171, 186.
 Robber-flies, 48, 49, 53, 119, 164, 182, 186, 187, 210, 230.
 Robin, 287, 297.
Robinia, 148, 226.
Romaleum atomarium, 146.
 rufulum, 146.
 Root-louse, grass, 120.
Rosa, 57, 190.
 Rose, 57, 124, 198.
 -breasted grosbeak, 178.
 wild, 180, 190.
 Rosin-weed, 39, 40, 48, 53, 55, 108, 174, 180, 181, 185, 197, 233.
 arrow-leaved, 169.
 broad- or large-leaved, 55, 168, 176, 199, 200.
 cup-leaved, 54.
 Rotten-log caterpillar, 61, 150, 153, 154, 228.
Rozites gongylophora, 426.
Rubus, 57.
Rumex, 183.
 Rushes, 283, 286.
Russula, 136, 437, 438, 446.
 foetentula, 446.
 green, 444.
 slightly ill-smelling, 446.
 virescens, 444.
- Rutela*, 369.
 Rye, wild, 39, 41, 42, 43, 107, 168.
- ## S
- Sagittaria*, 343.
Salamander, dusky, 293.
Salamanders, 66.
S[alicylis] brassicoides, 157.
Salix, 44, 103, 106, 283, 350.
Sandpiper, pectoral, 302.
 solitary, 285.
Saperda, 143.
 candida, 146.
 discoidea, 144.
 tridentata, 144, 146, 148, 154, 159.
 vestita, 146.
Sapsucker, yellow-bellied, 295.
Sarracenia flava, 195.
Sassafras, 57, 60, 124, 125, 126, 137, 149, 206, 207, 212, 215, 218, 225, 226, 227, 299.
 variifolium, 57, 60, 124.
 Saturniidae, 227.
 Saw-fly, 158.
 larch, 156.
 Scale insects, 106.
Scalopus aquaticus machrinus, 289
 (see Errata), 299.
Scaptomyza adusta, 347.
 flaveola, 347.
 graminum, 347.
Scarabaeidae, 177, 223, 225, 233.
Scatopse pulicaria, 104.
Scepsis fulvicollis, 110.
Schilbeodes gyrinus, 570.
Schistocerca alutacea, 55, 56, 167.
Schizoneura corni, 112, 122.
 panicola, 120, 121.
Sciara spp., 50, 185, 320.
Sciaridae, 320.
Sciomyzidae, 42, 43, 189.
Scirpus, 44, 103, 105, 283.
 robustus, 286.
Sciuropterus volans, 299.
Sciurus carolinensis, 299:
 niger rufiventer 297, 299.
 sp., 296.

- Scolecocampa liburna*, 61, 125, 150, 153, 154, 159, 209, 221, 223, 228.
Scolia, 192, 193.
 bicineta, 192.
 tricincta, 193.
Scoliidae, 192.
Scolytidae, 137, 144.
Scolytoidea, 27.
Scolytus quadrispinosus, 144, 154, 159.
Scorpion flies, 62.
 -fly, brown-tipped, 210.
 clear-winged, 64, 209.
 spotted crane-like, 210.
Scotobates calcaratus, 151.
Scudderia furcata, 58, 124, 215.
 texensis, 42, 44, 48, 50, 107, 108, 111, 168.
Scytonotus granulatus, 134.
Sedge, 44, 283.
Semotilus atromaculatus, 65, 293, 567.
Senotainia trilineata, 196.
Serica, 369.
Serpents, 100.
Setaria, 182.
 glauca, 352.
Setophaga ruticilla, 296.
Setulia grisea, 195.
Sheep, 426.
Shelf fungus, 136, 224.
Shiner, 567.
 common, 387.
 golden, 387.
Shrew, short-tailed, 289.
 smaller, or small short-tailed, 288, 299.
Shrike, loggerhead, 287.
 migrant, 287.
Shrikes, 289, 290.
Sialia sialis sialis, 297.
Silkworm, American, 61, 227.
Silphium, 73, 86, 108, 118, 171, 283.
 integrifolium, 48, 54, 108, 166, 167, 169, 174, 180, 181, 185, 196, 197, 198.
 laciniatum, 53, 73, 108.
 terebinthinaceum, 39, 40, 48, 55, 56, 108, 161, 168, 176, 180, 199, 200. |
- Silverside, brook*, 387, 567.
Simuliidae, 307, 309.
Sinea diadema, 50, 51, 65, 111, 173, 219.
Sinoxylon basilare, 146.
Siricidae, 231.
Skipper, common, 64, 226.
Skunk, 289, 299.
Slug, Carolina, 58, 61, 150, 202, 236.
 caterpillar, 61, 140, 229.
Slugs, 133, 420, 426.
Smartweed, 183.
Smilax, 55, 56, 63, 299.
Smodicum cucujiforme, 148.
Snail, alternate, 64, 203.
 predaceous, 58, 64, 201.
Snails, 45, 50, 58, 61, 64, 133, 138, 160, 234, 294.
Snake, garter, 284, 290.
Snakes, 297, 302.
Snakeworms, 320.
Snipe, Wilson's, 288.
Snout-beetle, imbricated, 141.
Snout-beetles, 52, 53, 104, 116, 181, 182.
Snowberry, 183.
Soldier-beetle, 45, 46, 47, 53, 55, 65, 104, 118, 120, 169, 176.
 margined, 65, 222.
 Pennsylvania, 118. (See also Soldier-beetle.)
Soldier-bug, rapacious, 50, 51, 65, 173, 219.
Solidago, 109, 110, 111, 118, 145, 162, 171, 172, 174, 176, 179, 180, 182, 184, 185, 188, 189, 190, 192, 196, 283.
Sow-bugs, 137.
Span-worm, 229.
Sparganium, 43.
Sparnopolius fulvus, 121, 174, 186, 319, 326, 327, 331-332.
Sparrow, English, 286.
 field, 295.
 fox, 298.
 grasshopper, 302
 lark, 298.
 savanna, 302

- Sparrow—*continued*.
 song, 287, 296.
 tree, 287, 298.
 white-crowned, 298.
 white-throated, 295.
- Spartina, 39, 40, 41, 43, 44, 107, 167, 168, 169, 170, 175, 189.
 michauxiana, 41.
- Sphaerophthalma, 59, 124, 132, 192, 238.
- Sphaerularia bombi, 200.
- Sphagnum, 79.
- Spharagemon bolli, 58, 61, 124, 213.
- Sphecidae, 194, 238.
- Sphecius speciosus, 196.
- Sphenophorus, 116.
 ochreus, 104.
 placidus, 181.
 robustus, 182.
 venatus, 50, 181.
- Sphex brunneipes, 195.
 ichneumonea, 194.
- Sphingidae, 183, 226.
- Sphinx, honeysuckle, 45, 46, 183.
- Sphyrapticus varius varius, 295.
- Spice-bush, 138, 207.
- Spider, ambush, crab-, or flower, 42, 43, 45, 46, 47, 50, 51, 52, 53, 54, 64, 104, 163, 168, 175, 200, 216, 231.
 common garden or garden 42, 44, 45, 48, 50, 51, 52, 53, 54, 104, 162, 182.
 ground, 58, 64.
 harvest-. See Harvest-spider.
 island, 58.
 jumping, 112, 138, 164.
 rugose, 58, 64, 65, 207.
 spined, 64, 65, 207.
 three-lined, 207.
 white-triangle, 58, 65, 207.
- Spiders, 35, 119, 131, 138, 140, 238.
- Spirobolus marginatus, 134.
- Spirogyra, 292.
- Spizella monticola monticola, 287.
 pusilla pusilla, 295.
- Spogostylum, 327.
 anale, 186, 319, 326, 328-329.
- Sporobolus, 49, 111, 112, 168, 212.
 cryptandrus, 39, 49, 53.
- Sporotrichum, 427.
- Spragueia leo, 110, 184.
- Spruce, 149, 156.
 Engelmann, 149.
- Spurge, flowering, 53, 55.
- Squash-bug, 173, 189.
- Squirrel, flying, 299.
 fox, 297, 299.
 gray, 297, 299.
- Squirrels, 293, 301.
- Staphylinidae, 116.
- Stelis, 198.
- Stenosphenus notatus, 144, 147.
- Stigmatomma pallipes, 61, 133, 202, 205, 224, 233, 236.
- Stilbolemma, 369.
- Stilt-bug, spined, 64, 219.
- Stink-bug, 45, 50, 51, 53, 110, 187.
- Stiretrus anchorago, 172.
- Stizidae, 196.
- Stizus brevipennis, 52, 196.
 speciosus, 196.
- Stone-roller, 65-66, 293.
- Strawberry, 176.
- Strepsiptera, 49.
- Strix varia varia, 298.
- Strobilomyces strobilaceus, 534.
- Stropharia, 437.
 epimyces, 423, 494.
 parasitic, 494.
 semiglobata, 496.
 semiglobosa, 496.
- Sturnella magna magna, 286.
- Sucker, common, 387, 567.
- Suckers, 385, 387, 391.
- Sumac, 55, 56, 57, 60, 124, 138, 139, 227, 292, 299.
- Sunfish, 387, 402, 404.
 blue-spotted, 387, 567.
 green, 562.
 long-eared, 387, 391.
 orange-spotted, 387, 403, 405, 406, 408, 562.
- Sunfishes, 568.
- Sunflower, 111.
 wild, 169, 288.
- Swallow, barn, 287.

- Sweet potato, wild, 178.
 Sycamore, 149, 186, 227, 231.
 Sylvilagus floridanus mearnsi, 288, 297, 299.
 Sympetrum rubicundulum, 50, 51, 164.
 Symphoricarpos orbiculatus, 63.
 Synchroa punctata, 149.
 Syrphula admirabilis, 50, 111, 166.
 Syrphid, American, 52.
 corn, 53, 54, 59, 65, 188, 231.
 Vespa-like, 59, 64, 231.
 Syrphidae, 158, 188, 231, 342-345.
 Syrphus americanus, 52, 188.
 Systoechus, 327.
 oreas, 186, 327 and 330 (see Errata).
 vulgaris, 185.
 Systropus, 327.
- T**
- Tabaniade, 325, 341.
 Tabanus, 325.
 Tachinidae, 158, 182, 189, 195.
 Tadpole cat, 570.
 Taeniocampa rufula, 333.
 Tamarack, 149.
 Tamias striata, 297.
 hysteri, 297, 299.
 Tanager, scarlet, 296.
 summer, 296.
 Tanypinae, 317.
 Tanypus carneus, 317.
 Tapinoma sessile, 64, 126, 236.
 Tautogolabris, 382.
 Telea, 140.
 polyphemus, 61, 227.
 Telephorus bilineatus, 222.
 sp., 65, 222.
 Tench, 397, 400, 403.
 Tenebrionidae, 136, 224.
 Termes, 125, 147.
 flavipes, 58, 61, 150, 152, 154, 159, 202, 204, 208, 234.
 virginicus, 209.
 Termites, 208, 234, 235.
 Termitidae, 208.
 Terns, black, 302.
- Terrapene carolina, 294.
 Tetanocera pictipes, 43, 189.
 plumosa, 42, 43, 107, 189.
 Tetraopes, 51, 104, 112, 185.
 femoratus, 45, 46, 47, 178.
 tetraophthalmus, 45, 46, 50, 52, 111, 177, 178.
 Tetrogium cinnamopterum, 156.
 Tettigidea lateralis, 58, 211.
 parvipennis, 58, 212.
 Tettigonellidae, 218.
 Thalesa, 145, 148, 156.
 lunator, 64, 125, 126, 159, 231, 232, 233.
 Thamnophis sirtalis, 284.
 Thereva haemorrhoidalis, 334.
 Therevidae, 324, 325, 334.
 Thistle, 46, 199.
 Thomisidae, 163.
 Thrasher, brown, 287, 298.
 Thrush, hermit, 299.
 water, 296.
 wood, 299.
 Thryothorus ludovicianus ludovicianus, 296.
 Thyanta custator, 108.
 Thyreocoridae, 172.
 Thyreocoris pulcarius, 172.
 Thyridopterix ephemeraeformis, 154, 156.
 Thysanura, 131.
 Tibicen septendecim, 58, 130, 217.
 Tick-trefoil, 57, 63, 124.
 Canadian, 171.
 Tiger-beetle, woodland, 59, 219.
 Tiger-beetles, 132, 187, 220, 328.
 Tilia, 149.
 Timothy grass, 352.
 seeds, 175, 176.
 Tiphia, 115, 119, 120, 121, 181, 185, 193, 319, 331.
 Tipulidae, 115, 133, 136.
 Titmouse, tufted, 296, 300.
 Toad, common, 293.
 Toads, 66.
 Toadstools, 414, 466 (See also Mushroomrooms.)

- Tobacco, Indian, 63.
 Tomato, 224.
 Tortoise-beetle, clubbed, 65, 224.
 Totanus flavipes, 285.
 melanoleucus, 285.
 Towhee, 296.
 Toxophora, 327.
 Toxostoma rufum, 287, 298.
 Tree-frog, swamp, 284.
 Tree-toad, common, 294.
 Tremex columba, 59, 16, 125, 132, 144,
 Tyrannus tyrannus, 285, 298.
 Trichius piger, 152.
 Trichocera, 136, 159.
 brumalis, 136.
 Tricholoma, 437, 498.
 album, 498.
 personatum, 498.
 white, 498.
 Trichopepla semivittata, 108.
 Trichopoda pennipes, 189.
 plumipes, 189.
 ruficauda, 52, 189.
 Triepeolus, 197.
 Trifolium, 229.
 Triphyllus humeralis, 136.
 Trirhabda tomentosa, 52, 179.
 Trissolcus euschisti, 218.
 Tritoma biguttata, 136.
 thoracica, 136.
 Trogositids, 145.
 Trogus, 140.
 obsidianator, 65, 233.
 Trombidiidae, 164.
 Trombidium spp., 45, 46, 52, 120, 121,
 164, 306.
 Tropidia quadrata, 343, 344.
 Trout, 401.
 Truffles, 420.
 Truxalis brevicornis, 214.
 Trypetidae, 189.
 Turkey, wild, 303.
 Turnip, 347.
 Turtles, 426.
 Tussock-moth, white-marked, 154, 156.
 Twig-pruners, 141.
 Typha, 79, 80.
 Tyrannus, 285, 298.
- U
- Ulmus, 225, 292.
 americana, 40, 62, 63, 126, 217
 fulva, 63.
 Umbellifers, 182, 188.
 Uropod mites, 222.
 Urtica, 225.
- V
- Verbena, 185, 196, 197.
 stricta, 185.
 Vernonia, 118, 171, 172.
 Veronica virginica, 174.
 Vespa, 135, 188, 190, 210, 230.
 maculata, 135.
 Vespidae, 193.
 Viburnum, 223, 229.
 Vireo, red-eyed, 300.
 Virginia creeper, or five-leaved ivy,
 57, 60, 63, 177, 223.
 Vitis cinerea, 60, 63, 292.
 Vitrea indentata, 61, 64, 201, 202, 203,
 204.
 rhoadsi, 61, 201, 202, 204.
 Volucella, 200.
 Volvaria, 437.
 bombycina, 456.
 silky, 456.
 Vulture, turkey, 294.
- W
- Walking-stick, forest, 58, 140, 211.
 Walnut, 57, 60, 63, 145, 146, 148, 151,
 226, 227, 228, 292.
 black, 149.
 moth, royal, 227.
 Warbler, black and white, 296.
 myrtle, 287, 298.
 Wasp, 65.
 digger-. (See Digger-wasp.)
 potter mud-, 193.
 social, 48.
 solitary, 52.
 spider, 65, 193.
 white-grub, 185.

Wasps, 119, 175, 181, 185, 201.
 Water horehound, 44.
 -strider, 66, 127, 219, 292.
 Waxwing, cedar, 298.
 Weasel, 289, 299.
 Web-worm, fall, 156.
 Weevils, 144, 195.
 grain, 99, 100.
 nut-, 141.
 Wheat, 175, 218.
 -stem maggot, greater, 107.
 Whippoorwill, 298.
 White ant, 58, 61, 147, 150, 152, 154,
 159, 202, 204, 208, 234.
 -grubs, 106, 116, 119, 120, 174, 181,
 186, 193, 233.
 Wildcat, 303.
 Willow, 44, 47, 49, 103, 106, 120, 121,
 283, 286, 287.
 -gall insects, 157, 158.
 Wireworms, 61, 224.
 Wolf, black timber, 303.
 large gray, 303.
 Wolves, prairie, 301.
 Woodbine, 299.
 Woodpecker, downy, 294, 300.
 hairy, 294.
 pileated, 228.
 red-bellied, 294, 300.
 red-headed, 285, 298.
 Woodpeckers, 291.
 Wren, Carolina, 296.
 Wrens, marsh, 302.

X

Xanthium, 49, 189.
 Xenodusa cava, 237.
 Xiphidium attenuatum, 53, 54, 169.
 nemorale, 58, 64, 124, 126, 216.
 strictum, 42, 44, 48, 52, 53, 54, 107,
 108, 109, 169.
 Xyleborus, 137.
 Xylocopa virginica, 45, 46, 47, 104, 198.
 Xylocopidae, 198.
 Xylopinus saperdioides, 151.
 Xyloryctes satyrus, 152.
 Xylota quadrata, 343.
 Xyloterus, 137.
 Xylotrechus colonus, 144, 147, 148, 154
 undulatus, 154.

Y

Yellow-jacket, 188.
 Yellowlegs, greater, 285.
 lesser, 285.
 Yellow-throat, Maryland, 287.
 Ypsolophus, 140.
 ligulellus, 59, 65, 229.

Z

Zamelodia ludoviciana, 296.
 Zanthoxylum, 138, 179, 183, 225.
 americanum, 60, 63.
 Zenaidura macroura carolinensis, 285.
 Zonitidae, 202.
 Zonitis bilineata, 111, 112, 180.
 Zonitoides arborea, 58, 61, 136, 150,
 202, 204.
 Zonotrichia albicollis, 295.
 leucophrys leucophrys, 298.

