

THE UNIVERSITY
OF ILLINOIS
LIBRARY

630.7

C71b

no 220-33

NON CIRCULATING

CHECK FOR UNBOUND
CIRCULATING COPY



BULLETINS

of the

AGRICULTURAL EXPERIMENT STATION

of the

COLORADO AGRICULTURAL COLLEGE

16359 7/28
148

BULLETINS

220- 33

FORT COLLINS, COLORADO *R*

a

Digitized by the Internet Archive
in 2019 with funding from
University of Illinois Urbana-Champaign

<https://archive.org/details/bulletin2202unse>

630.7

C71b

CONTENTS

UNIVERSITY OF ILLINOIS
AGRICULTURE LIBRARY

no 220-33

- 6512 514
- 220-Potato growing in Colorado by E. P. Sandsten
- 221-Hotbeds and cold frames by T. F. Limbocker
- 222-The forcing of strawberries by Florence I. Kinnison
- 223-A fruit survey of Mesa County by E. P. Sandsten and others
- 224-Native vegetation and climate of Colorado in their relation to agriculture by Wilfred W. Robbins
- 225-A comparative bacteriological study of the water supply of the city and county of Denver, Colorado by Walter G. Sackett
- 226-Beans in Colorado and their diseases by Alvin Kezer and Walter G. Sackett
- 227-Dry farming in Colorado by Alvin Kezer
- 228-Divisors by V.M. Cone
- 229-Brisket disease by George H. Glover and I. E. Newsom
- 230-The waters of the Rio Grande by W. P. Headden.
- 231-Black alkali in the San Luis valley by W.P. Headden.
- 232-Harvesting and storing vegetables for home use by J. J. Gardner
- 233-Grasshopper control by Charles R. Jones
- 50
- 50

FEB 20 1916

Bulletin 220

January, 1917

The Agricultural Experiment Station
OF THE
Colorado Agricultural College

POTATO GROWING IN COLORADO

BY
E. P. SANDSTEN

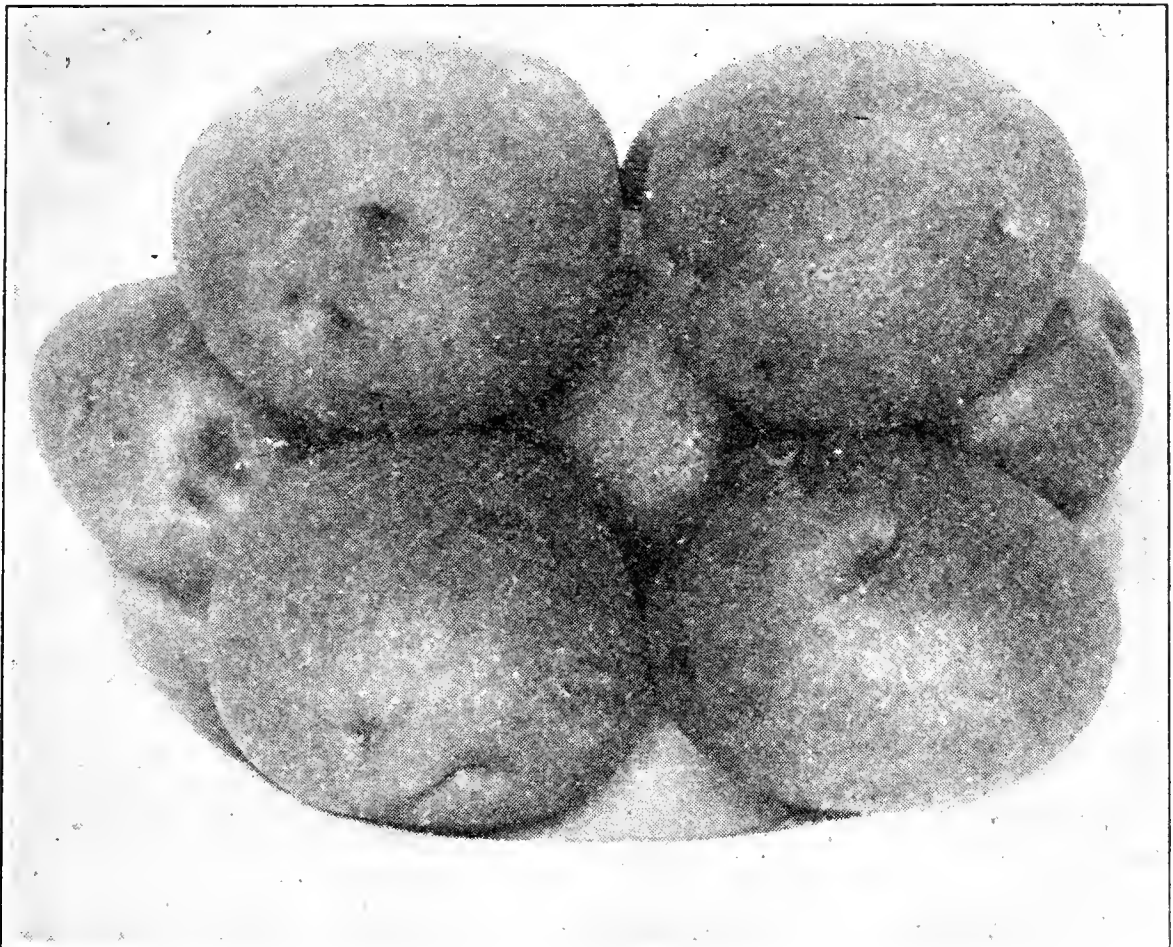

PUBLISHED BY THE EXPERIMENT STATION
FORT GOLLINS, COLORADO
1916

The Colorado Agricultural College

FORT COLLINS, COLORADO

THE STATE BOARD OF AGRICULTURE

	Term Expires
HON. J. S. CALKINS.....Westminster,	1917
HON. J. C. BELL.....Montrose,	1917
HON. CHAS. PEARSON.....Durango,	1919
HON. R. W. CORWIN.....Pueblo,	1919
MRS. J. B. BELFORD.....Denver,	1921
HON. A. A. EDWARDS.....Fort Collins,	1921
MRS. AGNES L. RIDDLE.....Denver,	1923
HON. H. D. PARKER.....Greeley,	
PRESIDENT CHAS. A. LORY, GOVERNOR JULIUS C. GUNTER, } <i>Ex-Officio</i>	
L. M. TAYLOR, Secretary	G. A. WEBB, Treasurer

EXECUTIVE COMMITTEE

A. A. EDWARDS, *Chairman*

J. C. BELL

J. S. CALKINS

STATION STAFF

C. P. GILLETTE, M.S., <i>Director</i>	ENTOMOLOGIST
W. P. HEADDEN, A.M., Ph.D.....	CHEMIST
G. H. GLOVER, M.S., D.V.M.....	VETERINARIAN
W. G. SACKETT, B.S.....	BACTERIOLOGIST
ALVIN KEZER, A.M.....	AGRONOMIST
E. P. SANDSTEN, M.S., Ph.D.....	HORTICULTURIST
B. O. LONGYEAR, B.S.....	ASSISTANT FORESTER
G. E. MORTON, B.S.A., M.S.....	ANIMAL HUSBANDMAN
E. B. HOUSE, B.S. (E.E.), M.S.....	IRRIGATION ENGINEER
V. M. CONE, B.S., C.E.....	IRRIGATION INVESTIGATIONS
W. P. LITTLE, B.S., <i>U. S. Expert-in-charge</i>	HORSE BREEDING
R. E. TRIMBLE, B.S.....	ASSISTANT IRRIGATION INVESTIGATIONS
P. K. BLINN, B.S., ROCKY FORD.....	ALFALFA INVESTIGATIONS
EARL DOUGLASS, M.S.....	ASSISTANT CHEMIST
S. ARTHUR JOHNSON, M.S.....	ASSISTANT ENTOMOLOGIST
L. C. BRAGG.....	ASSISTANT IN ENTOMOLOGY
J. W. ADAMS, B.S., CHEYENNE WELLS.....	AGRONOMY ASSISTANT, DRY FARMING
W. W. ROBBINS, M.A.....	BOTANIST
RALPH L. PARSHALL, B.S.....	ASSISTANT IRRIGATION INVESTIGATIONS
I. E. NEWSOM, B.S., D.V.S.....	VETERINARY PATHOLOGIST
MIRIAM A. PALMER, M.A.....	DELINEATOR
R. A. MCGINTY, B.S.....	ASSISTANT IN HORTICULTURE
CHAS. R. JONES, B.S.....	ASSISTANT IN ENTOMOLOGY
GEO. M. LIST, B.S.....	ASSISTANT IN ENTOMOLOGY
JAS. D. BELL, B.S.....	ASSISTANT IRRIGATION INVESTIGATIONS
CARL ROHWER, B.S., C.E.....	ASSISTANT IRRIGATION INVESTIGATIONS
BREEZE BOYACK, B.A., M.S.....	ASSISTANT IN AGRONOMY
CHAS. I. BRAY, B.S.A., M.S.....	ASSISTANT ANIMAL HUSBANDRY
RALPH L. CROSMAN.....	EDITOR
J. L. TAYLOR.....	MARKETS AND MARKETING
T. E. LEIPER, B.S.....	ASSISTANT ANIMAL HUSBANDMAN

OFFICERS

CHAS. A. LORY, M.S., LL.D., D.Sc.....	<i>President</i>
C. P. GILLETTE, M.S.....	<i>Director</i>
L. M. TAYLOR.....	<i>Secretary</i>
MABEL LEWIS.....	<i>Executive Clerk</i>

POTATO GROWING IN COLORADO

By E. P. SANDSTEN

FOREWORD

The Horticultural Department has received numerous requests for information on the various phases of potato growing in the State. These inquiries cannot be answered fully nor adequately in personal letters, as the subject covers too extensive a field. To answer these inquiries and to furnish reliable information upon the fundamental problems of the grower, this bulletin is written.

While the information contained within is fundamentally correct for the State as a whole, local peculiarities in soil, situation, and climate may necessitate modifications in details, and the grower must meet these modifications as they occur.

The soil and climatic conditions of Colorado are admirably adapted for the growing of high quality potatoes. The development of the industry has not measured up to the possibilities. The present acreage devoted to potatoes is less than it was five years ago. This is particularly true in the Greeley district where diseases have been destructive. With better methods of farming, especially along the line of rotation, and with better seed, the outlook for the future is very encouraging. The acreage devoted to this crop in the State has varied from year to year, generally with the prices obtained. The State may be roughly divided into two general sections known as the Eastern Slope and the Western Slope with the Inter-Mountain Valleys. On the Eastern Slope the most prominent region is the Greeley district in Weld County. The acreage in this section has varied from 6,000 to 20,000 acres annually. The varieties grown are the Pearl and the Rural. These are late standard white potatoes, and have proven well adapted to the conditions in this section.

The Western Slope and the inter-mountain valleys produce a very high quality of potatoes, and these general sections bid fair to become the best potato producing regions of the United States. The soil, taken as a type, is a mellow, sandy loam which permits perfect root development, and offers no resistance to the normal growth and expansion of the tubers. With a perfect system of rotation and the plowing under of clover or alfalfa, the vigor and yield of the plants can be not only maintained, but also enormously increased. The principal varieties grown here are the Russet Burbank, Rural, Peoples, Cobbler, and Downing. In the high mountain

valleys, the Peachblow is grown to perfection, and in the San Luis Valley, Barklay's Prolific or Brown Beauty is extensively grown.

The total acreage devoted to potatoes in Colorado in 1916, was, in round numbers, 29,000, somewhat less than in 1915. The U. S. Census has in the past credited the State with as high as 70,000 acres. If these figures are correct, they show a heavy decline in the total acreage, but we are inclined to believe that the estimates were excessive to begin with.

Present indications point to a revival in potato growing, due to a better understanding of the fundamental requirements of the crop. While the acreage devoted to potatoes is less than formerly, the yield per acre is higher and the net returns to the grower, larger.

SOIL AND CLIMATIC REQUIREMENTS

The potato is naturally a North Temperate crop. The highest yield, as well as the highest quality, is obtained in the northern states and in the cool high valleys in the Mountain States. In warm climates, the potatoes suffer greatly from the summer heat and seem to be unable to produce a satisfactory crop. When grown in the South the crop must be matured before the warm summer weather sets in, and the later crop may be planted in the autumn, maturing during the fall and early winter months.

There is at least one native species of potato found in southwestern Colorado around an altitude of from 6,000 to 8,000 feet, showing conclusively that the mountain sections of Colorado are naturally better suited for the growing of this crop than are the plains sections where the summers are usually hot, and where the plants are subject to diseases occurring in these soils.

The Greeley district has been an exception to the general failure of growing potatoes on the plains, and here potato growing has been carried on ever since the district was first settled, with uniform success, up to within the last four or five years. During the last five years, considerable trouble has been experienced from the presence of diseases, which have caused great losses to the growers. The season of 1915 was very favorable to potato growing, and a normal crop was obtained. Whether this favorable turn in the industry is permanent or not, only the future can tell.

The mountain sections of the State have large acreages in mountain valleys and mesas which have ideal soil and climatic conditions for the highest development of the plant, and these areas should develop into typical potato growing sections, both for the production of seed for the Southern states, and also for high grade market potatoes. Political economy should teach our farmers to

grow those crops that are best adapted to a given section, and not endeavor to grow them where the conditions are unfavorable.

The failure in growing potatoes on the Eastern plains is due to several causes: First, the soil is too heavy and puddles badly under irrigation. This puddling and subsequent baking of the soil prevents proper aeration of the soil and prevents the normal development of tubers. Second, the day temperature during the summer months is generally too high and imparts a correspondingly high temperature to the soil. Third, potato diseases, due to unfavorable temperature and soil conditions are very prevalent and destructive. On the lighter soil, and in long rotation with alfalfa, potatoes may be grown. On virgin soil and in rotation with grain crops, potato growing should not be attempted.

POTATOES AS A CROP IN FARM ROTATION

Many of our farmers have ruined their land by a one crop system, and many of the complaints about the failure of potato growing on a given area are due, not to unsuitable soil and climatic conditions, but rather to the presence of diseases which have been introduced thru continuous cropping of potatoes, and also to the burning out of vegetable matter in the soil, which is greatly hastened by the continued growing of cultivated crops. It is a safe rule to go by that potatoes should not be planted on the same land more than once, or, under extremely favorable conditions, twice in succession. In other words, rotation with other crops is necessary.

The potato requires an open, porous soil, perfectly drained, and rich in vegetable matter. For this reason, it fits in well with the rotation of other farm crops, and should always follow a crop of alfalfa, either immediately or the second year after. The turning under of alfalfa adds to the soil the needed fiber and improves the condition so that potatoes can develop normally. There is a tendency to grow potatoes on the same land year after year, especially if the land was originally well suited for this crop, but such practice generally brings disastrous results. It is far better to reduce the acreage of potatoes than to plant land that is not in the right condition for the production of an average crop.

In Colorado, where alfalfa is easily grown, potatoes should follow it in a five to six years rotation. The rotation system should be as follows: Potatoes first year, followed with grain and seeding alfalfa the second year; third, fourth and fifth years in alfalfa, and the sixth year, back to potatoes. On the small farm this would mean a reduced acreage, but the grower will find that the net returns would be much greater because of increased yield.

In many of the higher mountain valleys, where alfalfa cannot be grown so successfully, clover and timothy should be substituted

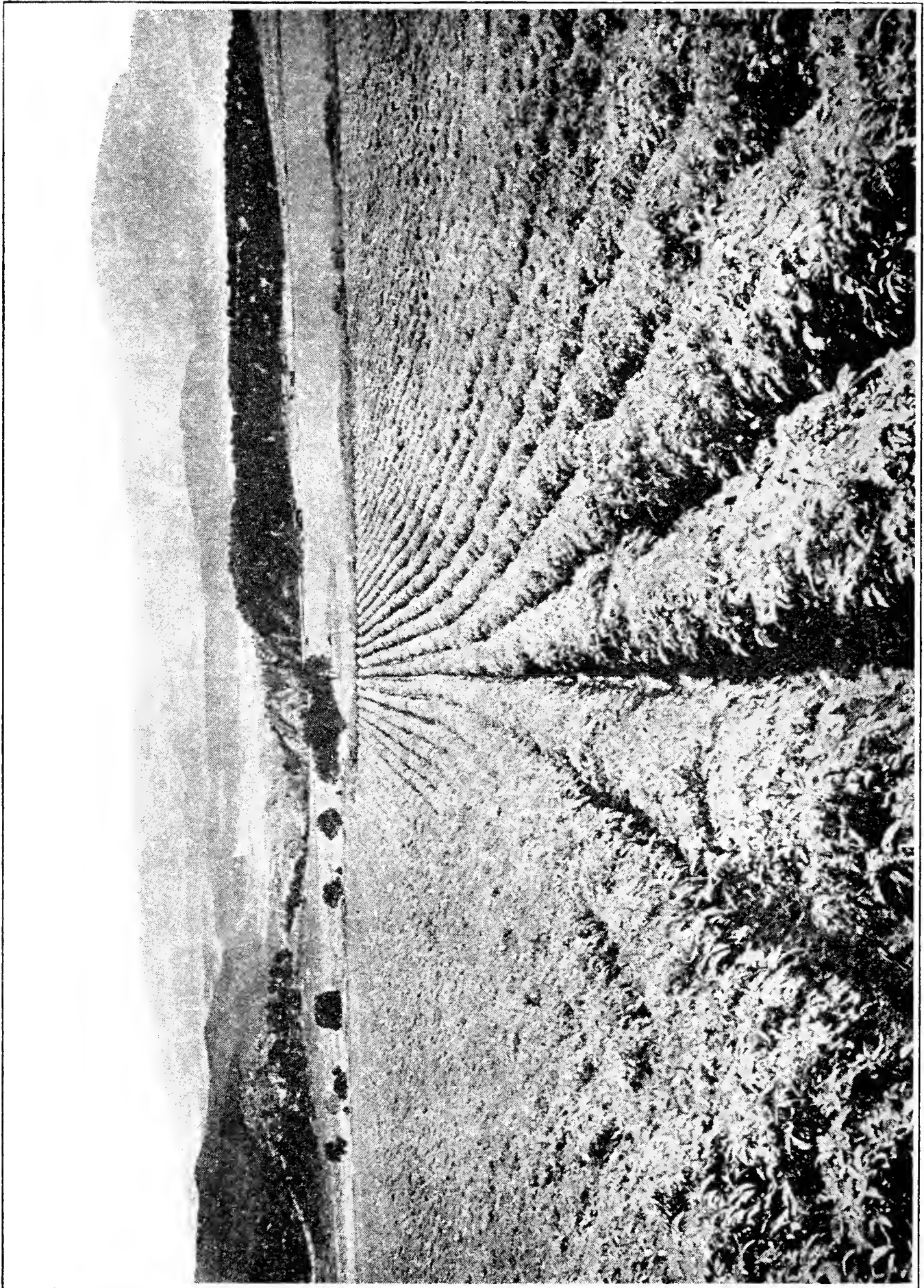

Showing a typical Mountain Valley potato field at Carbondale, Colorado.

and the rotation period may be shortened to four years. In this case, larger acreages may be planted to potatoes. Not only would the average yield of potatoes per acre be greatly increased, but a corresponding increase in the yield of grain per acre would be attained following a crop of potatoes.

If this system of crop rotation could be extended from six to eight, or even ten years, leaving the land in alfalfa for a longer period, even better results would be obtained. Long rotation period is only suited for large farms in combination with extensive livestock operations.

PREPARATION OF THE LAND

The preparation of the land intended for potato growing should be thorough, as the potato develops its crop below the ground, and needs a loose, open soil so that the tubers can expand normally, and also to give the root system a chance to develop to its fullest extent. On the heavier soils, deep fall plowing is necessary, as it gives the elements a chance to act upon the land during the winter. Then again, the land should be plowed a couple of weeks before planting and kept cultivated so as to conserve the moisture stored in the soil during the winter months. When alfalfa is turned under, this may be done in the fall, but shallow plowing in this case is necessary, just deep enough to cut the crown of the alfalfa plants. Deep plowing will not kill all the alfalfa roots. The field should be cross-plowed again in the spring to the depth of eight to ten inches. Deep plowing is a very important factor in the preparation of potato land, so as to give the roots the largest possible feeding area. Where the soil conditions are favorable, the potato plant will send its roots down to the depth of three feet, while if the soil conditions are unfavorable, the root system is confined to the top soil and the food supply curtailed, and the yield will correspond with the food supply. If the spring plowing is done early, the land should be kept harrowed to keep it in fine tilth until planting time. The preparation of the land is really one of the most important factors in potato production, and unless a grower is willing to take the time and perform this work thoroughly, he cannot expect a large return.

PLANTING

The depth at which potatoes should be planted varies with the character of the soil, locality and method of culture. When high hilling or ridging is practiced, the planting is shallow—about two inches below the level of the field. On heavy soil the planting may be more shallow. When low hilling is practiced, the planting should be from three to four inches deep, depending upon the character of the soil—the lighter the soil, the deeper the planting.

The time of planting necessarily depends upon the season and

whether early or late crops are wanted. It generally requires four months to grow a crop of late potatoes normally. This time may be shorter, but if shortened it is generally at the expense of quality. It is better to let the plant develop normally than first to stunt the growth and afterwards hasten it.

Planters.—There are two general types of planters on the market, and in use,—one known as the “picker” and the other as the “disk” type. Both of these types have their advocates. The picker is perhaps less accurate, as it will not always spear a seed—or it may spear the seed in the only bud or eye of that particular seed, thus causing a miss in the stand.

The disk type of machine has to be operated by two persons—one driving and one sitting behind and seeing to it that each compartment in the disk has a seed. In this way, there can be no miss, if the person behind attends to his business.

It costs more to plant a given acreage with the last mentioned type of machine, but if the seed is good and other conditions are favorable, a perfect stand may be obtained.

The importance of a perfect stand is hardly ever realized by the grower.

The average stand of hills in the potato fields in Colorado is only between 75 and 80 per cent. The losses from this neglect alone is fully 20 per cent of the total yield of the State. Practically, a perfect stand is rarely possible, tho at least a 90 per cent stand should be obtained.

SEED POTATOES

The importance of good seed is too often overlooked by potato growers, and more failures result from the planting of poor seed than from any other cause. We speak of seed potatoes in the same sense that we do of seed grains, while in reality we are not planting seed, but cuttings. The potato, itself, is an underground stem greatly enlarged, and serves as a storehouse in which food for the future plant is stored up, and this underground stem or potato is either planted whole or in pieces. The eyes of the potato are equivalent to the buds on the stem of a plant. They perform the same functions in plant economy. When potatoes are exposed to light for a considerable length of time, the green color, or chlorophyll develops.

The common method of obtaining potato seed is well known. Generally, it is the small potatoes which go thru the grader, or, in some cases, the potatoes left over in the cellar or pit at planting time that are used. These methods of obtaining seed for planting are to say the least, poor. It reverses the practice that we are following in the selection of seed grain and in the selection of breed-

ing of stock for animals. It also reverses the common practice of gardeners in taking propagating stock from the best plants, instead of taking them from the poorest.

The common complaint that potatoes "run out" is due not to the potatoes "running out" of themselves, but to the planting of tubers from the poorest hills and the poorest potatoes of good hills. When this process of selection downward has been continued for a few years, the result is disastrous to the grower, and instead of blaming himself for the result, he blames it to the "running out" of the potatoes. The potatoes do not run out—it is really the farmer who runs the potatoes out. It stands to reason that if a given variety is adapted to the soil and climatic conditions of a given section, that that variety, if proper care is taken in seed selection, will continue to give good results, and instead of showing a decrease in yield, actually show an increase. This is especially true where the soil and climatic conditions are favorable for the development of the potato plant. It is not true in sections where the soil and climatic conditions are not favorable to the plants. In these sections the importation and the planting of seed from more favorable sections is always advisable.

MATURE SEED vs. IMMATURE SEED

The potato being botanically an underground stem, has perhaps a greater bud activity before maturity than after. This has led many to believe that immature seed, that is, seed that has not reached its full growth, but ripened off before this has been attained, is better for seed purposes than seed that has matured in the normal way. While theoretically, the buds may be more alive or more active in partly matured potatoes, it is not true so far as the value for seed is concerned. It is true that the terminal bud and cluster of buds in the immature potato are more active than in the fully mature one, but the eyes or buds located on the stem half of the immature tubers are really less developed than on a fully mature tuber, and this is the real reason why an immature tuber has, in many instances, given better results than fully mature tubers, for seed. In other words, immature tubers planted whole will develop one strong shoot, the terminal one, while the rest of the buds or eyes may never reach the top of the soil, thus producing a strong vigorous plant with one main shoot—an ideal plant for the grower. Where such seed can be obtained, it is undoubtedly preferable to use fully mature seed.

The development of a prominent terminal bud is especially noticeable in certain varieties of potatoes, particularly potatoes of the Peachblow type, and, so far as this particular variety is concern-

ed, whole seed is preferable to cut seed, and immature seed preferable to mature seed. But where soil and climatic conditions are favorable for potato culture, this is less important, and mature seed may be used with equal success.

WHOLE SEED vs. CUT SEED

During the last few years, considerable emphasis has been placed upon the value of whole seed as against cut seed. It is undoubtedly true that in planting whole seed a better stand is obtained. Whole seed naturally has more eyes and hence capable of producing a larger number of shoots. Then, too, in planting whole seed, the terminal eye is most active and will invariably produce a strong shoot. Further, under our uncertain climatic conditions

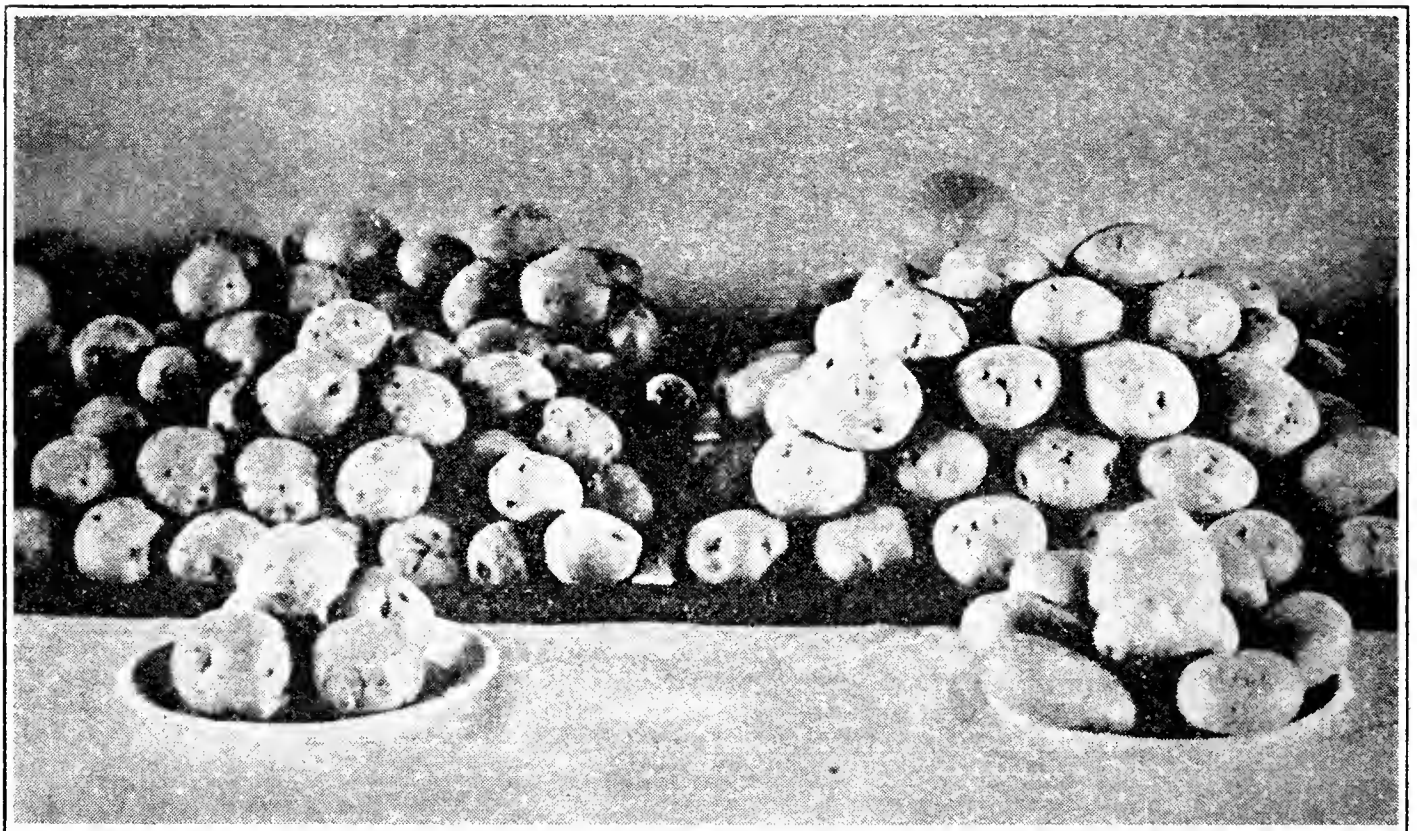

Seed Potatoes, Peachblow Variety, from Selected Seed; Note Uniformity and Trueness to Type.

at planting time, it is sometimes difficult to obtain a good stand when cut seed is used. This is especially true in dry, poorly prepared soil, when the cut seed has a tendency to decay, resulting in a poor stand. Under such conditions, whole seed is preferable.

The spring of 1916 was very dry and warm in the Greeley district and in some cases the land was in poor state of preparation. Under these conditions, a large percentage of the cut seed rotted, and very poor stands were obtained. On the other hand, where whole seed was used, the stand of plants was normal. These facts would lead us to believe that whole seed should be used where sufficient soil moisture at planting time is uncertain. On the other hand,

where soil and moisture conditions are normal, cuttings containing one to two eyes are to be preferred above the whole seed, especially when the whole seed are small potatoes obtained from the screenings.

It is universally recognized that hills having a large number of sprouts produce a larger number of small potatoes and a fewer number of marketable potatoes than hills having one or two main sprouts. From this discussion, the question whether the grower should plant whole seed or cut seed will depend upon his local climatic conditions and upon the preparation of the land, and no exact rule can be laid down.

METHODS OF SEED SELECTION

Bin Method.—This method is commonly used by potato growers who wish to keep up the standard of a given variety without



Field Demonstration in Potato Seed Plot, Carbondale, Colorado.

going to the trouble and expense connected with the more thorough method of hill selection. The essential thing to bear in mind in selecting seed potatoes from the bin is to have the correct type for the variety clearly in mind. As a rule, very few growers grow potatoes that are true to name. In most cases, the potatoes are badly mixed, and instead of one single variety, the grower generally has several, and without the knowledge of the standard and type of the different varieties he cannot hope to make an intelligent selection, but by knowing the type and color of the particular variety

which he wishes to plant he can select from the bin. Those tubers should be selected which most closely correspond with this type.

In making the selection, medium sized potatoes should be chosen, as these will most nearly show the true type. Large, overgrown tubers, as well as small ones, should be discarded. The selection should be done early and before the potatoes have been picked over and the best ones removed. After selection, they should be kept separate until planting time:

While this method will show a noticeable increase in stand and yield above average seed potatoes, it is not a method to recommend

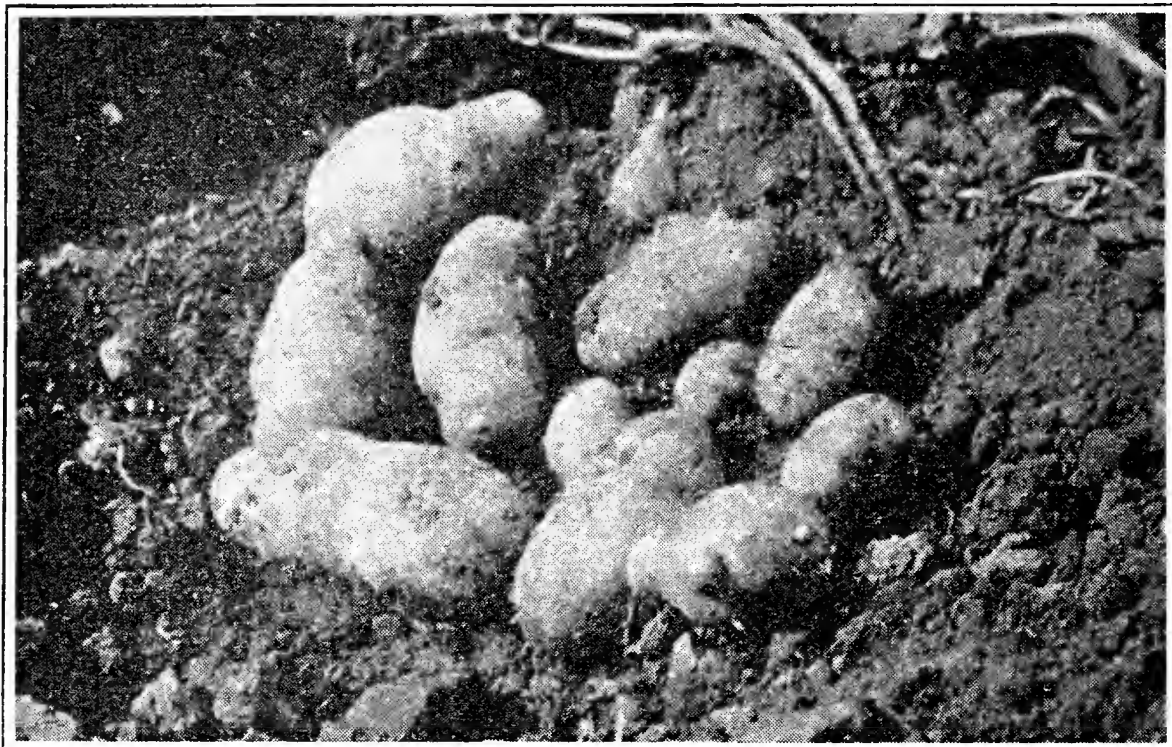

Poor hill and type to select from

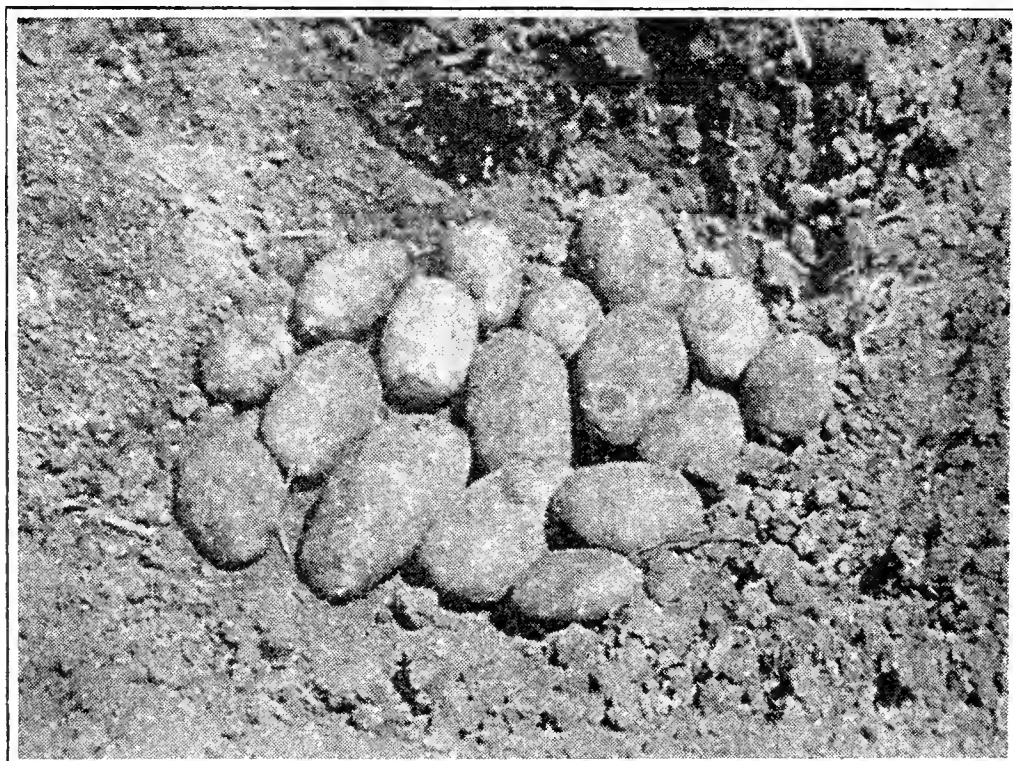

Good hill and type to select from

for those growers who wish to make a more thoro selection and who wish to continuously improve the variety grown. For such growers, the "hill method" is recommended.

Hill Method.—As the name indicates, the selection is made in the field while the potatoes are growing. Hills which are strong and vigorous are selected and staked. At digging time, but before the main field is dug, these hills are dug by hand, and if the potatoes in the hill correspond with the vigor and growth of the vine in the number and size of tubers, they should be saved and kept separately for seed.

If a grower will select 500 hills in this manner and keep those for planting the following spring, he will have a supply of seed potatoes that should be true to type and variety and be superior in vigor and yield to any seed that he can obtain. This method necessitates the use of a seed plot which is described elsewhere in this bulletin.

In hill selection, both large and small tubers should be saved, since a small potato from an otherwise good hill is better for seed than a large tuber from a poor hill. A good potato grower should continue this method of hill selection from year to year, improving the variety both in quality and in yield.

The expense connected with this method of selection is relatively small for the benefits derived. If our growers would follow this method, they would eliminate the necessity of changing seed and the extra expenses connected with the buying of new seed every few years. It may be stated, that under favorable soil and climatic conditions potatoes can be grown continuously in rotation in a given section and will continue to improve and become better adapted to this section if proper seed selection is pursued to keep up the quality and yield of the varieties.

SEED PLOTS

Every potato grower should grow his seed potatoes separately and distinct from his general crop. It need not be a separate field, but they should be planted separately, so that the seed plot can be under special observation during the growing season. Careful watch should be kept over the seed plot and all weak growing plants and plants showing any tendency to attack from diseases should be removed at once, leaving only the best hills to mature. This is a secondary step in selection and will do much towards bringing up the high standard of the seed. Ordinarily, at the end of the first season of the field grown seed, enough should be on hand to make the entire planting from it. Then hill selection should start from this planting. In other words, in order to obtain best results, hill selection should

be practiced once every two years, so as to keep up and improve the standard in yield and in quality. This may seem an expensive practice, but since the grower has to provide seed for next season's planting, the extra trouble and cost in selecting and keeping the seed separate is small in proportion to the benefits derived. If every grower should follow this practice, we would hear less of run-out seed, and less of poor yields and diseased fields.

In planting potatoes for seed, especially if the seed is to be used for planting whole the following year, it is better to have the seed dropped from eight to ten inches apart in the rows and the rows three feet apart. This will somewhat crowd the plants and will cause them to produce a larger number of seed potatoes of relatively smaller size, that is, of a size best suited for seed purposes. It is also well to delay the planting of the seed plot until the rest of the crop is planted, in some instances, two weeks later than the main crop. The soil for the seed plot need not be better nor be given



A promising Seed Plot of Ed. Clamson, Carbondale, Colorado
Note the strong and vigorous growth of vines

better treatment than that given to the main crop. The main purpose of having a separate seed plot is to keep the behavior of the individual potato plants under close observation.

Roguing.—While the seed plot represents a definite stage in the improvement of a given variety, it does not follow that the grower should rest satisfied with the results obtained. No matter how careful the hill selection has been and how much care has been taken in preparing and planting the seed plot, there will always be a certain number of individual plants that show weakness, either along the line of disease or in lack of growth vigor. These undesirable hills should be removed during the growing season or whenever they are found. The grower should watch his seed plot and

see to it that all hills that do not come up to the standard, or to the average, are removed and destroyed. This is the most effective method of keeping up the purity of the seed, as well as the productivity. Further, it eliminates diseased plants and those that show a predisposition to become infected. In fact, it is advisable to follow the method of roguing not only in the seed plot, but in the general field, for considerable improvement can be brought about by a system of roguing in any field of potatoes, whether grown for seed exclusively, or for the general market.

The time and effort expended on this work will be more than repaid in a higher grade of potatoes, besides eliminating diseases in the field and tubers.

CULTIVATING AND HILLING

There is no crop grown on the farm that requires better cultivation or that responds more readily to good cultivation and favorable soil conditions than potatoes. Being a tuber-producing plant, the shape and size of the tubers are adversely affected by a hard, lumpy, and poorly prepared seed-bed. The practice of preparing the soil after planting and during the growing season should be discouraged—as no amount of after-cultivation can properly prepare the land without disturbing the growing crop. Not only should the surface soil be in fine tilth, but also the soil below, to the depth of ten inches. In loose, mellow soil, the feeding roots of the potatoes will often penetrate the soil to a depth of from twenty-four to thirty-six inches.

Cultivation should start soon after planting, using an ordinary spike-toothed harrow, going over the land every few days. When the potatoes are above ground, harrowing should be continued, but the teeth of the harrow should be set slanting so as not to tear up the sprouts. This harrowing will keep the soil in fine tilth and conserve the moisture in the soil, besides keeping the field free from weeds. Ordinarily, at planting time, the soil should contain enough moisture for the potatoes to come up, without resorting to irrigation, especially if the land has been properly handled up to this time. However, there may be seasons when this is impossible, and irrigation has to be given.

Cultivation is more important than irrigation, and the grower should never substitute irrigation for cultivation. After the potatoes are up and too tall for the harrow, the cultivator should be started and kept going until the vines interfere.

Hilling.—Hilling is almost universal among potato growers in the State. This is especially true on the plains east of the mountains where this practice is possibly carried to an extreme. The prac-

tice of high hilling has grown out of the conception that the potatoes should not come into direct contact with irrigation water, but that the water should be applied from below, and thence move upward into the soil by capillarity. One might argue that it makes no difference whether the tubers get moisture from below or from the side, so long as they are not in contact with the free water.

The writer is inclined to believe that less hilling or lower ridges is preferable to the high ones, as high ridges invariably raise the soil temperature around the tubers to several degrees above that of level soil, thus creating a condition that is not the most favorable for the normal development of the plant. This is especially true of the Eastern Slope where the summer days are hot and the soil temperature becomes correspondingly high. In the mountain sections, the grower does not hill his potatoes to the extent done on the Eastern Slope, yet no one would question that the results obtained by those growers are less satisfactory than those obtained on the Eastern Slope.

In the Greeley section, high hilling is almost universally practiced, and is looked upon as essential to success. While high hilling may be successful during certain seasons, it is also true that during a warm, dry season, lower ridges would tend to keep the soil temperature lower and thus furnish better conditions for the potato plant.

IRRIGATION

The Horticultural Department is frequently called upon to give advice as to when and how potatoes should be irrigated. To answer such questions intelligently, a knowledge of soil conditions is absolutely necessary. Many growers believe that potatoes should not be irrigated until the vines are setting the tubers, even tho the vines are actually suffering from lack of water. This may work out all right, but one may well question the wisdom of following such a rule. It is universally the rule that when a growing plant needs water and shows signs of wilting, water should be applied, so that the normal growth will not be checked. When the tubers have once set, it is necessary to irrigate so as to keep the soil in best growing condition possible for the balance of the season, or until the crop is matured. In other words, there should be no check to the growth of the plants after the tubers have once started to develop. If a check is given during this period and the plant resumes its growth afterwards, knobby and gnarly tubers result. Hence the importance of keeping the young potatoes growing without check thruout the period.

In irrigating potatoes, it is much better to apply enough water to thoroly saturate the ground, rather than small amounts of water at frequent intervals, as frequent applications of water will puddle and harden the soil to a much greater extent. Also, a small stream running for a long period is better than a large stream for a short period.

On the Eastern Slope, it is preferable to apply the water during cloudy days or at night time. When the potatoes have reached their full growth, which depends largely upon the season and locality, it is advisable to withhold the water so that the skin of the tubers may ripen and harden. Otherwise, the keeping quality of the potatoes will be impaired.

There is a tendency in some potato growing sections to crowd the growth and development, or, as some express it, to make the crop "in the shortest possible time," generally during the month of August and half of September—by the liberal use of water. This practice may be advantageous during favorable seasons, but such practice invariably results in a poorer quality of the crop produced and the tubers are watery and soggy, with poor keeping qualities. Further, seed potatoes grown in this way lack vigor. A normal growth development when the plant is not forced is preferable, so far as quality is concerned. It is also probable that unduly forcing the plants makes them more susceptible to disease attack.

HARVESTING

For the main crop, harvesting should not be done until the vines are dead and the skin of the tubers hardened or ripe, so as to stand the necessary handling before reaching the consumer. If the skin is not hard, it will peel and bruise, and wherever the bruises occur, there will be dark areas which have to be pared away before the potato can be consumed as food. The keeping qualities, too, are greatly impaired from immaturity, as the bruised areas invite the attack of fungi, causing decay.

If the vines are still alive and growing when frost occurs, the potatoes in the ground at this time are necessarily in the growing stage and are not fit for harvesting. They should be left in the ground as long as possible, so as to give the tubers a chance to ripen. The digging should be done when the weather conditions are most favorable and the soil is not water-logged. It is advisable to leave the potatoes on top of the ground for two or three hours to permit them to dry off before they are sacked. Where the potatoes are placed in cellars, the importance of field curing cannot be over-emphasized, as a considerable portion of the losses occurring in storage is due to poor grading and to imperfectly dried potatoes when placed in storage. Whether sold directly from the field or

placed in storage, the small and bruised potatoes should be eliminated.

In digging the potatoes, enough horse-power should be utilized so that the digger will get under the hills—otherwise, many potatoes will be cut and spoiled. It is much more economical to use an extra horse, or even two, so as to be able to have the machine go to the required depth. The extra cost is more than repaid, first, in getting all the potatoes out of the ground, and second, in eliminating cut or bruised tubers which cannot be sold. Practically all of the potato digging machinery now on the market is satisfactory, if properly used. We do not recommend any particular make over others.

GRADING (STANDARDIZATION)

Less attention has been paid to the grading and standardizing of potatoes than any other agricultural crop. Most of the agricultural products are bought and sold on grades or standards, while in the case of potatoes, each grower seems to establish his own standard, and, as a consequence, the purchaser does not know what he is getting until he has an opportunity of inspecting his purchase. There is more waste in this crop than any other grown on the farm, and this waste could be entirely prevented by the grower. It has been estimated that from 15% to 20% of the total potato crop placed on the market is below commercial standards and should never have left the farm. This would mean that out of the total yield of 350,000,000 bushels in America, 15%, or 52,500,000 bushels are virtually thrown away. Besides this waste, the grower, in addition, is paying for containers, railroad freight, and hauling and cost of marketing in handling these 52,500,000 bushels, and finally, he is lowering the actual value of the whole crop, by selling inferior products. It is a great economic loss, since this 15% is not utilized for any purpose, but is thrown away by the consumers, while if left on the farm it could be utilized as a food for livestock. There should be a standard grade or grades of potatoes the same as we have standard grades for the grains, and the crop should be priced on these standards. In order to accomplish this, the grower must pay more attention to the grading side of his work. At present, most of the potatoes are graded in the field, being run over a grading machine. The machine, under the best conditions, will not grade the potatoes properly, but under the conditions that the grading is done in order to follow up the digger, the potatoes are poured over the grader and only a small proportion of the undersized potatoes are taken out. More than half of the small tubers go into the sacks, together with gnarly, cut, and diseased tubers.

In some instances, the grower, in order to swell the total yield per acre will go to the trouble of stretching gunny sacks over the grader so as to prevent any of the smaller potatoes from getting thru. In such cases, it would be more economical if the grading were entirely dispensed with.

The potatoes should be graded at least into two sizes—from four to twelve ounces, and from twelve ounces up. This would not mean that the potatoes would have to be weighed individually any more than in grading apples, but it would produce a uniform product, so that the buyer would know what he was getting, and the consumer would not have to buy small potatoes and earth with the marketable tubers. The extra cost for grading would be more than compensated for by the higher prices obtained, and in the utilization of inferior potatoes as food on the farm.

There are commercial graders of the improved type now on the market, and should be utilized by the grower. The only way to obtain uniformity in grading and packing would be to have a community grader where all potatoes in a community could be graded at one place before being loaded on board a car. By such method, the whole crop could be taken from the field and hauled to the grader, and run thru the same, returning to the grower the inferior product to be taken back to the farm for feeding purposes. In most cases, the community grader should be located at the loading station.

So long as grading is left to the individual grower, so long will the present confusion and disorganization exist, and so long will the grower obtain a lower price for his product. There are a great number of instances that have come under our observation where buyers have re-sorted or re-graded the crop bought from the grower and sold them at a higher price—more than paying for the cost of grading and the loss in weight.

The question of uniform packages is also important. There is no reason why a sack of potatoes should not have a standard weight, either 100 or 120 pounds. This would eliminate considerable trouble and make it easier to keep track of sales, as each sack or each container would weigh the same.

The question of using boxes as containers for potatoes has been agitated and met with more or less favor. Personally, we believe in the box as a package for potatoes, especially if special grades are put up in this way. The potatoes will suffer less in handling, and besides, would provide a convenient package for the small household to buy. But the box is not the proper package for the average grower under the present conditions, as the potatoes, in some cases, would not be worth more than the box. Where the

box has been used to put up high grade potatoes for fancy trade, it has been a success.

One of the aims of the Colorado State Potato Growers' Association is to establish standard grades and containers so that the buyers will know what they are buying. The importance of the potato crop as a universal human food makes it all the more necessary that it should be marketed and sold under certain required standards.

SEED CERTIFICATION

With the development of the potato growing industry in this State, some provisions are necessary to secure the purchaser of seed potatoes against inferior product. To obtain this condition a system of seed certification is necessary. It is true that here and there, are seed producers who make a specialty of producing high grade potatoes from which the average grower may obtain high class seed. But these seed growers are few and far between, and as the welfare of an industry depends upon the intelligence and standards of the average grower, it is necessary that the largest possible number of them should have access to high grade seed.

A system of seed certification by properly qualified officials who can certify to the quality of the seed is necessary. This would tend to raise the general standard of the product, and also furnish an incentive to many growers to produce certified seed.

A system of certification was formulated by the Colorado State Potato Growers' Association and incorporated in its constitution and by-laws. This certification calls for two inspections of the growing field during the summer, and a bin inspection after the harvest. In the field inspection special attention is paid to the health and vigor of the plants, the absence or presence of disease, the fullness of the stand and the uniformity of the plants in the field. The two field inspections should be made at intervals of four to six weeks. The last inspection should be made as late as possible before the harvest, so as to detect the most dangerous diseases.

The bin inspection gives the inspector an opportunity to determine the trueness to type of the variety grown, the freedom from scab and the general quality of the tubers. If, after the inspection, the inspector finds that the product measures up to the standard, a certificate to this effect is granted to the grower. This certificate states the variety, the results of the inspection, and in fact all possible information connected with the potatoes. The grower may then use his certificate in advertising his product and

the fact that his potatoes have passed the necessary inspection gives the grower a prestige over those who do not hold such certificate.

It is a fact that the Colorado potato growers every year find considerable difficulty in obtaining first-class seed. This is especially true during a year like the present one when prices were abnormally high and where the grower disposed of his product regardless of standards. A year of extremely high prices tends to demoralize standards, but the grower should bear in mind that extremely high prices are the exception rather than the rule with a standard crop like potatoes, and the success of a grower is not based alone upon the large profit obtained in a single season. We must provide for the average years and average prices and raise the standard of the product so that during the year of average prices the grower still can make a profit and find a market because of the excellency of the tubers produced.

A State law fixing standards both as to grading and seed would be beneficial to the grower, but it is doubtful if such law could be passed until there is greater demand for it. Meanwhile, it is the duty of organizations and individuals to do everything possible to raise the general standard of the crop.

Our potato growers do not realize the future before them in the production of high grade potato seed for the Southern planters. This phase of potato growing has unlimited possibilities, as the demand for high grade seed is constantly growing. Colorado is the natural territory to supply the seed for this section of the country, not only because of the advantages in soil and climate, but also because of the nearness to the markets and the lower transportation charges.

The demand for seed potatoes from the South calls for the growing of varieties that are not now grown to any extent. The varieties in demand for seed are the Cobbler and the Triumph. Both of these can be successfully grown in most parts of the State. From all indications, the Triumph is well adapted to the conditions in the San Luis Valley, while the Cobbler can be grown successfully in every section of the State.

This department has had numerous requests for seed potatoes of these two varieties from the South, and these requests have been more numerous during the last two years than before, indicating that the Southern growers are beginning to learn the value of Colorado grown seed.

QUALITY OF COLORADO POTATOES

It is generally understood that quality in potatoes is gauged on the character of the cooked product. Mealiness and uniformity in cooking being the two important points. Mealiness is more or

less associated with the starch content of the tubers, and the amount of starch present in turn dependent upon soil and climatic conditions, especially those of rainfall.

From determinations made of Colorado potatoes and those grown in other states, it would seem to indicate that the Colorado potatoes have a higher starch content, and hence should have better quality, tho this may not always be true, as quality may, to a large degree, be determined by local conditions during the growing season. Too much rain or too much water in irrigation will invariably produce a soggy potato, and hence a potato of low quality.

The climatic conditions of Colorado are eminently adapted to the production of high quality potatoes if proper precautions are taken in the use of irrigation water. Records show conclusively that over-irrigation here is just as harmful against the production of high quality of potatoes as an excessively rainy season is in the Eastern states, and that the Colorado grower may, and sometimes does, produce potatoes of inferior quality.

DEGENERACY OF POTATOES

During the last few years, a considerable amount of investigational work has been done to determine what factors are responsible for the general decline of a given variety in a given locality. These experiments seem to agree that the different varieties as generally grown in a section do show a decline in productiveness and in type. This degeneracy or decline was not confined to any particular variety, nor to fields where poor seed was used in planting. In many cases degenerate hills were found in fields that were planted to the best seed obtainable. This seems to indicate that the potato is more or less variable even under the best conditions, and calls for a greater care in selecting seed, especially in the selection of hills for future seed production.

This universal tendency towards degeneracy or decline may possibly be due to a physiological condition inherent with the potatoes. The fact that the tuber is a highly specialized part of the plant and one that has developed by repeated selection and breeding, and further, its development being dependent upon factors of soil and climate, would make the question of retaining a permanent type of a given variety difficult, and by the very nature of the plant, variable. This undoubtedly being a fact, the question of careful selection by the hill method becomes more important, if we are to retain the essential qualities we wish to perpetuate. A given variety cannot be made to retain its desirable qualities without constant care in selection and cultural methods.

STORAGE

Pits and Cellars.—Pits are not utilized in the West to the extent that they are in the East. Many of our potato growers have now regular cellars for storage which fulfill all the requirements. Storage cellars are really necessary structures in connection with potato growing, as they enable the growers to avail themselves of higher prices which usually follow harvest time. Where potatoes are grown on a smaller scale, the pit can be utilized without any material loss of the crop. In fact, potatoes stored in pits properly made are as good, or better, in the spring than potatoes stored in cellars.

The following method of pit construction has been employed by the writer, with complete success:

Level off a piece of ground of sufficient size to hold the potatoes intended for storage, then excavate to the depth of four inches, and



An Up-to-date Potato Cellar; Capacity 25,000 bushels; at Carbondale, Colorado.

use the earth taken from the excavation as sides, that is, heap the dirt up along the edges of the cleared space. This cleared space should then be firmed down and the potatoes piled into this area. A convenient size for the pit is ten feet in width, making it any length needed. The ten feet should measure from embankment to embankment.

The potatoes should be piled up in the shape of a pyramid, or like the roof of a house, making the pitch to the sides as steep as possible, and yet keep the potatoes in place.

It is necessary to do a little hand work in finishing off the sides after the potatoes have been dumped into the pit.

When the potatoes are in proper position, they should be covered with a layer of clean, dry straw, or clean, dry marsh hay, not less than two feet in thickness, and just enough earth put on the same to hold the straw in position. In some cases, it is advisable to use poles or rafters to hold the straw down, instead of earth. The pit should be left in this condition until cold weather sets in. The straw is sufficient to keep out ordinary frost, and it will keep the pile ventilated and permit surplus moisture to escape. As cold weather approaches, a thin layer of earth is added. Every three or four feet at the apex of the pile, openings in the earth should be left to permit moisture to escape. It is also advisable to keep openings at the base of the pit, but these openings should be covered with straw so that the frost will not get in, and before winter arrives, more earth covering should be applied, the amount depending upon the severity of the weather. When regular winter sets in, more earth should be added to the covering. If very cold weather should occur, a coating of stable manure on top of the earth is advisable. The ventilators at the top and at the bottom should be entirely closed during the cold weather.

It is very important that the potatoes be dry and free from rot when stored in pits.

VARIETIES OF POTATOES

In a State like Colorado where the soil, altitude and climatic conditions are so varied, the choice of varieties to plant becomes, to a great extent, a local question.

In the Greeley section, the Pearl and the Rural are grown almost exclusively for the main crop and the Early Ohio for the early crop. The rural variety is better adapted to the heavy soils and to plains conditions than the Pearl. The latter is inclined to grow rough and ill-shaped on heavy soil, while on lighter or loamy soils, the Pearl is preferred.

In the San Luis Valley the Barklay's Prolific, Russet Burbank, Rural and Pearl are the leading varieties. Barklay's Prolific is grown most extensively and is admirably adapted to this section. It is a heavy yielder, is of excellent cooking qualities, and stands shipment better than almost any other variety grown. It will be more extensively planted in the future than in the past. This variety is not true white, but has a golden brownish tint that does not in any way detract from its salability. Barklay's Prolific is probably only a local name. Early varieties are not grown to any extent in this section, due to late spring frosts. The Irish Cobbler is admirably adapted and is grown to a limited extent. The Triumph

has also been grown to a very small extent and indications are that this variety will do well. The San Luis Valley has a future before it as a seed-growing center for Southern trade. Cobbler and Triumph for this trade always bring a high price and are in great demand.

In the Carbondale and Eagle River district, Peachblow, Russet Burbank, Rural and the Peoples are the late varieties grown extensively. The Peachblow reaches its highest perfection in this section and is grown extensively. There is some objection to a colored potato for the main crop as the market is somewhat limited, especially for markets outside of the State. On this account, the acreage planted with this variety is on the decline. Irish Cobblers are grown for an early crop.

Grand River Valley, Gunnison and Uncompahgre Valleys devote a large acreage to early potatoes. The varieties grown are the Irish Cobbler, Downing, and Early Ohio. Late varieties are the Pearl, Russet Burbank, and Rural.

In the Northwestern section the main attention is paid to medium early varieties, due to the shortness of the growing season. Russet Burbank and Pearl are the leading varieties. Few, if any, early varieties are grown in this section.

It will be noticed from the above discussion that relatively few varieties are grown in commercial quantities in the State. This is an encouraging condition, as it eliminates a mixture which is undesirable in commercial shipments. It also aids in keeping the varieties true to name so that a definite standard can be obtained for each section.

While a number of other varieties have been tried in different sections of the State, our growers realize that by paying attention to proper seed selection, a satisfactory yield can be obtained from year to year without introducing new varieties. There is a considerable difference in the adaptability of different varieties to different types of soil. For example, it is not advisable to grow the Russet Burbank on heavy soils, nor on soil that is extremely fertile. For, under such conditions, this variety produces over-grown and ill-shaped tubers which are not desirable, while on light, mellow, and moderately fertile soil it is very satisfactory.

Farmers who expect to grow a large acreage in any of our potato growing sections should make careful inquiries as to varieties and the type of soil on which they are grown, so as to eliminate losses from growing varieties ill-suited to the locality.

POTATO DISEASES

Late Blight.—This disease so destructive in the East does not occur in Colorado. At least it has done no damage so far as we know.

Early Blight.—It occurs in the State, and, under favorable conditions, does considerable damage. The favorable conditions are, high temperature accompanied with high humidity. The disease generally occurs late in July and early in August, and is easily distinguishable by dark brown patches and rings on the foliage. In extreme cases, the whole foliage of the plant becomes affected and may drop off and kill the plant so far as future growth is concerned. This greatly reduces the yield, as the potatoes do not have time to develop to their normal size. So far as we know, the disease is confined to the foliage in this State and does not seem to attack the tubers.

Spraying with Bordeaux Mixture before the disease appears will, if thoroly done, prevent its appearance, but after the disease has once gotten a foothold and becomes distributed over the field, the application of Bordeaux will not eradicate it. Bordeaux Mixture is not a cure, but a preventative. Due to the fact that Early Blight does not occur annually, but only during favorable seasons, our growers, as a rule, do not spray to insure their crop against losses from this trouble, tho yearly application of Bordeaux to the potato vines would insure against its appearance and the losses caused by it.

Fusarium Disease.—This disease is found in every potato growing section of the State and is the most destructive disease with which the potato grower has to deal. The disease is favored by high temperature, moisture and poor soil drainage. In heavy adobe soil, the disease appears to be particularly bad. It is introduced into the soil either by a previous crop, or thru diseased seed potatoes. The fact that the disease may remain in the soil for more than one year makes the subject of rotation important to the potato grower, and it is one of the reasons why we advocate growing potatoes only one year on the same piece of land without the intervention of other crops.

The most common way of dissemination of this disease is by the seed. The grower can easily ascertain for himself whether the seed potatoes are free from *Fusarium* or not by cutting off a thin slice at the stem end. (See figure 8.) If the meat on the cut surface of the tuber shows a dark circle extending around it, this indicates the presence of the disease, and such seed should not be planted, as it will work its way thru the seed potato up to the stem and

destroy the whole plant. Such seed may be used for feeding animals, but should under no circumstances be planted.

There is no known remedy that is effective against this disease; only precautionary measures can be taken, such as rotation of the crop and the planting of seed free from the disease.

The appearance of the disease in the field is, in some cases, almost identical with the Early Blight, with the exception that the leaves turn a paler shade of yellow and do not show the brown patches and circles. The stem is also attacked, and if a cross-section is made of the stem close to the ground, dark areas will be found in the bundle or fiber portion of the stem. These dark areas indicate the presence of the disease, and greatly interfere with the transportation of food materials up and down these fibers or vessels in the stem. It is also maintained that the curling of the leaves sometimes present in many of our potato fields is caused directly or indirectly by the same fungus. Undoubtedly other factors contribute to the presence of the trouble known as the "Curly Leaf Disease."

Rhizoctonia.—This disease is present in practically all of our cultivated fields, and under favorable conditions will do considerable damage to the crop. The presence of the disease on the vines can be distinguished by dry rot or lesions that occur at the base of the stem from the ground upward. In some cases these lesions or wounds extend around the whole stem and completely shut off the food supply. In other cases, the disease attacks only one side of the stem and does not completely cut off the supply of food to the roots, but curtails the food supply and lessens the production of tubers. The disease may occasionally be found on the potatoes in the form of black spots or wart-like growths all over the skin. (See figure No. 9.) These little areas vary in size from a pin-head to the size of a dime. They are black and corky in structure and are known as sclerotia. These structures carry the spores over from year to year and reinfest the crop. A careful examination of potato fields in the State this year show that this disease is very prevalent. In one section of the State the writer was unable to find a single tuber that did not have some sclerotia present on it. This disease seems to thrive on dry land as well as on that which is irrigated, but seldom develops to a dangerous point on the dry lands.

The disease can be controlled, so far as disseminating it from diseased tubers is concerned, by means of disinfection. The most effective method is a corrosive sublimate treatment, using 4 ounces of corrosive sublimate in 30 gallons of water. The solution may be made up in a barrel and the potatoes placed in a gunny

sack and kept suspended in the solution for from an hour and a half to two hours. This solution will penetrate the sclerotia and kill the spores, after which the seed can be planted with safety, so far as this disease is concerned. The potatoes treated cannot be used for feeding livestock, as the solution is exceedingly poisonous. The solution may be used three to four times, after which a new mixture should be made.

Potato Scab.—This well-known disease is common in every section of the State, and during some years does considerable damage to the crop. The disease is external, penetrating the tubers only to a very small extent. Its greatest damage is to the appearance and keeping quality.

There is very little excuse for the existence of this disease, as it can easily be controlled by treating the seed potatoes. The same treatment as recommended for the *Rhizoctonia* disease should be used, that is, the potatoes, before cut, should be dipped into a solution containing 4 ounces of corrosive sublimate to 30 gallons of water. The easiest way of treating the seed is to make up the solution in a barrel holding about fifty gallons. The barrel should contain about thirty gallons of the solution and the potatoes placed in a gunny sack and suspended in the solution for an hour and a half, after which the seed may be cut and planted. Precautions should be taken not to feed the treated seed to livestock, as the poison is very deadly.

Numerous complaints have been received that the scab has occurred in some fields in spite of treatment, and often when clean seed has been used. In such cases the presence of the scab fungus is undoubtedly due to the feeding of cattle on the field the season before planting. This disease propagates very readily on the manure dropped by the cattle, and in this way the land becomes infested. If the disease is in the soil, the treatment of the seed potatoes cannot be effective against it. Clean land, as well as clean seed, is essential for the production of clean tubers.

CELLAR FUMIGATION

One of the fertile sources of loss in potato storage is due to poor and disease-infested cellars. The cellar should be cleaned out and fumigated every spring after potatoes and other stored articles have been removed.

The best method of cellar fumigation is undoubtedly the formalin permanganate method. The following formula is recommended:

For every 1,000 cubic feet of cellar space, 3 pints of formaldehyde and 23 ounces of potassium permanganate. The permanga-

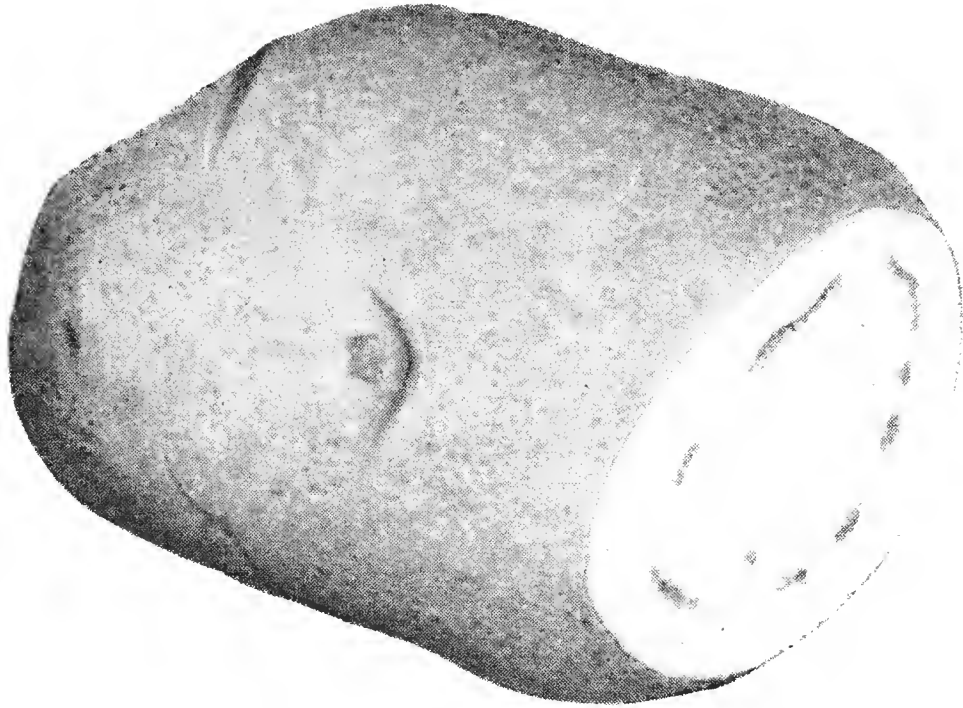

FUSARIUM DISEASE

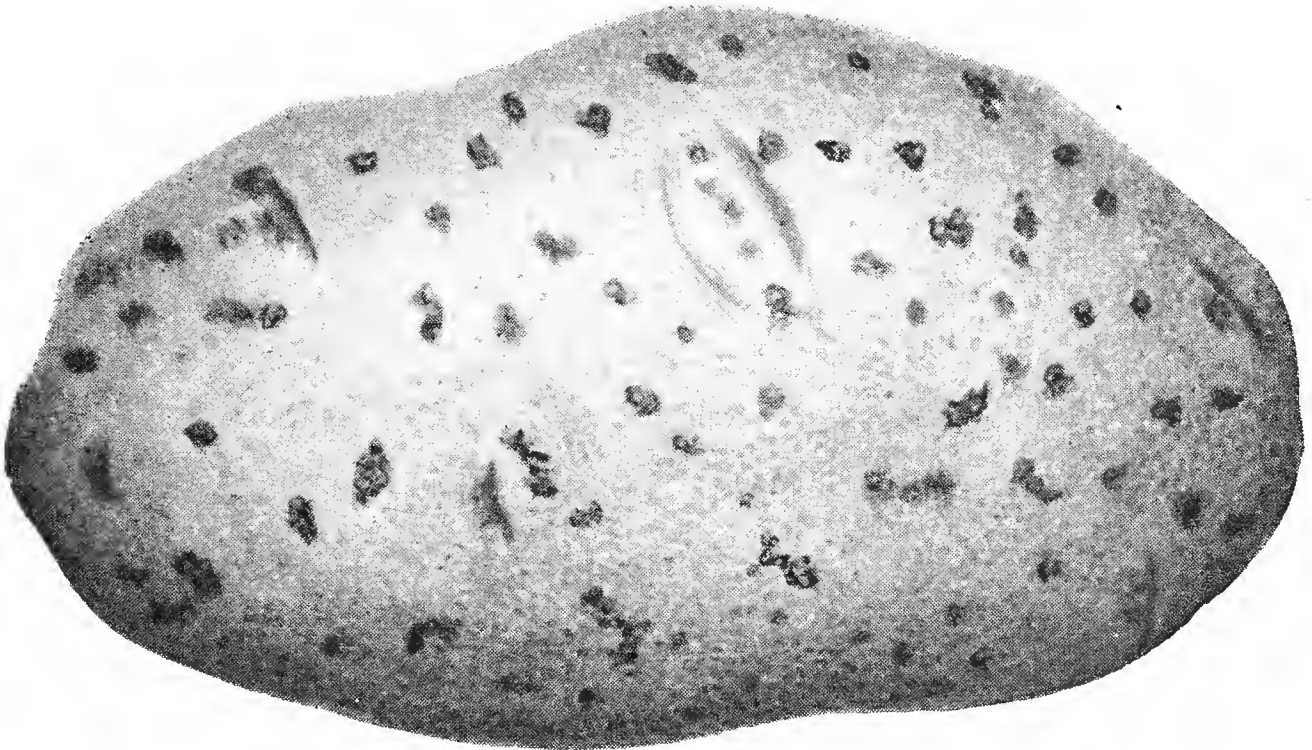

RHIZOCTONIA DISEASE

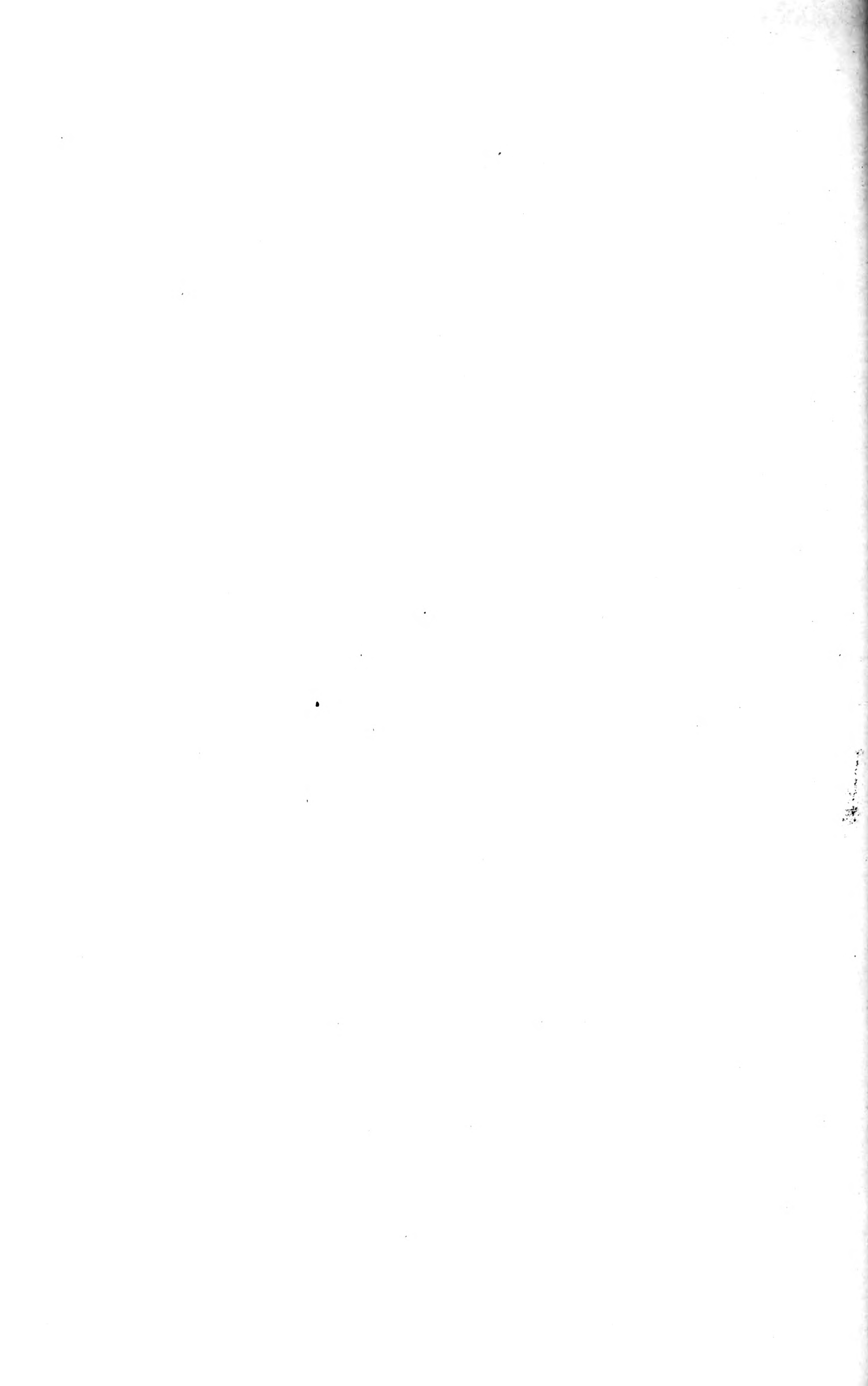

nate is placed in a shallow dish or earthen vessel and the formaldehyde solution is poured over it. The operator must leave the cellar immediately and close it up tightly to escape the fumes. If the cellar is large and requires large quantities of chemicals, several vessels or dishes should be used, placing them in different portions of the cellar so that the fumigation may be more uniform. The cellar should be left closed for 48 hours, or longer.

ACKNOWLEDGMENT

The writer wishes to thank Mr. Lou D. Sweet, of Denver, for the loan of several of the illustrations in this bulletin.

AVAILABLE BULLETINS

Any of the following bulletins will be sent free to those who request them so long as the supply lasts. C. P. GILLETTE, Director.

- No.
- 150 Measurement and Division of Water, by L. G. Carpenter.
- 183 Deterioration in Quality of Sugar Beets Due to Nitrates Formed in the Soil, by Wm. P. Headden.
- 189 Cost of Beef Production on Enclosed Range, by G. E. Morton.
- 190 Variation Studies in Brome Grass, by Alvin Kezer.
- 192 Home-made Cider Vinegar, by W. G. Sackett.
- 193 Nitrifying Efficiency of Certain Colorado Soils, by W. G. Sackett.
- 194 Frictional Resistance in Artificial Waterways, by V. M. Cone.
- 195 Small Fruits for Colorado, by E. P. Sandsten.
- 196 Some Soil Changes Produced by Micro-organisms, by W. G. Sackett.
- 198 The Onion in Colorado, by E. R. Bennett.
- 199 Vegetable Growing in Colorado; Hot Beds and Cold Frames; Common Insects of the Garden, by R. A. McGinty and C. P. Gillette.
- 200 Silos and Silage in Colorado, by H. E. Dvorachek.
- 201 Some Colorado Mushrooms, by B. O. Longyear.
- 202 Testing and Handling of Milk and Cream, by Roud McCann.
- 203 Costs on the Colorado Agricultural College Farm, by Alvin Kezer.
- 205 Yellow-berry in Wheat, by Wm. P. Headden.
- 206 Spur Blight of the Red Raspberry Caused by *Sphaerella rubina*, by W. G. Sackett.
- 208 A Study of Colorado Wheat, Part I, by Wm. P. Headden.
- 209 Irrigated Agriculture in the San Luis Valley, by V. M. Cone and A. Kezer.
- 210 Insects and Insecticides, by C. P. Gillette and G. M. List.
- 211 Colorado Plants Injurious to Live Stock, by Geo. H. Glover and W. W. Robbins.
- 213 Poultry Raising in Colorado, by W. E. Vaplon.
- 214 Forage Crops for Colorado Plains, by Alvin Kezer.
- 216 Studies of Health in Potatoes, by C. L. Fitch.
- 217 A Study of Colorado Wheat, Part II, by Wm. P. Headden.
- 218 A Bacterial Stem Blight of Field and Garden Peas, by W. G. Sackett.
- 219 Study of Colorado Wheat, Part III, by Wm. P. Headden.
- 220 Potato Growing in Colorado, by E. P. Sandsten.
- 221 Hot Beds and Cold Frames, by T. F. Limbocker.
- 222 Forcing of Strawberries Under Glass, by Florence I. Kinnison.
- 223 A Fruit Survey of Mesa County, by E. P. Sandsten.
- 224 Native Vegetation of Colorado in Their Relation to Agriculture, by W. W. Robbins.

Bulletin 221

January, 1917

The Agricultural Experiment Station
OF THE
Colorado Agricultural College

HOTBEDS AND COLD FRAMES

BY

T. F. LIMBOCKER

PUBLISHED BY THE EXPERIMENT STATION
FORT COLLINS, COLORADO
1917

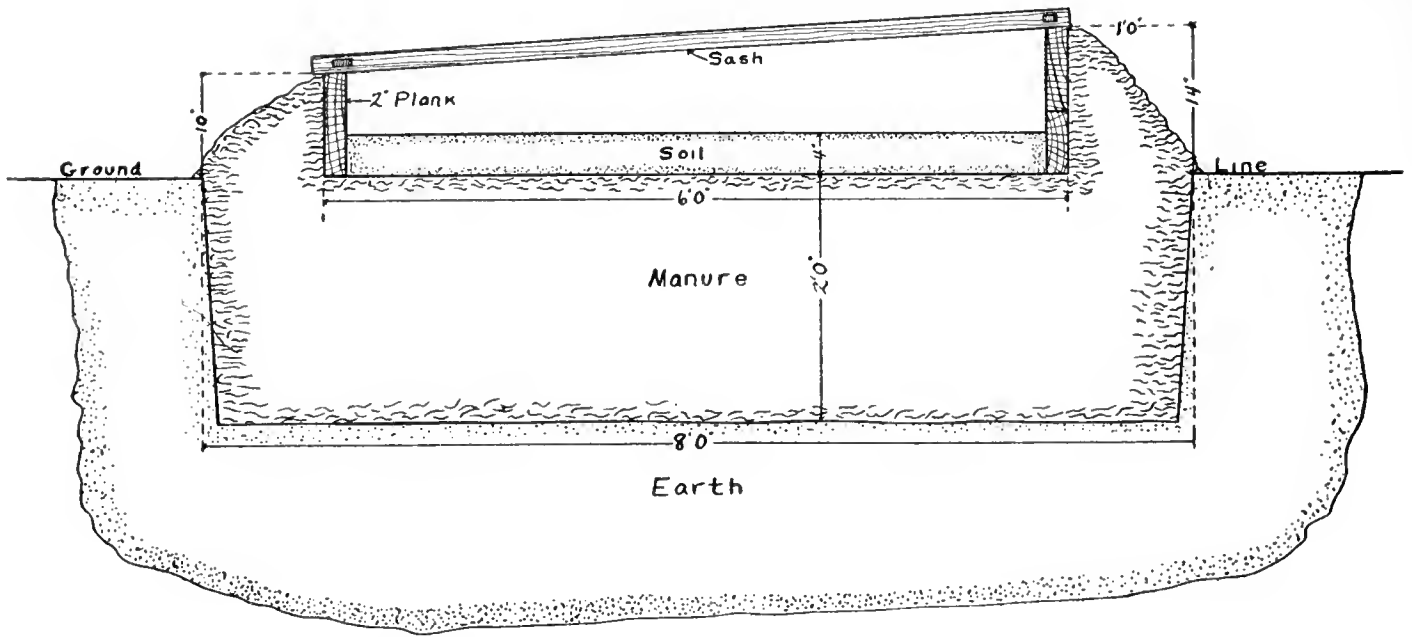

Cross section of a temporary, unlined pit hotbed.

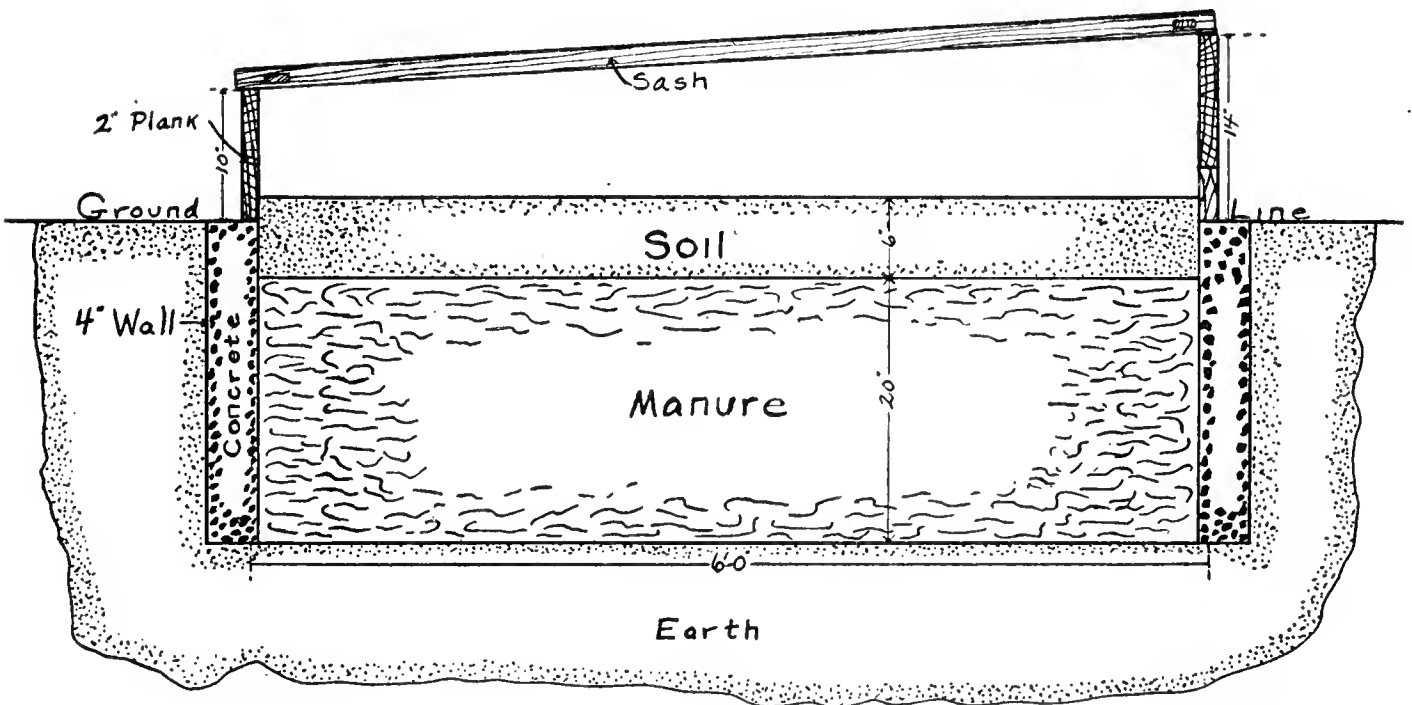

Cross section of permanent pit hotbed, lined with four-inch concrete wall.

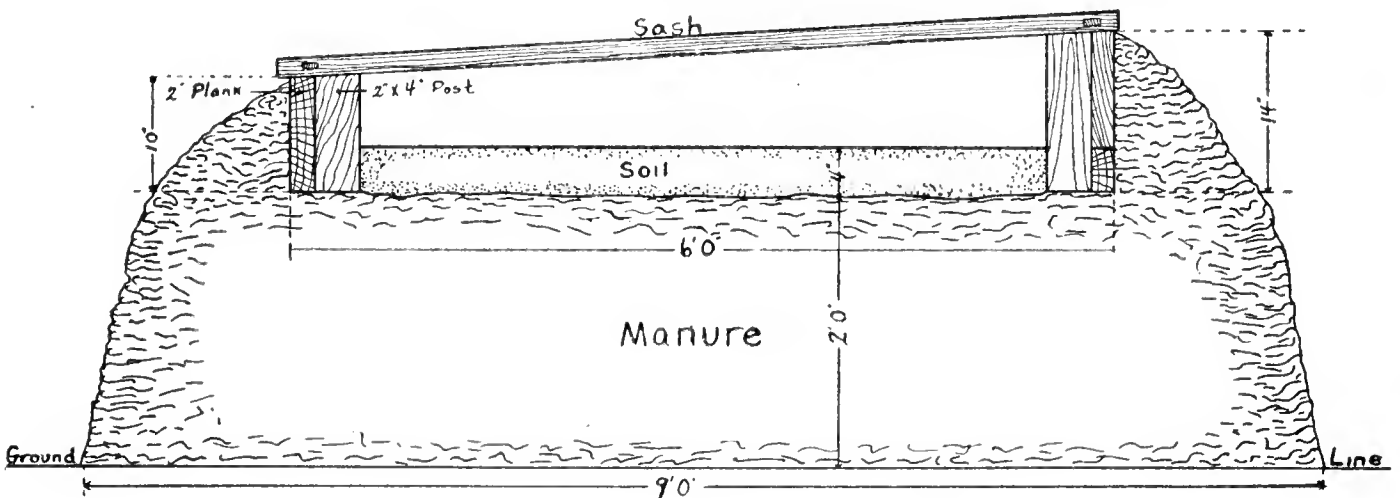

Cross section of surface hotbed

HOTBEDS AND COLD FRAMES

By T. F. LIMBOCKER

Hotbeds and cold frames are so essential to gardening, so easily made and operated, yet so little used, that this pamphlet has been prepared to give briefly their construction, uses and management. By means of these devices fresh vegetables may be had out of their usual season.

Hotbeds are used for growing short-season vegetables (lettuce, radishes, etc.) to maturity, and for starting other garden crops so that they may be well advanced for planting out when warm weather arrives.

Cold frames are used to carry half-hardy plants over winter for planting the next spring and for starting, hardening off, or maturing plants when only slight protection is needed.

DEFINITIONS

Hotbed.—A bed heated from the bottom by means of pipes, flues or fermenting organic matter (manure, leaves, etc.), used for seed germination and plant growing.

Cold frame.—An unheated frame for protecting plants from frost.

LOCATION OF BEDS

A hotbed or cold frame should, if possible, have protection against the north and northwest winds and be located preferably on ground with a gentle slope to the south. It is best to have the beds where they will be passed frequently so that they will receive proper attention.

CONSTRUCTION OF HOTBEDS

Hotbeds are usually built 6 feet wide and some multiple of 3 feet in length, so that the ordinary hotbed sash may be used to cover them. A 6x12 ft. bed will produce enough plants for use in an ordinary kitchen garden, or enough short-season vegetables for the average family.

The walls of the frame may be made of concrete, brick or plank. The latter is more commonly used, altho concrete is the best. Particulars are given for 6x12 ft. plank frame hotbeds which are very con-

* The writer wishes to acknowledge his indebtedness to Mr. Hal Goodacre, the College Florist who offered many very helpful suggestions in the preparation of this bulletin.

venient for general use. As manure is far the most common heating element for hotbeds, only this kind is described.

Hotbeds are of two general types—pit beds and surface beds.

PIT BEDS

This type of hotbed is so called because the fermenting matter which supplies the heat is put in a pit in the ground. It retains its heating power longest and is most desirable for that reason. It is advisable to get the pit ready when the ground is easily dug and not wait until it is actually needed. These beds may be further classified as temporary pits and permanent pits.

Temporary Pits.—A temporary pit is one which is desired for use only one or two seasons, and is consequently unlined. To make a bed

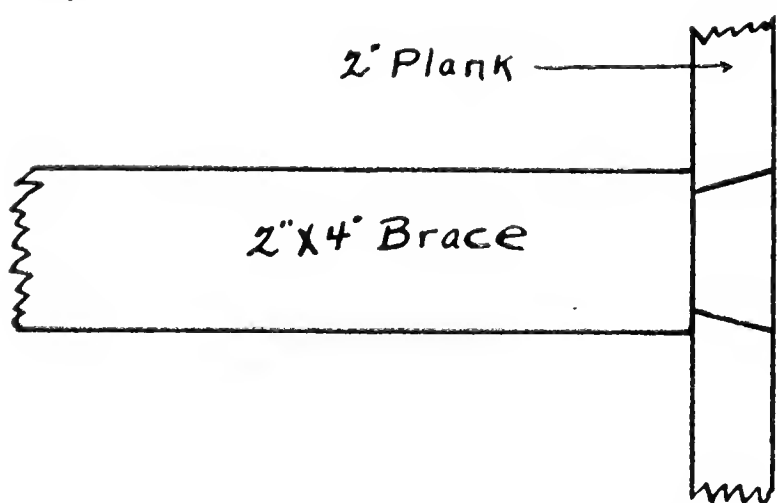

Method of letting cross braces into sides of frame, thus avoiding the use of nails and making the removal of the cross braces easy.

of this kind, build a substantial frame 6 ft. wide and 12 ft. long of 2-inch planks, 14 inches high at the back side and 10 inches high in front, with the ends conforming to the slope. A 2x4 inch cross-piece should be let into the frame flush with the top every 3 feet so that it acts as a brace and helps support the sashes. (See illustration.)

Dig a pit 2 feet deep, about 8 feet wide and 14 feet long with the long way running east and west. Fill the pit as described later. When the pit has been filled, set the frame on the manure, bank up around the sides and ends and put on the sashes.

This is a cheap, yet very satisfactory form of hotbed. Since the frame rides on the manure, the whole bed, frame and all, sink together as the manure settles. It is desirable for this to occur rather than for the bed alone to sink, and the frame to remain in place. In this particular the temporary pit is superior to the permanent pits.

Permanent pits are intended for use for several years. They are generally lined with walls of concrete, brick or wood, concrete being the most satisfactory.

To make a 6x12 ft. permanent pit, dig a pit 2 ft. deep and 6 ft. 6 in. wide by 12 ft. 6 in. long, making the bottom level. Put in a 4 in. concrete wall 5 ft. 9 in. by 11 ft. 9 in., inside dimensions, extending to the surface of the ground. On this wall a frame made as described

above is set. This frame is easily handled by two men and may be moved about as desired.

If it is desired, a double-walled partition of 1 in. boards may be built in the middle of the frame, leaving a 4 in. space between the boards to be filled with soil. Inside of the boards used for the wall a lining of heavy building paper should be put making the wall consist of two 1-inch boards, two thicknesses of building paper and 4 in. of soil. This makes a tight wall and enables the two parts of the pit to be started at different times. When one side of the pit has been filled, the partition should be banked well with manure on the opposite side.

After the frame has been completed, the spaces round it should be filled with soil firmly tamped.

The manure is put in and the bed handled as described later.

This makes a very serviceable pit which will last several years.

SURFACE BEDS

A surface bed is made by putting the manure, when properly heated in a flat pile about 3 ft. high and 3 or 4 ft. longer and wider than the pile is to be. The frame used is the same kind as that described above under temporary pit beds. It is placed on the manure heap and banked up well around the sides. The advantages of this bed are its ease of construction and the economy of space by its use. Since the manure is put on top of the ground, the beds may be cleared away after they have served their purpose and the ground used for later crops. Where land is scarce or expensive, this saving of space is an important factor, and for this reason, surface beds are the more desirable. Especially is this true in commercial gardening. Surface beds have the drawback, however, of losing their heating power sooner than pit hotbeds.

SASHES

Hotbeds and coldframes are generally covered with glass sashes 3 ft. wide and 6 ft. long. These sashes have three rows of glass 10 in. wide. They will cost \$2.50 to \$3.00 complete, and local dealers will usually order them if they do not have them in stock.

Double-glazed sashes cost about one-half again as much as the single glazed sashes. They are very convenient for use and no mats need be used with them. They contain two rows of glass with a dead air space between. However, they are considerably heavier than the single-glazed sash, and there is a good question whether the advantages justify the additional original cost.

MATS

In very cold weather an additional protection will be needed for the plants. This is best furnished by mats made of grass, straw, rattan

or waste cotton and wool, which mats may be bought from the dealers. Good mats may be had at from \$1.00 to \$1.50 each and will last a long time. Satisfactory coverings may be made by stuffing burlap covers with straw. Ordinary gunny sacks, horse-blankets, boards or any other convenient covering may be used.

It is not advisable to leave the covering over the plants any more than necessary, as it causes them to become spindly and yellow from lack of light. When the plants have been covered for a considerable length of time, light should be admitted gradually, as too sudden exposure to sunlight might be fatal to them.

During very cold weather, it is also helpful to bank up the sides and ends of the frame with manure.

HANDLING MANURE

The best manure for hotbeds is from grain-fed horses or mules. It should contain about one-third of its bulk of straw, hay or leaves. The manure should be carefully handled in collecting to prevent excessive decomposition.

About two weeks before time for seeding the hotbed, the manure should be hauled to it and piled in a flat, compact heap 3 to 5 feet high near the hotbed. If the weather is very cold, several buckets of warm water may be added to start the manure to heating. In four or five days the pile should be well heated thruout. It should then be turned inside out, putting the coldest manure on the inside of the heap. When the manure has again heated, the pit should be filled. In filling the pit, put in layers about 6 inches at a time and tramp well, especially around the edges of the pit. If the manure is not moist enough, warm water should be sprinkled over each layer. Enough manure has been used when the pit lacks about 4 inches of being full after the manure has been well tramped. The sashes should be put on and left until the manure has thoroly warmed up, when the soil may be put in. The heating period of a hotbed is usually 8 to 10 weeks. When this is over, the bed may be continued as a coldframe.

SOIL

Good garden loam soil should be used for hotbeds. Four inches of soil is enough for most plants grown in the hotbed, but root crops such as radishes need five or six inches. As the soil is put in, it should be well pulverized, packed and leveled. When this has been completed, it should be watered, if necessary, and the sashes again put on.

SEEDING

For several days after the manure is put in the temperature rises, often going above 125° F. It then begins to fall. When it has lowered to 90° or 85°, the seed may be planted.

Hotbed or "plunging" thermometers are made for determining the temperatures. In use they are thrust thru the soil into the manure and left until the correct reading is obtained.

The seed should be planted in rows 3 or 4 inches apart. When the plants begin to crowd, they should be thinned or transplanted.

Radishes and lettuce may be planted the latter part of January or early in February; early cabbage, late in February; tomatoes and cauliflower the first week in March; eggplants, peppers, cucumbers and melons about the middle of March. The hotbed should be made, that is, the manure put in, a week to ten days before seeding time.

Plants are sometimes grown in hotbeds in shallow boxes (flats) which are set on the soil. In such cases, only two or three inches of soil are necessary. This is also enough when potted plants are grown. For this purpose the soil may be replaced by sand.

WATERING

Hotbeds require very careful attention in watering. Enough water must be given to keep the soil moist, yet not to wet the manure excessively, as this shortens the heating period and makes the heat uneven.

Occasional thoro irrigations are better than frequent light ones. The sprinkling can with a rose nozzle is best for applying water. This distributes the water more evenly and does not wash the soil as does a hose. Water in the morning when there is bright sunlight. Watering late in the afternoon lowers the temperature at a most critical time and should never be done.

VENTILATION

Unless proper ventilation is given, the plants are likely to die from over-heating. Whenever drops of water collect on the inside of the glass, the sashes must be raised to admit air. In very cold weather it may be necessary only to raise the sashes and lower them almost immediately. As a rule, they may be left raised somewhat during the warm part of the day. Hot, moist air is favorable to "damping off" (the worst hotbed disease) and one must be careful to avoid this by giving sufficient ventilation.

CONSTRUCTION OF COLD FRAMES

Cold frames are built essentially the same as hotbeds, and, like them, are temporary or permanent.

Permanent cold frames are built the same as permanent pit hotbeds, making the pit of the depth required for the particular use to which it is to be put.

For temporary cold frames the low frames are simply set on the ground where the soil has been made sufficiently rich for growing plants. The frames are made the same as for hotbeds. Cold frames are covered with glass sashes, oiled paper, canvas, or muslin dipped in linseed oil and dried. Glass sashes are best for cold weather, but in the latter part of spring when only a few degrees of frost are had, one of these substitutes may be used.

USES OF COLD FRAMES

Cold frames are used for maturing crops late in the fall, for carrying over winter young plants such as cabbage and cauliflower for planting in the spring, for protecting semi-hardy flowering plants during the winter, for starting plants before the weather is warm enough to plant the seed in the open, and for hardening off before planting in the open young plants grown in the hotbed or greenhouse. Occasionally permanent cold frames are used as storage pits for vegetables, such as celery, cabbage, potatoes and root crops.

For starting plants in the cold frame the seed is sown either in the soil or in flats or pots and set within the frame. Young plants are sufficiently protected from the cold to prevent freezing, as they become hardened enough to withstand light frost. When the weather is mild enough, the plants are transplanted into the open.

A very common form of temporary cold frame in the south consists simply of two parallel rows of planks set up in the field six feet apart and covered with sashes. The seeds are planted in their regular rows between the planks, and when the weather is warm enough the sashes and boards are removed, leaving the plants well started in the field. This process may be reversed in the fall, starting the plants in the open and later putting up the frame to protect them.

Semi-hardy flowering plants like pansies and geraniums are put in cold frames for winter protection. Usually two or three inches of sand or cinders are put in the bed and the pots sunk into them.

Ag. Serv.
UNIVERSITY OF ILLINOIS LIBRARY
MAY 2 1917
Bulletin 222

February, 1917

The Agricultural Experiment Station
OF THE
Colorado Agricultural College

THE FORCING OF STRAWBERRIES

BY
By FLORENCE I. KINNISON



PUBLISHED BY THE EXPERIMENT STATION
FORT COLLINS, COLORADO.
1917

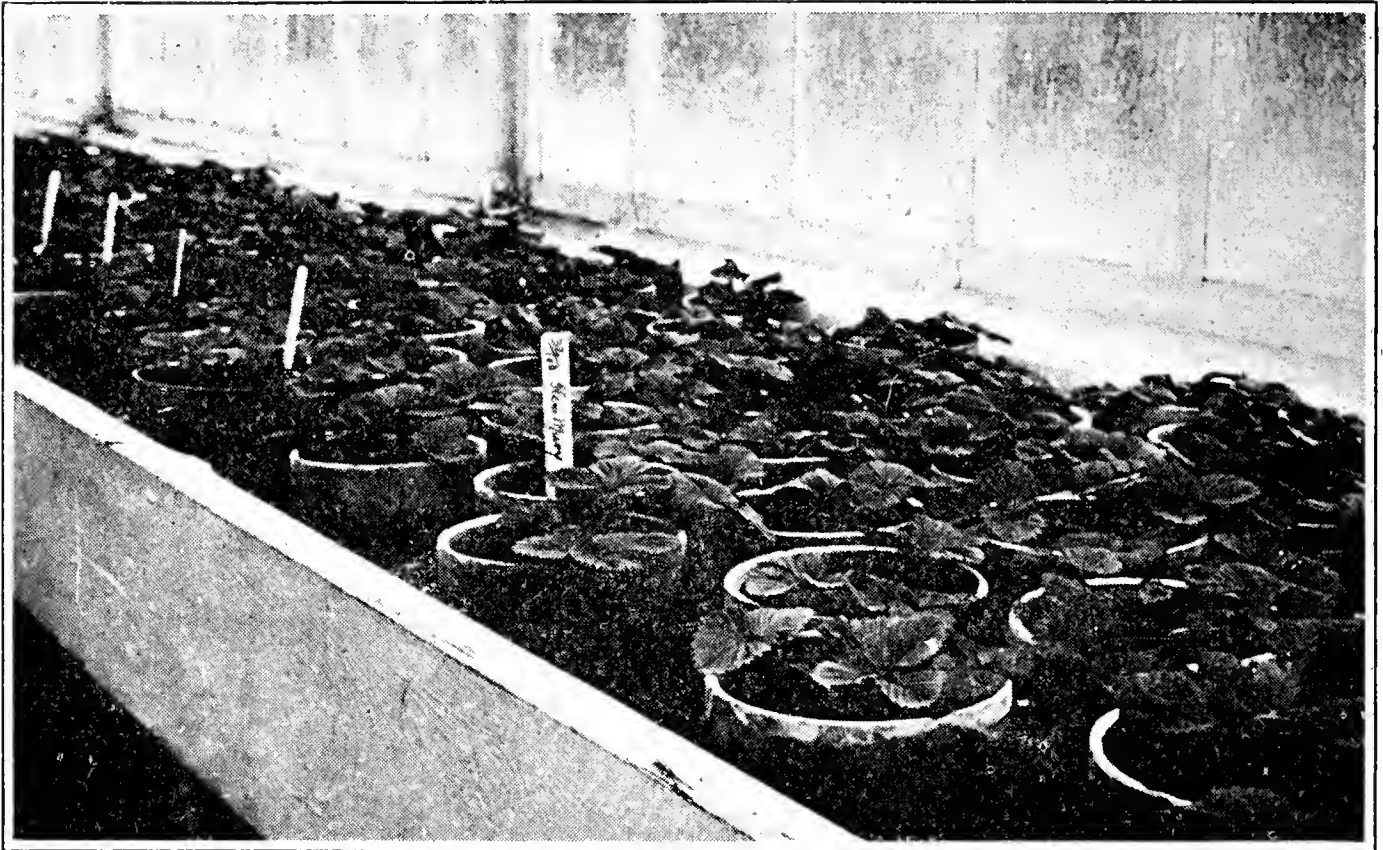

Appearance of Plants When First Placed In Cool House



Forced Fruit of the Marshall Strawberry

THE FORCING OF STRAWBERRIES

By FLORENCE I. KINNISON

The forcing of vegetables and some of the small fruits has a great future before it in Colorado. The climatic conditions, abundant sunshine and the dry atmosphere are great assets, as the crops will grow more rapidly, mature more uniformly, and there is a relative freedom from diseases and insect pests.

The cheapness of fuel is another item of importance in the economical production of the crop. At present, the forcing business is confined to the large cities, such as Denver, Colorado Springs, and Pueblo, where a good local market is obtainable. The industry in these cities is well established and is of sufficient magnitude to supply the local demand.

The forcing industry is necessarily restricted in its development by the lack of a wide local market, as the cost of transportation of perishable products makes it difficult for the growers to compete with other centers where the industry is more established and where the population is much greater.

However, little effort has been made to enlarge the market outside of Colorado for vegetables grown under glass, tho there is no reason why the Colorado growers should not compete successfully in many sections where the conditions for the growing of these crops are less favorable, and expensive.

While the forcing of vegetables is a relatively old industry and is well understood, the forcing of small fruits, especially strawberries, has not heretofore been undertaken, and little is as yet known of the commercial possibilities in this line.

In order to study cultural methods and to discover the best varieties for forcing, an experiment described in the following pages was planned and executed.

PLANTS FOR FORCING

The following varieties were used in the experiment: Warfield, Early Ozark, Senator Dunlap, Haverland, Bubach, William Belt, Marshall, Glen Mary, and Aroma.

The plants were selected from the first runners of mother plants which had been set out in the early spring. These runners were led over 5-inch pots which were plunged into the bed so that the rim of the pots were even with the soil. The soil in the

pots consisted of one-third garden loam, one-third leaf mold, and one-third clean sand. Bone meal was added to this soil at the rate of 30 pounds to each 500 pounds of soil. Drainage was provided for by placing pieces of broken pots in the bottom of each pot. After the runners had become firmly established in the pots, they were detached from the mother plants. They were kept watered and in good growing condition until the middle of August when they were brought up to the greenhouses and shifted into 7-inch pots, after which they were placed in a coldframe and plunged into sand up to the rim. The same kind of soil, with the same fertilizer, was used as in the first potting. In the coldframe the plants were watered and the runners removed as soon as they appeared. The plants were in most excellent condition, and when freezing weather came, the coldframe was covered with a layer of leaves to protect the crowns from freezing and thawing during the early winter months. By this time, the pots were well filled with roots, and the crowns were large and plump.

To test whether the year-old plants were better for forcing than the young plants, a number of old plants were planted in pots at the same time that the runners were taken, and were treated exactly in the same manner as the young runner plants, but only two varieties of old plants were used, namely, Marshall and Glen Mary.

FORCING THE PLANTS

The pots were left in the coldframe until the latter part of January, having remained in a frozen condition during part of November, December and January. The plants were uncovered and the sun permitted to act on the coldframe until the pots could be loosened from the frozen bed; then they were taken into a cold cellar where the dead leaves and rubbish were removed, the pots washed and prepared for the greenhouse. They were left in the cold cellar for ten days to permit the soil to thaw out and to gradually start the root system into activity. The temperature of the cellar was from five to ten degrees F. above freezing. If they are removed to the greenhouse immediately after being taken out of the frozen soil, the crowns develop more rapidly than the root system, and the result is a poor crop and weak plants, while if left in a low temperature for a week or ten days the crown remains dormant while the root system starts its activity and is able to supply the plant food when the plant is placed in a higher temperature. Before final removal of the plants to the forcing house, each plant was thoroly sprayed with Bordeaux mixture to

prevent the attack of fungous diseases. The plants were then moved into the forcing house and placed upon a bench. The different varieties were arranged in groups to vacillitate pollination and record-keeping. The temperature of the forcing house was kept at 40° to 50° F., the object being to develop a strong root system with a more gradual development of leaves. The bed on which the plants were placed had a layer of fine sand into which the pots were partially embedded. This prevented a rapid drying out of the plants and retained the moisture, which is an important element in our dry atmosphere.

After two weeks, the temperature of the house was raised from 50° to 65° F., and the plants began to show signs of putting out flower stems. At this time, it is important that the greenhouse be kept relatively dry to insure a more perfect pollenization.

POLLINATION

When the flowers were ready to be pollinated, the temperature was raised to 70° and 75° F., and kept at this temperature as nearly as possible for the balance of the flowering period. Pollenization began March 8 and was completed March 15. During this time we had a bright sunshine and practically no cloudiness, which resulted in perfect setting of the fruit. The process of pollination is the most important thing in raising a perfect crop. If this is not done carefully and thoroughly, lop-sided and knobby berries result. Each pistil has to receive a pollen. The pollen were first collected in a watch glass by the use of a fine camelhair brush, and then transferred from the glass, by the aid of the brush, to the pistillate flowers. The operation was performed during the middle of the day, from ten o'clock, a. m., until two or three o'clock in the afternoon. The pollination was aided considerably by the presence of a large number of bees which gained an entrance to the greenhouse thru the ventilator. The pollination was continued every day until every blossom had been pollinated several times. After this work has been accomplished, the thinning of the fruit set is important. The individual plant will set more fruit than it can properly mature without sacrificing size and appearance. For this reason, each plant was limited to 8 or 12 fruits, the number depending upon the vigor of the plant.

THE FEEDING OF THE PLANTS

After the fruit was well set, the feeding of the plants began. This is the most critical period in forcing strawberries, as there is considerable danger from disease and insect attacks. The watering must not be overdone, yet the plants should not suffer

from lack of water. The red spider is the worst pest to contend with in forcing strawberries. It is prevented by frequent sprinkling of water on the leaves, previous to flowering to have the leaves as free as possible from this insect, as, during the flowering period little or no sprinkling can be done without injury to the process of pollination.

In this experiment, the red spider was entirely eliminated by the early treatment and did not interfere with the progress of the work. The plants were given a dressing of bone meal at the rate of one-half ounce to each plant. It was worked into the soil. In addition, one application of liquid manure was made, also an application of nitrate of soda in liquid form at the rate of 2 grams to 100 c. c. of water. This constituted the fertilizers applied to the plants after the fruit was set. Too heavy application of fertilizers at this time is apt to produce tasteless fruit, and fruit too soft for handling.

FRUITING PERIOD

The development of the fruit and the coloring was very rapid, as the weather conditions were exceptionally favorable.

It is important that the forcing house be kept dry during the ripening period. The flavor, as well as the keeping quality of the berries are impaired by too much moisture.

To keep the fruit clean and above the soil in the pots, screens made out of wire gauze or netting were used. The netting was cut into squares and a slit made from the edge to the center of the pieces, and these slipped around the crown of the plants, covering the top of the pot completely. This gave a clean place for the berries to rest upon.

By keeping the temperature and moisture conditions in the forcing house even, the crop ripened very uniformly, and there was very little difference in the time of ripening of the different varieties in the experiment. The time that intervened between the ripening of the first berries and the last, was 14 days.

HARVESTING THE BERRIES

While the ripening process was fairly uniform, several pickings were necessary. The fruits were clipped off, leaving about one-half an inch of the stem adhering to the berry. Half-pint raspberry boxes were used and a few green leaves placed with the berries to make them attractive. The fruits should not be handled, except by the stem. Ready sales were found at twenty-five cents per half-pint box.

YIELD OF DIFFERENT VARIETIES

Number of Pots	Variety	Weight in Grams
10	Warfield	327
10	Early Ozark	647
10	Senator Dunlap	497
10	Haverland	633
20	Bubach	1000
23	Wm. Belt	740
50	Marshall (old and new crown).....	2053
100	Glen Mary (old and new crown).....	6064
10	Aroma	217

It will be noticed that Early Ozark gave the highest yield per pot; Haverland second highest; Glen Mary third; Marshall fourth; Senator Dunlap fifth; Bubach sixth; William Belt seventh; Warfield eighth, and Aroma ninth. Eliminating the old plants of the Marshall and Glen Mary from the total number, Glen Mary is the highest yielder in weight and marketable fruit, followed by Marshall. While the Early Ozark gave a high yield, the fruit was small, soft and of rather poor quality. The same was true of the Warfield. This variety bore the largest number of fruits, but the fruit is too small. Haverland gave a large yield, but the fruit was poorly colored and too soft for handling. Bubach gave a fine yield, but the fruit was somewhat irregular and not up to the standard. William Belt produces the largest berries, but this variety has a decided tendency to produce double fruit, and does not ripen evenly. Senator Dunlap produced fine fruit, but not of sufficient quantity. Aroma proved to be a very poor yielder, and gave the lowest results of all varieties. The old plants both of Marshall and Glen Mary produced small and inferior fruits. The vigor and general appearance of the plants were poor.

CONCLUSIONS

Marshall and Glen Mary proved to be the best two varieties for forcing in Colorado. The fruit produced is large, fine color, firm and of excellent quality. Marshall does not yield as heavily as the Glen Mary, but compensates for this deficiency by producing an extra high quality of fruit. The chief reason for using Marshall in forcing is because of its ability to produce an abundance of pollen, while Glen Mary produces few, if any.

New crowns are preferable to old ones, as they produce a heavier yield and larger and better berries.

The secret of success in forcing strawberries depends upon the following points:

First.—Strong, vigorous plants.

Second.—Proper resting period, which should be about three months.

Third.—A dry, well-ventilated forcing house.

Fourth.—Slow starting of the plants to permit a strong development of the root system before the leaves expand.

Fifth.—Frequent sprinkling of the foliage previous to flowering to keep away the red spider.

Sixth.—Special care and thoroughness in the pollination, to insure a perfect setting of fruit.

Seventh.—Carefulness in picking and packing.

Due to the shortness of time required for the crop of strawberries, the crop can be made a paying one at twenty-five cents per half-pint.

ACKNOWLEDGMENT

The author of this bulletin is indebted to Dr. E. P. Sandsten for planning and outlining the work, and for suggestions and help in preparing the material for publication.

The Agricultural Experiment Station
OF THE
Colorado Agricultural College

A FRUIT SURVEY OF MESA COUNTY

BY

E. P. SANDSTEN, T. F. LIMBOCKER and R. A. MCGINTY

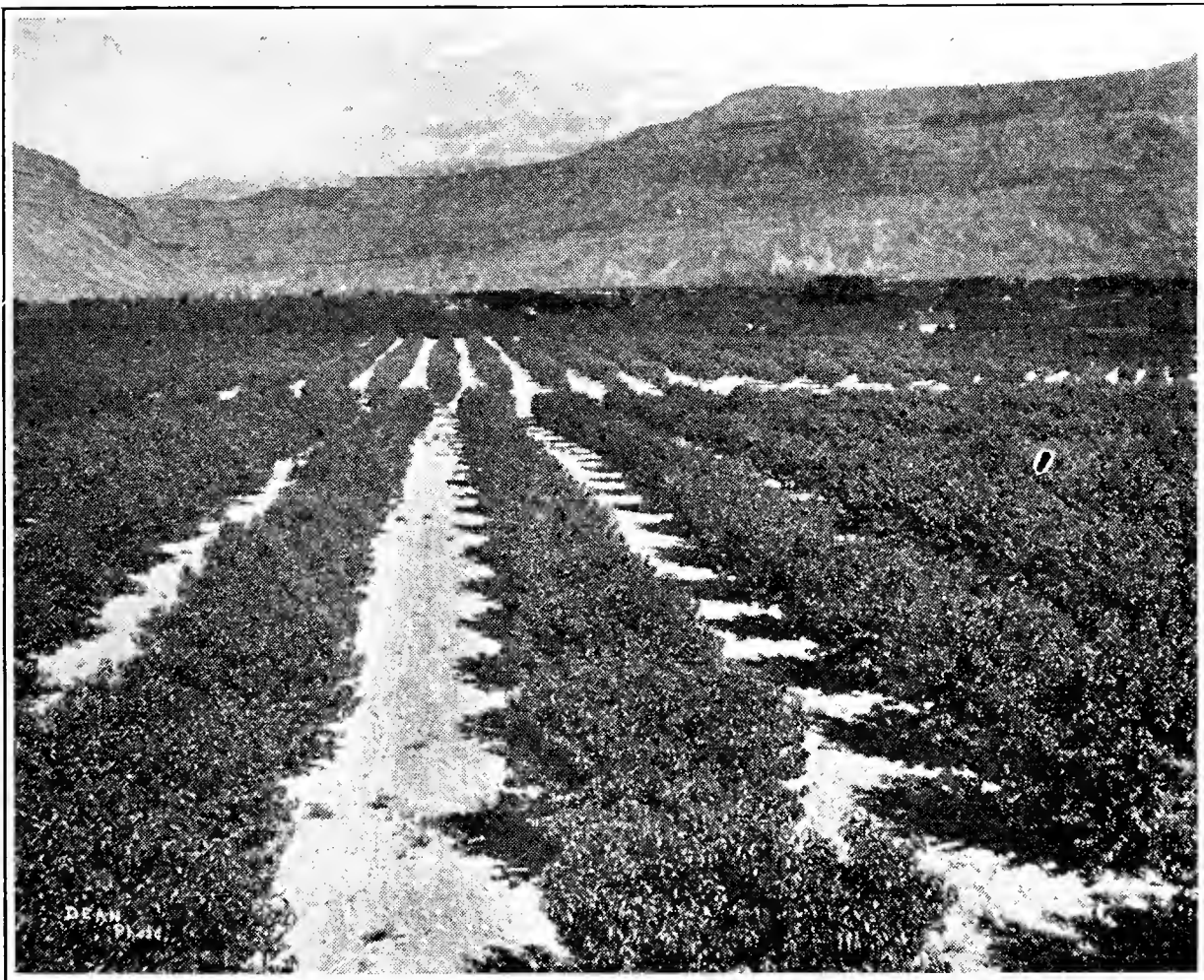

A Birds-Eye View of a Peach Orchard Near Palisade, Colo.

PUBLISHED BY THE EXPERIMENT STATION
FORT COLLINS, COLORADO
1917

The Colorado Agricultural College

FORT COLLINS, COLORADO

THE STATE BOARD OF AGRICULTURE

	Term Expires
HON. CHAS. PEARSON.....Durango,	1919
HON. R. W. CORWIN.....Pueblo,	1919
HON. A. A. EDWARDS.....Fort Collins,	1921
MRS. J. B. BELFORD.....Denver,	1921
HON. H. D. PARKER.....Greeley,	1923
MRS. AGNES L. RIDDLE.....Denver,	1923
HON. J. C. BELL.....Montrose,	1925
HON. E. M. AMMONS.....Denver,	1925

PRESIDENT CHAS. A. LORY,
GOVERNOR JULIUS C. GUNTER, } *Ex-Officio*

L. M. TAYLOR, Secretary G. A. WEBB, Treasurer

EXECUTIVE COMMITTEE

A. A. EDWARDS, *Chairman*

J. C. BELL

STATION STAFF

C. P. GILLETTE, M.S., <i>Director</i>	ENTOMOLOGIST
W. P. HEADDEN, A.M., Ph.D.....	CHEMIST
G. H. GLOVER, M.S., D.V.M.....	VETERINARIAN
W. G. SACKETT, B.S.....	BACTERIOLOGIST
ALVIN KEZER, A.M.....	AGRONOMIST
E. P. SANDSTEN, M.S., Ph.D.....	HORTICULTURIST
B. O. LONGYEAR, B.S.....	ASSISTANT FORESTER
G. E. MORTON, B.S.A., M.S.....	ANIMAL HUSBANDMAN
E. B. HOUSE, B.S. (E.E.), M.S.....	IRRIGATION ENGINEER
V. M. CONE, B.S., C.E.....	IRRIGATION INVESTIGATIONS
W. P. LITTLE, B.S., <i>U. S. Expert-in-charge</i>	HORSE BREEDING
R. E. TRIMBLE, B.S.....	ASSISTANT IRRIGATION INVESTIGATIONS
P. K. BLINN, B.S., ROCKY FORD.....	ALFALFA INVESTIGATIONS
EARL DOUGLASS, M.S.....	ASSISTANT CHEMIST
S. ARTHUR JOHNSON, M.S.....	ASSISTANT ENTOMOLOGIST
L. C. BRAGG.....	ASSISTANT IN ENTOMOLOGY
J. W. ADAMS, B.S., CHEYENNE WELLS.....	AGRONOMY ASSISTANT, DRY FARMING
W. W. ROBBINS, M.A.....	BOTANIST
RALPH L. PARSHALL, B.S.....	ASSISTANT IRRIGATION INVESTIGATIONS
I. E. NEWSOM, B.S., D.V.S.....	VETERINARY PATHOLOGIST
MIRIAM A. PALMER, M.A.....	DELINEATOR
R. A. MCGINTY, B.S.....	ASSISTANT IN HORTICULTURE
CHAS. R. JONES, B.S.....	ASSISTANT IN ENTOMOLOGY
GEO. M. LIST, B.S.....	ASSISTANT IN ENTOMOLOGY
JAS. D. BELL, B.S.....	ASSISTANT IRRIGATION INVESTIGATIONS
CARL ROHWER, B.S., C.E.....	ASSISTANT IRRIGATION INVESTIGATIONS
BREEZE BOYACK, B.A., M.S.....	ASSISTANT IN AGRONOMY
CHAS. I. BRAY, B.S.A., M.S.....	ASSISTANT ANIMAL HUSBANDRY
RALPH L. CROSMAN.....	EDITOR
W. H. KERR.....	MARKETS AND MARKETING
T. E. LEIPER, B.S.....	ASSISTANT ANIMAL HUSBANDMAN

OFFICERS

CHAS. A. LORY, M.S., LL.D., D.Sc.....	<i>President</i>
C. P. GILLETTE, M.S.....	<i>Director</i>
L. M. TAYLOR.....	<i>Secretary</i>
MABEL LEWIS.....	<i>Executive Clerk</i>

A FRUIT SURVEY OF MESA COUNTY

BY

E. P. SANDSTEN, T. F. LIMBOCKER and R. A. MCGINTY

Ten years ago, fruit growing in Grand Valley was very profitable. Peaches often netted the growers \$1.25 per box, while apples and pears cleared \$2.50 per box. It was like picking money off of the trees. The growers were getting rich and real estate men were in their glory. It was an easy matter to get easterners to buy fruit land at \$1,000 or more per acre, for, as the real estate men pointed out, one year's crop might pay for the land. Hundreds of men from all walks of life invested their money in fruit land, speculation was rife, many companies were formed for planting orchards, and thousands of fruit trees were set out on land wholly unsuited for fruit growing. Bearing orchards were divided into five and ten-acre tracts and sold to persons, most of whom were inexperienced in fruit growing. Many of these new orchardists sat back in their easy chairs to watch the dollars grow. Others, uninitiated into the art of fruit growing, did not care for their crops as they should have done. As a result, the fruit became poorer in quality, and not being carefully graded, the demand for Colorado fruit became less. Prices continued to drop until, in the season of 1914, with an enormous crop all over the country as well as at home, most growers lost money on their fruit. Many carloads of fruit were shipped which did not pay for the freight. Thousands of bushels were allowed to drop and rot on the ground. The season of 1915 was a very hard one; with the exception of the immediate Palisade district, practically all of the Valley was frozen out. To make matters worse, prices were poor and very many growers had to give up their orchards. It was rightfully an exceedingly discouraged lot of orchardists which were visited by the writers in the summer and fall of 1915. Most of them were sick of the fruit business and wanted to quit. Some few, however, who had used good methods in growing and marketing their fruit were still making money.

It was with the idea of studying in the field the conditions prevailing there that this fruit survey of Mesa County was made.

EXTENT OF SURVEY

That part of Mesa County in which the fruit survey was made is the portion of Grand Valley which was irrigated previous to the opening of the Government ditch in 1915. It is about 32 miles in



Apple Harvest in Grand Valley.

length and extends from about 2 miles above Palisade to an equal distance west of Loma. In width it varies from less than a mile at Palisade to about 5 miles at a point about midway between Clifton and Grand Junction. The total area of land within these limits is about 75,000 acres. The elevation of the Valley varies from 4,500 to about 4,800 feet. Nearly every orchard in the Valley was visited and the owner or tenant interviewed personally. Altogether about 1,800 places were listed.

PERCENTAGE OF LAND SET TO FRUIT WITHIN LIMITS OF SURVEY

Nearly all of the bearing orchards of the Valley, except on Orchard Mesa, southeast of Grand Junction, and a few scattering orchards, are planted north of the river. The percentage which is planted to fruit trees between the river and the highest irrigation canal on the north is, approximately, 70% in the Palisade District, 56% in the Clifton District, 20% in the Grand Junction District, 12% in the Fruita District, and 13% in the Loma District. The

Orchard Mesa and Redlands Mesa orchards are, except those mentioned, young, and most of them have never borne. On account of the uncertainty of irrigation water, many of them have been neglected and are in poor condition.

TIME OCCUPIED IN SURVEY

The field work of this survey was begun early in the summer of 1915 and finished late in the fall. The data were carefully worked up at the Agricultural College in Fort Collins during the winter. Due to the enforced absence of the junior author during the summer of 1916, the publication of the results was delayed several months.

METHODS USED IN SURVEY

In order to get detailed information in regard to the situation in Mesa County, very complete blank forms were prepared for use in the survey. See Page 6 for reproduction of this form. The fruit growers were visited personally and the information received from them recorded on the blanks. Care was taken to get accurate answers to the questions asked. The blanks were filed away in order until ready for tabulation. In working up the notes, caution was used to put the orchards in their proper sections. Thus it was possible to determine with a fair degree of accuracy the acreage and kinds of orchards located in each section of the Valley. The trees were divided into age classes, to show approximately their state of production. The four classes used were, six years and under, classed as non-bearing trees; seven to ten years, eleven to fifteen years, and sixteen years or over.

For convenience, the Valley was divided into five districts by the range lines, and each named after the town located in it. That part of the Valley lying east of the range line which runs about one and a half miles east of Clifton, is called the Palisade District. That in Range 1 East, or lying between the aforesaid range line and that running just west of the Teller School of Agriculture and Mechanic Arts, about one mile east of Grand Junction, is called the Clifton District. The Grand Junction District comprises that land in Range 1 West and extends westward from the above range line to that lying just west of the Ute switch of the Denver & Rio Grande railroad. From this range line to that one mile west of Fruita is the Fruita District, and the fifth, or Loma District, extends from the latter range line to that just west of the town of Mack. The northern and southern limits of these districts are marked by the highest irrigation system on the north and south sides of the river. These districts are clearly shown on the map.

Fruit Survey of Mesa County, Colorado

T. _____ R. _____ Sec. _____ Lot _____

No. of acres in fruit..... No. of trees..... Distance to Station.....
SOIL S. Loam.... Clay.... Silt.... Adobe.... Distance to water table....

APPLES

No. of acres..... No. of trees..... Age of trees..... Condition of trees.....
Variety..... No..... Var..... No..... Var..... No..... Var..... No.....
Variety..... No..... Var..... No..... Var..... No..... Var..... No.....
Variety..... No..... Var..... No..... Var..... No..... Var..... No.....

PEARS

No. of acres..... No. of trees..... Age of trees..... Condition of trees.....
Variety..... No..... Var..... No..... Var..... No..... Var..... No.....

PEACHES

No. of acres..... No. of trees..... Age of trees..... Condition of trees.....
Variety..... No..... Var..... No..... Var..... No..... Var..... No.....

PLUMS

No. of acres..... No. of trees..... Age of trees..... Condition of trees.....
Variety..... No..... Var..... No..... Var..... No..... Var..... No.....

APRICOTS

No. of acres..... No. of trees..... Age of trees..... Condition of trees.....
Variety..... No..... Var..... No..... Var..... No..... Var..... No.....

CHERRY (Sour)

No. of acres..... No. of trees..... Age of trees..... Condition of trees.....
Variety..... No..... Var..... No..... Var..... No..... Var..... No.....

CHERRY (Sweet)

No. of acres..... No. of trees..... Age of trees..... Condition of trees.....
Clean culture..... Cover crops..... No. of irrigations.....
Cost of Prod. per box,—Apples... Pears... Plums... Cherry (So)... (Sw)...
Acreage increased or decreased,—Apple... Pear... Peach... Plum... Cherry..
Is fruit growing profitable?..... Which fruit?.....

SPRAYING

No. of times,—Apples..... Pears..... Peaches..... Plums..... Cherries.....
How much poison per 100 gal. of water..... Does it pay?.....
Cost of spraying..... Per cent clean fruit.....
Would special or general farming be profitable with fruit growing?.....
What can C. A. C. do to aid the fruit industry?.....
Remarks:.....
.....

The data for these districts are given separately throughout the bulletin for comparison.

After the data were compiled, such increases to the total acreage, total number of trees, etc., were made as were deemed necessary to allow for orchards missed. These varied from 1% to 4½% and are fairly accurate. The figures as listed in the tables are, we believe, as nearly correct as it is possible to make them.

Only the more important of the data collected are given in the bulletin. For instance, of more than 100 varieties of apples, only six are discussed and 21 others mentioned. Many varieties, especially of apricots, plums and cherries, were unknown and were so listed.

TOPOGRAPHY

In general, the Valley is quite level. In fact, portions are too level for good drainage. It slopes westward with the direction of the river, from the north, southward to the river, and on the south side, northward to the river. While the Valley is level, there are found in many places ridges and depressions, the former containing a loamy soil excellent for fruit, and on which are found some of the finest orchards in the Valley. The lower places generally become seep holes under irrigation, as water collects from the higher adjacent lands. On the whole, the Valley possesses natural conditions for adequate drainage, when developed.

CLIMATIC CONDITIONS

The Grand Valley, being located on the western slope of the main range of the Rockies, enjoys a milder climate than a similar location and elevation on the eastern slope, and, as a consequence, the Valley produces a great variety of fruit to perfection. The annual rainfall is less than on the eastern slope, being only 7 or 8 inches per annum. This small rainfall makes irrigation an important factor in fruit growing. While the climatic conditions are favorable for the growth of all standard varieties of temperate-zone fruits, the occurrence of belated spring frost makes for a short crop year now and then.

On the whole, it can be said that the Valley is very well adapted for commercial fruit growing from a climatic point of view.

SOIL

The soil of Grand Valley is of a silt formation, rather heavy in texture, approaching the adobe type. A few ridges and a small district adjoining the river are more sandy and loamy, but in general the soil is heavy and not easily managed. While the soil of

Grand Valley is well adapted to the different kinds of fruit, local soil problems have arisen that need special attention from the growers. The most important problem is that of niter accumulating in the orchard soils. For a technical discussion of this problem, see Bulletin No. 193 of the Colorado Experiment Station.

A full discussion of the niter problem from the orchardist's point of view will be given under the head of "cover crops."

DRAINAGE

While the natural drainage of the Valley is good, yet, due to liberal irrigation, much of the land occupying somewhat depressed portions of the Valley is suffering from seepage and standing water. The water-table, on the whole, for a considerable portion of the Valley has been raised to within 10 feet of the surface, and in some parts of the fruit sections it is less than 5 feet from the surface. This raising of the water-table has a decided influence upon commercial fruit growing in the Valley, but the difficulty bids fair to be eliminated by a system of drainage to be installed through the whole length of the Valley.

ALKALI

Like most irrigated sections, the Grand Valley has a considerable acreage of what might be termed alkali land. These alkali areas are not uniformly distributed, but occur in different sections, especially where there has been a large amount of seepage water, which upon evaporation deposits the alkali on the surface. These alkali areas are particularly noticeable east and west of Grand Junction and on the low-lying land close to the river. Many of these alkali areas are unsuited for fruit growing, and some of them are so heavily impregnated with alkali as to make them useless for all agricultural purposes. Undoubtedly the larger portion of these alkali lands could be reclaimed by heavy washing, if sufficient drainage is provided for them. The alkalis are all white ones, ex-drainage is provided for them. The alkalis are all white ones. Black alkalis or carbonates, so far as is known, do not occur in the Valley.

DISTANCE FROM STATION

For the purpose of learning the average distance fruit had to be hauled in shipping, the distance to the nearest shipping point was recorded. It was found that the average distance to the station for all orchards of the entire Valley was 1.55 miles. For the districts separately it was as follows: Palisade 1.2 miles, Clifton 1.25 miles, Grand Junction 1.8 miles, Fruita 1.85 miles. The shipping points used were Palisade, Bridges' Switch, Clifton, Fruit-

vale, Grand Junction, Fruita and Loma on the D. & R. G. railroad, and Hollandville and Hunter stations on the electric railroad between Grand Junction and Fruita.

As this indicates, most of the farms are very close to loading points, doing away with the necessity of long hauls.

SIZE OF ORCHARDS

The survey reveals the fact that the average size of orchards in the Grand Valley is 8.8 acres; the average for Palisade is 7.0 acres, for Clifton 10.8 acres, Grand Junction 8.5 acres, Fruita 7.5 acres. The average size of orchards in the Loma district could not be obtained, due to the fact that most of the owners of orchards in this district are non-residents and their property is being attended by tenants who have often 100 acres in their care. It is estimated at 10 acres.

A majority of orchards are of 10 acres or less. Especially in the east end of the Valley are the orchards cut up into small tracts, some of less than 5 acres. It is hardly possible, except in the best of fruit years, to make a reasonable profit from 5 acres of land, when it is all planted to fruit trees, and a bad year is almost disastrous. The necessity of re-adjusting the land to increase the size of farms seems imperative. With the return of reasonable land values, this re-adjustment is practicable.

IRRIGATION

The problem of irrigation has been a big one. Water has, as a rule, been plentiful and the growers have used entirely too much. The tendency with many has been to let irrigation take the place of cultivation. This has resulted in leaching out of the soluble plant food and puddling the soil so that it bakes and is hard to work. Then, too, it has raised the water-table in many places so close to the surface of the soil that it is impossible for trees to live.

As a general thing, the farmers have irrigated lightly and very frequently, instead of giving thorough irrigations at less frequent intervals. The latter plan results in soaking the ground to a good depth and when followed by cultivation holds the moisture for a long time. It does not puddle the soil, causing it to bake, but accomplishes the desired purpose of supplying plenty of water for the trees better than lighter irrigations.

The statistics gathered show five or six irrigations to be the average number applied for fruit crops. The growers in the Palisade District irrigate somewhat oftener than those in the western part of the Valley. There is also more land under clean cultivation in this district than in cover crops. There are several seepage



Irrigating Scene in the Grand Valley.

areas in the Valley caused from over-irrigation and poor drainage. In many of these, it is impossible to grow anything, and some of them will mire a horse. Many once profitable orchards have been utterly ruined by seepage, and a good many more are doomed unless the needless over-irrigation is discontinued.

The water for irrigation is taken from the Grand River some distance above the main Valley. Naturally, the lower land or the land adjacent to the river was first developed, due to the cheapness in constructing irrigation canals. The upper lands closer to the foothills at Palisade and south of the river are irrigated by water from pumping plants, making the irrigation expensive. The new government project which was completed last year opens up an extensive area of land above the old canals. This will have a considerable bearing upon the land under the old irrigation system. Water is abundant, and, with the exception of that supplied by pumping plants, is cheap.

COVER CROPS

The use of cover crops in the Grand Valley is of relatively recent date. Clean culture has been the universal practice throughout the district. With the appearance of the niter troubles and with the gradual burning out of vegetable matter in the soil in many orchards, the decline of trees has been very rapid. A num-



A Peach Orchard at Palisade Showing Methods of Furrow Irrigation.

ber of growers early realized the necessity for a more rational system of culture and are seeding their orchards to some kind of crop that can be plowed under, thus adding the necessary humus to the land.

Alfalfa has been the favorite cover crop in the orchards, but this crop has several drawbacks, the main one being that it is difficult to eradicate after it has been once established. A cover crop should not be kept in the orchard for more than two or three years, after which clean culture should be practiced for an equal period. In other words, a cover crop and clean culture should alternate if the best results are to be obtained.

Medium red clover is used by a number of growers with very satisfactory results. The first crop can be cut and either used for hay or left as a mulch on the ground, the second crop being left uncut, which will help to hold the snow and moisture in the winter. The second year the same method may be pursued except that the second crop should be plowed under, leaving the orchard to be

clean cultivated. Where it is difficult to obtain a stand of clover, oats may be used, but it should be plowed under and not cut for hay. After this has been done for one or two years, it is generally easy to obtain a good stand of clover.

Hairy vetch gives promise of becoming an important cover crop in Grand Valley. This is a biennial plant that should be sown in September and plowed under the following May. It starts to grow in the fall, stands the winter well and makes a heavy mat of green herbage by the last week in May.



An Apple Orchard in Cover Crop of Red Clover, Grand Valley, Colorado.

The use of cover crops has proven beneficial to the orchards in the Grand Valley and the practice should be extended to every orchard. When cover crops are grown, they should be left on the ground to plow under, as hay and fruit cannot both be grown on the same land successfully.

The practice of dividing the orchard into several parts by fences and allowing hogs to run alternately in each gives promise of success where alfalfa or clover are used as cover crops. This permits moving the hogs from one part of the orchard to another when irrigating. The hogs eat up the culls and fallen fruit as well as the cover crop, and their manure is left on the ground, thus adding to the fertility of the soil. This practice is not recommended for orchards in which the trees are small and easily injured by the rubbing and rooting of the animals.

The most serious soil problem in Grand Valley is niter. The presence of a large amount of niter was noticed several years ago

by Dr. Headden and later by Professor Sackett of this station, and these gentlemen have carried on extensive experiments to discover the cause or origin of the niter. These experimentors have clearly proven that the presence and accumulation of the niter in the Grand Valley is of a bacterial origin. The accumulation of niter is much more rapid on lands under a clean culture system, and consequently the orchards were first to suffer from this trouble. In some cases the niter has accumulated to the extent that all vegetation has been killed and the land left entirely barren and unproductive. A considerable percentage of the older orchards were killed and the land left barren through niter accumulations.

The Horticultural Department, about three years ago, undertook to carry on some experiments with the view of eliminating or neutralizing the effect of the niter and making the land produce a normal crop. The results of these experiments show that the niter problem can be handled by the use of cover crops which will protect the land during the summer and by the effect upon the soil of turning under the green materials grown. This method is effective and should be practiced by fruit growers whose orchards are not as yet suffering to any extent from niter trouble. Where the land has gone so bad as to become barren, the only method known by which it can be reclaimed is by washing the soil. The nitrates being soluble in water can easily be washed out by heavy flooding or heavy irrigation. This method was tried on a piece of land that was entirely barren and in two years the land was entirely reclaimed and produced normal crops. This washing or flooding of the land calls for drainage to carry off the surplus water. It also requires that the land should have at least a gentle slope to permit the water to run off freely. This method of reclaiming niter land is not applicable to land in growing orchards. The cover crop method is the only safe and rational way of overcoming niter accumulation, and it is a rational method of orchard management that every intelligent fruit grower should follow. In other words, the niter problem should not occur if rational methods of orchard management are followed out.

COST OF SPRAYING

The mean of 34 estimates on the cost of spraying per 200 gallon tank is \$2.05. For the cost per acre per season of arsenical sprays, 41 estimates gave an average of \$20.00. This, divided by 5.85 (the average number of sprays per season for apples for the Valley), gives \$3.40, or the average cost per acre for one applica-

tion of arsenical spray. The cost per spray of lime-sulphur, the mean of 95 estimates, is \$6.65 per acre.

There was much variation in the answers given for the spraying data. Many of the orchardists have absolutely no idea of the cost of this work.

INCREASE AND DECREASE OF ACREAGE

The past five years have seen considerable decrease in the acreage of orchards in the Grand Valley. It is safe to say that during this period at least 2,500 acres of orchards have been pulled out. Various reasons are assigned for the removal of the trees, chief among them being poor prices, seepage and neglect.

The decrease in acreage has affected the apples most severely, and the loss has been heavier in the older districts. The following estimates, based on actual figures, give an idea of the amount of orchard pulled out between 1911 and 1915. These estimates are, probably, in most cases, low. Palisade shows a decrease of about 150 acres of peaches and an increase of 50 acres of apples and 75 acres of pears. The Clifton District has lost 400 acres of apples and 450 acres of peaches, the acreage of pears remaining about the same. In the Grand Junction District the acreage has been diminished by 600 acres of apples, 150 of pears, and 50 of peaches. Fruita shows a loss of 750 acres of apples, and Loma has a decrease of 100 acres of apples.

In some few cases, good bearing orchards have been pulled out, but in most cases it was better that the trees were removed. The Valley as a whole would be vastly improved if all the ill-planted, seeped, neglected or otherwise unprofitable fruit trees were removed and a lot of inferior fruit thus kept off the market.

Fruit growing, like all other agricultural industries, thrives best only under favorable conditions. One cannot profit from an orchard under adverse conditions. When it is seen that fruit trees will never yield a fair return, they should be taken out and the land devoted to other crops.

YIELD

For the years 1911 to 1915, the average number of acres of bearing orchard was about as follows: Apples, 6,000; pears, 1,100; peaches, 1,800. Assuming that 90% of the fruit grown during this period was shipped out of the Valley, the average yield for the Valley would be about 800,000 boxes of apples, 60,000 boxes of pears, and 1,150,000 boxes of peaches. This would give an average yield per acre of about 135 boxes of apples, 145 boxes of pears, and 640 boxes of peaches.

It is absolutely impossible to obtain accurate figures on the number of acres of bearing orchard or the yield per acre. No claim of authenticity is made for these data on yields. Yet, though they are merely estimates, they give some idea as to the probable yields and are as nearly correct as can be determined from the data at hand.

THE COST OF PRODUCTION

One of the questions asked the growers was the cost of production per box of the different fruits. Many of them had absolutely no idea of the cost, and others had pretty close figures on this. While there is considerable variation in the estimates given, the mean is no doubt very close to the actual cost of the fruit. The averages of the estimates for the cost of fruit f. o. b. their shipping point, including all expenses, was as follows: Apples, 61.2c per box (the average of 61 estimates ranging from 40c to 86c); pears, 60.5c (average of 37 estimates, varying from 40c to \$1.00); peaches, 31.2c (average of 78 estimates, varying from 20c to 43c).

It is quite evident that the growers must receive at least 65c per box net for apples and pears in order to make interest on their investment. At an average of \$1.00 per box a fair profit can be made. At this price they should reach the consumer at \$1.50 to \$2.00 per box, which is not too much to pay for first-class fruit.

Peaches should net 40c to 50c per box, making them retail at \$1.00 to \$1.25 per box.

MARKETING

The greatest trouble the fruit growers have to contend with is the marketing problem. This has, for several years, been causing unlimited trouble. Numerous methods of selling fruit have been tried and, without exception, all have been found wanting. Experience has proved that co-operative selling associations offer the most satisfactory solution to the problem. This system of co-operative selling originated in Grand Valley and has been tried here a number of times, but with varying degrees of success. When fruit was bringing good prices things went all right, but with the drop in price, trouble brewed.

There is one big defect in the system—the average farmer will not co-operate. Whenever he sees a chance to get a little more for his fruit than he is getting through the association, he will do so, regardless as to what happens to his associates. It is to this failing that the success of unscrupulous commission agents is due. The plan of these men is to promise the farmers a little more for their fruit than their associates are getting for it. The farmers usually let the agent take their fruit. If they are too skeptical

and hesitate to leave the association, the agents advance a certain amount per box on the fruit, the balance to be paid when the fruit is sold. There are many instances in which the growers never hear from the agent again; in others, where they receive a bill for the freight, and still others where money has been advanced for the fruit, they get a bill for a refund on the payment advanced. This they are often compelled to pay.

The strangest thing of all is that often the very men who are defrauded in this way are "taken in" again the next year. It is easy to see that under these conditions a co-operative association cannot be successful.

The consignment system has not proved very satisfactory. In any carload of fruit not strictly graded, there will be boxes which are below standard. The commission men, finding this, refuse to handle the consignment, except at a lower grade. Oftentimes consignments are reported in bad condition when they are as good as represented. The owners must either allow the fruit to be marked down or turn it over to someone else. This is not very easy to do when they are several hundred miles away. Sales on an f. o. b.



Modern Method of Transportation. The Apple Crop is Handled by Interurban Electric System which Connects with the Railroad.

basis would do away with this practice. Even where commission men are honest, there is much complaint. Fruit is often not up to the standard, and when the market is full, as it frequently is, they cannot sell the fruit at good prices. The commission man then gets the blame for poor prices and is accused of dishonesty.

Many growers have tried the plan of selling their fruit direct, or of shipping it to some town and selling it from the car. There have been varying degrees of success with this system of selling. Some men have netted good returns from it, while others failed utterly. Altogether, the plan is not satisfactory.

Yielding to the pressure from many growers, the Grand Junction association tried out the plan of sending men to the more important middle western markets and shipped fruit to them for distribution. The belief, held by many orchardists, was that these men could watch the market more closely and hence dispose of the fruit to much better advantage than the association manager in Grand Junction. The plan fell far short of the expectation of its advocates and was declared by the association to be a failure.

The ultimate solution of the marketing problem will in all probability be a more closely co-operative association through which the members alone may ship their fruit without extra charges. The members must agree to sell all of their crop through the association, and any fruit growers who are not members must pay considerably more for having their products marketed by the organization.

Another factor which would doubtless work a benefit in marketing would be the establishment of community packing houses. These would be located in the most accessible places and would be sufficiently numerous to take care of all the growers without delay or long hauls. These packing houses would be under the direct supervision of the association representatives who would see that all growers received fair and impartial treatment and that the fruit was strictly graded and carefully packed. This would insure uniform packages and facilitate f. o. b. sales.

Besides, with the work carefully done, the association would gain a reputation for good fruit and the fruit would largely sell itself on its own name. Under the present system, every man packs his own fruit and there is little uniformity in the packages. Such lack of conformity leads dealers to distrust the quality of produce in any grade, and hence refrain from buying except on consignment.

The shipping of standards, or fruit below the second grade, has worked a great detriment to the fruit industry. It would be

far better not to ship this fruit at all, as it competes with the better grades on the markets.

The shipping of second-grade fruit in baskets will most likely become more popular with the growers in the future, as it affords a cheaper method of putting up the fruit, and the baskets themselves are much more useful to the ordinary consumer than the boxes. This should be especially true with apples and pears. Another advantage in marketing in baskets is that the consumer can see the quality of the product he is getting and it sells itself on sight more often than when packed in boxes.

FARM EFFICIENCY

There are very few fruit growers in Mesa County who keep any kind of records of their transactions. Thus it is almost impossible for them to know where they are gaining or losing money, what the different operations cost, or where they could save money.

Neither do most growers follow any system in their work, but go at their work blindly, often doing things several times where one time properly done would suffice. The men who have been making money during the low-price period have, in nearly all cases, been men who study their business and keep a set of books to show where they stand financially. They are also usually men who are ready to listen to suggestions for improvement in their methods.

It is very important that a set of books be kept and a system worked out which will give the greatest possible efficiency. The aim should be to avoid all waste, and arrange the work so that it will not conflict and so that there will be always something to do. This will materially add to the profits of the farm.

DIVERSIFICATION

The question of diversified farming arises in connection with fruit growing, especially in view of the recent poor years for fruit. The majority of farmers in the Valley, when interviewed, were of the opinion that diversification would pay in connection with fruit growing. With land at its present prices and cut up in tracts of ten acres or less, diversified farming is hardly practicable. However, there is little doubt that with 20 acres or more the vast majority of growers would benefit by diversifying.

There are a few of the best fruit growers who can always make more money with fruit than anything else. These men are the exception and not the rule. Every grower should at least have a cow, a few pigs and chickens, and a small garden patch. The first cutting of alfalfa or clover may be used for hay where there is a good stand in the orchard, but no more should be taken. Many

farmers have tried the growing of special crops such as canteloupes and small fruits, and some of them have been very successful in this venture.

Regarding the Valley as a whole, there are too many men in the orchard business who are not fruit growers, and too many tracts of fruit trees which are not orchards in a real sense, for the business to thrive except under extraordinary conditions.

More land devoted to alfalfa, sugar beets, grain, and stock and less to fruit growing, would undoubtedly mean better success for most of the Grand Valley farmers.

SMUDGING (Orchard Heating)

The concensus of opinion among orchardists in Mesa County is that the attempt to ward off frosts by smudging (building fires in the orchard to raise the temperature) is not a paying proposition. Practically all systems of smudging have been tried with varied results, but the practice has been abandoned by most of the growers.

The trouble is that the conditions must be very favorable for effective smudging. At best, the temperature can be raised only a few degrees and when the frost is accompanied by a wind, it is almost impossible to do any good. As a safeguard, many nights of wearisome toil are often spent in smudging, only to find that the frost was not hard enough to do any appreciable damage. Under any conditions, smudging is a very disagreeable, man-killing task, as well as being expensive. When one spends several nights in smudging only to be caught by a late frost, or to find that his neighbors who did not smudge have as much fruit as he, he very seriously questions the utility of the practice.

Disregarding all worry and hard work, it is doubtful whether orchard heating is profitable. If one is not situated where fruit growing is fairly safe without smudging, the advisability of the business is exceedingly questionable. One had better either raise other crops, or move to a safe fruit-growing country. There are too many precautions that must be taken to successfully grow fruit in any district without adding that of constant danger from frost.

The continuance of smudging in commercial fruit growing will very likely be limited to vicinities where there are infrequent killing frosts and to the larger orchards. As a general practice, it appears to be a thing of the past.

TREE GROWTH IN THE GRAND VALLEY

The vigorous growth of fruit trees in the Valley indicates that the climatic and soil conditions are favorable for the development

of sturdy and productive trees. The trees come into bearing early, and, with most varieties, large annual crops are produced.

The heavy wood growth makes the problem of proper pruning an important one, and this phase of fruit growing in the Valley has, in most cases, been given less attention than it deserves, for it is a well recognized principle in fruit growing that a tree, in order to produce the maximum crop of first-class fruit, must be reduced in wood growth so as to permit a free circulation of air and light through the tree and to produce fruit of sufficient size. If pruning is not systematically performed, the trees become too heavy in wood growth, which, in turn, will produce a large number of small, poorly colored fruits. In general, it should be said that fruit growing in the Grand Valley represents the advanced process in American fruit growing.

There is danger of neglect during a year of failure when the grower does not feel like spending money on the proper care of his orchard because there is no income. This is a mistaken practice, because it is universally recognized that no agricultural crop will suffer greater permanent injury from neglect than a fruit orchard. A few years of neglect will, in most cases, completely ruin the orchard and spoil it for future profitable crops.

SOME POINTS REVEALED BY THE SURVEY

The fruit survey shows that the development of the fruit industry in the Valley has been along logical lines, so far as the adaptation of the different kinds of fruit to the soil and climatic conditions is concerned. In the Palisade District, which occupies the upper end of the Valley, the peach industry predominates. This is natural because of the topography of this section. The Valley at this point is narrow and is shaped like a crescent, protected on the north and northeast by high bluffs, which retain the day's heat and make this part of the Valley practically frost-proof. The soil is of a sandy loam nature and admirably adapted for the growing of peaches, sour and sweet cherries and pears.

The Clifton District, immediately below Palisade, is the largest apple-producing section of the Valley. The Valley broadens out immediately after leaving Palisade, yet it is sufficiently close to the mountains to afford some protection against belated spring frosts. The soil bed is intermediate in character between a heavy adobe and loam, and is admirably adapted for the growing of apples. The topography of this section of the Valley provides for a better system of air and water drainage than sections below. The section immediately surrounding Clifton is planted almost solidly to fruit trees.

The Grand Junction section occupies about the center of the Valley. This section is more uniformly level and suffers perhaps more from lack of drainage of both air and soil. Still there are several elevated portions of this section known locally as fruit ridges on which are located some of the finest orchards in the Valley. The soil in this section is, with the exception of the fruit ridges, heavy adobe and quite difficult of handling. The Fruita section follows the Grand Junction District in order westward. This section has a large acreage of sandy loam soil that is capable of producing a great variety of fruit, potatoes and vegetables, but, due to its position in the Valley, the orchards are subject to belated frosts which often cause the total or partial loss of a crop. A considerable portion of the low-lying land has suffered from lack of drainage. The Loma District occupies the most westerly portion of the Valley and is less developed. Although over 1,300 acres of orchard have been planted, the greater portion of it is in young trees. This section was mostly set out six to eight years ago during the boom period.

EXPLANATION OF MAP OF FRUIT BELT OF GRAND VALLEY

The map on Page 22 is designed to show the relative density of orchard in each square mile which contains over five acres of fruit land. This map is adapted from the United States Reclamation Service map of the Grand Valley Irrigation Project, and shows most of the land watered by the new Government canal, as well as by the older ditches. The various markings show how extensive the orchards are in each section.

The entire Palisade District north of the river is marked as being three-fourths orchard. It is possible that some sections of this district have not such a high per cent of orchard, but there is even a larger percentage of fruit land in most sections of this district.

There are a few sections which are left blank, but which should have been marked on the map. This is due to the fact that it was impossible to locate the orchard as to sections when the orchard itself was listed.

West of the Palisade District there is only one section which is over three-fourths orchard, and only one section west of the Clifton District is over one-half orchard.

EXPLANATION OF TABLES AND DIAGRAMS

For clearness and compactness, we have presented much data in the form of tables. In some instances, diagrams have been con-

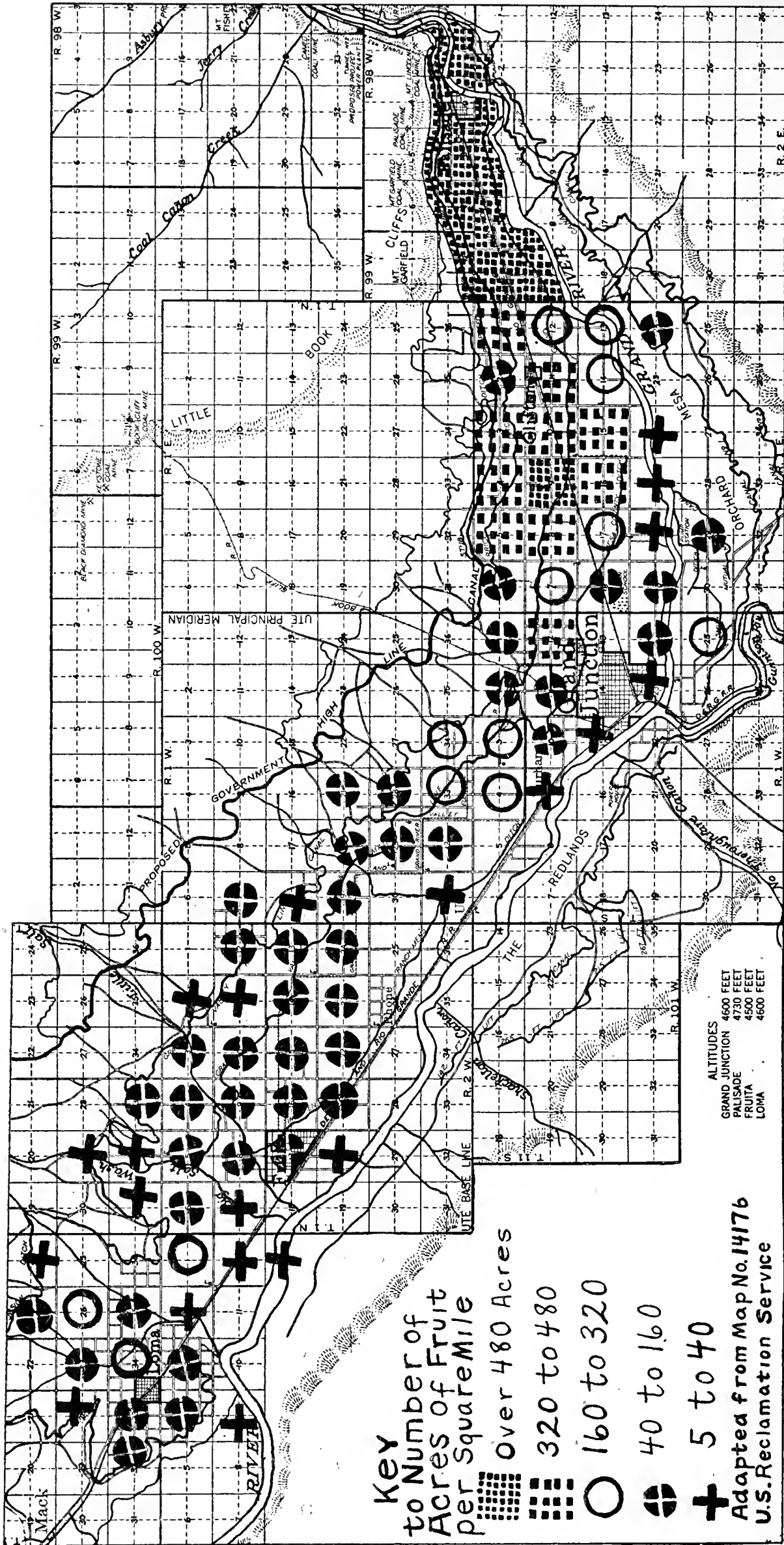

Map Showing Relative Density of Orchard in Each Square Mile Containing Over Five Acres of Fruit in Grand Valley.

constructed from the tables, showing graphically what the latter contain. These are very easily interpreted. Their method of construction is as follows: Suppose we want to show the number of fruit trees in each district of the Valley. Heavy perpendicular lines at regular intervals are chosen to represent the districts, these being arranged in order from left to right. Thus, the left line represents the Palisade District, the next one the Clifton District, etc. (See Diagram 1.) Next, horizontal lines are selected to represent the number of trees. The figures at the right of the sheet show the number represented. Referring, now, to Table I we find that the Palisade District contains 416,500 trees. (Total in right-hand column.) At a point on the left perpendicular equal to this number a mark is made. The same is done for the other districts, the mark on the second line being made at 578,625; the third at 217,350; the fourth at 150,575, and the fifth at 89,550. These points are then connected by a solid line which represents the total number of fruit trees in each district of the Valley. To represent the number of trees of each fruit the same method is used, the only difference being that different kinds of connecting lines are used, in order to be easily distinguishable from each other. A "key" is given on the diagrams to show what each line represents. In some cases, the lines are also lettered for greater facility of interpretation. By studying and comparing the tables and diagrams, much interesting information may be obtained. We have endeavored to present this information in the way easiest to comprehend.

CONTENTS OF TABLES AND DIAGRAMS

To prevent confusion, the diagrams are numbered the same as the tables from which they are constructed. There are, consequently, several numbers missing, as some tables have no diagrams corresponding to them.

Table I, Page 25.—This table shows the number of trees of the different fruits for each separate fruit district, and for the Valley as a whole; also the total number of fruit trees of all kinds for each district, and the total of all fruit trees in the Valley.

Table Ia.—An adaptation of Table I to show the percentage of all trees of each fruit contained in each district. The same is shown for the Valley as a unit. For example, we see that of the apple trees of the Valley, the Palisade District has 5.7%, the Clifton District, 47.2%, etc. Thus, it is clearly seen where any fruit is grown most extensively.

Table II, Page 26.—Shows the number of acres of orchards in each district in the Valley.

Table IIa.—Shows the estimated number of acres of bearing orchards in each district.

Table III.—This shows the number of cars of fruit shipped from Grand Valley for each year from 1911 to 1915, inclusive.

Tables IIIa, IIIb, IIIc, and IIId give the number of cars of apples, pears, peaches and mixed fruits shipped from each town in Grand Valley for the years 1911 to 1915, inclusive.

Table IV.—This shows the six most important commercial apples of Mesa County, with their percentage of all apples grown for each district, also for the Valley as a whole.

Diagram 4. Same as Table IV.

Tables V, VI, VII, VIII and IX.—These tables give the principal varieties respectively of pears, peaches, plums, apricots and cherries for each district, and for the Valley as a whole. In the case of apricots and cherries, many varieties were unknown, and consequently, the percentage of fruits listed as "all others" is, in these cases, quite large.

Tables X, XI and XII.—These tables show the number of trees of apples, pears and peaches, respectively, in each of the fruit districts, separated into the age classes as defined on Page From this we learn that the Clifton District has 196,000 apple trees from seven to ten years old, and only 46,000 over sixteen years old (Table X); that there are 20,300 pear trees in the Palisade District, and 47,750 in the Clifton District less than seven years old (Table XI); that the Palisade District contains 214,000 peach trees from seven to ten years old (Table XII).

Diagrams 10, 11 and 12.—Adapted from the above tables and show graphically what these tables contain.

Tables Xa, XIa and XIIa.—These tables are constructed from Tables X, XI and XII to show what part of all the trees of any age in the entire Valley are planted in each separate district. These are given in percentage form. Thus we see that 33.4% and 32.2% of the apple trees one to six years old are planted in the Clifton and Loma Districts, respectively, while only 6% are in the Palisade District, etc.

Tables Xb, XIb and XIIb.—By referring to these tables we may find what percent of the trees of any district are of any given age class. For example, from Table XIIb, it is found that 66.8% of all the peaches of the Valley were planted seven to ten years ago, when the fruit business was at its height.

Tables XIII, XIV and XV give the percentage of trees in each age class for plums, apricots and cherries and also show the total number of trees for each age class and for each district.

TABLE I.—SHOWING NUMBER OF FRUIT TREES IN EACH DISTRICT.

District	Apples	Pears	Peaches	Plums	Apricots	Cherries	District Totals
Palisade	42,750	44,500	320,000	1,750	2,200	5,300	416,500
Clifton	354,000	149,500	69,000	2,150	800	3,175	578,625
Grand Junction	134,750	67,000	10,500	1,600	350	3,150	217,350
Fruita	129,750	13,600	5,400	500	250	1,075	150,575
Loma	88,750	400	100	300	89,550
Valley Totals..	750,000	275,000	405,000	6,000	3,600	13,000	1,452,600

TABLE Ia.—DISTRIBUTION (IN PERCENTAGES) OF TOTAL NUMBER OF TREES OF EACH FRUIT IN GRAND VALLEY BY DISTRICTS.

District	Apples	Pears	Peaches	Plums	Apricots	Cherries	Entire Valley
Palisade	5.7	16.2	79.0	29.2	61.0	40.8	28.6
Clifton	47.2	54.3	17.1	35.8	22.3	24.4	39.8
Grand Junction... .	18.0	24.3	2.6	26.7	9.7	24.2	15.0
Fruita	17.3	5.0	1.3	8.3	7.0	8.3	10.4
Loma	11.8	0.2	2.3	6.2
Total	100.0	100.0	100.0	100.0	100.0	100.0	100.0

TABLE Ib.—SHOWING RATIO IN PERCENT EACH FRUIT BEARS TO TOTAL NUMBER OF FALL FRUIT TREES FOR EACH DISTRICT.

District	Apples	Pears	Peaches	Plums	Apricots	Cherries	Total
Palisade	10.2	10.7	77.0	0.4	0.5	1.2	100.0
Clifton	61.2	25.9	11.8	0.4	0.1	0.6	100.0
Grand Junction... .	62.2	30.9	4.8	0.7	...	1.4	100.0
Fruita	86.1	9.1	3.6	0.3	0.2	0.7	100.0
Loma	99.0	0.5	0.1	0.4	100.0
Entire Valley.....	51.5	19.0	28.0	0.4	0.2	0.9	100.0

INVENTORY OF FRUIT TREES

In making the survey, a careful record was kept regarding the number and varieties of all of the various fruits. These data, when compiled, gave the approximate number of each variety of fruit grown. The more important data are listed in tables, and by referring to them one may learn very nearly the position which these varieties hold in Grand Valley and each of the districts thereof.

As is shown in Tables I and II, there are 10,250 acres of apples comprising 750,000 trees; 2,400 acres of pears, or 275,000 trees; 3,000 acres of peaches, 405,000 trees; 190 acres of plums, apricots and cherries, comprising together, 22,600 trees. This gives a total for all fruits of 15,840 acres, or 1,452,600 trees. From this it may be seen that of the total number of fruit trees, 51.5 are apples, 19% pears, 28% peaches, 4% plums, 2% apricots, and 9% cherries. Approximately 75% of the apples, 70% of the pears, 90% of the peaches, and 90% of the plums, apricots and cherries are in bearing. Of all the trees listed in the Palisade District, 77% are peaches, 10.7% pears, 10.2% apples, and 2.1% other fruits (plums, apricots and cherries).

The Clifton District has 61.2% apples, 25.9% pears, 11.8% peaches, and 1.1% other fruits.

TABLE II.—NUMBER OF ACRES OF ORCHARD FOR EACH DISTRICT IN GRAND VALLEY.

	Palisade	Clifton	Grand Jct.	Fruita	Loma	Valley Totals
Apples	520	4,515	2,010	1,855	1,350	10,250
Pears	350	1,260	650	136	4	2,400
Peaches	2,375	500	80	44	1	3,000
Plums, Cherries and Apricots...	78	52	42	15	3	190
Totals, All Fruits.....	3,323	6,327	2,782	2,050	1,358	15,840

TABLE IIa.—NUMBER OF ACRES ORCHARD OF BEARING AGE FOR EACH DISTRICT.

	Palisade	Clifton	Grand Jct.	Fruita	Loma	Valley Totals
Apples	388	3,750	1,572	1,530	450	7,690
Pears	190	857	481	125	1—	1,654
Peaches	2,175	463	62	43	1—	2,744
Plums, Cherries and Apricots	66	47	47	10	3—	173
Totals, All Fruits.....	2,819	5,117	2,162	1,708	455	12,264

Grand Junction has 62.2% apples, 30.9% pears, 4.8% peaches, and 2.1% other fruits.

Fruita District has 86.1% apples, 9.1% pears, 3.6% peaches, and 1.2% other fruits.

In the Loma District, 99% of all the fruit trees are apples, .5% pears, .1% peaches, and .4% other fruits.

From Table Ia, it is seen that 79% of all the peaches grown in the Valley are in the Palisade District, 54.3% of the pear trees, and 47.2% of the apple trees are in the Clifton District. The table also shows the Clifton District to contain 39.8% and the Palisade District 28.6% of all the fruit trees in the Valley.

TABLE III.—NUMBER CARS OF FRUIT SHIPPED BY FREIGHT FROM GRAND VALLEY FOR YEARS 1911 TO 1915 INCLUSIVE.

	1911	1912	1913	1914	1915	5-Year Total
Apples	1,253	1,627	813	2,622	145	6,460
Pears	212	314	228	519	55	1,328
Peaches	149	1,336	856	1,302	744	4,387
Mixed Fruits	36	86	89	121	46	378
Valley Totals, All Fruits.....	1,650	3,363	1,986	4,564	990	12,553

NUMBER CARS OF FRUIT SHIPPED FROM GRAND VALLEY FOR YEARS 1911 TO 1915 INCLUSIVE AND NUMBER FROM EACH SHIPPING POINT.

TABLE IIIa.—APPLES.

	1911	1912	1913	1914	1915	5-Year Total
Palisade	138	73	117	117	51	496
Clifton	258	405	226	861	30	1,780
Grand Junction	645	760	412	1,307	64	3,188
Fruita	212	389	58	336	...	995
Loma	1	...	1
Valley Totals, by Years.....	1,253	1,627	813	2,622	145	6,460

TABLE IIIb.—PEARS.

	1911	1912	1913	1914	1915	5-Year Total
Palisade	19	22	36	36	24	137
Clifton	56	97	74	198	6	431
Grand Junction	137	193	118	285	25	758
Fruita	2	2
Valley Totals, by Years.....	212	314	228	519	55	1,328

TABLE IIIc.—PEACHES.

	1911	1912	1913	1914	1915	5-Year Total
Palisade	138	989	851	1,091	733	3,802
Clifton	10	215	3	168	...	396
Grand Junction	1	131	2	43	11	188
Fruita	1
Valley Totals, by Years.....	149	1,336	856	1,302	744	4,387

TABLE III d.—MIXED FRUITS.

	1911	1912	1913	1914	1915	5-Year Total
Palisade	17	25	81	58	45	226
Clifton	25	2	34	...	61
Grand Junction	19	36	6	29	1	91
Valley Totals, by Years.....	36	86	89	121	46	378
Valley Totals by Yrs., All Fruits	1,650	3,363	1,986	4,564	990	12,553

APPLES

The apple has been grown commercially in Grand Valley for only about 25 years, although much of the Valley is especially adapted to its culture. It was here that Colorado apples first came into prominence, and this section of the country was one of the first to adopt the box pack for apples. The fruit developed wonderfully and so far surpassed eastern fruit that the sale for it was practically unlimited. The prices obtained were very good, and the pioneer apple growers reaped rich returns for a few years.

Soon there was a mad rush into the business. All kinds of trees were planted under all kinds of conditions. Nurserymen sold badly mixed up lots of trees, and the result was that over 150 varieties were grown in the Valley. There are still over 100 varie-

ties grown, but only ten varieties which include over 1% each of the apples. They are, in order of importance, Jonathan, Winesap, Gano, Ben Davis, Missouri Pippin, Rome Beauty, Arkansas (Mammoth Blacktwig), White Winter Pearmain, York Imperial, and Delicious. The first six of these comprise 85.7% of the total trees planted. Table IV and Diagram 4 show the percentage of each of these varieties in each district and in the Valley as a whole. Note that there are three varieties which have a larger percentage than the miscellaneous varieties (over 100 in all), which are listed as "All Others."

The Jonathan is by far the most important apple grown. Over one-fourth of all the annual output is of this variety. The Jonathan is a fall variety, ripening in September, and is a splendid dessert apple. It thrives well under a variety of conditions, and is usually an annual bearer. The demand for this apple is always good.

The Winesap is second in rank. It is a greenish-red winter apple with a spicy flavor and is a general favorite with most persons. It seldom attains good size, but bears very heavily.

Gano is rapidly replacing Ben Davis, of which it is a seedling. It resembles the Ben Davis very much in appearance but is solid red, instead of being striped. It has a somewhat better flavor than the Ben Davis, and, like this apple, is a splendid keeper, often holding up well until the early summer apples come on. It is rather inferior in quality, but is very much in demand in southern



A Perfect Apple Orchard Twenty-five Years Old in Grand Valley.

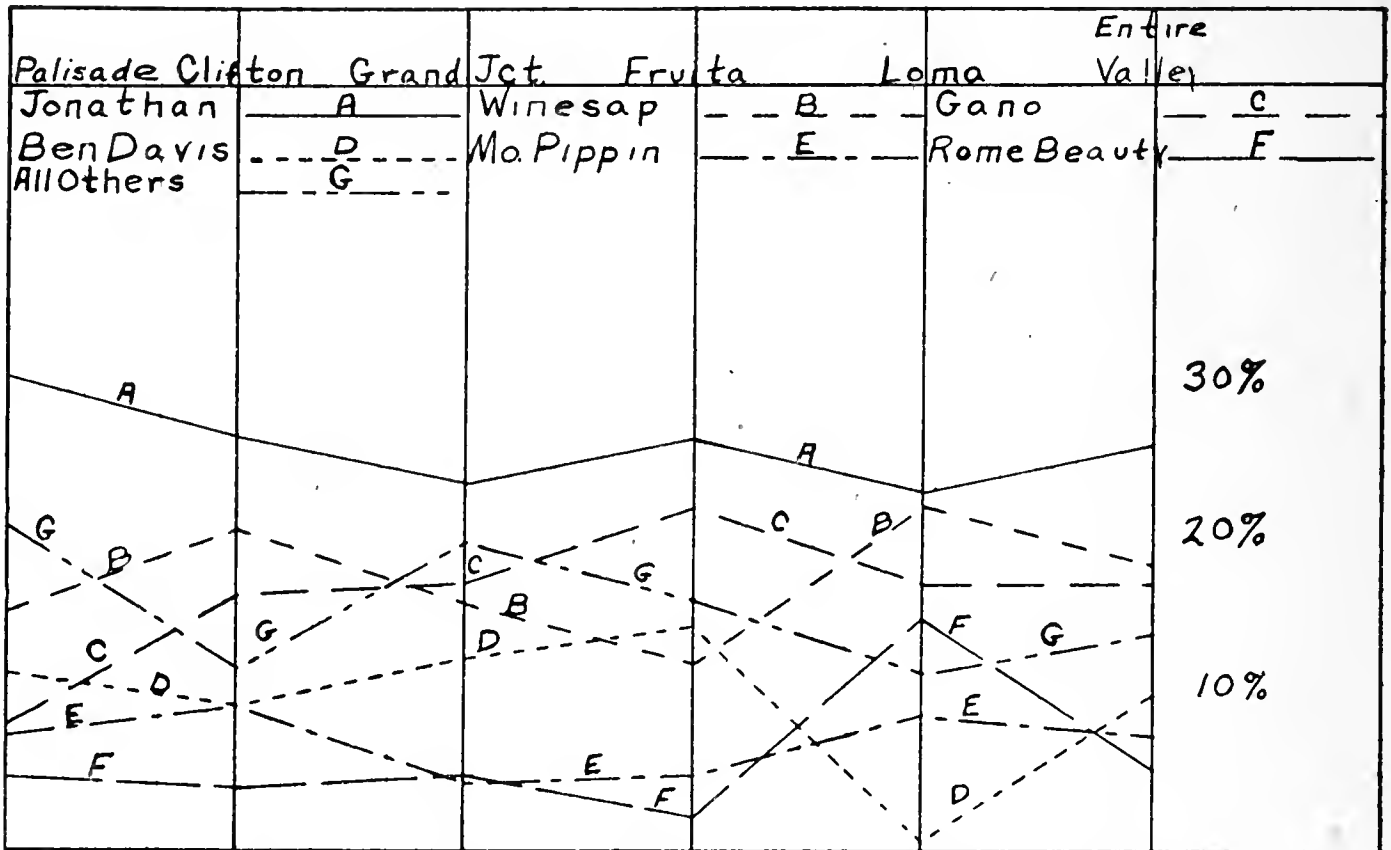

Diagram 4.—Percentage of Principal Varieties of Apples for Each District and for Valley as a Whole (Adapted from Table IV).

CULTURAL METHODS

As a general thing, apple orchards are cover cropped. Alfalfa and clover are mostly used for this purpose. Where properly treated, this is undoubtedly beneficial to the trees, since it adds fertility and humus to the soil and keeps the soil in better condition than when cultivated. Clover is the more desirable of the two, since it is easier to eradicate.

Many growers in 1915 took a fair yield of hay from their orchard cover crops. Ordinarily, this practice is to be condemned, but in most cases since there was no fruit crop, it did not injure the trees noticeably.

PRUNING

In order to produce apples of good size and color, regular pruning is essential. This must be done systematically and intelligently, but fearlessly. The object should be to thin out surplus wood growth, keeping the trees open to light and air, and to induce a low-spreading form of tree rather than a high and narrow one. A considerable amount of thinning may be eliminated by proper pruning.

Few orchardists have paid enough attention to pruning. The failure has been not to prune regularly or properly, and often both are wanting. Many trees are headed and pruned high, so that a very long ladder is necessary for picking. Most of the younger orchards, however, are better pruned.

THINNING

In ordinary years thinning is absolutely essential to the growing of fruit of marketable size. One must be heartless in order to do good work at thinning, as it is often necessary to remove over half of the apples. It is a paying proposition in the end, as more first-grade fruit is produced than if no thinning had been done.

One can best learn to thin fruit by watching somebody who is expert at this work. By looking at a tree properly thinned and trying to follow this as a model, one soon learns just how much fruit to leave on the tree.

DISTANCE OF PLANTING

The writers were amazed to find apple trees planted so thickly in the Grand Valley orchards. In the majority of cases the trees were set 20 feet or less apart. Common distances of planting were 16x20 feet and 18x20 feet, and several orchards were even set 15x15. One case is recalled of an orchard about 20 years old set 15x15 in which the trees were so interlaced that sunlight seldom touches the ground. There are several such orchards in the Valley.

Permanent apple trees should not be closer than 25 feet each way, and 30 feet is better, depending of course, upon the variety. When set at this distance, fillers may be used, but they should be removed as soon as they interfere with the permanent trees. The latter will occupy very nearly all of the space when they attain their full growth.

One of the best young orchards in the Valley is that of Warren Walker, one-half mile north and one-fourth mile east of Fruitvale Switch. It is a ten-year-old orchard of Jonathan, Gano and Winesap apples set 25x30 feet, and shows what can be obtained with proper setting and good care.

FILLERS

A filler is a temporary tree placed between the permanent ones to be removed before it interferes with them. The trees selected for fillers are usually short-lived and come into bearing early. The majority of the orchards in Grand Valley have been planted with fillers, mostly of the pomaceous fruits though stone fruits are sometimes used for this purpose.

The use of fillers is to be recommended where there is ample room between permanent trees, and where the fillers are taken out in time. Too often the fillers are left long enough to spoil the shape of the permanent trees. This practice is the rule rather than the exception and should be condemned.

Missouri Pippin is the apple most used for fillers, and is admirably adapted to this purpose. It is a small tree, short-lived, and an early and heavy bearer. Grimes Golden, too, is well suited for use as a filler. Pears are also often used and serve the purpose very well. Bartlett and Keiffer are the best for Grand Valley. Peaches and cherries are sometimes planted as fillers, but so little of the apple territory is adapted to their growth that they are almost excluded as fillers among the apples.

SPRAYING

Spraying is absolutely imperative for the production of good apples. The codling moth is so bad in Grand Valley that many growers spray eight to ten times a season, thinking thereby to get clean fruit. As a matter of fact, their fruit is no less wormy than it would have been with four or five sprays applied at the right time. It is the concensus of opinion of the Grand Valley orchardists that with less than four sprays it is impossible to grow clean fruit. However, it has often been proven that fully as much depends upon the time and thoroughness of spraying as upon the number of applications.

The amount of arsenate of lead paste used per 200-gallon tank varies from 5 to 16 lbs., with an average for the Valley of 9 lbs. This is somewhat more than necessary. Eight pounds is enough when kept well agitated in the tank. The powder form of arsenate of lead is used by many in preference to paste. Only half as many pounds of poison is necessary when the powdered form is used.

Pears are sprayed the same as apples except that the calyx spray is omitted, since the calyxes do not close.

The average percent of the clean fruit for the Valley, according to the growers' estimates, is $77\frac{1}{2}\%$ for apples and $87\frac{1}{2}\%$ for pears. The estimates vary from 50% to 98% .

The spraying of peaches for twig borer varies from nothing to two applications of spray per year. Few growers, however, can be accused of spraying peaches twice a year. The best practice is to give a dormant spray of lime-sulphur every year just before the buds begin to open. The trees which are regularly sprayed with this solution are more healthy and the fruit is cleaner than when the trees are not sprayed. Some growers prefer arsenate of lead applied shortly after the buds have opened, but general usage favors lime-sulphur.

The spraying should be done according to directions of the State Entomologist, who will gladly furnish instructions for this work.

Probably less than half of the fruit growers own spraying machines. This means that they must hire a machine to do their spraying. This is usually more expensive and less satisfactory than having a machine of one's own, because the rented sprayers can not always be had at the most effective time for spraying.

The usual charge for a man, team and sprayer is \$1.00 for each tank (200 gallons) of arsenical spray applied and \$1.25 per tank for lime-sulphur.

PEARS

From a financial standpoint, the pear seems to be the best fruit for Grand Valley to grow. Most pears are grown here to perfection, and the supply is seldom greater than the demand on any good market.

Pears thrive on a heavier soil and succeed where the stone fruits fail. They also stand more neglect than the other tree fruits. Their chief drawback is the danger from pear blight.

PEAR BLIGHT

Pear blight, also known as fire blight, spur blight, blossom blight and body blight, is a bacterial disease which has caused the loss of thousands of good pear trees in Grand Valley. The disease was very prevalent in 1915. While it was found all over the Valley, it was worse in a few localities, as for example, just east of Grand Junction, about six miles northwest of Grand Junction, on Orchard Mesa southeast of Grand Junction, and a few localities at Palisade, where the attacks were less severe.

Blight is usually associated with succulent wood growth caused by too much irrigation. It also gives evidence of being related more or less directly to injury by late spring frosts. As blight was found on some orchards which had not been watered and which had made very little wood growth the preceding year, it seemed very plausible that the blight was materially aided by frost. There is no known cure for the disease. The best method of control is to cut out the branches as soon as the blight is discovered. The cut should be made 10 inches or more below the point where the blight occurs. The limb should never be cut off and left as a stub, but should be removed to the nearest lateral branch.

As a precaution against spreading the disease, the tools should be disinfected by dipping into a 1-1000 solution of corrosive sublimate. Nearly all of the blight in Grand Valley in 1915 gave evidence of starting in the blossoms. Some of it did little damage except to the fruit spurs. In many orchards, however, where fruit

spurs were located on scaffold branches, the disease spread so that the entire limb had to be removed.

Many cures for blight have been advertised and some of them have been tried out by Grand Valley fruit growers. They usually consist of a paint which is applied to the trees, the supposition being that some poisonous substance in the paint will penetrate the bark and be carried in the circulation of the sap and thus kill the bacteria which cause the disease. This belief is erroneous, however, as it is not in the least effective in curing the disease. The authors saw some of these paints tried, and trees which had been painted with it blighted as badly as those to which it had not been applied. The best and surest method of preventing blight is to keep the trees in a slow growing condition by refraining from too frequent irrigation or over-cultivation.

There is a great varietal difference in resistance to blight. Keiffer withstands the disease exceptionally well. Anjou, Garber and Lawrence are fairly resistant while Bartlett and P. Barry are very susceptible to blight.

Pears are grown most extensively in the three eastern districts of the Valley. Clifton takes first place in the production of pears, having 54.3% of the trees in the Valley. Grand Junction is second with 24.3%, and Palisade, third, with 16.2%.

At Palisade nearly half, and at Loma over nine-tenths of the pears have never borne fruit, but two-thirds of the pear trees of the Clifton District, three-fourths of those in the Grand Junction District, and nine-tenths of the pears in the Fruita District are of bearing age.

In the Palisade District, a good many pears are being planted, often replacing peaches. The Loma District has but few pears, and almost all of the trees are young. Practically no pear trees are being planted in the Fruita District, and very few in the Grand Junction District. There are some pear orchards in these two districts whose development it will be interesting to watch. Chief of these are the Wallace orchard about one mile south of Hollandville, the Copeco orchard two miles east of the Hunter schoolhouse, and the Chula Vista orchard one and one-half miles north of the Copeco ranch. These are all large orchards and are planted to good varieties.

VARIETIES

Bartlett is the most popular pear grown in Mesa County. Almost one-half of the trees are of this variety. The Bartlett trees in the Clifton District alone constitute one-fourth of all the pears

in the Valley. This pear ripens in August. It is of good quality and sells well. The tree bears regularly, but is very susceptible to blight.

TABLE V.—THREE PRINCIPAL VARIETIES OF PEARS, SHOWING PERCENTAGE GROWN IN EACH DISTRICT AND IN ENTIRE VALLEY.

Variety	Palisade	Clifton	Grand Jct.	Fruita	Loma	Entire Valley
Bartlett	56.6	46.5	44.5	25.5	7.8	47.5
Keiffer	26.8	33.8	32.2	28.4	52.2	31.8
Anjou	5.3	8.6	12.7	23.2	9.6	9.8
All others (over 40 varieties)	11.3	11.1	10.6	22.9	30.4	10.9
Totals	100.0	100.0	100.0	100.0	100.0	100.0

Keiffer ranks second in importance. It is a late fall pear, rather poor in quality, and much used for canning. It is an excellent shipper and a good keeper. The tree is very vigorous, an upright grower, and quite resistant to blight. Due to the prevalence of blight in Grand Valley, it is very well adapted for planting.

Anjou comprises nearly 10% of the Grand Valley pear trees. It is a wonderful pear and brings top prices on the market. The fruit ripens late in the fall and keeps well. The quality is excellent. Anjou is fairly resistant to blight, and should be more commonly planted. Its chief faults are, coming into bearing late and not bearing a full crop every year. These failings may be somewhat corrected by judicious pruning.

There are five other varieties, each of which includes 1% or more of the total pears of the Valley. They are: Winter Nelis, 1.8%; Flemish Beauty, 1.7%; Garber, 1.3%; Lawrence, 1.3%; P. Barry, 1%.

About 50 varieties are grown, but those mentioned are the most important. There will probably be many pear trees planted in Grand Valley in the future, and this list should serve as a guide in choosing varieties.

CULTURAL METHODS

Clean cultivation and cover cropping are about equally divided among pears. Cover crops are used more in the western part of the pear belt, while in the eastern part, clean culture is the rule. There is perhaps less tendency to blight when a cover crop is grown. The trees seem to do better when this practice is followed, although they are usually slower growing than when under clean culture. Too frequent irrigations accompanying continued clean cultivation have been the ruin of many good pear orchards.

PRUNING

Pears require considerably less pruning than apples. A common belief is that they should not be pruned any more than is ab-

solutely necessary. This is wrong, however, as experience has shown that many bad habits may be rectified by proper pruning. Smallness of fruit and irregularity of bearing are among the ills which may be largely corrected in this manner. The pruning of pears has been too much under-estimated and neglected by Mesa County growers.

THINNING

It is essential that in the normal crop year pears should be thinned in order to get proper size. Thinning also tends to promote annual bearing instead of biennial crops as often occur when pears are allowed to mature too heavy crops. If the pear growers would thin heavier, the demand for Colorado pears and the net return from them would increase.

DISTANCE OF PLANTING

Like apple trees, pears are often set much too closely. While they should be allowed 18 or 20 feet, they are often set 15 feet apart, and sometimes as close as 12 feet, in which case the orchards develop into veritable thickets. It is farcical to believe that the profits increase with the number of trees per acre. It will be a glorious day for horticulture when orchardists give their trees plenty of room to develop.

PEACHES

“Palisade Peaches” is a term that has been as popular as “Rocky Ford Melons.” There was, indeed, good reason for this, since the Palisade products were superior to nearly all others on the market. The Palisade District is especially adapted to peach growing. Most of the soil is of a sandy loam character, naturally well drained, and easily worked.

The orchards on the north extend clear to the foot of the cliffs, which rise abruptly to a height of several hundred feet above the Valley. These bluffs absorb the heat of the sun and radiate the heat so strongly that peaches grown next to them are from one to several days earlier than those grown lower down. These bluffs are also a great protection against frost. Some growers report that the blush on peaches grown close to the bluffs is often on the side nearest the cliffs, due to the additional heat.

VARIETIES

The Elberta has been the leading variety in Palisade, as in nearly all commercial peach sections. Although there are over 50 varieties grown in Grand Valley, five-sixths of the trees are El-

bertas. This variety is a freestone, attractive in appearance, a good shipper, and splendid for canning, although rather poor in quality.

Carman ranks second in number of trees, with 3.8% for the Valley as a whole. It is a freestone, creamy white, with a delicious flavor, flesh sometimes streaked with red near the seed, an excellent peach.

Only four other varieties, comprising more than 1% each of the peaches of the Valley, are grown. These are: Salway, 1½%; Crawford, 1.3%; Triumph, 1.1%, and Champion, 1.1%. All other varieties combined constitute 7.3%.

The early peaches are not commercially profitable. They do not stand up well under shipment and the market for them is very limited. Their use must be confined largely to planting for local market.

CULTURAL METHODS

As a general thing, peaches are clean cultivated. Many orchards have been thus handled for so long that practically all the organic matter is burnt out of the soil. The soil in these cases bakes easily and is hard to handle.

Practically all of the peach orchards in which clover or alfalfa was grown and properly handled appeared to be in much better condition than those which had been continually clean cultivated. Some growers, of course, use the cover crop as hay, but where this is done the trees suffer from the treatment. The cover crop is intended to provide organic matter for the land and reduce evaporation of soil moisture. It is ridiculous to suppose that the cover crop can be removed from the land without injury to the trees, for the land cannot support two crops successfully where nothing is returned to it.

Some of the best peach growers in the Valley practice clean cultivation, but supply large amounts of stable manure every year. This supplies the organic matter which is so essential for successful fruit growing. The chief drawback in this practice is the scarcity of manure available. Cover cropping will be best for the majority of orchardists.

PRUNING

The peach is a tree that requires very heavy pruning. Unless severely pruned, insufficient new wood is formed to provide for the next year's crop. Whenever neglected, the fruit will be small and unprofitable. Good growers always pay close attention to their pruning.

THINNING

Thinning is another item that is of extreme importance. The majority of growers do not thin enough, and as a result their fruit is too small to be of first-grade. There is very little danger of thinning too much.

DISTANCE OF PLANTING

There has been a tendency in the past to plant peaches too close together. Numerous orchards have the trees 15x15 feet, and some even less. This is entirely too close. For proper development they should be at least 18, and preferably 20 feet apart.

TABLE VI.—PRINCIPAL VARIETIES OF PEACHES WITH PERCENTAGE GROWN IN EACH DISTRICT AND IN ENTIRE VALLEY.

Variety	Palisade	Clifton	Grand Jet.	Fruita	Entire Valley
Elberta	83.0	88.0	80.5	73.5	83.9
Carman	3.6	4.6	4.4	6.6	3.8
Salway	1.7	0.7	1.5	...	1.5
Crawford	1.3	0.8	0.7	...	1.3
Triumph	1.1	0.7	1.1	...	1.1
Champion	1.0	1.0	2.1	...	1.1
All others (about 50 varieties).....	8.3	4.2	9.8	19.9	7.3
Totals	100.0	100.0	100.0	100.0	100.0

PLUMS

Plums are not grown very extensively in Mesa County, totaling only about 6,000 trees, and are grown mostly in the eastern part of the Valley. They are not profitable commercially as a rule, although some varieties yield very fair returns.

Satsuma is the leading variety, numbering almost one-fifth of all the plum trees. It is a good-sized plum with a dark-red skin and firm meat. It is one of the Japanese plums, an upright grower and a fair bearer.

The Italian prune comprises 18.2% of the plums. In size it is medium to large, with dark-blue skin, firm greenish-yellow flesh and good quality. It is a general favorite among the prunes.

The other important varieties, with percentage of each grown, are: Burbank, 9.4%; Agen (French prune), 7.2%; Wild Goose, 6.5%; Hungarian prune, 4.6%; Red June, 4%; Golden Drop (Silver prune), 3.2%; Damson, 3%; Green Gage, 2.5%; Bradshaw, 2.1%; Abundance, 1.8%; Peach, 1.8%.

CULTURE OF PLUMS

Plums are pruned less heavily than peaches, but are thinned much the same. It is almost impossible to prune the native plums satisfactorily, as they are such bushy growers. European and Japanese plums are adapted to almost the same conditions as the peach.

Prunes are also considered under plums in this discussion.

The native varieties are hardier and succeed under less favorable conditions. Plums should be set 18 to 20 feet apart and given about the same cultural treatment as peaches.

TABLE VII.—PRINCIPAL VARIETIES OF PLUMS AND PRUNES, WITH PERCENTAGE GROWN IN EACH DISTRICT AND IN ENTIRE VALLEY.

Variety	Palisade	Clifton	Grand Jct.	Fruita	Entire Valley
1. Satsuma	29.3	17.2	19.0	2.9	19.5
2. Italian Prune	12.8	26.5	15.0	12.4	18.2
3. Burbank	10.5	9.4	6.7	15.0	9.4
4. Agen (French Prune).....	3.9	9.4	4.5	7.2
5. Wild Goose	3.0	2.5	8.1	30.5	6.5
6. Hungarian Prune	9.5	4.5	1.7	4.6
7. Red June	5.8	2.2	5.8	4.0
8. All others (15 varieties).....	29.1	33.8	34.3	34.7	30.6
Totals	100.0	100.0	100.0	100.0	100.0

TABLE VIII.—PRINCIPAL VARIETIES OF APRICOTS, WITH PERCENTAGE FOR EACH DISTRICT AND FOR ENTIRE VALLEY.

Variety	Palisade	Clifton	Grand Jct.	Fruita	Entire Valley
Montgamet	38.0	3.6	1.4	...	24.8
Moorpark	18.0	19.0	19.0	41.5	19.8
Newcastle	13.5	0.7	8.7	...	8.7
Royal	7.3	4.7
Miscellaneous and unknown.....	23.2	76.7	70.9	58.5	42.0
Totals	100.0	100.0	100.0	100.0	100.0

APRICOTS

Only about 3,600 apricot trees are grown in Mesa County, and nearly two-thirds of them are in the Palisade District. They are not very popular with the fruit growers, although it is difficult to understand why they are not grown more extensively.

Apricots thrive under about the same conditions as are required by the peach, although they are somewhat more discriminating. They need about the same care as the peach. Apricots are not very well known by the growers, as to variety, consequently, nearly one-third of the apricots were listed as unknown varieties. Of those known varieties the leading ones were Montgamet, 24.8% ; Moorpark, 19.8% ; Newcastle, 8.7% ; Royal, 4.7% . The miscellaneous and unknown varieties constitute the remaining 42% .

CHERRIES

Grand Valley has about 30 varieties of cherries, comprising approximately 1,300 trees. Palisade leads in the number of trees, followed by Clifton and Grand Junction.

Comparatively few cherries are grown in the western part of the Valley, the conditions here being too severe for their proper development. Many varieties of cherries are grown the names of

which are unknown to growers, 10% of the trees listed being classed as unknown.

VARIETIES

Royal Duke, 41%, a semi-acid cherry, is the leading variety. It is an upright grower, bearing large, dark-red fruit which has red, tender flesh of excellent quality. It is the favorite cherry and a good seller.

Early Richmond, 18%; Montmorency, 11%; English Morello, 4.9%. These three are sour cherries and are the hardiest varieties grown in the Valley. For canning they are excellent.

Napoleon (Royal Anne), 4.9%, and "Sixteen-to-One," 4.7%, are both sweet cherries and complete the six largely grown varieties.

Other, less important varieties are: Mayduke, 2%; Republican, 1.3%; Olivet, 1%, and Bing, 1%.

CULTURE OF CHERRIES

Cherries need 16 to 20 feet distance in the orchard, according to varieties. They demand a fairly dry soil and should be cultivated much the same as the peach and apricot. Little pruning is necessary, although moderate pruning increases the size of the fruit and induces more regular bearing. Sour cherries are tolerably hardy and will endure more rigorous conditions than the sweet varieties. The latter succeed only under favorable conditions.

Cherries have not been very successful commercially in Grand Valley, and will probably be grown only to a limited extent for outside markets.

TABLE IX.—PRINCIPAL VARIETIES OF CHERRIES, WITH PERCENTAGE GROWN IN EACH DISTRICT AND IN ENTIRE VALLEY.

Variety	Palisade	Clifton	Grand Jct.	Fruita	Loma	Entire Valley
Royal Duke	51.2	40.3	37.8	3.7	3.8	41.0
Early Richmond	13.5	22.2	16.6	32.2	...	18.0
Montmorency	4.7	10.5	17.6	7.7	30.4	11.0
English Morello	3.8	2.8	7.8	4.3	16.6	4.9
Napoleon	6.5	5.7	2.7	1.0	...	4.9
16 to 1	2.4	7.6	4.6	1.9	22.6	4.7
All others (20 varieties).	17.9	10.9	12.9	49.2	26.6	15.5
Totals	100.0	100.0	100.0	100.0	100.0	100.0

TABLE X.—NUMBER OF APPLE TREES OF EACH DISTRICT BY AGE CLASS.

Age Class	Palisade	Clifton	Grand Jct.	Fruita	Loma	Totals
1- 6 Years	11,000	61,000	29,500	22,500	59,000	183,000
7-10 Years	14,000	196,000	60,000	51,500	26,500	348,000
11-15 Years	11,000	51,000	13,250	18,750	1,500	95,500
16 and above.	6,750	46,000	32,000	37,000	1,750	123,500
Totals	42,750	354,000	134,750	129,750	88,750	750,000

TABLE Xa.—PERCENTAGE OF APPLE TREES OF EACH AGE CLASS PLANTED IN EACH DISTRICT.

Age Class	Palisade	Clifton	Grand Jct.	Fruita	Loma	Totals
1- 6 Years	6.0	33.4	16.1	12.3	32.2	100.0
7-10 Years	4.0	56.4	17.2	14.8	7.6	100.0
11-15 Years	11.5	53.5	13.8	19.6	1.6	100.0
16 and above.....	5.5	37.2	25.9	30.0	1.4	100.0

TABLE Xb.—PER CENT OF APPLE TREES OF EACH DISTRICT WITH RESPECT TO AGE.

Age Class	Palisade	Clifton	Grand Jct.	Fruita	Loma	Totals
1- 6 Years	25.7	17.0	21.8	17.5	66.4	24.4
7-10 Years	32.8	55.5	44.4	39.6	30.0	46.4
11-15 Years	25.8	14.5	9.8	14.3	1.6	12.7
16 and above.....	15.7	13.0	24.0	28.6	2.0	16.5
Totals	100.0	100.0	100.0	100.0	100.0	100.0

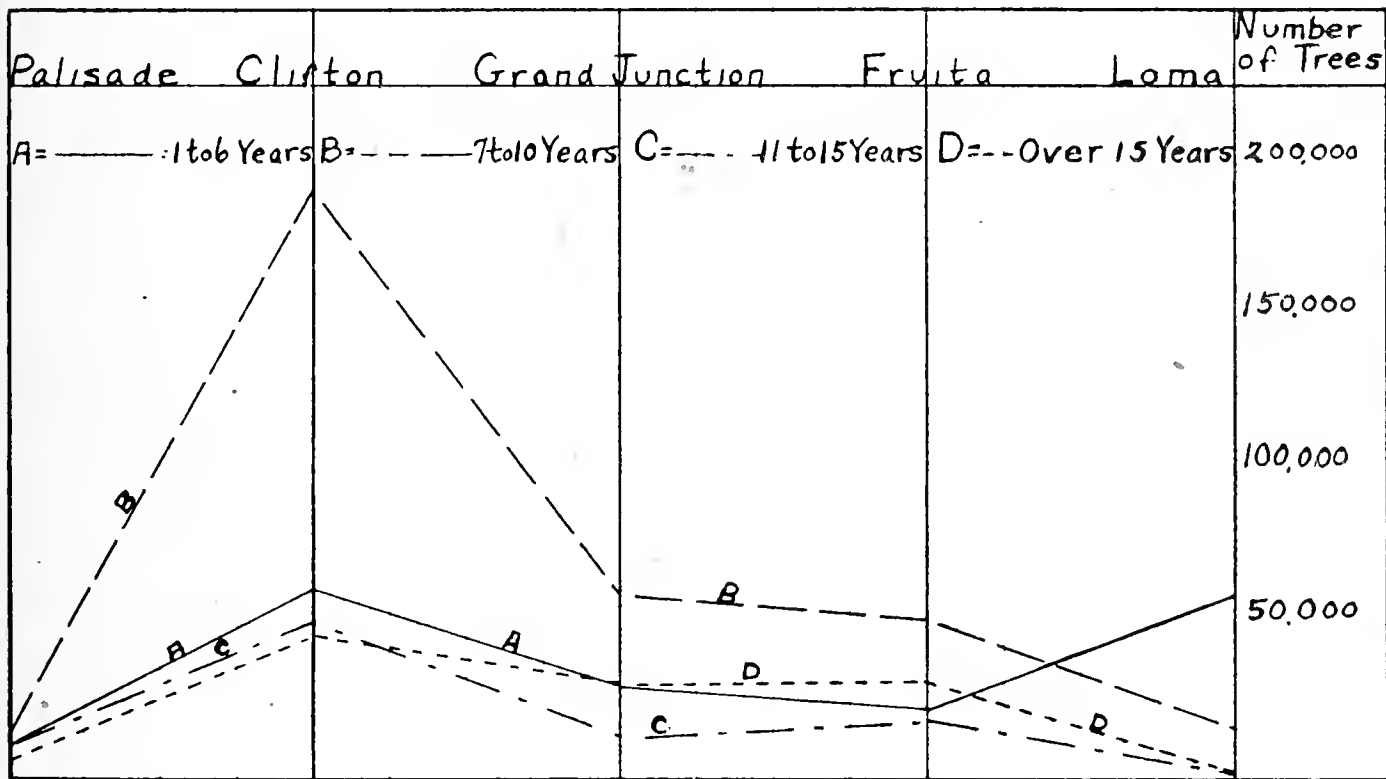

Diagram 10.—Number of Apple Trees in each Age Class for each District (Adapted from Table X).

TABLE XI.—NUMBER OF PEAR TREES OF EACH DISTRICT AND OF ENTIRE VALLEY BY AGE CLASS.

Age Class	Palisade	Clifton	Grand Jct.	Fruita	Loma	Entire Valley
1- 6 Years	20,300	47,750	17,400	1,100	365	86,915
7-10 Years	9,900	62,000	30,200	11,000	10	113,110
11-15 Years	7,700	22,500	8,500	600	39,300
16 and over.....	6,600	17,250	10,900	900	25	35,675
Totals	44,500	149,500	67,000	13,600	400	275,000

TABLE XIa.—PERCENTAGE OF PEAR TREES OF EACH AGE CLASS FOR EACH DISTRICT.

Age Class	Palisade	Clifton	Grand Jet.	Fruita	Loma	Entire Valley
1- 6 Years	23.2	55.0	20.0	1.4	0.4	100.0
7-10 Years	8.7	54.9	26.8	9.6	...	100.0
11-15 Years	19.6	57.2	21.7	1.5	...	100.0
16 and over.....	18.5	48.0	30.3	2.5	0.7	100.0

TABLE XIb.—PERCENTAGE OF PEAR TREES OF EACH DISTRICT WITH RESPECT TO AGE CLASS.

Age Class	Palisade	Clifton	Grand Jet.	Fruita	Loma	Entire Valley
1- 6 Years	45.6	32.0	26.0	8.0	91.2	31.7
7-10 Years	22.2	41.4	45.2	81.0	2.5	41.0
11-15 Years	17.3	15.0	12.6	4.4	...	14.3
16 and over.....	14.9	11.6	16.2	6.6	6.3	13.0
Totals	100.0	100.0	100.0	100.0	100.0	100.0

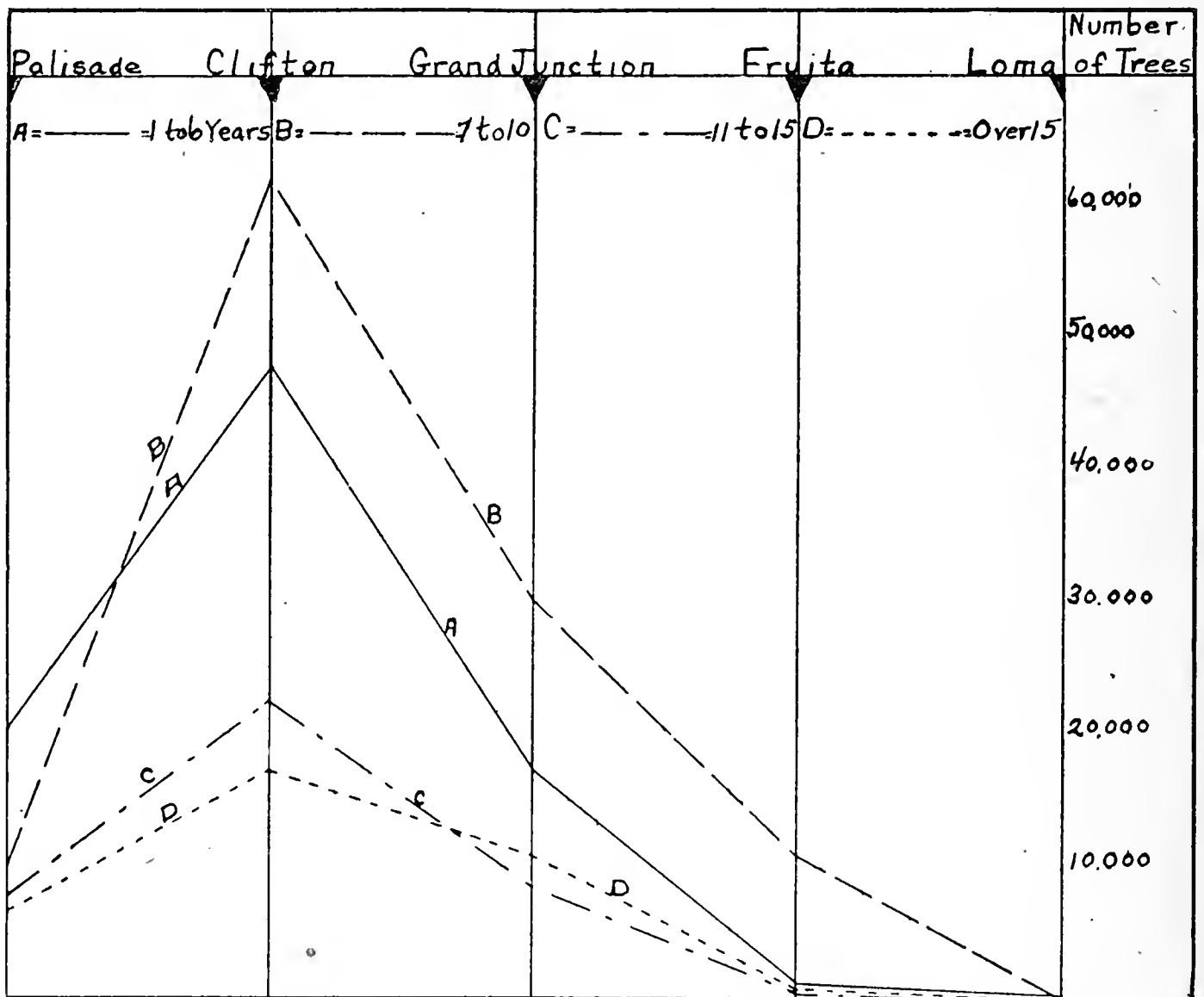

Diagram 11.—Number of Pear Trees in each Age Class for each District (Adapted from Table XI).

TABLE XII.—NUMBER OF PEACH TREES OF EACH DISTRICT AND OF ENTIRE VALLEY BY AGE CLASS.

Age Class	Palisade	Clifton	Grand Jct.	Fruita	Loma	Entire Valley
1- 6 Years	27,000	5,000	2,400	80	20	34,500
7-10 Years	214,000	51,000	5,400	10	65	270,475
11-15 Years	72,000	9,000	1,600	5,250	87,850
16 and over	7,000	4,000	1,100	60	15	12,175
Totals	320,000	69,000	10,500	5,400	100	405,000

TABLE XIIa.—PER CENT OF TOTAL PEACH TREES OF EACH AGE CLASS FOR EACH DISTRICT.

Age Class	Palisade	Clifton	Grand Jct.	Fruita	Loma	Per-cent-age Totals
1- 6 Years	78.3	14.5	7.0	0.2	...	100.0
7-10 Years	79.0	19.0	2.0	100.0
11-15 Years	82.0	10.2	1.8	6.0	...	100.0
16 and over	57.5	32.9	9.1	0.5	...	100.0
Valley Totals	79.1	17.0	2.6	1.3	...	100.0

TABLE XIIb.—PER CENT OF TOTAL PEACH TREES OF EACH DISTRICT WITH RESPECT TO AGE.

Age Class	Palisade	Clifton	Grand Jct.	Fruita	Loma	Entire Valley
1- 6 Years	8.4	7.2	22.8	1.5	20.0	8.5
7-10 Years	67.0	74.0	51.5	0.2	65.0	66.8
11-15 Years	22.4	13.0	15.2	97.2	...	21.7
16 and over	2.2	5.8	10.5	1.1	15.0	3.0
Percentage total	100.0	100.0	100.0	100.0	100.0	100.0

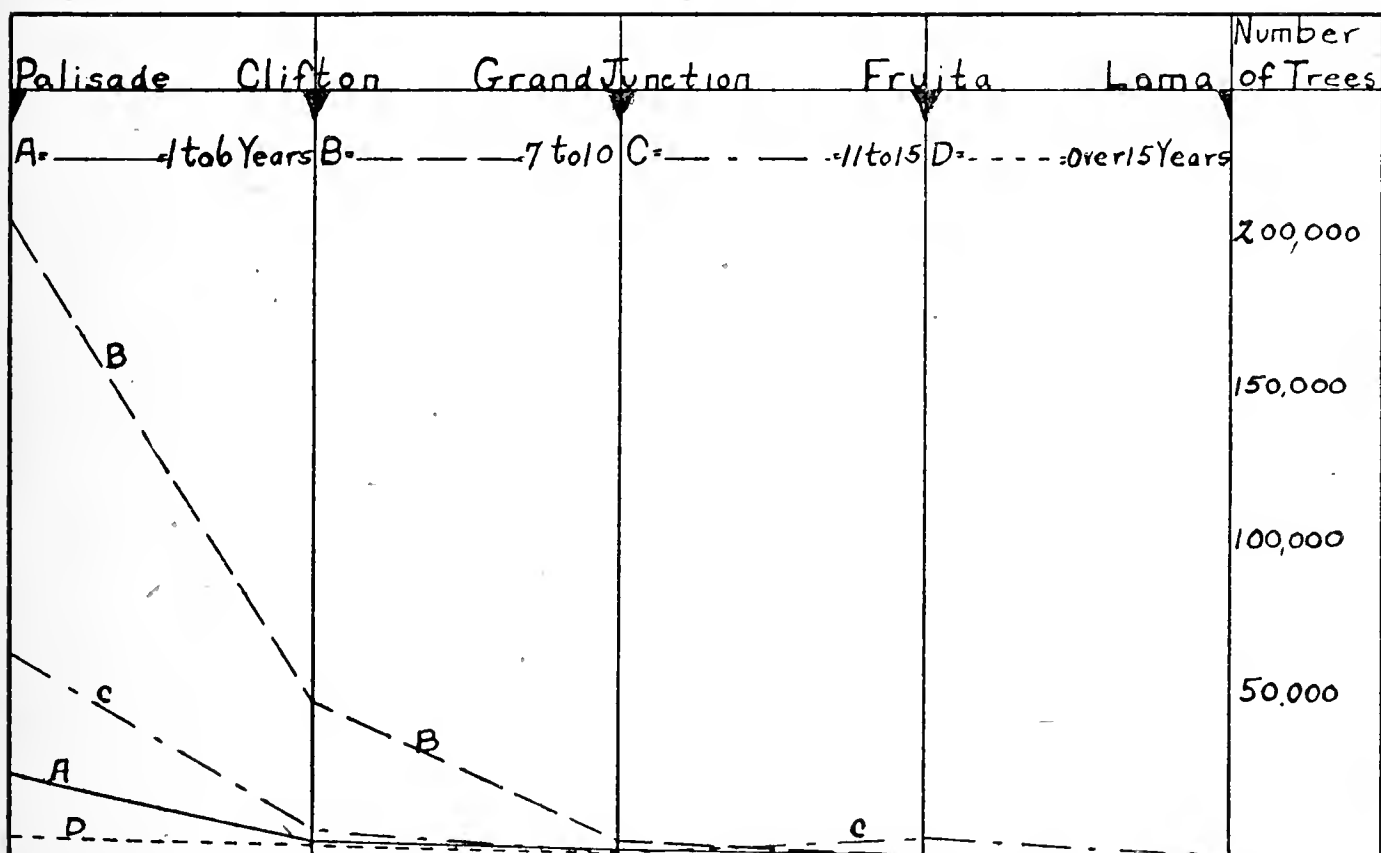

Diagram 12.—Number of Peach Trees in each Age Class for each District (Adapted from Table XII).

TABLE XIII.—PERCENTAGE OF PLUM TREES OF EACH DISTRICT FOR EACH AGE CLASS.

Age Class	Palisade	Clifton	Grand Jct.	Fruita	Entire Valley	Total Trees for Valley
1- 6 Years	8.5	2.6	9.6	8.5	6.4	385
7-10 Years	54.0	50.6	35.3	11.2	43.6	2,615
11-15 Years	30.5	38.4	10.6	22.7	27.7	1,660
Over 15 Years.....	7.0	8.4	44.5	57.6	22.3	1,340
Percentage totals	100.0	100.0	100.0	100.0	100.0	
Total Plum Trees.....	1,750	2,150	1,600	500	6,000

TABLE XIV.—PERCENTAGE OF APRICOTS OF EACH DISTRICT FOR EACH AGE CLASS.

Age Class	Palisade	Clifton	Grand Jct.	Fruita	Entire Valley	Total Trees for Valley
1- 6 Years	13.0	17.0	16.4	3.6	13.6	490
7-10 Years	45.0	45.0	42.8	18.6	43.0	1,550
11-15 Years	31.5	36.0	10.8	17.6	30.0	1,080
Over 15 Years.....	10.5	2.0	30.0	60.2	13.4	480
Percentage totals	100.0	100.0	100.0	100.0	100.0	
Total Apricot Trees.....	2,200	800	350	250	3,600

TABLE XV.—PERCENTAGE OF CHERRY TREES OF EACH DISTRICT FOR EACH AGE CLASS. TOTAL NUMBER OF TREES FOR ENTIRE VALLEY.

Age Class	Palisade	Clifton	Grand Jct.	Fruita	Loma	Entire Valley	Total Cherries for Valley
1- 6 Years	12.8	7.3	19.0	51.3	97.0	18.2	2,360
7-10 Years	55.4	53.3	49.0	15.0	48.0	6,250
11-15 Years	17.0	35.8	19.0	7.0	21.0	2,730
Over 15 Years.....	14.8	3.6	13.0	27.7	3.0	12.8	1,660
Percentage Totals	100.0	100.0	100.0	100.0	100.0	100.0	
Total Cherries for Val.	5,300	3,175	3,150	1,075	300	13,000

VARIETIES OF FRUIT GROWN IN THE GRAND VALLEY

APPLES

Aiken Red	³ Belleflower (Yellow)
Alexander	Ben Davis
² Arkansas (Mammoth Black Twig)	Ben Hur
² Arkansas Black	Benoni
Babbitt	Bismarck
Bailey Sweet	¹ Black Ben
³ Baldwin	Blue Pearmain
Barbour's Pride	Buckingham
Basket	Canada Red
Beitigheimer	Champion
	³ Chenango Strawberry

- Cole Quince
 Colorado Orange
 Cooper Market
¹Delicious
 Dominic
 Duling
³Early Harvest
 Early Pennock
 English Russett
 Fallowater
 Fall Orange
 Fall Pippin
 Fall Wine
²Fameuse
 Flora Bell
 French Pippin
 Fulton
¹Gano
²Geniton
 Gideon
 Golden Russett
³Gravenstein
²Grimes Golden
 Haas
 Hawley
 Hubbardston
 Huntsman
³Hyslop (Crab)
 Ingram
 Iowa Blush
 Isham's Sweet
³Jefferis
¹Jonathan
 Keswick
 Kinnard
²King David
 King (Tompkins County)
²Lawver
 Limbertwig
³Livland Raspberry
 Lowell
 Loy
³Maiden Blush
 Mann
 Martha
²McIntosh
³McMahon (White)
 Milam
 Minkler
²Missouri (Pippin)
 Mrs. Bryan
 Munson (Sweet)
 Newtown Pippin
²N. W. Greening
²Northern Spy
 Nova Scotian
²Oldenburg (Duchess)
 Opalescent
 Ortley (White Belleflower)
²Paragon
 Payne
 Peck
³Peewaukee
 Plumb Cider
 Rambo
 Ramsdell
³Red Astrachan
 Red June
 Red Pearmain
 Red Stripe
 R. I. Greening
 Romanite
 Roman Stem
¹Rome Beauty
 Roxbury Russet
 Salome
 Santa Clara King
²Senator
 Shackleford
 Shockley
 Siberian (Crab)
 Smith Cider
 Smokehouse
³Spitzenburg
 Stark
¹Stayman
 Steele's Red
 Summer Pearmain
 Summer Pippin
 Summer Queen
 Sweet Bough
 Thunderbolt
³Tolman (Sweet)
³Transcendent (Crab)
 Trenton Beauty
 Twenty Ounce Pippin

³ Utter Red	Williams
Vandevere Pippin	Willow Twig
³ Wagener	Wine (Hay's Winter Wine)
Walbridge	¹ Winesap
² Wealthy	² Winter Banana
Westfield	Winter Paradise
³ White Winter Pearmain	Wolf River
White Winter Pippin	³ Yellow Transparent
³ Whitney No. 20 (Crab)	² York Imperial

1—Recommended for commercial planting.

2—Varieties for semi-commercial, or, in certain localities, commercial planting.

3—Best adapted for home use and in some instances for semi-commercial use.

APRICOTS

Breda	¹ Montgamet
Cole's Mammoth	¹ Moorpark
Colorado	¹ Newcastle
Early Golden	Peach
Hemskirke	¹ Royal
¹ Jackson	Russian
Japan	Smith's Early
Jones	Tilton

CHERRIES

Baldwin	¹ Napoleon, s.
Bing's	Occident (Sultan)
Choisy	Olivet
Dyehouse	Oxheart, s.
¹ Early Richmond	Reine Hortense
¹ English Morello	¹ Royal Duke, s. a.
Knight, s.	Rocky Mountain (P. Bessayi)
Lambert, s.	¹ Sixteen-to-One, s.
Late Duke	Tartarian, s.
¹ Lewelling, s. (Black Republican)	¹ Windsor, s.
¹ May Duke	Wood (Gov. Wood), s.
¹ Montmorency	Yellow Spanish, s.

CURRANTS

Albert (Prince Albert)	Pomona
¹ Cherry	¹ Red Cross
¹ Fay (Fay's Prolific)	¹ Red Dutch
Holland	Versaillaise
London	¹ White Grape (Imperial White)
¹ North Star	Wilder
¹ Perfection	

GOOSEBERRIES

Berkeley (Dwinelle)	Josselyn (Red Jacket)
Chataqua	¹ Oregon (Oregon Champion)
Champion (Mills Champion)	¹ Pearl
Crown Bob	Smith (Smith's Improved)
¹ Downing	Wellington (Wellington's Glory)
Industry	Whitesmith (Sir Sidney Smith)
¹ Houghton	

¹—Best for commercial planting.

s.—Sweet.

s. a.—Semi-acid.

GRAPES

Agawam	Ives
America	Lindley
Alexandria	² Mission
² Black Hamburg	¹ Moore (Moore's Early)
Brighton	¹ Niagara
¹ Concord	Prentiss
² Cornichon	Salem
¹ Delaware	² Suldanina (Thompson's Seed- less)
Duchess	Wilder
² Flame Tokay	¹ Worden
Goethe	
Isabella	

PEACHES

Alexander	Foster
Alton	Francis
Banner	Globe
Barnard	Gold Drop
¹ Belle of Georgia	Greensboro
Bergen	¹ Hale's Early
Bokhara	Indian Cling
¹ Carman	J. H. Hale
Chairs Choice	Krummel
¹ Champion	Lemon Cling
Chinese Cling	Lovell
¹ Crawford (Early)	Mamie Ross
Crawford (Late)	Mathew's Beauty
Crosby	Mayflower
Decker	Mellow St. John
Dewey	Moore's Favorite
Early Rivers	¹ Mountain Rose
Early York	Muir
¹ Elberta	New Prolific
Emma	Niagara
Favorite	Oldmixon Cling

Oldmixon Free
¹Orange Cling
¹Phillips Cling
 Prince
 Reeve's Favorite
 Richmond
 Russell

Smock
 Sneed
 Steven's Rareripe
 Stump-the-World
 Victor
 Wheatland
 Wonderful

1—Best for commercial planting.

2—Recommended only for home planting.

PEARS

¹Anjou
 Anjou Dwarf
 Angouleme (Duchess)
 Angouleme (Duchess) Dwarf
 Braseck
¹Bartlett
 Bartlett Dwarf
 Bosce
 Boussock
 Brandwine
 Clairgeau
¹Clapp's Favorite
 Columbia
 Cornice
 Easter
¹Flemish Beauty
 Fred Clapp
 Garber
 Howell
 Idaho
¹Kieffer
 King Carl
 Koonce
 Krull

¹Lawrence
 Lawson
 LeConte
 Lincoln
 Louise Bonne
 Lucrative
 Margaret
 Mt. Vernon
 Orange
¹P. Barry
 Reihl's Best
 Roosevelt
 Rossney
 Rutter
¹Seckel
¹Sheldon
 Sugar
 Summer Doyenne
 Urboniste
 Vicar
 White Doyenne
 Wilder
 Winter Bartlett
¹Winter Nelis

PLUMS

¹Abundance
 Agen
 American Eagle
 Archduke
 Bavay
 Bradshaw
 Brittlewood
¹Burbank
 Burwood
 Chabot
 Cheney

Climax
 Clyman
¹Damson
¹DeSoto
 Duane
¹Fellenberg (Itanial Prune)
 Forest Garden
¹German (Prune)
 Giant (Prune)
 Golden
 Golden Beauty

¹ Green Gage	Rollingstone
Hawkeye	¹ Satsuma
Hudson	Shropshire
Hungarian Prune	Simon's
Imperial Gage	Sugar
¹ Lombard	¹ Surprise
Marianna	¹ Terry
Miner	Tragedy (Prune)
¹ Moore's Arctic	¹ Weaver
¹ Peach	Wickson
Pond	Wild Goose
Quackenboss	¹ Wolf
¹ Red June	¹ Wyant
Rockford	Yellow Egg

1—Best for commercial planting.

BRAMBLES

(Blackberries, Dewberries and Raspberries)

Blackberries

Acme	Lawton
¹ Briton (Ancient Briton)	Mercereau
Early Harvest	¹ Minnewaska
Eldorado	¹ Snyder
Erie	Stone
Kittatiny	Wilson

Dewberries

Bartel	Mayes (Austin)
¹ Lucretia	

Raspberries

Brandwine (Wilmington)	McCormick (Mammoth Cluster), b.
¹ Columbian, p.	Nemaha, b.
¹ Conrath, b.	Ohio, b.
Cumberland, b.	Palmer, b.
¹ Cuthbert	St. Regis
Golden (Golden Queen)	¹ Shaffer, p.
¹ Gregg, b.	Soubegan
¹ Kansas, b.	¹ Turner
¹ King	Tyler
Loudon	
¹ Marlboro	

STRAWBERRIES

Aroma	Captain Jack
¹ Bederwood	Crawford
Brandywine	Cumberland
¹ Bubach	Downing

¹ Dunlap (Senator Dunlap)	Saunders
Gandy	Sharpless
¹ Glen Mary	Splendid
¹ Haverland	Thompson
Ivanhoe	¹ Warfield
Jessie	¹ Wm. Belt
¹ Marshall	Wilson
Parker Earle	Wolverton
² Progressive (Everbearing)	

1—Best for commercial planting.

2—Recommended for home use.

b.—Black caps.

p.—Purple Cane.

THE FUTURE OUTLOOK FOR FRUIT GROWERS IN GRAND VALLEY

The readers of this bulletin will naturally wonder whether fruit growing in the Grand Valley has any future before it or not, whether the decline in productiveness, in prices obtained for fruit, and in the deterioration of some of the orchards will not permanently cripple the fruit industry in Grand Valley. It is undoubtedly true that fruit growing in the Grand Valley will be restricted to certain limited areas where fruit growing under all conditions will be reasonably safe. It is also true that a considerable portion of the land now in orchards will be put into agricultural crops because of the unfavorable conditions of these lands for fruit.

The Palisade and Clifton Districts, and part of the Grand Junction District, will very likely remain profitable fruit growing sections. For the Fruita and Loma Districts as a whole, the writers are less hopeful. Many of the orchards in the Fruita District are unprofitable at present, and more are reaching this state each year. A large part of the young orchard at Loma will probably never pay for itself. True, some of it will, with proper care, develop into profitable orchards, but as a district the odds are against this.

For profit, pears give the most promise. There is usually a good market for them, and they may be grown very well east of Grand Junction. Apples will always remain profitable, and, for a long-time average, may give as much return as pears.

The by-product problem must be solved before peach growing will be permanently profitable.

SUMMARY

The fruit industry in Grand Valley, Mesa County, as a commercial enterprise is about 20 years old. Fabulous prices were ob-

tained for fruit eight or ten years ago. Wildcat speculation was prevalent for a time. The business is now in the process of re-adjustment from the speculative basis. Many orchards and many growers belonging to the speculative class are being eliminated in the re-adjustment. Land is getting back to sensible prices and a few years will no doubt see the business flourishing again.

There are nearly 16,000 acres of orchard in the Valley. Of this, over 10,000 are apples, 3,000 peaches, 2,400 pears, and less than 200 acres plums, apricots and cherries.

Probably more than 2,500 acres of orchard have been pulled out in the last five years, most of this being removed from the western portion of the Valley.

Most of the best orchards lie east of Grand Junction. The older ones are mostly in the Fruita District and many are being pulled out to make the land available for general farming.

Less than one-third of the fruit trees of Grand Valley are over twelve years old.

The orchards are, as a rule, too small. The average size for the Valley is slightly below nine acres.

Too many farmers grow fruit exclusively, and a year of poor prices or crop failure is disastrous to them.

More land must be devoted to general farming, stock raising and dairying and the average fruit grower must grow something besides fruit in order to be most successful.

Marketing is the worst problem the growers have to solve.

The pack of fruit must be standardized and poor fruit utilized in by-products.

Clean cultivation has been practiced too much, but is now giving way to the more sensible system of cover cropping.

Due to over irrigation, the water table has risen in some places to within 5 feet, or less, of the surface. Many orchards have been ruined by seepage and a drainage system is probably to be installed throughout the entire Valley to give relief from this trouble.

The codling moth is very bad. Most growers spray four to six times with arsenate of lead, using 4 or 5 pounds of paste to 100 gallons of water. The average cost of spraying apples per acre per season is \$20.00.

Peaches are generally sprayed for twig borer with lime-sulphur just before the buds begin to open. Some orchardists spray with arsenate of lead shortly after the leaves come out.

The ravages of pear blight have some years been great. Many acres of good pear orchard have been ruined by this disease. The industry, however, continues to yield good profits.

The average cost of production per box of fruit, laid down at the platform, including all expenses, as determined from the estimates given, is, for apples 61.2c, pears 60.5c, peaches 31.2c.

The average number of cars of fruit shipped out of the Grand Valler for the years 1911 to 1915, inclusive, is about 2,525 per year.

The average yield per acre for the years 1911 to 1915 has been about 25% of a car for apples, 30% of a car for pears, and 55% of a car for peaches per year for all bearing orchard in the Valley.

About 30% of all the irrigated land on the north side of the river is planted to fruit trees, while only about 5% of the irrigable land south of the river is set to orchard. Over 80% of the orchard in the Valley is located north of the river, less than 20% being on the south side.

ACKNOWLEDGMENTS

The authors received much valuable assistance in various ways, and wish to acknowledge their indebtedness to all who so kindly aided them in the survey.

They wish especially to express their thanks to the following persons and organizations for the help rendered:

To Mr. Ocee O. Fellows, county assessor of Mesa County, and his associates, whose assistance to the authors was invaluable; to the U. S. Reclamation Service for the use of their map of the Grand Valley Project; to Mr. E. F. McKune, former instructor in horticulture in the Colorado Agricultural College, for help in compiling the statistics gathered; to the Denver & Rio Grande and Colorado Midland railroads, and the various fruit growers' associations of the Grand Valley; to the Western Sugar and Land Company, the Loma Securities Company, and many others who were helpful in the work.

Bulletin 224

February, 1917

The Agricultural Experiment Station

OF THE

Colorado Agricultural College

NATIVE VEGETATION AND CLIMATE OF
COLORADO IN THEIR RELATION
TO AGRICULTURE

By WILFRED W. ROBBINS

PUBLISHED BY THE EXPERIMENT STATION
FORT COLLINS, COLORADO
1917

The Colorado Agricultural College

FORT COLLINS, COLORADO

THE STATE BOARD OF AGRICULTURE

	Term Expires
HON. CHAS. PEARSON.....Durango,	1919
HON. R. W. CORWIN.....Pueblo,	1919
HON. A. A. EDWARDS.....Fort Collins,	1921
MRS. J. B. BELFORD.....Denver,	1921
HON. H. D. PARKER.....Greeley,	1923
MRS. AGNES L. RIDDLE.....Denver,	1923
HON. J. C. BELL.....Montrose,	1925
HON. E. M. AMMONS.....Denver,	1925
PRESIDENT CHAS. A. LORY, GOVERNOR JULIUS C. GUNTER, } <i>Ex-Officio</i>	
L. M. TAYLOR, Secretary	G. A. WEBB, Treasurer

EXECUTIVE COMMITTEE

A. A. EDWARDS, *Chairman*

J. C. BELL

STATION STAFF

C. P. GILLETTE, M.S., <i>Director</i>	ENTOMOLOGIST
W. P. HEADDEN, A.M., Ph.D.....	CHEMIST
G. H. GLOVER, M.S., D.V.M.....	VETERINARIAN
W. G. SACKETT, B.S.....	BACTERIOLOGIST
ALVIN KEZER, A.M.....	AGRONOMIST
E. P. SANDSTEN, M.S., Ph.D.....	HORTICULTURIST
B. O. LONGYEAR, B.S.....	ASSISTANT FORESTER
G. E. MORTON, B.S.A., M.S.....	ANIMAL HUSBANDMAN
E. B. HOUSE, B.S. (E.E.), M.S.....	IRRIGATION ENGINEER
V. M. CONE, B.S., C.E.....	IRRIGATION INVESTIGATIONS
W. P. LITTLE, B.S., <i>U. S. Expert-in-charge</i>	HORSE BREEDING
R. E. TRIMBLE, B.S.....	ASSISTANT IRRIGATION INVESTIGATIONS
P. K. BLINN, B.S., ROCKY FORD.....	ALFALFA INVESTIGATIONS
EARL DOUGLASS, M.S.....	ASSISTANT CHEMIST
S. ARTHUR JOHNSON, M.S.....	ASSISTANT ENTOMOLOGIST
L. C. BRAGG.....	ASSISTANT IN ENTOMOLOGY
J. W. ADAMS, B.S., CHEYENNE WELLS.....	AGRONOMY ASSISTANT, DRY FARMING
W. W. ROBBINS, M.A.....	BOTANIST
RALPH L. PARSHALL, B.S.....	ASSISTANT IRRIGATION INVESTIGATIONS
I. E. NEWSOM, B.S., D.V.S.....	VETERINARY PATHOLOGIST
MIRIAM A. PALMER, M.A.....	DELINEATOR
R. A. MCGINTY, B.S.....	ASSISTANT IN HORTICULTURE
CHAS. R. JONES, B.S.....	ASSISTANT IN ENTOMOLOGY
GEO. M. LIST, B.S.....	ASSISTANT IN ENTOMOLOGY
JAS. D. BELL, B.S.....	ASSISTANT IRRIGATION INVESTIGATIONS
CARL ROHWER, B.S., C.E.....	ASSISTANT IRRIGATION INVESTIGATIONS
BREEZE BOYACK, B.A., M.S.....	ASSISTANT IN AGRONOMY
CHAS. I. BRAY, B.S.A., M.S.....	ASSISTANT ANIMAL HUSBANDRY
RALPH L. CROSMAN.....	EDITOR
W. H. KERR.....	MARKETS AND MARKETING
T. E. LEIPER, B.S.....	ASSISTANT ANIMAL HUSBANDMAN

OFFICERS

CHAS. A. LORY, M.S., LL.D., D.Sc.....	<i>President</i>
C. P. GILLETTE, M.S.....	<i>Director</i>
L. M. TAYLOR.....	<i>Secretary</i>
MABEL LEWIS.....	<i>Executive Clerk</i>

NATIVE VEGETATION AND CLIMATE OF COLORADO IN THEIR RELATION TO AGRICULTURE

By WILFRED W. ROBBINS

INTRODUCTION*

A close relationship exists between climate and vegetation, whether vegetation in the native state or under cultivation. Each climatic region has its characteristic natural plant life. There are, also, certain crop plants best suited to every distinct climatic area.

Colorado has a variety of climates. One may travel from the warm valleys of the Western Slope, or from the Great Plains, to the crest of the Continental Divide, and pass through as many distinct climates as he would in travelling from Virginia to arctic Greenland. This variety is largely a result of differences in altitude, although range of latitude and topographic diversity are also responsible. The lowest point in Colorado has an elevation of 3,386 feet, and the highest, 14,402 feet, thus giving an altitudinal range of 11,016 feet. The latitudinal range is 4° (37° to 41°). Chiefly as a consequence of the great altitudinal variation, Colorado has many distinct climates, each with native plants and with crop possibilities peculiar to it.

Climatic and Local Environmental Factors.—It is worthy of mention that native plants and crop plants are subject to the same environmental factors. We may separate the external factors affecting plants into two classes: *Climatic factors and local (edaphic) factors.* Climatic factors, such as light, temperature of

*This bulletin is an outgrowth of a number of years of observation and study of the native vegetation of Colorado in its relation to climate and to agriculture. During the summer season of 1916, special attention was directed to this study, and an automobile trip, which covered the territory shown in Fig. 1, was taken for the purpose of testing conclusions arrived at, and finding new relations. Little consideration is given to the question of the value of native plant life as an indicator of the local physical conditions of the environment. Such detailed study, however, is of much practical importance, and it is planned to engage in such a study later. But, the attempt here is to point out the broader relations between our large native plant associations and the principal climatic factors under which they are growing, and to show their relation, in a very general way, to Colorado agriculture. The writer realizes that a number of conclusions herein drawn rest upon insufficient data, and therefore are subject to more or less modification, as further information comes to hand. Furthermore, he well knows that climatological data employed, in the form given us, in the interpretation of biological phenomena, although not without qualitative meaning, frequently have little quantitative value.

the air, moisture of the air, precipitation (rainfall and snowfall), wind, and atmospheric pressure, are those which work over areas of great extent. Local factors, such as temperature of the soil, water and air in the soil, texture and composition of the soil, life of the soil, direction of slope, degree of slope, etc., are those which work within rather narrow limits and are determined by local physical conditions. Differences in the character of the vegetation of a certain climatic area are determined by the local factors just mentioned. For example, the climatic type of vegetation over the Great Plains is that of a dry grass-land (grass-steppe). Within this large climatic grass-land area, there are local variations in the plant covering which may be due to differences in soil texture, slope, exposure, etc. For example, in soil readily penetrated by water, *Psoralea*, a deep-rooted plant, is locally very abundant; again, in low, seeped places, alkali plants may prevail, and on shale knolls, *Yucca* be locally dominant.

There are many possible combinations of factors that may operate upon a plant. In a state like Colorado, with its varied climatic conditions, its slopes and exposures of all degrees, its highly varied geologic structures calling forth many soil types, these combinations become innumerable. Each combination of environmental factors calls forth corresponding activities in the plant life; and these activities are represented, in a practical way, by the quality and quantity of the crop yield.

Man's Control of the Environmental Factors.—Man, in his agricultural pursuits, has attempted, and often successfully, to artificially modify the external conditions about the plants he is growing. He may decrease the light intensity by shading or thick planting, increase the light intensity by thinning the plants, lengthen the duration of light by the use of artificial light, as is sometimes done in the forcing of vegetables in the greenhouse, and may even change the quality of the light by the use of stained glass, although such a practice is not practical. He may increase the temperature of the air about plants by the use of hot-houses, hot-beds, and by different methods of orchard heating, and decrease the temperature of the air by cold-houses, and by shading. Moisture in the air is increased by housing, by shading, by planting so as to have a thick stand, and by having windbreaks; and the moisture may be decreased by housing and by having a thin stand. Man may modify the effects of wind movements by windbreaks and by increasing the density of crop stand. Local factors are also more or less under control by man. The structure of the soil may be modified by cultivation and by the application of

water and fertilizers. The amount and quality of air in the soil may be changed by cultivation and by the use of water and fertilizers. The quantity of water in the soil and soil temperature may be controlled by irrigation, drainage, fallowing, windbreaks, and by the kind of crop planted. The nutrient material in the soil may be changed by the use of fertilizers, by irrigation, drainage, the kind of crop planted and the cropping system. And even the life of the soil, composed as it is of innumerable microscopic plants and animals, may be regulated by irrigation, drainage, method of cultivation, cropping system, and by the use of fertilizers.

Of the two groups of environmental factors, *climatic* and *local*, the former group is less under the control of man than the latter, except when he is dealing with a very small group of plants. However, it is possible for man to modify and control, even in an extended way, the structure of the soil, the "plant food" of the soil, and the plant and animal life of the soil. It is quite beyond his powers to modify and control, in general farming practice, light, air temperature, moisture of the air, precipitation and movements of the air, except in a limited way by means of windbreaks in the last.

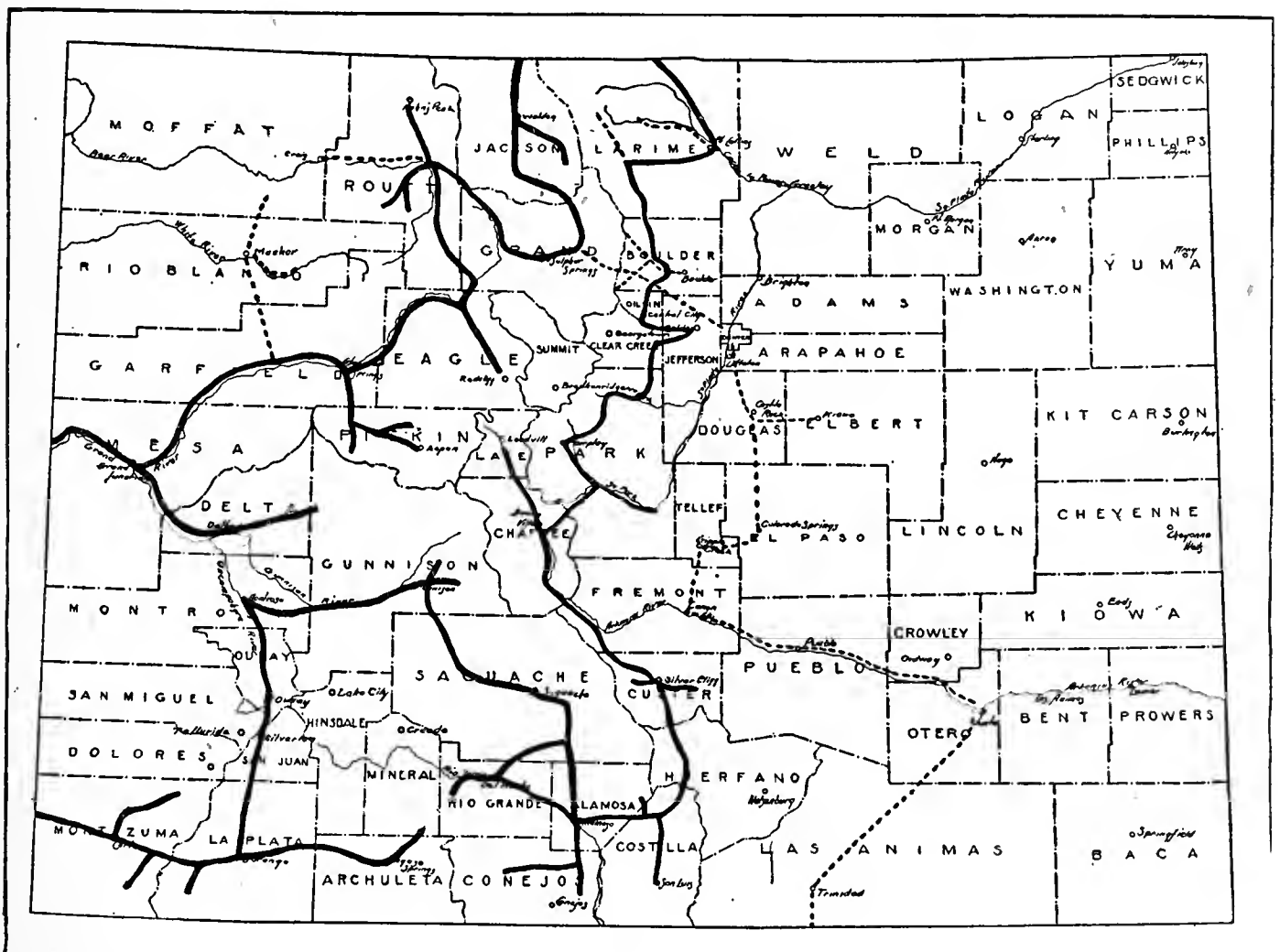

Fig. 1.—The heavy black line indicates itinerary of automobile trip during summer of 1916. Dotted line indicates wagon and train trips.

CLIMATIC FACTORS***TEMPERATURE OF AIR**

Mean Annual Temperature.—The Arkansas Valley up as far as Canon City, the plains east of the Arkansas-Platte Divide, a strip along the eastern foothills from below Denver to Boulder; and the lower Grand and Uncompaghre sections, have a mean annual temperature of $50^{\circ}\ddagger$ and above. An average yearly temperature of between 45° and 50° is experienced by the northern Great Plains, the Arkansas-Platte Divide and a belt along the eastern foothills up to about 7,000 or 7,500 feet. Much of the sagebrush country below 7,500 feet in the southwestern counties and in western Dolores and San Miguel counties, and also narrow belts running up the Grand, Gunnison and Uncompaghre rivers, have a mean annual temperature of between 45° and 50° . The foothills proper along the eastern mountain front, the entire level of San Luis Valley, thousands of square miles in Moffat, Routt and Rio Blanco counties, and extensive areas in the southwest and middle-west valleys below about 9,000 feet, have a mean annual temperature of 40° to 50° . Yearly average temperatures of 35° to 40° prevail in North Park, Middle Park, and South Park. Most stations above 10,000 feet have a mean annual temperature below 35° .

Mean Summer‡ Temperature.—Fig. 2 shows the mean summer temperatures for Colorado. The summer temperature is of more significance in its relation to agriculture than that for the year. The 70° isotherm follows very closely the 5,000-foot contour line. The effect of the Arkansas-Platte Divide is shown in the eastward deflection of the isotherms for 70° and 65° . The 65° summer isotherm and the 45° annual isotherm touch similar points quite generally. That portion of the State with a mean summer temperature between 60° and 65° ranges in altitude from about 6,500 feet to 8,500 feet, and within this belt a type of agriculture which is sometimes called "high-altitude agriculture" is practiced. The summer mean for the San Luis Valley is near 60° ; the same temperature prevails throughout Middle Park. North Park has a summer mean between 55° and 60° . It is well to keep in

*Throughout the bulletin, the climatological data are from the records of the Colorado Section of the United States Department of Agriculture, Weather Bureau, and from Bulletin 182, by Robert E. Trimble, of the Colorado Agricultural Experiment Station.

‡All temperatures throughout are Fahrenheit, unless otherwise indicated.

‡The "summer" months here considered are June, July and August.

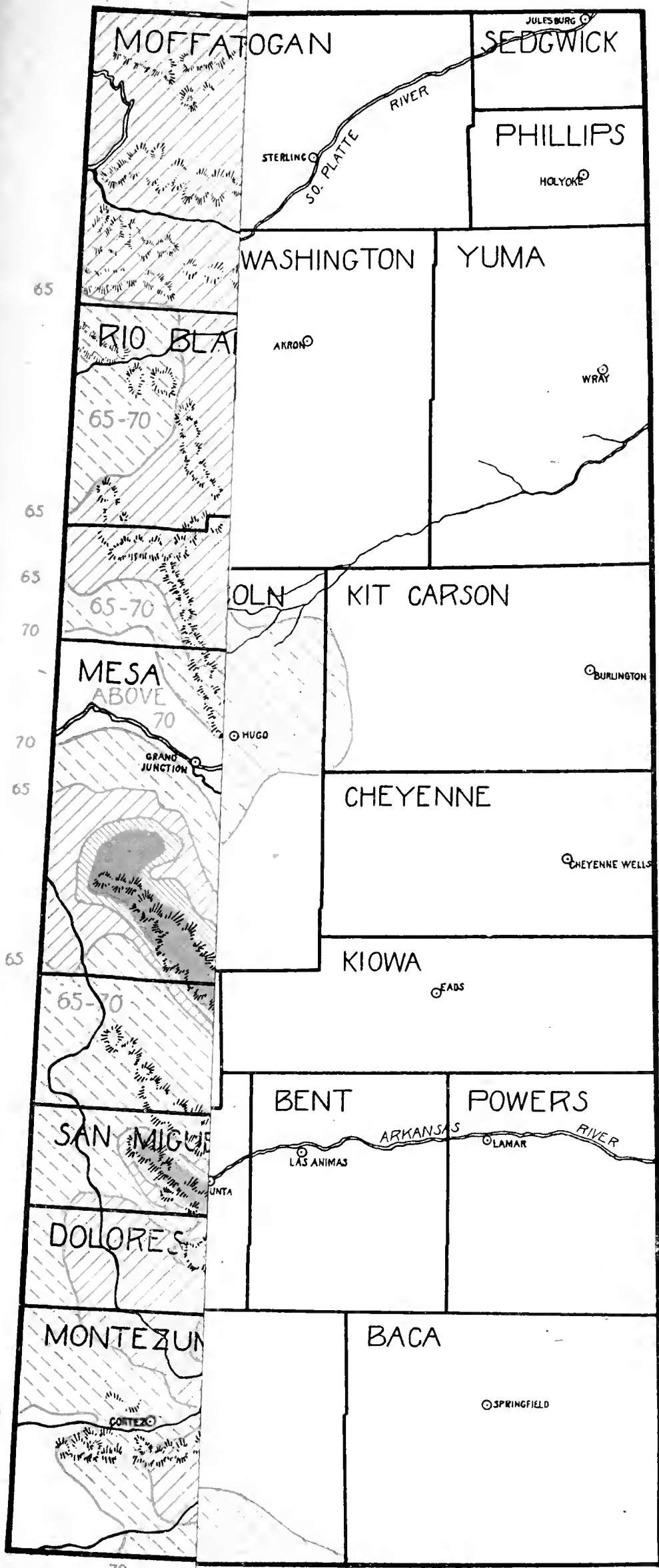

mind the fact that two localities with the same mean temperature for any period may experience quite marked differences in their temperature extremes for the same period.

Mean Annual March of Temperature.—The march of temperature from month to month throughout the year may be shown graphically in a curve (Fig. 3). A steep curve signifies a wide temperature range, while a flat curve indicates a narrow range. The mean temperature for any month is seen at a glance, as are also the warmest and coldest months.

Decrease of Temperature with Altitude.—The rate of decrease of temperature varies with altitude and season. The rate seems

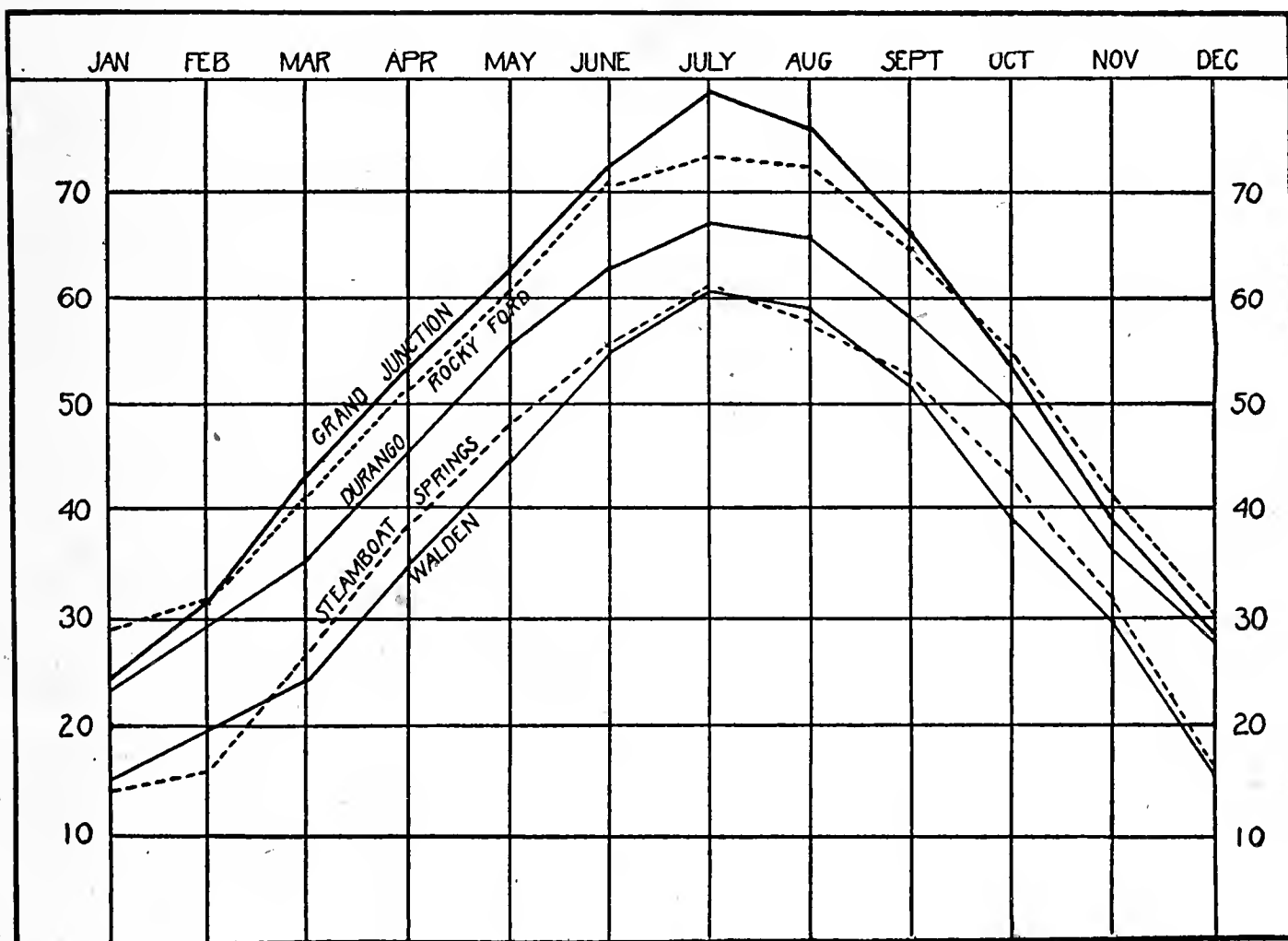

Fig. 3.—Mean annual march of temperature for Rocky Ford, Grand Junction, Durango, Walden, and Steamboat Springs.

to be less at high altitudes than at low, and less in winter than in summer. The following table shows the decrease in temperature per 1,000 feet elevation, for a number of stations in Colorado, for the year 1915. The stations compared are within the same drainage system.

TABLE I.—DECREASE IN TEMPERATURE WITH INCREASE IN ALTITUDE.

Station	Altitude in Feet.	Decrease of temperature per 1000 feet elevation (1915)												Year
		Monthly and yearly means												
		Jan.	Feb.	Mar.	Apr.	May	June	July	Aug.	Sep.	Oct.	Nov.	Dec.	
Salida	7035													
Leadville	10248	2.5	3.3	3.9	3.2	3.5	3.4	3.1	2.3	2.3	2.9	4.3	3.3	3.2
Denver	5272													
Idaho Springs..	7543	1.4	2.2	1.4	3.0	3.3	2.9	2.9	3.3	3.2	2.9	3.2	2.2	2.7
Ft. Collins.....	4985													
Long's Pk. ... (near)	8600	1.4	1.9	2.2	3.2	3.1	3.3	3.0	3.0	2.6	1.9	2.1	1.1	2.6
Colo. Springs...	6098													
Lake Moraine..	10265	1.8	2.5	3.2	3.4	3.3	2.3	2.7	2.8	2.9	2.5	2.8	2.4	2.6
Glenwood Spgs.	5758													
Aspen	7981	-.03	3.2	5.3	5.0	4.1	3.2	2.5	3.1	3.2	2.7	3.1	3.1	3.2
Durango	6546													
Silverton	9400	2.3	3.4	4.1	2.9	4.2	5.2	2.2	4.2	3.5	3.1	2.9	0.9	3.5
Glenwood Spgs.	5758													
Marble	7951	-.03	2.0	3.4	2.7	2.3	2.1	1.7	1.8	2.1	2.0	1.7	1.0	0.8
Garnett	7576													
Wagon Wh Gap	9610	1.6	3.8	5.2	4.0	4.8	3.9	2.6	3.2	3.4	2.7	2.8	1.6	3.3
Delta	5025													
Cedaredge	6175	-3.4	0.04	2.8	3.3	3.2	4.6	4.5	..	2.0	-.01	2.1	0.04	..
Boulder	5347													
Frances	9300	2.5	2.6	2.0	3.1	3.5	3.8	2.9	2.7	2.7	2.6	3.4	2.0	2.8
Average.....		.98	2.5	3.4	3.4	3.5	3.5	2.8	2.9	2.8	2.3	2.8	1.8	2.7

The difference between low and high altitude stations in the mean temperatures for January is less than for any other month. In fact, the records show that the mean temperature for January, 1915, at Marble (7,951 feet) is .6° higher than that at Glenwood Springs (5,758 feet), and that at Cedaredge (6,175 feet) the mean temperature for January of that year was 3.9° higher than at Delta (5,025 feet). In general, the differences in temperature between low and high altitude stations are less during the winter months than during the summer months, as may be seen from Table I. As a general rule, it may be stated that in Colorado an increase in elevation of 1,000 feet decreases the mean temperature for the year about 2½°; for the summer months (June, July, August), about 3°; for the fall, about 2½°; winter, about 1½°; and spring, about 3½°. That is, in order to effect a decrease of 1° in the mean temperature for the year, one must ascend about 370 feet; to effect a decrease in the mean temperature for the spring, about 294 feet; summer, about 322 feet; fall, about 361 feet; and for the winter, about 588 feet. There is a retardation in the development of the vegetation, amounting to about 13 days for every 1,000 feet increase in altitude.

Daily Range of Temperature.—By daily range of temperature is meant the difference between the highest and lowest temperature which occurs during the day. The daily ranges of temperatures are quite high in Colorado, particularly on the plains and in the high and broad mountain parks. One may gain an idea of the *greatest* daily ranges of temperature at a number of stations in Colorado, by examining data for 1915 in the following table:

TABLE II.—GREATEST DAILY RANGES OF TEMPERATURE (1915).

Station	County	Altitude	Jn.	Fb.	Mr.	Ap.	My.	Ju.	Jly.	Ag.	Sp.	Oc.	Nv.	Dc.
Blue Val. Ranch.	Grand	7150	..	49	44	41	44	42	..	49	49	48
Canon City	Fremont	5343	48	48	48	46	41	43	44	..	42	57	51	48
Chey. Wells	Cheyenne	4279	43	45	44	41	42	43	36	38	37	56	46	37
Cortez	Montezuma	6100	46	40	43	46	61	52
Denver	Denver	5198	38	39	38	34	37	37	38	36	32	37	36	41
Durango	La Plata	6534	40	46	38	43	44	46	45	43	42	51	41	37
Frances	Boulder	9300	33	32	36	..	33	31	35	30	30	35	24	42
Garnett	Saguache	7576	51	57	47	46	51	49	47	46	46	53	53	54
Gd. Junction	Mesa	4602	31	31	36	33	34	36	35	36	33	38	33	27
Greeley	Weld	4600	51	56	45	45	51	44	..	51	51	59	49	51
Gunnison	Gunnison	7670	58	53	48	48	52	53	49	50	50	54	52	39
Hayden	Routt	7500	39	54	68	44	57	66	55	50	50	52	46	42
Lamar	Prowers	3592	54	53	49	45	48	38	41	46	45	59	53	50
Long's Pk. (nr.)	Larimer	8600	43	41	42	32	44	40	40	45	40	44	37	46
Meeker	Rio Blanco	6182	50	55	..	46	49	48	48	46	59	56	50	44
Pagosa Spgs.	Archuleta	7108	64	67	52	46	47	..	56	44	47	..	69	53
Spicer	Jackson	8700	34	36	36	35	38	52	41	36	60	54
Steamboat Spgs.	Routt	6500	50	58	51	45	46	53	54	55	55	57	52	47
Trinidad	Las Animas	5994	48	45	38	38	38	40	42	37	..	45	44	45
Westcliffe	Custer	7861	54	53	47	45	44	48	50	45	52	56	55	68

The maximum daily ranges throughout Colorado are high; but the figures given in the above table do not consider sun temperatures, and hence do not represent the extremes of temperature to which sun plants are exposed. There is a marked difference between sun and shade temperatures at high altitudes, and this difference becomes greater as the elevation increases. Temperature differences in the sunshine and shade may be judged from the following data taken from Hann's Handbook of Climatology:

TABLE III.—SUN AND SHADE TEMPERATURES AT DIFFERENT ALTITUDES.

Altitude of Station (feet)	Temperatures		
	Sun	Shade	Difference
150.9	106.70	86.00	20.70
8431.7	113.90	76.10	37.80
9481.6	118.58	68.18	50.40
65.6	100.04	89.96	10.08
5905.5	111.20	79.70	31.50
7644.3	115.52	66.35	49.14
9776.9	171.10	42.80	128.30

The heating effect of the sun at high altitudes is much greater than at low elevations. This means that at high altitudes, objects heat up much more quickly during the day than at low altitudes.

It has been estimated that the sun's rays, in passing from the upper boundary of the air to sea level, lose 20% of their heating effect. Shortness of growing season is compensated for, in a large measure, by the intensity of the sun's rays.

Absolute Annual Range of Temperature.—The absolute annual range of temperature is the difference between the highest and lowest temperatures of the year. This range gives us an index of the severity of the climate, although not always a reliable one. Very low temperatures with a snow cover on the ground are less harmful to vegetation in the dormant state, than when there is no snow cover. The following table gives the absolute annual range of temperature for a few Colorado localities. The temperatures are for the shade, as are all ordinary meteorological records.

TABLE IV.—ABSOLUTE ANNUAL RANGE OF TEMPERATURE (1915).

Station	County	Altitude (in feet)	Absolute Annual Range of Temperature
Arriba	Lincoln	5243	100
Aspen	Pitkin	7909	106
Beuna Vista	Chaffee	7955	95
Boulder	Boulder	5346	98
Castle Rock	Douglas	6220	116
Cheyenne Wells	Cheyenne	4279	107
Colorado Springs	El Paso	6098	98
Delta	Delta	4965	115
Denver	Denver	5272	98
Durango	La Plata	6534	99
Ft. Collins	Larimer	4985	106
Frances	Boulder	9300	88
Garnett	Costilla	7576	114
Grand Junction	Mesa	4602	101
Gunnison	Gunnison	7670	125
Holly	Prowers	3380	108
Lake Moraine	El Paso	10265	93
Lamar	Prowers	3592	117
Lay	Moffat	6190	116
Mancos	Montezuma	6960	96
Meeker	Rio Blanco	6182	105
Montrose	Montrose	5811	107
Pueblo	Pueblo	4734	103
Rocky Ford	Otero	4177	110
Salida	Chaffee	7035	111
Steamboat Springs	Routt	6683	125
Victor	Teller	10100	86
Wagon Wheel Gap Exp. Station	Mineral	9600	86
Westcliffe	Custer	7864	119

Difference Between Air Temperature and That of Soil and Plant Surfaces.—The temperature of soil and plant surfaces during the day usually, not always, exceeds that of the surrounding air. There is an increase in this difference of temperature with elevation above the sea level. High surface temperatures in the mountains, during the time that the sun is shining, compensate in

a measure for the comparatively short growing seasons, and cool nights. Clements* secured the following results at Minnehaha (altitude 8,400 feet) on Pike's Peak. The air temperature was 75.2° , the surface of the gravel soil 104° , and the surfaces of the plant leaves as follows. *Parmelia* (lichen), 104° ; *Eriogonum*, 101.48° ; *Arctostaphylos* (kinnikinnick), 95° ; *Thlaspi* (wild candytuft), 89.24° ; and *Senecio*, 87.8° . As is the case with native plants, the temperature of crop plants at high elevations is greater than that of the air about them, the difference depending somewhat upon the transpiring power of the plant considered.

Effect of Exposure upon Air and Surface Temperatures.—By *exposure* is meant direction of slope. A north exposure, for example, *faces* north. The effect of exposure at high altitudes is much more marked than at low elevations. This greater effect is a direct result of the increased rate of radiation at high altitudes. The intensity of sunlight is distinctly affected by exposure and also by degree of slope. A given area of soil or plant surface that is at right angles to the direction of the rays of light will receive much more heat than one upon which the sun's rays fall obliquely, for under the latter condition the rays are spread out over a larger area than when they fall perpendicularly. If we assume the intensity of sunlight to be 100 when it strikes a surface at right angles, its intensity when striking that surface at an angle of 70° will be approximately 98.5; at an angle of 60° , 96.5; and at an angle of 10° , 33.4. Light intensity has its effect upon both air and surface temperatures, which indirectly affect the amount of moisture in the soil, and the relative humidity over the soil. The differences between the native vegetation on adjacent north and south exposures is so conspicuous in the mountainous sections as to attract the attention of the most inobservant person. In a valley that trends east and west the slope exposed to the south has a much greater total effective heat during the year than the northerly exposure across the valley. The greater light intensity on the south exposure not only results in a warmer, but a drier, habitat than occurs on the neighboring north exposure. A south exposure receives the greatest total heat during the day, the east the next greatest, then the west, and the north exposure least of all. There are numerous examples illustrating the differences between the native vegetation of north and south exposures. In the lower mountain valleys of the north and central parts of Colorado, the south exposures support a semi-arid type of vegetation, composed of cedars, scattered yellow pine (*Pinus scopulorum*), yucca, Colo-

*Research Methods in Ecology, page 71.

rado candy-tuft (*Thlaspi coloradense*), double bladder-pod (*Physaria didymocarpa*), Indian millet (*Eriocoma cuspidata*), sandwort (*Arenaria fendleri*), oat-grass (*Trisetum montanum*), stipa-grass (*Stipa viridula*), fescue-grass (*Festuca arizonica*), stickseed (*Lappula occidentalis*), phacelia (*Phacelia leucophylla*), geranium (*Geranium fremontii*), beard-tongue (*Pentstemon humilis*), vetch (*Astragalus shortianus*), and common sage (*Artemisia frigida*). The cooler and moister north exposures are frequently clothed with Douglas fir (*Pseudotsuga mucronata*), aspen (*Populus tremuloides*), Rocky Mountain maple (*Acer glabrum*), spring anemone or pasque flower (*Pulsatilla hirsutissima*), saxifrage (*Saxifraga rhomboidea*), buckbean (*Thermopsis divaricarpa*), bedstraw (*Galium boreale*), and false Solomon's seal (*Vagnera stellata*).

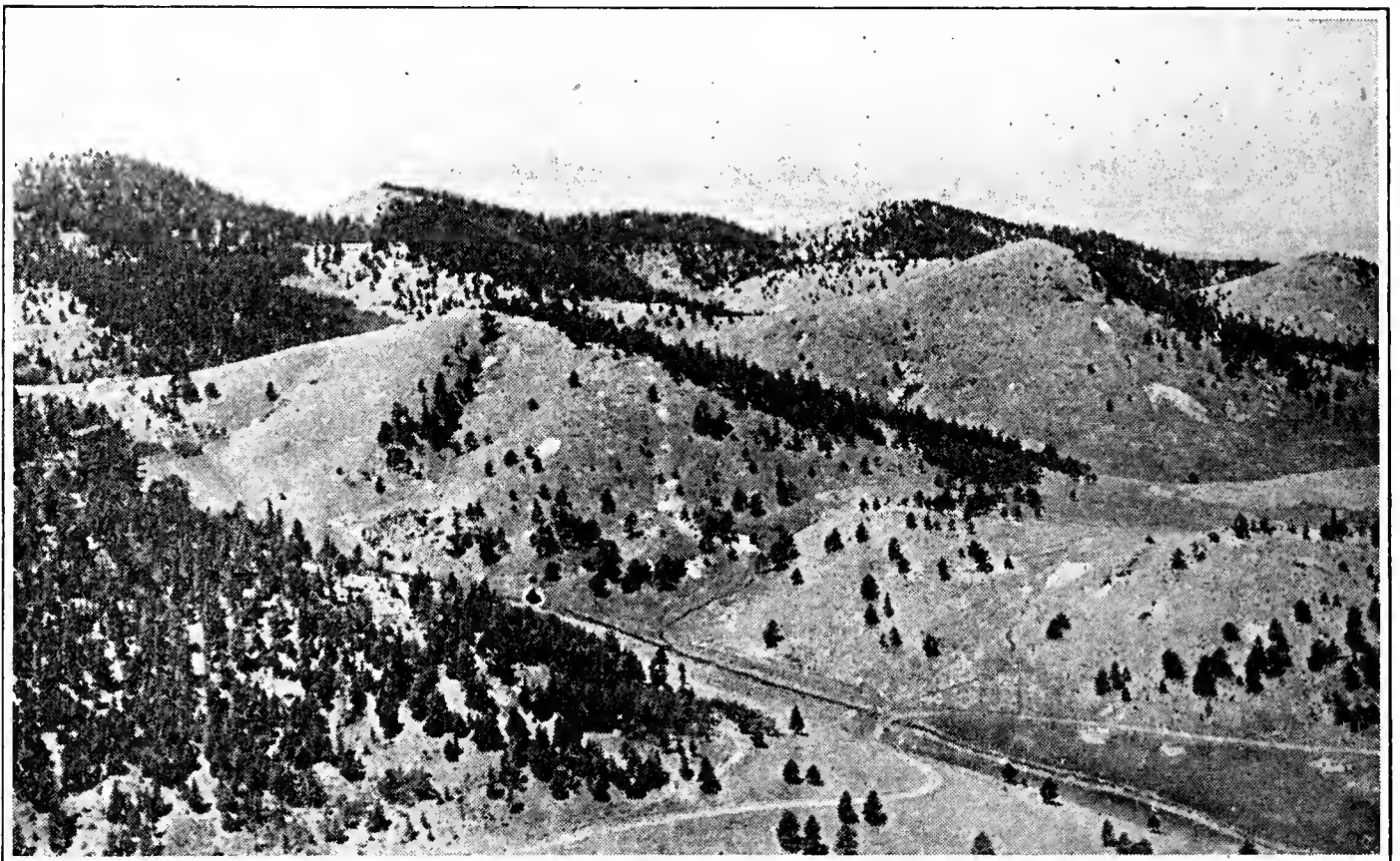
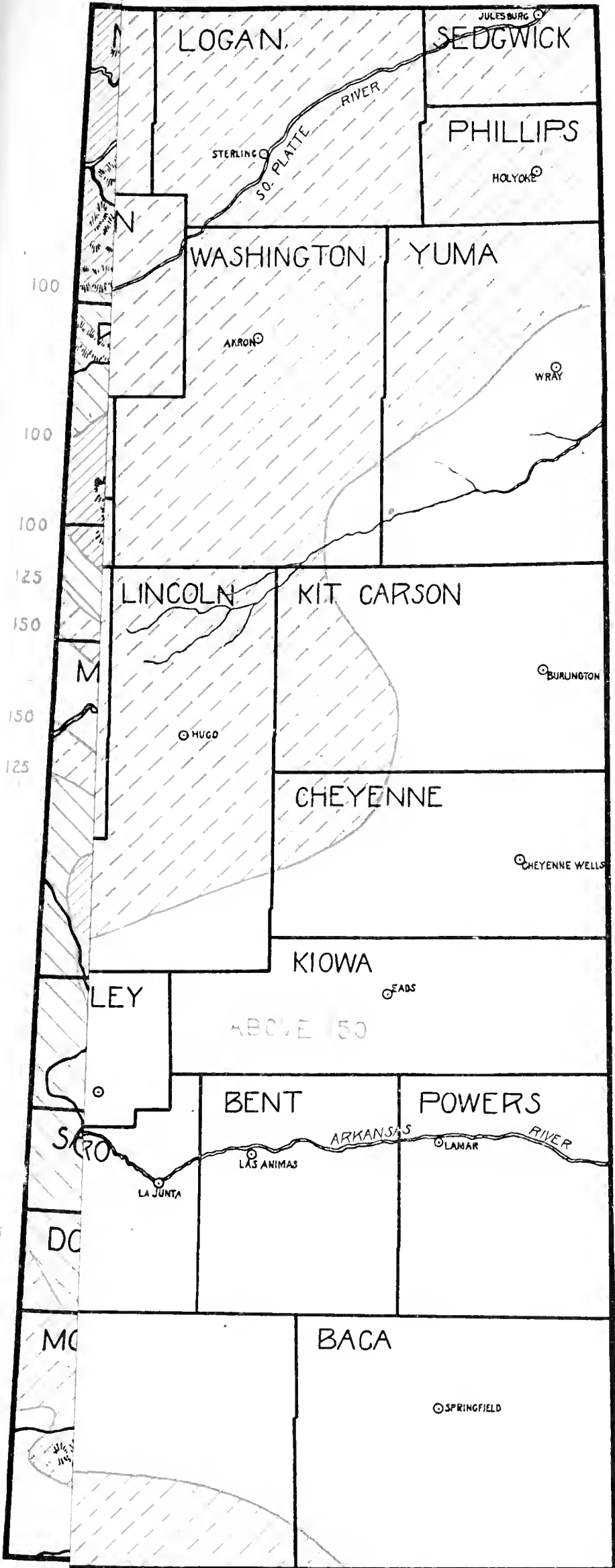

Fig. 4.—In the Wet Mountain Valley. The view is looking due west. Note the bare south exposures and timbered north exposures.

Fig. 4 is a scene in the Wet Mountain Valley, and it shows very clearly the effect of exposure upon local conditions that influence plant growth. The view is looking due west. Douglas fir and white fir clothe the north-facing slope, while grasses and low shrubs dominate the south-facing slope; the two plant communities meet sharply at the crest of the slope. In many of the east-west valleys of the Western Slope, pinyon pine and juniper abound on the warm, dry, south exposures, while Douglas fir and



LOGAN

SEDGWICK

PHILLIPS

WASHINGTON

YUMA

LINCOLN

KIT CARSON

CHEYENNE

KIOWA

RILEY

BENT

POWERS

BACA

JULESBURG

STERLING

HOLYOKE

AKRON

WRAY

BURLINGTON

HUGO

CHEYENNE WELLS

EADS

ABOVE 50

LA JUNTA

LAS ANIMAS

LAMAR

DC

MC

SPRINGFIELD

100

100

100

125

150

150

125

125

50

50

FIG. 5. AVERAGE LENGTH OF FROSTLESS SEASON

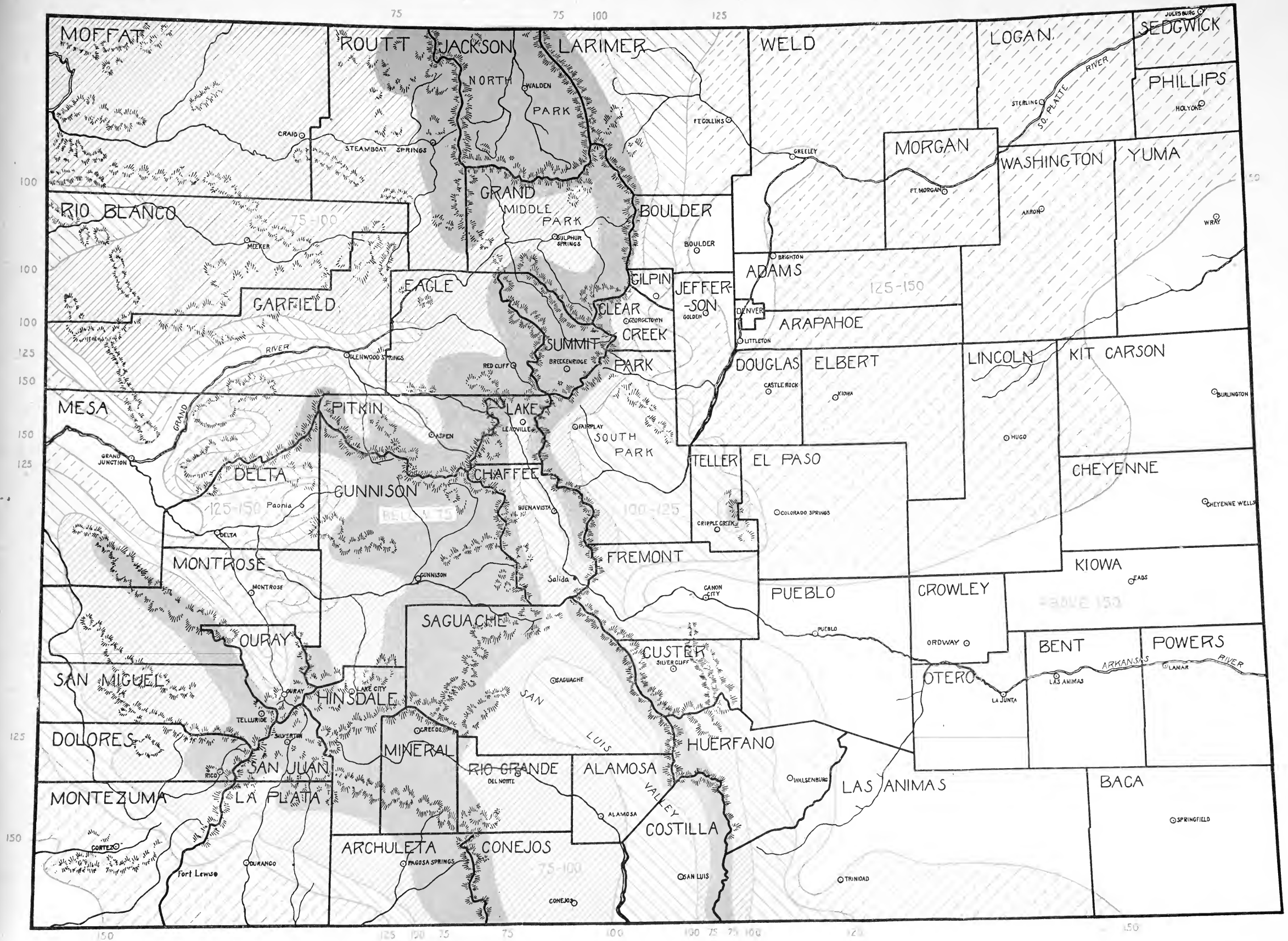

its associates, are to be found on the cooler and moister north exposures.

Plants most abundantly distributed at lower elevations find their uppermost altitudinal limits on warm, south exposures, while plants normally distributed at high elevations reach their lowermost altitudinal limits on cool, moist, north exposures. For example, lodgepole commonly ranges from 8,000 to 10,000 feet, but on southwest exposures may reach 11,000 feet, as it does on Boreas Pass, and quite frequently goes down to 7,500 on cool, north exposures. Timber-line is frequently 1,000 feet, or more, higher on slopes facing south than on those facing north.

The effect of exposure and slope is so marked at high altitudes that great care needs to be exercised in the selection of sites for crop purposes. Alter* emphasizes the significance of slope and exposure in this way: "Likewise, a 5° slope to the south in southern Idaho is in the same solar climate as is a level field in the latitude of southern Utah, 305 miles nearer the Equator."

Throughout the state there are many locally "warm spots", and "warm strips" surrounded by cooler districts. Such locally warm areas owe their higher temperature to topography.

In narrow valleys, shaded slopes may have sometimes an advantage over the sunny ones in the placement of an orchard. Slopes along the south side of narrow valleys that trend east and west may be shaded one or two hours longer each day than the neighboring slope across the stream. As a result of this shadow protection, there may be a delay in the time of blooming, postponing it until the frost danger period is past. On the other hand, on the sunny slope, buds are hastened into activity, possibly to be injured later by frost.

Length of Frostless Season.—"Length of frostless season" as used here means the number of days between the last frost in the spring and the first frost in the fall. From the climatological records it is evident that when the temperature goes to 32° , the day is reported as experiencing a frost. From Tables VII and VIII it is seen that our common fruits are not seriously injured by a temperature of 32° in any stage of their development. However, it must be held in mind that a recorded temperature of 32° , for example, is that of the air 6 feet from the ground, while the air temperature 6 inches from the ground surface is usually 3° to 8° lower. The maps showing length of frostless season and average date of last spring frost enable us to make valuable comparisons, and to better judge of the different localities in the state. Fig. 5 gives the average length of the frostless season for the different

*Crop Safety on Mountain Slopes, U. S. Dept. Agr. Yearbook, pp. 309-318, 1912.

sections of the state. There is a pronounced variation in the length of this period. Grand Junction has the longest season (average 183 days) of any locality in the state, while on the highest peaks there is no day in the year without frost. Those sections of Colorado with a frostless season averaging above 150 days are the lower Grand Valley, a limited area on the North Fork of the Gunnison about Paonia, the lower McElmo Valley, the Arkansas Valley up as far as Canon City, and an area along the foothills from below Denver to north of Boulder. The tenderer crops are, of course, grown with best success in those sections in which the frostless season averages 150 days or more. However, this statement must not be taken to mean that all portions of the state with a frostless season of 150 days and over are climatically well adapted to tender crops like peaches and apricots, nor that some localities with a slightly shorter average frostless season can not grow such crops with considerable success. There are other climatic conditions besides length of growing season to be considered, for example, coldness and dryness of the winter season, the character of the springs, and total effective heat during the period free from frost. Those stations with a frostless season of 75 days or less are usually such as may experience frost any month of the year. However, over the lower part of this extensive area, which has a growing season averaging less than 75 days, alfalfa, timothy, potatoes, Canada field peas, the small cereals, gooseberries, currants, raspberries, strawberries, and a large list of vegetables are grown with profit.

It is obvious that two stations with the same number of frostless days may have temperature values during this period that differ widely in their effectiveness in determining the rate of plant growth. Daily mean temperatures may be the same, but the maximum and minimum temperatures different. Furthermore, although the number of hours of a day during which the temperature is sufficient to promote plant growth may be the same in two localities, the total effective heat in the two instances may differ widely. Thus it is realized that it is difficult to relate ordinary temperature data, in their usual recorded form, to plant growth; but a number of attempts* have been made to do this in a manner which is more satisfactory than the rough, qualitative method here employed.

*Livingston, B. E., and Livingston, Grace J. Temperature coefficients in plant geography and climatology. *Bot. Gaz.* 56:349-375. 1913.

MacDougal, D. T. The auxothermal integration of climatic complexes. *Amer. Jour. Bot.* 1:186-193. 1914.

Livingston, B. E. Physiological temperature indices for the study of plant growth of relation to climatic factors. *Physiol. Res.* 1:399-420. 1916.

NATIVE VEGETATION

TABLE V.—FROST DATA FOR REPRESENTATIVE COLORADO STATIONS.
(Data available up to and including year 1915).

Station	County	Altitude in Feet	Average Date Last Spring Frost	Latest Date Last Spring Frost	Average Date First Fall Frost	Earliest Date First Fall Frost	Aver. Length Frostless Seas.	Shortest Frost- less Season
Arriba	Lincoln	5240	May 21	June 7	Oct. 4	Sept. 20	133	119
Ashcroft	Pitkin	9483	July 1	July 28	Sept. 1	Aug. 1	61	28
Boulder	Boulder	5347	Apr. 29	May 20	Oct. 12	Sept. 15	166	125
Buena Vista	Chaffee	7955	June 3	June 28	Sept. 20	Sept. 8	108	91
Burlington	Kit Carson	4160	May 3	May 27	Oct. 8	Sept. 25	158	137
Calhan	El Paso	6700	May 15	May 27	Sept. 28	Sept. 2	138	111
Canon City	Fremont	5343	Apr. 28	May 23	Oct. 11	Sept. 17	166	136
Castle Rock	Douglas	6220	May 14	June 10	Sept. 21	Sept. 10	132	99
Cedaredge	Delta	6175	May 16	June 9	Sept. 8	Sept. 10	129	95
Cheyenne Wells	Cheyenne	4279	May 3	May 26	Oct. 6	Sept. 12	157	122
Collbran	Mesa	6000	May 16	June 8	Sept. 26	Sept. 12	132	114
Colorado Spgs.	El Paso	6098	May 6	May 23	Oct. 2	Sept. 11	149	124
Cope	Washington	4250	May 6	May 28	Oct. 5	Sept. 21	150	122
Delta	Delta	4965	May 11	May 28	Sept. 27	Sept. 11	138	113
Denver	Denver	5272	May 4	June 6	Oct. 7	Sept. 13	156	117
Durango	La Plata	6534	May 17	June 5	Sept. 25	Sept. 11	130	98
Ft Collins	Larimer	4985	May 5	May 21	Sept. 26	Sept. 7	144	125
Ft. Morgan	Morgan	4319	May 6	May 25	Sept. 30	Aug. 25	145	95
Frances	Boulder	9300	May 31	June 20	Sept. 20	Aug. 25	110	88
Fruita	Mesa	4510	Apr. 30	May 22	Oct. 3	Sept. 15	156	133
Garnett	Costilla	7576	June 6	July 7	Sept. 12	Aug. 13	95	51
Glenwood Spgs.	Garfield	5823	May 22	June 19	Sept. 18	Aug. 9	112	58
Grand Valley	Garfield	5089	Apr. 3	May 27	Oct. 7	Sept. 11	187	115
Grand Junction	Mesa	4602	Apr. 18	May 14	Oct. 19	Sept. 14	181	144
Greeley	Weld	4649	May 1	May 21	Oct. 1	Sept. 7	156	126
Gunnison	Gunnison	7670	June 28	July 28	Sept. 1	Aug. 1	63	19
Hoehne	Las Animas	5700	May 17	July 4	Oct. 2	Sept. 10	136	73
Holly	Prowers	3380	Apr. 25	May 27	Oct. 11	Sept. 17	166	130
Idaho Springs	Clear Creek	7543	May 20	June 7	Sept. 27	Sept. 13	132	112
Lake City	Hinsdale	8686	June 11	June 24	Sept. 18	Sept. 6	99	80
Lake Moraine	El Paso	10265	June 19	July 24	Sept. 9	Aug. 6	78	52
Lamar	Prowers	3592	Apr. 23	May 14	Oct. 8	Sept. 17	167	140
Las Animas	Bent	3899	Apr. 27	May 20	Oct. 6	Sept. 9	161	123
Lay	Moffat	6190	June 11	July 9	Sept. 5	Aug. 11	85	30
Leadville	Lake	10248	June 17	July 28	Sept. 12	Aug. 2	92	65
LeRoy	Logan	4388	May 3	May 27	Oct. 1	Aug. 25	142	128
Longmont	Boulder	4950	May 3	May 19	Oct. 1	Sept. 15	152	135
Long's Pk (nr.)	Larimer	8600	June 29	July 31	Aug. 30	Aug. 1	62	3
Mancos	Montezuma	6960	June 6	July 6	Sept. 21	Aug. 27	106	78
Meeker	Rio Blanco	6182	June 13	July 4	Sept. 11	Aug. 22	88	57
Montrose	Montrose	5811	May 12	June 8	Sept. 27	Sept. 14	137	113
Moraine	Larimer	7775	June 14	July 20	Sept. 10	Aug. 22	88	57
Pagoda	Routt	6500	May 17	July 19	Aug. 9	Aug. 20	82	55
Pagosa Springs	Archuleta	7108	June 28	July 29	Sept. 12	Sept. 5	78	58
Paonia	Delta	5694	Apr. 30	May 20	Oct. 16	Sept. 21	161	130
Pueblo	Pueblo	4734	Apr. 27	May 23	Oct. 7	Sept. 12	163	139

TABLE V.—FROST DATA FOR REPRESENTATIVE COLORADO STATIONS.—CONT.
(Data available up to and including year 1915).

Station	County	Altitude in Feet	Average Date Last Spring Frost	Latest Date Last Spring Frost	Average Date First Fall Frost	Earliest Date First Fall Frost	Aver. Length Frostless Seas.	Shortest Frost- less Season.
Rangely	Rio Blanco	5050	May 16	June 23	Aug. 21	Aug. 31	115	88
Rocky Ford	Otero	4177	Apr. 27	May 15	Oct. 8	Sept. 13	164	140
Saguache	Saguache	7740	May 26	June 18	Sept. 25	Sept. 10	124	93
Salida	Chaffee	7035	May 26	July 6	Sept. 17	Sept. 6	113	68
San Luis	Costilla	7794	July 5	July 6	Sept. 20	Sept. 5	106	68
Sapinero	Gunnison	8125	June 17	June 30	Sept. 15	Sept. 6	91	81
Silverton	San Juan	9400	June 3	July 9	Aug. 8	Aug. 26	65	55
Spicer	Jackson	8700	June 27	July 11	Aug. 27	Aug. 31	61	34
Steamboat Spgs.	Routt	6683	July 7	July 30	Aug. 30	Aug. 2	57	24
Sterling	Logan	3892	May 6	May 22	Sept. 27	Sept. 5	144	127
Sugar Loaf	Boulder	7800	May 25	June 14	Sept. 18	Aug. 25	116	93
Telluride	San Miguel	8756	June 29	July 27	Sept. 5	Aug. 18	74	66
Trinidad	Las Animas	5994	May 1	May 23	Oct. 11	Sept. 22	162	133
Victor	Teller	10100	June 4	July 3	Sept. 21	Sept. 5	111	76
Wagon Wh. Gap.	Mineral	9610	July 11	July 31	Aug. 19	Aug. 1	25	1
Walden	Jackson	8050	July 6	July 20	Aug. 31	Aug. 14	56	25
Westcliffe	Custer	7864	July 10	July 29	Oct. 14	Aug. 1	101	67
Whitepine	Gunnison	9500	June 3	July 9	Aug. 7	Aug. 22	64	46
Wray	Yuma	3512	May 6	May 27	Oct. 3	Sept. 12	150	124

Variations in Frost Dates and Length of Frostless Season.—

It is of value to know the frequency of late frosts in the spring, of early frosts in the autumn and also of short frostless seasons.

Variation in the length of frostless seasons for a number of Colorado stations is shown in Fig. 6. In some localities, there is not much departure from the normal from year to year, and the farmer or fruit-grower finds the seasons much the same from year to year, while in other localities there is very marked variation, which leads to much uncertainty and uneasiness on the part of the farmer or fruit-grower.

Effect of Altitude on Length of Frostless Season.—The average length of the frostless season for all stations in the different altitudinal zones is shown in the accompanying table.

TABLE VI.—ALTITUDE AND LENGTH OF FROSTLESS SEASON.

Feet	Days
Below 5000	146
5000—6000	138
6000—7000	113
7000—8000	98
8000—9000	56

A pronounced difference exists between the average length of the frostless season of stations having approximately the same

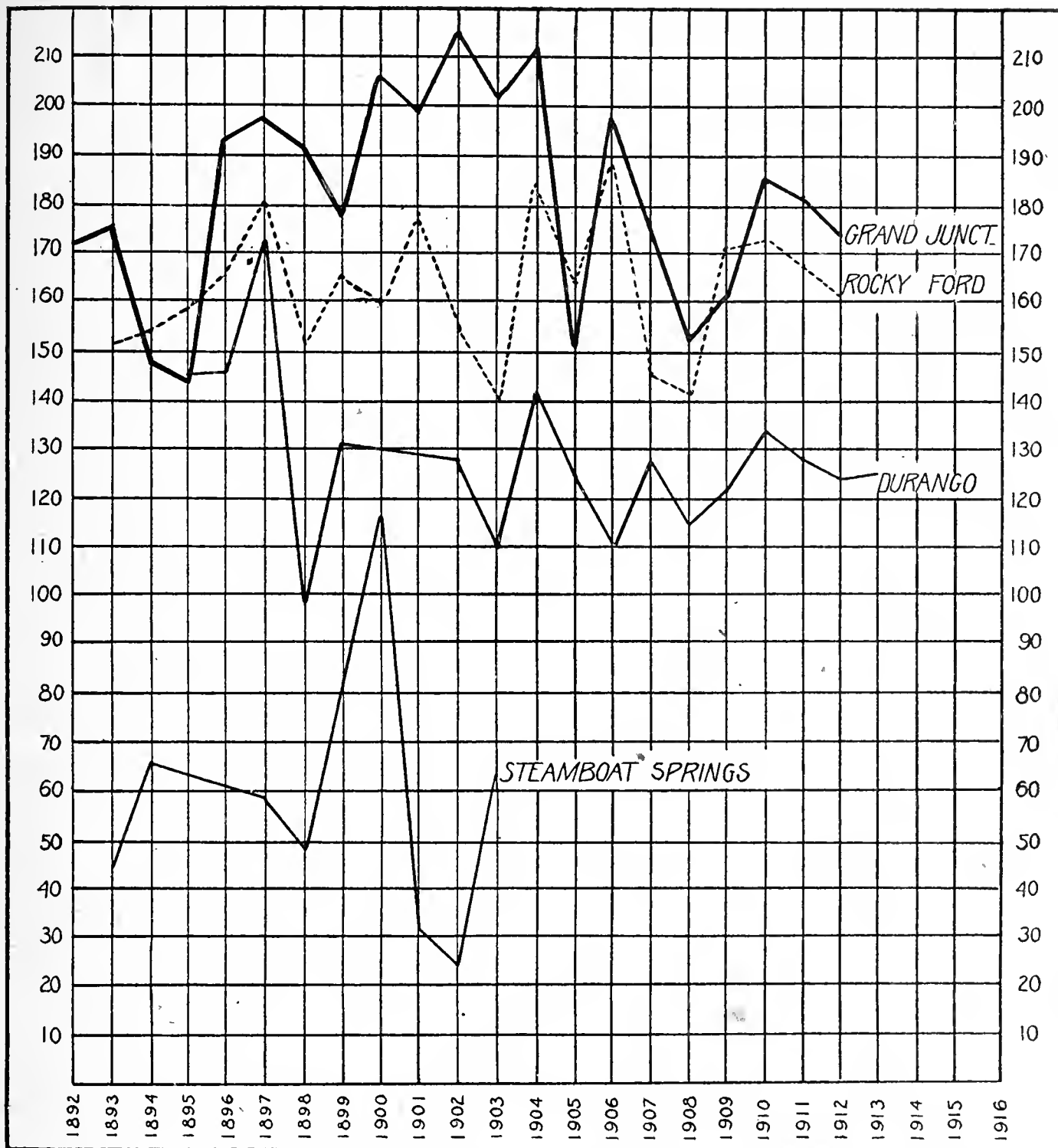

Fig. 6.—Variation in length of frostless seasons for Grand Junction, Rocky Ford, Durango, and Steamboat Springs.

altitude, but located differently topographically. A few examples will illustrate this point: Castle Rock (altitude 6,220 feet), has an average frostless season of 98 days, Cedaredge (altitude 6,175 feet), 127 days; Conejos (altitude 7,880 feet), 128 days; Westcliffe (altitude 7,864 feet), 106 days; and Pagosa Springs (altitude 7,100 feet), 85 days.

Frosts.—The formation of frost and the factors conditioning it are quite well known. Plants lose their heat by radiation to the surrounding air. In fact, radiation is more rapid from plant surfaces than from the surrounding air. If the temperature of the plant surface is lowered far enough, the water vapor of the sur-

rounding air condenses on the plant, and, if further lowering of the temperature takes place, the condensed vapor freezes, and "frost" is formed.

The rate of radiation of heat from a plant surface is increased and hence the formation of frost favored by the following conditions: (1) Clear sky; (2) dry air; (3) still nights; (4) rare atmosphere (as at high altitudes). Clear nights are the rule in Colorado, and hence the radiation at night is pronounced. A blanket of fog or clouds tends to retard the loss of heat from bodies on the earth's surface. The actual amount (not relative amount) of water vapor in the air decreases with altitude, and since water vapor absorbs and retains heat radiated from the earth's surface, the atmosphere at high altitudes is less able to hold this heat than atmosphere at lower elevations. It is a common observation that frosts are more prevalent on still nights than when the air is in motion. Radiation of heat proceeds with greater rapidity in a rare atmosphere, such as is found at high altitudes, than it does in a dense atmosphere, such as is found at low elevations.

Freezing of Plants.—In the freezing of plant tissues, injury may result in two ways: (1) Water may be withdrawn from the plant cells and ice crystals from this water form in the spaces between cells; subsequently the ice in the intercellular spaces may evaporate, and cause death of the plant tissue by drying out. It is well-known that many plants may survive extremely cold weather provided it is not accompanied by a dry atmosphere; (2) again, the injury from low temperatures may result from the actual freezing of the cell sap, which may cause a mechanical rupture of the living material in the cell itself.

It is a familiar observation that some of the more tender plants are injured by temperatures above the freezing point; and that, on the other hand, there are many plants that may withstand temperatures considerably below the freezing point. This statement may apply not only to dormant plant parts, but to swelling buds, open flowers, and forming fruit as well. The plants at timber-line and above are subject to freezing temperatures almost every night in the year. The exact nature of this immunity to low temperatures is not known.

There are remarkable differences between varieties of plants, between individuals of the same variety, and even between different buds on the same tree, in their resistance of low temperatures. This resistance may depend much upon the age of the tissue, and the treatment and care the plant has had during its life. Old plant tissue is more resistant than newly-formed tissue. A pruning prac-

tice that stimulates the production of tender shoots and a cultural method that favors the development of succulent tissue may result in more or less freezing. Temperature conditions preceding and leading up to a freeze are important in influencing the resisting power of a plant. A series of warm days preceding a freeze, which permits the formation of many new plant cells, with their thin walls and an abundance of water, is especially injurious. Such warm days are prevalent in Colorado, coming even weeks ahead of the last frost. During a favorable spring, the minimum and maximum temperatures, as well as the mean, for the 24 hours of the day, should become gradually greater. Under such circumstances, even though the warm days induce the swelling of buds, they are better able to undergo the low temperatures of the nights. An unfavorable spring is one whose maximum, minimum and mean daily temperatures fluctuate greatly. Many mountain valleys are so shaded during a portion of the day that fruit buds are delayed in opening. A shaded mountain slope is quite likely to have daily extremes of temperature that are much less than those of a sunny slope. The latter warms up rapidly and to a high point in the day time, and at night cools as rapidly, and reaches as low a temperature as its neighboring shaded slope. Furthermore, if there be any efficacy in the gradual thawing of frosted plant tissues, mountain shadows will be of value in retarding the rate of this process.

In the Monthly Weather Review for March, 1912, are published data showing temperatures injurious to peaches, apples and pears in various stages of development. The data were compiled by a committee appointed by the Fruit Growers' Association of the Grand Valley, Colorado. The tables (VII and VIII) are taken verbatim from the Monthly Weather Review.

TABLE VII.—SHOWING AT WHAT TEMPERATURES SMUDGING IS NECESSARY IN THE VARIOUS STAGES OF DEVELOPMENT OF PEACH BUDS.

	Degrees
Peaches $\frac{1}{4}$ inch in diameter.....	30
Dropping the shuck.....	31
Setting	31
Full bloom	29 to 30
Buds in pink	22
Buds swelling	15
Buds dormant	15

TABLE VIII.—SHOWING AT WHAT TEMPERATURES SMUDGING IS NECESSARY IN THE VARIOUS STAGES OF DEVELOPMENT OF APPLE AND PEAR BUDS.

	Degrees
Calyx closed	30
Flowers gone, calyx closing.....	30
Petals dropping	31
Fruit forming	30
Full bloom	30
Buds in pink	25
Buds separating	20
Buds swelling	15

From the two tables above, it is evident that a temperature of 32°, which may be accompanied by the formation of frost, is not low enough to cause injury to our fruits in any stages of their development. It very frequently happens that the temperature just touches 32°, not going lower, and after remaining there for a short time, becomes higher.

Average Date of Last Spring Frost.—Fig. 7 shows the average date of the last spring frost in the different sections of Colorado. In a few localities the average date is before May 1. Over the greater part of the Great Plains it is between May 10 and May 20. Throughout the entire mountainous parts of the state above about 7,000 feet, and also at lower altitudes in the northwest counties, the average date is after June 1.

Inversion of Temperature.—As a rule, temperature decreases with an increase in altitude. Occasionally, however, as a result of air drainage, the valleys and canyon bottoms are cooler than the adjacent hillsides; in other words, temperature may increase locally with altitude. Temperature inversion is a common phenomenon in mountainous regions, and is particularly noticeable in the spring and autumn.

A comparative study* of temperatures on two mesas near Boulder, with a difference in elevation of 415 feet, showed for May, 1908, the mean monthly temperature to be 2.6° higher on the upper mesa than on the lower. Furthermore, the last frost in the spring was 16 days later on the lower mesa than on the upper one. This inversion is undoubtedly present all along the foothills and in many other sections of the state, not occurring every year, but to be expected.

At certain periods, inversion of temperature of more than local influence occurs along the eastern edge of the foothills, which up to a considerable altitude experience a higher temperature than the plains. Loud† points out that on the eastern slope of the

*Ramaley, Francis. Climatology of the mesas near Boulder, Colo., in Studies on mesa and foothill vegetation. Univ. Colo. Studies 6:11-49. 1909.

†Loud, F. H., The Colorado Sky 1:1-9. 1908.

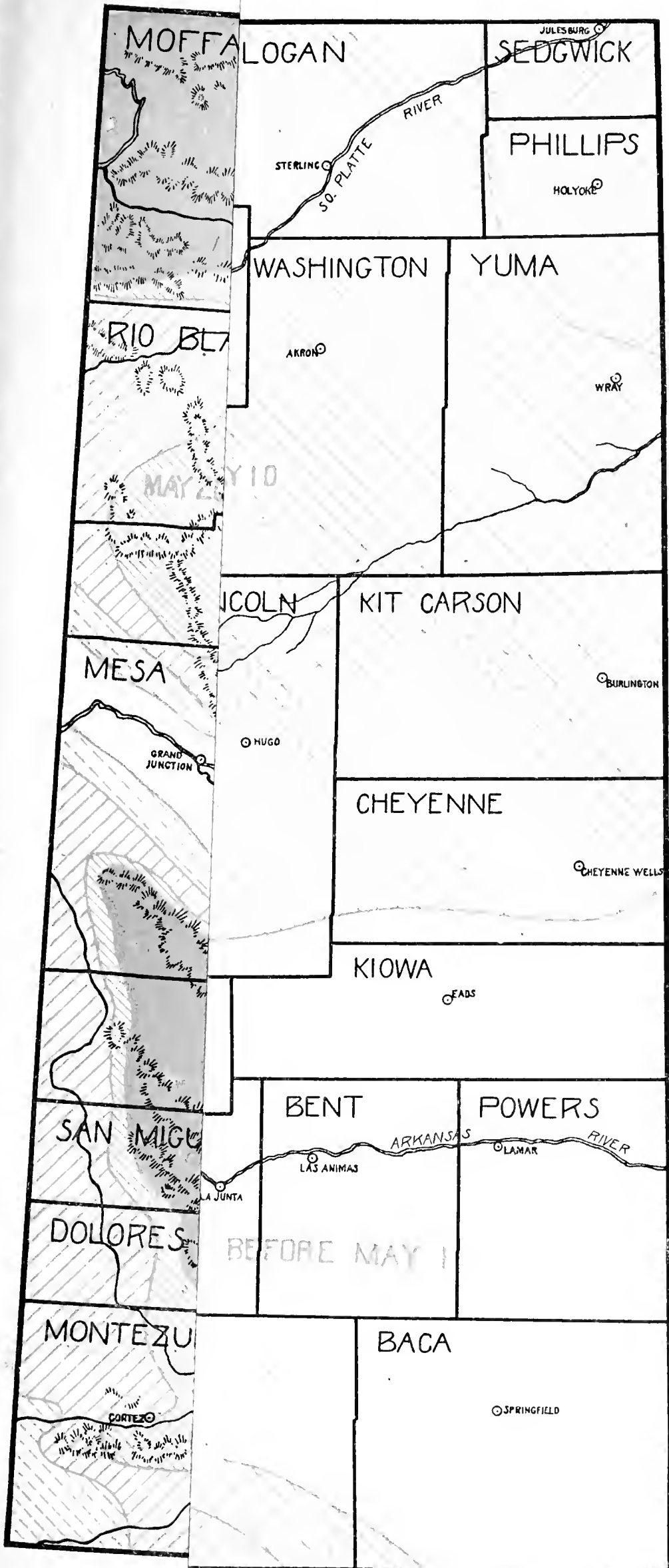
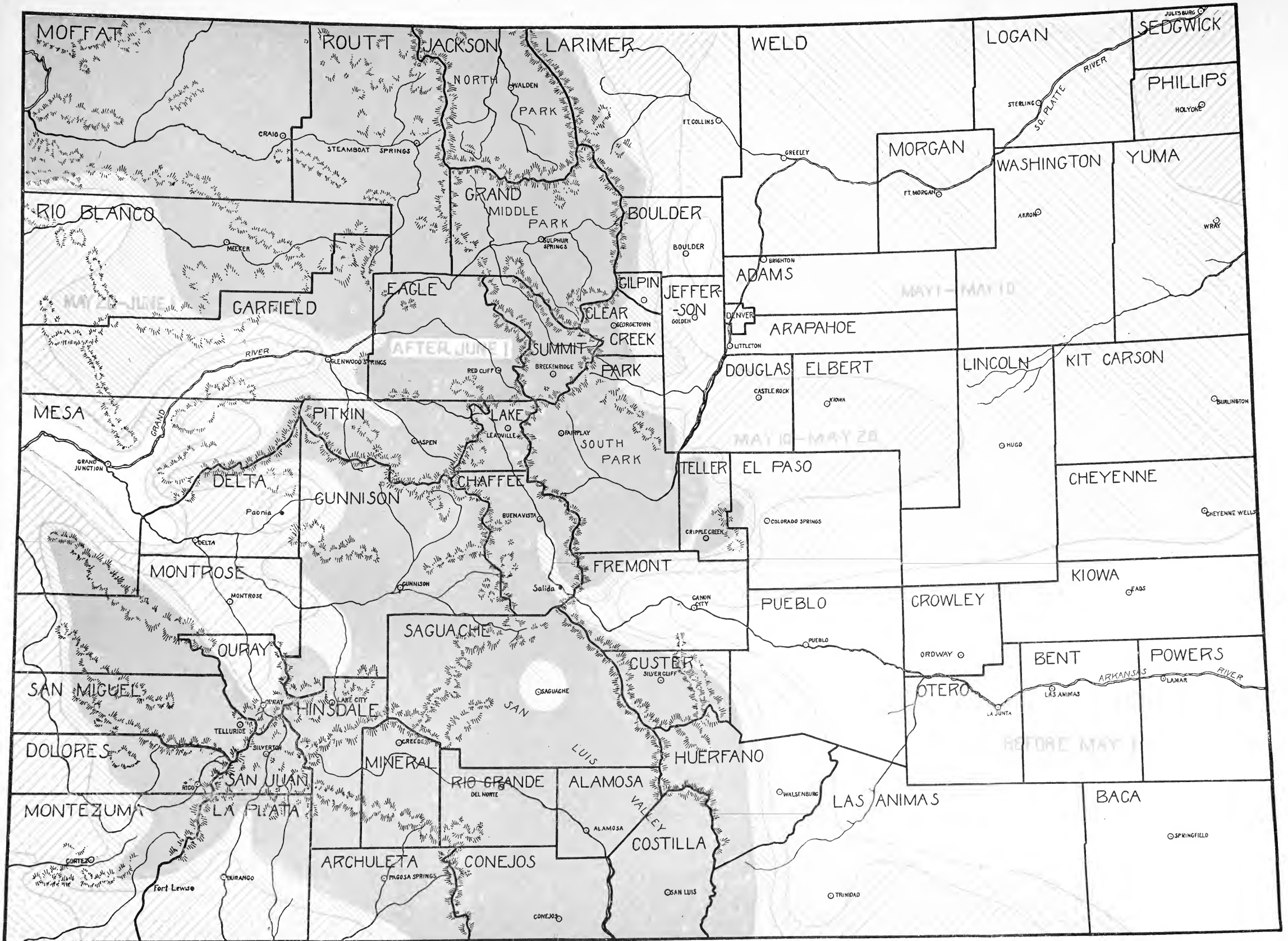

FIG. 7. AVERAGE DATE OF LAST SPRING FROST



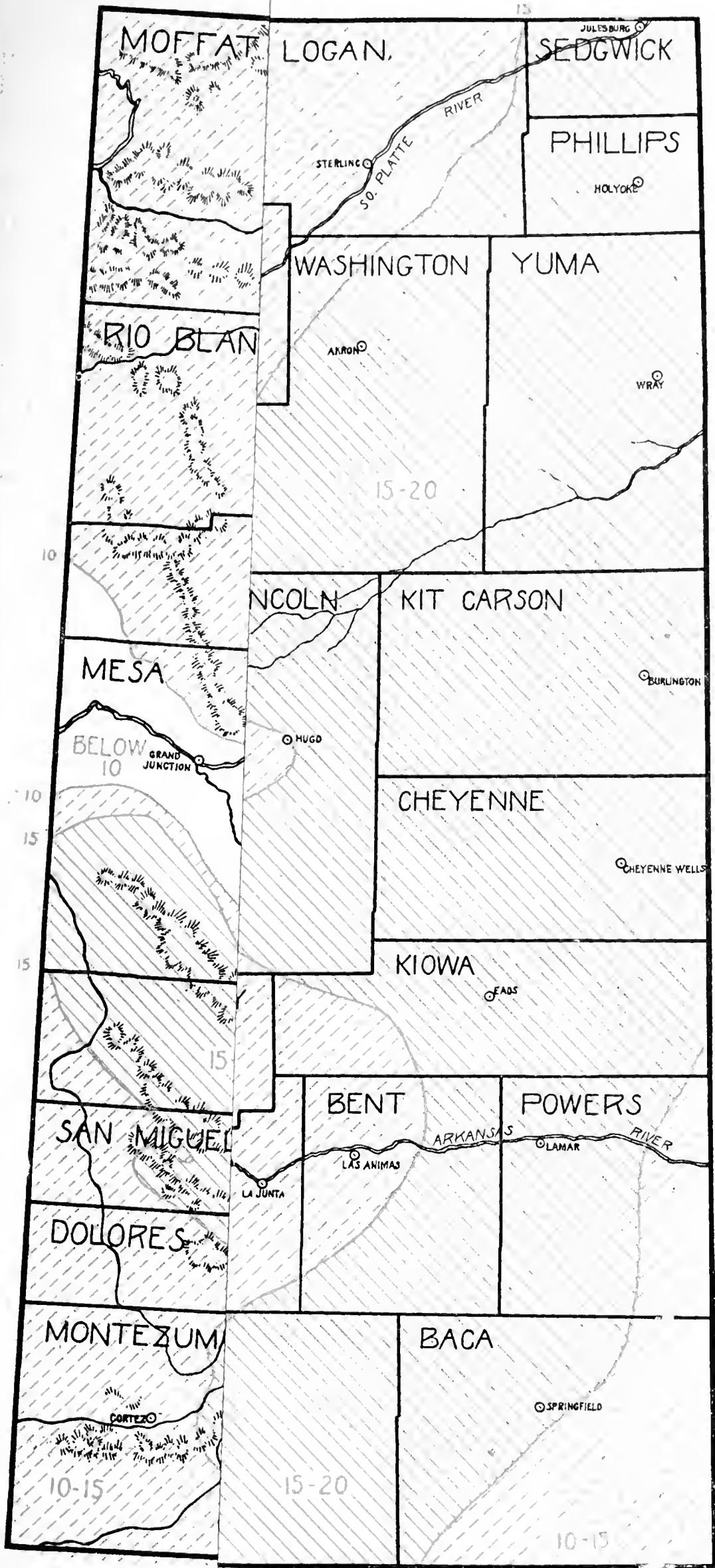
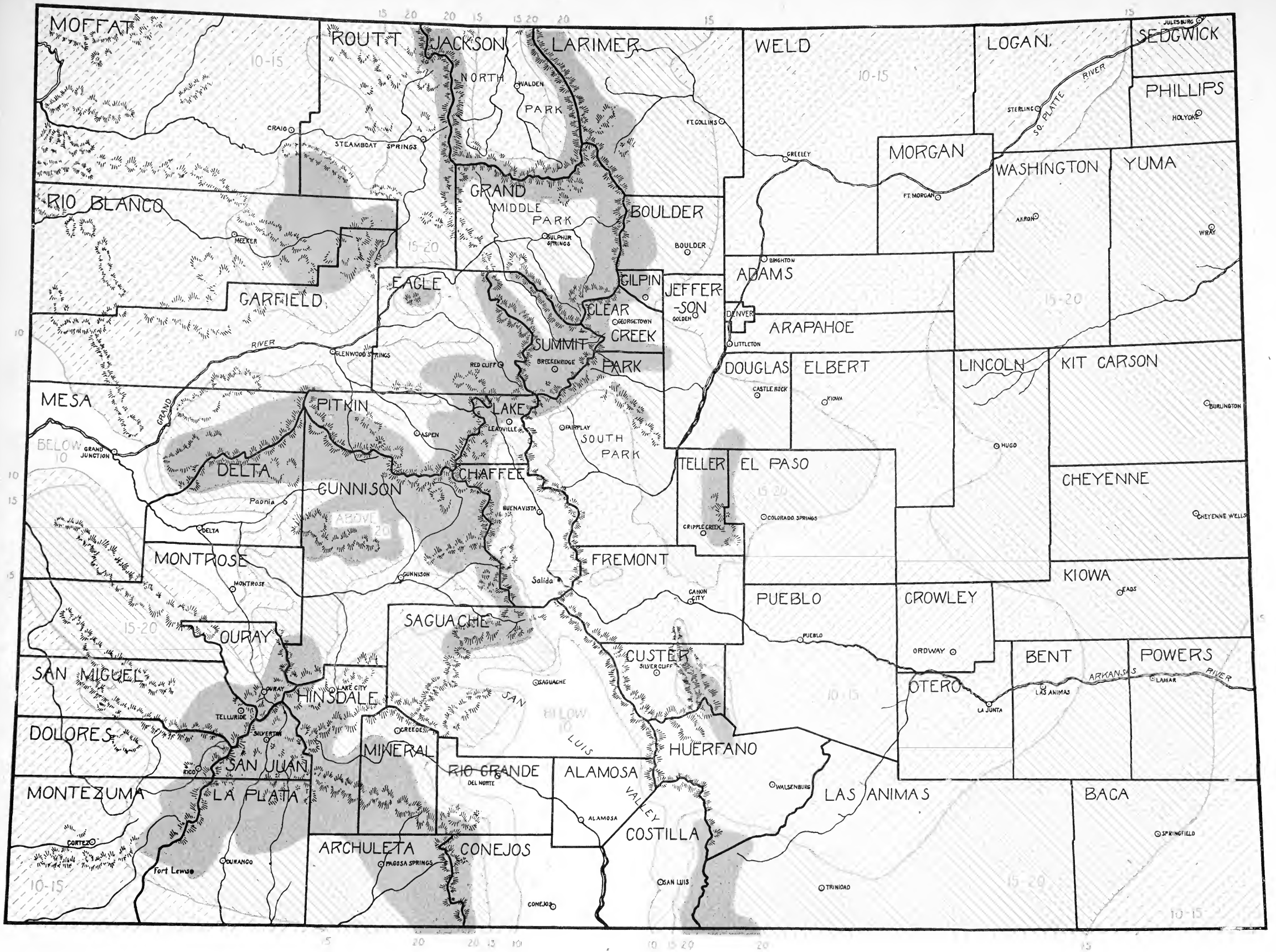

FIG. 8. MEAN ANNUAL PRECIPITATION



Rocky Mountains in Colorado he has often noticed that elevated stations retain a mild temperature for some time after a cold wave has set in at a lower level. Marked temperature inversion has been observed in the orchard sections of western Colorado. As pointed out on page 8, the mean temperature for January, 1915, at Marble (7,951 feet) was 6° higher than at Glenwood Springs (5,758 feet) in the same drainage system, and that at Cedaredge (6,175 feet) was 3.9° higher than at Delta (5,025 feet).

Batchelor and West* have shown, in the neighborhood of Logan, Utah, that "The minimum temperatures experienced by the brush lands, and upper slopes of the tillable area in a mountain valley average from 6° to 10° warmer than the valley bottoms, due to the drainage of cold air to the low areas during the typical clear, calm, frosty nights".

Temperature inversion is largely eliminated by cloudiness and by wind movement. Temperatures are not as low at the mouths of canyons where canyon breezes exert an influence, as they are at stations of about the same elevation which are not under the influence of these breezes.

PRECIPITATION

Mean Annual Precipitation.—In making a mean annual precipitation map of Colorado it is found difficult to depend entirely upon rain-gage records, for in some sections of the state stations are so very far apart and the topographical conditions between them may be so varied as to indicate quite clearly that the rainfall and snowfall are much different in amount from that indicated by the nearest stations. Therefore, in the construction of the precipitation map (Fig. 8), not only were all available records taken into account, but the directions of lines at intermediate points were guided by topography, and by the character of the native plant associations.

The portions of Colorado with an average annual precipitation less than 10 inches include most of the San Luis Valley and the lower altitudes in the Grand and Uncompaghre drainages. A large percentage of Colorado has an annual precipitation between 10 and 15 inches. This includes the western half of the Great Plains lying next to the foothills, a corner in the southeast, much of South Park and the Wet Mountain Valley, most of North Park, almost all of the northwest counties, intermediate elevations in the western valleys, lower altitudes in Montezuma, Dolores and

*Batchelor, L. D., and West, F. L. Variation in minimum temperatures due to the topography of a mountain valley in its relation to fruit growing. Utah Agr. Exp. Sta., Bul. 141:1-27. 1915.

San Miguel counties, and a strip bordering San Luis Valley. The 15-inch precipitation line follows quite closely the 6,000-foot contour line along the eastern mountain front and the 7,000-foot line in the western portion of the state, except in the Gunnison district where it is elevated to 8,000 or 8,500 feet. The 15-inch line runs at an altitude of about 9,500 feet in the Wet Mountain Valley, North Park, and San Luis Valley. The eastern half of the Great Plains and also a strip along the southern border, except the corners of Baca and Prowers counties, experience 15 to 20 inches of precipitation on the average, which gives this section an advantage over the western half of the Plains in dry land agriculture. The 20-inch isohyetal line varies in altitude from about 8,500 feet to 10,000 feet. The higher elevations in the state have over 20 inches of rainfall. Although there are localities with an annual precipitation considerably over 25 inches, there are too few stations to enable one to put in the 25-inch line with any degree of accuracy.

In connection with this discussion, it should be pointed out that the total precipitation for the year may not give us a true idea of the effectiveness of such in increasing the moisture content of the soil, and in influencing plant growth. In addition, we need to know particularly the distribution of the precipitation throughout the year, and the frequency and nature of the same. For example, torrential rains, although they swell the total annual amount, may run off in large part as flood waters, and only a small fraction be left in the soil for plant use. Again, frequent light showers, followed by sunny skies, may moisten merely the surface of the soil, and the moisture be carried away shortly; moreover, light showers may effect the formation of a surface crust on the soil, which may actually be harmful in that it establishes a capillary connection with the soil below, and moisture from these lower layers is lost to the air. The minimum effective amount of rainfall will not be the same for different soil types, or for similar soil types when atmospheric conditions vary. Light showers followed by cloudy weather are more beneficial than when followed by bright, sunny weather.

Variation in Precipitation from Year to Year.—Very wet and very dry years, or a consecutive series of these, are not uncommon in Colorado. The mean difference between the wettest and driest years is somewhat greater for localities east of the Continental Divide than for localities west. The following brief table gives one an idea of this fluctuation.

TABLE IX.—GREATEST AND LEAST YEARLY PRECIPITATION (INCHES).

Station	No. of Years		
	Considered	Greatest	Least
Cheyenne Wells	16	25.46	9.72
Cowdrey, North Park.....	19	21.27	10.01
Denver	42	22.96	7.75
Durango	16	34.29	8.90
Fort Collins	32	22.79	7.11
Garnett	17	9.82	3.50
Grand Junction	19	11.61	3.64
Hamps	18	24.15	7.63
Meeker	17	24.30	12.67
Long's Peak (near)	20	29.66	13.50
Rocky Ford	22	18.75	6.93
Wray	17	26.99	10.74
Yuma	20	29.29	10.26

The variation in precipitation from year to year for a number of localities is shown graphically in Fig. 9.

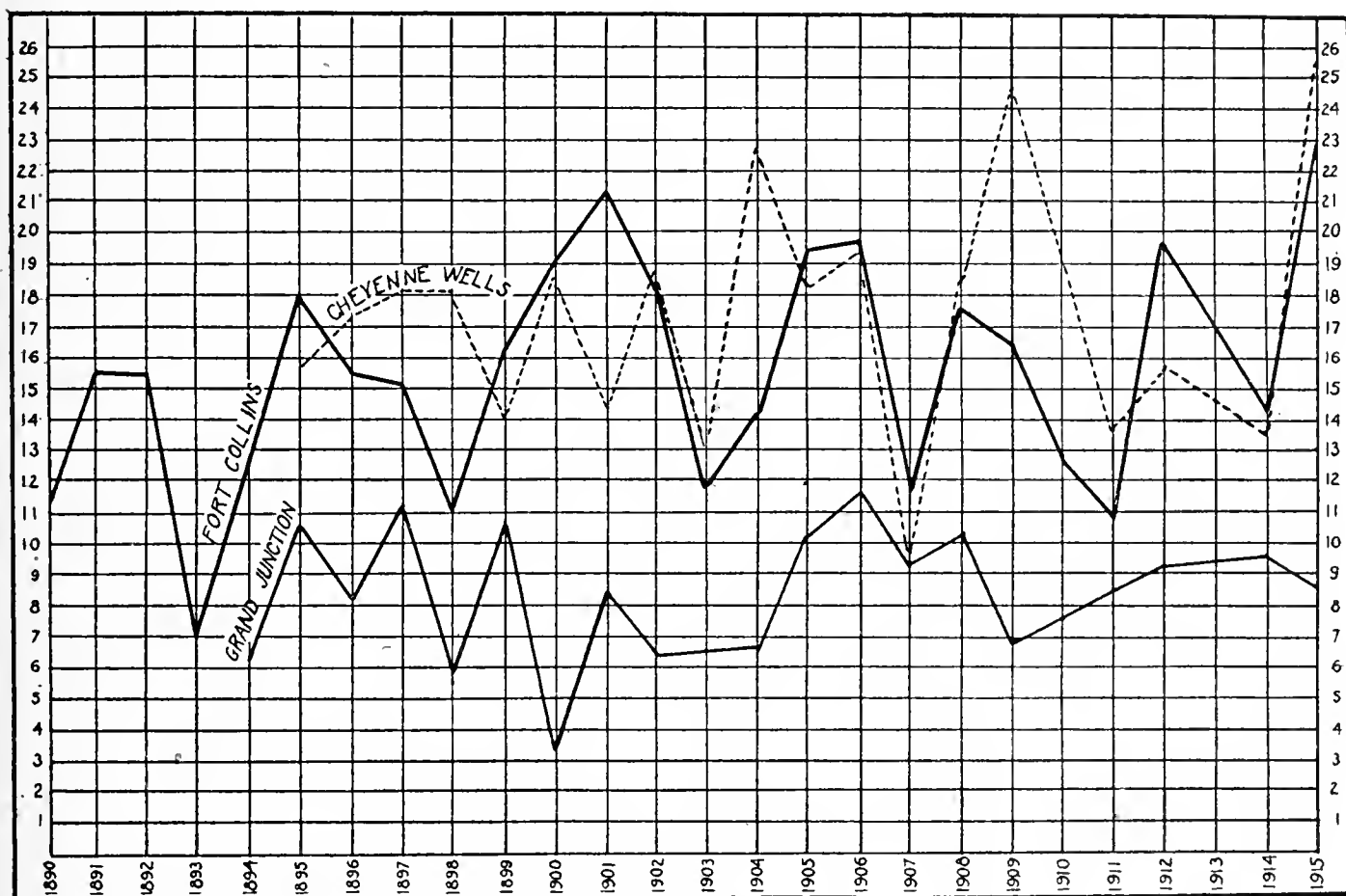

Fig. 9.—Variation in total precipitation from year to year for Cheyenne Wells, Fort Collins, and Grand Junction.

Distribution of Rainfall Throughout the Year.—There are several distinct types of rainfall in Colorado. The Great Plains section is characterized by a rainfall, about 75% of which occurs during the growing season, and 50% to 74% of which may come during the months of June, July, August, and September. This section has two main types of rainfall. In the region north of the Arkansas-Platte Divide, comprising the South Platte drainage sys-

tem, the rainy months are April and May, with the exception of a few localities in Yuma and Phillips counties, where the maximum usually comes in June. The Arkansas-Platte Divide and the entire Arkansas Valley receive their maximum rainfall during the summer, July showing the greatest monthly amount.

July and August are the wettest months throughout the San Luis Valley. The same months are usually the wettest in the valleys of the Las Animas, La Plata, Mancos and McElmo. Over practically the whole of the western slope, the spring is wetter than the other seasons, and there is quite wide variation as to the month that shows the greatest precipitation, although July and August are usually the wettest. In North Park, March and April are usually the two rainiest months. April and May are normally quite rainy months on the mountains of the eastern slope; this period is followed by a relatively dry June, and then July and August, with their afternoon showers, show large monthly amounts. July is usually the month of greatest rainfall in the Wet Mountain Valley.

The marked differences in the seasonal distribution of precipitation east and west of the Continental Divide are worthy of special mention. East of the Divide the greater part of the total precipitation for the year comes during the growing season, when plant life can use it. On the other hand, west of the Continental Divide only about one-half of the yearly amount comes during the growing season; here from 30% to 50% of the total for the year falls during the four months, June, July, August and September. Although the Western Slope has not the advantage of spring rainfall, this is offset in a measure by its greater snowfall, and by the presence of a ground cover of snow a good part of the winter season.

Increase of Precipitation with Increase of Altitude.—It may be stated as a general rule that rainfall increases in amount and frequency with elevation above the sea level. There are, of course, exceptions which are due to topography. For example, the average yearly precipitation for Saguache (altitude 7,740 feet) in the San Luis Valley is 7.39 inches, while that for Pueblo (altitude 4,734 feet) on the plains is 11.67 inches. The low precipitation of San Luis Valley stations, although at considerable elevations, is due to their almost complete enclosure by high mountain ranges. There is wide variation in the rate of increase. It may require as little as 200 feet or as much as 1,200 feet increase in altitude to give an increase of one inch of precipitation.

Snowfall.—The annual snowfall throughout the state varies as widely from year to year as does the annual precipitation as a

whole. A low amount of snowfall may be due to a normally low precipitation for the year as a whole, or to an unequal distribution of the precipitation of a locality that shows a considerable annual amount. For example, the average annual snowfall in the San Luis Valley ranges from 7 to 30 inches. This small amount is to be expected, as the total precipitation (rainfall plus snowfall) for the year is below 10 inches. However, on the Great Plains, where the total snowfall averages less than 30 inches, (Limon 18, Holly 13, Blaine 23, Las Animas 24, Pueblo 23, Ft. Morgan 25), the low figure is explained by the fact that about 75% of the yearly precipitation comes during the growing season.

In general, the amount of snowfall increases at higher altitudes. The mean total snowfall for the year at some typical high altitude stations is as follows:

TABLE X.—MEAN ANNUAL SNOWFALL.

Station	Altitude (feet)	Mean Annual Snow- fall (inches)
Ashcroft	9482	148
Breckenridge	9536	199
Corona	11660	377
Crested Butte	8867	158
Cripple Creek	9400	84
Frances	9300	175
Georgetown	8550	94
Lake Moraine	10265	151
La Veta Pass	9000	107
Leadville	10248	132
Long's Peak (near).....	8600	127
Rico	8824	148
Silverton	9400	169

The snowfall in northwestern Colorado is high. At Meeker the average in inches is 66, at Buford 86, Pagoda 105, Hayden 81, Yampa 71, and Steamboat Springs 119. It is also quite high in North and Middle Parks; for example, Walden and Spicer, each in North Park, have about 70 inches, and in Middle Park, Kremmling has 110 inches, Hot Sulphur Springs close to 100 inches, and Fraser 104 inches. There is also an abundance of snowfall in the southwest. At Durango the average is 62 inches; at Tacoma, 87; Pagosa Springs, 84; and Chromo, 102.

On the plains and the lower slopes of the eastern part of Colorado, snows do not, as a rule, lie on the ground for any length of time, but disappear within a few days, and vegetation is without the protection which snow offers. On the western slope, however, the snows accumulate, not only protecting the vegetation but furnishing the soil with a supply of moisture that is not often exhausted until in July. The dry, open winters of the Great Plains, with the absence of a protecting snow cover, are often detrimental

to such plants as alfalfa. The wind movement in the winter bears a relation to plant growth. For example, there is ample snowfall in North Park, but the winds pile the snow into drifts, sweeping it from the level places. The exposure to the low temperatures thus brought about often makes conditions unfavorable for the wintering over of alfalfa, strawberries, etc.

HUMIDITY

The rate of water loss from the surfaces of plants is largely determined by the relative humidity of the atmosphere. The higher the relative humidity, that is, the nearer the air is to the point of saturation, the less rapid the rate of water loss (transpiration); the lower the relative humidity, the more rapid is the loss of water. For example, a plant growing in an atmosphere with a relative humidity of 50% will lose water at a much greater rate than one in the same kind of atmosphere having a relative humidity of 60% or 70%, providing other environmental conditions are approximately the same.

The relative humidity of the atmosphere is affected by the following conditions: 1. *Temperature*.—In two regions, each with the same precipitation, the warmer has the lower relative humidity, that is, is drier. High temperatures increase the capacity of the air for moisture, and hence decrease the relative humidity. The relative humidity of the air falls during the day, and rises during the night. It is nearly always higher at 6 a. m. than at 6 p. m. For example, a ten-year average of the relative humidity at Denver for the year at 6 a. m. varies from 61% to 70%, and at 6 p. m. from 37% to 48%. 2. *Wind*.—The relative humidity is less in a region where high winds prevail. Winds have a pronounced drying effect. Winds are particularly injurious to plants that have parts of them exposed during the winter season, for then the cold soil retards the intake of water by the roots, and the rate of intake does not keep pace with the rate of outgo. It is well to remember that the bare stems of fruit trees, the bare canes of raspberries, currants, blackberries and gooseberries, the crowns of alfalfa, and of strawberries, are losing some water throughout the winter period. Winter killing of fruit trees, cane fruits, and alfalfa in Colorado is not the result of low temperatures alone, but of the combined effect of low temperatures and a dry atmosphere. Plants are particularly sensitive to winter cold if the air is dry. 3. *Air Pressure*.—Other factors remaining constant, a decrease in the air pressure lowers the relative humidity. 4. *Exposure*.—South exposures, with their greater heat, have a lower relative humidity than north exposures. Moreover, slopes exposed to the

wind experience a lower relative humidity than those protected.

5. *Cloudiness*.—Clear, sunny winters are dry, and are usually much more unfavorable to resting plants than cloudy winters.

The intensity of evaporation throughout Colorado is generally great, that is, the relative humidity is low, or in other words, the air is dry. Hence the plants are making a strong demand for water from the soil. The following data from Bulletin 182, Colorado Agricultural Experiment Station, show the average evaporation from a free water surface at Ft. Collins.

TABLE XI.—AVERAGE EVAPORATION IN INCHES FROM FREE WATER SURFACE, FT. COLLINS.

Jan.	Feb.	Mar.	Apr.	May	June	July	Aug.	Sept.	Oct.	Nov.	Dec.	Year
1.3	1.59	2.88	4.26	4.62	5.37	5.58	5.00	4.30	3.32	1.54	1.14	40.9

The amount of water evaporated from a free water surface, at Ft. Collins, increases from winter to spring and summer, reaching its maximum in July. The evaporation from a dry or medium dry soil surface is less than that from a free water surface, while evaporation from a wet soil surface is about the same as that from a free water surface.

The monthly evaporation during June, July and August is heavy, and although these months are not rainless, the rainfall does not have as much effect upon plant life as that coming in April and May, which months have a lighter evaporation.

There is a decrease in the absolute amount of water vapor in the atmosphere with an increase in altitude. But there is no constant and regular relation between relative humidity and altitude. However, high elevations are subject to an extremely dry atmosphere, which results in excessive water loss from soil and plant surfaces. The periods of excessive dryness come in clear weather, accompanied by high winds, both during the warm and cold seasons. A low relative humidity, which means an increased rate of evaporation, is especially pronounced in the elevated, open mountain valleys, and on south exposures.

SUNSHINE

Colorado is a state with ample sunshine. The percentage of possible sunshine is higher in the mountain states than in the more humid sections of the country. The following table will give the reader an idea of the amount of sunshine in Colorado as compared with other stations throughout the United States.

TABLE XII.—PERCENTAGE POSSIBLE SUNSHINE AT DIFFERENT POINTS IN THE UNITED STATES.

Station	Percentage Possible Sunshine
Albany, N. Y.	48
Amarillo, Texas	78
Atlanta, Georgia	58
Baltimore, Md.	59
Boston, Mass.	58
Chicago, Ill.	58
DENVER, COLORADO	65
Dubuque, Ia.	57
DURANGO, COLORADO	75
GRAND JUNCTION, COLORADO.....	67
Indianapolis, Indiana	55
LaCross, Wis.	56
Memphis, Tenn.	62
New Orleans, La.	58
Omaha, Neb.	59
PUEBLO, COLORADO	76
Richmond, Va.	60
St. Louis, Mo.	58
San Diego, Cal.	68
Santa Fe, New Mexico	75
Tacoma, Washington	38
Yuma, Arizona	88

The average percentage of possible sunshine for the four Colorado stations in the table above is 70.7. This percentage is lower at most high elevations, except the large highland parks, such as San Luis, Middle and North.

EFFECT OF INCREASE IN ALTITUDE UPON CLIMATIC FACTORS

Mention has been made of the great range of altitude in Colorado. All are familiar with the fact that an increase in altitude brings about changes in the factors which make up our climate, and which operate upon plants. However, altitude must not be considered as a single environmental factor, like precipitation, or light, or humidity. An increase in altitude generally brings with it a number of changes in environmental factors. The principal changes resulting from an increase in altitude are as follows:

1. Decrease of Air Pressure.—The amount of this decrease may be judged from the following table. Atmospheric pressure is affected slightly by temperature; in the table a temperature of 68° is taken. (Table modified from Hann's Handbook of Climatology.)

TABLE XIII.—DECREASE OF AIR PRESSURE WITH ALTITUDE.

Altitude (feet)	Air Pressure (inches)
0	30
1640.42	28.307
3280.8	26.693
4921.2	25.157
6561.7	23.622
8202.1	22.283
9842.5	20.905
11482.9	19.724
13123.3	18.504
16404.2	16.339

Providing other factors remain the same, a decrease in the atmospheric pressure increases the rate of evaporation. Furthermore, radiation of heat increases in intensity with an increase in the rarity of the atmosphere. Hence, as a result of the increased rate of radiation, and of evaporation at high altitudes, objects cool off very rapidly, the formation of frost is favored, and the length of the growing season is shortened.

2. Decrease of air temperature.—As a rule, in Colorado, an increase in elevation of 1,000 feet decreases the mean temperature for the year about $2\frac{1}{2}^{\circ}$, spring $3\frac{1}{2}^{\circ}$, summer 3° , fall $2\frac{1}{2}^{\circ}$, and winter $1\frac{1}{2}^{\circ}$. (Page 7).

3. Decrease in the difference between the mean temperature of the warmest month and that of the coldest month.

4. Greater difference between sun and shade temperatures page 9).

5. Greater difference between day and night temperatures page 9).

6. Increase in heating effect of the sun (page 9).

7. Increase in the difference between the temperature of soil and plant surfaces and that of the surrounding air (page 10).

8. Increase in the effect of exposure (page 11).

9. Shortening of the growing season (page 13).

10. Increase in precipitation (page 24).

11. Decrease in absolute amount of moisture in the air (page 27).

12. Increase in the rate of evaporation (page 27).

13. Stronger wind movement.—However, the rate of wind movement is very dependent upon local topographic conditions, such as direction of mountains, and exposure.

14. Increase in the intensity of ultra-violet rays.

SUMMARY OF CHARACTERISTIC FEATURES OF COLORADO CLIMATE, ESPECIALLY THOSE THAT BEAR UPON AGRICULTURE

1. Great variation throughout the state. We have a variety of climates such as one would pass through in going from Virginia to Greenland within the Arctic Circle. This variation necessitates the development of special crops, and special varieties, for the different climatic districts.

2. Low precipitation in districts where temperature conditions are most favorable for crops, hence necessity for irrigation.

3. Short growing season in regions with considerable precipitation.

4. Extremes of heat and cold, both diurnal and annual, especially on the plains, in the upland valleys, and in the western section of the state.

5. Cool nights and warm days.

6. Frequent late spring and early fall frosts, that is, a great variation from year to year in the length of the growing season.

7. High winds which, together with low winter temperatures, have much to do with winter killing.

8. Comparatively low relative humidity throughout the year, resulting in rapid loss of water from plant surfaces. The absence from Colorado of many fungous diseases is in part due to the low relative humidity of its atmosphere.

9. Wide variations from the normal as regards almost all climatic factors.

NATIVE VEGETATION

*Chief Native Plant Communities**.—No attempt will be made here to give a full discussion of all the native plant communities in Colorado. Only those that cover large areas, or are in the main climatically determined, will receive attention. However, as has been stated, the character of a plant covering is a response to local as well as climatic factors, and it is difficult to distinguish the relative effects of the two sets of factors.

The following large communities of Colorado native plants, with their climatic and agricultural relations, are discussed:

1. Grass-steppe or short-grassland (Great Plains).
2. Shrub-steppe. Sagebrush, greasewood, rabbitbrush, etc.

*The term "community" is used here in a general, unrestricted sense to include any aggregation of plants, such as grassland, oakbrush chaparral, yellow pine forest, etc., regardless of its vegetational rank.

3. Chaparral or brushland (thicket). Oakbrush, buckbrush, willow thicket, chokecherry, thornapple, mountain mahogany, etc.
4. Coniferous woodland. Pinyon pine and juniper woodland.
5. Coniferous forests.
 - a. Yellow pine-Douglas fir forest.
 - b. White fir forest.
 - c. Lodgepole pine forest.
 - d. Engelmann spruce-balsam fir forest.

It is realized that some of the above groups, particularly greasewood shrub-steppe, and chaparral, have a wide range of climatic conditions, and are called forth by local factors to a large degree, but they are such prevalent types of vegetation in the state, that they are included here and the range of their factors given.

Altitudinal Zones of Vegetation in Colorado.—Altitudinal vegetation zones or belts in the state are quite clearly recognized. As one travels from the sage plains of western Colorado, or from the grass plains of the eastern section of the state, to the crest of the Continental Divide, he passes through quite distinct and often sharp belts of vegetation. Realizing the changes in the supply of moisture, in the temperature, and in other environmental factors that accompany an increase in altitude, one is led to suspect that the different vegetation belts are a response to these factors, and, furthermore, that the presence of this or that dominating plant group might be correlated with crop possibilities. At least, it is believed possible to establish the broader and more general correlations.

NORTHEASTERN COLORADO

1. Plains (grass-steppe or short grassland). Up to 6,000 feet.
2. Chaparral or brushland of chokecherry, thornapple, mountain mahogany, etc. A narrow, interrupted belt.
3. Yellow pine-Douglas fir zone. 6,000-8,000 feet.
4. Lodgepole pine zone. 8,000-10,000 feet.
5. Engelmann spruce-balsam fir zone. 10,000-11,500 feet (timber-line).
6. Alpine zone. Above timber-line.

SOUTHEASTERN COLORADO

1. Plains. Up to 5,500 or 6,000 feet.
2. Pinyon pine-juniper zone. 5,500 or 6,000-7,000 feet. Oak chaparral is frequently an associate.
3. Yellow pine-Douglas fir zone. 7,000-8,500 feet.

4. White fir zone. 8,500-10,000 feet.
5. Engelmann spruce-balsam fir zone. 10,000-11,500 feet.
6. Alpine zone. Above timber-line.

SAN LUIS VALLEY

1. Shrub-steppe, chiefly greasewood and rabbitbrush. 7,500-8,000 feet.
2. Pinyon pine-juniper zone. 8,000-8,500 feet.
3. Yellow pine-Douglas fir zone. 8,500 or 9,000-9,500 feet.
4. Lodgepole pine zone. 9,500-10,000 or 10,500 feet. Lodgepole pine is rare on the eastern side of the Valley. White fir may here take its place.
5. Engelmann spruce-balsam fir zone. 10,000 or 10,500—timber-line.
6. Alpine zone. Above timber-line.

SOUTHWESTERN AND MIDDLE-WESTERN COLORADO

1. Shrub-steppe. Sagebrush. Best developed under 7,000 feet, but frequently running up to 9,500 feet in warm valleys.
2. Pinyon pine-juniper zone. A belt of varying vertical width.
3. Yellow pine-Douglas fir zone. 7,000 or 7,500-8,000 or 8,500 feet. Douglas fir frequently goes much beyond the limits of yellow pine. Aspens well developed.
4. Engelmann spruce-balsam fir zone. Up to timber-line.
5. Alpine zone. Above timber-line.

NORTHWESTERN COLORADO

1. Shrub-steppe. Sagebrush. Up to 6,000 or 7,000 feet.
2. Chaparral, chiefly of oak and buckbrush. 6,000 or 7,000-8,000 feet.
3. Lodgepole pine zone. 8,000-10,000 feet. Aspens abundant.
4. Engelmann spruce-balsam fir zone. 10,000-11,500 feet.
5. Alpine zone. Above timber-line.

In Middle and North Parks the zone immediately bordering on sagebrush is one of lodgepole pine and aspen.

It must be understood that the width of these vegetation zones, as well as their vertical ranges and their composition, vary considerably over the state. Furthermore, the lines of demarcation are seldom sharp and abrupt, but the change from one zone to another is gradual and, over a considerable area, there is a mingling of the typical plants of each zone.

Throughout the state, the pinyon pine-juniper and chaparral associations are usually intermediate between grassland or sagebrush and the timbered slopes. Yellow pine is always a tree of

lower altitudes than lodgepole pine, while lodgepole pine flourishes at lower elevations than Engelmann spruce and balsam fir. Douglas fir is an associate of both yellow pine and lodgepole pine, but usually does not extend far into the lodgepole pine belt. Aspen, although found from 5,000 feet to timber-line, is best developed in the lodgepole pine zone. White fir has about the same altitudinal limits as lodgepole pine.

GRASS-STEPPE

Distribution.—Grass-steppe or a short-grass formation is the dominating vegetation over the Great Plains of Colorado, from its eastern border up to the foothill base, where it meets a woody type of vegetation, which may be thicket or coniferous forest. It is almost uninterrupted, except by fringes of broadleaf forests along the watercourses, and by fragments of the prairie-grass type of vegetation in its eastern portion, represented by bunch-grasses, and that vegetation peculiar to sand-hills and blowouts. The short-grass type of vegetation, so well exemplified on the plains of Colorado, extends from almost the Canadian line to southern Texas, and eastward to the prairies (tall-grass formation) in the central part of the Dakotas, Nebraska and Texas.

Character of Vegetation.—The two most characteristic grasses of the Great Plains are buffalo-grass (*Buchloe dactyloides*), and grama-grass (*Bouteloua oligostachya*), shallow-rooted plants, indicating a soil with considerable run-off and little penetration. However, there are localities, more or less limited, over which these two grasses may appear relatively unimportant, and taller forms hold sway. For example, near the mountains, especially on a course, non-agricultural soil, which permits a deeper penetration of water, bushy snakeweed (*Gutierrezia sarothrae*) and common, small silvery sage (*Artemisia frigida*) are locally important. Again, in eastern Colorado, adjacent to sand-hills, wire-grass (*Aristida longiseta*) may cover wide stretches. Moreover, taller herbaceous plants may seem to dominate during certain seasons. But, take it the Great Plains over, the distinctive vegetation is a short-grass formation in which buffalo-grass and grama-grass are the most important components.

Climate.—Grass-steppe is a vegetative response to a low, infrequent rainfall, the greater percentage (approximately 75%) of which comes during the growing season, and about 60% of which is during the four months June, July, August and September. Grass-steppe in Colorado occupies territory with a mean annual precipitation ranging from 10 to 20 inches. There is seldom more than 50 inches of snow. The average for 13 stations is 26.6 inches.

At no period does the snow lie on the ground for any length of time.

TABLE XIV.—PRECIPITATION IN SHORT-GRASS FORMATION (GREAT PLAINS).

Station	Altitude	County	Mean Annual	Total from Oct. to May (inc.)	% from Oct. to May (inc.)	% from June to Sept. (inc.)	Mean Annual Snowfall
Akron	4650	Washington	22.11	32.7
Arriba	5243	Lincoln	16.22	6.27	38.65	61.35	24.9
Blaine	3935	Baca	14.02	22.9
Burlington	4160	Kit Carson	19.90	8.19	41.16	58.84	18.5
Cheyenne Wells	4279	Cheyenne	17.70	4.45	25.15	74.85	25.1
Cope	4250	Washington	19.90	40.7
Ft. Collins	4985	Larimer	15.64	4.62	29.54	70.46	43.5
Grover	5076	Weld	14.37	7.08	49.26	50.74	14.0
Holly	3380	Prowers	13.66	6.48	47.44	52.56	13.0
Las Animas	3899	Bent	13.13	5.95	45.32	54.68	24.0
Pueblo	4734	Pueblo	12.09	5.37	44.33	55.67	23.0
Wray	3512	Yuma	18.88	5.46	28.98	71.02	32.7
Yuma	4138	Yuma	19.13	8.46	48.97	51.03	34.0
Average			16.67	5.83	39.89	60.11	26.6

The distribution of the precipitation throughout the year in grass-steppe territory is shown in Fig. 10, where it may be compared with that in the sagebrush type of country. Droughts fre-

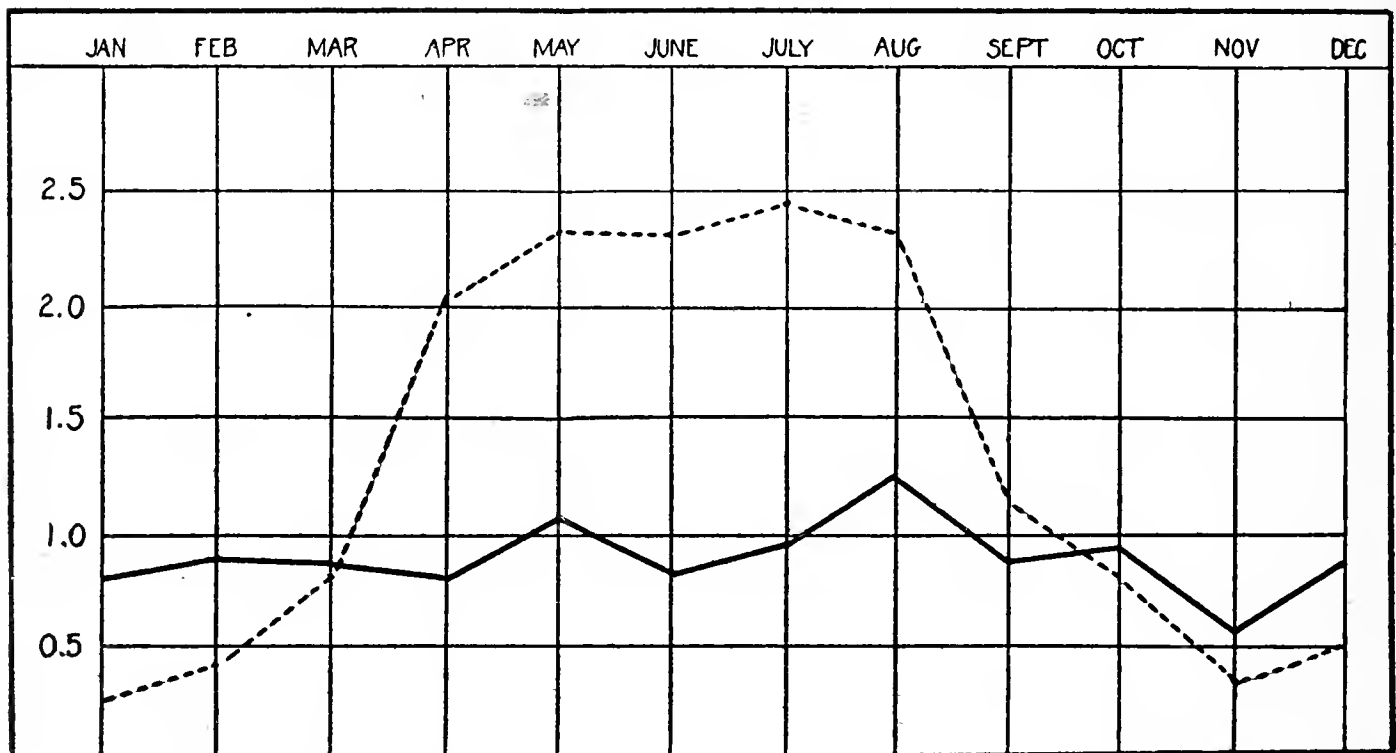

Fig. 10.—Two chief types of rainfall in Colorado. The dotted line shows the grass-steppe (Great Plains) type of rainfall, and the solid line the sagebrush type of rainfall. The first curve, showing monthly precipitation, is an average of 13 grass-steppe stations. The solid-line curve, showing the monthly precipitation in the sagebrush plant community, is an average of 11 stations.

quently come in late summer. There is a strip along the eastern border of the Great Plains with an annual precipitation approaching 20 inches, an amount slightly higher than for the Plains as a whole, and it is within this strip that we find elements of the prairie-grass formation of the states to the east, and here too "dry-farming" is carried on with slightly more advantage than in the western part of the grass-steppe area. The Plains experience marked variations from the average precipitation (see Fig. 9), that is, there may be very wet years and very dry ones, or a series of these.

The average temperature for the year over the Great Plains is mostly above 50° , the range being from 45° to 56° . Its western limit is approximately the 45° isotherm. However, the factor heat is not the critical one in determining grass-steppe. Water outweighs it in influence. A limited area of grass-steppe in South Park exists under a mean temperature for the year of about 35° to 40° . The summer mean temperature of the Great Plains ranges from 65° to 75° , by far the greater portion being above 70° . The highest temperatures come in July and August. The daily ranges are high, which means warm days and cool nights. The average length of the frostless season is from 125 to 150 days in the northern two-thirds of the Great Plains of Colorado, and on the high land running east of Trinidad, and from 150 to 163 days throughout the Arkansas Valley. There is considerable variation in the length of the frostless season from year to year, (see Fig. 6). The average date of the last spring frost is from May 10 to May 30, although many stations have had frosts as late as May 25 to 30, and some few as late as June 15 to 25. The average date of the first fall frost ranges from August 29 to October 20. As a rule, the first frosts in the fall come near the first part of October.

The relative humidity is generally low, in the neighborhood of 50% to 55%. This low relative humidity, associated with a high percentage of cloudless days, high temperatures, and considerable wind movement, causes a heavy evaporation from the soil surface. Here, again, is a climatic condition with which the dry farmer has to contend. The rate of evaporation is somewhat more rapid in the southern part of the Great Plains than in the northern, hence 15 inches of rainfall in northern Colorado is worth more in crop production than the same amount in the southern localities at the same elevation, and with similar soil conditions.

The percentage of possible sunshine is 65 or above.

Relation to Agriculture.—The grass-steppe of Colorado is a type of vegetation indicative of a low rainfall. Within its area,

crops are grown with success only under irrigation or under "dry-farming" methods. These methods of dry-farming are concerned with the conservation in the soil of the natural rainfall, that is the prevention of the run-off, which is normally rapid, and of evaporation. The rather pronounced variations in the annual precipitation from year to year make dry-land farming a decided success some years, and as decided a failure other years. Grass-steppe is a region of summer rainfall (see Fig. 10), and dry falls and winters. Hence the germination and growth of summer annuals is favored, while winter annuals frequently find the falls and winters too dry for their development. Fall-sown wheat is liable to have insufficient moisture to bring about germination, and it may suffer from drying out or blowing out during the winter. However, in spite of these difficulties, fall-sown wheat usually is a more satisfactory crop on dry land than spring-sown wheat. Spring wheat suffers from the late summer period of low rainfall, all the more, as this period is accompanied by a high evaporation. A method quite in harmony with the seasonal distribution of the rainfall on the Great Plains is one in which summer tillage is adopted to conserve the rainfall, and is followed by fall-sown grain. This plan enables the cereals to survive the dry fall and winter, by calling upon the stored soil moisture, and the following season finds them well toward maturity before the dry summer months.

Grass-steppe of the Plains is indicative of temperature conditions favorable to a varied agriculture. Corn, sorghum, millet, and the common small cereals are brought to maturity in any portion of its area. The same is true of apples, sour cherries, plums, and small fruits, which are grown with the greatest success in the Arkansas Valley as far up as Canon City, and adjacent to the foothills from Denver northward. There are, however, local districts within these large areas that are not adapted to commercial fruit-growing. Examination of Figs 2, 5 and 7, shows that these areas have an average frostless season of 150 days and over, that the average date of the last spring frost is about May 10, and that the mean temperature for the summer months is close to 70°. Peaches in Colorado are not a safe commercial crop in areas with an average frostless season of less than 150 days, where the average date of the last spring frost is later than May 1 to 10, and where the mean temperature for the summer months (June, July and August) is less than 65°. However, average length of frostless season, average date of last spring frost, and mean temperature for the summer months are not sufficient temperature data upon which to base a conclusion regarding the desirability of an area for the

growth of a crop. A very important consideration, particularly as regards the fruits, is the character of the winters and springs. Are the winters open and windy? Are there series of early warm days which induce the swelling of buds, and which may be followed by freezing weather? Or does the spring open gradually? The failure of a tender crop, like peaches, on the Plains, even in those sections with a long growing season, and an early date for the last spring frost, and warm summer months, is largely due to the dry, windy winters, and to the inconstancy and fluctuations of the spring weather. Melons find conditions for their growth and maturity most favorable in the southern part of the Great Plains steppe, where the growing season is close to 150 days, and where the average date of the first frost in the autumn is not earlier than October 1. Great Plains localities with frosts coming as early as the middle of September, are unsafe for melon growing as the fruit is usually caught, under such circumstances, about two weeks before maturity.

The establishment of trees under dry land conditions in grass-steppe territory is a difficult, although not impossible, undertaking. The open winters, with their high rate of evaporation, droughts in July and August, the frequent low temperatures, and great diurnal ranges, are difficult hazards for the young tree. However, once established, many of the more drought-resistant trees do well over the Great Plains, even on dry land.

The absence of a snow cover during most of the winter season, accompanied by a cold soil, a dry atmosphere, and a clear sky, is a condition which makes winter-killing from drying out a menace to the fruit-grower, the owner of forest tree plantations, and to the alfalfa-grower. The tenderer cane fruits are regularly buried, and strawberries mulched.

SHRUB-STEPPE

Distribution and Vegetation.—A large part, close to 25 per cent, of Colorado, is covered with a shrub type of vegetation. The principal species composing this shrub-land are sagebrush (*Artemisia tridentata*), greasewood (*Sarcobatus vermiculatus*), shadscale or saltbush (*Atriplex confertifolia*), orache or grey saltbush (*Atriplex canescens*), salt sage (*Atriplex nuttalli*), kochia (*Kochia vestita*), and rabbitbrush (*Chrysothamnus* species). The most important and by far the most extensive shrub-steppe in Colorado is sagebrush. It is the characteristic type of vegetation of the arid districts of western Colorado; this region represents the eastern limit of the sagebrush formation which dominates the

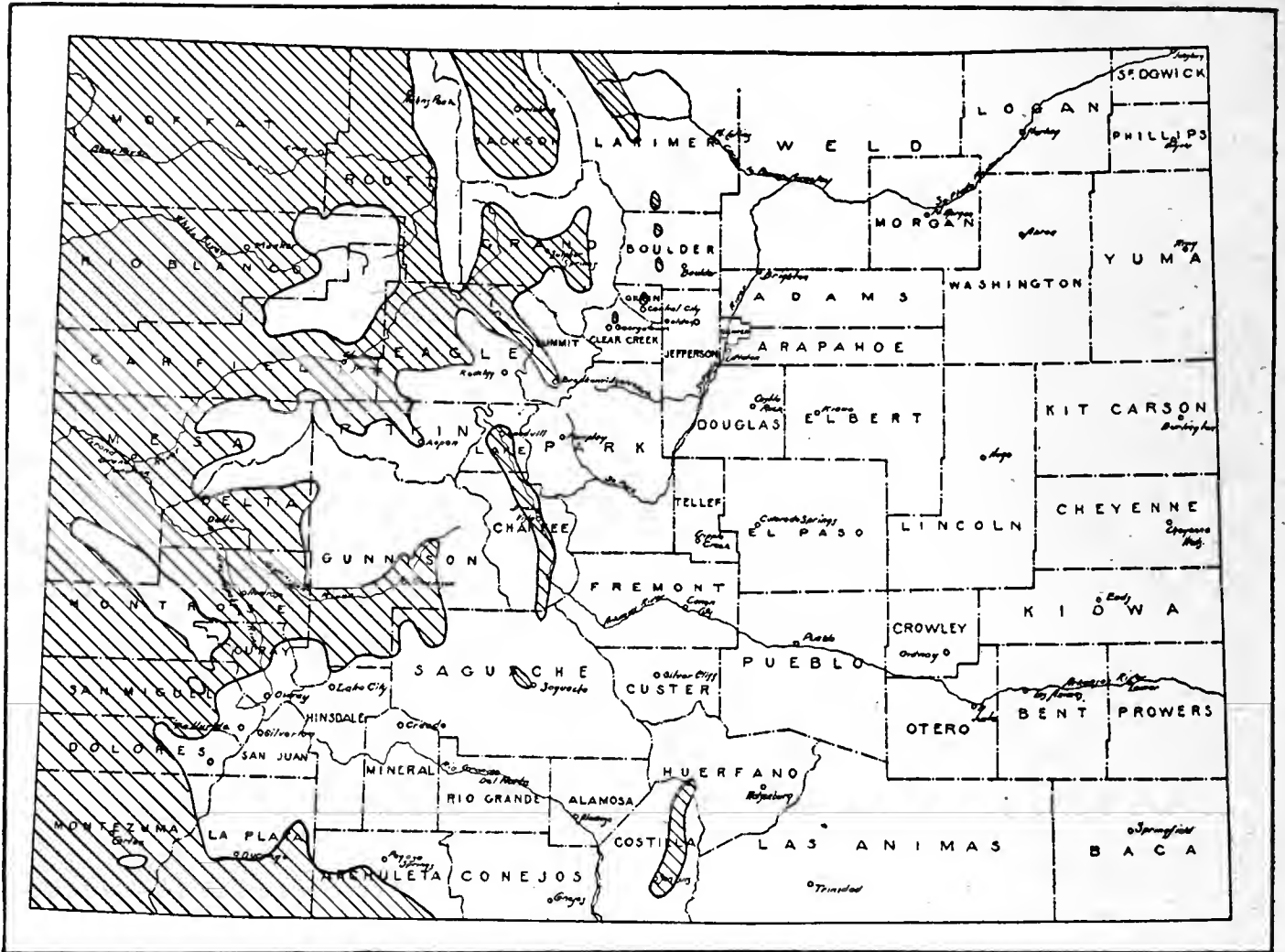

Fig. 11.—Distribution of sagebrush (*Artemisia tridentata*) shrub-steppe in Colorado.

whole Great Basin area. Fig. 11 gives the general distribution of sagebrush in Colorado. It is seen to occupy much of western Colorado, North Park and Middle Park. In narrow valleys, it is on the narrow benches bordering the streams (Fig. 12). It may also clothe rounded hills to their summit. The most typical sagebrush territory in Colorado is in the northwest counties. It grows to an altitude of 10,000 feet in some localities, but as a plant formation it reaches its best development below 9,000 feet. Competition, not temperature, seems to be the limiting factor in its upper altitudinal distribution. Where precipitation and topographic conditions are such as to permit the growth of trees, sagebrush is at a disadvantage. In North Park and Middle Park sagebrush and lodgepole pine forest meet, and the boundary line is sharp. Again, it may form a sharp boundary line with the yellow pine, or aspen, or oak brush, or pinyon pine and juniper. But, in nearly all of these cases, factors other than temperature are determinative.

Types of shrub-steppe that are second in importance only to sagebrush are the greasewood and rabbitbrush associations, which cover the larger part of San Luis Valley, and more limited areas in other sections of the state. Greasewood is present throughout

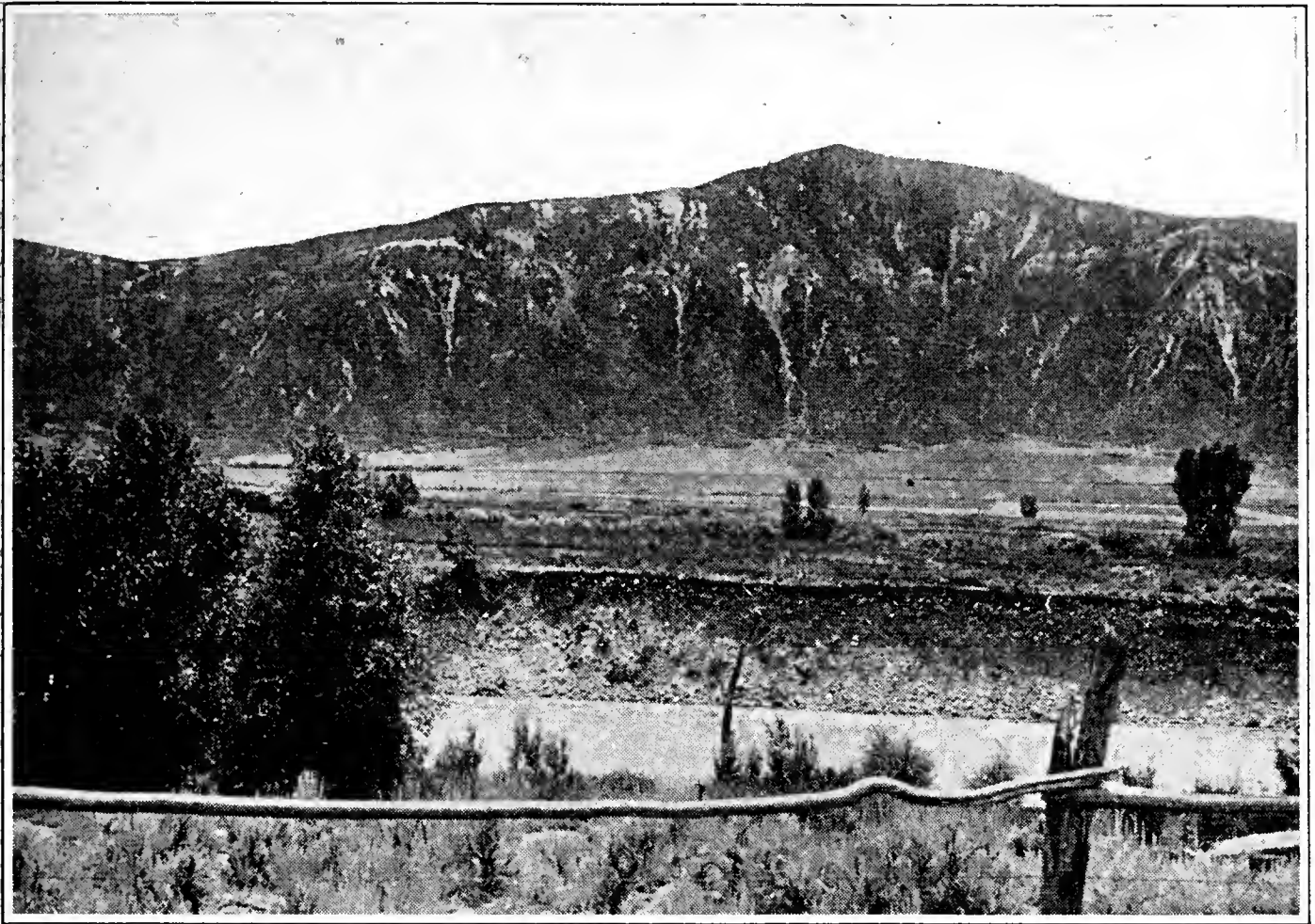

Fig. 12.—Near Basalt, Colorado, on Roaring Fork River. The sagebrush slopes, at the base of the mountain, have been cleared, and are now growing excellent crops of small grain, alfalfa and potatoes. Narrow-leaf cottonwood (*Populus angustifolia*) along the stream; oak, aspen and Douglas fir on the steep slopes.

the western section of the state, chiefly at elevations below 7,000 feet.

Shrub-steppe is scattered throughout the entire intermountain area. It occurs in some parts of South Park, and in the Wet Mountain Valley. Locally, it is also found in small patches on the eastern mountain front, and even here and there on the Great Plains. The round-leaved saltbush (*Atriplex confertifolia*), sometimes along with greasewood (*Sarcobatus vermiculatus*) and common Grayia (*Grayia spinosa*), is found chiefly on alkaline flats in western Colorado, especially in the lower valleys. Extensive and typical areas of this association are found in the lower Snake River Valley. The soil it occupies is usually fine-grained, the surface layers dry, and the soil below the first and second foot quite high in salt content. Salt sage or small salt-brush (*Atriplex nuttalli*) is another plant of alkaline flats. Cary* reports it as being the "most conspicuous shrub in Midland Basin, western Routt (Moffat) County; on the desert north of Mack; and on the alkaline stretch of country between Hotchkiss and the West Elk Mountains."

*Cary, M. A biological survey of Colorado, U. S. Dept. of Agri. North Amer. Fauna. No. 33. 1911.

The Sagebrush (Artemisia tridentata) Steppe.—This is the most important plant community of the shrub type occurring in the state. The name “sage plains” aptly describes this plant community as it appears in many sections. This applies to a uniform and uninterrupted growth over scores of square miles. When viewed from a distance, the sagebrush plant itself seems to be the only plant present. Closer examination shows a few associated shrubby and half-shrubby plants, and a considerable number of herbs. But even at the height of their flowering time, these herbs rarely modify the aspect of the community. There is considerable space between the individual sagebrush plants, and for most of the year, especially after the middle of July, the soil is quite bare. The average height of sagebrush is about 3½ feet. In shallow soil, underlaid by hardpan or rock, or in habitats with an alkaline subsoil, the plants are much smaller, while along streams in deep soil which is easily penetrated by water the plants may be 6 or 7 feet tall.

An extremely prevalent condition in western Colorado is an admixture of sagebrush and pinyon pine-juniper (Fig. 13). One may travel for miles now through sagebrush, now pinyon pine-juniper, the two communities alternating frequently. The transition from one to the other may be abrupt. It is quite obvious that both live under similar climatic conditions, as is evinced by their frequent alternation, and by the growth of sagebrush between the individual pinyon pine and juniper trees, but typical pinyon pine-juniper indicates a rocky soil. “Sage plain” may be interrupted by

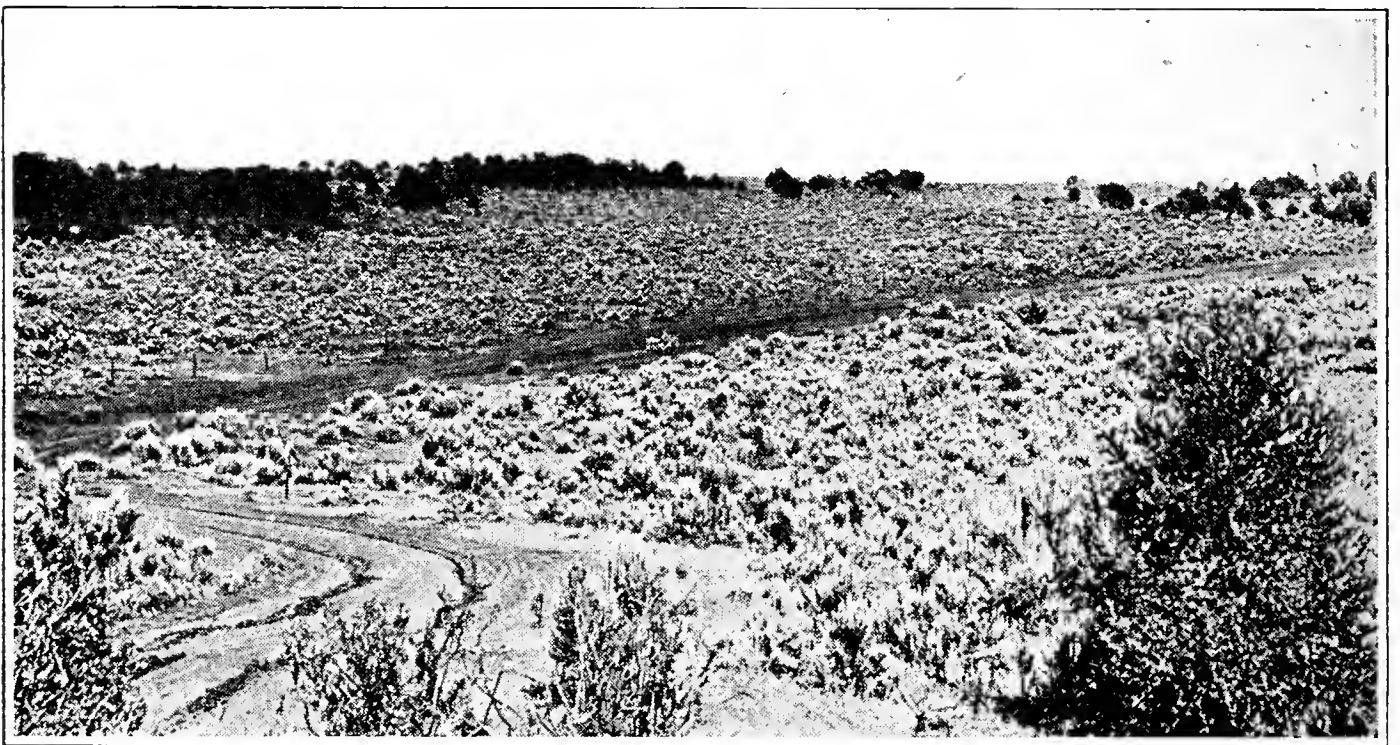

Fig. 13.—Alternation of sagebrush and pinyon pine-juniper in western Dolores County. Pinyon pine-juniper occupies a shallow or stony soil, while sagebrush is on a deep, rather fine-grained soil.

fringes of pinyon pine-juniper on stony outcrops, or where the soil is shallow and underlaid by rock.

Sagebrush seldom occupies a habitat where soil moisture is near the surface. Furthermore, typical sagebrush soil is well-drained, low in water content, and always practically free of "alkali."

The behavior of the native herbaceous plants in the sagebrush steppe suggests what will be the behavior of cultivated herbs under similar conditions. The surface soil, upon which herbs are dependent for their water, becomes exhausted of water in early summer, and the native herbs mature quickly before complete exhaustion takes place. From the middle of July on through the rest of the growing season there is little available water in the soil for shallow-rooted plants.

Climate of Sagebrush Steppe.—The mean annual precipitation on Colorado sagebrush areas ranges from under 10 inches to 17 or 18 inches. The community is most typical, however, in those sections with less than 15 inches of precipitation. The average amount of 11 stations is 13.1 inches. (See Table 15). Shallow-rooted short grasses, such as dominate the Great Plains, could not flourish in a habitat with rainfall distributed throughout the year as it is in shrub-steppe. In fact, the distribution of the rainfall throughout the year is one of the most important climatic differences between these two formations of plants. The precipitation is quite evenly distributed over the different seasons (Fig. 10). There is a winter snowfall. Moreover, snows of the Western Slope lie on the ground for longer periods than they do on the

TABLE XV.—PRECIPITATION IN SAGEBRUSH SHRUB-STEPPE.

Station	Altitude	County	Mean Annual	Total from Oct. to May (inc.)	% from Oct. to May (inc.)	% from June to Sept. (inc.)	Mean Annual Snowfall
Delta	4965	Delta	8.38	4.96	58.95	41.05	14.0
Glenwood Springs	5823	Garfield	12.12	8.11	66.91	34.09	53.0
Grand Junction	4602	Mesa	8.36	5.42	65.09	34.91	17.0
Gunnison	7670	Gunnison	11.09	5.65	50.94	49.06	49.0
Kremmling	7337	Grand	16.79	10.22	61.00	60.90	11.0
Lay	6190	Routt	12.68	8.96	70.66	29.34	67.2
Montrose	5811	Montrose	9.91	5.94	59.94	40.06	28.0
Rangely	5050	Rio Blanco	12.74	7.67	60.20	39.80	49.0
Redvale	6300	Montrose	15.35	9.22	60.07	39.93	28.3
Sapinero	8125	Gunnison	18.69	12.99	69.50	30.50	12.0
Walden	8050	Jackson	7.94	29.7
Average.....			13.10	7.91	62.33	37.64	32.6

Plains, and in many parts of sagebrush territory, particularly above 7,000 feet, snow accumulates to considerable depths and remains on the ground for long periods.

Sagebrush, as a dominating plant community, flourishes under a quite wide range of temperature conditions (see Table XVI). The mean annual temperature ranges from about 52° to as low as 37° in the Gunnison area, North Park and Middle Park, and the mean summer from 76° to about 56°. The frostless season is exceedingly variable. At Grand Junction it averages 183 days, while at Walden, in North Park, a typical sagebrush country, freezing temperatures may be expected every month, the average length of the frostless season being 56 days. The absolute annual range of temperature is high (102° to 129°).

All in all, sagebrush grows under a wide range of environmental conditions.

Agriculture in the Sagebrush Shrub-Steppe.—Some of the best general farming and orchard lands of Colorado are sagebrush land. Typical sagebrush soil is well-drained, usually deep, and always practically free of "alkali." Sagebrush is not a reliable indicator of temperature conditions, for it is equally well-developed in the lower valleys of the west which have a frostless season suitable to the growth of peaches, sweet cherries, and other tender crops, and in North Park at an altitude of 8,000 feet, where the frostless season is less than 75 days, where the date of the last spring frost is seldom earlier than June 15, and where in many years freezing temperatures are experienced every month. However, from observation throughout Colorado, and judging from the crops grown on sagebrush land at its upper altitudinal limit, it may be concluded that wherever sagebrush forms an extensive and dominating growth, temperature conditions are such as not to make impossible, except in unusual years, the maturing of timothy, alsike, oats, wheat, barley and rye, alfalfa, potatoes, Canadian field peas, strawberries, raspberries, currants, gooseberries, and all of the hardy vegetables. It is not to be assumed, however, that the mere presence of the sagebrush species, or the occurrence of small patches at high altitudes, indicates temperature conditions in the surrounding country favorable to these crops.

In the greater part of the sagebrush area there is a considerable amount of snow, and a snow cover during long periods. This condition favors the wintering over of low perennials, such as alfalfa and strawberries. Furthermore, the stored moisture of winter precipitation is often sufficient to carry spring-sown annuals far into July. Dry land agriculture of the sagebrush country of

TABLE XVI.—TEMPERATURE IN THE SAGEBRUSH SHRUB-STEPPE.

Station	Altitude	County	Mean Annual	Mean Winter	Mean Spring	Mean Summer	Mean Fall	Average Length Frostless Season	Aver. Date Last Spring Frost	Aver. Date First Fall Frost	Absolute Annual Range
Delta	4965	Delta	49.8	26.7	50.4	72.3	50.0	138	May 11	Sept. 27	114
Glenwood Springs...	5823	Garfield	44.3	24.4	46.2	64.5	46.6	112	May 22	Sept. 18	110
Grand Junction.....	4602	Mesa	52.3	28.0	52.8	76.0	53.3	181	Apr. 18	Oct. 19	106
Gunnison	7670	Gunnison	37.3	9.8	38.1	58.9	40.2	63	June 28	Sept. 1	121
Hot Sulphur Springs	7600	Grand	38.2	65.6	117
Kremmling	7337	Grand	37.4	14.5	47.8	64.9	39.1	83	June 12	Sept. 2	128
Lay	6190	Routt	44.7	18.9	41.1	63.6	43.6	85	June 11	Sept. 5	124
Paonia	5694	Delta	49.4	28.1	48.2	69.7	51.0	161	Apr. 30	Oct. 16	102
Rangely	5050	Rio Blanco	44.5	17.5	45.1	65.6	45.4	115	May 16	Aug. 21	129
Sapinero	8125	Gunnison	37.5	16.2	31.4	56.7	40.3	91	June 17	Sept. 15	103
Spicer	8700	Jackson	37.1	18.5	61	June 27	Aug. 27
Walden	8050	Jackson	37.6	17.0	36.0	58.4	40.4	56	July 6	Aug. 31	119
Average.....			42.6	20.0	43.7	65.1	44.9	104	June 1	Sept. 14	116

western Dolores and Montezuma Counties is largely dependent upon the stored moisture of winter snowfall.

Greasewood Shrub-Steppe (Fig. 14).—This type of vegetation is widely distributed throughout the state, both east and west of the Continental Divide. It is not indicative of any particular set of climatic factors, but is called forth by local soil conditions. Greasewood is almost always an indicator of a high water-table, and consequently of a soil quite rich in “alkali.”

The most extensive stretch of greasewood in Colorado is that in the San Luis Valley, where there is an annual rainfall of less than 10 inches. Throughout some parts of this area, the level of ground water is kept high and within the reach of the roots of the shrubs by natural seepage conditions in the Valley. San Luis Valley is a natural basin, with drainage from the mountains on three sides, and although the surface layers of soil are kept dry by excessive evaporation, both summer and winter, and by the scarcity



Fig. 14.—Typical growth of greasewood (*Sarcobatus vermiculatus*)

of rainfall, the subsoil often has a high water content. The level of the water-table has been elevated by the system of subirrigation long practiced in the Valley, and conditions have been made very favorable for the development of a greasewood type of vegetation. In fact, this type of vegetation has widened its limits in the Valley, encroaching upon the rabbitbrush and sagebrush types of vegetation. So-called “seeped” land in the San Luis Valley invariably runs to an almost pure stand of greasewood within twenty to twenty-five years.

Although, as has been said, the presence of a greasewood type of vegetation is not a dependable index of climatic factors, herewith follows a table giving temperature relations of the very extensive shrub-steppe of the San Luis Valley. From this table it is seen that the mean summer temperature (60.9°) is suitable for the maturing of the small cereals, except millets and sorghums, of po-

tatoes, alfalfa, Canada field peas, and some of the hardiest fruits and vegetables. The tenderer fruits and melons are not a success, as might be judged from the mean summer temperature, the short frostless season (average, 103 days) and the average date of the last spring frost (June 11).

TABLE XVII.—TEMPERATURE, SAN LUIS VALLEY.

Station	Altitude	Mean Annual Temperature	Mean Winter Temperature	Mean Spring Temperature	Mean Summer Temperature	Mean Fall Temperature	Aver. Length Frostless Season	Aver. Date Last Spring Frost	Aver. Date First Fall Frost	Absolute Annual Range
Blanca	7865	42.6	23.4	103	June 11	Sept. 21	108
Garnett	7576	40.5	18.8	41.3	60.6	41.2	95	June 6	Sept. 12	115
Manassa	7700	42.4	22.7	41.7	60.6	43.4	90	June 4	Sept. 9	101
Saguache	7740	43.5	22.0	43.5	62.3	45.2	124	May 26	Sept. 25	112
San Luis	7794	42.6	22.7	42.2	60.2	44.8	106	July 5	Sept. 20	111
Average.....	42.3	23.9	42.2	60.9	43.7	103	June 11	Sept. 18	109

CHAPARRAL OR BRUSHLAND

Chaparral is a dense growth of shrubs. It is synonymous with thicket. Chaparral in Colorado is mainly of scrub oak (*Quercus spp.*), or buckbrush (*Symphoricarpos spp.*), or mountain mahogany (*Cercocarpus parvifolius*), or Juneberry (*Amelanchier*), or "canyon thicket" composed of chokecherry (*Prunus melanocarpa*), thornapples (*Crataegus spp.*), and others.

Scrub oak forms the most extensive thicket growth in the State. It is absent from the northeastern part of the State, from North Park, Middle Park, and South Park. Its northernmost limit along the eastern front range is somewhere between Palmer Lake and Denver. It is sometimes an alternating association with pinon pine-juniper; again it may form a distinct fringe along the upper edge of the sagebrush association. As a well-defined chaparral, oakbrush is seldom above 8,000 feet. Although it is growing under a wide range of climatic conditions, such as is found between 4,000 and 9,000 feet, its upper altitudinal limit, as a well-formed plant community, is not above the limit of the successful growth of alfalfa, potatoes, small grains, strawberries, hardy cane fruits, and the hardy vegetables.

In western Colorado, oakbrush is commonly associated with buckbrush (*Symphoricarpos spp.*). Both scrub oak and buckbrush usually occupy a soil that is deep, rich, and suitable for agricultural purposes. The hill slopes in Fig. 15 show patches of scrub oak and buckbrush.

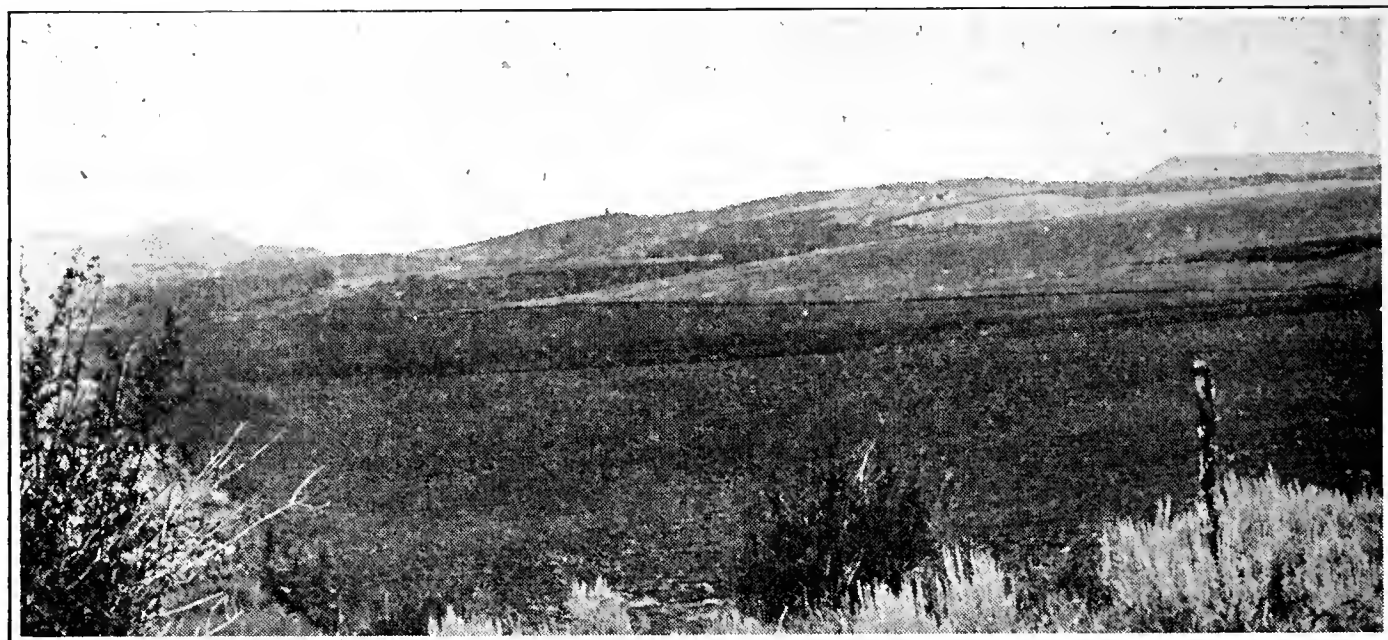

Fig. 15.—Cultivated sagebrush land in vicinity of Steamboat Springs. Alfalfa, potatoes, small grain, timothy and alsike clover are grown.

Mountain mahogany is generally distributed throughout Colorado in the foothills and on the lower mesas. It clothes dry, rocky hill-slopes, indicating arid conditions that are incapable of being utilized agriculturally. Climatically, it belongs to the western yellow pine zone. Skunk-brush (*Rhus trilobata*) is a common associate.

The “canyon thicket”, of chokecherry, thornapples, ninebark, etc., is found at the mouths of canyons at low elevations, and is indicative, generally, of a climate intermediate between that of the Great Plains and the yellow pine zone, or between the “sage plains” and the zone above it.

Chokecherry (*Prunus melanocarpa*) forms a chaparral growth in western Colorado, alternating on the slopes with oakbrush, buckbrush, and other shrubs of the yellow pine zone. Its distribution and agricultural relations are similar to those of the scrub oak chaparral.

Common Juneberry (*Amelanchier alnifolia*) makes a dense thicket growth in sections of western Colorado, at elevations much the same as occupied by scrub oak, buckbrush and chokecherry.

PINYON PINE-JUNIPER WOODLAND ZONE

Distribution and Vegetation.—Pinyon pine (*Pinus edulis*) and the one-seeded juniper (*Juniperus monosperma*) form a rather distinct belt of vegetation which occupies a position just below the yellow pine zone. The general distribution of this belt is shown in Fig. 16. It is seen to form a belt along the lower foothills in the section south of Colorado Springs, and running up the

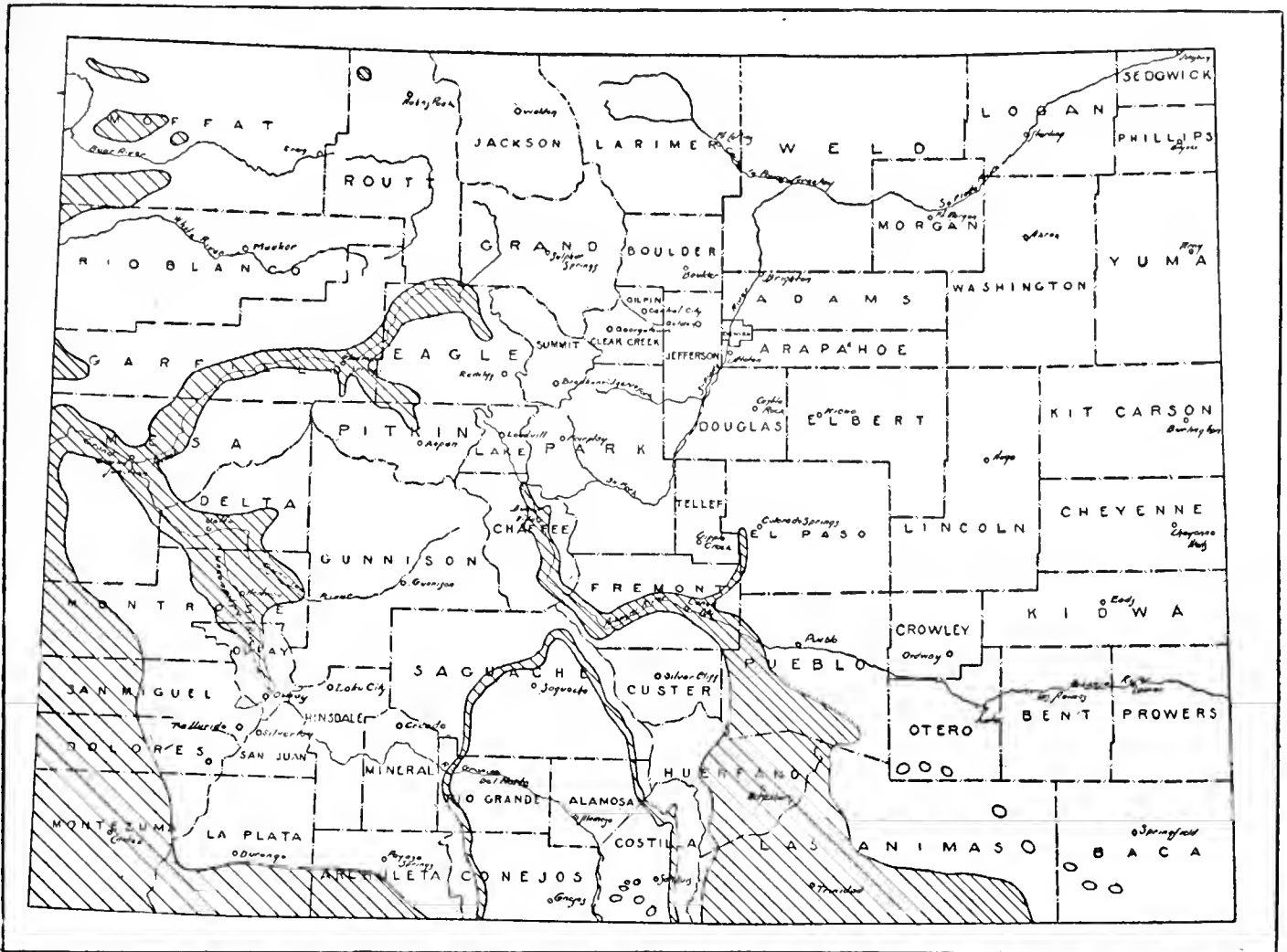

Fig. 16.—Distribution of pinyon pine-juniper in Colorado.

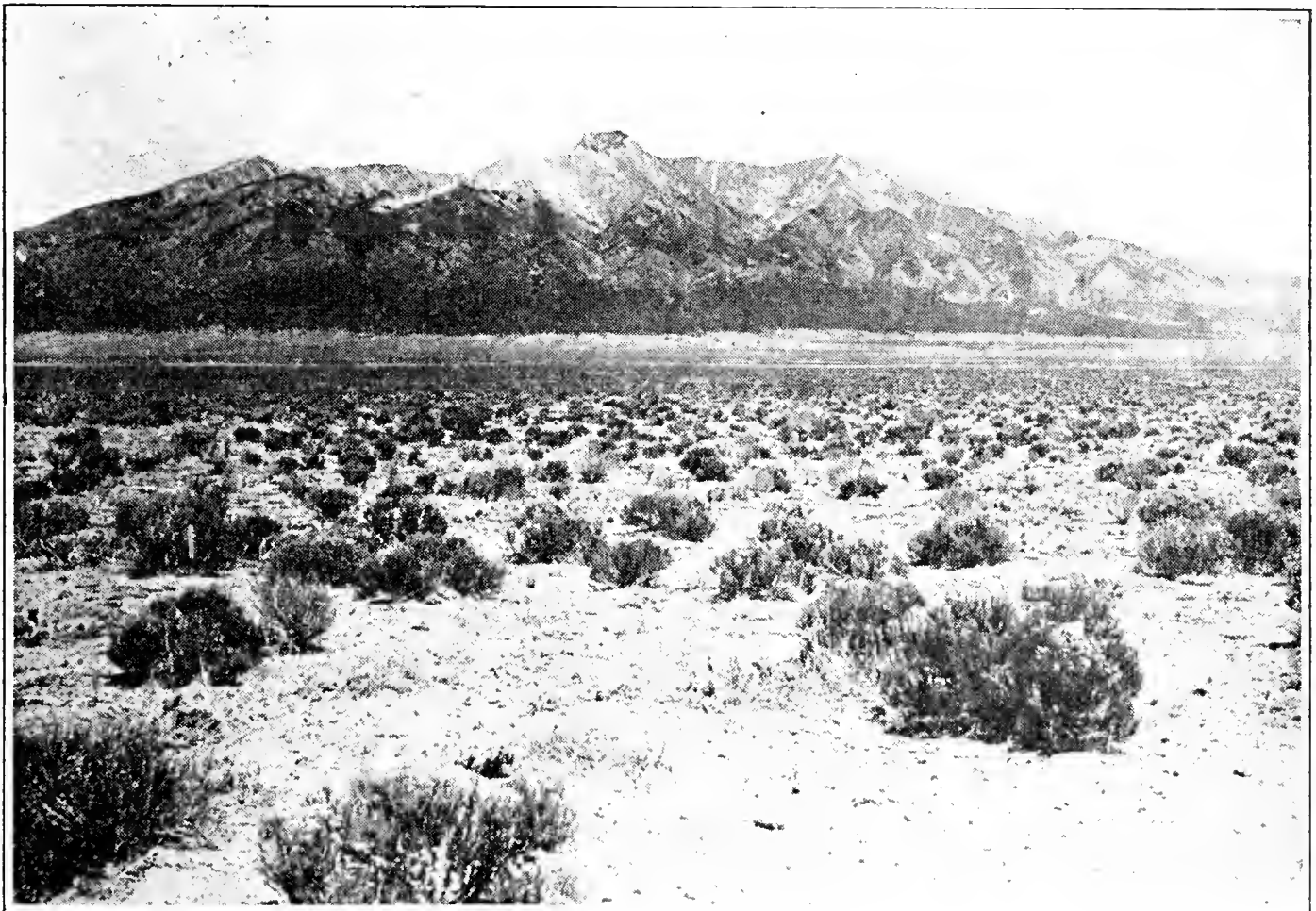

Fig. 17.—Rabbitbrush in San Luis Valley. Mt. Blanca in background. Note the dark strip of pinyon pine-juniper at the base of the mountain, above which are sparsely timbered slopes, and the alpine treeless areas at the crest.

Arkansas River to above Buena Vista. There is a fringe of pinyon pine-juniper on the warm slopes that overlook San Luis Valley (Fig. 17). The south corner of Archuleta County, the southern part of La Plata County, and most of Montezuma County, have scattering growths of this community. It extends northward, including the western half of Dolores, San Miguel and Montrose Counties. The warm slopes in the Grand and Uncompaghre Valleys, up to McCoy in Eagle County, above Basalt in Pitkin County, and to Ouray in Ouray County, bear stands of pinyon pine-juniper, which may be pure in places, but often mixed with sagebrush. In the northwest counties, there are a few areas of pinyon pine and juniper, particularly along the western border of the State. The pinyon pine-juniper belt is best developed below 7,000 feet, but in the San Luis Valley and many other sections it may reach close to 9,000 feet. When found at high altitudes, it is always on south exposures that become very warm. It does not reach the altitudes that sagebrush does, and its range of temperature conditions is much less than that of sagebrush. However, over thousands of square miles, pinyon pine-juniper and sagebrush alternate (Fig. 13), the former occupying rough, broken country, or shallow, stony soil, while sagebrush occurs on the more level ground, which has a deeper and finer soil. It is not uncommon to see sagebrush land cultivated up to the edge of a rocky knoll, capped with pinyon pine and one-seeded juniper.

Climate, and Relation to Agriculture.—The mean annual precipitation in the pinyon pine-juniper belt is uniformly under 15 inches. The summer temperature in a large percentage of the area is not below 65°, although in some few localities it may be several degrees lower. The average length of the frostless season is usually between 100 and 125 days, and the average date of the last spring frost about May 20. Pinyon pine-juniper is a plant community of warm slopes, and warm soil (Fig. 18). Although often local in its distribution above 6,500 feet, it is a reliable indicator there of a warm habitat, of a warm island, so to speak, in a cool area. The pinyon pine-juniper woodland is a mark of temperature conditions which permit the growth of all but the tenderest fruits, all the small grains, flax, sugar beets, potatoes, alfalfa, and the garden vegetables, excluding melons. In the lower part of the belt, peaches, sweet cherries, melons, and other tender crops yield bountifully. Much valuable orchard land of Colorado is cleared pinyon pine-juniper soil. Scattered pinyons, and less often one-seeded junipers, will be found considerably above the limits of growth for the crops mentioned, but such individual spec-

imens are growing only in very isolated spots. Care should be exercised in the selection of sites for fruit growing along the upper limits of the pinyon pine-juniper zone.

YELLOW PINE FOREST ZONE

Distribution, and Vegetation.—The yellow pine forest community belongs to the foothills in most sections of Colorado. On the eastern foothills from the Colorado-Wyoming line to the Palmer Lake Divide, yellow pine quite regularly comes in at about 6,000 feet, and extends to 8,000 feet, where it meets the lodgepole

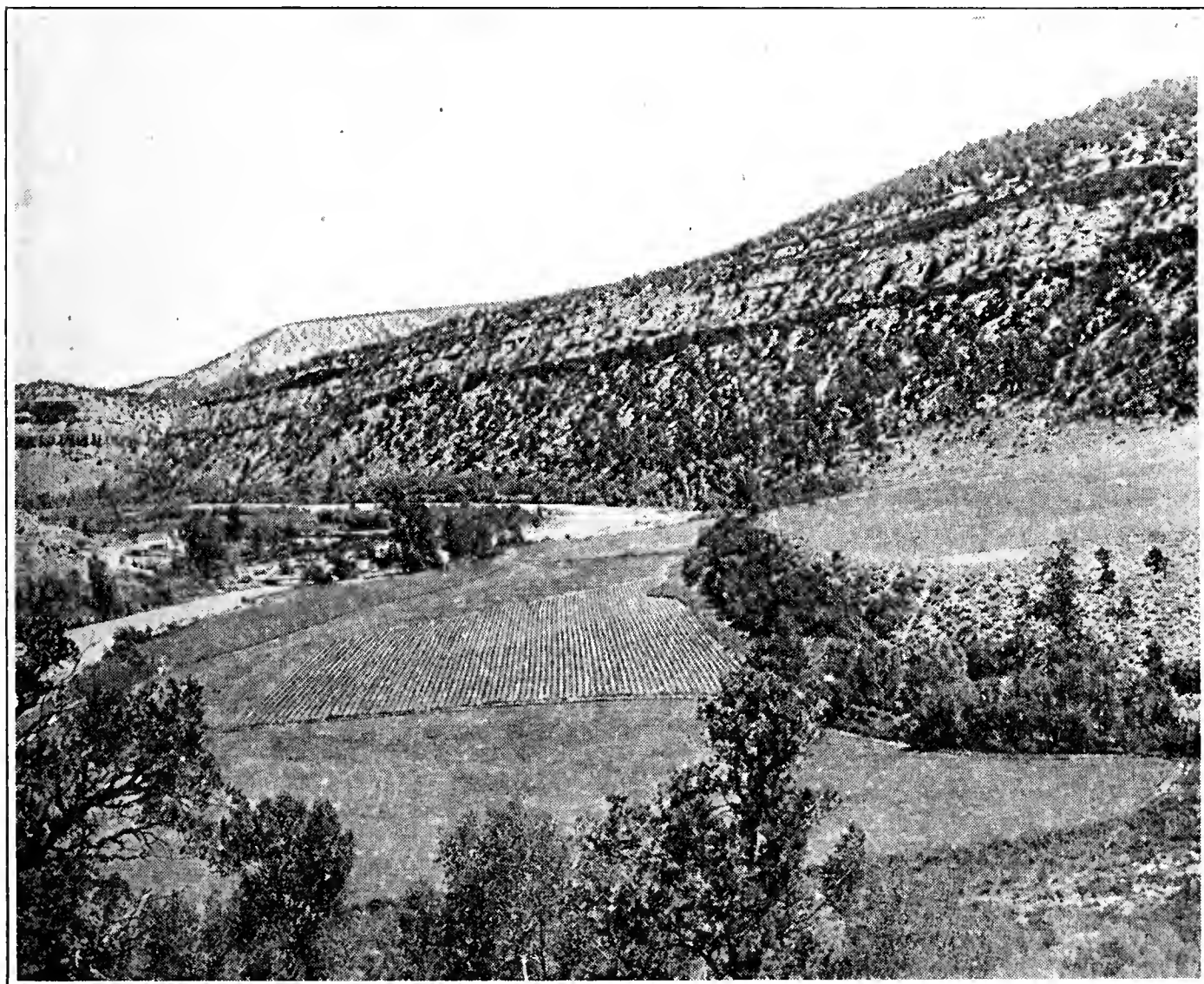

Fig. 18.—Below Ouray; potatoes and grain on sagebrush land. Pinyon pine and juniper on the slopes.

pine forest. Often, its lowermost limit is on the mesas, meeting there the grassland of the Plains. Yellow pine extends eastward on the Arkansas-Platte Divide, 50 miles or more east of Castle Rock. The transition from grass-steppe to yellow pine on the east foothills of southern Colorado is made by pinyon pine and juniper. Yellow pine fringes the San Luis Valley, occurring above

the pinyon pine-juniper belt. In the southwestern counties the lower altitudinal limit of the forest is about 7,000 to 7,500 feet; at this limit it may be mingled with chaparral of oak, chokecherry, Juneberry, buckbrush, etc. It extends northward to the Gunnison and Grand drainage systems, the growth becoming more scattering as it reaches in that direction. In the northwest counties, in Middle Park and North Park, yellow pine is not an important tree, and seldom forms a forest of any extent.

The principal tree associate of yellow pine is Douglas fir (*Pseudotsuga mucronata*). These two trees will alternate throughout the yellow pine belt; Douglas fir dominates the cooler and moister north exposures, while yellow pine more frequently holds to the warmer, and drier exposures. This alternation is most noticeable at lower altitudes. Douglas fir extends to higher altitudes than yellow pine, and is often a strong element in the lodgepole pine belt of the eastern slope.

Other characteristic plants in the yellow pine association are: Chokecherry (*Prunus melanocarpa*), buckbrush (*Symphoricarpos spp.*), skunk-bush (*Rhus trilobata*), sumac (*Rhus glabra*), yellow-flowered currant (*Ribes longiflorum*), red currant (*Ribes cereum*), New Jersey tea (*Ceanothus fendleri*, *C. pubescens*), wax flower (*Edwinia americana*), Rocky Mountain maple (*Acer glabrum*), *Kunzia tridentata*, Juneberry (*Amelanchier*), squaw apple (*Peraphyllum ramosissimum*), narrow-leaved cottonwood (*Populus angustifolia*), alder (*Alnus tenuifolia*), stream-side birch (*Betula fontinalis*), Oregon grape (*Berberis repens*), bearberry (*Arctostaphylos uva-ursi*) and spiraea (*Holodiscus dumosus*). The quaking aspen is abundant in the yellow pine belt, but it finds a more suitable environment above it.

The yellow pine forest goes to higher elevations on south exposures than on north exposures, and long tongues of vegetation more properly belonging to the lodgepole pine belt, or its altitudinal equivalent, penetrate it along cool mountain streams and on north exposures.

Climate.—The yellow pine forest seldom displays its typical development in those regions possessing less than 15 inches of precipitation annually. In northern Colorado, the 15-inch precipitation line (see Fig. 8), is practically co-extensive with the lower limit of the yellow pine zone, while in the southern part of the state the 20-inch line quite closely follows the lower limit of the belt. The snowfall exceeds that of the grass-steppe, sagebrush,

and pinyon pine-juniper communities by a large amount. The mean annual temperature ranges from 40° to 47°, while that for the summer months is never below 60°. The frostless season is very rarely below 75 days, the usual length being from 85 to 125 days. The average date of the last spring frost is usually between May 20 and June 1, although in the southwestern counties, it may frequently come as late as the middle of June.

TABLE XVIII.—PRECIPITATION IN YELLOW PINE FOREST ZONE.

Station	Altitude	County	Mean Annual	Total from Oct. to May (inc.)	% from Oct. to May (inc.)	% from June to Sept. (inc.)	Mean Annual Snowfall
Castle Rock	6220	Castle Rock...	19.40	12.80	64.33	35.67	62.8
Fremont Exp. Sta.....	8850	El Paso	18.08	90.7
Ft. Lewis	7610	La Plata	19.46
Georgetown	8550	Clear Creek ..	15.62	7.87	50.39	49.61	93.6
Gold Hill	7200	Boulder	20.19	10.23	50.67	49.33
Husted	6596	El Paso	14.79	51.0
Idaho Springs	7543	Clear Creek ..	15.74	8.89	50.52	49.48	67.0
Monument	7200	El Paso	24.36	8.25	33.46	66.54	82.0
Pagosa Springs	7108	Archuleta	21.15	11.08	52.39	47.61	84.0
Tacoma	7300	La Plata	21.57	16.37	75.94	24.06	87.0
Average.....			19.04	10.70	53.95	46.05	77.4

Relation to Agriculture.—The yellow pine forest community forms a vegetative belt in our mountains varying in width, and with an altitudinal range of approximately 6,000-8,000 feet in northern Colorado, and 7,000-9,000 feet in the southern sections. Throughout much of this area, the slopes are too steep to cultivate, or the soil is stony and shallow; moreover, many cultivated areas are as yet inaccessible, except to the stockman. In fact, a very large percentage of the area is economically adapted only to grazing and timber growing.

The presence of the yellow pine forest is quite a reliable index of temperature conditions favorable to the maturing, most seasons, of wheat, oats, barley and rye. Oats and barley are the two most common small cereals of this belt, and in seasons that are considerably below the average in length, are cut for forage. Potatoes

TABLE XIX.—TEMPERATURE, YELLOW PINE FOREST ZONE.

Station	Altitude	Mean Annual Temperature	Mean Winter Temperature	Mean Spring Temperature	Mean Summer Temperature	Mean Fall Temperature	Aver. Length Frostless Season	Aver. Date of Last Spring Frost	Aver. Date of First Fall Frost	Absolute Annual Range	Mean July Temperature
Castle Rock	6220	46.5	27.6	44.7	65.6	47.6	132	May 14	Sept. 21	116	67.5
Fremont Exp. Station	8850	40.7	83	June 18	Sept. 9	103	55.7
Georgetown	8550	42.2	29.2	40.6	60.2	43.9	101	62.1
Gold Hill	7200	45.1	31.8	62.1	May 17	Oct. 3	...	63.9
Husted	6596	46.2	29.1	44.9	65.4	48.2	116	67.5
Idaho Springs	7543	44.8	28.5	41.4	61.2	45.3	132	May 20	Sept. 27	99	62.8
Monument	7200	42.2	24.6	40.1	60.5	45.7	106	June 3	Sept. 17	102	61.1
Pagosa Springs	7108	41.2	19.2	40.3	60.1	43.9	78	June 28	Sept. 12	119	62.1
Tacoma	7300	42.1	125	May 15	Sept. 17	90
Average	43.4	26.4	40.9	62.2	45.8	109	June 1	Sept. 19	106	62.8



Fig. 19.—On the South Fork of the South Platte River, altitude about 8,000 feet. Hill slopes clothed with typical yellow pine. Alfalfa and small grain in the cultivated area.

and alfalfa (Figs. 19 and 20) are both well-suited to the yellow pine zone. Smith* has shown that the potato makes its best development in those sections of the country where the mean annual temperature is between 40° and 50° , and where the mean for July is not over 70° . Reference to the climatic data for the yellow pine forest community shows a range of the mean annual temperature from 40° to 47° , and the mean for July 62° to 67° . The hardier cane fruits and strawberries are usually a success, except in the higher parts of the zone. All of the hardier vegetables, such as onion, carrot, parsnip, parsley, beet, radish, lettuce, turnip, cabbage, rutabaga, rhubarb, mangel-wurzel, pea, and early sugar corn, do well. Tomatoes, cucumbers, peppers, beans, and other tender vegetables are grown with success only during the most favorable seasons, or in the lower part of the zone.

LOGEPOLE PINE FOREST ZONE

Distribution and Vegetation.—Lodgepole pine (*Pinus murrayana*) is bounded on its lower edge by the yellow pine forest and on its upper by the Engelmann spruce-balsam fir forest. Its usual altitudinal range is from 8,000 to 10,000 feet. However, its verti-

*The Effect of Weather Upon the Yield of Potatoes, Monthly Weather Review Vol. 43, No. 5, pp. 222-236, 1915.



Fig. 20.—Above Pagosa Springs. Yellow pines dominate the surrounding hills; scattered yellow pines in a field of timothy. Alfalfa, small grain and potatoes grown in vicinity.

cal distribution varies considerably; sometimes it goes as low as 7,500, and as high as 11,000 feet.

The chief tree-associates of lodgepole pine are the aspen (*Populus tremuloides*), Douglas fir at its lower limit, and Engelmann spruce at its upper limit. The narrow-leaf cottonwood does not penetrate the zone; it is climatically restricted to the yellow pine belt. The chief shrubs of the lodgepole pine zone are blueberries (*Vaccinium erythrocarpum*, and *V. oreophilum*), bear berry (*Arctostaphylos uva-ursi*), American twin flower (*Linnaea americana*), shrubby cinquefoil (*Dasiphora fruticosa*), elder (*Sambucus microbotrys*), honeysuckle (*Lonicera involucrata*) and Canadian buffalo-berry (*Lepargyrea canadensis*). Some of the most common herbs are anemone or pasque flower (*Pulsatilla hirsutissima*), candy tuft (*Thlaspi coloradense*), buckbean (*Thermopsis divaricarpa*), wall flower (*Erysimum wheeleri*), fireweed (*Chamaenerion angustifolium*), Indian paint brush (*Castilleja spp.*), Arnica (*Arnica cordifolia*), beard tongue (*Pentstemon alpinus*, *P. procerus*), and erigeron (*Erigeron eximius*, *E. macranthus*).

Climate, and Relation to Agriculture.—The mean annual temperature in the lodgepole pine belt ranges from about 28° to 40°. The average of 11 stations is 34.9° (see Table XX). In many parts of the state, the 40° isotherm follows quite closely the lower limit

of the lodgepole pine zone. The isotherm 60° for the summer months is approximately co-extensive with the lower limit of this community, and its upper limit has a summer average of 53.6° . The frostless season is seldom longer than 75 days, and very frequently much shorter.

Except in a few localities, the annual precipitation is above 18 inches, and in places as high as 25 to 28 inches. Where lodgepole pine and yellow pine grow under equal precipitation amounts, the former will usually occupy exposures that are cooler and moister.

TABLE XX.—TEMPERATURE, LODGEPOLE PINE FOREST ZONE.

Station	Altitude	Mean Annual Temperature	Mean Winter Temperature	Mean Spring Temperature	Mean Summer Temperature	Mean Fall Temperature	Aver Length of Frostless Season	Aver. Date of Last Spring Frost	Aver. Date of First Fall Frost	Absolute Annual Range
Ashcroft	9583	35.7	17.8	33.4	53.4	34.7	61	July 1	Sept. 1	103
Breckenridge	9524	32.6	16.4	30.9	51.7	36.5	35
Crested Butte	8867	33.1	12.7	109
Cripple Creek	9396
Dillon	8800	33.9	13.4	113
Dumont	8000	43.0	112	94
Frances	9300	40.3	23.6	37.6	58.5	41.9	110	May 31	Sept. 20	94
Fraser	8671	31.3	12.9	111
Fremont Exp. Sta..	8850	40.7	83	June 18	Sept. 9	103
Long's Peak (near)	8600	28.2	22.8	53.8	53.4	43.2	62	June 29	Aug. 30	102
Hermit	9843	31.7	11.8	45	110
White Pine	9500	33.3	15.7	31.1	50.9	35.9	32	100
Average.....		34.9	18.4	33.4	53.6	38.4	67	June 20	Sept. 9	104

Lodgepole pine, as a strongly developed plant association, indicates temperature conditions too low for the maturing of the small cereals, for the profitable growth of alfalfa, potatoes, peas, and any but the most hardy vegetables. Some of the hardier small fruits are raised for home use along its lower edge; timothy and alsike clover are grown now and then. Excellent growths of alfalfa and potatoes, and small grains are frequently grown in the sagebrush strips or oakbrush land that touches the lodgepole pine association, but, as a rule, an increase of but 200 to 300 feet in elevation is sufficient to bring about temperature conditions unfavorable to these crops. It is at the very upper limit of agricultural possibilities, that the greatest care needs be exercised in the selection of areas for cropping purposes. Just here, exposure counts for the most, and here too, a hundred feet difference in altitude may be the deciding factor in making for a success or a failure in the growth of a crop. A growth of lodgepole pine tells one that he is approaching, or is beyond, the upper altitudinal limit of

TABLE XXI.—PRECIPITATION, LODGEPOLE PINE FOREST ZONE.

Station	Altitude	County	Mean Annual Precipitation	Mean Annual Snowfall
Ashcroft	9483	Pitkin	20.78	148.1
Breckenridge	9524	Summit	24.03	199.4
Cassels	8445	Park	13.57	51.8
Crested Butte	8867	Gunnison	25.82	157.5
Cripple Creek	9396	Teller	17.19	83.9
Dillon	8800	Summit	13.51	94.0
Dumont	8000	Clear Creek	17.56	75.0
Estes Park Fish Hatchery....	8000	Larimer	18.35	102.0
Frances	9300	Boulder	28.66	175.0
Fremont Experiment Station..	8850	El Paso	18.08	90.7
Hermit	9843	Hinsdale	19.22	12.5
Long's Peak (near).....	8600	Larimer	19.83	127.0
Whitepine	9500	Gunnison	33.30	157.0
Average.....			25.53	112.9

profitable agriculture. The area is economically adapted to lumbering and grazing.

WHITE FIR FOREST ZONE

The white fir (*Abies concolor*), plant community belongs to the southern mountains of the State. Here, it takes the place of lodgepole pine of the northern mountains. Its common altitudinal range is 8,000 to 10,000 feet. Its climate is very similar to that of the lodgepole pine association, and it bears the same relation to agriculture.

ENGELMANN SPRUCE-BALSAM FIR FOREST ZONE

This forest comes in at an altitude of about 10,000 feet, and extends to timber-line. It covers all the high mountain ranges and isolated peaks. There are open parkings and streamside meadows in abundance, and summer grazing is excellent. On account of its low temperatures, the growing of crops is excluded. Some native hay is cut here and there. The association indicates non-agricultural climatic conditions.

ACKNOWLEDGMENTS

Special thanks are due Mr. Frederick H. Brandenburg, District Forecaster and Section Director of the Weather Bureau, who placed the records of his office at the disposal of the writer; Mr. V. M. Cone, of the Colorado Experiment Station, for his helpful criticisms of the manuscript; Mr. Robert E. Trimble, also of the Colorado Experiment Station Staff, who granted the use of the records of his office, and who gave valued suggestions; Mr. Norman Lee Foster, who assisted in the field work, and in the preparation of some of the figures; and Mr. Carl Hopkins and Mr. C. Z. Wight, who helped in the compilation of climatological data. The writer assumes full responsibility for all errors.

Bulletin 225

February, 1917

The Agricultural Experiment Station

OF THE

Colorado Agricultural College

A COMPARATIVE BACTERIOLOGICAL
STUDY OF THE WATER SUPPLY OF
THE CITY AND COUNTY OF
DENVER, COLORADO

—
BY

WALTER G. SACKETT

PUBLISHED BY THE EXPERIMENT STATION
FORT COLLINS, COLORADO

1917

The Colorado Agricultural College

FORT COLLINS, COLORADO

THE STATE BOARD OF AGRICULTURE

	Term Expires
HON. J. S. CALKINS.....Westminster,	1917
HON. J. C. BELL.....Montrose,	1917
HON. CHAS. PEARSON.....Durango,	1919
HON. R. W. CORWIN.....Pueblo,	1919
MRS. J. B. BELFORD.....Denver,	1921
HON. A. A. EDWARDS.....Fort Collins,	1921
MRS. AGNES L. RIDDLE.....Denver,	1923
HON. H. D. PARKER.....Greeley,	1
PRESIDENT CHAS. A. LORY, GOVERNOR JULIUS C. GUNTER, } <i>Ex-Officio</i>	
L. M. TAYLOR, Secretary	G. A. WEBB. Treasurer

EXECUTIVE COMMITTEE

A. A. EDWARDS, *Chairman*

J. C. BELL

J. S. CALKINS

STATION STAFF

C. P. GILLETTE, M.S., <i>Director</i>	ENTOMOLOGIST
W. P. HEADDEN, A.M., Ph.D.....	CHEMIST
G. H. GLOVER, M.S., D.V.M.....	VETERINARIAN
W. G. SACKETT, B.S.....	BACTERIOLOGIST
ALVIN KEZER, A.M.....	AGRONOMIST
E. P. SANDSTEN, M.S., Ph.D.....	HORTICULTURIST
B. O. LONGYEAR, B.S.....	ASSISTANT FORESTER
G. E. MORTON, B.S.A., M.S.....	ANIMAL HUSBANDMAN
E. B. HOUSE, B.S. (E.E.), M.S.....	IRRIGATION ENGINEER
V. M. CONE, B.S., C.E.....	IRRIGATION INVESTIGATIONS
W. P. LITTLE, B.S., <i>U. S. Expert-in-charge</i>	HORSE BREEDING
R. E. TRIMBLE, B.S.....	ASSISTANT IRRIGATION INVESTIGATIONS
P. K. BLINN, B.S., ROCKY FORD.....	ALFALFA INVESTIGATIONS
EARL DOUGLASS, M.S.....	ASSISTANT CHEMIST
S. ARTHUR JOHNSON, M.S.....	ASSISTANT ENTOMOLOGIST
L. C. BRAGG.....	ASSISTANT IN ENTOMOLOGY
J. W. ADAMS, B.S., CHEYENNE WELLS.....	AGRONOMY ASSISTANT, DRY FARMING
W. W. ROBBINS, M.A.....	BOTANIST
RALPH L. PARSHALL, B.S.....	ASSISTANT IRRIGATION INVESTIGATIONS
I. E. NEWSOM, B.S., D.V.S.....	VETERINARY PATHOLOGIST
MIRIAM A. PALMER, M.A.....	DELINEATOR
R. A. MCGINTY, B.S.....	ASSISTANT IN HORTICULTURE
CHAS. R. JONES, B.S.....	ASSISTANT IN ENTOMOLOGY
GEO. M. LIST, B.S.....	ASSISTANT IN ENTOMOLOGY
JAS. D. BELL, B.S.....	ASSISTANT IRRIGATION INVESTIGATIONS
CARL ROHWER, B.S., C.E.....	ASSISTANT IRRIGATION INVESTIGATIONS
BREEZE BOYACK, B.A., M.S.....	ASSISTANT IN AGRONOMY
CHAS. I. BRAY, B.S.A., M.S.....	ASSISTANT ANIMAL HUSBANDRY
RALPH L. CROSMAN.....	EDITOR
J. L. TAYLOR.....	MARKETS AND MARKETING
T. E. LEIPER, B.S.....	ASSISTANT ANIMAL HUSBANDMAN

OFFICERS

CHAS. A. LORY, M.S., LL.D., D.Sc.....	<i>President</i>
C. P. GILLETTE, M.S.....	<i>Director</i>
L. M. TAYLOR.....	<i>Secretary</i>
MABEL LEWIS.....	<i>Executive Clerk</i>

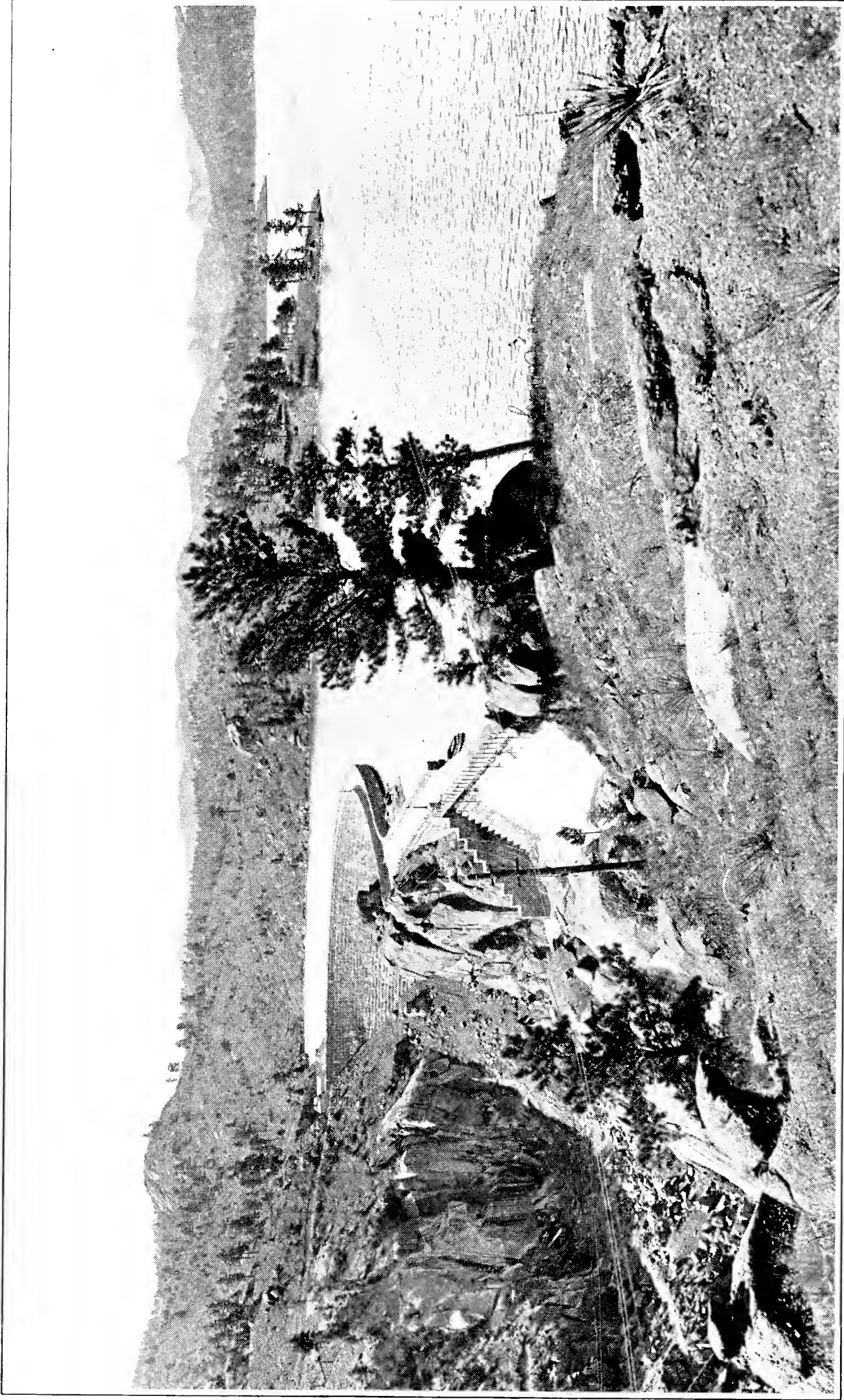

Denver's Water Supply---Lake Cheesman, Showing Dam and Water Flowing Over Spillway

A Comparative Bacteriological Study of the Water Supply of the City and County of Denver, Colorado

By WALTER G. SACKETT

There is, perhaps, no city in the United States where an abundant supply of pure, wholesome drinking water is more important to the health of the public at large than Denver, Colorado. This is very apparent to any one who has traveled in the West during the summer time and has observed the thousands of tourists who visit the Capitol City each season. Even with her magnificent climate, cloudless skies, and her other natural advantages, Denver could never have attained to her present enviable position among the cities of the world as a health resort and a most desirable place to live, were it not for her splendid supply of pure, mountain water.

Pure as such a water is believed to be in the popular mind, yet a supply of this character may become the source of much grief from a health standpoint and may prove extremely dangerous to the community unless it is under the constant supervision of experts who watch its chemical and bacteriological character from day to day.

The Denver Union Water Company, a Colorado corporation organized in 1894, which supplies Denver with its water, has recognized the great importance of bacteriological and chemical examinations of the water, as well as the necessity for the accurate control of its filters and sterilizing plants. To this end it maintains a modern chemical and bacteriological laboratory in Denver in charge of Dr. H. I. de Berard. The laboratory is finished throughout in white enamel, has cement floors, and in every respect presents a most pleasing and sanitary appearance. Its equipment, including electrically heated and regulated incubators, sterilizing and distilling apparatus, is of the very latest design.

Daily analyses of the water from each source of supply, as well as from different taps over the city, are made in the Company's laboratory to test the condition before it enters the filters and after it is treated. An accurate check is thus kept on the work done each day by each unit of the system. Any trace of im-

purity in the raw water is at once discovered and remedied by proper treatment.

In addition to its resident chemist and regular assistants in the laboratory and at the filtration plants, the Company employs as consulting chemists and bacteriologists a number of the best known and most skilled water experts in the country. These experts visit Denver frequently for the purpose of checking the work done by the filter plants and offering suggestions for keeping the purification system fully abreast of the times.

SOURCE OF SUPPLY

The principal source of supply is Lake Cheesman, located fifty miles from Denver, and formed by impounding the waters of the South Fork of the South Platte River and Goose Creek. The surface area of this reservoir is 879 acres, and it has a storage capacity of 26,000,000,000 gallons—enough to supply Denver for two years without replenishment or assistance from any other source. From Cheesman Lake the water is carried down South Platte Canon in the channel of the South Platte River to the intake of the water system, 25 miles below, and 25 miles from Denver. A 60-inch pipeline conveys the water from the intake works to Marston Lake, which can accommodate 6,400,000,000 gallons and to Platte Canon reservoir, with a storage capacity of 300,000,000 gallons.

Besides the Platte River water, Marston Lake receives an additional supply from Bear Creek taken out above Morrison.

Cherry Creek, thru a system of infiltration galleries, contributes a limited amount to the city supply.

FILTRATION AND TREATMENT

Three methods of purification by filtration are employed in connection with the Denver supply:

1. Mechanical filtration is practiced at the Willard plant, which has a daily capacity of 15,000,000 gallons, and at the two Marston Lake plants with a combined daily capacity of 25,000,000 gallons. The filtered water from the Willard plant is subsequently treated with hypochlorite. Chlorine gas and hypochlorite are used at the two Marston Lake plants, respectively.

2. An English slow sand plant located at Platte Canon with six filter beds having a total filtering area of 10½ acres is capable of furnishing 30,000,000 gallons of filtered water daily. Preliminary sedimentation is accomplished in Platte Canon Reservoir. Hypochlorite is added to the filtered water as needed.

3. Infiltration galleries located near the slow sand filter beds and Lehow Lake, along the South Platte River above Mississippi

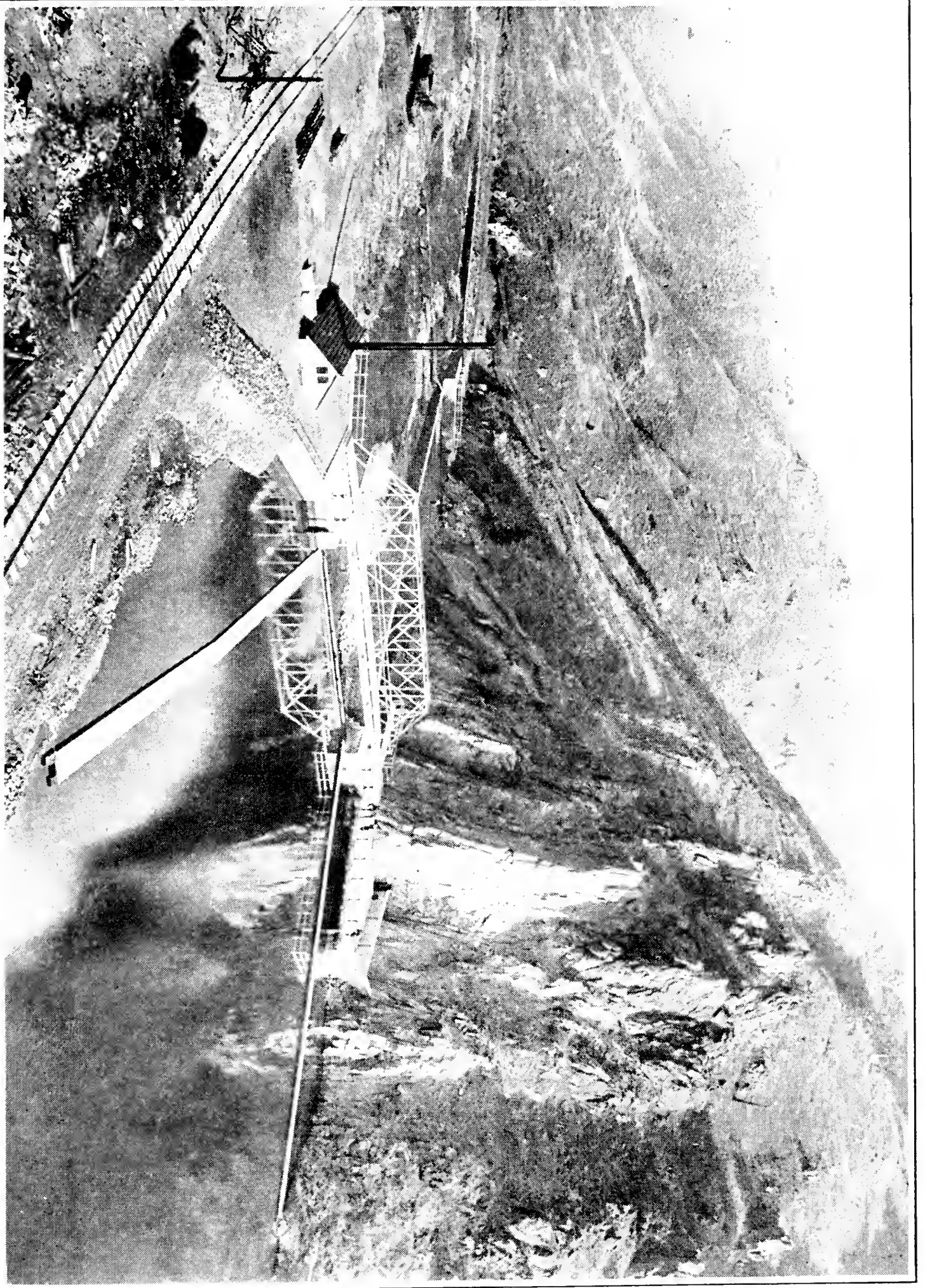

Intake on South Platte River in Platte Canon

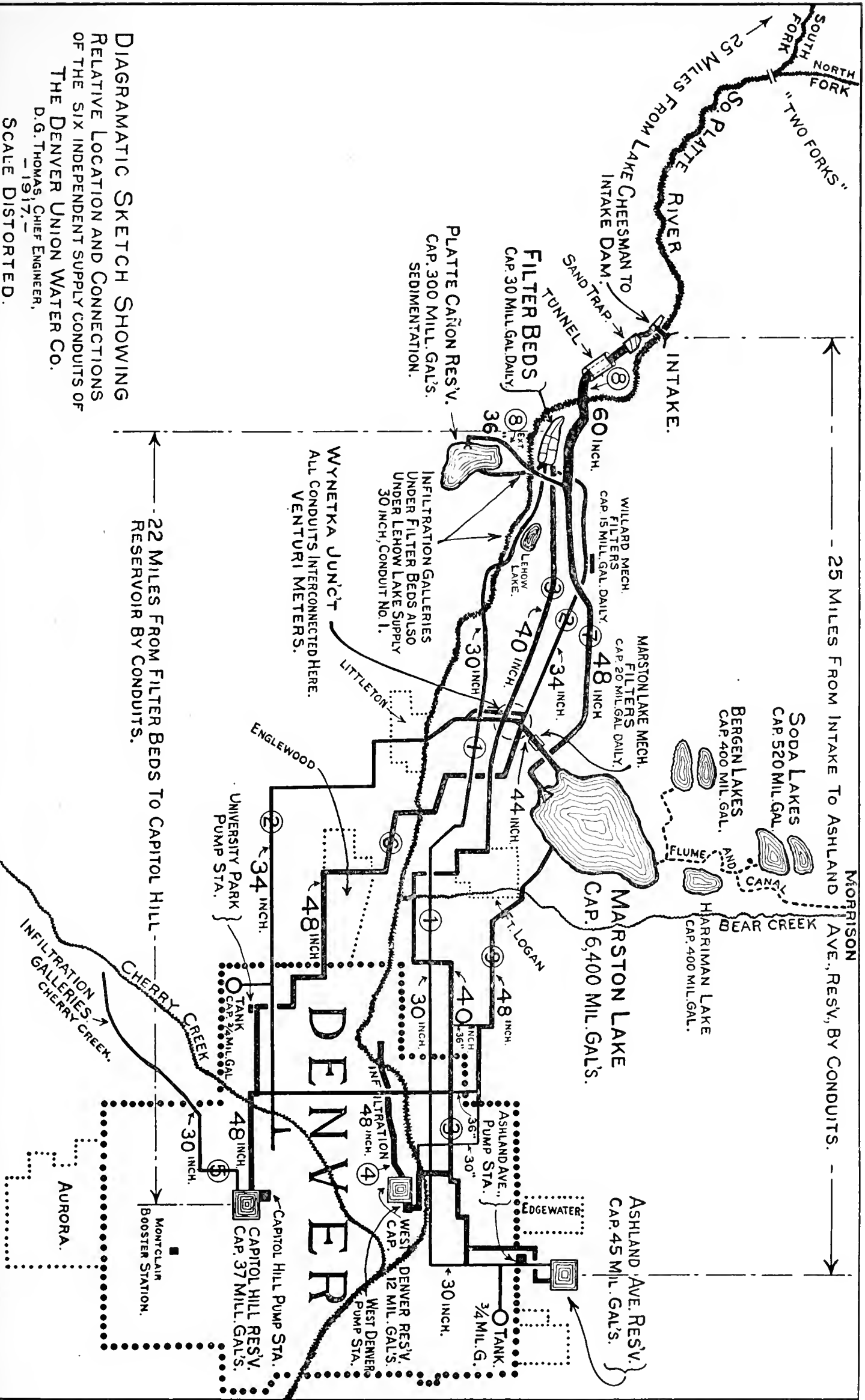

DIAGRAMATIC SKETCH SHOWING
 RELATIVE LOCATION AND CONNECTIONS
 OF THE SIX INDEPENDENT SUPPLY CONDUITS OF
 THE DENVER UNION WATER CO.

D.G. THOMAS, CHIEF ENGINEER,
 1917,
 SCALE DISTORTED.

Avenue, and Cherry Creek near Sullivan complete the filtration system.

All of these waters, with the exception of that from Cherry Creek, are treated with either chlorine gas or hypochlorite. The total capacity of the combined plants approximates 81,000,000 gallons of filtered water daily. The population of Denver is, in round numbers, 250,000; the daily water consumption varies from 250 to 350 gallons per capita.

A diagrammatic representation of the entire system is shown on page 5.

PATROL OF THE WATER SHED

While the Denver Union Water Company is exercising every precaution to make the water safe for domestic purposes, it does not depend entirely upon the purification plants to accomplish this. It goes without saying that, all things being equal, the purer the raw water the more easily can the impurities be removed and the purer will be the filtered water.

Altho the water-shed in the vicinity of Cheesman Lake is so sparsely settled that it will average little more than one person to the square mile, the Denver Union Water Company recognized the possible danger of pollution from this source, as well as from Platte Canon, and secured the passage of an ordinance which provides for the protection and preservation of the purity of the water supply of the City and County of Denver and for the patrol of the water-shed, and the arrest and punishment of all persons who violate the provisions of the act. The ordinance covering this point follows:—

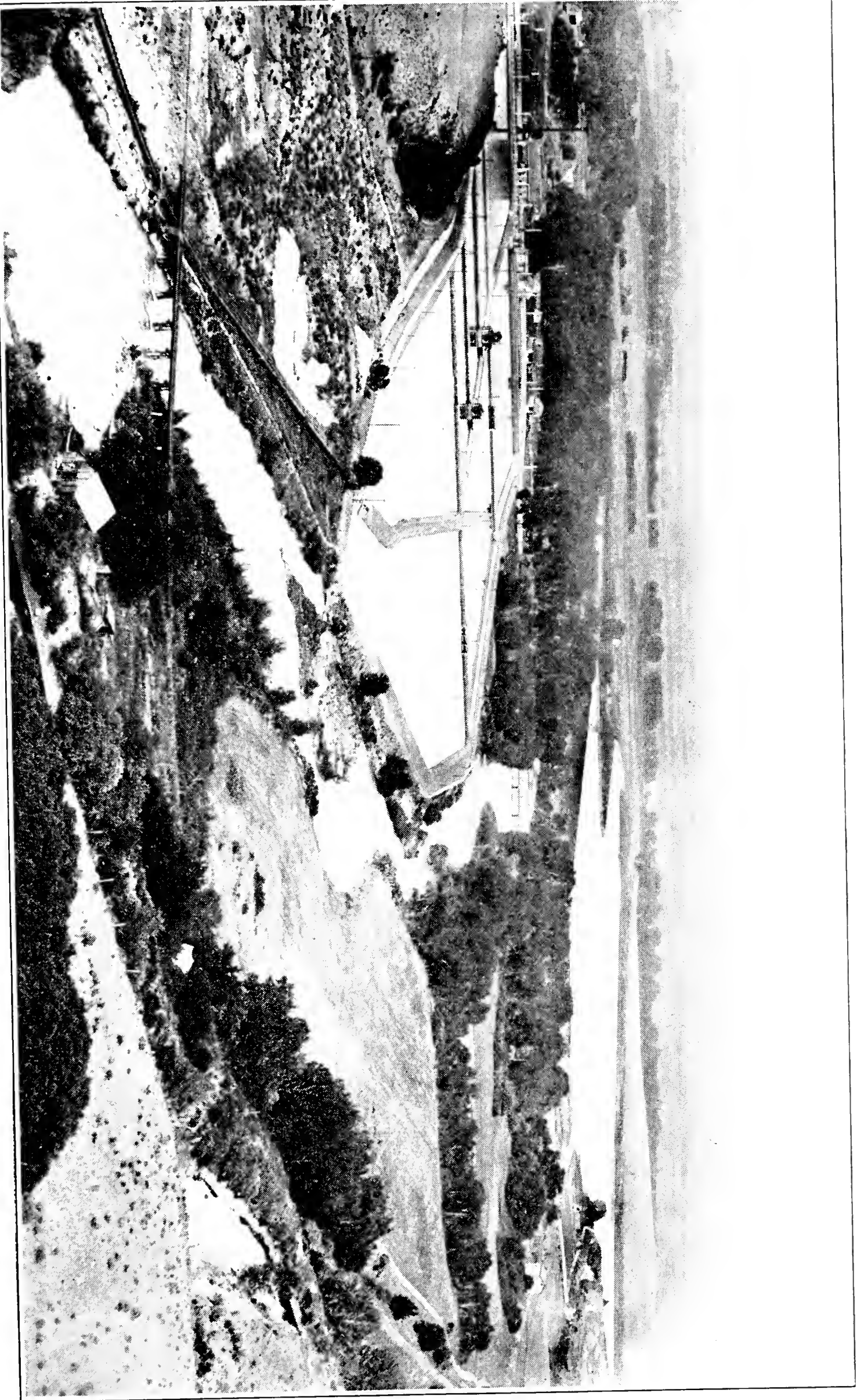

View Showing Filter Beds and Subsidence Reservoir at Platte Canon



BY AUTHORITY

Ordinance No. 102.

Series 1909

Supervisor's Bill No. 32,

Introduced by Sup. Robertson

A BILL FOR

AN ORDINANCE TO PROTECT AND PRESERVE THE PURITY OF THE WATER SUPPLY OF THE CITY AND COUNTY OF DENVER, AND PROVIDING FOR THE PATROL OF THE SOUTH PLATTE RIVER AND BEAR CREEK AND ANY OF THEIR TRIBUTARIES FROM THE FIFTEENTH STREET BRIDGE OVER SAID RIVER IN THE CITY AND COUNTY OF DENVER TO THE HEADWATERS OF SAID STREAMS AND FOR THE ARREST AND PUNISHMENT OF ALL PERSONS VIOLATING THE PROVISIONS OF THIS ORDINANCE.

Be it Enacted by the Council of the City and County of Denver:

Section 1. It shall be unlawful for any person to deposit into the channel of the South Platte river or Bear creek, or any of their tributaries above the Fifteenth street bridge over said river in the City and County of Denver or between or upon the banks of said streams, any unwholesome matter or substance whatever tending to the defilement or pollution of the water of said streams, or to allow the drainage from any sewer, drain or cesspool to drain into or percolate into said streams, or their tributaries, or any of them, or to permit any dead animal or decaying vegetable matter to be placed or left within a distance of three hundred (300) feet of the banks of any said streams, or their tributaries, or to do any other act or thing whereby the water of said streams might become polluted or unfit or unwholesome for human consumption; Provided, That the disturbances of water by placer mining or tailings from ore reduction mills flowing into any of said streams or tributaries shall not be construed as defilement or pollution of the water thereof.

Section 2. The Health Department of the City and County of Denver shall appoint one or more special officer or officers as shall be determined by the Health Department and the Mayor, to be approved by the Mayor, to patrol the South Platte river and Bear creek and their tributaries from the Fifteenth street bridge over said South Platte river in the City and County of Denver to the headwaters of said South Platte river and Bear creek and their tributaries, to enforce the provisions of Section one of this

ordinance, which officer or officers shall have power to cause the arrest of any person or persons who shall violate the provisions of Section one of this ordinance, or who shall omit, neglect or refuse to obey said officer or officers or shall resist the same, or shall refuse, omit or neglect to obey any special regulations of the said Health Department of Mayor adopted or made to carry out and fulfill provisions of Section one of this ordinance, and to transport the parties so offending to the City and County of Denver to be tried before the Justice of the Peace of the City and County of Denver having exclusive original jurisdiction under the charter of said City and County of all cases arising under the charter and the ordinances of said City and County, and upon a conviction of the said party or parties, shall be fined in a sum not less than twenty-five dollars (\$25.00), nor more than two hundred dollars (\$200.00), and every omission, neglect or continuance of the thing commanded or prohibited by this ordinance for a period of twenty-four (24) hours shall constitute a separate and distinct offense, and shall be fined accordingly."

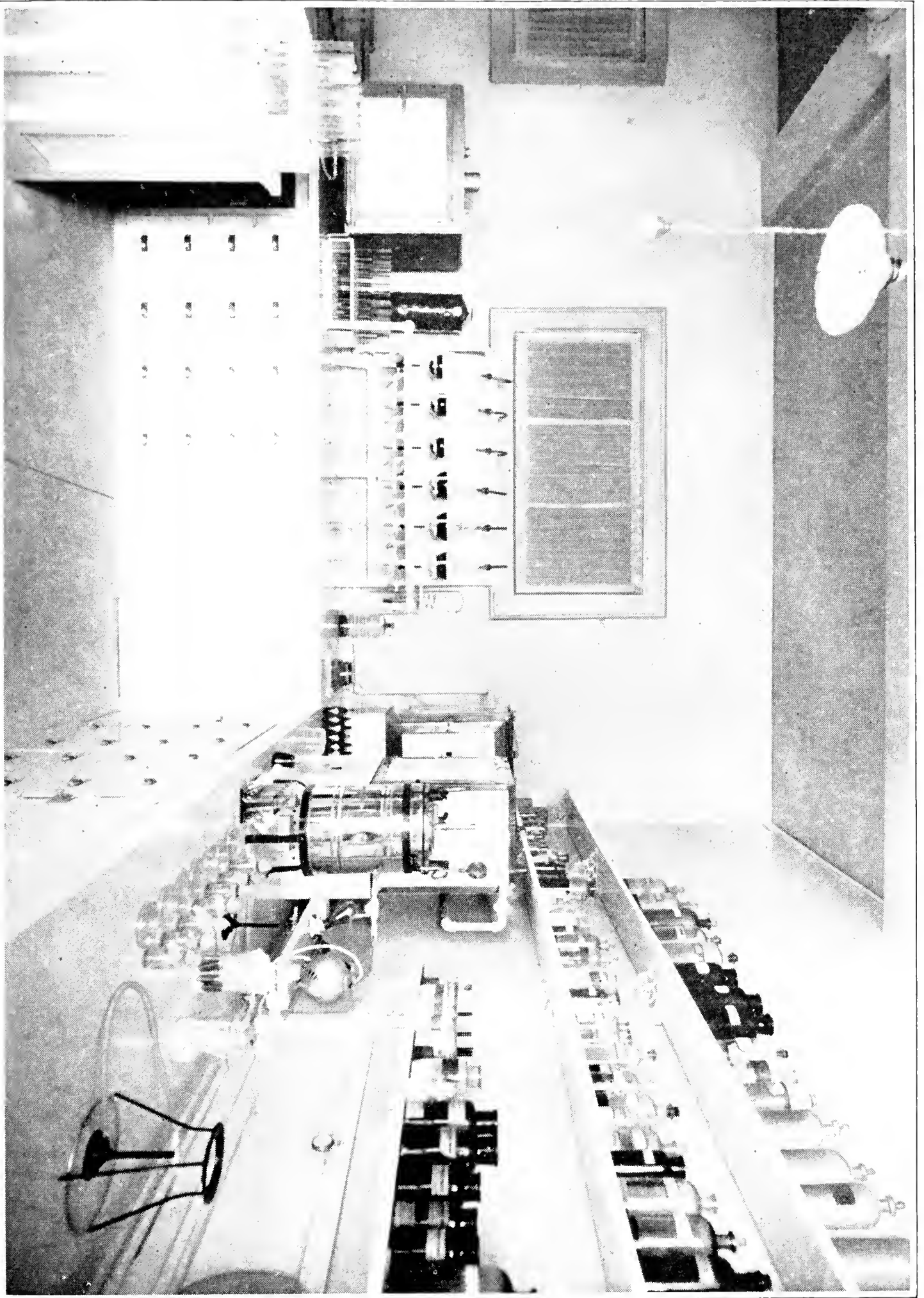

Laboratory of The Denver Union Water Company

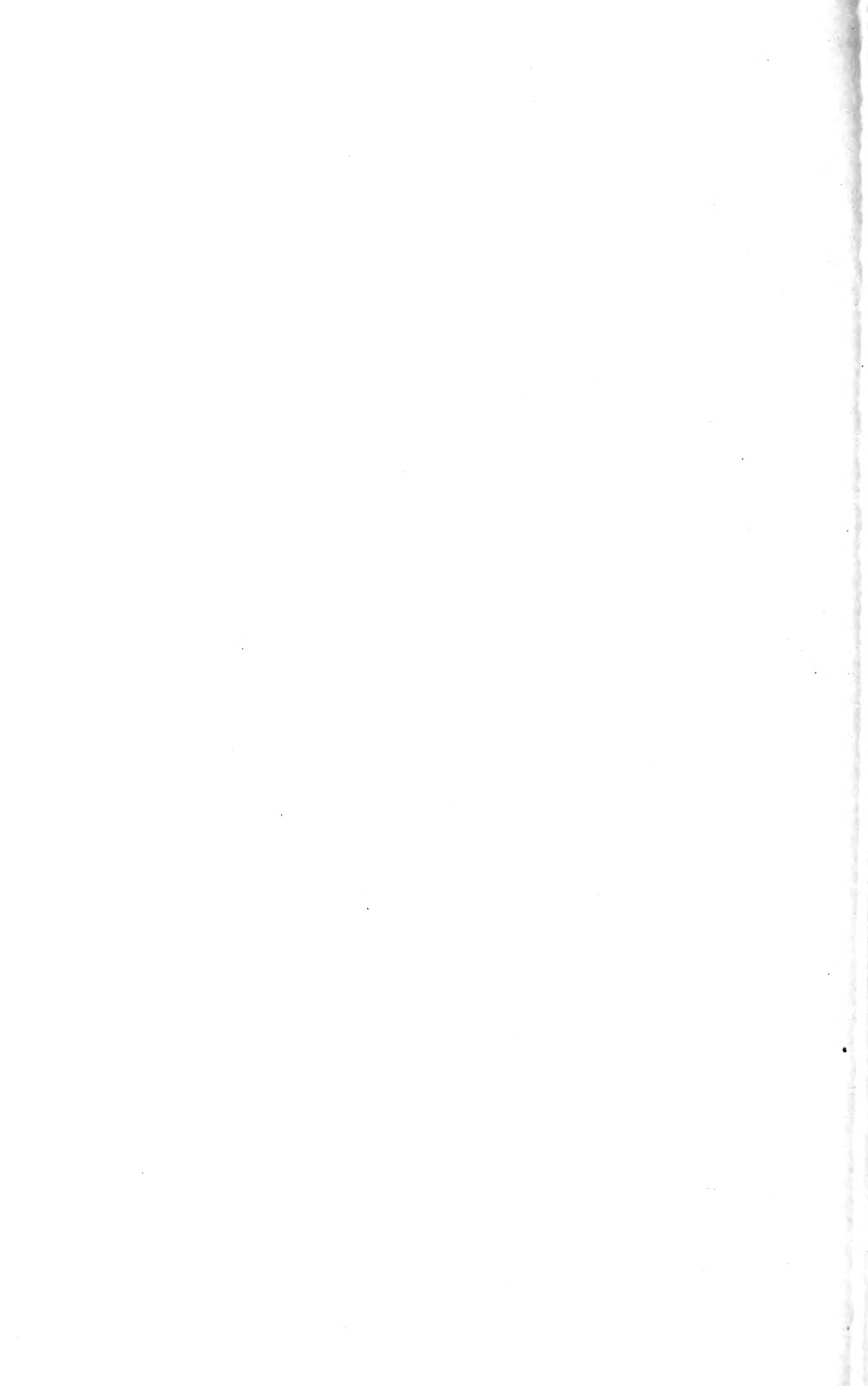

BACTERIOLOGICAL EXAMINATION OF DENVER CITY WATER SUPPLIED BY THE DENVER UNION WATER COMPANY—COMPARATIVE RESULTS FROM FOUR LABORATORIES.

At the request of Mr. D. G. Thomas, Chief Engineer of the Denver Union Water Company, a comparative study of the raw and treated waters furnished by the Company was undertaken November 11, 1916, by four different laboratories working separately and independently. Those co-operating in this investigation were Dr. Wm. C. Mitchell, Bacteriologist for the City and County of Denver, Denver, Colorado, Dr. John B. Ekeley, State Chemist, University of Colorado, Boulder, Colorado, Dr. H. I. de Berard, Chemist, Denver Union Water Company, Denver, Colorado, and Professor W. G. Sackett, Bacteriologist, Colorado Experiment Station, Fort Collins, Colorado.

On November 11th, representatives from the four above laboratories met in Denver and were taken by automobile on an inspection trip over practically the entire system. Each had his own sterilized sample bottles and took samples according to his own particular practice from twelve different points over the system. These included the following:—

1. Mississippi Avenue, infiltration galleries, inlet West Denver reservoir; treated.
2. Platte River, intake to Marston Lake, 48-inch conduit; raw.
3. Bear Creek; intake to Marston Lake, flume; raw.
4. Marston Lake; outlet to North Side Marston Lake plant; raw.
5. North Side Marston Lake plant; treated.
6. Platte Canon infiltration galleries, 30-inch conduit, Wynetka; treated.
7. Slow sand filters, 40-inch conduit, Wynetka; treated.
8. Willard rapid filters, 34-inch conduit, Wynetka; treated.
9. South Side Marston Lake plant, 48-inch conduit, Wynetka; treated.
10. Drinking fountain, City, First and Broadway.
11. Cherry Creek infiltration galleries, Capitol Hill reservoir; not treated.
12. Tap in City chemical laboratory.

All samples were iced immediately upon collection and kept in this condition during transit and until arrival at destination.

Samples examined by Dr. Ekeley, University of Colorado at Boulder, were about one hour in transit, and those sent to the Experiment Station, Fort Collins, were approximately three hours on the way. All samples were plated inside of twelve hours after collection.

Duplicate plates were made for the agar and gelatin counts, and in testing the waters for the presence of *Bacillus coli*, one 1/10 c. c. portion, one 1 c. c. portion and five 10 c. c. portions were used on all waters, and for the raw waters additional higher dilutions of 1/100 and 1/1000 c. c. were employed.

Each laboratory carried out the examinations according to its own particular routine, which was essentially the same thruout except for the medium used in the fermentation tubes for the *B. coli* tests. On this point the four laboratories differed: One used lactose broth; another, fresh ox bile; another "Bacto-bile"; and still another, dried ox gall. In spite of this lack of uniformity in methods, the results of the examination are strikingly uniform.

In Tables I, II and III, on pages 11, 12 and 13, the data from the four laboratories are given in detail.

Little comment is necessary on these results other than to call attention to the excellent and safe condition of the filtered and treated waters as shown by the low gelatin and agar counts and by the total absence of *B. coli* from the main supply, complying in all respects with the standard adopted by the Public Health Service of the U. S. Treasury Department.

Additional evidence of the excellent quality of the Denver water is to be had in the low death rate from typhoid fever, particularly during the past few years, amounting to only 8.57 per 100,000 population for 1914, and 6.72 for 1915. A diagrammatic representation of the decrease in typhoid death rate for the past ten years is shown on page 14.

Denver is peculiarly fortunate in having at its service a corporation like the Denver Union Water Company, which unquestionably has the health of her citizens at heart as is clearly manifested by the minute precautions that are taken to insure the purity of the water; furthermore, in visiting the different plants and grounds of the Company, one cannot fail to be impressed with the business-like methods of operation and the splendid condition of the property—lawns beautifully kept, unsightly ditch banks in flowers, buildings, bridges, pipelines and equipment well painted, ditch banks and drives free from weeds and rubbish, and last but not least, the interior of the filter houses clean and sanitary.

COMPARATIVE RESULTS OF CO-OPERATIVE INVESTIGATION
 Samples Collected November 11, 1916.

Table No. I.—Number of Bacteria per c. c. on Gelatin at 20° C.
 after 48 hours.

Sample No.	Source	Jno. B. Ekeley State Chemist U. of C.	W. G. Sackett Bact. Colo. Ag. Exp. Sta.	Dr. W. C. Mitchell Bact. City & Co. of Denver	H. I. de Berard Chemist D. U. W. Company	Average
1.	Mississippi Av. Infiltration Galleries Inlet W. D. Res.	6	14	16	7	11
2.	Platt Riv. Raw—Intake Marston Lake—48" Cond.	165	2080	1400	1325	1240
3.	Bear Cr. Raw—Intake Marston Lake—Flume . . .	1400	5400	Liq	4850	3880
4.	Marston Lake—Outlet N. S. Plant—Raw	435	750	300	600	520
5.	Marston Lake N. S. Plant—Treated	6	19	16	16	14
6.	P. C. Infiltration Galleries—30" Cond.	58	96	8	74	59
7.	Slow Sand Filters, Treated—40" Cond. Wynetka	54	12	53	75	49
8.	Willard Rapid Filters, Treated—34" Cond. Wynetka	6	43	9	62	30
9.	Marston Lake So. Side Plant—Treated—48" Cond. Wynetka	8	20	12	23	16
10.	Drinking Fountain in City—Cor. 1st & Bdwy.	18	41	20	57	34
11.	Cherry Cr. Infiltration Galleries—Cap. Hill Res.	(Bottle Broken)	1	5	1	2
12.	Tap in City Chemical Laboratory	51	25	21	69	42

COMPARATIVE RESULTS OF CO-OPERATIVE INVESTIGATION
Samples Collected November 11, 1916.

Table No. II.—Number of Bacteria per c. c. on Agar at 37° C.
 after 24 hours.

Sample No.	Source	Jno. B. Ekeley State Chemist U. of C.	W. G. Sackett Bact. Colo. Ag. Exp. Sta.	Dr. W. C. Mitchell Bact. City & Co. of Denver	H. I. de Berard Chemist D. U. W. Company	Average
1.	Mississippi Av. filtration Galleries, Inlet W. D. Res.	2	1	Cont.	1	1
2.	Platt Riv. Raw—Intake Marston Lake—48" Cond.	17	51	73	68	52
3.	Bear Cr. Raw—Intake Marston Lake—Flume . .	61	76	68	280	121
4.	Marston Lake—Outlet N. S. Plant—Raw . . .	27	36	25	104	48
5.	Marston Lake N. S. Plant—Treated	6	5	11	12	8
6.	P. C. Infiltration Galleries—30" Cond. Wynetka .	1	1	6	2	2
7.	Slow Sand Filters, Treated—40" Cond. Wynetka	2	0	7	7	4
8.	Willard Rapid Filters, Treated—34" Cond. Wynetka	4	2	5	2	3
9.	Marston Lake So. Side Plant—Treated—48" Cond. Wynetka .	2	0	3	3	2
10.	Drinking Fountain in City—Cor. 1st & Bdwy.	3	3	17	11	8
11.	Cherry Cr. Infiltration Galleries—Cap. Hill Res.		1	5	1	2
12.	Tap in City Chemical Laboratory	4	0	6	7	4

COMPARATIVE RESULTS OF CO-OPERATIVE INVESTIGATION

Samples Collected November 11, 1916:

Table No. III.—Number of Bacillus coli per 100 c. c.

Sample No.	Source	Jno. B. Ekeley State Chemist U. of C.	W. G. Sackett Bact. Colo. Ag. Exp. Sta.	Dr. W. C. Mitchell Bact. City & Co. of Denver	H. I. de Berard Chemist D. U. W. Company	Average
1.	Mississippi Av. filtration Galleries, Inlet W. D. Res.	0	0	0	0	0
2.	Platt Riv. Raw—Intake Marston Lake—48" Cond.	10	10	6	10	9
3.	Bear Cr. Raw—Intake Marston Lake—Flume ..	10	10	6	100	32
4.	Marston Lake—Outlet N. S. Plant—Raw	6	0	6	6	4.5
5.	Marston Lake N. S. Plant-Treated	0	0	0	0	0
6.	P. C. Infiltration Galleries—30" Cond. Wynetka .	0	4	2	2	2
7.	Slow Sand Filters, Treated—40" Cond. Wynetka	0	0	0	0	0
8.	Willard Rapid Filters, Treated—34" Cond. Wynetka	0	0	0	0	0
9.	Marston Lake So. Side Plant—Treated—48" Cond. Wynetka .	0	0	0	0	0
10.	Drinking Fountain in City—Cor. 1st & Bdwy.	0	0	0	0	0
11.	Cherry Cr. Infiltration Galleries—Cap. Hill Res.		0	0	0	0
12.	Tap in City Chemical Laboratory	2	0	0	0	0.5

TYPHOID FEVER DEATH RATE PER 100,000 POPULATION DENVER, COLORADO.

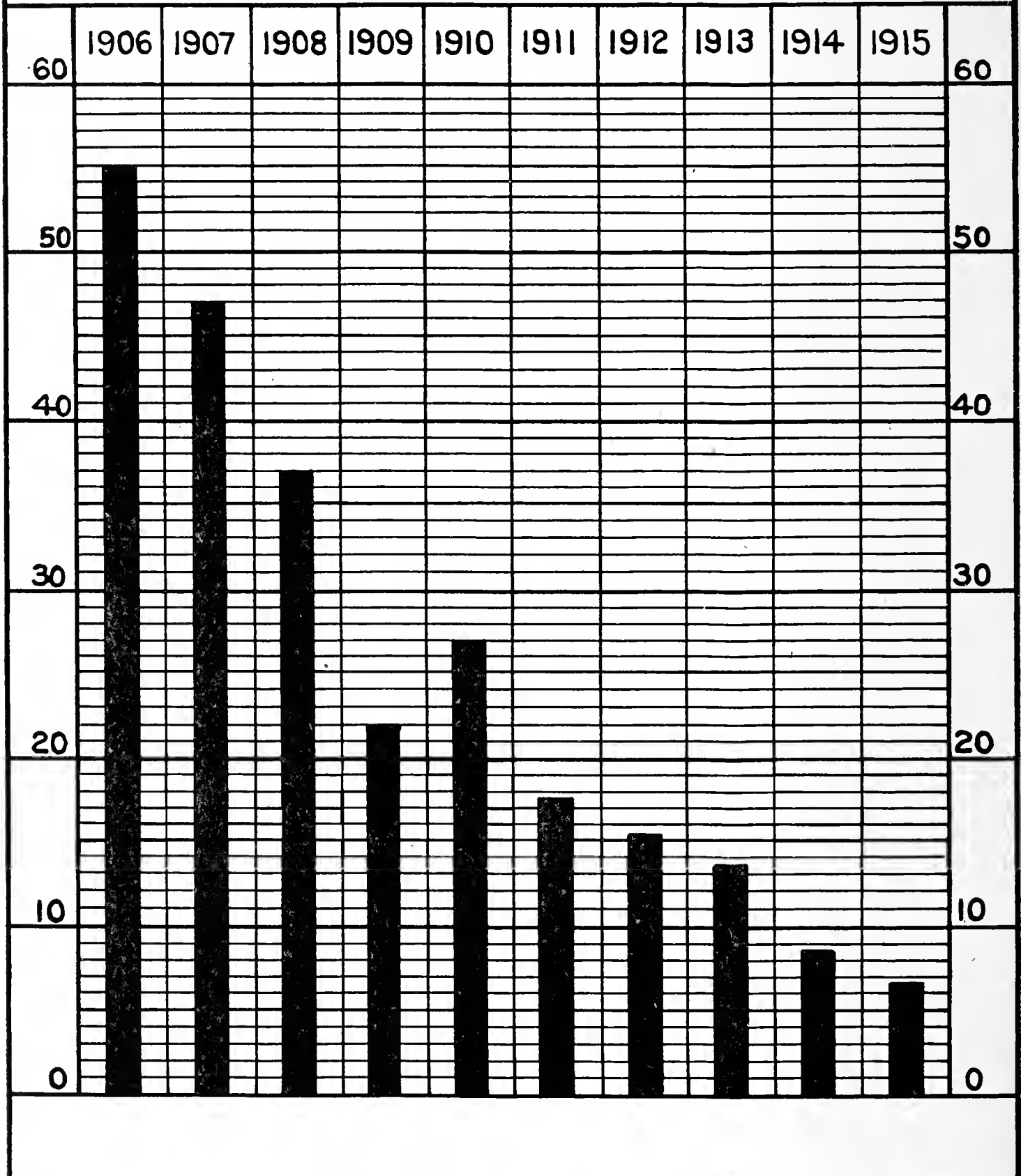

THE ABOVE CHART PLOTTED FROM STATISTICS OBTAINED FROM THE HEALTH DEPARTMENT OF THE CITY AND COUNTY OF DENVER.

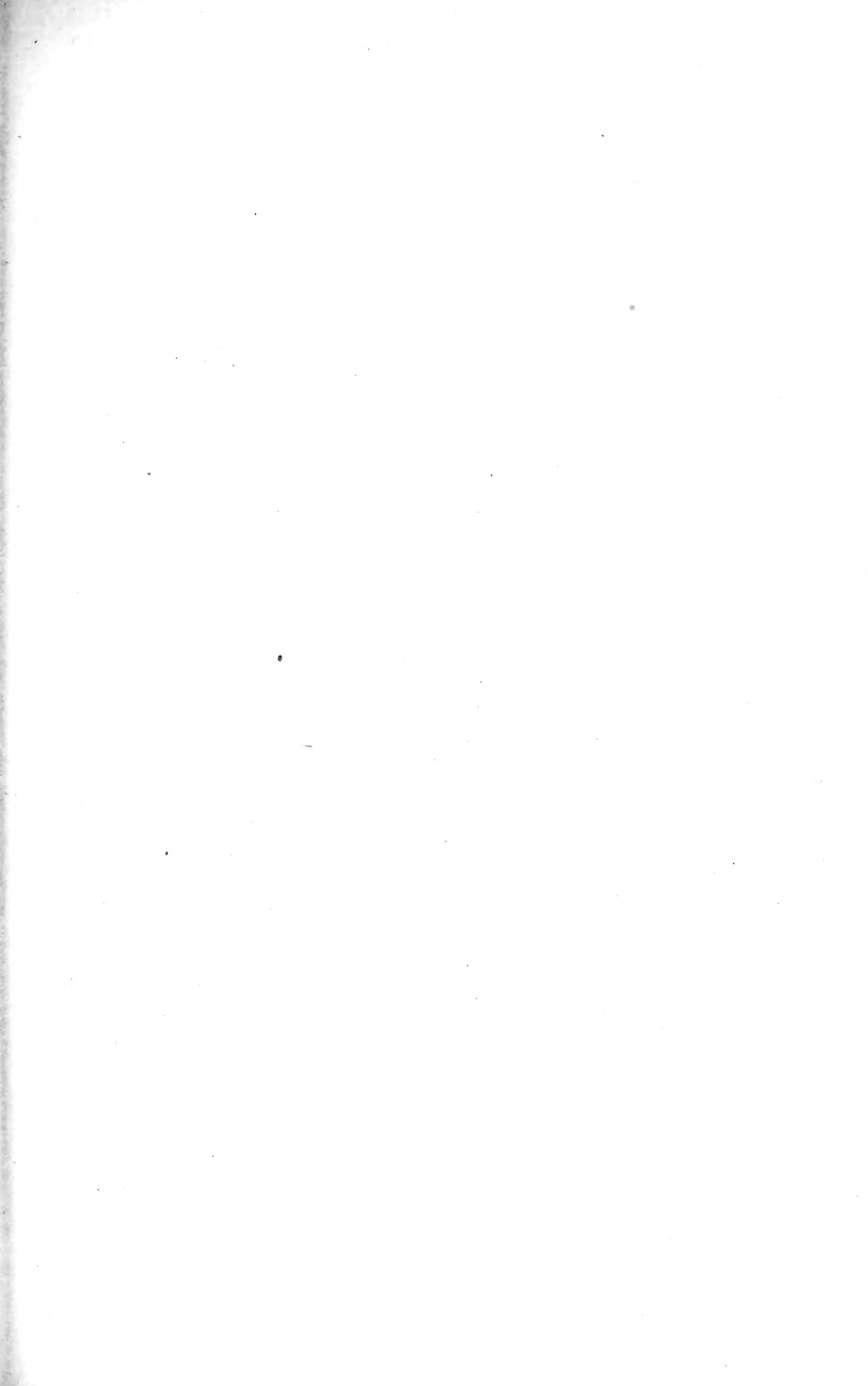



Bulletin 226

March, 1917

The Agricultural Experiment Station
OF THE
Colorado Agricultural College

BEANS IN COLORADO AND
THEIR DISEASES

By
ALVIN KEZER and WALTER G. SACKETT

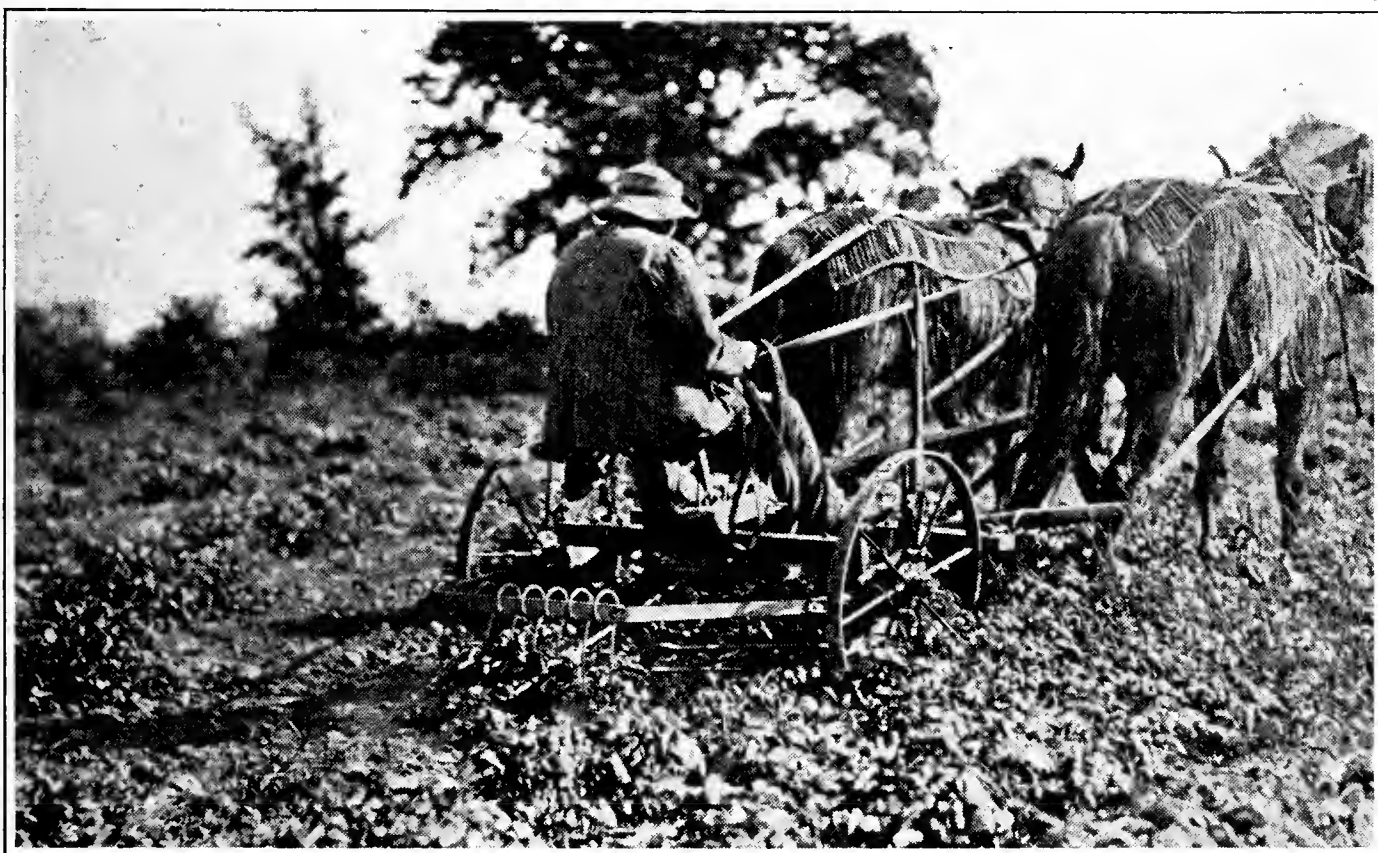

PUBLISHED BY THE EXPERIMENT STATION
FORT COLLINS, COLORADO
1917

The Colorado Agricultural College

FORT COLLINS, COLORADO

THE STATE BOARD OF AGRICULTURE

	Term Expires
HON. CHAS. PEARSON.....Durango,	1919
HON. R. W. CORWIN.....Pueblo,	1919
HON. A. A. EDWARDS.....Fort Collins,	1921
MRS. J. B. BELFORD.....Denver,	1921
HON. H. D. PARKER.....Greeley,	1923
MRS. AGNES L. RIDDLE.....Denver,	1923
HON. J. C. BELL.....Montrose,	1925
HON. E. M. AMMONS.....Denver,	1925
PRESIDENT CHAS. A. LORY, } GOVERNOR JULIUS C. GUNTER, } <i>Ex-Officio</i>	
L. M. TAYLOR, Secretary	G. A. WEBB. Treasurer

EXECUTIVE COMMITTEE

A. A. EDWARDS, *Chairman*

J. C. BELL

STATION STAFF

C. P. GILLETTE, M.S., <i>Director</i>	ENTOMOLOGIST
W. P. HEADDEN, A.M., Ph.D.....	CHEMIST
G. H. GLOVER, M.S., D.V.M.....	VETERINARIAN
W. G. SACKETT, B.S.....	BACTERIOLOGIST
ALVIN KEZER, A.M.....	AGRONOMIST
E. P. SANDSTEN, M.S., Ph.D.....	HORTICULTURIST
B. O. LONGYEAR, B.S.....	ASSISTANT FORESTER
G. E. MORTON, B.S.A., M.S.....	ANIMAL HUSBANDMAN
E. B. HOUSE, B.S. (E.E.), M.S.....	IRRIGATION ENGINEER
V. M. CONE, B.S., C.E.....	IRRIGATION INVESTIGATIONS
W. P. LITTLE, B.S., <i>U. S. Expert-in-charge</i>	HORSE BREEDING
R. E. TRIMBLE, B.S.....	ASSISTANT IRRIGATION INVESTIGATIONS
P. K. BLINN, B.S., ROCKY FORD.....	ALFALFA INVESTIGATIONS
EARL DOUGLASS, M.S.....	ASSISTANT CHEMIST
S. ARTHUR JOHNSON, M.S.....	ASSISTANT ENTOMOLOGIST
L. C. BRAGG.....	ASSISTANT IN ENTOMOLOGY
J. W. ADAMS, B.S., CHEYENNE WELLS.....	AGRONOMY ASSISTANT, DRY FARMING
W. W. ROBBINS, M.A.....	BOTANIST
RALPH L. PARSHALL, B.S.....	ASSISTANT IRRIGATION INVESTIGATIONS
I. E. NEWSOM, B.S., D.V.S.....	VETERINARY PATHOLOGIST
MIRIAM A. PALMER, M.A.....	DELINEATOR
R. A. MCGINTY, B.S.....	ASSISTANT IN HORTICULTURE
CHAS. R. JONES, B.S.....	ASSISTANT IN ENTOMOLOGY
GEO. M. LIST, B.S.....	ASSISTANT IN ENTOMOLOGY
JAS. D. BELL, B.S.....	ASSISTANT IRRIGATION INVESTIGATIONS
CARL ROHWER, B.S., C.E.....	ASSISTANT IRRIGATION INVESTIGATIONS
BREEZE BOYACK, B.A., M.S.....	ASSISTANT IN AGRONOMY
CHAS. I. BRAY, B.S.A., M.S.....	ASSISTANT ANIMAL HUSBANDRY
RALPH L. CROSMAN.....	EDITOR
W. H. KERR.....	MARKETS AND MARKETING
T. E. LEIPER, B.S.....	ASSISTANT ANIMAL HUSBANDMAN

OFFICERS

CHAS. A. LORY, M.S., LL.D., D.Sc.....	<i>President</i>
C. P. GILLETTE, M.S.....	<i>Director</i>
L. M. TAYLOR.....	<i>Secretary</i>
MABEL LEWIS.....	<i>Executive Clerk</i>

BEANS IN COLORADO

By ALVIN KEZER

SUMMARY

Beans are becoming an increasingly important crop in Colorado.

They are well adapted for both dry farming and irrigated conditions.

The "Plains" section is almost entirely adapted for the growing of beans. They do well also in mountain valleys at altitudes not to exceed 7,000 feet. In many localities 6,000 feet is too high for their proper growth because of the shortness of the season and the tendency of early and late frosts.

Beans are an excellent cash crop, with a well established market and market facilities.

In Colorado the chief market bean is the pinto. Navies, teparies and the Red Mexican or Red Miner are grown to some extent.

Many beans are being grown under contracts with seed houses. These beans represent a number of different varieties produced for seed, because of peculiar advantages for clean seed which the semi-arid climate possesses. The chief danger of seed bean contracts is injury to standard markets by growers attempting to throw rejected seed onto the standard markets.

Beans are a hot weather crop, consequently, they should not be planted until frost danger is past. In most localities this will be approximately June 1st.

Planting should be shallow. Planting may be done preferably with the regular bean planters. Corn planters with bean plates may be used. The ordinary grain drill, stopping the proper number of holes, is feasible where necessity requires.

Beans are a shallow-rooted crop. Consequently, the first cultivation should be the deeper. Later cultivation should be as shallow as the first cultivation, or even shallower. Cultivation should not be over 3 inches.

In irrigated districts, beans should be irrigated so as to keep the beans growing. A very dark green color is generally indicative of a need of water. Beans should not be irrigated later than full bloom on most soils, as later irrigation will delay maturity

and not increase yield materially. Ordinarily one to two irrigations are sufficient.

Harvesting should be done preferably with a bean harvester. This is especially true where any considerable acreages are planted. On very small acreages, they may be harvested by taking the mold board off the plow or by using a shovel.

Beans shatter in thrashing very easily, consequently the bean huller should be used unless the acreages are very small. There are special attachments which may be used on the regular grain separator, provided the separator is run at very low speed. Patches of one to two acres can be thrashed with a flail as cheaply as by machine unless a machine is near. Machines for cleaning are available and should be used, as they increase market value.

Pinto beans, the chief Colorado market sort, will average from 300 to 800 pounds under dry lands and may yield as high as 1,800. The same beans will average from 1,200 to 2,000 pounds under irrigation, and may yield as high as 3,000 pounds or even above.

Market prices may be increased by putting beans up in uniform packages and having them thoroly cleaned.

Bean straw should be carefully saved, as it is a valuable feed. This applies especially to dry lands.

Beans make an excellent rotation crop. Wheat on the dry land after beans will do as well as after clean summer fallow most seasons.

The yield of beans may be increased and their quality improved by wise field selection.

Seed beans should be hand picked to get uniform quality and freedom from disease. Care should be taken not to plant beans which have been frost bitten.

There are many diseases which affect beans. The best methods of controlling these diseases is the picking of clean seed and following a rotation. Beans should not be planted on the same land two years in succession. Two to three years should elapse before beans are again planted on the same land.

INTRODUCTION

The Colorado bean acreage has been steadily growing for the last ten years. The rate of growth in 1915 and 1916 has been as great as in the previous eight years. According to the Bureau of Statistics, United States Department of Agriculture, 38,000 acres were grown in Colorado in 1916, a jump from 21,000 acres in 1915, and 20,000 acres in 1914. The total production of the State in this period has jumped from 18,000,000 pounds to 25,440,000 pounds, in round numbers. In other words, the acreage has increased 81%

and the total production has increased in the same period about 41%. The 1916 yield per acre was low on account of one of the worst drouths in the history of the Colorado Plains. The seasons of 1914 and 1915 were especially favorable, with high average acre yields.

Beans are well adapted for growing in nearly all sections of the plains. Beans are a hot weather crop and as a consequence must be produced in the frost-free period. To successfully produce a bean crop, the season should be at least 95 days in length; 95 to 100 days should be the minimum. A season of this length is seldom found above an average of 6,000 feet in elevation. There are localities where the slopes are favorable and the soils sandy, where the seasons are somewhat longer, permitting the production of beans at altitudes as high as 7,000 feet. If the season is bright and rather warm, some of the early varieties may be matured in as short a season as 60 days. A cloudy season, however, always lengthens the growing period. Cool, cloudy weather may extend the growing season, especially if rains accompany these weather conditions or if irrigation is given. In such cases the season required for maturity may be as long as 130 days, too long for many sections even 6,000 feet in altitude.

The pinto bean, which formerly went under the name "Mexican", is by far the most important market bean, as it exceeds in acreage and total production all other beans produced. The seed industry beans, which are of numerous varieties, are the only ones which begin to compete in acreage with the pintos. These seed beans are largely produced under contracts with seed houses and consequently do not reach bean markets.

While beans may be successfully grown practically anywhere on the plains, at altitudes below 6,000 feet, they are most abundantly grown in Weld County and Las Animas County. They may be as successfully grown in other places, but development in other regions has not yet been carried to the extent which these two counties have made. The realization of the value of beans as a cash crop, and the ease with which they fit into a rotation by throwing in an annual cultivated crop, will very likely tend to increase their general production.

VARIETIES

The chief market variety is the pinto. The pinto bean was formerly called the Mexican. This name, however, is inappropriate, as there are numerous other Mexican varieties. The name "Mexican" as a consequence did not mean any definite bean. "Pinto" applies to a specific bean.

The pinto bean is about the same shape as the kidney bean, so well known as a garden variety. It is also about the same size as the kidney bean just mentioned. The pinto is buff-colored, is speckled with tan to brown spots and splashes. In many places in the southwest the pinto is called the Mexican tick bean. The name "pinto", however, has become so well established that it should be universally used.

While the pinto is the chief market bean, other beans are grown and frequently do well. The navies are grown and produced to a small extent—both the pea bean and the little navy. For garden purposes considerable quantities of kidney beans and "snaps" are grown. In most of our territory the season is too short for the proper development of limas; consequently, they do not figure in our bean problem to any extent. In parts of Colorado the Red Mexican or Pink Mexican, or Red Miner, is grown. This bean, however, is more extensively grown in New Mexico and Arizona and other points of the Southwest than in Colorado.

PREPARATION OF THE SOIL

Beans will grow on almost any kind of soil, from adobes to light sandy loams. They do best, however, on warm, sandy loams and sandy silts. Preparation of the soil for beans should commence prior to the season in which the beans are grown and should take into consideration proper rotation and manuring. The soil should be prepared by plowing. Wherever fall plowing may be done without danger of serious fall blowing, the soil should be plowed in the fall. In the spring this land should be worked down into a seed bed, making as good a seed bed as would be made for beets or corn. Where spring plowing is done it should be done early.

Beans respond to good preparation. Consequently enough attention should be paid to disking, harrowing and compacting the seed bed. In some sections listing has been attempted as the method of preparing the soil for bean planting. Listing, however, is poor practice, except upon soils which cannot be safely plowed, because of their very strong tendency to blow. Where the land is prepared by listing, there is a tendency to slow up the development of the crop and delay maturity. In addition to these handicaps, beans planted by the listing method are more difficult to harvest; especially if there is damp weather during the harvest there is likely to be much damage to the pods by coming in contact with the soil. The tendency to pick up adobe soil or stones is increased at harvesting time. If listing is done at all, it should

be very shallow so as to make the furrow to be filled about the growing plants as shallow as possible.

It is not always necessary to plow land in preparing a bean seed bed. Where the land was well plowed the year previous and in wheat, a good seed bed may be prepared without plowing, provided the wheat stubble is disked right after the binder to keep down weeds in the fall. The spring preparation may consist of disking when the weeds start, which will destroy the weeds and prevent the formation of a crust, and then disking and harrowing immediately before planting. After a cultivated crop such as corn, which has been well cultivated, a seed bed may often be prepared by disking and harrowing.

On irrigated lands after sugar beets or potatoes, it is not necessary to plow in preparing a bean seed bed. Disking, leveling and harrowing will be sufficient in these circumstances.

PLANTING

Care in Selecting Seed Beans.—The importance of getting good seed beans is sufficient to warrant special care in picking the seed. It is worth while taking a little extra care in Colorado on account of the short seasons. In many localities there is danger of beans being frost bitten in the early fall. Sometimes this light freezing will very materially weaken the germ so that the crop will have very small germinating power, altho the frost may not be sufficient to injure the beans seriously for market purposes. Care should therefore be taken not to use beans for seed which have been frost bitten before full maturity.

Many of the diseases which affect beans leave spots on the beans themselves. One of the most effective remedies in combating bean diseases is to pick out plants for seed which are not affected by the disease. Accordingly all seed beans should be from plants selected in the field and hand picked. Plants having discolored beans with strange colored spots should be rejected, planting only from those having bright, clean seed.

These statements hold, no matter what variety of beans are planted.

Time to Plant.—Beans are a hot weather crop. Seed is injuriously affected if it is planted in cold soil. Germination will not take place while the soil is cold, and if the soil happens to be wet enough, rotting may take place before the soil warms up sufficiently to permit germination.

Beans will not stand any frost. The very slightest degree of frost is apt to kill them entirely. On account of these reasons, beans should not be planted until the soil is thoroly warmed up.

In most Colorado sections this will be the last week in May or early in June. Successful plantings have been made as late as the first week in July, but the grower is tempting fate too much to make a practice of such planting, as frosts are likely to occur as early as the 25th of August.

While pinto beans and some of the teparies and a few of the Mexican and Indian varieties have been matured in 60 days or less, it normally takes about 90 days to mature a crop even for these short-season beans. In those seasons when frosts hold off until late in the fall, late planting will often make a crop, but frosts do not always hold off until late.

Method of Planting.—If there is any considerable acreage of beans to be put in, a bean planter should be procured, or a corn planter with bean plates. In Colorado beans should always be planted in drills so that the bean planters or corn planter should be so arranged as to drill the seed one in a place. It is possible to make use of a grain drill by stopping up the proper number of holes, in fact, many beans are successfully planted with such an implement. The type of grain drill having a revolving cup feed is adapted for this kind of planting.

Most of our grain drills have 7 or 8 inches between the drill holes. Stopping up three drill holes would therefore plant 28 inches apart, which is about right for irrigated planting. With a 7-inch drill, stopping up five holes, that is, leaving open the first and sixth drill, would plant 42 inches apart, which is about right for dry land. Some dry lands are strong enough to justify planting 36 inches apart. Stopping up four drill holes, leaving the first and fifth open, would plant 35 inches apart, which is about right.

Under irrigated conditions the rows should be about 28 inches apart. On dry lands, they should be from about 3 to 3½ feet apart. Under very dry conditions it is sometimes advisable to plant 7 feet apart and cultivate all of the intervening space. For irrigated conditions the drill should be thick enough to make one plant every 4 to 6 inches. This will require around 30 to 35 pounds per acre of seed for pinto beans. It will require a greater number of pounds for larger beans and a somewhat smaller number of pounds for the small pea beans.

For dry land conditions beans should, under normal conditions, be planted in rows about 3½ feet apart and in drills in the row 10 to 12 inches apart. If dry land conditions are a little severe, or uncertain, the space can be made a little further in the drills, say from 12 to 16 inches. According to the rate of drilling, it would take from 8 to 20 pounds of seed to plant an acre under dry land conditions. For an average planting, probably about 15

pounds per acre will be used. Where the rows are made 7 feet apart, under very severe conditions, the planting should be 6 to 8 inches in the drills.

Of the many beans planted only a few are put in by plowing shallow and dropping the beans in every third or fourth furrow, covering the beans by plowing and then packing and harrowing afterwards to compact the surface soil over the beans. This is not a good practice, but can sometimes be used in very small patches. Where large plantings are made, a bean planter adjusted to plant in exactly the proportion desired, should be used.

CULTIVATION

Beans of all varieties are rather shallow-rooted surface feeders. Consequently all cultivation after the crop starts should be shallow. The most important part of the cultivation should be done in the preparation of a seed bed. Immediate cultivation should commence about the time the rows can be seen in the field. Where the stand is extra good, beans may sometimes be harrowed a time or two if care is taken to do this work when the young vines are perfectly dry. If the soil is a little moist and the vines moist, the young vines will be found to be quite brittle so that harrowing will break off a large number. With the surface of the soil rather dry and the plants dry, the young plants are tough and will stand harrowing.

Some of the weeders on the market are excellent tools to use at this time.

The first cultivation with the regular cultivator should be the deepest. This first cultivation should not be over 3 to 4 inches



Cultivating dry-land pinto beans in El Paso County

deep. Later cultivations should be as deep or slightly shallower than the first cultivation. When the first cultivation is made, the roots have not extended very far into the space between rows. The stirring of the surface layer at that time by the cultivator makes a dry layer on top. If this is maintained the beans will root below the dry layer. Cultivation should be aimed primarily to keep down weeds and prevent the formation of a crust. Usually all cultivation should cease by the time the first pods commence to set. Sometimes the plants have grown enough so that cultivation should cease before this time. Care should be taken never to cultivate when the young bean plants are wet, as they are easily broken at such times, and when so broken are very susceptible to certain bean diseases. Under irrigated conditions cultivation should follow irrigation, as soon as the surface moisture and the plants will permit. The aim should be to prevent the loss of water by cultivation rather than to furnish water by excessive irrigation.

Irrigating Beans.—A study has been made of bean irrigation in eight Colorado counties. This study shows conclusively that it is fully as easy to over-irrigate beans as to under-irrigate them. As an average of all results obtained, two irrigations give higher yields than three or more irrigations. There was some difference as to quality of land; very open gravelly lands would stand more irrigation than sandy loams, loams and clay loams.

In irrigated regions beans should be given water when they show a need for water, namely, when the plants show a very dark green and commence to wilt during hot periods of the day. If the plants are light green and growing vigorously, irrigation may often be delayed unless it is necessary to irrigate to get the water.

Beans in irrigated districts will usually be planted in rows around 24 or 28 inches apart. The first step in irrigation is to use a furrow opener and make furrows between the rows. Water is run down these furrows under proper control, until the soil is moistened laterally and to a depth of at least 2 feet. This figure 2 feet is a relative one. Sometimes there is moisture enough in the subsoil at less than 2 feet from the surface when the surface needs irrigation. In such cases a lighter run of water will suffice. The last irrigation should very seldom be given after the blooming period; just as the plants are coming into bloom is as late as water should be applied in ordinary seasons, and on ordinary soils. Later irrigations delay the maturity of the crop and endanger proper ripening, because of possible frost injury. Such later irrigations do not materially increase the yield of beans.

The chief consideration, either on irrigated land or dry land, is good thoro cultivation. Such cultivation should be given as soon after irrigation as possible to get onto the land, and on dry lands such cultivation should be given after rains as soon as it is safe to work the soil. Cultivation should not be given after the vines begin to run, which is about the blooming period, as previously mentioned.

HARVESTING

All harvesting methods can be classified into hand harvesting and machine harvesting.

Hand harvesting is only adapted to small patches. Hand harvesting is usually done by either pulling the vines or cutting them off just under the surface of the ground with a sharp shovel. The vines thus pulled or cut off are shocked by means of pitch forks.

The best machines for harvesting beans are the regular bean harvesters. These machines cut the bean plants off just below the

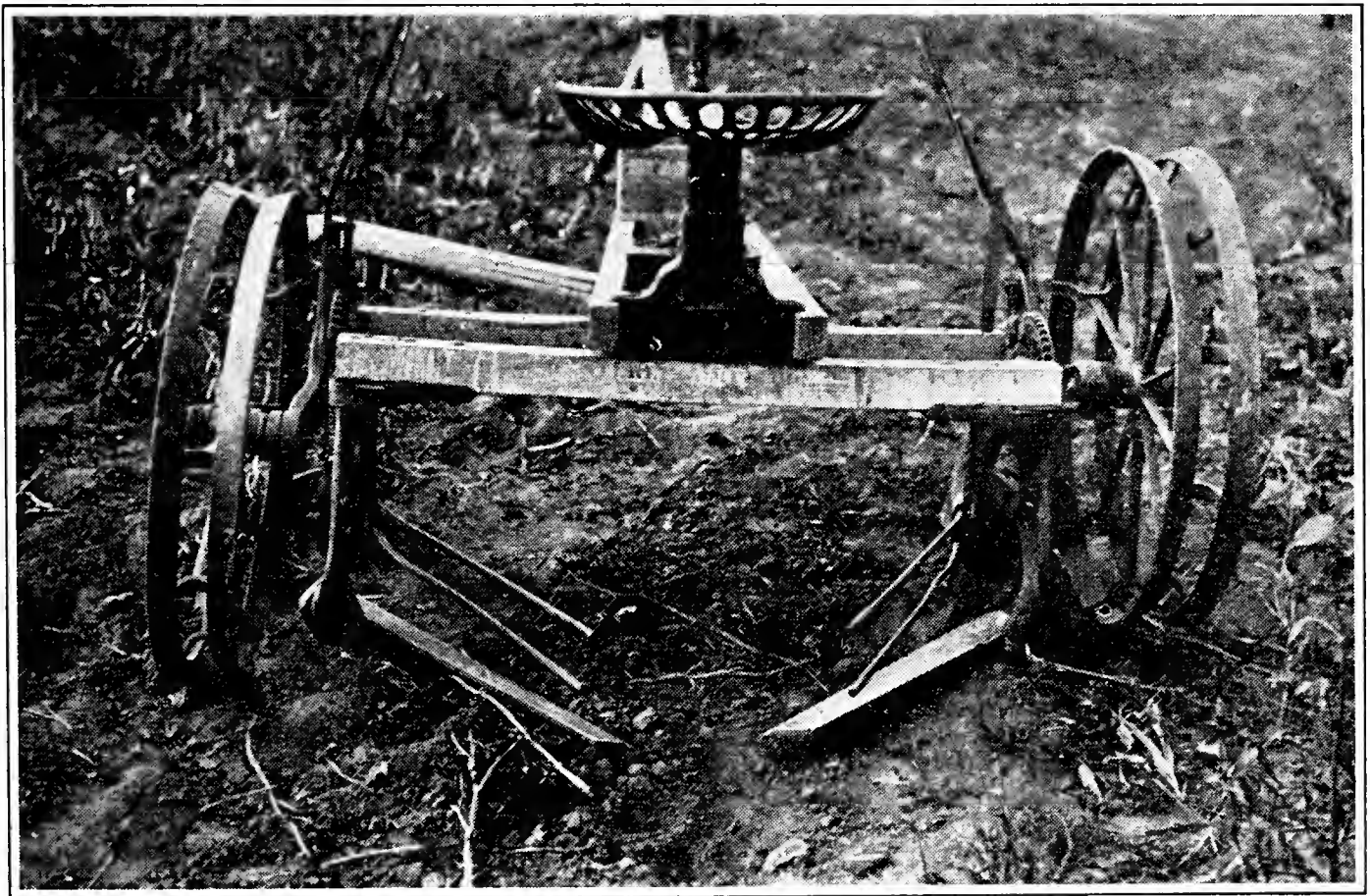

A common type of bean harvester

surface of the ground and by means of fingers push two rows together into one harvested row. The most up-to-date machines have bunching devices on the machine which bunch the cut vines into small, neat bunches. These bunches can be dressed up a little by a man with a pitch fork, for curing. Many of the machines, however, have no bunching device. In this case the bunching must

be done by hand. Men follow the machine with pitch forks putting the cut beans into neat shocks.

While a regular bean harvester is desirable and should always be used if there is any considerable acreage of beans grown, they may be harvested by using a breaking plow of the rod type, or by using a common sod plow with the mold board removed. Such expedients are much better than hand work on patches an acre or more in size, but should only be used on small patches where the size of the patch is not large enough to justify the purchase of a regular harvester.

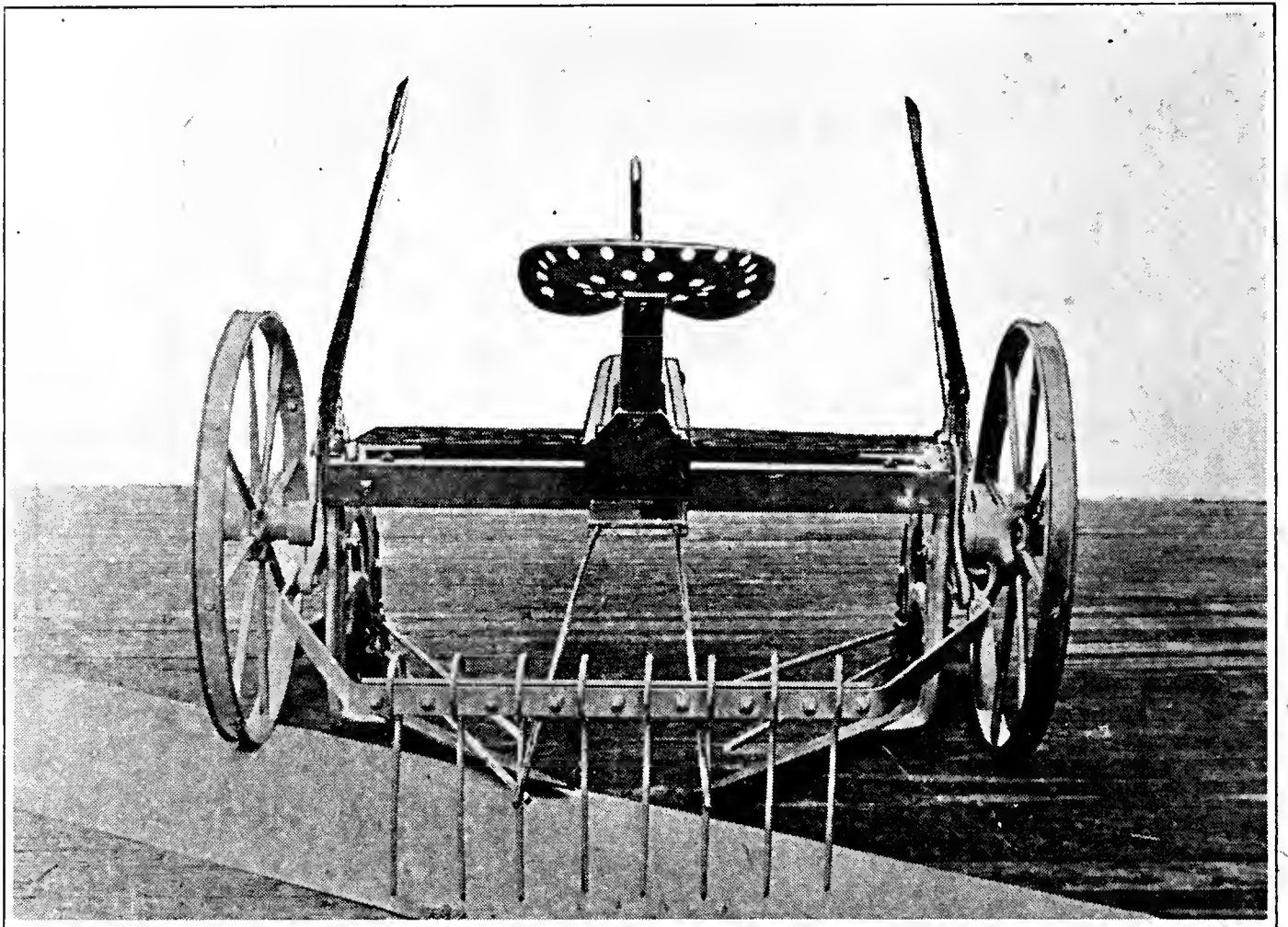

One of the newer bean harvesters with bunching attachment

Harvesting Period.—Opinions differ as to the proper time of harvesting. But experience and experimental work both show that if the beans are allowed to become completely ripe on the vine, heavy loss occurs from shattering. A good rule to follow is to harvest when the pods are turning yellow but have not yet dried out; at this stage there will usually be about half of the pods yellow ripe and a few still showing some green, providing the beans are ripening uniformly. When cut at this yellow-ripe stage, the beans will ripen up in the shock during the curing process and the loss in weight by drying out is very much less than the

loss in weight thru shattering if the beans are allowed to become too ripe.

Care of Harvested Beans.—The beans thus cut with the harvester should be made into small shocks. The height of the shock will be just as high as possible, and have the shock stay erect. In windy plains sections small round shocks are less likely to be blown away or thrashed out by blowing. In drying weather the shocked beans will cure rapidly. If it is impossible to thrash them when cured, it would be far better to stack them in neat stacks so as to prevent loss by blowing, discoloration from weather conditions and also to leave the land free for cultivation. If the beans have been properly shocked, there will be very little shattering in stacking as the stacking can be done early in the day,



A good field of dry-land pinto beans ready for harvest

or loss may be prevented by covering the hay rack or bean rack with canvas. In building a stack a bottom should be made with straw and the stack should be topped out with straw and weighted. If straw or millet is not at hand to be used for this purpose, a stack cover of canvas or corrugated iron will be advisable if any considerable time is to elapse before thrashing.

The harvesting process, together with summer cultivation, leaves the land in excellent shape for fall planted crops such as wheat, or even for spring planted crops, as plowing is not necessary after the tillage given the beans.

THRASHING

Beans split very easily unless handled with care. Split beans are docked on the market. Consequently, tools should be used which split the minimum of beans. It is for this reason that the regular bean hullers or bean thrashers should be used for thrashing the crop.

There are a number of manufacturers having bean hullers on the market. It is possible by using some of the modern attachments to thrash beans with the regular grain separator. This should not be done unless a bean huller is so expensive, acreage considered, as to make it inadvisable. Where the grain separator is used to thrash beans, special attachments are put in and the cylinder is run at a very slow speed. Usually all the concave teeth with the exception of one row are removed.

Where a grower has only one-half an acre, or one acre, it is sometimes easiest and cheapest to thrash out his beans with a flail. Fifteen to eighteen hundred pounds a day can be thrashed out in this way by a single man.

Very few of the thrashing machines on the market will properly clean beans for the market. Consequently, machines called bean cleaners have been devised to clean up the beans ready for marketing. If any considerable acreage is grown, it would pay to have a bean cleaner to clean the thrashed beans before they are put on the market. Where only small acreages are grown, neighbors might well co-operate in the purchase of a cleaner, as one cleaner would do the work for several small growers.

YIELD

The Colorado pinto is the great market bean for Colorado. As has already been said, it is grown on more acres than all other kinds of beans combined. The average yield of pintos per acre on the dry lands in 1914 and 1915 was close to 800 pounds. In 1916 the average varied from 300 to 600 pounds per acre, with total failures in some neighborhoods. The season of 1916 was one of the driest in the history of the Colorado plains. The average yield of Colorado pintos on irrigated lands in 1914 and 1915 was 1,400 pounds per acre. In 1916 the average pinto yield under irrigation was close to 1,600 pounds per acre. Yields as high as 2,000 pounds per acre have been produced on the dry lands and as high as 3,200 pounds have been produced on irrigated lands. These higher yields are by no means average, but they show the possibilities of the crop when all conditions are made favorable.



A good set of pinto beans; after a light frost

MARKETING

One of the most important problems in the marketing of beans is to have a clean, high-grade, uniform product. Mixed beans, with discolored, broken beans, seriously docks the price. Since the pinto outyields most other beans in practically all the Colorado bean-growing sections, it should constitute the chief market bean.

Machine-cleaned pintos will usually sell on the market within a cent of the price asked for hand-picked navies. The actual net return on pintos will usually be higher than for navies, because the cost of cleaning is not so great and the rejections under good market conditions are a great deal less.

In abnormal years, like 1916, buyers will take almost any kind of a bean, but even in 1916 buyers were paying a premium for uniform lots of clean, well-graded pintos. In some localities pintos are handled in bulk. Where this is true a uniform grade and cleanliness should prevail in the bulk delivered. Many bean markets, however, require that the beans be bagged for shipment. Where such is the case, the beans should be thoroly cleaned and graded. Uniform, standard quality should be bagged in bags of uniform size and marking. The marking suggested is "100 Pounds Colorado Pintos". The remaining marking can specify the grower and address when so desired.

Growers will be able to receive much better prices where a uniform product is produced and where the entire neighborhood

is growing one kind of bean. This is due to the fact that the marketing costs are lower under such conditions.

With the exception of one season, Colorado pintos have netted the growers around 4 to 4½ cents for the past eight or ten years. In 1916, prices much higher than this prevailed. But 1916 prices were as abnormally high as 1912 prices were abnormally low. At 4c a pound to the grower, pintos constitute a reliable cash crop which will return good acre net profits to the grower.

The red Mexicans, the spotted Indian beans and teparies do not have a standard market in this section. They are grown extensively in the Southwest. In fact, the pink bean in southern California, Arizona and New Mexico is quite generally grown and is perhaps the most common bean on the market, but for those sections to which Colorado normally ships, namely, the South and East, pintos and navies are the types known. Navy beans may be successfully grown under Colorado conditions, but they require much more hand work and care. Consequently, they are much more expensive to produce. While they bring higher prices on the market, the spread between navies and pintos is usually not over one cent. This spread will be more than obliterated by the increased cost of preparing navies for market. Besides, there will be a very much lower rejection in grading and cleaning from pintos than from navies, so that a greater proportion of the crop will actually reach the market.

Market grades have been established for the pinto beans. These grades have been adopted by the bean buyers' associations. It is quite probable that the Bureau of Markets may standardize grades for this crop. When such is done, it will be much easier for growers to prepare a standard product for the market. A standard product can be marketed to a better advantage than an unstandardized product, because very much less inspection is required to determine the quality of the product offered, where beans are so standardized and graded as to permit them to be sold on grade and sample without the necessity of sampling each individual bag.

Communities could do much in helping out their market problem by growing uniform quality and following market demands as to package and cleaning.

COST OF PRODUCING BEANS

It is impossible to give exact figures which will really represent the cost of producing beans, as so many factors enter into the cost of production on different farms. On dry land it was found that beans could be raised with as little labor as corn. The aver-

age amount of labor, therefore, required to produce an acre, would be equivalent to about 15 man hours per each acre of beans per year, and about 42 horse hours. The labor cost of producing a bean crop on the dry lands will probably run from a minimum of \$5 to a maximum of \$8 per acre. To this labor cost must be added interest and depreciation on machinery used and interest on the land or rentals.

The cost of producing beans under irrigation will give a labor cost somewhat higher, running from \$9 to \$15 per acre. Under irrigation, in addition to machinery costs, which will be quite comparable to those on the dry land, there will be added the cost of irrigation, water rentals or ditch up-keep. Land rentals, or interest on land investment will be consequently higher.

It is possible that where a farmer does all his own work, he will be able to produce beans on the dry lands for from \$5 to \$7 per acre, and under irrigation for from \$15 to \$30 per acre, depending upon the locality and land conditions and land values. If all labor must be hired, it is quite possible that the efficiency of labor will be lower and the price somewhat higher than normal going wages in dry land and irrigated regions because if all labor is hired, it will usually be wanted at times when everybody is busy and as a consequence more will have to be paid for the labor. This will likely raise these estimated costs somewhat.

For two years, during which studies were made on the dry lands, it was found that the cost of operations for the production of beans varied from a minimum of \$2.15 per acre to a maximum of about \$6 per acre. The cost of operations included the cost of all horse and man labor and does not include seed costs, interest and depreciation on machinery or land rentals. The differences in cost were due to differences in number of cultivations and the manner of preparing the seed bed. In computing these costs, 15c per hour was allowed for the value of man labor and 10c per hour for horse labor. Where the farmer is doing the work himself, if he allows these costs, he is, of course, paying himself wages at these rates. Labor is occasionally cheaper than these prices and in rush periods is often higher. The figure given was found to be the average paid in dry-land regions for two successive years, the average being the average wages paid for the entire season, and not the average paid during rush periods.

USE OF BEAN STRAW

The bean straw and hulls after the beans have been thrashed out will yield from one-half to three-quarters of a ton per acre on dry lands, and somewhat heavier yields will be received from

irrigated lands. This bean straw is capable of utilization. Especially on the dry lands every bit of bean straw should be saved and fed. Enough experience has already been obtained to indicate that on the dry lands if bean straw is fed with silage that it will return a food value nearly as great as alfalfa. If the bean straw is fed with other dry feeds, it is not as valuable as alfalfa. In fact, it appears to return about one-half the feeding value if fed with dry feeds, and almost as much as alfalfa when fed with succulent feeds. The utilization of bean straw, therefore, constitutes a very material addition to the feed supply under dry land conditions.

BEANS IN ROTATION

Under irrigated conditions, beans furnish an opportunity for a cultivated cash crop, which is their chief value in irrigated rotations. Some types of weed pests can only be cleaned up where a cultivated crop can be introduced. Beans furnish such a crop, which may not only be cultivated, but hoed. On the dry lands, however, beans have a still greater value, because they furnish a cash cultivated crop well adapted for dry lands and capable of returning very good money values, dry-land possibilities considered. It has been found by experience that wheat, after a bean crop which has been well cultivated, will yield as well as after summer tillage or a summer fallow. Since they will usually pay well for growing, beans may be produced on lands which in many cases would be without a crop.

On the dry lands beans have a tendency to build up the soil. If the bean straw is fed to livestock and the manure properly applied to the land, the beans will be a decided, positive asset. If bean growing is a part of the regular farming system, the beans themselves should be grown in rotation. There are many bean diseases which tend to not only reduce the yield of beans, but to reduce their salability. One of the best methods of fighting these diseases is to plant beans in rotation, that is, never plant beans two years in succession upon the same land. At least two or three years should intervene in order that the land may not become inoculated with the diseases which affect the bean crop.

IMPROVEMENT OF PINTO BEANS BY SELECTION

The greater proportion of the planting of pinto beans has been done with little or no seed selection. Sufficient experimental work has been done to show that as much progress may be made from selection with pinto beans as is sometimes done with corn in the corn belt. The bean plants are mostly self-fertilized, thus, if a good strain is once obtained, no further selection within

the strain is necessary, because the strain is a pure line and breeds true. Every pinto bean grower who is making a business of bean production should start a seed patch. The start should be made by selecting plants in the field. In making selection, the following points should be watched for:

1. High individual plant yield
2. Early maturity
3. Uniform ripening of pods on the plant
4. Freedom from disease

To make a seed plat, the seed of each of these selected bean plants should be planted by itself in a row. These rows are really



A desirable type of plant—dry-land pinto beans

comparative tests of the value of the selections. The high-yielding rows which are produced represent the mother plants which it is desirable to keep. All the seed from high-yielding rows having other desirable characteristics should be saved. If one strain

should prove to be very much better than all others, this should be saved for seed and increased to the fullest extent possible. In this way the entire bean acreage will soon be planted from this high-yielding, early-maturing, even-ripening, disease-free strain.

Preliminary work with bean selection shows that it is easily possible to increase the yield 25 per cent by selection alone. To increase the yield this much would pay for all of the extra work of starting a seed patch and testing out in comparative tests the various selections, thus enabling the grower to pick out the highest-yielding strain of his crop from which he may eventually plant his entire crop. It will pay to hand select seed to get seed of uniform marking, uniform size and freedom from disease, even if time and conditions do not permit the better work of the selection of pure, high-yielding strains.

DISEASES OF BEANS

By WALTER G. SACKETT

As mentioned elsewhere, the growing of beans in Colorado for seed purposes is one phase of the industry which has developed at a remarkably rapid rate, considering the length of time that the crop has been raised with this in view. In all probability, one reason for this has been the desire on the part of the seedsmen to obtain seed grown under conditions which normally tend to reduce the percentage of diseased seed. Such conditions obtain to a greater or less extent in both the dry land and the irrigated sections of the State. The absence of moisture in the form of rain, which tends to spread disease over the plants and from plant to plant, together with abundant sunshine are both valuable assets to the localities where beans are being grown.

Another consideration which made Colorado a desirable place for raising seed beans was the fact that until two years ago the disease question was practically negligible. There was plenty of disease-free land, new so far as bean culture was concerned, on which there was good reason to believe that no difficulty would be experienced for years to come in the line of plant diseases. But the inevitable has happened, and in the remarkably short space of two years.

Someone innocently planted diseased seed from which unhealthy plants developed, and from these as a starting point, it has been a relatively simple matter for the infection to spread from vine to vine, plant to soil, and field to field.

Where irrigation is practiced, the irrigating water, flowing as it does thru infected fields, carrying more or less trash and diseased soil with it, cannot be lost sight of as a means of disseminating the various ailments to which the bean is heir.

Our severe and prolonged winds which may assume the form of sand storms, transport quantities of soil, irrespective of whether it is diseased or not, from one locality to another. The mechanical injury to the pods and beans which results from this incessant pounding by the sand grains, not only weakens the plant, but also opens up the way for subsequent infection with germ-laden soil particles.

Some growers have failed to use beans in a rotation and have planted beans after beans on the same land, having lost sight of

the fact that, aside from this being poor farm practice, the dangers from disease are increased very greatly by such a procedure.

Little if any attention has been given either to the planting or the selecting of disease-free seed, with the result that we have built up a big seed business in a phenomenally short time, but a business which is destined to fail, as has been the history elsewhere, unless we can establish a reputation for our seed with respect to quality, purity and freedom from disease.

Now is the time to do this, before our fields become generally infected, and while the prevalence of disease is so slight that it can be controlled for the most part by the means that we have at our disposal.

For the present consideration, we shall confine the discussion of bean diseases to those which have been observed to occur in the State during the last two years, and which, if neglected, may prove a serious menace to the industry.

DESCRIPTION OF DISEASES

Bacteriosis or Bacterial Blight

Without doubt, the greatest damage to our bean crop during 1916 resulted from an attack of the bacterial blight. This is caused by a germ, *Pseudomonas phaseoli*, which enters the plants thru the breathing pores or stomata and thru wounds produced by mechanical injury.

The disease is common upon field, garden and lima beans and attacks leaves, pods, stems and seed. It is very conspicuous upon the pods and leaves and can be recognized most easily, perhaps, upon the former, particularly in the wax varieties. Here we find watery spots ranging in size from tiny specks to areas three-eighths of an inch and more in diameter. They are usually irregular in outline and roughly circular in shape. On the wax varieties, the spots are translucent or watery, amber-yellow in color and frequently have a rosy-red margin. Their appearance, on the whole, is not unlike an ordinary blister, except that they are neither raised nor sunken. In the more advanced stages, they may be coated over with a thin, pale yellow or amber-colored crust which is composed largely of the bacteria which produce the disease. Ulcers in all stages of development can usually be found on a single pod. (See Fig. I.) When the lesions are numerous, they frequently coalesce, or run together, so that the whole side of the pod presents one continuous canker.

The injury to the leaves is very marked. In the early stages, irregular, watery spots can be found scattered over the surface

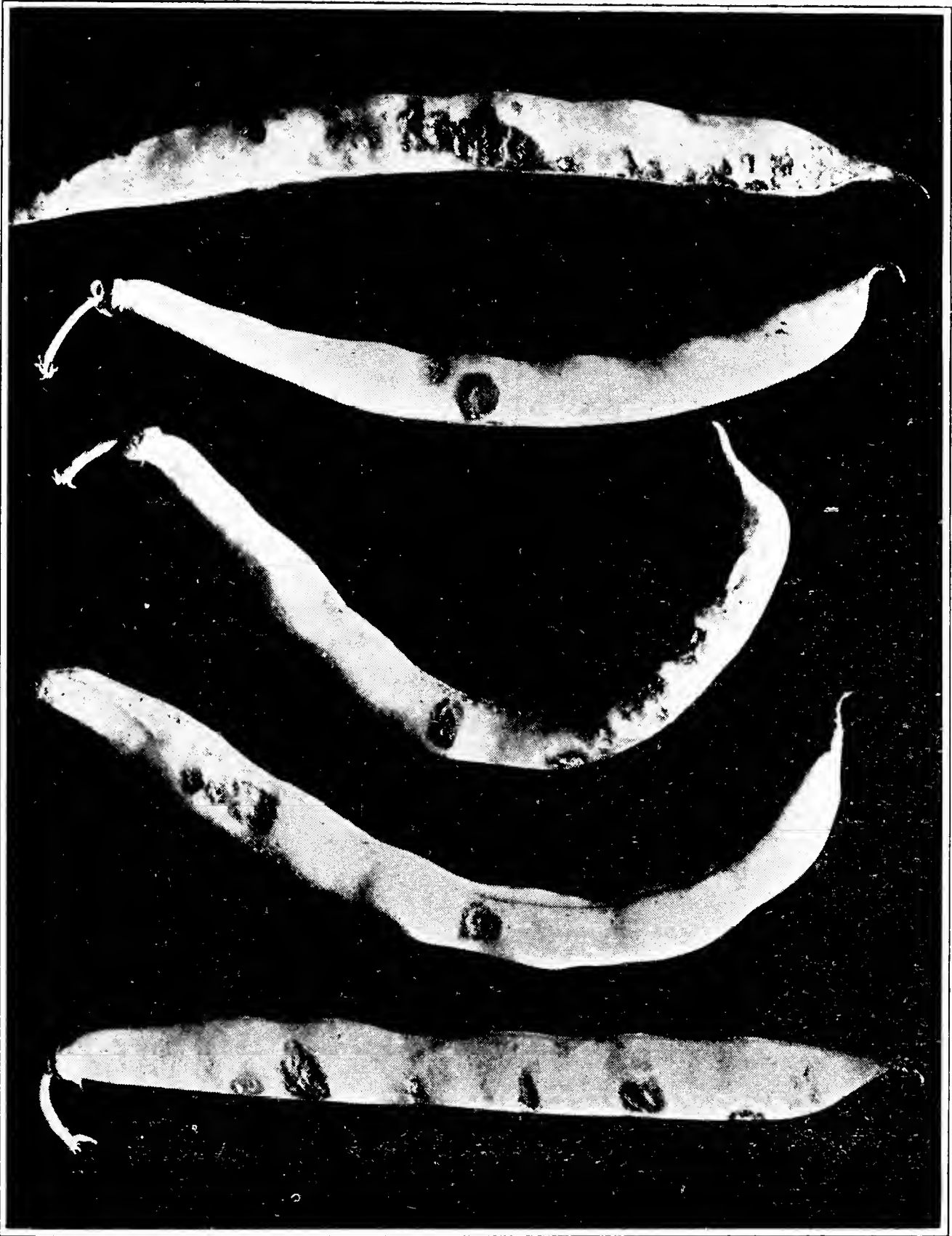

Fig. 1.—Bean pods affected with Bacteriosis or Bacterial Spot

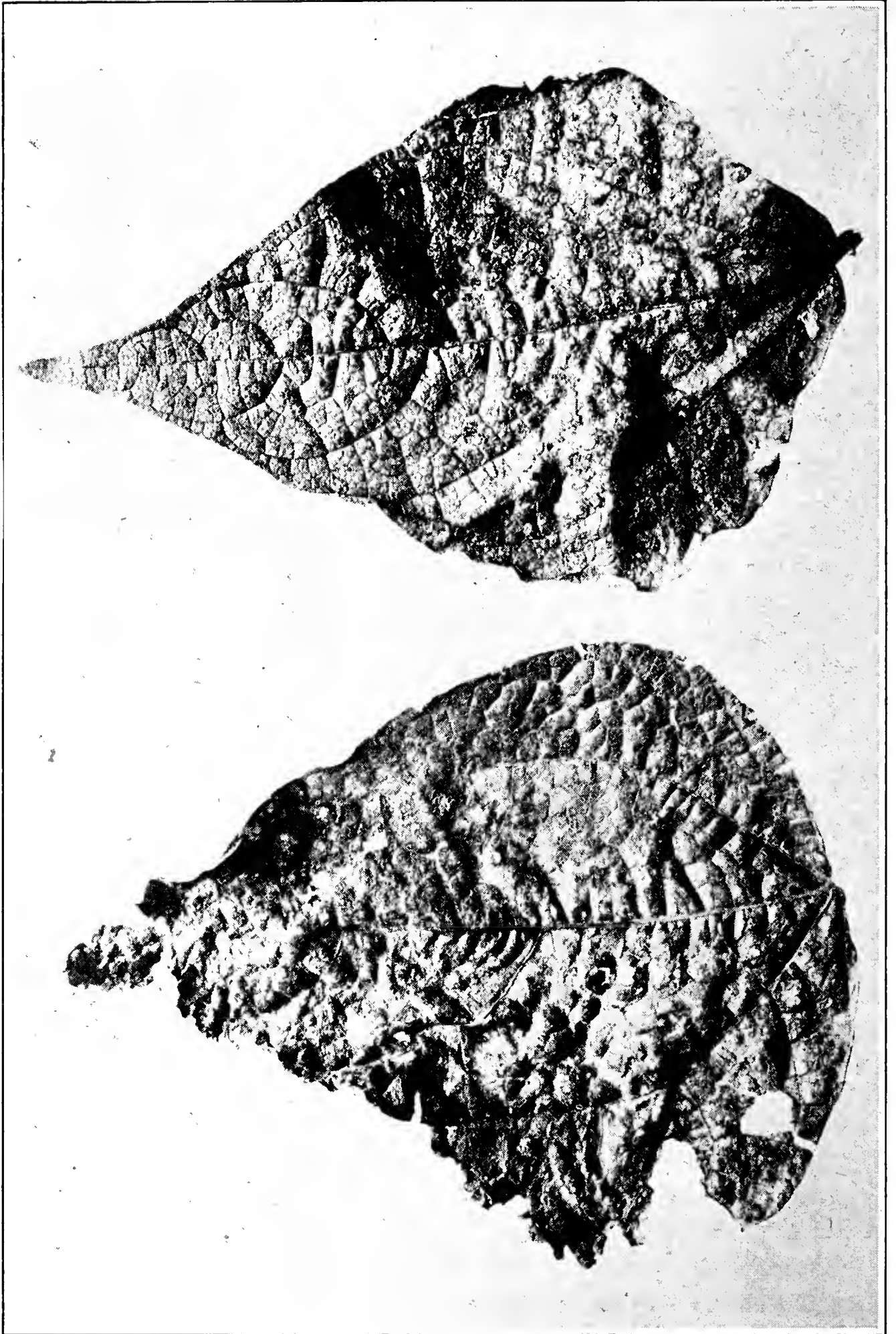

Fig. II.--Bean leaves affected with Bacteriosis or Bacterial Spot

which soon turn yellow and in a short time become frosty-brown in color. If the spots are numerous they will often coalesce and give the dry, brown leaf a peculiar blistered appearance. (See Fig. II.) The tissue in this condition is extremely brittle and is easily torn and broken, which accounts for the ragged condition of blighted leaves. The stems are affected in much the same way as the foliage.

Badly diseased plants lose their leaves early and fail to mature their seed. Spotted pods are unfit for the market as green beans, and seed from them is very apt to be diseased as the infection is communicated to the seed from the pod.

Pod-Spot or Anthracnose

Pod-spot or Anthracnose has been of relatively little importance thus far in Colorado bean fields, but because of its ravages in other localities, it seems advisable to become acquainted with its symptoms in order that it may be recognized should it become serious.

The disease makes its first appearance on the seed-leaves and stems of the seedling plants. It manifests its presence there by brown, discolored, sunken spots or ulcers, indicating rather clearly that the causal fungus, *Colletotrichum lindemuthianum*, has been carried over winter in the seed.

In due course of time, spores, by means of which the disease is spread, are produced in these early spots. Eventually they are blown, or otherwise carried, to the growing stems, leaves and pods, where they soon become established and begin their destruction.

On the leaves we find reddish or blackened areas developing along the large veins on the under surface. The veins may be eaten thru by the fungus and destroyed, while the blade shows numerous cracks or holes with shriveled, blackened margins. Leaves in this condition are practically worthless as food-building organs, and as a result the nutrition of the plant is greatly impaired; either the yield of seed is reduced appreciably or the seed fails to mature.

Previous to the time of blossoming, the attack has been concentrated against the leaves, and by the time the young pods make their appearance the fungus has become well established and is amply supplied with spores. These soon find their way to the young, tender pods where they produce rusty-brown or black sunken spots with reddish or yellowish margins. (See Fig. III.) These vary in size, much as the bacterial spots previously described. The spores of the fungus are produced in the center of the black ulcers and form little pink masses visible to the naked eye.

They are glued together with a mucilaginous material which sticks them securely to the spot. However, as soon as a drop of moisture touches them, the mucilage is dissolved and the spores are set free in the water. At this time any disturbance of the plant is apt to scatter the spores in the flying drop of water, and for this reason



Fig. III.—Bean pods affected with Anthracnose or Pod Spot (After Whetzel. Bulletin 255, Cornell Experiment Station).

beans affected with anthracnose should never be cultivated while the dew is on them or while they are wet from a shower.

From the affected pods, the disease finds its way to the seed where it produces the familiar rusty-red or brown spots. In severe cases, the whole seed may be involved, altho ordinarily only a slight discoloration is produced on one side.

Bean Rust

Bean rust was observed in several fields last year, but it came so late in the season that little if any damage resulted. The causal fungus, *Uromyces appendiculatus*, attacks the leaves, stems and pods. The rust, as the name implies, can be recognized in its summer stage by the small, raised, rusty-brown powdery specks on the under side of the leaf which rub off easily with the fingers as a rusty-brown powder.

In the winter stage, the specks are black in color and occur on both surfaces of the leaf. When found on the upper side, they are usually surrounded by a light border, apparently where the green leaf tissue has been killed. (See Fig. IV.) While the rust is not uncommon, it has rarely been of sufficient economic importance to cause any considerable alarm. Of course, if the attack should come early in the season and be very general, the crop would suffer in proportion as the vitality of the plant was affected. As the disease winters over on the leaves, the destruction of these by burning offers the best means of eradication.

Bean "Streak"

For want of a better name, the term "Streak" is used here to designate what appears to be a new and undescribed disease of beans, which was observed in Colorado for the first time during the summer of 1916. Whether this is in reality something new, or merely a different manifestation of an old trouble, remains to be seen. It attacks stems, leaves and pods, the symptoms on the first two of these being much the same as with the bacterial blight. On the pods there appear peculiar rusty or orange-brown discolorations in the form of irregular splotches, just as if a brown stain had been spattered on them, and had run down in lines or streaks. (See Fig. V.) The side of the pod next to the plant is practically free from the discoloration, while the outer side may be more or less affected over its entire surface. The leaves are destroyed and the plants become defoliated before the crop matures.

It is our purpose to make a study of this disease during the coming summer and to determine, if possible, its cause and control.

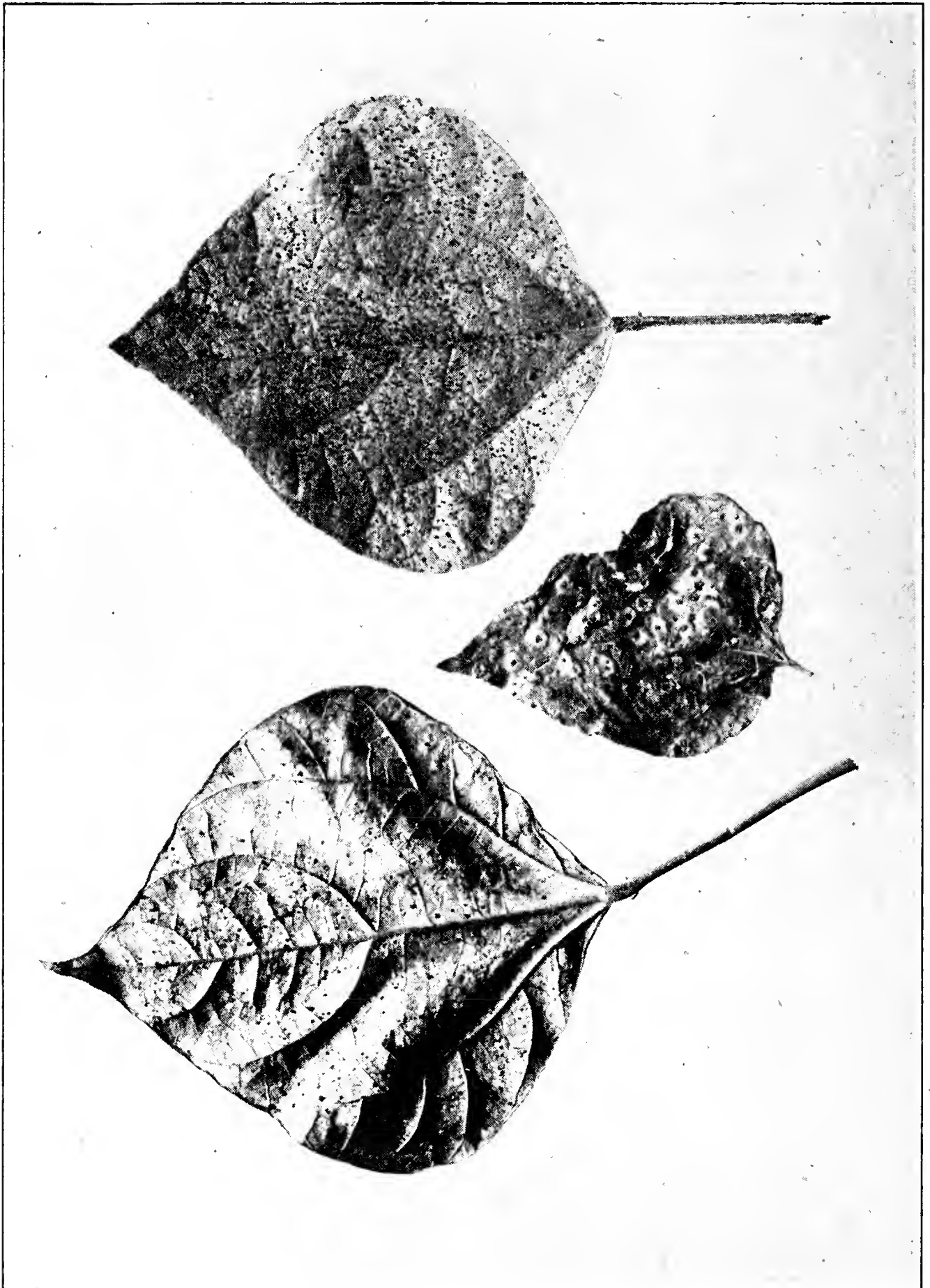

Fig. IV.—Bean leaves affected with Rust



Fig. V.—Bean pods affected with “Streak”

MEASURES OF CONTROL

The measures of control which can be recommended for any one of the diseases described, apply equally well to all. Accordingly, this phase of the question has not been taken up in connection with the individual diseases, but has been reserved for consideration as a whole.

1. Plant beans on the same land not oftener than once in three or four years, particularly if disease has been prevalent. Soils which once become thoroly infected as a result of continuous cropping are seldom safe to use for the same or closely related crops for years to come.

2. Wherever practical, destroy all diseased vines and trash by burning.

3. If the bean straw from diseased vines is to be fed, do not use the manure on a field that is to be planted to beans.

4. As far as possible, avoid cultivating the beans early in the morning when there is dew on them, or when they are wet with rain.

5. Hand pick disease-free pods, or if possible, select disease-free plants, for seed. Use these to plant a seed plat on land which has never raised beans and which is removed some distance from the main crop.

Remember that hand picking of seed as it comes from the flail or thrasher for the purpose of controlling disease is of no value, since it is impossible to detect even a small percentage of diseased seed.

6. Seed treatment for beans is of no practical value since any chemical that would penetrate the seed deeply enough to destroy the disease-producing organism would likewise be apt to kill the seed.

7. Spraying with Bordeaux mixture, 5-4-50 formula, even when done thoroly by competent persons, is at best unsatisfactory, unprofitable and only partially successful. However, if one

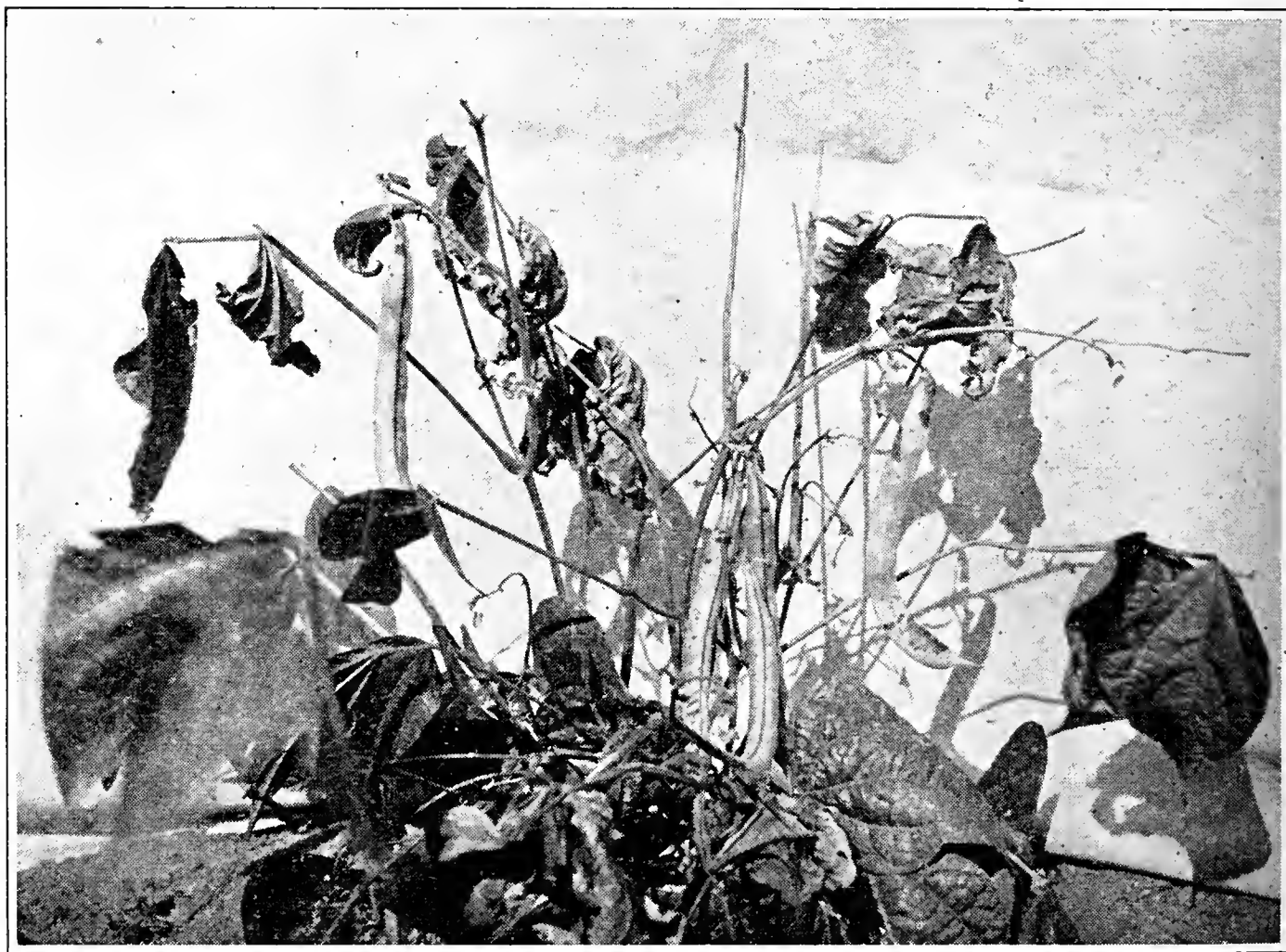
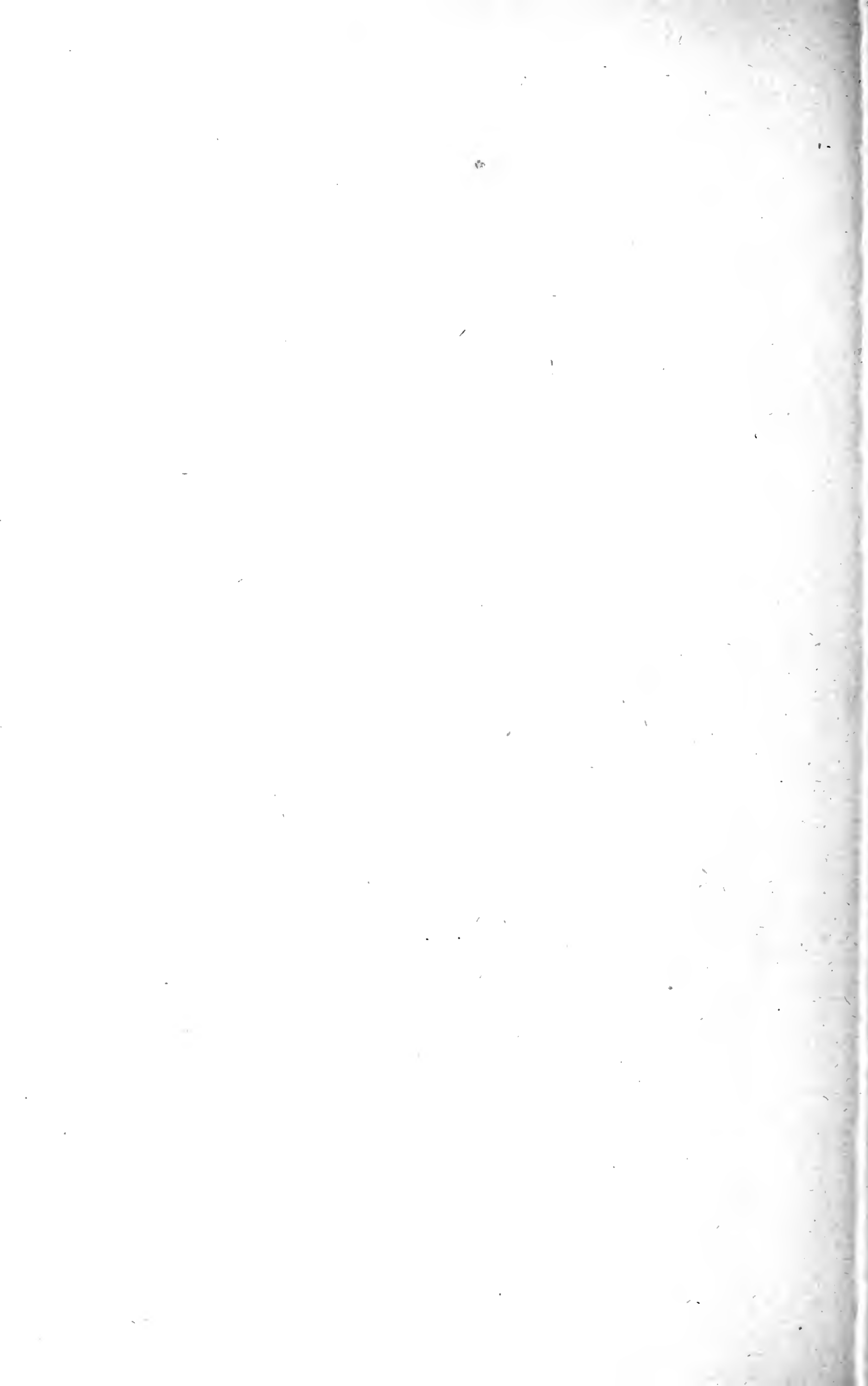

Fig. VI.—Bean plant affected with "Streak". (By courtesy of Dr. H. G. McMillan.)

desires to try this, the first application should be made when the plants have their first set of true leaves, repeated ten days later, and again just after blossoming. Remember that if any real benefit is to be derived, the stems, leaves and pods must be kept covered with the spray material.



The Agricultural Experiment Station
OF THE
Colorado Agricultural College

DRY FARMING IN COLORADO

BY
ALVIN KEZER



PUBLISHED BY THE EXPERIMENT STATION
FORT COLLINS, COLORADO
1917

Colorado Agricultural College

FORT COLLINS, COLORADO

THE STATE BOARD OF AGRICULTURE

	Term Expires
HON. CHAS. PEARSON.....Durango,	1919
HON. R. W. CORWIN.....Pueblo,	1919
HON. A. A. EDWARDS.....Fort Collins,	1921
MRS. J. B. BELFORD.....Denver,	1921
HON. H. D. PARKER.....Greeley,	1923
MRS. AGNES L. RIDDLE.....Denver,	1923
HON. J. C. BELL.....Montrose,	1925
HON. E. M. AMMONS.....Denver,	1925

PRESIDENT CHAS. A. LORY, }
GOVERNOR JULIUS C. GUNTER, } *Ex-Officio*

L. M. TAYLOR, Secretary

CHAS. H. SHELDON, Treasurer

EXECUTIVE COMMITTEE

A. A. EDWARDS, *Chairman*

E. M. AMMONS

H. D. PARKER

STATION STAFF

C. P. GILLETTE, M.S., <i>Director</i>	ENTOMOLOGIST
W. P. HEADDEN, A.M., Ph.D.....	CHEMIST
G. H. GLOVER, M.S., D.V.M.....	VETERINARIAN
W. G. SACKETT, B.S.....	BACTERIOLOGIST
ALVIN KEZER, A.M.....	AGRONOMIST
E. P. SANDSTEN, M.S., Ph.D.....	HORTICULTURIST
B. O. LONGYEAR, B.S.....	ASSISTANT FORESTER
G. E. MORTON, B.S.A., M.S.....	ANIMAL HUSBANDMAN
E. B. HOUSE, B.S. (E.E.), M.S.....	IRRIGATION ENGINEER
V. M. CONE, B.S., C.E., <i>U. S. Irrigation Engineer</i>	IRRIGATION INVESTIGATIONS
W. P. LITTLE, B.S., <i>U. S. Expert-in-charge</i>	HORSE BREEDING
R. E. TRIMBLE, B.S.....	ASSISTANT IRRIGATION INVESTIGATIONS
P. K. BLINN, B.S., ROCKY FORD.....	ALFALFA INVESTIGATIONS
EARL DOUGLASS, M.S.....	ASSISTANT CHEMIST
S. ARTHUR JOHNSON, M.S.....	ASSISTANT ENTOMOLOGIST
L. C. BRAGG.....	ASSISTANT IN ENTOMOLOGY
J. W. ADAMS, B.S., CHEYENNE WELLS.....	AGRONOMY ASSISTANT, DRY FARMING
W. W. ROBBINS, M.A.....	BOTANIST
RALPH L. PARSHALL, B.S.....	ASSISTANT IRRIGATION INVESTIGATIONS
I. E. NEWSOM, B.S., D.V.S.....	VETERINARY PATHOLOGIST
MIRIAM A. PALMER, M.A.....	DELINEATOR
R. A. MCGINTY, B.S.....	ASSISTANT IN HORTICULTURE
CHAS. R. JONES, B.S.....	ASSISTANT IN ENTOMOLOGY
GEO. M. LIST, B.S.....	ASSISTANT IN ENTOMOLOGY
JAS. D. BELL, B.S.....	ASSISTANT IRRIGATION INVESTIGATIONS
CARL ROHWER, B.S., C.E.....	ASSISTANT IRRIGATION INVESTIGATIONS
BREEZE BOYACK, B.A., M.S.....	ASSISTANT IN AGRONOMY
CHAS. I. BRAY, B.S.A., M.S.....	ASSISTANT ANIMAL HUSBANDRY
RALPH L. CROSMAN.....	EDITOR
H. E. VASEY, A.M.....	ASSISTANT BOTANIST
W. H. KERR, A.B., J.D.....	MARKETS AND MARKETING
T. E. LEIPER, B.S.....	ASSISTANT ANIMAL HUSBANDMAN

OFFICERS

CHAS. A. LORY, M.S., LL.D., D.Sc.....	<i>President</i>
C. P. GILLETTE, M.S.....	<i>Director</i>
L. M. TAYLOR.....	<i>Secretary</i>
MABEL LEWIS.....	<i>Executive Clerk</i>

DRY FARMING IN COLORADO

By ALVIN KEZER

SUMMARY

In dry farming, a crop system adapted to the locality must be adopted. Success depends upon the observance of this rule.

An understanding of the principles of moisture conservation, and of the proper methods of cultivation, is distinctly essential.

Forage crops are best adapted to dry-land conditions.

Cash crops should be raised, but they should be extra enterprises, not the chief dependence.

Rotation is necessary to keep up permanent production.

The crop system should be planned so that the owner can handle the maximum number of acres without hiring help. The more acres the owner can care for unaided, the greater will be his income.

Livestock provides the surest market for dry-land crops.

Excess feed in good crop years should be saved, to tide the stock over lean years, which are sure to come.

There should be a silo on every dry-land farm. It makes it possible to get a maximum of feed value from the crops.

It is highly essential that a new settler have sufficient cash to furnish materials for his farming operations and to pay living expenses for the first year or two. Experience has demonstrated that a dry-land farm does not commence to produce steadily and in a dependable manner until it has been under cultivation a year or more.

A well to furnish water for domestic purposes is an absolute necessity.

A garden, a few chickens and pigs will help make more secure the living of the family.

COLORADO HAS A LARGE AREA OF DRY LAND

Colorado still has a very large acreage of unoccupied and undeveloped lands. Much of these lands lie in regions where irrigation is not feasible; consequently they must be farmed without irrigation, by so-called "dry farming" methods. In order to answer many of the questions raised by settlers and prospective settlers on these lands, this publication has been prepared. It is well known that complete information cannot be given in so short a space, but it is hoped that the essentials of the problem can be handled in such a way that prospective settlers will understand

the possibilities and difficulties to be met, and some of the means necessary for the successful development of this great unoccupied domain.

What Dry Farming Is.—Dry farming, as commonly understood, means the production of crops without irrigation, in a region where the rainfall lies between the approximate limits of 10 to 20 inches per annum. If the rainfall is much less than 10 inches, the type of farming becomes arid, and when the rainfall lies much above 20 inches, the type of farming followed falls in the class of humid farming.

Successful dry farming depends upon the proper adaptation of crops, the finding of the principles of water movement in the

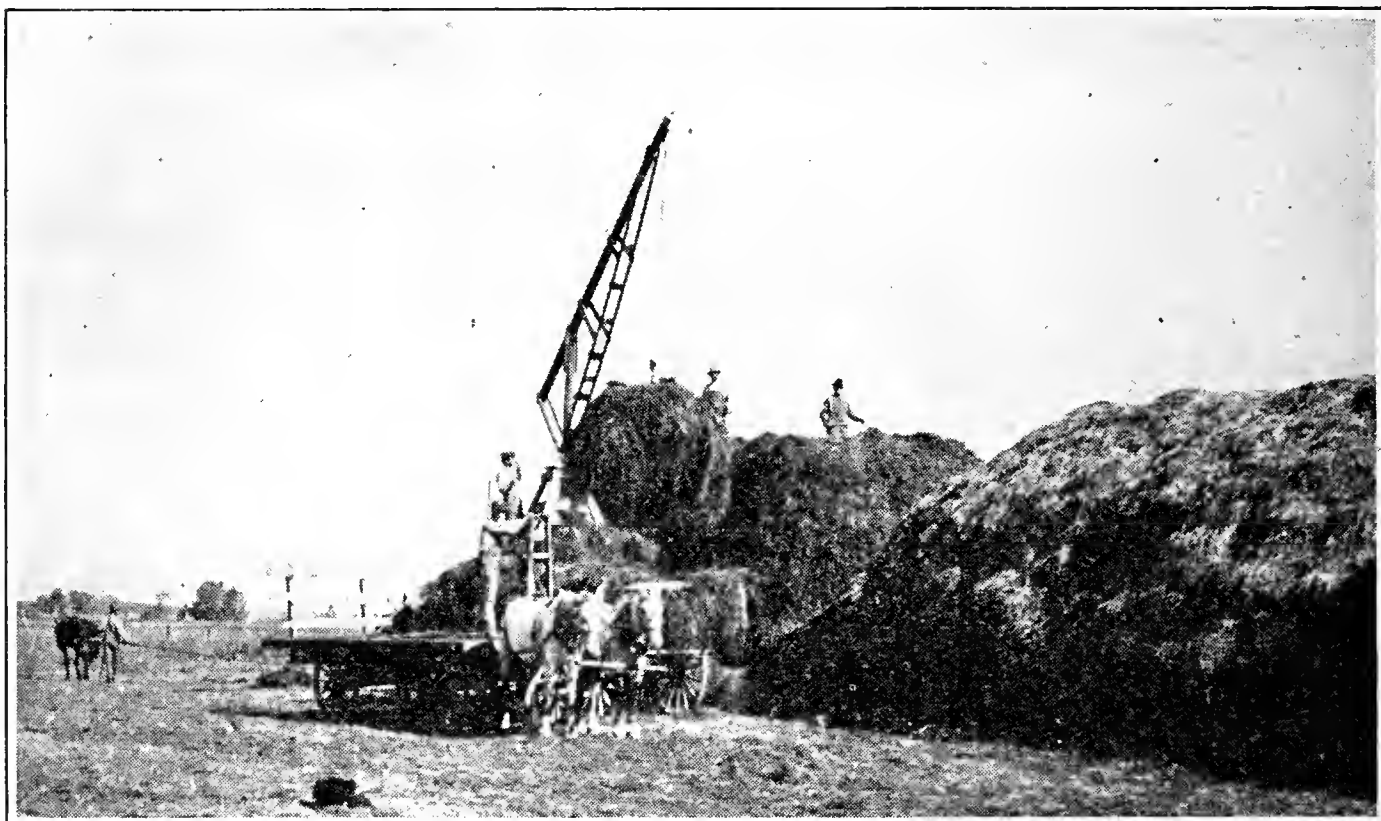

Swales and bottom lands in dry regions may often be used to produce alfalfa

soil, and an understanding of the principles of moisture conservation and what practical methods of plowing and other cultivation must be followed to get paying results. Most new settlers in Colorado dry-farming sections have attempted to gain success by grain farming. Long experience has shown that a permanent agriculture may be built up in dry-farming sections only where a diversified system of farming is followed. This means a variety of crops, combining cash crops, feed and forage crops, with a properly balanced amount of livestock.

TYPES OF PRECIPITATION

Any discussion of dry farming must consider the time when rain falls, as well as the amount which falls. In different dry-

farming regions we have at least three types of precipitation—the spring and early summer, the evenly distributed, and the winter season precipitation. In most of the Colorado dry-farming sections, the spring and early summer type of precipitation prevails; that is, the precipitation commences to increase in March and increases month by month until July, when it decreases rapidly for the rest of the year. Such a type of precipitation throws most of the rainfall during the growing season. This type of precipitation prevails thruout the Colorado plains, the region lying east of the Rocky Mountains, and extending to the eastern border of the State. The same type of precipitation prevails in most of the foothills and intermountain dry-farming sections, altho there are localities in the mountains and on the Western Slope where the precipitation largely occurs during the winter season. A different type of dry farming and a different set of farm crops may be grown in regions having the spring and early summer type of rainfall. Here cultivated crops, grains, and diversified farming, are easily possible.

Where the winter type of precipitation prevails, as it does in small areas, the types of crops which may be grown are limited to those which are capable of growing and maturing on the stored water supply of the soil.

COLORADO DRY FARMING REGIONS

The dry-farming regions of Colorado may be easily divided into the "plains", which comprise the area lying east of the mountains, the "foothills", which comprise the valleys and swales in the foothill regions of the mountains, and "intermountain districts".

The plains region is characterized by great extremes of temperature and moisture. The climatic conditions of the foothills and intermountain regions are most equable, but the season is short, due to high altitude. Precipitation is usually, tho not always, greater, but evaporation is nearly always much less than on the plains. Consequently, the plains furnish the most difficult dry-farming problems.

The foothills and intermountain regions present problems largely of precipitation and length of season, while the plains present problems of evaporation, precipitation, violent changes of temperature and violent extremes of wind velocity.

THE PLAINS

Climate and Topography.—Since the plains constitute an area of about twenty-two million acres, possibly three-fourths of the entire possible dry-farming area of Colorado, and since they present most of the problems, the climate and topography of this

region will be given more attention than that of the foothills and intermountain regions.

The Colorado plains constitute a part of what is known as "The Great Plains Area". They comprise all of that region lying east of the Rocky Mountains from the base of the foothills to the State line. These plains are largely smooth to rolling prairies. The Platte River has cut its valley northeasterly from the city of Denver to the State line. The Arkansas River has made a valley almost directly east and west, just about thru the center of the south half of the plains section. The valley of each of these streams constitutes a depression. Between them lies a more or less flattened ridge of land separating the drainage of the two rivers, known as the Divide, or sometimes better known as the Platte-Arkansas Divide. Many points on the Divide near the foothills reach an altitude of 9,000 feet and even above. Towards the east, the sharpness of slope of the Divide area, and its altitude, decreases until it is relatively flat at the eastern border of the State. These streams and their tributaries cause more or less breaks and rugged features to appear in the otherwise smooth to rolling surface of the plains. These modifications also produce marked changes in soils.

The climate is mild tempered, but subject to very sharp extremes of heat and cold, moisture and dryness. The normal rainfall, according to government and State records, varies from a minimum of close to 8 inches to a maximum of above 18. In years of drouth, the rainfall is decidedly less than the normal. In so-called wet years, rainfall is greatly above. In 1911 the rainfall of the growing season thru the central portion of this region was 7.69 inches. In 1916 it was 7.38 inches. In the years of 1914 and 1915, however, the rainfall was nearly three times this amount, during the growing seasons. These just about mark the extremes of rainfall to be expected, as these four seasons exhibit two of the driest and two of the wettest years since rainfall has been recorded in the State.

The region is a vast plain, unprotected by timber or hills; as a consequence, it is subject, especially during the spring and fall months, to violent winds. A knowledge of these climatic features is necessary in order to arrange proper methods of cropping and soil treatment. The minimum altitude of the section is about 3,500 feet, and the maximum is a little over 10,000 feet; consequently the seasons are relatively short and the nights cool.

DRY FARMING SOILS

The first essential of success in dry farming is a soil adapted for the production of crops in regions of deficient rainfall. The first essential is that the soil shall be of proper and uniform texture to a considerable depth. The soils best adapted to Colorado dry-farming conditions run from sandy loams to silt loams in texture. No matter what the texture of the soil, however, it must be uniform to a considerable depth. A shallow soil will not hold water enough to carry crops thru periods of prolonged drouth. A layered or stratified soil gives rise to a different series of water relations, which prevent the crops from getting and taking out the watter supply in the soil, except during wet years. Gravels, heavy clays and adobes are very poorly adapted for dry farming. A shallow soil overlying gravel, rock, shale, or clay, will only produce crops in wet years.

For the most part, the soils of Colorado dry-farming regions are deep and rich. They are rich because they have been formed in an arid or semi-arid climate, consequently the mineral elements of fertility have not been leached out. Most of these soils are deficient in organic matter (vegetable matter). For the most part, they are rather light in nature, sandy loams and silt loams being much more numerous than adobes and clays. In some localities there are areas of gravel; in a few, there are areas of almost pure sand. Such areas are often wind blown into sand dunes or sand hills. A few regions have soils of almost pure silt. These regions are characterized by soils of great depth, very desirable water relations and great certainty of productivity, rainfall considered. Only a few soils surveys have been made. These have been made by the United States Bureau of Soils in Larimer and Weld Counties, in the Arkansas Valley, in the San Luis Valley and in the Grand Valley.

Owing to the prevalence and tendency of high winds, methods to prevent soils blowing must often be devised and practiced. Control methods consist largely in keeping the immediate soil surface rough on all cultivated land which is in crop. Anything which will break the force of the wind at the soil's surface is effective. Over much of the plains area fall plowing is inadvisable because of the tendency and danger of soil blowing. In such sections, fall listing may be successfully practiced, making furrows crosswise of the direction of prevailing winds. Soil listing not only conserves moisture, but it prevents blowing, keeps down weed growth and leaves the soil in good shape for catching any winter precipitation.



Listed to prevent soil blowing and for summer fallow. This system has been practiced for fifteen years on this farm. During this period this farm has not had a complete crop failure

In the spring, a seed bed may be prepared by breaking out the middles and leveling down the land with disk and harrow, or, in many instances simply by leveling down the land with disk and harrow. Where soils have a tendency to blow during the summer season, the tendency can be largely overcome by planting crops in strips so that strips of corn or sorghums are interspersed with strips of grain. These methods will almost entirely prevent soil blowing except in sand-hill sections where the soils are almost pure sand.

SOME PRINCIPLES OF SOIL MOISTURE FOR DRY FARMING

Dry farming never means farming without moisture. But it always means farming where the supply of natural moisture is deficient or low. Consequently, any discussion of dry farming that does not take into consideration the principles and conditions under which moisture is obtained, conserved and used, fails to meet all of the problem.

In saving soil moisture, the first and most important process is to get it into the soil. If a rain of 3 inches falls and only 1 inch penetrates the soil, the land is worse off than if it had a 1-inch rain, all of it entering the soil. The 2 inches of water which did not soak in, ran off the top, carrying with it some soil, beating and puddling the surface, thus favoring the formation of a soil crust. Consequently, all cultivated land should be kept in the best possible condition to catch rainfall.

What is that condition? Moist soil takes water rapidly, while dry soil takes water slowly. The first effort then should be to

keep the soil always moist. This may be illustrated by experiments made during the summer of 1907. The summer was wet early, but dry from July on until September 28th. In the experiment the stubble of grain fields was given this treatment. One field was disked behind the binder. As soon as the grain could be taken off, the field was plowed. Each half day of plowing was disked and harrowed. The plowing was done in July. A second field was not touched after harvest until the first of September. No treatment was given after plowing. The soil of the first field was in fair tilth. The soil of the second field was in poor tilth, being very dry, lumpy and cloddy. Rains came September 28th and 29th and October 3d and 4th. In all, a fraction over 4 inches of water fell in the period. Field No. 1 was in fairly good condition before the rains. The 4 inches of rain wet the soil in this field so the surface moisture went down slightly over 2 feet. In field No. 2 the same rain only went down about 8 inches. Thus, field No. 1 was in very excellent condition for fall seeding, while field No. 2 was too dry to justify fall seeding in spite of 4 inches of rain. In other words, in field No. 2, 4 inches of rain had only been sufficient to put the soil in shape to catch future rains.

The time of breaking is very important. Plowing should be done in the spring or early summer for fall crops, and in the summer and fall for spring crops. Where there is danger of soil blowing, listing or middle breaking may be used in place of plowing.

Water moves very much faster in a moist soil than in a dry one. Very dry soils actually repel water at first. It might be asked, how is it possible to keep a soil moist? Never let it get dry. Keeping soil from becoming dry requires careful methods of cultivation and cropping.

Surface Treatment to Catch Rainfall.—What kind of treatment the surface soils shall be given to assist in catching rainfall or snowfall depends upon the kind of soil—whether sandy, silt or clay—upon the kind and time of plowing, whether the plowing is on breaking or old land, and upon the kind of crop grown.

Sandy lands are open and porous. They take rainfall readily. Such lands may be plowed relatively shallow, because they will take rain practically as fast as it falls. Silty and clayey soils are less open. Under natural conditions such soils will not take rain as fast as it falls, unless the rain is a drizzle. To make such heavy, close-textured soils take water as fast as it falls in normal rains, it is necessary to plow very deeply. Deep plowing makes a rough layer which takes in rainfall rapidly. This loose layer

forms a temporary reservoir, holding the water for a time and then passing it on slowly to the more tight subsoil.

Kind of Plowing for New or Old Land.—Plowing on old lands should be as deep as possible. If the plowing is done long enough before seeding to permit nature to do the settling and compacting, it can scarcely be too deep on silt and clay lands. If, however, breaking cannot be done a considerable period before seeding, it should be relatively shallow, because usually it cannot be properly settled and compacted immediately prior to seeding. The disk following the plow will be of service. But it does not equal time and rainfall. Besides, plowing breaks the existing moisture relations and time is essential for readjustment. Unless followed by rain, deep plowing immediately before seeding will give poorer yields than shallow plowing.

Movement of Water in Soil.—After the water is caught by the soil, it undergoes certain movements. When it moves downward thru the spaces between the soil particles by its own weight, we say it percolates. When it crawls upward or downward or sidewise like water in a lump of sugar, or oil in a lamp wick, we say it is capillary or film movement, because it moves along as a thin film over the surface of the soil particles. Sometimes changes in temperature cause soil water to move. In that case we say there is temperature movement or thermal movement.

Water is held in two ways in the soil, as a film which surrounds the soil particles and in the tiny spaces between soil particles. When it rains, water enters the soil. When the surface gets more water than it can hold, it loses some by percolation to the soil below. That is, some of the free water flows from the soil spaces above to the soil spaces below. This process continues as long as it rains and often for a time afterwards, depending on the amount of rain.

When percolation ceases, another movement begins. The films begin to crawl from particle to particle as water in a lump of sugar, only much slower. Very dry soils wet very slowly, but when the particles are very slightly moistened, they tend to draw water from the moister towards the drier soil particles. This movement continues until the pull away is balanced by the pull to hold.

Most deep soils in regions of moderate or slight rainfall never have their subsoils thoroly wet. In fact, they are rarely ever moistened beyond the depth of a few feet. The rains wet the surface. A portion of the water percolates a little further in. After percolation ceases, the water penetrates a little further by film movement. In such deep soils free water moving in the soil

spaces does not exist for any length of time. The water is all held as thin films around soil particles. These are stretched as thin as they can be by soil attraction, because there is always dry soil below trying to pull it away from the moister soil above. The condition is a balanced one, one portion of the soil trying to pull the water away and the other resisting with equal strength. This condition we call the minimum capillary or film capacity. In a sandy soil this minimum film capacity varies somewhat, but is from 7 percent to 11 percent. This percentage of water ranges from 0.84 inch to 1.32 inch per foot of soil. In a silty soil the percentage is higher, ranging around 12 percent to 18 percent, depending on the proportion of silt in the soil. This equals from



In dry years, Russian Thistles may help out the feed supply, if harvested at the proper time

1.44 inches to 2.16 inches of water per foot of soil. In a clay or adobe soil the percentage of minimum film water amounts to 18 to 25 percent and even more where the percentage of clay or adobe is very high in the soil. The percentages equal from 2.16 inches to 3 inches of water per foot of soil. Thus it is seen that heavy soils, as silt and clay, retain more water per foot than light sandy soils.

Available Water.—But all the water a soil contains is not available for the growth of plants. Plants can only take out a portion. Some plants can take out more than others. For instance, sorghum will dry out a soil more than wheat. Wheat will take away more water than corn. Russian thistles and sunflowers will dry out a soil worse than any of those crops which we try to grow for profit. Most crops will dry out a sandy soil so that only 2 to 4 percent of the moisture remains.

From the minimum capillary capacity, we see that a sandy soil would have from 5 to 7 percent of available water, amounting to 0.6 inch to 0.84 inch per foot. A silty soil would be dried under similar conditions to 7 to 12 percent, depending upon the physical composition of the soil, giving from 5 to 9 percent of available water amounting to from 0.6 to 1.08 inch of water per foot of soil. A clay soil under similar conditions would retain from 12 to 18 percent, depending upon composition, leaving available from 6 to 7 per cent or slightly more, equivalent to from 0.72 inch to about 1 inch of water per foot of soil. While there are great variations in individual soils, it is seen that, under dry land conditions, the available water is nearly the same in widely different soil types.

Amount of Water It Takes to Grow Crops.—Investigators in dry-land crops agree pretty well that it takes from 300 to 400 and up to as high as 1,000 pounds of water to produce a pound of dry matter in the crop. That is, the crop uses up that much water in growing a pound of dry matter.

Thus a sandy soil which contained from 0.6 to 0.8 inch of available water per foot would have to contain this amount of available water 5 to 7 feet in depth to grow a 15-bushel crop of wheat from the soil water unless helped out by rain. The same principle holds with other soils and other crops altho the limits are somewhat different for each soil and crop. This principle is: A dry-land soil must be deep in order to hold enough water to insure crops. Crops will dry out a shallow soil quickly. Then, if no rains come, the crop dies.

The dry-farming soil must be of uniform texture, also; a layer of gravel or gypsum below the surface will cut off the effective depth of soil. This was very well shown in the season of 1911 at Rocky Ford. In a field of alfalfa two spots were noticed where the crop was not growing. Borings revealed a gravel layer under one spot and a gypsum layer under the other spot. These layers of different texture broke the continuity of the soil mass and prevented the roots getting water at lower depths.

Under normal dry-farming conditions, there is very little movement of the soil moisture except after rains. The soil water does not move to the plant roots. The roots move to the moisture. If one will take a dish of wet soil and sprinkle dry soil on top, water will move up into the dry soil. If this is then scraped off and dry soil again sprinkled on top and scraped off when moistened, a point will soon be reached when the dry soil will no longer be moistened. We will then have a condition comparable to dry-farming soils (except immediately after rains). This is

the minimum capillary or film condition already mentioned. In such condition the soil water does not move unless more water is added or the temperature changes so as to alter the soil water relation.

Loss of Water by Evaporation.—Experiments were made in California to determine the water loss by evaporation. The experiments were run from June to September. The average evaporation from a free water surface was about 2.88 inches per week. The evaporation from a saturated soil surface was 4.88 inches per week. When the moisture in the surface soil was about 11 per cent the evaporation was less than 1 inch per week. When the percentage of water in the surface soil was slightly above 4 per cent the loss by evaporation was less than 0.25 inch per week. In other words, a dry surface soil prevents surface evaporation.

Most dry land soils do not lose their moisture by evaporation. The moisture is lost by plants which use up the soil water in growing. In order to conserve soil water, plants must be kept from growing while it is being conserved.

Advantage has been taken of the soil properties which have just been mentioned to store up the water falling one season to be used the next, by summer tillage or summer fallowing. If the land is cultivated one season to keep down weeds, to keep a dry surface and to put the soil in better shape to catch rainfall, a large part of the precipitation of the season can be caught and saved to be used the next season. Just how much can be caught and saved depends on how the precipitation comes. When the precipitation falls in quarter-inch or half-inch rains, very little can be saved because most of it will be lost when the dry surface is produced. Very heavy, dashing rains run off faster than they can soak in, even when the soil is in the best of shape to take in moisture. More water can be saved from a heavy slow rain or drizzle than from any other kind of precipitation. On the average, on good normal soils, it will be possible to store from 50 to 70 percent of a season's rain to be used the next. Thus, if the normal rainfall is 15 inches, the clean summer fallow will make from 20 inches to 22 or 23 inches of water available for the use of the growing crop, as a portion of the rainfall of the previous season is stored for use in the present season. The clean summer fallow greatly increases the certainty of getting crops.

It has been found by experiment, and proved by experience on many farms, that it is possible to get practically all the benefits of a clean summer fallow and at the same time raise some crop on the land. The crop, of course, must be a cultivated crop. Pinto beans, corn, grain or forage sorghums may be used as a crop. When

they are used to accomplish the objects of a clean summer fallow, about half the usual number of rows of corn are put on the land. The method may be illustrated by using corn. Corn is ordinarily planted in rows $3\frac{1}{2}$ feet apart. Where it is desirable to grow corn, and still get part of the benefits of a clean summer fallow, the corn is planted in rows 7 feet apart. The space between the rows is kept cultivated so as to keep down all weeds. About three-fourths as much crop may be grown by this method of tillage as by the thicker planting. Crops such as wheat and other small grains after corn grown in this way do just as well as after clean summer fallow. This method has a very decided advantage over the clean fallow in that a paying crop may be grown. Thus the work of keeping the land clear by this method is paid for by the crops grown, while the clean summer fallow method produces no return the year of the fallow.

The farming methods which will enable the most crops to be produced, and make the best out of the available water with the least amount of work, are to be preferred. Many successful dry-land farmers, especially on the lighter lands, follow a system which reduces the amount of plowing and still conserves moisture and prevents weed growth. For these lighter lands the suggested system is about as follows: The system makes use of a partial summer fallow. If we start a description of the system at the point where the land has been partially summer tilled, we may carry the process thru its logical steps. After the partial summer tillage, winter wheat is the first crop. When the winter wheat is harvested, the land is double disked immediately after the binder for the purpose of killing all weeds which spring up and to put the surface in good condition to catch rainfall. The next spring the land is double disked early to kill all weeds starting. If weeds start later, it is disked again and harrowed; after which, corn or some other cultivated crop is planted. After corn, small grain of some kind is planted, the soil being prepared by disk-ing and harrowing. The yields of grains after corn are nearly as much as after a fallow. When this latter small grain crop is harvested, the land is at once double disked. No other treatment is given until the next spring. Then, as soon as weeds start, the soil is disked to kill weeds, and the better to catch rainfall. In June and July the land is plowed thoroly and deeply. It is disked and harrowed immediately behind the plow. Upon this plowed land, so prepared, winter wheat is planted in September, and the system starts in again where we began.

Under this system the land is plowed only once in every three years. The system produces excellent results on the lighter lands,

reduces the danger of soil blowing and can be carried out very much more cheaply. Some of the heavier lands, such as the clays and adobes, require more frequent plowing. On such lands the loss ordinarily caused by the summer fallow can largely be overcome by planting a cultivated crop and spacing rows double the usual distance.

It must be remembered that the supply of water in all dry-farming sections is limited or likely to be limited; consequently, if more crop is planted on the land than the soil is capable of supplying with water, yields will be reduced. Thus the stands of crops, to produce best yields under dry farming, must be much thinner than is required in humid or irrigated regions. If too many plants are on the land, none will get enough water and all will fail. The best success is obtained with relatively thin stands. It is impossible to give the exact amount of seed which should be planted for dry-farming conditions, because the amount varies widely according to the severity of the climatic conditions, the type of soil and the total precipitation.

The following list, however, can be taken as a general guide and is suggestive of the practice which should be followed, namely, to make the stand of grain proper for the conditions of soil moisture:

AMOUNT OF SEED TO USE FOR THICKNESS OF STAND FOR DIFFERENT CROPS UNDER DRY FARMING

Wheat, 20 to 35 pounds.

Oats, 40 to 60 pounds.

Barley, 40 to 60 pounds.

Rye, 30 to 40 pounds.

Corn, stand for ordinary cropping, rows 3½ ft. apart, stand in the row, 20 to 24 inches, drilled.

Corn to be used on land in place of summer fallow, rows 7 ft. apart, stand in row, 20 to 24 inches, drilled.

Cane, for seed, broadcasted, 15 to 20 pounds.

Cane, for seed, drilled, 6 to 15 pounds.

Cane, for hay, broadcasted, 30 to 40 pounds.

Kafir, for hay, in rows 3½ ft. apart, 2 to 4 inches in the row.

Milo, for seed, in rows 3½ ft. apart, 4 to 8 inches in the row.

Kafir, for seed, in rows 3½ ft. apart, 6 to 12 inches in the row.

(Kafir and milo will require from 3 to 10 pounds of seed per acre, depending on the thickness of the planting.)

Feterita, for seed, in rows 3½ ft. apart, 8 to 12 inches in the row.

Flax, 20 to 30 pounds per acre.

Millet, 15 to 30 pounds per acre, depending on conditions.

Alfalfa, broadcasted, 3 to 5 pounds per acre. In rows 3 to 3½ ft. apart, 2 pounds per acre. If the seed is good and proper tools for drilling are available, half a pound of seed per acre will make the stand thick enough.

Potatoes, in rows 3½ ft. apart, 1 to 2 ft. in the row, 300 to 400 pounds seed per acre.

Pinto beans, in rows 3 to 3½ ft. apart, 6 to 10 inches in the row, approximately 15 pounds of seed per acre.

Field peas, preferably in rows and cultivated, 20 to 30 pounds per acre.

GENERAL FARMING PRACTICE AND MANAGEMENT

Dry farming at its best is serious business. As a consequence, there are certain fundamental considerations which the settler should bear in mind. A well for domestic water supply is absolutely essential. If such domestic water supply cannot be obtained upon the land or immediately adjacent to it, other features would have to be extremely desirable to make it advisable to locate a home there. The production of crops is more or less uncertain and the prospective settler should by all means bring sufficient capital in money, or in money and materials, to carry him thru at least one year until production can be started.

For the most part the plains are treeless. In the building of a home, one of the first things, after the house and sheds for livestock are provided, should be the making of some provision for trees. Where land is properly prepared and properly cultivated, trees can be grown almost anywhere on the plains, providing they are given sufficient space. The moisture supply on dry-land soils is always less abundant than it is in the humid regions; consequently, the trees should be set much farther apart. The sod should be broken up at once in preparation for planting trees. A strip should be plowed at least 20 feet wider than the expected space which the trees will occupy. This should be kept free of



Thrashing "smutty" wheat, a source of heavy loss to many wheat growers. Seed treatment, costing from 8 to 15 cents per acre, will prevent smut

weeds by plowing or other form of cultivation to permit the accumulation of water. Sometimes the soil can be sufficiently moistened, when such clean cultivation is followed, in one season to permit perfect safety in tree planting. Sometimes two seasons must elapse, and in extreme seasons as many as three. The ground should be ready and have sufficient moisture before trees are put out.

The planting of trees will make it possible to have some shade about the home. In addition to this, trees will break the dreary monotony of the plains, a monotony which is very real to all those not born and bred plainsmen. The women folks of the family are especially susceptible to this loneliness because of the isolation and difficulty of social relations with the neighbors.

The dry farmer should make provision for a garden somewhere near his well. If a good well is present for domestic water supply, it can be used, especially if a little storage is possible, to insure a good small garden if the water is properly applied at the right time.

The dry farmer should by all means plan his cropping system so as to grow feed for at least a few chickens and pigs, so that the family living will be insured. The type of other livestock which he chooses to grow will depend a good deal upon his location, as either dairy or meat animals can be made profitable. There will be seasons when an abundance of feed will be produced. There will be other seasons when the amount of feed produced must be very carefully husbanded in order to permit existence; consequently, sooner or later the dry farmer should come to the proposition of saving all of his feed, and in extra good crop years to store up excess feed to tide him over the lean years which are bound to follow one season or another.

The wide use of the silo is sure to come as a part of this development, because it permits all, or practically all, the feed grown to be stored in available succulent condition for future feeding. In 1912 the Experimental Substation at Cheyenne Wells produced feed enough to have carried the herd on the land at that time for a period of two years. The silo capacity was limited to two pit silos at that time. They were filled to capacity, but they were only capable of carrying the herd thru the winter and the following early summer. In 1913 by saving every bit of feed that it was possible to save, and putting it into the silo, it was not possible to quite fill even these two silos. In 1914 two more silos were put down so that now we have capacity enough to carry the normal regular herd thru a period of two years if extreme conditions should appear.

No method of dry curing of the crop is so efficient that it does not waste at least as much as 30 per cent. In the dry, windy conditions which prevail, as much as 80 percent of the feed value may be lost. If put in the silo, at least 90 percent should be saved, under normal conditions. In other words, the loss need not be over 10 percent and often will be less than 5 percent. The silo making possible this great saving in feed is bound to have a much greater use upon the dry farms.

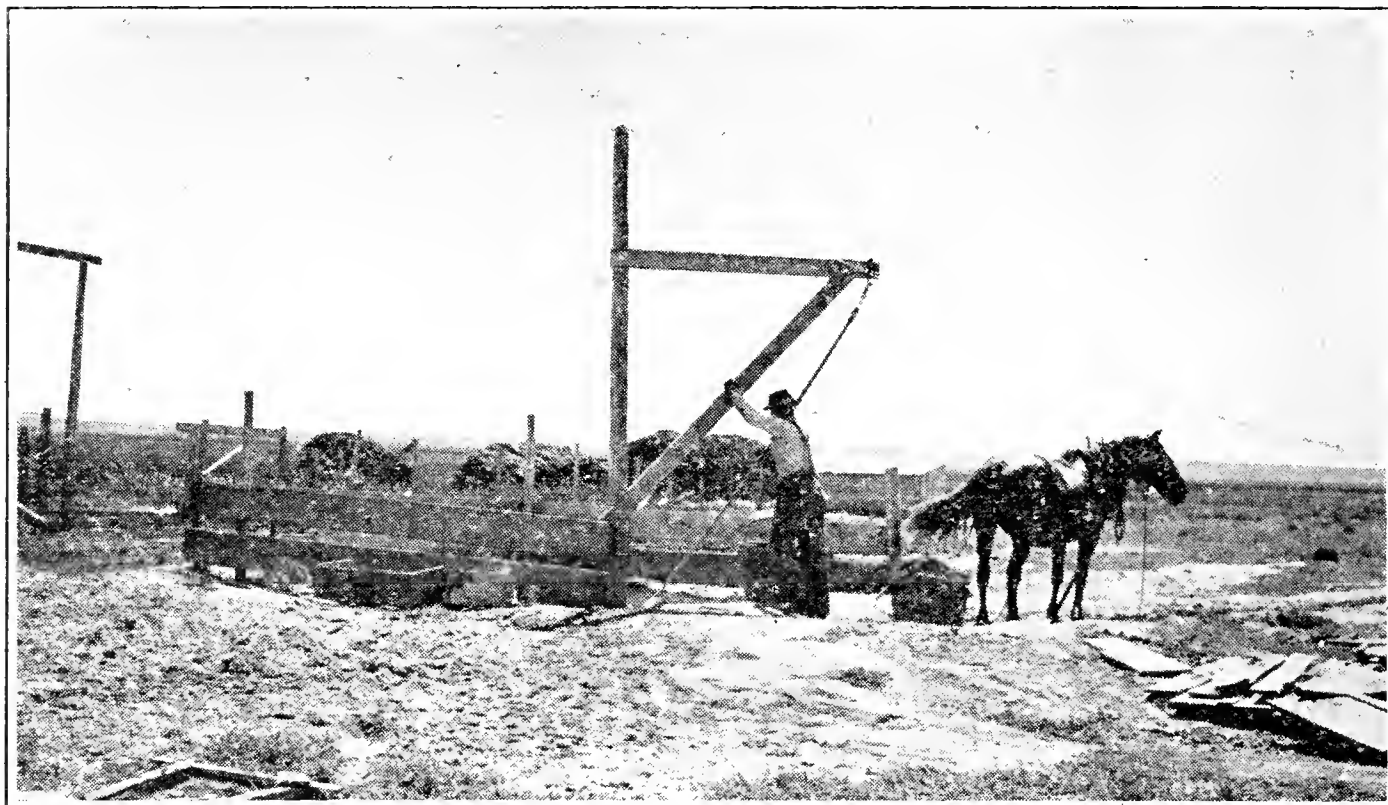

Removing silage from pit silo, the type of silo best adapted to dry-land regions

In many places dry farmers are making use of open range available to carry their stock in the summer. During some seasons this open range will be cut short by extreme drouth so that the animals lose flesh or fall off in milk production according to the kind of animals kept. If the dry farmer had a silo at this time, he could open the silo and feed some silage during the period of short pasture and keep up his gains on beef animals and his milk production on dairy animals.

The entire question of dry farming and its success, then, can be summarized in the following brief statement of conditions: Forage crops are best adapted to the soil and climatic conditions. Under the best management, they should be grown and placed in the silo and be fed later to livestock. The livestock will constitute a constant market for successful crops which have no other available market. Cash crops should be grown, but they should be put on as an extra, or extra enterprises, rather than the chief dependence of the dry farmer. In most seasons some saleable

crop will be available from these so-called cash crops. Such income will be a welcome addition to that brought in by livestock. Of the cash crops which may be grown, winter wheat, pinto beans, flax in some of the northeastern sections of Colorado, broom corn in many sections, and some of the grain sorghums in the southeastern part of the State, will constitute the larger portion possible. In a few localities, corn may be successfully used as a cash crop, tho in most sections it will make the greatest returns harvested entire and siloed.

SOME SPECIAL FEATURES OF MANAGEMENT INFLUENCING THE SUCCESS OF DRY FARMING

During the past few seasons, the Experiment Station has been making studies of a number of dry farms in five counties in the dry-farming district of Colorado. These studies have had several objects in view, primarily, however, they hope to discover the fundamental principles of success in the organization of the farming business under dry-land conditions. Already these studies have resulted in much valuable information being obtained. We have long known that one of the causes of failure on dry lands was the lack of sufficient means or capital to survive the first year or two of development. These studies have further shown that the profit of the farming business under dry-land conditions increases with the amount of capital invested. We have a way of measuring the profitableness of the business, that is, by a study of the labor incomes. The labor income is considered as the net farm income, less interest on the capital invested in real estate and working equipment. In other words, labor income is that income which the labor earns whether that labor is physical or managerial.

On dry farms in Eastern Colorado the labor income has increased uniformly with the increases in capital up until the capital reached about \$20,000. In other words, the greatest returns from the labor used on dry-land farms in Colorado has been obtained where the capital in the shape of real estate and equipment amounted to about \$20,000.

But the amount of capital used is not the only thing which influenced the size of the labor income. Uniformly, in the five counties studied, the labor incomes increased as the number of acres in crops increased and the labor income increased uniformly as the number of acres in crops tended by one man increased. In other words, the man who could so conduct his business as to handle more acres, either by a better system of working, or by

diversifying his crops so as to distribute the work thru longer periods, was rewarded by a higher labor income.

In those counties where dairy stock was kept, the labor income was almost in exact proportion to the receipts from dairy products. Dairy stock has uniformly been more profitable than beef stock, as the following comparison, taken from El Paso County, will show. The illustration is typical of other counties:



One way of utilizing many dry-land crops

On fourteen farms the average receipts per year per cattle unit (a cattle unit is a full grown animal or its equivalent in young stock) was \$44, and the average feed cost per animal unit was \$28, or an average net return of \$16 per animal unit. On fourteen farms in the same locality beef cattle returned an average of \$28 per cattle unit, while the feed cost per animal unit in the case of the beef animals was \$21, leaving a margin of \$7. On the dairy cattle farms, 94 percent of all live stock was dairy cattle. On the beef cattle farms 96 percent of all live stock was beef cattle. Dairy cattle adapt themselves much better to a small business than beef cattle. In a large business both may be successfully used. If properly managed, both are capable of profit.

A thoro study of these investigations brings out the further fact that the proper proportion of live stock to crop acres must be maintained to get the largest profits. On the average, this has been found to be about eight crop acres per animal unit. The average crop value per acre in the five counties studied was about \$12.30. It is not yet possible to give average costs for producing this average crop value. But it is possible to give the amount of

work normally required. The item of work covers everything except interest or rentals, depreciation and similar items of cost. Labor costs differently in different neighborhoods, so that it is at present almost impossible to place a fair average value for the labor expended. Accordingly there are listed below figures which show the number of hours of man labor and the average number of hours of horse labor required to produce a few standard crops.

The following table gives several crops, the number of acres of each kind of crop used, and the amount of labor required per acre per year for the production:

Kind of crop	No. of acres studied for each crop	No. of man hours per acre per year	No. of horse hours per acre per year
Corn.....	13,000	15	42
Spring Wheat.....	470	12	26
Winter Wheat.....	370	10	23
Oats.....	1,200	15	28
Barley.....	140	10	28
Rye.....	180	12	23

Oftentimes, by taking advantage of good management principles, the same amount of labor can be made to accomplish a greater amount of work. For instance, the farmer who arranges his cropping in a rotation system so as to require plowing only once in three years, and still keeps up his production and soil fertility, will produce his crops with much less labor than the man whose system requires him to plow all of his tilled land each season. It has been shown above that the labor income was increased when the crop acres tended by one man was increased. To increase the crop acres per man requires some extra equipment, usually, but more often a better arrangement of work and farming system. The largest labor incomes have not been produced on farms getting the highest yields. They have been produced, however, on those farms getting just about or a little above the average yield. Extra high yields are usually produced too expensively to return a profit. The law which economists call the law of diminishing returns comes into play. Briefly stated, this law is: Extra work or capital applied to an enterprise sooner or later reaches a point beyond which the addition of capital or labor produces increases in product at greatly increased expense.

The most profitable businesses on the dry lands have been those which had considerable diversity—at least from three to five sources of income. These different sources of income can be kept up by the growth of live stock, forage crops and cash crops.

CROPS FOR DRY FARMING

In considering crops for dry-land agriculture, it must always be remembered that a rotation is necessary to keep up permanent production on the land. In any rotation, legumes must be used sooner or later. The available and profitable legumes are limited. They consist principally of alfalfa, sweet clover, field peas and pinto beans. Legumes are just as necessary to help balance up the feed ration as they are to assist in maintaining soil productivity. The crops which are most certain and are easiest to grow make rather starchy feeds. Some legume to mix with such feeds is highly desirable.

ALFALFA

Alfalfa can be grown in many localities if the land is properly prepared and the crop properly cared for. Alfalfa may be grown for forage if planted in rows from 3 to 3½ feet apart. When so planted, alfalfa should be cultivated to keep down weeds. Only a few cultivations are necessary if they are done at the right time. If drilled or seeded broadcast, alfalfa should be seeded thinly. Three pounds of good seed is amply sufficient if the soil is properly prepared. When well cared for, alfalfa should produce from three-fourths to 1 ton of cured hay per acre per year. Since this alfalfa hay is worth pound for pound as much as bran to feed with the common feeds of dry-land sections, it

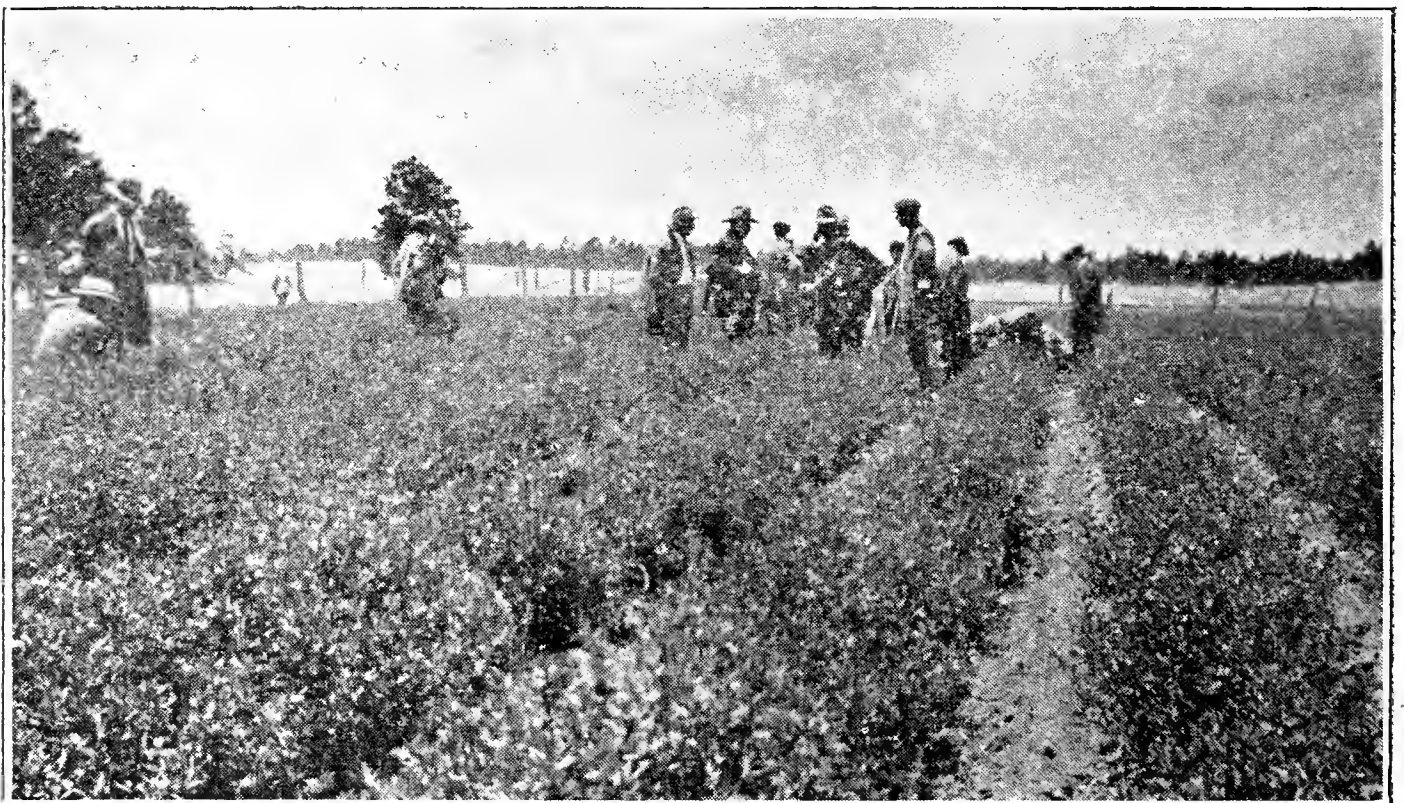

Alfalfa in rows for seed production or increased hay production under dry conditions

really has a greater value to the dry farmer than the average price of alfalfa hay would indicate.

Varieties.—Experimental work has shown that the best varieties to grow on the dry lands are the Baltic and Grimm. The Baltic and Grimm are very much alike. In fact the Baltic is a selection from the Grimm. These two sorts are superior for both hay and seed production.

Preparation of the Seed Bed.—Alfalfa will probably occupy the land for a number of years, so every possible precaution should be taken to get it started right. In order to do this a properly prepared seed bed must be provided. The seed bed should be moist to at least 2 feet in depth in order to insure sufficient water to germinate the seed and keep the young plants growing for a considerable period. Of course, rains may come and render all of these preparations unnecessary, but it should be understood that rains sometimes fail to come for a period of three months. If the seed bed has been properly prepared, the young crop will stand this long a period of drouth. In preparing such a seed bed, it is often necessary to follow complete or partial summer tillage. Alfalfa does best on land which has been plowed and afterwards well packed. The surface should be granular rather than fine and dusty. The granular or "small cloddy" surface takes up moisture better than a dusty surface, and blows less easily. Usually the best time to plant will be from May to July; more often May is the preferable month.

SWEET CLOVER

In Colorado, sweet clover has been considered a serious pest until very recently. Now many are coming to recognize the value of this crop. As a soil renovator there is no legume that will give as quick and desirable results as sweet clover. When cut at the proper time it makes very nutritious hay and produces a very fair yield. In many places where alfalfa is difficult to start, sweet clover will do well. It is sufficiently valuable to be given a thoro trial in many dry-land sections.

Varieties.—There are three varieties of sweet clover which may be encountered. The white sweet clover, the yellow sweet clover and the small annual sweet clover. The two first named varieties are biennial, that is, the plants live two years. The annual yellow sweet clover is not agriculturally valuable in any of our territory. In most sections white sweet clover is preferable. In regions where the altitude is from 7,000 feet upward, yellow sweet clover is to be preferred over the white.

Soil Preparation.—The soil for sweet clover should be prepared exactly as for alfalfa.

Seeding.—Sweet clover may be seeded in the spring or fall. Where it is not in danger of being blown out in the winter time, fall seeding may be used. When seeded in the spring it should be seeded as early as possible to get it in the ground.

When cut for hay, the first cutting should not be made until the sprouts which shall produce the second crop begin to appear. Usually one crop may be cut the first year. The second year two cuttings should be received, except in years of extreme drouth. In cutting the second year's crop, the cutter bar on the mower should be set high, in order not to kill the plants. The plants start from sprouts which come out on the stalks close to the ground. If cut below these sprouts, the crop will be killed. High cutting obviates this danger.

FIELD PEAS

Field peas, or Canada peas, are exceedingly well adapted for the dry farms in altitudes of from 6,500 to 8,500 feet. They are not so well adapted in the lower and warmer sections. It is possible to grow them but usually they will not pay a profit. They should be seeded on well prepared land at the rate of about 20 to 30 pounds per acre, preferably using a disk drill with a revolving cup type of feed so as not to crush the seed. Peas grow best in cool regions. It is for this reason that they are better adapted for the higher altitudes.

PINTO BEANS

The so-called pinto beans are one of the Mexican varieties. This variety is most commonly grown, is one of the very best yielders, is well adapted for dry-farming sections below 7,000 feet in altitude, and has an established market. The average yield of these beans under dry-farming conditions has been from 300 to 800 pounds per acre. Many growers have obtained much higher yields. These beans sell on the market from as low as 2 to as high as 6½ and 7 cents per pound, depending upon the market demand. They, therefore, constitute a very excellent and certain source of cash income. The straw will yield from one-half to three-fourths of a ton and sometimes more, per acre. The straw, when fed with silage, is worth as much as alfalfa hay. In addition, beans are legumes and assist somewhat in keeping up soil productivity when they are used in rotation.

Preparation of the Soil.—Pinto beans should be planted on flat, prepared land in rows 3 to 3½ feet apart and in drills in the rows. The amount of seed for dry-land conditions will vary from 8 to 18 lbs. Fifteen pounds may be put as a fair general average, where growing conditions are favorable.

Cultivation should be shallow, as beans are a surface-rooted crop. Cultivation, while shallow, should be frequent enough and thoro enough to prevent the formation of a crust on the soil and to keep down weed growth. Great care must be exercised not to cultivate when the vines are wet. At such a time the vines are easily broken and the danger of being infected with some of the common bean diseases is greatly increased. Beans are harvested by means of a bean harvester. Many of the modern forms of harvester have a bunching attachment which materially decreases the labor of bunching. Pinto beans should be harvested before they are completely ripe, because they will ripen in the shock or bunch and, by harvesting in this way, danger of shattering is almost eliminated.

Increased prices may be obtained by thoro machine-cleaning and uniform bagging of the product. Pinto beans should not usually be planted more than one year on the same patch of land because of the danger of bean diseases. In order to reduce the danger of disease still further and to increase the yield, it pays to hand-select the seed from high-yielding plants which ripen early and uniformly.

CORN

Corn is one of the most important grain and forage crops. In many sections no forage will produce as high yields per acre. In the higher and moister sections, on the Arkansas-Platte Divide region, corn will produce a greater tonnage than any other similar forage. There are many other localities where it will out-yield the grain or forage sorghums. Where corn will out-yield such other crops it should be used for forage. It makes an excellent fodder where properly cured and when stored in the silo makes the very best silage possible. Corn can be grown in cooler localities than can any of the sorghums. It is probable, therefore, that corn will take the first place in the cooler and moister sections, while the sorghums will take first place in the drier and hotter sections of our territory.

Preparation of the Soil.—The best method of soil preparation for corn depends upon the character of the soil, the rotation, and the crop which precedes corn on the land. If the land is rather light and sandy, fall plowing is not wise on account of danger of soil blowing. However, such lands may usually be managed so as to keep down weeds and put the surface in shape for catching winter and spring moisture. Where small grain or an early harvested cultivated crop preceded corn, the land may be double disked at once to kill weeds and put the surface in good condition for catching rainfall. Then, instead of plowing, the land is

listed. Experiment shows that this practice stops danger of blowing. In the spring, just as early as possible, the middles are broken out.

Listing tends to lengthen the time required to develop corn to full maturity, consequently, planting corn on listed land is not always advisable. Where, on account of the difficulty of maturing listed corn, it is advisable to surface plant, the listed ground is worked down by disking and harrowing.

Often on the lighter lands, experiment has shown that a system may be followed which keeps down weeds and conserves moisture at a great reduction of labor without reducing yields. Thus the cost of production is kept down. The suggested system is carried out as follows: Starting the system and rotation with summer tilled land, the first crop put on is winter wheat. Immediately after the binder, the land is double disked for the double purpose of killing all weeds which spring up and to put the surface in good condition to catch rainfall. The following spring the land is double disked early, then corn or other cultivated crop is planted. Following corn, small grain is planted. The yields of grain after corn or other clean cultivated crop are nearly as large as after the fallow. After this last small grain crop is cut, the land is double disked. It is then allowed to lie. The following spring, as soon as weeds start, the soil is again disked to kill weeds, preserve tilth and the better to catch rainfall. In June and July the land is plowed thoroly and deeply, disked and harrowed immediately behind the plow. Winter wheat is planted in September and the rotation is under way again. Such management has been found more successful on many soils than more frequent plowing and the cost of following the system is very low.

Upon the soils which give better results from plowing each season, the soil should preferably be plowed early in the fall, the earlier the better.

Time for Planting.—Over most of the plains area, corn can be planted by the 10th of May. In the extreme southeastern part of the Colorado plains, planting can be done the last of April or the first of May. In the extreme eastern part, some planting may be done by the first of May, but usually it is not wise to put in corn very much before May 10th. Nearly always the plains are subjected to a frost about the middle of May and there is little use of getting corn in prior to this danger period for frosts. By this time the ground has become somewhat warmed so that the crop will start off readily.

How to Plant.—Corn should be planted in rows $3\frac{1}{2}$ feet apart. If drilled on the dry land there should be one seed about every 18 to 22 inches. If checkrowed, only two kernels to the hill should be planted.

In very dry localities where experience shows difficulty of getting sufficient moisture to produce a crop, the rows may be planted 7 feet apart, or double the usual distance. When thoroly cultivated, such wide planting insures a crop in years when ordinary planting fails. With such wide planting, the seed may be put in a little thicker, 15 to 18 inches, in the row when drilled. This method of planting has been tried with success in several Colorado plains localities.

Varieties.—There are an infinite number of corn varieties, but owing to the altitude and the shortness of the season, only the short season or so-called northern corns should be planted. Of the native varieties which have been tried out, the Swadley Dent, the White Australian Flint, and Parson's High Altitude corn have given very excellent results. For the more northern portions of the Colorado plains area, Pride of the North, Minnesota No. 13, Minnesota No. 23, and Wisconsin No. 7 have been tried and give good results. Of the imported corns, Minnesota No. 13 and Wisconsin No. 7 have been among the best. Minnesota No. 23 has not been tested a very long period of time, but gives promises.

For dry-land forage purposes, it is unwise to plant the large-eared, late-maturing types of corn. They are more subject to injury, will not produce as heavy yields and will not mature seed with any certainty.

Cultivation.—The major portion of corn cultivation should be done in the preparation of the seed bed. Cultivation after planting should be relatively shallow and frequent enough to prevent weeds gaining a foothold, and prevent the formation of a crust. For this purpose, the use of a type of cultivator having numerous shovels to the gang should be used. Numerous small shovels work up the entire surface thoroly and do a better job than the larger shovels as ordinarily used. Cultivation should be approximately 4 inches deep. It is seldom wise to go deeper, as root pruning becomes severe and very injurious, especially in dry times.

Harvesting.—For forage purposes it should be the plan of the dry farmer to put his corn crop largely in the silo. Corn should be allowed to mature pretty well, at least to mature until the ears are well dented and glazed before the crop is harvested, as it will make better silage and a greater yield of feed if harvested at this time. It will not be harmful if some of the lower

leaves are dry, because water can be run into the silage as the silo is being filled.



A home-made cutter saving all the corn crop in a dry year

If cut for fodder, it should be cut at about the same time as for silage and put at once into shocks. As soon as cured it should be taken in from the field and stacked in order to reduce the waste from the dry, high winds of winter to as low a minimum as possible. With the silo, it is possible to save 90 to 95 percent of all of the feed produced in the field. With the best methods of dry fodder making, not over 70 percent will be saved, and there will be a great deal more waste in feeding, as the animals will not eat it up nearly so completely. Often, where the crop is harvested by cutting and shocking, weather conditions will be such that as much as 80 percent may be lost, altogether too high a loss to be permitted where forage is as scarce as it is upon the ordinary plains farm.

Seed corn should be selected in the field at about the time the corn is ready to cut for fodder or silage. Only in a few sections will it be desirable to harvest corn for grain, and in those sections it will frequently be the best policy to get the grain by thrashing out well-cured fodder which has been cut at the proper time.

SORGHUMS

Two kinds of sorghums are commonly grown. Both have about equal resistance to dry weather and drouthy conditions. These are forage, or saccharine sorghums, and grain, or nonsaccharine sorghums. The latter are distinguished from the saccharine sorghums in that the juices are not sweet. They are ordinarily called grain sorghums because they produce heavy yields of



Badly injured by hail, but the silo will save what's left

seed or grain which is well adapted for feeding purposes. The sorghums have one very valuable characteristic—in drouthy periods they will cease growth and unless the drouthy period is exceedingly prolonged, will recover and continue growth if moisture comes later. The sorghums have a very large place in the forage crops of our dry-land regions because of their ability to withstand drouth. They cannot be successfully grown in some localities, because of the cold climate resulting from the high altitudes. Where the sorghums will out-yield corn, they should be grown for forage purposes in preference to corn.

Forage Sorghums or Sorgos.—The forage sorghums can be grown practically all over the Colorado plains. In some localities near the foothills and in some localities on the Platte-Arkansas Divide, the altitudes are too high and the climate too cool for the best development of even the shortest-season sorghums.

There are a large number of varieties and types of sorghums. Practically only two types are adapted to any of our regions. These are the ambers and Sudan Grass. Of the ambers we have Black Amber, Red Amber, and White Amber. The White Amber was produced by selection by Mr. Freed, of Western Kansas. It is called in many sections, and in some government literature, “Freed’s Sorgo”.

Sudan Grass is not commonly called a sorghum, but for the purpose of this bulletin, it can be classed with the sorghums. It crosses readily with the ambers or other sorghums, showing its close relationship.

Of the ambers, the Black is the best variety. Altho in our experimental work at Cheyenne Wells, the White did well, it was not equal to our local strains of Black Amber. The amber sorghums are best adapted to the southeastern portion of the State, altho they do well in the extreme eastern portion. They are less well adapted as the altitudes rise close to the mountains, but even here they may be grown to some extent.

Sudan Grass has been tried in the State for three years. It was imported from Khartum in 1909. Sudan is a province in Central Africa, of which Khartum is the leading city. On this account the Department of Agriculture officials called the grass "Sudan Grass". This grass has been tested for three years in Colorado and has given promise of being the best adapted hay crop of the forage sorghum types. It matures in a shorter season than amber, stands drouth well, and grows vigorously. Its yield will, of course, be largely according to the moisture supply available and it will vary from 1 to 8 or 9 tons. The latter yield is only possible under irrigated conditions. Sudan Grass is not adapted to the higher altitudes next to the foothills nor in the Platte-Arkansas Divide, but is adapted to the rest of the Colorado plains:



Sudan Grass, one of the best annual hay crops. This crop was hailed to the ground August 18; picture taken Sept. 28, 1915

Preparation of the Soil.—The soil for sorghums should be prepared the same as for corn. Owing to the fact that all of the sorghums are what might be termed hot weather crops, they require a warm soil before it is safe to plant. This planting should follow corn planting, usually from the 15th to the 20th of May is a safe time. Planting may even be delayed until early in June.

If seeded broadcast, 20 to 30 pounds of amber will make a thick enough stand. In most of the dry-land regions, it will pay, however, to plant the sorghums in rows so as to permit of cultivation. Six to fifteen pounds per acre in rows, according to width of rows, will be amply sufficient upon most soils. Sudan Grass is smaller seeded and consequently a fewer number of pounds will do. If planted in rows, 3 to 6 pounds will make a sufficiently heavy stand. If planted broadcast, 10 to 15 pounds is abundantly sufficient.

Not Safe to Pasture.—Owing to the fact that the sorghums develop a poisonous principle which causes the liberation of hydrocyanic acid, commonly called prussic acid, it is unsafe in dry-land regions to pasture with livestock. This poisonous principle seemingly does not hold its effectiveness when the crop is cut and made into hay or made into silage. In other words, changes occur so that the poison is no longer injurious.

Harvesting.—If not planted too thinly, amber cane or Sudan Grass can be mowed and cured as hay. Either of these crops can be allowed to mature to be put into the silo if conditions warrant. When made into hay the crop should be raked, after allowing partial drying in the swath, immediately cocked and allowed to cure in the cock. Often cane and Sudan Grass may be harvested with the grain or corn binder. The bundles are much more easily handled than the loose hay.

GRAIN SORGHUMS

Varieties.—The grain sorghums for the most part require a longer season to properly mature than amber cane or Sudan Grass. The following varieties of grain sorghums have been tried in an experimental and practical way: Kafir, milo, kaoliang, shallu and feterita (Sudan Dura). Each of these crops is represented by a large number of varieties.

Of the kafirs, the Black Hulled White kafir has been the best. Black Hulled White kafir can only be matured in Colorado in the extreme southeastern part of the State and in a narrow belt extending along the eastern border practically as far north as Wray. It can be used for a forage considerably further west.

There is only one type of milo that should be grown in Colorado, and that is the Dwarf Yellow. The tall milos require too long a season. Dwarf Yellow milo, in Colorado, is the earliest maturing of the grain sorghums and can be grown farther north and west and at higher altitudes than any other grain sorghum now grown. In Kansas, Oklahoma and Texas, feterita is as early or earlier than Dwarf milo, but in Colorado the situation is reversed; Dwarf milo will mature in a shorter season than feterita.

Brown kaoliang is very promising for many sections. It has been possible to mature kaoliang at higher altitudes and in cooler situations than other grain sorghum. It has about the same feeding quality and value as the kafirs. Milo and feterita are better adapted where the season is long enough to mature them. In very dry situations with excessively short seasons, kaoliang may have a place. In such locations corn does not thrive and other sorghums are not adapted.

Shallu has been tried and gives some promise. At the present time, however, the kaoliangs and shallu cannot be recommended for the Colorado plains as strongly as kafir and milo. It is advisable to confine the grain sorghum production largely to those two crops.

Feterita is a white-seeded crop, resembling milo very much, except that the heads are usually erect. Milo and feterita belong to the group of sorghums known as duras. Feterita was first tried in Colorado under the name of Sudan Dura. It is adapted to practically the same territory to which milo is adapted. It is more drouth resistant than milo, but is somewhat more adversely affected by the cool climate. As a consequence, milo is to be preferred for planting.

Methods of Planting.—All of the grain sorghums should preferably be planted in rows, whether it is expected they are to be used for grain or forage. The rows should be at least $3\frac{1}{2}$ feet apart. The rate of planting should be such that kafir should have a space of 8 to 10 inches between plants (in very dry situations 12 to 15 inches); feterita should be planted about as milo. This rate of seeding will require 5 or 6 pounds of seed per acre, ordinarily. For planting, an ordinary corn planter provided with milo plates can be used. If milo plates are not at hand, blank plates can be made into milo plates by having a blacksmith drill holes of the proper size and spacing.

In the hotter, drier sections of the plains the grain sorghums will produce heavier yields of forage than corn. In such sections they should be grown for the silo or for fodder in preference to corn.

Harvesting.—When harvested for forage, these crops should be made into fodder, or preferably siloed. They should be allowed to stand in the field under ordinary conditions until the seed is practically ripe. If put into the silo earlier, they will not make as much feed and there is a tendency to the formation of a sour silage.

In addition to being valuable for forage, the seed of the grain sorghums is valuable for feeding to all kinds of animals. It is

possible to feed the seed of amber sorghum, but it is usually not advisable. The seed coat of amber sorghum is very hard and impervious to moisture. As a consequence amber sorghum seed is very much more difficult for the animals to eat than the seed of grain sorghums. Besides, the grain sorghums, where adapted, will produce a heavier amount of seed.

Milo and feterita, when mature, have rather woody stalks and do not make a good fodder. They make a good silage, however. For fodder purposes, kafir is a much superior grain sorghum. If hay alone is desired, it is better to grow Sudan Grass or amber sorghum than any of the grain sorghum varieties.

Harvesting for Seed.—When it is desired to harvest the grain or seed of the grain sorghums, it is best to allow the crop to get ripe, then, if possible, to cut with a binder and shock.

For feeding purposes the fodder having the ripe seed can be run thru a thrashing machine as soon as the stalks are well cured. Where the seed is to be used for seed, the heads should be picked out and stored under cover. Any of the grain sorghums, if stored in bulk, are very liable to heat, and only a very slight heating is necessary to render the germ infertile. Where a corn binder is not possible, the crop can be harvested by cutting by hand or by the



A field of cane—sure roughness

use of a cutting sled. These methods are more economical of time and labor than to attempt to harvest the heads separately in the field. For seed purposes only it is possible to economically harvest heads from desirable plants in the field.

MILLETS

Owing to the fact that they will develop with relatively small moisture supplies and that they will mature in a short season, millets must be considered among the important dry-land forage crops. Millets, as are the sorghums, are "hot weather" crops and will not do well at higher and cooler altitudes. For the most part their place among the dry-land forage crops is to furnish hay for horses, cattle and other similar livestock.

Varieties.—The varieties commonly met with on the plains are the German, Common, Hungarian, Siberian, and Hog millet. Hog millet is grown more frequently for the grain than for the forage. In some sections it will produce quite heavy yields of seed. It is not widely adapted to Colorado plains conditions. Where it is adapted it is worthy of a place in the rotation. Elsewhere, it should not be grown at all. Most of the sections where it does well lie in the northeastern part of the State.

In general, German millet is recommended in preference to others. It grows more rank than the Common, and consequently, where moisture supplies are fairly good, should be seeded a little thicker. If this precaution is taken, it will make as fine hay and usually a little more tonnage than Common. The other varieties are adapted, but do not possess any superiority. As a consequence, planting for hay purposes should be limited to the German and Common.

Preparation of the Soil.—The soil for millets must be prepared as thoroly, or more thoroly, than for sorghums and corn, as it is small seeded and must have a comparatively congenial seed bed if it is to produce a good crop. In order to accomplish the production of such a seed bed, plowing should be very early, in order to allow the accumulation and protection of the moisture supply.

Seeding.—Millet should not be seeded until approximately the first of June for most of the plains territory. It will not develop in a cold soil, and since it matures in a short season, planting can be delayed until the soil is thoroly warm, which is about the first of June. Preferably the seed should be put in with a press drill, using about 25 to 30 pounds of seed per acre. It can, however, be seeded by broadcasting and harrowing the seed in, or better still, rolling it in and following the roller with a harrow.

Harvesting.—Millet makes a valuable hay if it is cut at the right time. The right time is about the time the seed is in the milk. If allowed to mature farther than this the seed is liable

to injure livestock to which it is fed. This is especially true of horses. When cut at the proper time, just as the seed is reaching the milk, it makes a palatable, nutritious hay. The hay can be cut and allowed to partly cure in the swath, raked and cocked for complete curing. As soon as thoroly cured, it should be stacked to prevent loss.

STOCK MELONS

Another source of possible late fall and early winter succulent feed is stock melons. Stock melons look very much like watermelons, but have a very much thicker rind. Experiments at Eads and Cheyenne Wells show that stock will eat these melons with relish. They make an excellent sod crop and if weeds are kept down will do well on old lands. They are best adapted to the hotter portions of the eastern and southeastern parts of the State. The land should be well prepared, and if sod land, the sod should be rolled flat immediately behind the plow. The melons should be planted in hills at least 10 feet apart each way. On sod land they need very little cultivation. On old lands they will need sufficient cultivation to keep the weed crop down.

The keeping quality of the melons is good, if kept from freezing. Thus they may be fed out in the fall as desired, if properly protected from being frozen, by straw or other covering.

THE GRAINS FOR HAY

A large use is already being made of many of the grains for both hay and pasture. Winter wheat and rye each make fairly good late fall and summer pasture. These two grains are the only ones at all well adapted for pasture purposes, but they are very well adapted for dry-land annual pastures. In the cooler regions, and in the northern and northwestern parts of the Colorado plains, rye is probably preferable. In the warmer portions, winter wheat will be preferable. Wheat, oats, beardless barleys, rye and emmer will each make a good quality of hay if harvested when the seed is in the milk or soft dough stage. Often these crops will make profitable hay yields, the season taken into consideration, when the grain which is produced upon them would not be worth harvesting.

When grown for hay, these crops are planted and cared for as they would be for grain. For pasture purposes, winter wheat and rye should be seeded in July; for hay purposes, the latter part of September is preferable, where the crop is to be harvested the following year. Barley and emmer can be seeded in March if conditions are such that the land can be worked. Oats should not

usually be seeded until the middle of April at least, on account of possible injury from late spring frosts. Wheat and rye should be seeded at the rate of about 30 to 35 pounds of seed per acre. Oats should be seeded at the rate of from 40 to 50 pounds; hulless barley should be seeded at the rate of 50 to 60 pounds, and hulled barley at about 60 pounds for hay purposes. Emmer should be seeded at the rate of 60 to 70 pounds. Each of these crops should be seeded with a press drill to obtain best results.

BROOM CORN

Broom corn is very well adapted to the southeastern portions of the State and as far west as two tiers of counties from the eastern border. This crop should not be grown in preference to other sorghums for a forage crop, but in some localities broom corn is grown for a cash crop. In such localities, if the fodder is harvested, it will make a very useful and valuable feed. Except to be used in this way, it cannot be recommended because it is not so valuable as other adapted sorghums as an exclusive forage crop. Where it is grown for the brush, however, it is worth while to take particular pains to save the fodder, which can be dry cured or siloed as circumstances permit.

WHEAT

One of the great cash crops for dry farming is winter wheat. There is no variety so well adapted as some one of the various strains of Turkey Red.

Preparation of the Soil.—Wheat in the rotation should follow corn or summer tillage. Where it follows summer tillage, the land should be plowed in June or July so as to give sufficient time for nature to compact the soil. Wheat does best on a seed bed that is loose at the surface and thoroly compacted below. Where wheat follows corn, especially if the corn has been planted in 7-foot rows, usually no preparation is necessary. The wheat is simply drilled in between the rows of corn or in the corn stubble where the corn has been cut away for silage or for fodder, as shown in illustration on cover page.

Seeding.—Turkey Red winter wheat should be seeded with a press drill, preferably a disk press drill, at the rate of 30 to 35 pounds of good seed per acre. Seeding should preferably be done by the middle of September, altho it may be done as late as the first of November in most seasons. Usually the early seeding has the advantage because it is in better shape to endure winter and gets an earlier start in the spring.

Treatment of the Seed.—No wheat should be planted except after treatment with formaldehyde or bluestone. This is necessary to check and prevent smut. The loss from smut is becoming

so serious a problem that the slight cost of seed treatment is very cheap insurance.

BARLEY

One of the most certain grain crops for feed purposes on the plains is barley. No winter variety has yet been found which is able to withstand the dry, cold winters. Consequently, spring varieties will be used exclusively when barley appears in the cropping system. Experience has shown that barley does as well on a seed bed prepared by disking and harrowing in corn stubble as it does after summer fallow, and even better than where the land is plowed especially for this crop. In some localities fall listing, where the previous crop will permit such treatment, working the listing down in the spring to a seed bed, has been found as successful and cheaper than fall plowing.

Varieties.—The varieties of barley which do best on the plains are both two-row and six-row. Of the two-row, the Hannchen and Hanna have been the best. Of the six-row types California, or Coast, as it is now called in a good many places, and White Smyrna, a variety recently introduced by the United States Department of Agriculture, are the best, in a number of trials made at different points on the plains. The so-called Bald barley, or White Hulless barley, which is properly called Nepal, is a six-row hulless barley, probably the best of the hulless barleys for dry-land growing. This barley is better for barley hay or for hogging down than any of the two or six-row types mentioned above, but it does not yield so heavily. The best practice would be for neighborhoods to grow not over two varieties, one hulled variety and one hulless. Thus the seed problem and marketing problem would be almost automatically taken care of.

A large number of other varieties of barley have been grown and are being grown, but the varieties given have sufficient merit so that they should predominate to the exclusion of the other varieties. Barley is being grown for feed, and to some extent for a cash crop. As a feed, it supplies the same place that corn fills.

OATS

Oats are not a very successful crop on the dry lands, but may be sometimes grown. When so grown they will be grown almost entirely for feed. Oats will very rarely make yield enough to be used as a cash crop. Kherson are the best oats to use if oats are used at all.

FLAX

Flax is not adapted to the entire Colorado dry-farming area. It is well adapted to that portion of the great plains lying on the Arkansas-Platte Divide and northward. Owing to the fact that

flax covers the land very thinly, it has been mostly a new land crop, because weeds bother very slightly on new land or breaking. On old land, weeds bother the flax crop to a considerable extent, unless the seed bed has been prepared by deep plowing.

The lack of a stable market has been the greatest drawback to the growing of flax as an auxiliary cash crop. Prices have been unusually good for a year or so, but frequently when the acreage is high, prices have been too low to be profitable. In addition to the northeastern part of the State, flax is adapted to growth in most of the foothills and intermountain regions. In such regions, however, the difficulty of marketing unless the seed is fed, makes it an undesirable crop.

Preparation of New Land.—Flax has always been considered a new-land crop. Experiments have conclusively shown, however, that the advantage of new lands is one of freedom from weeds. In breaking up new lands, if a heavy sod covers the soil, the sod should be broken from $2\frac{1}{2}$ to $3\frac{1}{2}$ inches deep. The furrow slice should be turned over as flatly as possible and rolled flat with a heavy roller or weighted disk, immediately after the breaking plow. Best results are obtained by plowing very early in the spring. Rolled sod can usually be made into a proper new-land seed bed by harrowing. Occasionally light disking with the disk set nearly straight, is necessary. Care should be taken to leave the sod smooth and tightly rolled down if good results are to be obtained. If plowing may be done a long time previous to seeding, the first plowing may be deep. Time and the disk harrow will put this deep plowing in proper shape for planting.

Preparation for Old Land.—The most important thing in preparing old land for flax is to have it free from weeds. Weeds cause more old-land crop failures than any other one thing. Deep plowing, if done early enough, will usually submerge the weed seeds so deeply that weeds will not bother that year. Clean corn stubble can be made into an almost perfect seed bed by disking and harrowing. Flax should be seeded with a press drill, using from 15 to 25 pounds of seed to the acre.

Time to Plant.—Flax matures in a short season, but it grows best in the cool of the season. Consequently, most of the flax should be seeded from April 10th to May 15th. Only good, bright, clean seed, treated with formaldehyde in the same manner that wheat is treated for smut should be used. Flax, owing to the danger from flax wilt, should never be grown more than one year at a time on the same land. At least three or four other crops in the rotation should be grown before it is again put upon the same tract.



One method of marketing the dry-land corn crop

PASTURES AND NATIVE HAYS

Native Hays.—Many of the native grasses of the plains make very nutritious hays. But, except in low places or swales, the growth is normally insufficient for hay. The wheat grasses, blue-stem, and grammas are the most common native hay species.

Native Pastures.—There are still many places on the plains where there are large areas of native pasture. Where these native pastures are open range, little may be done to improve their carrying capacity. Where under fence and private control, it is possible to very materially improve carrying capacity by letting part of the pasture rest while the other portion is grazed.

Some improvement may often be made by seeding in sweet clover. This is especially true of the sandier localities.

In the high Divide country brome grass (*Bromus inermis*) does well. Here it may be seeded in the native pastures with a disk drill. The wet valleys in the sand-hills often produce brome quite well. Except under the conditions just mentioned, brome grass is very indifferently successful or a total failure.

Tame Pastures.—Tame pastures are among the most serious and difficult problems of dry farming.

No tame grass is ever successful. Brome and orchard grass may be grown in the few limited sections above mentioned. But they are not generally adapted. Yet they are the best tame grasses with which experiments have thus far been conducted.

For hog and horse pasture, alfalfa in rows may be used. Probably for those animals which may safely be pastured upon it, alfalfa will furnish more feed than any other permanent crop.

Sweet clover will make some pasture practically anywhere on the plains, even under conditions too severe for alfalfa. It may be grazed with greater safety than alfalfa, but it is unsafe to graze sweet clover with either cattle or sheep when wet from dew or rain.

The Agricultural Experiment Station
OF THE
Colorado Agricultural College

DIVISORS

(For the Measurement of Irrigation Water)

By

V. M. CONE, Irrigation Engineer
U. S. Office of Public Roads and Rural Engineering



The work upon which this bulletin is based was done in the hydraulic laboratory, Fort Collins, Colorado, during the seasons of 1915-16, under a cooperative agreement between the Colorado Experiment Station and the Office of Public Roads and Rural Engineering, U. S. Department of Agriculture

The Colorado Agricultural College

FORT COLLINS, COLORADO

THE STATE BOARD OF AGRICULTURE

	Term Expires
HON. CHAS. PEARSON.....Durango,	1919
HON. R. W. CORWIN.....Pueblo,	1919
HON. A. A. EDWARDS.....Fort Collins,	1921
MRS. J. B. BELFORD.....Denver,	1921
HON. H. D. PARKER.....Greeley,	1923
MRS. AGNES L. RIDDLE.....Denver,	1923
HON. J. C. BELL.....Montrose,	1925
HON. E. M. AMMONS.....Denver,	1925

PRESIDENT CHAS. A. LORY,
GOVERNOR JULIUS C. GUNTER, } *Ex-Officio*

L. M. TAYLOR, Secretary

CHAS. H. SHELDON, Treasurer

EXECUTIVE COMMITTEE

A. A. EDWARDS, *Chairman*

E. M. AMMONS

H. D. PARKER

STATION STAFF

C. P. GILLETTE, M.S., <i>Director</i>	ENTOMOLOGIST
W. P. HEADDEN, A.M., Ph.D.....	CHEMIST
G. H. GLOVER, M.S., D.V.M.....	VETERINARIAN
W. G. SACKETT, B.S.....	BACTERIOLOGIST
ALVIN KEZER, A.M.....	AGRONOMIST
E. P. SANDSTEN, M.S., Ph.D.....	HORTICULTURIST
B. O. LONGYEAR, B.S.....	ASSISTANT FORESTER
G. E. MORTON, B.S.A., M.S.....	ANIMAL HUSBANDMAN
E. B. HOUSE, B.S. (E.E.), M.S.....	IRRIGATION ENGINEER
V. M. CONE, B.S., C.E., <i>U. S. Irrigation Engineer</i>	IRRIGATION INVESTIGATIONS
W. P. LITTLE, B.S., <i>U. S. Expert-in-charge</i>	HORSE BREEDING
R. E. TRIMBLE, B.S.....	ASSISTANT IRRIGATION INVESTIGATIONS
P. K. BLINN, B.S., ROCKY FORD.....	ALFALFA INVESTIGATIONS
EARL DOUGLASS, M.S.....	ASSISTANT CHEMIST
S. ARTHUR JOHNSON, M.S.....	ASSISTANT ENTOMOLOGIST
L. C. BRAGG.....	ASSISTANT IN ENTOMOLOGY
J. W. ADAMS, B.S., CHEYENNE WELLS.....	AGRONOMY ASSISTANT, DRY FARMING
W. W. ROBBINS, M.A.....	BOTANIST
RALPH L. PARSHALL, B.S.....	ASSISTANT IRRIGATION INVESTIGATIONS
I. E. NEWSOM, B.S., D.V.S.....	VETERINARY PATHOLOGIST
MIRIAM A. PALMER, M.A.....	DELINEATOR
R. A. MCGINTY, B.S.....	ASSISTANT IN HORTICULTURE
CHAS. R. JONES, B.S.....	ASSISTANT IN ENTOMOLOGY
GEO. M. LIST, B.S.....	ASSISTANT IN ENTOMOLOGY
JAS. D. BELL, B.S.....	ASSISTANT IRRIGATION INVESTIGATIONS
CARL ROHWER, B.S., C.E.....	ASSISTANT IRRIGATION INVESTIGATIONS
BREEZE BOYACK, B.A., M.S.....	ASSISTANT IN AGRONOMY
CHAS. I. BRAY, B.S.A., M.S.....	ASSISTANT ANIMAL HUSBANDRY
RALPH L. CROSMAN.....	EDITOR
H. E. VASEY, A.M.....	ASSISTANT BOTANIST
W. H. KERR, A.B., J.D.....	MARKETS AND MARKETING
T. E. LEIPER, B.S.....	ASSISTANT ANIMAL HUSBANDMAN

OFFICERS

CHAS. A. LORY, M.S., LL.D., D.Sc.....	<i>President</i>
C. P. GILLETTE, M.S.....	<i>Director</i>
L. M. TAYLOR.....	<i>Secretary</i>
MABEL LEWIS.....	<i>Executive Clerk</i>

DIVISORS

(For the Measurement of Irrigation Water)

By V. M. CONE, Irrigation Engineer
U. S. Office of Public Roads and Rural Engineering

Many of the canal companies of the West are co-operative stock companies in which the individual water users have rights to proportional parts of the supply of water furnished by their canal, the divisions being in the ratio of the stock owned in the canal company. Even a few rivers have their waters divided into proportional parts among the canals, regardless of the flow in the stream at any time. Under this system it is often considered unnecessary to have the water actually measured, so long as each gets his proportionate part of all the water available in the ditch or stream. This led to the use of the divisor, division box, or proportional divisor, which are different names for a device placed in a channel for the purpose of dividing the flow into two or more parts, as might be desired.

Divisors are made in many forms and sizes. In all of them the division is made in accordance with the cross-sectional area of the box, the assumption being that the rate of flow is the same in all parts of a section across the box. This assumption is incorrect to a greater or less degree, depending upon conditions as indicated in the tables contained in this bulletin, but they are convenient devices because when they have once been set, they will give approximately the same division of the flow regardless of the later increase or decrease in the main supply. However, they are inaccurate and unreliable unless constructed and operated under definite conditions and, therefore, they should not be used as measuring devices where any considerable reliability is required.

Divisors are used extensively in some districts in Colorado and Utah, but are not known in others. As early as 1867 a divisor patterned somewhat after an Italian device was used near Greeley, Colorado, by Hon. J. Max Clark.* The Max Clark box, as it is known, is used to both measure and make a fair division of the water. Its characteristic feature is an enlargement on the upstream side of the box, which reduces the velocity of the water

*Colorado Station Bulletin 27, p. 8, and U. S. G. S. Water Supply Paper 9, p. 70.

and thereby improves the value of the measurement.

Divisors are not generally applicable to use on rivers or large canals because of the difficulty in operating them. They are principally used on the smaller laterals.

The greater number of them are built to divide the flow in the ditch into two ditches, but they are made sometimes as a single structure to divide the stream into four parts or more. The divisor consists essentially of a flume or box placed in the ditch with one or more openings for side ditches and a partition board, or divisor board, which may be either fixed or movable. Movable partition boards are either hinged, as shown in Figures 1 to 6, or are made to move parallel to the side of the flume as shown in Figures 7 and 8. Provision is usually made for fastening the divisor board to a timber across the top of the box when the desired set has been made. Fixed divisor boards are used where the division of the flow is not often changed, but when a change in the division of the water between the two channels is desired, it is usually accomplished with this type of divisor by placing boards in a vertical position in one or the other of the channels. This method gives only approximate accuracy because it reduces the total available width of opening in the two channels and also changes the freedom of discharge.

When the proportional division of the flow gives a quantity too small for economical use, such as during a shortage of water late in the season, or when for any reason the supply is not sufficient to meet the demands of all the irrigators, it is better to give each user in turn a greater flow than his share, but for a proportionately shorter time. This amounts to dividing the total water available in a period of time rather than a division of the flow at a certain time.

To cover the full range of variations in sizes and methods of building boxes, and conditions of flow in the different channels would take an endless number of experiments. The tests on divisors were, therefore, confined to the forms shown in Figures 1 to 8, inclusive, and the accompanying tables are based upon the results of these 341 tests. In the table headings the word "divisor" means the channel or ditch which is taken out from the side of the main ditch; "width of divisor opening" is the distance from the upstream end of the partition board to the "divisor" side of the flume; "channel" is part of the box which carries the remainder of the flow of the main ditch; "head" is difference between the elevation of the water surface in the main ditch, taken 3 feet upstream from the end of the divisor board, and the top of the dam, or the floor of the box if no dam was used; and "effective head"

is the difference between the "head" in the main ditch and the depth of water in the "divisor" taken 3 feet downstream from the point of the divisor board.

In the experimental work the divisor board was given a bevel of 1 to 4 on the "divisor" side, leaving the end about $\frac{1}{8}$ inch thick. Rubber packing was placed under the divisor board and the board screwed to the floor of the box to insure against leakage. The flow through the "divisor" and "channel" was measured volumetrically in every experiment.

As used in the field, sometimes a drop is placed in the ditch immediately below the box, depending on which, if either, of the ditches has an excessive grade. The ditch with the drop will have the "fastest" flow, as it is commonly expressed, and, therefore, get the lion's share of the water. Since the conditions in the two ditches may be such as to produce a combination of velocities varying from slow to fast, it is evident that the divisor box cannot be classed as an accurate measuring device, and this is proved in the accompanying tables. Different types of boxes, settings of divisor board, depths of water and conditions of flow in the two ditches, are given in the tables with the hope that irrigators may know some of the facts connected with their own divisor boxes and apply the information.

A comparison of columns 2 and 3 in the tables will give the error caused by assuming the discharge to be proportional to the distances from the point of the divisor board to the sides of the flume; column 4 gives the per cent of the flow in the main ditch which will flow through the "divisor" for the corresponding width of "divisor opening" shown in column 5; and columns 6, 7 and 8 give the discharge of the "divisor", "channel", and the main ditch, respectively. To convert the discharge in second-feet, as given in columns 6, 7 and 8 into "inches" of water, multiply those values by the number of "inches" equivalent to a second-foot under the conditions in question. The quantity of water which an "inch" represents is sometimes different under neighboring canal systems.*

A dam placed across the divisor box at the point of the partition board increases the accuracy of the division of the water, its effect being most decided for low heads. When the velocity of flow was practically the same in both ditches, an effect on the division of a maximum of only approximately 1 or 2 per cent was caused by substituting a 6-inch dam for a 4-inch dam. A long box is more accurate than a short box, because the long box tends to equalize the velocities across the width of the flume be-

*See Colorado Experiment Station Bulletin No. 207.

fore the water reaches the end of the partition board. The parallel divisor board is preferable to the swing divisor board.

In addition to the tests on divisor boxes, 196 tests were made on dividing the flow over rectangular and Cipolletti weirs. Crest lengths of 2 and 4 feet were used for both types of weirs. A thin metal plate was placed on the downstream side of the weir so that its edge touched the crest of the weir and extended vertically above the weir crest into the weir notch. This plate was set for different experiments at intervals of 2 inches across the entire width of the weir, and separate channels caught the flow over the weir on the two sides of the plate. These channels were placed far enough below the crest of the weir to allow a free passage of air under the over-pouring sheet of water. Under these conditions both types of weirs give reasonably accurate divisions, the greatest error being with the rectangular weir set to divide the flow between two parties on a basis of $\frac{1}{4}$ and $\frac{3}{4}$, when the actual deliveries will be 24 and 76 per cent for a head of 0.2 foot, and $22\frac{1}{2}$ and $77\frac{1}{2}$ per cent for a head of 0.8 foot. The errors with Cipolletti weirs used as divisors were in the opposite direction and about one-half as great. When either weir would be used to divide the water equally between three parties the error would be quite negligible.

If the divisor plate is placed out some distance from the weir, or the edge is placed in a horizontal position below the weir crest, the discharge for the end division would be considerably short and the flow for the middle division would be accordingly greater than the desired amount.

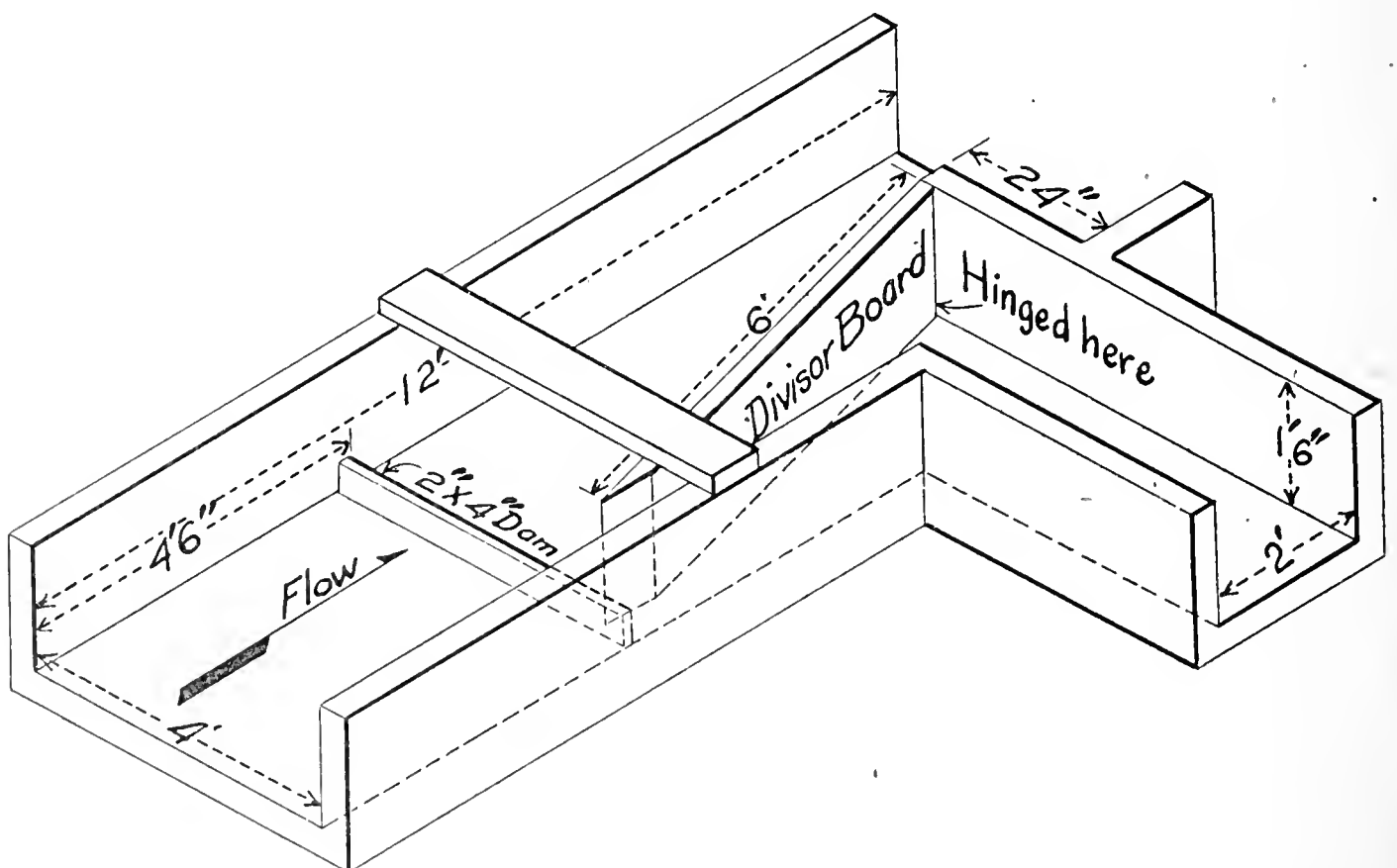

Fig. 1

DIVISORS

TABLE I
 For Divisor Box Shown in Figure 1
 Long box; 4-inch dam; divisor board hinged
 24 inches from side of flume; free flow in both channels

Divisor opening in inches	Percent divisor opening is of total width of box	Percent divisor flow is of total flow in box	Width of Divisor opening to give percent- age of flow		Discharge in Second-feet		
			Percent	Inches	Divisor	Channel	Total
Head = 0.2 ft. or 2 3/8 inches							
1	2.1	2.8	2	1
2	4.2	4.9	4	2	0.1	1.2	1.3
3	6.3	6.9	6	3	0.1	1.2	1.3
4	8.3	8.9	8	4	0.1	1.1	1.2
5	10.4	10.9	10	5	0.1	1.1	1.2
6	12.5	12.9	12	6	0.2	1.1	1.3
7	14.6	14.9	15	7	0.2	1.1	1.3
8	16.7	16.9	17	8	0.2	1.0	1.2
9	18.8	19.0	19	9	0.2	1.0	1.2
10	20.8	21.0	21	10	0.3	1.0	1.3
11	22.9	23.0	23	11	0.3	1.0	1.3
12	25.0	25.1	25	12	0.3	0.9	1.2
13	27.1	27.1	27	13	0.3	0.9	1.2
14	29.2	29.1	29	14	0.4	0.9	1.3
15	31.2	31.1	31	15	0.4	0.9	1.3
16	33.4	33.2	33	16	0.4	0.8	1.2
17	35.4	35.2	35	17	0.4	0.8	1.2
18	37.5	37.2	38	18	0.5	0.8	1.3
19	39.6	39.2	40	19	0.5	0.8	1.3
20	41.7	41.2	42	20	0.5	0.7	1.2
21	43.8	43.3	44	21	0.5	0.7	1.2
22	45.8	45.3	46	22	0.6	0.7	1.3
23	47.9	47.3	48	23	0.6	0.7	1.3
24	50.0	49.3	50	24	0.6	0.6	1.2
Head = 0.4 ft. or 4 13-16 inches							
1	2.1	2.9	2
2	4.2	5.5	4	1 3/8	0.1	3.1	3.2
3	6.3	8.0	6	2 1/4	0.2	3.1	3.3
4	8.3	10.3	8	3	0.2	3.1	3.3
5	10.4	12.3	10	3 7/8	0.3	3.1	3.4
6	12.5	14.4	12	4 3/4	0.4	3.1	3.5
7	14.6	16.5	15	6 1/4	0.5	3.0	3.5
8	16.7	18.5	17	7 1/4	0.6	3.0	3.6
9	18.8	20.5	19	8 1/4	0.7	3.0	3.7
10	20.8	22.4	21	9 1/4	0.7	3.0	3.7
11	22.9	24.3	23	10 1/4	0.8	2.9	3.7
12	25.0	26.3	25	11 1/4	0.9	2.9	3.8
13	27.1	28.2	27	12 3/8	1.0	2.9	3.9
14	29.2	30.2	29	13 3/8	1.1	2.8	3.9
15	31.2	32.1	31	14 1/2	1.1	2.8	3.9
16	33.4	33.9	33	15 1/2	1.2	2.7	3.9
17	35.4	35.8	35	16 1/2	1.3	2.6	3.9
18	37.5	37.7	38	18 1/8	1.4	2.5	3.9

TABLE I (Continued)

Divisor opening in inches	Percent divisor opening is of total width of box	Percent divisor flow is of total flow in box	Width of Divisor opening to give percent- age of flow		Discharge in Second-feet		
			Percent	Inches	Divisor	Channel	Total
Head = 0.4 ft. or 4 13-16 inches							
19	39.6	39.7	40	19 ¼	1.5	2.4	3.9
20	41.7	41.5	42	20 ¼	1.6	2.3	3.9
21	43.8	43.4	44	21 ¼	1.7	2.2	3.9
22	45.8	45.3	46	22 ⅜	1.8	2.1	3.9
23	47.9	47.3	48	23 ⅜	1.9	2.0	3.9
24	50.0	49.2	50	24 ½	1.9	1.9	3.8
Head = 0.8 ft. or 9 ⅝ inches							
1	2.1	3.6	2
2	4.2	6.7	4	1 ⅛	0.3	7.2	7.5
3	6.3	9.4	6	1 ¾	0.4	7.2	7.6
4	8.3	11.8	8	2 ½	0.6	7.2	7.8
5	10.4	14.1	10	3 ¼	0.8	7.2	8.0
6	12.5	16.2	12	4 ⅛	1.0	7.2	8.2
7	14.6	18.2	15	5 ½	1.3	7.2	8.5
8	16.7	20.2	17	6 ⅜	1.5	7.2	8.7
9	18.8	22.1	19	7 ⅜	1.7	7.2	8.9
10	20.8	23.9	21	8 ½	2.0	7.1	9.1
11	22.9	25.7	23	9 ½	2.2	7.1	9.3
12	25.0	27.5	25	10 ⅝	2.5	7.1	9.6
13	27.1	29.3	27	11 ¾	2.7	7.0	9.7
14	29.2	31.1	29	12 ⅜	2.9	7.0	9.9

TABLE II

For Divisor Box Shown in Figure 1
 Long box; 4-inch dam; divisor board hinged
 24 inches from side of flume; 0.1 foot or 1 3-16 inches
 effective head in both channels

Divisor opening in inches	Percent divisor opening is of total width of box	Percent divisor flow is of total flow in box	Width of Divisor opening to give percent- age of flow		Discharge in Second-feet		
			Percent	Inches	Divisor	Channel	Total
Head = 0.4 ft. or 4 13-16 inches							
1	2.1	2.2	2
2	4.2	4.6	4	1 ¾	0.1	2.3	2.4
3	6.3	6.9	6	2 ⅝	0.2	2.3	2.5
4	8.3	9.2	8	3 ½	0.2	2.3	2.5
5	10.4	11.4	10	4 ⅜	0.3	2.2	2.5
6	12.5	13.6	12	5 ¼	0.3	2.2	2.5

TABLE II (Continued)

Divisor opening in inches	Percent divisor opening is of total width of box	Percent divisor flow is of total flow in box	Width of Divisor opening to give percent- age of flow		Discharge in Second-feet		
			Percent	Inches	Divisor	Channel	Total
Head = 0.4 ft. or 4 13-16 inches							
7	14.6	15.8	15	6 $\frac{7}{8}$	0.4	2.2	2.6
8	16.7	17.9	17	7 $\frac{1}{2}$	0.4	2.2	2.6
9	18.8	20.0	19	8 $\frac{1}{2}$	0.5	2.1	2.6
10	20.8	22.0	21	9 $\frac{1}{2}$	0.6	2.1	2.7
11	22.9	24.1	23	10 $\frac{1}{2}$	0.6	2.1	2.7
12	25.0	26.0	25	11 $\frac{1}{2}$	0.7	2.0	2.7
13	27.1	28.1	27	12 $\frac{1}{2}$	0.7	2.0	2.7
14	29.2	30.1	29	13 $\frac{1}{2}$	0.8	2.0	2.8
15	31.2	32.0	31	14 $\frac{1}{2}$	0.9	1.9	2.8
16	33.4	34.0	33	15 $\frac{1}{2}$	1.0	1.9	2.9
17	35.4	36.0	35	16 $\frac{1}{2}$	1.1	1.9	3.0
18	37.5	38.0	38	18	1.2	1.8	3.0
19	39.6	39.9	40	19	1.2	1.8	3.0
20	41.7	41.9	42	20	1.3	1.7	3.0
21	43.8	43.9	44	21	1.3	1.7	3.0
22	45.8	45.8	46	22	1.4	1.7	3.1
23	47.9	47.7	48	23 $\frac{1}{8}$	1.5	1.6	3.1
24	50.0	49.7	50	24 $\frac{1}{8}$	1.6	1.6	3.2
Head = 0.8 ft. or 9 $\frac{5}{8}$ inches							
1	2.1	3.3
2	4.2	6.7	4	1 $\frac{1}{8}$	0.2	4.8	5.0
3	6.3	9.7	6	1 $\frac{3}{4}$	0.3	4.5	4.8
4	8.3	12.4	8	2 $\frac{1}{2}$	0.4	4.3	4.7
5	10.4	15.0	10	3 $\frac{1}{8}$	0.5	4.2	4.7
6	12.5	17.6	12	3 $\frac{7}{8}$	0.6	4.1	4.7
7	14.6	20.0	15	5	0.7	3.9	4.6
8	16.7	22.3	17	5 $\frac{3}{4}$	0.8	3.8	4.6
9	18.8	24.6	19	6 $\frac{5}{8}$	0.9	3.8	4.7
10	20.8	26.8	21	7 $\frac{3}{8}$	1.0	3.8	4.8
11	22.9	28.9	23	8 $\frac{1}{4}$	1.1	3.8	4.9
12	25.0	31.0	25	9 $\frac{1}{4}$	1.3	3.8	5.1
13	27.1	33.0	27	10 $\frac{1}{8}$	1.4	3.8	5.2
14	29.2	35.0	29	11 $\frac{1}{8}$	1.6	3.8	5.4

TABLE III

For Divisor Box Shown in Figure 1

Long box; 4-inch dam; divisor board hinged

24 inches from side of flume; free flow in main channel;

0.1 foot or 1 3-16 inches effective head in divisor channel

Divisor opening in inches	Percent divisor opening is of total width of box	Percent divisor flow is of total flow in box	Width of Divisor opening to give percent- age of flow		Discharge in Second-feet		
			Percent	Inches	Divisor	Channel	Total
Head = 0.4 ft. or 4 13-16 inches							
1	2.1	1.0	2	1 5/8	0.1	3.1	3.2
2	4.2	2.7	4	2 3/4	0.2	3.1	3.3
3	6.3	4.4	6	4	0.2	3.1	3.3
4	8.3	6.1	8	5 1/8	0.3	3.1	3.4
5	10.4	7.8	10	6 1/4	0.4	3.0	3.4
6	12.5	9.6	12	7 3/8	0.4	3.0	3.4
7	14.6	11.3	15	9 1/8	0.5	3.0	3.5
8	16.7	13.1	17	10 1/8	0.6	2.9	3.5
9	18.8	14.9	19	11 1/4	0.7	2.9	3.6
10	20.8	16.7	21	12 1/4	0.7	2.9	3.6
11	22.9	18.5	23	13 3/8	0.8	2.8	3.6
12	25.0	20.4	25	14 3/8	0.9	2.8	3.7
13	27.1	22.3	27	15 1/2	1.0	2.7	3.7
14	29.2	24.2	29	16 1/2	1.0	2.7	3.7
15	31.2	26.2	31	17 1/2	1.1	2.6	3.7
16	33.4	28.1	33	18 5/8	1.2	2.5	3.7
17	35.4	30.0	35	19 5/8	1.2	2.4	3.6
18	37.5	31.9	38	21 1/8	1.3	2.3	3.6
19	39.6	33.8	40	22 1/8	1.4	2.2	3.6
20	41.7	35.8	42	23	1.5	2.1	3.6
21	43.8	37.8	44	24	1.6	2.0	3.6
22	45.8	39.8
23	47.9	41.8
24	50.0	43.9
Head = 0.8 ft. or 9 5/8 inches							
1	2.1	1.4	2	1 1/4	0.1	7.2	7.3
2	4.2	3.2	4	2 1/2	0.3	7.2	7.5
3	6.3	5.0	6	3 5/8	0.4	7.2	7.6
4	8.3	6.8	8	4 3/4	0.6	7.2	7.8
5	10.4	8.5	10	5 7/8	0.8	7.2	8.0
6	12.5	10.2	12	7	1.0	7.2	8.2
7	14.6	12.0	15	8 5/8	1.2	7.1	8.3
8	16.7	13.8	17	9 3/4	1.5	7.1	8.6
9	18.8	15.6	19	10 7/8	1.7	7.1	8.8
10	20.8	17.4	21	11 7/8	1.9	7.0	8.9

TABLE III (Continued)

Divisor opening in inches	Percent divisor opening is of total width of box	Percent divisor flow is of total flow in box	Width of Divisor opening to give percent- age of flow		Discharge in Second-feet		
			Percent	Inches	Divisor	Channel	Total
Head = 0.8 ft. or 9 5/8 inches							
11	22.9	19.3	23	13	2.1	7.0	9.1
12	25.0	21.2	25	14 1/8	2.4	6.9	9.3
13	27.1	23.0	27	15 1/8	2.6	6.9	9.5
14	29.2	24.9	29	16 1/8	2.8	6.8	9.6

TABLE IV

For Divisor Box Shown in Figure 1
 Long box; 4-inch dam; divisor board hinged
 24 inches from side of flume; free flow in divisor channel
 and 0.1 foot or 1 3-16 inches effective head in main channel

Divisor opening in inches	Percent divisor opening is of total width of box	Percent divisor flow is of total flow in box	Width of Divisor opening to give percent- age of flow		Discharge in Second-feet		
			Percent	Inches	Divisor	Channel	Total
Head = 0.4 ft. or 4 13-16 inches							
1	2.1	5.0	2
2	4.2	8.1	4	0 3/4	0.1	2.3	2.4
3	6.3	11.0	6	1 3/8	0.1	2.3	2.4
4	8.3	13.8	8	2	0.2	2.3	2.5
5	10.4	16.6	10	2 5/8	0.2	2.3	2.5
6	12.5	19.3	12	3 3/8	0.3	2.3	2.6
7	14.6	21.8	15	4 3/8	0.4	2.2	2.6
8	16.7	24.3	17	5 1/8	0.5	2.2	2.7
9	18.8	26.5	19	5 7/8	0.5	2.2	2.7
10	20.8	28.7	21	6 3/4	0.6	2.2	2.8
11	22.9	30.9	23	7 1/2	0.6	2.2	2.8
12	25.0	33.0	25	8 3/8	0.7	2.1	2.8
13	27.1	34.9	27	9 1/4	0.8	2.1	2.9
14	29.2	36.8	29	10 1/8	0.9	2.1	3.0
15	31.2	38.7	31	11	0.9	2.1	3.0
16	33.4	40.6	33	12	1.0	2.0	3.0
17	35.4	42.4	35	13	1.1	2.0	3.1
18	37.5	44.2	38	14 5/8	1.2	1.9	3.1

TABLE IV (Continued)

Divisor opening in inches	Percent divisor opening is of total width of box	Percent divisor flow is of total flow in box	Width of Divisor opening to give percent- age of flow		Discharge in Second-feet		
			Percent	Inches	Divisor	Channel	Total
Head = 0.4 ft. or 4 13-16 inches							
19	39.6	46.0	40	15 $\frac{3}{4}$	1.3	1.9	3.2
20	41.7	47.8	42	16 $\frac{3}{4}$	1.4	1.9	3.3
21	43.8	49.6	44	17 $\frac{7}{8}$	1.5	1.8	3.3
22	45.8	51.3	46	19	1.6	1.8	3.4
23	47.9	53.0	48	20 $\frac{1}{8}$	1.7	1.7	3.4
24	50.0	54.7	50	21 $\frac{1}{4}$	1.7	1.7	3.4
Head = 0.8 ft. or 9 $\frac{5}{8}$ inches							
1	2.1	5.2
2	4.2	10.0	4	0 $\frac{3}{4}$	0.2	4.9	5.1
3	6.3	14.3	6	1 $\frac{1}{8}$	0.3	4.7	5.0
4	8.3	18.3	8	1 $\frac{5}{8}$	0.4	4.6	5.0
5	10.4	22.0	10	2	0.5	4.5	5.0
6	12.5	25.4	12	2 $\frac{1}{2}$	0.6	4.3	4.9
7	14.6	28.3	15	3 $\frac{1}{8}$	0.7	4.2	4.9
8	16.7	31.0	17	3 $\frac{5}{8}$	0.8	4.1	4.9
9	18.8	33.5	19	4 $\frac{1}{8}$	0.9	4.0	4.9
10	20.8	35.7	21	4 $\frac{3}{4}$	1.0	3.9	4.9
11	22.9	37.8	23	5 $\frac{1}{4}$	1.1	3.9	5.0
12	25.0	39.7	25	5 $\frac{7}{8}$	1.3	3.8	5.1
13	27.1	41.5	27	6 $\frac{1}{2}$	1.4	3.8	5.2
14	29.2	43.2	29	7 $\frac{1}{4}$	1.5	3.8	5.3

TABLE V

For Divisor Box Shown in Figure 2
Long box; no dam; divisor board hinged 24
inches from side of flume; free flow in both channels

Divisor opening in inches	Percent divisor opening is of total width of box	Percent divisor flow is of total flow in box	Width of Divisor opening to give percent- age of flow		Discharge in Second-feet		
			Percent	Inches	Divisor	Channel	Total
Head = 0.2 ft. or 2 $\frac{3}{8}$ inches							
1	2.1	8.9	2
2	4.2	11.7	4
3	6.3	14.4	6
4	8.3	17.2	8
5	10.4	19.7	10	1 $\frac{3}{8}$	0.1	0.6	0.7
6	12.5	22.2	12	2 $\frac{1}{8}$	0.1	0.6	0.7

TABLE V (Continued)

Divisor opening in inches	Percent divisor opening is of total width of box	Percent divisor flow is of total flow in box	Width of Divisor opening to give percent- age of flow		Discharge in Second-feet		
			Percent	Inches	Divisor	Channel	Total
Head = 0.2 ft. or 2 3/8 inches							
7	14.6	24.6	15	3 1/4	0.1	0.6	0.7
8	16.7	26.7	17	4	0.1	0.6	0.7
9	18.8	28.7	19	4 3/4	0.1	0.6	0.7
10	20.8	30.6	21	5 1/2	0.2	0.6	0.8
11	22.9	32.4	23	6 3/8	0.2	0.6	0.8
12	25.0	34.1	25	7 1/4	0.2	0.6	0.8
13	27.1	35.6	27	8 1/8	0.2	0.6	0.8
14	29.2	37.1	29	9 1/8	0.3	0.6	0.9
15	31.2	38.4	31	10 1/4	0.3	0.6	0.9
16	33.4	39.7	33	11 3/8	0.3	0.6	0.9
17	35.4	40.8	35	12 5/8	0.3	0.6	0.9
18	37.5	41.9	38	14 5/8	0.4	0.7	1.1
19	39.6	42.8	40	16 1/4	0.4	0.7	1.1
20	41.7	43.6	42	18 1/8	0.5	0.7	1.2
21	43.8	44.3	44	20 5/8	0.5	0.7	1.2
22	45.8	44.9	46	24	0.6	0.7	1.3
23	47.9	45.4
24	50.0	45.9
Head = 0.4 ft. or 4 13-16 inches							
1	2.1	6.8	2
2	4.2	9.6	4
3	6.3	12.4	6	0 3/4	0.1	1.6	1.7
4	8.3	15.1	8	1 1/2	0.1	1.6	1.7
5	10.4	17.9	10	2 1/8	0.2	1.7	1.9
6	12.5	20.6	12	2 3/4	0.2	1.7	1.9
7	14.6	22.9	15	3 7/8	0.3	1.7	2.0
8	16.7	25.2	17	4 5/8	0.4	1.7	2.1
9	18.8	27.4	19	5 3/8	0.4	1.7	2.1
10	20.8	29.5	21	6 1/4	0.5	1.7	2.2
11	22.9	31.4	23	7	0.5	1.8	2.3
12	25.0	33.3	25	7 7/8	0.6	1.8	2.4
13	27.1	35.0	27	8 3/4	0.6	1.8	2.4
14	29.2	36.6	29	9 3/4	0.7	1.8	2.5
15	31.2	38.0	31	10 3/4	0.8	1.8	2.6
16	33.4	39.3	33	11 7/8	0.9	1.9	2.8
17	35.4	40.5	35	13	1.0	1.9	2.9
18	37.5	41.6	38	15	1.1	1.9	3.0
19	39.6	42.5	40	16 1/2	1.2	2.0	3.2
20	41.7	43.3	42	18 1/2	1.4	2.0	3.4
21	43.8	44.1	44	21	1.6	2.0	3.6
22	45.8	44.7	45	22 1/2	1.7	2.1	3.8
23	47.9	45.3
24	50.0	45.8

TABLE V (Continued)

Divisor opening in inches	Percent divisor opening is of total width of box	Percent divisor flow is of total flow in box	Width of Divisor opening to give percent- age of flow		Discharge in Second-feet		
			Percent	Inches	Divisor	Channel	Total
Head = 0.6 ft. or 7 3-16 inches							
1	2.1	6.3	2
2	4.2	9.2	4
3	6.3	12.1	6	0 7/8	0.2	3.0	3.2
4	8.3	14.8	8	1 5/8	0.2	3.0	3.2
5	10.4	17.5	10	2 1/4	0.3	3.0	3.3
6	12.5	20.2	12	3	0.4	3.0	3.4
7	14.6	22.6	15	4	0.5	3.1	3.6
8	16.7	24.9	17	4 3/4	0.7	3.1	3.8
9	18.8	27.1	19	5 1/2	0.8	3.1	3.9
10	20.8	29.2	21	6 3/8	0.9	3.1	4.0
11	22.9	31.1	23	7 1/4	1.0	3.2	4.2
12	25.0	32.9	25	8	1.1	3.2	4.3
13	27.1	34.7	27	9	1.3	3.2	4.5
14	29.2	36.3	29	10	1.4	3.2	4.6
15	31.2	37.7	31	11	1.5	3.3	4.8
16	33.4	39.1	33	12	1.7	3.3	5.0
17	35.4	40.2	35	13 1/4	1.9	3.3	5.2
18	37.5	41.3	38	15 1/4	2.1	3.4	5.5
19	39.6	42.2	40	16 3/4	2.3	3.4	5.7
20	41.7	43.1	42	18 3/4	2.6	3.5	6.1
21	43.8	43.8	44	21 1/4	2.9	3.5	6.4
22	45.8	44.5	45	22 7/8	3.1	3.6	6.7
23	47.9	45.1
24	50.0	45.7
Head = 0.8 ft. or 9 5/8 inches							
1	2.1	6.3	2
2	4.2	8.8	4
3	6.3	11.7	6	1	0.3	4.6	4.9
4	8.3	14.6	8	1 5/8	0.4	4.6	5.0
5	10.4	17.2	10	2 3/8	0.5	4.7	5.2
6	12.5	19.8	12	3 1/8	0.7	4.7	5.4
7	14.6	22.2	15	4 1/8	0.9	4.8	5.7
8	16.7	24.6	17	5	1.1	4.8	5.9
9	18.8	26.8	19	5 3/4	1.2	4.8	6.0
10	20.8	28.8	21	6 1/2	1.3	4.9	6.2
11	22.9	30.8	23	7 1/4	1.5	4.9	6.4
12	25.0	32.7	25	8 1/8	1.7	5.0	6.7
13	27.1	34.4	27	9 1/8	1.9	5.0	6.9
14	29.2	36.1	29	10 1/8	2.1	5.1	7.2
15	31.2	37.6	31	11 1/8	2.3	5.1	7.4
16	33.4	38.8	33	12 1/8	2.5	5.2	7.7

TABLE V (Continued)

Divisor opening in inches	Percent divisor opening is of total width of box	Percent divisor flow is of total flow in box	Width of Divisor opening to give percent- age of flow		Discharge in Second-feet		
			Percent	Inches	Divisor	Channel	Total
Head = 1.0 ft. or 12 inches							
1	2.1	5.7	2
2	4.2	8.7	4
3	6.3	11.5	6	1 1/8	0.4	6.4	6.8
4	8.3	14.2	8	1 3/4	0.6	6.5	7.1
5	10.4	16.9	10	2 1/2	0.7	6.5	7.2
6	12.5	19.5	12	3 1/4	0.9	6.6	7.5
7	14.6	22.0	15	4 1/4	1.2	6.7	7.9
8	16.7	24.4	17	5	1.4	6.8	8.2
9	18.8	26.6	19	5 3/4	1.7	6.8	8.5
10	20.8	28.7	21	6 5/8	1.9	6.9	8.8
11	22.9	30.7	23	7 3/8	2.1	7.0	9.1
12	25.0	32.5	25	8 1/4	2.4	7.1	9.5

TABLE VI

For Divison Box Shown in Figure 2
 Long box; no dam; divisor board hinged 24
 inches from side of flume; 0.1 ft. or 1 3-16
 inch effective head in both channels

Divisor opening in inches	Percent divisor opening is of total width of box	Percent divisor flow is of total flow in box	Width of Divisor opening to give percent- age of flow		Discharge in Second-feet		
			Percent	Inches	Divisor	Channel	Total
Head = 0.4 ft. or 4 13-16 inches							
1	2.1	4.0	2
2	4.2	7.3	4	1	0.1	1.5	1.6
3	6.3	10.6	6	1 5/8	0.1	1.5	1.6
4	8.3	13.8	8	2 1/4	0.2	1.6	1.8
5	10.4	16.7	10	2 3/4	0.2	1.6	1.8
6	12.5	19.5	12	3 3/8	0.2	1.6	1.8
7	14.6	22.1	15	4 3/8	0.3	1.6	1.9
8	16.7	24.5	17	5 1/8	0.4	1.6	2.0
9	18.8	26.8	19	5 3/4	0.4	1.6	2.0
10	20.8	28.9	21	6 5/8	0.5	1.7	2.2
11	22.9	31.0	23	7 3/8	0.5	1.7	2.2
12	25.0	33.0	25	8 1/4	0.6	1.7	2.3
13	27.1	34.8	27	9 1/8	0.7	1.7	2.4
14	29.2	36.6	29	10	0.7	1.7	2.4
Head = 0.8 ft. or 9 5/8 inches							
1	2.1	4.0	2
2	4.2	7.7	4	1	0.1	3.2	3.3
3	6.3	11.2	6	1 1/2	0.2	3.3	3.5
4	8.3	14.6	8	2 1/8	0.3	3.3	3.6
5	10.4	18.0	10	2 5/8	0.4	3.4	3.8

TABLE VI (Continued)

Divisor opening in inches	Percent divisor opening is of total width of box	Percent divisor flow is of total flow in box	Width of Divisor opening to give percent- age of flow		Discharge in Second-feet		
			Percent	Inches	Divisor	Channel	Total
Head = 0.8 ft. or 9 $\frac{5}{8}$ inches							
6	12.5	21.2	12	3 $\frac{1}{4}$	0.5	3.4	3.9
7	14.6	24.3	15	4 $\frac{1}{8}$	0.7	3.5	4.2
8	16.7	27.1	17	4 $\frac{3}{4}$	0.9	3.5	4.4
9	18.8	29.8	19	5 $\frac{1}{4}$	1.0	3.6	4.6
10	20.8	32.4	21	5 $\frac{7}{8}$	1.1	3.6	4.7
11	22.9	34.8	23	6 $\frac{5}{8}$	1.2	3.7	4.9
12	25.0	37.1	25	7 $\frac{1}{4}$	1.4	3.7	5.1
13	27.1	39.3	27	8	1.5	3.8	5.3
14	29.2	41.3	29	8 $\frac{5}{8}$	1.6	3.8	5.4

TABLE VII

For Divisor Shown in Figure 2
 Long box; no dam; divisor board hinged 24 inches
 from side of flume: 0.1 ft. or 1 3-16 inches
 effective head in divisor channel,
 and free flow in main channel

Divisor opening in inches	Percent divisor opening is of total width of box	Percent divisor flow is of total flow in box	Width of Divisor opening to give percent- age of flow		Discharge in Second-feet		
			Percent	Inches	Divisor	Channel	Total
Head = 0.4 ft. or 4 13-16 inches							
1	2.1	4.7	2
2	4.2	7.5	4	0 $\frac{3}{4}$	0.1	1.6	1.7
3	6.3	10.2	6	1 $\frac{1}{2}$	0.1	1.6	1.7
4	8.3	12.9	8	2 $\frac{1}{4}$	0.2	1.7	1.9
5	10.4	15.6	10	2 $\frac{7}{8}$	0.2	1.7	1.9
6	12.5	18.3	12	3 $\frac{5}{8}$	0.3	1.7	2.0
7	14.6	20.8	15	4 $\frac{3}{4}$	0.3	1.7	2.0
8	16.7	23.3	17	5 $\frac{1}{2}$	0.4	1.7	2.1
9	18.8	25.7	19	6 $\frac{1}{4}$	0.4	1.7	2.1
10	20.8	27.9	21	7 $\frac{1}{8}$	0.5	1.8	2.3
11	22.9	30.1	23	7 $\frac{7}{8}$	0.6	1.8	2.4
12	25.0	32.2	25	8 $\frac{3}{4}$	0.6	1.8	2.4
13	27.1	34.2	27	9 $\frac{5}{8}$	0.7	1.8	2.5
14	29.2	36.1	29	10 $\frac{1}{2}$	0.8	1.8	2.6
Head = 0.8 ft. or 9 $\frac{5}{8}$ inches							
1	2.1	4.0	2
2	4.2	6.9	4	1	0.2	4.6	4.8
3	6.3	9.8	6	1 $\frac{3}{4}$	0.3	4.6	4.9
4	8.3	12.6	8	2 $\frac{3}{8}$	0.5	4.7	5.2
5	10.4	15.4	10	3	0.6	4.7	5.3

TABLE VII (Continued)

Divisor opening in inches	Percent divisor opening is of total width of box	Percent divisor flow is of total flow in box	Width of Divisor opening to give percent- age of flow		Discharge in Second-feet		
			Percent	Inches	Divisor	Channel	Total
Head = 0.8 ft. or 9 5/8 inches							
6	12.5	18.0	12	3 3/4	0.7	4.7	5.4
7	14.6	20.5	15	4 7/8	0.9	4.8	5.7
8	16.7	23.0	17	5 5/8	1.0	4.8	5.8
9	18.8	25.4	19	6 3/8	1.2	4.9	6.1
10	20.8	27.8	21	7 1/4	1.4	4.9	6.3
11	22.9	30.2	23	8	1.5	4.9	6.4
12	25.0	32.4	25	8 3/4	1.7	5.0	6.7
13	27.1	34.7	27	9 5/8	1.9	5.0	6.9
14	29.2	36.9	29	10 1/2	2.0	5.1	7.1

TABLE VIII

For Divisor Shown in Figure 2
 Long box; no dam; divisor board hinged 24 inches
 from side of flume; 0.1 ft. or 1 3-16 inches
 effective head in main channel,
 and free flow in divisor channel

Divisor opening in inches	Percent divisor opening is of total width of box	Percent divisor flow is of total flow in box	Width of Divisor opening to give percent- age of flow		Discharge in Second-feet		
			Percent	Inches	Divisor	Channel	Total
Head = 0.4 ft. or 4 13-16 inches							
1	2.1	4.0	2
2	4.2	7.3	4	1	0.1	1.5	1.6
3	6.3	10.6	6	1 5/8	0.1	1.5	1.6
4	8.3	13.7	8	2 1/4	0.2	1.6	1.8
5	10.4	16.6	10	2 3/4	0.2	1.6	1.8
6	12.5	19.3	12	3 1/2	0.3	1.6	1.9
7	14.6	21.9	15	4 3/8	0.3	1.6	1.9
8	16.7	24.3	17	5 1/8	0.4	1.6	2.0
9	18.8	26.4	19	5 7/8	0.4	1.6	2.0
10	20.8	28.5	21	6 5/8	0.5	1.6	2.1
11	22.9	30.4	23	7 1/2	0.5	1.7	2.2
12	25.0	32.2	25	8 3/8	0.6	1.7	2.3
13	27.1	33.8	27	9 1/4	0.7	1.7	2.4
14	29.2	35.3	29	10 1/4	0.8	1.7	2.5
15	31.2	36.7	31	11 3/8	0.8	1.8	2.6
16	33.4	38.0	33	12 1/2	0.9	1.8	2.7
17	35.4	39.3	35	13 3/4	1.0	1.8	2.8
18	37.5	40.5	38	16	1.2	1.9	3.1

TABLE VIII (Continued)

Divisor opening in inches	Percent divisor opening is of total width of box	Percent divisor flow is of total flow in box	Width of Divisor opening to give percent- age of flow		Discharge in Second-feet		
			Percent	Inches	Divisor	Channel	Total
Head = 0.4 ft. or 4 13-16 inches							
19	39.6	41.6	40	17 5/8	1.3	1.9	3.2
20	41.7	42.6	42	19 3/8	1.4	1.9	3.3
21	43.8	43.6	44	21 3/8	1.6	2.0	3.6
22	45.8	44.6	46	23 1/2	1.7	2.0	3.7
23	47.9	45.6
24	50.0	46.5
Head = 0.8 ft. or 9 5/8 inches							
1	2.1	5.0	2
2	4.2	10.0	4	0 3/4	0.1	3.2	3.3
3	6.3	14.3	6	1 1/4	0.3	3.2	3.5
4	8.3	18.2	8	1 5/8	0.3	3.3	3.6
5	10.4	21.7	10	2	0.4	3.3	3.7
6	12.5	24.7	12	2 1/2	0.5	3.3	3.8
7	14.6	27.4	15	3 1/4	0.6	3.4	4.0
8	16.7	29.8	17	3 5/8	0.7	3.4	4.1
9	18.8	32.0	19	4 1/4	0.8	3.5	4.3
10	20.8	34.0	21	4 3/4	1.0	3.5	4.5
11	22.9	35.8	23	5 3/8	1.1	3.6	4.7
12	25.0	37.5	25	6 1/8	1.2	3.6	4.8
13	27.1	38.9	27	6 7/8	1.4	3.7	5.1
14	29.2	40.3	29	7 5/8	1.6	3.8	5.4

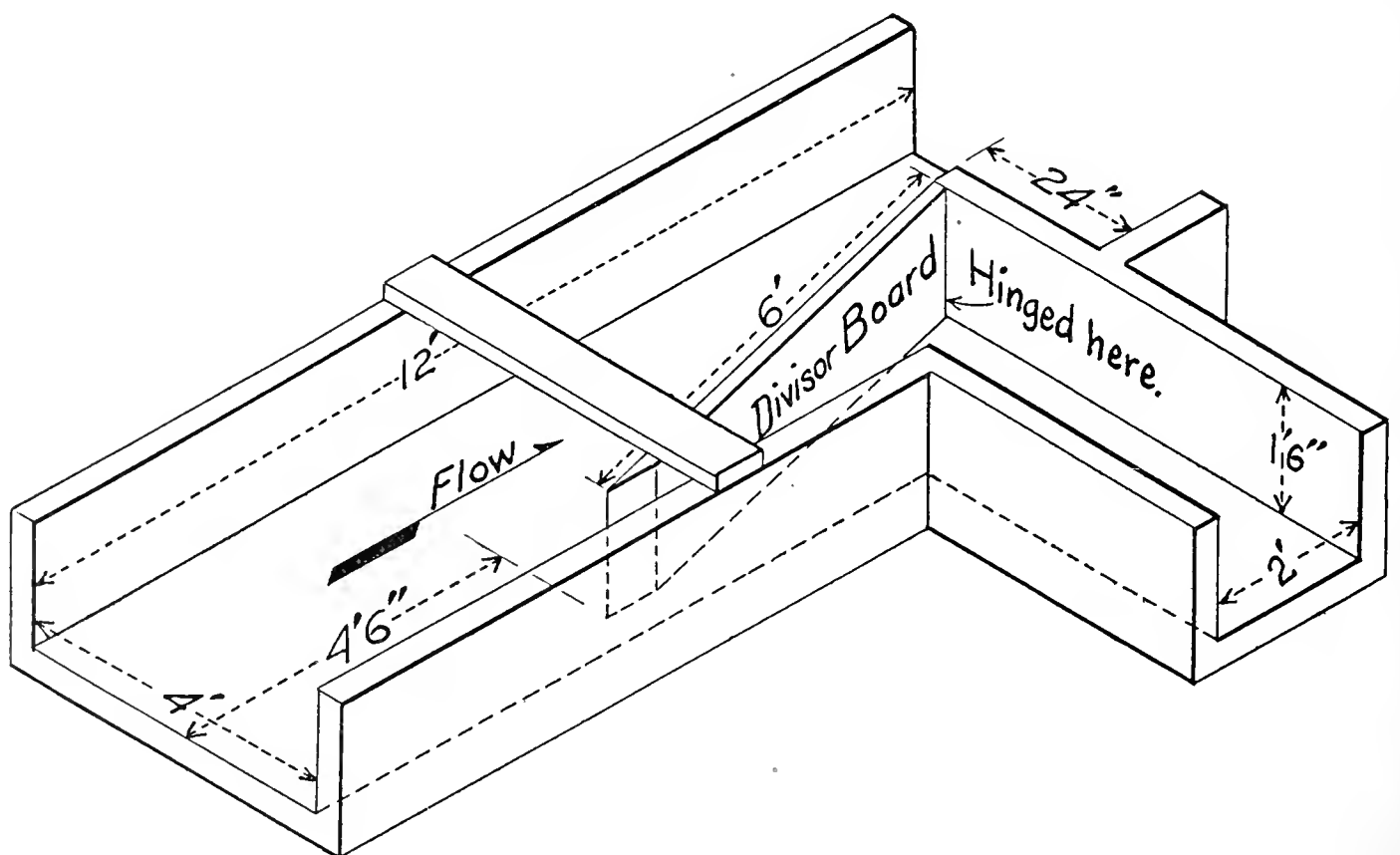

Fig. 2

TABLE IX
 For Divisor Box Shown in Figure 3
 Short box; 4-inch dam; divisor board hinged 24
 inches from side of flume; free flow in both channels

Divisor opening in inches	Percent divisor opening is of total width of box	Percent divisor flow is of total flow in box	Width of Divisor opening to give percent- age of flow		Discharge in Second-feet		
			Percent	Inches	Divisor	Channel	Total
Head = 0.2 ft. or 2 3/8 inches							
1	2.1	2.0
2	4.2	4.0	4	2
3	6.3	6.0	6	3	0.1	1.1	1.2
4	8.3	8.0	8	4	0.1	1.1	1.2
5	10.4	10.0	10	5	0.1	1.1	1.2
6	12.5	12.0	12	6	0.2	1.0	1.2
7	14.6	14.0	15	7 1/2	0.2	1.0	1.2
8	16.7	16.1	17	8 3/8	0.2	1.0	1.2
9	18.8	18.2	19	9 3/8	0.2	1.0	1.2
10	20.8	20.2	21	10 3/8	0.3	0.9	1.2
11	22.9	22.3	23	11 3/8	0.3	0.9	1.2
12	25.0	24.3	25	12 1/4	0.3	0.9	1.2
13	27.1	26.4	27	13 1/4	0.3	0.9	1.2
14	29.2	28.5	29	14 1/4	0.4	0.8	1.2
15	31.2	30.6	31	15 1/4	0.4	0.8	1.2
16	33.4	32.7	33	16 1/8	0.4	0.8	1.2
17	35.4	34.7	35	17 1/8	0.4	0.8	1.2
18	37.5	36.8	38	18 1/2	0.5	0.7	1.2
19	39.6	39.0	40	19 1/2	0.5	0.7	1.2
20	41.7	41.1	42	20 3/8	0.5	0.7	1.2
21	43.8	43.2	44	21 3/8	0.5	0.7	1.2
22	45.8	45.3	46	22 1/4	0.5	0.7	1.2
23	47.9	47.4	48	23 1/4	0.6	0.6	1.2
24	50.0	49.6	50	24 1/4	0.6	0.6	1.2
Head = 0.4 ft. or 4 13-16 inches							
1	2.1	1.8	2	1 1/8	0.1	2.9	3.0
2	4.2	3.6	4	2 1/4	0.1	2.9	3.0
3	6.3	5.5	6	3 1/4	0.2	2.9	3.1
4	8.3	7.4	8	4 3/8	0.3	2.8	3.1
5	10.4	9.3	10	5 3/8	0.3	2.8	3.1
6	12.5	11.2	12	6 3/8	0.4	2.8	3.2
7	14.6	13.2	15	7 7/8	0.5	2.7	3.2
8	16.7	15.2	17	8 7/8	0.5	2.7	3.2
9	18.8	17.2	19	9 7/8	0.6	2.6	3.2
10	20.8	19.2	21	10 7/8	0.7	2.6	3.3
11	22.9	21.3	23	11 3/4	0.7	2.6	3.3
12	25.0	23.4	25	12 3/4	0.8	2.5	3.3
13	27.1	25.6	27	13 5/8	0.9	2.4	3.3
14	29.2	27.7	29	14 5/8	0.9	2.4	3.3
15	31.2	29.9	31	15 1/2	1.0	2.3	3.3
16	33.4	32.1	33	16 3/8	1.1	2.2	3.3
17	35.4	34.3	35	17 3/8	1.1	2.2	3.3
18	37.5	36.5	38	18 5/8	1.2	2.1	3.3

TABLE IX (Continued)

Divisor opening in inches	Percent divisor opening is of total width of box	Percent divisor flow is of total flow in box	Width of Divisor opening to give percent- age of flow		Discharge in Second-feet		
			Percent	Inches	Divisor	Channel	Total
Head = 0.4 ft. or 4 13-16 inches							
19	39.6	38.7	40	19 $\frac{5}{8}$	1.3	2.0	3.3
20	41.7	40.9	42	20 $\frac{1}{2}$	1.4	1.9	3.3
21	43.8	43.2	44	21 $\frac{3}{8}$	1.4	1.9	3.3
22	45.8	45.3	46	22 $\frac{1}{4}$	1.5	1.8	3.3
23	47.9	47.5	48	23 $\frac{1}{4}$	1.6	1.7	3.3
24	50.0	49.7	50	24 $\frac{1}{8}$	1.7	1.7	3.4
Head = 0.8 ft. or 9 $\frac{5}{8}$ inches							
1	2.1	2.5	2	0 $\frac{3}{4}$	0.1	6.6	6.7
2	4.2	4.6	4	1 $\frac{3}{4}$	0.3	6.6	6.9
3	6.3	6.7	6	2 $\frac{5}{8}$	0.4	6.6	7.0
4	8.3	8.8	8	3 $\frac{5}{8}$	0.6	6.5	7.1
5	10.4	10.9	10	4 $\frac{1}{2}$	0.7	6.5	7.2
6	12.5	13.1	12	5 $\frac{1}{2}$	0.9	6.5	7.4
7	14.6	15.2	15	7	1.2	6.4	7.6
8	16.7	17.3	17	7 $\frac{7}{8}$	1.3	6.4	7.7
9	18.8	19.4	19	8 $\frac{7}{8}$	1.5	6.3	7.8
10	20.8	21.5	21	9 $\frac{3}{4}$	1.7	6.3	8.0
11	22.9	23.6	23	10 $\frac{3}{4}$	1.9	6.2	8.1
12	25.0	25.7	25	11 $\frac{5}{8}$	2.0	6.2	8.2
13	27.1	27.7	27	12 $\frac{5}{8}$	2.2	6.1	8.3
14	29.2	29.8	29	13 $\frac{5}{8}$	2.4	6.0	8.4

TABLE X

For Divisor Box Shown in Figure 3
Short box; 4-inch dam; divisor board hinged 24
inches from side of flume, 0.1 ft. or 1 3-16 inches
effective in both channels

Divisor opening in inches	Percent divisor opening is of total width of box	Percent divisor flow is of total flow in box	Width of Divisor opening to give percent- age of flow		Discharge in Second-feet		
			Percent	Inches	Divisor	Channel	Total
Head = 0.4 ft. or 4 13-16 inches							
1	2.1	1.3	2	1 $\frac{1}{2}$	0.1	2.1	2.2
2	4.2	2.7	4	2 $\frac{5}{8}$	0.1	2.1	2.2
3	6.3	4.5	6	3 $\frac{3}{4}$	0.1	2.1	2.2
4	8.3	6.4	8	4 $\frac{3}{4}$	0.2	2.1	2.3
5	10.4	8.4	10	5 $\frac{3}{4}$	0.2	2.1	2.3
6	12.5	10.4	12	6 $\frac{3}{4}$	0.3	2.1	2.4

TABLE X (Continued)

Divisor opening in inches	Percent divisor opening is of total width of box	Percent divisor flow is of total flow in box	Width of Divisor opening to give percent- age of flow		Discharge in Second-feet		
			Percent	Inches	Divisor	Channel	Total
Head = 0.4 ft. or 4 13-16 inches							
7	14.6	12.5	15	8 1/4	0.4	2.0	2.4
8	16.7	14.6	17	9 1/8	0.4	2.0	2.4
9	18.8	16.7	19	10 1/8	0.4	2.0	2.4
10	20.8	18.8	21	11	0.5	1.9	2.4
11	22.9	20.9	23	12	0.5	1.9	2.4
12	25.0	23.0	25	13	0.6	1.8	2.4
13	27.1	25.1	27	13 7/8	0.6	1.8	2.4
14	29.2	27.2	29	14 7/8	0.7	1.8	2.5
15	31.2	29.3	31	15 7/8	0.8	1.7	2.5
16	33.4	31.3	33	16 3/4	0.8	1.7	2.5
17	35.4	33.4	35	17 3/4	0.9	1.6	2.5
18	37.5	35.6	38	19 1/8	0.9	1.6	2.5
19	39.6	37.7	40	20	1.0	1.5	2.5
20	41.7	39.9	42	21	1.0	1.5	2.5
21	43.8	42.0	44	21 7/8	1.1	1.4	2.5
22	45.8	44.2	46	22 7/8	1.2	1.3	2.5
23	47.9	46.3	48	23 3/4	1.2	1.3	2.5
24	50.0	48.4	50	24 7/8	1.3	1.2	2.5

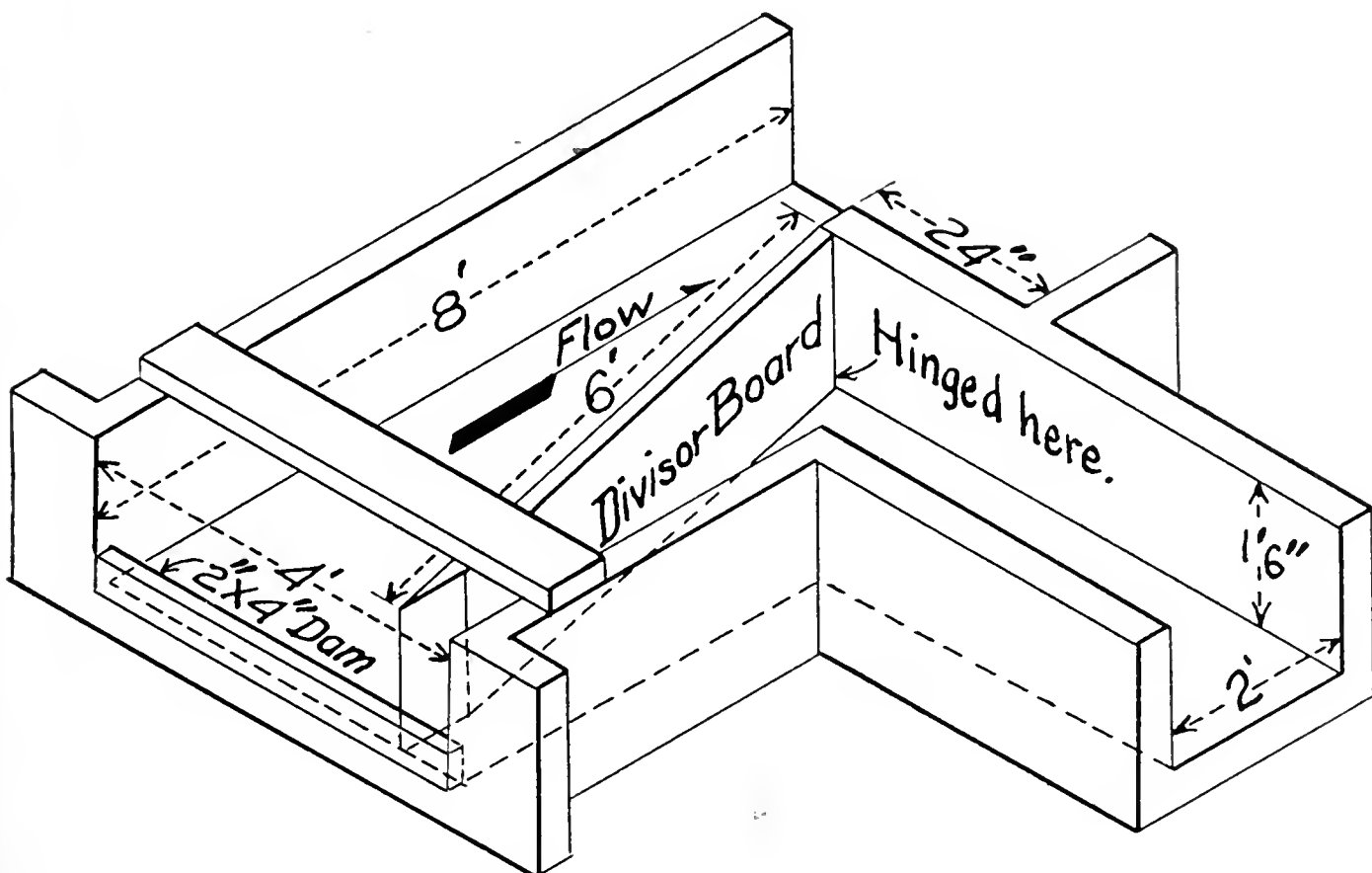

Fig. 3

TABLE X (Continued)

Divisor opening in inches	Percent divisor opening is of total width of box	Percent divisor flow is of total flow in box	Width of Divisor opening to give percent- age of flow		Discharge in Second-feet		
			Percent	Inches	Divisor	Channel	Total
Head = 0.8 ft. or 9 5/8 inches							
1	2.1	1.7	2	1 1/8	0.1	3.7	3.8
2	4.2	3.4	4	2 3/8	0.2	3.8	4.0
3	6.3	5.2	6	3 3/8	0.3	3.9	4.2
4	8.3	7.0	8	4 1/2	0.4	3.9	4.3
5	10.4	9.0	10	5 1/2	0.5	3.9	4.4
6	12.5	10.9	12	6 1/2	0.6	3.9	4.5
7	14.6	12.9	15	8	0.7	3.9	4.6
8	16.7	14.9	17	9	0.8	3.9	4.7
9	18.8	17.0	19	10	0.9	3.8	4.7
10	20.8	19.0	21	10 7/8	1.0	3.7	4.7
11	22.9	21.1	23	11 7/8	1.1	3.6	4.7
12	25.0	23.2	25	12 7/8	1.2	3.6	4.8
13	27.1	25.3	27	13 3/4	1.3	3.5	4.8
14	29.2	27.4	29	14 3/4	1.5	3.4	4.9

TABLE XI

For Divisor Box Shown in Figure 3
 Short box; 4-inch dam; divisor board hinged 24
 inches from side of flume; free flow in main channel;
 0.1 ft. or 1 3-16 inches effective head in divisor channel

Divisor opening in inches	Percent divisor opening is of total width of box	Percent divisor flow is of total flow in box	Width of Divisor opening to give percent- age of flow		Discharge in Second-feet		
			Percent	Inches	Divisor	Channel	Total
Head = 0.4 ft. or 4 13-16 inches							
1	2.1	1.0	2	2	0.1	2.9	3.0
2	4.2	2.0	4	3 7/8	0.1	2.9	3.0
3	6.3	3.0	6	5 1/2	0.2	2.8	3.0
4	8.3	4.1	8	7	0.3	2.7	3.0
5	10.4	5.3	10	8 1/4	0.3	2.8	3.1
6	12.5	6.7	12	9 1/2	0.4	2.7	3.1
7	14.6	8.1	15	11 1/4	0.5	2.6	3.1
8	16.7	9.6	17	12 3/8	0.5	2.6	3.1
9	18.8	11.1	19	13 1/2	0.6	2.5	3.1
10	20.8	12.7	21	14 5/8	0.7	2.4	3.1
11	22.9	14.4	23	15 5/8	0.7	2.4	3.1
12	25.0	16.2	25	16 5/8	0.7	2.3	3.0
13	27.1	18.0	27	17 5/8	0.8	2.2	3.0
14	29.2	19.8	29	18 5/8	0.9	2.1	3.0
15	31.2	21.8	31	19 5/8	0.9	2.1	3.0
16	33.4	23.8	33	20 1/2	1.0	2.0	3.0
17	35.4	25.8	35	21 1/2	1.0	2.0	3.0
18	37.5	27.8	38	22 7/8	1.1	1.8	2.9

TABLE XI (Continued)

Divisor opening in inches	Percent divisor opening is of total width of box	Percent divisor flow is of total flow in box	Width of Divisor opening to give percent- age of flow		Discharge in Second-feet		
			Percent	Inches	Divisor	Channel	Total
Head = 0.4 ft. or 4 13-16 inches							
19	39.6	29.8	40	23 3/4	1.2	1.7	2.9
20	41.7	31.9	42	24 5/8	1.2	1.7	2.9
21	43.8	34.0
22	45.8	36.1
23	47.9	37.3
24	50.0	40.5
Head = 0.8 ft. or 9 5/8 inches							
1	2.1	...	2	3 3/4	0.1	6.5	6.6
2	4.2	1.0	4	5 5/8	0.3	6.5	6.8
3	6.3	1.5	6	7 1/8	0.4	6.4	6.8
4	8.3	2.4	8	8 5/8	0.5	6.4	6.9
5	10.4	3.3	10	9 7/8	0.7	6.3	7.0
6	12.5	4.5	12	11	0.8	6.2	7.0
7	14.6	5.7	15	12 3/4	1.1	6.1	7.2
8	16.7	7.2	17	13 7/8	1.2	6.0	7.2
9	18.8	8.7	19	14 7/8	1.4	5.9	7.3
10	20.8	10.3
11	22.9	11.9
12	25.0	13.7
13	27.1	15.5
14	29.2	17.3

TABLE XII

For Divisor Box Shown in Figure 3

Short box; 4-inch dam; divisor board hinged 24
inches from side of flume; free flow in divisor channel;
0.1 ft. or 1 3-16 inches effective head in main channel

Divisor opening in inches	Percent divisor opening is of total width of box	Percent divisor flow is of total flow in box	Width of Divisor opening to give percent- age of flow		Discharge in Second-feet		
			Percent	Inches	Divisor	Channel	Total
Head = 0.4 ft. or 4 13-16 inches							
1	2.1	3.7	2
2	4.2	6.2	4	1 1/8	0.1	2.2	2.3
3	6.3	8.7	6	1 7/8	0.1	2.2	2.3
4	8.3	11.2	8	2 3/4	0.2	2.1	2.3
5	10.4	13.7	10	3 1/2	0.2	2.2	2.4
6	12.5	16.2	12	4 1/4	0.3	2.1	2.4

TABLE XII (Continued)

Divisor opening in inches	Percent divisor opening is of total width of box	Percent divisor flow is of total flow in box	Width of Divisor opening to give percent- age of flow		Discharge in Second-feet		
			Percent	Inches	Divisor	Channel	Total
Head = 0.4 ft. or 4 13-16 inches							
7	14.6	17.7	15	5 1/2	0.4	2.1	2.5
8	16.7	21.2	17	6 1/4	0.4	2.1	2.5
9	18.8	23.7	19	7 1/8	0.5	2.0	2.5
10	20.8	26.2	21	7 7/8	0.6	2.0	2.6
11	22.9	28.6	23	8 3/4	0.6	2.0	2.6
12	25.0	30.9	25	9 1/2	0.6	2.0	2.6
13	27.1	33.3	27	10 3/8	0.7	2.0	2.7
14	29.2	35.7	29	11 1/4	0.8	1.9	2.7
15	31.2	38.0	31	12	0.8	1.9	2.7
16	33.4	40.3	33	12 7/8	0.9	1.8	2.7
17	35.4	42.5	35	13 3/4	0.9	1.8	2.7
18	37.5	44.7	38	15	1.0	1.8	2.8
19	39.6	46.9	40	15 7/8	1.1	1.7	2.8
20	41.7	49.1	42	16 3/4	1.2	1.6	2.8
21	43.8	51.3	44	17 3/4	1.2	1.6	2.8
22	45.8	53.5	46	18 5/8	1.3	1.5	2.8
23	47.9	55.6	48	19 1/2	1.4	1.5	2.9
24	50.0	57.7	50	20 1/2	1.4	1.5	2.9
Head = 0.8 ft. or 9 5/8 inches							
1	2.1	6.6	2
2	4.2	9.9	4
3	6.3	13.2	6	0 7/8	0.2	3.7	3.9
4	8.3	16.4	8	1 3/8	0.3	3.8	4.1
5	10.4	19.5	10	2	0.4	3.8	4.2
6	12.5	22.4	12	2 5/8	0.5	3.9	4.4
7	14.6	25.3	15	3 5/8	0.7	3.9	4.6
8	16.7	28.1	17	4 1/4	0.8	3.9	4.7
9	18.8	30.7	19	4 7/8	0.9	3.9	4.8
10	20.8	33.3	21	5 1/2	1.0	3.9	4.9
11	22.9	35.8	23	6 1/4	1.2	3.9	5.1
12	25.0	38.2	25	6 7/8	1.3	3.9	5.2
13	27.1	40.5	27	7 5/8	1.4	3.9	5.3
14	29.2	42.8	29	8 3/8	1.5	3.9	5.4

TABLE XIII

For Divisor Box Shown in Figure 4
 Short box; floor flush with top of 4-inch dam;
 divisor board hinged 24 inches from side of flume;
 free flow in both channels.

Divisor opening in inches	Percent divisor opening is of total width of box	Percent divisor flow is of total flow in box	Width of Divisor opening to give percent- age of flow		Discharge in Second-feet		
			Percent	Inches	Divisor	Channel	Total
Head = 0.2 ft. or 2 3/8 inches							
1	2.1
2	4.2	1.4	4	3 7/8	0.1	0.9	1.0
3	6.3	2.6	6	5 3/8	0.1	0.9	1.0
4	8.3	3.8	8	6 5/8	0.1	0.9	1.0
5	10.4	5.4	10	7 5/8	0.1	0.9	1.0
6	12.5	7.0	12	8 5/8	0.1	0.9	1.0
7	14.6	8.8	15	10	0.2	0.8	1.0
8	16.7	10.7	17	10 7/8	0.2	0.8	1.0
9	18.8	12.8	19	11 3/4	0.2	0.8	1.0
10	20.8	15.0	21	12 5/8	0.2	0.8	1.0
11	22.9	17.3	23	13 1/2	0.2	0.8	1.0
12	25.0	19.6	25	14 1/4	0.2	0.7	0.9
13	27.1	21.9	27	15 1/8	0.3	0.7	1.0
14	29.2	24.3	29	16	0.3	0.7	1.0
15	31.2	26.7	31	16 3/4	0.3	0.7	1.0
16	33.4	29.1	33	17 1/2	0.3	0.7	1.0
17	35.4	31.6	35	18 3/8	0.3	0.6	0.9
18	37.5	34.2	38	19 1/2	0.4	0.6	1.0
19	39.6	36.7	40	20 1/4	0.4	0.6	1.0
20	41.7	39.2	42	21 1/8	0.4	0.6	1.0
21	43.8	41.6	44	22	0.4	0.6	1.0
22	45.8	44.0	46	22 7/8	0.5	0.5	1.0
23	47.9	46.5	48	23 5/8	0.5	0.5	1.0
24	50.0	47.8	50	24 1/2	0.5	0.5	1.0
Head = 0.4 ft. or 4 13-16 inches							
1	2.1	2	2 1/2	0.1	2.7	2.8
2	4.2	1.4	4	3 7/8	0.1	2.7	2.8
3	6.3	2.6	6	5 3/8	0.2	2.6	2.8
4	8.3	3.9	8	6 5/8	0.2	2.6	2.8
5	10.4	5.4	10	7 5/8	0.3	2.5	2.8
6	12.5	7.0	12	8 5/8	0.4	2.4	2.8
7	14.6	8.8	15	10	0.4	2.4	2.8
8	16.7	10.7	17	10 7/8	0.5	2.3	2.8
9	18.8	12.8	19	11 3/4	0.5	2.3	2.8
10	20.8	15.0	21	12 5/8	0.6	2.2	2.8
11	22.9	17.3	23	13 1/2	0.6	2.2	2.8
12	25.0	19.6	25	14 1/4	0.7	2.1	2.8

TABLE XIII (Continued)

Divisor opening in inches	Percent divisor opening is of total width of box	Percent divisor flow is of total flow in box	Width of Divisor opening to give percent- age of flow		Discharge in Second-feet		
			Percent	Inches	Divisor	Channel	Total
Head = 0.4 ft. or 4 13-16 inches							
13	27.1	21.9	27	15 $\frac{1}{8}$	0.8	2.0	2.8
14	29.2	24.3	29	16	0.8	2.0	2.8
15	31.2	26.7	31	16 $\frac{3}{4}$	0.9	1.9	2.8
16	33.4	29.1	33	17 $\frac{1}{2}$	0.9	1.9	2.8
17	35.4	31.6	35	18 $\frac{3}{8}$	1.0	1.8	2.8
18	37.5	34.2	38	19 $\frac{1}{2}$	1.1	1.7	2.8
19	39.6	36.7	40	20 $\frac{1}{4}$	1.1	1.7	2.8
20	41.7	39.2	42	21 $\frac{1}{8}$	1.2	1.6	2.8
21	43.8	41.6	44	22	1.2	1.6	2.8
22	45.8	44.0	46	22 $\frac{7}{8}$	1.3	1.5	2.8
23	47.9	46.5	48	23 $\frac{5}{8}$	1.4	1.4	2.8
24	50.0	48.9	50	24 $\frac{1}{2}$	1.4	1.4	2.8
Head = 0.8 ft. or 9 $\frac{5}{8}$ inches							
1	2.1	...	2	1 $\frac{5}{8}$	0.1	6.6	6.7
2	4.2	2.6	4	2 $\frac{3}{4}$	0.3	6.6	6.9
3	6.3	4.4	6	3 $\frac{7}{8}$	0.4	6.5	6.9
4	8.3	6.3	8	4 $\frac{7}{8}$	0.6	6.5	7.1
5	10.4	8.2	10	5	0.7	6.5	7.2
6	12.5	10.1	12	7	0.9	6.4	7.3
7	14.6	12.0	15	8 $\frac{1}{2}$	1.1	6.4	7.5
8	16.7	14.0	17	9 $\frac{1}{2}$	1.3	6.3	7.6
9	18.8	16.0	19	10 $\frac{1}{2}$	1.5	6.2	7.7
10	20.8	18.1	21	11 $\frac{3}{8}$	1.6	6.2	7.8
11	22.9	20.0	23	12 $\frac{3}{8}$	1.8	6.1	7.9
12	25.0	22.1	25	13 $\frac{1}{2}$	2.0	6.0	8.0
13	27.1	24.1	27	14 $\frac{3}{8}$	2.2	5.9	8.1
14	29.2	26.2	29	15 $\frac{1}{4}$	2.3	5.8	8.1
15	31.2	28.3	31	16 $\frac{1}{4}$	2.5	5.7	8.2
16	33.4	30.5	33	17 $\frac{1}{8}$	2.7	5.5	8.2
17	35.4	32.8	35	18	2.9	5.4	8.3
18	37.5	35.0	38	19 $\frac{1}{4}$	3.1	5.2	8.3
19	39.6	37.3	40	20 $\frac{1}{4}$	3.3	5.0	8.3
20	41.7	39.6	42	21 $\frac{1}{8}$	3.5	4.8	8.3
21	43.8	41.9	44	21 $\frac{7}{8}$	3.6	4.6	8.2
22	45.8	44.1	46	22 $\frac{3}{4}$	3.8	4.4	8.2
23	47.9	46.5	48	23 $\frac{1}{2}$	3.9	4.3	8.2
24	50.0	48.8	50	24 $\frac{3}{8}$	4.1	4.1	8.2

TABLE XIV

For Divisor Box Shown in Figure 4
 Short box; floor flush with top of 4-inch dam;
 divisor board hinged 24 inches from side of flume;
 0.1 ft. or 1 3-16 inches effective head in both channels

Divisor opening in inches	Percent divisor opening is of total width of box	Percent divisor flow is of total flow in box	Width of Divisor opening to give percent- age of flow		Discharge in Second-feet		
			Percent	Inches	Divisor	Channel	Total
Head = 0.4 ft. or 4 13-16 inches							
1	2.1	2	3 5/8	0.1	2.2	2.3
2	4.2	4	4 7/8	0.1	2.2	2.3
3	6.3	1.0	6	6 1/8	0.2	2.2	2.4
4	8.3	2.6	8	7 3/8	0.2	2.2	2.4
5	10.4	4.2	10	8 1/2	0.3	2.1	2.4
6	12.5	5.8	12	9 1/2	0.3	2.1	2.4
7	14.6	7.4	15	11	0.4	2.0	2.4
8	16.7	9.2	17	12	0.4	2.0	2.4
9	18.8	11.1	19	12 7/8	0.5	1.9	2.4
10	20.8	13.0	21	13 3/4	0.5	1.9	2.4
11	22.9	15.0	23	14 3/4	0.6	1.8	2.4
12	25.0	17.1	25	15 5/8	0.6	1.8	2.4
13	27.1	19.3	27	16 3/8	0.6	1.8	2.4
14	29.2	21.4	29	17 1/4	0.7	1.7	2.4
15	31.2	23.7	31	18	0.7	1.7	2.4
16	33.4	26.1	33	18 7/8	0.8	1.6	2.4
17	35.4	28.5	35	19 5/8	0.8	1.6	2.4
18	37.5	31.0	38	20 3/4	0.9	1.5	2.4
19	39.6	33.4	40	21 1/2	0.9	1.5	2.4
20	41.7	36.0	42	22 1/4	1.0	1.4	2.4
21	43.8	38.6	44	23	1.0	1.4	2.4
22	45.8	41.4	46	23 3/4	1.1	1.3	2.4
23	47.9	44.1
24	50.0	46.8

Head = 0.8 ft. or 9 5/8 inches

1	2.1	2	2	0.1	4.0	4.1
2	4.2	2.0	4	3 1/8	0.2	4.0	4.2
3	6.3	3.8	6	4 1/8	0.3	4.0	4.3
4	8.3	5.8	8	5 1/4	0.4	3.9	4.3
5	10.4	7.7	10	6 1/4	0.4	3.9	4.3
6	12.5	9.6	12	7 1/4	0.5	3.9	4.4
7	14.6	11.5	15	8 7/8	0.7	3.8	4.5
8	16.7	13.4	17	9 7/8	0.8	3.8	4.6
9	18.8	15.3	19	11	0.9	3.8	4.7
10	20.8	17.2	21	12	1.0	3.7	4.7
11	22.9	19.1	23	13 1/8	1.1	3.7	4.8
12	25.0	21.0	25	14 1/8	1.2	3.6	4.8

TABLE XIV (Continued)

Divisor opening in inches	Percent divisor opening is of total width of box	Percent divisor flow is of total flow in box	Width of Divisor opening to give percent- age of flow		Discharge in Second-feet		
			Percent	Inches	Divisor	Channel	Total
Head = 0.8 ft. or 9 $\frac{5}{8}$ inches							
13	27.1	22.8	27	15 $\frac{1}{8}$	1.3	3.6	4.9
14	29.2	24.8	29	16 $\frac{1}{4}$	1.5	3.5	5.0
15	31.2	26.7	31	17 $\frac{1}{4}$	1.6	3.5	5.1
16	33.4	28.6	33	18 $\frac{1}{4}$	1.7	3.4	5.1
17	35.4	30.5	35	19 $\frac{1}{4}$	1.8	3.3	5.1
18	37.5	32.5	38	20 $\frac{3}{4}$	2.0	3.2	5.2
19	39.6	34.6	40	21 $\frac{3}{4}$	2.1	3.1	5.2
20	41.7	36.6	42	22 $\frac{5}{8}$	2.2	3.1	5.3
21	43.8	38.6	44	23 $\frac{5}{8}$	2.3	3.0	5.3
22	45.8	40.7
23	47.9	42.7
24	50.0	44.8

TABLE XV

For Divisor Box Shown in Figure 4
 Short box; floor flush with top of 4-inch dam;
 divisor board hinged 24 inches from side of flume;
 free flow in main channel, and 0.1 ft. or 1 3-16 inch
 effective head on divisor channel

Divisor opening in inches	Percent divisor opening is of total width of box	Percent divisor flow is of total flow in box	Width of Divisor opening to give percent- age of flow		Discharge in Second-feet		
			Percent	Inches	Divisor	Channel	Total
Head = 0.4 ft. or 4 13-16 inches							
1	2.1	2	5 $\frac{7}{8}$	0.1	2.6	2.7
2	4.2	4	7 $\frac{1}{4}$	0.1	2.6	2.7
3	6.3	6	8 $\frac{3}{8}$	0.2	2.5	2.7
4	8.3	8	9 $\frac{1}{2}$	0.2	2.4	2.6
5	10.4	10	10 $\frac{5}{8}$	0.3	2.3	2.6
6	12.5	2.2	12	11 $\frac{5}{8}$	0.3	2.3	2.6
7	14.6	3.6	15	13	0.4	2.2	2.6
8	16.7	5.3	17	14	0.4	2.2	2.6
9	18.8	7.0	19	14 $\frac{7}{8}$	0.5	2.1	2.6
10	20.8	8.9	21	15 $\frac{5}{8}$	0.5	2.1	2.6
11	22.9	10.8	23	16 $\frac{1}{2}$	0.6	2.0	2.6
12	25.0	12.8	25	17 $\frac{3}{8}$	0.6	2.0	2.6
13	27.1	15.0	27	18 $\frac{1}{8}$	0.7	1.9	2.6
14	29.2	17.2	29	18 $\frac{7}{8}$	0.7	1.9	2.6
15	31.2	19.4	31	19 $\frac{3}{4}$	0.8	1.8	2.6
16	33.4	21.7	33	20 $\frac{1}{2}$	0.8	1.8	2.6
17	35.4	24.1	35	21 $\frac{1}{4}$	0.9	1.7	2.6
18	37.5	26.7	38	22 $\frac{1}{4}$	1.0	1.6	2.6

TABLE XV (Continued)

Divisor opening in inches	Percent divisor opening is of total width of box	Percent divisor flow is of total flow in box	Width of Divisor opening to give percent- age of flow		Discharge in Second-feet		
			Percent	Inches	Divisor	Channel	Total
Head = 0.4 ft. or 4 13-16 inches							
19	39.6	29.2	40	23	1.1	1.6	2.7
20	41.7	31.8	42	23 ⁵ / ₈	1.1	1.6	2.7
21	43.8	34.5	44	24 ³ / ₈	1.2	1.5	2.7
22	45.8	37.2
23	47.9	40.0
24	50.0	42.9
Head = 0.8 ft. or 9 ⁵ / ₈ inches							
1	2.1	2	6 ⁷ / ₈	0.2	6.5	6.7
2	4.2	4	8 ¹ / ₂	0.3	6.4	6.7
3	6.3	6	10	0.4	6.3	6.7
4	8.3	8	11 ¹ / ₂	0.5	6.2	6.7
5	10.4	10	12 ³ / ₄	0.7	6.0	6.7
6	12.5	1.0	12	14 ¹ / ₈	0.8	5.9	6.7
7	14.6	2.1	15	15 ⁷ / ₈	1.0	5.7	6.7
8	16.7	3.3	17	17	1.1	5.6	6.7
9	18.8	4.6	19	18 ¹ / ₈	1.3	5.4	6.7
10	20.8	6.0	21	19	1.4	5.3	6.7
11	22.9	7.4	23	20	1.5	5.1	6.6
12	25.0	8.8	25	20 ⁷ / ₈	1.6	5.0	6.6
13	27.1	10.3	27	21 ³ / ₄	1.7	4.8	6.5
14	29.2	11.9	29	22 ⁵ / ₈	1.9	4.6	6.5
15	31.2	13.5	31	23 ³ / ₈	2.0	4.5	6.5
16	33.4	15.2	33	24 ¹ / ₄	2.1	4.3	6.4
17	35.4	17.0
18	37.5	18.9

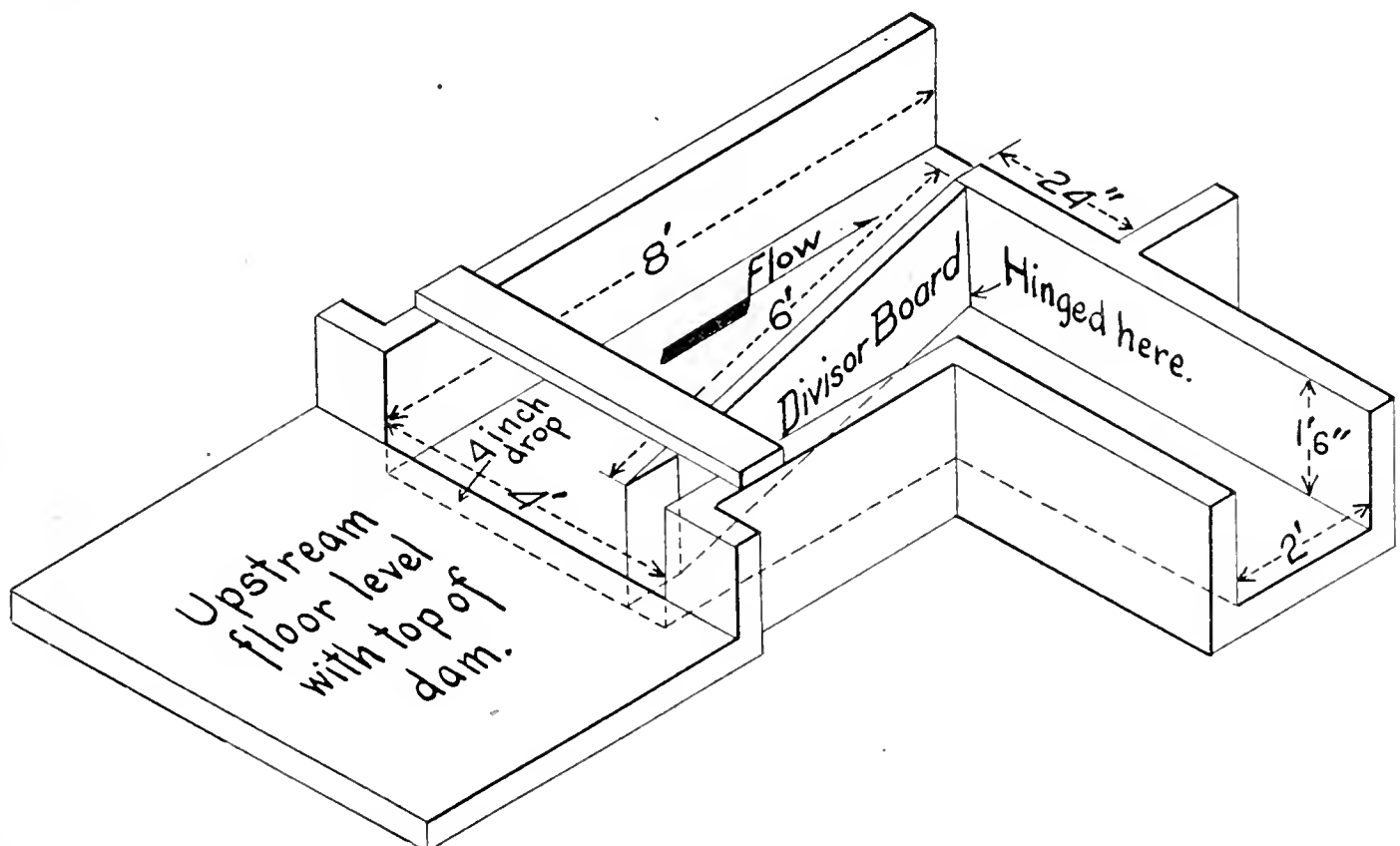

Fig. 4

TABLE XV (Continued)

Divisor opening in inches	Percent divisor opening is of total width of box	Percent divisor flow is of total flow in box	Width of Divisor opening to give percent- age of flow		Discharge in Second-feet		
			Percent	Inches	Divisor	Channel	Total
Head = 0.8 ft. or 9 $\frac{5}{8}$ inches							
19	39.6	20.9
20	41.7	23.0
21	43.8	25.2
22	45.8	27.5
23	47.9	30.0
24	50.0	32.5

TABLE XVI

For Divisor Box shown in Figure 4
Short box; floor flush with top of 4-inch dam;
Divisor board hinged 24 inches from side of flume; free flow in
divisor channel and 0.1 ft. or 1 3-16 inches effective head
in main channel

Divisor opening in inches	Percent divisor opening is of total width of box	Percent divisor flow is of total flow in box	Width of Divisor opening to give percent- age of flow		Discharge in Second-feet		
			Percent	Inches	Divisor	Channel	Total
Head = 0.4 ft. or 4 13-16 inches							
1	2.1	1.0	2	1 $\frac{1}{2}$	0.1	2.4	2.5
2	4.2	3.0	4	2 $\frac{1}{2}$	0.1	2.4	2.5
3	6.3	4.8	6	3 $\frac{5}{8}$	0.2	2.3	2.5
4	8.3	6.7	8	4 $\frac{5}{8}$	0.2	2.3	2.5
5	10.4	8.7	10	5 $\frac{5}{8}$	0.3	2.2	2.5
6	12.5	10.8	12	6 $\frac{5}{8}$	0.3	2.2	2.5
7	14.6	12.9	15	8	0.4	2.1	2.5
8	16.7	15.0	17	8 $\frac{7}{8}$	0.4	2.1	2.5
9	18.8	17.3	19	9 $\frac{3}{4}$	0.5	2.0	2.5
10	20.8	19.6	21	10 $\frac{5}{8}$	0.5	2.0	2.5
11	22.9	21.9	23	11 $\frac{3}{8}$	0.6	1.9	2.5
12	25.0	24.3	25	12 $\frac{1}{4}$	0.6	1.9	2.5
13	27.1	26.7	27	13 $\frac{1}{8}$	0.7	1.9	2.6
14	29.2	29.1	29	14	0.8	1.8	2.6
15	31.2	31.7	31	14 $\frac{3}{4}$	0.8	1.8	2.6
16	33.4	34.3	33	15 $\frac{1}{2}$	0.9	1.7	2.6
17	35.4	36.8	35	16 $\frac{3}{8}$	0.9	1.7	2.6
18	37.5	39.4	38	17 $\frac{1}{2}$	1.0	1.6	2.6
19	39.6	42.0	40	18 $\frac{1}{4}$	1.0	1.6	2.6
20	41.7	44.8	42	19	1.1	1.5	2.6
21	43.8	47.6	44	19 $\frac{3}{4}$	1.2	1.4	2.6
22	45.8	50.5	46	20 $\frac{1}{2}$	1.2	1.4	2.6
23	47.9	53.5	48	21 $\frac{1}{8}$	1.3	1.4	2.7
24	50.0	56.5	50	21 $\frac{3}{4}$	1.3	1.3	2.6

TABLE XVI (Continued)

Divisor opening in inches	Percent divisor opening is of total width of box	Percent divisor flow is of total flow in box	Width of Divisor opening to give percent- age of flow		Discharge in Second-feet		
			Percent	Inches	Divisor	Channel	Total
Head = 0.8 ft. or 9 5/8 inches							
1	2.1	4.0	2	0 1/2	0.1	4.1	4.2
2	4.2	7.7	4	1	0.2	4.0	4.2
3	6.3	11.3	6	1 1/2	0.3	4.0	4.3
4	8.3	14.7	8	2 1/8	0.4	4.0	4.4
5	10.4	17.9	10	2 5/8	0.5	4.0	4.5
6	12.5	20.8	12	3 1/4	0.6	4.0	4.6
7	14.6	23.7	15	4 1/8	0.7	4.0	4.7
8	16.7	26.4	17	4 3/4	0.8	3.9	4.7
9	18.8	29.1	19	5 3/8	1.0	3.9	4.9
10	20.8	31.7	21	6	1.1	3.9	5.0
11	22.9	34.2	23	6 3/4	1.2	3.9	5.1
12	25.0	36.7	25	7 1/2	1.3	3.8	5.1
13	27.1	39.2	27	8 1/4	1.4	3.8	5.2
14	29.2	41.5	29	9	1.6	3.8	5.4
15	31.2	44.0	31	9 3/4	1.7	3.7	5.4
16	33.4	46.4	33	10 1/2	1.8	3.7	5.5
17	35.4	48.7	35	11 3/8	2.0	3.6	5.6
18	37.5	51.1	38	12 1/2	2.2	3.6	5.8
19	39.6	53.2	40	13 1/4	2.3	3.5	5.8
20	41.7	55.4	42	14 1/8	2.5	3.4	5.9
21	43.8	57.5	44	15	2.6	3.4	6.0
22	45.8	59.5	46	15 7/8	2.8	3.3	6.1
23	47.9	61.5	48	16 5/8	3.0	3.2	6.2
24	50.0	63.5	50	17 1/2	3.1	3.1	6.2

TABLE XVII

For Divisor Box Shown in Figure 5
 Short box; 4-inch dam; divisor board hinged
 12 inches from side of flume; free flow in both channels

Divisor opening in inches	Percent divisor opening is of total width of box	Percent divisor flow is of total flow in box	Width of Divisor opening to give percent- age of flow		Discharge in Second-feet		
			Percent	Inches	Divisor	Channel	Total
Head = 0.2 ft. or 2 3/8 inches							
1	2.1	1.5	2
2	4.2	3.1	4	2 1/2	0.1	1.1	1.2
3	6.3	4.9	6	3 1/2	0.1	1.1	1.2
4	8.3	6.9	8	4 1/2	0.1	1.1	1.2
5	10.4	9.0	10	5 1/2	0.1	1.0	1.1
6	12.5	11.2	12	6 3/8	0.1	1.0	1.1

TABLE XVII (Continued)

Divisor opening in inches	Percent divisor opening is of total width of box	Percent divisor flow is of total flow in box	Width of Divisor opening to give percent- age of flow		Discharge in Second-feet		
			Percent	Inches	Divisor	Channel	Total
Head = 0.2 ft. or 2 $\frac{3}{8}$ inches							
7	14.6	13.3	15	7 $\frac{3}{4}$	0.2	1.0	1.2
8	16.7	15.4	17	8 $\frac{3}{4}$	0.2	1.0	1.2
9	18.8	17.5	19	9 $\frac{3}{4}$	0.2	0.9	1.1
10	20.8	19.6	21	10 $\frac{5}{8}$	0.2	0.9	1.1
11	22.9	21.7	23	11 $\frac{5}{8}$	0.3	0.9	1.2
12	25.0	23.8
Head = 0.4 ft. or 4 13-16 inches							
1	2.1	1.0	2	1 $\frac{3}{4}$	0.1	3.3	3.4
2	4.2	2.3	4	3 $\frac{1}{8}$	0.1	3.2	3.3
3	6.3	3.8	6	4 $\frac{1}{4}$	0.2	3.1	3.3
4	8.3	5.6	8	5 $\frac{1}{4}$	0.3	3.0	3.3
5	10.4	7.5	10	6 $\frac{1}{4}$	0.3	3.0	3.3
6	12.5	9.5	12	7 $\frac{1}{4}$	0.4	2.9	3.3
7	14.6	11.6	15	8 $\frac{5}{8}$	0.5	2.8	3.3
8	16.7	13.7	17	9 $\frac{5}{8}$	0.6	2.7	3.3
9	18.8	15.8	19	10 $\frac{1}{2}$	0.6	2.7	3.3
10	20.8	17.9	21	11 $\frac{1}{2}$	0.7	2.6	3.3
11	22.9	20.0
12	25.0	22.2
Head = 0.8 ft. or 9 $\frac{5}{8}$ inches							
1	2.1	1.0	2	1 $\frac{7}{8}$	0.2	8.5	8.7
2	4.2	2.1	4	3 $\frac{1}{4}$	0.4	8.3	8.7
3	6.3	3.6	6	4 $\frac{1}{4}$	0.6	8.1	8.7
4	8.3	5.4	8	5 $\frac{3}{8}$	0.7	8.0	8.7
5	10.4	7.3	10	6 $\frac{3}{8}$	0.9	7.8	8.7
6	12.5	9.3	12	7 $\frac{1}{4}$	1.0	7.7	8.7
7	14.6	11.3	15	8 $\frac{3}{4}$	1.3	7.4	8.7
8	16.7	13.5	17	9 $\frac{3}{4}$	1.5	7.2	8.7
9	18.8	15.6	19	10 $\frac{5}{8}$	1.7	7.0	8.7
10	20.8	17.7	21	11 $\frac{1}{2}$	1.8	6.9	8.7
11	22.9	19.8
12	25.0	22.0

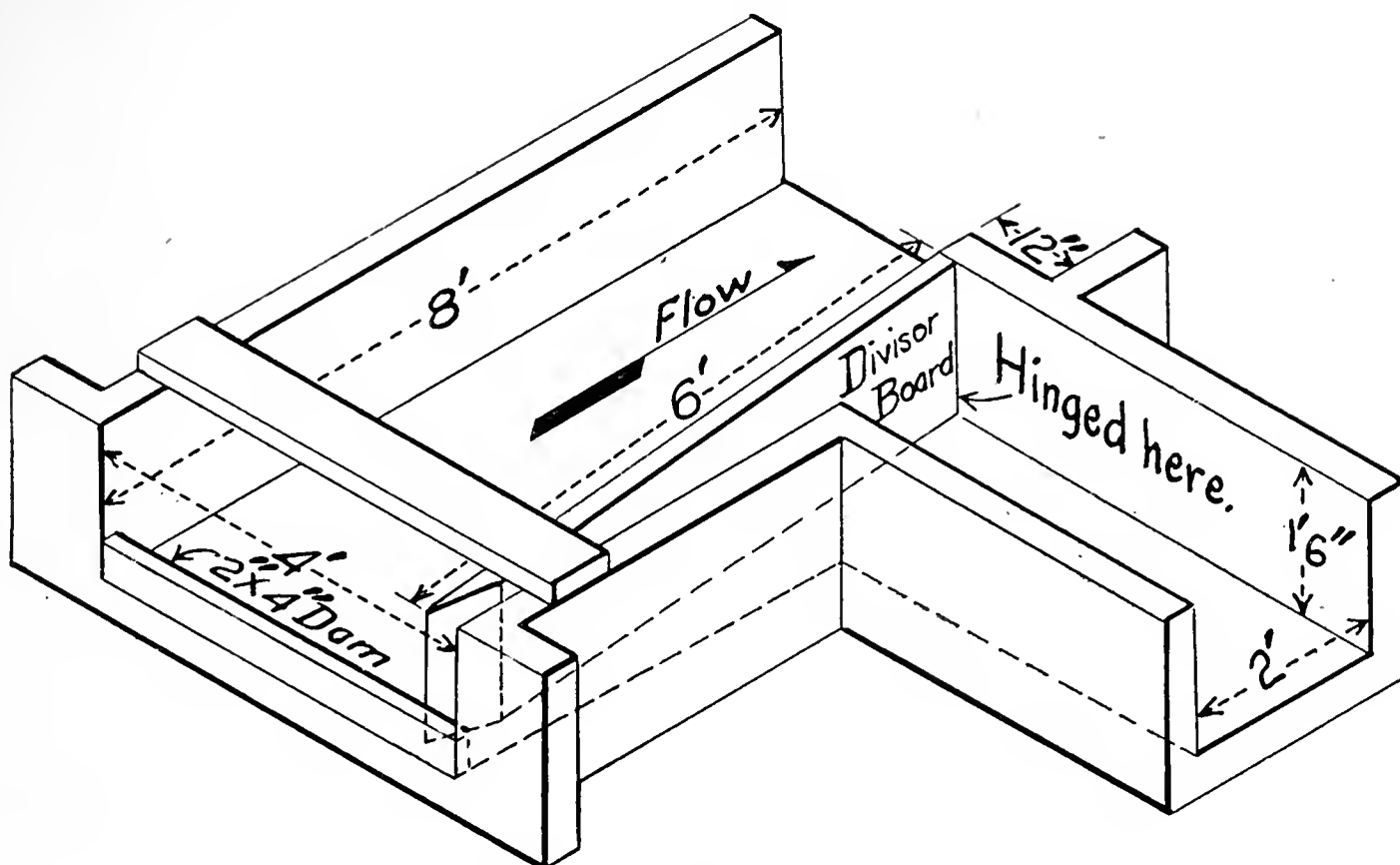

Fig. 5

TABLE XVIII

For Divisor Box Shown in Figure 5
 Short box; 4-inch dam; divisor board hinged
 12 inches from side of flume; 0.1 ft. or 1 3-16 inches
 effective head in both channels

Divisor opening in inches	Percent divisor opening is of total width of box	Percent divisor flow is of total flow in box.	Width of Divisor opening to give percent- age of flow		Discharge in Second-feet		
			Percent	Inches	Divisor	Channel	Total
Head = 0.4 ft. or 4 13-16 inches							
1	2.1	0.6	2	2 3/8	0.1	2.5	2.6
2	4.2	1.6	4	3 3/4	0.1	2.5	2.6
3	6.3	2.9	6	4 7/8	0.2	2.4	2.6
4	8.3	4.4	8	5 7/8	0.2	2.4	2.6
5	10.4	6.3	10	6 7/8	0.3	2.3	2.6
6	12.5	8.3	12	7 3/4	0.3	2.3	2.6
7	14.6	10.4	15	9 1/8	0.4	2.2	2.6
8	16.7	12.6	17	10	0.5	2.1	2.6
9	18.8	14.8	19	10 3/4	0.5	2.1	2.6
10	20.8	17.1	21	11 3/4	0.6	2.0	2.6
11	22.9	19.4
12	25.0	21.7
Head = 0.8 ft. or 9 5/8 inches.							
1	2.1	0.8	2	2 1/4	0.1	5.2	5.3
2	4.2	1.8	4	3 5/8	0.2	5.2	5.4
3	6.3	3.1	6	4 5/8	0.3	5.2	5.5
4	8.3	4.7	8	5 5/8	0.4	5.2	5.6
5	10.4	6.6	10	6 5/8	0.6	5.1	5.7
6	12.5	8.7	12	7 1/2	0.7	5.0	5.7

TABLE XVIII (Continued)

Divisor opening in inches	Percent divisor opening is of total width of box	Percent divisor flow is of total flow in box	Width of Divisor opening to give percent- age of flow		Discharge in Second-feet		
			Percent	Inches	Divisor	Channel	Total
Head = 0.8 ft. or 9 $\frac{5}{8}$ inches							
7	14.6	10.9	15	8 $\frac{3}{4}$	0.8	4.9	5.7
8	16.7	13.2	17	9 $\frac{5}{8}$	1.0	4.8	5.8
9	18.8	15.5	19	10 $\frac{1}{2}$	1.1	4.7	5.8
10	20.8	17.9	21	11 $\frac{3}{8}$	1.2	4.6	5.8
11	22.9	20.2	23	12 $\frac{1}{8}$	1.3	4.4	5.7
12	25.0	22.6

TABLE XIX

For Divisor Box Shown in Figure 5
 Short box; 4-inch dam; divisor board hinged
 12 inches from side of flume; free flow in main channel;
 0.1 ft. or 1 3-16 inches effective head in divisor channel

Divisor opening in inches	Percent divisor opening is of total width of box	Percent divisor flow is of total flow in box	Width of Divisor opening to give percent- age of flow		Discharge in Second-feet		
			Percent	Inches	Divisor	Channel	Total
Head = 0.4 ft. or 4 13-16 inches							
1	2.1	0.5	2	2 $\frac{7}{8}$	0.1	3.2	3.3
2	4.2	1.3	4	4 $\frac{5}{8}$	0.1	3.1	3.2
3	6.3	2.2	6	6 $\frac{1}{8}$	0.2	3.0	3.2
4	8.3	3.2	8	7 $\frac{3}{8}$	0.3	2.9	3.2
5	10.4	4.4	10	8 $\frac{1}{2}$	0.3	2.8	3.1
6	12.5	5.8	12	9 $\frac{5}{8}$	0.4	2.7	3.1
7	14.6	7.4	15	11 $\frac{1}{4}$	0.4	2.6	3.0
8	16.7	9.0	17	12 $\frac{3}{8}$	0.5	2.5	3.0
9	18.8	10.8
10	20.8	12.6
11	22.9	14.4
12	25.0	16.4
Head = 0.8 ft. or 9 $\frac{5}{8}$ inches							
1	2.1	...	2	5 $\frac{1}{4}$	0.2	7.8	8.0
2	4.2	0.5	4	7 $\frac{1}{8}$	0.4	7.6	8.0
3	6.3	0.9	6	8 $\frac{3}{8}$	0.5	7.5	8.0
4	8.3	1.4	8	9 $\frac{1}{2}$	0.7	7.3	8.0
5	10.4	2.1	10	10 $\frac{1}{2}$	0.8	7.1	7.9
6	12.5	2.9	12	11 $\frac{1}{2}$	1.0	6.9	7.9
7	14.6	3.9
8	16.7	5.3
9	18.8	7.0
10	20.8	8.9
11	22.9	11.0
12	25.0	13.2

TABLE XX

For Divisor Box Shown in Figure 5
 Short box; 4-inch dam; divisor board hinged
 12 inches from side of flume; free flow in divisor channel;
 0.1 ft. or 1 3-16 inches effective head in main channel

Divisor opening in inches	Percent divisor opening is of total width of box	Percent divisor flow is of total flow in box	Width of Divisor opening to give percent- age of flow		Discharge in Second-feet		
			Percent	Inches	Divisor Channel	Total	
Head = 0.4 ft. or 4 13-16 inches							
1	2.1	2.4	2
2	4.2	4.7	4	1 3/4	0.1	2.5	2.6
3	6.3	7.1	6	2 1/2	0.1	2.5	2.6
4	8.3	9.5	8	3 3/8	0.2	2.4	2.6
5	10.4	11.9	10	4 1/4	0.3	2.4	2.7
6	12.5	14.3	12	5	0.3	2.4	2.7
7	14.6	16.8	15	6 1/4	0.4	2.3	2.7
8	16.7	19.2	17	7 1/8	0.4	2.3	2.7
9	18.8	21.6	19	7 7/8	0.5	2.2	2.7
10	20.8	24.0	21	8 3/4	0.6	2.2	2.8
11	22.9	26.3	23	9 5/8	0.6	2.2	2.8
12	25.0	28.7	25	10 1/2	0.7	2.1	2.8
Head = 0.8 ft. or 9 5/8 inches							
1	2.1	3.0	2
2	4.2	5.9	4	1 3/8	0.2	5.2	5.4
3	6.3	8.7	6	2	0.3	5.2	5.5
4	8.3	11.4	8	2 3/4	0.5	5.2	5.7
5	10.4	14.1	10	3 1/2	0.6	5.2	5.8
6	12.5	16.8	12	4 1/4	0.7	5.2	5.9
7	14.6	19.5	15	5 3/8	0.9	5.2	6.1
8	16.7	22.1	17	6 1/8	1.0	5.1	6.1
9	18.8	24.6	19	6 7/8	1.2	5.1	6.3
10	20.8	27.1	21	7 5/8	1.3	5.0	6.3
11	22.9	29.6	23	8 3/8	1.4	5.0	6.4
12	25.0	32.0	25	9 1/8	1.6	4.9	6.5

TABLE XXI

For Divisor Box Shown in Figure 5*
 Short box; 6-inch dam; divisor board hinged
 12 inches from side of flume; free flow in both channels

Divisor opening in inches	Percent divisor opening is of total width of box	Percent divisor flow is of total flow in box	Width of Divisor opening to give percent- age of flow		Discharge in Second-feet		
			Percent	Inches	Divisor	Channel	Total
Head = 0.2 ft. or 2 3/8 inches							
1	2.1	1.5	2
2	4.2	3.2	4
3	6.3	5.1	6	3 1/2	0.1	1.1	1.2
4	8.3	7.1	8	4 3/8	0.1	1.1	1.2
5	10.4	9.2	10	5 3/8	0.1	1.1	1.2
6	12.5	11.4	12	6 1/4	0.1	1.1	1.2
7	14.6	13.6	15	7 5/8	0.2	1.0	1.2
8	16.7	15.8	17	8 1/2	0.2	1.0	1.2
9	18.8	18.0	19	9 1/2	0.2	0.9	1.1
10	20.8	20.2	21	10 3/8	0.2	0.9	1.1
11	22.9	22.4	23	11 1/4	0.2	0.9	1.1
12	25.0	24.6	25	12 1/4	0.3	0.8	1.1
Head = 0.4 ft. or 4 13-16 inches							
1	2.1	1.3	2	1 1/2	0.1	3.2	3.3
2	4.2	2.7	4	2 3/4	0.1	3.2	3.3
3	6.3	4.3	6	3 7/8	0.2	3.1	3.3
4	8.3	6.2	8	4 7/8	0.3	3.0	3.3
5	10.4	8.2	10	5 7/8	0.3	3.0	3.3
6	12.5	10.2	12	6 7/8	0.4	2.9	3.3
7	14.6	12.3	15	8 1/4	0.5	2.8	3.3
8	16.7	14.4	17	9 1/4	0.6	2.7	3.3
9	18.8	16.5	19	10 1/8	0.6	2.7	3.3
10	20.8	18.7	21	11 1/8	0.7	2.6	3.3
11	22.9	20.8	23	12	0.8	2.5	3.3
12	25.0	23.0
Head = 0.6 ft. or 7 3-16 inches							
1	2.1	1.2	2	1 5/8	0.1	5.9	6.0
2	4.2	2.5	4	3	0.3	5.7	6.0
3	6.3	4.1	6	4 1/8	0.4	5.6	6.0
4	8.3	5.8	8	5 1/8	0.5	5.4	5.9
5	10.4	7.8	10	6 1/8	0.6	5.3	5.9
6	12.5	9.8	12	7	0.7	5.2	5.9
7	14.6	11.9	15	8 1/2	0.9	5.0	5.9
8	16.7	14.0	17	9 3/8	1.1	4.9	6.0
9	18.8	16.1	19	10 3/8	1.2	4.8	6.0
10	20.8	18.3	21	11 1/4	1.4	4.6	6.0
11	22.9	20.4	23	12 1/4	1.5	4.5	6.0
12	25.0	22.6

*Figure 5 applies, except for 6-inch dam instead of 4-inch dam as shown.

TABLE XXII

For Divisor Box Shown in Figure 6
 Short box; floor flush with top of 4-inch dam;
 divisor board hinged 12 inches from side of flume;
 free flow in both channels

Divisor opening in inches	Percent divisor opening is of total width of box	Percent divisor flow is of total flow in box	Width of Divisor opening to give percent- age of flow		Discharge in Second-feet		
			Percent	Inches	Divisor	Channel	Total
Head = 0.2 ft. or 2 3/8 inches							
1	2.1	0.6
2	4.2	1.6	4	3 7/8	0.1	0.9	1.0
3	6.3	2.8	6	5 1/8	0.1	0.9	1.0
4	8.3	4.2	8	6 1/4	0.1	0.9	1.0
5	10.4	5.8	10	7 3/8	0.1	0.9	1.0
6	12.5	7.6	12	8 3/8	0.1	0.9	1.0
7	14.6	9.4	15	9 3/4	0.1	0.9	1.0
8	16.7	11.3	17	10 5/8	0.2	0.8	1.0
9	18.8	13.4	19	11 1/2	0.2	0.8	1.0
10	20.8	15.6
11	22.9	17.9
12	25.0	20.2
Head = 0.4 ft. or 4 13-16 inches							
1	2.1	0.5	2	2 3/4	0.1	2.8	2.9
2	4.2	1.3	4	4 3/8	0.1	2.8	2.9
3	6.3	2.3	6	5 5/8	0.2	2.7	2.9
4	8.3	3.5	8	6 3/4	0.2	2.7	2.9
5	10.4	5.0	10	7 3/4	0.3	2.6	2.9
6	12.5	6.7	12	8 3/4	0.3	2.5	2.8
7	14.6	8.6	15	10	0.4	2.4	2.8
8	16.7	10.6	17	10 7/8	0.5	2.3	2.8
9	18.8	12.7	19	11 3/4	0.5	2.3	2.8
10	20.8	15.0
11	22.9	17.4
12	25.0	19.8
Head = 0.8 ft. or 9 5/8 inches							
1	2.1	0.3	2	3 1/4	0.2	7.9	8.1
2	4.2	0.8	4	4 3/4	0.4	7.7	8.1
3	6.3	1.7	6	5 7/8	0.6	7.5	8.1
4	8.3	2.9	8	6 7/8	0.7	7.4	8.1
5	10.4	4.5	10	7 3/4	0.9	7.2	8.1
6	12.5	6.3	12	8 3/4	1.0	7.1	8.1
7	14.6	8.3	15	10	1.3	6.8	8.1
8	16.7	10.4	17	10 3/4	1.4	6.7	8.1
9	18.8	12.7	19	11 5/8	1.6	6.5	8.1
10	20.8	15.0
11	22.9	17.5
12	25.0	20.0

TABLE XXIII

For Divisor Box Shown in Figure 6
 Short box; floor flush with top of 4-inch dam;
 divisor board hinged 12 inches from side of flume;
 0.1 ft. or 1 3-16 inch effective head in both channels

Divisor opening in inches	Percent divisor opening is of total width of box	Percent divisor flow is of total flow in box	Width of Divisor opening to give percent- age of flow		Discharge in Second-feet		
			Percent	Inches	Divisor	Channel	Total
Head = 0.4 ft. or 4 13-16 inches							
1	2.1	...	2	3 5/8	0.1	2.3	2.4
2	4.2	0.8	4	5 3/8	0.1	2.3	2.4
3	6.3	1.5	6	6 5/8	0.2	2.2	2.4
4	8.3	2.4	8	7 3/4	0.2	2.2	2.4
5	10.4	3.6	10	8 3/4	0.2	2.2	2.4
6	12.5	5.0	12	9 5/8	0.3	2.1	2.4
7	14.6	6.6	15	11	0.4	2.1	2.5
8	16.7	8.5	17	11 3/4	0.4	2.1	2.5
9	18.8	10.5
10	20.8	12.7
11	22.9	15.1
12	25.0	17.5
Head = 0.8 ft. or 9 5/8 inches							
1	2.1	1.0	2	2 1/8	0.1	5.1	5.2
2	4.2	1.9	4	3 7/8	0.2	5.0	5.2
3	6.3	2.9	6	5 3/8	0.3	4.9	5.2
4	8.3	4.1	8	6 5/8	0.4	4.9	5.3
5	10.4	5.5	10	7 7/8	0.5	4.8	5.3
6	12.5	6.9	12	8 7/8	0.6	4.7	5.3

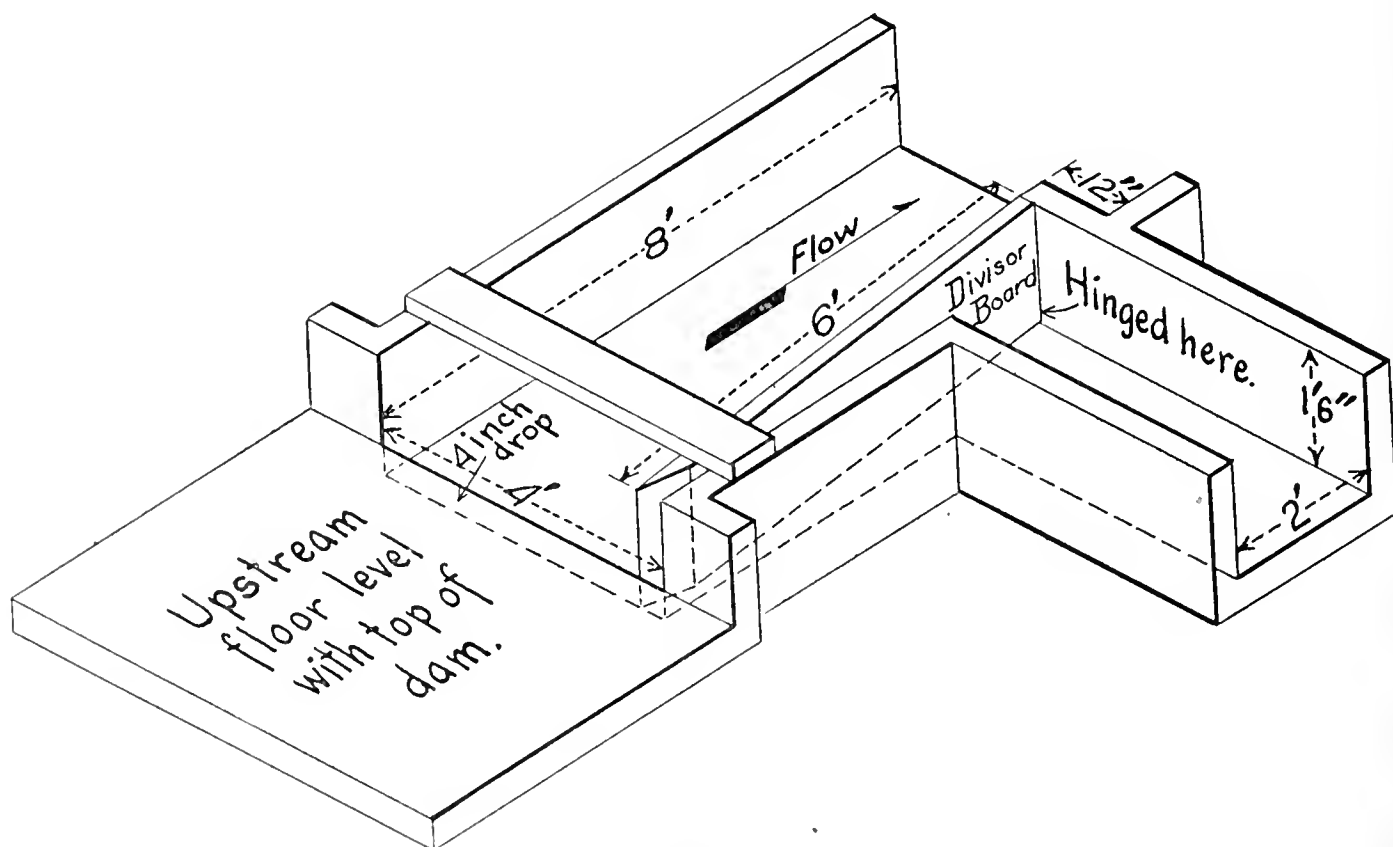

Fig 6

TABLE XXIII (Continued)

Divisor opening in inches	Percent divisor flow is of total flow in box of box	Percent divisor opening is of total width	Width of Divisor opening to give percent- age of flow		Discharge in Second-feet		
			Percent	Inches	Divisor	Channel	Total
Head = 0.8 ft. or 9 5/8 inches							
7	14.6	8.6	15	10 3/8	0.8	4.5	5.3
8	16.7	10.4	17	11 1/4	0.9	4.4	5.3
9	18.8	12.3	19	12 1/4	1.0	4.3	5.3
10	20.8	14.3
11	22.9	16.4
12	25.0	18.5

TABLE XXIV

For Divisor Box Shown in Figure 6
 Short box; floor flush with top of 4-inch dam;
 divisor board hinged 12 inches from side of flume;
 free flow in main channel;
 0.1 ft. or 1 3-16 inch effective head in divisor channel

Divisor opening in inches	Percent divisor opening is of total width of box	Percent divisor flow is of total flow in box	Width of Divisor opening to give percent- age of flow		Discharge in Second-feet		
			Percent	Inches	Divisor	Channel	Total
Head = 0.4 ft. or 4 13-16 inches							
1	2.1	...	2	3 5/8	0.1	2.7	2.8
2	4.2	...	4	5 3/4	0.1	2.7	2.8
3	6.3	...	6	7 3/8	0.2	2.6	2.8
4	8.3	2.3	8	8 5/8	0.2	2.5	2.7
5	10.4	3.2	10	9 7/8	0.3	2.4	2.7
6	12.5	4.3	12	11	0.3	2.3	2.6
7	14.6	5.6	15	12 5/8	0.4	2.2	2.6
8	16.7	6.9
9	18.8	8.5
10	20.8	10.1
11	22.9	11.9
12	25.0	13.8

Head = 0.8 ft. or 9 5/8 inches

1	2.1	...	2	5 5/8	0.2	7.5	7.7
2	4.2	...	4	8	0.3	7.1	7.4
3	6.3	...	6	9 7/8	0.5	6.8	7.3
4	8.3	1.1	8	11 3/8	0.6	6.5	7.1
5	10.4	1.6	10	12 5/8	0.7	6.2	6.9
6	12.5	2.3
7	14.6	3.1
8	16.7	4.0
9	18.8	5.0
10	20.8	6.1
11	22.9	7.5
12	25.0	8.9

TABLE XXV

For Divisor Box Shown in Figure 6
 Short box; floor flush with top of 4-inch dam;
 divisor board hinged 12 inches from side of flume;
 free flow in divisor channel;
 0.1 ft. or 1 3-16 inch effective head in main channel

Divisor opening in inches	Percent divisor opening is of total width of box	Percent divisor flow is of total flow in box	Width of Divisor opening to give percent- age of flow		Discharge in Second-feet		
			Percent	Inches	Divisor	Channel	Total
Head = 0.4 ft. or 4 13-16 inches							
1	2.1	1.0
2	4.2	2.4	4	3 1/8	0.1	2.5	2.6
3	6.3	3.8	6	4 3/8	0.1	2.5	2.6
4	8.3	5.4	8	5 3/8	0.2	2.4	2.6
5	10.4	7.3	10	6 1/4	0.2	2.4	2.6
6	12.5	9.4	12	7 1/8	0.3	2.4	2.7
7	14.6	11.6	15	8 3/8	0.4	2.3	2.7
8	16.7	14.0	17	9 1/4	0.4	2.2	2.6
9	18.8	16.4	19	10	0.5	2.1	2.6
10	20.8	18.9	21	10 3/4	0.5	2.1	2.6
11	22.9	21.5	23	11 1/2	0.6	2.0	2.6
12	25.0	24.2
Head = 0.8 ft. or 9 5/8 inches							
1	2.1	2.5	2	0 3/4	0.1	5.3	5.4
2	4.2	5.0	4	1 5/8	0.2	5.2	5.4
3	6.3	7.5	6	2 3/8	0.3	5.2	5.5
4	8.3	10.0	8	3 1/4	0.5	5.2	5.7
5	10.4	12.5	10	4	0.6	5.1	5.7
6	12.5	15.1	12	4 3/4	0.7	5.1	5.8
7	14.6	17.6	15	6	0.9	5.0	5.9
8	16.7	20.2	17	6 3/4	1.0	4.9	5.9
9	18.8	22.7	19	7 1/2	1.1	4.9	6.0
10	20.8	25.3	21	8 1/4	1.3	4.8	6.1
11	22.9	27.9	23	9 1/8	1.4	4.8	6.2
12	25.0	30.5	25	9 7/8	1.6	4.7	6.3

TABLE XXVI

For Divisor Box Shown in Figure 7
 Short box; floor flush with top of 4-inch dam;
 divisor board parallel to side of flume;
 free flow in both channels

Divisor opening in inches	Percent divisor opening is of total width of box	Percent divisor flow is of total flow in box	Width of Divisor opening to give percent- age of flow		Discharge in Second-feet		
			Percent	Inches	Divisor	Channel	Total
Head = 0.2 ft. or 2 3/8 inches							
1	2.1	0.5	2	2 3/4
2	4.2	1.3	4	4 1/4
3	6.3	2.3	6	5 3/8	0.1	0.9	1.0
4	8.3	3.6	8	6 3/8	0.1	0.9	1.0
5	10.4	5.3	10	7 3/8	0.1	0.9	1.0
6	12.5	7.2	12	8 3/8	0.1	0.9	1.0
7	14.6	9.1	15	9 3/4	0.1	0.9	1.0
8	16.7	11.2	17	10 5/8	0.2	0.8	1.0
9	18.8	13.3	19	11 1/2	0.2	0.8	1.0
10	20.8	15.6	21	12 3/8	0.2	0.8	1.0
11	22.9	17.9	23	13 1/4	0.2	0.8	1.0
12	25.0	20.2	25	14	0.3	0.7	1.0
13	27.1	22.5	27	14 7/8	0.3	0.7	1.0
14	29.2	24.9	29	15 3/4	0.3	0.7	1.0
15	31.2	27.3	31	16 1/2	0.3	0.7	1.0
16	33.4	29.7	33	17 3/8	0.3	0.7	1.0
17	35.4	32.1	35	18 1/4	0.4	0.6	1.0
18	37.5	34.5	38	19 1/2	0.4	0.6	1.0
Head = 0.4 ft. or 4 13-16 inches							
1	2.1	0.4	2	2 7/8	0.1	2.7	2.8
2	4.2	1.1	4	4 3/8	0.1	2.7	2.8
3	6.3	2.2	6	5 1/2	0.2	2.6	2.8
4	8.3	3.5	8	6 1/2	0.2	2.6	2.8
5	10.4	5.1	10	7 5/8	0.3	2.5	2.8
6	12.5	6.9	12	8 1/2	0.3	2.5	2.8
7	14.6	8.8	15	9 7/8	0.4	2.4	2.8
8	16.7	10.9	17	10 3/4	0.5	2.3	2.8
9	18.8	13.0	19	11 5/8	0.5	2.3	2.8
10	20.8	15.3	21	12 1/2	0.6	2.2	2.8
11	22.9	17.6	23	13 3/8	0.6	2.2	2.8
12	25.0	19.9	25	14 1/4	0.7	2.1	2.8
13	27.1	22.2	27	15	0.8	2.0	2.8
14	29.2	24.5	29	15 7/8	0.8	2.0	2.8
15	31.2	26.8	31	16 3/4	0.9	1.9	2.8
16	33.4	29.2	33	17 5/8	0.9	1.9	2.8
17	35.4	31.6	35	18 3/8	1.0	1.9	2.9
18	37.5	34.1	38	19 5/8	1.1	1.8	2.9

TABLE XXVI (Continued)

Divisor opening in inches	Percent divisor opening is of total width of box	Percent divisor flow is of total flow in box	Width of Divisor opening to give percent- age of flow		Discharge in Second-feet		
			Percent	Inches	Divisor	Channel	Total
Head = 0.6 ft. or 7 3-16 inches							
1	2.1	0.3	2	3 1/8	0.1	5.1	5.2
2	4.2	0.8	4	4 1/2	0.2	5.0	5.2
3	6.3	1.9	6	5 5/8	0.3	4.9	5.2
4	8.3	3.2	8	6 5/8	0.4	4.8	5.2
5	10.4	4.8	10	7 5/8	0.5	4.7	5.2
6	12.5	6.7	12	8 5/8	0.6	4.6	5.2
7	14.6	8.7	15	10	0.8	4.5	5.3
8	16.7	10.7	17	10 7/8	0.9	4.4	5.3
9	18.8	12.8	19	11 3/4	1.0	4.3	5.3
10	20.8	15.0	21	12 5/8	1.1	4.2	5.3
11	22.9	17.3	23	13 1/2	1.2	4.1	5.3
12	25.0	19.6	25	14 3/8	1.3	4.0	5.3
13	27.1	21.9	27	15 1/8	1.4	3.9	5.3
14	29.2	24.2	29	16	1.5	3.8	5.3
15	31.2	26.6	31	16 7/8	1.6	3.7	5.3
16	33.4	29.0	33	17 5/8	1.7	3.6	5.3
17	35.4	31.4	35	18 1/2	1.9	3.4	5.3
18	37.5	33.8	38	19 3/4	2.0	3.3	5.3
Head = 0.8 ft. or 9 5/8 inches							
1	2.1	0.1	2	3 1/4	0.2	7.9	8.1
2	4.2	0.7	4	4 5/8	0.4	7.7	8.1
3	6.3	1.6	6	5 3/4	0.5	7.6	8.1
4	8.3	2.9	8	6 7/8	0.7	7.4	8.1
5	10.4	4.6	10	7 3/4	0.9	7.2	8.1
6	12.5	6.4	12	8 3/4	1.0	7.1	8.1
7	14.6	8.3	15	10 1/8	1.3	6.8	8.1
8	16.7	10.4	17	11	1.4	6.7	8.1
9	18.8	12.5	19	11 7/8	1.6	6.5	8.1
10	20.8	14.7	21	12 3/4	1.8	6.4	8.2
11	22.9	17.0	23	13 5/8	2.0	6.2	8.2
12	25.0	19.3	25	14 1/2	2.1	6.1	8.2
13	27.1	21.6	27	15 1/4	2.3	5.9	8.2
14	29.2	23.9	29	16 1/8	2.4	5.8	8.2
15	31.2	26.3	31	17	2.6	4.6	8.2
16	33.4	28.7	33	17 3/4	2.7	5.5	8.2
17	35.4	31.1	35	18 5/8	2.9	5.3	8.2
18	37.5	33.5	38	19 7/8	3.1	5.1	8.2

TABLE XXVII

For Divisor Shown in Figure 7

Short box; floor flush with top of 4-inch dam;

divisor board parallel to side of flume;

0.1 ft. or 1 3-16 inches effective head in both channels

Divisor opening in inches	Percent divisor opening is of total width of box	Percent divisor flow is of total flow in box	Width of Divisor opening to give percent- age of flow		Discharge in Second-feet		
			Percent	Inches	Divisor	Channel	Total
Head = 0.4 ft. or 4 13-16 inches							
1	2.1	2	3 3/4	0.1	2.4	2.5
2	4.2	0.5	4	5 3/8	0.1	2.4	2.5
3	6.3	1.3	6	6 1/2	0.2	2.3	2.5
4	8.3	2.4	8	7 5/8	0.2	2.3	2.5
5	10.4	3.6	10	8 5/8	0.2	2.2	2.4
6	12.5	5.0	12	9 1/2	0.3	2.1	2.4
7	14.6	6.9	15	10 7/8	0.3	2.1	2.4
8	16.7	8.9	17	11 3/4	0.4	2.0	2.4
9	18.8	10.9	19	12 5/8	0.4	2.0	2.4
10	20.8	13.0	21	13 5/8	0.5	1.9	2.4
11	22.9	15.2	23	14 3/8	0.5	1.9	2.4
12	25.0	17.5	25	15 1/4	0.6	1.8	2.4
13	27.1	19.8	27	16 1/8	0.6	1.8	2.4
14	29.2	22.0	29	17	0.7	1.7	2.4
15	31.2	24.3	31	17 7/8	0.8	1.6	2.4
16	33.4	26.6
17	35.4	29.0
18	37.5	31.4
Head = 0.8 ft. or 9 5/8 inches							
1	2.1	2	3 1/4	0.1	5.7	5.8
2	4.2	0.9	4	4 3/4	0.2	5.5	5.7
3	6.3	1.7	6	6	0.3	5.4	5.7
4	8.3	2.8	8	7 1/8	0.4	5.2	5.6
5	10.4	4.3	10	8 1/8	0.5	5.0	5.5
6	12.5	6.0	12	9	0.6	4.9	5.5
7	14.6	7.8	15	10 3/8	0.8	4.7	5.5
8	16.7	9.9	17	11 3/8	0.9	4.5	5.4
9	18.8	11.9	19	12 1/4	1.0	4.4	5.4
10	20.8	14.0	21	13 1/8	1.1	4.3	5.4
11	22.9	16.2	23	14	1.2	4.1	5.3
12	25.0	18.4	25	14 7/8	1.3	4.0	5.3
13	27.1	20.7	27	15 3/4	1.4	3.8	5.2
14	29.2	23.0	29	16 5/8	1.5	3.7	5.2
15	31.2	25.3	31	17 1/2	1.6	3.5	5.1
16	33.4	27.6
17	35.4	29.9
18	37.5	32.3

TABLE XXVIII

For Divisor Shown in Figure 7

Short box; floor flush with top of 4-inch dam;
divisor board parallel to side of flume; free flow in main channel;
0.1 ft. or 1 3-16 inches effective head in divisor channel

Divisor opening in inches	Percent divisor opening is of total width of box	Percent divisor flow is of total flow in box	Width of Divisor opening to give percent- age of flow		Discharge in Second-feet		
			Percent	Inches	Divisor	Channel	Total
Head = 0.4 ft. or 4 13-16 inches							
1	2.1	0.6	2
2	4.2	1.2	4	5 1/2	0.1	2.6	2.7
3	6.3	1.9	6	7 3/8	0.2	2.5	2.7
4	8.3	2.7	8	8 7/8	0.2	2.5	2.7
5	10.4	3.5	10	10 1/8	0.3	2.4	2.7
6	12.5	4.5	12	11 1/8	0.3	2.3	2.6
7	14.6	5.6	15	12 5/8	0.4	2.2	2.6
8	16.7	6.8	17	13 1/2	0.4	2.2	2.6
9	18.8	8.2	19	14 1/2	0.5	2.1	2.6
10	20.8	9.8	21	15 3/8	0.5	2.1	2.6
11	22.9	11.7	23	16 3/8	0.6	2.0	2.6
12	25.0	13.7	25	17 1/4	0.7	1.9	2.6
13	27.1	15.8	27	18 1/4	0.7	1.9	2.6
14	29.2	17.9
15	31.2	20.1
16	33.4	22.3
17	35.4	24.5
18	37.5	26.7
Head = 0.8 ft. or 9 5/8 inches							
1	2.1	...	2	4 3/4	0.2	7.4	7.6
2	4.2	0.6	4	7 3/4	0.4	7.1	7.5
3	6.3	1.1	6	9 3/4	0.6	6.7	7.3
4	8.3	1.6	8	11 3/8	0.7	6.4	7.1
5	10.4	2.2	10	12 3/4	0.8	6.2	7.0
6	12.5	2.8	12	14	0.9	6.0	6.9
7	14.6	3.5	15	15 3/4	1.1	5.7	6.8
8	16.7	4.2	17	16 7/8	1.2	5.5	6.7
9	18.8	5.2	19	18	1.3	5.4	6.7
10	20.8	6.3
11	22.9	7.5
12	25.0	9.0
13	27.1	10.5
14	29.2	12.0
15	31.2	13.7
16	33.4	15.4
17	35.4	17.2
18	37.5	19.0

TABLE XXIX

For Divisor Shown in Figure 7
 Short box; floor flush with top of 4-inch dam;
 divisor board parallel to side of flume;
 free flow in divisor channel;
 0.1 ft. or 13-16 inches effective head in main channel

Divisor opening in inches	Percent divisor opening is of total width of box	Percent divisor flow is of total flow in box	Width of Divisor opening to give percent- age of flow		Discharge in Second-feet		
			Percent	Inches	Divisor Channel	Total	
Head = 0.4 ft. or 4 13-16 inches							
1	2.1	1.1
2	4.2	2.4	4	3 1/8	0.1	2.5	2.6
3	6.3	3.8	6	4 3/8	0.2	2.4	2.6
4	8.3	5.3	8	5 3/8	0.2	2.4	2.6
5	10.4	7.1	10	6 3/8	0.3	2.3	2.6
6	12.5	9.2	12	7 1/4	0.3	2.3	2.6
7	14.6	11.6	15	8 3/8	0.4	2.2	2.6
8	16.7	14.1	17	9 1/8	0.4	2.2	2.6
9	18.8	16.6	19	9 7/8	0.5	2.1	2.6
10	20.8	19.2	21	10 3/4	0.5	2.1	2.6
11	22.9	21.7	23	11 1/2	0.6	2.0	2.6
12	25.0	24.2	25	12 3/8	0.7	1.9	2.6
13	27.1	26.7	27	13 1/8	0.7	1.9	2.6
14	29.2	29.3	29	13 7/8	0.8	1.8	2.6
15	31.2	31.9	31	14 5/8	0.8	1.8	2.6
16	33.4	34.5	33	15 3/8	0.9	1.7	2.6
17	35.4	37.0	35	16 1/4	0.9	1.7	2.6
18	37.5	39.6	38	17 3/8	1.0	1.6	2.6

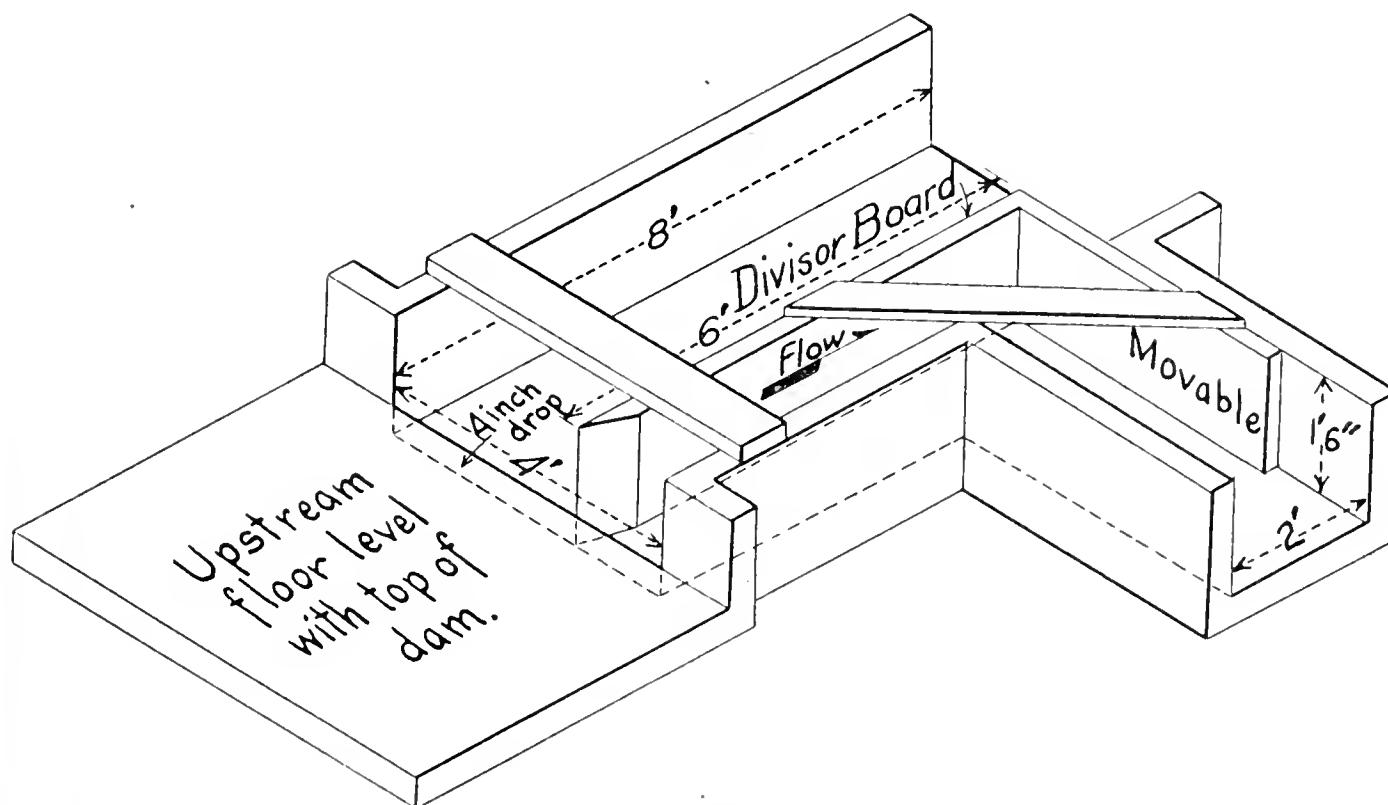

Fig. 7

TABLE XXIX. (Continued)

Divisor opening in inches	Percent divisor opening is of total width of box	Percent divisor flow is of total flow in box	Divisor opening Width of to give percent- age of flow		Discharge in Second-feet		
			Percent	Inches	Divisor	Channel	Total
Head = 0.8 ft. or 9 $\frac{5}{8}$ inches							
1	2.1	1.6	2	1 $\frac{1}{4}$	0.1	6.0	6.1
2	4.2	3.4	4	2 $\frac{1}{4}$	0.2	5.9	6.1
3	6.3	5.5	6	3 $\frac{1}{4}$	0.4	5.7	6.1
4	8.3	7.8	8	4	0.5	5.6	6.1
5	10.4	10.3	10	4 $\frac{7}{8}$	0.6	5.5	6.1
6	12.5	13.1	12	5 $\frac{5}{8}$	0.7	5.4	6.1
7	14.6	15.9	15	6 $\frac{5}{8}$	0.9	5.3	6.2
8	16.7	18.7	17	7 $\frac{3}{8}$	1.0	5.2	6.2
9	18.8	21.5	19	8	1.2	5.0	6.2
10	20.8	24.4	21	8 $\frac{3}{4}$	1.3	4.9	6.2
11	22.9	27.3	23	9 $\frac{1}{2}$	1.5	4.8	6.3
12	25.0	30.2	25	10 $\frac{1}{4}$	1.6	4.7	6.3
13	27.1	33.1	27	10 $\frac{7}{8}$	1.7	4.6	6.3
14	29.2	36.0	29	11 $\frac{5}{8}$	1.9	4.5	6.4
15	31.2	38.9	31	12 $\frac{1}{4}$	2.0	4.4	6.4
16	33.4	41.8	33	13	2.1	4.3	6.4
17	35.4	44.7	35	13 $\frac{5}{8}$	2.2	4.2	6.4
18	37.5	47.6	38	14 $\frac{3}{4}$	2.5	4.0	6.5

TABLE XXX

For Divisor Shown in Figure 8
Short box; no dam; divisor board parallel to side of flume;
free flow in both channels

Divisor opening in inches	Percent divisor opening is of total width of box	Percent divisor flow is of total flow in box	Width of Divisor opening to give percent- age of flow		Discharge in Second-feet		
			Percent	Inches	Divisor	Channel	Total
Head = 0.2 ft. or 2 $\frac{3}{8}$ inches							
1	2.1	...	2	2 $\frac{3}{8}$	0.1	0.8	0.9
2	4.2	1.2	4	3 $\frac{5}{8}$	0.1	0.8	0.9
3	6.3	2.9	6	4 $\frac{3}{4}$	0.1	0.8	0.9
4	8.3	4.6	8	5 $\frac{7}{8}$	0.1	0.8	0.9
5	10.4	6.4	10	7	0.1	0.8	0.9
6	12.5	8.2	12	8	0.1	0.8	0.9
7	14.6	10.0	15	9 $\frac{1}{2}$	0.1	0.8	0.9
8	16.7	12.0	17	10 $\frac{3}{8}$	0.2	0.7	0.9
9	18.8	14.0	19	11 $\frac{3}{8}$	0.2	0.7	0.9
10	20.8	16.1	21	12 $\frac{1}{4}$	0.2	0.7	0.9
11	22.9	18.2	23	13 $\frac{1}{4}$	0.2	0.7	0.9
12	25.0	20.4	25	14 $\frac{1}{8}$	0.2	0.7	0.9

TABLE XXX (Continued)

Divisor opening in inches	Percent divisor opening is of total width of box	Percent divisor flow is of total flow in box	Width of Divisor opening to give percent- age of flow		Discharge in Second-feet		
			Percent	Inches	Divisor	Channel	Total
Head = 0.2 ft. or 2 3/8 inches							
13	27.1	22.6	27	15	0.2	0.7	0.9
14	29.2	24.8	29	15 7/8	0.3	0.6	0.9
15	31.2	27.0	31	16 3/4	0.3	0.6	0.9
16	33.4	29.3	33	17 5/8	0.3	0.6	0.9
17	35.4	31.6	35	18 1/2	0.3	0.5	0.8
18	37.5	33.8
Head = 0.4 ft. or 4 13-16 inches							
1	2.1	2	2 1/4	0.1	2.6	2.7
2	4.2	1.5	4	3 1/2	0.1	2.6	2.7
3	6.3	3.1	6	4 5/8	0.1	2.5	2.6
4	8.3	4.8	8	5 3/4	0.2	2.4	2.6
5	10.4	6.6	10	6 3/4	0.2	2.4	2.6
6	12.5	8.5	12	7 7/8	0.3	2.3	2.6
7	14.6	10.4	15	9 1/4	0.4	2.2	2.6
8	16.7	12.4	17	10 1/4	0.4	2.2	2.6
9	18.8	14.4	19	11 1/4	0.5	2.1	2.6
10	20.8	16.4	21	12 1/8	0.5	2.1	2.6
11	22.9	18.5	23	13	0.6	2.0	2.6
12	25.0	20.7	25	14	0.6	2.0	2.6
13	27.1	22.9	27	14 7/8	0.7	1.9	2.6
14	29.2	25.1	29	15 3/4	0.7	1.9	2.6
15	31.2	27.3	31	16 5/8	0.8	1.8	2.6
16	33.4	29.6	33	17 1/2	0.9	1.7	2.6
17	35.4	31.9	35	18 3/8	0.9	1.7	2.6
18	37.5	34.2
Head = 0.6 ft. or 7 3-16 inches							
1	2.1	2	2 1/4	0.1	4.9	5.0
2	4.2	1.6	4	3 3/8	0.2	4.8	5.0
3	6.3	3.3	6	4 1/2	0.3	4.7	5.0
4	8.3	5.1	8	5 5/8	0.4	4.6	5.0
5	10.4	6.9	10	6 5/8	0.5	4.5	5.0
6	12.5	8.7	12	7 3/4	0.6	4.4	5.0
7	14.6	10.6	15	9 1/4	0.8	4.2	5.0
8	16.7	12.6	17	10 1/8	0.9	4.1	5.0
9	18.8	14.6	19	11 1/8	1.0	4.0	5.0
10	20.8	16.7	21	12	1.1	3.9	5.0
11	22.9	18.8	23	12 7/8	1.2	3.8	5.0
12	25.0	21.0	25	13 7/8	1.3	3.7	5.0
13	27.1	23.2	27	14 3/4	1.4	3.6	5.0
14	29.2	25.4	29	15 5/8	1.4	3.5	4.9
15	31.2	27.6	31	16 1/2	1.5	3.4	4.9
16	33.4	29.8	33	17 3/8	1.6	3.3	4.9
17	35.4	32.1	35	18 1/4	1.7	3.2	4.9
18	37.5	34.5

TABLE XXX (Continued)

Divisor opening in inches	Percent divisor opening is of total width of box	Percent divisor flow is of total flow in box	Width of Divisor opening to give percent- age of flow		Discharge in Second-feet			
			Percent	Inches	Divisor	Channel	Total	
Head = 0.8 ft. or 9 $\frac{5}{8}$ inches								
1	2.1	...	2	2 $\frac{1}{8}$	0.1	7.6	7.7	
2	4.2	1.7	4	3 $\frac{1}{4}$	0.3	7.5	7.8	
3	6.3	3.5	6	4 $\frac{3}{8}$	0.4	7.4	7.8	
4	8.3	5.3	8	5 $\frac{1}{2}$	0.6	7.2	7.8	
5	10.4	7.1	10	6 $\frac{1}{2}$	0.8	7.0	7.8	
6	12.5	9.0	12	7 $\frac{5}{8}$	1.0	6.9	7.9	
7	14.6	10.9	15	9	1.2	6.7	7.9	
8	16.7	12.9	17	10	1.4	6.5	7.9	
9	18.8	14.9	19	11	1.5	6.4	7.9	
10	20.8	17.0	21	11 $\frac{7}{8}$	1.7	6.2	7.9	
11	22.9	19.1	23	12 $\frac{7}{8}$	1.8	6.0	7.8	
12	25.0	21.2	25	13 $\frac{3}{4}$	1.9	5.9	7.8	
13	27.1	23.4	27	14 $\frac{5}{8}$	2.1	5.7	7.8	
14	29.2	25.6	29	15 $\frac{1}{2}$	2.3	5.5	7.8	
15	31.2	27.8	31	16 $\frac{3}{8}$	2.4	5.4	7.8	
16	33.4	30.0	33	17 $\frac{1}{4}$	2.6	5.2	7.8	
17	35.4	32.3	35	18 $\frac{1}{8}$	2.7	5.1	7.8	
18	37.5	34.6	
Head = 1.0 ft. or 12 inches								
1	2.1	...	2	2 $\frac{1}{8}$	0.2	10.8	11.0	
2	4.2	1.8	4	3 $\frac{1}{4}$	0.4	10.5	10.9	
3	6.3	3.6	6	4 $\frac{1}{4}$	0.6	10.3	10.9	
4	8.3	5.4	8	5 $\frac{3}{8}$	0.8	10.1	10.9	
5	10.4	7.3	10	6 $\frac{3}{8}$	1.0	9.9	10.9	
6	12.5	9.2	12	7 $\frac{1}{2}$	1.3	9.6	10.9	
7	14.6	11.1	15	9	1.7	9.3	11.0	
8	16.7	13.1	17	9 $\frac{7}{8}$	1.9	9.1	11.0	
9	18.8	15.1	19	10 $\frac{7}{8}$	2.1	8.9	11.0	
10	20.8	17.2	21	11 $\frac{3}{4}$	2.3	8.7	11.0	
11	22.9	19.3	23	12 $\frac{3}{4}$	2.6	8.4	11.0	
12	25.0	21.4	25	13 $\frac{5}{8}$	2.8	8.2	11.0	
13	27.1	23.6	27	14 $\frac{1}{2}$	3.0	8.0	11.0	
14	29.2	25.8	29	15 $\frac{3}{8}$	3.2	7.8	11.0	
15	31.2	28.0	31	16 $\frac{1}{4}$	3.4	7.6	11.0	
16	33.4	30.3	33	17 $\frac{1}{4}$	3.6	7.3	10.9	
17	35.4	32.6	35	18 $\frac{1}{8}$	3.8	7.1	10.9	
18	37.5	34.8	

TABLE XXXI

For Divisor Shown in Figure 8

Short box; no dam; divisor board parallel to side of flume;
0.1 ft. or 1 3-16 inches effective head in both channels

Divisor opening in inches	Percent divisor opening is of total width of box	Percent divisor flow is of total flow in box	Width of Divisor opening to give percent- age of flow		Discharge in Second-feet		
			Percent	Inches	Divisor	Channel	Total
Head = 0.4 ft. or 4 13-16 inches							
1	2.1	...	2	2 1/2	0.1	2.4	2.5
2	4.2	1.3	4	3 3/4	0.1	2.4	2.5
3	6.3	2.8	6	5	0.1	2.3	2.4
4	8.3	4.3	8	6 1/8	0.2	2.2	2.4
5	10.4	6.0	10	7 1/4	0.2	2.2	2.4
6	12.5	7.7	12	8 1/4	0.3	2.1	2.4
7	14.6	9.6	15	9 3/4	0.3	2.1	2.4
8	16.7	11.5	17	10 3/4	0.4	2.0	2.4
9	18.8	13.4	19	11 3/4	0.4	2.0	2.4
10	20.8	15.5	21	12 5/8	0.5	1.9	2.4
11	22.9	17.6	23	13 1/2	0.6	1.9	2.4
12	25.0	19.7	25	14 3/8	0.6	1.8	2.4
13	27.1	21.9	27	15 1/4	0.6	1.8	2.4
14	29.2	24.1	29	16 1/8	0.7	1.7	2.4
15	31.2	26.4	31	16 7/8	0.7	1.7	2.4
16	33.4	28.8	33	17 3/4	0.8	1.6	2.4
17	35.4	31.2	35	18 5/8	0.8	1.6	2.4
18	37.5	33.6
Head = 0.8 ft. or 9 5/8 inches							
1	2.1
2	4.2	1.4	4	3 5/8	0.2	5.6	5.8
3	6.3	3.1	6	4 3/4	0.4	5.4	5.8
4	8.3	4.8	8	5 7/8	0.5	5.3	5.8
5	10.4	6.5	10	6 7/8	0.6	5.2	5.8
6	12.5	8.3	12	7 7/8	0.7	5.1	5.8
7	14.6	10.2	15	9 3/8	0.9	4.9	5.8
8	16.7	12.2	17	10 3/8	1.0	4.8	5.8
9	18.8	14.2	19	11 1/4	1.1	4.7	5.8
10	20.8	16.2	21	12 1/4	1.2	4.6	5.8
11	22.9	18.3	23	13 1/8	1.3	4.5	5.8
12	25.0	20.5	25	14 1/8	1.5	4.4	5.9
13	27.1	22.7	27	15	1.6	4.3	5.9
14	29.2	24.9	29	15 7/8	1.7	4.2	5.9
15	31.2	27.1	31	16 3/4	1.8	4.1	5.9
16	33.4	29.3	33	17 5/8	1.9	4.0	5.9
17	35.4	31.5	35	18 5/8	2.1	3.8	5.9
18	37.5	33.7

TABLE XXXII

For Divisor Shown in Figure 8
 Short box; no dam; divisor board parallel to side of flume;
 free flow in main channel;
 0.1 ft. or 1 3-16 inches effective head in divisor channel

Divisor opening in inches	Percent divisor opening is of total width of box	Percent divisor flow is of total flow in box	Width of Divisor opening to give percent- age of flow		Discharge in Second-feet		
			Percent	Inches	Divisor	Channel	Total
Head = 0.4 ft. or 4 13-16 inches							
1	2.1	2	2 $\frac{5}{8}$	0.1	2.6	2.7
2	4.2	1.3	4	4	0.1	2.5	2.6
3	6.3	2.6	6	5 $\frac{3}{8}$	0.2	2.4	2.6
4	8.3	3.9	8	6 $\frac{5}{8}$	0.2	2.4	2.6
5	10.4	5.4	10	7 $\frac{3}{4}$	0.3	2.3	2.6
6	12.5	7.0	12	8 $\frac{3}{4}$	0.3	2.3	2.6
7	14.6	8.7	15	10 $\frac{1}{4}$	0.4	2.2	2.6
8	16.7	10.5	17	11 $\frac{1}{4}$	0.4	2.1	2.5
9	18.8	12.4	19	12 $\frac{1}{4}$	0.5	2.0	2.5
10	20.8	14.4	21	13 $\frac{1}{8}$	0.5	2.0	2.5
11	22.9	16.5	23	14	0.6	1.9	2.5
12	25.0	18.6	25	15	0.6	1.9	2.5
13	27.1	20.7	27	15 $\frac{7}{8}$	0.7	1.8	2.5
14	29.2	22.9	29	16 $\frac{3}{4}$	0.7	1.8	2.5
15	31.2	25.1	31	17 $\frac{1}{2}$	0.8	1.7	2.5
16	33.4	27.4
17	35.4	29.8
18	37.5	32.2
Head = 0.8 ft. or 9 $\frac{5}{8}$ inches							
1	2.1	2	3 $\frac{1}{4}$	0.1	7.4	7.5
2	4.2	0.7	4	4 $\frac{3}{4}$	0.3	7.2	7.5
3	6.3	1.8	6	6 $\frac{1}{4}$	0.5	7.0	7.5
4	8.3	3.0	8	7 $\frac{1}{2}$	0.6	6.8	7.4
5	10.4	4.3	10	8 $\frac{3}{4}$	0.7	6.6	7.3
6	12.5	5.7	12	10	0.9	6.4	7.3
7	14.6	7.2	15	11 $\frac{5}{8}$	1.1	6.1	7.2
8	16.7	8.8	17	12 $\frac{3}{4}$	1.2	5.9	7.1
9	18.8	10.4	19	13 $\frac{3}{4}$	1.4	5.7	7.1
10	20.8	12.1	21	14 $\frac{3}{4}$	1.5	5.6	7.1
11	22.9	13.8	23	15 $\frac{3}{4}$	1.6	5.4	7.0
12	25.0	15.6	25	16 $\frac{5}{8}$	1.7	5.3	7.0
13	27.1	17.5	27	17 $\frac{5}{8}$	1.9	5.1	7.0
14	29.2	19.5	29	18 $\frac{1}{2}$	2.0	4.9	6.9
15	31.2	21.6
16	33.4	23.7
17	35.4	25.9
18	37.5	28.1

TABLE XXXIII

For Divisor Shown in Figure 8

Short box; no dam; divisor board parallel to side of flume;
free flow in divisor channel; 0.1 ft. or 1 3-16 inches effective
head in main channel

Divisor opening in inches	Percent divisor opening is of total width of box	Percent divisor flow is of total flow in box	Width of Divisor opening to give percent- age of flow		Discharge in Second-feet		
			Percent	Inches	Divisor	Channel	Total
Head = 0.4 ft. or 4 13-16 inches							
1	2.1	2	2 1/4	0.1	2.4	2.5
2	4.2	1.7	4	3 3/8	0.1	2.4	2.5
3	6.3	3.4	6	4 1/2	0.2	2.3	2.5
4	8.3	5.3	8	5 1/2	0.2	2.3	2.5
5	10.4	7.2	10	6 1/2	0.3	2.2	2.5
6	12.5	9.1	12	7 1/2	0.3	2.2	2.5
7	14.6	11.0	15	9	0.4	2.1	2.5
8	16.7	13.0	17	9 7/8	0.4	2.1	2.5
9	18.8	15.1	19	10 3/4	0.5	2.0	2.5
10	20.8	17.3	21	11 5/8	0.5	2.0	2.5
11	22.9	19.5	23	12 1/2	0.6	1.9	2.5
12	25.0	21.7	25	13 3/8	0.6	1.9	2.5
13	27.1	24.0	27	14 1/4	0.7	1.8	2.5
14	29.2	26.3	29	15 1/8	0.7	1.8	2.5
15	31.2	28.7	31	16	0.8	1.7	2.5
16	33.4	31.1	33	16 3/4	0.8	1.7	2.5
17	35.4	33.6	35	17 5/8	0.9	1.6	2.5
18	37.5	36.1
Head = 0.8 ft. or 9 5/8 inches							
1	2.1	2	1 7/8	0.1	5.8	5.9
2	4.2	2.3	4	2 5/8	0.2	5.7	5.9
3	6.3	4.8	6	3 1/2	0.3	5.6	5.9
4	8.3	7.3	8	4 1/4	0.5	5.5	6.0
5	10.4	9.8	10	5 1/8	0.6	5.4	6.0
6	12.5	12.2	12	5 7/8	0.7	5.3	6.0
7	14.6	14.7	15	7 1/8	0.9	5.2	6.1
8	16.7	17.2	17	7 7/8	1.0	5.1	6.1
9	18.8	19.6	19	8 3/4	1.2	5.0	6.2
10	20.8	22.0	21	9 5/8	1.3	4.9	6.2
11	22.9	24.4	23	10 3/8	1.4	4.8	6.2
12	25.0	26.8	25	11 1/4	1.6	4.7	6.3
13	27.1	29.2	27	12 1/8	1.7	4.6	6.3
14	29.2	31.5	29	12 7/8	1.8	4.5	6.3
15	31.2	33.8	31	13 3/4	2.0	4.4	6.4
16	33.4	36.2	33	14 5/8	2.1	4.3	6.4
17	35.4	38.5	35	15 1/2	2.3	4.2	6.5
18	37.5	40.8	38	16 3/4	2.5	4.1	6.6
..	40	17 5/8	2.6	4.1	6.7

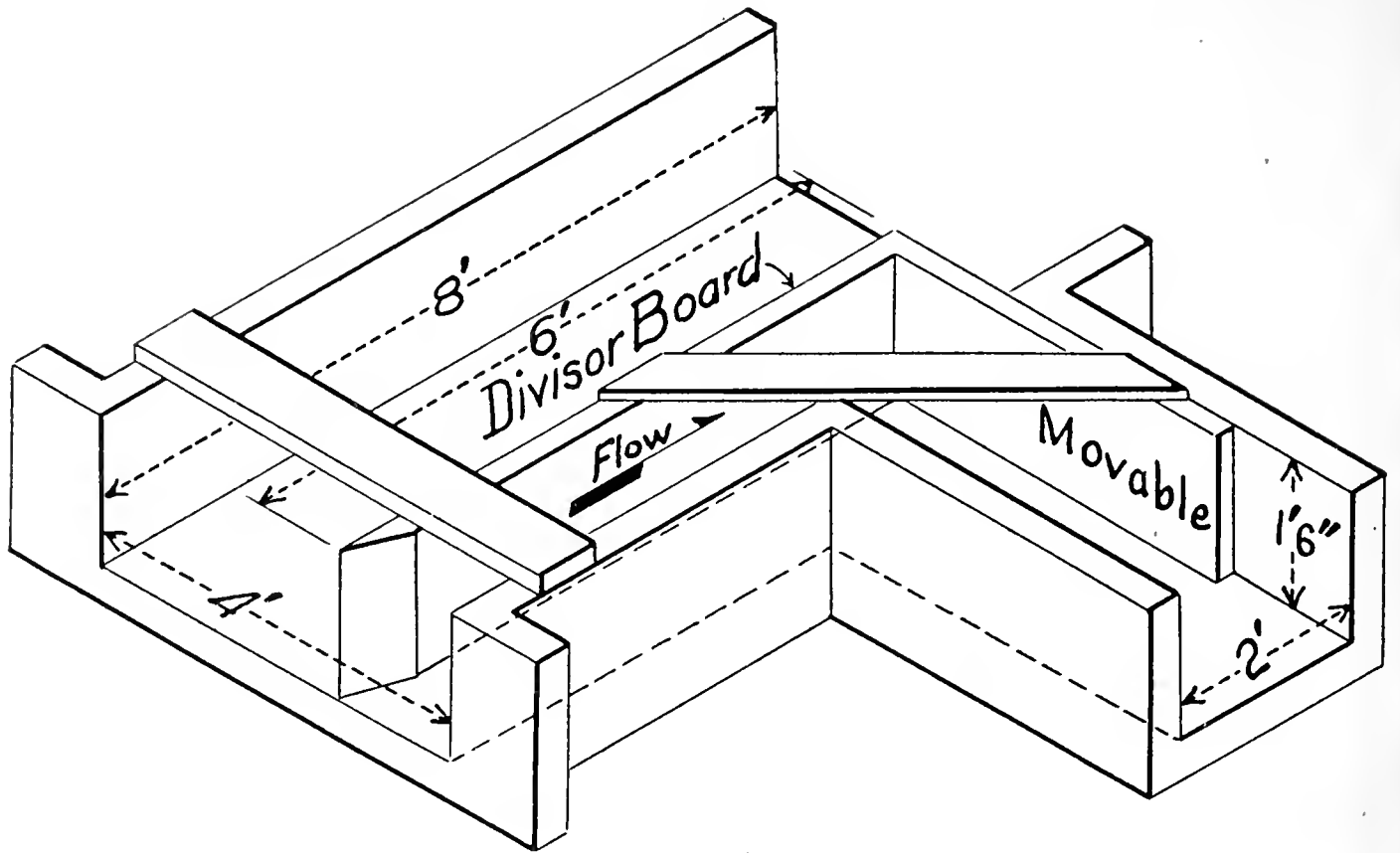

Fig. 8

Bulletin 229

May, 1917

The Agricultural Experiment Station

OF THE

Colorado Agricultural College

BRISKET DISEASE

(Bulletin No. 204 revised and abbreviated)

By

GEORGE H. GLOVER and I. E. NEWSOM

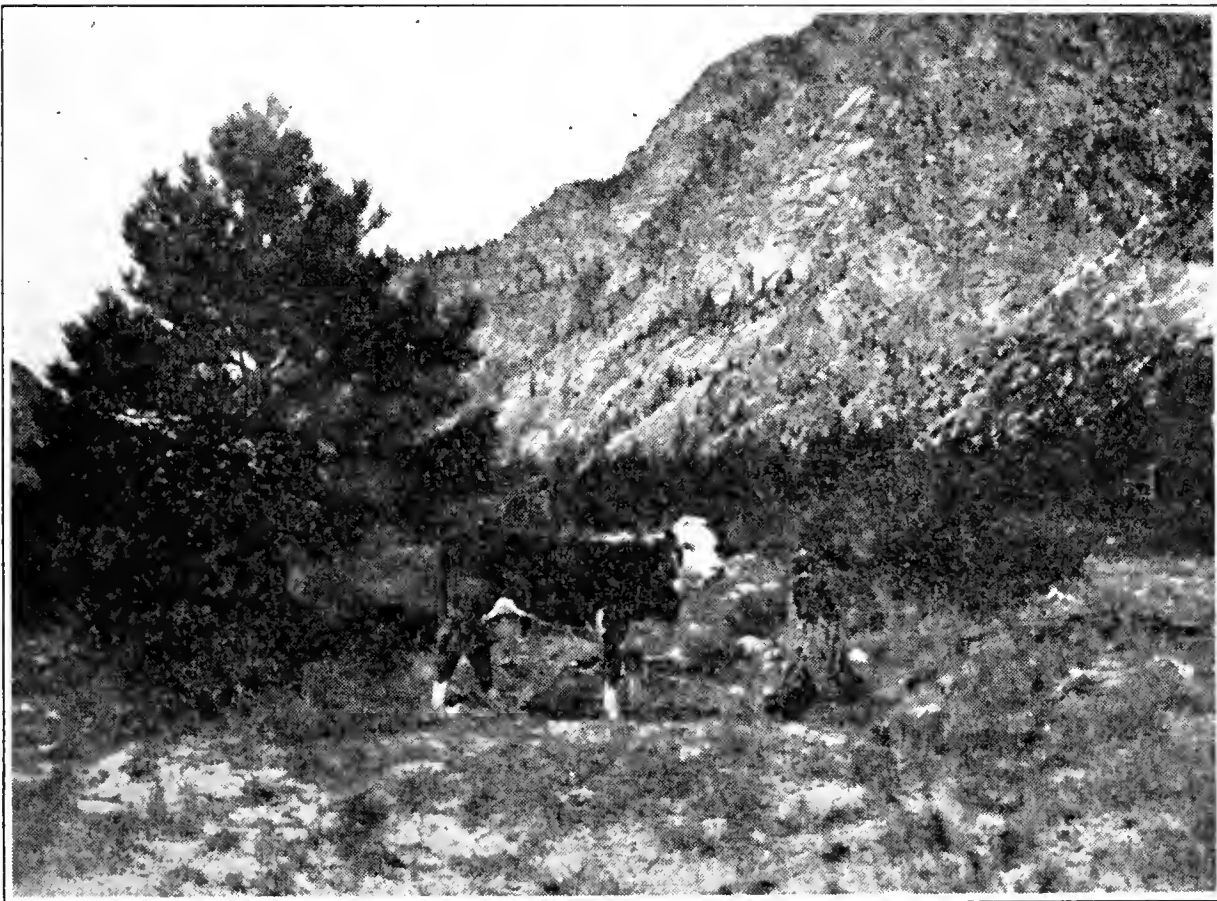

PUBLISHED BY THE EXPERIMENT STATION
FORT COLLINS, COLORADO
1917



This bull was raised at Golden, Colo., altitude 5,693 feet, shipped to South Park, where he was ranged between 11,000 and 12,000 feet. He developed the disease during the summer of 1914, was shipped to Denver and recovered within two weeks after arrival. No medicinal treatment was given.

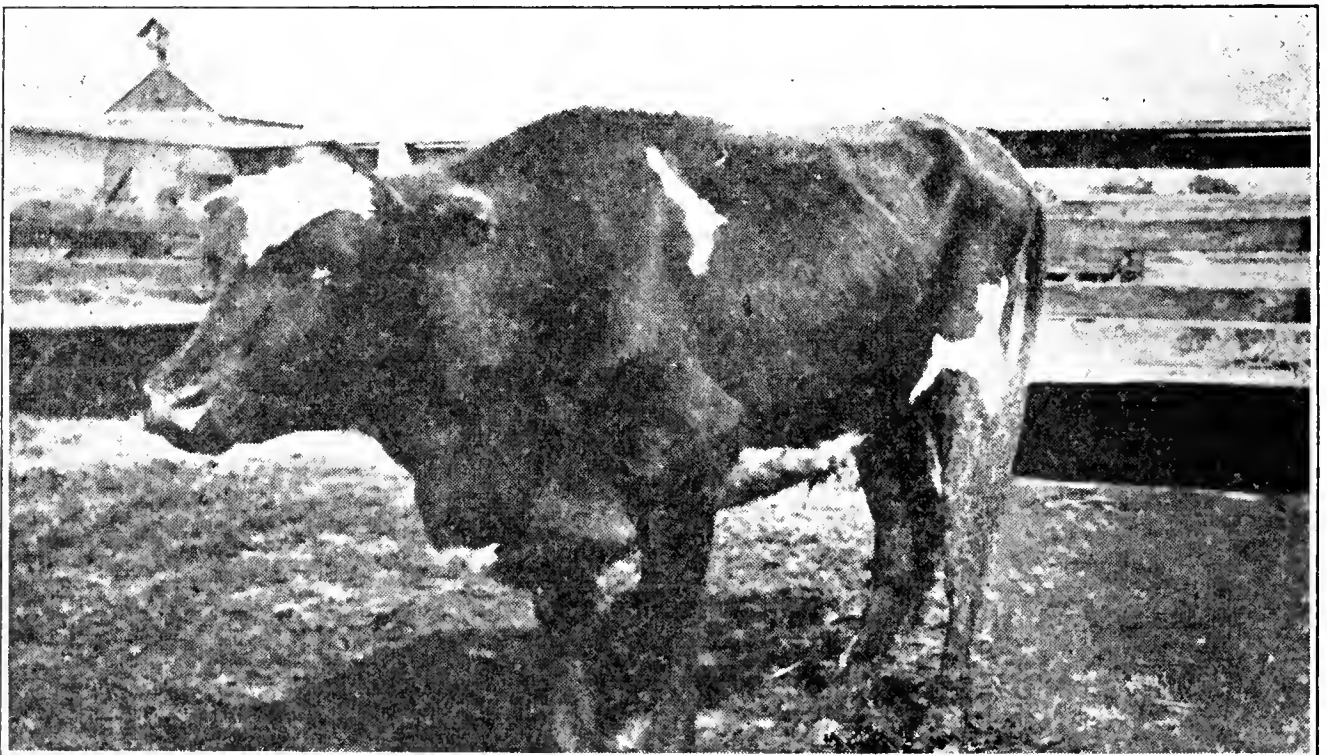

A Shorthorn steer raised in Texas and sent to South Park a year previous to the development of the disease. Ranged at an altitude of between 11,000 and 12,000 feet. He was shipped to Denver, where he recovered in less than three weeks, without medicinal treatment.

BRISKET DISEASE

(Bulletin No. 204 revised and abbreviated)

By

GEORGE H. GLOVER and I. E. NEWSOM

SUMMARY

A disease occurs in cattle in the high altitudes of Colorado, the principal symptoms of which are swelling of the brisket and of the loose tissues under the jaw, usually diarrhoea and a moist cough, with gradual emaciation and death. It is chronic in character but is fatal in practically all cases.

On autopsy the most marked features are generalized dropsy, enlarged and hard liver and dilated heart.

It appears to be caused by an exhaustion of the heart muscle associated with a varying degree of dilatation and hypertrophy, this being brought about by failure of acclimatization at high altitudes.

Medical treatment has so far proven of little avail, but, where possible, shipping the affected animals to a lower altitude is recommended.

Preventive measures include the use of bulls that have been raised at altitudes of 8,000 feet or more, with a view to building up a hardier strain of cattle; also the curtailment of indiscriminate shipping of low altitude cattle to high altitudes.

BRIEF FACTS HERE GIVEN

Bulletin No. 204 of this Station entitled "Brisket Disease" having become exhausted, it has seemed desirable to set down briefly such facts about the disease as will be of value to the stockmen of the State. The inquiries concerning this disease continue to come to the Station and it is to answer these in a more comprehensive manner than can be done by letter that this bulletin is prepared. The Station began its work on this malady in 1913 at the special request of many stockmen who had sustained loss of animals.

HISTORY AND DISTRIBUTION

Brisket disease has been known in Colorado since 1889 and since that time has caused an annual loss of approximately 1 per cent of all cattle maintained above an altitude of 8,000 feet. It has been especially prevalent in the high mountain parks. Practically every year numerous cases are seen in North, Middle and South Parks and on the forest reserves surrounding the same. It is a frequent cause of loss on nearly

all of the forest reserves since these are usually found at high altitudes. It seems not to occur in the San Luis Valley to any extent, but is frequent on the ranges adjacent to that territory. In fact it has been seen in practically every part of the State where many cattle are maintained above an altitude of 8,000 feet.

The disease is known definitely to exist in Wyoming and New Mexico but so far has not been diagnosed in any other state or country. One report of its occurrence in Montana has not been verified. It is said by competent authority not to exist in the Alps of Switzerland.

ANIMALS AFFECTED

Cattle of all ages are susceptible, even calves as young as one month often showing well marked symptoms. In fact many calves die from the disease when the owners do not recognize the ailment.

CAUSE

It seems to have been demonstrated that the cause lies in failure of acclimatization to extreme altitudes. The malady is far more prevalent in animals that are shipped in from low altitudes. In the case of calves, those that are sired by low altitude bulls are much more susceptible. The higher the altitude the more prevalent is the disease and the shipping of affected animals to lower levels will in a majority of the cases effect a cure. All of these observations clearly indicate that the altitude is the chief factor. In order to eliminate the food as a factor the Station shipped six affected animals to Fort Collins (altitude 5,000 feet) and fed them on South Park hay after arrival. (This disease is very prevalent in South Park, altitude 9,000 to 10,000 feet.) Four of these animals recovered, while two died. Since the two which died arrived in a moribund condition, and one of them died within 24 hours after arrival, it is not believed the food could have been responsible for their death.

The disease does not appear to be contagious, since only a small percentage of animals is ordinarily affected. The work of the Station has never revealed a micro-organism that could in any way be a causative factor. Transmission experiments resulted negatively in the two instances tried.

It is the belief of those who have investigated the disease that the lack of oxygen, the exhausting labor involved in grazing over the mountains, and the severe climate, all result in over-strain of the heart in some individuals, which leads to the generalized dropsy that has been called brisket disease.

SYMPTOMS

The first evidence of the disease is a dull, listless appearance, the hair stands on end and the ears droop. The animal appears gaunt owing to failure to take the usual amount of food. There may be a slight, moist cough. A diarrhoea usually appears soon after the other symptoms, or it may even be the first symptom noted. The respiration is increased and the pulse is rapid and weak. Many calves die in this stage without showing any swelling of the brisket. In some instances the appetite remains good up to within a few days of death.

Later, there appears a swelling of the loose tissue under the jaw and a swelling of the loose tissues of the brisket. Either swelling may appear first, but gradually the two merge into each other as the whole under part of the neck becomes dropsical. In male animals, the sheath may swell considerably and the hind limbs become puffy. The fore limbs may stock in extreme cases. The swelling of the brisket may become enormous in size, extending out in front of the fore limbs as a rather firm doughy mass. There is no pain on pressure and the part is not increased in temperature. The abdomen may swell markedly in its lower portion, due to accumulation of fluid.

The respiration becomes increased, but labored only on exercise. A clear, mucous discharge comes from the eyes and nostrils. There is no fever. The heart-beats are increased, especially on slight excitement or exercise, when they may run 100 to 120 per minute. Under these circumstances the beat is tumultuous but lacks force, as evidenced by a very weak pulse. A pronounced jugular pulse is common in the later stages.

Forced exercise in this later stage will cause labored breathing, coughing, hemorrhage from the nose, and if continued, quick death. Consequently, it is difficult to drive an afflicted animal any considerable distance.

The animals become very weak, so that the slightest exertion or excitement causes them to fall. This has been noticed repeatedly when attempting to restrain them for close observation.

The usual course of the disease is from two weeks to three months, although a few animals have been known to apparently recover in the spring, only to be taken down again the following fall. We may say that most animals die within a month after symptoms are first noticed, the older cattle living longer than the younger. Death seems to be due either to suffocation or exhaustion and paralysis of the heart.

LESIONS

The carcass is usually emaciated. The subcutaneous tissues in the region of the brisket, lower side of the neck, and under the jaw are infiltrated with a clear serum. It does not flow freely when incised, but can be squeezed out. Sometimes the subcutaneous tissue of the limbs is similarly affected.

When the abdomen is opened, a considerable quantity of straw-colored fluid escapes, sometimes as much as six or eight gallons.

The liver is always much enlarged and is tough, firm and leathery. On section it has a grayish mottled appearance, the cut veins being very large. The condition of the liver is very noticeable and seems to be constant.

In the thorax a large amount of fluid is to be found, as in the abdomen. The lungs are edematous. The heart is enlarged, dilated and usually flabby.

DIFFERENTIAL DIAGNOSIS

It simulates traumatic pericarditis, but can be differentiated by the fever which usually accompanies the latter disease. On post-mortem examination the finding of pus in the pericardium would eliminate brisket disease and point to traumatism.

It could easily be mistaken for pneumonia, especially if complicated with pleurisy, in which case the brisket might be swollen. The diagnosis of these latter conditions would be based on the presence of fever in the live animal and, on autopsy, signs of inflammation in the lungs and pleura.

TREATMENT

Of twelve animals shipped to a lower altitude under the direction of the Station, ten recovered, although no other treatment was administered. It is the belief of most stockmen who have had experience that getting the animals to a lower level is sufficient to effect a cure. It appears that taking the animals from the ranges around the San Luis Valley down into the Valley proper (altitude 7,500 feet) has effected a cure in many cases. Most of the animals that have been shipped from South Park to Denver (5,280 feet) have recovered. Consequently, removal to a lower altitude is always to be recommended if feasible. The difficulty comes in getting these animals to a shipping point, as they are so weak that they can be driven only with difficulty.

Medicinal treatment has always been unsatisfactory but can be tried if the animals can be put into a warm place. Any treatment on the range is believed to be out of the question.

If the animals can be gotten to a place where they can receive daily care, then treatment should be tried as follows:

Keep them quiet, do not excite them any more than absolutely necessary. Give them plenty of water and hay, preferably alfalfa. Drench them daily with a teaspoonful of fluid extract of digitalis for adult animals and ten drops for young calves. The medicine can be put into a few ounces of water. This treatment can be kept up for two or three weeks, when it should be discontinued for a time. This suggested treatment is not given with the expectation that many animals will be saved by it, but only that it may be tried where it is impracticable to get the animals to a lower altitude. Such animals, even if they recover, should be shipped out at the first convenient opportunity.

PREVENTION

Since the disease is far more prevalent in cattle shipped in from low altitudes than in natives, it would seem only wise that importations be somewhat curtailed or, if practiced, that the animals be brought more gradually to the extreme altitudes.

Since extreme exertion on first arrival at the higher level seems to play a part, more care should be taken in the handling of the animals during the first few weeks to see that they are not subjected to long, hard drives. Realizing that these animals are usually wild, we are aware of the difficulty in complying with this suggestion.

The practice of buying pure-bred bulls from low altitudes, while praiseworthy in its intent, seems to be responsible for some of the difficulty. Not only do the bulls themselves in many instances die of the disease after some months residence under the new conditions, but their calves appear to be much more susceptible than calves sired by native bulls. In order to reduce this source of trouble it is recommended that bulls be purchased from altitudes more nearly approaching that at which they are to be used. We believe that this practice, if followed, would do much toward eliminating the disease. The idea is to breed a more vigorous animal that can stand the unusual conditions incident to a high altitude. Finally, it may become necessary to abandon some of the higher ranges, especially during cold and wet summers. Since the disease has not been seen in sheep, it may be possible to range these animals at the higher levels where the cattle do not thrive.

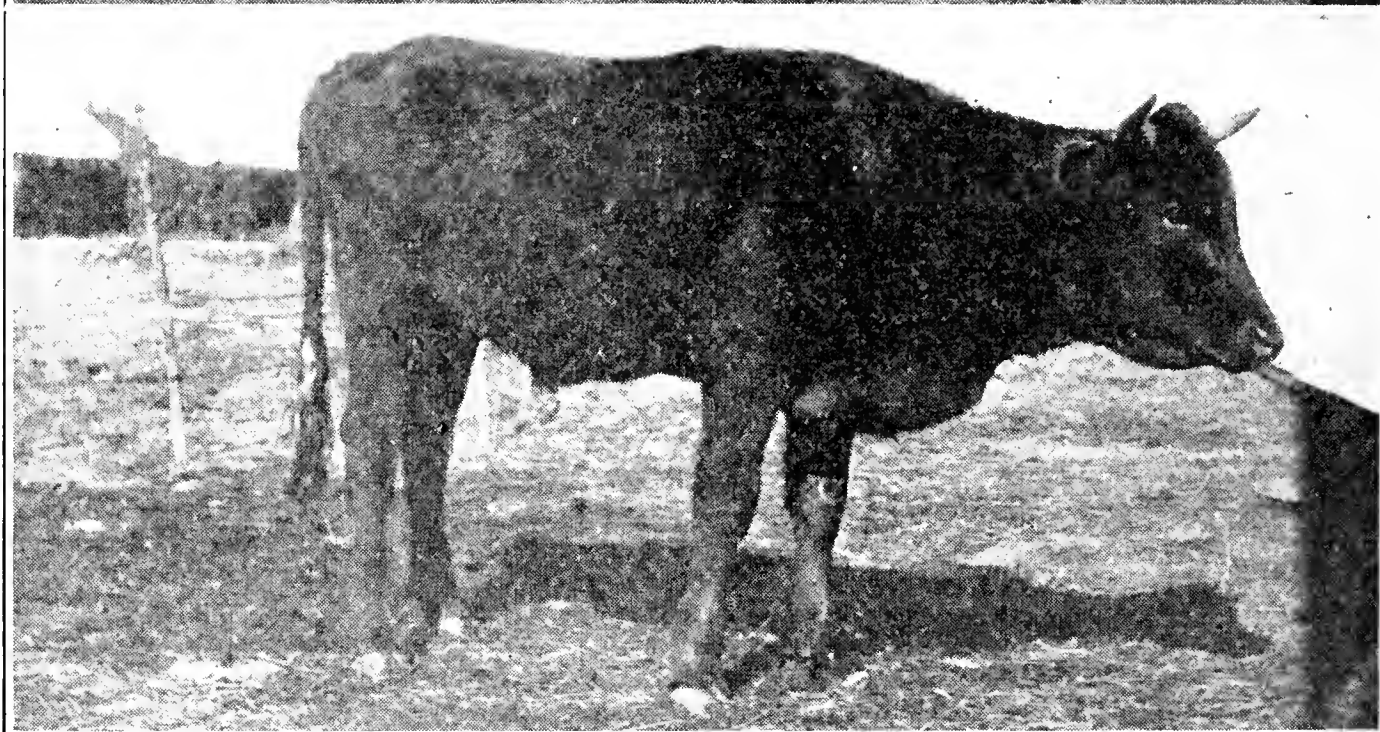
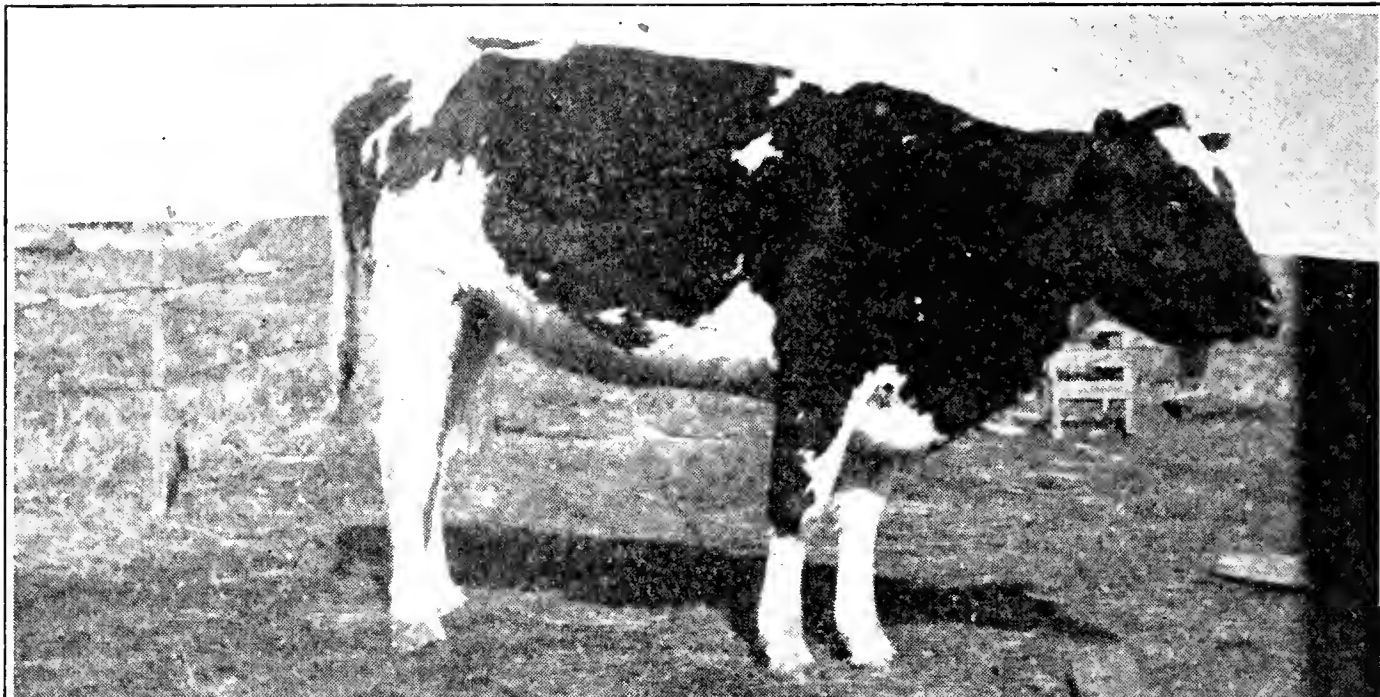

The two animals pictured above were from a lot of 35 that were raised near Parker, Colorado. One is a four-year-old cow, the other a two-year-old steer. They were shipped to a ranch near Fairplay, Colorado (altitude 9,500 ft.) where they were ranged with about 50 native cattle. Six of the animals raised at Parker (altitude 6,000 ft.) became ill with brisket disease, while none of the natives were affected. These animals were seen on October 17, 1915, at which time they had been sick about three weeks. On this same date a six-months-old calf of the Parker lot born at the high altitude was found to be suffering from the same disease.



Bulletin 230

July, 1917

The Agricultural Experiment Station
OF THE
Colorado Agricultural College

THE WATERS OF THE RIO GRANDE

A Contribution to the Hydrology of the
San Luis Valley, Colorado

By

WM. P. HEADDEN



PUBLISHED BY THE EXPERIMENT STATION
FORT COLLINS, COLORADO
1917

Colorado Agricultural College

FORT COLLINS, COLORADO

THE STATE BOARD OF AGRICULTURE

	Term Expires
HON. CHAS. PEARSON.....Durango,	1919
HON. R. W. CORWIN.....Pueblo,	1919
HON. A. A EDWARDS, President of the Board.....Fort Collins,	1921
MRS. J. B. BELFORD.....Denver,	1921
HON. H. D. PARKER.....Greeley,	1923
MRS. AGNES L. RIDDLE.....Denver,	1923
HON. J. C. BELL.....Montrose,	1925
HON. E. M. AMMONS.....Denver,	1925
PRESIDENT CHAS. A. LORY, GOVERNOR JULIUS C. GUNTER, L. M. TAYLOR, Secretary	} Ex-Officio CHAS. H. SHELDON, Treasurer

EXECUTIVE COMMITTEE

A. A. EDWARDS, Chairman

E. M. AMMONS

H. D. PARKER

STATION STAFF

C. P. GILLETTE, M.S., D. Sc., Director.....	Entomologist
W. P. HEADDEN, A.M., Ph.D.....	Chemist
G. H. GLOVER, M.S., D.V.M.....	Veterinarian
W. G. SACKETT, B.S.....	Bacteriologist
ALVIN KEZER, A.M.....	Agronomist
E. P. SANDSTEN, M.S., Ph. D.....	Horticulturist
B. O. LONGYEAR, B.S.....	Assistant Forester
G. E. MORTON, B.S.A. M.S.....	Animal Husbandman
E. B. HOUSE, B.S. (E.E.), M.S.....	Irrigation Engineer
V. M. CONE, B.S., C.E., U. S. Irrigation Engineer.....	Irrigation Investigations
W. P. LITTLE, B.S., U. S. Expert-in-charge.....	Horse Breeding
R. E. TRIMBLE, B.S.....	Assistant Irrigation Investigations
P. K. BLINN, B.S., Rocky Ford.....	Alfalfa Investigations
EARL DOUGLASS, M.S.....	Assitant Entomologist
S. ARTHUR JOHNSON, M.S.....	Assistant Entomologist
L. C. BRAGG.....	Assistant in Entomology
J. W. ADAMS, B.S. Cheyenne Wells.....	Agronomy Assistant, Dry Farming
W. W. ROBBINS, M.A.....	Botanist
RALPH L. PARSHALL, B.S.....	Assistant Irrigation Investigations
I. E. NEWSOM, B.S., D.V.S.....	Veterinary Pathologist
MIRIAM A. PALMER, M.A.....	Delineator
R. A. MCGINTY, B.S.....	Assistant in Horticulture
CHAS. R. JONES, B.S., M.S.....	Assistant in Entomology
GEO. M. LIST, B.S.....	Assistant in Entomology
JAS. D. BELL, B.S.....	Assistant Irrigation Investigations
CARL ROHWER, B.S., C.E.....	Assistant Irrigation Investigations
BREEZE BOYACK, B.A., M.S.....	Assistant in Agronomy
CHAS. I. BRAY, B.S.A., M.S.....	Assistant Animal Husbandry
RALPH L. CROSMAN.....	Editor
H. E. VASEY, A.M.....	Assistant Botanist
W. H. KERR, A.B., J.D.....	Markets and Marketing
T. E. LEIPER, B.S.....	Assistant Animal Husbandman

OFFICERS

CHAS. A. LORY, M.S., LL.D., D.Sc.....	President
C. P. GILLETTE, M.S., D.Sc.....	Director
L. M. TAYLOR.....	Secretary
MABEL LEWIS.....	Executive Clerk

THE WATERS OF THE RIO GRANDE

By WM. P. HEADDEN

In Bulletin No. 82 of this station, "Colorado Irrigation Waters and Their Changes", I dealt with the waters of the eastern slope, treating those of the Poudre Valley in greater detail than the rest, for four reasons, the principal one being that irrigation has been practiced on a larger scale in this valley than in any other section of the State. Irrigation was practiced on a small scale in the San Luis Valley by the Mexicans earlier than by the settlers of the Poudre Valley, but this practice was by no means so extended as it has been in the Poudre Valley, from the time of its introduction.

The second reason for confining our study largely to the waters used in the Poudre Valley was the fact that we are situated within this territory and all parts of it; the streams, ditches and reservoirs, are easily accessible at all times. These reasons were formulated in the bulletin referred to as follows: "The considerations which have led me to confine myself to the study of the Poudre River water to so great an extent as I have done, are evident. First, the water of the Poudre irrigates, at the present time, as much if not more land than that of any other stream in the State. Second, it flows through our home valley, is easy of access, and we have fuller data and more intimate knowledge of it than of any other stream in the State. Third, irrigation has been practiced in this valley as long as in any other part of the State (a few sections where irrigation was practiced by the Mexicans expected), extending over a period of 43 years. Fourth, the oldest, and at the same time an extensive system of reservoirs, whose beginning dates back to 1875, has been made to supplement the summer flow of the river.

"Under these conditions the flow of the return waters has already been established, the first exaggerated effects of irrigating this land have passed away and the rate at which the return waters are carrying the soluble salts from the soil has presumably approached, if it has not already reached, the point at which it will remain for years to come. The same may be assumed to be true in regard to the character of the salts taken into solution.

"In this section, the period of drainage has begun, land having become valuable enough and water in such demand that drainage has already been instituted for the double purpose of preventing the land from being waterlogged or seeped, and for rendering the water available for irrigating other land."

CHANGES IN WATERS OF EASTERN SLOPE

These paragraphs were written thirteen years ago and are as applicable now as then. The work done preparatory to the publication of Bulletin No. 82 made the changes which take place in the amount

and character of the mineral constituents, held in solution by these waters upon their entrance into that part of their course which lies outside of the mountains very definite and showed that these changes were radical. The total solids increased from 2.9 and 2.6 grains per imperial gallon in samples taken within the mountain section of its course, to 114.5 grains in a sample taken perhaps thirty miles further down its course. The composition of the mass of salts had changed to even a greater degree than the amount of them held in solution. The reader may judge for himself how radical these changes are from the following statements of analytical results given in grains per imperial gallon:*

ANALYSES OF CACHE LA POUUDRE WATER

I		II	
Taken within the mountains		Taken about thirty miles out from the mountains	
Salts	Grains per imperial gal.	Salts	Grains per imperial gal.
Calcic sulfate.....	0.3417	Calcic sulfate	46.013
Calcic carbonate	0.7186	Magnesian sulfate	36.406
Magnesian carbonate	0.2628	Potassic sulfate	0.719
Sodic chlorid	0.1711	Sodic sulfate	6.059
Potassic carbonate	0.1254	Sodic chlorid	4.565
Sodic carbonate	0.2652	Sodic carbonate	14.337
Sodic silicate	0.2544	Sodic silicate	2.099
Ferric and Al. oxid....	0.0113	Ferric and Al. oxid....	0.079
Manganic oxid	0.0018	Manganic oxid	Trace
Excess silicic acid....	0.0798	Excess sodic oxid	0.096
Ignition	(0.2678)	Ignition	4.191
	<hr/>		<hr/>
Total	2.8999	Total	114.504

SANITARY ANALYSES

Taken within the mountains		Taken about thirty miles out from the mountains	
Salts	Parts per Million	Salts	Parts per Million
Tota solids	41.4286		1,635.710
Chlorin	1.9804		36.630
Nitrogen as nitrates.....	Trace		0.400
Nitrogen as nitrites.....	None		0.022
Saline ammonia	0.0350		0.060
Albuminoidal ammonia	0.0900		0.160
Oxygen consumed	2.550		1.160

The total solids contained in this water had been increased approximately forty times, though it had reached a point only about 30 miles beyond the mountains. The carbonates which predominated in the mountain water have disappeared, with the exception of sodic

*I retain this old form of statement because I believe it to be, all things considered, more easily apprehended by the general reader than other forms often used. The imperial gallon, being an even ten pounds, is a convenient measure and the hypothetical compounds are, for the most part, familiar, at least by name, to the general reader. The scientific man will have no difficulty in accommodating himself to this mode of statement, even though he is accustomed to the really more simple and scientific ionic statement.

carbonate, and in their place we find sulfates, with a very great increase in the amount of the bases present in this form. The total sodium present in various forms also has been increased very greatly.

The water of the Cache la Poudre is typical of all of our mountain streams in its composition and the changes in its composition due to its use in irrigating our lands are typical of those produced in the waters of other streams when used for this purpose. These changes have been studied for the Arkansas and the results justify the statement just made. The results obtained were:

ANALYSES OF ARKANSAS RIVER WATER

I		II	
Taken at	Canon City	Taken about 120 miles below	Canon City
Salts	Grains per imperial gallon	Salts	Grains per imperial gallon
Calcic sulfate	2.037	Calcic sulfate	64.942
Calcic carbonate	3.733	Magnesic sulfate	27.994
Magnesic carbonate	1.856	Potassic sulfate	0.942
Potassic sulfate	0.138	Sodic sulfate	32.449
Sodic chlorid	0.659	Sodic chlorid	12.044
Sodic carbonate	0.573	Sodic carbonate	7.007
Sodic silicate	1.280	Sodic silicate	1.358
Ferric & Alum. oxids.	0.023	Excess sodic oxid	3.832
Manganic oxid (br)	0.011	Ignition	6.797
Excess Silicic acid	0.216		
Ignition	0.273		
	<hr/>		<hr/>
Total	10.799	Total	157.363

SANITARY ANALYSIS

	Parts per million
Total solids	2,234.290
Chlorin	103.971
Nitrogen as nitrates	1.500
Nitrogen as nitrites	0.040
Saline ammonia	0.065
Albuminoidal ammonia	0.140
Oxygen consumed	2.000

This sample of Arkansas River water was taken at Canon City, a little way below the Royal Gorge, and while it carries more salts in solution than the Poudre water, it remains in its essential features a mountain water. This is more remarkable than the fact that it carries nearly four times as much solid matter in solution as the Poudre water, for the course of the Poudre River, up to the point where the sample was taken, is wholly within a granitic area, with but little meadow land along its borders and with an exceedingly sparse population.

The Arkansas at Canon City has already traversed a long course, some of the way through meadow lands. It received during a portion of the year the sluicings from placer workings and its drainage

area includes the towns of Leadville, Buena Vista and Salida. The conditions, however, have not been such as to materially change the character of the water. The sample of water taken about 120 miles further down the stream, was wholly return water, namely, irrigating water that had been applied to the land and had found its way back into the river's course. At the time that this sample was taken, no river water was flowing past Rocky Ford, the point at which the sample was taken, for all of the river water had been diverted into the various irrigating canals or ditches. The differences shown in the two cases, those of the Poudre and Arkansas river waters, are wholly quantitative; the changes shown are identical in kind.

The waters of the South Platte have been studied but to a less extent than those of the other streams. The conditions obtaining in this case are somewhat different from those obtaining in the cases of the Poudre and Arkansas. Still, the results obtained agree in showing that the changes produced in the character of the solids held in solution are the same as in the cases previously given.

These changes are thorough-going; in the mountain waters we have the carbonates of lime, magnesia and soda predominating, while in the return waters we have these changed to sulfates and the quantity of these salts very greatly increased—ten times in the case of the Arkansas and forty times in the case of the Poudre water.

These general statements evidently hold for the Laramie, for its waters are partly diverted into the Poudre without perceptible modification of the results. They will probably hold for all of the streams of our arid regions where the conditions are similar to those obtaining in these cases; but it is not safe to assert that they will hold for all of our streams.

CONDITIONS IN SAN LUIS VALLEY EXCEPTIONAL

We recognize, on examining the water conditions of the San Luis Valley, that they are exceptional. While the big features of the case may be very simple, there are others which are not, and the problem becomes, taken in its entirety, far more difficult to explain satisfactorily than those of the eastern slope, where our problems of natural drainage and return waters are quite simple, and the changes in the waters of our streams are really such as should be produced by the waters entering them after flowing through adjacent higher-lying lands whether under cultivation or not.

The Rio Grande enters the San Luis valley a little north of the middle of the west side and flows southeasterly and south to the state line. We shall consider it only as far as the State Bridge, a distance of about 60 miles.

BED OF RIVER HIGHER THAN VALLEY

The river has built up its bed till it is higher than the valley. It does not matter to us when or how this has been done; the important fact is, that the present bed is higher than the adjacent territory. Under such conditions it may seem a perfectly simple matter that a river flowing over a pervious bottom should lose a considerable portion of its water and that none could flow into it, if these conditions prevail in all sections of its course. The annual discharge of the Rio Grande at the State Bridge, is about two-thirds of its discharge at Del Norte; or, in flowing about 60 miles, it loses one-third of its annual flow. There is no other visible outlet for the waters of the valley. The discharge at Embudo in New Mexico, however, is much greater than at the State Bridge, though the river receives no considerable visible streams in the intervening section. This last statement is made to avoid the plainly legitimate inference from the preceding statement that the valley is being filled with water by the Rio Grande. While the facts to be presented may appear at times to approach very near to this problem, it remains entirely beyond our purpose to discuss it. As stated, our problem would seem very simple, if its solution depended wholly upon the Rio Grande waters, which flow over a pervious bed higher than the surrounding country. Such waters should flow, as they actually do, for about 60 miles, over such a bed with small, almost insignificant changes in their composition.

In the beginning of this work we proposed to treat it as an extension of the work presented in Bulletin 82. This included ground and return-waters and had been preceded by a presentation of the composition of the soil, its water-soluble portion and of the ground-waters. While the water-soluble portion of the soil is not necessarily identical with our alkalis, it is so closely related to them that it seems useless to insist on the difference. While I disclaim any intention to discuss the water-supply questions of the valley and its drainage, the smaller questions suggested above cannot be avoided. It is true that these questions are subordinate to the geological question of the drainage of the valley, but they involve the questions pertaining to the river and well waters used for irrigation, the ground waters and the alkalis.

The waters used for irrigation in the San Luis Valley are, as in the Poudre Valley, essentially mountain waters, and I shall take the Rio Grande waters as typical of them, but I have no proper return-waters to present, and but few ground-waters.

The Rio Grande has no tributary entering it from the north, though the valley receives the waters from a very large mountain area at this end. I am credibly informed that the water flowing into the

valley north of the Rio Grande aggregates 2,000 second-feet for several months during the year and a very considerable amount at all times. There is no doubt in regard to the source of the artesian waters found throughout a large portion of the valley. It is assumed to be from the streams flowing from the mountains, mostly from the north and west, and also from the east, but in a smaller measure. This artesian water has received attention from several writers as a supply for irrigation. I have made some inquiry and have failed to learn of its application for this purpose. It furnishes an excellent water supply for stock and perhaps for irrigating some small areas but I have no definite information of such excepting lawns. The ranches depend upon the ditches for their irrigating water. The Rio Grande, Conejos, and some other streams furnish the ditch water but of these the Rio Grande is by far the most important.

ANALYSES OF RIO GRANDE WATERS

The course of the Rio Grande extends many miles into the mountains west of the San Luis Valley. We did not go up the river further than just above the mouth of Willow Creek near the town of Creede. We took samples of the water from here down to the State Bridge. We present the analytical results in the order in which the samples were taken beginning just above the mouth of Willow Creek and going down the stream. This will present such changes as we found in their natural order.

SAMPLES TAKEN ABOVE MOUTH OF WILLOW CREEK

Analytical Results		Combined	
	Percent		Grains per Gal.
Carbon	1.685*	Carbon	0.090
Silicic acid	43.395	Calcic Sulfate	0.553
Sulfuric acid	6.096	Calcic Carbonate	1.497
Carbonic acid	13.352	Magnesian Chlorid	0.066
Phosphoric acid	0.229	Magnesian Carbonate ..	0.148
Chlorin	0.907	Magnesian Phosphate ..	0.019
Calcic oxid	19.845	Magnesian silicate	0.283
Magnesian oxid	3.791	Potassic Silicate	0.255
Potassic oxid	2.886	Sodic Silicate	0.542
Sodic oxid	6.759	Ferric oxid	0.035
Ferric oxid	0.610	Manganic oxid	0.032
Manganic oxid (br).....	0.657	Excess Silicic acid....	1.899
	<hr/>		<hr/>
Sum	100.212	Total	5.420
Oxygen equivalent to			
Chlorin	0.212		
	<hr/>		
Total	100.000		

The total solids in this water was 5.39 grains per imperial gallon. Loss on ignition 1.2 grains.

*The carbon was separated during the drying necessary to render the residue anhydrous and is given as such in the analysis. Of course, it was present as organic matter which could not be burned out of such a mixture without altering its composition and yet this organic matter rendered the solution very difficult to work if not destroyed.

Sanitary Analysis

	Parts per Million
Total solids	77.0000000
Chlorin0001400
Nitrogen as nitrates.....	None
Nitrogen as nitrites.....	.0000700
Saline ammonia0000014
Albuminoidal ammonia0000021

SAMPLE TAKEN AT DEL NORTE

Analytical Results		Combined	
	Percent		Grains per Imp. Gal.
Carbon	3.032	Calcic Sulfate	0.7753
Silicic acid	32.102	Calcic Carbonate	1.4301
Sulfuric acid	7.870	Magnesic Carbonate ...	0.4105
Carbonic acid	14.710	Sodic Carbonate	0.0166
Chlorin	1.514	Sodic Chlorid	0.1447
Calcic oxid	19.350	Sodic Silicate	0.7798
Magnesic oxid	3.428	Potassic Silicate	0.2749
Potassic oxid	2.893	Ferric oxid	0.0412
Sodic oxid	8.481	Aluminic oxid	0.0231
Ferric oxid	0.721	Manganic oxid	0.0069
Aluminic oxid	0.399	Carbon	0.1716
Manganic oxid (br).....	0.120	Excess Silicic acid.....	1.3767
Ignition	(5.722)		
	<hr/>		
Sum	100.342	Total	5.4559
Oxygen equivalent to			
Chlorin	342		
	<hr/>		
Total	100.000		

Total solids in the water 5.46 grains per imp. gal.; loss on ignition 1.26 grains. The loss on ignition probably includes a large part, if not all, of the carbonic acid, owing to the action of free silicic acid.

COLORADO EXPERIMENT STATION

SAMPLE TAKEN AT MONTE VISTA

Analytical results		Combined*	
	Percent		Grains per Imp. Gal.
Carbon	2.227		
Silicic acid	31.372	Calcic Sulfate	0.7954
Sulfuric acid	7.570	Calcic Carbonate	1.6953
Carbonic acid	16.120	Magnesian Carbonate ...	0.4498
Phosphoric acid	Trace	Sodic Carbonate	0.0366
Chlorin	1.541	Sodic Chlorid	0.1570
Calcic oxid	20.700	Sodic Silicate	0.8439
Magnesian oxid	3.484	Potassic silicate	0.2914
Potassic oxid	2.876	Ferric oxid	0.0355
Sodic oxid	8.783	Aluminic oxid	0.0155
Ferric oxid	0.574	Manganic oxid (br).....	0.0054
Aluminic oxid	0.251	Carbon	0.1375
Manganic oxid (br).....	0.088	Excess Silicic acid.....	1.4178
Ignition	(4.761)		
	<hr/>	Total	5.8811
Sum	100.348		
Oxygen equivalent to chlorin	0.348		
	<hr/>		
Total	100.000		

Total solids 5.88 grains per imperial gallon. Loss on ignition 1.68 grains. nil.

SAMPLES TAKEN AT ALAMOSA 30 SEPT., 1908

Analytical results		Combined	
	Percent		Grains per Imp. Gal.
Silicic acid	28.312		
Sulfuric acid	8.837	Calcic Sulfate	1.4277
Carbonic acid	16.386	Calcic Carbonate	2.1450
Chlorin	2.053	Magnesian Carbonate ...	0.7136
Calcic oxid	21.797	Potassic Carbonate ...	0.2871
Magnesian oxid	3.978	Potassic Chlorid	0.0635
Potassic oxid	2.747	Sodic Chlorid	0.2409
Sodic oxid	9.709	Sodic Silicate	1.3917
Ferric oxid	0.559	Ferric oxid	0.0480
Aluminic oxid	0.583	Aluminic oxid	0.0500
Manganic oxid (br)....	0.098	Manganic oxid (br).....	0.0084
Ignition	(5.404)	Excess Silicic acid.....	1.7441
	<hr/>		
Sum	100.463	Total	8.1000
Oxygen equivalent to Chlorin	0.463		
	<hr/>		
Total	100.000		

Total solids 8.12 grains per imperial gallon. Loss on ignition 1.68 grains.

SANITARY ANALYSIS

	Parts per Million
Total solids	101.71428
Loss on ignition.....	24.00000
Chlorin	2.00000
Nitrogen as nitrates.....	0.00030
Saline Ammonia	0.01200
Nitrogen as nitrites.....	0.03000

*In this and the preceding analysis the loss on ignition is not included in the statement of grains per gallon because all of the errors are thrown into this factor and its influence upon the statement of the analysis is practically

THE WATERS OF THE RIO GRANDE

SAMPLES TAKEN AT STEWART'S PLACE 6 OCT., 1908

Analytical results	Percent	Combined	Grains per Imp. Gal.
Silicic acid	23.392		
Sulfuric acid	10.222	Calcic Sulfate	1.5860
Carbonic acid	16.289	Calcic Carbonate	2.8244
Phosphoric acid	Trace	Magnesian Carbonate ...	0.3761
Calcic oxid	24.644	Potassic Carbonate	0.1337
Magnesian oxid	1.949	Potassic Chlorid	0.2227
Potassic oxid	2.553	Sodic Chlorid	0.1815
Sodic oxid	10.239	Sodic Silicate	1.6454
Ferric oxid	0.686	Ferric oxid	0.0620
Aluminic oxid	0.475	Aluminic oxid	0.0432
Manganic oxid (br)....	0.111	Manganic oxid (br)....	0.0101
Ignition	(7.569)	Excess Silicic acid....	1.3145
Sum	100.536	Total	8.3996
Oxygen equivalent to Chlorin	0.535		
Total	100.000		

Total solids 8.4 grains per imperial gallon. Loss on ignition 2.24 grains.

SAMPLE TAKEN AT STATE BRIDGE 10 OCT., 1908

Analytical results	Percent	Combined	Grains per Imp. Gal.
Silicic acid	22.568		
Sulfuric acid	11.674	Calcic Sulfate	1.8700
Carbonic acid	17.193	Calcic Carbonate	2.3570
Phosphoric acid	Trace	Magnesian Carbonate....	0.8747
Chlorin	2.228	Potassic Carbonate....	0.3840
Calcic oxid	22.204	Sodic Carbonate....	0.0114
Magnesian oxid	4.444	Sodic Chlorid	0.3463
Potassic oxid	2.780	Sodic Silicate	1.6092
Sodic oxid	10.685	Ferric oxid	0.0486
Ferric oxid	0.517	Aluminic oxid	0.0520
Aluminic oxid	0.552	Manganic oxid (br)....	0.0048
Manganic oxid (br)....	0.049	Excess Silicic acid....	1.3320
Ignition	(5.608)		
Sum	100.502	Total	8.8900
Oxygen equivalent to Chlorin	0.503		
Total	100.000		

Total solids 8.89 grains per imperial gallon. Loss on ignition 2.38 grains.

SANITARY ANALYSIS

	Parts per Million
Total solids	127.000000
Chlorin	0.000315
Nitrogen as nitrates....	None
Nitrogen as nitrites...	None
Saline Ammonia	None
Albuminoidal Ammonia	0.0000014

The distance between the points where the first and last of these Rio Grande waters were taken is not far from 100 miles, probably more than 60 of these are within the valley proper. The total solids

increased only from 5.4 to 8.9 grains per imperial gallon though farms and pastured meadows border a large portion of its course and the three towns of Del Norte, Monte Vista and Alamosa are located on its banks. In addition to these factors, which usually cause radical changes in the character of our river waters, the Rio Grande may receive waters from the Alamosa, La Jara, Conejos and other streams. I cannot state from what streams the river received water at the time the sample was taken at the State Bridge. There was some water flowing into the Rio Grande from the Conejos but how much I do not know, neither do I know whether this flow was continuous or only accidental.

ANALYSES SEEM TO INDICATE THAT NO RETURN WATER FLOWS INTO RIVER

The analyses of the six samples taken at different points in the river, the extreme points being about 100 miles apart, show no differences in the character of the total solids held in solution and no differences in the quantity of solids held in solution that might not be accounted for by evaporation. These results are wholly different from those obtained in our study of the Poudre, the Arkansas and other streams. These results are, however, in harmony with the inferences to be drawn from the topography of the valley, i. e., from the fact that the bed of the river is higher than the valley and further that the volume of the flow is decidedly less as we go down the river, at least, as far as the State Bridge. At this point the flow of the river during the months of August, September and October is usually very small, in fact, is never large, except during the months of flood, which are May and June, and, exceptionally, a part of July. The range of the flow for the other months of the year, given for the eight years of which I find records, is from 17 second feet in August, 1902, to 196 second feet in September, 1904. The usual flow is considerably under 75 second feet. The flow at Del Norte for the same months and years was 152 second feet in August, 1902, and 689 second feet in September, 1904.* The irrigating canals take out, at times, nearly all of the water by the time it passes a little way beyond Monte Vista.

If any volume of return waters finds its way into the river, it would follow from our results, that these waters have the same characteristics and composition as the river water before it is used for irrigating the land or while it is still within the mountain section of its course. This is very improbable, or, judging from our knowledge of the changes which take place in the waters of other streams, impossible.

*These data are taken from U. S. Geo. Survey Water Supply Paper No. 240. C. E. Siebenthal.

The nature of the land irrigated with the water taken from the Rio Grande, as it abounds in alkali salts, practically precludes the possibility that return waters should have the composition of that applied as irrigating water. There are, it is true, two classes of water which might be considered as furnishing an increase in the flow of the river, i. e., waters previously used for irrigation, yielding what we usually understand as return waters, and artesian waters. The latter class of waters occur throughout the greater part of the cultivated portion of the valley. I am informed that, up to the present time, some 5,500 artesian wells have been sunk in the valley. The fact that some of these wells are not flowing at the surface does not necessarily preclude their discharge of water into the valley in such a way as to affect the water problems of the soil and the river. The great majority of these wells are, however, flowing freely and but few of them are cased for more than a few feet, leaving the waters entirely free to fill up any strata not already full and to affect in this way the general water problems of the valley.

While our problem clearly contains these factors, we assume that the waters, the river being for the most part actually higher than the neighboring portions of the valley, retain their character because there is actually no admixture of other waters. This assumes that the Rio Grande actually fails to drain the valley. I believe that this assumption is essentially correct and consider the results obtained in the analyses of the water as positively indicating this condition.

There are two classes of artesian waters, white and brown. If the former class should find their way into the river through strata of sand, or as springs, they would not affect the character of the river water. The flow of the river might be increased in this way and the character of the water not changed any more than we find indicated by our analyses, namely, a slight increase in the quantity of the solids held in solution without any essential change in their character. In making this statement I am not forgetful of the fact that the increase in the amount of solids contained in the water may be accounted for by evaporation. It must be remembered that the increase found is only 3.5 grains per imperial gallon in samples taken at points in the river 100 miles apart. While we shall neglect the effects of evaporation it is evident that it may be an important factor.

Prof. L. G. Carpenter gives, in a bulletin not yet issued, the results of river gaugings in August, 1898, which show a total gain between the U. S. Gauging Station above Del Norte and the State Bridge, of 15.75 ft.; in 1900, a total gain of 63.06 ft.; in 1901, a total loss of 11.01 ft.; in 1902, a total loss of 37.7 ft.; and in 1910, a total gain of 46.19 ft. Our samples of river water were taken in 1908 for

which year we unfortunately have no gaugings so we do not know whether the flow would have shown a gain or loss between the U. S. Gauging Station and the State Bridge.

THE GROUND-WATER AND ALKALIS SOUTH AND WEST OF THE RIVER

The statement has been made that no return waters could be finding their way into the river, and the reason assigned was that, owing to the character of the soil and the prevalence of alkali, such waters would change the composition of the river water. We have, in fact, no return waters by whose composition we can definitely demonstrate that this is the case—the best that we can do is to present some ground- and drain-waters.

The use of these, unfortunately, needs an explanation as to why they are of limited and not of general application to the whole valley. Any samples taken to the south and west of the river would be applicable to this portion of the valley but samples taken north of the river and in the eastern part of the valley, about Hooper for instance, would not apply to that portion of the valley south and west of the river, though both sections abound in alkalis.

There are two classes of artesian wells in the valley which are commonly designated as white and brown waters. The former waters are colorless and of excellent quality, the latter are of various shades of brown. Analyses of these waters will be given subsequently, but it may be stated here that these brown waters differ in composition from the white waters in carrying considerable quantities of sodic carbonate which forms, in the deeper strata, a solution of humus, imparting the brown color to the waters. These brown waters are confined to the northern and eastern part of the valley. I may anticipate a little by stating that the color of the water is determined by the humus obtained from the strata underlying this section of the valley and in this case may be taken as definite proof of the presence of sodic carbonate, but the converse of this, that a colorless water is free from sodic carbonate, is not necessarily true.

Our statement is practically this, that no ground or return waters are finding their way into the Rio Grande during its flow through the valley, because the composition of its waters retains the characteristics which it possesses on entering the valley, those of a mountain water, i. e., such as contain carbonates as the essential salts in solution with subordinate quantities of sulfates and chlorids with an excess of silicic acid. The character of the ground and drainage waters will undoubtedly vary somewhat from place to place, but their general character will persist just as the character of mountain waters per-

sists. In the ground waters the sulfates and chlorids become predominant, the carbonates of the alkaline earths and the silicates recede or disappear while the carbonate of soda is usually present in small quantities.

The following sample of ground-water was taken from SE. ¼ sec. 23, T. 38 N., R. 8 E. and less than 400 feet from a drainage ditch which had been opened for 21 months at the time the sample was taken. The land had never been cultivated, cleared or in any way improved. The water was encountered at 3' 11" in stratum of sand. Beneath this was a clay mixed with large quantities of calcic sulfate and carbonate. I do not know whether the neighboring drainage ditch had lowered the level of the ground water or not. This water did not come from the irrigation of land in the immediate neighborhood. I consider it as representing the permanent ground water of this locality.

ANALYSIS OF GROUND-WATER
SE. ¼ sec. 23, T. 38 N., R. 8 E.

Analytical results		Combined	
	Percent		Percent
Silicic acid	6.303	Calcic sulfate	55.647
Sulfuric acid	32.720	Calcic carbonate	15.081
Carbonic acid	6.931	Magnesian carbonate	0.577
Chlorin	8.795	Magnesian chlorid	11.809
Calcic oxid	31.378	Magnesian silicate	3.233
Magnesian oxid	6.870	Potassic silicate	0.377
Potassic oxid	0.230	Sodic silicate	8.441
Sodic oxid	4.279	Ferric and Alum. oxids.	0.075
Ferric and Alum. oxids.	0.075	Excess Silicic acid.....	0.056
Ignition	(4.704)	Ignition	(4.704)
Sum	101.985	Total	100.000
Oxygen equivalent to			
Chlorin	1.985		
Total	100.000		

Total solids 98.9 grains per imperial gallon. Loss on ignition 16.9 grains.

The drainage ditch referred to in connection with the preceding ground-water was upwards of 4 miles long at this time and was being extended. The discharge was given to me as varying from 4 to 10 second feet. At this time it was carrying the smaller amount, about 4 second feet. There was probably no admixture of run-off water in the ditch at this time, so we may take the results obtained in the analyses of this drain-water as representing the ground-water in the land above the point at which the sample was taken, probably a mile and a half below the then upper end of the ditch.

COLORADO EXPERIMENT STATION

ANALYSIS OF DRAINAGE-WATER
Parma Land Company Ditch

Analytical results		Combined	
	Percent		
Carbon	3.102	Carbon	3.102
Silicic acid	8.105	Calcic sulfate	49.087
Sulfuric acid	28.863	Calcic carbonate	5.835
Carbonic acid	8.536	Magnesian carbonate	6.655
Chlorin	9.561	Potassic carbonate	0.106
Calcic oxid	23.495	Sodic carbonate	5.946
Magnesian oxid	3.184	Sodic chlorid	15.778
Potassic oxid	0.072	Sodic silicate	5.338
Sodic oxid	14.560	Ferric and Alum. oxids..	0.089
Ferric and Alum. oxids..	0.098	Excess silicic acid.....	5.473
Manganic oxid	0.089	Ignition	(2.493)
Ignition	(2.493)	Total	<u>100.000</u>
Sum	<u>102.158</u>		
Oxygen equivalent to .			
Chlorin	2.158		
Total	<u>100.000</u>		

The remoteness of the relation between the alkalis or in the surface portions of the land and the salts removed by the drainage-waters is made evident by the analyses of the alkalis from the land through which this drain, or its laterals, run.

This sample of alkali was taken a few feet from a lateral open drain emptying into the main ditch a few hundred feet south of this point.

ANALYSIS OF ALKALI

Sample taken just inside Parma Land Company's Gate

	Percent
Silicic acid	0.065
Calcic sulfate	8.135
Magnesian sulfate	6.209
Sodic sulfate	61.473
Sodic chlorid	20.974
Organic matter	3.144
Sum	<u>100.000</u>

ALKALI NE. ¼ SEC 14, T. 38 N., R. 8 E. PARMA LAND CO.

Analytical Results		Combined	
	Percent		Percent
Silicic acid	0.345	Calcic sulfate	10.347
Sulfuric acid	45.463	Magnesian sulfate	2.121
Carbonic acid	Trace	Potassic sulfate	10.314
Chlorin	8.352	Sodic sulfate	59.010
Calcic oxid	4.263	Sodic chlorid	13.782
Magnesian oxid	0.710	Sodic silicate	0.681
Potassic oxid	5.578	Excess Sodic oxid	9.586
Sodic oxid	34.015	Ignition	(3.159)
Ignition	(3.159)		
	<hr/>	Total	100.000
Sum	101.885		
Oxygen equivalent to			
Chlorin	1.885		
	<hr/>		
Total	100.000		

The crust on the soil was very thin. The soluble portion of the sample as taken was 5.88 percent.

The next sample was taken from the same section as the preceding but at a subsequent time. The sample was prepared by the manager, Mr. W. H. Sommers.

ALKALI—SAME LOCALITY AS PRECEDING

Analytical results		Combined	
	Percent		Percent
Silicic acid	1.232	Calcic sulfate	4.040
Sulfuric acid	43.665	Magnesian sulfate	2.242
Chlorin	9.667	Potassic sulfate	8.015
Calcic oxid	1.667	Sodic sulfate	64.143
Magnesian oxid	0.751	Sodic chlorid	15.593
Potassic oxid	4.336	Sodic silicate	2.431
Sodic oxid	39.563	Ferric and Alum. oxids.	0.176
Ferric and Alum. oxids.	0.176	Excess sodic oxid.....	1.875
Ignition	(1.125)	Ignition	(1.125)
	<hr/>		
Sum	102.182	Total	100.000
Oxygen equivalent to			
Chlorin	2.182		
	<hr/>		
Total	100.000		

The next alkali was collected from the bank of the drainage-ditch of the Parma Land Company. Incrustation as taken varied from 1 inch to 2 inches in thickness. The water-soluble portion of the sample equalled 27.7 percent.

COLORADO EXPERIMENT STATION

ALKALI—DRAINAGE DITCH, PARMA

Analytical results		Combined	
	Percent		Percent
Silicic acid	0.922	Calcic sulfate	1.456
Sulfuric acid	52.779	Magnesian sulfate	0.326
Carbonic acid	0.540	Potassic sulfate	1.442
Chlorin	0.815	Sodic sulfate	90.639
Calcic oxid	0.600	Sodic carbonate	1.302
Magnesian oxid	0.109	Sodic chlorid	1.345
Potassic oxid	0.780	Sodic silicate	0.869
Sodic oxid	41.522	Ferric and Alum. oxid..	0.160
Ferric and Alum. oxid..	0.160	Manganic oxid	0.030
Manganic oxid	0.030	Excess Silicic acid.....	0.504
Ignition	(1.927)	Ignition	(1.927)
	<hr/>		<hr/>
Sum	100.184	Total	100.000
Oxygen equivalent to			
Chlorin184		
	<hr/>		
Total	100.000		

ALKALI

(This sample was taken because we took a sample of ground-water at the same place, SE. $\frac{1}{4}$ sec. 23 T. 38 N, R. 8 E. The incrustation as gathered yielded 7.4 percent of its weight to water.)

Analytical results		Combined	
	Percent		Percent
Silicic acid	1.044	Calcic sulfate	0.874
Sulfuric acid	46.816	Magnesian sulfate	0.033
Carbonic acid	1.440	Potassic sulfate.....	3.217
Chlorin	4.468	Sodic sulfate	79.557
Calcic oxid	0.360	Sodic carbonate	3.472
Magnesian oxid	0.011	Sodic chlorid	7.373
Potassic oxid	1.740	Sodic silicate	0.748
Sodic oxid	41.087	Ferric and Alum. oxid..	0.130
Ferric and Alum. oxid..	0.130	Excess Silicic acid.....	0.684
Ignition	(3.912)	Ignition	(3.912)
	<hr/>		<hr/>
Sum	101.008	Total	100.000
Oxygen equivalent to			
Chlorin	1.008		
	<hr/>		
Total	100.000		

A sample of the soil and subsoil was also taken at this place. The series of analyses thus presents as complete a set of analytical data as we can present from the chemical standpoint.

ANALYSES OF THE SOIL SAMPLES DRIED AT 100° C.

	Soil 7 inches deep	Subsoil Sample 10 inches
	Percent	Percent
Insoluble (sand)	56.271	51.285
Soluble silicic acid.....	17.531	11.662
Sulfuric acid	0.255	0.128
Phosphoric acid	0.651	0.019
Carbonic acid	3.956	10.207
Chlorin	0.462	0.184
Calcic oxid	6.900	14.318
Magnesian oxid	1.618	1.444
Potassic oxid	1.047	1.183
Sodic oxid	1.464	0.679
Ferric oxid	4.420	3.567
Aluminic oxid	3.382	2.868
Manganic oxid	0.192	0.161
Ignition	1.867	3.085
Sum	100.017	100.790
Oxygen equivalent to chlorin	0.104	0.042
Total	99.913	100.748
Total Nitrogen	0.071	0.050

These analyses show that the soda salts were very largely in the top 7 inches of soil and that the calcium carbonate probably was concentrated below the surface soil which was, at this place, 7 inches deep. Our marls sometimes contain calcium as a silicate. This may, by giving rise to soluble double silicates, account for the high silicic acid in some of the alkalis.

The preceding samples of alkali were all taken in the latter part of the summer, mostly in the month of August. This is a season when the general prevalence of alkali is not apparent as in mid or late spring, especially after light snows or rains. At this time we sometimes find areas of several square miles in a body white with these alkalis.

The following sample was taken on 8 May, 1916, in the same general section of country in which the preceding samples were taken. This land has never been cultivated, so I doubt whether it has ever been irrigated. The principal vegetation is chico and greasewood (*Sarcobatus and Bigelovia*). The surface of the ground at this time was perfectly white over an area of many, probably 15 or 20 square miles.

COLORADO EXPERIMENT STATION

ALKALI FROM UNCULTIVATED LAND

Sample taken from near Parma. The portion soluble in water equalled 27.55 percent

Analytical results		Combined	
	Percent		Percent
Carbon	0.070	Carbon	0.070
Silicic acid	0.165	Calcic sulfate	3.474
Sulfuric acid	54.222	Magnesian sulfate	0.462
Carbonic acid	0.358	Potassic sulfate	0.652
Phosphoric acid	0.152	Sodic sulfate	91.507
Chlorin	0.632	Sodic carbonate	0.863
Calcic oxid	1.431	Sodic phosphate	0.352
Magnesian oxid	0.155	Sodic chlorid	1.043
Potassic oxid	0.352	Sodic silicate	0.334
Sodic oxid	41.506	Ferric and Alum. oxids.	0.001
Ferric and Alum. oxids.	0.001	Manganic oxid (br)....	0.338
Manganic oxid	0.338	Excess sodic oxid.....	0.143
Ignition	(0.761)	Ignition	(0.761)
	<hr/>		<hr/>
Sum	100.143	Total	100.000
Oxygen equivalent to chlorin143		
	<hr/>		
Total	100.000		

It is not safe to assume that the alkali covering this large area was identical in the details of its composition, but it is safe to assume that this analysis represents the general character of all of the alkali in this area, and even further, that this is the general type of alkali occurring in this whole section of the valley. We have other analyses that support this statement, but I consider it needless to indicate how general this type of alkali is. I took a sample of alkali within the limits of the town of Alamosa which on analysis proved to consist of upwards of 96.0 percent of sodic sulfate. This alkali occurred very abundantly at the point where it was collected and the following note entered at the time the sample was collected may be of some interest:

“The lot adjoining the one from which this sample was collected. was improved and the house occupied. The lawn (blue grass) was excellent, and the garden in fine condition. Corn, beets, peas, cabbage, carrots and potatoes were growing thriftily.”

Another sample of alkali collected near La Jara some 16 miles south of the Alamosa sample, contained 25.5 percent of water-soluble of which 91.0 percent was sodic sulfate. Two samples of soil were taken with this last sample. One of them represented the top 2 inches of soil of a cultivated field; the other one represented the succeeding 4 inches. The following partial statement will suffice for our purpose:

WATER-SOLUBLE IN TWO SAMPLES OF SOIL FROM LA JARA

Top 2 inches		Succeeding 4 inches	
	Percent		Percent
Water-soluble	3.05	Water-soluble	1.50
Calcic sulfate	12.76	Calcic sulfate	30.17
Magnesian sulfate	2.30	Magnesian sulfate	4.44
Sodic sulfate	65.21	Sodic sulfate	46.12
Potassic sulfate	0.736	Potassic sulfate	7.29

This land was occupied by a crop of peas at the time the samples were taken. The stand was irregular but the peas were, in the main, fairly thrifty.

NO RETURN WATERS FROM SOUTH AND WEST

I have presented the composition of the drainage, the ground-waters, the alkalis and the soil extracts of a section of the valley lying south and west of the Rio Grande to a sufficient extent and in sufficient detail to support the statement made, that return waters from this section cannot, in any considerable quantity, find their way into the Rio Grande. The flow of the river is so small (as low as 17 second-feet at times), while the maximum found at the State Bridge in 7 years' observation, was only 150 second-feet for the month of August, that the ground-water would change wholly the character of the river-water, which is contrary to what we found in 1908. Further, the gaugings carried out under the direction of Prof. Carpenter, show a loss about as often as they show a gain.

This last observation would seem just as applicable to the area north and east of the river as to that south and west of it. The conditions north and east of the river are not the same as those obtaining south and west of it. If the surface conditions ever were the same, which I am inclined to think was the case, at least in the main, in the early nineties, say 1894, they are no longer so.

The character and importance of the results that have followed justify a more complete presentation of the facts than I shall be able to give. Nevertheless, we can present the big features of these facts just as we have done for the section already discussed.

CONDITIONS NORTH AND EAST OF THE RIVER

I will digress to justify in a measure the acknowledgement of insufficiency contained in the last sentences which, however, will come to light again and again in the following pages. In the first place, the area of the valley mentioned here does not lie wholly within Colorado, and is credited with a total area of 900 square miles. The area which is discussed probably exceeds 3,300 square miles within which we encounter unusual conditions; for instance, practically the whole of this

area constitutes an artesian basin, but this artesian water varies greatly in its character. We have already presented the fact that we have immense quantities of soluble salts in our soil which, so far as we have presented them, are almost harmless but they constitute a factor which cannot be disregarded; in fact, many evils are attributed to these same salts by the public at large and by some students of our agricultural conditions. The character of these soluble salts may change from place to place in so large a territory without our chancing to discover it and statements which are perfectly applicable to one place might be a sad misfit applied to another. But, with all this, the main features of our presentation are without doubt faithful to the facts. We shall give, as we proceed, facts which we believe justify our views. Some of these facts, both of conditions and practices, may be unusual in other places and still be very real in this area.

We shall now proceed to present the facts pertaining to the ground-waters, soil extracts and alkalis of that section of the valley designated as the Hooper Mosca section. The limits of this section are difficult to define. This does not matter much on the eastern side but the limits to the west are important. This will be appreciated when it is stated that to the eastward of the D. & R. G. Railroad, we soon encounter land that is still open to entry under the desert-land laws, while to the westward lies land that 30 years ago was under cultivation and produced excellent crops—from 30 to 50 bushels of wheat to the acre—but this is not now true of much of the land lying within 14 to 16 miles west of it. This is a part of the reason why I stated that I believe that conditions have changed since the period of this productivity. The reason seems sufficient and the conclusion self-evident.

The first ground- and drain-waters are from the extreme western portion of this district.

GROUND-WATER SW. $\frac{1}{4}$ SEC. 24, T. 40 N., R. 8 E.

Analytical results		Combined	
	Percent		Percent
Carbon	1.128	Carbon	1.128
Silicic acid	5.356	Calcic sulfate	29.453
Sulfuric acid	26.081	Magnesian sulfate	10.750
Phosphoric acid	0.169	Sodic sulfate	2.863
Carbonic acid	6.185	Sodic phosphate	0.506
Chlorin	16.311	Sodic carbonate	14.914
Calcic oxid	12.135	Potassic chlorid	6.162
Magnesian oxid	3.599	Sodic chlorid	22.081
Potassic oxid	3.893	Sodic silicate	7.232
Sodic oxid	25.703	Ferric and Alum. oxids	0.463
Ferric and Alum. oxids.	0.463	Manganic oxid	0.089
Manganic oxid (br)	0.089	Excessive Silicic acid	1.790
Ignition	(2.569)	Ignition	(2.569)
Sum	103.681	Total	100.000
Oxygen equivalent to chlorin	3.681		
Total	100.000		

Total solids 56.56 grains per imperial gallon. Loss on ignition 7.07 grains.

DRAIN-WATER SW. ¼ SEC. 24, T. 40 N., R 8 E.

Analytical Results		Combined	
	Percent		Percent
Carbon	1.563	Carbon	1.563
Silicic acid	14.456	Calcic sulfate	24.995
Sulfuric acid	14.697	Calcic phosphate	0.310
Phosphoric acid	0.142	Calcic carbonate	12.406
Carbonic acid	14.813	Magnesian carbonate	10.934
Chlorin	6.309	Potassic carbonate	9.213
Calcic oxid	17.418	Sodic carbonate	1.748
Magnesian oxid	5.231	Sodic chlorid	10.411
Potassic oxid	6.282	Sodic silicate	19.726
Sodic oxid	16.549	Ferric and Alum. oxids.	0.205
Ferric and Alum. oxids.	0.205	Manganic oxid	0.210
Manganic oxid (br)....	0.210	Excess Silicic acid.....	4.730
Ignition	(3.549)	Ignition	(3.549)
	<hr/>		<hr/>
Sum	101.424	Total	100.000
Oxygen equivalent to chlorin	1.424		
	<hr/>		
Total	100.000		

Total solids 21.8 grains per imperial gallon.
Loss on ignition 8.6 grains.

The above analyses are given to show the general composition of the ground- and drain-waters in this portion of the district under discussion and to show that they are widely different from the Rio Grande water proper, but they also serve very well to show the differences between a ground-water and a drain-water for they were taken within a very short distance of one another.

The next samples of water are from the center of this district. The lake-water was from a temporary lake and probably represents run-off water.

GROUND-WATER MOSCA		TEMPORARY LAKE, RUN-OFF WATER	
	Percent	Partial Analysis	Percent
Silicic acid	2.226	Sodic sulfate	69.92
Sulfuric acid	37.249	Sodic carbonate	13.91
Phosphoric acid	0.076	Sodic chlorid	14.54
Chlorin	5.342	Ferric and Alum oxids.	0.56
Carbonic acid	10.042	Calcic oxid	0.61
Calcic oxid	4.651	Silicic acid	0.85
Magnesian oxid	2.906		<hr/>
Potassic oxid	3.596		100.39
Sodic oxid	34.289		
Ferric and Alum. oxids.	0.035		
Manganic oxid (br)....	0.059		
Ignition	(3.792)		
	<hr/>		
Sum	102.263		
Oxygen equivalent to chlorin	2.263		
	<hr/>		
Total	100.000		

The next sample is a ground-water from a drained, cultivated field. The draining was effected at this place by an open ditch and as the water plane had fallen below the bottom of the ditch there was no other than ground-water to be obtained. This residue was also prepared in the field and the total solids are not given.

GROUND-WATER. DIBBERS, MOSCA

Analytical Results		Combined	
	Percent		Percent
Silicic acid	9.591	Calcic sulfate	25.312
Sulfuric acid	22.588	Magnesian sulfate	11.589
Carbonic acid	11.790	Magnesian carbonate	1.332
Chlorin	5.018	Potassic carbonate	11.857
Calcic oxid	10.429	Sodic carbonate	17.661
Magnesian oxid	4.512	Sodic chlorid	8.281
Potassic oxid	8.085	Sodic silicate	16.240
Sodic oxid	22.965	Ferric and Alum. oxids.	0.542
Ferric and Alum. oxids.	0.542	Manganic oxid (br).....	0.054
Manganic oxid (br).....	0.054	Excess silicic acid.....	1.584
Ignition	(5.548)	Ignition	(5.548)
	<hr/>		<hr/>
Sum	101.131	Total	100.000
Oxygen equivalent to chlorin	1.131		
	<hr/>		
Total	100.000		

ALKALIS

(These two samples of effloresced alkalis were collected 4 miles south and 5 miles west of Hooper.)

NW. $\frac{1}{4}$ sec. 23, T. 40 N., R. 9 E.SE. $\frac{1}{4}$ sec. 15, T. 40 N., R. 9 E.

Percent		Percent	
Silicic acid	0.200	Silicic acid	0.427
Sulfuric acid	51.436	Sulfuric acid	52.175
Chlorin	3.463	Carbonic acid	0.992
Nitric acid	Present	Chlorin	2.712
Calcic oxid	3.300	Calcic oxid	0.223
Magnesian oxid	0.522	Magnesian oxid.....	Trace
Potassic oxid	2.831	Potassic oxid	1.164
Sodic oxid	35.800	Sodic oxid	41.282
Ignition	3.228	Ferric and Alum. oxids.	0.135
	<hr/>	Ignition	(1.530)
Sum	100.780		<hr/>
Oxygen equivalent to chlorin780	Sum	100.620
	<hr/>	Oxygen equivalent to chlorin620
Total	100.000		<hr/>
		Total	100.000

ALKALI

From Uncultivated Land at Hooper, Greasewood (*Sarcobatus*) Abundant

Analytical Results		Combined	
	Percent		Percent
Silicic acid	0.355	Calcic sulfate	4.155
Sulfuric acid	46.810	Magnesian sulfate	0.459
Carbonic acid	3.451	Potassic sulfate	3.143
Chlorin	1.589	Sodic sulfate	75.688
Calcic oxid	1.712	Sodic carbonate	8.321
Magnesian oxid	0.153	Sodic chlorid	2.621
Potassic oxid	1.699	Sodic silicate	0.721
Sodic oxid	40.202	Ferric and Alum. oxids.	0.081
Ferric and Alum. oxids.	0.081	Manganic oxid	0.090
Manganic oxid (br)....	0.090	Excess sodic oxid	0.505
Ignition	(4.216)	Ignition	(4.216)
Sum	100.358	Total	100.000
Oxygen equivalent to chlorin	0.358		
Total	100.000		

THE WATER-SOLUBLE PORTION OF SOIL

From the same locality from which the preceding alkali was taken. It equalled 1.935 percent of air-dried soil.

Analytical Results		Combined*	
	Percent		Percent
Silicic acid	3.483	Calcic sulfate	1.456
Sulfuric acid	25.744	Magnesian sulfate	0.345
Phosphoric acid	0.211	Potassic sulfate	8.256
Carbonic acid	10.533	Sodic sulfate	37.085
Chlorin	9.702	Calcic phosphate	0.461
Calcic oxid	0.850	Sodic carbonate	25.398
Magnesian oxid	0.115	Sodic chlorid	16.010
Potassic oxid	4.483	Sodic silicate	2.617
Sodic oxid	40.893	Ferric and Alum. oxids.	0.030
Ferric and Alum. oxids.	0.030	Manganic oxid (br)....	0.050
Manganic oxid (br)....	0.050	Excess silicic acid.....	2.149
Ignition	5.503	Ignition	5.503
Sum	101.552	Total	99.360
Oxygen equivalent to chlorin	2.186		
Total	99.366		

*The amount of water-soluble carbonates in this soil extract is noteworthy.

The soil dried at 100° C. was digested with hydrochloric acid for 5 days and the solution gave the following results:

SOIL, HOOPER, COLORADO. SAMPLE DRIED AT 100° C.	
	Percent
Insoluble (sand)	62.241
Soluble silicic acid.....	15.229
Sulfuric acid	0.362
Phosphoric acid	0.320
Carbonic acid	2.629
Chlorin	0.081
Calcic oxid	4.295
Magnesian oxid	1.595
Potassic oxid	1.383
Sodic oxid	1.326
Ferric oxid	3.930
Aluminic oxid	4.259
Manganic oxid (br)	0.175
Ignition	2.260
Sum	100.085
Oxygen equivalent to chlorin.....	0.018
Total	100.067

These samples were collected in 1907. It is unfortunate that we cannot give the total solids present in these ground- and drain-waters but it can be stated that those from Sec. 24, T. 40, N., R. 8 E. were not remarkably rich, while those from the neighborhood of Mosca were quite rich. The drain-water from Sec. 24, T. 40 N., R. 8 E., however, is sufficiently rich in calcic sulfate to distinguish it from mountain waters though its other salts are very similar to the salts present in these. This is also a noticeable feature in the composition of the ground- and drain-waters previously given. The waters, alkalis, and soil extracts, so far given, with only one exception, are poor in chlorids. In this exception, the ground-water from Sec. 24, T. 40 N., R. 8 E., the chlorin, calculated as sodic chlorid, amounts to 22.0 percent of the total solids, which were not excessively abundant.

WATERS ON EITHER SIDE OF RIVER DIFFER GREATLY FROM RIVER-WATER

These data present the conditions existing on both sides of the Rio Grande up to 1908 and they reveal no such marked differences as one acquainted with the sections might expect. They are, however, consistent in one point, namely, they show that the waters, whether they are surface-, ground- or drain-waters, differ from the Rio Grande waters in that they carry very greatly increased quantities of sulfates. The ground- and drain-waters of these sections differ from other ground- and drain-waters that we have studied in that they, in general, seem to carry the carbonates of the alkaline earths and an excess of silicic acid. This last feature is not for the moment the specific object of our study. The main point, in this part of our discussion, is that the character of the alkalis, the soil extracts, the ground- and

drain-waters is such that an admixture of them with Rio Grande waters would reveal itself in the changed composition of the latter. We shall have further use for these data, but, for the present, the main purpose is to demonstrate the absence of their influence on the composition of the river water.

RELATION OF GREASEWOOD TO SODIC CARBONATE CONTENT OF SOIL

We may observe in passing that the last alkali given was collected amid greasewood (*Sarcobatus*)* bushes with the expectation of finding large quantities of sodic carbonate present, but we find only 8.3 percent of this salt in the water-soluble portion of the effloresced mass which, as gathered, probably contained 75.0 percent of its weight of surface soil. The aqueous extract of this soil, amounting to 1.94 percent of the soil, contained 25.4 percent of this salt, or 0.49 percent calculated on the soil. We have presented no sample of ground-water from this locality, for we took none.

The theory that soil about these bushes is rich in carbonates because of the nature of these plants was advanced by Prof. Hilgard. These greasewood (*Sarcobatus*) bushes may have been the cause of the presence of this carbonate in the soil but there is also another, and perhaps a better, explanation possible in this case, but we shall refer to this subsequently. In the following case the debris of the greasewood growth may have been the source of the carbonate, I know of no other probable source of the salt. The sample is of a virgin soil taken from a rather low place, with an abundant growth of greasewood (*Sarcobatus*). The surface soil yielded 3.71 percent of soluble salts to water. Organic matter was very abundant; there was no calcium, and only a trace of magnesium present. The acid determined and calculated as sodic salts corresponds to sodic sulfate 44.8 percent, sodic carbonate 31.7 percent, sodic chlorid 8.0 percent and organic matter 15.0 percent. This sample of soil was not taken to a greater depth than 2 inches. The sodic carbonate in this sample amounts to 1.1 percent of the soil and its presence may account for the growth of the *Sarcobatus*. It is a question whether any other plant can tolerate so large an amount of this salt, owing to its toxic qualities. Another sample of alkali containing sodic carbonate was obtained two miles from the latter. It would not be at all unreasonable to attribute the occurrence of the sodic carbonate in the two preceding samples to the prevalence of the greasewood, but in this case, I know of no source to which it could reasonably be attributed, therefore, I have considered it as an isolated sample of little or no importance, an exception, a curiosity among our alkali waters. The dried salt consisted of:

*Bigelovia is locally called "Greasewood" and this is the reason for the word, "Sarcobatus" in parentheses.

Sodic sulfate	31.780
Calcic sulfate	0.928
Sodic chlorid	6.691
Sodic carbonate	39.706
Organic matter	20.896
	100.000

The last two samples were met with in the section south and west of the Rio Grande. The explanations offered are the only ones possible in this case. These are, so far as I know, of very limited occurrence, and could not in any event modify in any important manner the character of the Rio Grande waters though they might be local factors in the unproductiveness of the soil.

THE PRODUCTION OF SODIC CARBONATE FROM THE FELSPARS

While there are differences between the composition of the Rio Grande water and the drain- and ground-waters, and the extracts of the soils presented, there are also persistent resemblances which we did not find in our study of these subjects in the neighborhood of Fort Collins and other sections.

In an article entitled "The Significance of Silicic Acid in the Mountain Waters, etc.,"* I pointed out that the characteristic results of the action of natural waters on the feldspars is the production of a solution carrying principally the carbonates of the alkaline earths and alkalis with some sulfates and chlorids. Of the carbonates of the alkalis, the carbonate of soda occurs in excessively large amounts in proportion to the amount of soda in the feldspar; in other words, the amounts of lime and soda taken into solution indicate the predominant decomposition of the soda-lime feldspars. This characteristic in the composition of the salts in solution persists almost wholly unmodified in the Rio Grande water in spite of the long distance that it flows through the valley, but it also persists in the drain and ground waters in a marked degree with only one pronounced modification, namely, the increase of sulfates; the ground-water, for instance, from SE. $\frac{1}{4}$, sec. 23, T. 38 N., R. 8 E., or the drain-water from the Parma Land Company's ditch, or that taken from a drain in SE. $\frac{1}{4}$, sec. 24, T. 40 N., R. 8 E., might be taken for mountain waters, except for the large amounts of calcic sulfate present, which reach a maximum of 55.6 percent. It is not easily explicable why sodic carbonate does not appear in this analysis unless it be due to the abundance of calcic and magnesian oxids, but the appearance of this salt in ground- and drain-waters, as well as in river waters, is to be expected, except under such conditions as are indicated in the case just given.

Attention is called to these facts in this place, not only because these ground- and drain-waters present these characters, but also for

*Am. Jour. of Sc., Vol. XVI. Aug., 1903, pp. 169-184.

the reason that the artesian waters, to be presented in this connection, will offer another phase of this, if not an entirely new question. It is for this reason that I call attention to the production of sodic carbonate in the decomposition of the felspars and at the same time to show that it is also possible to lay too much stress on this fact, as the sodic carbonate may be changed wholly into other forms. Still, it is a fact that sodic carbonate is almost always present in soil extracts and natural waters in larger or smaller quantities. The original source and general distribution of sodic carbonate may be easily explained, but these are not the questions to be answered in the case in hand, and do not answer the specific question presenting itself.

It is evident that neither the ground-waters nor solutions of these alkalis or soil extracts from either side of the river find their way into it, for if they did, they would both increase the amount of salts in the river-water and change their character.

THE ARTESIAN WATERS

Artesian water in the San Luis Valley was discovered by accident in 1887 and I am informed that there have been sunk, up to the present time, more than 5,500 such wells, ranging in depth from about 70 to upwards of 1,800 feet. It is indifferent, in our inquiry, whether any of these wells are used for irrigating purposes or not. Very many of these wells are now flowing at the surface, and but few of them are cased to any considerable depth and may consequently be furnishing water to the general supply of the valley by leakage, though they may not be flowing at the surface. We are, therefore, interested in the character of these waters.

There is a thoroughly justified classification of these artesian waters into white and brown, according to their color. The color, however, is probably due to an accident, the occurrence of humified matter in the strata of certain portions of the valley. It is possible that some of the white waters may contain the same mineral constituents as the brown water and that in as large quantities. This is more than a possibility, for every sample taken shows that the former statement, i. e., that the dissolved salts are the same in kind, is true, but the brown waters are usually richer in total solids. Two wells, locally designated as the gas-well and the soda-well, yielded waters which were not highly colored, but were comparatively rich in total solids. The water from the gas-well carried 37.63 grains, and that from the soda-well 103 grains of total solids per imperial gallon. In the brown water the upper flows are not strongly colored and are not excessively rich in total solids whereas the deeper flows are darker colored and are richer in total solids. The deepest flows, however, do not necessarily furnish the darkest waters.

ANALYSES OF WHITE ARTESIAN WATERS
BUCHER WELL, ALAMOSA. DEPTH FROM WHICH FLOW COMES,
923 FEET. WATER IS COLORLESS

Analytical Results	Percent	Combined	Percent
Silicic acid	50.202	Calcic sulfate	5.689
Sulfuric acid	3.345	Calcic carbonate	0.951
Phosphoric acid	None	Potassic carbonate	2.791
Carbonic acid	14.346	Sodic carbonate	31.443
Chlorin	0.485	Sodic chlorid	0.800
Calcic oxid	2.877	Sodic silicate	8.756
Magnesian oxid	None	Ferric and Alum. oxids.	0.260
Potassic oxid	1.903	Excess Silicic acid.....	45.885
Sodic oxid	23.267	Ignition	3.081
Ferric and Alum. oxids.	0.260		
Manganic oxid	None	Total	99.656
Ignition	3.081		
	Sum		
	99.766		
Oxygen equivalent to chlorin	0.110		
	Total		
	99.656		

Total solids, 14.07 grains per imperial gallon. Loss on ignition, 2.2 grains.
 An older determination of the total solids in this water gave 15.9 grains.

Sanitary Analyses

	Parts per Million
Total solids	201.00000
Ignition	31.42860
Chlorin	3.00000
Nitrogen as Nitrates	0.00002
Nitrogen as Nitrites	0.01000
Saline Ammonia	0.00100
Albuminoidal ammonia	0.00400

WELL AT ELECTRIC LIGHT PLANT, ALAMOSA. DEPTH, 820 FEET.
WATER IS COLORLESS

Analytical Results	Percent	Combined	Percent
Silicic acid	50.592	Calcic sulfate	4.976
Sulfuric acid	2.926	Calcic carbonate	2.104
Phosphoric acid	None	Potassic carbonate	2.898
Carbonic acid	14.610	Sodic carbonate	30.775
Chlorin	0.468	Sodic chlorid	0.772
Calcic oxid	3.229	Sodic silicate	11.175
Magnesian oxid	None	Ferric and Alum. oxids.	0.236
Potassic oxid	1.976	Manganic oxid	0.100
Sodic oxid	24.087	Excess of Silicic acid...	45.082
Ferric and Alum. oxids.	0.236	Ignition	(1.882)
Manganic oxid	0.100		
Ignition	(1.882)	Total	100.000
	Sum		
	100.106		
Oxygen equivalent to chlorin	0.106		
	Total		
	100.000		

Total solids 14.63 grains per imperial gallon. Loss on ignition 2.59.

Sanitary Analyses

	Parts per Million
Total solids	209.00000
Loss on ignition.....	37.00000
Nitrogen as nitrates.....	0.00270
Nitrogen as nitrites.....	0.07000
Chlorin	2.97060

The waters of the two wells just given represent the composition of the white artesian waters of this basin. I have an older analysis of the water from the Bucher well, we have also analyzed the water of the Spriesterbach and McNeiland wells, but the statement of these analyses in full would show only minor variations in analytical results and nothing more. The big features of the analyses are absolutely identical with the two already given. These wells are all comparatively deep ones. While there are very many shallow wells in the valley, from 70 to 250 feet deep, I have only one representative of these which is entered in my notes as "Widow Smith's place, depth of well uncertain, less than 300 feet, temperature 53° F., flow very strong". The only new point of interest in the analytical data of this well is the small amount of total solids that it contained, 6.6 grains per imperial gallon; otherwise we have essentially the same facts in regard to composition—very high silicic acid, abundance of sodic carbonate and some calcic sulfate. This sulfate is more abundant than usual, due, possibly, to the fact that the well was probably not cased for more than a few feet.

Some of these samples, together with others made by different analysts, may be found on p. 112 of Water Supply Paper No. 240, by Dr. C. E. Siebenthal of the U. S. Geological Survey.

Spring-Waters

In connection with white artesian waters, at least some of the spring waters deserve presentation. I regret, however, that I have studied these only in an incidental way. Some of these springs occur in the eastern part of the valley, under conditions which suggest that they may be directly connected with the artesian waters of the basin rather than with the surface waters as is usually the case. Some of these springs have a very considerable flow and are constant without any easily discernible source of supply. Other springs are not of this nature and evidently owe their supply to melting snows or surface waters; such springs should scarcely be considered in this connection.

Washington Springs may be taken as a type of some springs occurring in the eastern part of the valley. The artesian well mentioned as Widow Smith's was not far from these springs. There is one and may be more artesian wells at or near the springs at this time but these have been put down more recently and I know nothing about the composition of the water discharged by these. My impression is that the

Widow Smith well closed up some years ago. The analyses of one of these spring-waters (there were five of them at the time the sample was taken) and of the water from the Widow Smith well, were made at the same time, some years ago. These two waters are identical in character and very similar in the details of composition. The spring-waters carry 5.8 grains total solids per gallon, the well-water 6.6; the spring-water 1.74 grains silicic acid, the well-water 1.89; the spring 2.98 grains carbonates, the well 1.64; the spring .98 grains of sulfates, the well 1.02 grains. These waters are so similar that the suggestion that they are both really artesian waters is reasonable. Against this may be offered the fact that the ground- and drain-waters so far given have not lost all of the characteristics of mountain-waters; for instance, they show the presence of carbonates and some silicic acid which may be at least partly free, for there are more acids than is sufficient to satisfy the bases present. Such a statement is correct, but does not consider the decided increase in the sulfates, nor does it consider the fact that the artesian waters differ from the mountain-waters in containing very subordinate quantities of the alkaline earths and always notably high percentages of sodic carbonate. The springs in the southern part of the valley, with which I am acquainted, are either within or at the edge of igneous rocks which form the San Luis Hills. This sheet of rocks might simply serve to divert the artesian waters upward, or the waters may come from beneath, finding their way through fissures. I have examined the Dexter and the McIntyre springs. These waters differ from the artesian waters that I have examined in that they are richer in lime than the artesian waters; this is especially true of the McIntyre springs, also, in that they are richer in sulfates, which is equally true of the two springs. In regard to the silicic acid, they retain the richness of artesian waters.

In this connection it may be asked why I have made no mention of bicarbonates but have expressed the facts as though there were no bicarbonates. We have worked almost entirely with water residues obtained by evaporation to dryness in which we would have only carbonates. These residues in many instances were prepared in the locality where the waters occurred, as this was the only practical plan of procedure. The samples that we sent to the laboratory were several days old before they were examined so we have not deemed the omission of the half bound or even free carbonic acid of much importance, especially as the primary object had in view concerned itself very largely with the question of the mineral constituents present in the water.

WHITE ARTESIAN AND SPRING WATERS WOULD NOT AFFECT RIVER-WATER

It is evident that neither white artesian waters nor spring-waters such as those of the Washington Springs, nor even such as those of

the McIntyre and Decker Springs, would greatly modify the Rio Grande waters even if a fairly large quantity of them should find their way into the river. They might change the volume of the river but they would not radically change the character of the water as we find the waters of the Poudre and other streams changed within very short reaches of their courses. If the volume of flow were the principal change effected, it would be purely a matter for mechanical measurement. The results of gaugings vary; some years they showed an increase and in other years they showed almost as decided a decrease. At this time it appears to be a matter for regret that the chemical examinations and the gaugings were not made at the same time. This, however, is the first time that the peculiar problems presenting themselves in connection with these waters have been made the subject of inquiry.

FACTS INDICATE THAT RIVER LOSES IN VOLUME AND MAINTAINS CHARACTER OF MOUNTAIN STREAM

It would appear from the results obtained that the Rio Grande, in flowing through the San Luis valley, loses in volume and maintains the character of its water as a mountain stream to such an extent that it is difficult to believe that it is receiving any significant amount of return waters, even though the ground- and drain-waters given differ in material respects from those found in or issuing from irrigated lands under cultivation in other sections.

These facts seem almost incredible and yet they are concordant with one another. First, there is a loss of water between Del Norte and the State Bridge during some months. Second, there appears to be a mean gain between Del Norte, Colorado, and Embudo, N. M.* The discharge of the river at Del Norte, is given as 711,186 acre feet, the result of 17 years' observation; at Embudo, 769,098 acre feet, observation of 14 years, a gain of approximately 58,000 acre feet. Dr. Siebenthal gives the comparative discharge of the Rio Grande at Del Norte, State Bridge and Embudo for 1900, 1901, 1902 and 1903. At Del Norte, he gives 641,017, 583,271, 315,790 and 921,561 acre feet for the respective years, and at Embudo 537,381, 572,153, 282,032 and 1,006,600 acre feet. It will be noticed that there is a loss in three of the four years. Dr. Siebenthal gives these data in discussing the interstate aspect of the Rio Grande and shows that while the flow at the State Bridge is smaller than at Del Norte the loss is largely made up in the course of the Embudo canyon. His data show that this is the case in one year in four. This point made by Dr. Siebenthal and the geologists whom he quotes is undoubtedly well taken but this point of view is an entirely different one from that from which

*Gaugings given by Dr. Siebenthal, Water Supply Paper No. 240, U. S. Geo. Surv. pp. 13-14.

we approach the question. The question between the states pertains to the waters collected within the water-shed by the Rio Grande—whether the impounding of these waters will militate against the interests of Mexico—and their comparisons of the flow of the Rio Grande at Embudo and at Del Norte are greatly to the advantage of the citizens of Colorado and show that the discharge of the river at Embudo is largely dependent upon water which cannot be affected by the impounding of the head waters of the Rio Grande.

RIVER ONLY DISCHARGE BUT NOT ONLY SOURCE

It is not our purpose to discuss this question but to consider the discharge of the Rio Grande from another point of view. This discharge is the only one from the valley. We have seen that the discharge at the State Bridge shows a loss, two years out of five,* and at Embudo a loss three years out of four. The discharge during the year of maximum flow was over three and a half times that for the year of minimum flow, but this was also true of the discharge at Del Norte. The Rio Grande is the only visible discharge from the valley but it is not the only discharge into the valley. While it is perfectly legitimate to consider it in this light in discussing the interstate relations of the Rio Grande waters it is misleading, as it appears to me, in discussing the water relations of the San Luis Valley. It confines our consideration to the fate of the water gathered within the watershed of the Rio Grande as though there were no other water-shed around the valley, which is, as a fact, practically surrounded by high mountains from which waters descend into the valley.

WHAT BECOMES OF EXCESS WATER?

The discharge from the valley is, at best, probably no more than equal to the discharge of the Rio Grande into the valley. There are but two conclusions to be drawn in regard to what becomes of the excess of the discharge into the valley. It must flow out by unknown channels, or evaporate, or it is accumulating in the valley. The artesian waters do not constitute an addition to the waters of the valley, and all the irrigating water taken from the Rio Grande is already taken into consideration.

The facts that the Rio Grande loses water instead of gaining, and that the composition remains practically unchanged through a course of 60 miles through an irrigated country are entirely compatible, and the latter fact excludes the accession of any return waters, for these, even in this valley, where they seem to be of exceptional composition, would increase the amount of total solids in a materially greater degree than we find to be actually the case, and would increase the ratio of the sulfates. This is not true of the white, artesian waters, which differ mainly from the waters of mountain streams in their low content of carbonates of the alkaline earths. This difference between

* See page 13.

the water of a mountain stream and that of these artesian wells is shown quite clearly by the analysis of the Rio Grande water taken at Del Norte and that of the Bucher or Electric Light Plant well. The Rio Grande water contained 5.46 grains of total solids per gallon, the artesian water 14.63 grains, the solids from the river water contained lime and magnesia, 22.77 percent, sodic oxid 8.48 percent; the solids from the artesian water contained, of lime and magnesia 3.23 percent, of sodic oxid, 24.09 percent. These changes are interesting for there is no question expressed by those who have investigated the artesian waters of this basin but that they are furnished by the mountain streams as they flow over or into the edges of the sand strata.

THE BROWN ARTESIAN WATERS

We have given the brown waters no consideration as yet, because we accept it as evident that, if the white waters affect the composition of Rio Grande waters in no appreciable manner, it is not probable that the brown waters, peculiar to an area more remote from the river, would exercise a perceptible influence upon its waters, especially, as there is an area in which the white artesian water occurs between the brown water area and the river.

The area of brown artesian waters is designated as the Mosca-Hooper section, because these are the two important towns lying within the area.

The following analyses will show the uniformity in the composition of these waters and their marked differences in this respect from the white artesian waters, analyses of two of which have been given with the explanation that these are thoroughly typical of all the samples analyzed.

ANALYSES OF THE RESIDUES FROM BROWN ARTESIAN WATERS, HOOPER, COLO.

	Railroad Well 450 feet deep Percent	Mill Well 750 feet deep Percent
Silicic acid	9.576	5.167
Sulfuric acid	0.389	0.196
Carbonic acid	34.387	36.923
Chlorin766	0.434
Calcic oxid	0.371	0.563
Magnesian oxid	0.118	0.179
Potassic oxid	0.107	0.456
Sodic oxid	49.688	51.766
Ferric and Alum. oxids.	0.208	0.170
Manganic oxid (br)....	0.239	0.146
Ignition	(4.324)	4.267
Sum	100.173	100.276
Oxygen equivalent to chlorin	0.173	0.098
Total	100.000	100.178
Total solids, gains imperial gallon	3.92	6.7
Loss in ignition	70.56	104.3

ANALYSES OF THE RESIDUES FROM BROWN ARTESIAN WATERS CONTD.

	Mosca Town Well	Mosca Mill Well	Hooper Mill Well*
	Percent	Percent	Percent
Silicic acid	5.537	4.821	4.160
Sulfuric acid	0.342	0.046	0.063
Phosphoric acid	0.247	0.148	0.168
Carbonic acid	37.603	37.104	37.365
Chlorin	0.425	0.148	0.470
Potassic oxid	0.982	1.148	1.433
Sodic oxid	53.077	53.665	54.045
Calcic oxid	0.413	0.651	0.282
Magnesic oxid	0.153	0.391	0.219
Ferric oxid	0.086	0.031	0.039
Aluminic oxid	0.121		
Manganic oxid (br).....	0.086	0.054	0.048
Lithium, Iodin, Bromin, Titanic acid and Boric acid.....	Traces	Traces	Traces
Carbon or Organic matter.....	0.365	(1.721)	(1.814)
Sum	99.437	100.064	100.106
Oxygen equivalent to chlorin.....	.096	0.064	0.106
Total	99.341	100.000	100.000
Total solids, grains per imp. gal..	78.7	108.9	104.3

The sanitary analyses of the Mosca town well gave us a great deal of trouble. The results were as follows:

Total solids	1124.2857
Chlorin	6.9310
Nitrogen as nitrates	0.2000
Nitrogen as nitrites.....	0.0010
Saline ammonia.....	2.1300
Albuminoidal Ammonia	0.1750
Oxygen consumed	28.1000

The oxygen consumed was reduced from 28 to 10 parts per million by treating the water with calcic hydrate. The first two samples were taken in 1897 and the last three in 1907 and the analytical work was done by two different analysts, and yet the analyses are very nearly alike. The waters are essentially solutions of sodic carbonate colored by humus. The taste and odor of hydrogen sulfide is more or less strongly perceptible in many of the artesian waters, both white and brown. Some of the wells emit a comubstible gas; such wells do not furnish the most strongly colored waters. The waters from the deeper flows are richer in sodic carbonate, but not so strongly colored as those from a depth of about 500 feet. A comparison of the white and brown waters shows some marked differences. The white waters carry small amounts of total solids, 20.7 grains per imperial gallon being the maximum that I have found in the white waters, and there was some danger of pollution in this case, as it was from an uncased well in Alamosa. The well is now closed. The minimum that I have found in any tinted water is 25 grains per gallon in water from the

*These analyses appeared in the American Journal Sc. Vol. XXVII, p. 315.

first flow, while the maximum is 108 grains, in water from a depth of 880 feet. The two great differences in these classes of artesian waters are, the very marked disappearance of the silicic acid from the brown waters, and the very marked increase in the total solids. The minor changes consist of an acquired color and the lessened amounts of calcium and magnesium. The color is accounted for by the presence of humus dissolved from peaty matter in the strata traversed by the water. We accept the fragments of wood appearing in refuse washed out in sinking the wells as indicating the source of the brown matter held in solution.

ORIGIN OF THE CARBONATES

I shall later attempt to explain the concentration of the sodic carbonate. Its original source may be given correctly by tracing it back to a mineral origin, but this does not account for the concentration in these waters. The "Soda Well", now closed, carried 97 grains of this salt per gallon. One can scarcely appeal successfully to the masses of organic matter that may be indicated by the humus as the source, for our most alkali-tolerant plants would scarcely yield such pure solutions of soda, unless we assume that the plants of that time were different from those of the present, which is not probable.

The source of the soda and its predominance in the area north of the Rio Grande may far more reasonably be explained by the action of water on the igneous rocks, fragments of which constitute a very large percentage of the sand occurring in the strata. The remnants of trees (wood) which are met with in making these wells, and the peaty or brown color of the water, indicate that lake or marshy conditions existed for probably long periods in this section. At the present time the lowest portion of the valley lies within this area of artesian water rich in sodic carbonate. This area has probably been the lowest portion of the valley in former times, and for the same or similar reasons as now, i. e., because the bed of what we call the Rio Grande was higher than this portion of the valley, perhaps enough higher to prevent drainage southward, and what was then lake or swamp waters were removed by evaporation.

The action of water on the plagioclase feldspars present in the sand, formed largely of small, more or less worn fragments of igneous rocks, would give rise in the first instance to carbonates of soda and calcium with the liberation of silicic acid. That the carbonate of calcium was formed and separated is evidenced by the presence of very numerous kidney-shaped concretions of this substance in the sand as it was washed up in sinking the artesian wells. Sample available was from a depth of 550 feet.

The character of the white, artesian and spring waters, at the present time, is exactly such as is produced by the action of water on

plagioclase as is also that of river water flowing over sands and boulders of granitic origin. This character is very marked in the two artesian waters given as typical of the white artesian waters of the valley.

Here we find that, approximately, one-third of the total solids consist of sodic carbonate, with relatively large quantities of silicic acid and calcium salts. The latter substances are practically removed from the brown waters. The river waters show the same fact, only to a less marked degree, and the elimination of the silicic acid and alkaline earths has not taken place. In the spring waters we find the same fact. In the water from the Washington Springs, for instance, we find a total of 5.7 grains of solids in an imperial gallon, of which, 1.74 grain is silica, 2.85 grains are alkaline carbonates and 0.98 grain is sulfates of the alkaline earths.

This process of taking sodic carbonate into solution from the plagioclase feldspars is going on at this time and the only adverse question attaching itself to this view of the origin of the sodic carbonate is in regard to its sufficiency, of which I think there can be no reasonable doubt. The carbonate of calcium has been deposited in the form of small concretions and the silica may have been used in a variety of ways, perhaps to enlarge sand grains or to form new silicates. I have no knowledge of any direct proof that this latter process is going on. In the case of the Cache la Poudre water we find the whole of the silica removed on its first contact with the conditions that obtain in its plains section. It seems probable that this disappears in the formation of new silicates.

The origin of the carbonates here suggested is in harmony with the facts that we find obtaining in regard to the action of water on these plagioclase feldspars, also with the composition of the artesian waters themselves. It is immediate and simple, and is suggested by the facts in the case.

LARGE AMOUNTS OF SODIC CARBONATE POURED ONTO LANDS BY WELLS

In order that the general reader may form some appreciation of the amount of sodic carbonate involved in this question, let us suppose that the "Soda Well" discharged 200 gallons a minute and that it carried 97 grains to the gallon. Such a well would deliver $5\frac{3}{4}$ tons of anhydrous sodic carbonate a month, or more than 12 tons of washing soda. Some of these wells have been flowing for 20 years, others even longer. It is true that many of these wells are only 2, 3 and 4 inches in diameter, but there are many of them, and the amount of soda yielded during the past 25 years must have been considerable.

I offered, 20 years ago, to furnish a complete analysis of any sample of black alkali found in this State without charge. I excepted

this section, for it has long been known that there are occurrences of pure sodic carbonate within its limits. I do not know who first discovered it. Attempts have been made to prepare and market it. It matters but little to the facts in the case whether we have any explanation to offer for them or not, the facts remain just the same, i. e., that the artesian waters in this section are rich in sodic carbonate, and the people who live in this section have observed that these waters are not good for irrigation.

Concerning the use of these waters for irrigating crops, Dr. Siebenthal says: "It seems to be pretty generally agreed, however, as the result of experience, that the dark water is nowhere as good as ditch water and that in many places it is positively harmful and should always, if possible, be used in conjunction with ditch water. Its moderate use is likely to cause a "case-hardening", or the formation of a hard crust on the soil surface. In any event, even if one application is not injurious, its continued use in subirrigation will surely impregnate the soil with alkali."*

We shall have occasion to return to this subject for a fuller consideration of the conditions and facts as they have developed during the past 20 years.

THE SAN LUIS LAKE WATER

There still remains a small body of water which is entitled to consideration. This is the San Luis Lake which presents a surface of a little more than one square mile and has an average depth of 15 feet under ordinary conditions. This is the statement usually made. I have no other knowledge as to the depth, which varies with the season and is greater some years than others. There are several lakes, but only one of them has any considerable size, which is the San Luis Lake. This lake is peculiar in that it has no outlet, though the last time that I was there I was told that it was overflowing on the west side. There was a condition of affairs at this time that I had never seen before though I have been there often. The land to the west of the lake for a distance of quite two miles I would judge, was, for the most part, under water. This water, I was informed, was from the tailings of the irrigating and drainage ditches and water flowing out of the lake. I can not well verify these statements. This lake not only has no outlet, it also has no visible inlet except at rare intervals, when the waters of the Saguache and San Luis creeks flow overland into it. I have been informed that this happened but once in 40 years prior to 1909 and I was also informed that it had happened once in 21 years prior to that time. These two statements are of course not contradictory. The persons giving the information may have referred to the same occasion. Be that as it may, it is evident that this is a rare occurrence. The Saguache and San Luis creeks, especially the Saguache, would be classed as mountain streams and undoubtedly carry

*C. E. Siebenthal. Water Supply Paper No. 240, U. S. Geo. Survey, p. 115.

water similar in composition to that of our other mountain streams, fairly represented by the waters of the Rio Grande which we will use for comparison.

ANALYSES OF RESIDUES FROM SAN LUIS LAKE WATER

	Sample taken 15 Oct. 1902	Sample taken 8 May, 1916
	Percent	Percent
Silicic acid	9.118	13.401
Sulfuric acid	5.801	10.255
Phosphoric acid	—	0.116
Carbonic acid	22.096	16.813
Chlorin	4.209	5.146
Calcic oxid	2.673	4.178
Magnesian oxid	5.613	4.632
Potassic oxid	13.832	8.559
Sodic oxid	35.590	28.210
Aluminic oxid }	0.629	0.856
Ferric oxid }		0.301
Manganic oxid	0.216	0.465
Ignition	1.574	(6.350)
Sum	101.351	101.162
Oxygen equivalent to chlorin948	1.162
Total	100.413	100.000
Total solids in grains per imp. gal.....	62.2	55.9
Loss on ignition in grains per imp. gal	8.2	

Sanitary Analyses of the Waters

	Parts per Million	Parts per Million
Total solids	888.5900	798.0000
Chlorin	36.1420	39.0000
Nitrogen as nitrates.....	Trace	0.1500
Nitrogen as nitrites.....	1.4000	0.0100
Saline ammonia	0.6250	0.3300
Aluminoidal ammonia	0.7130	1.0700
Oxygen consumed	31.5000*	14.1000

*The oxygen consumed was reduced to 10 p.p.m. by treatment with calcic hydrate.

These samples were taken at different seasons of the year and nearly 14 years apart. I personally took both samples and remember distinctly that the lake was very low when the first of these was taken and, though I have seen this lake very often, I do not remember ever to have seen it so high as when the last sample was taken; therefore, it is probable, that these results represent the extreme differences to be met with in samples of this water. The results are remarkable, for, as I understand it, the drain ditches have been tailing their water into the trough of the valley for three or four years, and, as stated, the country for about two miles to the west of the lake was, at the

time of taking the last sample, covered with water. This was the case to such an extent that, had I not been accompanied by a person thoroughly acquainted with the ground, I would not have ventured to try to approach the lake.

An examination of these analyses makes evident the fact that the solids held in solution differ materially from those of any water so far presented. They differ from the river waters in containing less silicic acid, less lime and magnesia, more chlorin, as much or more carbonic acid, about the same amount of sulfuric acid and very much more potassic and sodic oxids. This is particularly noticeable in the case of the potassic oxid. The differences are not such as we find in the drain- or ground-waters, nor do they correspond to the changes that we might expect as due to evaporation of the river waters. Evaporation is without doubt an important factor in the case. The evaporation from the lake surface is probably not less than 60 inches annually and must effect some changes, but we find the sulfuric acid at the time of low water less than in the river waters. The concentration of these waters is very far from the point at which any sulfates would separate due to this cause. The total solids in the lake water amount to, approximately, 8 or 12 times as much as we find in the river water. The potassic oxid is from 4 to 6 times as high in the residue from the lake-water as in that from the river-water.

There is, further, no relation between the lake and artesian waters. The differences mentioned above are even more strongly pronounced in this case than in that of the river waters. This would be a natural inference as the source of the lake- and river-waters is evidently the waters supplied directly by the mountain streams, and still it is altogether possible that the lake-water may be directly supplied from the artesian basin, as I believe some of the springs in this section of the valley to be, the Washington Springs for instance. There are artesian wells on the east side of the lake and very close to it. The water is white, tastes distinctly of hydrogen sulfide but is an agreeable, potable water. The water furnished by the nearest well that I know of on the west side of the lake, furnishes a tinted water. These wells may, indeed almost certainly do, tap different flows. The soda lakes are close to the San Luis lake on the east and south. I hold that these soda deposits owe their origin to the brown artesian waters which come to the surface at these points and are evaporated. Such an explanation is clearly not applicable to the water of the San Luis lake. These relations are pointed out because the statement of our work on the waters of the valley would not be complete without reference to it, and also for the better reason that the water presents interesting questions.

There are some very important questions which have not yet been touched upon, or if they have been suggested, they can be put much more plainly. We have given analyses of artesian waters from the town of Alamosa, others from the town of Mosca. The difference in altitude between these two towns is 15 feet. The intervening country is without known folds or faults, the distance is less than 14 miles, and yet the artesian water at Mosca is wholly different from that at Alamosa. This is true for all the different flows encountered at the respective places, which may be illustrated by the Electric Light well at Alamosa and the Mill well at Mosca. The former has a depth of 820 feet, the latter a depth of 780; the former is a white water carrying 14.6 grains of total solids per imperial gallon, 50 percent of which is silicic acid; the latter is a brown water carrying 104.3 grains of total solids, of which only 4.2 percent is silicic acid and approximately 90.0 percent is sodic carbonate. In 1896 I examined the water of a well 8 miles north of Alamosa, on what is given as the probable limit of the brown waters, and found that it carried 103.6 grains of total solids, almost 90.0 percent of which was sodic carbonate, with only about 0.33 percent of silicic acid. It is a question how waters of such different characteristics can occur in the same aquifers without any barriers caused by foldings or faults. These differences are found in all of the flows within these respective areas. The limits of the brown waters are not necessarily the limits of the alkaline water for the last water mentioned was scarcely colored at all. The limits of the alkaline waters have not been determined, neither has there ever been any attempt, so far as I know, to trace the alkalinity of the waters between the two sections to determine whether there is a comparatively sharp line of separation or no line at all. The amounts of solids held in solution might be used as a criterion but this has not been attempted to my knowledge. In other words, the line between the acid and alkaline waters has not been determined. It is difficult to conceive how such lines can continue to exist, for even within the aquifers themselves there must be some diffusion, especially when so many openings have been made, which must establish some movement of these waters. A single 2- or 6-inch vent might not be of much significance, but when thousands of vents—upwards of 5,000—even if they are not greater than 2 inches in diameter are furnished, one would expect a considerable aggregate movement within these aquifers which might tend to bring about a mingling of these waters and to eliminate any sharp boundary. No observations at all have been established on these points so far as I know and it is wholly unknown whether the limits of the alkali water may have changed during the past 20 or more years. This period of time is not too long, for there were as many as 2,000 wells estimated to have been put down by 1891.

AGRICULTURAL FEATURES OF THE QUESTION

The strictly agricultural features of this problem are interesting and also involve a large territory. The facts in the case are simple but most conclusive in their character. The Hooper-Mosca section was, in 1893 to 1896, probably the greatest wheat producing section of the State. In 1916 this section was very largely non-productive, between 300,000 and 500,000 acres of land having long since been allowed to go back into greasewood and chico. The flouring mill at Mosca was torn down some years ago and the one at Hooper has been dismantled recently as a flouring mill after running many years on an inadequate supply of grain. This mill, I am told, may be continued as a feed mill. These are a few of the bald facts.

I do not know that anyone has ever formulated a statement of causes to account for this condition. It has generally been assumed that it is due to a high water-table. On this basis, drainage has been advocated strongly and with much confidence by a number of persons. In fact, much capital has already been invested in drainage projects and a number of proposed projects have not been carried out because of the difficulties encountered in financing them.

SUBIRRIGATION HAS CAUSED WATER-LOGGING

The system of irrigation practiced almost exclusively in the valley, i. e., subirrigation, has hastened the water-logging of the lower lands; of this there can be no question. In this system it is the practice to keep the water-table within a few inches of the surface during the whole, or most, of the season. I have not personally investigated the height of the water-table usually maintained, so I cannot make definite assertions in regard to this point, but inquiry has elicited the information that this depth varies from 12 to 24 inches. The latter is the greatest depth assigned to it. I recently made inquiry of a prosperous ranchman in regard to this point. He stated that he kept the water within 12 inches of the surface. The crops grown with this high water-plane were alfalfa, peas, oats, potatoes and wheat. This man asserted that his teams would mire on his land most of the time. I made inquiry in regard to this man's standing in the community and the results obtained on his lands. I learned that he was a man of influence and that he had probably told me the truth about his crops, both in regard to growing conditions and yields. I inquired further in regard to the depth to which this water-table fell during the winter when irrigation was not being practiced. The answer was prompt, that it varied, but that in none of the land did it fall to more than $3\frac{1}{2}$ or 4 feet. I have bored, or dug with a spade, holes in other wholly unproductive sections of the valley during the irrigating season, and found no such high water-plane assigned to the lowest plane

for subirrigated land, 24 inches. In July of 1916, I dug a hole in unproductive land near Mosca and found the water-table 36 inches from the surface. Later a sample of water was obtained from this place and a more careful measurement made of the depth of the water-plane, 37 inches. Southwest of Alamosa, I made a boring and did not find free water at 4 feet. It is difficult to reconcile the success generally had with subirrigation in which the water-plane is intentionally held within a short distance of the surface and the failures on land with a lower water-plane, if excessive water be the cause of unproductiveness as is claimed. Facts such as those just cited lead naturally to a doubt in regard to the correctness of the assertions made in this connection.

Other facts lead to a similar conclusion regarding the insufficiency of the high-water plane to explain the cause of the unproductiveness of these lands. One of these facts is the results being obtained by flooding without other than the natural drainage of the land. In some instances a fair degree of success has been obtained with alfalfa by this method, just as marked as by drainage, perhaps more so. The trouble is not to maintain the plantation of alfalfa but to get the seed to come up and to establish the young plants. When once established the alfalfa does fairly well, some of it very well. These facts indicate a trouble at the surface of the soil and not an excess of water that drowns the plants. Some ranchmen are seriously considering these facts. I do not know to what extent such views prevail among the people but some of them do not accept the seepage theory as the principal cause of the trouble which prevails throughout many thousands of acres—from 400,000 to 500,000

I do not wish to leave the impression that I have not found any cases in which the water-plane in unproductive land was not higher than 36 inches. I have found it very near the surface, but nowhere within 12 inches, that I can recall. I have found the water-plane high, within 18 inches of the surface, in very unexpected places and under conditions which we would judge to be favorable for drainage, i. e., in sandy soil with a good fall in one direction. This instance is interesting for several reasons. It was a desert claim. Irrigation was effected on a small scale by artesian wells. The person who had taken up these claims had made an honest effort to comply with the government's conditions to obtain a patent to the land. He had failed according to the authorities and the patent was withheld. The party had sunk 17 wells on this tract of land. He had diked several pieces of it and turned in his artesian water. The first year or two he had good results, the next 4 or 5 years everything failed and the land was entirely barren during the past summer. I cannot state that these diked sections were seeped. I think that they were not, but other areas,

some occupied by alkali grass, others by clumps of greasewood, were seeped. The water-table in some land near the house was within 18 inches of the surface. This party stated his case as becoming worse the more water he used. He could not grow anything without irrigation and to irrigate with this water for one or two years, was to make it impossible to grow anything. Fortunately, the government representatives sent to examine into the facts of the case, realized that this party had made an honest effort to meet the requirements of the law and that his failure was due to some cause for which he was not responsible. We have the following facts: The land had produced good crops for one or two years on the application of water; it then became unproductive, and a comparatively small well sufficed to seep a considerable area of this desert claim.

The water furnished by the wells that I saw was of good quality, it was a white water carrying 5.5 grains of total solids to the imperial gallon, 37.27 percent of which was silicic acid and the rest was essentially sodic carbonate. This is very similar to the water furnished by the Washington Springs and the Widow Smith's Well. The sample of water taken was from the second flow.

Two samples of alkali were gathered from different parts of the tract, but neither one very far from a well. These wells have been flowing 5 or 6 years. The composition of these alkalis is unusual for our state and for the San Luis Valley as well. Analyses of alkalis which appear as efflorescences from localities pretty well distributed, and I believe representative of the general conditions in the Valley, have been given in the preceding pages. These consist chiefly of sulfate of soda. The soil extracts which are given are from various sections and indicate that it is usual to find the same salts in these as in the efflorescences which occur on the surface. The exception to this statement is found in the water-soluble from a soil sample, taken amid greasewood bushes in which we find sodic carbonate making up 25.4 percent of the 1.935 percent of water-soluble. The efflorescent alkali, corresponding to this sample, carried 8.3 percent of sodic carbonate. This land was once under cultivation, but how long it had been occupied by greasewood at the time this sample was taken, I do not know.

GREASEWOOD INDICATES PRESENCE OF SODIC CARBONATE

While I am not prepared to reject wholly Prof. Hilgard's theory that the debris from these plants enrich the soil in sodic carbonate, I am strongly inclined to think that in this valley the growth of greasewood is indicative of a soil condition favoring their development and that their presence is a result of the prevalence of this salt in the soil, perhaps in such quantities as to render the soil already an inhospitable one to most cultivated plants, and for this reason the *sarcobatus* becomes the predominant vegetation, for it can endure the sodic carbo-

nate. This in no wise asserts that this plant cannot or does not flourish in other soils. The most vigorous samples of *sarcobatus* plants that I remember having seen were growing at the edge of a kitchen garden with which no one could possibly find any fault on account of any lack of luxuriant growth. But, I think, that it is true in the section of the San Luis Valley land had in mind, that the presence of this greasewood indicates a strongly alkaline soil in which sodic carbonate forms a relatively large proportion. On a preceding page we have given an analysis of the water-soluble portion of such a soil and find that sodic carbonate makes up a little better than $\frac{1}{2}$ of the total, while in the alkali that effloresced from this soil, about $\frac{1}{12}$ of the salts soluble in water was sodic carbonate.

WHITE ALKALIS NOT INJURIOUS TO CROPS

My judgment relative to the injurious nature of our white alkalis, the efflorescences of which are designated by this name in this State, is that they are so good as harmless in any quantities in which they actually occur. It is a matter for regret that there has been so much said about the injurious effects of these alkalis that there has grown up a general belief in their injurious properties. These alkalis in Colorado consist usually, of the sulfates of soda, lime and magnesia, usually with small quantities of chlorids and carbonates. I have grown beets carrying from 14 to 19 percent sugar and yielding from 9 to 19 tons per acre on land the top 2 inches of which carried 3.5 percent of water-soluble salts. I measured incrustations formed on this land which attained a maximum of more than $\frac{1}{2}$ inch. I have seen so many other instances of extremely alkaline land, in so many different sections of the State, on which excellent crops were produced, that I am convinced after 23 years of observation of this particular subject, that our ordinary white alkali is not sufficiently abundant in any of our ordinary soils to deserve any serious consideration. I have elsewhere stated, apropos to this subject, that on one occasion I measured alkali incrustations $\frac{3}{16}$ inch thick under the leaves of beet plants and on digging found the ground water within 18 inches of the surface. This crop of beets was irrigated with seepage water, carrying 259 grains of total solids to the gallon. I was interested to learn what the harvest of this crop revealed, and wrote to the officers of the factory which handled the crop. They kindly gave me their record—9 tons per acre one year and 10 tons the next, with 16 and 16.5 percent sugar in the respective years. There was more of this alkali land which yielded much larger crops and slightly better beets. I saw a crop of wheat grown on land that I, at first, thought wholly unfit for wheat-growing, but the yield was 60 bushels per acre. Such facts as these can be duplicated in many sections of the State and are so patent that one cannot justly make the unqualified assertion so often met with, that the alka-

lis are injurious and have rendered the land worthless. I undertook some 15 years ago to ascertain the maximum amount of alkalis that might be present in an irrigating water without becoming injurious to the crop. I found the maximum so high that its ascertainment might have been interesting, but was of no practical value. The 60-bushel crop of wheat referred to in this paragraph was irrigated with seepage water that carried nearly 500 grains of ordinary alkalis to the imperial gallon, and the land was already rich in these salts. I took a sample of this soil during the summer of the preceding year, selecting a spot in which corn had almost failed and obtained 4.67 percent soluble in water, of which 69.0 percent was sulfates and 19.0 percent chlorids. This of course was the surface soil, but this is the portion invariably considered when this subject is spoken of. It is true that sometimes the alkali in a certain depth of soil is mentioned, but this is not usually the case.

UNPRODUCTIVENESS DUE TO SOME CAUSE OTHER THAN ALKALIS

When an ordinary alkali land is unproductive, or practically barren, as some of the San Luis Valley land is, there is some other condition contributing to the unproductiveness rather than the ordinary alkalis. Too much water is sometimes an efficient cause, but my observations in the field, as well as my experience with beets in thoroughly seeped land, make me rather more cautious in making assertions in regard to this as a cause of unproductiveness than many persons are. The practice of subirrigating may be unreasonable, but if the statements of those practicing it be in any reasonable measure reliable, the results obtained throw doubt on the correctness of much that is said regarding the subject of a high water-plane. Their practice may amount to water-culture on a large scale, be it so—*they raise the crops*. The fact is probably this; that parties expected to give an explanation, knowing, as every other person knows, that something is wrong when large areas formerly productive become unproductive, and feeling impelled to assign a cause, practically adopt the irresponsible view that they might as well assign it to alkali or to a high water-table as to anything else, because these are visible, and it is difficult to prove that they may not be the cause. The assertion, especially concerning the common white alkali, is of little value by whomsoever it may be made, while the evils due to seepage have been well ridden in our country for some years. There is no question, but that seepage is a real, and a serious problem, and one that is likely to become more so, but it is possible to attribute results to seepage for which it may be only indirectly, if at all, responsible. There may be troubles in a seeped country due to other causes than the seepage and which drainage may or may not alleviate.

It is well in this connection to state the preceding facts, that there may be no doubt about the value that I believe attaches to the assertions very generally made, particularly in reference to the alkalis, as the term is commonly used among us, where it means the ordinary white efflorescences on our soils.

I stated that the samples of alkali gathered on the desert claim were of an unusual type. The analyses of these samples show the presence of 14.75 and 40.368 percent of sodic carbonate respectively. The full statement of these analyses follows:

ALKALIS FROM A DESERT CLAIM

	I	II
Calcic sulfate	1.489	3.781
Magnesian sulfate	0.367	1.065
Potassic sulfate	2.874	4.978
Sodic sulfate	26.162	30.807
Sodic carbonate	40.368	14.750
Sodic chlorid	20.938	40.161
Sodic phosphate	0.959	0.391
Sodic silicate	4.271	2.866
Ferric and Alum. oxids.	0.082	0.340
Manganic oxid	0.202	0.265
Excess of sodic oxid...	2.288	0.596
	100.000	100.000

The soil where sample II was taken was not very badly encrusted and contained only 9.2 percent soluble in water, but the sodic carbonate present amounted to 1.35 percent of this surface portion.

The presence of such large quantities of sodic carbonate and the known toxicity of this salt to ordinary vegetation, were suggestive of the cause of the failure of the grain or the unproductiveness of the plots after the second year's irrigations. I have already stated that we have examined the water from the second flow and found it excellent water from the ordinary standpoint. This water carried 5.5 grains of total solids per imperial gallon, of which essentially 37.0 percent was silicic acid and the rest sodic carbonate. Such a water is apparently a good water, but the experience of this settler was that the more water he applied, the worse the conditions became.

The evaporation from a free water surface at this place is, according to the best information that I have, 60 inches or rather more per annum; taking the evaporation from a soil surface at 36 inches and neglecting the loss by percolation which, judging by the readiness with which local water-logging may be effected, seems at most very small, even such water might be an efficient, contributing factor in bringing about unproductiveness in the soil and justify the hard fact stated by the settler, "the more water I apply the worse I'm off". Even this water will deposit 354 pounds of sodic carbonate per acre per annum under the assumed conditions. It is not at all improbable

that the sodic carbonate found in these alkalis came, principally at least, directly from the evaporation of this artesian water, for these wells had been flowing for more than four years. This water belongs to the white artesian waters. A short distance from this, about $\frac{3}{4}$ of a mile, a well sunk to irrigate some meadow land yields a strong flow of brown water. Concerning the effects of this water there is no room for argument, for it had killed the grass wherever it flowed over it. The water from this particular well was not analyzed, but we assume it to be similar in composition to other brown water from the same flow.

It is a very generally admitted fact that even the white artesian waters are not good for irrigating purposes. The almost universal testimony is that ditch or river water is preferable. Further, it is a common observation that the brown waters are not at all good for this purpose but that they are bad, for they kill some plants and cause the ground to become hard and it is then impossible to get alfalfa or other crops to come up and grow.

SEVERAL DISTINCT QUESTIONS INVOLVED

The agricultural problems present several distinct questions, each one of which may be of greater or less importance. The first question is in regard to the effects of our ordinary alkali salts.

That this question should be the first one suggested by the ordinary inquirer is natural, for the occurrence of these salts is abundant and sufficient to coat large sections of the valley with a covering, quite literally, as white as snow.

I have already stated my personal conviction, that this of itself is not a very serious matter. This conviction is based upon cultural facts and not on a theory to explain something.

The second one is the question of seepage. This is *per se* a more important question, perhaps, than that of the alkalis. Unfortunately this condition seldom occurs with us without being accompanied by the first question. The results of practicing subirrigation for many years raises serious questions in connection with the problems directly involved, to which general principles scarcely apply. In order to indicate more fully, but not to argue the question, it may be stated that in one section of the valley excellent crops, alfalfa, peas, oats, potatoes, etc., are grown with a water-plane intentionally kept nearer than 24 inches of the surface, sometimes as near as 12 inches, while other sections are only partially productive or wholly unproductive, with a water-plane 36 or more inches below the surface. The productive, subirrigated land is very far from being free from alkalis. How abundant they may be I do not know.

A third question, one presenting itself in the case of the desert claim, applies to a very large section, but not to all of the valley; this

question is: Has the carbonate of soda, or black alkali, become so abundant as to be the determining factor in the unproductive condition of the area had in mind—in this case, the Hooper-Mosca section, an area coincident with the brown, artesian waters?

A fourth question pertains to this and to other sections of the valley as well: This is the question of the development of nitrates in injurious quantities. I have seen at least one tract of 640 acres on which the pea crop was wholly destroyed due to the presence of excessive nitrates. I heard of a second tract of 80 acres which was destroyed by the same agent. The people attributed these failures of the crop to the grasshoppers, though the peas that I saw either had not come up at all or had turned yellow and died without having been touched by the hoppers, if indeed there had ever been any hoppers there.

This general statement of the case by no means presents all of the problems of the valley, but these are the big, patent ones.

The United States Land Office sent a party out to investigate claims on which patents had been withheld for one cause or another. Some of these investigators recognized that there was something radically wrong in many of the cases. These settlers are not all dishonest men, trying to get patents to land for unworthy purposes, and yet they have been unable to satisfactorily comply with the government's requirements, as in the case of the desert claim mentioned in preceding paragraphs, or have abandoned the claims after having spent several years and perhaps all of the money that they have been able to get in order to make a success of them. In conversation with a member of this party, I found that he was seriously considering these questions. The trend of his argument was that men would not spend two or three thousand dollars and four years of their lives, perhaps with their families, on these claims, and then fail to comply with the government's reasonable demands or abandon the claims altogether, unless there was something wrong, for which an adequate explanation had not yet been found. I believe that his conviction was an honest one, that the government ought to protect such parties against the possibility of undertaking to prove up on such lands without full knowledge of the difficulties, or of giving them a full chance to try if they wished to knowingly undertake it.

It was not our intention to take up these agricultural features in this bulletin, but the growing conviction of their unusual character, their seriousness, and, as I believe, their intimate relation to the character of the artesian waters of the section justify me in giving the outlines of the salient problems presenting themselves. Up to the present time these questions have been dealt with only as they were incidental to the chief work presented, i. e., a study of the hydrology of the valley.

A REVIEW OF THE HYDROLOGICAL FACTS

In this work we find that the river water is characterized by a composition peculiar to mountain waters which is the result of the action of pure water on the rocks of the mountains, or the gathering grounds of the rivers. There are but comparatively few minerals concerned in the reactions which it is necessary to consider in this connection, in fact, we can confine our consideration to the plagioclase feldspars, because these are the minerals that play the predominant part in these reactions. It is scarcely necessary to state that it does not matter whether the feldspar constitutes a part of a metamorphic or an igneous rock, though its association and physical condition may affect the rate of alteration. Our white artesian water, especially from the shallower flows, differs but little from the mountain water, in fact, the water from a depth of 923 feet from the Bucher Well at Alamosa, carries only about three times as much mineral matter in solution as the Rio Grande water taken just above Willow Creek, but otherwise it is similar, exchanging lime for soda.

The residue from the water of this deep well contains 50 percent silicic acid, 14 percent carbonic acid (CO_2) and 23 percent sodic oxid, with some lime. The river water contains 43 percent silicic acid, 13 percent carbonic acid and 20 percent lime with 6.8 percent soda. The great change here is the exchange of lime for soda. When we pass from the area of white waters to that of the brown waters we find a further change in the elimination of the silicic acid and an increase in the amount of soda present with an almost complete elimination of the lime. The brown color is accidental for we have almost colorless water from this same area very rich in sodic carbonate. These peculiarities of composition are maintained by the different flows. The shallower flows may not be so deeply colored nor so heavily charged with mineral matter, but the composition of the mineral matter has the same peculiarities—absence of silicic acid and lime with sodic carbonate very strongly predominant. This is true of shallower wells, 15 feet in depth, which yield a white water carrying about 20 grains of total solids to the imperial gallon. Fifty percent of this was found to be sodic carbonate. The sulfates were not determined in this sample. This is an agreeable, cool water used for domestic purposes. The excellent quality of this water seems remarkable, for the whole country in this section is quite alkaline, in fact, there is a piece of land within a short distance of this well that is in very bad condition and white alkali is very abundant. The prevalent unproductive condition of the land and the area of sodic carbonate-bearing artesian water, usually brown in color, are nearly if not altogether coincident.

It is true in both areas, that of the white acid artesian waters and that of the brown alkaline waters, that the deeper flows are richer in

total solids than the shallower, but the increase in the brown water area is much more marked than in the white water area. In the latter area this increase is from about 5 grains to 15.9 grains per imperial gallon; in the former, the brown-water area, the first flow carries about 22 grains which increases to 108 grains per imperial gallon in the deepest flow examined. For the present, we may consider the source of the carbonate to be the country itself, i. e., we may consider it as existing throughout this whole section as ready formed sodic carbonate without any regard to the original source from which it was derived or the agencies contributing to its formation. I have previously indicated my belief in its formation by the action of water on the sands consisting very predominately of grains of igneous rocks and possibly in a large measure to the evaporation of such water within this area due to a lack of drainage throughout a long period. It is, however, much more convenient for our present purpose to adopt the preceding statement—that it occurs, already formed, in the strata of this section of the valley. This agrees with the fact that if you start at Alamosa and go northward, the water increases both in alkalinity and the amount of total solids contained, until you get a little north of McGinty; from here to Hooper it remains about the same. It is understood that these statements are, in a sense, general in character, for, at the present time, it is practically impossible to obtain reliable information relative to the depth from which a well may be delivering water and general statements are the only ones that can be made, as the flows taken may not be the same.

If we start at Center near the western rim of the artesian basin and sample the waters eastward to Hooper, we find a very similar series of results—an increase in both the alkalinity and total solids.

While the foregoing statements are, in a sense, general ones, they are based upon two series of samples taken, as suggested, from Alamosa northward and from Center eastward to Hooper. In a few instances we can ascertain the depth from which the water rises, but in the majority of cases we cannot get satisfactory information. Another difficulty is that but few of the wells are so cased that we get the water from a definite flow. In the instances in which the depth of the well is known, I shall give it, in other cases I can only designate the wells as shallow or deep.

ALKALINITY OF ARTESIAN WATERS

Locality	Depth of Well	Sodic Carbonate in parts per Million
Alamosa	923 feet	68.0
Alamosa	820 feet	68.0
½ mile south McGinty	Deep	795.0
North of McGinty	Deep	1070.9
2 miles north McGinty	Deep	1171.3
2 miles north McGinty	Deep	1229.6
4 miles north McGinty	Shallow	371.0
Mosca	780 feet	1388.6
Mosca	500-600	1003.0
2 miles north Mosca	Shallow	318.0
3 miles south Hooper	Deep (780?)	1446.9
2 miles so' east Hooper	Shallow (2d flow or deeper)	593.6
1 mile north Hooper	Shallow (1st flow)	371.0
Hooper	750 feet	1356.0
Center	200 feet	74.2
3 miles east Center	Shallow	74.2
4 miles west Hooper	375 feet	79.2
4 miles west Hooper	739 feet	477.0
2 miles west Hooper	Shallow	212.0
1 mile west Hooper	Shallow	291.5
Hooper	450 feet	840.0

The samples from Alamosa to Hooper represent water taken in an almost straight line beginning south of and outside of the alkaline area and running due north to approximately the center of the area. The samples from Center to Hooper represent a line beginning west of and running due east to the central portion of the area.

In addition to the above data the results obtained on examining the water carried by the Sylvester drainage ditch will give an idea of the character of the ground-water in the line of the latter samples, Center to Hooper. A sample of this water was taken two miles west of Hooper and carried 159.0 p.p.m. of sodic carbonate; another sample was taken as tailing water one mile east of Hooper, and this carried 227.9 p.p.m. A shallow well, 15 feet deep, used for domestic purposes, carried 159.0 p.p.m. of sodic carbonate. The depth of the Sylvester drainage ditch where the sample was taken, west of Hooper, was probably 8 feet.

The data herewith presented to exhibit the alkalinity of the artesian and even surface waters of the section under discussion are sufficient to show that we are justified in presenting them for serious consideration in connection with the unfavorable agricultural conditions that prevail throughout this section of country, which, as I have previously stated, is co-extensive with the area of alkaline water. I do not know the exact outline of this area, but there are probably at least 400,000 acres of land affected by these conditions.

The quantities of sodic carbonate given in the above statements may not convey any definite idea to some readers, therefore it may be

advisable to state how much they may mean. The annual evaporation from a free water surface in the San Luis Valley may be taken as 60 inches, and from a soil surface as 30 inches. The drainage water carries 159 p.p.m., or each million pounds of water carries 159 pounds of sodic carbonate. If 3 acre-feet of such water were evaporated to dryness on an acre of land, and the whole of the carbonate were left on the surface, it would mean the deposition of 1,300 pounds of sodic carbonate, which would add, if thoroughly mixed through the top foot of soil, 0.03 percent of sodic carbonate. In experimenting with beet seedlings years ago, I ascertained that the presence of 0.05 percent of this salt in the soil was injurious and could not be exceeded without killing the seedlings. This is the importance of the preceding figures, i. e., the ground- and drainage-waters, and all of the artesian wells in this area contain sodic carbonate. The brown artesian waters are, for all purposes proper to consider at this time, simply weaker or stronger solutions of this salt. This is true to such an extent that we illustrate it by the following statement: If a gallon of brown water contains 70 grains of salts in solution, 63 grains of these 70 grains are sodic carbonate or black alkali. The presence of this salt is a fully adequate and satisfactory explanation of the fact observed by many ranchmen that artesian water is not so good for irrigating purposes as ditch, or river-water, which is a conservative statement, for many of them have observed that the brown waters are fatal to vegetation. The water from one of the wells mentioned in the preceding table flowed over some land for a few months and the owner told me that it was several years, four years I think, before he succeeded in overcoming its effects.

I have previously stated that, for our view of agricultural conditions, we can consider this black alkali, sodic carbonate, as existing in strata of this country to a depth of at least 900 feet, for we find the water of cased, artesian wells becoming richer in this salt till we gain this, approximately our greatest depth. We certainly do not need to concern ourselves about the more remote origin of the salt so far as it pertains to the agricultural questions of the section.

UNFAVORABLE CONDITIONS PREVAIL WHEREVER WATER IS ALKALINE

An important consideration in this connection is the actual soil conditions that obtain. If these contradicted the views set forth, we would certainly conclude that their presentation was worse than unwise. *It is, however, a fact that the unfavorable agricultural conditions and the alkaline character of the water are coincident in their occurrence, which is of itself very suggestive.*

SOIL SAMPLES TAKEN TO PROVE RESULT

In order to prove this question further, two series of soil samples were taken along the same lines that the water samples were taken. It is readily foreseen that soil samples taken to represent so long a stretch of land, the lines aggregating more than 30 miles, will vary greatly and it would be no matter for surprise if some of them seemed to contradict the statements made. This, fortunately, is not the case, for we find that our results agree very well with the facts as seen in the field.

In the following statement of results, I shall give the conditions of the land as of more interest than the locality and state the results in parts per million of air-dried soil.

Sodic carbonate present to the extent of 400 p.p.m. is injurious to most crops and I doubt whether any cultivated crop can endure as much as 500 p.p.m. I think that it is perfectly safe for the general reader to use these figures as guides in judging the results given in the following table:

ALKALINITY OF SOIL EXTRACTS

Condition of land or crop	Sodic Carbonate (Black Alkali) in parts per million
An old "gone-back" ranch.....	865.0
Land in bad condition, crops failed.....	375.0
Land barren for some years.....	722.0
Land barren	925.0
Barren, sandy soil.....	5103.0
Alfalfa field, stand good	144.0
Old alfalfa, stand medium.....	200.0
Alfalfa field, stand good.....	259.0
Sandy soil, alkali grass, some sweet clover.....	121.0
Diked and flooded soil.....	109.0
Sandy loam, uncultivated.....	253.0
Oats, a failure in 1916.....	609.0
Deserted land	200.0
Wholly unproductive, though under good treatment.....	510.0
Wholly unproductive and has been for many years.....	3222.0
Land just surfaced.....	200.0
Flooded 1916, planted to rye, poor stand.....	398.0
Flooded 1916, planted to rye, not much living.....	410.0
Planted to peas 1916, died	633.0

The preceding samples represent both good and bad conditions as they are found throughout this area.

Unfortunately, the problem, like most of our agricultural problems, is not a simple one, for there are several factors playing their respective parts. The one here pointed out, sodic carbonate, is, without doubt, the principal one affecting the conditions in this area, though it has not previously been pointed out, or even given serious recognition. Excessive water alone has been charged with the ruin of the land and drainage urged as its greatest need. I am among those who do not believe this.

DRAINAGE NOT THE MAIN PROBLEM

That our ordinary crops, oats, wheat, alfalfa or potatoes, cannot be successfully grown with the water-plane an inch above the surface, no one doubts, and lands that become filled with water to such an extent as this should be provided with an outlet for the excess water. This can be effected by surface drains. The practice of sub-irrigation, under which crops are grown with a water-plane maintained within 18, or even 12 inches of the surface, gave my ideas on aeration, etc., a decided shock at first. While some drainage is necessary, this is not the main problem to be solved in this section. In a great big sense, the problem has been, for a period extending back to the draining of the old lake and the building of the bed of the Rio Grande, a drainage question.

HEIGHT OF BED OF RIO GRANDE CAUSE OF EXCESS SODIC CARBONATE

I believe that the sodic carbonate owes its origin to the fact that the drainage south has been no better since the valley itself was formed than it is now and for the same reason as now. The bed of the Rio Grande has never been cut down so as to let the water north of it drain southward out of the valley. The efficiency of this simple cause to account for the concentration of sodic carbonate in this area to the extent that we find it, is impressive on a little consideration. Under this condition, the water-plane has always been high in this section of the valley. Evaporation has gone on rapidly from the surface of the land at all times. Assuming that this evaporation has been 3 feet per annum over an area of 500,000 acres, we have 1,500,000 acre-feet of water. Taking 720 acre-feet as equivalent to a flow of 1 second-foot for a year, we account for a discharge of 2,000 second-feet of water into the territory. The evaporation of 1,500,000 acre-feet of mountain water, carrying only $2\frac{1}{2}$ grains of sodic carbonate in each imperial gallon, will deposit 145,500,000 pounds of sodic carbonate, or 291 pounds on each acre which must remain within the area if there be no drainage to remove it, so there would be an accumulation of this salt just in proportion as this drainage was inadequate. In this sense the whole situation resolves itself into a drainage problem, but no one has heretofore suggested this question.

There are intelligent men in the valley who appreciate that the water, *per se*, is not the most important question that they have to deal with. Many of them have become convinced that the liberal application of water to the surface, so long as there is space enough between the water-plane and the surface of the land to let the water applied pass a few inches below the surface, ameliorates conditions materially though the water-plane has not been lowered. They know that this is only a palliative, but it enables them in some cases to establish a crop,

alfalfa for instance, which when once established may tolerate the conditions.

APPLICATION OF GYPSUM WOULD BE HELPFUL

The important question is, Can the ranchmen ameliorate these conditions? They are proving that they can by diking and washing, which, to the present time, has proven the most effective means of reclamation. A still more effective measure would be the application of land plaster, ground gypsum, which occurs very abundantly within the State. The amount of sodic carbonate in most of the surface soil, is not so abundant that the cost of the land plaster necessary to correct the alkalinity would be prohibitive; in fact, the cost ought to be very moderate. The most serious item would probably be haulage or freight owing to the location of the valley between high mountains. If, however, the use of this material should prove to be sufficiently beneficial, as I firmly believe it will, proper organization of the users can undoubtedly bring about the production and transportation of this material to the valley at a very reasonable cost. It would be greatly to the advantage of the railroad, the Denver & Rio Grande for instance, to encourage this development. I believe that the production of the land plaster ought to be a community undertaking, and also all transportation arrangements, if the most extended and beneficial results are to be obtained, for private production will look principally to private profit, whereas the amelioration of conditions in this section, to such an extent as to restore from 300,000 to 500,000 acres of land to a condition of productiveness which it formerly possessed, but which it has almost entirely lost, is a consideration worthy of the united effort of all the parties concerned.

The facts given at the beginning of this discussion, to-wit, that one large flouring mill has been torn down, that a second one has recently been dismantled, that an elevator still standing, has not been used for its legitimate purpose for years, that the towns have dwindled instead of grown, that homes have been deserted, to which remnants of fallen houses still bear witness, and the lands have been permitted to go back to the native vegetation, chico and greasewood, ought to constitute a sufficient appeal for the united and beneficial effort of the whole community. Further, the State or the Government, for the latter is still largely interested, ought to devise some effective measures for the protection of the interests of both the individual and the public against those of selfish private enterprise. Such effort and protective regulations ought to be capable of accomplishment, but it is, perhaps, useless to hope for such a consummation.

SUMMARY

The Rio Grande flows for about 60 miles through the San Luis Valley without any considerable change in the character of its waters.

The flow of the river diminishes rather than increases in its passage through the valley.

There are only a few streams having a visible discharge into the Rio Grande.

The drainage is practically out of the Rio Grande into the valley, instead of out of the valley into the Rio Grande.

The ground-waters of the valley retain the characters of the mountain waters in a noteworthy degree.

The ground-waters, though retaining some of the features of mountain waters, have their own characteristics which are pronounced enough to affect those of the Rio Grande water if any significant volume of them is mingled with it.

The alkalis, i. e., salts that collect in the surface portions of the soil or appear as efflorescences, are of three types which are not further discussed.

These types are:

Plain sulfates, soda and lime being the predominant bases. This type is the predominant one.

Sulfates and chlorids. This type is not abundant though it is well distributed.

A type in which sulfates and carbonates occur. The occurrence of this type is for the most part confined to the area north of the Rio Grande.

Solutions of these alkalis do not find their way into the Rio Grande in sufficient quantities to noticeably modify the composition of its water.

The valley is an exceedingly large artesian basin, but the waters are of two characters. Those of the southern portion and the rim of the basin are white and carry an excess of acids. Silicic is especially high, while those of the northern interior portion of the basin are alkaline and usually brownish or brown in color.

The white artesian waters, especially those flowing from shallow wells, from 75 to 300 or even more feet, are very similar to river or mountain water and would simply increase the volume and would not change the character of the river-water if they mingled with it.

The brown water is free from silicic acid and contains so good as no salts except sodic carbonate.

This character of the brown waters is the same for all flows from the shallowest to the deepest examined, 880 feet.

The deeper flows increase in the amount of salts held in solution without any change in their character.

This increase was from 22 grains to 108 grains in each imperial gallon.

These waters would change the character of the river water if they mingled with it, which they appear not to do.

The brown color is accidental and is due to peaty material dissolved out of the aquifers themselves. The presence of fragments of wood obtained in sinking the wells and the deportment of these waters when submitted to sanitary analysis is taken as proof of the peaty nature of the color.

The presence of peaty substances and wood in this area is interpreted as indicating that this portion of the valley was, in former times, low land and probably marshy, i. e., poorly drained.

The sodic carbonate is considered as originally coming from the mineral constituents of the rocks furnishing the sands and clays that form the strata now composing the floor of the valley.

The changes necessary to remove the silicic acid and lime from the mountain waters are simple. The small concretions of calcic carbonate met with in the sand from the strata passed through at 550 feet indicate simple precipitation as the method of removing the lime.

As the drainage of this portion of the valley has probably been just what it is now for the whole period of the existence of the valley with but little or no change in its water supply, evaporation alone is considered adequate to account for the concentration of the sodic carbonate that we find in this section.

Evaporation at the present time is sufficient to add 145,500,000 pounds of sodic carbonate to this section of the valley yearly. This is on the supposition that the mountain water carries $2\frac{1}{2}$ grains of sodic carbonate in each imperial gallon, or 10 pounds of water evaporated.

The present agricultural condition of this section of the valley is due to the accumulation of this salt, black alkali, rather than to an excess of water.

Local surface drainage is necessary in many small localities.

The evaporation from the area involved is equivalent to an inflow of 2,000 second-feet throughout the year. This is probably a larger amount than this section of the valley actually receives, except for a very short period in the spring of the year when the direct overland inflow may equal or possibly exceed this amount.

The San Luis Lake water is peculiar in its composition and unlike either the river- ground- or artesian-waters.

The deposit of sodic carbonate east of the San Luis Lake is probably derived from the evaporation of the brown artesian water, and has no connection with the lake.

The conditions which have determined the character of the brown artesian waters are still active in determining the agricultural features and questions of this section of the valley.

The question of black alkali in this section is in places further involved by the occurrence of nitrates.

The conditions which obtain and are inimical to vegetation can be ameliorated by rational irrigation, chemical treatment of the soil and surface drainage where needed.

INDEX

Agricultural features of the question.....	43
Alkalis—	
Unfavorable conditions prevail wherever water is alkaline.....	54
south and west of river.....	14
Unproductiveness due to some cause other than alkalis.....	47
White alkalis not injurious to crops.....	46
Analyses—(See Index to Tables)	62
Application of gypsum would be helpful.....	57
Artesian waters—	
artesian waters, the	29
Analyses of white artesian waters.....	30
Brown artesian waters	35
Spring-waters	31
White artesian waters and spring-waters would not affect river- water	32
Carbonates, origin of the.....	37
Changes in waters of eastern slope.....	3
Drainage not the main problem.....	56
Greasewood (<i>sarcobatus</i>)—	
indicates presence of sodic carbonate.....	45
relation to sodic carbonate content of soil.....	27
Ground-water, south and west of river.....	14
Gypsum, application of would be helpful.....	57
Hydrological facts, a review of.....	51
Return water, none flows into river.....	12
Review of hydrological facts	51
Rio Grande river, height of bed cause of excess sodic carbonate.....	56
Rio Grande water—	
analyses of	8
Analyses seem to indicate no return water flows into river.....	12
Excess water, what becomes of?	34
Facts indicate that river loses in volume and maintains character of mountain stream	33
No return water flows into river.....	12
River only discharge but not only source.....	34
White artesian and spring waters would not affect.....	32
San Luis Valley—	
Bed of river higher than valley.....	7
conditions exceptional	6
San Luis Lake water	39
Sodic carbonate—	
greasewood indicates presence of.....	45
Height of bed of Rio Grande cause of excess sodic carbonate.....	56
large amounts of poured onto lands by wells.....	38
origin of	37
production of from felspars.....	28
Relation of greasewood to sodic carbonate content of soil.....	27
Soil samples taken to prove result.....	55
Spring-waters	31
Sub-irrigation has caused water-logging.....	43
Summary	58
Unfavorable conditions prevail wherever water is alkaline.....	54
Unproductiveness due to some cause other than alkalis.....	47
Waters of valley, including surface-, ground-, and drain-waters, differ from waters of Rio Grande.....	26
Water-logging, subirrigation has caused.....	43
White alkalis not injurious to crops.....	46

INDEX TO TABLES GIVING ANALYSES

Artesian Waters, alkalinity of.....	53
Alkalis—	
Alkalinity of artesian waters.....	53
Alkalinity of soil extracts.....	55
drainage ditch, Parma	18
from a desert claim	48
from uncultivated land (sample taken near Parma).....	20
from uncultivated land at Hooper (greasewood (sarcobatus) abundant)	25
NE ¼ sec. 14, T. 38 N., R. 8 E. Parma Land Co.....	17
sample taken just inside Parma Land Company's gate.....	16
SE ¼ sec. 23, T. 38 N., R. 8 E.....	18
two samples of effloresced alkalis collected 4 miles south and 5 miles west of Hooper	24
Brown artesian waters—	
analyses of residues from, Hooper.....	35
analyses of residues from, Hooper mill well.....	36
analyses of residues from, Mosca mill well.....	36
analyses of residues from, Mosca town well.....	36
Drain-water—	
Parma Land Company ditch.....	16
SW ¼ sec 24, T. 40 N., R. 8 E.....	23
Ground-water—	
Dibbers, Mosca	24
Mosca	23
SE ¼ sec. 23, T. 38 N., R. 8 E.....	15
SW ¼ sec. 24, T. 40 N., R 8 E.....	22
Lake-water—	
analyses of residues from, San Luis Lake.....	40
temporary lake, (run-off water).....	23
River-water—	
Arkansas River	5
Cache La Poudre River	4
Rio Grande River—	
sample taken at Alamosa.....	10
sample taken at Del Norte.....	9
sample taken at Monte Vista.....	10
sample taken at State Bridge.....	11
samples taken at Stewart's place.....	11
samples taken above mouth of Willow Creek.....	8
Soil—	
Alkalinity of soil extracts.....	55
sample taken at Hooper (dried at 100° C.).....	26
soil 7 inches deep, subsoil 10 inches (dried at 100° C.).....	19
water-soluble in two samples from La Jara.....	21
water-soluble portion from sample from uncultivated land at Hooper (greasewood (sarcobatus) abundant)	25
White artesian waters—	
sample taken from Bucher well, Alamosa.....	30
sample taken from well at Electric light plant, Alamosa.....	30

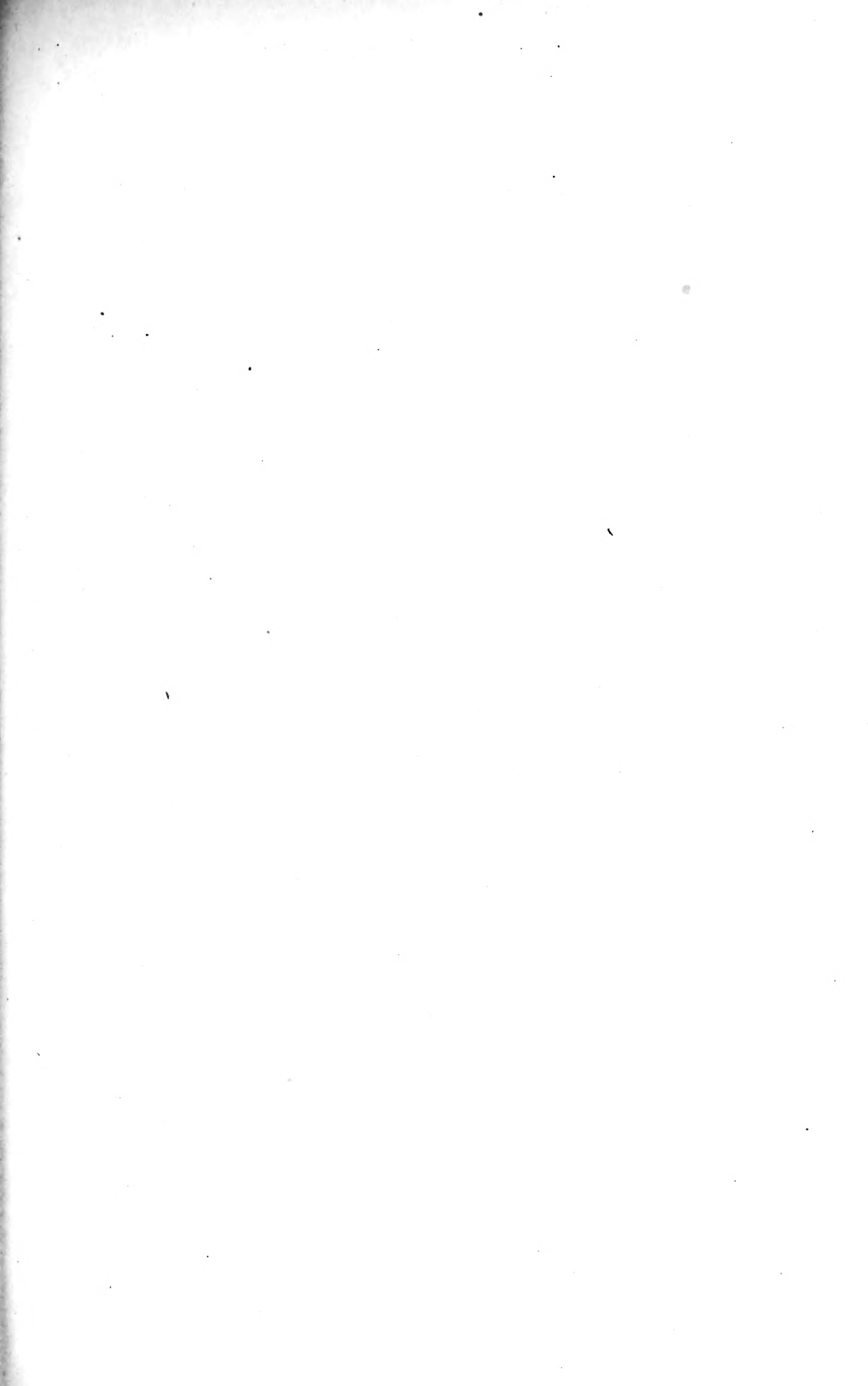

Library
College of Agriculture
University of Illinois

Library
College of Agriculture
University of Illinois
Bulletin 231

October, 1917

The Agricultural Experiment Station
OF THE
Colorado Agricultural College

“BLACK ALKALI” IN THE SAN LUIS
VALLEY

By
WM. P. HEADDEN



PUBLISHED BY THE EXPERIMENT STATION
FORT COLLINS, COLORADO
1917

The Colorado Agricultural College

FORT COLLINS, COLORADO

THE STATE BOARD OF AGRICULTURE

	Term Expires
HON. CHAS. PEARSON.....Durango,	1919
HON. R. W. CORWIN.....Pueblo,	1919
HON. A. A. EDWARDS.....Fort Collins,	1921
MRS. J. B. BELFORD.....Denver,	1921
HON. H. D. PARKER.....Greeley,	1923
MRS. AGNES L. RIDDLE.....Denver,	1923
HON. J. C. BELL.....Montrose,	1925
HON. E. M. AMMONS.....Denver,	1925

PRESIDENT CHAS. A. LORY,
GOVERNOR JULIUS C. GUNTER, } *Ex-Officio*

L. M. TAYLOR, Secretary

CHAS. H. SHELDON, Treasurer

EXECUTIVE COMMITTEE

A. A. EDWARDS, *Chairman*

E. M. AMMONS

H. D. PARKER

OFFICERS OF THE EXPERIMENT STATION

CHAS. A. LORY, M.S., LL.D., D.Sc.....	<i>President</i>
C. P. GILLETTE, M.S., D.Sc.....	<i>Director</i>
L. M. TAYLOR.....	<i>Secretary</i>
MABEL LEWIS.....	<i>Executive Clerk</i>

STATION STAFF

C. P. GILLETTE, M.S., D.Sc., <i>Director</i>	ENTOMOLOGIST
W. P. HEADDEN, A.M., Ph.D.....	CHEMIST
G. H. GLOVER, M.S., D.V.M.....	VETERINARIAN
W. G. SACKETT, B.S.....	BACTERIOLOGIST
ALVIN KEZER, A.M.....	AGRONOMIST
E. P. SANDSTEN, M.S., Ph.D.....	HORTICULTURIST
B. O. LONGYEAR, B.S.....	ASSISTANT FORESTER
G. E. MORTON, B.S.A., M.S.....	ANIMAL HUSBANDMAN
E. B. HOUSE, B.S. (E.E.), M.S.....	IRRIGATION ENGINEER
V. M. CONE, B.S., C.E., <i>U. S. Irrigation Engineer</i>	IRRIGATION INVESTIGATIONS
W. P. LITTLE, B.S., <i>U. S. Expert-in-charge</i>	HORSE BREEDING
R. E. TRIMBLE, B.S.....	ASSISTANT IRRIGATION INVESTIGATIONS
P. K. BLINN, B.S., ROCKY FORD.....	ALFALFA INVESTIGATIONS
EARL DOUGLASS, M.S.....	ASSISTANT CHEMIST
S. ARTHUR JOHNSON, M.S.....	ASSISTANT ENTOMOLOGIST
L. C. BRAGG.....	ASSISTANT IN ENTOMOLOGY
J. W. ADAMS, B.S., CHEYENNE WELLS.....	AGRONOMY ASSISTANT, DRY FARMING
W. W. ROBBINS, M.A.....	BOTANIST
RALPH L. PARSHALL, B.S.....	ASSISTANT IRRIGATION INVESTIGATIONS
I. E. NEWSOM, B.S., D.V.S.....	VETERINARY PATHOLOGIST
MIRIAM A. PALMER, M.A.....	DELINBATOR
R. A. MCGINTY, B.S.....	ASSISTANT IN HORTICULTURE
CHAS. R. JONES, B.S.....	ASSISTANT IN ENTOMOLOGY
GEO. M. LIST, B.S.....	ASSISTANT IN ENTOMOLOGY
JAS. D. BELL, B.S.....	ASSISTANT IRRIGATION INVESTIGATIONS
CARL ROHWER, B.S., C.E.....	ASSISTANT IRRIGATION INVESTIGATIONS
BREEZE BOYACK, B.A., M.S.....	ASSISTANT IN AGRONOMY
CHAS. I. BRAY, B.S.A., M.S.....	ASSISTANT ANIMAL HUSBANDRY
RALPH L. CROSMAN.....	EDITOR
H. E. VASEY, A.M.....	ASSISTANT BOTANIST
W. H. KERR, A.B., J.D.....	MARKETS AND MARKETING
T. E. LEIPER, B.S.....	ASSISTANT ANIMAL HUSBANDMAN

“BLACK ALKALI” IN THE SAN LUIS VALLEY

By

WM. P. HEADDEN

Bulletin No. 230 of this station, entitled “Rio Grande Waters”, gives as full a statement of the water conditions peculiar to the San Luis Valley as we are able to present. The work on this feature of the valley has extended over a number of years. There are a great many features of the subject which are not of special interest to the general farmer or even to those interested in the lands of this valley, while there are others of vital importance to the ranchman, but of less interest from other points of view.

AGRICULTURE OF VALLEY RETARDED FOR A NUMBER OF YEARS

It is known to everyone acquainted with the irrigation of the valley since the early nineties, that at one time the section of the valley about Mosca and Hooper was a most remarkable wheat producing country. Mosca, for instance, was a thriving town with a large flouring mill, an elevator and a flourishing business. This prosperity passed a number of years ago; the elevator is unused, the mill was torn down, and, if I am rightly informed, a part of the machinery was taken out of the valley and the rest of it used in building the mills at Alamosa and La Jara. The mill at Hooper has only recently been dismantled as a flouring mill. As wheat growing was the biggest interest of this section, the milling industry may be assumed to present faithfully the course of the farming industry. Stock-raising, sheep, hogs and cattle, has enabled some to continue operations with some success, but as a general statement, the condition of this section of the valley has been deplorable for the past 10 or 15 years.

The towns of Mosca and Hooper are mentioned because they were the centers of this former prosperity, which was participated in by a large section of country.

The area now mostly unproductive is from 400,000 to 500,000 acres. The cause usually assigned for this condition is seepage.

SUB-IRRIGATION HAS CAUSED SEEPED LANDS

The system of irrigation used in the past was undoubtedly unfortunate and the practice of the people in applying it was in many cases unwise. I am credibly informed that, in some in-

stances, in the application of sub-irrigation, the water-plane is raised to within 12 inches of the surface, while in the most conservative cases the aim is to raise it within 22 inches. It is not our intention to consider the conditions under which these results may be obtained or to discuss methods of irrigation, but simply to present the facts. One result has been the seeping of that section of the valley lying to the north of the Rio Grande and east of Center. This fact has called into existence the Gibson and Sylvester ditches for the purpose of drainage. The conviction is very general that drainage will remedy conditions in this section of the valley. It does not matter whether this conviction is wholly or only partially correct, it establishes the prevalence of this seeped condition.

SOIL IS NOT EXHAUSTED

Another cause of failure might be exhaustion of the soil. This probably plays only a small part, if any, in the present unfavorable condition of this section. How unfavorable this general condition is, is not appreciated by any except those who have an intimate knowledge of the country. The practice of the ranchmen in farming this land may have been bad, but exhaustion of the soil is not at all a contributing factor.

An ordinary agricultural analysis of a soil from Hooper gave the following results:

ANALYSIS OF SOIL, HOOPER, COLORADO

	Percent
Sand*	62.241
Soluble silica	15.229
Sulfuric acid	0.363
Phosphoric acid	0.320
Carbonic acid	2.629
Chlorin	0.081
Lime (calcic oxid).....	4.295
Magnesia	1.595
Potash	1.383
Soda	1.326
Ferric oxid	3.930
Aluminic oxid	4.259
Manganic oxid (br.).....	0.175
Ignition	2.260
Sum	100.085
Oxygen equal to chlorin.....	0.018
Total	100.067

* This sand consists of particles of igneous and other rocks rich in felspar and has, comparatively, a small amount of quartz particles.

This soil is quite typical of by far the larger part of the soils found in the valley and, so far as this kind of an analysis is reliable as an indication of the supply of plant food, the soil is excellent

in regard to its content of phosphoric acid and potash. The nitrogen is not given in this analysis, but judging from the amount of this element found in other samples, it is probably about 0.10 of 1 percent. The question of exhaustion of this soil, even if we assume that the addition of nitrogen would be advisable, can be dismissed as the cause of the unproductiveness of this large section of the country.

"WHITE ALKALI" IS NOT INJURIOUS

Another cause often assigned for an unproductive condition of our lands is "white alkali". That there is alkali in this, as well as in other sections of the valley, is thoroughly well known. There is more evidence of this class of alkalis outside this section than within it.

It is natural that, when a section of country measured in square miles is covered by a white efflorescence, perhaps literally as white as snow, that it should make an impression upon one as an important factor in any unproductiveness of the land which may be observed. That this has been the case and has been passed on from one to another and from one section of country to another from the beginning of our agriculture till the present time is true, and it is unfortunate that it is true, for, whatever the results of laboratory experiments may be, I have yet to see the proof that these "white alkalis" constitute any seriously unfavorable factor in our field practice. When something is wrong, many of us, especially if we have not learned that it is no disgrace to acknowledge that we do not know everything, attempt to give a reason for the condition, whether it has anything to do with the question or not. In this way our ordinary "alkali" has been assigned as the cause of much evil.

I do not intend to go into this question here, but I may state that the alkali question is more complex than the average person imagines and includes much more than the white efflorescences so abundant, especially at times during the spring months, in some sections of the valley. This white efflorescence, our ordinary "white alkali", as it occurs west and south of Alamosa, or very generally throughout the valley, is essentially sodic sulfate, often mixed with calcic sulfate. I do not believe that these salts occur in these soils in sufficient quantities to cause any damage. The general reader should be reminded that these salts, as he sees them on the surface of the country, are what is left from the evaporation of large amounts of water which have brought them to the surface of the soil and left them there in the form of a very strikingly white powder whose quantity in the soil he greatly

over-estimates. More especially has he been led to over-estimate the injurious effects of these salts. I remember the impression made upon me by the whiteness of the country west of Alamosa during a trip in the spring of 1914. For more than two miles the surface of the ground on both sides of the road was perfectly white and this condition extended, especially to the southward, as far as one could see. I measured this efflorescence at some points and found it attaining a thickness of one-quarter of an inch or rather more. I took a sample of this, analyzed it, and found it to contain more than 91.0 percent of sodic sulfate. It is not a matter that should cause surprise that such a condition should impress one as very bad indeed, but I do not believe that it is a fact that it is very bad.

Some years ago I took some samples of soils at La Jara. Among them there were two from a field planted to peas; the stand was irregular but the peas were thrifty. These two samples represented 6 inches of soil, the top 2 inches and the succeeding 4 inches. The top 2 inches carried 3.0 percent of salts soluble in water; the next 4 inches 1.5 percent. Of these salts, 65 and 46 percent respectively were sodic sulfate, the rest, essentially, calcic sulfate. The peas undoubtedly had pushed their roots to a greater depth than 6 inches, but they had passed through this 6 inches and they were thrifty. I have seen just as marked instances in the eastern part of Alamosa, where a good lawn and garden were separated from land heavily charged with this "white alkali" by an ordinary picket fence. In this case the effloresced alkali contained 96 percent of sodic sulfate. These are only a few instances of this character that I have met with which lead me to believe that ordinary, so-called white alkalis are of themselves not sufficiently injurious to justify their consideration in this connection.

"BLACK ALKALI" POISONOUS TO PLANTS

There is a so-called "black alkali", which consists essentially of sodic carbonate, whereas the "white alkali" consists essentially of sulfates. The "white alkali" does not discolor the land; the "black alkali", when the soil contains much organic matter, gives rise to very dark, almost black, solutions and crusts, for which reason it is called "black alkali". The alkali itself is not black, it is white, just as white as the so-called white alkali, but it dissolves organic matter (humus) with a brown or black color. This alkali is so corrosive that it will destroy the tissues of young plants and even of older ones, and, of course, may kill them. Another effect of sodic carbonate, "black alkali", is to make the ground puddle and cake so

that when it is plowed it breaks up in hard cakes or lumps. This effect is so marked on some soils that the carbonate formed, due to the application of Chile saltpetre, cakes the ground so badly that anyone can tell just where the saltpetre was applied. This was so noticeable in a field in which I had made some fertilizer experiments that the plowman who was sent to do the fall plowing picked out of the 48 plots into which the field was divided, the 12 plots to which the Chile saltpetre had been added. The smallest amount added was 62.5 pounds to one million pounds of the soil. This would give rise to about 75 pounds of carbonate to each million pounds of soil, provided the largest possible amount of carbonate was formed, and yet this actually sufficed to puddle and cake the land to the extent that I have indicated. This amount expressed in percentage is seventy-five ten thousandths of 1 percent. This amount is very much less than is necessary to injure plants by directly eating off the roots or to poison them. The amount necessary to do this is from four to five one hundredths of 1 percent, or from 400 to 500 pounds in each million pounds of soil. This "black alkali" is really very poisonous to plants and its effect on the physical or mechanical condition of the soil is very bad.

NITRATES DESTRUCTIVE IF PRESENT IN SUFFICIENT QUANTITIES

There are still other salts that occur in our soils of which we must take some note, for they may easily become so abundant as to be injurious, or even to be fatal, to all vegetation. In bulletins Nos. 155, 160, 178, 183 and 186 of this Station I have described in some detail, the occurrence of these salts, nitrates, in some of our Colorado soils in such quantities as to kill vegetation, even old, well established apple trees. One of the very first occurrences of this sort that I recognized was in the San Luis Valley. The occurrence of these salts may have two effects. A small amount of them, 10 to 20 parts to a million parts of the soil, may produce big crops of oats or other farm products, whereas, too much of them will burn and kill the crop. At this time I wish only to call attention to the fact that this question exists in the agriculture of the San Luis Valley. I may state that I saw in Rio Grande County in the season of 1916, a quarter section that had been planted to peas, on which no peas were grown. The grasshoppers were blamed for the destruction of the crop, but no grasshoppers were to be found on the quarter section. Nitrates, however, were present in this soil in fatal quantities. These statements are made simply to impress upon the minds of interested parties that there

are real, serious questions pertaining to the agriculture of the San Luis Valley besides the question of seepage.

There are still other salts whose occurrence is most remarkable, but they need not be so much as mentioned in this place.

HIGH WATER-PLANE NOT THE CAUSE OF CROP TROUBLES

The people of this valley themselves are not all satisfied that the benefits claimed for drainage have been realized or are attainable. That the presence of a high water-plane alone has, in fact, done the harm to the 400,000 or 500,000 acres of land included in the Moffat-Hooper-Mosca section is claimed by some. The view that I take is that this is not so. The water-plane is certainly too high in many places in this section, but in others, it is low enough for the production, under other conditions, of good crops, whereas this land produces nothing. In the practice of sub-irrigation, the water-plane is intentionally raised to within 22 inches, and even as near as 12 inches, of the surface, with no detrimental results; at least, this is the information that I have received. Doubting some of the information, I have made inquiry concerning the parties giving it, and concerning the facts; they seem to be reliable.

Agronomists may doubt that good crops of alfalfa may be grown year after year on land in which the water-plane is held within 12 inches of the surface throughout the growing season. It seemed to me remarkable but, after what I have seen and learned from some of these people, I feel compelled to accept their statements. I have presented these facts of farm practice because of their suggestiveness in connection with the claims made—that it is because of the waterlogged condition of the Hooper-Mosca section that it will not only not produce as in former years, but almost not at all. I have refrained from writing of these facts for ten years or more, but the bad condition of this section is now so well known to everyone that there is no good reason why one should not write frankly about it.

There is no question but that water has been used unwisely and that sub-irrigation is not the best practice for this valley, nor is there any question but that there should be drainage enough to take the water off the surface of the ground. There is, further, no question but that some bad results would be experienced in changing from the system of sub-irrigation to irrigating by furrows and flooding, but we have the following facts:

Good crops, even excellent crops, are raised by sub-irrigating, whereby a higher water-plane is maintained than exists in parts of the valley which are now practically wholly unproductive. If

in the same country a high water-plane during the cropping season produces good results, why should we attribute the unproductiveness of other parts of the same country to a water-plane no higher, or to one that is even lower? So far as the variability in the height of this water-plane is concerned, there is not much room for movement, in the case stated, from 42 inches below the surface in the winter to 12 inches in the cropping season. The permanent water-plane in the unproductive section lies within these limits, at about 36 or 37 inches, according to my personal observations.

I do not think that any practical farmer will deny that the practical results obtained by the expenditure of considerable sums of money on drainage ditches have been disappointingly small. These experiments with drainage ditches have been made on a sufficient scale and length of time to justify a very good judgment of how much is to be hoped for from these alone and, as said, the results are disappointingly small.

ABUNDANT “WHITE ALKALI” OF VALLEY NOT A SERIOUS PROBLEM

Another fact is that the ordinary “white alkali” which occurs abundantly in the valley is not a serious problem, though it has been made to appear such. I am not alone in this view of the question and know that many practical men are fully convinced of this.

I shall not discuss the question of the occurrence of some chlorides in this valley at this time. The nitrate question is really of some importance and the occurrence of certain chlorides in this fresh water valley is an interesting problem, but they do not constitute the big important fact that I want to present in this bulletin.

“BLACK ALKALI” PRESENT IN DETRIMENTAL QUANTITIES

This fact is that, while the total amount of alkali in the soil of the Hooper-Mosca section is comparatively moderate, the character of this alkali is very bad. There is present, in most of the land, sodic carbonate, “black alkali”, enough to be detrimental, if not fatal, to any crop that may be planted. The best information at my disposal indicates that the presence of 400 parts of sodic carbonate to the million parts of soil is injurious, or possibly fatal, while it is probable that few, if any, crops can survive in the presence of as much as 500 parts to the million. The amount of alkali in this land is generally taken at something like 1,000 to 1,200 parts to the million. This amount of “white alkali” would not be in the least dangerous, but if one-half of it were “black alkali”, very serious trouble would ensue. In fact, the land would be ruined for all practical purposes.

In order to ascertain how generally the carbonate of soda may be distributed throughout this district, I took two sets of samples, beginning in the first case a little south of McGinty and continuing to Hooper, and in the second case a little east of Center and continuing to Hooper, but to make the two series continuous, I shall give the results from Hooper to Center.

SODIC CARBONATE IN SOME SAN LUIS VALLEY SOILS IN PARTS PER MILLION

	Black Alkali in Parts Per Million
An old, gone-back ranch.....	865.0
Land in bad condition, crops failed.....	375.0
Land barren for some years.....	722.0
Land barren	925.0
Land barren, soil sandy.....	5103.0
Alfalfa field, stand good.....	144.0
Alfalfa field, stand medium, old.....	200.0
Alfalfa field, stand good.....	259.0
Sandy soil, alkali grass, some sweet clover.....	121.0
Diked and flooded soil.....	109.0
Sandy loam, uncultivated.....	253.0
Oats, a failure.....	609.0
Deserted land	200.0
Wholly unproductive land, treatment excellent.....	510.0
Wholly unproductive for many years.....	3222.0
Land just surfaced.....	200.0
Land flooded 1916 rye poor.....	398.0
Land flooded 1916, rye, only a little living.....	410.0
Land planted to peas; peas did not live.....	633.0

These samples represent flooded, cultivated and uncultivated lands and there is not one of them that does not contain notable quantities of this very objectionable salt. We see that flooded land planted to rye and containing 398 and 410 parts of "black alkali" to the million of the soil produced nothing. Further, that no single sample taken was free from this salt, even though some of it had just been flooded in the manner that is now frequently practiced in this section. The people, at least some of them, realize that this method, as practiced, is not a perfect success (see the two fields of rye), but they know that it is the best way yet adopted to handle this land.

If we can discover the source and supply of this carbonate, it will help us to form some clear notion of our chances of correcting the evil. It will help us to form an idea of how much we may hope to accomplish.

"Black Alkali" Comes from Waters of Valley

The source of this carbonate is the water of the valley. The artesian water at La Jara, obtained at 65 to 70 feet, is good water, and that obtained at Alamosa, at a depth of 923 feet, is also good water. This is not the case with the town well or the mill well at

Mosca, nor with the mill well or the railroad well, or the town well at Hooper. These waters are brown, strongly alkaline and contain sulfur; they even smell of it. The older residents of the section well remember that there was a well near the present railroad station of McGinty that was called the soda well, because, so it was said, they could use this water instead of baking powder for making light bread. I never believed this story, but it shows that the water was remarkable and that the citizens were resourceful in presenting the advantages of the country. This well is now closed.

The presence of gas in this district is, in some instances, abundant enough to furnish light and fuel for the houses of the owners.

The conditions that cause the waters to be brown and to carry sodic carbonate in such easily recognizable quantities have produced the difficulties that threatened the district from the beginning and which the practice of sub-irrigation has made real.

All of the ground waters that I have examined from Center east to Hooper and from Hooper, I may add from Moffat, south to below McGinty, carry sodic carbonate in solution. In the case of the brown waters, there is present in the strata from which the waters come, enough humus which is soluble in sodic carbonate, to impart the brown color. Some of the wells near the edge of this area, especially shallow wells, carry sodic carbonate, though they are only slightly or not at all colored. The characteristic of our mountain waters is that they carry only a small amount of substances in solution, and these substances are silicic acid, the carbonate of lime, and the carbonate of soda. The silicic acid and the carbonate of lime can be removed easily, but not the carbonate of soda. This salt is not removed to any great extent when its solution passes through the soil, nor is it thrown out of solution by any agent or by the evaporation of its solution as the lime may be by the escape of carbonic acid on exposure to the air.

The artesian waters along and south of the Rio Grande are excellent waters for all domestic purposes; they carry carbonate of soda with the carbonate of lime and silica just as the waters of the mountain streams do and in only slightly greater quantities. This is not true of the brown waters, for they carry almost nothing besides the sodic carbonate and they carry a great deal of this salt. The mill well at Mosca, for instance, carries $1\frac{1}{2}$ pounds of sodic carbonate in every 1,000 pounds of water and only 1-10 of a pound of all other solids taken together. A barrel of this water weighs a trifle over 300 pounds and this well will furnish a great many barrels in an hour.

A few results stated in parts to the million will serve to show how generally and abundantly this salt occurs in these brown artesian waters.

SODIC CARBONATE IN SOME ARTESIAN WATERS

	Parts Per Million
Rio Grande water.....	14.1
Bucher Well, 923 feet deep Alamosa.....	68.0
Well near McGinty, shallow.....	371.0
Well north of McGinty, deep.....	1229.0
Well at Mosca, shallow, 1st flow.....	318.0
Well at Mosca, 780 feet deep.....	1388.0
Well between Hooper and Center, 375 feet deep.....	79.2
Well between Hooper and Center, 739 feet deep.....	477.0
Well at Hooper, 1st flow.....	371.0
Well at Hooper, 780 feet deep.....	1446.9
Well near McGinty, 15 feet deep.....	236.0
Sylvester drainage ditch.....	228.0

The water of the Gibson drainage ditch is not rich in total solids and carries but little sodic carbonate. Alkali from a claim, Harper I think was the claimant's name, was rich in sodic carbonate, as was also an incrustation taken from near the ditch.

These data are enough to show how rich these brown waters and all others in this section are in sodic carbonate compared with the Rio Grande water or with the deep artesian water at Alamosa.

Brown Water Kills Vegetation Because It Contains "Black Alkali"

These results show that even the drain-water and that of shallow wells is rich in sodic carbonate. This sodic carbonate does not make the water unpleasant to drink, on the contrary, waters carrying only a moderate amount of it are pleasant waters; for instance, the waters from the first flow at either Mosca or Hooper which carry less than 400 parts per million are agreeable, though they taste slightly of sulfur. The water from the 15-foot well near McGinty is very pleasant to drink, though it carries 236 parts of sodic carbonate to the million. It is a very different matter when these waters are applied to the surface of the ground or to crops and allowed to evaporate to dryness or the solution to become concentrated. When this happens, the crops will not grow and the land becomes hard and difficult to handle. Such land does not necessarily show any other signs of its bad condition. This is the explanation for the fact that this brown water is not good for irrigating purposes. This is the reason for its killing vegetation.

I saw a meadow north of Blanca, and about east of McGinty, to which some of this brown water had been applied. The vegetation had been killed, whether it was blue-stem or sedges. The

water was not good for it. This explains, too, the statements made to me by a party who had taken up a desert claim, that, "the more water I used, the worse I was off". He claimed to have raised good crops the first year or so, but that subsequently he could raise nothing. I gathered two samples of alkali at this man's place and found that one of them carried 40 percent and the other 15 percent of sodic carbonate, or "black alkali". This man had come to the conclusion that he could raise nothing on this land. He hoped only to use it for grazing purposes. His judgment was good, for it was based on experience; he had tried to grow grain and alfalfa and they would not grow. The land contained enough sodic carbonate to kill these plants. Some of the artesian water that he obtained on this place was good for domestic purposes.

The presence of sodic carbonate explains the experience of another man who stated that water flowing from a well had spread out over a strip of ground and continued to do so for several months, and after this nothing would grow on this land. This took place several years ago and the land has not yet recovered.

The brown artesian water is bad and the testimony of users of water in the valley is that they prefer river-water to artesian for irrigating their crops. The brown artesian waters have not been used for irrigating but they, as well as the water from the shallow well and that from the drainage ditch, show that this "black alkali" is in the soil and, more than this, that it is in all of this section of the valley down to a depth of 780 feet at least. The greater the depth from which the water comes the richer it is in "black alkali". (See preceding analyses.)

SUB-IRRIGATION, EVEN WITH RIVER-WATER, BRINGS "BLACK ALKALI" TO THE SURFACE BY CAPILLARITY AND EVAPORATION

The system of irrigation generally practiced is sub-irrigation, in which the water-plane is brought within a few inches of the surface, from 22 to 12 inches. River-water is used for this purpose but it effects the bringing of this "black alkali" to the surface by capillarity and evaporation. The fact that it is possible to maintain the level of the water so near the surface shows that for some reason or other the water does not run down through the soil to any great depth, but is held near the surface, either because the lower part of the soil is so full of water that the irrigating water applied simply lies on top of the previous water-table, or that the lower portion of the soil won't let the water run through. The fact is that, in this portion of the valley, the water-plane is generally high; I found it 36 or 37 inches below the surface, but it can be

found at a less depth in other places. This ground-water carries about 260 parts of "black alkali" to the million parts of water. It mixes with the river-water added in sub-irrigating the land and brings the "black alkali" with it. This went on for a number of years till the land became so rich in "black alkali" that crops were no longer successfully raised and this is the condition today throughout this section of some 400,000 or 500,000 acres. Most of the people of the valley still think that sub-irrigation is a good system. A few are convinced that it is not.

CONDITIONS CAN BE CORRECTED

The important questions for the valley are, Can this condition be corrected? and, Is it feasible to correct it?

I answer "Yes" to both questions, but there are difficulties in the way.

The conditions are very bad. There is no hope of removing, in any way, the great reserve supply of sodic carbonate as indicated by the richness of the artesian waters in this "black alkali". This section of the valley is full of this water, and the deeper we go the richer is the water in "black alkali". The more of this water we bring to the surface or allow to leak into the upper strata out of uncased wells, the worse we are off. No man can tell how long it has taken to bring about these conditions, but they have already existed from the very early history of the valley and, so far as we are concerned, they are as permanent as the mountains inclosing the valley. The water has probably never run out of this section of the valley and the deep artesian waters never will, if we measure time in terms of human lives.

We do not care how these conditions have come into existence, the question is, To what extent can we modify them? Can we modify the surface portion of this land so that we can raise crops?

GYPSUM WILL CONVERT "BLACK ALKALI" -INTO HARMLESS "WHITE ALKALI"

It is well known that gypsum, sulfate of lime, will convert this "black alkali" into "white alkali", which is so good as harmless compared with the black. By the application of this gypsum we can mitigate the evil, but this will be a difficult problem if we continue the practice of sub-irrigation which brings the "black alkali" up; it will be necessary to change the system and wash the "black alkali" with the gypsum down. The people have found out that, at the present time, about the only thing they can do to make any headway against the present conditions is to dike and flood the land. There is usually space enough between the permanent water-plane and the surface to permit them to better the

conditions in this way by carrying the "black alkali" into the deeper portions of the land, but they do not destroy it or even permanently remove it. The addition of a sufficient amount of gypsum, theoretically, $1\frac{3}{4}$ pounds for every pound of "black alkali" in the soil, practically about 9 pounds of gypsum to one of "black alkali", will change it into "white alkali" and then the land will not get hard for 4 inches on the surface and the crops will grow again. The application of the water must be to the surface by means of furrows or by flooding.

A very important consideration is, How can the gypsum be obtained? It would have to be brought in, as this mineral does not occur in the valley. At the present time, freight rates are prohibitive. The net cost to me of 6 tons of ground gypsum at Portland was \$24.00, the freight to Center was \$48.00. The cost of this gypsum was too high and the freight was much worse.

While gypsum does not occur in the valley, it is usually very abundant between the first line of hogbacks, the Dakota sandstones, and the east flank of the Front Range. It usually outcrops and its quarrying is easy. The quarrying, transportation and grinding ought to be a community matter if this section of the valley is to be reclaimed. These things must be done on small profits.

Some drainage is necessary to reclaim portions of this land, but how much benefit is to be expected from large systems, aiming to drain the whole section is an open question.

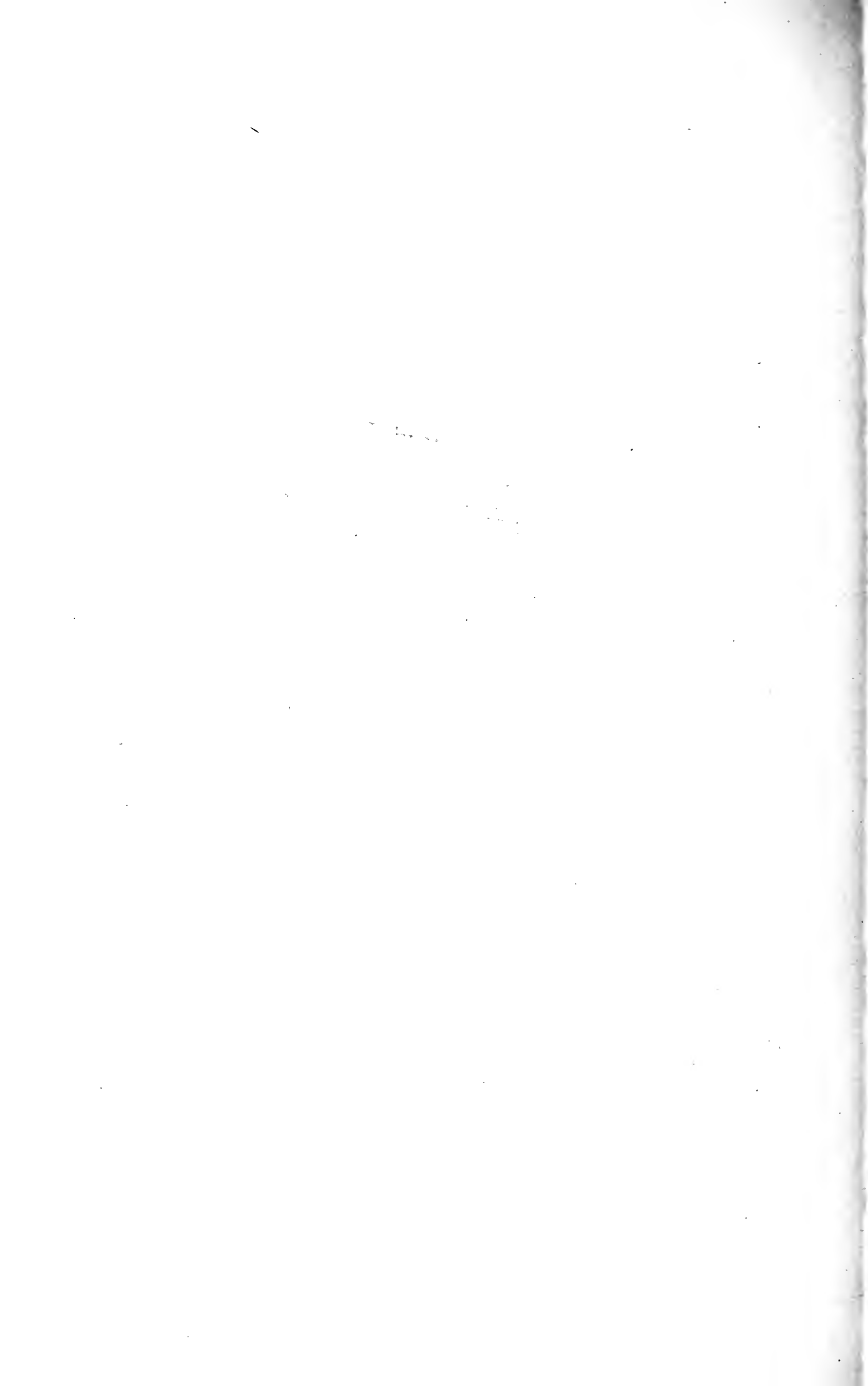

The Agricultural Experiment Station
OF THE
Colorado Agricultural College

HARVESTING AND STORING VEG-
ETABLES FOR HOME USE

BY
J. J. GARDNER



Series of Compartment Pits

PUBLISHED BY THE EXPERIMENT STATION
FORT COLLINS, COLORADO
1917

The Colorado Agricultural College

FORT COLLINS, COLORADO

THE STATE BOARD OF AGRICULTURE

	Term Expires
HON. CHAS. PEARSON.....Durango,	1919.
HON. R. W. CORWIN.....Pueblo,	1919
HON. A. A. EDWARDS.....Fort Collins,	1921
MRS. J. B. BELFORD.....Denver,	1921
HON. H. D. PARKER.....Greeley,	1923
MRS. AGNES L. RIDDLE.....Denver,	1923
HON. J. C. BELL.....Montrose,	1925
HON. E. M. AMMONS.....Denver,	1925

PRESIDENT CHAS. A. LORY,
GOVERNOR JULIUS C. GUNTER, } *Ex-Officio*

L. M. TAYLOR, Secretary

CHAS. H. SHELDON, Treasurer

EXECUTIVE COMMITTEE

A. A. EDWARDS, *Chairman*

E. M. AMMONS

H. D. PARKER

STATION STAFF

C. P. GILLETTE, M.S., D.Sc., <i>Director</i>	ENTOMOLOGIST
W. P. HEADDEN, A.M., Ph.D.....	CHEMIST
G. H. GLOVER, M.S., D.V.M.....	VETERINARIAN
W. G. SACKETT, B.S.....	BACTERIOLOGIST
ALVIN KEZER, A.M.....	AGRONOMIST
E. P. SANDSTEN, M.S., Ph.D.....	HORTICULTURIST
B. O. LONGYEAR, B.S.....	ASSISTANT FORESTER
G. E. MORTON, B.S.A., M.S.....	ANIMAL HUSBANDMAN
E. B. HOUSE, B.S. (E.E.), M.S.....	IRRIGATION ENGINEER
V. M. CONE, B.S., C.E., <i>U. S. Irrigation Engineer</i>	IRRIGATION INVESTIGATIONS
W. P. LITTLE, B.S., <i>U. S. Expert-in-charge</i>	HORSE BREEDING
R. E. TRIMBLE, B.S.....	ASSISTANT IRRIGATION INVESTIGATIONS
P. K. BLINN, B.S., ROCKY FORD.....	ALFALFA INVESTIGATIONS
EARL DOUGLASS, M.S.....	ASSISTANT CHEMIST
S. ARTHUR JOHNSON, M.S.....	ASSISTANT ENTOMOLOGIST
L. C. BRAGG.....	ASSISTANT IN ENTOMOLOGY
J. W. ADAMS, B.S., CHEYENNE WELLS.....	AGRONOMY ASSISTANT, DRY FARMING
W. W. ROBBINS, M.A.....	BOTANIST
RALPH L. PARSHALL, B.S.....	ASSISTANT IRRIGATION INVESTIGATIONS
I. E. NEWSOM, B.S., D.V.S.....	VETERINARY PATHOLOGIST
MIRIAM A. PALMER, M.A.....	DELINEATOR
R. A. MCGINTY, B.S.....	ASSISTANT IN HORTICULTURE
CHAS. R. JONES, B.S.....	ASSISTANT IN ENTOMOLOGY
GEO. M. LIST, B.S.....	ASSISTANT IN ENTOMOLOGY
JAS. D. BELL, B.S.....	ASSISTANT IRRIGATION INVESTIGATIONS
CARL ROHWER, B.S., C.E.....	ASSISTANT IRRIGATION INVESTIGATIONS
BREEZE BOYACK, B.A., M.S.....	ASSISTANT IN AGRONOMY
CHAS. I. BRAY, B.S.A., M.S.....	ASSISTANT ANIMAL HUSBANDRY
RALPH L. CROSMAN.....	EDITOR
H. E. VASEY, A.M.....	ASSISTANT BOTANIST
W. H. KERR, A.B., J.D.....	MARKETS AND MARKETING
T. E. LEIPER, B.S.....	ASSISTANT ANIMAL HUSBANDMAN

OFFICERS

CHAS. A. LORY, M.S., LL.D., D.Sc.....	<i>President</i>
C. P. GILLETTE, M.S., D.Sc.....	<i>Director</i>
L. M. TAYLOR.....	<i>Secretary</i>
MABEL LEWIS.....	<i>Executive Clerk</i>

HARVESTING AND STORING VEGETABLES FOR HOME USE

By J. J. GARDNER

The home garden should be planted with a view to furnishing a large assortment and a continuous supply of vegetables, not only during the growing season, but for winter use as well. Most people have no conception of the number of common vegetables that may be kept in a fresh or preserved state for winter use. The list includes about 30 different kinds. There are about 20 different kinds, namely, potatoes, beets, carrots, horseradish, winter radishes, parsnips, rutabagas, salsify, turnips, kohlrabi, cabbage, celery, leek, chicory, parsley, onions, dry beans, pumpkins, squashes and sweet potatoes that may be easily stored in the fresh state.

In addition, the following vegetables may be had for winter use by either canning or preserving: Rhubarb, tomatoes, sweet corn, peas, string beans, cauliflower, cucumbers, citron, green peppers and green tomatoes.

TIME OF PLANTING

In order to secure the best results in storage, it is generally necessary to regulate the time of planting so that crops will be at the proper stage of maturity at the right time for storage. For example, beets sown extremely early in the spring would hardly make desirable roots for winter storage because of their being over-grown and woody. Later planting would produce smaller beets of better quality for winter keeping. No particular care is necessary in regard to the time of planting for vegetables which are to be canned or preserved, except that they be given plenty of time to develop and that there be a sufficient quantity available at the right time.

HARVESTING

The time for harvesting, where crops are to be stored, is just as late in the fall as possible, avoiding any possible chance of injury by freezing. This time will vary slightly with different vegetables; for instance, turnips may be allowed to remain in the ground longer than beets, they being more hardy, and beets slightly longer than carrots. Only vegetables free from blemishes or injuries should be used.

Vegetables to be stored for winter use should be harvested and handled with care. Root crops, such as beets, carrots, winter radishes, rutabagas, turnips and kohlrabi may usually be harvested by pulling by the tops. In case the vegetables are long rooted, digging with a fork may be necessary.

Horseradish, parsnips, salsify and chicory usually require digging in order to get the root out without injury, and should be removed so that the tip is not more than a quarter of an inch in diameter in case it is broken off.

Cabbage, celery and parsley are taken roots and all with the soil clinging to them. Only injured parts are removed. Root tops should be removed carefully, cutting about three-fourths of an inch from the crown of the vegetable so that no injury will occur. Otherwise, the roots are subject to bleeding and soon wither because of loss of moisture. The portion of the leaf remaining on the crown soon withers and falls off, with no injury to the root.

Onions for winter storage are harvested when the necks begin to wither. The tops are removed and the onions placed in a well ventilated place, preferably under cover, to "cure".

STORAGE

Nearly all of the common vegetables are satisfactorily stored under one of four conditions:

- 1st. Cool, moist conditions and no circulation of air.
- 2nd. Cool, dry conditions with a circulation of air.
- 3rd. Cool, moist condition of roots and a circulation of air about the top.
- 4th. Warm, dry conditions with a free circulation of air.

Most of the common vegetables are stored under the first condition of coolness, moisture, and no circulation of air, namely, potatoes, beets, carrots, horseradish, parsnips, winter radishes, rutabagas, salsify, cabbage and kohlrabi.

The second group includes only the onion.

The third group includes such vegetables as the celery, leek, brussels sprouts, chicory and parsley that continue their growth in storage.

The fourth group includes such vegetables as dry beans, sweet potatoes, pumpkins and squashes.

The conditions for the first group may be met in several ways. Where only a limited supply is to be stored, the best method is to

place the vegetables in a box of moist sand or soil in layers. Where larger quantities are to be put away, they may be stored in what is known as an out-of-door pit.

Parsnips, salsify and horseradish, being perfectly hardy, are not injured by freezing and may be left in the ground over winter, but it is often difficult to secure them when wanted, under these conditions. They may be placed in a conical pile in a well drained place and covered with about six inches of earth which may be chopped away at any time it is desired to get at the vegetables.

Beets, carrots, winter radishes, rutabagas, turnips and kohlrabi are not hardy and must be protected from freezing. The vegetables are placed in a conical pile on a well-drained piece of land, covered with a layer of from six to eight inches of straw, and about the same amount of earth, leaving some of the straw protruding at the top to provide ventilation, as the vegetables are likely to develop some heat when first covered. As soon as cold weather sets in, the earth may be thrown over the top to completely seal the pit. In extremely cold sections, a layer of strawy manure is sometimes put on the top of this after the earth covering has become frozen.

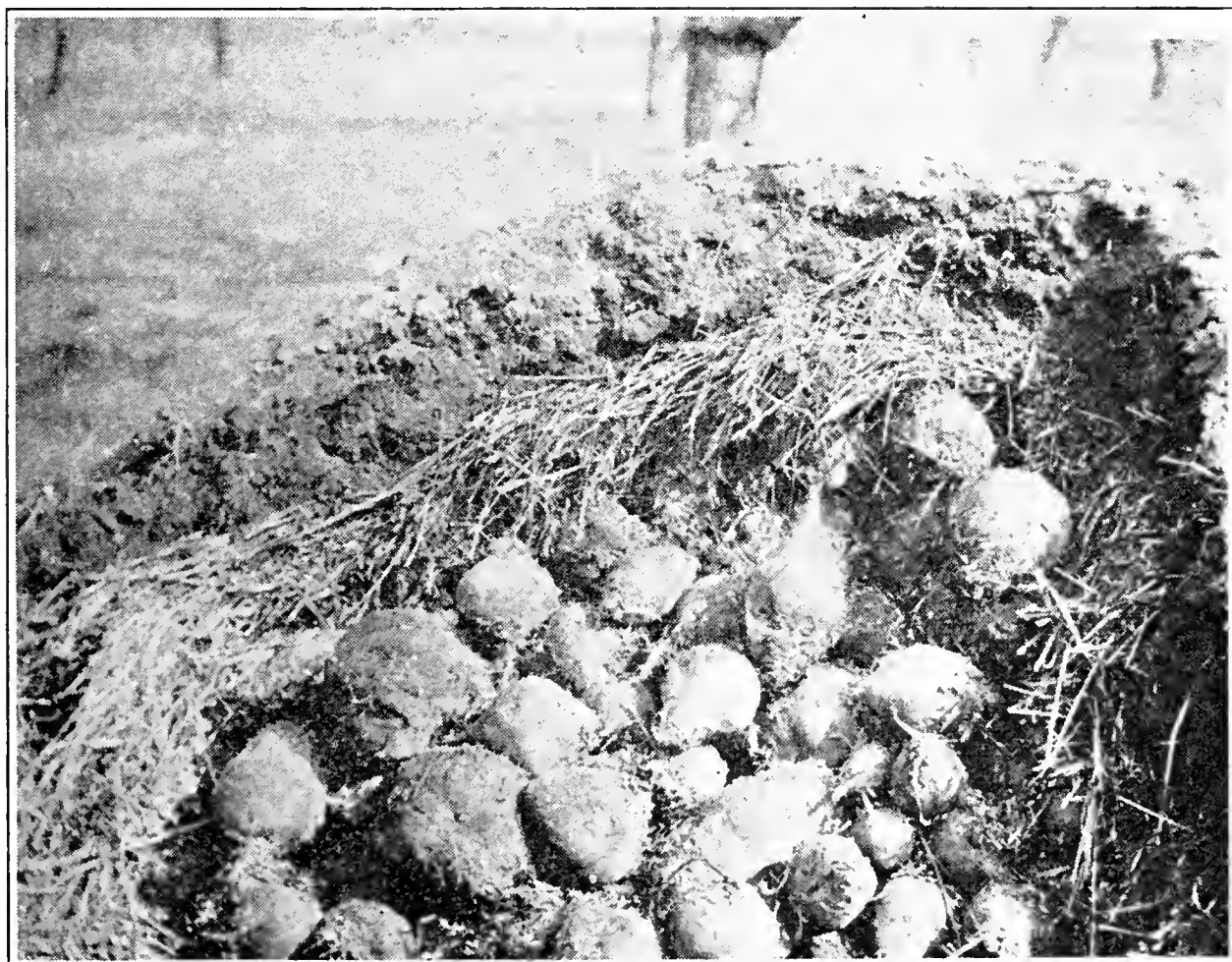

Pit of Beets opened April 15th

Where a considerable quantity of vegetables is to be stored in this way, a series of pits, one adjoining the other, may be made, with only an amount of vegetables in each pit that can be economically used at any time. In this way, no pits are opened until the vegetables are to be used.

Cabbages are stored by placing them head down three in a row and two on top making a tier of five cabbages, the roots extending in the air. The pile may be as long as necessary. Several inches of straw or leaves should then be put over the cabbage and the same amount of earth thrown on them. Cabbage may be kept frozen solid without injury to the head, providing it is thawed out very gradually.

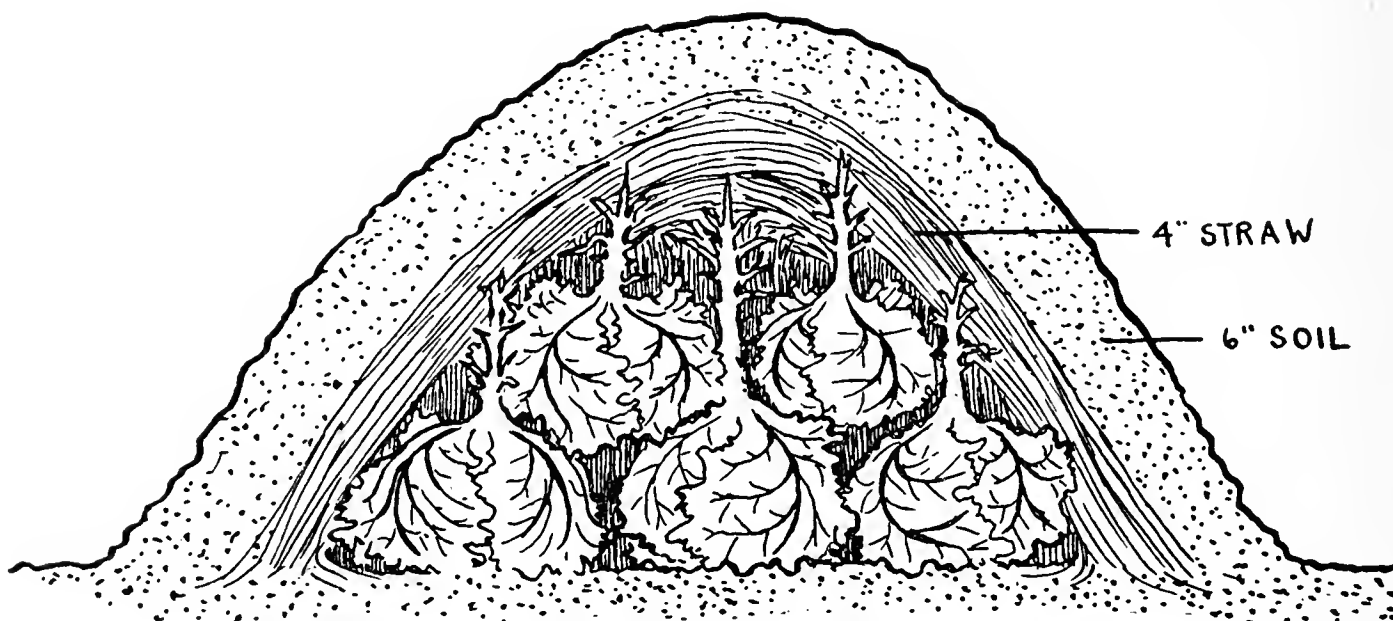

Cabbage Pit

Onions, in limited amounts, may be easily stored in a cool place where there is a free circulation of dry air about them; the main point to bear in mind is that they require a low temperature, as they sprout readily where there is any heat. A bushel or so may be hung up in a basket suspended from a rafter in a cool cellar. Larger quantities are usually stored in slatted crates, one piled on top of the other, allowing a free circulation of air between the crates.

Celery, leek, brussels sprouts, chicory, and parsley—vegetables that continue their growth after storage—are transplanted with soil clinging about the roots.

For home purposes, parsley may be taken and put into a pot or box and kept well watered, at an ordinary room temperature.

Celery, leek and chicory, in a small way, may be transplanted into a box, with holes in it for ventilation, and the roots covered with moist sand or soil, the air being allowed to circulate thru the

tops. Watering will be frequently necessary and should be applied to the roots and not the tops; otherwise disease is liable to start, and decay soon follows.

Brussels sprouts require more room than the celery and it is hardly practical to store them in a box, but they may be put upon the floor of the cellar, the roots covered with moist sand or soil and kept in this way.

Celery, leek and chicory may be also placed under the same conditions, or, if a hotbed is available, they may be transplanted into the bottom of the bed and kept for a considerable length of time, if additional covering is put on during severe weather.

Dry beans, sweet potatoes, squashes and pumpkins, in a limited way, may be stored on a shelf in a furnace-room, or in a warm place, where they may be kept dry and free from moisture. In order to insure squashes and pumpkins keeping satisfactorily, they should be harvested with the whole stem and part of the vine attached—otherwise, they are likely to start decaying on the stem end.



The Agricultural Experiment Station

OF THE

Colorado Agricultural College

GRASSHOPPER CONTROL

By

CHARLES R. JONES



A field demonstration of mixing and application of Paris green-bran mash, conducted on the premises of Mr. Tiner, grasshopper campaign, 1916, San Luis Valley (Original).

PUBLISHED BY THE EXPERIMENT STATION
FORT COLLINS, COLORADO
1917

The Colorado Agricultural College

FORT COLLINS, COLORADO

THE STATE BOARD OF AGRICULTURE

	Term Expires
HON. CHAS. PEARSON.....Durango,	1919
HON. R. W. CORWIN.....Pueblo,	1919
HON. A. A. EDWARDS.....Fort Collins,	1921
MRS. J. B. BELFORD.....Denver,	1921
HON. H. D. PARKER.....Greeley,	1923
MRS. AGNES L. RIDDLE.....Denver,	1923
HON. J. C. BELL.....Montrose,	1925
HON. E. M. AMMONS.....Denver,	1925

PRESIDENT CHAS. A. LORY, }
GOVERNOR JULIUS C. GUNTER, } *Ex-Officio*

L. M. TAYLOR, Secretary

CHAS. H. SHELDON, Treasurer

EXECUTIVE COMMITTEE

A. A. EDWARDS, *Chairman*

E. M. AMMONS

H. D. PARKER

STATION STAFF

C. P. GILLETTE, M.S., D.Sc., <i>Director</i>	ENTOMOLOGIST
W. P. HEADDEN, A.M., Ph.D.....	CHEMIST
G. H. GLOVER, M.S., D.V.M.....	VETERINARIAN
W. G. SACKETT, B.S.....	BACTERIOLOGIST
ALVIN KEZER, A.M.....	AGRONOMIST
E. P. SANDSTEN, M.S., Ph.D.....	HORTICULTURIST
B. O. LONGYEAR, B.S.....	ASSISTANT FORESTER
G. E. MORTON, B.S.A., M.S.....	ANIMAL HUSBANDMAN
E. B. HOUSE, B.S. (E.E.), M.S.....	IRRIGATION ENGINEER
V. M. CONE, B.S., C.E., <i>U. S. Irrigation Engineer</i>	IRRIGATION INVESTIGATIONS
W. P. LITTLE, B.S., <i>U. S. Expert-in-charge</i>	HORSE BREEDING
R. E. TRIMBLE, B.S.....	ASSISTANT IRRIGATION INVESTIGATIONS
P. K. BLINN, B.S., ROCKY FORD.....	ALFALFA INVESTIGATIONS
EARL DOUGLASS, M.S.....	ASSISTANT CHEMIST
S. ARTHUR JOHNSON, M.S.....	ASSISTANT ENTOMOLOGIST
L. C. BRAGG.....	ASSISTANT IN ENTOMOLOGY
J. W. ADAMS, B.S., CHEYENNE WELLS.....	AGRONOMY ASSISTANT, DRY FARMING
W. W. ROBBINS, M.A.....	BOTANIST
RALPH L. PARSHALL, B.S.....	ASSISTANT IRRIGATION INVESTIGATIONS
I. E. NEWSOM, B.S., D.V.S.....	VETERINARY PATHOLOGIST
MIRIAM A. PALMER, M.A.....	DELINERATOR
R. A. MCGINTY, B.S.....	ASSISTANT IN HORTICULTURE
CHAS. R. JONES, B.S., M.S.....	ASSISTANT IN ENTOMOLOGY
GEO. M. LIST, B.S.....	ASSISTANT IN ENTOMOLOGY
JAS. D. BELL, B.S.....	ASSISTANT IRRIGATION INVESTIGATIONS
CARL ROHWER, B.S., C.E.....	ASSISTANT IRRIGATION INVESTIGATIONS
BREEZE BOYACK, B.A., M.S.....	ASSISTANT IN AGRONOMY
CHAS. I. BRAY, B.S.A., M.S.....	ASSISTANT ANIMAL HUSBANDRY
RALPH L. CROSMAN.....	EDITOR
H. E. VASEY, A.M.....	ASSISTANT BOTANIST
W. H. KERR, A.B., J.D.....	MARKETS AND MARKETING
T. E. LEIPER, B.S.....	ASSISTANT ANIMAL HUSBANDMAN

OFFICERS

CHAS. A. LORY, M.S., LL.D., D.Sc.....	<i>President</i>
C. P. GILLETTE, M.S., D.Sc.....	<i>Director</i>
L. M. TAYLOR.....	<i>Secretary</i>
MABEL LEWIS.....	<i>Executive Clerk</i>

GRASSHOPPER CONTROL

By CHARLES R. JONES

The agricultural interests of the United States have suffered for many years from the depredations of locusts, or grasshoppers, and every farmer should be more familiar with the methods of control. Usually the question of grasshopper control becomes a problem for concerted action, but co-operation is not always possible and the individual farmer should at all times keep this problem before him for consideration. In almost every county of Colorado there have been outbreaks of this pest, and various remedial measures have been applied. Should weather conditions favor insect development this year, practical control methods should be used to save the crops.

The past season witnessed several outbreaks in various parts of our State which were successfully controlled, and there is no longer any reason why the farmers should allow their crops to be destroyed by this pest. They are better informed than ever before as to the life history and habits of the grasshopper and the most efficient methods of destroying them. Colorado's "Amended Pest Law" provides for the forming of pest districts for the control of rodents and injurious insects, and can be applied effectively in all localities. This measure should have the active support of all county commissioners to give a basis for a county-wide organization, and the direct application of remedial measures for the complete control of this invading pest.

The general life history, habits, and practical methods of control of grasshoppers have been worked out and are given here, in order that the farmers may intelligently and successfully combat the pests. The investigations upon which this paper is based gives information that can be applied in any part of the State.

LIFE HISTORY

Egg.—The life histories of our various species of destructive grasshoppers are very similar. The female usually selects a spot to oviposit in some waste land. Ideal places are found along fence borders, ditch-banks, roadsides, weedy patches or fallow lands. Cultivated fields are not so susceptible to oviposition as the above mentioned places. The individual spot selected is generally slightly elevated, dry and somewhat protected from the sun.

After selecting a suitable place, the female forms a hole by forcing the tip of her abdomen down into the soil, and alternately

opening and closing the four horny processes at its tip. The depth of the hole depends upon the texture of the soil and the length of the abdomen of the hopper in question, the eggs being deposited between one-half and one and one-half inches from the surface. Upon completing this operation, the female deposits her eggs (Plate 1, Fig. 1), beginning at the bottom and gradually laying them singly and obliquely across the hole, at the same time covering the entire mass with a frothy mucilaginous substance which is secreted from the abdomen and forms a protective covering against dryness, excessive moisture, and, possibly, parasites.

All our injurious grasshoppers pass the winter in the egg stage. Active oviposition commences about the middle of August and extends thru the remaining warm days of fall, at least to the middle of November. Hatching begins in the following spring with the advent of the warm days of May and early June, and continues over an extended period, there being a great variation in time of hatching, as in oviposition.

The number of eggs laid varies with the species, generally ranging from 40 to 120. There are usually two egg-clusters deposited by the same female.

The individual eggs are cylindrical, about three- to four-sixteenths of an inch in length, curved slightly, and of a yellowish color. (Plate 1, Fig 2.)

Nymphs.—Upon hatching, the young hoppers, or nymphs, readily force their way to the surface of the soil thru the protective covering of the egg mass. The young hoppers closely resemble the adult, except that they are wingless and the head is very large and out of proportion with the rest of the body. They are very pale in color at first, but soon take on the coloration of their surroundings which, together with their small size, makes them very inconspicuous.

After hatching, the nymphs remain grouped for a day or two, but they soon develop ravenous appetites and begin feeding upon any green herbage. They do not feed at night, but usually crawl upon some grass stem or other object, where they remain until it begins to warm up the following day.

During the process of development, the nymphs molt a series of times, each successive skin being larger than the preceding one, and it is in this manner that the insect grows. When ready to molt, the hopper ceases feeding, crawls on some grass stem or other object, and fastens itself thereto by its hind claws, head downward. Thus it hangs motionless for several hours. The thorax or middle part of the body gradually swells until the skin splits down the

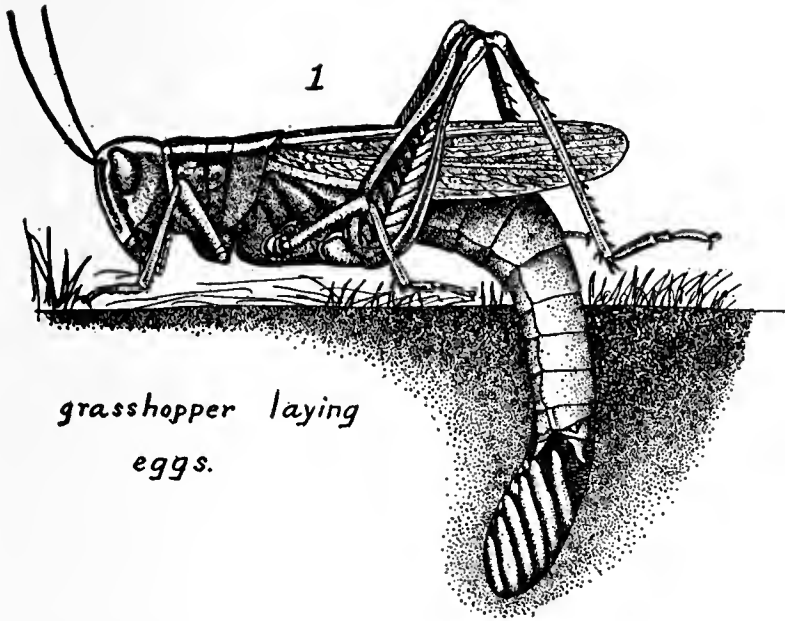

1

grasshopper laying
eggs.



2

egg mass.

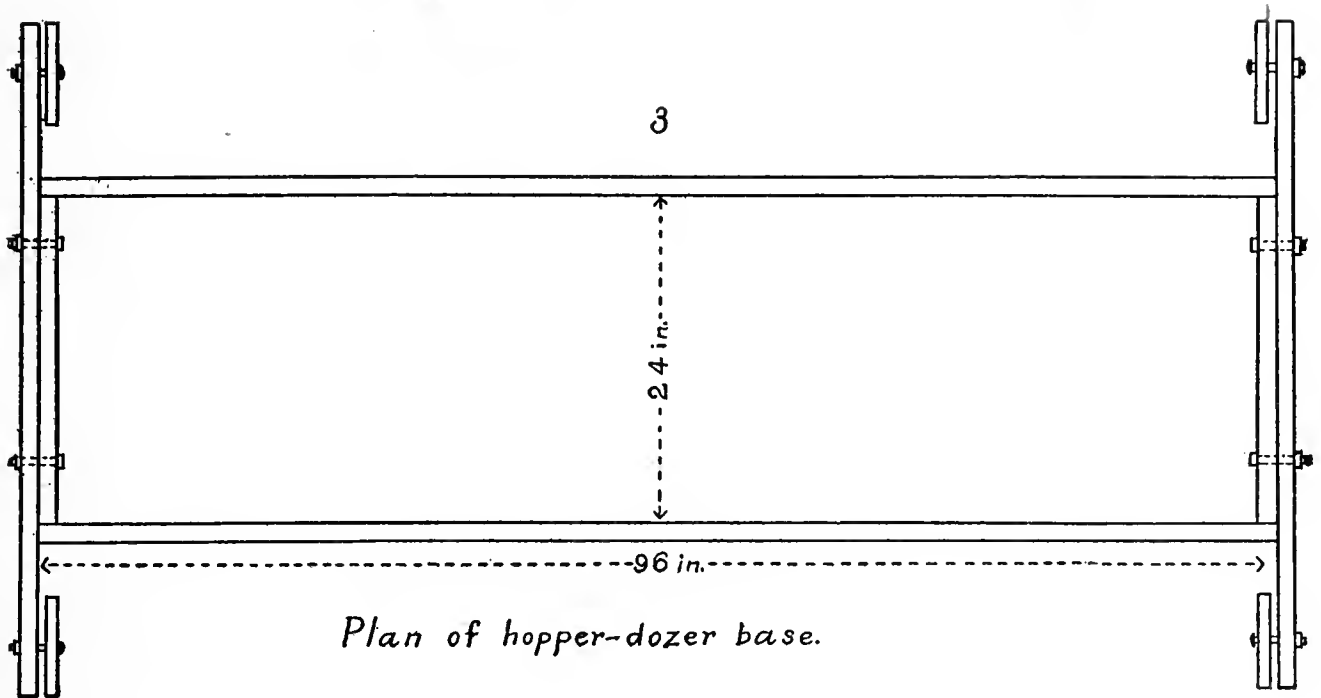

3

24 in.

96 in.

Plan of hopper-dozer base.

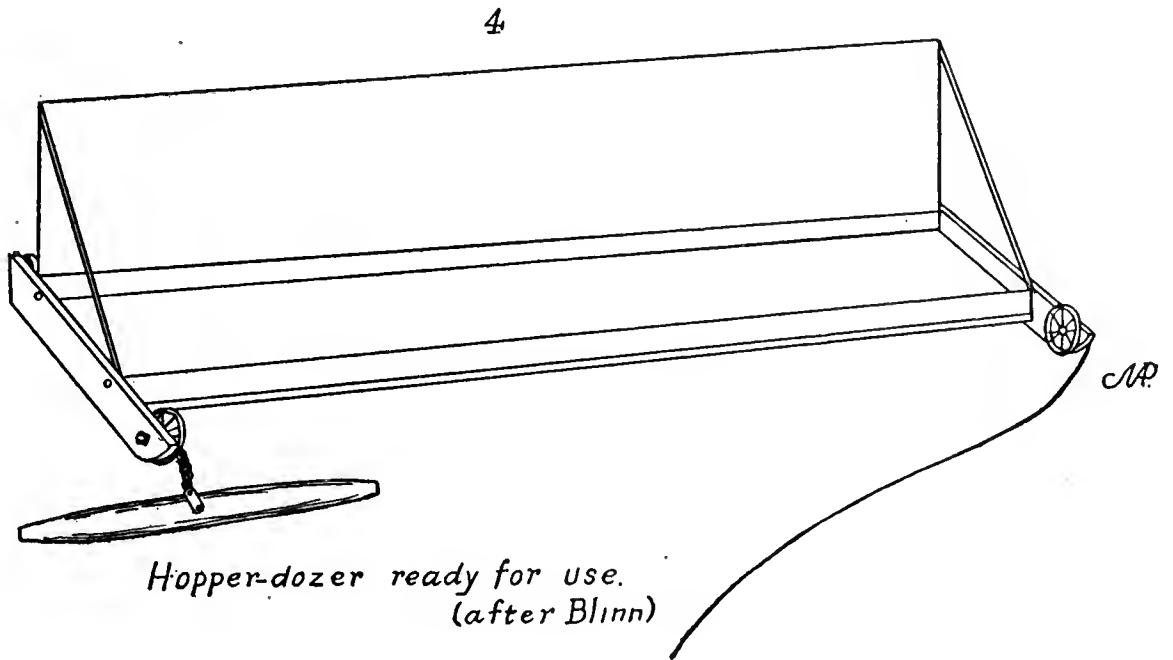

4

Hopper-dozer ready for use.
(after Blinn)

back. Then by a series of muscular contractions, the body of the insect is gradually worked out of the old skin. The nymph usually clings to the old skin for a short time until the tender new skin becomes dry and sufficiently hardened for it to be able to move about.

The time required for the nymph to reach maturity, that is, to gain its wings, is from 60 to 90 days, depending upon the climate and locality. During this period, there are generally five molts.

While this pest is in the nymphal stage, the farmer should endeavor to eradicate or control it, as its only means of locomotion is by hopping, and the methods and application of remedial measures require less labor and materials, as the insects cannot escape by flying to uninfested or untreated areas, as they will do when maturity is reached.

Adults.—At the fifth molt, the wings of the hopper, which have been mere pads, become fully formed. When ready to transform from the nymph to the adult stage, the young hopper climbs to some upright object and remains, as in the preceding molts, motionless until the old skin is shed. The wings, which have been represented in previous molts by mere pads, now come into evidence, and after they are thoroly dried, which is usually before nightfall, the hopper is ready to fly.

Climatic conditions affect the adults in the same manner as the nymphs. They are very active during the warm, sunny days, and are sluggish and quiet during cold, wet weather.

Egg Laying.—After the adult stage has been reached, which varies considerably, owing to variation in egg laying, oviposition and rate of development in individuals of the same brood, the females feed for a week or two, during which time they develop a mass of eggs and then oviposition takes place. The places selected will extend over a considerable area of ground in such places as before mentioned.

FOOD HABITS—PLANTS AFFECTED

Unlike most other insect pests which attack plants of an economic value, the grasshoppers are able to exist upon almost any green herbage, in most cases attacking the tender, succulent growth of the plant in question. In our irrigated sections, young alfalfa affords an ideal food for them, as well as young small grains, corn, field peas, and any garden or truck crop. Deciduous trees do not escape the ravages of this pest. Orchard trees, roses in the flower gardens, and even willows along ditch banks suffer severely at times. Young fruit trees are often severely injured by defoliation, or even by having the tender bark and twigs eaten to such an ex-

tent as to cause death of the trees. The attacks and damage to young orchards generally follow a shortage of other foods.

THE MORE DESTRUCTIVE SPECIES

There are many kinds of grasshoppers which are injurious to our agricultural crops. The more important ones are: The lesser migratory locusts (*Melanoplus atlantis* Riley), the two-striped locust (*Melanoplus bivittatus* Say), the differential locusts (*Melanoplus differentialis* Thom.), and the red-legged locust (*Melanoplus femur-rubrum* De G.).

There are other species involved, but they appear rather scattering, are of minor importance, and generally occur in fields bordering virgin lands.

CONTROL

The control of grasshoppers may be taken up under two heads:

First, **Natural**, which includes climatic conditions, predaceous and parasitic insects, diseases, birds, etc.

Second, **Artificial**, which includes all methods employed by man, such as cultivation, spraying, poison baits, hopper dozers, etc.

The complete eradication of a swarm of locusts in any given locality is almost impossible, tho under favorable circumstances, with co-operation and organization, enough can be killed to effect a complete control of the pest. However, this must be accomplished before the hoppers develop wings. Therefore, the attention of those engaged in locust destruction should be directed against the young hoppers and eggs.

NATURAL CONTROL

Insect Enemies.—There are several kinds of parasitic and predaceous insects which aid materially in the natural control of grasshoppers. Among these is a medium-sized fly, *Sarcophaga* (sp. ?), which has been bred in abundance from both nymphs and adults. This parasite was first noted at Trinidad June 1, 1916, and after haying, numerous parasitized hoppers were noted around the stacks. From two to four parasites of the above mentioned species were bred from those collected.

Other insects of secondary importance have been noted preying upon the nymphs of grasshoppers. A large, black ground beetle, (*Alosoma obsoletum* Say) was noted, on various occasions, feeding upon young hoppers. Large robber flies (*Promachus* sp.) have been seen feeding upon young grasshoppers. Solitary wasps are also instrumental in hopper control. They sting and stupefy the young hoppers and place them in their mud nests. The wasp deposits an egg among the stupefied hoppers, and, upon hatching,

the young grub has sufficient food for its development. One of the most common of these is *Priononyn atratus*.

Birds.—Insectivorous birds play a most important part in natural control of grasshoppers. They are always present thruout our agricultural districts, and are constantly feeding upon grasshoppers and other insects. The following are pointed out by W. R. Walton* as being the most important:

“Franklin’s gull, bobwhite, prairie chickens, red-tailed, red-shouldered, broad-winged and sparrow hawks; the screech and burrowing owls, yellow-billed cuckoo, road-runner, nighthawk, red-headed woodpecker, kingbird, horned lark, crow, magpie, red-winged and crow blackbirds, meadowlark, lark bunting, grasshopper and lark sparrows, butcherbird, wren and robin.”

All domestic fowls will feed upon grasshoppers whenever possible. Turkeys and chickens will aid materially in controlling them. They are very effective over small areas, as they will eat a great quantity of young hoppers. However, their effectiveness must not be over-estimated, as it is almost impossible for any farmer to have a sufficient flock to patrol his entire field. The wandering habit of turkeys takes them thruout the infested areas where they are very beneficial in hopper control, but chickens are of a different nature, and their houses must be placed in the infested field and be moved at intervals, if they are to rid a given locality of this pest. Mr. Jones, of Monte Vista, placed a coop and about 60 chickens (Fig. 1) in his field and affected a com-



Fig. 1.—Chickens in the field used as a method of control for grasshoppers, 1916, San Luis Valley. They did very efficient work immediately around the portable coop, which was moved every other day (Original).

*“Grasshopper Control in Relation to Cereal and Forage Crops,” Farmers Bulletin No. 747, U. S. D. A. (1916), p. 12.

plete control immediately surrounding the house. It must be taken into consideration that it would require an enormous number of hens and considerable attention to affect control over any great area of land.

ARTIFICIAL CONTROL

In the artificial control of grasshoppers, we may consider the two main heads: *Prevention* and *Remedies*.

Under the first, attention must be given to prevent hatching and lessen egg deposition. The latter may be brot about by clean cultivation along ditch banks and fence rows. This will expose the hoppers to natural enemies and weather conditions, which will reduce their numbers and cause the remainder to oviposit in areas likely to be cultivated, and so result in a subsequent destruction of the eggs.

Exposure of the eggs to air, sunshine, natural enemies and weather conditions is very effective in hopper control. This may be accomplished by plowing, discing or harrowing. The operation should be performed before the eggs hatch. It is therefore an excellent plan, in late fall or early spring, to plow all ditch banks, fence rows, and road-sides where grasshopper eggs are known to be deposited. Plowing should be at least eight inches deep. This will bury the eggs sufficiently to prohibit most of the young hoppers from making an exit thru the soil surface upon hatching. In alfalfa fields and other places that cannot be plowed,

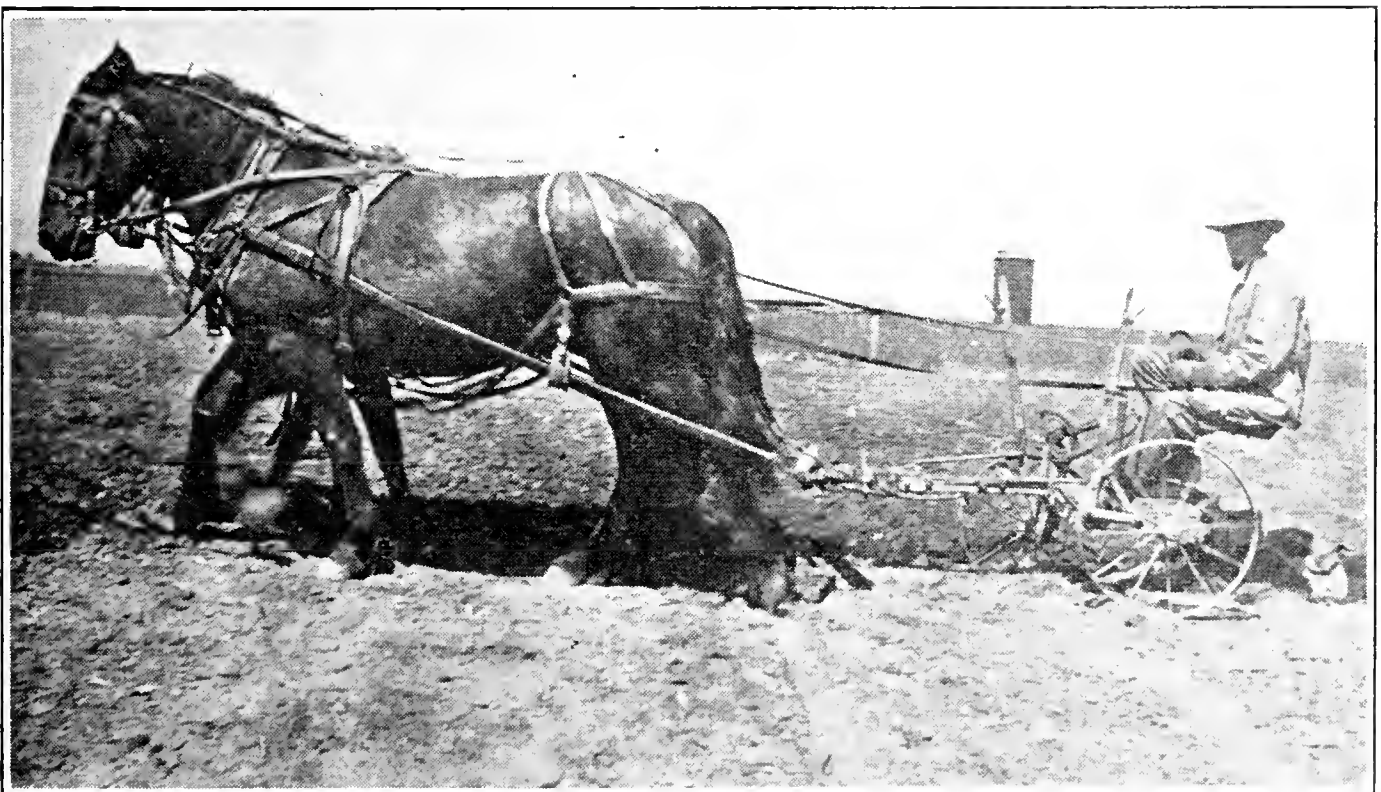

Breaking fallow land to destroy grasshopper eggs, San Luis Valley, 1916. (Original).

harrowing or discing will give excellent results in egg destruction. This should be to a depth of at least two inches, the ground thoroly stirred, and the egg clusters broken and exposed. This allows birds and other enemies, as well as temperature, to destroy them.

Young orchards may be protected by thoroly spraying the trees with arsenate of lead at the rate of 3 pounds of powder or 6 pounds of paste, to 50 gallons of water.

APPARATUS FOR CAPTURING GRASSHOPPERS

There are three principal mechanical devices used in catching young grasshoppers. These are all under the same general plan, but may be classed as the "Hopper Dozer", the "Balloon Hopper Catcher", and the "Live-Hopper Machine". The first two are designed to be used on level cultivated fields or meadows, and are the most economical methods for mechanically destroying grasshoppers, but their use will not insure as complete and effective control as the poison bait method. However, some users of the above machines are very much in favor of them. This is probably due to the fact that with these they can see the immediate fruits of their labor.

Hopper Dozer.—A very cheap and practical hopper dozer (Plate 1, Figs. 3-4) consists of a sheet-iron pan three or four inches deep, placed upon wooden runners with an upright oil-cloth or piece of canvas two and one-half feet high at the back. This is to prevent the insects from flying or jumping over the pan. When ready for use, put an inch of water in the pan with a little coal oil and drag it across the field, and the hoppers will jump or fly into it. The horses should be hitched, well spread, at either end of the dozer, so as not to frighten the hoppers from in front of it, and then, as the machine approaches, many of the hoppers will jump and alight in the oil and water. The winged hoppers will, in most cases, fly against the back of the hopper dozer and fall into the pan and be killed by the oil. Those that crawl out will soon die from the effects of the oil. Where the hoppers are very numerous, they will soon fill the pan and have to be removed. At intervals, a fresh supply of oil and water will be needed. To prevent slopping from end to end, it is well to put partitions across the pan every two or three feet with a small opening beneath them.

Anyone can build one of these pans or dozers to suit himself. Mr. P. K. Blinn*, of Rocky Ford, Colorado, has constructed a

*"A Hopper Dozer," Bulletin No. 112, Colorado Agricultural Experiment Station.

very inexpensive and convenient hopper dozer (Plate I, Figs. 3 and 4), which may be operated with one horse. The plan is such that any farmer should be able to construct it for himself.

The pan was made by nailing a sheet of 24-gage galvanized roofing iron, 30x96 inches, to a frame, 24x96 inches, made of two-by-fours. Three inches were allowed to turn up on either side of the frame to make the pan more secure. A strip of candle wicking was nailed beneath the iron between two rows of nails, to prevent leakage. The ends of the pan were bolted to runners made of 2 inch x 10 inch strips, 4 feet long, and at either end of this runner was a small cast iron 10-inch wheel. The object of the wheel was to steady the pan over rough places and to lighten the draft of the dozer. The pan was supported on runners about four inches above the ground and the wheels supported the runners about half an inch. A light frame, 3 feet high, covered with oilcloth, was fitted to the back of the dozer with the smooth side in front. The bottom of the cloth was tacked to the inside of the pan, and the framework was braced in front of the runner.

The material and cost of building the dozer, according to Mr. Blinn, was as follows:

One sheet of No. 24 galvanized iron. 23 lbs., 92.....	\$2.07
One piece of 2x4, 16 ft.	
One piece of 2x4, 8 ft.	
One piece of 2x10, 8 ft.	
One piece of 1x4, 16 ft.	
Total—32 ft. at 2½c.....	.95
Three yards of table oilcloth at 18c.....	.54
Four cast wheels50
Bolts, nails and rope.....	.40
One ball of candle wicking.....	.10
	<hr/>
Total cost.....	\$4.56

By hitching a horse in front to one runner, and having a rope from the other runner attached to the hame staple of the harness, the dozer, by the aid of the wheels, may be dragged at right angles and to one side of the horse, thus preventing the hoppers from being frightened away from the advancing pan.

Balloon Catcher.—The “balloon” hopper catcher consists of a light frame of wood twelve feet long and two feet high, to which is attached a bag about eight feet long, the framework forming the mouth of the bag. The apex is open, but, when in use, tied with a string. The apparatus is drawn by a single rope which forks and re-forks, sending a branch to each corner. The draw rope is fastened to the single-tree of a light harness or to the pommel of a saddle. In dragging this sack over the infested areas

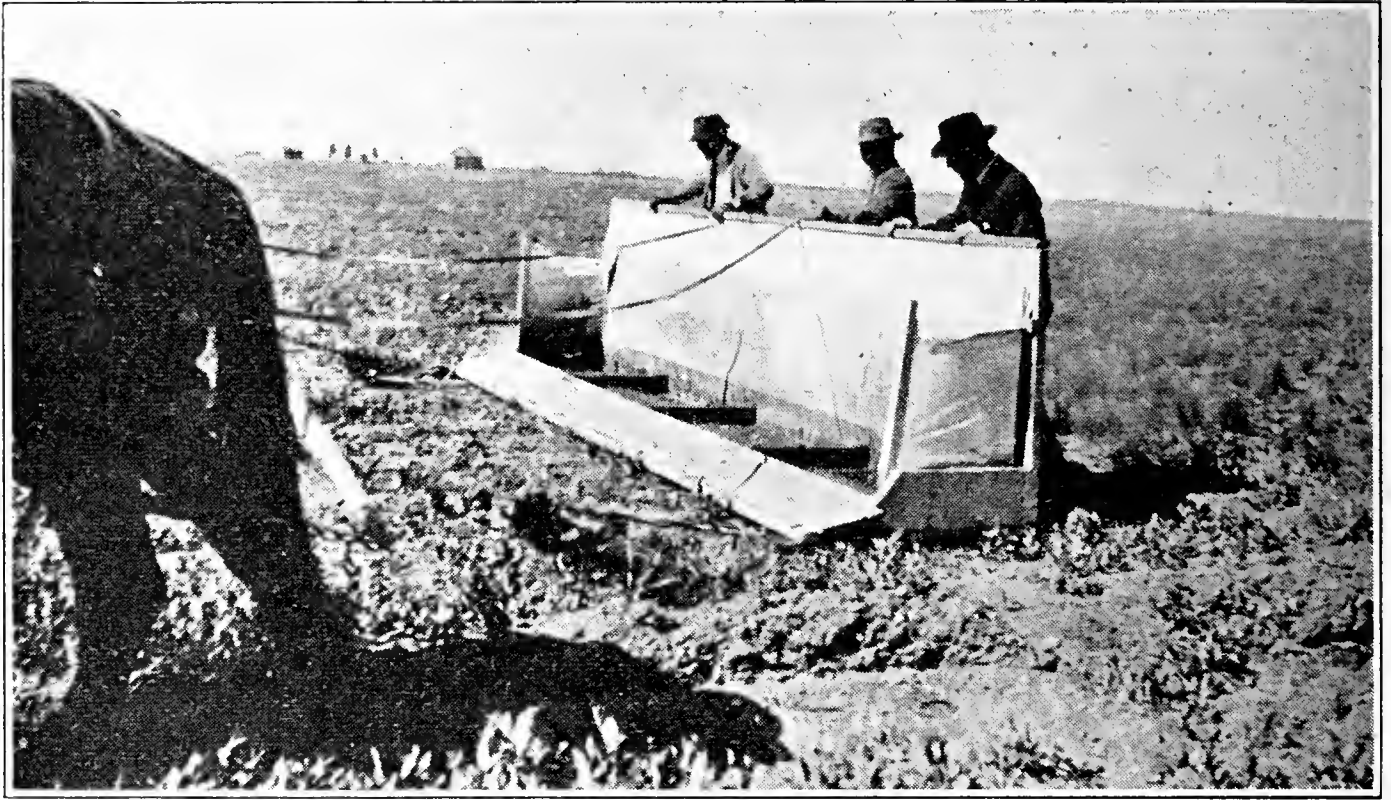

A hopper dozer in action. One of the many machines that was used in the grasshopper campaign, 1916, San Luis Valley. Note the hoppers in the pan. (Original).

the hoppers jump to avoid it and are caught in the sack. When a sufficient quantity of hoppers are thus trapped, the rider, with the assistance of a helper, opens the apex and shakes the captured grasshoppers into a sack.

This apparatus originated in British Guiana, and is used extensively in India and other countries where grasshoppers appear in immense swarms.* It was also used effectively in Utah in the outbreak of grasshoppers in 1915, when it was reported that at least four hundred tons of grasshoppers were captured by the use of these balloons.**

The Live Hopper Machine.—This apparatus (Plate II) was constructed and successfully used in Colorado in 1902, and has later given satisfaction as a hopper machine in Utah and New Mexico, and in the San Luis Valley the past season. It has the advantage over other hopper dozers in that it can be operated on rough areas. Its construction is very simple. It consists of a rectangular box two feet square and sixteen feet long, fastened on runners. The top and back of the box should be covered with screen wire and provided with a door for getting the hoppers out. The front should be concave, three feet high, and covered with

*Philippine Agricultural Review III, 4, 1910, pp. 237-238.

**"How to Control Grasshoppers," Utah Agr. Exp. Sta. Bul. No. 138, 1915, pp. 98.-99.

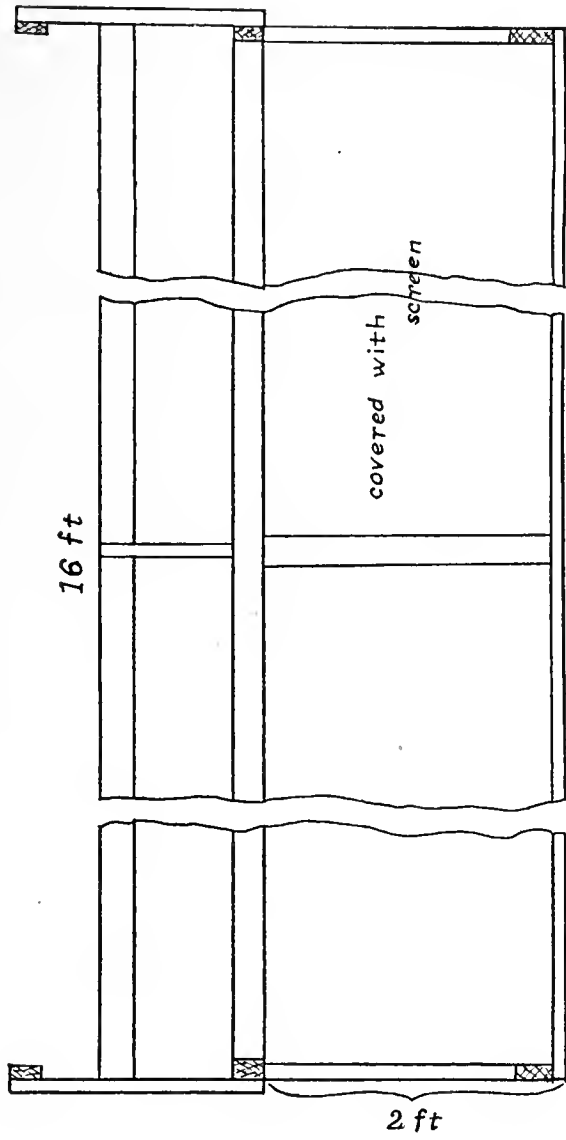

Top Elevation

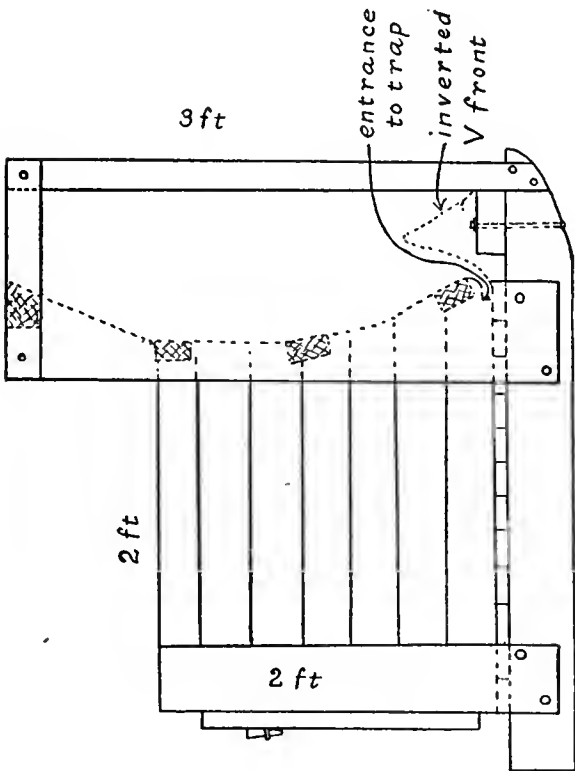
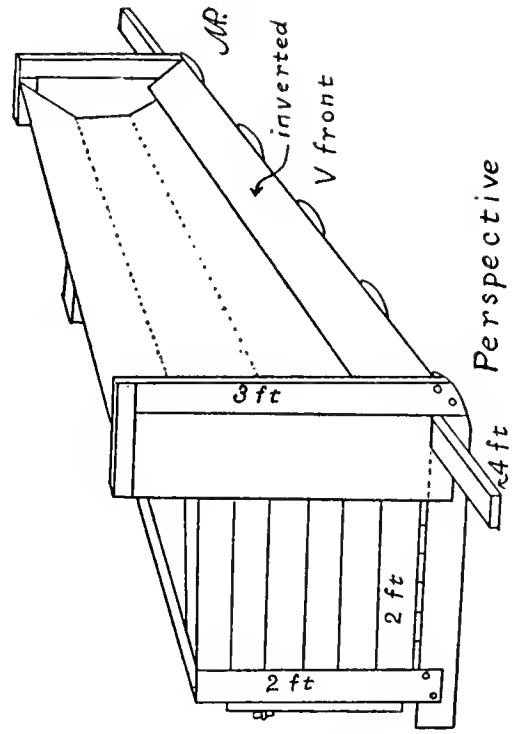

End Elevation

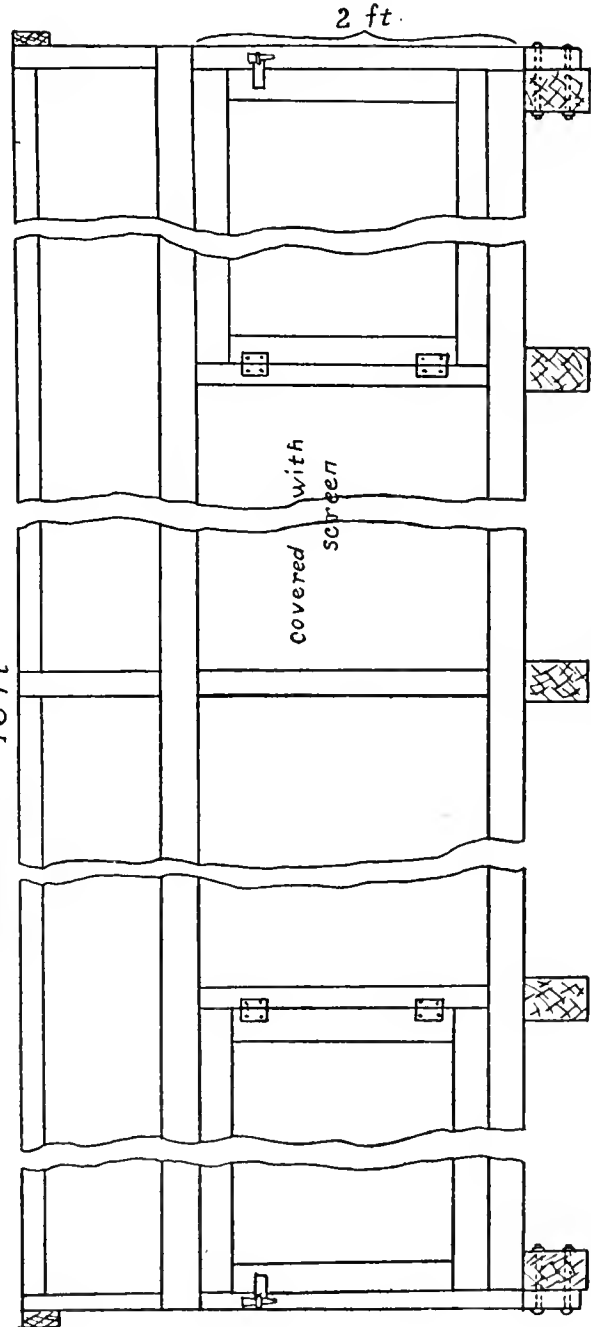

Rear Elevation

Plate II

oilcloth or tin extending to within two inches of the bottom of the machine, the floor of which is extended forward about four inches in front of the shield. A two-by-four extends outward from either end to the distance of four feet and to this is attached the single-tree. An inverted V-shaped tin is fastened to the front end of the extended floor, the back part of the V being free and slightly curved upward and extending under the base of the shield. In operation, this tin shakes up and down, and the hoppers jumping up strike the curved shield, slide down to the inverted V front, and, being unable to obtain a foothold, pass down and under the main shield and into the box.

This machine operates in the same manner as the hopper dozer, with the exception that the hoppers must be killed before the machine is unloaded. This may easily be accomplished by spraying them with kerosene.

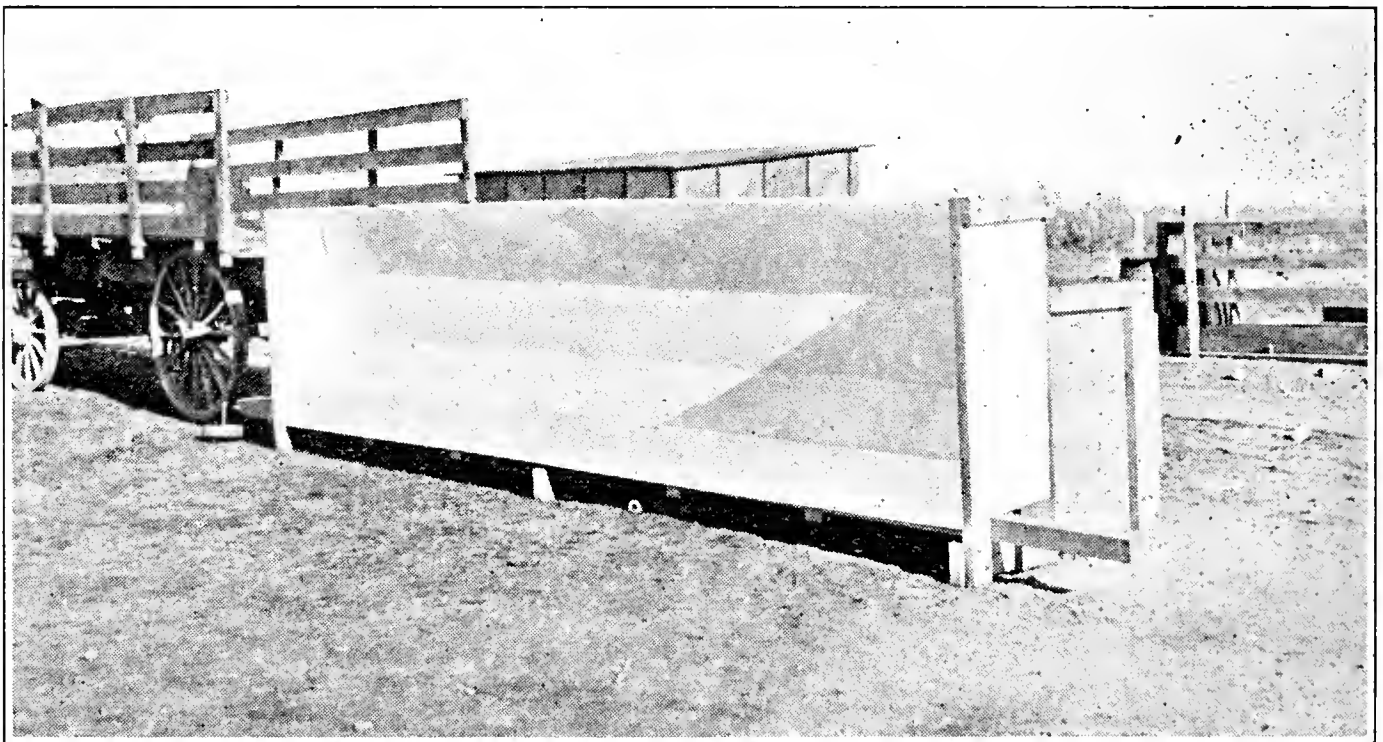

The "Live Hopper Machine," showing concave shield front and inverted "V" at the base. These machines were used on rough areas in the grasshopper campaign, 1916, San Luis Valley. (Original).

INSECTICIDES

Insecticides used in hopper control may be grouped under two heads, those which kill by contact, such as kerosene, kerosene emulsion, etc., and those which act upon the digestive tract. The latter may be applied by means of spraying the poison directly upon the foliage which the hoppers will feed upon, or by mixing it with bran or other material in the form of a mash.

Poisonous Sprays.—Poisoning vegetation with arsenical sprays is often practical in areas where the young hoppers are

abundant and localized about the borders of the fields or elsewhere. The poisons used should be Paris green or arsenate of lead, the former at the rate of 2 pounds, and the latter at about 3 pounds of powder or 6 pounds of paste, to 50 gallons of water. Care should be taken not to use these sprays on plants where domestic animals are likely to feed. Either of the above sprays can be used very effectively after cutting alfalfa. In these cases, narrow swaths of alfalfa should be left standing at intervals thruout the field and thoroly sprayed with one of the above poisons. This green strip will act as a trap row and innumerable hoppers will be killed. After the hoppers are all killed, this trap-strip should be cut and burned, to eliminate the danger of feeding to domestic animals.

There is one objection to the use of the spray method, and that is that it is rather hard to make the spray material adhere and spread on plants sprayed. This, however, can be partly overcome by adding about 3 pounds of common laundry soap to 100 gallons of the spray.

Arsenic-bran Mash.—This can be used effectively, and it is one of the very best methods for controlling a grasshopper plague. Mix thoroly, 25 pounds of bran with 1 pound of white arsenic or Paris green, and enough water to moisten it so that the mixture will adhere. About 3 gallons of water will be sufficient. Add 2 quarts of some common cheap syrup to keep the bran from drying out too readily and make it more attractive to the hoppers.

The above quantity of materials, properly strewn, is sufficient to sow around 5 or 6 acres and will completely cover 3 acres. This would cost about 30 cents per acre, figuring the cost of materials as they were the past season.

The poison should be sown broadcast where the hoppers are the most abundant. Avoid dropping it in piles, as more hoppers are reached and better results are obtained where the particles are as small as possible. This mixture should be used with care where domestic fowls are apt to feed, as there is danger of poisoning them. However, Dr. Morrill* reports that chickens will not eat this poison mash and that there is no danger to poultry when it is scattered broadcast. His report is as follows:

“Experimentation has shown that there is no danger to poultry from eating the bran mash if it is scattered broadcast. The writer has seen no dead wild birds over ground that was treated. One season a pan of the prepared bran mash was exposed where chickens could get it if they

*“Grasshopper Control,” N. Mex. College of Agriculture and Exp. Sta. Bul. No. 102, 1916, pp. 29-30.

wished. Only occasionally would one peck at the bran and then only desultorily. None showed any signs of poisoning.

“Reports have come to the writer of chickens dying from eating grasshoppers, both alive and poisoned. Such deaths were evidently due to over-eating of a food to which the fowls were not accustomed.”

Experiments were conducted the past season in Rio Grande County relative to the liability of poisoning pigs and cattle, and no ill resulted. *Figs. 2 and 3.) These experiments consisted in letting pigs and cattle graze on areas over which bran mash had

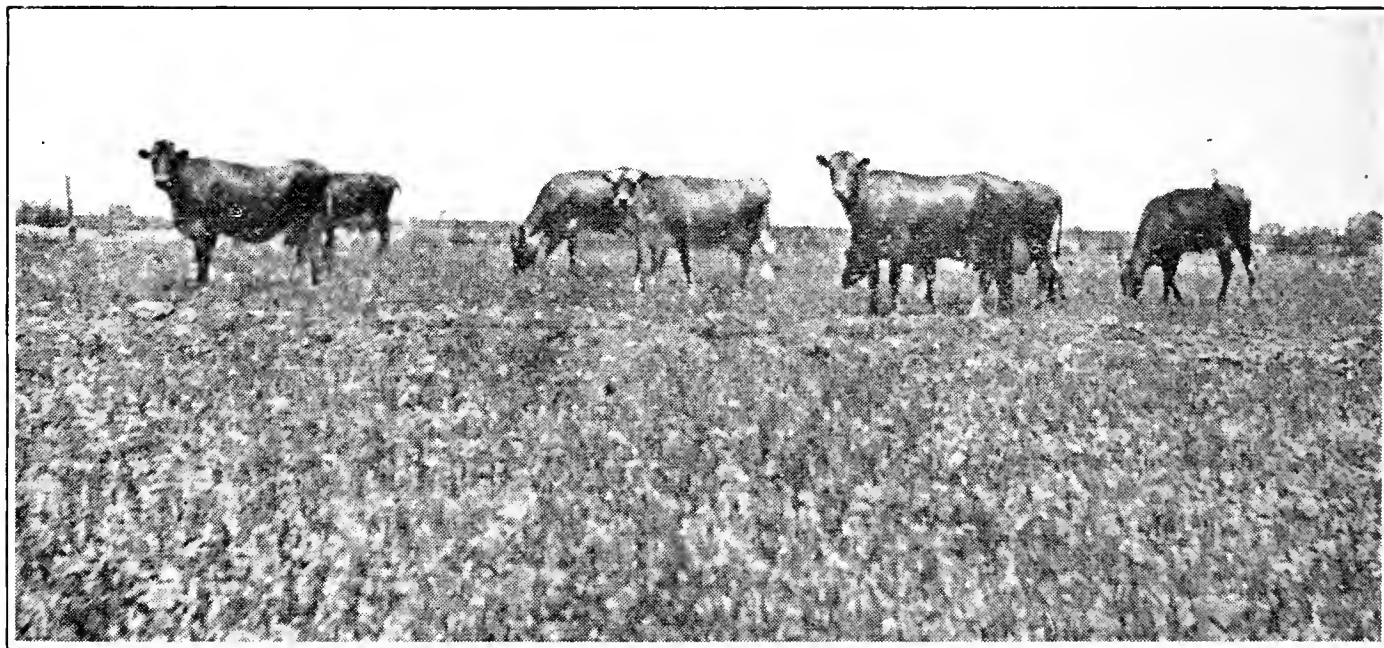

Fig. 2.—Part of a dairy herd in the San Luis Valley, where experiments were conducted relative to the liability of poisoning domestic animals by use of Paris green-bran mash, when properly applied in grasshopper control, 1916. (Original).

been strewn. In one case, 135 hogs grazed on 15 acres of poisoned alfalfa. On the third day, one pig died, but the post mortem examination showed no signs of poisoning. However, some stock died from poisoning, but upon investigation it was found, in all cases, that the poisoning occurred thru carelessness. One case, for instance, was where two calves died from licking a tub in which the poison mash had been mixed. This tub was left in the yard where the calves were running. Had it been cleaned, or turned upside down, the poisoning would not have occurred.

The following Kansas formula for poisoned bran mash for grasshoppers, developed by Professor M. F. Dean, is highly recommended by all who have used it, and gave decided results the

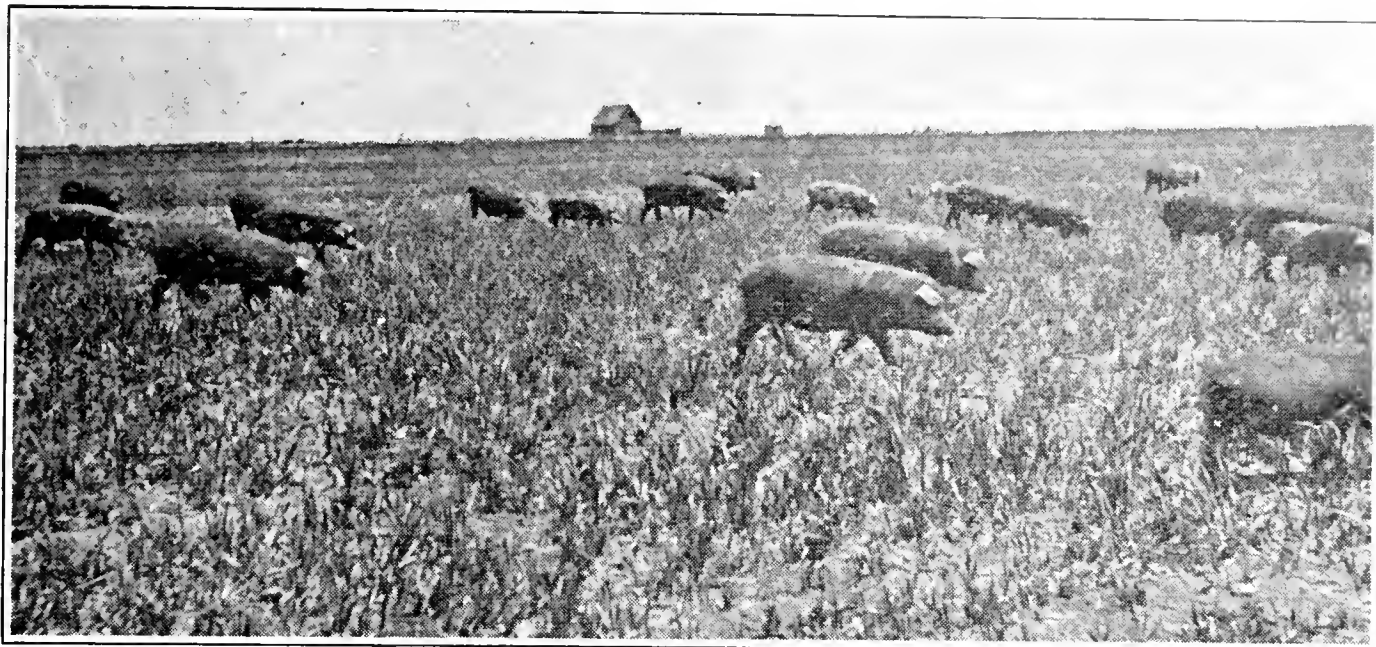

Fig. 3.—Part of the 553 hogs grazing on alfalfa after Paris green bran mash had been sown to control grasshoppers at the rate of eight pounds per acre. No animals were poisoned. (Original).

past season in the grasshopper control in the San Luis Valley and elsewhere:

Paris Green	3 pounds
Bran	50 pounds
Syrup (a cheap grade).....	1 gallon
Water	5 gallons
Lemons	10

Mix thoroughly the bran and Paris green while dry; dissolve the syrup in the water; squeeze the lemons into this, and finely chop the peel and pulp and add them also; pour this mixture into the bran and Paris green and stir so as to dampen the mash thoroughly. Then sow broadcast as thinly as possible. The above amount will cover, if properly applied, 6 acres of ground.

This Kansas formula has been used and checked with four other formulas: Bran, Paris green and water; bran, Paris green, syrup and water; bran, Paris green, syrup, lemon extract and water, and bran, Paris green, salt and water, and the results were decidedly in favor of the Kansas formula.

DISEASES

Grasshoppers, like other animals, are susceptible to diseases. There are two or three known to attack them:

First.—A fungous disease (*Empusa grylli* Fres.) (Figs. 5 and 6), which has been reported to be successful in grasshopper control, but later experiments have proved it to be of no practical value. It appears that under favorable conditions this disease will appear, with more or less virulence, and spread with

sufficient rapidity to cause the destruction of a large number of locusts.



Fig. 5.—Grasshoppers killed by the grasshopper disease, *Empusa grylli* Fres. Note how they cling in clusters at the top of the dead grass.

Several years ago the so-called “South African grasshopper fungus” was distributed to a large number of farmers in the State for trial against grasshoppers, and several very favorable reports were received, but the attempts at this Station to inoculate grasshoppers and spread the disease were an utter failure, both in the breeding-cage where the conditions of heat and moisture could be controlled, and in the fields. In no instance was any substantial evidence found that a single hopper had been killed by the fungus. It was decided that in every case reported, the hoppers were killed by the disease *Empusa grylli*, first mentioned above, or by parasites, and not at all by the fungus that was distributed.

A very striking peculiarity of *Empusa grylli* Fres. is, that it causes the hoppers to climb to the tops of the stems of alfalfa,



Fig. 6.—Grasshoppers killed by *Empusa grylli* Fres clinging to oat heads, Trinidad, 1916. (Original).

sweet clover, or other plants, where their dead bodies remain for days and weeks. (See Figs. 5 and 6.)

Professor Sacket*, bacteriologist of this Station, makes the following statement relative to *Empusa grylli* Fres.:

“Experiments carried on in co-operation with the Division of Entomology have demonstrated that the grasshopper is not susceptible to the organism when brought in contact with the ordinary form of the fungus, such as is obtained from the bodies of dead grasshoppers. In these experiments to which I refer, the grasshoppers were literally fed with the fungus, and the pure culture was spread upon their bodies. More than this, grasshoppers free from the disease were placed in breeding-cages with sick grasshoppers and grasshoppers dead of the disease, but, in spite of these numerous attempts to infect them, all remained healthy.”

*Twenty-fourth Annual Report, Colorado Agricultural Experiment Station, p. 20.

Second— A bacterial disease (*Coccobacillus acridiorum* D'H.) was reported by D'Herelle as having worked successfully in Argentina. Later experiments with this organism, both in the Philippine Islands* and in South Africa, have proved it useless after the infection of grasshoppers in the field.

Under artificial conditions, such as are found in a laboratory, these diseases may possibly be applied with good results, but as yet, no disease organism has been found that can be artificially applied with success for the destruction of grasshoppers in the field.

WORK OF 1916

During the past season, the losses caused by grasshoppers in Colorado were particularly large. Word was received from various parts of the State reporting outbreaks and requesting information relative to their control. The prevailing condition that favored this increase of hoppers is not exactly known, but in every locality where grasshoppers occur this same increase may be looked for in any season favorable to insect development.

The value and necessity of organization and co-operation to control these serious outbreaks of grasshoppers was early recognized in the southern part of the State, the first request coming from County Agent C. E. Smith, of Trinidad, Las Animas County, June 1. On June 10th, a like request was received from County Agent E. H. Thomas, of the San Luis Valley. Later, these were followed by County Agents W. H. Lauck and G. C. Burckhalter of El Paso and Morgan Counties, respectively, and others.

In Las Animas County and the San Luis Valley, the prevailing opinion for a time was that the remedial measures recommended by the county agents, such as sprays and poisoned baits were not effective. This was due to the fact that all the grasshoppers in a given locality were not immediately killed and those that were poisoned had crawled out of sight in secluded patches of grass or under rubbish and died.

An inspection of the farms about Trinidad and the adjacent communities revealed the fact that the grasshoppers were appearing in alarming numbers. At the evening meetings held at various places to discuss the situation it was ascertained that the county had had no previous outbreaks that would necessitate remedial measures. While the people were very enthusiastic, they seemed slightly skeptical as to the control of this pest. The demonstrations held at various parts of the county were always at-

*"A Test of the *Coccobacillus acridiorum* D'Herelle on Locusts in the Philippines," Philippine Jr'l of Sci., X, No. 2, Sec. B. Tropical Medicine, March, 1915, pp. 163-176.

tended by a good representation of the community, but the results obtained were not as satisfactory to the minds of the farmers as they should have been. This was due to the fact that the grasshoppers were, in every case, just hatching, thus furnishing a fresh supply over a period of time longer than the effectiveness of the poison. The hoppers being very small, from newly hatched to not over one-half grown, when killed, soon dried and were blown away, rendering it almost impossible to find any dead ones, and with the increasing supply of newly hatched ones it appeared as though the remedy was of no avail.

It was ascertained that Mr. C. E. Smith had made an application of the Kansas formula for bran mash on a small garden tract near Trinidad when the hoppers were over one-half grown. Here the results were clearly in evidence. Previous to the application, the hoppers were in a bean and cabbage garden in alarming numbers. Investigation showed these fields free of hoppers. In the adjacent, uncultivated, weedy areas they were plentiful, but up to the line of poison, or where the bran mash had been spread, they disappeared entirely.

Through the efforts of County Agent E. H. Thomas of the San Luis Valley, it was found that several methods of grasshopper control were in progress, such as sprays, poison bait and the hopper dozer.

The condition of hatching was about the same as in Trinidad, but the hoppers were slightly larger, and the same general opinion as to the effectiveness of poisons prevailed. However, the poisons were doing their work, but the hoppers dying in secluded places made it appear otherwise.

At the "West Side Farm", Mr. McArthur had sprayed a fifteen-acre tract of alfalfa with Paris green and reported his results as negative. Upon a close inspection it was found that the spraying had been very effective. On making various examinations thruout the field, it was ascertained that there were, on an average, 25 dead grasshoppers for each square foot of area. Figuring from the size of the hoppers in question, this gave a total of 5 bushels of dead hoppers per acre. Mr. McArthur had previously stated that, in a previous inspection made by him, he found only three dead hoppers. This was due to the fact that he did not know where to look for them. However, he admitted that the number of live hoppers had decreased materially, but it was his opinion that they had migrated to an adjacent field. The apparatus used in this experiment was an ordinary barrel spray with a series of 13 nozzles attached. (Fig. 7.)



Fig. 7.—A 13-nozzle beet spraying machine. The type that was used in the grasshopper campaign, 1916, San Luis Valley. (Original).

In fields where the Paris green bran mash had been applied and reported ineffective, an estimate as to the efficiency of the poison was made, and it was found that the dead hoppers averaged 37 to the square foot. On computation, it was found that, at this rate, there would be about 9 bushels of dead hoppers per acre.

The general prevailing opinion at that time was that the hopper dozer was more effective than the poison. This was undoubtedly due to the fact that the fruits of their labor were discernible and not scattered, as was the case with the poison. However, estimates showed that the spray and the poison bait were at least four times as effective as the hopper dozer.

Demonstrations relative to mixing and applying sprays and poisons in various communities were held, and always with a good attendance of interested farmers. Several trips were made to fields of peas, part of which had been plowed in the early spring, and the remainder left uncultivated, the peas being simply drilled into the old stubble as is the common custom in that vicinity.

The plowed areas demonstrated quite clearly the effect of early spring or fall cultivation for the destruction of eggs, as there were very few, or in most cases, no grasshoppers in the cultivated plots, while where the peas were simply drilled in the stubble, there appeared about as many hoppers as in the uncultivated fields of that vicinity.

An inspection of the infested areas of El Paso County revealed the fact that the same general opinion prevailed as in the San Luis Valley. However, it was found that the main trouble was in the mixing and application of the poison. The mixtures examined were poorly made, the syrup having been poured directly into the bran and Paris green, consequently causing it to be formed into small balls, so that it could not be applied properly. The applications were made from a tub of this mixture placed in the back of a buggy and driven promiscuously thru the fields.

Too much stress cannot be laid upon mixing and applying the poison, as the success of the application depends entirely upon these operations. If the points relative to mixing and applying, heretofore discussed, are carried out in detail, I believe there need be no trouble in controlling a plague of hoppers or from poisoning animals.

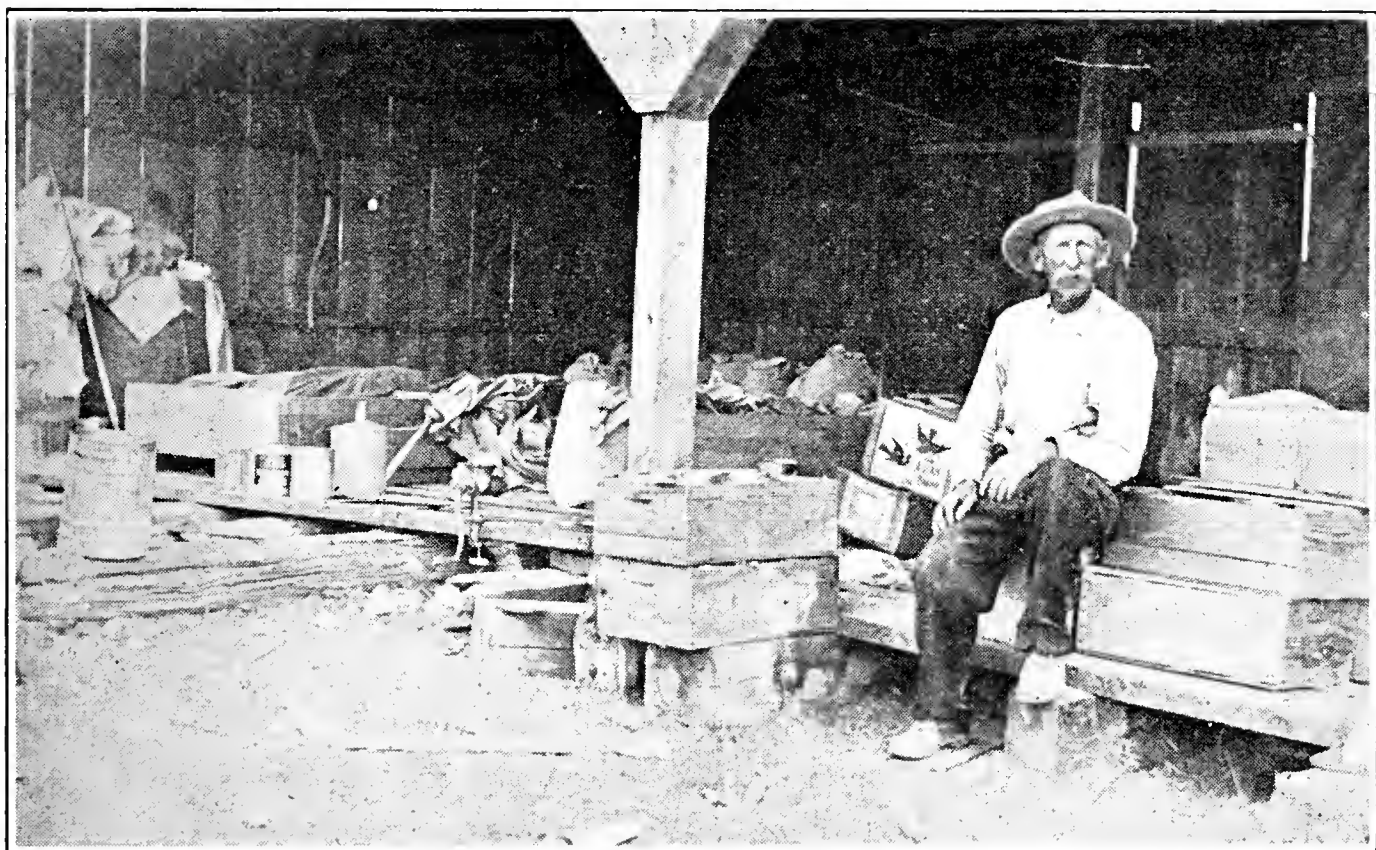

Shed in which was mixed by hand a large quantity of Paris green-bran mash during the grasshopper campaign, 1916, San Luis Valley (Original).

The conditions in Pueblo County were somewhat different than in the other infested territory, they having had a slight outbreak of hoppers two years previous and being informed as to remedial measures. The outbreak was not very alarming, but in most places where hoppers occurred, the bran mash had been applied with good results.

The campaign was taken up by County Agent Stanley V. Smith, thru the county commissioners, who furnished a given amount of Paris green to those who would apply it. This Paris green was distributed from various centers, consequently it had a wide distribution and was applied in many localities, but not in all cases where it should have been.

One field on Orchard Mesa was very badly infested, there being 7 acres of alfalfa which was almost entirely defoliated. The owner was distributing Paris green for the county and did not deem it necessary to apply it to his own land. Adjacent to this infested field were 15 acres of beans. The idea of the owner was to let the hoppers eat his alfalfa in order to save the beans. Had he applied the Paris green bran mash, he could have saved the entire crop. The yield would have been at least five tons, and hay was then selling at \$13.00 per ton. This individual was paying a toll of at least \$65.00 to the hoppers and not killing one, where he could have made an entire clean-up for \$5.00, had he applied the bran mash.

At the time of visiting the above place, the hoppers were leaving the defoliated alfalfa field and entering the bean patch around the edges. In all probability the entire bean crop was destroyed by the grasshoppers.

In accordance with the pest law, several pest districts were formed thruout the State, three in the San Luis Valley, two in Rio Grande, one in Saguache County, one in the Fountain and Mesa district in El Paso County, and three were arranged for in Logan County, giving in the latter an almost continuous district thru the Platte Valley from Messex to Red Lion. This covers the principal irrigated section of said county.

On July 1, a second trip was made to the San Luis Valley at the request of the commissioners of Rio Grande County, to further the work commenced in the grasshopper investigations and assist Mr. W. E. Kistler, who was to be the pest inspector for the above mentioned districts.

The first duty of the inspector was to check over various previously poisoned places to determine the effectiveness of the Paris green bran mash. The first forenoon, four farms were visited where there had been from 70 to 105 acres each, poisoned three weeks previous. The results were surprisingly good. In three out of the four farms visited, a complete eradication, instead of a control, had been effected. This was especially true on Mr. Tiner's premises. Mr. Tiner was the first man in that section to take hold of the poison bait method for grasshopper control, and

it was upon his farm that the first demonstrations were conducted. At that time the hoppers were so numerous that a complete devastation of his crop was threatened. On checking over the results, three weeks later, one had to go, on an average, from 30 to 60 steps before seeing a live grasshopper.

In a great many places in the valley, numerous pigs are raised and pastured on alfalfa, and in most cases these fields were badly infested with grasshoppers. The owners of such fields were skeptical about treating these fields for fear of poisoning their stock. While some were not afraid of the Paris green directly, they were afraid that the hogs would eat the dead hoppers and thus be poisoned. However, this point was cleared by Tiner, Drake, Arthur and Davis. Mr. Tiner had 28 spring pigs (Figs. 2 and 3) feeding at all times on the poisoned area, and the other men had 135, 243, and 175 pigs, respectively, of all ages, feeding upon grasshopper-infested pastures that had been sown with Paris green bran mash, and one pig died. The owner thought this pig was poisoned, but it is possible that one pig out of 553 could have died from some other cause than poisoning from the bran mash.

In the counties of Rio Grande and Saguache, San Luis Valley, practically all the infested land, where control work was conducted, was organized into pest districts and the farmers used the Paris green bran mash according to the Kansas formula. All materials used were purchased in large quantities and distributed from a central point, ready mixed.

In Rio Grande County, Mr. Fuller, a druggist of Monte Vista, furnished most of the poison used. This he mixed, upon application, and furnished to the farmers at a less rate than they could buy the materials at retail and do the mixing themselves. During the campaign he mixed and distributed:

6,550 pounds of Paris green
38 tons of bran
41 cases of lemons
1,380 gallons of syrup

However, this does not represent all the materials used in the two pest districts in his county, as a large quantity of Paris green was obtained from the sugar factory and some from Center.

In Saguache County, Mr. Sumpter, a druggist, furnished and mixed the materials used. An exact account of the amounts used was not kept, but it is safe to estimate that the quantity used was at least half that of Rio Grande County. A machine mixer, (Fig. 8) was used by Mr. Sumpter which greatly lessened the work of

mixing the poison. It consisted of a cylinder sufficiently large to hold at least 400 pounds of bran, revolving upon an axle, the power furnished by an old Ford machine. Only 100 pounds, dry weight, was mixed at a time. This gave plenty of room for mixing. The time required to mix and sack one filling was eight minutes.

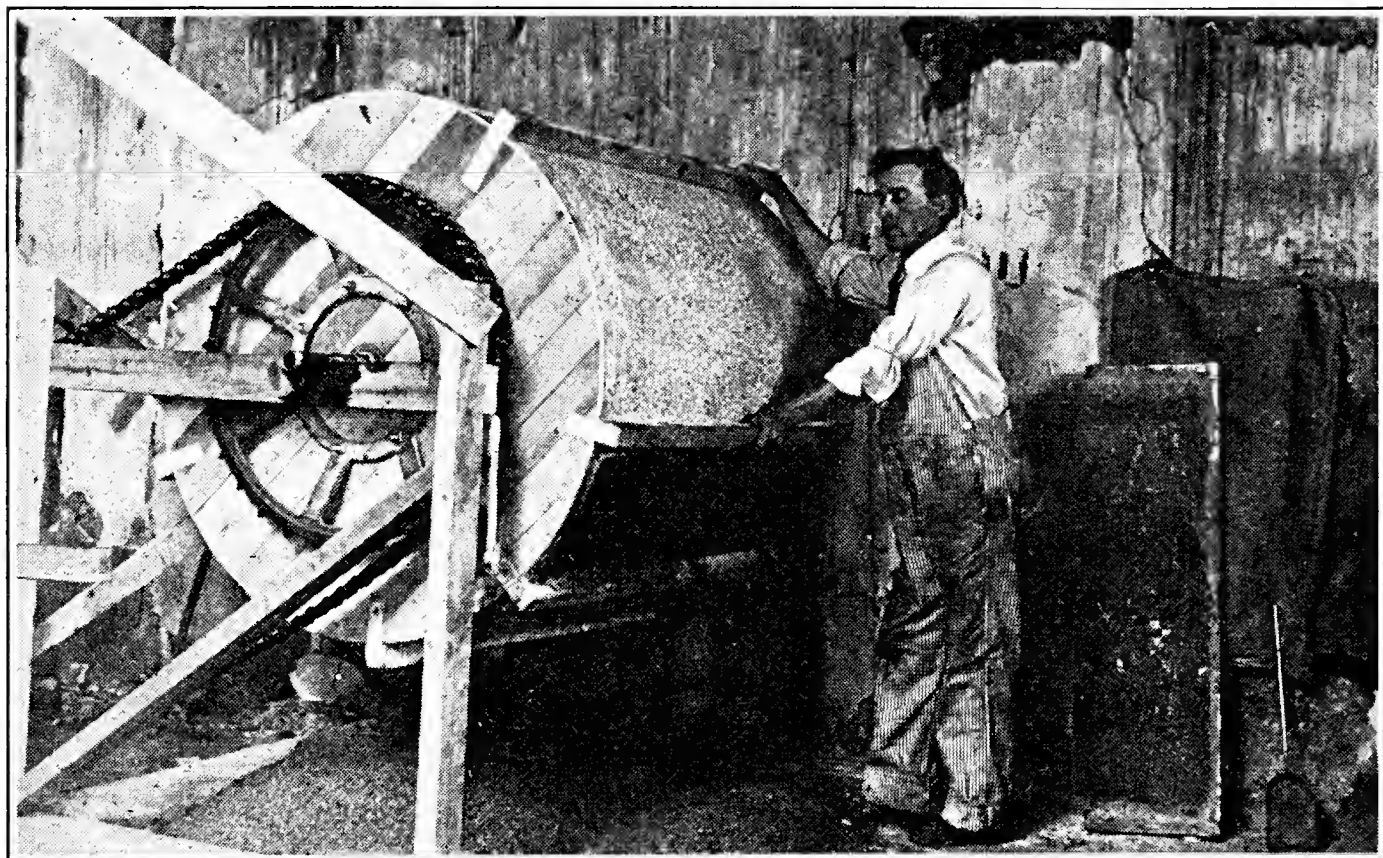

Fig. 8.—Sumpter mixing machine used to mix Paris green-bran mash, Center, Colorado, 1916. Time required to prepare, mix and sack 100 lbs., dry weight, of the bran mash, eight minutes. (Original).

In the San Luis Valley and elsewhere where the Kansas formula for poisoned bait was used, the results obtained, as a whole, were entirely satisfactory, the County Agent, E. H. Thomas, reporting a gain of from \$3 to \$5 per acre on something over twenty thousand acres in favor of the treated areas. In many cases a complete eradication, instead of control, was effected. The results are shown in the table on pages 28 and 29, which is compiled from information obtained thru a circular letter.

The question of grasshopper control is a very important one in any district where grasshoppers occur in sufficient numbers to warrant remedial measures. It is hoped that the results of our experimental and field demonstration work will convince the most skeptical person that the destruction of this pest in future outbreaks will be a very simple matter.

Farmers living in districts where grasshoppers are destructive or threaten destruction to crops, should organize at an early

date and order a sufficient quantity of necessary materials for distribution when necessity demands. The mixture should be applied in the evening, or in the early morning before the hoppers begin to feed. In fields where the hoppers are localized, the poison should be scattered over the infested areas. In fields where a total infestation occurs, it should be applied everywhere and at the rate of about 8 pounds to the acre.

THE FOLLOWING TABLE IS A SUMMARY OF THE INFORMATION OBTAINED IN AUGUST, 1916, RELATIVE TO THE RESULTS OF THE GRASSHOPPER CAMPAIGN IN THE SAN LUIS VALLEY, COLORADO.

The information in this table was supplied by the farmers whose names appear therein and the statements in the column headed "Remarks" were taken from their communications.

REPORTED BY	ACREAGE		Stock Poisoned	Grass-hoppers Appeared	Land Plowed	REMEDIAL MEASURES		REMARKS	
	Cultivated	Treated				What Used	Time Applied		Results
J. McLodgan	160	160	None	June	Spring & Fall	Bran Mash	July	Good	Only a few hoppers left.
Alice B. Cheney....	925	925	None	Spring & Fall	Bran Mash	July	Splendid	
Anna McCormick ..	155	100	None	May	Bran Mash	June	Good	Ravages effectively stopped. Killed cutworms also.
F. S. Jones.....	144	115	None	May	Spring & Fall	Bran Mash	May	98% perfect	Used dozer on pasture. Partial success.
Henry Seth	155	120	None	June	Spring only	Bran Mash	June	Killed them all	
A. J. Stoeber.....	249	100	None	April	Spring only	Bran Mash	May	Good	Poisoned pasture; lost no stock.
A. O. Miner.....	170	120	None	May	Spring & Fall	Bran Mash	June	Fine	Results entirely satisfactory
V. Drake	310	250	1 pig	May	Spring only	Bran Mash	June	Good	Poisoned pasture, grazing 135 head hogs; lost one.
I. P. Taylor.....	160	103	None	May	Early Fall	Bran Mash	June 15	Pest practically destroyed	Very favorable.
C. W. Myers.....	500	500	None	May	Spring & Fall	Bran Mash	June	Favorable	Bran mash a good remedy.
J. M. Arthur.....	1975	1975	None	April	Spring	Bran Mash	June & July	90% killed	Poisoned pasture. Lost no stock. Have 243 head.
F. H. Johnson.....	150	130	None	April	Spring	Bran Mash	June & July	75% killed	Results very satisfactory.
W. H. Towne.....	160	None	June 1	Spring	Bran Mash	June	Good	Dozer used, but abandoned it for poison.
Fred Schield	157	17	None	July	Summer 1915	Bran Mash	June	Favorable	
C. F. James.....	380	5	None	June	Spring & Fall	Bran Mash	Good	

G. W. Maxey.....	128	60	None	June	Spring & Fall	Bran Mash	Fair	Lost a few chickens.
E. C. Harper.....	116	80	None	May 15	Spring & Fall	Bran Mash	Very good	
E. G. Mathias.....	160	150	None	Spring & Fall	Bran Mash	Good	Sawdust used with fair results
W. E. Kistler.....	290	100	None	June	Spring	Bran Mash	July	Good	Used 200 lb. sawdust mixture; results good.
Cris Selters	503	100	None	June	Spring	Bran Mash	June	Fair	Results fair.
Felix Kaiser	145	30	None	June	Spring	Bran Mash	July 7	Very good	Plowing destroys many eggs.
James H. Neeley....	148	113	None	May	Spring	Bran Mash	Very satisfactory	Used spray, 2 lbs. Paris green to 1 bbl. water; results poor.
M. Metz	395	130	None	May	Spring	Bran Mash	June	Very good	Poisoned mash, best control. Not many left.
W. L. Starbuck....	450	60	1 calf*	May	Spring & Fall	Bran Mash	June	Very good	Got to mixing pan and licked it.
W. A. Elwood.....	110	30	None	July 1	Fall & Spring	Bran Mash	July	Good	No hoppers on fall plowed land.
C. G. Wright.....	296	150	None	May	Fall & Spring	Bran Mash	June	Very favorable	Land fall plowed had scarcely any hoppers.
J. W. Davis.....	368	368	None	May	Fall & Spring	Bran Mash	June	Good	175 hogs on poisoned pasture. Lost none.
O. A. Cramer.....	335	175	None	April	Fall & Spring	Bran Mash	July	Good	Used with good success elsewhere.
Seth Methias	440	440	None	April	Spring	Bran Mash	Very favorable	Used dozer; results good.
H. M. Wright.....	155	140	None	June	Spring	Bran Mash	June & July	Very good	
J. Becraft	260	40	None	May 15	Spring	Bran Mash	June	Extra good	Results very favorable.
E. W. Jackson.....	110	110	None	April	Spring	Bran Mash	May	Very favorable	Used 700 lb. poison, poisoned pasture; lost none of 78 head.
W. W. Wright.....	605	100	None	May	Fall & Spring	Bran Mash	Good	
Center	160	160	None	Fall & Spring	Bran Mash	Good	75 hogs on poisoned alfalfa; Lost none.
J. P. Warren.....	130	50	None	May	Spring	Bran Mash	June	Very good	
R. C. Dillon.....	155	20	None	Spring	Bran Mash	Very favorable	Used 200 lbs. on 20 acres.
E. E. Newmeyer....	205	150	None	May	Fall & Spring	Bran Mash	June & July	Good	Results very favorable.
B. H. Smith.....	150	140	None	June	Fall & Spring	Bran Mash	June	Cleaned up	





PRESERVATION REVIEW

11/5/04 _____

UNIVERSITY OF ILLINOIS-URBANA

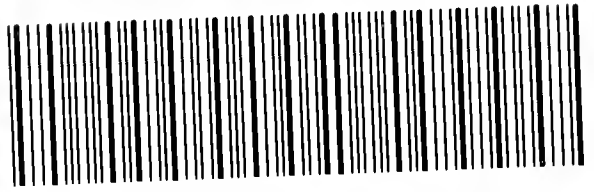

3 0112 062301772