

10
U8835
83
2 1

SOUTHERN CALIFORNIA ACADEMY OF SCIENCES

BULLETIN

Volume 83

LIBRARY

Number 2

AUG 31 1984

**NEW YORK
BOTANICAL GARDEN**



Southern California Academy of Sciences

Founded 6 November 1891, incorporated 17 May 1907

© Southern California Academy of Sciences, 1984

OFFICERS

Richard E. Pieper, *President*
Peter L. Haaker, *Vice President*
Camm C. Swift, *Secretary*
Robert G. Zahary, *Treasurer*
Robert J. Lavenberg, *Technical Editor*
Gretchen Sibley, *Managing Editor*

BOARD OF DIRECTORS

1982-1984	1983-1985	1984-1986
Jules M. Crane	William A. Akersten	Charles P. Galt
Michael H. Horn	Takashi Hoshizaki	Peter L. Haaker
Richard E. Pieper	Steven N. Murray	Harlan Lewis
John D. Soule	Camm C. Swift	June Lindstedt-Siva
Gloria Takahashi	Robert G. Zahary	Martin L. Morton

Membership is open to scholars in the fields of natural and social sciences, and to any person interested in the advancement of science. Dues for membership, changes of address, and requests for missing numbers lost in shipment should be addressed to: Southern California Academy of Sciences, the Natural History Museum of Los Angeles County, Exposition Park, Los Angeles, California 90007.

Annual Members	\$ 15.00
Student Members	10.00
Life Members	300.00

Fellows: Elected by the Board of Directors for meritorious services.

The *Bulletin* is published three times each year by the Academy. Manuscripts for publication should be sent to the appropriate editor as explained in "Instructions for Authors" on the inside back cover of each number. All other communications should be addressed to the Southern California Academy of Sciences in care of the Natural History Museum of Los Angeles County, Exposition Park, Los Angeles, California 90007.

Date of this issue 15 August 1984

Algal Distributions and Temperature: Test of an Hypothesis Based on Vegetative Growth Rates

Joan G. Stewart

Abstract.—Algal distributions and temperature: test of an hypothesis based on vegetative growth rates by Joan G. Stewart. *Bull. Southern California Acad. Sci.*, 83(2):57-68, 1984. Vegetative growth rates were measured for five species of red algae in response to different water temperatures under laboratory conditions to consider whether the behavior of the plants might help explain the restriction of certain taxa to subtidal habitats off southern California coasts. The thalli from which cultures were initiated were adult—i.e., of a size characteristic of collected non-juvenile specimens in natural populations. All thalli grew more rapidly at warmer temperatures (16°C or 20°C) than at 12°C indicating that these species are not segregated into colder or warmer habitats by direct effects of temperature on vegetative growth.

Hutchins' often cited comment (1947) that restricted north-south distributions for most near-shore marine organisms can be interpreted largely in terms of water temperature, was based in part on data for benthic algae (e.g., Setchell 1915). More recent analyses of correlations between latitude, water temperature data, and algal floras as summarized by Murray and Littler (1981) and Murray, Littler, and Abbott (1980) for the Pacific coast of North America, led to similar conclusions and temperature accordingly is presumed to be a primary regulator of algal distributions (Abbott and North 1972). Murray and Littler (1981) stated that surface water temperature is important in "determining the distributions of southern California macrophytes," and Thom (1980) contended that water temperature is the "overriding factor causing changes in algal species composition along the southern California coast line." Such comments can be countered by arguing that in many studies distributional records are incomplete, available temperature data are not relevant to algal habitats, and that methods of gradient analyses are based on a measure of circularity, to varying degrees, although Hill (1973) defends their theoretical validity to produce useful information. A fundamental problem is the uncertainty about the relationship between current nomenclature and "species."

The apparent relationship between algal distributions and temperature has historically depended primarily on correlations of species lists with latitude. Two secondary correlations also have been described in support of the general hypothesis. Several species that are easily recognized and identified are common in low intertidal zones in central and northern California but are found only in deep subtidal sites beneath the summer thermocline, in San Diego County. Of the 10-12 species I can cite in this category, *Polyneura latissima* is perhaps the best known example. Secondly, along the Pacific coast of Baja California there are intertidal localities where the algal flora contains large populations of species absent from southern California but common again north of Santa Barbara. Dawson (1945) first associated the disjunct Mexican occurrences with areas where

upwelling brought colder water close to shore. Recent surveys have located additional sites where northern taxa are conspicuous intertidally in sharp contrast with long stretches of coastline where the vegetation resembles that found in southern California (Aguilar et al. 1982, and pers. comm.).

None of these correlations of presence/absence data with water temperature data have been studied experimentally in ways that explain the observed distributions. The series of culture experiments described in this study were undertaken with the objective of considering the possibility that relative growth rates of post-juvenile stages of species in both shallow water and deeper sites may be adapted to warmer or colder water.

Available records (Abbott and Hollenberg 1976; Norris 1975; Dawson 1953, 1962, 1963a, b) indicate that the geographic ranges of the 8 species reported on here are different but overlapping. *Branchioglossum woodii* (J. Ag.) Kyl. grows from British Columbia to the Gulf of California. On the Pacific coast it is found largely in subtidal habitats and colder water, but in the Gulf of California intertidal specimens including the clumps from which my cultures originated, occur where water can reach 33°C (Roden 1964). *Tiffaniella snyderae* (Farl.) Abb. has a similar north-south range but it is often abundant on low intertidal rocks as well as subtidally in southern California. Although a delicate form of this species was recognized by Dawson in Gulf collections, Norris (1975) has not found specimens in his recent collections from the Gulf of California. *Platythamnion pectinatum* Kyl. is known from only subtidal collections within the Pacific Coast range reported for *B. woodii* and *T. snyderae*.

Heterosiphonia erecta Gardn. has been found subtidally at the southern California islands and south from Los Angeles County to Baja California. Norris (1975) has recorded it from cold-water sites near Bahía de los Angeles in the Gulf. The San Diego plants used in this study came from a low intertidal habitat where it is seasonally (winter) abundant. Geographic and vertical distributions of *Sorella delicatula* (Gardn.) Hollenb. are similar to *Heterosiphonia erecta*.

Gelidium nudifrons Gardn. is restricted to subtidal sites on the mainland of southern California, the southern California islands, and south to Pta. Santa Rosalia in Baja California on the Pacific coast.

Lomentaria hakodatensis Yendo was aligned with warm water floras (Abbott and North 1972) on the basis of published records from southern California to Costa Rica including tropical regions of the coast of Mexico. The several syntypes (Dawson 1963a) however, are from between 42°–45°N on Hokkaido Island in northern Japan. Several Baja California specimens (Dawson 1963a) came from sites with colder upwelled water such as Punta Lobos near Todos Santos. I have found occasional specimens in the mid-low intertidal zone and subtidally to 20 m in San Diego County but it is never abundant.

Phrix gregarium (Daws.) Stewart is apparently confined to beneath-thermocline subtidal habitats; it has been found off southern California, in the Gulf of California (Stewart 1974), and at the Galápagos Islands (Richard Moe, pers. comm.).

Materials and Methods

Cultures were established from apical pieces cut from fullsize (=adult) thalli collected from habitats that are typical for each of the species in San Diego County, except for *Branchioglossum woodii* that was collected from shaded sides of low

Table 1. Conditions, inocula, and sample size (n) for growth experiments.

Species	Figure	Duration of experiment	Apical segments in each dish (n); initial length	Light regimes	Temperatures tested
<i>Gelidium nudifrons</i>	—	140 days	unbranched n = 3 single branch initial 6–10 mm n = 3	12-12	12°C, 16°C
<i>Tiffaniella snyderae</i>	Table 3 A,B	8 days	n = 14	8-16, 12-12,	12°C,
		18 days	n = 10 3–6 mm, 10 cells	16-8, 20-4	16°C, 20°C
<i>Lomentaria hakodatensis</i>	Table 2, Figs. 1, 4	54 days	n = 3	8-16,	12°C,
			4 mm, unbranched	16-8	16°C, 20°C
<i>Branchioglossum woodii</i>	Figs. 2, 5	50 days	n = 6	8-16,	12°C,
			3 mm, unbranched	16-8	16°C, 20°C
<i>Heterosiphonia erecta</i>	Fig. 3	82 days	n = 5	8-16,	12°C,
			3–5 mm,	16-8	16°C,
			1–2 branch initials		20°C

intertidal tidepools at Puerto Peñasco, Sonora, Mexico. All stock cultures were grown for several months under the same conditions: 12°C, 8 h light : 16 h dark under the low illuminance levels used later in the experiments. For experiments, replicate subcultures were grown in 200 ml modified von Stosch medium (Murray, Dixon, and Scott 1972) in deep Petri dishes as described in Table 1. Illuminance levels, between 50–75 ft c measured with a Weston 703-67 meter ($\sim 10.76\text{--}16.2 \mu\text{E m}^{-2} \text{s}^{-1}$), approximated ambient subtidal conditions rather than light levels in shallow water or on exposed intertidal rocks. Light conditions were not the same for all species but within the experiments with each species all dishes received similar amounts of light from 40 W Cool White fluorescent lamps.

The algae of this study, like most Rhodophyta, elongate by divisions in apical cells. Tips cut from healthy unialgal cultures therefore include the apical meristems and their growth can be measured and compared. As long as these segments remained unbranched or with few branches, lengths were individually measured with a dissecting microscope. When branching interfered with the accuracy of this method, the thalli were xeroxed or photographed for visual comparison (Figs. 4, 5) or weighed to give numerical data (Figs. 2, 3). *Tiffaniella snyderae* is uniseriate, with large cells. Because only the apical cell of each cell row divides, the number of cells and their respective lengths can be assessed as measures of growth. These several methods of recording growth were used in combinations when necessary, to compare in the most precise way the growth of small amounts of thallus tissue in each of the morphologically different species.

Results

For *Lomentaria hakodatensis* the mean lengths of primary axes (vertical lines), secondary (diagonal lines) and third order (horizontal lines) branches after 19

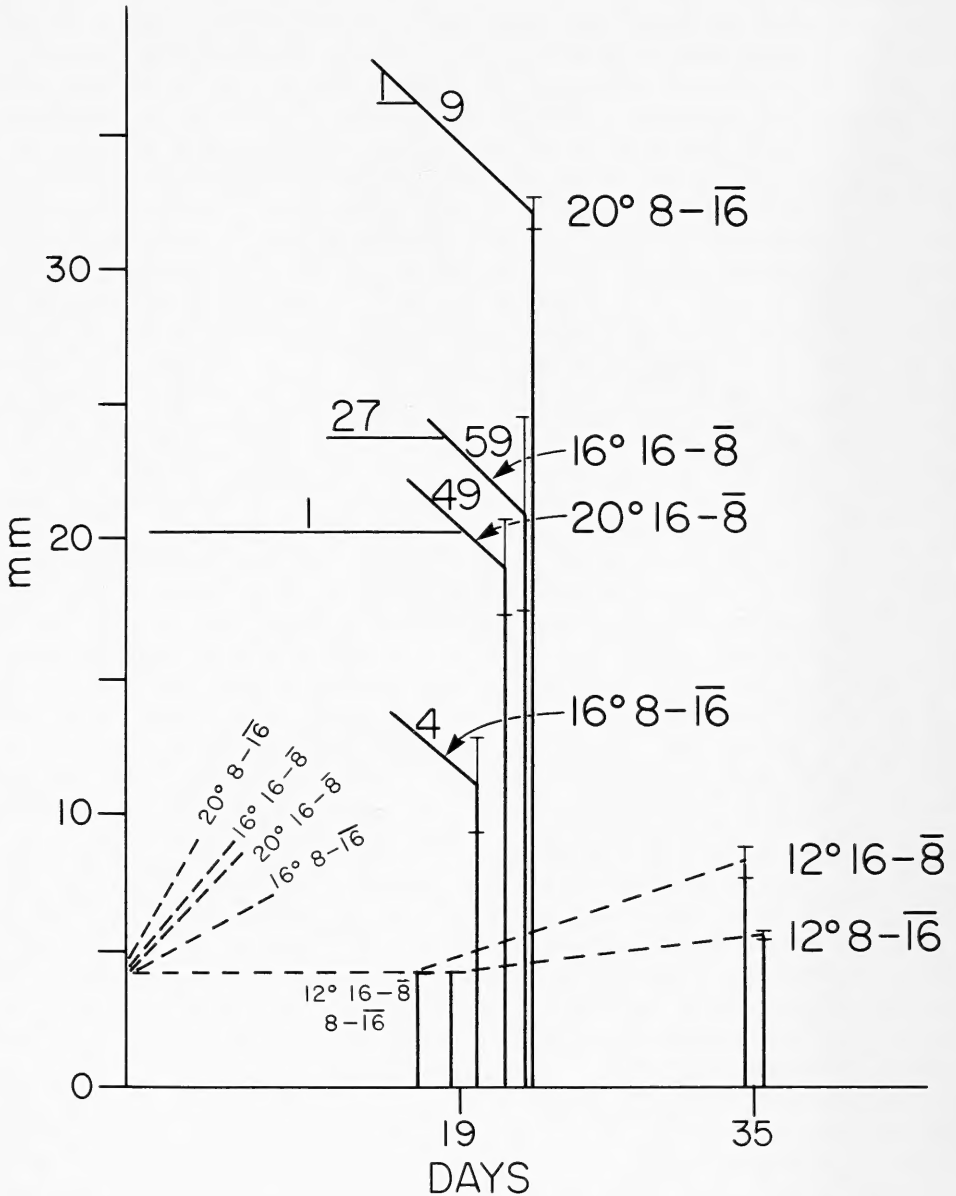

Fig. 1. Elongation and branching under six culture conditions: *Lomentaria hakodatensis*. Standard deviations are included for primary axes. Numbers on diagonal lines = number of secondary branches and the length of the line corresponds to mean length. Third order branching is similarly described with horizontal lines.

days are compared in Figure 1. The total numbers of each branch order are shown over the lines in Figure 1 and are summarized in Table 2. Maximal branching and growth occurred at the warmer temperatures and longer daylengths. Growth of 12°C plants was measured after 5 weeks (Fig. 1); soon after this the cultures became overgrown with contaminants and were discarded. Cultures at 20°C 8-16

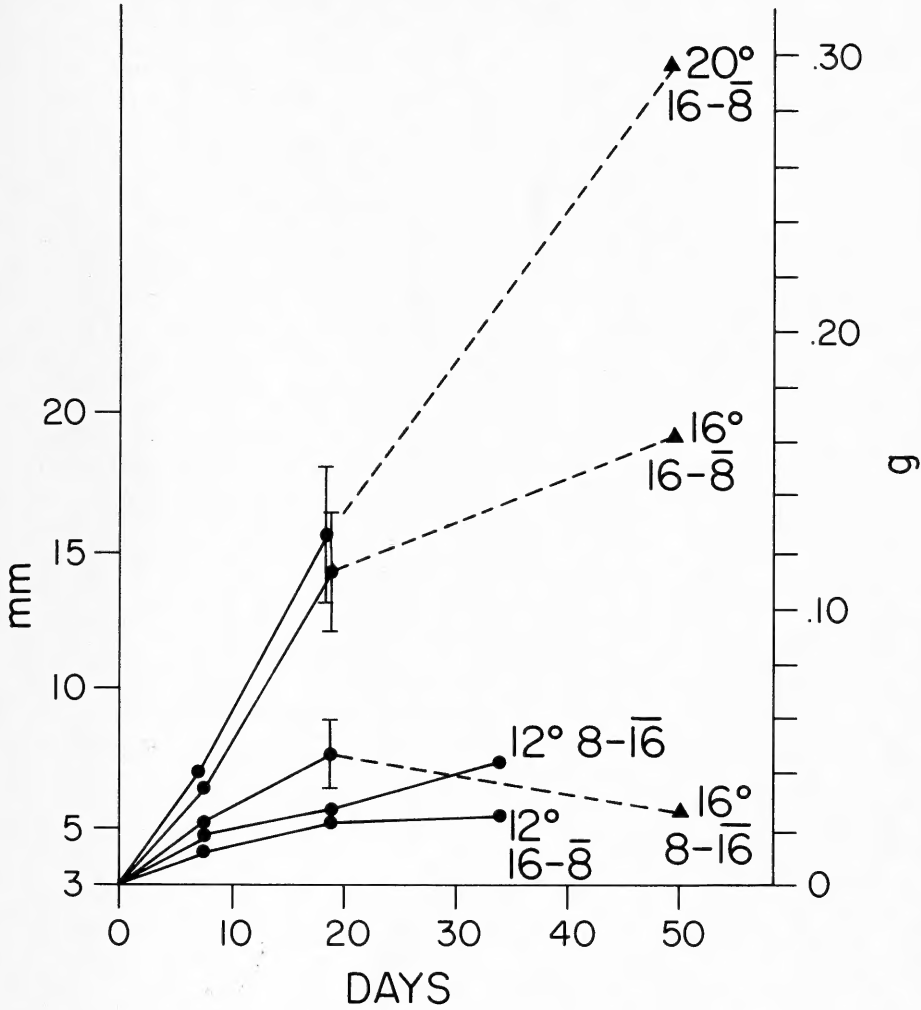

Fig. 2. Vegetative growth, in mm (elongation) ● and g (weight) ▲ under five culture conditions: 2, *Branchioglossum woodii*. Standard deviations for all 12°C cultures, and for 16°C and 20°C on Day 7 were ≤ 1.86 mm.

were killed when the room overheated prior to Day 52, when the remaining dishes from the experiment were photocopied as illustrated in Figure 4. Throughout the period thalli grew less with 16 hours than with 8 hours of light at 20°C but at 16°C and 12°C growth was greater at the longer light period. After the first 20 days at 16°C, 16-8 the main axes had elongated approximately five times the initial length, while at 20°C, 8-16 comparable elongation was eight times. Little or no growth had occurred at either day length at 12°C.

The number of branches initiated at both 16°C and 20°C was distinctly greater with longer light, but only a single third order axis was produced at 20°C, in contrast with the 27 that developed at 16°C. Thalli of field-collected specimens are uncinata, with curved hook-like tips. In culture this same morphology de-

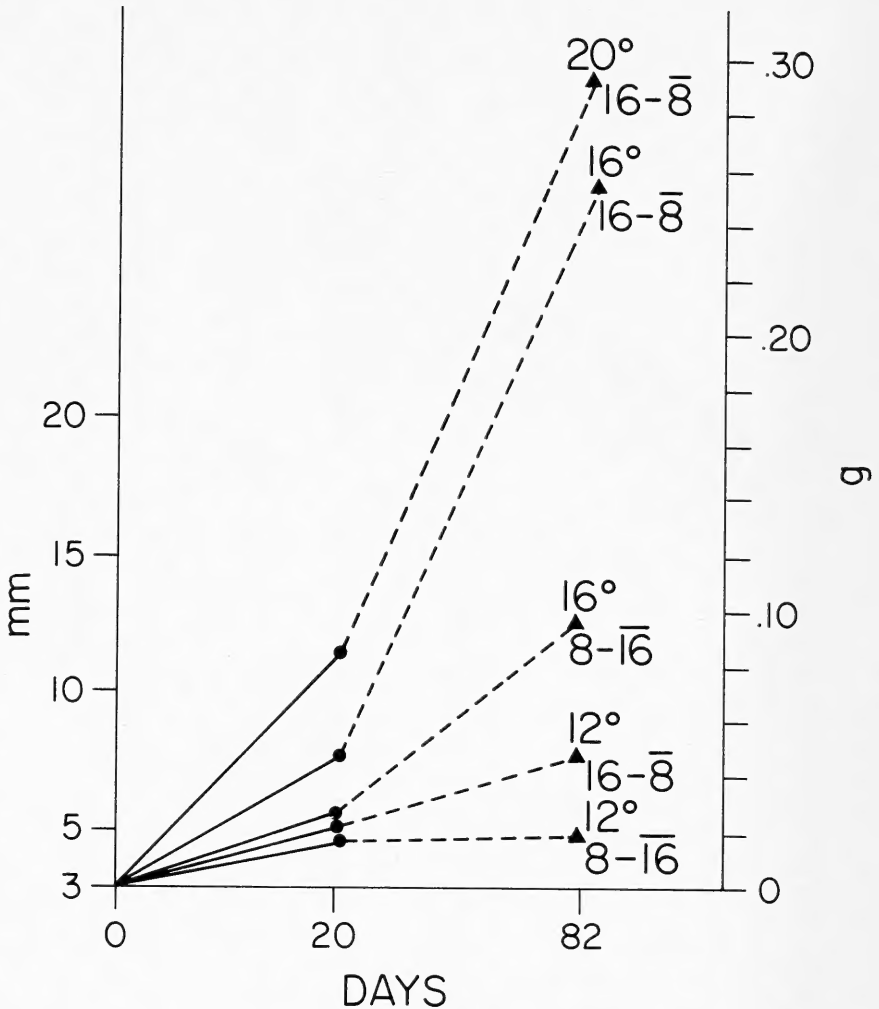

Fig. 3. *Heterosiphonia erecta*. All standard deviations were ≤ 1.34 mm.

veloped within 4 mm behind free-floating apices and in this characteristic the laboratory plants resembled typical naturally occurring plants.

Branching in *Branchioglossum* species is irregular and variable (=indeterminate) and at 12°C no branches formed in cultures. At 16°C 8-16 few short branches developed, but at both 16°C and 20°C with 16 hours of light, numerous branches were initiated, grew, and branched repeatedly, making it virtually impossible to measure the lengths of original axes after three weeks. The final growth is shown with weight data in Figure 2 and photographs in Figure 5. None of the cultures became pale or changed color during the nearly two months of experimental growth.

Heterosiphonia erecta developed typical close, regularly-spaced sympodial branching under all growth conditions and consequently after 20 days the original primary axes could not be accurately measured. The final comparison of growth

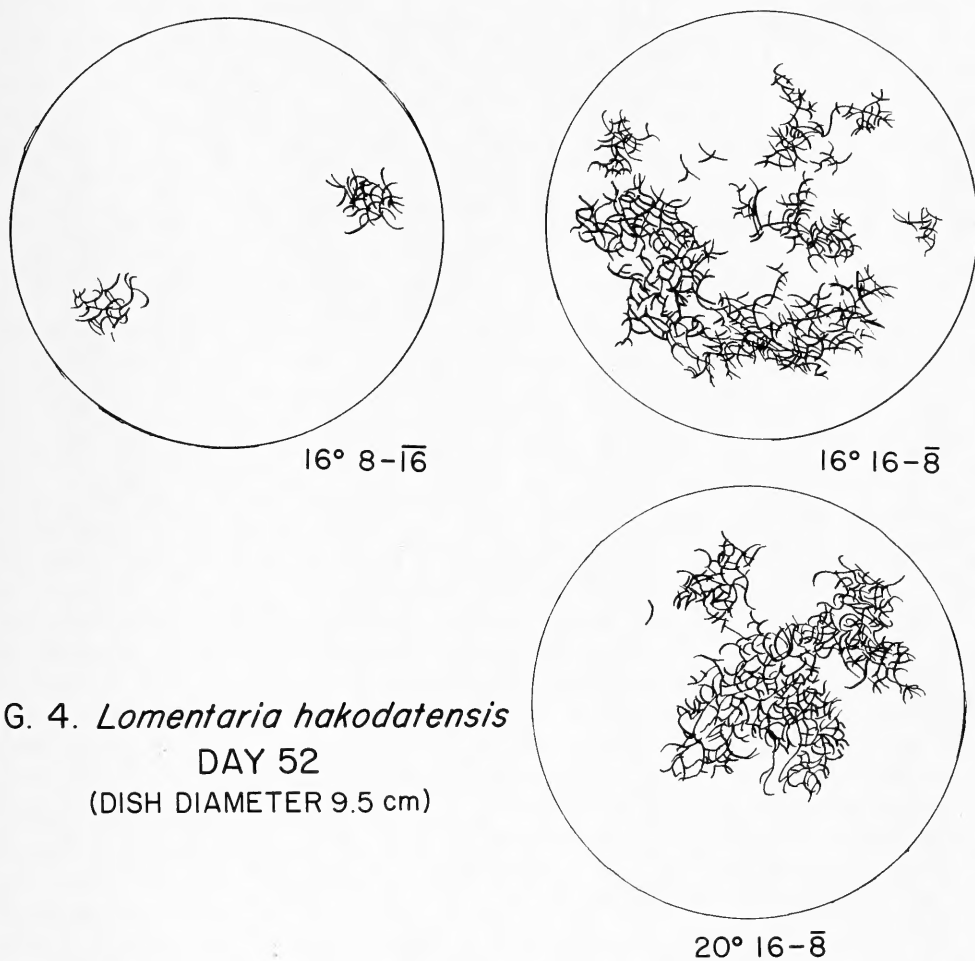

FIG. 4. *Lomentaria hakodatensis*
DAY 52
(DISH DIAMETER 9.5 cm)

Fig. 4. Comparative growth of three cultures of *Lomentaria hakodatensis* after 52 days.

relied on weights (Fig. 3). At 20°C 16-8 the thalli became greenish-yellow after several weeks although growth continued. At 16°C 16-8 the thalli remained bright pink throughout the several months of growth.

Elongation rates for *Branchioglossum woodii* (Fig. 2) and *Heterosiphonia erecta* (Fig. 3) were similar, with mean elongation 2-4 times the initial length after 20 days at 16°C and 20°C, 16 hours of light. There was less visual contrast between the appearance of these two sets of conditions and cultures grown at 12°C than was found in *Lomentaria* cultures.

Judging from many collected specimens of *Gelidium nudifrons*, sparse and irregular branching is characteristic of plants wherever they grow. The only two branches that were initiated on cultured thalli did not grow beyond 1-2 mm in length. Apices grown for 7 weeks at 12°C grew an average of 0.57 mm week⁻¹; the same apices transferred to 16°C and grown for another 10 weeks with the same (12-12) period of light, grew an average of 0.92 mm week⁻¹. Preliminary

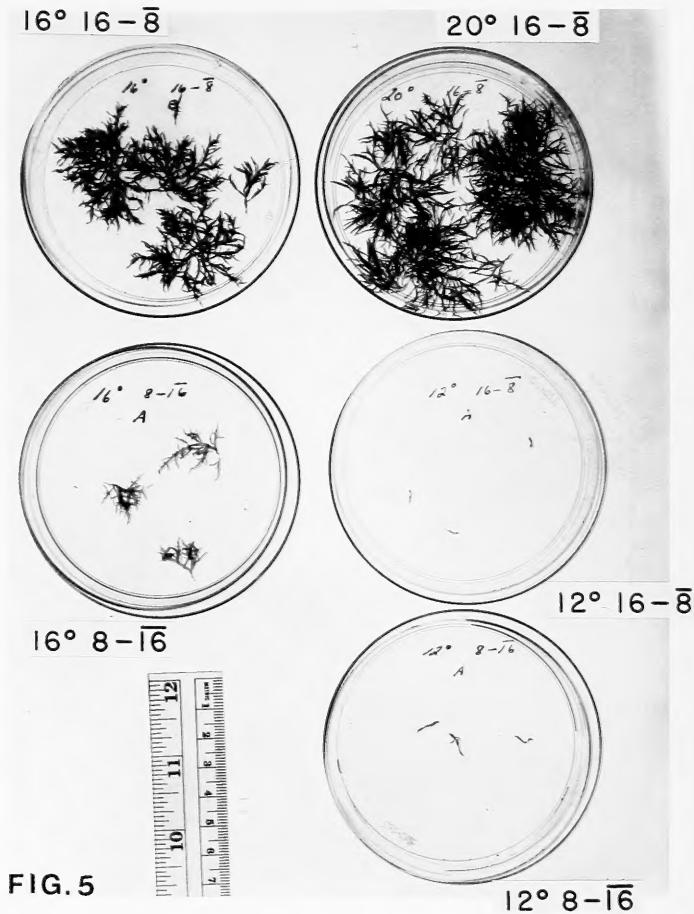

FIG. 5. Comparative growth of five cultures of *Branchioglossum woodii* after 50 days.

experiments showed no consistent differences between 8, 12, and 16 h of light when the cultures were grown at $12^{\circ}\text{C} \pm 2^{\circ}\text{C}$.

Results of two experiments with *Tiffaniella snyderae* are shown in Table 3. In A (8 days, 12°C) more branches were initiated at longer day lengths but the division rates of apical cells in the branches remained constant. In B (18 days, three temperatures, two light periods) branching was markedly greater at 20°C than at 16°C . At 16°C more branches were initiated with more light. Elongation of the original filaments and of branches, shown in Table 3-B as the # of cells/branch, and \bar{x} cells in primary (1°) filament, was similar under both light periods at each temperature but increased with temperature. The difference between the two variables at 16°C ($16\text{-}\bar{8}$) and at 20°C ($16\text{-}\bar{8}$) was highly significant: $P < 0.1\%$, t -test.

Subcultures of *Phrix gregarium*, *Sorella delicatula*, and *Platythamnion pectinatum* were grown under the low light levels used in the preceding experiments, with temperatures between $12\text{-}24^{\circ}\text{C}$. Measurement data were inadequate for quan-

Table 2. *Lomentaria hakodatensis*. Number of branches after 19 days laboratory growth.

	# 2° branches	+	# 3° branches	=	Total
12° 8-16	0		0		0
12° 16-8	0		0		0
16° 8-16	4		0		4
16° 16-8	59		27		86
20° 8-16	9		1		10
20° 16-8	49		1		50

titative comparison, but none of the thalli showed enhanced growth at lower temperatures that correspond to the conditions in the subtidal habitats where they occur.

Discussion

The temperature range tested is realistic for southern California macroalgae. Surface water temperatures at the end of the pier at Scripps Institution of Oceanography, La Jolla, range between approximately 11°C and 23°C with a typical yearly mean of about 16°C (SIO 1981). A year-long record of subtidal (20–27 m) nearshore temperatures (Clarke 1968) shows that the water was between 12–16°C on most days, with a minimum of 11.5°C and a maximum of 17°C.

From central California northwards to Washington, mean coastal surface water temperatures often fall to 11°C with yearly ranges typically between 7–16°C (SIO 1981).

The same trend—increased growth rates at warmer temperatures—summarizes culture studies of all the red algae I have grown in the laboratory. In general, growth of California species is negligible below 12°C, and most thalli bleach and die within days above 24°C. For most cultures, 20°C proves useful only when combined with low light levels, corresponding to subtidal conditions. The data of this report do not support the hypothesis that algae growing in sub-thermocline colder water, below 10–13 m in San Diego County, are at an advantage in these habitats because of enhanced vegetative growth nor that they are excluded directly from intertidal sites because of slower relative growth in warmer water.

Kapraun (1980) has published data from culture studies of small red algae also indicating that growth of adult thalli increases with temperature, rather than reflecting differential adaptations to differing vertical or geographical distributions.

In tests of the effects of temperature on photosynthetic rates of *Gastroclonium coulteri*, Hodgson (1981) found that in this alga of low intertidal zones photosynthetic rates reached a maximum at 17°C but dropped only slightly over the range 5–30°C. Photosynthetic temperature optima for four perennial mid-to-deep subtidal red algae in New England were seasonally variable over a wide range of temperatures between 1–31°C (Mathieson and Norall 1975).

Although thalli representing species with different deep/shallow distributions were not distinguished by the nature of their growth responses, the absolute growth rate of one species was clearly different from rates of other species: *Gelidium nudifrons* data show maximum elongation increments of less than 1 mm week⁻¹ compared with rates for *Lomentaria* (0.33 mm week⁻¹ at 12°C to 9 mm week⁻¹ maximum) and *Branchioglossum* and *Heterosiphonia* species (1.0–1.5 mm week⁻¹

Table 3. Elongation and branching: *Tiffaniella snyderae*.

	# branches/ 100 cells	# cells/ branch	Σ cells in branches	\bar{x} cells in 1° filament
(A.) Eight day experiment				
12° 8- $\overline{16}$	4.7	2.67		
12° 12- $\overline{12}$	7.6	2.00		
12° 16- $\overline{8}$	13.6	2.23		
12° 20- $\overline{4}$	13.6	1.83		
(B.) Eighteen day experiment				
12° 8- $\overline{16}$	11.6	1.97	71	15.5 \pm 1.44
12° 16- $\overline{8}$	10.4	1.94	66	16.3 \pm 1.53
16° 8- $\overline{16}$	17.9	4.55	323	22.0 \pm 1.50
16° 16- $\overline{8}$	45.6	6.57	1,281	26.7 \pm 2.87
20° 16- $\overline{8}$	60.3	9.68	3,388	30.5 \pm 3.52

at 12°C to 4 mm week⁻¹ maximum). Populations of these three latter species (and *Tiffaniella snyderae*) appear and disappear within weeks in the field. The complete life cycle of *Sorella delicatula* has been completed within 6–8 weeks in culture (Stewart 1977) with a calculated growth rate of ~ 2 mm week⁻¹ for blades that were producing branches. By contrast, in the field *Gelidium nudifrons* thalli 25–28 cm tall often are found, presumably representing several years' growth. The rates observed in culture for this species are similar to rates measured in subtidal field populations of *G. robustum* (1–2 mm week⁻¹) (Barilotti and Silverthorn 1972) and for cultures of *Pterocladia capillacea* (1–2 mm week⁻¹, 12–20°C) (Stewart 1984). *G. robustum* and *P. capillacea* are both perennial species. These comparisons provide evidence for a relationship between growth rate and thallus longevity.

Growth of main axes, measured in this study, involves both cell divisions and elongation in one direction, while branch growth is preceded by cell divisions at a different angle from the subtending axis. The three short-lived species that initiate secondary axes in an indeterminate manner showed increased branching with warmer temperatures and, under the same temperature condition, with longer light periods. The number of secondary branches of *Lomentaria hakodatensis* varied (4–59) with temperature but their mean elongation was similar under three of the four regimes, suggesting that initiation processes and growth respond dissimilarly to the factors tested. In the species with determinate arrangements of secondary and higher order axes, branching was unaffected by the various regimes.

Data in Table 3-B suggest that combined effects of increased light and temperature in shallow water habitats would produce densely branched *Tiffaniella* thalli by comparison with thalli growing where there is less light and in colder water. This observation corresponds with the conclusion by Waaland and Cleland (1972) that variation in light intensity and photoperiod produced striking changes in morphology of *Griffithsia pacifica* by means of controlling branch development. They describe sparsely branched forms from low light conditions and much-branched thalli under longer days.

Reproduction and responses of early germlings to light and temperature are

often suggested as critical to the establishment and maintenance of algal populations and there are numerous studies that document differential effects of environmental factors on these stages. Some data relating to this suggestion are conflicting or ambiguous (i.e., Figs. 3, 5, 7, 8 in Kapraun 1980) while other studies report results that clearly support the idea (Fain and Murray 1982). Dixon (1965) cites examples of several species where reproductive and sterile plants occur over different geographical ranges but temperature does not necessarily directly regulate these or other observed latitudinal or seasonal patterns, at least for benthic algae.

Despite the historical emphasis on the role of temperature in biogeographical studies the available experimental data for marine macroalgae do not point to any simple nor single link between described distribution patterns and water temperature data.

Acknowledgments

The laboratory work depended on space and facilities provided and shared over several years by R. A. Lewin. I appreciate the comments of S. N. Murray, who read an early draft of the manuscript.

Literature Cited

- Abbott, I. A., and G. J. Hollenberg. 1976. *Marine Algae of California*. Stanford University Press, 827 pp.
- , and W. J. North. 1972. Temperature influences on floral composition in California coastal waters. Pp. 72–79 in *Proceedings of the Seventh International Seaweed Symposium*. (K. Nisizawa, ed.), John Wiley & Sons, New York, N.Y.
- Aguilar Rosas, L. E., R. Aguilar Rosas, I. Pacheco Ruíz, E. Bórquez Garcés, M. A. Aguilar Rosas, and E. Urbieta González. 1982. Algas de importancia económica de la region noroccidental de Baja California, Mexico. *Ciencias Marinas (Mex.)*, 8:49–63.
- Barilotti, D. C., and W. Silverthorne. 1972. A resource management study of *Gelidium robustum*. Pp. 255–261 in *Proceedings of the Seventh International Seaweed Symposium*. (K. Nisizawa, ed.), John Wiley & Sons, New York, N.Y.
- Clarke, T. A. 1968. Territorial behavior and population dynamics of the Garibaldi, *Hypsypops rubicunda* (Girard). Scripps Institution of Oceanography, University of California, Dissertation.
- Dawson, E. Y. 1945. Marine algae associated with upwelling along the northwestern coast of Baja California, Mexico. *Bull. Southern California Acad. Sci.*, 44:57–71.
- . 1953. Marine red algae of Pacific Mexico. Part I. Bangiales to Corallinoideae. *Allan Hancock Pacific Expeditions*, 17:1–238.
- . 1962. Marine red algae of Pacific Mexico. Part 7. Ceramiales: Ceramiaceae, Delesseriaceae. *Allan Hancock Pacific Expeditions*, 26:1–207.
- . 1963a. Marine red algae of Pacific Mexico. Part 6. Rhodymeniales. *Nova Hedwigia*, 5:437–476.
- . 1963b. Marine red algae of Pacific Mexico. Part 8. Ceramiales: Dasyaceae, Rhodomelaceae. *Nova Hedwigia*, 6:401–481.
- Dixon, P. S. 1965. Perennation, vegetative propagation, and algal life histories with special reference to *Asparagopsis* and other Rhodophyta. *Bot. gothenburg*, 3:67–74.
- Fain, S. R., and S. N. Murray. 1982. Effects of light and temperature on net photosynthesis and dark respiration of gametophytes and embryonic sporophytes of *Macrocystis pyrifera*. *J. Phycol.*, 18:92–98.
- Hill, M. O. 1973. Reciprocal averaging: an eigenvector method of ordination. *J. Ecol.*, 61:237–249.
- Hodgson, L. M. 1981. Photosynthesis of the red alga *Gastroclonium coulteri* (Rhodophyta) in response to changes in temperature, light intensity, and desiccation. *J. Phycol.*, 17:37–42.
- Hutchins, L. W. 1947. The bases for temperature zonation in geographical distribution. *Ecol. Monogr.*, 17:325–335.

- Kapraun, D. R. 1980. Floristic affinities of North Carolina inshore benthic marine algae. *Phycologia*, 19:245-252.
- Mathieson, A. C., and T. L. Norall. 1975. Physiological studies of subtidal red algae. *J. Exp. Mar. Biol. Ecol.*, 20:237-247.
- Murray, S. N., P. S. Dixon, and J. L. Scott. 1972. The life history of *Porphyropsis coccinea* var. *dawsonii* in culture. *Br. Phycol. J.*, 7:322-333.
- , M. M. Littler, and I. A. Abbott. 1980. Biogeography of the California Marine Algae with emphasis on the southern California islands. Pp. 325-339 in *The California Islands: Proceedings of a multidisciplinary symposium*. (D. M. Power, ed.), Santa Barbara Museum of Natural History, Santa Barbara, California.
- , and M. M. Littler. 1981. Biogeographical analysis of intertidal macrophyte floras of southern California. *J. Biogeography*, 8:339-351.
- Norris, J. N. 1975. Marine algae of the northern Gulf of California. Dissertation, University of California, Santa Barbara.
- Roden, G. I. 1964. Oceanographic aspects of Gulf of California. Pp. 30-58 in *Marine Geology of the Gulf of California*. (T. H. van Andel and G. Shor, eds.), Amer. Assoc. Petroleum Geol., Mem. 3.
- SIO (Scripps Institution of Oceanography). 1981. Data Report. Surface water temperatures at shore stations, U.S. west coast. 1980. SIO Reference 81-30. University of California, Scripps Institution of Oceanography.
- Setchell, W. A. 1915. The law of temperature connected with distribution of the marine algae. *Ann. Missouri Bot. Gard.*, 2:287-305.
- Stewart, J. G. 1974. *Phrix*: a new genus in Delesseriaceae (Rhodophyta). *Phycologia*, 13:139-147.
- . 1977. Morphology of *Sorella* in Natural Habitats and under Laboratory Conditions. *Bull. So. Calif. Acad. Sci.*, 76:5-15.
- . 1984. Vegetative Growth Rates of *Pterocladia capillacea* (Gelidiaceae, Rhodophyta). *Bot. Mar.*, 27:85-94.
- Thom, R. M. 1980. A gradient in benthic intertidal algal assemblages along the southern California coast. *J. Phycol.*, 16:102-108.
- Waaland, S. D., and R. Cleland. 1972. Development in the red alga *Griffithsia pacifica*: Control by internal and external factors. *Planta (Berl.)*, 105:196-204.

Accepted for publication 15 November 1983.

Scripps Institution of Oceanography, A-002, La Jolla, California 92093.

Nesting Green Sea Turtles (*Chelonia mydas*) on Isla Clarión, Islas Revillagigedos, Mexico

Frank T. Awbrey, Stephen Leatherwood, Edward D. Mitchell,
and William Rogers

Abstract.—Nesting green sea turtles (*Chelonia mydas*) on Isla Clarión, Islas Revillagigedos, Mexico by Frank T. Awbrey, Stephen Leatherwood, Edward D. Mitchell, and William Rogers. *Bull. Southern California Acad. Sci.*, 83(2):69-75, 1984. Locations of green sea turtle (*Chelonia mydas*) nests were mapped and their density determined during beach surveys of Bahía Sulfur, Isla Clarión, Islas Revillagigedos, Mexico, conducted 9-11 October 1976. Based on 80 nests less than one year old in six sample quadrats, nest density was estimated as 0.027/m². One old nest contained 76 spent eggs. At two other nests 89 and 92 hatchlings were counted as they emerged. Possible annual turtle productivity in suitable areas of West Beach, Bahía Sulfur is estimated as 2.4 hatchlings/m². Predation of hatchlings by ravens, various fishes, and possibly bottlenose dolphins was observed. At least 13 female turtles visited the beach during the three days. Several copulating pairs were observed and photographed.

The survival of stocks and species of marine turtles is currently a matter of grave concern. All recognized species have been heavily exploited and now suffer from severe reductions in their numbers, suitable nesting sites, and undisturbed feeding areas. The green sea turtle, *Chelonia mydas*, has been severely affected. Once widely distributed in temperate and tropical waters between the 20°C isolines (Hirth 1971), the species' range has been reduced drastically. Many historically important nesting sites have been subjected to such intense hunting pressure that local stocks have been extirpated or have abandoned the sites. Throughout its range, the only green turtle populations that have escaped heavy exploitation are those nesting on remote islands uninhabited by humans.

In the eastern Pacific, green turtles have been reported from Chile (Hirth 1971) north to British Columbia (Radovich 1961; Logier and Toner 1961). A number of important but heavily exploited nesting sites have been identified on the coasts of Baja California and mainland Mexico (Carr 1961; Caldwell 1962; Marquez M. 1976; Fritts, Stinson, and Marquez M. 1982). Relatively unexploited stocks are known to nest in the Galapagos (Pritchard 1971) and in Mexico's Islas Revillagigedos archipelago (Hanna 1926; Brattstrom 1955). Studies of turtles at such remote nesting sites could fill some gaps in our knowledge of green turtle biology (see Hirth 1971 for review), most notably by defining the uses of and productivity at relatively undisturbed nesting sites. Such information is essential to conservation efforts.

Data on the turtles of the Islas Revillagigedos are limited to brief reports of their occurrence and nesting on Isla Socorro and Isla Clarión. Hanna (1926) reported seeing individuals swimming in Bahía Sulfur, Isla Clarión, and others trapped and dying in adjacent deep tidepools. Brattstrom (1955) reported finding

skeletons high up the beach, and tracks less than 24 hours old from sea turtles coming ashore to lay eggs at Hidden Cove, Bahía Academy, Isla Socorro on 18 March. He also found skeletons, tracks less than 12 hours old, and three live turtles at Bahía Sulfur, Isla Clarión on 24–25 March 1953. Brattstrom (1982) summarized his observations of mating and breeding activity on Isla Socorro and Isla Clarión. In six years between 1953 and 1981, he saw matings in May and November and fresh tracks in March, April, May, and November, as well as emerging young in March and November.

Isla Clarión (Fig. 1) is the westernmost of Mexico's Islas Revillagigedos. It is approximately 10 km long and 4 km wide and has five volcanic peaks rising to a maximum height of 1100 meters. Except for a small portion of the south side at a small embayment called Bahía Sulfur and an adjacent beach to the east (Fig. 1), the island's shores are steep bluffs pounded by breakers (Lewis 1971). The turtles have been reported only along a small sand beach inside Bahía Sulfur (Brattstrom 1955 and 1982).

Materials and Methods

On 9 October 1976, during a cruise undertaken to study porpoise behavior in the Eastern Tropical Pacific (see Stuntz 1977) the NOAA research vessel *David Starr Jordan* made an unscheduled three day stop at Isla Clarión. We used this opportunity to observe the *Chelonia mydas* population that breeds in and near Bahía Sulfur (Fig. 1 and inset). Close-up color photos taken of hatchlings were used to identify the species from standard keys.

Landing parties reconnoitered the beach on 9, 10, and 11 October, counting turtle tracks, empty eggshells, and hatchlings, and documenting behavior and extent of predation on hatchlings. Observers on shipboard and small skiffs saw turtles in the water from the tide pools to about one km seaward and two km east and west of Bahía Sulfur.

On 10 October, we surveyed a polygonal area that seemed typical of the nesting beach (Fig. 2). Boundaries of the area were drawn to include nests between the high water berm and a line of vegetation located about 50 m inland. A Lietz^o optical rangefinder and a Suunto^o KB-14 sighting compass were used to determine polar coordinates of boundary points and nests within the boundaries relative to a base point.

On 11 October, at each of the five arbitrarily chosen sites with nests along the berm, a 15 meter square quadrat was laid out with the aid of the compass and range finder (Fig. 1 inset). Polar coordinates for boundary points and nests were measured as before. All polar coordinates were then converted to rectangular coordinates and plotted on a Hewlett-Packard 9810^o calculator and 9862A^o plotter. Area of the first site was calculated from rectangular coordinates.

Results

The south coast of Isla Clarión has two sections of curved sandy beach, each several hundred meters long. Both beaches are bordered by lava outcrops or vertical cliffs and are separated from each other by an inactive volcanic cone (Fig. 1). The east beach is relatively steep and is composed of coral litter with occasional short segments of sandy beach. A vertical compacted sand ledge less than 1 m high usually prevents the animals from reaching deeper sand above. Turtle tracks

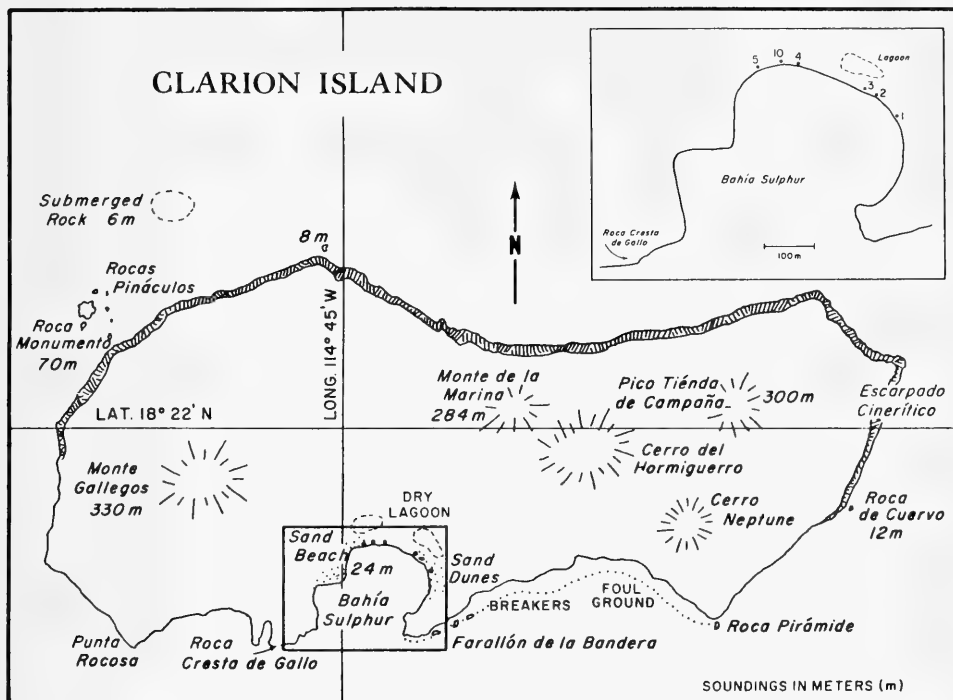

Fig. 1. Isla Clarión, Revillagigedos. The inset details the beach where green turtles were nesting and shows positions of quadrats where detailed observations were made.

and/or excavations were seen in all segments of sandy beach. On the east beach we counted twenty-one attempts by turtles to dig nesting holes that had been stopped by a hardpan 5 to 20 cm below the surface. The only apparently successful nests found on the east beach were in one area where the ledge had crumbled and the animals were able to reach the deeper sand above. Six nests in various stages of erosion were located in a narrow band extending inland about 20 m. Actual nest density was not measured but appeared comparable to that of the west beach.

The west beach, in Bahía Sulfur, with its accessible deep sand, is used most successfully for sea turtle nesting. It afforded generally favorable nesting sites along most of its length. The sandy beach has a gentle slope and is fairly well protected by coral or volcanic extrusions at each end, although a considerable surf strikes the beach. Nests generally were located in the 20 to 50 m of sparsely vegetated sand between a berm line, which apparently marked the maximum high tide line, and the shoreward edge of the vegetation. Most nests were located within 20–25 m of this berm line. A few females penetrated even farther inland in the area of the lagoon. Each day we found fresh turtle tracks leading to freshly dug nests. We did not dig up any of these nests to check for eggs. Five sets of tracks were counted on 10 October and four on 11 October. Four more sets of tracks were seen from the ship with 20× binoculars before we departed the cove on the morning of 12 October.

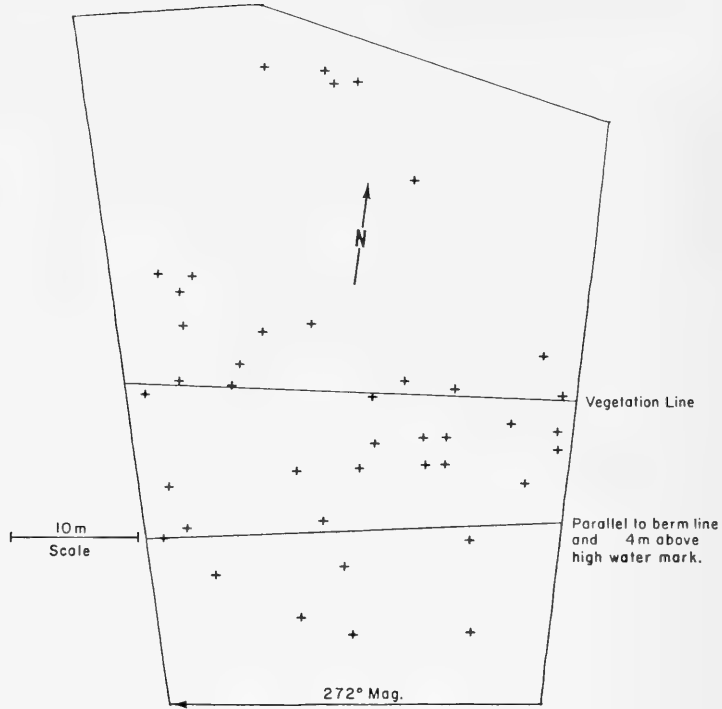

Fig. 2. Map of quadrat sampled 10 October 1976. This is site number 10 on Fig. 1, inset.

In the six quadrats sampled, with a total area of 2950 m², we counted 80 nests that we judged by degree of erosion to be less than one year old. Nest density in the sample areas was 0.027/m². Thirty adult turtle tracks entering and/or leaving the five quadrats were counted on 11 October, so as many as 15 females had entered the quadrats within the few days their tracks would be expected to last. Empty eggshells were common on the surface in many of the older nests. One such depression contained 76 shells.

One nest in the survey area was completely open. The bottom of the hole was in compact, dry sand approximately 20 cm below the level of the large excavation made by the turtle's body. The sides of the hole were almost vertical, forming a rectangle with sides of 15–20 cm. The female apparently had abandoned the nest at this point.

Hatchling sea turtles usually emerge from their nests at night, their activity during the day apparently being inhibited by higher temperatures (Mrosovsky 1968). Nevertheless, we saw hatchlings emerge from nests after mid-day on all three days. Also the hatchlings Brattstrom (1982) saw on 8 November 1981 emerged about 1500 hours (Brattstrom pers. comm.). As they emerged, we counted 89 from one nest and 92 from another. Although masked and red-footed boobies (*Sula*), frigate birds (*Fregata* spp.), and ravens (*Corvus corax*) are common on the island, only three groups of 6–12 ravens were seen preying on the hatchlings. The simplest way to locate emerging hatchlings was to watch for the group of ravens that gathered near a nest as the hatchlings began their exodus. Brattstrom (1982) recorded predation by an owl, a snake, and possibly by a hawk.

On three different occasions we followed hatchlings into the water and swam behind them for 100–200 m. Some hatchlings were taken by unidentified large fishes inside the reef. Hirth (1971) and Pritchard (1971) say that the Ghost Crab (*Ocypode*) preys on sea turtle hatchlings in the Galapagos Islands, but we saw none on Isla Clarión. At night, unidentified fish that were in the lighted perimeter around the ship anchored in the mouth of Bahía Sulfur also were seen to take an occasional turtle. One hatchling may have been eaten by one of the bottlenose dolphins (*Tursiops truncatus*) that chased flying fish near the ship each night. Most of the hatchlings that came by the ship were seen to pass unharmed through the lighted area. The several dozen hatchlings seen around the ship every night proved that substantial numbers regularly made it into the relative safety of deeper water.

One copulating turtle pair with two escorts (cf. Booth and Peters, 1972) was observed and photographed between the ship and the beach in Bahía Sulfur on 11 October.

Discussion

The Isla Clarión population of *Chelonia mydas*, along with those of Isla Socorro (Brattstrom 1955) and the Galapagos (Pritchard 1971), may well be extremely important to the continued existence of the green sea turtle in the Eastern Tropical Pacific. Human interference with nesting has been minimal on the island but problems may result from a military garrison now there. Fresh tracks of at least 4 females were seen on the beach on each of the three mornings we were anchored in Bahía Sulfur and hatchlings emerged from at least three nests on each of the three days we were there. In combination, Brattstrom's (1955 and 1982) reports of nesting in March–May and November, and the number of adults, the mating, nesting and hatchling emergence, and the variety of apparent ages of nests we observed, imply a prolonged reproductive period for the green sea turtles of Isla Clarión. The duration of the breeding season, as well as the timing and extent of a possible breeding peak are unknown. However, the waters surrounding Isla Clarión remain warm all year (Sharp 1978); so a year-round green turtle breeding season, as reported by Hendrickson (1958) for locations near the equator, is possible.

By adopting the tactic of breeding in lower numbers throughout the year, turtles would avoid the large buildup of birds and other predators common at emergence time on many nesting beaches. On the other hand their resident predators might have a more constant food supply (Hughes and Richard 1974).

The large number of hatchlings counted as they emerged from two different nests is consistent with Bustard's (1976) observation of approximately 85% successful hatch from undisturbed nests. If the approximately 90 hatchlings per nest that we saw is typical, and the nest density we measured is representative of a year's activity, annual turtle productivity on those areas of the west beach of Bahía Sulfur where we saw nests would be at least 2.4 hatchlings per m².

In view of the increasing human-caused mortality on sea turtles in most of the traditional nesting grounds of *Chelonia mydas*, remote islands such as Clarión may be critical for efforts to preserve the species. Even if mariculture proves to be commercially successful (Ehrenfeld 1974), wild populations are essential for maintaining genetic diversity. Isla Clarión, with its limited breeding area, presents a rare opportunity to quantify total annual turtle productivity in an undisturbed

habitat. The remote islands of the Revillagigedos should be included in international efforts to preserve this important biological resource.

Acknowledgments

We thank the Mexican Government for permission to land on Isla Clarión.

Literature Cited

- Booth, J., and J. A. Peters. 1972. Behavioral studies on the green turtle in the sea. *Anim. Behav.*, 20:808-812.
- Brattstrom, B. H. 1955. Notes on the herpetology of the Revillagigedo Islands, Mexico. *Amer. Midl. Nat.*, 54:219-229.
- . 1982. Breeding of the green sea turtle, *Chelonia mydas*, on the Islas Revillagigedo, Mexico. *Herp. Review*, 13:71.
- Bustard, H. R. 1976. Turtles of coral reefs and tropical islands. Pp. 343-368 in *Biology and Geology of Coral Reefs*. Vol. III: Biology 2. (Jones, O. A. and R. Endean, eds.) Academic Press, New York.
- Caldwell, D. K. 1962. Sea turtles in Baja Californian waters (with special reference to those of the Gulf of California) and the description of a new subspecies of northeastern Pacific Green turtle. *Los Angeles Co. Mus. Contrib. Sci.*, 61:1-31.
- Carr, A. 1961. Pacific turtle problem. *Nat. Hist.*, 70:64-71.
- Ehrenfeld, D. W. 1974. Conserving the edible sea turtle. Can mariculture help? *Amer. Sci.*, 62: 23-31.
- Fritts, T. H., M. L. Stinson, and R. Marquez M. 1982. Status of sea turtle nesting in Southern Baja California, Mexico. *Bull. Southern California Acad. Sci.*, 81(2):51-60.
- Hanna, G. D. 1926. Expedition to the Revillagigedo Islands, Mexico, in 1925. I. General Report, *Proc. Calif. Acad. Sci. 4th Ser.*, 15:1-113.
- Hendrickson, J. R. 1958. The green sea turtle, *Chelonia mydas* (Linn) in Malaya and Sarawak. *Proc. Zool. Soc. Lond.*, 130:455-535.
- Hirth, H. F. 1971. Synopsis of biological data on the green turtle *Chelonia mydas* (Linn) 1758. Rome: FAO Fisheries Synopsis No. 85:1-71.
- Hughes, D. A., and J. D. Richard. 1974. The nesting of the Pacific Ridley Turtle *Lepidochelys olivacea* on Playa Naucite, Costa Rica. *Marine Biology*, 24:94-107.
- Lewis, L. R. 1971. *Baja Sea Guide*. Miller Freeman Publications. 500 Howard St., San Francisco, California 94105.
- Logier, E. B. S., and G. C. Toner. 1961. Check list of the amphibians and reptiles of Canada and Alaska. Toronto: Royal Ontario Mus. Life Sci. Div., Cont. No. 53:1-92.
- Marquez M., Rene. 1976. Reservas naturales para la conservacion de las tortugas marinas de Mexico. Instituto Nacional de Pesca, INP/SI:183.
- Mrosovsky, N. 1968. Nocturnal emergence of hatchling sea turtles: control by thermal inhibition of activity. *Nature*, 220:1338-1339.
- Pritchard, P. C. H. 1971. Galapagos sea turtles—Preliminary findings. *J. Herpetol.*, 5:1-9.
- Radovich, J. 1961. Relationships of some marine organisms of the northeast Pacific to water temperatures, particularly during 1957 through 1959. *Calif. Fish and Game, Fish. Bull.*, 112:1-62.
- Sharp, G. D. 1978. Behavioral and physiological properties of tunas and their effects on vulnerability to fishing gear. Pp. 397-449 in *The Physiological Ecology of Tunas*. (G. D. Sharp and A. E. Dizon, eds.), Academic Press, New York.
- Stuntz, W. E. 1977. Report on the Tuna-Porpoise Cruise to the Marine Mammal Commission. Pp. 33-37 in *Hearings before the Subcommittee on Fisheries and Wildlife Conservation and the Environment of the Committee on Merchant Marine and Fisheries*. House of Representatives, Ninety-fifth Congress, First Session on Marine Mammal Oversight, 17 February 1977, Serial No. 95-8, U.S. Government Printing Office, Washington, D.C.

Accepted for publication 30 August 1983.

Frank T. Awbrey, *Department of Biology, San Diego State University, San Diego, California 92182*; Stephen Leatherwood, *Hubbs-Sea World Research Institute,*

1700 South Shores Road, San Diego, California 92109; Edward D. Mitchell, Arctic Biological Station, 555 St. Pierre Blvd., Ste. Anne De Bellevue, Quebec H9X 3R4, Canada; William Rogers, Department of Zoology and Museum of Vertebrate Zoology, University of California, Berkeley, California 94720.

***Paraliparis nassarum* n. sp. (Pisces, Liparididae) from off
Southern California with Description of Its Otoliths and
Others from North-east Pacific Liparidids**

David L. Stein and John E. Fitch

Abstract.—*Paraliparis nassarum* n. sp. (Pisces, Liparididae) from off southern California with description of its otoliths and others from north-east Pacific liparidids by David L. Stein and John E. Fitch. *Bull. Southern California Acad. Sci.*, 83(2):76-83, 1984. *Paraliparis nassarum*, a previously unknown species of liparidid fish, is described from specimens collected in sablefish traps on the continental slope off southern California. The new species is primarily distinguished from *P. rosaceus*, its most similar relative, by having sparser premaxillary teeth, mandibular teeth slanted anteriorly, fewer vertebrae, more pectoral fin rays, and more caudal fin rays.

Sagittal otoliths of *P. nassarum*, *P. rosaceus*, *Careproctus furcellus*, *C. attenuatus*, *C. melanurus*, *C. ovigerum*, *Acantholiparis opercularis*, *Lipariscus nanus*, *Nectoliparis pelagicus*, *Liparis liparis*, and *L. pulchellus* are described. The ostium of the otoliths of *A. opercularis*, *L. nanus*, *P. nassarum*, and *P. rosaceus* is closed over to form a tube, an apparently unique character among fishes. The medial face of the otolith of *C. ovigerum* is concave, unlike the flat medial faces of the otoliths of the other 10 species.

These significant differences in otolith morphology suggest that our present understanding of liparidid relationships is inadequate and that liparidid genera may need revision.

During the past few years, commercial vessels fishing with traps for sablefish (*Anoplopoma fimbria* [Pallas]) off southern California have captured many individuals of a previously undescribed species of *Paraliparis*, of which specimens were deposited at the Los Angeles County Museum of Natural History. This paper describes the new *Paraliparis*, which appears to be relatively common, and describes its otoliths and the otoliths of 10 other species of liparidids including *Paraliparis rosaceus* Gilbert, *Careproctus furcellus* Gilbert and Burke, *C. attenuatus* Gilbert and Burke, *C. melanurus* Gilbert, *C. ovigerum* (Gilbert), *Acantholiparis opercularis* Gilbert and Burke, *Lipariscus nanus* Gilbert, *Nectoliparis pelagicus* Gilbert and Burke, *Liparis liparis* (Linnaeus), and *Liparis pulchellus* Ayres.

Methods and Materials

All specimens were collected in sablefish traps by commercial fishermen. Materials examined are on deposit at the Natural History Museum of Los Angeles County (LACM), U.S. National Museum of Natural History (USNM), and California Academy of Sciences (CAS).

Methods of making measurements and counts follow Stein (1978). Counts and ratios given are the mode and mean respectively, the range in parentheses, and

the number of observations for that character in brackets. Internal organs of many specimens were in poor condition, often making sex determination impossible. Premaxillaries of three specimens having different numbers of teeth were cleared and stained with alizarin or with alcian and alizarin (Dingerkus and Uhler 1977) for closer examination. Otoliths from preserved (*P. rosaceus*, *L. nanus*, *A. opercularis*) and fresh (all other species) specimens were photographed with a scanning electron microscope (SEM).

Paraliparis nassarum new species

Fig. 1, 2b

Holotype.—LACM 38272-3, ♀, 229 mm SL, 18.5 km ENE of Pyramid Hd., San Clemente I., Calif., <4:X:1978, 951–1097 m.

Paratypes (38 specimens).—LACM 38342-4, ♀, 196+ mm SL, 32°18'N, 118°06'W, off Baja California, Mexico, 16:III:1979, 1024–1097 m; LACM 37278-1, ♀, 250+, ♀, 283 mm SL, off Santa Barbara I., Calif., <24:I:1978, 914 m; LACM 38272-2, ♂, 196 mm SL, 18.5 km ENE of Pyramid Hd., San Clemente I., Calif., <4:X:1978, 951–1097 m; LACM 37607-1, ♂?, 204, ♀, 232, ♀, 241, ♀, 242, ♀, 256, ♀, 257 mm SL, 5.6–18.5 km E by N and E by S of San Clemente I., Calif., <19:VII:1978, 1006 m; LACM 37666-1, ♀, 207, ♀, 236, ♀, 260 mm SL, 5.6–9.2 km NE by N of Pyramid Hd., San Clemente I., Calif., 15:VIII:1978, 1006 m; LACM 37601-1, ♀?, 214, ♀, 215, ♀?, 240, ♀, 252 mm SL, 5.6–14.8 km SE of San Clemente I., Calif., <3:VII:1978, 1006 m; LACM 37596-1, ♂, 226 mm SL, 32°29'N, 118°57'W, off Calif., <26:VI:1978, 900 m; LACM 37599-1, ♀, 230 mm SL, 5.6–14.8 km SE of San Clemente I., Calif., <10:VII:1978, 1006 m; LACM 37600-1, ♀?, 234, ♀, 243, ♀, 248+ mm SL, 5.6–14.8 km SE of San Clemente I., Calif., <10:VII:1978, 1006–1189 m; CAS 51781, ♂, 234, ♂, 258 mm SL, nr. 33°05'N, 118°20'W, off Calif., 1042 m, 12:V:1978; LACM 37462-1, ♀, 235 mm SL, 20.4 km 0° from E end of Santa Catalina I., Calif., 22:V:1978, 1159 m; LACM 376641, ♀, 236 mm SL, 21.3 km, 315° to E end of Santa Catalina I., Calif., 2:VIII:1978, 1070 m; LACM 37460-2, ♂, 239, 37460-1, ♂, 277 mm SL, 9.2 km, 350° off E end of Santa Catalina I., Calif., 5:VI:1978, 1152 m; LACM 37597-1, ♀, 240 mm SL, 9.2 km, 330° to E end of Santa Catalina I., Calif., 2:VII:1978, 1001 m; LACM 37459-1, ♀, 244 mm SL, 15.7 km, 345° off E end of Santa Catalina I., Calif., 28:V:1978, 1120 m; USNM 247250, ♂?, 253 mm SL, 11.6 km, 002° from E end of Santa Catalina I., Calif., 10:VI:1978, 1161 m; LACM 37336-1, ♀, 269 mm SL, off San Clemente I., Calif., 16–23:I:1978, 1134 m; USNM 247249, ♀, 278 mm SL, 10.2 km, 340° to E end of Santa Catalina I., Calif., 1:VII:1978, 1143 m; LACM 37277-1, ♀, 281, ♀, 285 mm SL, San Clemente Canyon, Calif., 16–23:I:1978, 1280 m; LACM 38507-2, ♂, 294 mm SL, 55.5 km SW of San Nicholas I., Calif., 6:VI:1979, 914 m; LACM 38667-1, ♂?, 313 mm SL, SW of San Nicholas I., Calif., <7:I:1980, 914 m; LACM 38357-1, ♀, 318 mm SL, 32°22.5'N, 118°38.0'W, off Baja California Mexico, <10:I:1979, 1097 m.

Diagnosis

A *Paraliparis* differing from all others in the following characters or combinations thereof: 51–55 anal fin rays, 21–24 pectoral fin rays, 8–9 caudal fin rays, and 64–67 vertebrae. Premaxillary teeth absent or 1–15 present anteriorly on each

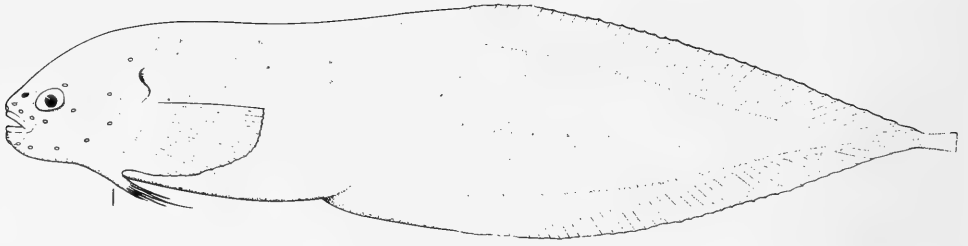

Fig. 1. Holotype of *Paraliparis nassarum*, new species, LACM 38272-3, 229 mm SL. Drawn by Donna Klentz.

premaxillary. A complete uniserial row of simple, triangular, anteriorly slanting canines present on each side of lower jaw.

Counts and Ratios.—Dorsal fin rays 60 (56–61) [29], anal fin rays 52 (51–55) [29], pectoral fin rays 22 (21–24) [51], caudal fin rays 8 (8–9) [33], pyloric caeca 7 (6–9) [17], vertebrae 66 (64–67) [31]. Cephalic sensory pores 2-6-7-1.

Head length 19.0 (17.2–20.8) [32]%SL; head depth at occipital 80.1 (69.9–90.4) [12]%HL, diameter of eye 14.4 (12.6–16.3) [23]%, length of upper pectoral fin lobe 70.9 (60.4–81.2) [31]%, length of lower pectoral fin lobe 60.7 (44.4–76.9) [29]%, mandible to anus 81.8 (67.1–100.2) [27]%, maximum body depth 105.5 (93.8–124.2) [13]%. Upper jaw 37.0 (32.9–41.8) [32]%.

Description

Snout blunt, dorsal profile of head rising rapidly to occipital region. Nostrils single, without a raised rim; external opening anterior to orbit a distance distinctly less than diameter of eyeball, on a horizontal through pupil of eye. Eye small, covered by skin; pupil round. Mouth subterminal, jaws horizontal, broad. Lower jaw slightly included by upper. Maxillary extending posteriorly to below orbit. Teeth of both jaws small, simple. Premaxillary teeth smaller than those of dentary, often obscure, occasionally completely absent. When present, premaxillary teeth form a single series posteriorly, often irregularly biserial or triserial near symphysis. Number of teeth present on each premaxillary varies from none to about 15, usually 4–10 present. Dentary teeth extending posteriorly behind cleft of mouth, closely spaced, forming a single series except often irregularly biserial or triserial near symphysis of mandible. Teeth simple, stout, curved canines, pointing distinctly anteriorly. Largest teeth posteriormost, gradually decreasing in size towards symphysis. Cephalic pores moderately large, not obvious. Gill opening small, completely above pectoral fin base. A small, weak opercular flap present, formed by reduced opercle.

Pectoral fins large, broad based, clearly divided into two lobes by a deep notch. Dorsalmost ray of upper lobe about on or below horizontal through posterior end of suborbital stay. Upper lobe of 15–19 rays, posterior margin broadly rounded. Distance between individual rays more or less gradually increasing from narrow to very wide in notch. Rays of notch entering margin of fin, not rudimentary. Lower fin lobe usually of 4 (occasionally 3) rays, narrowly spaced. Dorsalmost lower fin lobe ray often farther from lower rays than they are from each other. Lower pectoral fin lobe shorter than upper lobe.

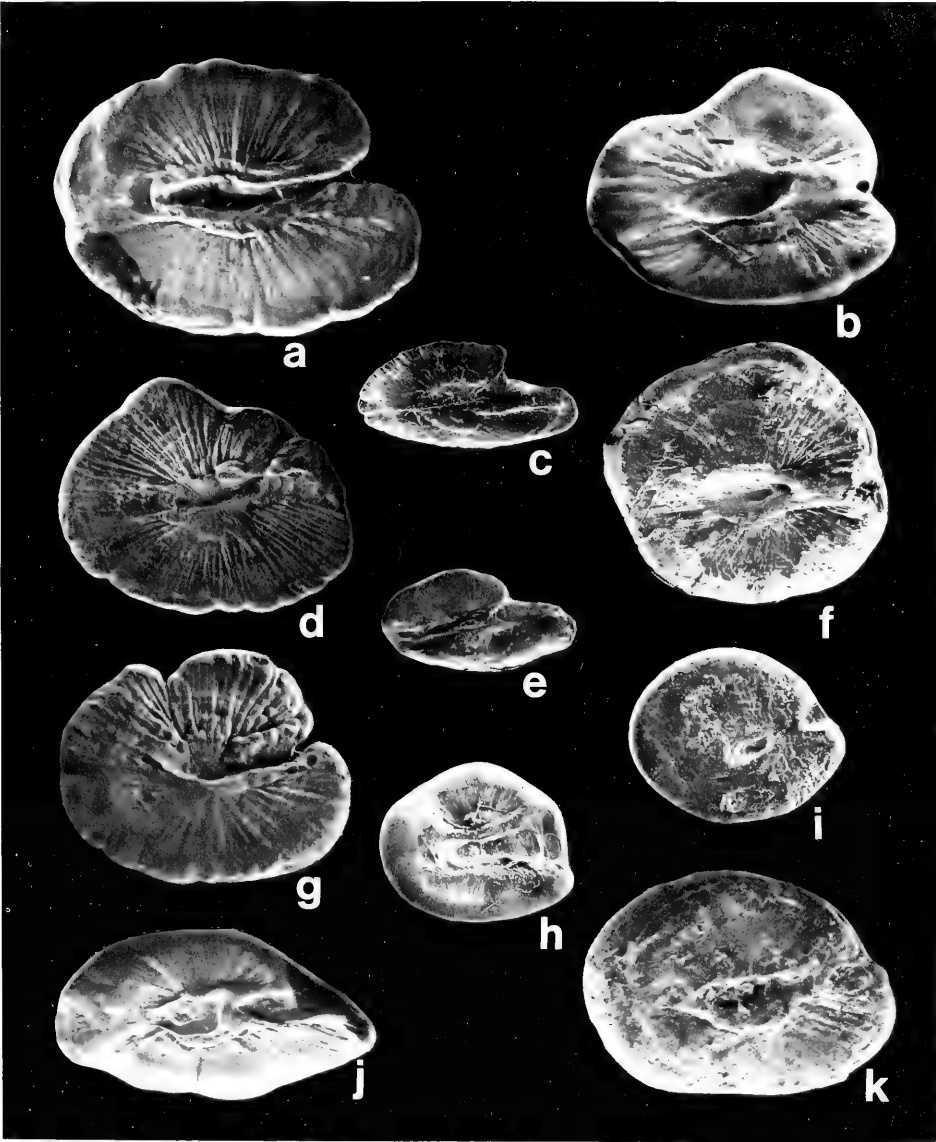

Fig. 2. Medial faces, left sagittae of 11 species of liparidids that inhabit waters of the eastern north Pacific and Bering Sea. Species name is followed by otolith length and height (in mm) and standard (SL) or total length of the fish it came from (if known): a. *Careproctus melanurus* 3.1 by 2.4 (203 mm SL); b. *Paraliparis nassarum* 2.5 by 2.0 (304 mm SL); c. *Liparis liparis* 1.9 by 0.9 (unk.); d. *Careproctus furcellus* 3.7 by 2.9 (unk.); e. *Liparis pulchellus* 2.8 by 1.5 (178 mm SL); f. *Paraliparis rosaceus* 1.9 (207 mm SL); g. *Careproctus attenuatus* 3.3 by 2.8 (unk.); h. *Nectoliparis pelagicus* 0.8 by 0.7 (94 mm TL); i. *Lipariscus nanus* 0.6 by 0.5 (36 mm TL); j. *Careproctus ovigerum* 3.0 by 1.6 (270 mm SL); k. *Acantholiparis opercularis* 1.2 by 0.9 (69.1 mm SL). SEM photos by Brian White.

Dorsal and anal fins well developed. Anterior rays of dorsal fin poorly developed, buried in gelatinous tissue, indistinct. Dorsal fin origin above or behind opercular flap. Anterior rays of anal fin distinct, well developed.

Body heavy, laterally compressed, deepest behind head. Tail tapers gradually to caudal fin, not particularly attenuate. Dorsal and anal fin rays overlap caudal fin rays by half to three-fourths caudal fin length. Skin usually thin, lax, easily damaged; occasionally thicker and tougher. Rudimentary pores present on head and extending in an irregular lateral line-like row posteriorly to behind anal fin origin.

Stomach large, thick-walled, pale, located dorsally in body cavity. Pyloric caeca covering anteroventral surface of stomach; pale, fingerlike, matted together, difficult to separate.

Color in life unknown. In alcohol, skin of most specimens pinkish-brown, except darker brown or blackish head and fins. Inside of mouth and brachial chamber dusky brown, peritoneum black. Peritoneum sometimes visible through thoracic wall and skin.

Distribution

Paraliparis nassarum is known from sablefish traps on the continental slope off southern California (mostly near the Channel Islands) and Baja California, Mexico. Depths of capture are only approximate, but all specimens were collected between about 900–1280 m. Because of the nature of the collections (incidental captures in a commercial fishery) distribution is not well known. Future captures will undoubtedly extend the known range.

Etymology

The specific epithet, *nassarum*, is the genitive plural of the Latin noun, *nassa*, "fish trap," and is appropriate because all known specimens were collected by fish traps.

Discussion

Paraliparis nassarum is most similar to *P. rosaceus*, which also occurs off southern California but at greater depths. The most obvious differences are the mandibular teeth (in *P. rosaceus* they are not angled forward), the paucity of premaxillary teeth (in *P. rosaceus* there is always at least a complete single tooth series extending half way or farther towards the posterior end of the oral cleft and there is often more than a single series medially), fewer vertebrae (67–71 in *P. rosaceus*) more pectoral fin rays (18–22 in *P. rosaceus*) and more caudal fin rays (6[6–8] in *P. rosaceus*).

The description of *Paraliparis nassarum* raises to five the number of species of the *P. rosaceus* "group" which have uniserial premaxillary teeth as adults. These species are *P. attenuatus* Garman, *P. copei* Goode and Bean, *P. nassarum*, *P. rosaceus*, and *P. wilsoni* Richards. They have the same general appearance, similar numbers of vertebrae and fin rays, tooth patterns and tooth morphology, pectoral fin morphology, and gill opening position. Despite the variable presence of premaxillary teeth and absence of mandibular teeth, *P. paucidens* Stein can presently be included in the group based on the other characters. The true relationships of these species are unclear at present and require analysis based upon other characters, including otoliths.

Otoliths

Liparidid otoliths (sagittae) have been found in digestive tracts of pinnipeds (Frost and Lowry 1980), small cetaceans, marine birds and occasionally predatory fish (J. E. Fitch, unpublished data). Although they have been reported from the Oligocene of Belgium (as "genus aff. *Liparis*" *minusculus* Nolf, 1977), the only North American fossil record appears to be an unreported otolith (*Liparis* cf. *fucensis*) from a Pliocene deposit near Santa Barbara, California (J. E. Fitch, unpublished data). If it were not for their small size (often much less than 5 mm diameter), we suspect that liparidid sagittae would be encountered and recognized much more frequently, both in digestive tracts and as fossils. Because of their potential importance in systematic and food habit studies and as fossils, we have included photos taken with an SEM of sagittae from 11 species (6 genera) of liparidids occurring in the eastern North Pacific and Bering Sea (Fig. 2).

The first known description of a snailfish otolith is that of *Liparis vulgaris* (= *L. liparis*) in a dissertation by Fryd (1901). Subsequently, Chaine (1956) described and figured a sagitta of *Liparis montagui* (Donovan), Nolf (1977) did the same for *L. liparis*, and Morrow (1979) illustrated sagittae of *Careproctus* sp., *C. furellus*, *C. melanurus*, *Liparis dennyi* Jordan and Starks, *L. gibbus* Bean, *L. liparis*, *L. pulchellus*, and *Nectoliparis pelagicus*. Unfortunately, most of these authors used line drawings or stippled figures and failed to show salient features which are critical for identifying otoliths accurately.

Characters on the medial faces (grooved side) of otoliths are extremely important for determining family and genus. Overall otolith shape, ratio of height into length, marginal ornamentation, etc., are important primarily at the species level. Among the otoliths we have figured (Fig. 2), two features of the sulcus (groove on medial face) are prominent: its relative depth, and differences in the ostium (front portion of the sulcus). In *Acantholiparis*, *Lipariscus*, and *Paraliparis*, the ostium is closed over forming a tube; in *Careproctus*, *Liparis*, and *Nectoliparis* the sulcus is an open channel for its entire length. We know of no other fish family in which the ostium of the otolith is tubular. Unfortunately, we do not know how widespread occurrence of the tubular ostium is among liparidids. We have not seen sagittae of species of the other five described genera of eastern North Pacific liparidids, so we do not know how many of these, if any, have tubular ostia also.

All of our figured otoliths are medial faces of left sagittae. Those of *Paraliparis rosaceus* (Fig. 2f), *Lipariscus* (Fig. 2i), and *Acantholiparis opercularis* (Fig. 2k) are from specimens preserved in formalin for a short period. Such preservation caused a slight chalkiness, so some of the finer features (e.g., radiating striae) are not as distinct as those from otoliths from unpreserved specimens. Otolith shapes and proportions as seen in the illustrated sagittae are typical for adults of each species.

The lateral faces (not shown) of the 11 figured otoliths are all smoothly rounded, whereas the medial faces of all except *Careproctus ovigerum* (Fig. 2j) are flat. In *C. ovigerum* the medial face is concave (anterior to posterior), a condition extremely rare among teleost otoliths. In all except *Acantholiparis*, *Liparis*, and *Lipariscus*, both the cristae superior and inferior (ridges bordering the sulcus) are very strong and distinct. In *Acantholiparis* and *Lipariscus*, neither is distinct, in *Liparis pulchellus* (Fig. 2e) only the crista superior is strong, but in *L. liparis* (Fig. 2c) the opposite is true with only the crista inferior well developed.

In *Careproctus ovigerum*, *Liparis*, *Nectoliparis pelagicus* (Fig. 2h) and *Paraliparis*, the sulcus is straight or nearly so for its entire length. In the other species of *Careproctus*, as well as in *Lipariscus* and *Acantholiparis* the ostial portion of the sulcus is bowed upwards.

Each species of *Liparis* has an extremely long rostrum (anteroventral projection); in the other genera and species, rostra are short and bluntly rounded or indistinct. Radiating ridges or striae are present in all species (medial faces), but are most distinct in *Careproctus furcellus* (Fig. 2d), *C. attenuatus* (Fig. 2g) and *C. melanurus* (Fig. 2a) among the figured species.

The apparently unique tubular ostium of *P. nassarum*, *P. rosaceus*, *A. opercularis*, and *L. nanus* suggests a previously unsuspected close relationship between these genera. Whether all species presently considered members of *Paraliparis* and *Acantholiparis* also possess this character state is unknown (*Lipariscus* is a monotypic genus). Additional information about the occurrence of the tubular ostium would test the hypothesis of Andriashev, Neelov, and Prirodina (1977) that *Paraliparis* is a taxonomic construct.

As noted above, the otolith of *C. ovigerum* is distinctly different from the other otoliths examined. In this connection, it is interesting to note that *C. ovigerum* was originally described by Gilbert (1895) as *Bathyphasma ovigerum*, and was later synonymized with *Careproctus* by Burke (1930), who commented ". . . *Careproctus* . . . is probably a polyphyletic [genus] but with our present knowledge we certainly are not justified in dividing it." This study supports the hypothesis that the original assignment of *C. ovigerum* to a different genus may have been correct. A final decision awaits further studies.

Acknowledgments

We have received assistance from many people. We would particularly like to thank Robert Lavenberg, LACM, for loaning specimens and Brian White, LACM, for the scanning electron microscope photos. Dirk Nolf, Geologische Institut, Rijksuniversiteit Gent, Belgium; Ed Best, International Pacific Halibut Commission, Seattle; Richard Grinols, formerly of National Marine Fisheries Service, Seattle; James Morrow, formerly of the University of Alaska; Greg Cailliet, Moss Landing Marine Laboratories; and Dorothy Pillion, California State College at Long Beach supplied liparidid otoliths. We would especially like to thank the commercial fishermen who donated specimens of *P. nassarum* via James Phelan, California Department of Fish and Game. Without their assistance the new species would have remained unknown to science.

Literature Cited

- Andriashev, A. P., A. V. Neelov, and V. P. Prirodina. 1977. On methods of study of the morphology and systematics of the fish family of sea snails (Liparidae). *Zool. Zh.*, 56(1):141-147.
- Burke, C. V. 1930. Revision of the fishes of the family Liparidae. *Bull. U.S. Nat. Mus.*, (150);1-204.
- Chaine, J. 1956. Recherches sur les otolithes des poissons. Etude descriptive et comparative de la sagitta des téléostéens. *Bull. du C.N.R.S., Biarritz*, 1:159-275.
- Dingerkus, G., and L. D. Uhler. 1977. Enzyme clearing of alcian blue stained whole small vertebrates for demonstration of cartilage. *Stain Technol.*, 52(4):229-232.
- Frost, K. J., and L. F. Lowry. 1980. Feeding of ribbon seals (*Phoca fasciata*) in the Bering Sea in spring. *Canadian J. Zool.*, 58(9):1601-1607.

- Fryd, C. 1901. Die otolithen der Fische in bezug auf ihre Bedeutung für Systematik und Altersbestimmung. Inaug. Dissertation Kiel, Altona, 54 pp.
- Gilbert, C. H. 1895. The ichthyological collections of the steamer *Albatross* during the years 1890 and 1891. Rep. U.S. Comm. Fish., 1893:393-476.
- Morrow, J. E. 1979. Preliminary keys to otoliths of some adult fishes of the Gulf of Alaska, Bering Sea, and Beaufort Sea. Nat. Ocn. Atm. Admin. Tech. Rept., Nat. Mar. Fish. Serv. Circular, (420):1-32.
- Nolf, D. 1977. Les otolithes des téléostéens de l'Oligo-Miocène Belge. Ann. Soc. Roy. Zool. Belg., 106:3-119 (for 1976).
- Stein, D. L. 1978. A review of the deepwater Liparidae (Pisces) from the coast of Oregon and adjacent waters. Occ. Pap. Calif. Acad. Sci., (127):1-55.

Accepted for publication 14 June 1983.

College of Oceanography, Oregon State University, Corvallis, Oregon 97331.

Additional Avian Records from the Miocene of Kern County, California with the Description of a New Species of Fulmar (Aves: Procellariidae)

Hildegarde Howard

Abstract.—Additional avian records from the Miocene of Kern County, California with the description of a new species of fulmar (Aves:Procellariidae) by Hildegarde Howard. *Bull. Southern California Acad. Sci.*, 83(2):84-89, 1984. Previously unrecorded avian taxa from the middle Miocene Sharktooth Hill Bonebed in Kern County, California are listed: *Fulmarus* n. sp., *Osteodontornis ?orri*, Ciconiidae gen. and sp. to be determined, and *Megapaloelodus* sp. *Fulmarus miocaenus* n. sp. is described from a humerus representing a smaller species than *F. hammeri*, the only other Tertiary fulmar recorded from California. It is also smaller than humeri of Recent species of fulmars and is further distinguished therefrom by a better developed bicipital area and more distally placed ectepicondylar prominence.

The middle Miocene marine deposits of the Sharktooth Hill Bonebed in Kern County, California, were discussed in detail by Mitchell (1965). His listing of the fauna recovered from these beds (sharks, bony fishes, reptiles, birds, and mammals) included the following birds:

Albatross—*Diomedea californica* Miller 1962.

Shearwaters—*Puffinus inceptor* Wetmore 1930, *P. priscus* Miller 1961, *P. mitchelli* Miller 1961.

Gannets—*Morus vagabundus* Wetmore 1930, *Morus* sp. (Miller 1961).

Waterbirds—*Presbychen abavus* Wetmore 1930, *Branta* sp. (Miller 1961).

Shorebirds—*Recurvirostra* sp. (Miller 1961).

As collecting continued in the years following Mitchell's report, a second albatross, *Diomedea milleri* Howard 1966, and an osprey, *Pandion homalopteron* Warter 1976, were added.

The collections at the Natural History Museum of Los Angeles County now contain over 120 unrecorded avian specimens from Sharktooth Hill. Included among these are representatives of four taxa not noted in the above listing:

Order Procellariiformes, Family Procellariidae (Shearwaters et al.).

Genus *Fulmarus*, n. sp. (Fulmar).

Order Pelecaniformes, Family Pseudodontornithidae (Bony-toothed Birds).

Genus *Osteodontornis*, species *?orri* Howard 1957.

Order Ciconiiformes, Family Ciconiidae (Storks).

Genus and species to be determined.

Order Charadriiformes, Family Phoenicopteridae (Flamingos).

Genus *Megapaloelodus* A. Miller 1944, species ?

The present paper concerns the description of *Fulmarus* n. sp. The material

representing the other taxa is under study and discussion thereof will be presented at a later date.

Methods and Materials

Acronyms Used

LACM—Natural History Museum of Los Angeles County.

USNM—National Museum of Natural History, Smithsonian Institution.

Comparative Material Available

Fossil: Distal fragment of humerus (LACM 18263) referred to *Fulmarus hammeri*.

Recent: Humeri of *Fulmarus glacialis rodgersi* (7), *F. glacialoides* (2), *Thalassoica antarctica* (1), *Daption capense* (2), *Pagodroma nivea* (1), *Pterodroma phaeopygia* (1), *P. lessoni* (1), *Halobaena caerulea* (2), *Pachyptila vittata* (2), *Puffinus creatopus* (2), *P. griseus* (2), *P. opisthomelas* (11), *P. pacificus* (1). All specimens of *Fulmarus glacialis*, one each of *F. glacialoides*, *Daption capense*, *Halobaena caerulea*, *Pterodroma lessoni*, *Pachyptila vittata*, and all of the several species of *Puffinus* are from the LACM collections; the other Recent material was loaned by USNM.

Description

Among the avian fossils collected from Sharktooth Hill in 1979 was a small, fragmented humerus (LACM 122995) bearing similarities to those of the family Procellariidae (see Fig. 1). This family, which includes the fulmars, petrels and shearwaters, is represented at Sharktooth Hill by more than 30 bones of the shearwaters, genus *Puffinus*. After expert preparation of the fragile LACM 122995 humerus, it became evident that the specimen represented a species more closely allied to the fulmars than to the shearwaters.

Although the living *Fulmarus glacialis* is recorded from the Pleistocene of California and Norway (Brodkorb 1963, p. 245), there are only two Tertiary records of the genus. Both are of Miocene age. Only one of these was described, *F. hammeri* Howard 1968 from Orange County, California, with holotype car-pometacarpus and referred distal fragment of humerus. The other, a portion of the shaft of a humerus, from Maryland, was recorded as *Fulmarus* sp. (Wetmore 1926). Both represent species of larger size than that represented by the specimen from Sharktooth Hill.

Generic Analysis

Humerus LACM 122995 is distinguished from this element in the shearwaters (genus *Puffinus*) by the deltoid crest having a prominently projecting, hooklike point, the bicipital crest longer and clearly delimited distally, the ectepicondylar prominence short and blunt, the entepicondyle more rounded and less bladelike in its proximal extension anconally, and the shaft above the brachial depression broad laterally and shallow in its palmar-anconal dimension.

In these characters resemblance is closest to the humerus of the fulmars, *Fulmarus glacialis* and *F. glacialoides*, and the petrels, *Thalassoica antarctica* and *Daption capense*. The humeri of *Thalassoica* and *Daption*, however, are relatively

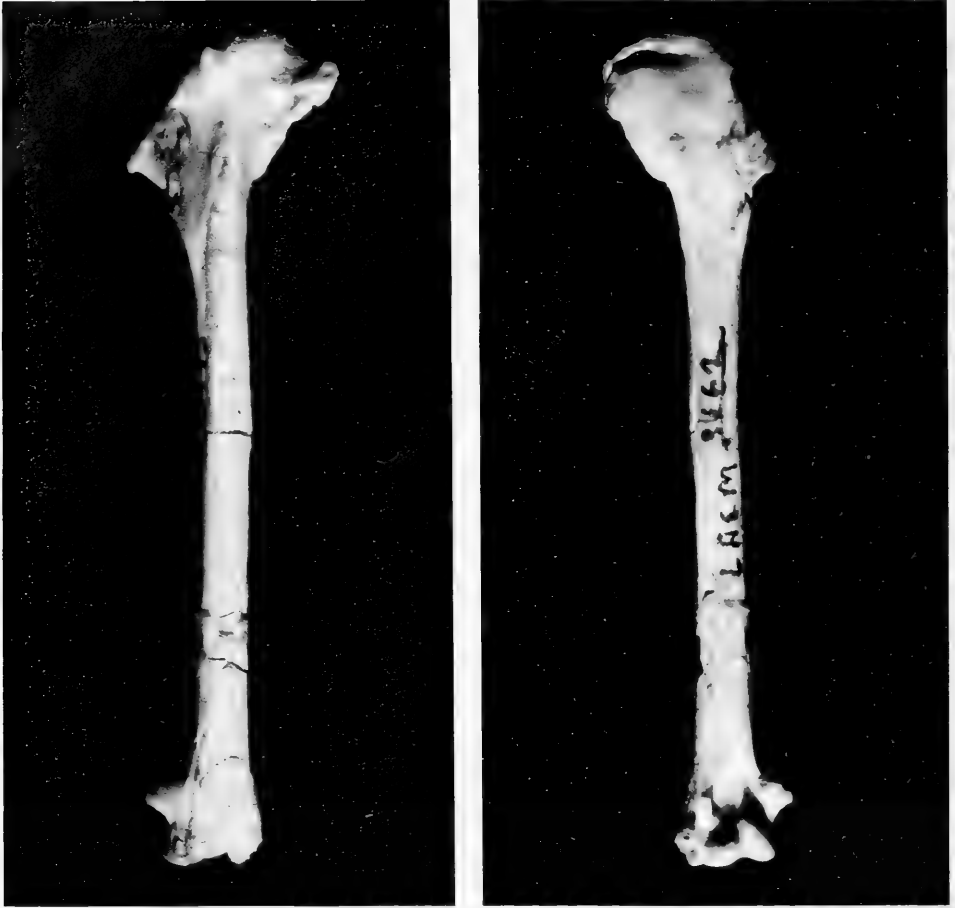

Fig. 1. Holotype humerus (LACM 122995) of *Fulmarus miocaenus* n. sp. Left, anconal view; right, palmar view. Greatest length = 78.3 mm.

broader proximally and have a marked depression on the anconal surface of the shaft immediately below the head, a depression which is not present in the two Recent species of *Fulmarus* or in the fossil at hand. Also, in *Daption*, the point of the deltoid crest is less sharply hooked.

The prominently projecting deltoid crest, with its hooklike point, is also present in members of the genus *Pterodroma*. The two species of this genus available for comparison (*P. phaeopygia* and *P. lessoni*), however, resemble the shearwaters in the long, pointed ectepicondylar prominence and blade-like proximal anconal extension of the entepicondyle. Other petrels, such as *Pagodroma nivea*, *Halobaena caerulea*, and *Pachyptila vittata*, lack the hooklike quality of the deltoid crest, although it is more pointed in these species than in the shearwaters. The *Pagodroma* humerus is further distinguished from the fossil by the depression of the shaft below the head. In *Pachyptila vittata* the bicipital crest is short as in *Puffinus*, and in *Halobaena caerulea* the pectoral attachment is longer and narrower than in the fossil humerus, and the ectepicondylar prominence is wider.

Table 1. Measurements (in millimeters) of humeri of *Fulmarus miocaenus* compared with those of Recent species of *Fulmarus*.

	<i>F. miocaenus</i> Holotype	<i>F. glacialis</i> 7 specimens		<i>F. glacialoides</i>	
		Min.	Max.	USNM 491469	LACM 100856
Greatest length	78.3	98.6	106.7	106.9	107.8
Proximal breadth ¹	13.0	16.0	17.0	18.0	18.6
Greatest breadth of distal end	9.5	11.7	12.7	12.7	12.9
Height of ectepicondylar prominence above distal end of humerus	7.8	11.0	11.7	13.0	13.6
Length of deltoid crest, from head	20.4	24.7	27.5	28.2	28.5
Length of bicipital crest, from head	15.2	16.9	18.4	19.7	20.2
Breadth of shaft ²	5.4	6.7	6.8	8.0	8.0
Depth of shaft ²	3.2	3.8	4.0	4.8	4.8

¹ Proximal breadth measured from external tuberosity to below tip of internal tuberosity.

² Breadth and anconal-palmar depth of shaft measured just above brachial impression.

Although the characters of the Sharktooth Hill humerus most closely resemble those found in *Fulmarus*, the differences noted between it and the Recent species of the genus are more marked than those that distinguish the latter from each other. In view of the similarities noted between the humeri of *Thalassoica* and *Daption* and those of *Fulmarus*, it is possible that a distinct, perhaps ancestral, genus is represented by this Miocene bone. With the limited knowledge at hand, however, it is considered advisable to record this single specimen as a new species within the genus *Fulmarus*.

Fulmarus miocaenus n. sp.

Holotype.—Nearly complete left humerus, Natural History Museum of Los Angeles County no. 122995; collected by Howell W. Thomas in 1979.

Locality.—LACM locality 3162, Sharktooth Hill Bonebed, Kern County, California.

Formation and age.—Round Mountain Silt, middle Miocene, Barstovian Land Mammal Age.

Diagnosis.—Distinguished from the humeri of *Fulmarus glacialis* and *F. glacialoides* by small size (Table 1) and the following morphological characters: shaft anconally below head less acutely angular, with capital shaft ridge more median in position and less proximal in extent; bicipital crest relatively longer with internal and distal contours more evenly rounded and distal termination more clearly marked; bicipital surface more swollen viewed from palmar side; ectepicondylar prominence less raised above distal end of humerus (ratio of height of prominence above distal end of humerus to breadth of distal end, 82 percent, as compared to 92–95 percent in *F. glacialis* and 102 percent in *F. glacialoides*). Distinguished from humerus of Miocene species *F. hammeri* by smaller size (distance from distal end of humerus to base of ectepicondylar prominence 7.8 mm, depth of

external condyle 5.8 mm; same measurements in the humerus of *F. hammeri* 13.0 mm and 9.1 mm respectively).

Measurements compared with living species of *Fulmarus*: Table 1.

Discussion.—The Maryland record of *Fulmarus* sp. (Wetmore 1926) is based on a fragment of the shaft of a humerus (USNM 237160) between the nutrient foramen and the lower half of the deltoid crest. It was placed in the genus *Fulmarus* on the basis of the high elevation of the nutrient foramen and general similarity and size with respect to the humerus of *F. glacialis*. Size alone precludes referral to *F. miocaenus*: breadth of shaft immediately below the deltoid crest in *F. miocaenus* 5.0 mm, depth of shaft at the same place 4.0 mm; the same measurements on USNM 237160, according to Storrs Olson of USNM, who examined the fragment for me, are 5.8 mm and 4.7 mm respectively—close to the minimum of the *F. glacialis* humeri at hand (5.7 mm breadth, 4.7 mm depth). Furthermore, Olson notes that the specimen preserves no diagnostic features that could be used in comparison with the holotype of *F. miocaenus*, and should probably now be classified only as “Procellariidae, gen. and sp. indet.”

Conclusion

Fulmarus miocaenus n. sp. is the ninth species to be described from the Sharktooth Hill Bonebed, and the fourth species of the family Procellariidae named from this middle Miocene site. The other members of the family are the shearwaters *Puffinus inceptor*, *P. mitchelli*, and *P. priscus*. Although the shearwaters are well represented in the Tertiary fossil record, *Fulmarus miocaenus* is only the second species of fulmar to be described, and only the third fulmarine record for the Tertiary. In addition to *P. hammeri* described from the Miocene of Orange County, California, *Fulmarus* sp. was recorded from the Miocene of Maryland. Based on a fragment of humeral shaft, the generic assignment of the Maryland specimen is now questioned.

Whether the species represented by the additional families herein recorded from the Bonebed—Pseudodontornithidae, Ciconiidae and Phoenicopteridae—are assignable to species previously described from other fossil sites, or represent species new to science is yet to be determined.

Acknowledgments

I wish to thank Howell W. Thomas for his gift to the Natural History Museum of Los Angeles County of fossils that he collected at the Sharktooth Hill site, which included the specimen here named as holotype of *Fulmarus miocaenus* n. sp.

I am grateful to the following palaeornithologists for helpful suggestions after reading an earlier draft of this paper: Pierce Brodtkorb, Kenneth E. Campbell Jr., and Storrs L. Olson. I also want to thank Dr. Olson for arranging the loan of skeletons from the National Museum of Natural History and for examining the “fulmarine” specimen from the Miocene of Maryland for me.

My thanks go to my husband, Henry Anson Wyld, for his painstaking care in photographing the fragile holotype of *Fulmarus miocaenus*, and to Richard Meier, LACM Photographer, for preparing the excellent prints.

Some specimens referred to in this paper were collected with support from National Science Foundation grant No. EAR-7916508 to the Natural History Museum of Los Angeles County Foundation.

Literature Cited

- Brodkorb, P. 1963. Catalogue of fossil birds. Part 1 (Archaeopterygiformes through Ardeiformes). Bull. Florida State Mus., Biol. Sci., 7(4):179-293.
- Howard, H. 1957. A gigantic "toothed" marine bird from the Miocene of California. Santa Barbara Mus. Nat. Hist. Dept. Geol. Bull. 1, 23 pp.
- . 1966. Additional avian records from the Miocene of Sharktooth Hill, California. Los Angeles Co. Mus. Contrib. Sci. no. 114, 11 pp.
- . 1968. Tertiary birds from Laguna Hills, Orange County, California. Los Angeles Co. Mus. Contrib. Sci. no. 142, 21 pp.
- Miller, A. H. 1944. An avifauna from the lower Miocene of South Dakota. Univ. California Publ. Bull. Dept. Geol. Sci., 27(4):85-100.
- Miller, L. 1961. Birds from the Miocene of Sharktooth Hill, California. Condor, 63:399-402.
- . 1962. A new albatross from the Miocene of California. Condor, 64:471-472.
- Mitchell, E. 1965. History of research at Sharktooth Hill, Kern County, California. Special Publ. Kern County Historical Soc. and County of Kern through its Museum, vi + 45 pp.
- Warter, S. 1976. A new osprey from the Miocene of California (Falconiformes: Pandionidae). In Collected papers in avian paleontology honoring the 90th birthday of Alexander Wetmore. (Storrs L. Olson, ed.), Smithsonian Contrib. Paleobiology no. 27:133-139.
- Wetmore, A. 1926. Observations on fossil birds described from the Miocene of Maryland. Auk, 48(4):462-468.
- . 1930. Fossil bird remains from the Temblor Formation near Bakersfield, California. Proc. California Acad. Sci., ser. 4, 19:85-93.

Accepted for publication 20 April 1984.

Chief Curator Emeritus Natural History Museum of Los Angeles County, 900 Exposition Blvd., Los Angeles, California 90007.

Plant Succession and Species Diversity in the Marblehead Quarry, Ohio

Gerald P. Hannes and Susan M. Hannes

Abstract.—Plant succession and species diversity in the Marblehead Quarry, Ohio by Gerald P. Hannes and Susan M. Hannes. *Bull. Southern California Acad. Sci.*, 83(2):90-98, 1984. In three abandoned sites in the Marblehead Quarry, plant species diversity generally increases through time, especially when examined on a vegetation strata basis. The composite diversity value is highest in an intermediately aged community where there is a great degree of habitat heterogeneity due to shading and increased litter and humus content in the soil. Dominance-diversity curves are initially geometric in the earliest successional stage and approach lognormal in the intermediate. That the oldest site does not generally conform to the expected pattern of traditional plant succession is possibly due to a physical characteristic other than time which affects this site and not the other two.

The concept of plant succession as a predictable process of change is central to ecological theory. The classical interpretation of succession is the development of vegetation through discrete seral stages or transitory communities which culminate in a stabilized ecosystem or climax community. Species replacement occurs as the result of the modification of the physical environment by the vegetation itself. Examples of changes in the land surface and microclimate through time include increased soil humus, a reduction of erosion, and a decrease in the amount of sunlight reaching the ground level. Trends expected in the development of mature ecosystems are high species diversity, complex community structure, closed mineral cycling, and a balance between production and respiration (Odum 1969).

Studies on ecosystem development are needed to define regional trends in vegetation through time as well as contribute to the model testing of theoretical ecology (Martin 1959; Bazzaz 1975; Nicholson and Monk 1974; Veno 1976).

This study presents successional changes in the vascular flora of three abandoned sites in a limestone quarry. Objectives of this paper are to (1) report successional changes in three strata for each site, (2) analyze composite samples representing the total species component for each of the three locations in the quarry, and (3) interpret the variations in species composition and diversity trends.

Study Area

The Marblehead Quarry is located approximately 64.4 km east of Toledo on the Marblehead Peninsula in northern Ohio (Fig. 1). Columbus limestone and Detroit River dolomite are the two geologic formations of the quarry area. Therefore, the quarry has a calcareous substrate with a soil pH value of approximately 7.2 (Ross 1970).

The Marblehead Quarry, consisting of approximately 1012 ha, started as numerous, small, privately owned quarries in the 1800's. The western end of the

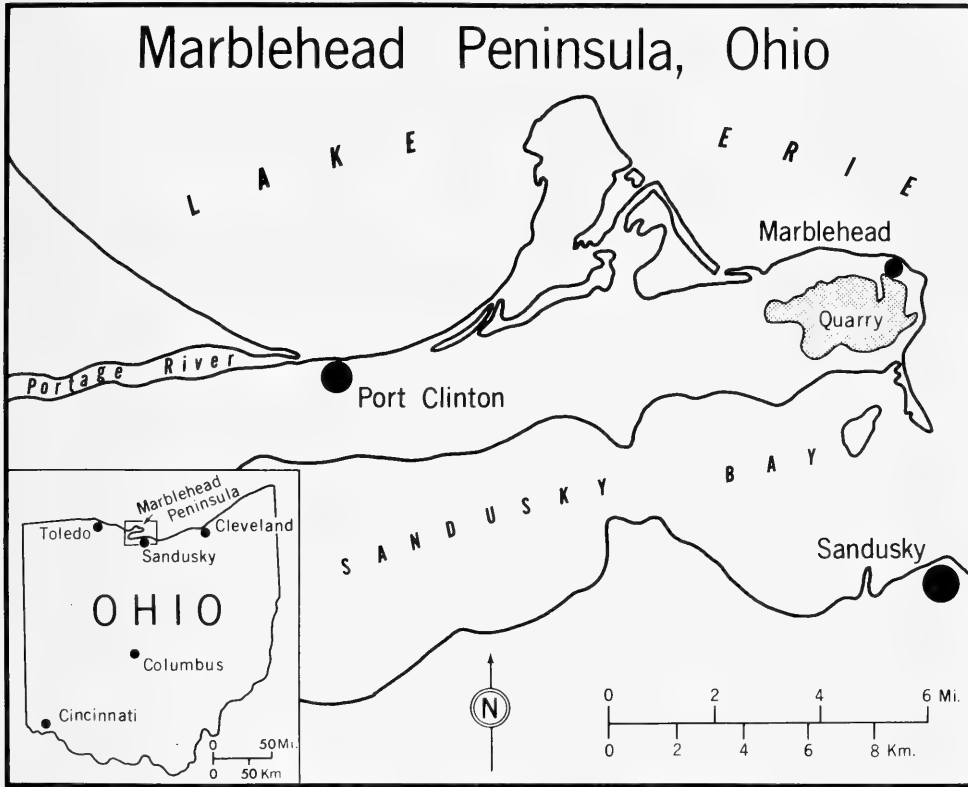

Fig. 1. Location of the Marblehead Peninsula in northern Ohio.

quarry has the higher elevations of approximately 202.7 m. The quarry floor slopes eastward approximately 4.8 km to some large, permanent pools of water at the eastern end. The lake bottom elevations are at approximately 176.8 m. The quarry floor thus has a local relief of about 25.9 m. Since the three sites of this study were located in the western half of the quarry, elevation should not be a factor affecting the overall species composition. Elevation is therefore assumed constant.

Ages of three abandoned areas were determined using the records of the Standard Slag Company. Site 1, the youngest site, consisted of approximately 32 ha and was abandoned in 1959. The depth of the soil cover ranged from exposed rock areas of 0.0 cm to places with 10 cm.

The intermediate site of approximately 40 ha was abandoned in 1948. It was lightly covered with gravel. The soil depth of Site 2 varied from 0.0 cm to about 12 cm. Drill holes, natural fractures in the rock, and cracks due to root wedging served as depressions for the collection of dust, organic matter, and water, especially in Site 1 and Site 2.

Site 3 was not located in the property currently owned by the Standard Slag Company. However, also an abandoned limestone quarry, it was less than 90 m north of the large quarry. It was hand quarried in about 1895. Having a size of

only about 2 ha, it was the smallest of the three sites. The size factor may have caused this site to be more moist as the pit collected water and distributed it over a smaller area. However, no standing water or ponds were noted. Exposures of bare rock to layers of organic debris nearly 30 cm thick formed the floor.

The Marblehead Peninsula has a climate of the humid continental, hot summer variety. The January average temperature at nearby Sandusky is -1.5°C , and the July average is 23.9°C . Sandusky receives a mean annual precipitation of 863.9 mm, with at least 50.8 mm each month and a slight summer maximum (U.S. Department of Commerce 1964). Lake Erie has a pronounced moderating effect upon the climate of this region. Sandusky has 194 frost free days, whereas Bucyrus, Ohio, 80.5 km south of the Peninsula, has a growing season of only 154 days (Verber 1955).

Methods

Three sites—19, 30, and 83 years after abandonment—were selected. All vegetation sampling was done during July and August 1978, a time when vegetative and reproductive parts facilitated species identification. No sampling was done beside or on the gravel roads in the quarry, in order to avoid roadside effect. Vegetation was not sampled in and along quarry ponds and on spoil heaps and other man-made mounds of material. The intent was to sample areas with relatively homogeneous characteristics at the time of abandonment, i.e., bare exposures of calcareous rock with, perhaps, a light gravel cover. Therefore, time was considered the only factor which differed from site to site.

Vascular plants in each site were sampled by strata defined as follows: (1) ground layer consisting of woody plants <30.5 cm tall and all herbaceous plants, (2) shrub-understory layer comprised of woody species ≥ 30.5 cm tall but <10.2 cm diameter at breast height (dbh), and (3) canopy consisting of woody species ≥ 10.2 cm dbh. This three strata system was deemed necessary especially for Site 3, the 1895 forested site. Species-area curves were constructed by plotting the cumulative species total against the number of samples taken. The sample was considered adequate when the curves became horizontal. The ground layer was sampled in 40 plots of $1\text{ m} \times 1\text{ m}$ in each site. The shrub-understory and canopy samples consisted of 20 quadrats of $4\text{ m} \times 4\text{ m}$ and $10\text{ m} \times 10\text{ m}$ respectively. The species present in each plot were identified. The projected cover for each species was estimated as a percent by visual inspection.

Species diversity was calculated for each stratum, as well as the composite for each site using the standard Shannon-Wiener index:

$$D = - \sum_{i=1}^n p_i \log p_i$$

where p_i is the proportion of the cover belonging to the i^{th} species and n the total number of species in the sample. This formula combines the two major components of diversity, species richness or variety and evenness or equitability, into one overall index of diversity. Dominance-diversity curves for each of the three sites were constructed by plotting the log of the relative cover on the vertical axis, against the rank of the species from highest to lowest on the horizontal axis (Whittaker 1965).

Results and Discussion

Although Ross (1970) recorded 213 species in her comprehensive treatment of the Marblehead Quarry flora, it must be remembered that our study did not deal with the entire 1012 ha. The vegetation of the often barren, soil-free limestone sites was generally quite different from that of nearby agricultural areas and other places with a developed soil (Core 1948; McCormick 1968). For example, the Lakeside daisy (*Actinea acaulis*) grows on the thin soiled limestone plains of the Marblehead Peninsula and no other place in Ohio (Weed 1890). Therefore, not only was time a factor in this succession study, but also the limestone-dolomite base.

General Description of the Sites

Site 1, abandoned 19 years, had a total of 27 species. Due to the expanses of bare stone and scattered gravel, only about 20% of the surface was covered by the vegetation of the ground layer. *Houstonia* (*Houstonia nigricans*), an herbaceous plant with stems from a perennial base, contributed the greatest relative cover of this site. *Houstonia* is well adapted to the dry, rocky conditions of the quarry floor typical of the early stages of succession. Among the other more common plants of the ground layer were panic grass (*Panicum lanuginosum*) and a few species of goldenrod (*Solidago* sp.). Woody plants less than 30.5 cm tall also appeared in the ground layer. Eastern poplar (*Populus deltoides*), eastern redcedar (*Juniperus virginiana*), two species of willow (*Salix* sp.), and two species of dogwood (*Cornus obliqua* and *C. drummondii*) were found in the ground layer as well as in the shrub-understory stratum. The eastern redcedar (*Juniperus virginiana*) is known to attain its largest size in dry, calcareous habitats. There was no canopy layer in Site 1, that is woody species ≥ 10.2 cm dbh were not encountered. This was the expected case in an area 19 years after abandonment.

Site 2, the 30 year old site, had 20 more species than the most recent site. Of the 47 species encountered, 23 were common to both Site 1 and Site 2. Since only 11 years separate these two sites in time of development, this species overlap was expected. Approximately 30% of the total surface was covered by the ground layer. Once again, *Houstonia* (*Houstonia nigricans*) had the highest cover of all the herbaceous species. Panic grass (*Panicum lanuginosum*), Canada bluegrass (*Poa compressa*), goldenrod (*Solidago* sp.), blazing star (*Liatris spicata*), and balsam ragwort (*Senecio pauperculus*) were also fairly common in some of the more open areas of Site 2. The shrub and tree species were similar to those of Site 1, with the inclusion in Site 2 of staghorn sumac (*Rhus typhina*). Their increased size was the main difference. Site 2 did have a canopy layer which covered approximately 5% of this stratum. It consisted mainly of eastern poplar (*Populus deltoides*), with a rare occurrence of large eastern redcedars (*Juniperus virginiana*). The increased size in the woody species produced microhabitats for other species due to shading and increased litter and humus, similar to the findings of Whitford and Whitford (1978). Such species as riverbank grape (*Vitis riparia*), black raspberry (*Rubus occidentalis*), poison ivy (*Rhus radicans*), and rose (*Rosa multiflora*) formed "islands" of vegetation beneath and around the larger trees.

Site 3, 83 years old, was a forested region containing 36 species. Only three species were common to all three sites. The most notable of these was eastern poplar (*Populus deltoides*) which, together with basswood (*Tilia americana*), com-

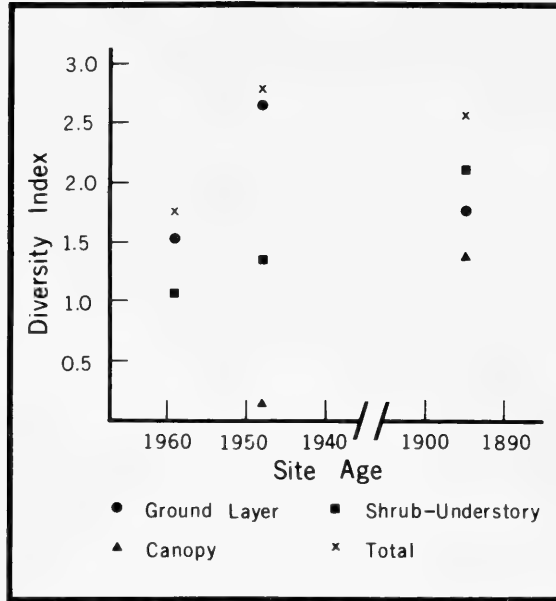

Fig. 2. Relationship between the Shannon-Wiener species diversity index and time. Each vegetation layer is represented by a different symbol.

prised much of the canopy stratum. The presence and dominance of the poplar suggests that a site characteristic, namely water accumulating in the 2 ha pit, may reduce the variety of species found here. This may be one of the reasons why Site 3 had 12 less species than the middle-aged Site 2. The ground layer of site 3 covered nearly 55% of the surface. Shading, slabs of limestone, and the presence of nonvascular plants such as mosses reduced the coverage value in this stratum. The shrub-understory coverage was also approximately 50%, and the canopy layer covered about 40%. Thus, there was more area covered by vascular plants in all three strata of Site 3. Common species of the ground layer included beggar ticks (*Bidens frondosa*), poison ivy (*Rhus radicans*), and Virginia creeper (*Parthenocissus quinquefolia*). Basswood (*Tilia americana*), a species of dogwood (*Cornus* sp.), ironwood (*Ostrya virginiana*), and hackberry (*Celtis occidentalis*) were among those species in the shrub-understory. Site 3 had a greater amount of organic matter and stratification typical of the more mature stages of succession.

Species Diversity

Species diversity tends to be low in physically controlled ecosystems and high in biologically controlled systems. Concerning the ground layer, diversity increased from the 19 year old site to the 30 year old site, but decreased from there to the 83 year old site (Fig. 2). As mentioned previously, shading, bare limestone exposures, and the occupation of some areas by nonvascular plants not recorded in this study would affect the diversity of the ground layer of Site 3. The diversity of the shrub-understory and canopy layers increased from Site 1 to Site 3 (Fig. 2). The shrub-understory values varied by approximately 0.28 from Site 1 to Site 2 and increased nearly 0.75 from the 30 year old Site 2 to the 83 year old Site 3.

The diversity index for the canopy varied by 1.24 from Site 2 to Site 3; there was no canopy present in Site 1.

By comparing the strata from each of the three sites, these results are in general agreement with the progressive developments of succession through time. The more mature site should have a better shrub-understory layer as well as a larger, richer canopy than the younger successional stages. As the height and differentiation into strata of the community increases through time, more microhabitats are created which should lead to more species in each layer.

The total diversity was found to be the highest at Site 2 (Fig. 2). A slight decrease of approximately 0.20 was observed from the intermediate site to the oldest. This slight decrease could be due to several factors. The shading of the ground layer, demonstrated by the lower diversity index in that stratum, could have caused the small decline in the overall diversity. The fact that Site 3 was a pit conducive to water collection could also have reduced the composite diversity value. Other authors such as McNaughton and Wolf (1973), Whittaker (1970), and Taylor (1973) have postulated a general increase in diversity with succession in the early stages, leveling off and even declining in the later. However, the fact that only 83 years had passed in this area of primary succession as well as the presence of the eastern poplar (*Populus deltoides*) seems to indicate that too much moisture may be a limiting factor to species diversity in Site 3.

Dominance-Diversity Curves

Dominance-diversity curves show richness on the ordinate and evenness or equitability by the slope of the curves (Fig. 3). Species were classified into herbs, shrubs, and trees. Although the distinction between herbs and shrubs, and shrubs and trees is arbitrary, this was done for general comparison purposes only. Concerning richness of vegetation, Site 2 had the most species. Site 3, however, had the greatest amount of cover by tree and shrub species. Of the top 15 species by relative cover, Site 1 and Site 2 had nine herbaceous species, whereas Site 3 had only four. Size of the woody species increased with age.

The curve for the 19 year old site (1959) is essentially linear on the semilog plot (Fig. 3). This may indicate a strong dominance by one or two species, supporting the niche-preemption hypothesis of Motomura (1932). This geometric curve is often typical of communities dominated by physical factors, such as the limestone, lack of soil, and lack of shade in this study, typical of the early stages of succession.

In communities rich in number of species and with a range of microenvironments, the curve may approach a lognormal form. Where the diversity is high, community resources are generally shared by many species; their relative cover values are more similar. Of the three plots, Site 2 appears to exhibit the greatest tendency towards a lognormal distribution (Fig. 3). The overall species diversity was highest for the 1948 site; the greatest number of species was found here. It is expected by some ecologists that the dominance-diversity curves change from initially geometric towards lognormal through time. This seems to be the case when comparing the curves of Site 1 and Site 2.

Once again, Site 3 (1895) does not quite fit the pattern expected through succession (Fig. 3). The curve is more linear, although there appears to be less slope in the curve than that of Site 1 due perhaps to water accumulation on the site. This

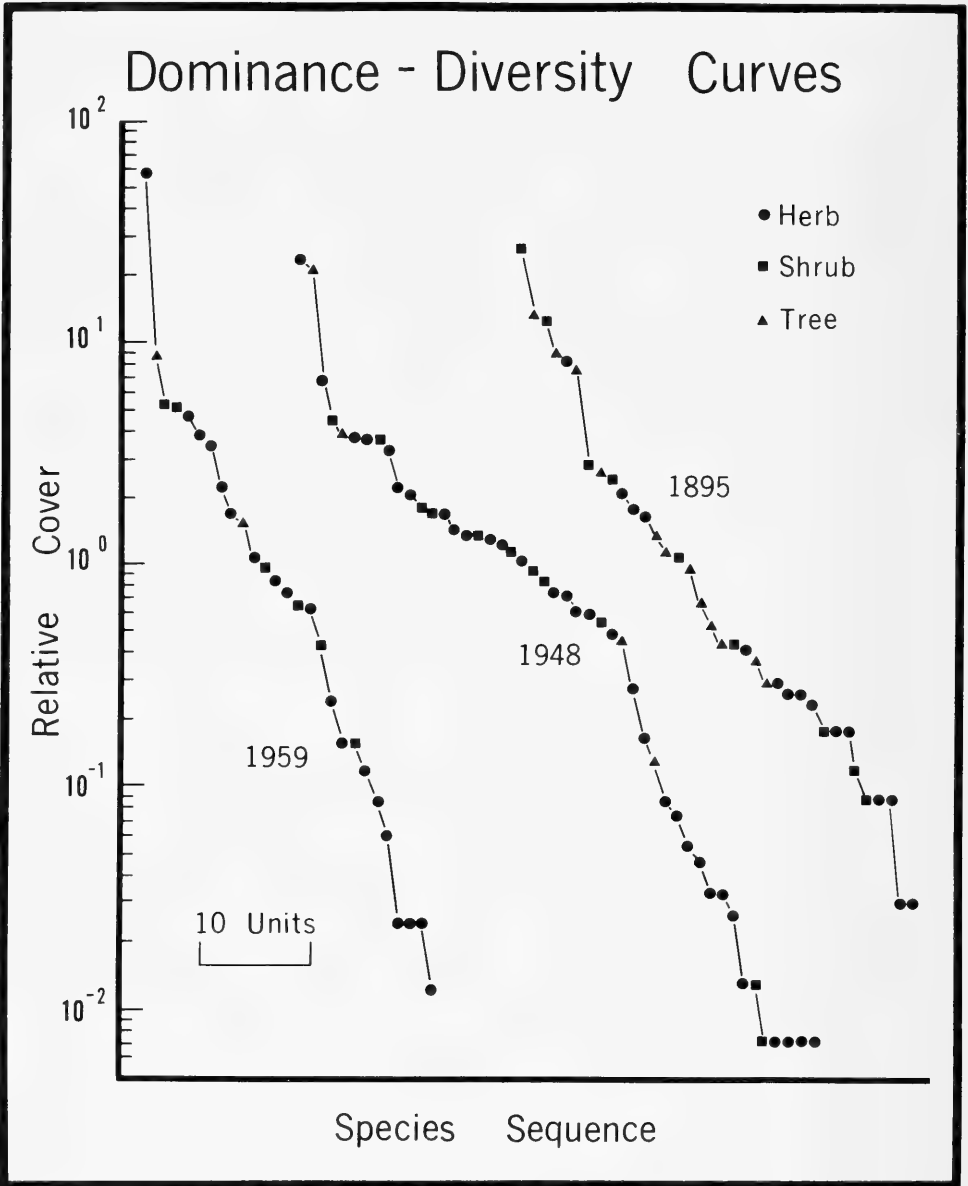

Fig. 3. Dominance-diversity curves for abandoned quarry sites of three different ages. Each species is represented by a symbol located by the species' relative cover on the vertical axis, and its position in the sequence of species from highest to lowest relative cover values on the horizontal axis. Thus, in the 1959 curve, an herb species with a relative cover of approximately 58% had the highest relative cover, followed by a tree species one unit over on the horizontal axis with a relative cover of 8%, and so on to the lowest species, an herb, with a relative cover of 0.012%.

physical "interference" may have interrupted biological complexities of resource sharing that would be expected to develop through time. It should also be remembered that the interpretation of dominance-diversity curves is not concrete; many explanations concerning dominance and the niche are available (McNaughton and Wolf 1970, 1973).

Conclusions

Plant succession has occurred in abandoned Marblehead limestone quarries in Ohio. The development sequence included a dominance by herbaceous plants in the early site to shrubs and trees in the oldest site. With the major exception of the eastern poplar (*Populus deltoides*), those species important in the early seral stages were not found in the more mature stage.

The Shannon-Wiener index values for each stratum were generally as expected. Diversity increased from the youngest to the oldest site in the shrub-understory and canopy strata. Concerning the overall diversity, however, the oldest site did not record the highest value. This is possibly due to shading and the abundance of water collected after a rainy period.

Dominance-diversity curves went from the more physically controlled geometric form of Site 1 towards a lognormal distribution of Site 2. The intermediate location was the richest in terms of number of species. The phenomenon of dominance by the poplar (*Populus deltoides*) and other species better adapted to moist conditions may have caused the curve of Site 3 to tend to be geometric.

Acknowledgments

We gratefully acknowledge Dr. Ronald L. Stuckey of the Ohio State University for supplying information about the vegetation of the Marblehead Quarry; Dr. Robert Romans of Bowling Green State University for his aid in species identification; Mr. J. Keith Pearson of the Standard Slag Company, Marblehead, Ohio for facilitating our research in the Marblehead Quarry; and Dr. Ted L. Hanes of California State University, Fullerton for his helpful comments on this manuscript.

Literature Cited

- Bazzaz, F. A. 1975. Plant species diversity in old-field successional ecosystems in southern Illinois. *Ecology*, 56:485-488.
- Core, E. L. 1948. The flora of the Lake Erie islands. Contr. No. 9, Ohio State University Franz Theodore Stone Laboratory. Columbus, Ohio. 106 pp.
- Martin, N. D. 1959. An analysis of forest succession in Algonquin Park, Ontario. *Ecol. Monogr.*, 29:187-218.
- McCormick, J. 1968. Vegetation in fallow vineyards, South Bass Island, Ohio. *Ohio J. Sci.*, 68: 1-11.
- McNaughton, S. J., and L. L. Wolf. 1970. Dominance and the niche in ecological systems. *Science*, 167:131-139.
- , and ———. 1973. *General ecology*. Holt, Rinehart and Winston, New York. 710 pp.
- Motomura, I. 1932. A statistical treatment of associations. *Japan J. Zool.*, 44: 379-383.
- Nicholson, S. A., and C. D. Monk. 1974. Plant species diversity in old-field succession on the Georgia Piedmont. *Ecology*, 55:1075-1085.
- Odum, E. P. 1969. The strategy of ecosystem development. *Science*, 164:262-270.
- Ross, J. J. 1970. A vascular flora of the limestone quarry on the Marblehead Peninsula, Ottawa County, Ohio. Master's Thesis, Ohio State University. 77 pp.

- Taylor, D. L. 1973. Some ecological implications of forest fire control in Yellowstone Park, Wyoming. *Ecology*, 54:1394-1396.
- U.S. Department of Commerce-Weather Bureau. 1964. Decennial census of United States climate-Climatic summary of the United States-Supplement for 1951 through 1960: Ohio. Government Printing Office, Washington, D.C.
- Veno, P. A. 1976. Successional relationships of five Florida plant communities. *Ecology*, 57:498-508.
- Verber, J. L. 1955. The climates of South Bass Island, western Lake Erie. *Ecology*, 36:388-400.
- Weed, C. M. 1890. The Lakeside daisy. *J. Columbus Hort. Soc.*, 5:72-73.
- Whitford, P. C., and P. B. Whitford. 1978. Effects of trees on ground cover in old-field succession. *Am. Mid. Nat.*, 99:435-443.
- Whittaker, R. H. 1965. Dominance and diversity in land plant communities. *Science*, 147:250-260.
- . 1970. *Communities and ecosystems*. MacMillan, New York. 162 pp.

Accepted for publication 22 December 1981.

Department of Geography, California State University, Fullerton, California 92634.

Primary Production in Grays Harbor Estuary, Washington

Ronald M. Thom

Abstract.—Primary production in Grays Harbor estuary, Washington by Ronald M. Thom. *Bull. Southern California Acad. Sci.*, 83(2):99-105, 1984. An estimate of annual primary production in Grays Harbor estuary, Washington, is presented. Eelgrass contributed the largest proportion of organic carbon production followed by benthic algae, marsh phanerogams and phytoplankton. The relatively great contribution of benthic microalgae and eelgrass to total estuarine primary production can be explained by the extensive mudflats with and without eelgrass that exist in the seaward parts of the estuary and the high per unit area rates by plants in these habitats. Average annual total primary production in the estuary was estimated to be 2.6×10^5 kgC/km², which is intermediate between published estimates for Chesapeake Bay (1.4×10^5 kgC/km²) and Nanaimo River estuary, British Columbia (6.8×10^5 kgC/km²).

The functioning of a temperate estuary is largely dependent upon the quantity and quality of organic material entering the estuary. Sources of organic material to estuaries may include resident aquatic plants, allochthonous material, oceanic material, precipitation and ground water (Teal 1962; Nixon and Oviatt 1973; Day, Smith, Wagner, and Stowe 1973; Pomeroy 1977; Correll 1978; Naiman and Sibert 1978; Valiela, Teal, Volkmann, Shafer, and Carpenter 1978). The production of organic material within estuaries on the west coast of North America is largely carried out by marsh phanerogams, eelgrass, benthic macroalgae and microalgae, and phytoplankton. Comprehensive data on primary production (i.e., carbon fixation) of major plant types in Pacific Northwest estuaries are few. Notable among published works is that of Naiman and Sibert (1978). They summarized data on particulate carbon input to Nanaimo River estuary, British Columbia. Their results indicated that fluvial sources contributed the largest proportion of organic carbon to the estuary followed in descending order by marsh phanerogams (*Carex*), eelgrass, benthic microalgae, phytoplankton, and macroalgae.

The purpose of the present paper is to provide the first estimate of total annual primary production for Grays Harbor estuary. Grays Harbor estuary is a large (240 km²) drowned river mouth located on the Pacific coast of Washington (Fig. 1). The estuary is characterized by extensive tideflats (ca. 58% of the high tide surface area), channels, and fringe marshes. Several rivers drain into the estuary; the primary one being the Chehalis River (flow rate 28×10^3 – 1.4×10^6 l/sec., Loehr and Collias 1981) located at the eastern end of the estuary (Fig. 1). Tides are semidiurnal with a mean range of 2.4 m at Aberdeen. Surface water salinity ranges for the inner portion and the mouth of the estuary are 0–10 ppt and 20–30 ppt, respectively. Coastal upwelling is most pronounced during low flow periods in summer, and results in lower dissolved oxygen levels and lower water tem-

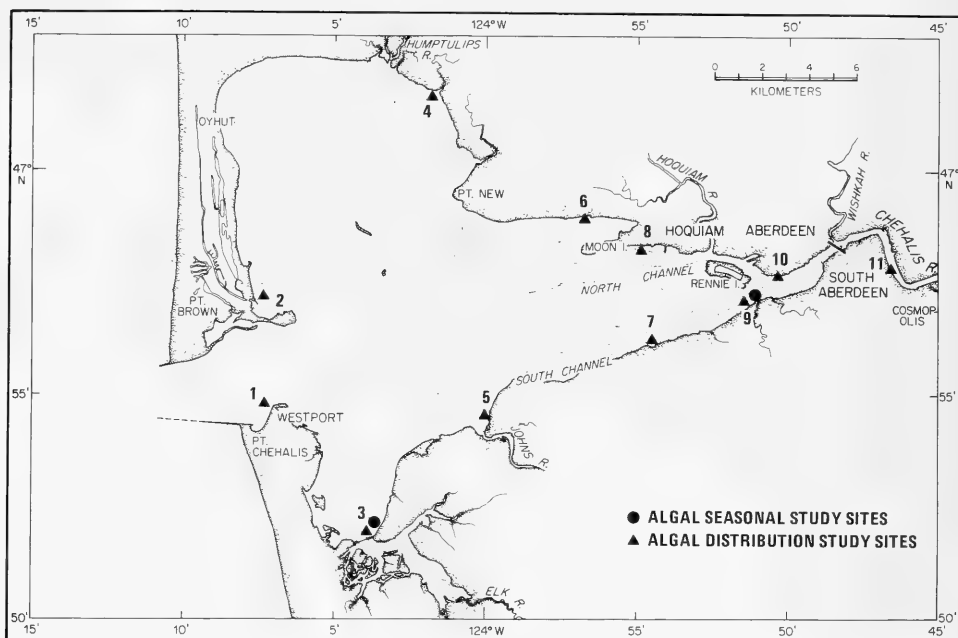

Fig. 1. Grays Harbor estuary. The dotted line within the estuary represents MLLW. The macroalgal study sites of Thom (1983) are indicated.

peratures in the outer portion of the estuary. Rain is heavy during winter months, with an annual average of approximately 207 cm (Loehr and Collias 1981). The estuary and surrounding habitat contain major biological resources including a large salmonid fish run (Simenstad and Eggers 1981) and Dungeness crab population (Armstrong, Stevens, and Hoeman 1982), and form a primary resting and feeding area for shorebirds migrating to Alaska along the Pacific flyway (Herman and Bulger 1981). These resources are undoubtedly supported at least partially by autochthonous carbon sources.

Previous studies on primary production in the estuary are few. Westley (1967) sampled phytoplankton productivity at 14 sites located from the inner to outer portion of the estuary during August and September 1964, and July, August, and September 1965. Herrmann (1971) measured oxygen production by mudflat organisms at six sites during June and August 1966 using bell jars. Rountree (1978) sampled bimonthly changes in standing stock of marsh phanerogams at three sites in the estuary. Benthic macroalgal productivity and distribution were studied by Thom (1984). Data from these studies were used here to arrive at estimates of annual primary production within Grays Harbor.

Materials and Methods

To make estimates of total yearly primary production, I relied on both published and unpublished data and a field study of marsh plant and benthic macroalgae. The rates gathered from the literature and the field study were used to derive an estimate of carbon fixation for various vegetation types in the estuary.

The field study was conducted during 1980–81, and consisted of sampling marsh

phanerogam productivity and macroalgal productivity of selected species at several sites in the estuary. The details of the algal productivity study are presented elsewhere (Thom 1984). Study site descriptions and methods for the algal and phanerogam investigations are given in Thom (1981). Briefly, marsh phanerogam productivity was estimated from above ground dry weight per unit area standing stock determinations made from quarterly collections at four sites. Algal rates were determined from dissolved oxygen changes in light and dark 300 ml bottles containing specimens of major macroalgal taxa. The bottles were incubated at ambient water temperatures in the field for 1–3 hrs during mid-day.

Annual production rates for macroalgal taxa and sediment microalgae (Herrman 1971) were determined from mean hourly rates using several conversion factors. Hourly rates were multiplied by the mean number of hours of non-limiting light energy (=4 hrs, C. D. McIntire, pers. comm.) to yield average daily rates. Daily rates were then multiplied by the approximate number of days that the taxon was present in the estuary (Thom 1981). The area of the estuary occupied by each taxon was determined using estimates of algal percentage cover made along transects positioned across the intertidal zone at 11 locations in the estuary (Thom 1984).

The data of Smith, Mudd, and Messmer (1976) were used to provide an estimate of total cover of each marsh type and eelgrass taxon in the estuary. The studies on marsh plants from which I acquired production rates included Rountree (1978), Eilers (1979), Berg, Rosenberg, and Tripp (1975), Hoffnagle (1980) and Thom (1981). Data on eelgrass (*Zostera marina*) production were obtained from the work of McIntire, Davis, Kentula, and Whiting (1983) in Netarts Bay, Oregon. No local estimates for the production of *Z. noltii* were available. I, therefore, arbitrarily chose a value equal to one-half of the production rate of *Z. marina* as an estimate of the production of the morphologically smaller *Z. noltii*.

The data of Westley (1967) as summarized in Westley and Tarr (1965) were used to estimate net phytoplankton productivity. Annual rates were calculated by multiplying hourly rates, integrated over the upper 3.1 m (10 ft) of the water column, by four hrs/day and 365 days/yr. The area occupied by phytoplankton was taken as the surface area covered by water at mean tide level. The mean rate for all sites and sampling dates between July–September was used. This probably overestimates the winter rate and underestimates the rate during spring increase.

Results

The green algal *Enteromorpha/Blidingia* complex had the greatest rate followed by two marsh assemblage types (low sandy marsh, immature high marsh) and the eelgrass *Zostera marina* (Table 1). Phytoplankton exhibited the lowest rate.

Zostera spp. had the greatest total annual productivity for the entire estuary (Table 1). Benthic microalgae along with eelgrass accounted for approximately 70% of the annual primary production in the estuary. Marsh phanerogams, which are largely restricted to fringes of the estuary, accounted for 22.4% of total autotrophy. Phytoplankton, in the turbid waters of the estuary, fixed the least total amount of carbon on an annual basis, with the exception of macroscopically evident benthic diatoms.

Variation in the relative production of the major vegetation types among regions in the estuary can be expected. North and South Bays and mid Harbor flats contain

Table 1. Annual net primary productivity (NPP) of aquatic vegetation in Grays Harbor.

Vegetation type	Mean NPP gC/m ² /yr	Area (×10 ³ m ²) of cover in estuary	Annual NPP (×10 ³ kgC/yr) weighted by cover	Percent of total for estuary
Low Silty Marsh	767	6,600	5,062.2	8.1
Low Sandy Marsh	979	2,600	2,545.4	4.1
Sedge Marsh	529	800	423.2	0.7
Immature High Marsh	956	1,000	956.0	1.5
Mature High Marsh	1,108	4,200	4,653.6	7.4
Freshwater Marsh	338	1,000	338.0	0.5
		Marsh Total	13,978.4	22.4
Eelgrass:				
<i>Zostera marina</i>	806	44,500	35,867.0	57.4
<i>Z. noltii</i>	403	2,800	1,128.4	1.8
		Eelgrass Total	36,995.4	59.2
Phytoplankton	9	171,865	1,546.8	2.5
Sediment Microalgae	59	114,000	6,726.0	10.8
Diatoms ¹	65	3	0.2	<0.1
Macroalgae:				
<i>Enteromorpha</i> <i>clathrata</i>	430	6,400	2,752.0	4.4
<i>E. linza</i>	26	7	0.2	<0.1
<i>E. sp./Blidingia sp.</i>	1,257	168	211.2	0.3
<i>Fucus evanescens</i>	729	340	247.9	0.4
<i>Porphyra sanjuanensis</i>	21	66	1.4	<0.1
<i>Ulva/Monostroma</i>	321	7	<2.2	<0.1
		Macroalgae Total	3,214.9	5.1
		TOTAL ALL TYPES	62,461.7	

¹ Diatoms evident macroscopically as tufts.

extensive intertidal areas with sediment associated microalgae and eelgrass meadows (Fig. 1). Marsh vegetation occurs in a narrow (5–100 m) fringe along the margins of the estuary in most regions. Macroalgae are attached to stable substrata (e.g., logs, pilings, rip rap) which is relatively rare in the estuary. A notable exception is the green tubular alga *Enteromorpha clathrata* that is found in unattached mats on tideflats during summer.

Discussion

The extensive shallow tideflats in Grays Harbor estuary are occupied by eelgrass and benthic algae. These vegetation types account for the vast majority of carbon fixation within the estuary annually. An estimate (Thom 1981) of fluvial input of organic carbon (893×10^6 kgC/yr) to the estuary is much greater than the total of all primary producers within this estuary. Fluvial sources also contributed the largest amount of organic carbon to the Nanaimo estuary, British Columbia (Naiman and Sibert 1978), however the rank order of secondary sources differed from that in Grays Harbor. Benthic sources were relatively more important in the Grays Harbor estuary than in the Nanaimo River estuary. The estuaries differ greatly in size and morphology, and possibly in the proportions of coverage by each source. Intertidal mudflats containing microalgae, drift macroalgae, and

eelgrass occupy ca. 73% of the intertidal zone in Nanaimo estuary (Foreman 1975) as compared to ca. 84% in Grays Harbor.

Biggs and Flemer (1972) constructed a carbon budget for upper and middle Chesapeake Bay, for which they used an estimate of ca. 300×10^6 kgC/yr for resident primary producers (phytoplankton only). In Grays Harbor, production by phytoplankton was much less, and total resident plant production was approximately 21% (62×10^6 kgC/yr) of the Chesapeake Bay value. The surface area of the Chesapeake study region was ca. 2,200 km² as compared to 240 km² in Grays Harbor. This difference probably largely accounts for the greater total productivity by phytoplankton in Chesapeake Bay. Total production is ca. twice as high in Grays Harbor (2.6×10^5 kgC/km²/yr) per unit area as compared to the Chesapeake Bay study region (1.4×10^5 kgC/km²/yr) based on the above estimates. The estimate for the Nanaimo River estuary is 6.8×10^5 kgC/km²/yr using a total production value of 680.5 gC/m²/yr (Naiman and Sibert 1978).

Benthic algal contributions were high in Grays Harbor, and these organisms may be highly important to the algae-detritus consumers in the estuary (Gallagher and Daiber 1974). Although generally inconspicuous, macroalgae and sediment associated microalgae are turning over very rapidly. Recent studies (Simenstad and Wissmar 1983) indicate that these organisms may be the primary energy resource for the detritus based food web in Pacific Northwest estuaries.

The sinks of organic material produced by aquatic vegetation in Grays Harbor probably include, as suggested for Chesapeake Bay (Biggs and Flemer 1972), export to the ocean, respiration and conversion of particulate carbon to dissolved organic matter, and burial in sediments. The magnitude of each sink awaits study. The abundant, productive and economically important faunal populations (Albright 1982; Albright and Bouthillette 1982; Simenstad and Eggers 1981; Armstrong et al. 1981) in the estuary are likely closely tied energetically to resident carbon fixing organisms. Studies on carbon sinks, cycling and flow are needed to describe the functioning of the Grays Harbor ecosystem relative to these resources. Further work on carbon sources, especially for phytoplankton, benthic microalgae and eelgrass, to increase the spatial and temporal coverage and precision of production estimates are also in order.

Acknowledgments

I sincerely appreciate the field and laboratory help of J. Armstrong, B. Britt, B. Holweg, and M. Rosenberg. In particular, I thank V. Yoshino for his constant assistance during the field portion of the study. K. Keegan kindly typed parts of the manuscript.

Literature Cited

- Albright, R. G. 1982. Population dynamics and production of the amphipod *Corophium salmonis* in Grays Harbor, Washington. M.S. thesis, University of Washington, Seattle, vi + 76 pp.
- Albright, R., and P. K. Bouthillette. 1982. Benthic invertebrate studies in Grays Harbor, Washington. Grays Harbor and Chehalis River Improvements to Navigation Environmental Studies, Seattle District, U.S. Army Corps of Engineers, Seattle, Washington, xvii + 224 pp.
- Armstrong, D. A., B. G. Stevens, and J. C. Hoeman. 1982. Distribution and abundance of Dungeness Crab and Crangon Shrimp, and dredging-related mortality of invertebrates and fish in Grays

- Harbor, Washington. Grays Harbor and Chehalis River improvements to navigation environmental studies, Seattle District, U.S. Army Corps of Engineers, Seattle, Washington, xvii + 349 pp.
- Berg, M. E., E. S. Rosenberg, and D. R. Tripp. 1975. Vegetation associations and primary productivity of the Nisqually Salt Marsh on Southern Puget Sound, Washington. Pp. 109-144 in *Contributions to the natural history of the Nisqually Salt Marsh on Southern Puget Sound, Washington*. (S. G. Herman and A. M. Wiedeman, eds.), The Evergreen State College, Olympia, Washington.
- Biggs, R. B., and D. A. Flemer. 1972. The flux of particulate carbon in an estuary. *Marine Biology*, 12:11-17.
- Correll, D. L. 1978. Estuarine productivity. *BioScience*, 28:646-650.
- Day, J. W. Jr., W. G. Smith, P. R. Wagner, and W. C. Stowe. 1973. Community structure and carbon budget of a salt marsh and shallow bay estuarine system in Louisiana. Publ. No. LSU-SG-72-04, Center for Wetland Resources, Louisiana State University, Baton Rouge, iv + 79 pp.
- Eilers, H. P. 1979. Production ecology in an Oregon coastal salt marsh. *Estuarine and Coastal Marine Science*, 8:399-410.
- Foreman, R. E. 1975. Nanaimo River Estuary study seasonal aspects of macrophyte distribution and standing crop on the Nanaimo River Estuary mudflats. BERP Report 75-3, Department of Botany, University of British Columbia, i + 41 pp.
- Gallagher, J. L., and F. C. Daiber. 1974. Primary production of edaphic algal communities in a Delaware salt marsh. *Limnology Oceanography*, 19:390-395.
- Herman, S. G., and J. B. Bulger. 1981. The distribution and abundance of shorebirds during the 1981 spring migration at Grays Harbor, Washington. Grays Harbor and Chehalis River improvements to navigation environmental studies, Seattle District, U.S. Army Corps of Engineers, Seattle, Washington, iv + 64 pp.
- Herrmann, R. B. 1971. Oxygen consumption and production of intertidal areas in Grays Harbor. Pp. 84-99 in *Grays Harbor cooperative water quality study*, Washington Department of Fisheries Technical Report 7.
- Hoffnagle, J. R. 1980. Estimates of vascular plant primary production in a west coast salt-marsh estuary system. *Northwest Science*, 54:68-79.
- Loehr, L. C., and E. E. Collias. 1981. A review of water characteristics of Grays Harbor 1938-1979 and an evaluation of possible effects of the widening and deepening project upon present water characteristics. Grays Harbor and Chehalis River improvements to navigation environmental studies, Seattle District, U.S. Army Corps of Engineers, Seattle, Washington, viii + 97 pp.
- McIntire, C. D., M. W. Davis, M. E. Kentula, and M. Whiting. 1983. Benthic autotrophy in Netarts Bay, Oregon. Final technical report to U.S. Environmental Protection Agency, Corvallis, Oregon, 309 pp.
- Naiman, R. J., and J. R. Sibert. 1978. Transport of nutrients and carbon from the Nanaimo River to its estuary. *Limnology Oceanography*, 23:1183-1193.
- Nixon, S. W., and C. A. Oviatt. 1973. Ecology of a New England salt marsh. *Ecological Monographs*, 43:463-498.
- Pomeroy, W. M. 1977. Benthic algal ecology and primary pathways of energy flow on the Squamish River Delta, British Columbia. Ph.D. dissertation, University of British Columbia, Vancouver, xvi + 175 pp.
- Rountree, R. A. 1978. Biomass values for dominant salt marsh angiosperms in five Pacific Coast estuaries, 1976-1977. Mimeo.
- Simenstad, C. A., and D. M. Eggers. 1981. Juvenile salmonid and baitfish distribution, abundance, and prey resources in selected areas of Grays Harbor, Washington. Grays Harbor and Chehalis River improvements to navigation environmental studies, Seattle District, U.S. Army Corps of Engineers, Seattle, xxi + 205 pp.
- Simenstad, C. A., and R. C. Wissmar. 1983. Origins and pathways of detritus in estuarine food webs. P. 26 in 1982 research in fisheries, annual report of the School of Fisheries, University of Washington, Seattle, xii + 95 pp.
- Smith, J. L., D. R. Mudd, and L. M. Messmer. 1976. Appendix E, impact of dredging on the vegetation in Grays Harbor. Maintenance dredging and the environment of Grays Harbor, Washington. Seattle District, U.S. Army Corps of Engineers, Seattle, Washington, 121 pp.
- Teal, J. M. 1962. Energy flow in the salt marsh ecosystem of Georgia. *Ecology*, 43:614-624.

- Thom, R. M. 1981. Primary productivity and carbon input to Grays Harbor Estuary, Washington. Grays Harbor and Chehalis River improvements to navigation environmental studies, Seattle District, U.S. Army Corps of Engineers, Seattle, Washington, v + 71 pp.
- . 1983. Composition, habitats, seasonal changes and productivity of macroalgae in Grays Harbor estuary, Washington. *Estuaries*, 7: *In press*.
- Valiela, I., J. M. Teal, S. Volkmann, D. Shafer, and E. J. Carpenter. 1978. Nutrient and particulate fluxes in a salt marsh ecosystem: tidal exchanges and input by precipitation and groundwater. *Limnology Oceanography*, 23:798-812.
- Westley, R. E. 1967. Phytoplankton photosynthesis and its relationship to oxygen in Grays Harbor, Washington. State of Washington, Department of Fisheries, Research Division, Olympia, Washington, iii + 30 pp.
- Westley, R. E., and M. A. Tarr. 1965. Physical-chemical and primary productivity data Grays Harbor, hydrographic trips p-12, 1964 and 1965. State of Washington, Department of Fisheries, Hydrographic Data 5(1) n.p.

Accepted for publication 19 January 1984.

Environmental Resources Section, Seattle District, U.S. Army Corps of Engineers, Box C-3755, Seattle, Washington 98124. Present address: School of Fisheries WH-10, College of Ocean and Fisheries Science, University of Washington, Seattle, Washington 98195. Contribution No. 655 from the School of Fisheries, University of Washington.

A New Species of *Rabdotus* (Gastropoda: Pulmonata: Bulimulidae) from Arizona

Walter B. Miller¹ and Richard L. Reeder²

Abstract.—A new species of *Rabdotus* (Gastropoda: Pulmonata: Bulimulidae) from Arizona by Walter B. Miller and Richard L. Reeder. *Bull. Southern California Acad. Sci.*, 83(2):106-109, 1984. A new species of the land snail family Bulimulidae, *Rabdotus christenseni* Miller & Reeder, is described from the Santa Rita Mountains of Arizona.

The genus *Rabdotus* Albers, 1850, in the family Bulimulidae, barely makes its appearance in southernmost Arizona, where *R. nigromontanus* (Dall, 1897) can be found in Peña Blanca Canyon of the Pajaritos Mountains.

During the course of an environmental impact study of the northern end of the Santa Rita Mountains, conducted by the University of Arizona in 1981, the senior author was surprised to find an isolated population of what appeared to be *R. nigromontanus*, in the immediate vicinity of Sycamore Spring, about 2½ mi NE of Helvetia. A second collection, on 25 July 1981, by the authors and two graduate students, Shelley Maxfield and Robert Carey, yielded several live adults which were found crawling, after a rain, along with many *Sonorella magdalenensis* (Stearns, 1890), in a large rockslide about 100 meters up canyon from Sycamore Spring. The lot was catalogued as *R. nigromontanus*, with the note that this isolated population represented a northern extension of the range of the species by some 70 kilometers.

Subsequently, in the course of a visit to the University of Arizona, Carl C. Christensen, who has done extensive work on the genus (Christensen 1978), examined the specimens and called to our attention that the shells differed substantially from those of *R. nigromontanus*. Critical examination of whole mounts of the reproductive anatomies also revealed significant differences, and it was determined that this population represented a new species, described below.

Family Bulimulidae

Rabdotus christenseni new species

Figs. 1 & 2

Description of shell of holotype.—Shell small, umbilicate, slender, the diameter about one-half of the height; rather thin, rib-striate, the striae mostly white to tan, on a tawny or white mottled ground, slightly glossy. Embryonic whorls 2 in number, rounded with strong, closely-spaced, axial riblets; faint traces of closely set, fine, spiral threads visible in the interstices of the axial riblets of the first whorl but absent on the second whorl. Post-embryonic whorls bearing irregularly-spaced growth ribs, with occasional minute pits and traces of scattered, fine, spiral striae. Peristome slightly reflexed, the ends joined by a thin parietal callus. Maximum height 17.7 mm, diameter 8.4 mm; 6 whorls.



Fig. 1. Left specimen: *Rabdodus nigromontanus* (Dall, 1897), WMB 7190. Middle and right specimens: Holotype of *Rabdodus christenseni*, new species, CAS 037525, apertural and dorsal views. All figures $\times 3.1$.

Reproductive anatomy of holotype.—Diagnostic characters are in the penial complex. Penis 7.5 mm in length, entirely contained within a thick penial sheath; epiphallus 7.0 mm, the lumen of the apical 3.0 mm lined by shallow longitudinal folds, then distally, for about 2.0 mm, the folds assume a spiral arrangement; remaining distal 2.0 mm contain highly convoluted, glandular diverticula. Junction of epiphallus and penis marked by a distinct constriction of the lumen. Epiphallic caecum 5.0 mm; penial retractor muscle very short, 0.8 mm long, attached to apex of epiphallic caecum. Vas deferens runs free from its origin at base of prostate gland, along free oviduct and vagina, and enters penial sheath at about 2.0 mm from genital orifice; it continues apically within the penial sheath, but free of the penis, and resurfaces at the apical end of the sheath, after which it runs alongside the epiphallus until its insertion at junction of epiphallus and epiphallic caecum.

Variations in paratypes.—A total of 4 adult, entire shells and 6 immature or damaged shells were collected in two separate visits. The largest adult paratype measures 17.3 mm in height and 8.4 mm in diameter, and the smallest measures 16.8 mm and 8.4 mm respectively. All specimens, adult and immature, show the characteristic sculpture and slenderness of the species.

Disposition of types.—Holotype: CAS 037525. Paratypes: WBM 7216, personal collection of W. B. Miller, and RLR 543, personal collection of R. L. Reeder.

Type locality.—Pima Co., Arizona; north end of the Santa Rita Mountains, in large rockslide on left bank of south fork of Sycamore Creek, ca. 100 meters upstream from Sycamore Spring; Lat. $31^{\circ}52.9'N$, Long. $110^{\circ}45.7'W$; elevation ca. 1300 meters (4250 ft).

Remarks.—*Rabdodus christenseni* is most closely related to *R. nigromontanus* and probably evolved, over a long period of geographical isolation, from a common ancestral population. It differs from *R. nigromontanus* in being more slender, with a height/diameter ratio of about 2.1 whereas *R. nigromontanus* has a typical

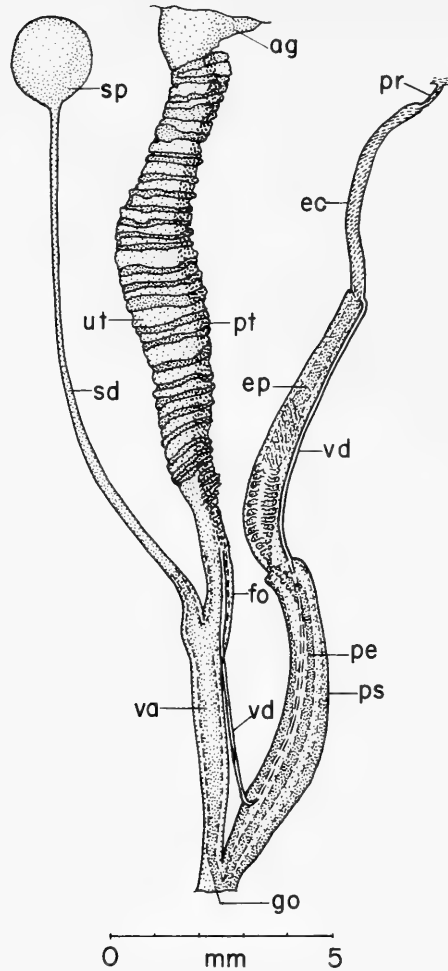

Fig. 2. Lower genitalia of *Raddotus christenseni*, new species; ag, albumen gland; ec, epiphallic caecum; ep, epiphallus; fo, free oviduct; go, genital orifice; pe, penis; pr, penial retractor muscle; ps, penial sheath; pt, prostate; sd, spermathecal duct; sp, spermatheca; ut, uterus; va, vagina; vd, vas deferens.

ratio of 1.6, as determined from 28 specimens in 8 lots collected in the Pajaritos Mountains and in northern Sonora. Moreover, *R. nigromontanus* does not have the prominent rib-striae sculpture of *R. christenseni*. In its reproductive anatomy, *R. christenseni* is distinguished by its long, thick penial sheath which encloses the entire length of the penis, whereas in *R. nigromontanus*, it encloses only the lower half of the penis.

Superficially, *R. christenseni* has the same general shape as *R. pasonis* (Pilsbry, 1902), found in Texas and New Mexico, with the nearest population about 300 miles to the east of the Santa Rita Mountains. *R. pasonis*, however, has a smaller and more slender shell, lacks the prominent rib striae of *R. christenseni*, and has a relatively smaller aperture.

Van Mol (1971), in his anatomical comparison of many species and genera of Bulimulidae, describes the histology of the various regions of the penial complexes; he considers the convoluted, glandular diverticula, the "*diverticules péniens*," to be a subdivision of the penis. Pilsbry (1946, p. 4) refers to these glandular structures, in *Rabdotus*, as numerous ducts in the lower end of the epiphallus. Christensen (1978), in his definitive, extensive treatment of *Rabdotus* in Baja California, considers them to be a part of the penis, as indeed they appear to be in the dissections of Baja California species available to us. In *R. christenseni* and *R. nigromontanus*, however, they are situated so far up in the penial complex and also so distinctly separated, by a pronounced constriction of the lumen, from the lower duct, that it appears logical to consider them to be a part of the epiphallus.

Although the Santa Rita Mountains have been explored extensively for land snails, this population of *R. christenseni* is the only population known to exist. It appears to be a relatively small population of scattered, rare individuals.

The vegetation at the type locality is representative of an ecotone between Lower and Upper Sonoran zones with admixture of riparian species. Dominant trees are *Juniperus monosperma*, *Prosopis juliflora*, *Quercus emoryi*, *Quercus arizonica*, and *Pinus cembroides*. Dominant shrubs are *Mimosa dysocarpa*, *Acacia greggi*, *Garrya wrightii*, *Rhus choriophylla*, and *Rhus trilobata*.

Etymology.—This species is named for Carl C. Christensen, friend and colleague, with whom we have enjoyed numerous pleasant collecting trips. His familiarity with the genus *Rabdotus* enabled him immediately to recognize that this species differed significantly from *R. nigromontanus*.

Acknowledgments

We are indebted to Carl C. Christensen for his critical examination and determination of the specimens and for his critical review of this report. We thank our former graduate students Shelley Maxfield and Robert Carey who accompanied us on the expedition to obtain several live adult specimens. The Anamax Mining Company provided funds to the University of Arizona to perform an Environmental Inventory of the Rosemont Area on Southern Arizona, in the course of which we were able to discover this new species.

Literature Cited

- Christensen, C. C. 1978. A revision of the genus *Rabdotus* (Pulmonata: Bulimulidae) in Baja California, Mexico. Ph.D. Dissertation, E9791, Univ. of Arizona, Tucson, Arizona, i-xiv + 1-354.
- Pilsbry, H. A. 1946. Land Mollusca of North America (north of Mexico). Acad. Nat. Sci. Philadelphia Monog. 3, 2(1):i-viii + 1-520.
- Van Mol, J.-J. 1971. Notes anatomiques sur les Bulimulidae (Mollusques, Gastéropodes, Pulmonés). Annales de la Société Royal Zoologique de Belgique, 101(3):183-226.

Accepted for publication 27 September 1983.

¹Department of General Biology, University of Arizona, Tucson, Arizona 85721, and ²Faculty of Natural Sciences, University of Tulsa, Tulsa, Oklahoma 74104.

Research Note

Distributions of Seven Species of Crustaceans Along the Pacific Coast of America

During 1979 a considerable number of species of crustaceans were obtained from catches of shrimp boats operating along the coast of Sinaloa, México, and from sampling activities in the area of Mazatlán, Sinaloa. The present note reports range extensions for seven species of Crustacea collected on these occasions, five of which have been collected for the first time in the Gulf of California.

Order Stomatopoda

Family Squillidae

Squilla parva Bigelow, 1891

Previous distribution.—From Cape San Francisco, Ecuador, north to Manzanillo, México (Manning 1972).

New records.—A single female taken in February 1979, off Teacapán, México. In May, a male was obtained from trawling operations off the light-house in Mazatlán.

Order Decapoda

Family Porcellanidae

Pisidia magdalenensis (Glassell, 1936)

Previous distribution.—Bahía de Santa María, west Baja California, México, south to Bahía de Santa Elena, Ecuador; absent from the Gulf of California (Haig et al. 1970). South to the area of Tumbes, Perú (Gore and Abele 1976).

New records.—A male specimen found in a cavity of a colony of polychaetes, *Filograna implexa* Berkeley, dredged from 9.5 meters off Punta Camarón (June 1979). An ovigerous female was later taken in Bahía del Puerto Viejo, Mazatlán, in an algae bed (*Padina*) (August 1979).

Petrolisthes sanfelipensis Glassell, 1936

Previous distribution.—Bahía de San Juanico and Bahía de la Magdalena, west Baja California, México; Gulf of California, from Puerto Peñasco, south to Guaymas (Haig 1960), Cabo San Lucas (Brusca and Haig 1972).

New records.—As for *Pisidia magdalenensis*, these crustaceans were taken in a colony of polychaetes (*Filograna implexa*). A single specimen taken in June 1979 off Punta Camarón and four additional specimens dredged up in Bahía del Puerto Viejo in August 1979.

Megalobrachium festai (Nobili, 1901)

Previous distribution.—Bahía de Santa Elena, Ecuador, north to Acapulco and to Zihuatanejo, México (Haig 1968). New records: (Haig 1960) two females (one ovigerous) and five males from Punta Piaxtla, México; and two females (one ovigerous), two males and two juveniles collected from Mazatlán, México. All specimens collected under stones in the low intertidal zone (October 1979).

Family Xanthidae
Eurytium albidigitum Rathbun, 1933

Previous distribution.—Known only from the upper Gulf of California south to San Felipe, on the western coast and to El Desemboque, on the mainland side (Brusca 1980).

New record.—A single male specimen was collected on a mud bank bordered by the white mangrove *Laguncularia racemosa* (L.) in July 1979; Estero El Verde, 30 km north of Mazatlán, México.

Sesarma (Sesarma) rhizophorae Rathbun, 1906

Previous distribution.—Mangroves of Panama, north to Boca del Jesús María, Costa Rica (Abele 1981).

New record.—Two females (one ovigerous) were collected from burrows in the bank of the Estero El Verde, México, in July 1979. The burrows also were inhabited by *Goniopsis pulchra* (Lockington).

Family Majidae
Notolopas mexicanus Garth, 1940

Previous distribution.—South and west of White Friars, near Acapulco, México, north to Bahía Tenacatita, México (Garth 1958).

New records.—One juvenile was found on a rock taken in a Van Veen grab off the light-house at Mazatlán (March 1979). One adult female which represents a new size record: length 9.3 mm, width 7.4 mm, was found in a cavity of a polychaete worm colony (*Filograna implexa*).

Acknowledgments

We thank J. Haig (Allan Hancock Foundation) and M. Wicksten (Texas A&M University) for confirmation of identifications of *Brachyura* and *Anomura*.

Literature Cited

- Abele, L. G. 1981. *Sesarma gorei*, new species, from Peru, with a key to the eastern Pacific species of *Sesarma* (Crustacea, Decapoda, Grapsidae). *J. Crustacean Biol.*, 1(3):433-440.
- Brusca, R. C. 1980. Common intertidal invertebrates of the Gulf of California. Univ. Arizona Press, 2d edition. Univ. Arizona Press, Tucson. 513 pp.
- , and J. Haig. 1972. Range extensions of porcelain crabs and hermit crabs in the Gulf of California. *Bull. Southern California Acad. Sci.*, 71(1):56.
- Garth, J. S. 1958. *Brachyura* of the Pacific coast of America, Oxyrhyncha. *Allan Hancock Pac. Exp.*, 21:1-854.
- Glassell, S. A. 1936. Affinities of the brachyuran fauna of the Gulf of California. *Jour. Washington Acad. Sci.*, 24:296-302.
- Gore, R. H., and L. G. Abele. 1976. Shallow water porcelain crabs from the Pacific coast of Panama and adjacent Caribbean waters (Crustacea: Anomura: Porcellanidae). *Smithson. Contrib. Zool.*, 237:1-30.
- Haig, J. 1960. The Porcellanidae (Crustacea: Anomura) of the eastern Pacific. *Allan Hancock Pac. Exp.*, 24:1-440.
- . 1968. Eastern Pacific expeditions of the New York Zoological Society. Porcellanid crabs (Crustacea: Anomura) from the west coast of tropical America. *Zoologica*, 53(2):57-74.
- , T. S. Hopkins, and T. B. Scanland. 1970. The shallow water anomuran crab fauna of southwestern Baja California, Mexico. *Trans. San Diego Soc. Nat. Hist.*, 16(2):13-32.

Manning, R. B. 1972. Eastern Pacific expeditions of the New York Zoological Society. Stomatopod Crustacea. *Zoologica*, 56:95-113.

Accepted for publication 7 June 1983.

Hendrickx, M. E. and A. M. van der Heiden, *Estación Mazatlán del Instituto de Ciencias del Mar y Limnología, UNAM, Post Office Box 811, Mazatlán, Sinaloa, México.*



INSTRUCTIONS FOR AUTHORS

The BULLETIN is published three times each year (April, August, and November) and includes articles in English in any field of science with an emphasis on the southern California area. Manuscripts submitted for publication should contain results of original research, embrace sound principles of scientific investigation, and present data in a clear and concise manner. The current AIBS *Style Manual for Biological Journals* is recommended as a guide for contributors. Consult also recent issues of the BULLETIN. Authors should strive for directness and lucidity, achieved by use of the active voice. Special attention should be given to consistency in tense, unambiguous reference of pronouns, and logically placed modifiers.

MANUSCRIPT PREPARATION

It is strongly recommended that, before submitting a paper, the author ask qualified persons to review it. The author is requested to submit *at least two additional copies with the original*, on 8½ × 11 opaque, nonerasable paper, double spacing the entire manuscript. **Do not break words at right-hand margin anywhere in the manuscript.** Footnotes should be avoided. Manuscripts which do not conform to the style of the BULLETIN will be returned to the author.

An abstract summarizing in concise terms the methods, findings, and implications discussed in the paper *must* accompany a *feature article*. Abstract should not exceed 100 words.

A **feature article** comprises approximately five to thirty typewritten pages. Papers should usually be divided into the following sections: abstract, introduction, methods, results, discussion and conclusions, acknowledgments, and literature cited. Avoid using more than two levels of subheadings.

A **research note** is usually one to six typewritten pages and rarely utilizes subheadings. Consult a recent issue of the BULLETIN for the format of *notes*. Abstracts are not used for notes.

Abbreviations: Use of abbreviations and symbols can be determined by inspection of a recent issue of the BULLETIN. **Omit periods after standard abbreviations:** 1.2 mm, 2 km, 30 cm, but Figs. 1–2. Use numerals *before* units of measurements; 5 ml, but nine spines (10 or numbers above, such as 13 spines). The metric system of weights and measurements should be used wherever possible.

Taxonomic procedures: Authors are advised to adhere to the taxonomic procedures as outlined in the International Code of Botanical Nomenclature (Lawjouw et al. 1956), the International Code of Nomenclature of Bacteria and Viruses (Buchanan et al. 1958), and the International Code of Zoological Nomenclature (Stoll et al. 1961). Special attention should be given to the description of new taxa, designation of holotype, etc. Reference to new taxa in titles and abstract should be avoided.

The literature cited: Entries for books and articles should take these forms.

McWilliams, K. L. 1970. Insect mimicry. Academic Press, vii + 326 pp.

Holmes, T. Jr., and S. Speak. 1971. Reproductive biology of *Myotis lucifugus*. J. Mamm., 54:452–458.

Brattstrom, B. H. 1969. The Condor in California. Pp. 369–382 in *Vertebrates of California*. (S. E. Payne, ed.), Univ. California Press, xii + 635 pp.

Tables and figures (line drawings, graphs, or black and white photographs) **should not repeat data contained in the text.** The author must provide *numbers* and *short legends* for tables and figures and place reference to each of them in the text. Legends should be typed on a separate sheet of paper and placed at the end of the manuscript. **Illustrations and lettering thereon should be of sufficient size and clarity to permit reduction to standard page size;** ordinarily they should be no more than twice the size of intended reduction and should not exceed 8½ by 11 inches in size. Photographs *must* be printed on glossy paper. Submit one photoduplicated copy of each illustration. All illustrations accompanying **Research Notes** will be reduced to one column width. **All half-tone illustrations will have light screen (grey) backgrounds. Special handling such as dropout half-tones, special screens, etc., must be requested by and will be charged to authors.**

A **cover illustration** pertaining to an article in the issue or one of general scientific interest will be printed on the cover of each issue. Such illustrations along with a brief caption should be sent to the Editor for review.

PROCEDURE

All manuscripts should be submitted to the Technical Editor, Jon E. Keeley, Biology Department, Occidental College, 1600 Campus Road, Los Angeles, California 90041. **Evaluation of a paper** submitted to the BULLETIN begins with a critical reading by the Editor; several referees also check the paper for scientific content, originality, and clarity of presentation. Judgments as to the acceptability of the paper and suggestions for enhancing it are sent to the author at which time he or she may be requested to rework portions of the paper considering these recommendations. The paper then is resubmitted and may be re-evaluated before final acceptance.

Proof: The galley proof and manuscript, as well as reprint order blanks, will be sent to the author. He or she should **promptly** and **carefully** read the proof sheets for errors and omissions in text, tables, illustrations, legends, and bibliographical references. He or she marks corrections on the galley (copy editing and proof procedures in *Style Manual*) and **promptly returns both galley and manuscript** to the Editor. Manuscripts and original illustrations will not be returned unless requested at this time. **All changes in galley proof attributable to the author (misspellings, inconsistent abbreviations, deviations from style, etc.) will be charged to the author.** Reprint orders are placed with the printer, not the Editor.

CONTENTS

Algal Distributions and Temperature: Test of an Hypothesis Based on Vegetative Growth Rates. By <i>Joan G. Stewart</i>	57
Nesting Green Sea Turtles (<i>Chelonia mydas</i>) on Isla Clarión, Islas Revilagigedos, Mexico. By <i>Frank T. Awbrey, Stephen Leatherwood, Edward D. Mitchell, and William Rogers</i>	69
<i>Paraliparis nassarum</i> n.sp. (Pisces, Liparididae) from off Southern California with Description of Its Otoliths and Others from North-east Pacific Liparidids. By <i>David L. Stein and John E. Fitch</i>	76
Additional Avian Records from the Miocene of Kern County, California with the Description of a New Species of Fulmar (Aves: Procellariidae). By <i>Hildegarde Howard</i>	84
Plant Succession and Species Diversity in the Marblehead Quarry, Ohio. By <i>Gerald P. Hannes and Susan M. Hannes</i>	90
Primary Production in Grays Harbor Estuary, Washington. By <i>Ronald M. Thom</i>	99
A New Species of <i>Rabdotus</i> (Gastropoda: Pulmonata: Bulimulidae) from Arizona. By <i>Walter B. Miller and Richard L. Reeder</i>	106
Research Note	
Distributions of Seven Species of Crustaceans Along the Pacific Coast of America. By <i>M. E. Hendrickx and A. M. van der Heiden</i>	110

COVER: Mother and pup elephant seals, *Mirounga angustirostris*, photographed on Guadalupe Island, Baja California, Mexico, by Gretchen Sibley, Managing Editor.