

SBM

1015







**Bulletin of the  
British Museum (Natural History)**

BRITISH MUSEUM  
(NATURAL HISTORY)  
29P 1985  
RECORDED  
GENERAL

Entomology series Vol 50 1985

British Museum (Natural History)  
London 1985





**Contents**  
**Entomology Volume 50**

No 1	Taxonomy of Neotropical Derbidae in the new tribe Mysidiini (Homoptera) By Peter S. Broomfield . . . . .	1
No 2	Nymphal taxonomy and systematics of the Psylloidea (Homoptera) By I. M. White & I. D. Hodkinson . . . . .	153
No 3	The whitefly of New Guinea (Homoptera: Aleyrodidae) By J. H. Martin . . . . .	303



# Bulletin of the British Museum (Natural History)

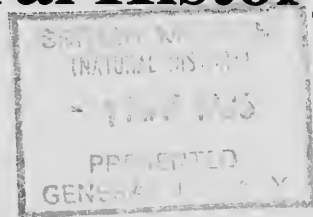

## Taxonomy of Neotropical Derbidae in the new tribe Mysidiini (Homoptera)

Peter S. Broomfield

Entomology series

Vol 50 No 1

28 February 1985

The *Bulletin of the British Museum (Natural History)*, instituted in 1949, is issued in four scientific series, Botany, Entomology, Geology (incorporating Mineralogy) and Zoology, and an Historical series.

Papers in the *Bulletin* are primarily the results of research carried out on the unique and ever-growing collections of the Museum, both by the scientific staff of the Museum and by specialists from elsewhere who make use of the Museum's resources. Many of the papers are works of reference that will remain indispensable for years to come.

Parts are published at irregular intervals as they become ready, each is complete in itself, available separately, and individually priced. Volumes contain about 300 pages and several volumes may appear within a calendar year. Subscriptions may be placed for one or more of the series on either an Annual or Per Volume basis. Prices vary according to the contents of the individual parts. Orders and enquiries should be sent to:

Publications Sales,  
British Museum (Natural History),  
Cromwell Road,  
London SW7 5BD,  
England.

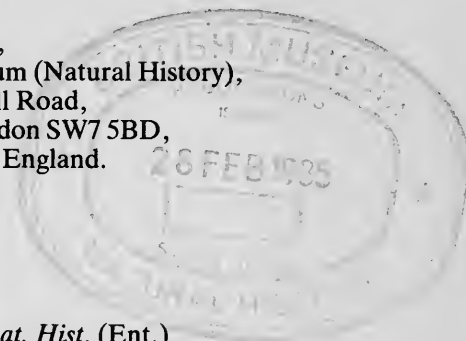

*World List* abbreviation: *Bull. Br. Mus. nat. Hist.* (Ent.)

© Trustees of the British Museum (Natural History), 1985

The Entomology series is produced under the general editorship of the  
Keeper of Entomology: Laurence A. Mound  
Assistant Editor: W. Gerald Tremewan

ISBN 0 565 06008 2  
ISSN 0524-6431

British Museum (Natural History)  
Cromwell Road  
London SW7 5BD

Entomology series  
Vol 50 No 1 pp 1-152

Issued 28 February 1985

# Taxonomy of Neotropical Derbidae in the new tribe Mysidiini (Homoptera)

Peter S. Broomfield

Department of Entomology, British Museum (Natural History), Cromwell Road, London SW7 5BD

## Contents

Synopsis.....	1
Introduction .....	1
Techniques .....	2
Acknowledgements .....	3
Derbinae.....	3
Key to tribes of Derbinae .....	4
Mysidiini trib. n. ....	5
Key to genera of Mysidiini .....	7
Checklist of Mysidiini .....	8
<i>Mysidia</i> Westwood .....	9
<i>Pseudomysidia</i> Metcalf .....	77
<i>Dysimia</i> Muir .....	87
<i>Dysimiella</i> gen. n. ....	96
<i>Mysidaloides</i> gen. n. ....	98
<i>Neomysidia</i> gen. n. ....	99
<i>Ipsemysidia</i> gen. n. ....	100
<i>Amysidiella</i> gen. n. ....	101
<i>Paramysidia</i> gen. n. ....	103
<i>Symidia</i> Muir .....	108
References .....	111
Index.....	151

## Synopsis

The subfamily Derbinae is divided into two tribes, the Derbini and Mysidiini, the latter newly described. Six genera and 136 species are described as new, one subspecies is raised to specific status, four specific synonymies and four combinations are newly established, and one neotype and 17 lectotypes are designated. Keys to the tribes, 10 genera and 182 species are provided.

## Introduction

The Derbidae is one of the largest and least-known families of the Fulgoroidea, with probably less than one-fifth of the species currently recognised. It is world-wide in distribution, and the majority of the genera and species are confined to the tropics.

The biology of the Derbidae is little known. The adults are phloem feeders, occurring on a wide variety of trees and shrubs, in grass land, and occasionally on cultivated cereals. In the U.S.A., Dozier (1928) recorded them feeding on numerous species of deciduous trees, frequently in moist situations. In the New World tropics they often appear to be randomly scattered throughout primary and secondary forest, although individual species may occur in very large numbers in plantations. There is little information on their host specificity, and they are of no known major economic importance. The nymphal stages, which are almost completely unknown, are frequently associated with decaying vegetation, and are often numerous amongst the litter of the forest floor or in plantations and orchards. They have been found by the present author in old beetle galleries in rotten timber, which suggests that they feed on fungal exudates.

The family-group name Derbidae was first proposed by Schaum (1850), with *Derbe* Fabricius (1803) as the type-genus. The family was divided into the Derbinae and Kermesiinae by Kirkaldy (1906), but subsequently the latter subfamily was rendered obsolete when *Kermesia* was shown to be more correctly placed in the Meenoplidae. Westwood (1840) divided *Derbe* into seven subgenera: *Derbe*, *Mysidia*, *Zeugma*, *Thracia*, *Phenice*, *Patara* and *Cenchrea*, all of which have subsequently been raised to generic status. In 1900 Kirkaldy proposed the name *Zoraida* as a replacement name for *Thracia*, the latter being preoccupied. Muir (1913), studying the Old World fauna, ignored the subfamilies and divided the family into four 'groups' based on tegminal venation. Later (1917) he rearranged these groupings into the subfamilies Derbinae, Otiocerinae, Cenchreinae and Rhotaninae, including in the Derbinae the genera *Zoraida*, *Zeugma*, *Mysidia* and *Sikaiana*. In 1918 Muir revised his classification as a result of his study of New World material. Still using characters of the wing and tegminal venation, he separated *Zoraida* and related genera into a distinct subfamily, the Zoraidinae, which he divided into the tribes Zoraidini and Sikaianini, and relegated the Cenchreinae, Otiocerinae, Derbinae and Rhotaninae to tribes within the Derbinae. This arrangement was confirmed in 1930 and was subsequently followed by Metcalf (1938). Of Westwood's original seven subgenera of *Derbe*, Muir (1930) assigned *Derbe*, *Mysidia* and *Zeugma* to the Derbini, though he had recognised (1913) that, with the inclusion of *Zeugma*, such a grouping was not a natural one. Metcalf (1938) erected *Pseudomysidia* and included it in the Derbini.

This classification was accepted by Metcalf (1945b), and revised by Fennah (1952) who, also using the venation of the tegmina and wings, omitted the subfamily groupings and divided the family directly into the tribes proposed by Muir (1918). Recognising their true affinities he transferred *Zeugma* to the Zoraidini, and *Symidia* and *Dysimia* from the Cenchreini to the Derbini. However, by ignoring subfamilies this classification restricts the grouping of taxa to only two levels below that of family, and does not acknowledge the relationship between the Zoraidini and Sikaianini.

In the present study of the Derbini (sensu Fennah, 1952), the male genitalia have been examined in order to evaluate their importance as taxonomic characters in the group; a secondary objective was to investigate the generic groupings, and to propose a classification whereby the affinities of these genera might be more clearly expressed.

## Techniques

The characters of the head may occasionally be obscured by deposits of white wax, which may be removed with a fine paint brush. The measurements in the species descriptions are taken with the insect in dorsal aspect; the width includes the eyes, and the length is from the base to the apex of the anterior extension. In most cases the vertex and frons merge imperceptibly into each other, and the length of the vertex is therefore not included. The length of the frons is assumed to be from its base to a point level with the dorsal margins of the eyes. The proportions of the thorax, and the presence or absence of carinae on the frontal and dorsal surfaces, are important at specific level. These are best observed under incident light at an angle of 45° to the surface under examination. The length of the abdomen varies according to the condition of the specimen. For this reason 'whole body' measurements are unreliable and are not provided.

The pigmentation of the tegmen and wing is frequently faint and occasionally obscured by waxy deposits; it is best observed at low magnification in natural light, against a white background. Frequently, specimens stored in alcohol rapidly lose all pigmentation. For this reason extensive use has been made of characters of the male genitalia, the diagnostic features of which are heavily sclerotised and do not require staining.

The method of preparation of the male genitalia is similar to that employed for those in the majority of auchenorrhynchous Homoptera. The abdomen is best removed entire at its junction with the thorax. After softening in heated 10% KOH, the abdomen is macerated in glacial acetic acid, cleared in clove oil, cleaned in alcohol, and examined in glycerine. Usually the characters of the aedeagus and parameres may then be observed without further dissection. The aedeagus is best examined from several aspects, so that permanent preparations are not recommended;



the lateral aspect is sufficient for examination of the parameres. The female genitalia are not used in the present study.

The terms used in the text are those commonly employed for the Fulgoroidea and are based largely on those of Kramer (1950).

### Acknowledgements

I thank the following individuals for their assistance in making available to me the material upon which much of this study is based, for the opportunity to examine type-material and, in many cases, for most helpful advice. The institutions are referred to in the text by the abbreviations given in parenthesis: Dr N. Møller Andersen, Zoologisk Museum, Copenhagen (ZM); Dr P. Arnaud and Dr D. Rentz, California Academy of Science, San Francisco (CAS); Dr R. G. Fennah, formerly of the Commonwealth Institute of Entomology, London; Dr K. G. A. Hamilton, Agriculture Canada, Ottawa (AC); Dr J. P. Kramer, United States National Museum, Washington D.C. (USNM); Dr I. Lansbury, University Museum, Oxford (UM); Dr P. Lindskog, Naturhistoriska Riksmuseet, Stockholm (NR); Dr J. T. Medler, Bernice P. Bishop Museum, Honolulu (BPBM); Dr A. F. Newton, Museum of Comparative Zoology, Harvard (MCZ); Dr L. B. O'Brien, Florida Agricultural & Mechanical University, Tallahassee (FAMU); Dr N. D. Penny, Instituto Nacional de Pesquisas da Amazonia, Manaus (INPA); Dr R. T. Schuh, American Museum of Natural History, New York (AMNH); Dr C. A. Triplehorn, Ohio State University, Columbus (OSU); Dr G. Wallace and Dr G. Ekis, Carnegie Museum, Pittsburgh (CM).

### DERBINAE

Derbini sensu Fennah, 1952: 109.

Species of the New World subfamily Derbinae range from the southern Nearctic region to the southern temperature zone of the Neotropical region, with the greatest number recorded from Central America and tropical South America. They appear to be restricted to moist, frequently forested, habitats and are unknown from either mountainous areas, e.g. the High Andes, or from the desert area of Mexico and the arid Pacific coastlands of South America.

Throughout the subfamily there appears to be a trend towards smaller size with a corresponding reduction in the venation of the tegmina and wings, especially in the medial and cubital areas. This reduction is paralleled in the Zoraidinae, reaching its fullest extent in the Sikaianini. In the Derbinae this tendency is evident by comparison of the tegminal venation of *Derbe*, in which the medial vein has an average of 12 branches, with that of *Symidia*, in which the medial vein has only six branches and the species are among the smallest and most specialised in the subfamily.

A second, related, tendency paralleled in the rest of the Derbidae is the lateral compression of the vertex and frons between the eyes. The extremes of this trend within the Derbinae are shown by the relatively broad and parallel-sided configuration of the vertex and frons in *Derbe*, and the strongly compressed condition of these parts in the more specialised genera *Symidia*, *Mysidaloides* and *Paramysidia*. A third, independent, trend is the shortening of the frons and clypeus with accompanying obsolescence of the longitudinal carinae of the latter, as in *Dysimia*, *Mysidaloides* and *Dysimiella* in contrast to *Derbe*.

While there is little variation in the proportions of the second antennal segment, except for the genus *Mysidaloides*, within the Derbinae, the antennal flagellum tends to migrate from the primitive apical position, as in *Derbe*, to a subapical position as in *Mysidia* and *Neomysidia*.

The male genitalia also show several trends in the Derbinae. The shaft of the aedeagus is horizontal, basically cylindrical, usually symmetrical and usually with anteriorly directed spine-like and/or flap-like processes subapically on the dorsal surface. The ventral surface is rarely armed. The paired parameres are large, usually slightly curved, with their apices directed medially and their ventral margins closely opposed when at rest. In the frequent absence of an extended subgenital plate, the parameres are presumed to shield the aedeagus ventrally and

posteriorly, while dorsal protection is commonly provided by the posterior extension of the hind margin of the anal tube.

The trends within the male genitalia are complex, though often correlated with reduction of the tegmina and constriction of the head. From a comparison with other families of auchenorrhynchous Homoptera, e.g., Membracidae and Cicadellidae, it is assumed that the heavily armed aedeagus bearing simple, paired, spine-like processes on the dorsal surface only, with the ventral surface unarmed, and with the grasping function of the parameres little developed, is the more primitive condition. This condition is seen in *Derbe*, in which there is also a small degree of asymmetry, and other genera such as *Pseudomysidia* (Figs 34–80). The tendency for the reduction of the dorsal spine-like processes of the aedeagus, or their replacement completely or partially by flap-like processes, the occasional development of one or more ventral processes, and an accompanying development of the dorsal process of the paramere, are seen in *Mysidia* and reach the extreme degree in *Dysimia* (Figs 94–129). A secondary modification occurs in *Paramysidia*, *Ipsemysidia* and *Amysidiella* in which the dorsal process of the paramere is frequently obsolete or absent and is often replaced by a small, hook-like, subbasal secondary process accompanied occasionally (*Paramysidia*) by pronounced asymmetry of the aedeagus. A separate tendency is seen in *Derbe* in which the aedeagus is heavily armed and the often very complex parameres show a variety of forms consistent with a grasping function during copulation.

The relatively primitive characters of *Derbe*, as seen in the tegminal and wing venation, the proportions of the head, and the distinctly different developmental trends in the male genitalia, set it sufficiently apart from other genera of Derbini (sensu Fennah, 1952) to divide the tribe into two groups. This necessitates the elevation of all the tribes recognised by Fennah, except Sikaianini, to subfamily rank, thereby permitting the division of Derbinae (Derbini sensu Fennah, 1952) into Derbini (type-genus *Derbe*) and Mysidiini (type-genus *Mysidia*). This action also illustrates the close relationship between the Zoraidini and the Sikaianini which remain as tribes within the Zoraidinae, as proposed by Muir (1918). The proposed classification of the Derbidae is as follows.

Derbidae	
Derbinae	
Derbini	New World
Mysidiini	New World
Otiocerinae	New and Old World
Cenchreinae	New and Old World
Rhotaninae	Old World
Zoraidinae	
Zoraidini	Old World
Sikaianini	New and Old World

### Key to tribes of Derbinae

- 1 Head with junction of frons and vertex marked by a distinct transverse carina. Tegmen with 20–23 branches of veins extending to posterior and apical margins; medial vein with basal fork not less than 6-branched; cubital vein with 4–6 branches. All branches of medial and cubital veins linked by a continuous oblique band of cross-veins. Wing with subcostal and radial veins fused over *c.* basal one-third length; total number of branches of medial and cubital veins attaining posterior and apical margins from 6–10 (Fig. 1) ..... **DERBINI** Schaum
- 2 Head with frons and vertex merging imperceptibly, lacking a transverse carina. Tegmen with never more than 16 branches of veins extending to posterior and apical margins (*Pseudomysidia*), commonly with 11–13; medial vein with basal fork not more than 3-branched; cubital vein never with more than 4 branches. Cross-veins of medial and cubital areas not as above. Wing with subcostal vein obsolete; total number of branches of medial and cubital veins attaining posterior and apical margins not exceeding 5 (Figs 2–11) ..... **MYSIDIINI** trib. n. (p. 5)

The Derbini is monotypic, the genus *Derbe* consisting of 16 species confined to Central America and northern South America.

The Mysidiini is erected to accommodate all the genera of Derbinae except *Derbe*, i.e., *Mysidia*, *Pseudomysidia*, *Dysimia* and *Symidia*, and the newly described *Amysidiella*, *Ipsemysidia*, *Mysidaloides*, *Neomysidia*, *Paramysidia* and *Dysimiella*. Species of the tribe extend from the southern U.S.A. to Uruguay, with the majority occurring in tropical Central and South America. Only one species of *Mysidia* and eight species of *Dysimia* have been recorded from the Caribbean Islands, excluding Trinidad. One *Dysimia* and one *Paramysidia* species are known from the U.S.A.; the former appears to have reached south-eastern U.S.A. by 'island hopping' across the Caribbean, while the latter probably first became established in Texas after dispersing through Central America.

#### MYSIDIINI trib. n.

Type-genus: *Mysidia* Westwood, 1840: 83.

Vertex extending not more than one-half of its length beyond eyes, junction with frons not marked by a transverse carina. Frons longer than wide; lateral margins apically subparallel, diverging subbasally. Pronotum longitudinally constricted at mid-dorsal line, not less than 6 times as wide as long. Tegmen 2.0–3.0 times as long as wide; radial and subcostal veins fused subbasally, combined radial, medial and cubital veins with not more than 16 branches. Wing with subcostal vein obsolete; combined radial, medial and cubital veins with not more than six branches.

The head in dorsal aspect is distinctly broader than long, its width across the eyes being between one and three-fourths greater than its length from the base to the apparent apex of the vertex. The vertex usually extends beyond the eyes for up to one-half its length except in *Mysidaloides*, in which it terminates approximately level with the anterior margins of the eyes, due to the exceptionally large size of the eyes. The junction of the vertex and frons is smoothly, regularly, and obtusely rounded, except in one species of *Dysimia* where it is subacute. The transverse carina present in *Derbe* is absent in the Mysidiini. The basal margin of the vertex is usually transverse, but in *Dysimia*, *Symidia*, and *Dysimiella*, and to a lesser extent in *Ipsemysidia* and *Paramysidia*, it is broadly and deeply incised medially.

The frons is laterally constricted and is usually from three to seven times as long as its apical width. In *Symidia* and *Pseudomysidia* its length may be up to 20 times its apical width. The ratio between the length and width of the frons is important at specific and sometimes also generic level. In all genera, with the exception of *Symidia* and *Pseudomysidia*, the lateral margins of the frons are strongly divergent from the level of the ventral margins of the eyes to the junction with the clypeus; the degree and regularity of this divergence are also important at generic level. The width of the frons at its junction with the clypeus is much greater than its apical width, varying between one-fourth (*Pseudomysidia*) of to approximately equal to its length (*Dysimiella* and *Neomysidia*), with the other genera occurring between these extremes.

The genae are broadly rounded in lateral aspect, with the exception of a single *Dysimia* species (see above), and extend anteriorly beyond the eyes from one-third to one-half the horizontal diameter of the eye. In *Mysidaloides*, due to the very large size of the eyes, this anterior extension is minimal. The eyes are large and reniform, with the ventral surfaces adjacent to the antennae weakly concave, except in *Mysidaloides* where they are hemispherical.

The second antennal segment is club-shaped, approximately one and one-half times as long as its maximum breadth, except in *Mysidaloides* in which the length is five times the maximum breadth. In the primitive condition, seen in *Symidia*, *Dysimia*, *Pseudomysidia*, and *Dysimiella*, the antennal flagellum arises apically from a truncate second segment. In *Mysida*, *Mysidaloides*, *Amysidiella*, *Paramysidia*, *Ipsemysidia*, and *Neomysidia* the flagellum has assumed a subapical position, and the apex of the segment is narrowly rounded.

The ocelli are commonly distinct and only rarely obscure or obsolete. They are small in *Dysimia*, *Symidia*, *Mysidaloides*, *Ipsemysidia* and *Amysidiella*, variable in size in *Mysidia*, *Pseudomysidia* and *Dysimiella*, are very large and prominent in *Paramysidia* and *Neomysidia*; they are of diagnostic value at species level in *Mysidia*.

In the majority of genera the clypeus is approximately as long as the frons (the term 'clypeus' being used throughout the text to denote the combined para- and ante-clypeus); in *Dysimiella*,

however, it is somewhat shorter than the frons, and in *Pseudomysidia* it is up to one-third longer. Slight variation in the length of the clypeus is of specific diagnostic value in many instances. In the primitive condition the clypeus bears distinct and percurrent medial and lateral longitudinal carinae, as seen in *Symidia* and *Pseudomysidia*, and occasionally in *Mysidia*; these are obsolete or absent in the remaining genera.

The rostrum in the primitive condition extends to the apex of the abdomen, as seen in *Pseudomysidia* and *Symidia*. In the majority of genera it terminates approximately level with the hind coxae, except in *Mysidia* where its length is extremely variable and is of value in specific diagnosis.

The pronotum is longitudinally constricted at the mid-dorsal line, with the posterior margin very broadly and deeply incised. In *Mysidia*, *Paramysidia*, *Mysidaloides*, *Dysimiella*, *Neomysidia*, *Ipsemysidia* and *Amysidiella*, its maximum width is usually 10–20 times its medial length, though in some species of *Mysidia* it may be so strongly constricted that the width is up to 50 times the medial length. In *Pseudomysidia*, *Symidia*, and *Dysimia* this constriction is relatively slight, and the width of the pronotum may be as little as 6–8 times its length. The ratio of the length to the breadth of the pronotum varies greatly between species, especially in *Mysidia*, and is often of considerable diagnostic value.

The fronto-lateral surfaces of the pronotum may be distinctly carinate in all genera, though they are not consistently so in *Mysidia* and *Pseudomysidia*; in which genera their presence or absence is of great diagnostic value at species level. In *Symidia* these carinae are greatly elevated and foliaceous, and continue along the lateral and ventral margins to form pronounced antennal foveae; which, although occurring intermittently in other subfamilies of the Derbidae, are otherwise absent in the Derbinae. The tegulae also vary in the possession of carinae, these being sometimes present in *Mysidia*, *Pseudomysidia*, and *Dysimia*, although absent in the other genera. The presence or absence of these carinae may be of value at specific level. Both the disc of the mesonotum and the scutellum are approximately as wide as long, their proportions varying little between genera; the former occasionally bears three distinct longitudinal carinae, but these are more usually obsolete or absent.

The tegmen is from two and one-half to three times as long as its maximum breadth (slightly broader in *Dysimiella*) with the radial and sub-costal veins fused over their basal one-third to one-half length. The radial and medial veins are distinct from near their base in *Mysidia*, *Paramysidia*, *Ipsemysidia*, *Pseudomysidia*, and *Mysidaloides*, but in *Symidia*, *Dysimiella*, *Dysimia*, *Neomysidia*, and *Amysidiella* they may be fused for up to one-quarter of their length. The radial vein is usually two branched, although three branches are present in *Symidia*, which also has the usual seven branches of the medial vein reduced to six. The medial vein of *Pseudomysidia* is eleven-branched, a condition unique in the tribe and considered to represent a primitive condition. The number of branches of the cubital vein also varies. The genera *Mysidia*, *Paramysidia*, *Mysidaloides*, *Dysimiella*, *Neomysidia*, *Ipsemysidia*, and *Amysidiella* have four branches; *Pseudomysidia* and *Dysimia* have three; and *Symidia*, perhaps due to the small size of the insects, only two. The total number of branches of the radial, medial and cubital veins is therefore usually thirteen, the exceptions being *Pseudomysidia* with sixteen, *Dysimia* with twelve, and *Symidia* with eleven. In the Derbini the total varies from twenty to twenty-three.

The wing is usually approximately one-half the length of the tegmen, but is somewhat longer in *Dysimiella* and *Paramysidia*, and occasionally longer in *Mysidia*. The subcostal vein is fused throughout its length with the radial vein, in contrast with the Derbini where it is distinct for the greater part of its length. The radial vein is also unbranched. The number of branches of the medial vein is variable; being two in the majority of genera, three in *Pseudomysidia*; in *Dysimia*, *Symidia*, and *Dysimiella* it is unbranched. The cubital vein has either two branches, as in *Pseudomysidia*, *Neomysidia* and *Symidia*, or three, as in *Amysidiella*, *Ipsemysidia*, *Mysidia*, *Mysidaloides*, *Paramysidia*, *Dysimia*, and *Dysimiella*. The total number of branches of the medial and cubital veins therefore varies from three to five, contrasting with the total of six to ten in the Derbini.

The head and body are usually pale yellowish brown, rarely dark brown, with brown, black or red markings frequently present, particularly on the head and the frontolateral surfaces of the

pronotum. The tegmina and wings are usually predominantly whitish hyaline but may also be clear, yellowish or smoky brown throughout in some species of *Mysidia*. They are frequently marked with darker spots or transverse bands or with the veins and cross veins dark margined. All markings are consistent within species and are of diagnostic value at this level.

The male genitalia are extremely variable in the shape of the aedeagus and parameres, with a distinct correlation in many cases between a reduction in the processes of the former and an increase in those of the latter. This correlation is well illustrated within *Dysimia*, where in the species *numa* Fennah the dorsal process of the paramere is but little developed while the aedeagus is the most highly armed in the genus.

Both the aedeagus and the parameres are of very great diagnostic importance at specific level, especially in the case of externally similar forms, and occasionally at generic level, i.e. *Paramysidia*. The primitive condition appears to be that in which the shaft of the aedeagus is armed subapically with simple, paired, symmetrically arranged, spine-like processes on the dorsal surface only, as in *Pseudomysidia*, *Amysidiella*, and a few species of *Mysidia*. The development of additional flap-like processes occurs in *Paramysidia*, *Dysimia*, *Symidia*, *Mysidaloides*, *Dysimiella*, *Ipsemysidia*, and most species of *Mysidia*. The possession of flap-like processes only, as seen in *Neomysidia* and some species of *Mysidia*, is regarded as being a further development which reaches its most advanced condition in certain species of *Dysimia*, where the grasping function of the aedeagal processes can only be minimal and the parameres appear to have assumed this task during copulation. The ventral surface of the aedeagus is usually unarmed, the exceptions being *Ipsemysidia* and a few species of *Mysidia*. The development of asymmetry in the aedeagal processes, present in *Symidia* and occasionally in *Mysidia*, reaches its greatest extent in *Paramysidia*, where an unpaired medial dorsal process is also present.

The dorsal process of the paramere is well developed in *Mysidaloides* and *Dysimiella*, and in the majority of species of *Mysidia* and *Dysimia*. It is less developed in *Pseudomysidia* and *Symidia*, and greatly reduced in *Amysidiella*, *Ipsemysidia*, *Neomysidia*, and *Paramysidia*, and in some species of *Mysidia* and *Dysimia*. The reduction, or loss, of the dorsal process is often compensated for by the development of a small hook-like secondary process subbasally. Only in *Mysidia* is there the occasional development of an additional process on the ventral surface.

The male subgenital plate is usually short with its posterior margin transverse; only in *Dysimiella* is it strongly produced medially.

The female genitalia appear not to be of taxonomic value at either the generic or specific level, with the possible exception of the subgenital plate. The variation in this character is however too slight to be of use diagnostically.

### Key to genera of Mysidiini

- |      |   |                                      |
|------|---|--------------------------------------|
| 1    | Medial vein of tegmen with 11 branches extending to posterior and apical margins (Fig. 11)                    | <i>PSEUDOMYSIDIA</i> Metcalf (p. 77) |
| -    | Medial vein of tegmen with not more than seven branches   | 2                                    |
| 2(1) | Cubital vein of tegmen two-branched; medial vein six-branched (Fig. 5)  | <i>SYMIDIA</i> Muir (p. 108)         |
| -    | Cubital vein of tegmen three- or four-branched; medial vein seven-branched                                    | 3                                    |
| 3(2) | Cubital vein of tegmen three-branched (Fig. 9)  | <i>DYSIMIA</i> Muir (p. 87)          |
| -    | Cubital vein of tegmen four-branched  | 4                                    |
| 4(3) | Second antennal segment not longer than 2.5 times maximum width   | 5                                    |
| -    | Second antennal segment 5.0 times as long as maximum width (Fig. 16)  | <i>MYSIDALOIDES</i> gen. n. (p. 98)  |
| 5(4) | Wing with medial vein unbranched (Fig. 3). Male with posterior margin of subgenital plate produced (Fig. 160) | <i>DYSIMIELLA</i> gen. n. (p. 96)    |
| -    | Wing with medial vein two-branched. Male subgenital plate transverse  | 6                                    |
| 6(5) | Head with length of frons little greater than width at base, c. 2.5 times width at apex (Fig. 31)             | <i>NEOMYSIDIA</i> gen. n. (p. 99)    |
| -    | Proportions of frons not as above   | 7                                    |
| 7(6) | Tegmen with subcostal and radial veins fused over c. basal third of length                                    | 8                                    |
| -    | Tegmen with subcostal and radial veins fused to c. mid-length   | 9                                    |

- 8(7) Length of frons not less than twice width at base (Fig. 33). Tegmen with radial and medial veins distinct subbasally (Fig. 7) ..... *MYSIDIA* Westwood (p. 9)
- Length of frons less than twice width at base (Fig. 25). Tegmen with radial and medial veins fused over basal sixth of length (Fig. 4) ..... *AMYSIDIELLA* gen. n. (p. 101)
- 9(7) Pronotal width less than 10 times length at mid-dorsal line (Fig. 21). Length of frons 3 times width at apex (Fig. 26) ..... *IPSEMYSIDIA* gen. n. (p. 100)
- Pronotal width not less than 10 times length at mid-dorsal line (Fig. 20). Length of frons at least 4 times width at apex (Fig. 27) ..... *PARAMYSIDIA* gen. n. (p. 103)

## Checklist of Mysidiini

### MYSIDIINI trib. n.

#### *MYSIDIA* Westwood

*acidalioides* Fowler

*adamare* sp. n.

*adusta* sp. n.

*agilis* sp. n.

*albicans* (Stål)

*albifasciata* sp. n.

*albipennis* Westwood

*parviceps* Fowler syn. n.

*amarantha* sp. n.

*amazona* sp. n.

*andes* sp. n.

*ariasi* sp. n.

*asinella* sp. n.

*athena* sp. n.

*augusta* sp. n.

*bella* sp. n.

*bianca* sp. n.

*bibula* sp. n.

*bizzara* sp. n.

*bolivianna* sp. n.

*calliginosa* Walker

*rubra* Metcalf syn. n.

*calypso* sp. n.

*carosella* sp. n.

*cheesemani* sp. n.

*cinerea* Fennah

*claudata* sp. n.

*clava* sp. n.

*cooperi* sp. n.

*costata* (Fabricius)

*decora* sp. n.

*delicatissima* Fowler

*diabola* sp. n.

*diana* sp. n.

*distanti* sp. n.

*distincta* sp. n.

*dollingi* sp. n.

*douglasi* sp. n.

*ecuadoria* sp. n.

*enjebetta* sp. n.

*erecta* sp. n.

*estfarchina* sp. n.

*etheldreda* sp. n.

*fasciata* Metcalf

*flavilla* sp. n.

*formosa* sp. n.

*fowleri* sp. n.

*fulvodorsalis* sp. n.

*fuscifrontalis* sp. n.

*fuscomaculata* sp. n.

*geoffreyi* sp. n.

*glauca* Distant

*gracilis* sp. n.

*grandis* sp. n.

*harmonia* sp. n.

*havilandi* sp. n.

*hengist* sp. n.

*henrietta* sp. n.

*hyalina* sp. n.

*immaculata* sp. n.

*infedelis* sp. n.

*inquinata* sp. n.

*insania* sp. n.

*insolita* sp. n.

*intima* sp. n.

*isteria* sp. n.

*jamesi* sp. n.

*josianna* sp. n.

*knighti* sp. n.

*krameri* sp. n.

*lacteola* sp. n.

*lactiflora* Westwood

*limpida* sp. n.

*liquida* sp. n.

*lloydi* sp. n.

*lucianna* sp. n.

*lucifera* sp. n.

*maculicosta* Fowler

*maculosa* sp. n.

*magica* sp. n.

*marshalli* sp. n.

*minerva* sp. n.

*molesta* sp. n.

*musica* sp. n.

*mylesi* sp. n.

*nebulosa* (Germar)

*nemorensis* sp. n.

*neoasinella* sp. n.

*neonebulosa* Muir

*nigrifrontalis* sp. n.

*nigrithorax* sp. n.

*nitida* sp. n.

*obscura* Metcalf

*pallescens* Metcalf

*pallida* (Fabricius)  
*panamensis* sp. n.  
*peregrina* sp. n.  
*persephone* sp. n.  
*perspicua* sp. n.  
*polyhymnia* sp. n.  
*pseudocostata* sp. n.  
*pseudoerecta* sp. n.  
*pseudonebulosa* Muir  
*pulchella* sp. n.  
*punctifera* Metcalf  
*punctum* (Fabricius)  
*steinbachi* Distant syn. n.  
*quadrifasciata* Walker  
*richardsi* sp. n.  
*robusta* sp. n.  
*sanguinea* sp. n.  
*silvana* sp. n.  
*simplicata* sp. n.  
*squamigera* (Fabricius)  
*stali* sp. n.  
*stigma* (Germar)  
*striata* sp. n.  
*subfasciata* Westwood  
*subfusca* Metcalf  
*testacea* (Fabricius)  
*citrina* Walker syn. n.  
*tikalme* sp. n.  
*transversa* sp. n.  
*unimaculata* sp. n.  
*varia* sp. n.  
*venusta* sp. n.  
*vista* sp. n.  
*whimperi* sp. n.  
*williamsi* sp. n.

**SYMIDIA** Muir  
*bucaya* sp. n.  
*flava* Muir  
*pintosamia* sp. n.  
*pseudoflava* sp. n.  
*withycombei* sp. n.

**DYSIMIA** Muir  
*astarte* sp. n.  
*distincta* sp. n.  
*fennahi* sp. n.  
*fuscolypeata* Fennah  
*jamaicensis* (Distant) comb. n.  
*maculata* Muir

*maculipennis* sp. n.  
*morrissi* sp. n.  
*muiri* sp. n.  
*numa* Fennah  
*obrieni* sp. n.  
*pseudomaculata* sp. n.  
*putilla* Fennah  
*telfordi* sp. n.

**PSEUDOMYSIDIA** Metcalf  
*araguana* Fennah stat. n.  
*debora* sp. n.  
*delicata* sp. n.  
*ecuadoriensis* sp. n.  
*fuscovaria* Metcalf  
*hindore* sp. n.  
*juliana* sp. n.  
*lepida* sp. n.  
*marshalli* sp. n.  
*obnubilia* sp. n.  
*pallida* sp. n.  
*palmeri* sp. n.  
*panamensis* sp. n.  
*rubidella* (Ball) comb. n.  
*similis* sp. n.  
*trinidadensis* sp. n.  
*vestis* sp. n.

**AMYSIDIELLA** gen. n.  
*micare* sp. n.  
*pseudomicare* sp. n.

**DYSIMIELLA** gen. n.  
*pennyi* sp. n.  
*williamsi* sp. n.

**IPSEMYSIDIA** gen. n.  
*beatifica* sp. n.

**MYSIDALOIDES** gen. n.  
*trinidadensis* sp. n.

**NEOMYSIDIA** gen. n.  
*willisi* sp. n.

**PARAMYSIDIA** gen. n.  
*barbara* sp. n.  
*boudica* sp. n.  
*felix* sp. n.  
*mississippiensis* (Dozier) comb. n.  
*nigropunctata* (Metcalf) comb. n.  
*tessellata* sp. n.  
*vulgaris* sp. n.

### **MYSIDIA** Westwood

*Mysidia* Westwood, 1840: 83. Type-species: *Derbe pallida* Fabricius, by original designation.

Width of head in dorsal aspect usually from one-quarter to one-half greater than length, rarely more or less. Vertex extending anterior to eyes for between one-third and one-half its length; lateral margins not

highly elevated, strongly converging from base to level of midline of eyes, thence subparallel to apex; base shallowly concave. Frons with lateral margins gradually diverging from apex to base; slender, length usually 4–7 times width at apex, 2.0–3.5 times width at base, seldom more or less; junction with vertex broadly rounded, indistinct, lacking a transverse carina; lateral carinae very prominent, often semifoliate. Genae extending anterior to eyes for one-third to one-half horizontal diameter of eye. Eye weakly reniform, ventral margin adjacent to antennal base weakly concave. Antenna with second segment club-shaped, apex narrowly rounded; length usually 1.5–2.5 times maximum width; flagellum arising subapically. Ocelli commonly distinct, often small, rarely obscure or obsolete, occasionally very large and prominent. Clypeus broad, not greatly swollen; commonly as long as, or rather longer than, frons; medial carina frequently obsolete or extending only over *c.* apical one-half length or less, seldom distinct or percurrent; lateral carinae commonly not extending over more than basal one-third length, rarely either obsolete or distinct throughout. Rostrum often extending to, or beyond, base of subgenital plate; but frequently terminating at level of hind coxae.

Dorsal surface of pronotum very deeply and broadly constricted at midline; width usually 10–20 times mid-dorsal length, occasionally much greater. Fronto-lateral surfaces often each with a single prominent carina curving horizontally from adjacent to midline of eye to lateral margin. Tegulae occasionally each with a single horizontal carina. Disc of mesonotum often slightly wider than length at midline; medial and two lateral longitudinal carinae rarely distinct and percurrent.

Tegmen usually 6–12 mm long, rarely distinctly shorter or longer; that of the female usually being up to 30 per cent longer than that of the male; length *c.* 3 times maximum breadth. Medial vein distinct from near base; subcostal and radial veins fused over *c.* one-third length from base. Radial vein with two branches extending to apical margin; linked to medial vein by a cross-vein at *c.* two-thirds length, and by another adjacent to apical fork. Medial vein forking at *c.* two-fifths length, and again at midlength; with seven branches extending to apical and posterior margins, second and third, and fourth fifth, linked by cross-veins. Cubital vein with four branches extending to posterior margin, first linked to apex of clavus and to second, third to fourth, and fourth to first branch of medial vein by cross-veins (Fig. 7).

Wing with length *c.* one-half to two-thirds that of tegmen. Radial and sub-costal veins fused over rather less than basal half of length, unbranched; the former linked to medial vein by a cross-vein at *c.* two-thirds length. Medial vein with two branches extending to apical margin, linked to cubital vein by a single cross-vein at *c.* midlength. Cubital vein with three branches extending to posterior margin.

Head and body usually pale yellowish brown, seldom dark, often with distinct markings. Tegmen and wing often hyaline or whitish hyaline, occasionally deep fuscous, frequently with veins and cross-veins broadly margined smoky brown, often with distinct transverse bands or with apical and posterior margins smoky brown.

Male genitalia with shaft of aedeagus horizontal, basically cylindrical, usually symmetrical, usually slender in lateral aspect, often broadly expanded subapically in vertical aspect. Dorsal surface subapically usually with one or two, rarely three or four, pairs of spine or flap-like processes occasionally extending over lateral surfaces. Lateral and ventral surfaces usually unarmed. Paramere often slender basally, frequently obtusely rounded apically; dorsal surface usually with a well-developed posteriorly produced process bearing opposed projections on its posterior surface; often with a distinct secondary process. Anal tube often very strongly produced and decurved posteriorly, apex often deeply notched at midline. Subgenital segment with lateral and ventral margins occasionally bearing distinct, posteriorly directed processes.

Female with posterior margin of subgenital plate commonly transverse or broadly rounded, rarely strongly produced or shallowly notched medially.

*Mysidia* was erected by Westwood (1840) as a subgenus of *Derbe* to accommodate the Fabrician species *pallida*, *squamigera*, *costata*, *punctum*, *testacea* and *nivea*, and his own new species *albipennis*, *lactiflora* and *subfasciata*; further species were added by various authors, mainly Metcalf, Fowler, Distant, Walker, Muir and, more recently, Fennah, bringing the total number to 34.

As a result of the present study the distribution includes Brazil (69 species), Trinidad (7), Surinam (5), Guyana (15), French Guiana (2), Venezuela (4), Colombia (10), Ecuador (11), Bolivia (10), Peru (11), Uruguay (1?), Panama (20), Costa Rica (2), Honduras (4), Belize (2), Guatemala (4), Mexico (2) and Jamaica (1 species).

The localities from which species are recorded more probably reflects, at least in northern South America, intensity of collecting rather than diversity of species; with the exception of Trinidad, Jamaica is the only Caribbean island from which the genus is recorded. Due to the previous confusion and frequent misidentification, most of the published locality data recorded by Metcalf (1945–6) must be regarded as suspect.



**Key to species of *Mysidia* (based on external characters)**

It has not been possible to examine the type-material of *stigma*, while the unique holotypes of *cinerea*, *pallida* and *pseudonebulosa* are badly damaged; these species are therefore omitted from this key.

Though external characters are consistent within species, between species they are occasionally slight; in these instances reference should be made to the structure of the male genitalia.

- |         |   |                                    |
|---------|---|------------------------------------|
| 1       | Tegmen entirely dark brown, veins and cross-veins concolorous.....  | 2                                  |
| -       | Tegmen pale or, if predominantly dark brown, with pale markings.....  | 6                                  |
| 2 (1)   | Wing entirely dark brown .....  | 3                                  |
| -       | Wing with a narrow, oblique, pale transverse band. Brazil .....   | <i>asinella</i> sp. n. (p. 22)     |
| 3 (2)   | Female tegmen more than 11 mm; tegula uniformly pale; fronto-lateral surfaces of pronotum each with a distinct, horizontal, scarlet band. Brazil .....              | <i>adusta</i> sp. n. (p. 22)       |
| -       | Female tegmen less than 10 mm, or with tegula not uniformly pale .....  | 4                                  |
| 4 (3)   | Tegula uniformly dark brown. Brazil .....   | <i>polyhymnia</i> sp. n. (p. 23)   |
| -       | Tegula not uniformly dark brown.....  | 5                                  |
| 5 (4)   | Fronto-lateral surfaces of pronotum uniformly pale; tegula with dorsal margins dark brown. Brazil, Guyana, Bolivia, Panama, Peru, Trinidad .....                    | <i>calliginosa</i> Walker (p. 23)  |
| -       | Fronto-lateral surfaces of pronotum reddish dorsally; tegula reddish, dorsal margins darker red. Brazil.....  | <i>inquinata</i> sp. n. (p. 24)    |
| 6 (1)   | Tegmen and wing pale, veins and cross-veins uniformly pale.....   | 7                                  |
| -       | Tegmen and wing either predominantly dark brownish; or, if pale, with cross-veins darker than veins; frequently with dark transverse bands .....                    | 19                                 |
| 7 (6)   | Tegmen and wing totally devoid of dark markings; costal cell of tegmen sometimes tinged yellowish brown.....  | 8                                  |
| -       | Tegmen and wing with one or more dark spots .....   | 14                                 |
| 8 (7)   | Tegmen more than 10 mm .....  | 11                                 |
| -       | Tegmen less than 10 mm .....  | 9                                  |
| 9 (8)   | Tegmen less than 8 mm; fronto-lateral surfaces of pronotum prominently carinate. Brazil.....  | <i>venusta</i> sp. n. (p. 24)      |
| -       | Tegmen more than 8 mm; fronto-lateral surfaces of pronotum not carinate .....   | 10                                 |
| 10 (9)  | Tegmen with costal cell pale yellowish brown; radial and medial areas hyaline throughout. Guyana .....  | <i>richardsi</i> sp. n. (p. 25)    |
| -       | Tegmen with costal cell hyaline; radial and medial areas smoky brown apically. Brazil .....   | <i>limpida</i> sp. n. (p. 25)      |
| 11 (8)  | Tegmen yellowish hyaline. Brazil .....  | <i>robusta</i> sp. n. (p. 26)      |
| -       | Tegmen whitish hyaline .....  | 12                                 |
| 12 (11) | Head and body unicolorous brownish yellow. Tegmen less than 12 mm .....   | 13                                 |
| -       | Head and body with distinct reddish markings. Tegmen more than 13 mm. Peru .....  | <i>immaculata</i> sp. n. (p. 27)   |
| 13 (12) | Tegmen with posterior margin weakly tinged smoky brown. Guyana .....  | <i>nitida</i> sp. n. (p. 26)       |
| -       | Tegmen entirely hyaline. Brazil.....  | <i>amazona</i> sp. n. (p. 26)      |
| 14 (7)  | Tegmen with a very prominent dark brown spot extending from costal margin to second branch of cubital vein at one-third length. Peru, Bolivia, Guyana, Brazil ..... | <i>punctum</i> (Fabricius) (p. 27) |
| -       | Tegmen not as above .....   | 15                                 |
| 15 (14) | Tegmen with apical fork of medial vein very narrowly dark brown, not otherwise pigmented. Jamaica .....   | <i>hyalina</i> sp. n. (p. 28)      |
| -       | Tegmen not as above .....   | 16                                 |
| 16 (15) | Tegmen less than 8.0 mm .....   | 17                                 |
| -       | Tegmen more than 9.5 mm .....   | 18                                 |
| 17 (16) | Tegmen with a large, prominent, brown spot between apex of clavus and first branch of cubital vein, otherwise unmarked. Brazil.....                                 | <i>unimaculata</i> sp. n. (p. 28)  |
| -       | Tegmen with numerous small dark spots. Brazil .....   | <i>flavilla</i> sp. n. (p. 29)     |
| 18 (16) | Male tegmen less than 10 mm; tegula distinctly carinate; width of pronotum less than 2 mm. Ecuador .....  | <i>athena</i> sp. n. (p. 28)       |
| -       | Male tegmen more than 11 mm; tegula with carinae obsolete; width of pronotum more than 2 mm. Ecuador, Panama, Costa Rica .....                                      | <i>acidaloides</i> Fowler (p. 29)  |

19 (6)	Tegmen brown with pale transverse bands .....	20
-	Tegmen predominantly pale hyaline or, if dark brownish, lacking distinct pale bands .....	28
20 (19)	Tegmen with a single, very narrow, pale transverse band. Brazil.... <i>neoasinella</i> sp. n. (p. 30)	
-	Tegmen with more than one pale transverse band .....	21
21 (20)	Tegmen with two narrow, pale, transverse bands, both on basal half. Guyana <i>vista</i> sp. n. (p. 30)	
-	Tegmen with four pale transverse bands .....	22
22 (21)	Tegmen with all pale transverse bands extending from costal to posterior margins .....	23
-	Tegmen without all pale transverse bands extending across entire width .....	26
23 (22)	Tegmen with width of alternating light and dark bands approximately equal .....	24
-	Tegmen with pale bands narrower than the dark bands. Ecuador ... <i>albifasciata</i> sp. n. (p. 31)	
24 (23)	Tegmen pale brown; head in dorsal aspect little wider than long. Brazil <i>quadrifascia</i> Walker (p. 31)	
-	Tegmen dark brown; head in dorsal aspect with width considerably greater than length	25
25 (24)	Male tegmen little more than 7 mm, 3 times maximum width; dorsal surface of abdomen basally dark brown. Brazil, Peru..... <i>transversa</i> sp. n. (p. 32)	
-	Male tegmen approximately 8 mm, 2.5 times maximum width; dorsal surface of abdomen pale. Bolivia .....	<i>fulvodorsalis</i> sp. n. (p. 32)
26 (22)	Tegmen more than 8 mm; third pale transverse band faint, broken medially. Brazil <i>musica</i> sp. n. (p. 32)	
-	Tegmen less than 8 mm; third pale transverse band extending unbroken from costal to claval margins .....	27
27 (26)	Tegmen with pale transverse bands narrower than intervening dark areas; disc of mesonotum deep brown. Brazil..... <i>williamsi</i> sp. n. (p. 33)	
-	Tegmen with pale transverse bands as broad as intervening dark bands; disc of mesonotum pale. Trinidad .....	<i>mylesi</i> sp. n. (p. 33)
28 (19)	Tegmen and wing predominantly brownish, veins pale-margined .....	29
-	Tegmen and wing predominantly pale or, if largely brownish, with veins broadly edged brownish .....	33
29 (28)	Tegmen more than 9 mm .....	30
-	Tegmen less than 9 mm.....	31
30 (29)	Tegmen with light and dark markings giving a strongly mottled appearance. Colombia, Ecuador, Brazil..... <i>varia</i> sp. n. (p. 34)	
-	Tegmen not distinctly mottled. Guyana, Brazil .....	<i>tikalme</i> sp. n. (p. 34)
31 (29)	Tegmen and wing pale only at margins of veins; fronto-lateral surfaces of pronotum distinctly carinate. Brazil .....	<i>glauca</i> Distant (p. 35)
-	Tegmen and wing with larger cells pale medially; fronto-lateral surfaces of pronotum not distinctly carinate.....	32
32 (31)	Rostrum hardly extending beyond hind coxae; tegula carinate. Brazil.. <i>gracilis</i> sp. n. (p. 35)	
-	Rostrum extending to midlength of abdomen; tegula not carinate. Brazil <i>lucifera</i> sp. n. (p. 35)	
33 (28)	Tegmen and wing predominantly brownish. Guyana, Brazil..... <i>havilandi</i> sp. n. (p. 36)	
-	Tegmen and wing predominantly pale .....	34
34 (33)	Tegmen with veins and/or cross-veins at least in part broadly margined smoky brown .....	47
-	Tegmen with veins and/or cross-veins not broadly margined smoky brown .....	35
35 (34)	Tegmen and/or wing with distinct darker transverse bands .....	76
-	Tegmen and wing lacking distinct dark transverse bands .....	36
36 (35)	Scutellum blackish brown. Brazil..... <i>etheldreda</i> sp. n. (p. 36)	
-	Scutellum pale .....	37
37 (36)	Fronto-lateral surfaces of pronotum each with a large, circular, dark brown spot .....	38
-	Fronto-lateral surfaces of pronotum either unmarked, or each with a dark band extending horizontally from adjacent to eye to lateral margin .....	40
38 (37)	Disc of mesonotum with a pair of large, dark brown spots posteriorly. Bolivia, Vene- zuela, Peru .....	<i>liquida</i> sp. n. (p. 37)
-	Disc of mesonotum lacking prominent markings.....	39
39 (38)	Fronto-lateral surfaces of pronotum carinate. Tegmen with a small, dark brown spot at apex of anal vein. Brazil..... <i>ariasi</i> sp. n. (p. 37)	
-	Fronto-lateral surfaces of pronotum not carinate. Tegmen not as above. Trinidad, Guyana, Brazil, Surinam, Peru, Ecuador .....	<i>costata</i> (Fabricius) (p. 40)

40 (37)	Fronto-lateral surfaces of pronotum each with a prominent, dark brown, horizontal band .....	41
-	Fronto-lateral surfaces of pronotum uniformly pale, or with horizontal bands orange .....	43
41 (40)	Tegmen with costal cell pale, bearing a single dark brown spot .....	42
-	Tegmen with subcostal cell yellowish brown, becoming darker distally, with three irregular brownish spots. Panama .....	<i>fuscofrontalis</i> sp. n. (p. 38)
42 (41)	Tegmen less than 10 mm. Pronotum with maximum width less than 20 times length at mid-dorsal line. Guatemala, Belize, Honduras, Brazil .....	<i>albipennis</i> Westwood (p. 38)
-	Tegmen more than 10 mm. Pronotum with maximum width greater than 40 times length at mid-dorsal line. Brazil .....	<i>lactiflora</i> Westwood (p. 39)
43 (40)	Wing broadly brownish at level of radial-medial cross-vein. Ecuador .....	<i>diana</i> sp. n. (p. 43)
-	Wing pale medially .....	44
44 (43)	Tegmen and wing with posterior and apical margins dark smoky brown between veins; wing with a small dark spot adjacent to first branch of cubital vein. Colombia .....	<i>cooperi</i> sp. n. (p. 42)
-	Tegmen and wing not as above .....	45
45 (44)	Tegmen with costal cell hyaline .....	46
-	Tegmen with costal cell opaque yellowish brown Panama, Costa Rica: <i>dollingi</i> sp. n. (p. 43); Peru, Ecuador, Brazil, Guyana: <i>pseudocostata</i> sp. n. (p. 41); Bolivia: <i>bianca</i> sp. n. (p. 42)	
46 (45)	Tegmen more than 9.0 mm. Tegmen and wing with faint yellow transverse bands. French Guiana, Trinidad .....	<i>lacteola</i> sp. n. (p. 39)
-	Tegmen less than 8.5 mm. Tegmen and wing unmarked. Mexico .....	<i>delicatissima</i> Fowler (p. 41)
47 (34)	Tegmen with apical fork of medial vein dark brown or black .....	48
-	Tegmen with apical fork of medial vein pale .....	66
48 (47)	Fronto-lateral surfaces of pronotum with alternating deep brown and white horizontal bands. Brazil .....	<i>striata</i> sp. n. (p. 43)
-	Fronto-lateral surfaces of pronotum not as above .....	49
49 (48)	Fronto-lateral surfaces of pronotum prominently carinate .....	50
-	Fronto-lateral surfaces of pronotum with carinae weak or absent .....	54
50 (49)	Fronto-lateral surfaces of pronotum pale dorsally, deep brown ventrally. Brazil, Peru, Surinam .....	<i>sanguinea</i> sp. n. (p. 44)
-	Fronto-lateral surfaces of pronotum not as above .....	51
51 (50)	Fronto-lateral surfaces of pronotum with carinae narrowly orange. Panama .....	<i>fowleri</i> sp. n. (p. 46)
-	Fronto-lateral surfaces of pronotum unicolorous .....	52
52 (51)	Wing with apex broadly smoky brown. Brazil .....	<i>calypso</i> sp. n. (p. 44)
-	Wing with apex pale .....	52
53 (52)	Ocelli prominent. Tegmen with veins dark brown. Brazil .....	<i>peregrina</i> sp. n. (p. 45)
-	Ocelli obsolete. Tegmen with veins yellowish; cross-veins dark. Brazil, Surinam .....	<i>lucianna</i> sp. n. (p. 45)
54 (49)	Tegula uniformly pale .....	56
-	Tegula dark, at least in part .....	55
55 (54)	Tegula entirely very dark brown. Brazil .....	<i>squamigera</i> (Fabricius) (p. 40)
-	Tegula dark brown dorsad of base of tegmen only. Panama .....	<i>grandis</i> sp. n. (p. 46)
56 (54)	Fronto-lateral surfaces of pronotum each with a very distinct, narrow, horizontal, orange band. Belize .....	<i>minerva</i> sp. n. (p. 47)
-	Fronto-lateral surfaces of pronotum not as above .....	57
57 (56)	Tegmen and wing with veins and/or cross-veins margined smoky brown, lacking other markings .....	60
-	Tegmen and wing with distinct brownish markings in addition to those around veins and cross-veins .....	58
58 (57)	Fronto-lateral surfaces of pronotum each with a horizontal orange band adjacent to eye. .....	59
-	Fronto-lateral surfaces of pronotum uniformly pale. Panama .....	<i>punctifera</i> Metcalf (p. 47)
59 (58)	Dorsal surface of abdomen with a large, dark brown, spot on either side of midline basally. Guatemala .....	<i>maculicosta</i> Fowler (p. 48)
-	Dorsal surface of abdomen uniformly pale. Brazil .....	<i>molesta</i> sp. n. (p. 48)
60 (57)	Tegmen with posterior margin broadly and continuously smoky brown. Panama .....	<i>obscura</i> Metcalf (p. 49)

-	Tegmen with posterior margin either hyaline, or narrowly and intermittently smoky brown .....	61
61 (60)	Head with genae pale, unicolorous yellowish brown .....	64
-	Head with genae not uniformly pale .....	62
62 (61)	Head with genae narrowly dark reddish brown adjacent to eyes. Brazil	
	<i>henrietta</i> sp. n. (p. 49)	
-	Head with genae dull brownish dorsally .....	63
63 (62)	Tegmen with external margins of medial, radial, and subcostal areas dark smoky brown medially. Belize, Honduras .....	
	<i>distanti</i> sp. n. (p. 49)	
-	Tegmen with posterior and apical margins hyaline. Brazil .....	
	<i>albicans</i> (Stål) (p. 50)	
64 (61)	Tegmen with costal cell hyaline with numerous irregular brown spots .....	65
-	Tegmen with costal cell yellowish brown, with a single, brownish, spot at level of point of separation of fused subcostal and radial veins. Brazil, Surinam ...	
	<i>nemorensis</i> sp. n. (p. 51)	
65 (64)	Tegmen densely mottled smoky brown over basal third. Ocelli large. Belize, Honduras .....	
	<i>insolita</i> sp. n. (p. 51)	
-	Tegmen with basal third predominantly hyaline. Ocelli obsolete. Mexico	
	<i>enjebetia</i> sp. n. (p. 51)	
(66) (47)	Fronto-lateral surfaces of pronotum broadly dark brown/black medially. Dorsal surface of abdomen with a large deep red spot. Panama .....	
	<i>nigrifrontalis</i> sp. n. (p. 52)	
-	Pigmentation of pronotum and abdomen not as above .....	67
67 (66)	Fronto-lateral surfaces of pronotum each with a distinct orange band extending horizontally from adjacent to eye to lateral margin .....	68
-	Fronto-lateral surfaces of pronotum yellowish brown, unmarked .....	70
68 (67)	Tegmen more than 10 mm, mostly smoky brown. Bolivia .....	
	<i>andes</i> sp. n. (p. 52)	
-	Tegmen less than 10 mm, predominantly hyaline .....	69
69 (68)	Clypeus with medial carina percurrent; ocelli prominent; tegula not carinate. Panama.	
	<i>bibula</i> sp. n. (p. 53)	
-	Clypeus with medial carina obsolete; ocelli small; tegula carinate. Ecuador	
	<i>ecuadoria</i> sp. n. (p. 53)	
70 (67)	Fronto-lateral surfaces of pronotum distinctly carinate .....	71
-	Fronto-lateral surfaces of pronotum not carinate .....	72
71 (70)	Fronto-lateral surfaces of pronotum unicolorous pale yellowish brown throughout. Trinidad .....	
	<i>cheesemani</i> sp. n. (p. 54)	
-	Fronto-lateral surfaces of pronotum with carinae narrowly edged reddish brown. Peru .....	
	<i>augusta</i> sp. n. (p. 54)	
72 (70)	Tegmen with an irregular brownish transverse band at one-third length, another very irregular band over second fork of medial vein. Ocelli small .....	74
-	Tegmen not as above. Ocelli prominent .....	73
73 (72)	Pronotum with width 25 times length at mid-dorsal line. Honduras, Mexico, Panama, Costa Rica .....	
	<i>nebulosa</i> (Germar) (p. 56)	
-	Pronotum with width approximately 15 times length at mid-dorsal line .....	75
74 (72)	Tegmen more than 8 mm. Head with vertex pale. Bolivia, Colombia ....	
	<i>erecta</i> sp. n. (p. 55)	
-	Tegmen less than 8 mm. Basal angles of vertex dark brown .....	
	<i>krameri</i> sp. n. (p. 54)	
75 (73)	Frons less than 6 times width at apex; clypeus longer than frons. Ecuador	
	<i>maculosa</i> sp. n. (p. 55)	
-	Frons more than 6 times width at apex; clypeus shorter than frons. Bolivia	
	<i>bizzara</i> sp. n. (p. 56)	
76 (35)	Tegmen and wing yellowish; tegmen lacking dark transverse bands .....	77
-	Tegmen and wing hyaline; tegmen with dark transverse bands .....	79
77 (76)	Wing with two brownish transverse bands. Brazil .....	
	<i>intima</i> sp. n. (p. 56)	
-	Wing with a single dark transverse band .....	78
78 (77)	Wing with dark transverse band extending from costal margin to apex of clavus. Brazil	
	<i>infedelis</i> sp. n. (p. 57)	
-	Wing with dark transverse band extending from medial-radial cross-vein to apex of clavus. Guyana .....	
	<i>testacea</i> (Fabricius) (p. 57)	
79 (76)	Thorax and abdomen predominantly dark brown. Brazil .....	
	<i>diabola</i> sp. n. (p. 58)	
-	Thorax and abdomen predominantly pale yellowish brown .....	80
80 (79)	Fronto-lateral surfaces of pronotum distinctly carinate .....	81
-	Fronto-lateral surfaces of pronotum not carinate .....	82

81 (80)	Wing with two distinct smoky brown transverse bands. Brazil .....	<i>lloydi</i> sp. n.	(p. 58)
-	Wing lacking dark transverse bands. Panama .....	<i>fuscomaculata</i> sp. n.	(p. 59)
82 (80)	Tegula each with a distinct horizontal carina .....		83
-	Tegula not carinate .....		87
83 (82)	Fronto-lateral surfaces of pronotum orange at level of eyes. Pronotum with width less than 20 times length at mid-dorsal line .....		84
-	Fronto-lateral surfaces of pronotum concolorous dull yellowish. Pronotum with width greater than 25 times length at mid-dorsal line .....		85
84 (83)	Tegmen with four faint transverse bands. Brazil .....	<i>adamare</i> sp. n.	(p. 60)
-	Tegmen with two faint transverse bands. Peru .....	<i>isteria</i> sp. n.	(p. 59)
85 (83)	Head with genae adjacent to eyes dark brownish. Panama .....	<i>pallescens</i> Metcalf	(p. 60)
-	Head with genae pale throughout .....		86
86 (85)	Tegmen with three irregular smoky brown transverse bands, apex brownish. Ecuador	<i>insania</i> sp. n.	(p. 60)
-	Tegmen with two very faint, transverse bands, apex hyaline. Panama	<i>panamensis</i> sp. n.	(p. 61)
87 (82)	Tegmen with a single distinct dark transverse band .....		88
-	Tegmen with at least two dark transverse bands .....		90
88 (87)	Genae adjacent to eyes, and posterior margin of pronotum, deep red. Venezuela	<i>formosa</i> sp. n.	(p. 61)
-	Genae and pronotum not as above .....		89
89 (88)	Disc of mesonotum deep orange. Ecuador .....	<i>whimper</i> sp. n.	(p. 62)
-	Disc of mesonotum yellowish. Brazil .....	<i>stali</i> sp. n.	(p. 62)
90 (87)	Tegmen with two dark transverse bands .....		91
-	Tegmen with three or more dark transverse bands .....		101
91 (90)	Tegmen with distal transverse band extending only over cubital area .....		92
-	Tegmen with distal transverse band extending to costal margin .....		94
92 (91)	Fronto-lateral surfaces of pronotum each with a narrow, light orange band extending horizontally from adjacent to eye to lateral margin. Brazil .....	<i>clava</i> sp. n.	(p. 62)
-	Fronto-lateral surfaces of pronotum unicolorous yellowish brown .....		93
93 (92)	Pronotum with width less than 20 times length at mid-dorsal line; fronto-lateral surfaces carinate. Ecuador .....	<i>simplicis</i> sp. n.	(p. 63)
-	Pronotum with width greater than 30 times length at mid-dorsal line; fronto-lateral surfaces not carinate. Trinidad, Brazil .....	<i>josianna</i> sp. n.	(p. 67)
94 (91)	Disc of mesonotum blackish brown. Peru .....	<i>nigrithorax</i> sp. n.	(p. 63)
-	Disc of mesonotum pale .....		95
95 (94)	Wing with two smoky brown transverse bands. Panama .....	<i>subfusca</i> Metcalf	(p. 64)
-	Wing either with a single transverse band, or such markings absent .....		96
96 (95)	Wing with a distinct transverse band .....		98
-	Wing without transverse markings .....		97
97 (96)	Pronotum with width less than 20 times length at mid-dorsal line. Brazil	<i>estfarchina</i> sp. n.	(p. 64)
-	Pronotum with width more than 20 times length at mid-dorsal line. Brazil	<i>subfasciata</i> Westwood	(p. 64)
98 (96)	Tegmen with claval area dark brown. Panama .....	<i>fasciata</i> Metcalf	(p. 65)
-	Tegmen with claval area pale .....		99
99 (98)	Tegmen with distal transverse band at level of second fork of medial vein. Panama	<i>douglasi</i> sp. n.	(p. 65)
-	Tegmen with distal transverse band at level of radial-medial cross-vein .....		100
100 (99)	Tegmen with distal transverse band much narrower and paler than basal band. Brazil	<i>knightsi</i> sp. n.	(p. 66)
-	Tegmen with distal transverse band as wide as, and little paler, than basal band. Brazil	<i>pulchella</i> sp. n.	(p. 66)
101 (90)	Tegmen with three dark transverse bands .....		102
-	Tegmen with four or more dark transverse bands .....		112
102(101)	Pronotum with width more than 30 times length at mid-dorsal line .....		103
-	Pronotum with width less than 30 times length at mid-dorsal line .....		105
103(102)	Wing lacking distinct markings. Female with length of tegmen not less than 11 mm. Peru	<i>distincta</i> sp. n.	(p. 66)

–	Wing with two distinct transverse bands. Female with length of tegmen less than 11 mm.	104
104(103)	Wing with basal transverse band at level of first fork of cubital vein, unbroken. Brazil <i>hengist</i> sp. n. (p. 67)	
–	Wing with basal transverse band at level of medial-cubital cross-vein, interrupted medially. Brazil, Trinidad	<i>josianna</i> sp. n. (p. 67)
105(102)	Disc of mesonotum with a dark brown spot medially. Brazil	<i>pseudoerecta</i> sp. n. (p. 68)
–	Disc of mesonotum unicolorous brownish yellow	106
106(105)	Pronotal width not more than 22 times length at mid-dorsal line	107
–	Pronotal width not less than 25 times length at mid-dorsal line	111
107(106)	Wing with cubital-medial cross-vein broadly margined pale smoky brown, lacking distinct transverse bands. Brazil	<i>perspicua</i> sp. n. (p. 68)
–	Wing with one or two distinct transverse bands	108
108(107)	Wing with a single transverse band	109
–	Wing with not less than two transverse bands	110
109(108)	Wing with posterior and apical margins dark smoky brown. Brazil, Guyana	
–	Wing with posterior and apical margins hyaline. Brazil	<i>agilis</i> sp. n. (p. 69)
110(108)	Wing with two dark transverse bands. Brazil	<i>claudata</i> sp. n. (p. 69)
–	Wing with three transverse bands	<i>jamesi</i> sp. n. (p. 70)
111(110)	Wing with second transverse band extending unbroken from apex of clavus to medial vein. Bolivia	<i>carosella</i> sp. n. (p. 70)
–	Wing with second transverse band interrupted between first and second branches of cubital vein. Colombia	<i>harmonia</i> sp. n. (p. 70)
112(101)	Tegmen with four transverse bands	115
–	Tegmen with five or six transverse bands	113
113(112)	Tegmen with six transverse bands. Peru	<i>silvana</i> sp. n. (p. 71)
–	Tegmen with five transverse bands	114
114(113)	Tegmen more than 8 mm. Pronotal width more than 25 times length at mid-dorsal line. Brazil	<i>decora</i> sp. n. (p. 72)
–	Tegmen less than 8 mm. Pronotal width less than 20 times length at mid-dorsal line. Brazil	<i>bella</i> sp. n. (p. 71)
115(112)	Head with genae adjacent to eyes narrowly very dark brown. Bolivia	<i>bolivianna</i> sp. n. (p. 72)
–	Head with genae pale throughout	116
116(115)	Ocelli very large and prominent. Brazil	<i>persephone</i> sp. n. (p. 73)
–	Ocelli small, not prominent	117
117(116)	Wing with three dark transverse bands. Bolivia	<i>marshalli</i> sp. n. (p. 73)
–	Wing with two transverse bands, or lacking dark markings	118
118(117)	Wing with two pale brownish transverse bands. Guyana	<i>neonebulosa</i> Muir (p. 74)
–	Wing lacking distinct transverse bands	119
119(118)	Fore tibia and tarsi unicolorous pale yellow	120
–	Fore tibia with a narrow dark brown band subapically, tarsi brownish. Ecuador	<i>amarantha</i> sp. n. (p. 74)
120(119)	Antenna very long, extending well beyond anterior margins of genae. Surinam	<i>magica</i> sp. n. (p. 74)
–	Antenna short, not extending beyond anterior margins of genae. Bolivia, Peru	<i>geoffreyi</i> sp. n. (p. 75)

### Key to species of *Mysidia* (based on male genitalia)

It has not been possible to examine the male genitalia of the following species, which are therefore omitted from this key: *immaculata*, *lactiflora*, *maculicosta*, *punctifera*, *quadrifasciata*, *squamigera*, *stigma*, *subfasciata* and *subfusca*. The genitalia of *robusta* are damaged, and this species is also omitted.

1	Paramere with a ventral process	2
–	Paramere lacking a ventral process	11
2 (1)	Paramere with primary dorsal process absent (Fig. 391)	<i>fowleri</i> sp. n. (p. 46)
–	Paramere with primary dorsal process well developed	3
3 (2)	Paramere with ventral process situated subbasally	4
–	Paramere with ventral process situated at, or distal to, midlength	6

4	(3)	Shaft of aedeagus with subapical dorsal processes rounded, flap-like (Fig. 174)	
			<i>distanti</i> sp. n. (p. 49)
-		Shaft of aedeagus with subapical dorsal processes long, slender, spine-like.....	5
5	(4)	Shaft of aedeagus with lateral pair of subapical processes short, medial pair apically bifurcate (Fig. 175).....	<i>claudata</i> sp. n. (p. 69)
-		Shaft of aedeagus with lateral processes long, medial processes simple (Fig. 176)	
			<i>pulchella</i> sp. n. (p. 66)
6	(3)	Shaft of aedeagus with subapical processes long and spine-like (Fig. 177)	
			<i>fulvodorsalis</i> sp. n. (p. 32)
-		Shaft of aedeagus with subapical processes flap-like.....	7
7	(6)	Paramere with ventral process small and hook-like (Fig. 396).....	<i>douglasi</i> sp. n. (p. 65)
-		Paramere with ventral process large and rounded.....	8
8	(7)	Paramere with primary dorsal process vertically directed (Fig. 397).....	<i>bizzara</i> sp. n. (p. 56)
-		Paramere with primary dorsal process strongly inclined posteriorly.....	9
9	(8)	Paramere with dorsal surface strongly dorsally produced subapically (Fig. 399).....	10
-		Paramere with apex rounded (Fig. 398).....	<i>jamesi</i> sp. n. (p. 70)
10	(9)	Shaft of aedeagus with subapical flap-like processes dorsally directed (Fig. 289)	
			<i>enjebeta</i> sp. n. (p. 51)
-		Shaft of aedeagus with subapical flap-like processes not dorsally directed (Fig. 290)	
			<i>carosella</i> sp. n. (p. 70)
11	(1)	Paramere with a small, hook-like, secondary dorsal process subbasally.....	12
-		Paramere with secondary dorsal process either large and rounded or absent.....	14
12	(11)	Paramere with primary dorsal process absent (Fig. 401).....	<i>peregrina</i> sp. n. (p. 45)
-		Paramere with primary dorsal process distinct.....	13
13	(12)	Shaft of aedeagus with lateral subapical processes apically bifurcate (Fig. 183)	
			<i>venusta</i> sp. n. (p. 24)
-		Shaft of aedeagus with lateral subapical processes apically simple (Fig. 184)	
			<i>augusta</i> sp. n. (p. 54)
14	(11)	Paramere with dorsal margin strongly produced and folded towards midline along entire length.....	15
-		Paramere with dorsal margin not produced throughout.....	17
15	(14)	Shaft of aedeagus with subapical dorsal processes each bearing a small acute spine (Fig. 295).....	<i>ariasi</i> sp. n. (p. 37)
-		Shaft of aedeagus with subapical dorsal processes greatly produced and apically bifurcate.....	16
16	(15)	Shaft of aedeagus with apices of subapical dorsal processes almost meeting at midline (Fig. 186).....	<i>amazona</i> sp. n. (p. 26)
-		Shaft of aedeagus with apices of subapical dorsal processes diverging (Fig. 187)	
			<i>molesta</i> sp. n. (p. 48)
17	(14)	Paramere with primary dorsal process large.....	19
-		Paramere with primary dorsal process reduced or absent.....	18
18	(17)	Paramere with primary dorsal process obsolete; secondary dorsal process small, bearing three acute spines (Fig. 407).....	<i>glauca</i> Distant (p. 35)
-		Paramere with primary dorsal process absent; secondary dorsal process large, hook-like, basally directed (Fig. 408).....	<i>cinerea</i> Fennah (p. 76)
19	(17)	Paramere with primary dorsal process produced dorsally and/or posteriorly.....	29
-		Paramere with primary dorsal process not produced.....	20
20	(19)	Paramere with primary dorsal process bearing interlocking surfaces.....	23
-		Paramere with primary dorsal process lacking interlocking surfaces.....	21
21	(20)	Shaft of aedeagus dorsally with two pairs of acute spine-like subapical processes (Fig. 190).....	<i>agilis</i> sp. n. (p. 69)
-		Shaft of aedeagus dorsally with a single pair of flap-like processes.....	22
22	(21)	Paramere with primary dorsal process bearing a single, posteriorly directed, spine-like projection only (Fig. 410).....	<i>ecuadoria</i> sp. n. (p. 53)
-		Paramere with primary dorsal process bearing a long, curving, hook-like projection and a small spine (Fig. 411).....	<i>decora</i> sp. n. (p. 72)
23	(20)	Paramere bearing a long, medially directed secondary process distad of primary process (Fig. 412).....	<i>lacteola</i> sp. n. (p. 39)
-		Paramere lacking a secondary dorsal process.....	24

24	(23)	Shaft of aedeagus with slender, apically bifurcate, lateral processes (Fig. 194)	
			<i>cheesemani</i> sp. n. (p. 54)
	-	Shaft of aedeagus lacking lateral processes .....	25
25	(24)	Shaft of aedeagus with subapical dorsal processes strongly bifurcate .....	26
	-	Shaft of aedeagus with subapical dorsal processes not bifurcate .....	27
26	(25)	Paramere with anterior component of primary dorsal process strongly curving posteriorly (Fig. 414) .....	<i>nemorensis</i> sp. n. (p. 51)
	-	Paramere with anterior component of primary dorsal process inclined anteriorly (Fig. 415) .....	<i>polyhymnia</i> sp. n. (p. 23)
27	(25)	Shaft of aedeagus with dorsal components of subapical processes strongly hooked posteriorly (Fig. 307) .....	<i>limpida</i> sp. n. (p. 25)
	-	Shaft of aedeagus with dorsal components of subapical processes regularly curving posteriorly .....	28
28	(27)	Paramere with anterior and posterior components of dorsal process of approximately equal size (Fig. 417) .....	<i>nitida</i> sp. n. (p. 26)
	-	Paramere with posterior component of dorsal process larger than the anterior (Fig. 418) .....	<i>amarantha</i> sp. n. (p. 74)
29	(19)	Paramere with dorsal process slender, greatly produced dorsally, apex hooked, lacking interlocking surfaces .....	30
	-	Paramere either with dorsal process not greatly produced dorsally, or with one or both interlocking surfaces present .....	31
30	(29)	Shaft of aedeagus in dorsal aspect with maximum width greater than two-thirds length (Fig. 201) .....	<i>erecta</i> sp. n. (p. 55)
	-	Shaft of aedeagus in dorsal aspect with maximum width little greater than one-half length (Fig. 202) .....	<i>pseudoerecta</i> sp. n. (p. 68)
31	(29)	Paramere with dorsal process bearing two interlocking surfaces, or with only the basal surface present .....	34
	-	Paramere with only the distal interlocking surface present .....	32
32	(31)	Paramere with a large, acute, medially directed process on dorsal surface subapically (Fig. 421) .....	<i>stali</i> sp. n. (p. 62)
	-	Paramere not strongly produced subapically .....	33
33	(32)	Shaft of aedeagus with ventral surface subapically bearing numerous small acute spines (Fig. 313) .....	<i>knighti</i> sp. n. (p. 66)
	-	Shaft of aedeagus with ventral surface unarmed (Fig. 314) .....	<i>persephone</i> sp. n. (p. 73)
34	(31)	Paramere with basal interlocking surface hook-like, distal surface obsolete (Fig. 424)	
			<i>minerva</i> sp. n. (p. 47)
	-	Paramere with both interlocking surfaces well developed .....	35
35	(34)	Paramere with basal interlocking surface greatly produced, curving dorsally and posteriorly (Fig. 425) .....	<i>harmonia</i> sp. n. (p. 70)
	-	Paramere with basal interlocking surface not produced .....	36
36	(35)	Paramere with a large, medially directed, apically acute process covered with very small tooth-like spines on dorsal margin distad of primary dorsal process .....	37
	-	Paramere lacking a secondary process .....	38
37	(36)	Shaft of aedeagus bearing long, acute, spine-like processes on dorsal surface subapically (Fig. 318) .....	<i>bianca</i> sp. n. (p. 42)
	-	Shaft of aedeagus with flap-like processes only (Fig. 319) .....	<i>pseudocostata</i> sp. n. (p. 41)
38	(36)	Paramere with dorsal process produced posteriorly .....	42
	-	Paramere with dorsal process not produced posteriorly .....	39
39	(38)	Paramere with dorsal process slender, dorsally directed (Fig. 428) .....	<i>bibula</i> sp. n. (p. 53)
	-	Paramere with dorsal process broadly rounded .....	40
40	(39)	Shaft of aedeagus in vertical aspect with length greater than three times maximum width (Fig. 210) .....	<i>panamensis</i> sp. n. (p. 61)
	-	Shaft of aedeagus with length less than three times maximum width .....	41
41	(40)	Shaft of aedeagus in lateral aspect with subapical dorsal processes very slender, apices curving dorsally (Fig. 321) .....	<i>isteria</i> sp. n. (p. 59)
	-	Shaft of aedeagus in lateral aspect with subapical processes broad, apices inclined antero-ventrally (Fig. 322) .....	<i>estfarchina</i> sp. n. (p. 64)
42	(38)	Paramere with dorsal process bearing a ventrally directed node-like projection at somewhat distad of midlength (Fig. 432) .....	<i>insolita</i> sp. n. (p. 51)



TAXONOMY OF NEOTROPICAL DERBIDAE IN THE NEW TRIBE MYSIDIINI (HOMOPTERA)		19
-	Paramere with dorsal process simple.....	43
43 (42)	Shaft of aedeagus with ventrally directed processes subapically on ventral surface .....	44
-	Shaft of aedeagus with ventral surface unarmed.....	49
44 (43)	Shaft of aedeagus with subapical process asymmetrical (Fig. 214). Paramere with apex strongly produced dorsally (Fig. 433).....	<i>athena</i> sp. n. (p. 28)
-	Shaft of aedeagus symmetrical. Paramere with apex not produced dorsally .....	45
45 (44)	Shaft of aedeagus slender, almost parallel-sided in dorsal aspect.....	46
-	Shaft of aedeagus considerably expanded subapically .....	48
46 (45)	Shaft of aedeagus with ventral processes only (Fig. 325) .....	<i>sanguinea</i> sp. n. (p. 44)
-	Shaft of aedeagus with both dorsal and ventral processes .....	47
47 (46)	Paramere with apex simple, acute; dorsal process situated at three-fifths length (Fig. 435).....	<i>acidaloides</i> Fowler (p. 29)
-	Paramere with apex obtusely rounded, bearing an acute, medially curving process; dorsal process subapical (Fig. 436) .....	<i>krameri</i> sp. n. (p. 54)
48 (45)	Shaft of aedeagus with two pairs of ventral spine-like processes subapically (Fig. 328)	<i>adusta</i> sp. n. (p. 22)
-	Shaft of aedeagus with a single pair of ventrally curving spine-like processes apically (Fig. 329).....	<i>hivilandi</i> sp. n. (p. 36)
49 (43)	Shaft of aedeagus with subapical processes flap-like and/or spine-like; if flap-like then terminating in long acute spines .....	61
-	Shaft of aedeagus with subapical processes flap-like, not terminating in long acute spines .....	50
50 (49)	Shaft of aedeagus with subapical processes each bearing a small, laterally directed, acute spine subbasally (Fig. 219) .....	<i>richardsi</i> sp. n. (p. 25)
-	Shaft of aedeagus with subapical processes not as above .....	51
51 (50)	Paramere with a large, medially directed, secondary dorsal process distad of primary process (Fig. 440).....	<i>costata</i> (Fabricius) (p. 40)
-	Paramere lacking a secondary dorsal process .....	52
52 (51)	Paramere very broadly rounded, length from base of apodeme to apex very little greater than maximum width (Fig. 441) .....	<i>adamare</i> sp. n. (p. 60)
-	Paramere with length well in excess of 1.5 times maximum width .....	53
53 (52)	Shaft of aedeagus in dorsal aspect more than four times maximum width; subapical processes longitudinally aligned and dorsally directed (Fig. 222) .....	<i>simpla</i> sp. n. (p. 63)
-	Shaft of aedeagus in dorsal aspect less than 3.5 times maximum width; subapical processes transversally aligned and anteriorly directed.....	54
54 (53)	Shaft of aedeagus in dorsal aspect less than twice maximum width (Fig. 224)	<i>liquida</i> sp. n. (p. 37)
-	Shaft of aedeagus in dorsal aspect not less than 2.5 times maximum width .....	55
55 (54)	Shaft of aedeagus with subapical processes each produced posteriorly and dorsally into a short, acute spine (Fig. 223).....	<i>marshalli</i> sp. n. (p. 73)
-	Shaft of aedeagus with subapical processes not as above .....	56
56 (55)	Shaft of aedeagus in dorsal aspect with subapical processes broadly rounded .....	59
-	Shaft of aedeagus with apices of subapical processes transverse, lateral angles acute.....	57
57 (56)	Shaft of aedeagus with apices of subapical processes finely serrated (Fig. 225)	<i>fasciata</i> Metcalf (p. 65)
-	Shaft of aedeagus with subapical processes not as above .....	58
58 (57)	Paramere with interlocking surfaces closely opposed, truncate (Fig. 445)	<i>hyalina</i> sp. n. (p. 28)
-	Paramere with interlocking surfaces acute, spine-like (Fig. 447) .....	<i>diana</i> sp. n. (p. 43)
59 (56)	Shaft of aedeagus with subapical processes extending anteriorly for two-fifths length (Fig. 228).....	<i>albipennis</i> Westwood (p. 38)
-	Shaft of aedeagus with subapical processes extending anteriorly for approximately one-quarter length .....	60
60 (59)	Shaft of aedeagus with subapical processes each bearing a large, rounded, medially directed lobe antero-dorsally (Fig. 229).....	<i>bella</i> sp. n. (p. 71)
-	Shaft of aedeagus with subapical processes simple (Fig. 230).....	<i>neonebulosa</i> Muir (p. 74)
61 (49)	Shaft of aedeagus with all subapical dorsal, processes slender, spine-like .....	62
-	Shaft of aedeagus with some or all subapical dorsal processes broad, flap-like .....	66
62 (61)	Shaft of aedeagus with three pairs of subapical processes .....	63
-	Shaft of aedeagus with two pairs of subapical processes .....	64

- 63 (62) Shaft of aedeagus with medial pair of subapical processes very long and slender (Fig. 231)..... *nigrithorax* sp. n. (p. 63)  
 - Shaft of aedeagus with medial pair of subapical processes short (Fig. 232)..... *lucifera* sp. n. (p. 35)
- 64 (62) Paramere with dorsal margin narrowly produced towards midline apically (Fig. 453)..... *infedelis* sp. n. (p. 51)  
 - Paramere with apex regularly rounded..... 65
- 65 (64) Paramere very slender from base to approximately midlength (Fig. 454). Shaft of aedeagus with subapical processes broad basally, medial pair strongly diverging (Fig. 234)..... *transversa* sp. n. (p. 32)  
 - Paramere gradually broadening from base (Fig. 455). Shaft of aedeagus with subapical processes slender from base, apices very weakly diverging (Fig. 235).. *intima* sp. n. (p. 56)
- 66 (61) Shaft of aedeagus with five pairs of subapical processes (Fig. 236).. *caliginosa* Walker (p. 23)  
 - Shaft of aedeagus with two pairs of subapical processes ..... 67
- 67 (66) Shaft of aedeagus with medial subapical process slender, longitudinally aligned, bearing numerous, very small, acute tubercles anteriorly and/or dorsally, lateral processes spine-like..... 68  
 - Shaft of aedeagus with medial subapical process lacking tubercles ..... 70
- 68 (67) Shaft of aedeagus with lateral subapical processes long, apically serrated (Fig. 346)..... *calypso* sp. n. (p. 44)  
 - Shaft of aedeagus with subapical processes short, apically acute ..... 69
- 69 (68) Shaft of aedeagus with lateral spine-like subapical processes very much shorter than medial processes (Fig. 238)..... *williamsi* sp. n. (p. 33)  
 - Shaft of aedeagus with lateral spine-like subapical processes only slightly shorter than medial processes (Fig. 239)..... *albifasciata* sp. n. (p. 31)
- 70 (67) Shaft of aedeagus with, in addition to paired lateral processes, a single, dorsally directed, spine-like, medial process subapically (Fig. 389)..... 71  
 - Shaft of aedeagus with all subapical processes paired ..... 72
- 71 (70) Shaft of aedeagus with paired spine-like processes long, antero-dorsally directed, situated submedially (Fig. 278)..... *pseudonebulosa* Muir (p. 75)  
 - Shaft of aedeagus with paired spine-like processes short, laterally directed, situated laterally (Fig. 240)..... *josianna* sp. n. (p. 67)
- 72 (70) Shaft of aedeagus with a single pair of slender, spine-like, antero-laterally directed processes subapically on lateral surfaces ..... 73  
 - Shaft of aedeagus not as above ..... 76
- 73 (72) Shaft of aedeagus with medial pair of subapical processes very large, flap-like, antero-dorsally directed, irregularly rounded anteriorly (Fig. 241) .... *nigrifrontalis* sp. n. (p. 52)  
 - Shaft of aedeagus with medial subapical processes not as above ..... 74
- 74 (73) Shaft of aedeagus with lateral subapical processes short, hooked, anteriorly directed (Fig. 242)..... *clava* sp. n. (p. 62)  
 - Shaft of aedeagus with lateral subapical processes long, slender..... 75
- 75 (74) Shaft of aedeagus with lateral subapical processes deeply serrated apically; medial processes each with a long, acute, anteriorly directed, spine-like projection dorsally (Fig. 354)..... *inquinata* sp. n. (p. 24)  
 - Shaft of aedeagus with lateral subapical processes apically acute; medial processes not as above (Fig. 355)..... *gracilis* sp. n. (p. 35)
- 76 (72) Paramere with dorsal margin strongly produced apically, inclined ventro-medially (Fig. 466)..... *fuscifrontalis* sp. n. (p. 38)  
 - Paramere with dorsal margin not produced apically ..... 77
- 77 (76) Paramere with primary dorsal process situated at three-quarters length (Fig. 467)..... *formosa* sp. n. (p. 61)  
 - Paramere with primary dorsal process situated at, or basad of, mid-length ..... 78
- 78 (77) Shaft of aedeagus asymmetrical, apex strongly rotated clockwise (Fig. 358)..... *cooperi* sp. n. (p. 42)  
 - Shaft of aedeagus symmetrical, not apically rotated..... 79
- 79 (78) Shaft of aedeagus with a pair of long, ventrally directed, lateral processes subapically..... 80  
 - Shaft of aedeagus with subapical processes not ventrally inclined..... 81
- 80 (79) Paramere with apex acute, interlocking surfaces small and acute (Fig. 469)..... *punctum* (Fabricius) (p. 27)

-	Paramere with apex broadly rounded, interlocking surfaces large and opposed (Fig. 470).....	<i>magica</i> sp. n. (p. 74)
81 (79)	Shaft of aedeagus with a pair of large, horizontal, flap-like subapical processes strongly overlapping medially .....	82
-	Shaft of aedeagus with subapical processes not strongly overlapping.....	85
82 (81)	Shaft of aedeagus with subapical processes each bearing a slender, dorsally directed, spine-like projection medially; anterior angles acute, greatly produced anteriorly .....	83
-	Shaft of aedeagus with flap-like processes lacking medial spine-like projections, not produced anteriorly.....	84
83 (82)	Shaft of aedeagus with anterior extensions of flap-like processes broad, overlapping basally (Fig. 250) .....	<i>bolivianna</i> sp. n. (p. 72)
-	Shaft of aedeagus with anterior extensions of flap-like processes slender, not overlapping basally (Fig. 251) .....	<i>silvana</i> sp. n. (p. 71)
84 (82)	Shaft of aedeagus with subapical flap-like processes each bearing a slender, curving, spine-like projection basally (Fig. 252) .....	<i>hengist</i> sp. n. (p. 67)
-	Shaft of aedeagus with subapical processes basally unarmed (Fig. 253).....	<i>musica</i> sp. n. (p. 32)
85 (81)	Shaft of aedeagus with a very broad, transverse, posteriorly directed, flap-like process subbasally, extending to midlength on dorsal surface (Fig. 365) ...	<i>etheldreda</i> sp. n. (p. 36)
-	Shaft of aedeagus not as above .....	86
86 (85)	Shaft of aedeagus with a medial subapical process in addition to paired lateral processes (Fig. 255) .....	<i>dollingi</i> sp. n. (p. 43)
-	Shaft of aedeagus with paired subapical processes only.....	87
87 (86)	Shaft of aedeagus with a single pair of subapical processes laterally, not extending over dorsal surface.....	88
-	Shaft of aedeagus with subapical processes on, or extending over, dorsal surface .....	89
88 (87)	Shaft of aedeagus with subapical processes triangular (Fig. 256) .....	<i>diabola</i> sp. n. (p. 58)
-	Shaft of aedeagus with subapical processes long and slender (Fig. 257).....	<i>neosinella</i> sp. n. (p. 30)
89 (87)	Shaft of aedeagus with a pair of very large, longitudinally aligned, flap-like processes subapically, each bearing two small, anteriorly directed, tooth-like projections .....	90
-	Shaft of aedeagus not as above .....	93
90 (89)	Shaft of aedeagus in lateral aspect with posterior tooth-like projection larger than the anterior (Fig. 369) .....	<i>andes</i> sp. n. (p. 52)
-	Shaft of aedeagus with posterior tooth-like projection not the larger.....	91
91 (90)	Shaft of aedeagus with posterior tooth-like projection much smaller than the anterior (Fig. 370) .....	<i>tikalme</i> sp. n. (p. 34)
-	Shaft of aedeagus with tooth-like projections of equal size .....	92
92 (91)	Shaft of aedeagus in dorsal aspect strongly tapering from base to apex (Fig. 260).....	<i>obscura</i> Metcalf (p. 49)
-	Shaft of aedeagus with lateral margins subparallel (Fig. 261).....	<i>varia</i> sp. n. (p. 34)
93 (89)	Paramere with apex broadly, if occasionally, somewhat irregularly, rounded .....	95
-	Paramere with apex somewhat produced dorsally, inclined towards mid-line .....	94
94 (93)	Shaft of aedeagus with a single pair of massive, flap-like, strongly asymmetrically arranged subapical processes (Fig. 262).....	<i>lucianna</i> sp. n. (p. 45)
-	Shaft of aedeagus with two pairs of symmetrically arranged, spine-like subapical processes (Fig. 263) .....	<i>fuscomaculata</i> sp. n. (p. 59)
95 (93)	Shaft of aedeagus with one pair of longitudinally aligned, dorsally directed, anteriorly acutely angled, flap-like processes adjacent to midline (Fig. 264) .....	<i>lloydi</i> sp. n. (p. 58)
-	Shaft of aedeagus not as above .....	96
96 (95)	Shaft of aedeagus in dorsal aspect with length not greater than twice maximum width .....	97
-	Shaft of aedeagus in dorsal aspect with length greater than two and one-half times maximum width.....	99
97 (96)	Paramere with basal interlocking surface very large, distal surface obsolete (Fig. 486).....	<i>insania</i> sp. n. (p. 60)
-	Paramere with interlocking surfaces of approximately equal size .....	98
98 (97)	Paramere with dorsal process very small (Fig. 487). Shaft of aedeagus with apices of subapical processes slender, dorsally directed (Fig. 377).....	<i>nebulosa</i> (Germar) (p. 56)
-	Paramere with dorsal process large (Fig. 488). Shaft of aedeagus with apices of subapical processes broad, anteriorly directed (Fig. 378) .....	<i>perspicua</i> sp. n. (p. 68)

99 (96)	Paramere with dorsal surface subapically produced into a rounded, medially directed secondary process bearing numerous robust spines .....	100
-	Paramere lacking a distinct subapical secondary process .....	101
100 (99)	Shaft of aedeagus with subapical processes simple, triangular (Fig. 268) <i>flavilla</i> sp. n. (p. 29)	
-	Shaft of aedeagus with subapical processes rounded, each bearing a long, slender, antero-ventrally directed, spine-like projection at midlength on anterior margin (Fig. 269) .....	<i>unimaculata</i> sp. n. (p. 28)
101(100)	Shaft of aedeagus with subapical processes long, slender, spine-like, dorsally or anteriorly directed .....	102
-	Shaft of aedeagus with subapical processes broad or, if slender, ventrally directed .....	105
102(101)	Shaft of aedeagus with subapical processes curving anteriorly .....	103
-	Shaft of aedeagus with subapical processes straight, dorsally directed (Fig. 381) .....	<i>maculosa</i> sp. n. (p. 55)
103(102)	Paramere with dorsal process situated at midlength (Fig. 492) .....	<i>distincta</i> sp. n. (p. 66)
-	Paramere with dorsal process situated somewhat distad of midlength .....	104
104(103)	Shaft of aedeagus with subapical processes strongly diverging (Fig. 272). Paramere with interlocking surfaces truncate, distant from each other (Fig. 493) .....	<i>whimperii</i> sp. n. (p. 62)
-	Shaft of aedeagus with subapical processes weakly diverging (Fig. 273). Paramere with interlocking surfaces acute, closely opposed (Fig. 494) .....	<i>testacea</i> (Fabricius) (p. 57)
105(101)	Paramere with dorsal process situated basad of midlength, very long and slenderly produced posteriorly (Fig. 495) .....	<i>geoffreyi</i> sp. n. (p. 75)
-	Paramere with dorsal process situated at approximately midlength .....	106
106(105)	Shaft of aedeagus with subapical processes longitudinally aligned, dorsally directed, massive, each produced posteriorly into a short, acute, ventrally directed, spine-like projection (Fig. 386) .....	<i>delicatissima</i> Fowler (p. 41)
-	Shaft of aedeagus with subapical processes transversally aligned, anteriorly directed .....	107
107(106)	Shaft of aedeagus with subapical processes each bearing a long, slender, anteriorly directed, spine-like projection basally (Fig. 276) .....	<i>mylesi</i> sp. n. (p. 33)
-	Shaft of aedeagus lacking slender projections .....	108
108(107)	Shaft of aedeagus with subapical processes deeply notched apically (Fig. 277) .....	<i>henrietta</i> sp. n. (p. 49)
-	Shaft of aedeagus with subapical processes apically acute (Fig. 279) ...	<i>albicans</i> (Stål) (p. 50)

### *Mysidia asinella* sp. n.

Female: head 0.97 mm long, 1.12 mm wide; pronotum 2.52 mm wide; tegmen 12.00–12.50 mm long; wing 7.05 mm long. Male unknown.

Length of frons 5 times width at apex, c. 2.5 times width at base; ocelli small, distinct; clypeus c. as long as frons; rostrum terminating immediately posterior to hind coxae. Pronotal width 18 times mid-dorsal length; fronto-lateral surfaces weakly carinate; tegula not carinate.

Head bright scarlet, antenna yellow. Pronotum with mid-dorsal and fronto-lateral surfaces scarlet; scutellum scarlet; disc of mesonotum brown; abdomen brownish dorsally, tinged scarlet apically. Tegmen and wing dark brownish, veins brown, posterior margins very narrowly scarlet. Tegmen unmarked, base narrowly scarlet; costal vein and branches, and apical part of subcostal vein and its branches reddish; radial-subcostal cross-vein, medial-radial apical cross-vein, and bases of fifth and sixth branches of medial vein white. Wing with a narrow, oblique, transverse, whitish band extending from costal to posterior margins immediately distad of radial-medial cross-vein; otherwise unmarked.

#### MATERIAL EXAMINED

Holotype ♀, **Brazil**: Belem, Para, vi.1924 (*Williams*) (BMNH).

Paratypes, **Brazil**: 4 ♀, Breves, Lower Amazon (INPA; BMNH).

In the absence of males, *asinella* is readily distinguished by the bright scarlet pigmentation of the head and thorax, and by the single pale band on the otherwise dark brownish wing.

### *Mysidia adusta* sp. n.

(Figs 217, 328, 437)

Male: head 0.67 mm long, 1.03 mm wide; pronotum 2.37 mm wide; tegmen 9.80 mm long; wing 5.90 mm long. Female: tegmen 11.70 mm long.

Length of frons *c.* 4.5 times width at apex, *c.* 3 times width at base; ocelli large, prominent; clypeus as long as frons; rostrum terminating immediately posterior to hind coxae. Pronotal width 14 times length at mid-dorsal line; fronto-lateral surfaces and tegula not carinate.

Head, excluding antenna, rostrum, and extreme baso-ventral margins usually scarlet; ocelli concolorous. Fronto-lateral surfaces of pronotum each with a broad, scarlet band extending horizontally from adjacent to dorsal margin of eye to lateral margin; tegula and disc of mesonotum pale brownish; scutellum irregularly tinged dull pink. Tegmen and wing dark smoky brown; veins and cross-veins dark brown; lacking prominent markings. Tegmen with veins over basal third narrowly edged yellowish hyaline; apical forks of medial vein, second radial-medial cross-vein, and radial-subcostal cross-vein white; costal and posterior marginal veins very narrowly crimson. Wing unmarked; posterior marginal vein narrowly crimson.

Shaft of aedeagus broad; apex with a pair of opposed, flap-like processes extending from ventral surface; dorso-lateral surfaces subapically each with a long, slender, spine-like process; ventral surface subapically with two pairs of small, transversally aligned spines. Paramere with apex very broadly rounded; dorsal process situated at three-quarters length, large, strongly produced posteriorly. Subgenital plate produced medially into a rounded, posteriorly directed, lobe bearing a fringe of long, erect, spine-like hairs.

#### MATERIAL EXAMINED

Holotype ♂, **Brazil**: Amazonas, 120 km E. of Tapuruquara, 19.i.1978 (*Penny*) (INPA).

Paratype. **Brazil**: 1 ♀, Amazonas, Manaus (BMNH).

*M. adusta* is readily distinguished by the pigmentation of the head and thorax, and the dark brown tegmen and wing, both lacking transverse markings.

### *Mysidia polyhymnia* sp. n.

(Figs 196, 306, 415)

Male: head 0.61 mm long, 0.86 mm wide; pronotum 1.97 mm wide; tegmen 9.00 mm long; wing 5.10 mm long. Female unknown.

Length of frons *c.* 5 times width at apex, 2.33 times width at base; ocelli small, not prominent; clypeus *c.* 0.33 longer than frons; rostrum extending to base of subgenital plate. Pronotal width *c.* 13 times mid-dorsal length, fronto-lateral surfaces and tegula distinctly carinate.

Fronto-lateral surfaces of pronotum dorsal to upper margins of eyes brownish; tegula dark brown; dorsal surface of abdomen tinged red basally. Tegmen and wing smoky brownish, veins dark brown. Tegmen with cross-veins pale, apical fork of medial vein surrounded by a very small white spot, costal margin basally dark brown. Wing unmarked.

Shaft of aedeagus slender in lateral aspect, greatly expanded laterally; dorsal surface at approximately two-thirds length with a pair of large processes, each terminating posteriorly in a long, slender, curving spine, and anteriorly in a shorter, straighter spine. Paramere very robust; apex very obtusely rounded, almost truncate; dorsal process situated at three-fifths length, reduced, proximal component slender, inclined antero-dorsally and terminating in a medially directed hook, distal component short and rounded.

#### MATERIAL EXAMINED

Holotype ♂, **Brazil**: Amazon, Fonteboa (BMNH).

The pigmentation of the tegmen and wing is closely similar to that of *caliginosa* and *inquinata*, but *polyhymnia* is distinguished by its larger size, relatively obscure ocelli, carinate tegula, and by the structure of the male genitalia.

### *Mysidia caliginosa* Walker

(Figs 236, 348, 456, 463)

*Mysidia caliginosa* Walker, 1858: 98. Holotype ♀, BRAZIL (BMNH) [examined].

*Mysidia rubra* Metcalf, 1945: 128. Holotype ♂, GUYANA (AMNH) [examined]. **Syn. n.**

Male: head 0.60 mm long, 0.80 mm wide; pronotum 1.60 mm wide; tegmen 7.00–7.65 mm long; wing 4.50 mm long. Female: tegmen 7.20–9.80 mm long.

Length of frons *c.* 5 times width at apex, 2.5 times width at base; ocelli very large and prominent; clypeus slightly longer than frons; rostrum terminating immediately posterior to hind coxae. Pronotal width from 10–12 times mid-dorsal length; fronto-lateral surfaces and tegula with carinae weak or obsolete.

Frons and genae dorsally scarlet; ocelli yellow, broadly edged scarlet. Dorsal surfaces of thorax and abdomen from pale brown to deep reddish brown, usually scarlet, abdomen rarely blackish; tegula with dorsal margin broadly dark brown. Tegmen and wing dark brownish, unmarked; veins and cross-veins dark brown; posterior marginal veins very narrowly crimson. Tegmen with costal, subcostal and radial veins frequently tinged crimson.

Shaft of aedeagus cylindrical; dorsal surface subapically with a pair of large, flap-like processes, each terminating in a slender, curving spine; lateral surfaces each with four slender spine-like processes. Paramere slender; apex narrowly rounded; dorsal process well developed, situated somewhat distad of mid-length, apex weakly produced posteriorly; dorsal surface subasally with a group of short robust spines.

#### MATERIAL EXAMINED

Holotype ♀ (*caliginosa*), **Brazil**: Santarem (*Bates*) (BMNH). Holotype ♂ (*rubra*), **Guyana**: Kartabo, Bartica District, 1920 (AMNH).

**Guyana**: 1 ♂, 2 ♀ (BMNH). **Brazil**: 1 ♀, Santarem (*Bates*) (BMNH); 2 ♀ (BMNH). **Bolivia**: 1 ♂ (BMNH). **Colombia**: 1 ♀ (BMNH). **Ecuador**: 2 ♂, 2 ♀ (BMNH). **Panama**: 1 ♂ (FAMU). **Peru**: 1 ♂ (FAMU). **Surinam**: 1 ♀ (FAMU). **Trinidad**: 1 ♀ (BMNH).

The holotype of *rubra* Metcalf has the tegmina and wings damaged or missing; the genitalia are preserved in balsam and are not accessible for detailed study.

This species is readily distinguished by the dark brown, unmarked, tegmen and wing, the pigmentation of the head and body, and by the structure of the male genitalia.

### *Mysidia inquinata* sp. n.

(Figs 243, 354, 464)

Male: head 0.62 mm long, 0.67 mm wide; pronotum 1.47 mm wide; tegmen 7.22–7.25 mm long; wing 4.34 mm long. Female: tegmen 8.70 mm long.

Length of frons *c.* 6 times width at apex, *c.* 3 times width at base; ocelli very large and prominent; clypeus slightly longer than frons; rostrum terminating immediately posterior to hind coxae. Pronotal width 14 times mid-dorsal length; fronto-lateral surfaces and tegula with carinae weak or obsolete.

Frons and genae anterior to eyes usually tinged deep crimson; lateral surfaces of clypeus weakly tinged crimson. Fronto-lateral surfaces of pronotum dorsal to level of eyes often suffused reddish; tegula reddish, dorsal margins dark reddish brown; disc of mesonotum reddish brown; dorsal surface of abdomen occasionally dark brown. Tegmen and wing uniformly dark brownish, unmarked; veins and cross-veins dark brown; posterior margins often very narrowly crimson. Tegmen with apical branches of subcostal and radial veins bright crimson or white.

Shaft of aedeagus cylindrical; dorsal surface subapically with a pair of large, flap-like processes, each bearing a long spine subasally on dorsal surface, and numerous very small and blunt spines on internal and ventral surfaces; lateral surfaces each with a long, apically serrated, process subapically. Paramere slender; apex broadly rounded; dorsal process situated at three-fifths length, apex strongly produced posteriorly; dorsal surface at one-quarter length with a rounded, internally directed secondary process bearing numerous short, robust spines.

#### MATERIAL EXAMINED

Holotype ♂, **Brazil**: Amazon, Fonteboa (BMNH).

Paratypes. **Brazil**: 14 ♂, 11 ♀, Amazonas (BMNH; INPA).

The tegminal and wing pigmentation of *inquinata* is very similar to that of *caliginosa* and *polyhymnia*, but it differs from the former in the proportions and pigmentation of the head and pronotum, and from the latter by its much smaller size, and from both in the structure of the male genitalia.

### *Mysidia venusta* sp. n.

(Figs 183, 293, 402)

Male: head 0.55 mm long, 0.69 mm wide; pronotum 1.47 mm wide; tegmen 6.20 mm long; wing 3.40 mm long. Female unknown.

Length of frons 4 times width at apex, 2.66 times width at base; ocelli small, indistinct; clypeus as long as frons; rostrum extending to posterior surface of hind coxae. Pronotal width slightly less than 12 times length at mid-dorsal line; fronto-lateral carinae prominent; tegula not carinate.

Head and body unmarked. Tegmen and wing whitish hyaline; veins pale yellow, otherwise totally devoid of pigmentation.

Shaft of aedeagus basally slender, broadly expanded subapically; dorsal surface subapically with a pair of large, apically shallowly bifurcate processes; a pair of rounded, flap-like processes; at midline, a single, apically shallowly concave, flap-like process. Paramere with ventral margin somewhat dorsally produced apically; dorsal process very reduced, situated at approximately midlength, not at all produced dorsally or posteriorly; dorsal surface at one-third length with a simple hook-like process, basally with a rounded lobe bearing numerous robust spines; ventral surface basally produced into a small rounded lobe bearing numerous robust spines.

**MATERIAL EXAMINED**

Holotype ♂, **Brazil**: Amazon, Rio Autaz, x (*Roman*) (NR).

The male genitalia bear a close resemblance to those of *cheesemani*, but *venusta* is readily distinguished by the complete absence of tegminal and wing pigmentation.

***Mysidia richardsi* sp. n.**

(Figs 219, 331, 439)

Male: head 0.73 mm long, 0.90 mm wide; pronotum 2.10 mm wide; tegmen 8.92 mm long; wing 5.20 mm long. Female unknown.

Length of frons 6.5 times width at apex, c. 2.5 times width at base; ocelli obsolete; clypeus as long as frons; rostrum terminating immediately posterior to hind coxae. Pronotal width 20 times mid-dorsal length; fronto-lateral surfaces and tegulae with carinae obsolete or absent.

Head and body unmarked. Tegmen and wing whitish hyaline, veins and cross-veins pale brownish yellow. Tegmen with costal cell pale smoky yellow; posterior margin very pale yellowish brown. Wing with posterior margin very narrowly and faintly yellowish.

Shaft of aedeagus with dorsal surface subapically bearing a pair of large flap-like lobes extending anteriorly to midlength, each with a small lateral spine at c. midlength; ventral surface at midlength with an antero-ventrally directed, apically rounded process at each lateral angle. Paramere slender, apex narrowly rounded; dorsal process situated slightly basad of midlength, posteriorly produced, with a large, rounded, medially directed process on internal surface at three-quarters length.

**MATERIAL EXAMINED**

Holotype ♂, **Guyana**: Blairmont, ix.1923 (*Williams*) (BMNH).

This species is distinguished by the lack of distinct markings on the head, body, tegmen and wing, and by the structure of the male genitalia.

***Mysidia limpida* sp. n.**

(Figs 197, 307, 416)

Male: head 0.63 mm long, 0.88 mm wide; pronotum 1.87 mm wide; tegmen 8.33–8.80 mm long; wing 4.75 mm long. Female unknown.

Length of frons 5 times width at apex, twice width at base; ocelli small, obscure; clypeus one-third longer than frons; rostrum extending beyond hind coxae. Pronotal width 30 times mid-dorsal length; fronto-lateral surfaces not carinate; tegula distinctly carinate.

Head and body unmarked. Tegmen and wing whitish hyaline basally, weakly tinged yellowish from midlength, veins yellow. Tegmen with posterior and apical margins, cross-veins and branches of veins broadly edged pale fuscous, the last coalescing at midlength to form a very indistinct, pale, transverse band. Wing unmarked.

Shaft of aedeagus very broad in dorsal aspect; apex transverse, flap-like, strongly produced dorsally; lateral surfaces subapically each with a very large, rounded, dorsally directed, flap-like process; dorsal surface subapically with a pair of very large, flap-like processes medially, apex of each with posterior angle produced into a long spine. Paramere robust, apex irregularly rounded; dorsal process situated somewhat distad of midlength, small, apex not produced posteriorly.

**MATERIAL EXAMINED**

Holotype ♂, **Brazil**: Mato Grosso, 12°50'S 51°47'W, cerradão, 2.iii.1968 (*Richards*) (BMNH).

Paratype. **Brazil**: 1 ♂, Para, Belem (BMNH).

This species appears closely related to *amarantha* and *nitida*, but differs in the detailed structure of the male genitalia and in the pigmentation of the tegmen and wing.

***Mysidia robusta* sp. n.**

(Fig 501)

Male: head 0.84 mm long, 1.20 mm wide; pronotum 3.02 mm wide; tegmen 13.60 mm long; wing 8.50 mm long. Female unknown.

Length of frons 5 times width at apex, 2.33 times width at base; ocelli small, distinct; clypeus slightly longer than frons; rostrum terminating slightly posterior to hind coxae. Pronotal width c. 10 times mid-dorsal length; fronto-lateral surfaces and tegula not distinctly carinate.

Head and thorax tinged reddish on dorsal surfaces, ocelli crimson. Tegmen and wing hyaline; veins yellowish brown; posterior margins crimson, narrowly edged smoky brown. Tegmen with medial, cubital and anal veins basally dark brown. Wing unmarked.

Shaft of aedeagus broad, robust; dorsal surface subapically with a pair of large, flap-like processes adjacent to midline and extending over apex onto ventral surface. Paramere robust; apex broadly rounded; dorsal process situated at approximately two-thirds length, large, posteriorly produced; dorsal surface subbasally produced towards midline. Subgenital plate produced medially into a pair of short, broad lobes covered in very small obtuse spines.

**MATERIAL EXAMINED**

Holotype ♂, **Brazil**: Amazon, Fonteboa (BMNH).

Amongst the largest species of the genus, *robusta* is readily distinguished by the yellowish hyaline pigmentation of the otherwise unmarked tegmen and wing.

***Mysidia nitida* sp. n.**

(Figs 198, 308, 417)

Male: head 0.62 mm long, 0.94 mm wide; pronotum 2.00 mm wide; tegmen 10.20 mm long; wing 5.85 mm long. Female unknown.

Length of frons 6.25 times width at apex, 2.5 times width at base; ocelli small, obscure; clypeus slightly longer than frons; rostrum extending to base of subgenital plate. Pronotal width 24 times mid-dorsal length; fronto-lateral surfaces and tegula not carinate.

Head and body unmarked. Tegmen and wing whitish hyaline, veins pale yellowish. Tegmen with posterior margin weakly tinged smoky brown; with a very indistinct, smoky brown, transverse band at level of first fork of cubital vein, and a very faint, intermittent, brownish, transverse band at level of medial-cubital cross-vein. Wing with posterior margin very weakly tinged smoky brown, otherwise unmarked.

Shaft of aedeagus slender in lateral aspect, broadly expanded laterally; dorsal surface subapically with a pair of large, flap-like processes, each bearing a large spine on postero-dorsal surface. Paramere very robust; apex obtusely rounded; dorsal process directed towards midline, not produced posteriorly.

**MATERIAL EXAMINED**

Holotype ♂, **Guyana**: Amazon-Courantyne Divide, head of Oronoque River, 1937 (*Beddington*) (BMNH).

The male genitalia show a similarity with those of *amarantha*, but the external characters are distinct.

***Mysidia amazona* sp. n.**

(Figs 186, 296, 405)

Male: head 0.76 mm long, 1.10 mm wide; pronotum 2.40 mm wide; tegmen 10.04–11.05 mm long; wing 6.00 mm long. Female unknown.

Length of frons 6 times width at apex, c. 2.5 times width at base; ocelli small, distinct; clypeus one-sixth longer than frons; rostrum extending to base of subgenital plate. Pronotal width 19 times mid-dorsal length; fronto-lateral surfaces not distinctly carinate; tegula with carinae distinct.

Head and body dark brownish, unmarked. Tegmen and wing hyaline, veins yellow. Tegmen with costal and subcostal areas pale brownish. Wing unmarked.



Shaft of aedeagus very broad in dorsal aspect; apex recurving; lateral surfaces each with a very large, flap-like process extending over dorsal surface and overlapping at midline, each with anterior margin produced dorsally into a slender secondary process with apical angles produced into acute spines. Paramere very robust, broadly rounded, apex obtuse; dorsal margin strongly curved medially and ventrally, considerably expanded from mid-length to apex; dorsal process very small, situated at two-fifths length, apex not produced.

**MATERIAL EXAMINED**

Holotype ♂, **Brazil**: Amazon, Rio Autaz, 31.x.1914 (*Roman*) (NR).

Paratype. 1 ♂, same data as holotype (BMNH).

This species is readily distinguished by its large size, lack of pigmentation, and by the structure of the male genitalia.

***Mysidia punctum* (Fabricius)**

(Figs 248, 359, 469)

*Derbe punctum* Fabricius, 1803: 82. LECTOTYPE ♀, CENTRAL AMERICA (ZM), here designated [examined].

*Mysidia punctum* (Fabricius) Westwood, 1840: 83.

*Mysidia steinbachi* Distant, 1907: 396. LECTOTYPE ♂, BOLIVIA (BMNH), here designated [examined].

**Syn. n.**

Male: head 0.55 mm long, 0.76 mm wide; pronotum 1.60 mm wide; tegmen 7.50–8.00 mm long; wing 4.52 mm long. Female: tegmen 8.50–10.20 mm long.

Length of frons slightly less than 8 times width at apex, 3 times width at base; ocelli small, indistinct; clypeus c. as long as frons; rostrum terminating immediately posterior to hind coxae. Pronotal width 15–20 times mid-dorsal length; fronto-lateral surfaces and tegula not carinate.

Head and body unmarked. Tegmen and wing whitish hyaline, veins pale brown, cross-veins weakly edged yellowish brown. Tegmen with a prominent dark brown/black spot at one-third length, extending from costal margin almost to second branch of cubital vein, a very indistinct, irregular, pale smoky brown, transverse band at midlength extending from costal margin over one-half width. Wing with cross-veins weakly brownish; costal margin with a pale brown spot at one-third length.

Shaft of aedeagus very greatly expanded dorso-ventrally and laterally over apical half; dorsal surface subapically with a pair of flap-like processes, each bearing a spine-like projection; ventral surface subapically with a pair of broad apically truncate processes. Paramere massive, tapering from midlength to acutely rounded apex; dorsal process situated at one-quarter length; dorsal surface at midlength with a large, flap-like, roughly rectangular secondary process.

**MATERIAL EXAMINED**

Lectotype ♀ (*punctum*), **Central America** (*Schmidt*) (ZM). Lectotype ♂ (*steinbachi*), **Bolivia**: 1904 (*Steinbach*) (BMNH) (badly damaged).

**Trinidad**: 1 ♂, St George (BMNH). **Peru**: 2 ♂, Callanga (BMNH). **Bolivia**: 1 ♀, San Antonio (BMNH).

**Guyana**: 3 ♀, Bartica (BMNH). **Brazil**: 1 ♂ (NR). **Central America**: 1 ♂ (paralectotype of *punctum*) (ZM) (head missing).

This species is readily distinguished by the prominent dark brown spot on the costal area of the tegmen.

***Mysidia immaculata* sp. n.**

Female: head 0.80 mm long, 1.25 mm wide; pronotum 2.90 mm wide; tegmen 14.80 mm long; wing 10.00 mm long. Male unknown.

Length of frons slightly greater than 5 times width at apex, 2.5 times width at base; ocelli obsolete; clypeus slightly longer than frons; rostrum terminating at level of hind coxae. Pronotal width 17 times mid-dorsal length; fronto-lateral surfaces and tegula prominently carinate.

Dorsal surfaces of head and thorax brownish; genae adjacent to eyes and fronto-lateral surfaces of pronotum at level of eyes reddish; abdomen dorsally with a small red spot on either side of midline on segments five and six, ventral surface and lateral margins reddish basally; median and posterior femora subapically tinged reddish. Tegmen and wing whitish hyaline, veins pale yellow. Tegmen with apical margin very narrowly reddish brown. Wing unmarked.

## MATERIAL EXAMINED

Holotype ♀, **Peru**: Callanga (BMNH).

One of the largest species of the genus, *immaculata* is distinguished by the lack of pigmentation of the tegmen and wing, and by the reddish pigmentation of the head and body.

***Mysidia hyalina* sp. n.**

(Figs 226, 337, 445)

Male: head 0.55 mm long, 0.82 wide; pronotum 1.66 mm wide; tegmen 8.68–8.48 mm long; wing 5.40 mm long. Female unknown.

Length of frons 6 times width at apex, twice width at base; ocelli very small, distinct; clypeus slightly longer than frons; rostrum terminating at level of hind coxae. Pronotal width 13 times mid-dorsal length, fronto-lateral surfaces without carinae; tegula basally carinate.

Vertex deep red; genae level with midline of eyes dark brown; fronto-lateral surfaces of pronotum each with a broad, horizontal, orange band extending from adjacent to eye to lateral margin; tegula with ventral margin dull brown. Tegmen and wing hyaline, veins yellowish. Tegmen with cross-veins and forks of veins pale brown; apical fork of medial vein narrowly dark brown; claval margin with a small brown spot at level of point of fusion of anal veins, a small brown spot adjacent to claval suture at level of first fork of medial vein. Wing with a small pale brown spot adjacent to claval suture at midlength; radial-medial cross-vein brown.

Shaft of aedeagus very slender; dorsal surface subapically with a pair of large flap-like processes. Paramere very robust; apex obtusely rounded; dorsal process situated at one-third length, small, apex strongly produced posteriorly; dorsal surface subbasally produced, bearing numerous, long, robust spines.

## MATERIAL EXAMINED

Holotype ♂, **Jamaica**: Moneague, ii.1904 (*Walsingham*) (BMNH).

Paratype. 1 ♂, same data as holotype (BMNH).

This species is readily distinguished by the pigmentation of the head and pronotum, the relative lack of pigmentation of the tegmen and wing, and by the structure of the male genitalia.

***Mysidia unimaculata* sp. n.**

(Figs 269, 380, 490)

Male: head 0.50 mm long, 0.66 mm wide; pronotum 1.28 mm wide; tegmen 6.12 mm long; wing 3.65 mm long. Female unknown.

Length of frons 6.5 times width at apex, twice width at base; ocelli distinct; clypeus c. as long as frons; rostrum terminating immediately posterior to hind coxae. Pronotal width 15 times mid-dorsal length, fronto-lateral carinae distinct; tegulae weakly carinate.

Head and body unmarked; disc of mesonotum with lateral angles brown. Tegmen and wing whitish hyaline. Tegmen with a prominent brown spot between apex of clavus and first branch of cubital vein, otherwise unmarked. Wing with a large brown spot between clavus and cubital vein at midlength, otherwise unmarked.

Shaft of aedeagus slender, slightly expanded apically; dorsal surface subapically with a pair of large, broadly rounded, flap-like processes, each bearing a long tapering spine near base on anterior surface. Paramere very slender basally, broadening towards apex; dorsal process situated slightly distad of mid-length, very large, not greatly produced; dorsal surface at one-quarter length with a short rounded secondary process bearing numerous robust spines.

## MATERIAL EXAMINED

Holotype ♂, **Brazil**: Para, Jabaty, v.1924 (*Williams*) (BMNH).

This species is readily distinguished by the unique pigmentation of the tegmen and wing, and by the structure of the male genitalia.

***Mysidia athena* sp. n.**

(Figs 214, 324, 433)

Male: head 0.69 mm long, 0.96 mm wide; pronotum 1.90 mm wide; tegmen 9.77–10.00 mm long; wing 6.40 mm long. Female unknown.

Length of frons *c.* 5 times width at apex, 2.5 times width at base; ocelli obsolete; clypeus *c.* as long as frons; rostrum terminating at level of hind coxae. Pronotal width 15 times mid-dorsal length, fronto-lateral carinae distinct; tegulae with carinae obsolete or absent.

Genae each with a small dark brown spot adjacent to dorsal margin of eye, occasionally extending onto frons, with a similar marking level with mid-line of eye; antenna deep red; lateral surfaces of paraclypeus deep red; fronto-lateral surfaces of pronotum each with a deep red horizontal band extending from adjacent to eye to lateral margin; apices of anterior and medial coxae broadly deep red. Tegmen and wing whitish hyaline, veins and cross-veins yellowish. Tegmen with a small dark brown spot on costal cell adjacent to first fork of radial vein; clavus with a larger dark brown spot at apex, and a smaller spot at level of point of fusion of anal veins. Wing with a dark brown spot on first branch of cubital vein at midlength; posterior margin with a single, semi-circular, dark brown spot between each branch of anal, claval and medial veins.

Shaft of aedeagus slender, cylindrical, asymmetrical; dorsal surface apically with a large, twisted, flap-like process terminating anteriorly in a blunt point; left dorso-lateral surface subapically with a large triangular process; right lateral surface subapically with a large flap-like process terminating posteriorly in an acute spine-like lobe. Paramere very large; apex acute, strongly produced dorsally; dorsal process well developed, situated at midlength, apex postero-dorsally directed.

#### MATERIAL EXAMINED

Holotype ♂, **Ecuador**: Cachabé, i.1897 (*Rosenberg*) (BMNH).

Paratype. 1 ♂, same data as holotype (BMNH).

The tegminal and wing pigmentation of this species closely resembles that of *acidalioides*, but the prominent markings of the head and thorax, and the structure of the male genitalia, render it readily distinguishable.

### *Mysidia flavilla* sp. n.

(Figs 268, 379, 489)

Male: head 0.42 mm long, 0.65 mm wide; pronotum 1.40 mm wide; tegmen 6.12–6.38 mm long; wing 3.65 mm long. Female unknown.

Length of frons 7.5 times width at apex, *c.* 1.5 times width at base; ocelli small, obscure; rostrum extending to anterior surface of hind coxae. Pronotal width 13 times mid-dorsal length, fronto-lateral carinae very prominent; tegula weakly carinate.

Head and body unmarked. Tegmen and wing whitish hyaline, veins pale. Tegmen with a small dark brown spot adjacent to point of separation of fused medial and radial-subcostal veins, another at point of separation of fused radial and subcostal veins, a third at first fork of cubital vein, another on posterior margin at midlength of clavus, a fifth adjacent to medial vein at level of first fork of cubital vein, another adjacent to apex of clavus, and a seventh over apical fork of radial vein; cell between second and third branches of medial vein with a pale brown spot medially. Wing with a large dark brown spot adjacent to claval fold at midlength; cells of claval area and first cubital cell each with a dark brown spot on posterior margin.

Shaft of aedeagus broadly laterally expanded subapically; dorsal surface subapically with a pair of apically acute flap-like processes. Paramere broadest at midlength, apex narrowly rounded; dorsal process slightly distad of midlength, produced posteriorly; dorsal surface subbasally with a broad secondary process bearing numerous, large, robust spines.

#### MATERIAL EXAMINED

Holotype ♂, **Brazil**: Nictheroy, iv.1924 (*Williams*) (BMNH).

Paratypes. **Brazil**: 1 ♂, Nictheroy; 1 ♂, Rezende (BMNH).

This species is distinguished by the intricate pattern of small dark spots on the tegmen and wing, and by the structure of the male genitalia.

### *Mysidia acidalioides* Fowler

(Figs 7, 15, 33, 216, 326, 435)

*Mysidia acidalioides* Fowler, 1900: 72. LECTOTYPE ♀, PANAMA (BMNH), here designated [examined].

Male: head 0.80 mm long, 1.10 mm wide; pronotum 2.30 mm wide; tegmen 11.00 mm long; wing 7.30 mm long. Female: tegmen 11.10–12.60 mm long.

Length of frons *c.* 4.5 times width at apex, *c.* twice width at base; ocelli obsolete; clypeus *c.* as long as frons; rostrum terminating at level of anterior surface of hind coxae. Pronotal width *c.* 16 times mid-dorsal length, fronto-lateral carinae very prominent; tegulae distinctly carinate.

Vertex dark brown between carinae; frons with a broad, often broken, dark brown transverse band at level of midline of eyes; antenna often reddish; paraclypeus and lateral surfaces of anteclypeus red; fronto-lateral surfaces of pronotum each with a broad, deep red, horizontal band extending from level of midline of adjacent eye to just above ventral margin; fore and mid coxae bright red over apical half; hind femur reddish apically. Tegmen and wing whitish hyaline, veins pale yellow. Tegmen with a small brown spot on costal cell at level of point of separation of fused subcostal and radial veins; clavus with a large, irregular, brown spot at apex, and a smaller spot on exterior margin adjacent to point of fusion of anal veins; posterior and apical margins narrowly and weakly brownish, somewhat darker between apical branches of medial and radial veins. Wing with a small, somewhat indistinct, brown marking between claval suture and midlength of first branch of cubital vein; posterior margin with a dark brown spot between each branch of anal, cubital and medial veins.

Shaft of aedeagus slender, cylindrical; dorsal surface subapically with a pair of triangular processes, each produced posteriorly into a slender, rounded, flap extending beyond apex of shaft; ventral surface apically produced into two pairs of large, acute, triangular processes. Paramere slender, broadest at three-fifths length, apex acutely rounded; dorsal process robust, situated at three-fifths length.

#### MATERIAL EXAMINED

Lectotype ♂, **Panama**: V. de Chiriqui, 2500–4000 ft (*Champion*) (BMNH). **Panama**: 2 ♀ (paralectotypes), same data as lectotype (BMNH); 5 ♂, 6 ♀ (USNM; FAMU; CAS). **Belize**: 1 ♀ (FAMU).

The species here designated as lectotype bears Fowler's handwritten determination label and the BMNH 'type' label.

This species is readily distinguished by the very slight pigmentation of the tegmen and wing combined with the distinctive markings of the head and thorax; from *athena* it is separated by its larger size and the structure of the male genitalia.

#### *Mysidia neoasinella* sp. n.

(Figs 257, 368, 477)

Male: head 0.70 mm long, 1.02 mm wide; pronotum 2.10 mm wide; tegmen 9.70 mm long; wing 6.00 mm long. Female unknown.

Length of frons 6 times width at apex, *c.* three times width at base; ocelli very prominent; clypeus slightly longer than frons; rostrum terminating somewhat posterior to hind coxae. Pronotal width 12.5 times mid-dorsal length; fronto-lateral surfaces and tegula not carinate.

Ocelli crimson; dorsal and lateral surfaces of pronotum irregularly pale crimson; tegulae tinged orange, margins narrowly brownish; disc of mesonotum pale yellowish brown, darker between lateral carinae. Tegmen and wing dark smoky brown. Tegmen with veins narrowly edged hyaline from base to level of apex of claval area; with a very narrow and indistinct, hyaline, transverse band extending from costal margin at level of second fork of cubital vein to posterior margin at apex of clavus. Wing with costal cell narrowly hyaline basally; with a very narrow and indistinct, hyaline, transverse band at approximately two-thirds length extending from costal to posterior margins.

Shaft of aedeagus slender, cylindrical, slightly expanded laterally over apical third; lateral surfaces each with a large flap-like process produced antero-dorsally into a long, slightly curving spine. Paramere short, rounded; apex acute; dorsal process situated slightly distad of mid-length, strongly produced posteriorly; dorsal surface subbasally roundly produced, bearing numerous, short, robust, spines. Lateral margins of subgenital segment each produced into a single, long, broad, apically rounded, posteriorly directed lobe at midline.

#### MATERIAL EXAMINED

Holotype ♂, **Brazil**: Amazonas, P. das Laranjeiras, viii.–ix.1981 (*Arias*) (INPA).

This species is distinguished by the pigmentation of the thorax and the structure of the male genitalia.

#### *Mysidia vista* sp. n.

Female: head 0.63 mm long, 0.71 mm wide; pronotum 1.25 mm wide; tegmen 6.88–7.68 mm long; wing 3.85 mm long. Male unknown.

Length of frons 6.5 times width at apex, 3 times width at base; ocelli very large, prominent; clypeus as long as frons; rostrum extending almost to base of subgenital plate. Pronotal width 15 times mid-dorsal length; fronto-lateral carinae weak; tegula not carinate.

Genae anterior and dorsal to eyes orange. Pronotum with dorso-lateral margins and a large, circular spot adjacent to eye on each fronto-lateral surface orange; scutellum with baso-lateral angles tinged orange; abdomen posteriorly orange on mid-dorsal line. Tegmen and wing smoky brown, veins pale brown. Tegmen with a narrow, transverse, whitish band extending from costal margin to apex of clavus at one-third length, another, fainter band at one-fifth length; brown pigmentation gradually becoming fainter from base to apex. Wing with brown pigmentation weakening from base; posterior and apical margins clear whitish hyaline.

#### MATERIAL EXAMINED

Holotype ♀, **Guyana**: Blairmont, x.1923 (*Williams*) (BMNH).

Paratypes. **Guyana**: 1 ♀, Blairmont; 1 ♀, New Amsterdam (BMNH).

In the absence of males this species is most readily distinguished by the pigmentation of the thorax, tegmen and wing.

### *Mysidia albifasciata* sp. n.

(Figs 239, 350, 459)

Male: head 0.59 mm long; 0.71 mm wide; pronotum 1.28 mm wide; tegmen 7.00 mm long; wing 3.70 mm long. Female: tegmen 7.40 mm long.

Length of frons 6 times width at apex, 3.5 times width at base; ocelli large, prominent; clypeus as long as frons; rostrum terminating immediately basad of subgenital plate. Pronotal width 15 times mid-dorsal length; fronto-lateral surfaces and tegula not carinate.

Ocelli occasionally deep red; pronotum with fronto-lateral surfaces tinged red adjacent to eyes; disc of mesonotum occasionally blackish brown. Tegmen smoky brown; veins pale brownish yellow, irregularly mottled white over basal quarter; a transverse, hyaline band extending from costal to posterior margins at one-third length, another at midlength, and a third at three-quarters; apex, beyond apical fork of medial vein, irregularly hyaline. Wing with whitish hyaline with a pale, smoky brown, transverse band at mid-length; apical third pale brownish.

Shaft of aedeagus slender, cylindrical; dorsal surface subapically with a pair of broad, apically acute processes adjacent to midline bearing small obtuse spines; laterally, a pair of slender, spine-like processes. Paramere slender, apex narrowly rounded; dorsal process situated at two-thirds length, strongly produced dorsally and posteriorly; dorsal surface subbasally with a broad, rounded secondary process.

#### MATERIAL EXAMINED

Holotype ♂, **Ecuador**: Mera, 1–2.ii.1923 (*Williams*) (BMNH).

Paratype. **Ecuador**: 1 ♀, Tena (BMNH).

This species is readily distinguished by the pigmentation of the tegmen and wing, and by the structure of the male genitalia.

### *Mysidia quadrifascia* Walker

*Mysidia quadrifascia* Walker, 1858: 97. Holotype ♀, BRAZIL (BMNH) [examined].

Female: head 0.66 mm long, 0.67 mm wide; pronotum 1.55 mm wide; tegmen 7.65 mm long, wing 4.25 mm long. Male unknown.

Length of frons c. 5 times width at apex, c. 3 times width at base; ocelli very prominent; clypeus slightly longer than frons; rostrum terminating level with midlength of abdomen. Pronotal width c. 11 times mid-dorsal length; fronto-lateral surfaces and tegula without distinct carinae.

Ocelli very dark crimson; disc of mesonotum brown. Tegmen and wing hyaline, veins and cross-veins pale brownish yellow. Tegmen pale smoky brown basally, with a smoky brown transverse band at level of first fork of cubital vein, a broader band at level of first and second forks of medial vein, and another at level of radial-medial cross-vein; apical margin very pale smoky brown. Wing with a very pale, irregular, smoky brown, transverse band at midlength; apical third pale smoky brown.

#### MATERIAL EXAMINED

Holotype ♀, **Brazil**: Santarem (*Bates*) (BMNH).

This species is distinguished by the prominent dark pigmentation of the tegmen and wing.

*Mysidia transversa* sp. n.

(Figs 234, 345, 454)

Male: head 0.62 mm long, 0.78 mm wide; pronotum 1.44 mm wide; tegmen 7.20 mm long; wing 3.85 mm long. Female unknown.

Length of frons 5 times width at apex, 3.33 times width at base; ocelli prominent; clypeus slightly longer than frons; rostrum terminating immediately basad of apex of subgenital plate. Pronotal width c. 14 times mid-dorsal length, fronto-lateral carinae absent; tegula with very weak carinae.

Ocelli scarlet; fronto-lateral surfaces of pronotum occasionally each with a scarlet spot adjacent to eye; disc of mesonotum and dorsal surface of abdomen dark brown. Tegmen and wing whitish hyaline, veins pale brownish. Tegmen with a broad, smoky brown, transverse band at one-eighth length, another at level of first fork of cubital vein, another, broader, band immediately distad of medial-cubital cross-vein, a fourth at approximately two-thirds length; apical area, distad of last fork of radial vein, broadly smoky brown. Wing smoky brown basally; with a broad smoky brown band extending obliquely from costal margin to posterior margin at midlength; apical quarter smoky brown.

Shaft of aedeagus cylindrical; dorsal surface subapically with two pairs of robust, anteriorly directed, spine-like processes. Paramere very slender basally, becoming abruptly expanded at midlength, apex obtusely rounded; dorsal process situated immediately distad of midlength, long, slender, apex strongly produced.

## MATERIAL EXAMINED

Holotype ♂, **Peru**: Iquitos, Rio Chinchicuy 1.5 km, 27.xi.1972 (*Waldo*) (FAMU).

Paratypes. **Peru**: 1 ♂ (BMNH). **Brazil**: 3 ♂, 1 ♀, Amazonas (INPA; BMNH).

Superficially this species resembles *quadrifascia*, but differs in the proportions of the head and pronotum and in the pigmentation of the tegmen.

*Mysidia fulvodorsalis* sp. n.

(Figs 177, 286, 395)

Male: head 0.63 mm long, 0.74 mm wide; pronotum 1.51 mm wide; tegmen 7.90–8.20 mm long; wing 4.25 mm long. Female: tegmen 8.00–8.40 mm long.

Length of frons c. 6 times width at apex, 3.33 times width at base; ocelli prominent; clypeus slightly longer than frons; rostrum extending to base of subgenital segment. Pronotal width 12 times mid-dorsal length, fronto-lateral carinae absent, tegula weakly carinate.

Ocelli crimson; disc of mesonotum brown. Tegmen and wing whitish hyaline. Tegmen with a broad, dark smoky brown, transverse band near base, another at level of first fork of cubital vein, another at midlength, a fourth at level of radial-medial cross-vein; apical area, distad of last fork of radial vein, dark smoky brown. Wing with a broad, transverse, smoky brown band extending from medial vein to posterior margin at midlength; apical third dark smoky brown.

Shaft of aedeagus somewhat laterally expanded subapically; dorsal surface subapically with a pair of long, spine-like processes laterally; a pair of long, slender, processes at midline. Paramere basally slender, becoming broadly expanded over distal half length, apex obtusely rounded; dorsal process situated at three-fifths length, apex slender; dorsal surface at one-fifth length with a small, conical, secondary process bearing numerous small spines; ventral surface at midlength with a rounded process bearing numerous long spines.

## MATERIAL EXAMINED

Holotype ♂, **Bolivia**: Cbb., Villa Tunari, 31.iii.1978 (*O'Brien*) (FAMU).

Paratypes. 1 ♂, 3 ♀, same data as holotype (FAMU; BMNH).

This species is distinguished by the pronotal and tegminal pigmentation, and by the structure of the male genitalia.

*Mysidia musica* sp. n.

(Figs 253, 364, 473)

Male: head 0.67 mm long, 0.95 mm wide; pronotum 1.80 mm wide; tegmen 8.40 mm long; wing 5.20 mm long. Female: tegmen 8.80 mm long.

Length of frons 5 times width at apex, 2.5 times width at base; ocelli large, prominent; clypeus c. as long

as frons; rostrum extending well beyond hind coxae. Pronotal width 20 times mid-dorsal length; fronto-lateral surfaces and tegula not carinate.

Genae and fronto-lateral surfaces of pronotum adjacent to eyes weakly pale orange; disc of mesonotum brownish. Tegmen and wing smoky brown. Tegmen with veins brownish; with a narrow, whitish, transverse band at one-fifth length, another at two-fifths; a third at three-fifths; an irregular, broken, band at approximately mid-length; posterior margin whitish from apex of first branch of cubital vein to fifth branch of medial vein; apical fork of radial vein irregularly pale. Wing pale, whitish hyaline, veins pale; with an irregular brownish, transverse band extending from costal margin to base of cubital vein; an irregular brownish band extending obliquely from medial-cubital cross-vein to posterior margin; a very faint band extending from radial-medial cross-vein almost to posterior margin.

Shaft of aedeagus broadly laterally expanded subapically; dorsal surface subapically with a pair of large, adpressed, overlapping, flap-like processes, each terminating anteriorly in a tapering spine near midline. Paramere massive, apex broadly rounded; dorsal process greatly reduced, situated at one-third length; dorsal surface at two-thirds length with a large, conical, secondary process.

#### MATERIAL EXAMINED

Holotype ♂, **Brazil**: Para, Jabaty, v.1924 (*Williams*) (BMNH).

Paratype. 1 ♀, same data as holotype (BMNH).

This species is distinguished by the pigmentation of the tegmen and wing.

### *Mysidia williamsi* sp. n.

(Figs 238, 349, 458)

Male: head 0.52 mm long, 0.76 mm wide; pronotum 1.34 mm wide; tegmen 6.46 mm long; wing 3.60 mm long. Female: tegmen 6.40–7.00 mm long.

Length of frons 5.5 times width at apex, 3 times width at base; ocelli very large and prominent; clypeus slightly longer than frons; rostrum terminating slightly basad of subgenital plate. Pronotal width c. 14 times mid-dorsal length; fronto-lateral surfaces and tegula not carinate.

Dorsal surface of mesonotum and abdomen brownish. Tegmen and wing dark, smoky brown, veins brownish yellow. Tegmen with a narrow, whitish, transverse band extending from costal margin to claval suture at one-sixth length, another extending from costal margin to apex of clavus at one-third, another extending from costa to hind margin somewhat distad of mid-length; an irregular whitish area around apical fork of medial vein extending broadly to costal margin; apical area between first and fifth branches of medial vein hyaline. Wing with an irregular pale band running transversely from costal margin at level of radial-medial cross-vein, becoming broader and less distinct towards posterior margin at level of first two branches of cubital vein.

Shaft of aedeagus slender, cylindrical, slightly asymmetrical; dorsal surface subapically with a pair of long, flap-like processes bearing clusters of very small, tooth-like spines apically; dorso-lateral surfaces subapically each with a small, spine-like process. Paramere slender; dorsal process large, situated at two-thirds length, strongly produced dorsally and posteriorly; dorsal surface subbasally with a cluster of short, robust spines; ventral surface subbasally with several long, robust spines.

#### MATERIAL EXAMINED

Holotype ♀, **Brazil**: Para, Jabaty, v.1924 (*Williams*) (BMNH).

Paratypes. **Brazil**: 1 ♂, 4 ♀, Amazonas (INPA; BMNH).

This species is readily distinguished by the pigmentation of the tegmen and wing, and by the structure of the male genitalia.

### *Mysidia mylesi* sp. n.

(Figs 276, 387, 497)

Male: head 0.52 mm long, 0.69 mm wide; pronotum 1.20 mm wide; tegmen 5.60 mm long; wing 3.20 mm long. Female: tegmen 6.40 mm long.

Length of frons 5.5 times width at apex, 3 times width at base; ocelli large, prominent; clypeus c. as long as frons; rostrum extending to base of subgenital segment. Pronotal width c. 12 times mid-dorsal length, fronto-lateral carinae absent; tegula with weak carinae.

Ocelli bright scarlet; fronto-lateral surfaces of pronotum adjacent to eyes pale reddish; abdomen with dorsal surface tinged reddish. Tegmen and wing whitish hyaline, veins pale brown. Tegmen with basal and

claval areas smoky brown, a smoky brown transverse band at level of first fork of cubital vein, another at midlength; apical third smoky brown, with anterior margin apically, and posterior margin between first and fifth branches of medial vein broadly pale. Wing pale smoky brown over basal half and apical third.

Shaft of aedeagus slender, cylindrical, slightly asymmetrical; dorsal surface subapically with two pairs of acutely pointed processes. Paramere slender; dorsal process situated slightly distad of midlength, apex strongly produced posteriorly.

**MATERIAL EXAMINED**

Holotype ♂, **Trinidad**: Caura, on *Parthenium* sp., 2.viii.1976 (*Noyes*) (BMNH).

Paratype. 1 ♀, same data as holotype (BMNH).

This species is readily distinguished by the pigmentation of the tegmen and wing, and by the relatively simple structure of the aedeagus.

***Mysidia varia* sp. n.**

(Figs 261, 372, 482)

Male: head 0.65 mm long, 1.05 mm wide; pronotum 2.39 mm wide; tegmen 9.40–10.54 mm long; wing 6.00 mm long. Female: tegmen 10.20–11.40 mm long.

Length of frons 5 times width at apex, 3.33 times width at base; ocelli obsolete; clypeus slightly longer than frons; rostrum extending beyond apex of subgenital plate. Pronotal width 11 times mid-dorsal length, fronto-lateral surfaces weakly carinate; tegula not carinate.

Head and pronotum often tinged pale orange. Tegmen smoky brown; veins dark brown, narrowly bordered whitish hyaline; central areas of cubital cells and larger medial cells irregularly whitish hyaline. Wing predominantly whitish hyaline, veins dark brown, cells irregularly smoky brown medially.

Shaft of aedeagus cylindrical, somewhat expanded apically; dorsal surface subapically with a pair of flap-like processes, each produced into two acute, spine-like processes dorsally. Paramere very long and slender; apex narrowly rounded; dorsal process situated somewhat distad of two-thirds length, little produced posteriorly; dorsal surface at one-fifth length with an obtusely rounded, secondary process.

**MATERIAL EXAMINED**

Holotype ♂, **Colombia**: Caqueta, Yuruyacu, 70 km SW. Florencia, 22.i.1979 (*Cooper*) (BMNH).

Paratypes. **Colombia**: 1 ♂, same data as holotype (BMNH). **Guyana**: 1 ♂, Essequibo River (BMNH). **Ecuador**: 8 ♂, 6 ♀, Tena (BMNH). **Brazil**: 1 ♂, Amazonas (INPA).

Though closely related to *tikalme*, *varia* may be distinguished readily by the pigmentation of the tegmen and wing, and by the detailed structure of the male genitalia.

***Mysidia tikalme* sp. n.**

(Figs 259, 370, 480)

Male: head 0.63 mm long, 0.99 mm wide; pronotum 2.30 mm wide; tegmen 11.00 mm long; wing 6.30 mm long. Female: tegmen 11.00–11.25 mm long.

Length of frons c. 6 times width at apex, 4.5 times width at base; ocelli obsolete; clypeus as long as frons; rostrum extending beyond base of genital segment. Pronotal width c. 12 times mid-dorsal length; fronto-lateral surfaces and tegula not carinate.

Genae occasionally tinged crimson; fronto-lateral surfaces of pronotum and disc and ventral surfaces of mesonotum frequently tinged deep crimson. Tegmen and wing hyaline, veins dark brown, central areas of cells broadly dark brown, with a narrow hyaline margin adjacent to veins.

Shaft of aedeagus simple; dorsal surface subapically with a pair of flap-like processes, each bearing two acute spines dorsally. Paramere slender; apex narrowly rounded; dorsal process situated at two-thirds length, small, little produced posteriorly; dorsal surface at one-fifth length with a slender secondary process bearing a row of long, robust spines.

**MATERIAL EXAMINED**

Holotype ♂, **Guyana**: confluence of Oronoque and New rivers, 650 ft, ix–xii.1937 (*Rosenberg*) (BMNH).

Paratypes. **Brazil**: 1 ♀, Para; 1 ♀, Amazonas (BMNH).

This species is distinguished by the pigmentation of the tegmen and wing, and by the structure of the male genitalia.



*Mysidia glauca* Distant

(Figs 188, 298, 407)

*Mysidia glauca* Distant, 1907: 397. LECTOTYPE ♂, BRAZIL (BMNH), here designated [examined].

Male: head 0.55 mm long, 0.80 mm wide; pronotum 1.60 mm wide; tegmen 7.10 mm long; wing 4.20 mm long. Female unknown.

Length of frons *c.* 5 times width at apex, *c.* 3 times width at base; ocelli obsolete; clypeus slightly longer than frons; rostrum terminating slightly posterior to hind coxae. Pronotal width 13 times mid-dorsal length, fronto-lateral carinae distinct; tegula not carinate.

Central area of frons, and genae dorsal to eyes and anterior to antennae, pale crimson; pronotum dorsally, around carinae on fronto-lateral surfaces, and anterior to fore coxae, pale crimson; mesonotum with lateral surfaces and coxae pale pinkish; posterior abdominal segments brown. Tegmen and wing pale smoky brown, unmarked, veins dark brown. Tegmen with costal vein narrowly crimson.

Shaft of aedeagus laterally expanded subapically; dorsal surface subapically with a pair of parallel flap-like processes; a pair of dorso-lateral flaps, each terminating anteriorly in an obtuse point. Paramere slender; apex broadly rounded; dorsal process situated at two-thirds length, rounded, not posteriorly produced, bearing a single, blunt spine; dorsal surface at one-third length with a low, rounded, secondary process bearing three robust spines.

## MATERIAL EXAMINED

Lectotype ♂, **Brazil**: Parana de Buyassu, Lower Amazon, 18.i.1896 (*Austin*) (BMNH).

This species is distinguished by the pigmentation of the head and body, the absence of markings on the wing and tegmen, and by the unique structure of the paramere.

*Mysidia gracilis* sp. n.

(Figs 244, 355, 465)

Male: head 0.53 mm long, 0.76 mm wide; pronotum 1.53 mm wide; tegmen 7.65–7.90 mm long; wing 4.80 mm long. Female: tegmen 8.50 mm long.

Length of frons 5.5 times width at apex, *c.* twice width at base; ocelli small, distinct; clypeus slightly longer than frons; rostrum extending slightly beyond hind coxae. Pronotal width *c.* 15 times mid-dorsal length, fronto-lateral carinae absent; tegula distinctly carinate.

Head and body tinged pale crimson; genae adjacent to eyes broadly crimson; pronotum dorsally, and adjacent to eyes on fronto-lateral surfaces, crimson. Tegmen and wing whitish hyaline; veins dark brown, edged pale smoky hyaline; cells distant from veins smoky brownish, pale hyaline medially. Wing with a very irregular, indistinct, pale brownish, transverse band at midlength; posterior and apical margins between veins broadly smoky brown.

Shaft of aedeagus expanded subapically; lateral surfaces each with a slender spine-like process subapically; dorsal surface subapically with a pair of large flap-like processes. Paramere slender, parallel-sided; apex rounded; dorsal process situated slightly distad of midlength, strongly produced posteriorly; dorsal surface basally with a large, flap-like secondary process bearing numerous, large, robust spines.

## MATERIAL EXAMINED

Holotype ♂, **Brazil**: Rio de Janeiro, i.1924 (*Williams*) (BMNH).Paratypes. **Brazil**: 2 ♂, 2 ♀, same data as holotype; Rezende (BMNH).

This species is distinguished by the pigmentation of the head, pronotum, tegmen and wing, and by the structure of the male genitalia.

*Mysidia lucifera* sp. n.

(Figs 232, 343, 452)

Male: head 0.56 mm long, 0.73 mm wide; pronotum 1.43 mm wide; tegmen 7.65 mm long; wing 4.25 mm long. Female: tegmen 8.50 mm long.

Length of frons 7 times width at apex, *c.* 2.5 times width at base; ocelli indistinct; clypeus slightly longer than frons; rostrum extending to midlength of abdomen. Pronotal width *c.* 14 times mid-dorsal length; fronto-lateral surfaces and tegula lacking distinct carinae.

Head and body tinged pale crimson; female with abdomen tinged crimson. Tegmen and wing whitish

hyaline, weakly and irregularly mottled pale smoky brown, veins and cross-veins brown. Tegmen with a very faint, pale brown, transverse band at midlength.

Shaft of aedeagus somewhat expanded over apical third; dorsal surface subapically with a pair of broad, apically bifid processes laterally; lateral surfaces each with a long, spine-like process subapically. Paramere slender; apex acutely rounded; dorsal process situated at two-thirds length, large, strongly produced posteriorly; dorsal surface at one-quarter length with a prominent, rounded, secondary process bearing numerous, long, robust spines.

#### MATERIAL EXAMINED

Holotype ♂, **Brazil**: Rezende, Estado de Rio, ii.1924 (*Williams*) (BMNH).

Paratype. 1 ♀, same data as holotype (BMNH).

This species is only readily distinguished by reference to the structure of the male genitalia.

#### *Mysidia havilandi* sp. n.

(Figs 218, 329, 438)

Male: head 0.59 mm long, 0.80 mm wide; pronotum 1.55 mm wide; tegmen 6.80–7.44 mm long; wing 4.40 mm long. Female: tegmen 8.24 mm long.

Length of frons 5.5 times width at apex, 2.25 times width at base; ocelli large, prominent; clypeus slightly longer than frons; rostrum extending well beyond hind coxae. Pronotal width 15 times mid-dorsal length; fronto-lateral carinae prominent; tegula not carinate.

Head and body predominantly brown; base of vertex often crimson; base of antenna narrowly red; pronotum reddish dorsally, occasionally on fronto-lateral surfaces also; disc of mesonotum brown; scutellum deep red or reddish brown, adjacent surfaces of metanotum dark brown; abdomen deep red to blackish brown. Tegmen and wing pale brownish hyaline, narrowly crimson basally, apical and posterior margins very narrowly crimson; veins reddish brown, very broadly edged smoky brown. Tegmen with costal vein and apices of subcostal and radial veins crimson, an indistinct, brown, transverse band extending from costal margin to first fork of cubital vein. Wing with posterior margins of cells narrowly smoky brown; first anal vein crimson.

Shaft of aedeagus slender, cylindrical, dorso-laterally expanded into a pair of large, curving, spine-like processes; apex with a pair of small curved processes. Paramere slender; dorsal process situated somewhat distad of midlength, robust; dorsal surface somewhat expanded at one-third length, bearing long robust spines.

#### MATERIAL EXAMINED

Holotype ♂, **Guyana**: Tumatumari, 19.vii.1923 (*Williams*) (BMNH).

Paratypes. **Guyana**: 4 ♂, 1 ♀, same data as holotype (BMNH). **Brazil**: 3 ♂, 5 ♀, Amazonas (INPA; NR).

This species is distinguished by the dark pigmentation of the body, tegmen and wing, and by the structure of the male genitalia.

#### *Mysidia etheldreda* sp. n.

(Figs 254, 365, 475)

Male: head 0.65 mm long, 1.00 mm wide; pronotum 2.14 mm wide; tegmen 9.60 mm long; wing 5.44 mm long. Female unknown.

Length of frons *c.* 7 times width at apex, 2.5 times width at base; ocelli small, distinct; clypeus *c.* one-third longer than frons; rostrum extending to base of subgenital plate. Pronotal width *c.* 24 times mid-dorsal length; fronto-lateral surfaces and tegula not carinate.

Disc of mesonotum dark brown, scutellum blackish brown. Tegmen and wing predominantly whitish hyaline, irregularly marked smoky brown; veins yellow; apical margins between branches of medial veins very broadly smoky brown. Tegmen pale smoky brown over basal quarter; medial and cubital areas pale brown from approximately one-third length to midlength; costal and radial areas brownish subapically. Wing narrowly brownish basally; a narrow and irregular, obliquely curving, smoky brown, transverse band immediately basad of first fork of cubital vein; second fork of cubital vein and cubital-medial cross-vein edged smoky brown; first branch of cubital vein subapically broadly edged smoky brown.

Shaft of aedeagus robust; apex strongly produced, curving antero-dorsad; lateral surfaces subapically each with a large flap-like process extending over dorsal surface, each process with a pair of anteriorly

directed spines at internal angle; dorso-lateral surfaces each with a triangular flap-like process at midlength; dorsal surface subbasally with a broad transverse process. Paramere broad; apex obtusely rounded; dorsal process situated at midlength, small, weakly produced posteriorly. Subgenital lateral sternites each with posterior margin produced into a very long, slender, parallel-sided, horizontally directed lobe.

**MATERIAL EXAMINED**

Holotype ♂, **Brazil**: Amazonas, P. das Laranjeiras, vii.–viii.1981 (*Arias*) (INPA).

This species, though closely related to *estfarchina* and *molesta*, is readily distinguished by the pigmentation of the tegmen and wing.

***Mysidia liquida* sp. n.**

(Figs 224, 335, 443)

Male: head 0.65 mm long, 0.82 mm wide; pronotum 1.60 mm wide; tegmen 9.35–10.20 mm long; wing 5.44 mm long. Female: tegmen 11.05–13.60 mm long.

Length of frons c. 6 times width at apex, c. 3 times width at base; ocelli distinct; clypeus one-sixth longer than frons; rostrum extending to base of subgenital plate. Pronotal width 40 times mid-dorsal length; fronto-lateral carinae indistinct; tegulae distinctly carinate.

Genae anterior to eyes tinged reddish orange; fronto-lateral surfaces of pronotum each with a large, dark brown irregularly circular spot at level of eye and adjacent to lateral margin; tegula dark brown medially; disc of mesonotum with a pair of large, prominent, roughly circular, dark brown spots posteriorly. Tegmen and wing pale, whitish hyaline, lacking prominent markings; veins pale; cross-veins pale brownish, narrowly margined smoky brown. Tegmen with costal area tinged brownish yellow, narrowly dark brown basally. Wing unmarked.

Shaft of aedeagus greatly expanded subapically; dorso-lateral surfaces each with a very large, flap-like process extending over dorsal surface, lacking spine-like secondary processes. Paramere slender; apex acute; dorsal process strongly produced posteriorly.

**MATERIAL EXAMINED**

Holotype ♂, **Bolivia**: Bueyas [?] (BMNH).

Paratypes. **Bolivia**: 2 ♂, 1 ♀, same data as holotype; Buena Vista (BMNH; FAMU). **Venezuela**: 1 ♂ (NR). **Peru**: 1 ♀, Callanga (BMNH).

This species is distinguished by the dark spots on the fronto-lateral surfaces of the pronotum, the almost complete absence of pigmentation on the tegmen and wing, and by the massive aedeagus.

***Mysidia ariasi* sp. n.**

(Figs 185, 295, 404)

Male: head 0.63 mm long, 1.08 mm wide; pronotum 2.06 mm wide; tegmen 9.40 mm long; wing 5.60 mm long. Female unknown.

Length of frons c. 6 times width at apex, 2.5 times width at base; ocelli obsolete; clypeus c. as long as frons; rostrum extending to base of subgenital plate. Pronotal width c. 24 times mid-dorsal length; fronto-lateral carinae distinct; tegula not carinate.

Fronto-lateral surfaces of pronotum at level of eyes each with a prominent, dark brown, roughly circular spot, not reaching either internal or lateral margins; tegula tinged brownish on ventral margins; fore tibia and tarsus brownish. Tegmen and wing hyaline, without distinct markings. Tegmen with costal area tinged yellowish brown; apical and posterior margins weakly smoky brown; cross-veins brownish; apex of anal vein with a small, triangular, brownish spot. Wing with posterior and apical margins indistinctly smoky brown; radial-medial cross-vein narrowly edged smoky brown.

Shaft of aedeagus broad; dorso-lateral surfaces subapically each with a large flap-like process extending over ventral surfaces, dorsally produced into a rounded lobe bearing a small conical projection. Paramere slender; apex acutely rounded; dorsal process situated slightly basad of mid-length, large, apex strongly produced posteriorly; dorsal surface distad of process somewhat produced.

**MATERIAL EXAMINED**

Holotype ♂, **Brazil**: Amazonas, P. das Laranjeiras, viii.–ix.1981 (*Arias*) (INPA).

This species is distinguished by the prominent dark spots on the fronto-lateral surfaces of the pronotum and the lack of distinct markings on the tegmen and wing; from *liquida* it is separated by the structure of the male genitalia.

***Mysidia fuscofrontalis* sp. n.**

(Figs 245, 356, 466)

Male: head 0.67 mm long, 0.88 mm wide; pronotum 2.37 mm wide; tegmen 8.90 mm long; wing 5.10 mm long. Female unknown.

Length of frons *c.* 4 times width at apex, 2.25 times width at base; ocelli large, not prominent; clypeus slightly longer than frons; rostrum terminating immediately posterior to hind coxae. Pronotal width 28 times mid-dorsal length, fronto-lateral carinae absent; tegula with carinae very prominent.

Head with base of vertex, and genae from base to level of ventral margins of eyes, bright scarlet; fronto-lateral surfaces of pronotum each with a narrow, bright scarlet, horizontal band extending from adjacent to base of head to lateral margin. Tegmen and wing whitish hyaline; veins, excepting subcostal and radial veins of tegmen, pale; cross-veins dark brown; posterior and apical margins broadly smoky brown between veins. Tegmen with subcostal and radial veins brown over greater part of length basally; clavus with a small, dark brown spot between anal veins, another slightly distad of point of fusion of anal veins, another subapically; cubital area with four, irregular brownish spots; costal cell dark brown between cross-veins, costal margin narrowly scarlet; medial vein with bases of first and second branches, and apical fork, dark brown, fifth and sixth branches each with two, evenly spaced, dark brown spots. Wing with first fork of cubital vein dark brown; with an irregular, dark brown spot over midlength of first cubital branch; second and third cubital branches, and both medial branches, dark brown from base to immediately prior to posterior margin.

Shaft of aedeagus slender; lateral surfaces subapically each with a large flap-like process, produced antero-dorsally into a long curving spine, and with a small spine ventrally. Paramere robust; apex broadly rounded, with a long, curving, flap-like process dorsally; dorsal process small, situated at midlength, posteriorly produced.

**MATERIAL EXAMINED**

Holotype ♂, **Panama**: Las Cumbres, 6.vi.1976 (*Wolda*) (FAMU).

This species is readily distinguished by the pigmentation of the head, pronotum, tegmen and wing.

***Mysidia albipennis* Westwood**

(Figs 228, 339, 448)

*Mysidia albipennis* Westwood, 1840: 83. LECTOTYPE ♂, BRAZIL (UM), here designated [examined].

*Mysidia parviceps* Fowler, 1900: 73. LECTOTYPE ♀, GUATEMALA (BMNH), here designated [examined]. **Syn. n.**

Male: head 0.63 mm long, 0.80 mm wide; pronotum 1.82 mm wide; tegmen 8.40–9.00 mm long; wing 5.60 mm long. Female: tegmen 8.84–9.20 mm long.

Length of frons *c.* 6 times width at apex, *c.* twice width at base; ocelli distinct; clypeus *c.* as long as frons; rostrum terminating at level of hind coxae. Pronotal width *c.* 14 times mid-dorsal length; fronto-lateral surfaces and tegula not distinctly carinate.

Vertex often scarlet from base to level of dorsal margins of eyes; genae each with a narrow, horizontal, dark brown/black band extending from adjacent to dorsal margin of eye to anterior margin; fronto-lateral surfaces of pronotum each with a broad reddish band extending horizontally from adjacent to eye to lateral margin, this band often incorporating a large black spot in its ventral margin; abdomen with a small, circular, black spot on either side of midline on dorsal surface of fifth segment. Tegmen and wing whitish hyaline, veins very pale brownish. Tegmen with cross-veins and first and second forks of medial vein dark brown; cells between branches of cubital and medial veins each with a smoky brown semicircular spot on posterior and apical margins; apical fork of medial vein covered by a prominent, circular, dark brown spot; clavus with an irregular dark brown spot between anal veins subbasally, another between fused anal veins and claval suture at two-thirds length, another between fused anal veins and posterior margin, and a fourth at apex of claval suture. Wing with apical and posterior margins narrowly smoky brown between veins; radial-medial cross-vein dark brown, an irregular, dark brown spot between medial and cubital veins at two-fifths length, and another between first branch of cubital vein and first anal vein.

Shaft of aedeagus slender, laterally expanded over apical half; dorsal surface with a pair of large flap-like processes arising subapically and extending anteriorly to midlength. Paramere with apex very obtusely rounded; dorsal process situated at two-fifths length, small, with apex slender and strongly produced posteriorly; dorsal surface subbasally with a group of short robust spines.

**MATERIAL EXAMINED**

Lectotype ♂ (*albipennis*), **Brazil**: Vera Cruz (UM). Lectotype ♀ (*parviceps*), **Guatemala**: Zapota (*Champion*) (BMNH).

**Honduras**: 6 ♂, 8 ♀, Lancertillo (FAMU; BMNH). **Belize**: 1 ♀ (FAMU).

Westwood did not indicate the number of specimens in the type-series of *albipennis*; the single male available for study is here designated as lectotype. The three female specimens of *parviceps* described by Fowler are not conspecific. The specimen here designated as lectotype has the tegmina damaged; it bears Fowler's handwritten 'type' label.

This species is readily distinguished by the distinctive pigmentation of the head and pronotum, the mottled appearance of the tegmen and wing, and by the structure of the male genitalia.

*Mysidia lactiflora* Westwood

*Mysidia lactiflora* Westwood, 1840: 83. LECTOTYPE ♀, BRAZIL (UM), here designated [examined].

Female: head 0.75 mm long, 0.98 mm wide; pronotum 2.63 wide; tegmen 12.07 mm long; wing 7.00 mm long. Male unknown.

Length of frons 10 times width at apex, 2.5 times width at base; ocelli small, distinct; clypeus one quarter longer than frons; rostrum only just reaching hind coxae. Pronotal width *c.* 50 times mid-dorsal length, fronto-lateral carinae absent; tegula prominently carinate.

Base of vertex reddish; genae from level of dorsal margins of eyes to level of midline of eyes dull crimson; fronto-lateral surfaces of pronotum each with a prominent, broad, brownish band extending horizontally from adjacent to eye to lateral margin, each band deep red along dorsal margin; tegulae ventral to carinae deep brownish. Tegmen and wing almost hyaline, veins pale yellow, cross-veins brownish. Tegmen with first, second and apical forks of medial vein pale brownish; costal cell yellowish brown, bearing a small, prominent, roughly circular, dark brown spot at level of first fork of cubital vein, another similar spot adjacent to point of separation of fused subcostal and radial veins, a third, smaller spot at *c.* one-third length; with a small, roughly circular, prominent, dark brown spot over cross-vein linking second and third branches of medial vein; a small dark brown spot on anal margin somewhat distad of point of fusion of anal veins. Wing with cross-veins slightly darker brown than those of tegmen; a small, irregular, indistinct, brownish spot over first branch of cubital vein somewhat basad of midlength.

**MATERIAL EXAMINED**

Lectotype ♀, **Brazil**: no further data (UM).

The lectotype has the abdomen partially eaten away, and the left tegmen and wing glued in place; Westwood's 'type' label gives the name as 'lactiflorea'.

This species, in the absence of reference to the male genitalia, is most readily distinguished by its large size, the markings on the fronto-lateral surfaces of the pronotum, and the paucity of markings on the tegmina and wings, in particular the absence of a dark spot over the apical fork of the medial vein of the tegmen.

*Mysidia lacteola* sp. n.

(Figs 193, 303, 412)

Male: head 0.88 mm long; 1.01 mm wide; pronotum 1.90 mm wide; tegmen 9.90–11.20 mm long; wing 5.80 mm long. Female: tegmen 11.20 mm long.

Length of frons 4.5 times width at apex, *c.* twice width at base; ocelli obscure; clypeus *c.* one-fifth longer than frons; rostrum extending to base of subgenital plate. Pronotal width *c.* 47 times mid-dorsal length, fronto-lateral carinae absent; tegula strongly carinate basally.

Antenna, frons at level of eyes, and fronto-lateral surfaces of pronotum occasionally tinged crimson. Tegmen and wing whitish hyaline, veins and cross-veins very pale brown. Tegmen with a pale brownish transverse band at level of first fork of cubital vein, another at level of medial-cubital cross-vein, and a third slightly distad of midlength; posterior and apical margins narrowly and faintly edged pale brown. Wing with a very faint, brownish, transverse band at midlength, and a second at level of radial-medial cross-vein.

Shaft of aedeagus slender, slightly expanded towards apex; dorso-lateral surfaces each expanded subapically into a low flap-like process; dorsal surface subapically with a slender spine on either side of midline. Paramere robust, dorsal process small, situated at two-fifths length, not posteriorly produced; dorsal surface at three-fifths length with a long, slender, apically rounded secondary process.

**MATERIAL EXAMINED**

Holotype ♂, **French Guiana**: Mana River, v.1917 (CM).

Paratypes. **French Guiana**: 1 ♀, same data as holotype (BMNH). **Trinidad**: 1 ♂ (USNM). **Brazil**: 5 ♂, 15 ♀, Taracua (NR; BMNH).

The structure of the male genitalia, in particular the paramere, is very distinctive.

***Mysidia squamigera* (Fabricius)**

*Derbe squamigera* Fabricius, 1803: 81. LECTOTYPE ♀, CENTRAL AMERICA (ZM), here designated [examined].

*Mysidia squamigera* (Fabricius) Westwood, 1840: 83.

Female: head 0.75 mm long, 1.08 mm wide; pronotum 2.37 mm wide; tegmen 10.50 mm long; wing 6.40 mm long. Male unknown.

Length of frons 7 times width at apex, *c.* 3 times width at base; ocelli small, distinct; clypeus *c.* one-fifth longer than frons; rostrum extending to base of subgenital plate. Pronotal width 50 times mid-dorsal length, fronto-lateral carinae absent; tegula prominently carinate.

Antenna and genae irregularly orange; fronto-lateral surfaces of pronotum very dark brown dorsally and laterally; tegula dark brown with dorsal margin narrowly pale; disc of mesonotum smoky brown over posterior three-quarters length; abdomen with dorsal surface narrowly smoky brown adjacent to midline. Tegmen and wing predominantly whitish hyaline, veins pale yellow or brown, cross-veins and posterior margins broadly smoky brown. Tegmen with costal and radial areas very dark brown, interrupted by narrow, irregular, yellow, transverse bands basad and distad of level of point of separation of fused subcostal and radial veins, and slightly basad of two-thirds length; base, including clavus, dark brown; a broad, transverse, dark brown band at one-sixth length; a narrower and more broken band over first fork of cubital vein; a more distinct, somewhat oblique band extending from medial vein to apex of clavus; indistinct irregular markings over radial-medial cross-vein and apical fork of radial vein. Wing with an irregular, smoky brown, transverse band at *c.* two-fifths length.

**MATERIAL EXAMINED**

Lectotype ♀, **Central America** (*Schmidt*) (ZM).

**Brazil**: 1 ♀ (INPA).

The second syntype is also female, but is not conspecific. The lectotype is damaged and its left tegmen is missing.

The pigmentation of this species is very distinctive, and readily separates it from *costata* with which it is frequently confused.

***Mysidia costata* (Fabricius)**

(Figs 220, 330, 440)

*Derbe costata* Fabricius, 1803: 81. LECTOTYPE ♀, CENTRAL AMERICA (ZM), here designated [examined].

*Mysidia costata* (Fabricius) Westwood, 1840: 83.

Male: head 0.74 mm long, 1.05 mm wide; pronotum 2.31 mm wide; tegmen 8.10–11.25 mm long; wing 6.30 mm long. Female: tegmen 10.60–13.00 mm long.

Length of frons 4.5 times width at apex, *c.* twice width at base; ocelli small, distinct; clypeus one-third longer than frons; rostrum extending to base of subgenital plate. Pronotal width 22 times mid-dorsal length; fronto-lateral surfaces and tegulae not carinate.

Fronto-lateral surfaces of pronotum each with a large, roughly circular, dark brown spot, *c.* as large as eye, situated adjacent to lateral margin, well distant from eye; tegula concolorous with, or slightly paler, than eye; disc of mesonotum usually brownish. Tegmen and wing whitish hyaline, veins pale yellow, cross-veins pale brownish, posterior margins between veins smoky brown. Tegmen with costal cell pale brownish, darker at base; otherwise unmarked. Wing unmarked.

Shaft of aedeagus broad, tapering from base to apex in dorsal aspect; dorsal surface subapically with a

pair of large flap-like processes, each strongly produced anteriorly into a long slender lobe bearing a small tooth-like spine laterally at apex; ventral surface subapically produced into a long, transverse, spine-like process. Paramere slender; apex acutely rounded; dorsal process well developed, situated at approximately one-third length, posteriorly produced; dorsal surface at two-thirds length strongly and roundly produced into a medially directed lobe.

**MATERIAL EXAMINED**

Lectotype ♀, **Central America**: no further data (*Schmidt*) (ZM).

21 ♂, 27 ♀ from various localities in **Guyana, Trinidad, Brazil, Surinam, Peru and Ecuador**.

Many of the above specimens were incorrectly determined as *squamigera* which is readily distinguished from *costata* by the strongly pigmented tegmina.

***Mysidia pseudocostata* sp. n.**

(Figs 208, 319, 427)

Male: head 0.55 mm long, 0.88 mm wide; pronotum 2.75 mm wide; tegmen 9.35–10.20 mm long; wing 5.53 mm long. Female: tegmen 10.20–11.90 mm long.

Length of frons c. 7 times width at apex, c. 2.5 times width at base; ocelli small, obscure; clypeus slightly longer than frons; rostrum extending to base of subgenital plate. Pronotal width 23 times mid-dorsal length; fronto-lateral carinae absent.

Fronto-lateral surfaces of pronotum each with a broad orange-brown band extending horizontally from adjacent to eye to lateral margin; tegula pale brownish. Tegmen and wing whitish hyaline; veins very pale; cross-veins slightly darker, brownish. Tegmen with costal cell yellowish brown, otherwise unmarked. Wing unmarked.

Shaft of aedeagus basally slender, gradually broadening towards apex; lateral surfaces subapically each with a large, flap-like, process bearing a small, tooth-like projection on external surface. Paramere slender; apex narrowly rounded; dorsal process large, situated somewhat basad of mid-length, strongly produced posteriorly; dorsal surface at three-fifths length produced into a large, apically acute secondary process densely covered with small tooth-like spines.

**MATERIAL EXAMINED**

Holotype ♂, **Guyana**: Bugaba, 800–1500 ft (*Champion*) (BMNH).

Paratypes. 4 ♂, 2 ♀, same data as holotype; San Isidro; Blairmont (BMNH). **Brazil**: 1 ♀, Campinas (BMNH).

The holotype, the other two specimens from the type-locality, and the single specimen from San Isidro, all collected by Champion, are part of the *Biologia Centrali Americana* material, and were previously determined as '*costata* Fowler'.

Externally this species closely resembles *costata* but is distinguished by the fronto-lateral surfaces of the pronotum which have a horizontal reddish band; in *costata* the fronto-lateral surfaces bear a circular dark brown spot. The structure of the male genitalia is also distinct.

***Mysidia delicatissima* Fowler**

(Figs 275, 386, 496)

*Mysidia delicatissima* Fowler, 1900: 74. LECTOTYPE ♂, MEXICO (BMNH), here designated [examined].

Male: head 0.48 mm long, 0.68 mm wide; pronotum 1.30 mm wide; tegmen 6.80 mm long; wing 4.40 mm long. Female unknown.

Length of frons 5 times width at apex, c. twice width at base; ocelli obsolete; clypeus as long as frons; rostrum terminating at level of hind coxae. Pronotal width 32 times mid-dorsal length; fronto-lateral surfaces and tegula not carinate.

Genae each with a brownish spot at level of eye; abdomen with an oval dark brown spot on dorsal surface at either side of midline on fifth and sixth segments. Tegmen and wing whitish hyaline, veins pale, cross-veins brownish, posterior margins pale smoky brown. Tegmen with medial forks brown.

Shaft of aedeagus laterally expanded over apical half; dorsal surface subapically with a pair of very large flap-like processes, each terminating anteriorly in an acute spine. Paramere robust; apex broadly rounded; dorsal process very large, prominent, situated at midlength.

## MATERIAL EXAMINED

Lectotype ♂, **Mexico**: Teapa, Tabasco, iii (*Smith*) (BMNH).

The size and the relative lack of pigmentation of the tegmina and wing, and the structure of the male genitalia, readily distinguish this species.

*Mysidia bianca* sp. n.

(Figs 207, 318, 426)

Male: head 0.60 mm long, 0.90 mm wide; pronotum 1.93 mm wide; tegmen 10.03 mm long; wing 5.95 mm long. Female unknown.

Length of frons 5 times width at apex, 2.5 times width at base; ocelli small, indistinct; clypeus slightly longer than frons; rostrum terminating slightly posterior to hind coxae. Pronotal width 16 times mid-dorsal length; fronto-lateral surfaces and tegula not carinate.

Genae dorsad of eyes, and vertex, brownish; fronto-lateral surfaces of pronotum brownish yellow. Tegmen and wing whitish hyaline, cross-veins narrowly edged smoky brown. Tegmen with costal margin narrowly brownish; costal cell with a small dark spot adjacent to fork of fused subcostal and radial veins, and another similar spot somewhat basad; a small indistinct spot at apex of clavus, and another at apex of anal vein. Wing lacking distinct markings, posterior margin weakly edged smoky brown.

Shaft of aedeagus broad, expanded over apical third; dorsal surface subapically with a pair of long, curving, spine-like processes, and a pair of flap-like processes, each terminating in an acute point and a pair of ventrally directed projections laterally. Paramere slender; dorsal process large, situated at midlength; dorsal surface at three-quarters length with a large secondary process bearing numerous short robust spines.

## MATERIAL EXAMINED

Holotype ♂, **Bolivia**: Prov. del Sara (*Steinbach*) (CM).

This species can be distinguished most readily by the structure of the male genitalia.

*Mysidia cooperi* sp. n.

(Figs 247, 358, 468)

Male: head 0.59 mm long, 0.88 mm wide; pronotum 2.06 mm wide; tegmen 8.60 mm long; wing 5.61 mm long. Female unknown.

Length of frons 5 times width at apex, 1.66 times width at base; ocelli small, obscure; clypeus *c.* as long as frons; rostrum extending fractionally beyond hind coxae. Pronotal width 16 times mid-dorsal length, fronto-lateral carinae very prominent; tegula with carinae weak.

Frons and genae at level of eyes irregularly brownish; fronto-lateral surfaces of pronotum at level of eyes broadly pale orange. Tegmen and wing whitish hyaline, veins pale, cross-veins very dark brown. Tegmen with costal margin narrowly black basally; costal cell with a prominent blackish spot at level of point of separation of subcostal and radial veins; clavus with a blackish brown spot at apex of anal vein; apical and posterior margins with semicircular smoky brown spots between veins. Wing with radial-medial cross-vein very dark brown; a dark brown spot between cubital vein and claval suture at midlength; a dark spot on posterior margin at apex of clavus; semi-circular dark spots on posterior margin between branches of cubital, medial and radial veins.

Shaft of aedeagus rotated 90° clockwise in anterior aspect; right lateral surface subapically produced into a pair of flap-like processes bearing very numerous, small, conical spines, ventral process terminating anteriorly in an acute spine. Paramere slender, apex acute; dorsal process situated at midlength, robust, apex little produced.

## MATERIAL EXAMINED

Holotype ♂, **Colombia**: Putumayo, Mocoa, 550 m, 16.viii.1978 (*Cooper*) (BMNH).

This species is readily distinguished by the pigmentation and by the unique structure of the aedeagus.



*Mysidia diana* sp. n.

(Figs 227, 338, 447)

Male: head 0.63 mm long, 0.80 mm wide; pronotum 1.82 mm wide; tegmen 9.35 mm long; wing 5.53 mm long. Female: tegmen 11.22 mm long.

Length of frons 6.5 times width at apex, 2.66 times width at base; ocelli small, distinct; clypeus one-quarter longer than frons; rostrum extending to base of subgenital plate. Pronotal width 18 times mid-dorsal length; fronto-lateral surfaces and tegula not carinate.

Head and body unmarked. Tegmen and wing whitish hyaline. Tegmen with costal margin smoky brown; an irregular brownish band extending over first fork of cubital vein almost to vanal fold; indistinct pale brown mottling immediately distad of midlength; a small, prominent, dark brown spot over bases of fourth, fifth and sixth branches of medial vein; a smaller dark spot on margin over apex of fifth branch of medial vein; cross-veins narrowly dark brown. Wing with anal area irregularly mottled smoky brown extending over first and second forks of cubital vein; a very large smoky brown area covering radial-medial cross-vein and branches of medial vein extending to apical margin between branches of medial and cubital veins.

Shaft of aedeagus robust; dorsal surface subapically with a pair of very large, apically truncate, flap-like processes. Paramere broad, apex rounded; dorsal process situated immediately basad of midlength, strongly produced posteriorly; internal lateral surface with a low curving ridge bearing robust spines at one-quarter length.

## MATERIAL EXAMINED

Holotype ♂, Ecuador: Feltons, 12 km Napo, nr Tema, 8.iv.1923 (*Williams*) (BMNH).

Paratype. Ecuador: 1 ♀, Tema (BMNH).

This species is readily distinguished by the pigmentation of the wing and by the structure of the male genitalia.

*Mysidia dollingi* sp. n.

(Figs 255, 366, 476)

Male: head 0.63 mm long, 0.95 mm wide; pronotum 1.97 mm wide; tegmen 9.35 mm long; wing 5.10 mm long. Female: tegmen 10.00–11.40 mm long.

Length of frons *c.* 7 times width at apex, 2.5 times width at base; ocelli indistinct; clypeus one-fifth longer than frons; rostrum extending to base of subgenital plate. Pronotal width 19 times mid-dorsal length, fronto-lateral carinae absent; tegula prominently carinate.

Head with a broad orange band extending horizontally from anterior margin of genae to eye, and continuing over fronto-lateral surface of pronotum to lateral margin. Tegmen and wing whitish hyaline, posterior and apical margins pale smoky brown, cross-veins dark brown; veins intermittently narrowly edged smoky brown. Tegmen with costal cell pale brownish, with a small dark brown spot at level of first fork of cubital vein and another immediately basad of second fork; claval margin with a small brown spot adjacent to point of fusion of anal veins and another at apex of anal vein.

Shaft of aedeagus basally slender, becoming laterally expanded towards apex; dorsal surface subapically with a pair of slender spine-like processes and a pair of lateral flap-like processes, each terminating in a small spine. Paramere very robust; apex broadly rounded; dorsal process situated somewhat distad of midlength, apex produced posteriorly; dorsal surface at one-quarter length with a rounded flap-like secondary process bearing numerous, very long, robust spines.

## MATERIAL EXAMINED

Holotype ♂, Panama: Canal Zone, Barro Colorado, 8.viii.1967 (*O'Brien*) (FAMU).

Paratypes. Panama: 1 ♂, 4 ♀, Canal Zone (FAMU; BMNH). Costa Rica: 4 ♀, Guan, 5 miles SE. Liberia (FAMU; BMNH).

*Mysidia striata* sp. n.

Female: head 0.50 mm long, 0.71 mm wide; pronotum 1.40 mm wide; tegmen 6.80 mm long; wing 3.80 mm long. Male unknown.

Length of frons 6 times width at apex, *c.* twice width at base; ocelli very large, prominent; clypeus slightly longer than frons; rostrum terminating immediately posterior to hind coxae. Pronotal width 14 times mid-dorsal length; fronto-lateral carinae distinct; tegula without carinae.

Genae dorsad of eyes tinged reddish; pronotum white, fronto-lateral surfaces each with a broad, dark reddish brown band extending horizontally dorsad of carina from adjacent to eye to lateral margin; another similar band terminating immediately prior to reaching lateral margin at level of ventral margin of eye; meso- and metanotum yellowish brown dorsally, tinged reddish ventrally; coxae reddish; abdomen dorsally deep brown, paler at mid-dorsal line, ventral surface deep reddish. Tegmen and wing yellowish hyaline, veins yellow. Tegmen with cross-veins edged pale brownish; a narrow, brown, transverse band extending from costal margin to apex of clavus; a large dark brownish spot at three-quarters length extending from costal margin over medial-radial cross-vein. Wing with a broad, brown, transverse band extending obliquely from costal to posterior margin at level of cross-veins; apical two-fifths brown, medial and apical cells broadly hyaline medially.

#### MATERIAL EXAMINED

Holotype ♀, **Brazil**: Para, Jabaty, v.1924 (*Williams*) (BMNH).

Paratype. 1 ♀, same data as holotype (BMNH).

In the absence of males, this species is very readily distinguished by its pigmentation, especially the unique double horizontal dark bands on the fronto-lateral surfaces of the pronotum.

### *Mysidia sanguinea* sp. n.

(Figs 215, 325, 434)

Male: head 0.71 mm long, 0.90 mm wide; pronotum 1.68 mm wide; tegmen 7.20–8.30 mm long; wing 4.33 mm long. Female: tegmen 7.40–8.40 mm long.

Length of frons 5.5 times width at apex, 2.5 times width at base; ocelli large, prominent; clypeus as long as frons; rostrum terminating immediately posterior to hind coxae. Pronotal width 17 times mid-dorsal length, fronto-lateral carinae highly elevated; tegula not distinctly carinate.

Frons, genae ventral to lower margins of eyes, and vertex deep reddish brown; ocelli orange; fronto-lateral surfaces of pronotum ventral to midline of eyes, fore tibia, apices of mid and hind tibia, and disc of mesonotum dark reddish brown; pronotum dorso-laterally, under surfaces of mesonotum, metanotum, and abdomen, and legs pale brownish; dorsal surface of abdomen dark reddish brown/black, pregenital segment narrowly crimson posteriorly. Tegmen and wing whitish hyaline, veins dark brown/black. Tegmen with a large, irregular, dark-brown spot near base, another at apex of clavus; a transverse dark band extending from costal margin to first fork of cubital vein, linking with another dark spot at first fork of medial vein, and extending to cover second cubital vein and medial-cubital cross-vein; apical forks of medial and radial veins narrowly edged orange or yellow; posterior margin between veins narrowly dark brown. Wing with an irregular, obliquely transverse dark brownish band covering forks and cross-veins; branches of medial and cubital veins narrowly edged dark brown; posterior margin narrowly and distinctly dark.

Male genitalia with shaft of aedeagus slender; ventral surface subapically with a pair of slender spines; dorsal surface unarmed. Paramere basally slender, becoming expanded from midlength; apex obtusely rounded; dorsal process large, robust, situated at two-thirds length; dorsal surface at one-third length with a large, obtusely rounded, secondary process bearing numerous short robust spines.

#### MATERIAL EXAMINED

Holotype ♂, **Brazil**: Vila Amazonas, Amapá, 21.iii.1963 (*Ross*) (CAS).

Paratypes. **Brazil**: 6 ♂, 13 ♀, Amazonas (CAS; INPA; BMNH). **Peru**: 1 ♂, Tingo Maria (CAS). **Surinam**: 1 ♂, Brokopondo (FAMU).

This species is readily distinguished by the striking pigmentation of the head, body, tegmina and wings, and by the unique structure of the male genitalia, in particular the aedeagus.

### *Mysidia calypso* sp. n.

(Figs 237, 146, 457)

Male: head 0.53 mm long, 0.78 mm wide; pronotum 1.72 mm wide; tegmen 8.84 mm long; wing 5.10 mm long. Female unknown.

Length of frons *c.* 7 times width at apex, *c.* 2.5 width at base; ocelli very large, prominent; clypeus *c.* as long as frons; rostrum terminating immediately posterior to hind coxae. Pronotal width 20 times mid-dorsal length; fronto-lateral carinae distinct; tegula not carinate.

Disc of mesonotum and dorsal surface of abdomen dark brown; ocelli yellow, narrowly edged scarlet.

Tegmen and wing whitish hyaline, veins dark brown. Tegmen with cross-veins narrowly edged dark brown; posterior margin between veins broadly brownish; basal cells irregularly smoky brown medially; apical cells and cells on posterior margin irregularly edged smoky brown; clavus with a dark spot subapically; a dark brown spot between apex of clavus and first branch of cubital vein. Wing with apex of clavus, adjacent area at level of first branch of cubital vein, and apical one-fifth length broadly dark smoky brown.

Shaft of aedeagus slender; dorsal surface subapically with a pair of long apically serrated processes laterally, and a pair of broad flap-like processes bearing numerous small conical spines medially, each with a small spine basally; ventral surface with a pair of short, apically acute, flap-like processes subapically. Paramere very slender; apex obliquely truncate; dorsal process arising slightly basad of midlength, greatly produced posteriorly; dorsal surface at one-fifth length with a broadly rounded secondary process bearing numerous short robust spines.

#### MATERIAL EXAMINED

Holotype ♂, **Brazil**: Rezende, Estado de Rio, ii.1924 (*Williams*) (BMNH).

This species is distinguished by the tegminal, and especially the wing, pigmentation, and by the structure of the male genitalia.

### *Mysidia lucianna* sp. n.

(Figs 262, 373, 481)

Male: head 0.54 mm long, 0.90 mm wide; pronotum 1.89 mm wide; tegmen 8.80–9.10 mm long; wing 5.35 mm long. Female: tegmen 9.35–9.84 mm long.

Length of frons *c.* 4 times width at apex, *c.* twice width at base; ocelli obsolete; clypeus *c.* one-third longer than frons; rostrum terminating at level of mid coxae. Pronotal width 13 times mid-dorsal length; fronto-lateral carinae very prominent; tegula distinctly carinate.

Frons with a narrow, transverse, dark brown band at level of dorsal margins of eyes; vertex mottled dark brown; fronto-lateral surfaces of pronotum each with a broad pale orange band extending horizontally from adjacent to eye to lateral margin. Tegmen and wing whitish hyaline, cross-veins narrowly dark brown. Tegmen with a small dark brown spot on costal margin slightly basad of one-third length; an irregular pale brown area around apical forks of radial and medial veins; a small brown spot on claval margin at apex of anal vein; a paler brown spot at level of junction of anal veins; apical margin between veins with small smoky brown spots. Wing with a transverse brown marking over cubital vein at midlength; posterior margin with dark brown spots between anal veins, between branches of cubital vein, and between cubital and medial branches.

Shaft of aedeagus slightly asymmetrical, somewhat expanded over apical half; dorsal surface subapically with a pair of large flap-like processes bearing numerous, extremely small, tooth-like projections; left-hand process terminating anteriorly in a curved spine. Paramere long and slender; apex acute; dorsal process robust, not greatly produced posteriorly, situated at midlength; dorsal surface at approximately one-fifth length with a small, blunt, secondary process bearing numerous long slender spines.

#### MATERIAL EXAMINED

Holotype ♂, **Brazil**: Belem, Para, vi.1924 (*Williams*) (BMNH).

Paratypes. **Brazil**: 15 ♂, 22 ♀ (BMNH; FAMU; INPA). **Surinam**: 1 ♂, S. Kraka (FAMU).

This species is most readily determined by the pigmentation of the head and pronotum, and by the structure of the male genitalia.

### *Mysidia peregrina* sp. n.

(Figs 182, 292, 401)

Male: head 0.52 mm long, 0.82 mm wide; pronotum 2.12 mm wide; tegmen 7.65 mm long; wing 4.42 mm long. Female unknown.

Length of frons 4 times width at apex, 2.5 times width at base; ocelli large, prominent; clypeus *c.* as long as frons; rostrum terminating at level of hind coxae. Pronotal width *c.* 9 times mid-dorsal length, fronto-lateral carinae very prominent; tegula not carinate.

Fronto-lateral surfaces of pronotum each with a brownish band extending horizontally from adjacent to eye to lateral margin; disc of mesonotum whitish anteriorly, gradually darkening posteriorly. Tegmen and wing whitish hyaline. Tegmen with cross-veins and branches of veins dark brown; cells, especially those adjacent to costal margin, densely mottled smoky brown; a small, distinct black spot over apical fork of

medial vein; a small, but very distinct, black spot in each of the five apical cells. Wing with veins dark brown; cells faintly and sparsely mottled smoky brown.

Shaft of aedeagus cylindrical; apex slightly expanded, curving dorsally; ventral surface subapically with numerous, extremely small, blunt spines; dorsal surface subapically with a pair of long spines laterally, and a pair of hooked spine-like processes adjacent to midline. Paramere basally slender, expanded apically; dorsal process reduced to a simple, posteriorly directed hook at one-third length; internal surface with a low, transverse, flap-like process bearing robust spines at one-quarter length.

#### MATERIAL EXAMINED

Holotype ♂, **Brazil**: Mato Grosso, Barra do Tapirape, 30.xii.1952 (*Malkin*) (CAS).

This species is readily distinguished by the prominent black spot on the tegmen; and by the unique structure of the male genitalia in which the complex armature of the aedeagus is coupled with the great reduction in the development of the dorsal process of the paramere.

### *Mysidia fowleri* sp. n.

(Figs 173, 282, 391)

Male: head 0.44 mm long, 0.61 mm wide; pronotum 1.64 mm wide; tegmen 5.50–5.90 mm long; wing 3.05 mm long. Female: tegmen 6.20–6.40 mm long.

Length of frons 4 times width at apex, twice width at base; ocelli large, not prominent; clypeus one-quarter longer than frons; rostrum terminating immediately posterior to hind coxae. Pronotal width 11 times mid-dorsal length, fronto-lateral carinae prominent; tegula distinctly carinate.

Fronto-lateral surfaces of pronotum each with an orange band extending horizontally from adjacent to eye to lateral margin. Tegmen and wing clear hyaline, costal margins and basal areas predominantly dark brown, veins and cross-veins broadly margined dark smoky brown.

Shaft of aedeagus slender in dorsal aspect; ventral surface at midlength and subapically thickly covered with tiny blunt spines; dorsal surfaces at two-thirds length with a pair of rounded flap-like processes and a pair of slender spines. Paramere with dorsal process situated at one-quarter length, greatly produced posteriorly; a large flap-like process on internal surface basally; dorsal surface over apical half strongly curved towards midline, bearing numerous short robust spines; ventral surface subbasally with numerous long slender spines, at midlength with a long, slender, apically rounded process.

#### MATERIAL EXAMINED

Holotype ♂, **Panama**: C.Z., Fort Kobbe, 24.vi.1976 (*Riley*) (FAMU).

Paratypes. 1 ♂, 3 ♀, same data as holotype (FAMU; BMNH).

The external characters confirm the placement of this species in *Mysidia*, but the male genitalia are not characteristic of the genus.

### *Mysidia grandis* sp. n.

Female: head 0.80 mm long, 1.05 mm wide; pronotum 2.56 mm wide; tegmen 13.25–13.40 mm long; wing 7.80 mm long. Male unknown.

Length of frons c. 6 times width at apex, 4 times width at base; ocelli large, not prominent; clypeus one-sixth longer than frons; rostrum extending to base of pregenital segment. Pronotal width 24 times mid-dorsal length; fronto-lateral carinae absent; tegula with distinct carinae.

Genae occasionally tinged brownish between eye and anterior margin; fronto-lateral surfaces of pronotum occasionally tinged with orange laterally; tegula dorsad to carinae dark brown; disc of mesonotum with a broad, dark brown, transverse band medially; metanotum with a large, circular, dark brown spot on either side at base of scutellum. Tegmen and wing whitish hyaline, veins pale brown, cross-veins edged smoky hyaline, posterior and apical margins with smoky brown spots between veins. Tegmen with costal cell white, with a small, dark brown spot at level of subcostal-radial fork, and another somewhat basad; basal half of cells between radial and medial veins, and entire cell between medial and cubital veins boldly and irregularly mottled dark brown and yellow, adjacent cells mottled smoky hyaline; radial vein with a prominent, roughly circular, blackish brown spot over apical fork; fifth and sixth radial branches linked by a paler, irregular, brownish spot; first cubital branch with a large, irregular, brown spot extending to claval margin. Wing with a large, irregular, broad, smoky brown band extending from cubital vein to anal margin at approximately one-fifth length.

## MATERIAL EXAMINED

Holotype ♀, **Panama**: Chiriqui, Fortuna, 82 15'W 8 44'N, 17.v.1978 (*O'Brien & Marshall*) (FAMU).  
Paratype. 1 ♀, same data as holotype (BMNH).

This species is readily distinguished by its large size and by the pigmentation of the thorax and tegmina.

*Mysidia minerva* sp. n.

(Figs 205, 315, 424)

Male: head 0.55 mm long, 0.63 mm wide; pronotum 1.25 mm wide; tegmen 5.70–6.55 mm long; wing 3.80 mm long. Female unknown.

Length of frons 5 times width at apex, twice width at base; ocelli large, prominent; clypeus slightly shorter than frons; rostrum terminating level with hind coxae. Pronotal width 20 times mid-dorsal length; fronto-lateral surfaces and tegula not carinate.

Genae and frons at level of eyes pale reddish brown; fronto-lateral surfaces of pronotum each with a prominent bright orange band extending horizontally from adjacent to eye to lateral margin; dorsal surface of abdomen basally mottled bright orange. Tegmen and wing hyaline. Tegmen with veins pale brown; cross-veins and forks of veins dark brown, very narrowly edged smoky brown; with two roughly circular dark smoky brown spots on costal cell subbasally; apex of clavus with a large, irregular, smoky brown spot. Wing with veins over apical two-thirds length dark brown; apex of claval area narrowly dark smoky brown.

Shaft of aedeagus slender, apex laterally expanded; dorsal surface subapically with a pair of large, rounded, flap-like processes, each bearing a small spine-like projection subbasally. Paramere with apex broadly and irregularly rounded; dorsal process large, situated at two-thirds length, strongly produced postero-dorsally.

## MATERIAL EXAMINED

Holotype ♂, **Belize**: Toledo District, Salamanca, 25 miles NW. Punta Gorda, 28.viii.1978 (*Broomfield*) (BMNH).

Paratypes. **Belize**: 1 ♂, Belize; 1 ♂, Orange Walk District (FAMU).

This species is most readily distinguished by the very sparse pigmentation of the tegmen and wing, coupled with the bright orange bands on the pronotum, and by the structure of the male genitalia.

*Mysidia punctifera* Metcalf

*Mysidia punctifera* Metcalf, 1938: 313. Holotype ♀, PANAMA (MCZ) [examined].

Female: head 0.71 mm long, 0.92 mm wide; pronotum 2.00 mm wide; tegmen 9.35 mm long; wing 5.53 mm long. Male unknown.

Length of frons 7 times width at apex, 3 times width at base; ocelli large, not prominent; clypeus slightly longer than frons; rostrum terminating at level of hind coxae. Pronotal width 19 times mid-dorsal length; fronto-lateral carinae absent; tegula weakly carinate basally.

Genae each with a narrow, pale brown band extending from adjacent to midline of eye to anterior margin; ocelli pale; fronto-lateral surfaces of pronotum broadly pale orange from adjacent to eyes to lateral margins; disc of mesonotum irregularly brown posteriorly between lateral carinae; dorsal surface of abdomen devoid of dark markings. Tegmen and wing predominantly whitish hyaline; veins yellowish; cross-veins dark brown, narrowly edged dark smoky brown, Tegmen with costal cell irregularly mottled dark brown over basal half; radial, medial and cubital areas densely mottled dark brown and yellow over basal two-fifths; claval area narrowly dark brown basally, with a large, prominent, irregular, dark brown spot between apex and first branch of cubital vein; medial area at slightly distad of two-fifths length, and again at level of second fork, broadly and irregularly dark brown, the latter marking extending anteriorly to subcostal vein and, indistinctly, posteriorly to adjacent to claval apex; apical fork of medial vein with a large, prominent, dark brown spot; posterior and apical margins with small pale brownish spots intermittingly between veins. Wing with a pale, indistinct, narrow, transverse brownish band at level of first fork of cubital vein; a large, indistinct, pale brown spot over fork of medial vein; a distinct, dark brown, roughly circular spot between first fork of cubital vein and claval suture at approximately midlength; posterior margin between anal veins and branches of cubital veins medially dark brown, the former very prominently so.

## MATERIAL EXAMINED

Holotype ♀, **Panama**: Canal Zone, Barro Colorado, 15.vii.1924 (*Banks*) (MCZ).

The antennae are unusually long, extending for one-half their length beyond anterior margins of genae. The species is also distinguished by the dark mottling and the prominent dark spot at the apex of the clavus of the tegmen.

*Mysidia maculicosta* Fowler

*Mysidia maculicosta* Fowler, 1900: 73. LECTOTYPE ♀, GUATEMALA (BMNH), here designated [examined].

Female: head 0.75 mm long, 0.88 mm wide; pronotum 1.80 mm wide; tegmen 9.60 mm long; wing 6.00 mm long. Male unknown.

Length of frons 7.5 times width at apex, 2.66 times width at base; ocelli large, prominent; clypeus slightly shorter than frons; rostrum terminating immediately posterior to hind coxae. Pronotal width 30 times mid-dorsal length, fronto-lateral carinae absent; tegula distinctly carinate.

Genae reddish at level of dorsal margins of eyes; fronto-lateral surfaces of pronotum each with a broad, horizontal, reddish brown band extending from adjacent to eye to lateral margin; abdomen dorsally with a large dark brown spot at midline over first three segments. Tegmen and wing whitish hyaline, veins pale, cross-veins narrowly edged dark brown. Tegmen with costal margin irregularly brownish from base to level of first fork of cubital vein, this marking extending posteriorly to cover base of first branch of cubital vein; apical fork of medial vein covered by an irregular dark brown spot; clavus with a brown spot at apex; fifth and sixth branches of medial vein each with a brown spot near base; posterior margin weakly brownish between veins. Wing with irregular brownish markings on cross-veins and posterior margin.

## MATERIAL EXAMINED

Lectotype ♀, **Guatemala**: Pantaleon, 1700 ft (*Champion*) (BMNH).

There is also a male from Costa Rica in the type-series; it is very badly damaged, with the head, pronotum and right wing and tegmen missing, and it is very doubtful if it represents this species. The specimen here designated as lectotype bears Fowler's handwritten 'type' label. The species is distinguished by the pigmentation of the pronotum and abdomen.

*Mysidia molesta* sp. n.

(Figs 187, 297, 406)

Male: head 0.69 mm long, 1.01 mm wide; pronotum 2.14 mm wide; tegmen 9.35 mm long; wing 5.52 mm long. Female: tegmen 9.35–10.20 mm long.

Length of frons 6.5 times width at apex, 2.33 times width at base; ocelli small, obscure; clypeus slightly longer than frons; rostrum extending to base of subgenital plate. Pronotal width 17 times mid-dorsal length; fronto-lateral surfaces and tegula not carinate.

Disc of mesonotum with a large dark brown spot posteriorly. Tegmen and wing whitish hyaline, veins yellow, posterior and apical margins broadly smoky brown. Tegmen heavily mottled dark brownish, these markings coalescing to form irregular transverse bands at one-third and two-thirds length. Wing with branches of cubital vein broadly and irregularly edged smoky brown; apical third smoky brown over radial and medial veins.

Shaft of aedeagus broadly laterally expanded; apex strongly produced dorsally; dorsal surface subapically with a pair of large flap-like processes extending over lateral surfaces, each bearing a single, deeply bifurcate projection. Paramere very robust, greatly expanded dorso-ventrally, longitudinally folded towards midline; dorsal process situated at two-fifths length, ventrally directed, small, not posteriorly produced.

## MATERIAL EXAMINED

Holotype ♂, **Brazil**: Amazonas, P. das Laranjeiras, vii–viii.1981 (*Arias*) (INPA).

Paratypes. 4 ♀, same data as holotype (INPA; BMNH).

Closely related to *estfarchina*, *molesta* is distinguished by the dark spot on the mesonotum and by the pigmentation of the tegmen and wing.

*Mysidia obscura* Metcalf

(Figs 260, 371, 483)

*Mysidia obscura* Metcalf, 1938: 317. Holotype ♀, PANAMA (USNM) [examined].

Male: head 0.84 mm long, 1.05 mm wide; pronotum 2.25 mm wide; tegmen 9.70 mm long; wing 5.44 mm long. Female: tegmen 11.05–12.00 mm long.

Length of frons c. 5.5 times width at apex, 3.5 times width at base; ocelli obsolete; clypeus slightly longer than frons; rostrum extending to subgenital plate. Pronotal width c. 14 times mid-dorsal length; fronto-lateral surfaces and tegula distinctly carinate.

Head and body unmarked. Tegmen and wing whitish hyaline, cross-veins and posterior and apical margins broadly edged smoky brown. Tegmen with central areas of cells irregularly smoky brown, these markings coalescing with those bordering cross-veins to form very irregular transverse bands. Wing with an irregular, smoky brown, transverse band at c. midlength, and another over radial-medial cross-vein.

Shaft of aedeagus very broad in lateral aspect; dorsal surface subapically with a pair of large, longitudinally aligned, dorsally directed, flap-like processes, each bearing a pair of short, robust, spine-like projections dorsally. Paramere slender; apex acutely rounded; dorsal process situated slightly distad of midlength, little produced posteriorly; dorsal surface subbasally with a blunt secondary process bearing robust spines.

## MATERIAL EXAMINED

Holotype ♀, Panama: Porto Bello, 27.ii.1911 (*Busck*) (USNM).

Panama: 1 ♂, 1 ♀, Barro Colorado (CAS; BMNH).

This species is distinguished by its large size, the mottled appearance of the tegmina and wings, and by the structure of the male genitalia.

*Mysidia henrietta* sp. n.

(Figs 277, 388, 498)

Male: head 0.59 mm long, 0.73 mm wide; pronotum 1.57 mm wide; tegmen 7.65–8.10 mm long; wing 4.68 mm long. Female: tegmen 8.90 mm long.

Length of frons 8 times width at apex, twice width at base; ocelli small, indistinct; length of clypeus equal to that of frons; rostrum terminating at level of hind coxae. Pronotal width 19 times mid-dorsal length; fronto-lateral carinae obsolete; tegula distinctly carinate.

Genae each with a narrow reddish or dark brown band extending from adjacent to eye to anterior margin; fronto-lateral surfaces of pronotum each with a pale, often indistinct, horizontal band extending from midline of eye to lateral margin. Tegmen and wing whitish hyaline, cross-veins dark brown. Tegmen with a small, prominent, dark brown spot over apical fork of medial vein; a small, often indistinct, pale brown spot on clavus adjacent to junction of anal veins. Wing unmarked.

Male genitalia with shaft of aedeagus slender, broadest at midlength; dorsal surface subapically with a pair of apically bifurcate flap-like processes. Paramere massive; apex rounded; dorsal process situated at midlength, slender, strongly produced posteriorly.

## MATERIAL EXAMINED

Holotype ♂, Brazil: Nietheroy, iv.1924 (*Williams*) (BMNH).

Paratypes. Brazil: 4 ♂, 7 ♀, same data as holotype; Itaparica; Bahia (BMNH; NR).

This species is readily distinguished by the pigmentation of the tegmen and wing, and by the structure of the male genitalia.

*Mysidia distanti* sp. n.

(Figs 174, 283, 392)

Male: head 0.59 mm long, 0.75 mm wide; pronotum 1.60 mm wide; tegmen 7.80–8.50 mm long; wing 4.70 mm long. Female: tegmen 8.90–10.00 mm long.

Length of frons c. 7.5 times width at apex, slightly less than 3 times width at base; ocelli distinct, not prominent; clypeus as long as frons; rostrum extending to base of subgenital plate. Pronotal width slightly greater than 19 times mid-dorsal length; fronto-lateral surfaces not carinate; tegula carinate basally.

Genae anterior to eyes often brownish; fronto-lateral surfaces of pronotum and tegula often orange at

level of eyes; dorsal surface of abdomen seldom with two pairs of small dark brown spots adjacent to midline basally. Tegmen and wing almost hyaline, very weakly tinged whitish, veins yellowish; cross-veins dark brown, edged smoky brown; posterior and apical margins broadly smoky brown between veins. Tegmen weakly and irregularly mottled smoky brown between branches of medial and cubital veins; clavus often with a small dark brown spot level with point of fusion of anal veins; apical fork of medial vein narrowly and distinctly dark brown or black. Wing with radial-medial cross-vein and adjacent branches very dark brown.

Male genitalia with shaft of aedeagus broad in lateral aspect; dorsal surface at midlength with a pair of large flap-like processes extending almost to apex; lateral surfaces each with a flap-like process extending from subapically almost to base. Paramere robust; apex broadly rounded; dorsal process situated slightly distad of midlength, strongly curved postero-ventrally.

#### MATERIAL EXAMINED

Holotype ♂, **Honduras**: Sta. B. 13 km SE. El Mochito, 22.vii.1977 (*O'Brien & Marshall*) (FAMU).

Paratypes. **Honduras**: 2 ♂, 3 ♀, same data as holotype (FAMU; BMNH). **Belize**: 1 ♂, Belize Distr. (FAMU).

This species closely resembles *insolita*, but differs in the almost hyaline tegmina and wings, the dark pigmentation of the veins of the wing around the radial-medial cross-vein, and in the structure of the male genitalia.

### *Mysidia albicans* Stål

(Figs 279, 390, 500)

*Derbe albicans* Stål, 1855: 191. LECTOTYPE ♂, BRAZIL (NR), here designated [examined].

*Mysidia albicans* (Stål) Stål 1856: 163.

Male: head 0.61 mm long, 0.71 mm wide; pronotum 2.40 mm wide; tegmen 8.40 mm long; wing 5.30 mm long. Female unknown.

Length of frons slightly less than 6 times width at apex, 2.25 times width at base; ocelli small, not prominent; length of clypeus one-fifth greater than that of frons; rostrum extending somewhat behind posterior coxae. Pronotal width 27 times mid-dorsal length; fronto-lateral surfaces not carinate.

Genae at level of eyes dull brownish; fronto-lateral surfaces of pronotum broadly and very indistinctly pale brown at level of eyes. Tegmen and wing whitish hyaline, veins pale yellow. Tegmen with cross-veins and branches of medial vein narrowly dark brown; clavus with a faint brownish spot subbasally, and another, more distant, spot adjacent to point of fusion of anal veins; costal cell with a small, dark brown spot at one-sixth length, and another at point of separation of subcostal and radial veins, the latter spot being somewhat fainter and extending transversely over medial vein; medial vein with a small, very prominent, roughly circular, dark brown/black spot over apical fork; a very faint and irregular, pale brownish, transverse band extending from costal margin to third branch of cubital vein slightly distad of midlength. Wing with radial-medial cross-vein brownish; very indistinctly mottled pale brown at level of first and second forks of cubital vein; a very irregular, broken, pale brownish, transverse band at level of fork of radial vein; an irregular, brownish spot between first branch of cubital vein and claval suture at two-thirds length of latter.

Male genitalia with shaft of aedeagus slender; lateral surfaces subapically each with a large, flap-like process extending over dorsal surface and produced anteriorly into an acute spine. Paramere robust; apex broadly rounded; dorsal process situated somewhat distad of midlength, strongly produced posteriorly; dorsal surface subbasally bearing numerous short, robust spines.

#### MATERIAL EXAMINED

Lectotype ♂, **Brazil** (*Westerman*) (NR).

The single specimen available for study is damaged and the tegulae are missing; it appears to be teneral but is believed to be free of distortion. In his description Stål did not cite the number of specimens, neither did he designate a holotype; the specimen listed above is here designated as lectotype.



*Mysidia nemorensis* sp. n.

(Figs 195, 305, 414)

Male: head 0.59 mm long, 0.86 mm wide; pronotum 1.95 mm wide; tegmen 7.91 mm long; wing 4.50 mm long. Female: tegmen 9.70 mm long.

Length of frons rather less than 5 times width at apex, slightly greater than twice width at base; ocelli small, distinct; clypeus one-quarter longer than frons; rostrum extending to base of subgenital plate. Pronotal width 22 times mid-dorsal length; fronto-lateral carinae obsolete; tegula with distinct carinae.

Fronto-lateral surfaces of pronotum usually each with a broad yellowish brown band extending horizontally from adjacent to eye to lateral margin. Tegmen and wing whitish hyaline, irregularly mottled smoky brown around forks of veins and cross-veins and on posterior and apical margins; veins pale brown. Tegmen with an irregular, smoky brown, transverse band at level of first fork of cubital vein. Wing unmarked.

Male genitalia with shaft of aedeagus broadly laterally expanded distad of midlength; dorsal surface subapically with a pair of large flap-like processes, broadening apically, each produced anteriorly and posteriorly into a long curving spine-like projection. Paramere robust; apex obtusely rounded; dorsal process situated at mid-length, not posteriorly produced.

## MATERIAL EXAMINED

Holotype ♂, **Surinam**: Brokopondo, 30.i.1969 (*O'Brien*) (FAMU).

Paratypes. **Surinam**: 1 ♂, 2 ♀, same data as holotype (FAMU; BMNH). **Brazil**: 11 ♂, 12 ♀, Amazonas (INPA; BMNH).

Not readily distinguished by external characters, this species can be recognized most easily by the complex armature of the aedeagus and the undeveloped paramere.

*Mysidia insolita* sp. n.

(Figs 213, 323, 432)

Male: head 0.61 mm long, 0.75 mm wide; pronotum 1.95 mm wide; tegmen 6.80–8.10 mm long; wing 4.50 mm long. Female: tegmen 9.35 mm long.

Length of frons 6.5 times width at apex, slightly less than 2.5 times width at base; ocelli large, not prominent; clypeus slightly longer than frons; rostrum extending to base of subgenital plate. Pronotal width slightly less than 18 times mid-dorsal length; fronto-lateral surfaces and tegula not carinate.

Genae tinged orange-brown; fronto-lateral surfaces of pronotum each with a broad, horizontal, orange band extending from adjacent to eye to lateral margin. Tegmen and wing whitish hyaline, veins yellow; cross-veins brown, broadly edged smoky brown; posterior and apical margins broadly smoky brown between veins. Tegmen with costal and radial cells mottled brown; with an irregular, smoky brown, transverse band at one-quarter length; apical fork of medial vein narrowly very dark brown. Wing irregularly mottled smoky brown.

Male genitalia with shaft of aedeagus broad; dorsal surface subapically with a pair of large flap-like processes adjacent to midline and extending anteriorly to base. Paramere slender; apex acute; dorsal process situated at one-third length, produced postero-dorsally, with a ventrally directed lobe at mid-length.

## MATERIAL EXAMINED

Holotype ♂, **Honduras**: Cortes, 27 km S. Potrerillos, 8.viii.1977 (*O'Brien & Marshall*) (FAMU).

Paratypes. **Honduras**: 1 ♂, same data as holotype (BMNH). **Belize**: 1 ♀, Altun Ha (FAMU).

Bearing a close superficial resemblance to *distanti*, this species is distinguished by the denser mottling of the tegmen and wing, the paler veins of the latter, and by the structure of the male genitalia.

*Mysidia enjebetta* sp. n.

(Figs 281, 289, 399)

Male: head 0.63 mm long, 0.80 mm wide; pronotum 1.70 mm wide; tegmen 7.90 mm long; wing 4.85 mm long. Female unknown.

Length of frons 6.5 times width at apex, slightly less than 3 times width at base; ocelli obsolete; clypeus as

long as frons; rostrum terminating immediately posterior to hind coxae. Pronotal width 27 times mid-dorsal length; fronto-lateral surfaces not carinate; tegula weakly carinate.

Lateral carinae of frons tinged brownish at level of eyes; fronto-lateral surfaces of pronotum each with a broad orange band extending horizontally from adjacent to eye to lateral margin; lateral surfaces of mesonotum tinged crimson ventral to bases of tegmina. Tegmen and wing whitish hyaline; veins pale yellowish brown; cross-veins and forks of veins dark brown; posterior and apical margins smoky brown between veins. Tegmen with cross-veins broadly margined smoky brown; apical fork of medial vein very prominently dark brown; non-apical cells narrowly and irregularly pale smoky brown medially. Wing with irregularly spaced, roughly circular, smoky brown spots between cubital vein and claval suture; apical cells irregularly tinged smoky brown medially.

Male genitalia with shaft of aedeagus broad; dorsal surface subapically with a pair of very large, flap-like processes; lateral surfaces each with a very large, flap-like process over apical half length. Paramere with apex acutely rounded; dorsal process situated slightly basad of mid-length, strongly produced; dorsal surface at three-quarters length strongly and roundly produced into an internally directed secondary process.

#### MATERIAL EXAMINED

Holotype ♂, Mexico: Tepic, Nayarit, 13.iii.1957 (*Dreisbach*) (USNM).

This species is distinguished by the combination of pronotal and tegminal pigmentation, and by the structure of the male genitalia.

#### *Mysidia nigrifrontalis* sp. n.

(Figs 241, 352, 461)

Male: head 0.52 mm long, 0.65 mm wide; pronotum 1.30 mm wide; tegmen 6.55 mm long; wing 3.91 mm long. Female: tegmen 8.33–8.92 mm long.

Length of frons 5 times width at apex, c. 3 times width at base; ocelli very prominent; clypeus slightly shorter than frons; rostrum extending to base of pregenital segment. Pronotal width slightly greater than 12 times mid-dorsal length; fronto-lateral surfaces weakly carinate; tegula not carinate.

Ocelli scarlet; fronto-lateral surfaces of pronotum each with a very large dark brown/black marking, considerably broader than eye, tapering gradually from adjacent to eye to lateral margin; abdomen with a very large, circular, scarlet spot on dorsal surface subapically; metanotum suffused smoky brown on either side of scutellum. Tegmen and wing whitish hyaline, veins pale brown, cross-veins edged dark smoky brown, otherwise unmarked.

Male genitalia with shaft of aedeagus slender, parallel-sided in dorsal aspect, somewhat expanded subapically in lateral aspect; ventro-lateral surfaces each with a rounded lobe bearing small obtuse spines; dorsal surfaces with a pair of very large, rounded, flap-like processes subapically; lateral surfaces each with a single, long, bifurcate process subapically. Paramere robust; apex broadly rounded; dorsal process large, situated subapically, strongly produced posteriorly; dorsal surface over basal one-third length with numerous, short, robust spines; ventral surface over basal half length with numerous, long, slender spines.

#### MATERIAL EXAMINED

Holotype ♀, Panama: Chiriqui, Fortuna, 82 15'W 8 44'N, 8.v.1978 (*O'Brien & Marshall*) (FAMU).

Paratypes. 2 ♀, same data as holotype (FAMU; BMNH).

This species is readily distinguished by the very striking pigmentation of the thorax and abdomen, and by the unique structure of the male genitalia.

#### *Mysidia andes* sp. n.

(Figs 258, 369, 479)

Male: head 0.73 mm long, 1.05 mm wide; pronotum 2.14 mm wide; tegmen 10.20–10.45 mm long; wing 6.00 mm long. Female unknown.

Length of frons 4.25 times width at apex, 3.33 times width at base; ocelli obsolete; clypeus as long as frons; rostrum extending to base of subgenital plate. Pronotal width c. 11 times mid-dorsal length; fronto-lateral surfaces not carinate; tegula weakly carinate.

Dorsal surfaces of pronotum tinged scarlet; disc of mesonotum dark brown posteriorly. Tegmen and wing smoky brown, veins brown, cells with hyaline spots medially; otherwise unmarked.

male genitalia with shaft of aedeagus robust, apically truncate; dorsal surface subapically with two pairs

of short, spine-like processes. Paramere slender; apex acutely rounded; dorsal process situated at two-thirds length, small, strongly produced posteriorly; dorsal surface basally with a rounded secondary process bearing short robust spines.

**MATERIAL EXAMINED**

Holotype ♂, **Bolivia**: La Paz, Rio Beni, San Buenaventura, 270 km, 22.iv.1979 (*Cooper*) (BMNH).  
Paratypes. **Bolivia**: 2 ♂, Prov. del Sara (*Steinbach*) (CM).

This species is distinguished by its large size, the pigmentation of the tegmina and wing, and by the very reduced armature of the aedeagus.

***Mysidia bibula* sp. n.**

(Figs 209, 317, 428)

Male: head 0.63 mm long, 0.78 mm wide; pronotum 1.70 mm wide; tegmen 7.90–8.70 mm long; wing 5.10 mm long. Female: tegmen 8.80–9.40 mm long.

Length of frons c. 7 times width at apex, 2.5 times width at base; ocelli very large, prominent; length of clypeus slightly greater than that of frons; rostrum extending to base of subgenital segment. Pronotal width 18 times mid-dorsal length; fronto-lateral surfaces and tegula devoid of carinae.

Genae dorsad of ocelli and fronto-lateral surfaces of pronotum at level of eyes tinged orange; disc of mesonotum brownish yellow. Tegmen and wing whitish hyaline, lacking distinct dark markings; veins pale; tinged pale smoky brown around cross-veins and, irregularly, around veins, within cells, and adjacent to posterior and apical margins.

Male genitalia with shaft of aedeagus slender in lateral aspect; apex acute; dorsal surface subapically with a pair of large, flap-like processes, each terminating in a long, spine-like projection; lateral surfaces at three-fifths length each with a narrow, flap-like process. Paramere apically rounded; dorsal process situated at one-third length, slender, produced dorsally; dorsal surface at one-quarter length with a cluster of short, tooth-like spines.

**MATERIAL EXAMINED**

Holotype ♂, **Panama**: Las Cumbres, 14.v.1978 (*O'Brien*) (FAMU).  
Paratypes. **Panama**: 8 ♂, 15 ♀, same data as holotype; Tocumen; Chorrera; Villa Real (FAMU; USNM; BMNH).

Though lacking distinctive external characters, this species may be distinguished by the structure of the aedeagus:

***Mysidia ecuadoria* sp. n.**

(Figs 191, 301, 410)

Male: head 0.52 mm long, 0.63 mm wide; pronotum 1.32 mm wide; tegmen 6.37–7.31 mm long; wing 4.10 mm long. Female: tegmen 7.90 mm long.

Length of frons 6.5 times width at apex, 2.66 times width at base; ocelli not prominent; clypeus slightly shorter than frons; rostrum terminating at midlength of abdomen. Pronotal width c. 13 times mid-dorsal length; fronto-lateral surfaces not carinate; tegula with distinct carinae.

Fronto-lateral surfaces of pronotum each with a broad, horizontal, brown band extending from adjacent to eye to lateral margin. Tegmen and wing whitish hyaline. Tegmen with branches of medial and cubital veins dark brown, narrowly edged smoky brown; basal third of length mottled smoky brown. Wing with veins and cross-veins in apical half pale brown.

Male genitalia with shaft of aedeagus laterally expanded over apical two-fifths length; dorsal surface subapically with a pair of rounded flap-like processes adjacent to midline; ventral surface with a transverse process at two-thirds length. Paramere slender, apex acute; dorsal process slightly distad of midlength, not produced; dorsal surface near base with a rounded secondary process bearing numerous, long, robust spines.

**MATERIAL EXAMINED**

Holotype ♂, **Ecuador**: Mera, 1–2.ii.1923 (*Williams*) (BMNH).  
Paratypes. 9 ♂, 13 ♀, same data as holotype (BMNH).

This species is most readily distinguished by the male genitalia.

***Mysidia cheesemani* sp. n.**

(Figs 194, 304, 413)

Male: head 0.59 mm long, 0.73 mm wide; pronotum 1.45 mm wide; tegmen 6.00–6.80 mm long; wing 3.40 mm long. Female: tegmen 6.40–7.60 mm long.

Length of frons 4 times width at apex, 2.5 times width at base; ocelli distinct; clypeus slightly shorter than frons; rostrum extending to midlength of subgenital plate. Pronotal width c. 13 times mid-dorsal length; fronto-lateral carinae distinct; tegula not carinate.

Head and body unmarked; abdomen occasionally tinged reddish dorsally. Tegmen and wing whitish hyaline, veins and cross-veins edged smoky brown, otherwise unmarked.

Male genitalia with shaft of aedeagus laterally expanded over apical half length; dorsal surface with a pair of transverse flap-like processes subapically; with a pair of long bifid processes at two-thirds length; a slender bifid process medially at two-fifths length. Paramere broad, shallowly concave apically; dorsal process small, situated at midlength, not posteriorly produced; ventral surface basally with a rounded lobe bearing long slender spines.

## MATERIAL EXAMINED

Holotype ♂, **Trinidad**: Palo Seco, 21.ix.1919 (*Williams*) (BMNH).

Paratypes. **Trinidad**: 69 ♂, 48 ♀, same data as holotype; *Caura*, on *Parthenium* sp. (BMNH). **Venezuela**: 3 ♂, Bolivar (BMNH). **Guyana**: 8 ♂, 5 ♀, Blairmont (BMNH).

External characters are unreliable in this species, and reference must be made to the male genitalia.

***Mysidia augusta* sp. n.**

(Figs 184, 294, 403)

Male: head 0.46 mm long, 0.63 mm wide; pronotum 1.40 mm wide; tegmen 6.20–6.30 mm long; wing 3.57 mm long. Female: tegmen 7.00 mm long.

Length of frons 4 times width at apex, 3 times width at base; ocelli small, often obscure; length of clypeus c. three-quarters that of frons; rostrum extending to base of subgenital plate; fronto-lateral surfaces with carinae prominent; tegula not carinate.

Fronto-lateral surfaces of pronotum with carinae narrowly edged brownish. Tegmen and wing whitish hyaline, veins and cross-veins broadly edged smoky brown. Wing with irregular, smoky brown, transverse bands at one-half and three-quarters length.

Male genitalia with shaft of aedeagus slender in dorsal aspect, apex somewhat expanded; dorsal surface at midlength with a slender bifurcate process; lateral surfaces at three-quarters length each with a spine-like process extending anteriorly to base of dorsal process. Paramere robust; apex obtusely rounded; dorsal process situated slightly distad of midlength, little produced; dorsal surface at one-third length with an acute, hook-like, secondary process.

## MATERIAL EXAMINED

Holotype ♂, **Peru**: Tingo Maria, Los Cuevos road, 2000 ft, 10.viii.1971 (*Broomfield*) (BMNH).

Paratypes. **Peru**: 3 ♂, 1 ♀, Tingo Maria (BMNH; CAS).

Though not readily distinguished by external characters, this species can be recognized by the structure of the male genitalia.

***Mysidia krameri* sp. n.**

(Figs 280, 327, 436)

Male: head 0.42 mm long, 0.71 mm wide; pronotum 1.36 mm wide; tegmen 6.40 mm long; wing 3.40 mm long. Female unknown.

Length of frons 6.5 times width at apex, 3 times width at base; ocelli small, not prominent; clypeus c. as long as frons; rostrum extending to apex of abdomen. Pronotal width 28 times mid-dorsal length; fronto-lateral surfaces and tegula not carinate.

Vertex with basal angles dark brown; ocelli pale; disc of mesonotum irregularly brownish. Tegmen and wing hyaline; veins pale yellow; cross-veins pale brown; both veins and cross-veins broadly edged smoky brown. Tegmen with a broad, irregular, brownish, transverse band extending from claval margin over first fork of cubital vein to costal margin at c. one-third length; with irregular smoky brown markings around

forks of medial vein; posterior and apical margins very broadly and indistinctly pale smoky brown. Wing with an indistinct smoky brown transverse band over radial-medial cross-vein.

Male genitalia with shaft of aedeagus slender; dorsal surface subapically with a pair of large flap-like processes adjacent to midline; ventral surface apically produced into a pair of rounded processes, numerous, very small, tooth-like spines laterally at three-quarters length. Paramere slender; apex obtusely rounded, produced into an acute hook-like process; dorsal process situated subapically, well developed; dorsal surface subbasally produced, bearing numerous long robust spines.

**MATERIAL EXAMINED**

Holotype ♂, **Panama**: Cerro Campana, 19.ix.1951 (*Blanton*) (USNM).

Though the male genitalia, in particular the aedeagus, resemble those of *lloydi*, the tegminal and wing pigmentation readily distinguish this species.

***Mysidia erecta* sp. n.**

(Figs 201, 310, 419)

Male: head 0.63 mm long, 0.82 mm wide; pronotum 1.90 mm wide; tegmen 8.25–8.90 mm long; wing 5.10 mm long. Female unknown.

Length of frons 6 times width at apex, 2.5 times width at base; ocelli small; clypeus slightly longer than frons; rostrum extending to base of subgenital segment. Pronotal width 22 times mid-dorsal length; fronto-lateral surfaces and tegula not carinate.

Head and body unmarked. Tegmen and wing whitish hyaline, cross-veins broadly edged smoky brown, veins irregularly and intermittently edged smoky brown. Tegmen with an irregular, curving, brownish, transverse band at one-third length, and another over second fork of medial vein; apical and posterior margins broadly edged pale smoky brown. Wing with apical and posterior margins irregularly edged smoky brown.

Male genitalia with shaft of aedeagus very greatly laterally expanded; dorsal surface subapically with a pair of large, rounded, flap-like processes extending over lateral surfaces; a pair of long acute processes medially. Paramere very robust; apex obliquely truncate; dorsal process situated slightly basad of midlength, produced dorsally into a long, slender, spine-like projection.

**MATERIAL EXAMINED**

Holotype ♂, **Bolivia**: La Paz, Rio Beni, 270 m, San Buenaventura, 22.iv.1979 (*Cooper*) (BMNH).

Paratype. **Columbia**: 1 ♂, Caqueta, Yuruyacu (BMNH).

This species, though lacking distinctive external characters, is readily distinguished by the dorsal extension of the paramere.

***Mysidia maculosa* sp. n.**

(Figs 270, 381, 491)

Male: head 0.73 mm long, 0.71 mm wide; pronotum 1.60 mm wide; tegmen 8.33 mm long; wing 5.10 mm long. Female: tegmen 8.50 mm long.

Length of frons 6.5 times width at apex, c. 4 times width at base; ocelli large, prominent; clypeus slightly longer than frons; rostrum extending to base of subgenital plate. Pronotal width 13 times mid-dorsal length; fronto-lateral surfaces and tegula not carinate.

Head and body unmarked. Tegmen and wing whitish hyaline. Tegmen with branches of medial and cubital veins broadly edged smoky brown; basal third of length mottled smoky brownish. Wing with veins on apical half pale brownish.

Male genitalia with shaft of aedeagus somewhat swollen subapically; dorsal surface subapically with a pair of slender processes. Paramere very slender, constricted at one-third length, apex obtusely rounded; dorsal process situated slightly distad of one-third length, posteriorly produced; dorsal surface subbasally with a cluster of small robust spines; ventral surface over basal half length with numerous similar spines.

**MATERIAL EXAMINED**

Holotype ♂, **Ecuador**: Mera, 1–2.ii.1923 (*Williams*) (BMNH).

Paratypes. **Ecuador**: 3 ♀, Mera (BMNH).

This species is distinguished by its lack of tegminal and wing pigmentation, and by the very simple armature of the aedeagus.

*Mysidia nebulosa* (Germar)

(Figs 266, 377, 487)

*Derbe nebulosa* Germar, 1830: 56. Syntypes, BRAZIL [examined by L. B. O'Brien].[*Derbe pallida* Fabricius; Spinola, 1839: 379. Misidentification.]*Mysidia nebulosa* (Germar) Schaum, 1850: 70.

Male: head 0.57 mm long, 0.74 mm wide; pronotum 1.58 mm wide; tegmen 7.20–7.85 mm long; wing 4.10 mm long. Female: tegmen 8.00–8.80 mm long.

Length of frons c. 5 times width at apex, 2.25 times width at base; ocelli large, distinct; clypeus one-quarter longer than frons; rostrum extending to base of subgenital plate. Pronotal width 25 times mid-dorsal length; fronto-lateral surfaces and tegula not distinctly carinate.

Fronto-lateral surfaces of pronotum occasionally pale orange at level of eye; abdomen with dorsal surface often brown or orange. Tegmen and wing whitish hyaline; veins and cross-veins yellowish, irregularly and broadly edged smoky brown; posterior and apical margins broadly smoky brown between veins. Tegmen with basal third deeply mottled smoky brown. Wing unmarked.

Male genitalia with shaft of aedeagus laterally expanded over apical half; dorsal surface subapically with a pair of flap-like processes, each terminating dorsally in a laterally curving spine. Paramere robust; apex very obtusely rounded; dorsal process situated somewhat basad of midlength, very small, little produced posteriorly.

## MATERIAL EXAMINED

**Honduras:** 22 ♂, 13 ♀, Comayagua (FAMU; BMNH). **Mexico:** 1 ♀, Cintalapa (FAMU). **Panama:** 1 ♂, Canal Zone (FAMU). **Costa Rica:** 1 ♂, 2 ♀, Guan (FAMU; BMNH). **Ecuador:** 2 ♂, 2 ♀, Tema (FAMU; BMNH).

Though this species was described from specimens from Brazil, the redescription above and the drawings of the male genitalia are based on the specimens from Honduras listed above; these specimens were compared with the type-material by Dr Lois B. O'Brien. The species is distinguished by the tessellated tegmen.

*Mysidia bizzara* sp. n.

(Figs 179, 288, 397)

Male: head 0.46 mm long, 0.65 mm wide; pronotum 1.30 mm wide; tegmen 6.80 mm long; wing 3.90 mm long. Female unknown.

Length of frons 6.5 times width at apex; 2.66 times width at base; ocelli distinct; clypeus slightly shorter than frons; rostrum extending to base of subgenital plate. Pronotal width c. 15 times length mid-dorsally; fronto-lateral surfaces and tegula not carinate.

Head and body unmarked. Tegmen and wing whitish hyaline, faintly smoky brown around cross-veins. Tegmen weakly mottled smoky brown over basal third, these markings coalescing to form a broad, irregular, transverse band over first fork of cubital vein. Wing unmarked.

Male genitalia with aedeagus greatly expanded laterally, widest at one-third length, dorso-ventrally compressed; dorsal surface subapically with a pair of flap-like processes extending over apical half. Paramere with apex very obtusely rounded; dorsal processes situated slightly distad of midlength; dorsal surface strongly produced apically; ventral surface slightly distad of midlength with a large internally directed lobe.

## MATERIAL EXAMINED

Holotype ♂, **Bolivia:** Prov. del Sara (*Steinbach*) (CM).

The lack of distinctive external characters makes the determination of this species largely dependent upon examination of the male genitalia.

*Mysidia intima* sp. n.

(Figs 235, 347, 455)

Male: head 0.63 mm long, 0.84 mm wide; pronotum 1.65 mm wide; tegmen 7.70 mm long; wing 4.70 mm long. Female unknown.

Length of frons 4.5 times width at apex, 3 times width at base; ocelli obsolete; clypeus one-quarter longer

than frons; rostrum extending to base of subgenital plate. Pronotal width 20 times mid-dorsal length; fronto-lateral surfaces and tegula not distinctly carinate.

Head and body unmarked. Tegmen and wing hyaline, veins yellow, posterior and apical margins narrowly and weakly pale yellowish brown, tegmen otherwise unmarked. Wing with a very indistinct pale yellowish brown transverse band over radial-medial cross-vein, and an even fainter band at two-fifths length.

Male genitalia with shaft of aedeagus slender; dorsal surface subapically with a pair of long, slightly curving, spine-like processes adjacent to midline; lateral surfaces each with a slender spine-like process subapically. Paramere with apex broadly rounded; dorsal process situated at midlength, slender, strongly produced postero-dorsally.

#### MATERIAL EXAMINED

Holotype ♂, **Brazil**: Rio Negro, Umarituba, 22.iv.[?] (*Roman*) (NR).

This species is distinguished by the lack of pigmentation (even the wing markings are extremely faint) and by the simple spines on the aedeagus.

### *Mysidia infedelis* sp. n.

(Figs 233, 344, 453)

Male: head 0.67 mm long, 0.92 mm wide; pronotum 1.90 mm wide; tegmen 8.50 mm long; wing 4.70 mm long. Female: tegmen 9.01 mm long.

Length of frons c. 5 times width at apex, 3.5 times width at base; ocelli obsolete; clypeus slightly longer than frons; rostrum extending to base of subgenital plate. Pronotal width 15 times mid-dorsal length; fronto-lateral surfaces and tegula not carinate.

Vertex, dorsal area and margins of frons dark brownish; dorsal and dorso-lateral surfaces of pronotum and tegula darker brownish. Tegmen bright yellowish hyaline, veins yellow, costal margin orange; anterior, apical and posterior margins regularly and narrowly dark smoky brown; claval margin unmarked. Wing with basal and claval areas hyaline, becoming tinged with yellow towards apex; veins yellow; posterior margins broadly and very distinctly edged dark smoky brown from first branch of cubital vein to apex; with a prominent, dark brownish, transverse band at level of apex of clavus, and another similar though rather oblique band at level of radial-medial cross-vein.

Male genitalia with shaft of aedeagus very slender in dorsal aspect; dorsal surface subapically with a pair of slender spines laterally, and a pair of long, somewhat overlapping, spine-like processes medially. Paramere slender; apex broadly rounded, with an acute, medially directed, hook-like projection dorsally; internal surface produced medially into a pair of acute, dorsally directed lobes; dorsal process situated at three-fifths length, slender, strongly produced postero-dorsally; dorsal surface subbasally somewhat produced.

#### MATERIAL EXAMINED

Holotype ♂, **Brazil**: Amazonas, P. des Laranjeiras, viii.–ix.1981 (*Arias*) (INPA).

Paratypes. 1 ♂, 2 ♀, same data as holotype (INPA; BMNH).

This species is most readily distinguished by the yellowish pigmentation of the tegmen and by the dark transverse bands on the wing.

### *Mysidia testacea* (Fabricius)

(Figs 273, 384, 494)

*Derbe testacea* Fabricius, 1803: 82. LECTOTYPE ♂, CENTRAL AMERICA (ZM), here designated [examined].

*Mysidia testacea* (Fabricius) Westwood, 1840: 83.

*Mysidia citrina* Walker, 1858: 98. Holotype ♂, BRAZIL (BMNH) [examined]. **Syn. n.**

Male: head 0.65 mm long, 0.73 mm wide; pronotum 1.42 mm wide; tegmen 6.43–7.65 mm long; wing 4.42 mm long. Female: tegmen 8.00 mm long.

Length of frons c. 5 times width at apex, 3 times width at base; ocelli distinct; clypeus slightly longer than frons; rostrum extending to base of subgenital plate. Pronotal width 8.5 times mid-dorsal length; fronto-lateral surfaces and tegula with carinae obsolete.

Dorsal surfaces of head and body suffused scarlet. Tegmen and wing yellowish hyaline, posterior

margins broadly dark fuscus. Tegmen with costal vein narrowly scarlet. Wing with a prominent fuscous band extending obliquely from radial-medial cross-vein to apex of clavus.

Shaft of aedeagus slender in dorsal aspect; a pair of large flap-like processes enclosing ventral and lateral surfaces subapically; dorsal surface subapically with a pair of curving spine-like processes adjacent to midline. Paramere robust; apex obtusely rounded; dorsal process situated at three-fifths length, strongly produced posteriorly.

#### MATERIAL EXAMINED

**Central America:** 1 ♂ (lectotype of *testacea*) (*Schmidt*) (ZM). **Brazil:** 1 ♂ (holotype of *citrina*), Santarem (*Bates*) (BMNH).

**Guyana:** 1 ♂, Kartabo; 1 ♀, no data (BMNH).

The tegmina of the *testacea* lectotype are missing, but its very distinctive wing pigmentation and the structure of the genitalia indicate that it is conspecific with *citrina*, thus confirming the synonymy of the latter.

### *Mysidia diabola* sp. n.

(Figs 256, 367, 478)

Male: head 0.55 mm long, 0.67 mm wide; pronotum 1.30 mm wide; tegmen 6.00 mm long; wing 3.40 mm long. Female unknown.

Length of frons c. 7 times width at apex, twice width at base; ocelli small, distinct; clypeus slightly longer than frons; rostrum terminating just short of base of subgenital plate. Pronotal width 12.5 times mid-dorsal length; fronto-lateral surfaces and tegula not carinate.

Head with vertex and adjacent surfaces of genae pale orange; frons apically yellowish brown, crimson between lateral carinae ventrad to midline of eyes, reddish brown basally; clypeus dark reddish brown, median and lateral carinae pale crimson. Pronotum dark brown, broadly white along posterior and ventral margins at level of midline of eyes; tegular dark brown, ventral margins paler; mesonotum dark brown anteriorly and laterally, becoming paler towards posterior margin; ventro-lateral surfaces pale crimson; lateral margins of scutellum and dorsal surface of abdomen dark brown. Tegmen and wing yellowish hyaline, veins yellow, cross-veins broadly edged dark smoky brown. Tegmen with posterior and apical margins narrowly edged smoky brown; with a prominent, narrow, brown band extending from costal to posterior margin at one-third length; area around apices of branches of cubital vein broadly and irregularly dark brown; with a large, irregular, dark brown marking extending from costal margin to first branch of medial vein at between two-thirds and three-quarters length; apex smoky brown between first branch of radial vein and seventh branch of medial vein. Wing with a narrow, irregular, transverse, smoky brown band extending from first fork of cubital vein to posterior margin; a very broad, dark brown band extending from costal to posterior margins between one-half and three-quarters length; apex irregularly dark brown around apices of radial and medial veins.

Shaft of aedeagus with dorsal surface unarmed; lateral surfaces at c. two-thirds length each with a triangular flap-like process. Paramere slender; apex narrowly rounded; dorsal process situated slightly basad of three-quarters length, large, strongly produced dorsally and posteriorly; dorsal surface subapically produced, bearing several short robust spines.

#### MATERIAL EXAMINED

Holotype ♂, **Brazil:** Amazonas, P. das Laranjeiras, 5.viii.1981 (*Arias*) (INPA).

Paratype. **Brazil:** 1 ♂, Amazonas (BMNH).

This species is readily distinguished by the pigmentation of the head, pronotum, tegmen and wing; the proportions of the head are also distinctive.

### *Mysidia lloydi* sp. n.

(Figs 264, 375, 485)

Male: head 0.63 mm long, 0.76 mm wide; pronotum 1.36 mm wide; tegmen 6.80 mm long; wing 3.80 mm long. Female unknown.

Length of frons 6.5 times width at apex, 3.25 times width at base; ocelli small, not prominent; clypeus as long as frons; rostrum terminating at level of hind coxae. Pronotal width 13 times mid-dorsal length; fronto-lateral carinae distinct; tegula not carinate.

Head and body unmarked. Tegmen and wing whitish hyaline, veins pale brown. Tegmen with a narrow,



pale brownish, transverse band at one-third length; another, less distinct, at *c.* midlength. Wing with an indistinct, pale brown, transverse band over first fork of cubital vein, and another over radial-medial cross-vein.

Shaft of aedeagus slender in lateral aspect, somewhat laterally expanded; dorsal surface subapically with a pair of flap-like processes with apices acute and spine-like. Paramere broad; apex obtusely rounded; dorsal process situated at two-thirds length, produced postero-dorsally; dorsal surface somewhat produced subbasally into a rounded lobe bearing robust spines.

**MATERIAL EXAMINED**

Holotype ♂, **Brazil**: Para, Jabaty, v.1924 (*Williams*) (BMNH).

Though this species closely resembles *josianna*, the proportions of the head and the structure of the male genitalia render it distinct.

***Mysidia isteria* sp. n.**

(Figs 211, 321, 430)

Male: head 0.61 mm long, 0.90 mm wide; pronotum 1.95 mm wide; tegmen 8.50 mm long; wing 4.70 mm long. Female unknown.

Length of frons *c.* 5 times width at apex, *c.* 2.5 times width at base; ocelli small, obscure; clypeus one-fifth longer than frons; rostrum extending to base of subgenital plate. Pronotal width *c.* 19 times mid-dorsal length; fronto-lateral carinae absent; tegula prominently carinate.

Fronto-lateral surfaces of pronotum broadly pale orange at level of eyes. Tegmen and wing whitish hyaline; veins and cross-veins yellowish, cross-veins narrowly edged pale smoky brown. Tegmen with an indistinct, narrow, transverse, smoky brown band at one-third length; another, broader, but even fainter band immediately distad of midlength. Wing unmarked.

Shaft of aedeagus very short and broad; apex truncate; a pair of large flap-like processes extending over dorsal and lateral surfaces from apex almost to midlength, each bearing a single, long, spine-like process dorsally. Paramere very large in relation to aedeagus, slender, apex acute; dorsal process situated at slightly less than one-third length, large, not posteriorly produced; dorsal surface distad of midlength strongly produced and directed towards midline.

**MATERIAL EXAMINED**

Holotype ♂, **Peru**: Iquitos 5 km, Marine road, 24.xi.1972 (*Wolda*) (FAMU).

In the structure of the male genitalia this species most closely resembles *panamensis*, but in the proportions of the head and body, and in the detailed structure of the aedeagus, it is quite distinct.

***Mysidia fuscomaculata* sp. n.**

(Figs 263, 374, 484)

Male: head 0.54 mm long, 0.60 mm wide; pronotum 1.47 mm wide; tegmen 6.80 mm long; wing 3.60 mm long. Female unknown.

Length of frons 9 times width at apex, *c.* twice width at base; ocelli obscure; clypeus as long as frons; rostrum extending to base of abdomen. Pronotal width 20 times mid-dorsal length; fronto-lateral carinae distinct.

Head and body unmarked. Tegmen and wing whitish hyaline, veins pale. Tegmen with a broad, smoky brown, transverse band extending from costal margin to apex of clavus; posterior margin very pale smoky brown. Wing very pale smoky brown on apical and posterior margins.

Shaft of aedeagus slender; dorsal surface subapically with a pair of flap-like processes laterally, each terminating in a long curving spine; lateral surfaces each with a small spine subapically. Paramere robust; dorsal process large, situated at two-thirds length, somewhat produced; dorsal surface at one-quarter length with a large rounded secondary process bearing numerous, large, robust spines.

**MATERIAL EXAMINED**

Holotype ♂, **Panama**: Cerro Campana, 2700 ft, 23.v.1978 (*O'Brien & Marshall*) (FAMU).

This species is distinguished by the tegminal pigmentation, apically very narrow frons, and by the structure of the male genitalia.

*Mysidia adamare* sp. n.

(Figs 221, 332, 441)

Male: head 0.63 mm long, 0.84 mm wide; pronotum 1.90 mm wide; tegmen 8.84 mm long; wing 5.10 mm long. Female unknown.

Length of frons 5.5 times width at apex, 2.33 times width at base; ocelli distinct; clypeus one-third longer than frons; rostrum extending to base of subgenital plate. Pronotal width 13 times mid-dorsal length, fronto-lateral surfaces not carinate; tegula distinctly carinate.

Fronto-lateral surfaces of pronotum each with a broad, horizontal, orange band extending from adjacent to eye to lateral margin; fore and mid femora narrowly scarlet apically. Tegmen and wing whitish hyaline, veins yellow. Tegmen with a faint, brownish, transverse band at one-seventh length; a broader, more prominent band slightly distad of one-quarter length; weaker, indistinct, bands over first and second forks of medial vein. Wing with a very pale, brownish, transverse band at midlength and another over radial-medial cross-vein.

Shaft of aedeagus slender; lateral surfaces each with a large flap-like process extending over dorsal surface and slightly overlapping at midline; dorsal surface subapically with a pair of large flap-like processes medially. Paramere extremely robust, almost circular in lateral aspect; dorsal processes small, situated slightly basad of midlength; dorsal surface subbasally with a large, rounded, secondary process bearing numerous robust spines.

## MATERIAL EXAMINED

Holotype ♂, **Brazil**: Mato Grosso, 12°50'S 51°47'W, 16.iv.1968 (*Richards*) (BMNH).

This species is most readily distinguished by reference to the male genitalia, in particular to the very broadly rounded paramere.

*Mysidia pallescens* Metcalf

*Mysidia pallescens* Metcalf, 1938: 315. Holotype ♀, PANAMA (MCZ) [examined].

Female: head 0.73 mm long, 0.88 mm wide; pronotum 2.05 mm wide; tegmen 8.70–9.35 mm long; wing 5.30 mm long. Male unknown.

Length of frons 5 times width at apex, 2.5 times width at base; ocelli small, distinct; clypeus *c.* as long as frons; rostrum extending almost to apex of subgenital plate. Pronotal width 34 times mid-dorsal length, fronto-lateral carinae absent; tegula distinctly carinate basally.

Genae adjacent to eyes brownish; posterior angle of mesonotal disc brownish. Tegmen and wing whitish hyaline, veins brownish yellow, veins and cross-veins irregularly edged smoky brown. Tegmen over *c.* basal third and over subcostal and medial cells mottled brownish; a distinct, smoky brown, transverse band over first fork of cubital vein; another, more irregular and less distinct, pale brownish, transverse band over second fork of medial vein; area between these bands, and between second band and apex, indistinctly and irregularly mottled pale brownish. Wing with a pale brown transverse band over first fork of cubital vein.

## MATERIAL EXAMINED

**Panama**: 2 ♀ (holotype and paratype), Canal Zone, Barro Colorado, 17.vii.1924 (*Banks*) (MCZ); 3 ♀, Canal Zone (FAMU; BMNH).

This species may be distinguished by the tegminal pigmentation, and by the relatively large head and broad pronotum.

*Mysidia insania* sp. n.

(Figs 265, 376, 486)

Male: head 0.67 mm long, 0.75 mm wide; pronotum 1.78 mm wide; tegmen 8.84 mm long; wing 4.93 mm long. Female unknown.

Length of frons 6 times width at apex, *c.* 2.5 times width at base; ocelli not prominent; clypeus one-fifth longer than frons; rostrum terminating slightly posterior to hind coxae. Pronotal width 28 times mid-dorsal length, fronto-lateral surfaces not carinate; tegula distinctly carinate.

Head and body unmarked. Tegmen and wing whitish hyaline. Tegmen with basal one-fifth length irregularly smoky brown; with a brownish transverse band at one-third length; another, more irregular band over medial-cubital cross-vein; and a third slightly distad of midlength, from thence to apex very pale

brownish; posterior margin tinged smoky brown. Wing with a very irregular, smoky brown, transverse band at midlength; apical third smoky brown.

Shaft of aedeagus slender, becoming greatly laterally expanded subapically; dorsal surface subapically with a pair of large, adpressed, flap-like processes, each terminating in a large curving spine. Paramere robust; apex broadly rounded; dorsal process situated slightly basad of midlength, weakly produced posteriorly.

**MATERIAL EXAMINED**

Holotype ♂, **Ecuador**: Morona, Santiago, Cordillera de Cutucu, 1000 m, 21.x.1978 (*Cooper*) (BMNH).

Though rather similar to some other species in external characters, the male genitalia show *insania* to be quite distinct.

***Mysidia panamensis* sp. n.**

(Figs 210, 320, 429)

Male: head 0.53 mm long, 0.76 mm wide; pronotum 1.64 mm wide; tegmen 8.00 mm long; wing damaged. Female unknown.

Length of frons 4.5 times width at apex, 4 times width at base; ocelli very small, distinct; clypeus slightly longer than frons, rostrum extending to base of subgenital plate. Pronotal width 26 times mid-dorsal length, fronto-lateral carinae absent; tegula distinctly carinate.

Head and body unmarked. Tegmen and wing hyaline. Tegmen with a very faint, smoky brown, transverse band over first fork of cubital vein; another immediately distad of midlength; cross-veins very narrowly edged smoky brown. Wing with cross-veins very indistinctly edged smoky brown.

Shaft of aedeagus greatly expanded dorso-ventrally over apical half length; dorsal surface subapically with a pair of very large, hooked, processes. Paramere slender; apex acutely rounded; dorsal process situated at one-third length, not posteriorly produced.

**MATERIAL EXAMINED**

Holotype ♂, **Panama**: 6 miles E. Porto Bello, 6.ii.1930 (*Zschokke*) (CAS).

Paratype. **Panama**: 1 ♂, Darien, Santa Fe (FAMU).

This species is readily distinguished by the combination of hyaline tegmina and wings, and by the massive structure of the aedeagus.

***Mysidia formosa* sp. n.**

(Figs 246, 357, 467)

Male: head 0.53 mm long, 0.67 mm wide; pronotum 1.55 mm wide; tegmen 7.10 mm long; wing 4.42 mm long. Female unknown.

Length of frons c. 7 times width at apex, 2.25 times width at base; ocelli very large, prominent; clypeus one-quarter longer than frons; rostrum extending to base of subgenital plate. Pronotal width c. 12 times mid-dorsal length; fronto-lateral surfaces and tegula not carinate.

Genae anterior to eyes crimson; pronotum with posterior margins crimson. Tegmen and wing almost hyaline, veins dark brown. Tegmen weakly smoky brown over basal one-fifth length; with a broad, pale smoky brown, transverse band over first fork of cubital vein. Wing with a large, irregular, pale smoky brown spot on anal area at one-fifth length; first fork of cubital vein and radial-medial cross-vein broadly and weakly edged smoky brown.

Shaft of aedeagus very slender; apex strongly recurved over dorsal surface, partially obscuring a single pair of large flap-like processes, each of which bears a hook-like spine on the dorsal surface subapically. Paramere slender, strongly constricted at midlength; apex obtusely and irregularly rounded, bearing a hook-like process on the internal surface; dorsal process situated at four-fifths length, strongly produced dorsally and posteriorly; dorsal surface between one-quarter and one-third length with a prominent secondary process bearing numerous, short, robust spines.

**MATERIAL EXAMINED**

Holotype ♂, **Venezuela**: Carabobo, San Esteban, 8 km SE. Puerto Cabello, 100 m, 7.v.1978 (*O'Brien & Marshall*) (FAMU).

This species is readily distinguished by the unique pigmentation of the head, pronotum, tegmen and wing, and by the structure of the male genitalia.

*Mysidia whimperi* sp. n.

(Figs 272, 383, 493)

Male: head 0.53 mm long, 0.57 mm wide; pronotum 1.22 mm wide; tegmen 6.40 mm long; wing 3.40 mm long. Female unknown.

Length of frons *c.* 6 times width at apex, *c.* 4 times width at base; ocelli small, distinct; clypeus as long as frons; rostrum extending to base of subgenital plate. Pronotal width *c.* 12 times mid-dorsal length; fronto-lateral surfaces and tegula not distinctly carinate.

Fronto-lateral surfaces of pronotum adjacent to eyes, and disc of mesonotum, pale reddish brown. Tegmen and wing whitish hyaline. Tegmen with a faint, smoky brown, transverse band over first fork of cubital vein. Wing with an obscure, smoky brown, transverse band at midlength.

Shaft of aedeagus subapically expanded into a pair of flap-like processes extending over lateral and dorsal surfaces, each terminating antero-dorsally in a long spine. Paramere with apex obtusely rounded; dorsal process situated at three-fifths length, posteriorly produced; dorsal surface at one-fifth length with a small rounded secondary process bearing numerous short spines.

## MATERIAL EXAMINED

Holotype ♂, Ecuador: 8 km NE. Puyo, 28.iv.1978 (*O'Brien & Marshall*) (FAMU).

The markings of the tegmina and wings are extremely faint, the species is therefore most readily determined by reference to the male genitalia.

*Mysidia stali* sp. n.

(Figs 200, 312, 421)

Male: head 0.61 mm long, 0.75 mm wide; pronotum 1.63 mm wide; tegmen 8.00 mm long; wing 4.10 mm long. Female unknown.

Length of frons 5.5 times width at apex, *c.* 3 times width at base; ocelli distinct; clypeus slightly longer than frons; rostrum extending slightly beyond hind coxae. Pronotal width 13 times mid-dorsal length; fronto-lateral surfaces and tegula not carinate.

Head and body unmarked. Tegmen and wing whitish hyaline, veins yellow. Tegmen with costal margin broadly dark brown at *c.* one-quarter length; with a broad brownish band extending transversally over first fork of cubital vein to posterior margin. Wing with a very faint, indistinct, brownish, transverse band slightly distad of one-third length; and a more prominent band over radial-medial cross-vein.

Shaft of aedeagus slender; dorsal surface subapically with a pair of long spine-like processes; lateral surfaces subapically each with a spine-like process; ventral surface with a slender, narrowly bifurcate, process subbasally. Paramere with apex acute; dorsal process situated at *c.* midlength, produced dorsally; dorsal surface with a robust hook-like process subapically, subbasally with a low, rounded, secondary process bearing numerous short spines; ventral surface subbasally with very numerous, small, tooth-like spines.

## MATERIAL EXAMINED

Holotype ♂, Brazil: Amazon, Rio Autaz (*Roman*) (NR).

Paratypes. 1 ♂, 1 ♀, same data as holotype (NR; BMNH).

This species is distinguished by the tegminal pigmentation, the proportions of the head and pronotum, and by the structure of the male genitalia, especially the paramere.

*Mysidia clava* sp. n.

(Figs 242, 353, 462)

Male: head 0.48 mm long, 0.65 mm wide; pronotum 1.10 mm wide; tegmen 5.80 mm long; wing 3.40 mm long. Female unknown.

Length of frons 7 times width at apex, 2.33 times width at base; ocelli small, obscure; clypeus *c.* as long as frons; rostrum extending to base of subgenital plate. Pronotal width *c.* 18 times mid-dorsal length; fronto-lateral surfaces and tegula with carinae weak or obsolete.

Fronto-lateral surfaces of pronotum each with a narrow, bright orange band extending horizontally from adjacent to midline of eye to lateral margin. Tegmen and wing whitish hyaline. Tegmen with a narrow, very faint, transverse, smoky brown band over first fork of claval vein; an irregular, pale, smoky brown area adjacent to apex of clavus. Wing with posterior and apical margins pale brownish grey.

Shaft of aedeagus very slender, gradually tapering over c. basal half length, somewhat expanded towards apex; ventral surface bearing numerous transverse rows of small blunt spines; lateral margins each with a long hooked process at three-quarters length; dorsal surface with a pair of slender processes at two-thirds length, a large, flap-like, bifurcate process at midline. Paramere slender; dorsal process situated slightly distad of midlength, posteriorly produced; dorsal surface subbasally with a rounded secondary process bearing numerous robust spines.

**MATERIAL EXAMINED**

Holotype ♂, **Brazil**: Belem, Para, v.1924 (*Williams*) (BMNH).

Its small size, relative lack of tegminal pigmentation, and the structure of the male genitalia readily distinguish this species.

***Mysidia simpla* sp. n.**

(Figs 222, 333, 442)

Male: head 0.53 mm long, 0.73 mm wide; pronotum 1.43 mm wide; tegmen 6.80–7.40 mm long; wing 4.16 mm long. Female: tegmen 7.60–8.50 mm long.

Length of frons 6.25 times width at apex, 3.33 times width at base; ocelli small, obscure; clypeus as long as frons; rostrum extending to base of subgenital plate. Pronotal width c. 14 times mid-dorsal length, fronto-lateral carinae distinct; tegulae not carinate.

Lateral carinae of frons often brownish; apex of disc of mesonotum occasionally reddish. Tegmen and wing pale brownish hyaline, veing pale brown. Tegmen pale brown basally; a brownish transverse band at one-third length; a fainter band at midlength. Wing with a pale brownish transverse band over first fork of cubital vein, another over radial-medial cross-vein.

Shaft of aedeagus slender; dorsal surface subapically with a pair of parallel flap-like processes. Paramere slender; dorsal process situated at three-fifths length, small, posteriorly produced; dorsal surface subbasally with a small conical secondary process bearing robust spines.

**MATERIAL EXAMINED**

Holotype ♂, **Ecuador**: Tena, 4.iv.1923 (*Williams*) (BMNH).

Paratypes, **Ecuador**: 1 ♂, 2 ♀, 18 km S. Tena (FAMU; BMNH).

Though this species closely resembles *lloydi*, the proportions of the head, and the very reduced armature of the aedeagus render it distinct.

***Mysidia nigrithorax* sp. n.**

(Figs 231, 342, 451)

Male: head 0.57 mm long, 0.82 mm wide; pronotum 1.50 mm wide; tegmen 7.65 mm long; wing 3.80 mm long. Female: tegmen 8.00 mm long.

Length of frons c. 5 times width at apex, 3 times width at base; ocelli prominent; clypeus slightly longer than frons; rostrum extending almost to base of subgenital plate. Pronotal width 10 times mid-dorsal length; fronto-lateral surfaces and tegulae not carinate.

Ocelli scarlet; disc of mesonotum dark brown; dorsal surface of abdomen brown. Tegmen and wing whitish hyaline, posterior and apical margins broadly smoky brown. Tegmen with a narrow, transverse, brownish band over first fork of cubital vein, another much broader band at midlength. Wing with a narrow, transverse, brownish band at midlength, apex broadly smoky brown.

Shaft of aedeagus somewhat expanded subapically; dorsal surface subapically with a pair of very long spine-like processes, a pair of much shorter spines, and laterally a pair of narrow flap-like processes. Paramere very slender; apex narrowly rounded; dorsal process situated at three-fifths length, slender, posteriorly produced; dorsal surface subbasally with a rounded secondary process bearing numerous short robust spines; ventral surface at midlength with a low flap-like process.

**MATERIAL EXAMINED**

Holotype ♂, **Peru**: Tingo Maria, 13.vii.1968 (*O'Brien*) (FAMU).

Paratypes. 1 ♂, 3 ♀, same data as holotype (FAMU; BMNH).

This species is distinguished by the pigmentation and by the structure of the male genitalia.

*Mysidia subfusca* Metcalf

*Mysidia subfusca* Metcalf, 1938: 315. Holotype ♀, PANAMA (MCZ) [examined].

Female: head 0.69 mm long, 0.88 mm wide; pronotum 1.72 mm wide; tegmen 8.85 mm long; wing 5.00 mm long. Male unknown.

Length of frons 8 times width at apex, 3.5 times width at base; ocelli large, distinct; clypeus *c.* as long as frons; rostrum extending almost to base of subgenital plate. Pronotal width *c.* 13 times mid-dorsal length; fronto-lateral surfaces and tegula not carinate.

Head and pronotum weakly tinged reddish. Tegmen and wing whitish hyaline, veins and cross-veins yellowish brown. Tegmen irregularly smoky brown over basal one-fifth length; with a narrow, smoky brown, transverse band immediately distad of first fork of cubital vein; broadly, irregularly, and faintly brownish from immediately distad of second fork of cubital vein to *c.* three-fifths length; apical one-third length irregularly pale smoky brownish. Wing with a very pale, smoky brown, transverse band over first fork of cubital vein, another over radial-medial cross-vein.

## MATERIAL EXAMINED

Holotype ♀, Panama: C.Z., Barro Colorado, 26.vi.1924 (*Banks*) (MCZ).

This species is very close to *pallescens* from which, in the absence of male genitalia for comparison, it is most readily distinguished by the proportions of the head and pronotum, and by the two transverse bands on the tegmen.

*Mysidia estfarchina* sp. n.

(Figs 212, 322, 431)

Male: head 0.63 mm long, 1.01 mm wide; pronotum 2.00 mm wide; tegmen 9.35–10.20 mm long; wing 5.10 mm long. Female unknown.

Length of frons *c.* 6 times width at apex, *c.* 2.5 times width at base; ocelli small, distinct; clypeus slightly longer than frons; rostrum extending to base of subgenital plate. Pronotal width 12 times mid-dorsal length; fronto-lateral surfaces and tegula not carinate.

Head and body unmarked. Tegmen and wing basally hyaline, veins pale, posterior and apical margins broadly and irregularly smoky brown between apices of veins, cross-veins narrowly edged smoky brown. Tegmen with an irregular, pale brownish, transverse band slightly basad of one-third length; another, more broken and paler band at midlength. Wing lacking distinct transverse markings; branches of veins irregularly edged smoky brown.

Shaft of aedeagus massively expanded subapically; dorsal surface subapically with a pair of very large, flap-like, apically acute and strongly diverging processes adjacent to midline; lateral surfaces subapically each with a large flap-like process extending over ventral surface. Paramere robust; apex acute; dorsal process situated slightly distad of one-third length, not posteriorly produced; dorsal surface strongly produced and inclined towards midline; ventro-lateral surface subbasally with very numerous, tiny, tooth-like spines.

## MATERIAL EXAMINED

Holotype ♂, Brazil: Amazonas, P. das Laranjeiras, 30.vii.1981 (*Arias*) (INPA).

Paratypes. 5 ♂, same data as holotype (INPA; BMNH; NR).

This species is distinguished by the pigmentation of the tegmina and wing, and by the structure of the male genitalia.

*Mysidia subfasciata* Westwood

*Mysidia subfasciata* Westwood, 1840: 83. LECTOTYPE (? sex), BRAZIL (BMNH), here designated [examined].

Head 0.62 mm long, 0.80 mm wide; pronotum 1.78 mm wide; tegmen 8.75 mm long; wing 4.85 mm long. The abdomen is missing, and the sex of the unique type-specimen is therefore unknown.

Length of frons 10 times width at apex, 3.33 times width at base; ocelli small, distinct; clypeus slightly shorter than frons; rostrum damaged. Pronotal width 28 times mid-dorsal length; fronto-lateral surfaces and tegula not carinate.

Head and body unmarked. Tegmen and wing whitish hyaline, veins and cross-veins yellowish. Tegmen with an indistinct very pale brown spot over cubital vein at midlength between base and first fork; a faint,

irregular, pale brown, transverse band over first fork of cubital vein; a very faint and indistinct, pale brown transverse band over first fork of medial vein. Wing lacking distinct markings.

**MATERIAL EXAMINED**

Lectotype, **Brazil**: Para [?] (*Burchell* [?]) (BMNH).

This is the only specimen available for study, and the abdomen is missing and the rostrum damaged; it bears Westwood's handwritten determination label. The species is distinguished by the very narrow frons and the tegminal markings.

***Mysidia fasciata* Metcalf**

(Figs 225, 336, 446)

*Mysidia fasciata* Metcalf, 1938: 314. Holotype ♀, PANAMA (MCZ).

Male: head 0.67 mm long, 0.80 mm wide; pronotum 1.68 mm wide; tegmen 7.20–7.65 mm long; wing 4.10 mm long. Female: tegmen 7.20–8.50 mm long.

Length of frons 7 times width at apex, c. 3 times width at base; ocelli distinct; clypeus one-sixth longer than frons; rostrum extending to base of subgenital plate. Pronotal width 10 times mid-dorsal length; fronto-lateral surfaces and carinae not carinate.

Ocelli narrowly edged crimson; disc of mesonotum often deep yellowish brown, occasionally with a narrow, longitudinal, dark brown band on either side of midline; fronto-lateral surfaces of pronotum rarely distinctly crimson; dorsal surface of abdomen rarely tinged reddish. Tegmen and wing whitish hyaline. Tegmen with veins and cross-veins brown; costal area pale smoky brown; claval area dark brown; a narrow, dark brown, transverse band over first fork of cubital vein; a broader, paler, less distinct, smoky brown, transverse band between first and second forks of medial vein; slightly less than apical one-half length entirely smoky greyish brown. Wing with posterior and apical margins broadly smoky brown; a dark brownish transverse band at c. three-quarters length.

Shaft of aedeagus slender; dorsal surface subapically with a pair of large, finely serrated, flap-like processes extending to just short of midlength; ventro-lateral surfaces each with a ventrally directed flap-like process at three-quarters length. Paramere basally slender, broadening abruptly to very obtusely rounded apex; dorsal process situated slightly distad of midlength, produced postero-ventrally.

**MATERIAL EXAMINED**

Allotype ♂, **Panama**: C.Z., Barro Colorado, 21.vi.1924 (*Banks*) (MCZ).

**Panama**: 14 ♂, 7 ♀, various localities in Canal Zone (USNM; CAS; FAMU; BMNH).

The genitalia of the allotype are damaged, and a preparation was not made of this specimen. The tegminal and wing markings of this species are distinctive.

***Mysidia douglasi* sp. n.**

(Figs 178, 287, 396).

Male: head 0.50 mm long, 0.67 mm wide; pronotum 1.32 mm wide; tegmen 6.97 mm long; wing 3.77 mm long. Female unknown.

Length of frons c. 8 times width at apex, c. 3 times width at base; ocelli large, distinct; clypeus slightly longer than frons; rostrum extending to apex of abdomen. Pronotal width 21 times mid-dorsal length; fronto-lateral surfaces and tegula not carinate.

Head and body unmarked. Tegmen and wing whitish hyaline. Tegmen with a pale brownish transverse band over first fork of cubital vein; another similar band at midlength. Wing with a pale brown transverse band over first fork of cubital vein and another over radial-medial cross-vein.

Shaft of aedeagus greatly expanded laterally; dorsal surface subapically with a pair of long, adpressed, flap-like processes, each terminating in an acute spine; a pair of small triangular processes at midline immediately distad of midlength. Paramere with apex obtusely rounded; dorsal process large, situated slightly distad of midlength, posteriorly produced; ventral surface at two-thirds length with a small hook-like process.

**MATERIAL EXAMINED**

Holotype ♂, **Panama**: Gatun Lake, x.1931 (*Zschokke*) (CAS).

The external characters alone are not considered sufficient for the positive determination of this species; reference should therefore be made to the male genitalia.

***Mysidia knighti* sp. n.**

(Figs 203, 313, 422)

Male: head 0.53 mm long, 0.68 mm wide; pronotum 1.15 mm wide; tegmen 6.05 mm long; wing 3.40 mm long. Female unknown.

Length of frons 4.5 times width at apex, c. 3 times width at base; ocelli very large, prominent; clypeus slightly longer than frons; rostrum extending to apex of abdomen. Pronotal width 10 times mid-dorsal length; fronto-lateral surfaces and tegula not carinate.

Head and body unmarked. Tegmen and wing whitish hyaline, veins pale. Tegmen with a prominent, broad, dark brown, transverse band extending from costal margin to claval suture over first fork of cubital vein; a paler, less distinct, more irregular, smoky brown band over radial-medial cross-vein. Wing with a faint, irregular, pale smoky brown, transverse band at midlength and at three-quarters.

Shaft of aedeagus very slender; dorsal surface subapically with two pairs of long spine-like processes; ventral surface with two longitudinal rows of small obtuse spines. Paramere slender, medially constricted, apex obtusely rounded; dorsal process situated at two-thirds length, strongly produced posteriorly; dorsal surface subbasally with a large rounded secondary process bearing numerous small robust spines.

**MATERIAL EXAMINED**

Holotype ♂, **Brazil:** Mato Grosso, 12°49'S 51°45'W, 18.xii.1968 (*Knight*) (BMNH).

Very similar to *pulchella*, this species is distinguished by the pale apex to the wing and by the structure of the paramere.

***Mysidia pulchella* sp. n.**

(Figs 176, 285, 394)

Male: head 0.53 mm long, 0.70 mm wide; pronotum 1.26 mm wide; tegmen 6.40 mm long; wing 3.57 mm long. Female unknown.

Length of frons slightly greater than 4.5 times width at apex, 3 times width at base; ocelli large, prominent; clypeus as long as frons; rostrum extending little beyond hind coxae. Pronotal width 12 times mid-dorsal length; fronto-lateral surfaces and tegula not carinate.

Head and body unmarked; ocelli broadly and irregularly edged scarlet. Tegmen and wing whitish hyaline, veins pale. Tegmen with a prominent, broad, dark brown, transverse band extending from costal to posterior margins over first fork of cubital vein; another over radial-medial cross-vein. Wing with a pale, irregular, smoky brown, transverse band extending from first fork of cubital vein to posterior margin; apical one-quarter length broadly pale smoky brown.

Shaft of aedeagus slender; dorsal surface subapically with two pairs of large spine-like processes; ventral surface at two-thirds length with a cluster of small obtuse spines. Paramere very slender, strongly constricted subbasally; dorsal process small, situated somewhat basad of midlength, little produced posteriorly; dorsal surface subbasally with a slender secondary process bearing numerous small robust spines; ventral surface at one-third length with a slender process bearing numerous robust spines.

**MATERIAL EXAMINED**

Holotype ♂, **Brazil:** Mato Grosso, 12°50'S 51°47'W, 17.x.1968 (*Richards*) (BMNH).

Though very similar to the preceding species, *pulchella* is distinguished by the markings of the wing and by the structure of the paramere.

***Mysidia distincta* sp. n.**

(Figs 271, 382, 492)

Male: head 0.73 mm long, 0.88 mm wide; pronotum 2.00 mm wide; tegmen 9.40–10.20 mm long; wing 5.95 mm long. Female: tegmen 11.56 mm long.

Length of frons 5.5 times width at apex, c. 3 times width at base; ocelli small, distinct; clypeus c. one-fifth longer than frons; rostrum extending to base of subgenital plate. Pronotal width 47 times mid-dorsal length, fronto-lateral carinae absent; tegula weakly carinate.

Genae brown level with anterior margins of eyes; ocelli narrowly edged scarlet; disc of mesonotum commonly dark brown. Tegmen and wing whitish hyaline. Tegmen pale smoky brown basally; a distinct, brownish, transverse band at c. one-third length, another at midlength; area between these bands with a



much fainter, indistinct, transverse band medially; posterior margin very pale brownish. Wing weakly and indistinctly pale brown over cross-veins; posterior margin very faintly pale brownish.

Shaft of aedeagus broadly laterally expanded over apical one-half length; dorsal surface with a pair of flap-like processes over apical two-fifths length, a pair of very long hook-like processes subapically. Paramere robust, apically truncate; dorsal process situated somewhat basad of midlength, strongly produced posteriorly.

#### MATERIAL EXAMINED

Holotype ♂, **Peru**: Callanga (BMNH).

Paratypes. 1 ♂, 2 ♀, same data as holotype (BMNH).

The dark brown mesonotal disc, the tegminal pigmentation, and the structure of the male genitalia distinguish this species.

### *Mysidia hengist* sp. n.

(Figs 252, 363, 474)

Male: head 0.57 mm long, 0.76 mm wide; pronotum 1.53 mm wide; tegmen 7.32–7.90 mm long; wing 4.00 mm long. Female: tegmen 8.15 mm long.

Length of frons, slightly less than 7 times width at apex, slightly less than twice width at base; ocelli small, obscure; clypeus one-quarter longer than frons; rostrum extending to base of subgenital plate. Pronotal width 37 times mid-dorsal length; fronto-lateral surfaces and tegula not carinate.

Head and body unmarked. Tegmen and wing hyaline, veins pale yellow. Tegmen with a smoky brown transverse band extending from costal margin to apex of anal vein between first and second forks of cubital vein; another much fainter and irregular band extending from medial-cubital cross-vein to posterior margin; another pale band extending from costal to posterior margins at level of second fork of medial vein; posterior margin narrowly and very indistinctly tinged smoky brown between branches of cubital vein. Wing with a pale smoky brown, transverse band extending from costal to posterior margin at level of first fork of cubital vein; another slightly darker band extending obliquely from around radial-medial cross-vein to posterior margin; posterior and apical margins faintly smoky brown between veins.

Shaft of aedeagus broad; lateral surfaces subapically each with a large flap-like process extending over dorsal surface and strongly overlapping at mid-dorsal line, each process bearing a long, slightly curving spine on its antero-dorsal surface, and a somewhat shorter spine on its posterior margin. Paramere very robust; apex very obtusely rounded, somewhat produced dorsally; dorsal process situated at midlength, little produced.

#### MATERIAL EXAMINED

Holotype ♂, **Brazil**: Amazonas, P. das Laranjeiras, 30.vii.1981 (*Arias*) (INPA).

Paratypes. 2 ♂, 1 ♀, same data as holotype (INPA; BMNH).

This species is distinguished by the pigmentation of the tegmina and wings, and by the structure of the aedeagus.

### *Mysidia josianna* sp. n.

(Figs 240, 351, 460)

Male: head 0.59 mm long, 0.80 mm wide; pronotum 1.75 mm wide; tegmen 7.10–8.15 mm long; wing 4.10 mm long. Female unknown.

Length of frons 5.5 times width at apex, 2.5 times width at base; ocelli small, distinct; clypeus as long as frons; rostrum extending to subgenital plate. Pronotal width 35 times mid-dorsal length; fronto-lateral surfaces and tegula not carinate.

Head and body unmarked. Tegmen and wing whitish hyaline, veins pale brown. Tegmen pale smoky brown over basal half length; a broad, dark brown, transverse band immediately basad of second fork of cubital vein; another somewhat fainter band over medial-cubital cross-vein; occasionally another very faint and indistinct band immediately distad of midlength; posterior margin between branches of cubital vein and first branch of medial vein edged smoky brown. Wing with cross-veins and forks of veins irregularly edged pale smoky brown; posterior margin between branches of cubital vein and medial vein broadly smoky brown.

Shaft of aedeagus laterally expanded over apical three-fifths length; lateral surfaces subapically each with a large flap-like process bearing a long acute spine; dorsal surface with a single, medial, spine-like

process slightly distad of midlength. Paramere slender; dorsal process situated slightly basad of midlength, well developed.

**MATERIAL EXAMINED**

Holotype ♂, **Trinidad**: Arima Valley, Arima 10 miles, 15.vii.1976 (*Noyes*) (BMNH).

Paratypes. **Trinidad**: 3 ♂, Mount Tucuche and Aripo Valley (BMNH). **Brazil**: 1 ♂, Para, Jabaty (BMNH).

This species, lacking definitive external characters, is readily distinguished by the structure of the male genitalia.

***Mysidia pseudoerecta* sp. n.**

(Figs 202, 311, 420)

Male: head 0.65 mm long, 0.90 mm wide; pronotum 1.90 mm wide; tegmen 8.50 mm long; wing 5.00 mm long. Female unknown.

Length of frons 6 times width at apex, 2.5 times width at base; ocelli small, obscure; clypeus slightly longer than frons; rostrum extending somewhat beyond posterior coxae. Pronotal width 25 times mid-dorsal length; fronto-lateral surfaces and tegula not carinate.

Disc of mesonotum with a roughly circular dark brown spot medially. Tegmen and wing clear hyaline, veins pale yellow. Tegmen with posterior and apical margins broadly pale smoky brown; a pale smoky brown spot in angle of anal veins at point of fusion; another similar spot on cubital vein at midlength between base and first fork; a distinct brown transverse band immediately basad of one-third length; a paler, irregular, less distinct band at level of medial-cubital cross-vein; a rather more distinct transverse band at level of second fork of medial vein. Wing with posterior and apical margins broadly pale smoky brown; a weak, very irregular, broken, smoky brown transverse band somewhat basad of midlength; an even less distinct smoky marking around medial-cubital cross-vein, extending to posterior margin; a transverse band extending from radial-medial cross-vein to posterior margin.

Shaft of aedeagus considerably expanded laterally over apical one-third length; lateral surfaces subapically each with a large flap-like process extending over dorsal surface and terminating anteriorly in a slender spine. Paramere robust, apex broadly rounded; dorsal process situated at c. midlength, slender, greatly produced vertically, apex acute and narrowly recurved.

**MATERIAL EXAMINED**

Holotype ♂, **Brazil**: Amazonas, P. das Laranjeiras, viii.-ix.1981 (*Arias*) (INPA).

The paramere and aedeagus of this species closely resemble those of *erecta*, but the tegminal and wing pigmentation are quite distinct.

***Mysidia perspicua* sp. n.**

(Figs 267, 378, 488)

Male: head 0.61 mm long, 0.78 mm wide; pronotum 1.47 mm wide; tegmen 7.65 mm long; wing 3.83 mm long. Female unknown.

Length of frons 8 times width at apex, 2.5 times width at base; ocelli small, obscure; clypeus one-quarter longer than frons; rostrum terminating immediately posterior to hind coxae. Pronotal width 14 times mid-dorsal length; fronto-lateral surfaces and tegula not carinate.

Fronto-lateral surfaces of pronotum each with a broad pale orange band extending horizontally from adjacent to eye to lateral margin. Tegmen and wing whitish hyaline, veins pale brown. Tegmen with a very faint, smoky brown, transverse band at one-third length; another less distinct band slightly distad of midlength. Wing unmarked.

Shaft of aedeagus greatly expanded subapically; dorsal surface subapically with a pair of very large flap-like processes, each terminating anteriorly in a large spine-like projection. Paramere very broad, apex obtusely rounded; dorsal process situated at midlength, strongly produced posteriorly.

**MATERIAL EXAMINED**

Holotype ♂, **Brazil**: Para, Jabaty, v.1924 (*Williams*) (BMNH).

Though externally very similar to *simpla*, this species is readily distinguished by the structure of the male genitalia.

*Mysidia agilis* sp. n.

(Figs 190, 300, 409)

Male: head 0.52 mm long, 0.65 mm wide; pronotum 1.15 mm wide; tegmen 5.40–5.95 mm long; wing 3.40 mm long. Female: tegmen 5.50 mm long.

Length of frons 7 times width at apex, slightly greater than twice width at base; ocelli small, not prominent; clypeus one-quarter longer than frons; rostrum extending to base of subgenital segment. Pronotal width 11 times mid-dorsal length; fronto-lateral surfaces and tegula not distinctly carinate.

Head and body unmarked. Tegmen and wing hyaline, only very weakly tinged whitish. Tegmen with a faint, transverse, smoky brown band at level of first fork of cubital vein; another less distinct, more irregular band immediately distad of mid-length; a very indistinct and irregular band over apical branches of medial vein; cross-veins weakly edged smoky brown. Wing with a prominent, transverse, smoky-brown band at level of radial-medial cross-vein; posterior and apical margins broadly smoky brown.

Shaft of aedeagus ventrally and laterally expanded apically, with a pair of slender processes dorsally; dorsal surface subapically with a large flap-like process at midline, a pair of slender, spine-like processes laterally. Paramere broad, robust; apex obtusely rounded; dorsal process situated slightly distad of midlength, apex vertically directed, not produced posteriorly.

## MATERIAL EXAMINED

Holotype ♂, **Guyana**: Tumatumari, 19.vii.1923 (*Williams*) (BMNH).

Paratypes. **Brazil**: 1 ♂, 2 ♀, Amazonas, P. das Laranjeiras (INPA; BMNH).

The structure of the male genitalia is very distinctive in this species; the heavily armed aedeagus coupled with the relatively undeveloped paramere, and the pigmentation of the tegmen and wing render it easily distinguishable.

*Mysidia claudata* sp. n.

(Figs 175, 284, 393)

Male: head 0.50 mm long, 0.74 mm wide; pronotum 1.26 mm wide; tegmen 5.60–6.03 mm long; wing 3.45 mm long. Female: tegmen 6.12–6.80 mm long.

Length of frons c. 6 times width at apex, twice width at base; ocelli small, obscure; clypeus c. as long as frons; rostrum extending to level of hind coxae. Pronotal width 15 times mid-dorsal length; fronto-lateral surfaces and tegula not carinate.

Fronto-lateral surfaces of pronotum rarely with a bright orange band extending horizontally from adjacent to midline of eye to lateral margin; females with last abdominal segment very narrowly orange at ventro-lateral angles. Tegmen and wing very faintly smoky hyaline, veins pale. Tegmen with a small brownish spot between subcostal vein and costal margin at one-sixth length; a narrow, irregular, transverse band extending from costal to claval margin at one-third length; a brownish band extending from second branch of cubital vein to claval margin slightly basad of midlength; a very faint and ill-defined transverse band over apical forks of radial and medial veins. Wing with a very faint, broken, oblique, smoky brown transverse band at approximately midlength; apical third of length with veins and branches of veins broadly edged smoky brown.

Shaft of aedeagus slender; lateral surfaces subapically each produced into a flap-like process extending basad from apex to midlength, terminating anteriorly in long, curving, lateral process at midlength; dorsal surface with five pairs of short, triangular, lateral spines subapically, and a large rounded process medially at three-fifths length. Paramere slender, apex truncate; dorsal process situated at two-thirds length, strongly produced posteriorly; dorsal surface subapically with a large secondary process bearing numerous short robust spines; internal surface narrowly produced and extended dorsally at one-third length; ventro-lateral surface at one-third length with a large, triangular, hook-like process.

## MATERIAL EXAMINED

Holotype ♂, **Brazil**: Amazonas, P. das Laranjeiras, 6.viii.1981 (*Arias*) (INPA).

Paratypes. 8 ♂, 30 ♀, same locality as holotype (INPA; BMNH).

This species is distinguished by the pigmentation of the tegmen and wing, and by the complex structure of the male genitalia.

*Mysidia jamesi* sp. n.

(Figs 181, 291, 398)

Male: head 0.53 mm long, 0.61 mm wide; pronotum 1.24 mm wide; tegmen 6.12 mm long; wing 3.50 mm long. Female unknown.

Length of frons 6 times width at apex, c. 3 times width at base; ocelli small, distinct; clypeus slightly longer than frons; rostrum extending to base of subgenital plate. Pronotal width c. 14 times mid-dorsal length, fronto-lateral carinae absent; tegula weakly carinate.

Head and body unmarked. Tegmen and wing whitish hyaline. Tegmen with a pale brownish transverse band over first fork of cubital vein; a paler, irregular, marking over medial-cubital cross-vein; a weak transverse band immediately distad of midlength; basal one-fifth length irregularly mottled pale smoky brown. Wing with a very faint, brownish, transverse band at midlength, another over radial-medial cross-vein.

Shaft of aedeagus slender in lateral aspect, very broad in dorsal aspect; dorsal surface expanded laterally into a pair of flap-like processes; with a pair of low flap-like processes adjacent to midline, each terminating in an acute spine posteriorly. Paramere robust; dorsal process situated slightly distad of midlength, greatly produced posteriorly; dorsal surface subbasally with numerous small robust spines; ventral surface at midlength with a rounded projection bearing a tuft of long robust spines.

## MATERIAL EXAMINED

Holotype ♂, **Brazil**: Para, Jubaty, v.1924 (*Williams*) (BMNH).

*Mysidia carosella* sp. n.

(Figs 180, 290, 400)

Male: head 0.57 mm long, 0.67 mm wide; pronotum 1.47 mm wide; tegmen 6.80 mm long; wing 3.80 mm long. Female unknown.

Length of frons 8 times width at apex, 2.5 times width at base; ocelli small, not prominent; clypeus slightly longer than frons; rostrum extending to base of subgenital plate. Pronotal width 25 times mid-dorsal length; fronto-lateral surfaces and tegula not carinate.

Genae and fronto-lateral surfaces of pronotum adjacent to eyes tinged orange. Tegmen and wing whitish hyaline; veins, cross-veins and forks of veins pale yellowish brown. Tegmen with radial, medial and claval areas irregularly smoky brown over basal one-quarter length; an irregular brownish band extending from costal to claval margins at level of first fork of cubital vein; a very irregular, somewhat oblique, brownish band extending from medial vein to apex of clavus at level of first fork of medial vein; a broad brownish band extending from costal to posterior margins at level of second fork of medial vein; apical one-third length irregularly mottled brownish around veins and forks of veins. Wing with an indistinct, pale brownish, transverse band extending from costal margin to claval suture at one-quarter length; a darker transverse band extending from medial vein to apex of clavus immediately posterior to first fork of cubital vein; a broad, rather irregular, transverse, brownish band at level of radial-medial cross-vein; apical margin narrowly pale smoky brown.

Shaft of aedeagus slender; apex broadly produced dorsally and anteriorly; dorso-lateral margins each subapically produced into a large, flap-like process extending to just short of midlength; dorsal surface at one-third length with a pair of rounded flap-like processes. Paramere complex, constricted medially; apex broadly rounded, strongly produced dorsally; dorsal process situated at c. two-thirds length, strongly produced dorsally and posteriorly; internal ventral surface with a rounded node at two-thirds length, bearing numerous, small, tooth-like spines subbasally.

## MATERIAL EXAMINED

Holotype ♂, **Bolivia**: 3 miles N. Buena Vista, 26.iii.1978 (*O'Brien*) (FAMU).

No single external character distinguishes this species, but the male genitalia are distinctive.

*Mysidia harmonia* sp. n.

(Figs 206, 316, 425)

Male: head 0.50 mm long, 0.75 mm wide; pronotum 1.51 mm wide; tegmen 7.35 mm long; wing 4.25 mm long. Female unknown.

Length of frons *c.* 6 times width at apex, 2.5 times width at base; ocelli small, distinct; clypeus one-third longer than frons; rostrum extending to base of subgenital plate. Pronotal width 26 times mid-dorsal length, fronto-lateral carinae obsolete; tegula weakly carinate.

Head and body unmarked. Tegmen and wing whitish hyaline. Tegmen with veins and cross-veins broadly edged very pale brownish; basal area irregularly mottled pale brown; an irregular, brownish, transverse band at one-third length; another, fainter, band over medial-cubital cross-vein; a third, very narrow, band over second fork of medial vein. Wing with an irregular, smoky hyaline, transverse band over first fork of cubital vein; another more broken band over medial-cubital cross-vein; a third over radial-medial cross-vein.

Shaft of aedeagus laterally expanded subapically; dorsal surface subapically with a pair of very large, acute, flap-like processes. Paramere broadly rounded apically; dorsal process small, situated at *c.* midlength, dorsally produced, laterally bifurcate apically; with a secondary process subbasally bearing a single rounded projection.

#### MATERIAL EXAMINED

Holotype ♂, **Colombia**: Putumayo, La Hormiga, 6.ix.1978 (*Cooper*) (BMNH).

In the absence of distinctive external characters, this species is most readily distinguished by the male genitalia.

### *Mysidia silvana* sp. n.

(Figs 251, 362, 472)

Male: head 0.55 mm long, 0.82 mm wide; pronotum 1.80 mm wide; tegmen 9.35 mm long; wing 5.10 mm long. Female unknown.

Length of frons *c.* 6 times width at apex, *c.* 3 times width at base; ocelli distinct; clypeus one-fifth longer than frons; rostrum extending to base of subgenital plate. Pronotal width 28 times mid-dorsal length, fronto-lateral carinae absent; tegula weakly carinate.

Head unmarked. Disc of mesonotum dark brown. Tegmen and wing whitish hyaline. Tegmen with cross-veins broadly edged pale smoky brown; an irregular, pale brown, transverse band at one-tenth length; another at one-fifth length; a third over first fork of cubital vein; another at two-fifths length; a fifth at midlength; another over second fork of medial vein; a seventh much fainter band at three-quarters length. Wing with a broken, irregular, indistinct, pale brownish, transverse band at midlength; another over first fork of medial vein.

Shaft of aedeagus slender, greatly expanded subapically; dorsal surface subapically with a pair of very large flap-like processes, each terminating in a long spine and bearing at midlength an erect spine. Paramere very robust, apex obtusely rounded; dorsal process situated at two-fifths length, posteriorly produced; dorsal surface at two-thirds length produced into a large, medially directed, flap-like secondary process.

#### MATERIAL EXAMINED

Holotype ♀, **Peru**: Tingo Maria, 13.vii.1968 (*O'Brien*) (FAMU).

The dark brown mesonotal disc and the structure of the male genitalia distinguish this species.

### *Mysidia bella* sp. n.

(Figs 229, 340, 449)

Male: head 0.63 mm long; 0.82 mm wide; pronotum 1.36 mm wide; tegmen 6.80 mm long; wing 4.00 mm long. Female unknown.

Length of frons *c.* 6 times width at apex, slightly less than 2.5 times width at base; ocelli small and obscure; clypeus slightly longer than frons; rostrum extending to base of subgenital plate. Pronotal width *c.* 15 times mid-dorsal length; fronto-lateral surfaces and tegula not carinate.

Head and body unmarked. Tegmen and wing whitish hyaline, veins pale. Tegmen with an indistinct, irregular, brownish, transverse band subbasally; another more broken band extending from medial vein to claval margin at approximately one-sixth length; another more continuous band extending from costal margin to apex of anal vein at one-quarter length; another irregular band extending from second fork of cubital vein to apex of clavus at three-eighths length; a very indistinct, pale, transverse band extending from costal margin to apex of first branch of cubital vein slightly distad of midlength. Wing with an irregular, smoky brown band extending transversely from medial vein to apex of clavus at one-third length,

and produced narrowly basad over apices of anal veins; another broader band extending from radial-medial cross-vein to posterior margin at three-quarters length, extending narrowly along posterior margin over apices of first and second branches of cubital vein.

Shaft of aedeagus slender in lateral aspect; lateral surfaces subapically each with a large, flap-like process extending over dorsal surface, bearing rounded projection dorsally; ventral surface at two-thirds length with a small, triangular process at midline. Paramere robust; apex obtusely rounded; dorsal process large, situated at midlength, strongly produced dorsally and posteriorly.

#### MATERIAL EXAMINED

Holotype ♂, **Brazil**: Amazonas, P. das Laranjeiras, 30.vii.1981 (*Arias*) (INPA).

This species is distinguished by the five transverse bands on the tegmen, the two transverse bands on the wing, and by the structure of the male genitalia.

### *Mysidia decora* sp. n.

(Figs 192, 302, 411)

Male: head 0.59 mm long, 0.71 mm wide; pronotum 1.64 mm wide; tegmen 8.25 mm long; wing 4.70 mm long. Female unknown.

Length of frons slightly greater than 6 times width at apex, slightly less than 3 times width at base; ocelli distinct; clypeus slightly shorter than frons; rostrum extending to apex of abdomen. Pronotal width 25 times mid-dorsal length; fronto-lateral surfaces and tegula not carinate.

Fronto-lateral surfaces of pronotum weakly tinged orange. Tegmen and wing whitish hyaline, veins pale yellow, cross-veins and forks of veins broadly edged pale smoky brown. Tegmen with a narrow, smoky brown, transverse band at one-tenth length; another at one-quarter length; another at one-third length; with less distinct and more irregular bands at two-fifths and midlength. Wing with an irregular, indistinct, smoky brown, transverse band at midlength, another over radial-medial cross-vein.

Shaft of aedeagus broadly expanded from midlength; lateral surfaces subapically each with a large flap-like process; dorsal surface subapically with a pair of long slender processes medially. Paramere robust, apex very obtusely rounded; dorsal process situated at midlength, small, little produced posteriorly.

#### MATERIAL EXAMINED

Holotype ♂, **Brazil**: Mato Grosso, 12 50'S 51 47'W, 6.iv.1968 (*Richards*) (BMNH).

This species, though closely related to *nitida*, *limpida* and *amarantha*, is readily distinguished by the structure of the male genitalia, especially the paramere, and by the tegminal pigmentation.

### *Mysidia boliviana* sp. n.

(Figs 250, 361, 471)

Male: head 0.67 mm long, 0.88 mm wide; pronotum 1.90 mm wide; tegmen 9.25 mm long; wing 5.20 mm long. Female unknown.

Length of frons c. 5 times width at apex, 2.5 times width at base; ocelli distinct; clypeus as long as frons; rostrum extending to posterior margins of hind coxae. Pronotal width 23 times mid-dorsal length, fronto-lateral surfaces and tegula not carinate.

Genae adjacent to eyes and dorsal to ocelli broadly dark brownish. Tegmen and wing whitish hyaline; veins pale, yellowish. Tegmen with a narrow, faint, pale brown band at approximately one-eighth length; a very broad, dark brown, transverse band over first and second forks of cubital vein; a very faint, broken, pale brownish transverse band extending from immediately basad of medial-cubital cross-vein to posterior margin; a broad, darker brownish, transverse band extending from costal to posterior margins immediately distad of second fork of medial vein. Wing with an irregular, pale brownish, transverse band immediately distad of first cubital fork; another, similar band extending from radial-medial cross-vein to posterior margin.

Shaft of aedeagus slender, somewhat expanded over apical one-quarter length; lateral surfaces subapically each with a large flap-like process extending over dorsal surface and strongly over-lapping at mid-dorsal line, each produced anteriorly into a long spine, bearing mid-dorsally a small spine. Paramere robust; apex broadly rounded; dorsal process situated slightly distad of midlength, strongly produced posteriorly; dorsal surface at c. three-fifths length strongly, conically and dorsally produced.

## MATERIAL EXAMINED

Holotype ♂, **Bolivia**: Buenavista, 400 m (*Steinbach*) (CM).

The male genitalia of this species closely resemble those of *silvana*, but it is readily distinguished by the prominent dark bands on the tegmina.

*Mysidia persephone* sp. n.

(Figs 204, 314, 423)

Male: head 0.57 mm long, 0.75 mm wide; pronotum 1.28 mm wide; tegmen 6.38 mm long; wing 3.57 mm long. Female unknown.

Length of frons *c.* 5 times width at apex, *c.* 3 times width at base; ocelli very large and prominent; clypeus one-quarter longer than frons; rostrum terminating slightly posterior to hind-coxae. Pronotal width *c.* 12 times mid-dorsal length; fronto-lateral surfaces and tegula without distinct carinae.

Head and body unmarked; ocelli narrowly edged reddish. Tegmen and wing whitish hyaline, veins pale. Tegmen with a broad, pale brownish, transverse band at one-seventh length; another, similar band extending from costal to claval margins over first fork of cubital vein; a very faint brownish band between first and second forks of medial vein; another similar band extending from radial-medial cross-vein almost to apical fork of radial vein; with an irregular and indistinct, pale brownish spot over apical branches of radial and medial veins. Wing with a faint, pale brownish spot over first branch of cubital vein at midlength; apical one-third length very faintly brownish.

Shaft of aedeagus slender; dorsal surface subapically with a pair of long, spine-like processes; dorso-lateral surfaces each with a curving spine-like process. Paramere slender; apex acutely rounded; dorsal process situated immediately distad of midlength, weakly produced dorsally and posteriorly; dorsal surface subbasally with a rounded projection bearing numerous short robust spines.

## MATERIAL EXAMINED

Holotype ♂, **Brazil**: Rio Uaupés, Taracua, 15.iii (*Roman*) (NR).

Paratype. 1 ♂, same data as holotype (BMNH).

The structure of the aedeagus closely resembles that of *intima* but that of the paramere is quite distinct; the species is also distinguished by the prominent ocelli and by the tegminal pigmentation.

*Mysidia marshalli* sp. n.

(Figs 223, 334, 444)

Male: head 0.69 mm long, 0.48 mm wide; pronotum 1.72 mm wide; tegmen 8.10–8.50 mm long; wing 4.68 mm long. Female unknown.

Length of frons 5 times width at apex, *c.* twice width at base; ocelli small, distinct; clypeus one-third longer than frons; rostrum extending to base of subgenital plate. Pronotal width *c.* 20 times mid-dorsal length; fronto-lateral surfaces and tegula without distinct carinae.

Head and body unmarked. Tegmen and wing whitish hyaline, veins pale brown. Tegmen with alternating transverse bands of pale and rather darker smoky brown over basal one-third length, enclosing a small, circular, pale spot between cubital vein and clavus; with an indistinct, smoky brown, transverse band over first fork of medial vein; another darker band over second fork of medial vein; apical two-fifths length very pale smoky brown. Wing with an irregular, smoky brown, transverse band over first fork of cubital vein; another broken band at midlength; a third over radial-medial cross-vein; apex smoky brown.

Shaft of aedeagus greatly expanded from two-fifths length to apex; lateral surfaces each with a very large flap-like process extending over dorsal surface. Paramere robust, apex broadly rounded; dorsal process situated at midlength, small, produced posteriorly.

## MATERIAL EXAMINED

Holotype ♂, **Bolivia**: Cbb., Pto., San Francisco, 19 miles NW. Villa Tunari, 1.iv.1978 (*O'Brien & Marshall*) (FAMU).

Paratype. 1 ♂, same data as holotype (BMNH).

Though the pigmentation of the wing is distinctive, reference should also be made to the male genitalia in determination of this species.

*Mysidia neonebulosa* Muir

(Figs 230, 341, 450)

*M[ysidia] neonebulosa* Muir, 1918: 424. Holotype ♂, GUYANA (OSU) [examined].

Male: head 0.56 mm long, 0.80 mm wide; pronotum 1.50 mm wide; tegmen 6.43–8.50 mm long; wing 4.00 mm long. Female: tegmen 7.70 mm long.

Length of frons 7 times width at apex, c. 2.5 times width at base; ocelli small, not prominent; clypeus as long as frons; rostrum extending to base of subgenital plate. Pronotal width 18 times mid-dorsal length; fronto-lateral surfaces not carinate; tegula with weak carinae.

Fronto-lateral surfaces of pronotum each with a broad orange band extending horizontally from adjacent to midline of eye to lateral margin. Tegmen and wing whitish hyaline. Tegmen with a faint, irregular, pale brownish, transverse band at one-eighth length, another at level of first fork of cubital vein, another at level of medial-cubital cross-vein, a fourth, very faint band immediately distad of midlength. Wing with an indistinct, very pale brownish, transverse band at midlength, another at three-quarters length.

Shaft of aedeagus somewhat expanded distad of midlength; dorsal surface subapically with a pair of broad, flap-like processes; ventro-lateral surfaces each with a short, rounded flap-like process subapically. Paramere broad, apex obtusely rounded; dorsal process situated immediately distad of midlength, apex strongly produced posteriorly.

## MATERIAL EXAMINED

Holotype ♂, Guyana: Bartica, 14.vii.1901 (*Parish*) (OSU).

Guyana: 1 ♂, 2 ♀, Kartabo (BMNH). Brazil: 4 ♂, Para, Jabaty (BMNH).

The holotype has one tegmen and both wings missing. A small delicate species; the markings of the tegmen and wing are often very faint; the structure of the male genitalia is, however, quite distinctive.

*Mysidia amarantha* sp. n.

(Figs 199, 309, 418)

Male: head 0.59 mm long, 0.80 mm wide; pronotum 2.00 mm wide; tegmen 8.50–9.70 mm long; wing 5.00 mm long. Female: tegmen 9.30 mm long.

Length of frons c. 5.5 times width at apex, c. 2.5 times width at base; ocelli small, distinct; clypeus one-quarter longer than frons; rostrum extending to midlength of abdomen. Pronotal width 20 times mid-dorsal length; fronto-lateral surfaces and tegula not carinate.

Head and body unmarked. Tegmen and wing whitish hyaline. Tegmen with a pale brownish transverse band at one-third length; another, more irregular and less distinct band over medial-cubital cross-vein; a third, more broken band over radial-medial cross-vein; cross-veins very weakly edged smoky brown. Wing with an indistinct transverse band at two-fifths length; another over radial-medial cross-vein, smoky brown.

Shaft of aedeagus greatly laterally expanded over apical two-fifths length; dorsal surface subapically with a pair of large flap-like processes, each with anterior margin adjacent to midline produced into a curving spine. Paramere broad, apex obtusely rounded; dorsal process situated at midlength, not posteriorly produced.

## MATERIAL EXAMINED

Holotype ♂, Ecuador: Napo, Muyana, 5 km SW. of Tena, 27.xi.1978 (*Cooper*) (BMNH).

Paratypes. French Guiana: 1 ♂, Mana River (CM). Brazil: 2 ♂, 1 ♀, Amazonas, P. das Laranjeiras (INPA; BMNH).

This species is only reliably distinguished by reference to the male genitalia.

*Mysidia magica* sp. n.

(Figs 249, 360, 470)

Male: head 0.63 mm long, 0.84 mm wide; pronotum 1.40 mm wide; tegmen 7.60–8.00 mm long; wing 4.30 mm long. Female: tegmen 8.65–9.60 mm long.

Length of frons 7 times width at apex, c. 3 times width at base; ocelli small, distinct; clypeus one-quarter



longer than frons; rostrum extending to base of subgenital plate. Pronotal width 22 times mid-dorsal length; fronto-lateral surfaces and tegula not carinate.

Head and body unmarked. Tegmen and wing whitish hyaline, veins yellowish. Tegmen with a narrow, pale brownish, transverse band over point of fusion of anal veins; another more distinct band extending from costal margin to apex of clavus; a third, fainter and more broken band extending from medial-cubital cross-vein to posterior margin; a fourth very faint band extending from costal to posterior margins at *c.* midlength. Wing occasionally with a very pale, indistinct, irregular, smoky brown, transverse band over first fork of medial vein, over radial-medial cross-vein, and a third over second fork of cubital vein.

Shaft of aedeagus apically expanded; dorsal surface subapically with a pair of conical processes, each terminating in a large spine; lateral surfaces subapically each with a large spine and a large rounded process. Paramere short and broad; dorsal process situated at midlength.

#### MATERIAL EXAMINED

Holotype ♂, **Surinam**: Brokopondo, 29.i.1969 (*O'Brien*) (FAMU).

Paratypes. **Surinam**: 1 ♂, 3 ♀, data as holotype and 17 km S. of Kraka (FAMU; BMNH).

This species is distinguished by the four transverse bands of the tegmen, the three bands of the wing, and by the structure of the male genitalia.

### *Mysidia geoffreyi* sp. n.

(Figs 274, 385, 495)

Male: head 0.63 mm long, 0.78 mm wide; pronotum 1.62 mm wide; tegmen 8.80–8.90 mm long; wing 5.10 mm long. Female: tegmen 9.77 mm long.

Length of frons 6 times width at apex, 2.33 times width at base; ocelli small, distinct; clypeus slightly longer than frons; rostrum extending to base of subgenital plate. Pronotal width *c.* 15 times mid-dorsal length, fronto-lateral carinae absent; tegula weakly carinate.

Fronto-lateral surfaces of pronotum occasionally each with a broad, pale orange, horizontal band extending from adjacent to eye to lateral margin. Tegmen and wing whitish hyaline. Tegmen with an irregular, often very pale, brownish, transverse band slightly basad of one-third length; a fainter, broken, band immediately distad of midlength; irregularly mottled pale brown basally and over first fork of medial vein; cross-veins very narrowly and irregularly edged pale brownish. Wing with irregular and indistinct, pale brown, transverse bands at one-third length and over radial-medial cross-vein.

Shaft of aedeagus greatly laterally expanded; dorsal surface over apical two-fifths length with a pair of broad flap-like lobes, a pair of overlapping apically acute processes at midline. Paramere broad, apically rounded; dorsal process situated at one-third length, greatly produced posteriorly.

#### MATERIAL EXAMINED

Holotype ♂, **Bolivia**: Pando, Provenir, 9.vii.1979 (*Cooper*) (BMNH).

Paratype. **Peru**: 2 ♂, 2 ♀, Callanga (BMNH).

Lacking distinctive external characters, this species is most readily distinguished by the structure of the male genitalia.

### *Mysidia pseudonebulosa* Muir

(Figs 278, 389, 499)

*Mysidia pseudonebulosa* Muir, 1918: 423. Holotype ♂, GUYANA (OU) [examined].

Male: head 0.63 mm long, 0.80 mm wide; pronotum 1.76 mm wide; tegmen 8.50 mm long. Female unknown.

Length of frons 7 times width at apex, 3 times width at base; ocelli large, prominent; rostrum extending beyond base of subgenital plate. Pronotal width 21 times mid-dorsal length; fronto-lateral surfaces and tegula not carinate.

Genae at level of eyes broadly tinged orange; fronto-lateral surfaces of pronotum broadly and irregularly orange from level of dorsal margins of eyes to lateral margins. Tegmen whitish hyaline, with a brownish transverse band at immediately basad of second fork of cubital vein, another immediately distad of second fork of medial vein.

Shaft of aedeagus, laterally expanded over apical two-fifths length; lateral surfaces subapically each bearing a large, flap-like process extending over dorsal surface, each bearing a long, curving, spine-like

projection; dorsal surface at three-quarters length with a single process medially. Paramere robust; apex broadly rounded; dorsal process situated at midlength, strongly produced posteriorly; dorsal margin subapically somewhat produced and medially inclined.

#### MATERIAL EXAMINED

Holotype ♂, **Guyana**: Bartica, 9.v.1901 (*Osborn*) (OU).

The clypeus is obscured and, due to the fragile and badly damaged condition of the unique specimen available for study, it is considered inadvisable to remount it. The right tegmen is mounted on a card below the specimen with the markings obscured by glue; it would appear, however, that more dark transverse bands may be present than the two noted above. The left tegmen and both wings are missing.

Due to the lack of distinctive external characters, this species may only be positively distinguished by reference to the male genitalia.

### *Mysidia cinerea* Fennah

(Figs 189, 299, 408)

*Mysidia cinerea* Fennah, 1945: 439. Holotype ♂, TRINIDAD (USNM) [examined].

Male: head 0.46 mm long, 0.63 mm wide; pronotum 1.95 mm wide; tegmen 6.00 mm long; wing 3.50 mm long.

Length of frons c. 5 times width at apex, 2.5 times width at base; ocelli distinct; clypeus c. as long as frons; rostrum extending slightly beyond hind coxae. Pronotal width 11 times mid-dorsal length, fronto-lateral carinae absent; tegula prominently carinate.

Head and body unmarked. Tegmen and wing clear hyaline; veins and cross-veins dull yellowish, very faintly margined pale smoky brown.

Shaft of aedeagus with lateral surfaces subapically each bearing a large flap-like process extending over dorsal surface; ventral surface with a pair of short triangular processes somewhat basad of two-thirds length. Paramere with apex regularly rounded; dorsal process large, situated slightly basad of midlength, reduced to a large, curving, posteriorly directed hook.

#### MATERIAL EXAMINED

Holotype ♂, **Trinidad**: Northern Range, 12.vi.1942 (*Fennah*) (USNM).

The paratype noted by Fennah as being in the BMNH is presumed lost. The holotype, probably due to having been previously stored in alcohol, has lost most of its pigmentation, which Fennah described thus:

. . . eyes red; tegmina hyaline, all veins faintly and broadly overlain with brown, a clear ellipsoidal spot near apical fork of M, with the veins tinged brown at fork, veins otherwise concolorous; wings pale hyaline, veins irregularly pale brown, apical cells clouded near margin, veins concolorous. Insect in life powdered pearly gray.

Due to the extremely shrivelled condition of the type, the above measurements are largely estimated, and the species can only be determined by reference to the male genitalia.

#### Nomina dubia

### *Mysidia pallida* (Fabricius)

*Derbe pallida* Fabricius, 1803: 81. LECTOTYPE ♀, CENTRAL AMERICA (UZM), here designated [examined].

*Mysidia pallida* (Fabricius) Westwood, 1840: 83.

Female: head 0.78 mm long, 0.96 mm wide; pronotum 2.31 mm wide; tegmen 9.70 mm long; wing 5.40 mm long. Male unknown.

Length of frons 5 times width at apex, c. twice width at base; ocelli small, distinct; clypeus one-fifth longer than frons; rostrum unknown. Pronotal width 25 times mid-dorsal length, lacking fronto-lateral carinae; tegula prominently carinate.

Fronto-lateral surfaces of pronotum each with a narrow orange band extending horizontally from adjacent to eye to lateral margin; tegula ventral to carina dark brown [?]; disc of mesonotum and dorsal

surface of abdomen brownish. Tegmen and wing clear hyaline; veins and cross-veins pale brown, narrowly edged brown. Tegmen with costal area yellowish brown; basal one-fifth length irregularly pale brownish; a pale brownish transverse band at slightly distad of first fork of cubital vein; another adjacent to first fork of medial vein; a third adjacent to second fork of medial vein; a fourth, very faint band extending from costal margin to radial-medial cross-vein; apical fork of radial vein dark brown. Wing with a pale, indistinct, brownish, transverse band immediately distad of first fork of cubital vein; an even fainter band over radial-medial cross-vein.

**MATERIAL EXAMINED**

Lectotype ♀, **Central America:** (*Schmidt*) (UZM).

Paralectotype. **Central America:** 1 ♀ (UZM).

The lectotype appears to be teneral and the pigmentation described above is by no means certain. The paralectotype lacks both tegmina and it may not be conspecific with the lectotype. *M. pallida* is known only from these two females, neither of which is in good condition; '*pallida*' is therefore regarded as a nomen dubium and is omitted from both keys.

***Mysidia stigma* Germar**

*Derbe stigma* Germar, 1830: 56. Syntypes, URUGUAY [not examined].

*Mysidia stigma* (Germar) Schaum, 1850: 70.

It has not been possible to examine the type-material of this species, which therefore cannot be redescribed and is omitted from the keys. Germar's description is as follows:

alba, elytris puncto ante apicem venisque transversis nigris. Habitat in Monte Video. Mus. de Winthem. Caput, thorax et abdomen alba. Elytra alba, opaca: puncta ante angulum anticum serieque venarum transversali nigris. Alae albae striga una alterave transversa nigra.

It would appear from the above description that the species is probably correctly placed in *Mysidia*; distinct transverse bands on the tegmina and wings are not a feature of the genus *Derbe*, nor within the other subfamilies of the Neotropical Derbidae. This is the only species recorded from as far south as Uruguay.

**Species previously transferred from *Mysidia***

***Heronax elatior* (Fowler)**

*Mysidia elatior* Fowler, 1900: 73.

*Heronax elatior* (Fowler) Muir, 1918: 230.

Examination of Fowler's type-material confirms Muir's transfer of this species from the Derbinae.

***Neocenchrea spreta* (Fowler)**

*Mysidia spreta* Fowler, 1900: 74.

*Basileocephalus spretus* (Fowler) Muir, 1918: 230.

*Neocenchrea spreta* (Fowler) Metcalf, 1938: 331.

Examination of the type-material confirms the transfer of the species from the Derbinae.

**PSEUDOMYSIDIA Metcalf**

*Pseudomysidia* Metcalf, 1938: 317. Type-species: *Pseudomysidia fuscovaria* Metcalf, by monotypy.

Width of head in dorsal aspect slightly less than one-third greater than length. Vertex with lateral margins strongly converging from base to level of anterior margins of eyes, then very gradually converging to junction with frons; extending beyond anterior margins of eyes for up to one-half length; basal margin transverse; lateral carinae distinct, but not foliate; junction with frons broadly and regularly rounded. Frons with lateral margins subparallel from apex to level of midline of eyes, then gradually and regularly diverging to base; very slender, length 12–17 times width at apex, c. 3.0–4.5 times width at base; lateral carinae very prominent subbasally. Genae extending anterior to eyes for from one-third to one-half

horizontal diameter of eye. Antenna with second segment club-shaped, *c.* twice as long as maximum breadth; apex transverse; flagellum arising apically. Ocelli small, distinct, occasionally prominent. Clypeus slender, length up to one-third greater than that of frons, 3.5–4.5 times width at base; medial carina distinct over *c.* apical three-quarters length; lateral carinae distinct and percurrent. Rostrum extending to from base of subgenital plate to slightly beyond apex of abdomen.

Pronotal width 6.5–11.0 times mid-dorsal length; very deeply, broadly and regularly incised basally. Fronto-lateral surfaces usually each with a distinct, rarely obsolete, horizontal carina extending from adjacent to midline of eye to lateral margin. Tegula rarely weakly carinate. Disc of mesonotum *c.* as long as wide; medial and lateral carinae usually distinct, extending over apical half to four-fifths length, rarely obsolete.

Tegmen length usually 5.50–6.80 mm; those of females being slightly longer than those of males. Medial vein becoming distinct from fused radial and subcostal veins at *c.* one-eighth length; radial and subcostal veins separating slightly basad of midlength. Radial vein with two branches extending to apical margin. Medial vein with 11 branches extending to apical and posterior margins, linked to radial vein by cross-veins at three-quarters length and subapically; cross-veins between first and third, fourth and fifth, six and seventh, and eighth and ninth branches. Cubital vein with three branches extending to posterior margin; first linked to claval suture and to second, second to third, and third to first branch of medial vein by cross-veins.

Wing *c.* half as long as tegmen. Subcostal and radial veins fused over basal one-third length; radial vein unbranched, linked to medial vein by a single oblique cross-vein somewhat distad of midlength. Medial vein distinct from base, with three branches extending to apical and posterior margins. Cubital vein with two branches extending to posterior margin, second linked to first medial by a cross-vein.

Head and thorax predominantly pale yellowish brown, often with dorsal surfaces, genae, and lateral surfaces of clypeus tinged reddish; ocelli often bright red; frons with lateral carinae rarely dark brown; fronto-lateral surfaces of pronotum often tinged reddish. Dorsal surface of abdomen, at least in part, bright red. Tegmen and wing whitish or hyaline; veins usually pale, occasionally with cross-veins and forks of veins brownish; veins and cross-veins usually edged smoky brown, these markings frequently very faint, often coalescing to form very irregular transverse bands; posterior and apical margins often broadly smoky brown, prominent markings absent.

Male genitalia with shaft of aedeagus symmetrical, horizontal, slender in lateral aspect, basally cylindrical; dorsal surface subapically with 4–6 pairs of mainly horizontal, anteriorly directed, occasionally strongly forked, serrated or apically bifurcate spine-like processes; ventral surface unarmed. Paramere slender, never very robust; basal apodeme one-quarter to slightly less than half total length; apex usually acutely rounded, narrowly inclined towards midline; dorsal process situated at or basad of midlength, simple, usually not produced posteriorly, very rarely with interlocking processes, usually short, broad and apically truncate, lacking a secondary dorsal process; ventral surface usually with numerous long robust spines subbasally. Anal tube little produced, *c.* as long as broad; apex commonly rounded, deeply notched medially.

Female with posterior margin of subgenital plate frequently strongly produced; apex broadly rounded, transverse, or shallowly concave.

The tegmen venation, the structure of the male genitalia and the apical position of the antennal flagellum tend to indicate that *Pseudomysidia* is the least specialised of the mysidiine genera, and that with *Dysimia*, *Dysimiella* and *Symidia* it diverged from the more common trend of development within the tribe, as exemplified by *Mysidia*, at a comparatively early stage in the development of the group. The 11 branches of the medial vein of the tegmen distinguish the genus from all others in the Mysidiini.

Although the aedeagal characters show continuity within the genus, two species-groups are proposed, based on the structure of the paramere.

The *fuscovaria*-group. Paramere with dorsal process slender, dorsally produced, bearing rudimentary interlocking processes which are most highly developed in *juliana*. This group also includes *palmeri*, *rubidella*, *debora* and *hindore*.

The *panamensis*-group. Paramere with dorsal process very much reduced, broad, apically truncate, with no suggestion of interlocking processes. This group includes all species not included above.

Distributed from Mexico to Costa Rica, Trinidad, Panama, Brazil, Bolivia, Venezuela and Ecuador.

### Key to species of *Pseudomysidia* (based on external characters)

The external differences between species are often very slight; where possible, reference should be made to the structure of the male genitalia.

- 1 Tegmen with claval area dark. Venezuela ..... *araguana* Fennah (p. 81)

-	Tegmen with claval area pale .....	2
2 (1)	Tegmen and wing with cross-veins and forks of veins strongly and broadly margined dark smoky brown .....	12
-	Tegmen with cross-veins and forks of veins weakly margined pale smoky brown; appearance predominantly hyaline.....	3
3 (2)	Abdomen with dorsal surface predominantly bright red .....	4
-	Abdomen with dorsal surface brown or yellow, rarely narrowly red basally at midline.....	6
4 (3)	Pronotum with fronto-lateral surfaces distinctly carinate. Panama .....	<i>palmeri</i> sp. n. (p. 82)
-	Pronotum with fronto-lateral carinae weak or absent .....	5
5 (4)	Male tegmen less than 6 mm. Mexico .....	<i>rubidella</i> Ball (in part) (p. 80)
-	Male tegmen greater than 6 mm. Panama.....	<i>juliana</i> sp. n. (p. 81)
6 (3)	Male tegmen not greater than 5 mm. Panama.....	<i>fuscovaria</i> Metcalf (p. 80)
-	Male tegmen greater than 5 mm.....	7
7 (6)	Fronto-lateral surfaces of pronotum distinctly carinate.....	10
-	Fronto-lateral surfaces of pronotum with carinae obsolete .....	8
8 (7)	Tegmen with veins and cross-veins pale yellow. Trinidad .....	<i>trinidadensis</i> sp. n. (p. 82)
-	Tegmen with veins and cross-veins brownish .....	9
9 (8)	Junction of frons and vertex usually dark brown. Tegmen with pigmentation around cross-veins and forks of veins coalescing to form two broken, very irregular, transverse bands. Costa Rica .....	<i>similis</i> sp. n. (p. 83)
-	Junction of frons and vertex unmarked. Tegmen with four very irregular transverse bands. Mexico.....	<i>rubidella</i> Ball (in part) (p. 80)
10 (7)	Tegmen with cross-veins and forks of veins dark brown. Costa Rica ....	<i>marshalli</i> sp. n. (p. 83)
-	Tegmen with cross-veins and forks of veins pale.....	11
11(10),	Head pale yellowish throughout. Panama .....	<i>hindore</i> sp. n. (p. 83)
-	Head with genae dorsal and ventral to eyes bright scarlet. Brazil.....	<i>vestis</i> sp. n. (p. 84)
12 (2)	Fronto-lateral surfaces of pronotum tinged reddish .....	13
-	Fronto-lateral surfaces of pronotum yellowish throughout .....	15
13(12)	Fronto-lateral surfaces of pronotum weakly carinate .....	14
-	Fronto-lateral surfaces of pronotum strongly carinate. Ecuador .....	<i>pallida</i> sp. n. (p. 84)
14(13)	Male tegmen less than 6 mm. Panama .....	<i>panamensis</i> sp. n. (p. 84)
-	Male tegmen greater than 6 mm. Ecuador .....	<i>ecuadoriensis</i> sp. n. (p. 85)
15(12)	Pronotal width 11 times length. Costa Rica .....	<i>debora</i> sp. n. (p. 85)
-	Pronotal width not greater than 8 times length.....	16
16(15)	Pronotal width 8 times length. Tegmen with posterior and apical margins broadly smoky brown. Bolivia .....	<i>lepida</i> sp. n. (p. 86)
-	Pronotal width distinctly less than 8 times length. Tegmen with posterior and apical margins pale. Ecuador .....	<i>delicata</i> sp. n. (p. 86), <i>obnubilia</i> sp. n. (p. 86)

**Key to species of *Pseudomysidia* (based on male genitalia)**

It has not been possible to examine a male of *lepida* which is therefore omitted from this key.

1	Paramere with dorsal process greatly reduced, situated basad of midlength, short, broad, and apically truncate.....	7
-	Paramere with dorsal process produced dorsally, situated at midlength, long, slender, apically acute .....	2
2 (1)	Aedeagus with four pairs of subapical spines (Fig. 34) .....	<i>palmeri</i> sp. n. (p. 82)
-	Aedeagus with five or six pairs of subapical spines .....	3
3 (2)	Aedeagus with five pairs of subapical spines (Fig. 35).....	<i>rubidella</i> Ball (p. 80)
-	Aedeagus with six pairs of subapical spines.....	4
4 (3)	Paramere with interlocking surfaces .....	5
-	Paramere without interlocking surfaces.....	6
5 (4)	Aedeagus with longest pair of subapical spines curving laterally and apically serrated (Fig. 36) .....	<i>juliana</i> sp. n. (p. 81)
-	Aedeagus with longest pair of subapical spines anteriorly directed and apically acute (Fig. 37) .....	<i>debora</i> sp. n. (p. 85)
6 (4)	Aedeagus with third pair of subapical spines serrated, lateral spines short (Fig. 38) .....	<i>similis</i> sp. n. (p. 83)

- Aedeagus with third pair of subapical spines not serrated, lateral spines long (Fig. 39) *hindore* sp. n. (p. 83)
- 7 (1) Aedeagus with three pairs of subapical spines ..... 8
- Aedeagus with four or more pairs of subapical spines ..... 9
- 8 (7) Aedeagus with medial pair of subapical spines strongly branched and dorsally serrated (Fig. 40)..... *panamensis* sp. n. (p. 84)
- Aedeagus with medial pair of subapical spines shallowly forked at apex (Fig. 41) *fuscovaria* Metcalf (p. 80)
- 9 (7) Aedeagus with four pairs of subapical spines ..... 10
- Aedeagus with at least five pairs of subapical spines ..... 11
- 10 (9) Aedeagus with third pair of subapical spines apically forked (Fig. 42) ..... *pallida* sp. n. (p. 84)
- Aedeagus with all spines simple (Fig. 43) ..... *araguana* Fennah (p. 81)
- 11 (9) Aedeagus with five pairs of subapical spines ..... 13
- Aedeagus with six pairs of subapical spines ..... 12
- 12(11) Aedeagus with fifth pair of subapical spines strongly branched (Fig. 44) *marshalli* sp. n. (p. 83)
- Aedeagus with fifth pair of subapical spines not as above (Fig. 45) ..... *vestis* sp. n. (p. 84)
- 13(11) Aedeagus with subapical spines strongly curving laterally (Fig. 46) *trinidadensis* sp. n. (p. 82)
- Aedeagus with subapical spines anteriorly directed ..... 14
- 14(13) Aedeagus with subapical spines strongly curving dorsally (Fig. 63) *ecuadoriensis* sp. n. (p. 85)
- Aedeagus with spines not as above ..... 15
- 15(14) Aedeagus with medial pair of subapical spines very slender, fourth pair longest (Fig. 48) *delicata* sp. n. (p. 86)
- Aedeagus with medial pair of subapical spines robust and longest (Fig. 49) *obnubilia* sp. n. (p. 86)

### *Pseudomysidia fuscovaria* Metcalf

(Figs 11, 41, 57, 73)

*Pseudomysidia fuscovaria* Metcalf, 1938: 317. Holotype ♂, PANAMA (MCZ) [examined].

Male: head 0.44 mm long, 0.48 mm wide; pronotum 0.90 mm wide; tegmen 4.75 mm long; wing 2.58 mm long. Female: tegmen 5.70 mm long.

Length of frons 16 times width at apex, 3.5 times width at base; ocelli distinct; clypeus slightly longer than frons; rostrum extending to base of subgenital plate. Pronotal width 7 times mid-dorsal length; fronto-lateral surfaces and tegula with carinae obsolete or absent.

Genae and fronto-lateral surfaces of pronotum occasionally tinged orange; ocelli crimson; scutellum and dorsal surfaces of abdomen occasionally tinged pale crimson. Tegmen and wing almost hyaline, faintly tinged whitish, veins yellowish brown; cross-veins and forks of veins darker brown, narrowly edged pale smoky brown; without transverse markings.

Shaft of aedeagus slender; dorsal surface subapically with three pairs of spine-like processes, medial pair apically bifid. Paramere slender, apex narrowly rounded; dorsal process situated at midlength, not posteriorly produced.

#### MATERIAL EXAMINED

Holotype ♂, **Panama**: Canal Zone, Barro Colorado, 15.vii.1924 (*Banks*) (MCZ).

Paratypes. **Panama**: 7 ♂, 12 ♀ same data as holotype (MCZ); 1 ♂, 1 ♀ (FAMU; BMNH).

This species is readily distinguished by its small size, lack of pigmentation on the tegmen and wing, and by the structure of the male genitalia.

### *Pseudomysidia rubidella* (Ball) comb. n.

(Figs 35, 51, 67)

*Mysidia rubidella* Ball, 1928: 199. Holotype ♂, MEXICO (USNM) [examined].

Male: head 0.46 mm long, 0.42 mm wide; pronotum 0.92 mm wide; tegmen 5.60–5.70 mm long; wing 3.00 mm long. Female: tegmen 6.30–6.45 mm long.

Length of frons 11 times width at apex, 4 times width at base; ocelli small, distinct; clypeus slightly longer than frons; rostrum terminating immediately posterior to hind coxae. Pronotal width 9 times mid-dorsal length; fronto-lateral surfaces and tegula weakly carinate.

Head and body often bright scarlet with frons, clypeus, tegula and legs yellowish brown; otherwise yellowish brown throughout. Tegmen and wing whitish hyaline, veins and cross-veins yellowish brown. Tegmen with cross-veins and forks of veins darker brown, broadly and irregularly edged smoky brown, these markings coalescing to form a very broken transverse band at level of second fork of cubital vein, and another at each of first, second and third branches of medial vein. Wing with a faint, oblique, smoky brown transverse band at level of radial-medial cross-vein; apical and posterior margins weakly tinged greyish brown.

Shaft of aedeagus slender; dorsal surface subapically with five pairs of long spine-like processes. Paramere broadly rounded apically; dorsal process situated at midlength, dorsally directed.

#### MATERIAL EXAMINED

Holotype ♂, **Mexico**: Veracruz, Presido, vi. (*Barrett*) (USNM).

**Mexico**: 3 ♂, 5 ♀ (AC; USNM; BMNH). **Honduras**: 5 ♂ (FAMU; BMNH).

The transfer of this species from *Mysidia* is based on the 11 branches of the medial vein of the tegmen and on the structure of the male genitalia. It is distinguished by its relatively large size, frequently bright red pigmentation, and by the structure of the male genitalia.

### *Pseudomysidia juliana* sp. n.

(Figs 36, 52, 68)

Male: head 0.52 mm long, 0.54 mm wide; pronotum 1.22 mm wide; tegmen 6.12–6.46 mm long; wing 3.40 mm long. Female: tegmen 6.31–6.48 mm long.

Length of frons 13 times width at apex, 4.5 times width at base; ocelli very prominent; clypeus slightly longer than frons; rostrum extending beyond base of subgenital plate. Pronotal width 8 times mid-dorsal length, fronto-lateral carinae weak or obsolete; tegula not carinate.

Genae ventral to eyes frequently reddish, ocelli crimson, lateral margins of frons at level of eyes rarely dark brown; fronto-lateral surfaces of pronotum occasionally reddish; dorsal surface of abdomen, excluding genital segment, often deep red. Tegmen and wing whitish hyaline, veins yellow; cross-veins and forks of veins brownish, narrowly and irregularly edged pale smoky brown; posterior margins weakly and indistinctly tinged smoky grey.

Shaft of aedeagus basally slender; dorsal surface subapically with six pairs of spine-like processes, those fourth from midline with apices narrowly serrated. Paramere slender, apex acute; dorsal process situated at midlength, long and slender; ventral surface subbasally with numerous long slender spines.

#### MATERIAL EXAMINED

Holotype ♂, **Panama**: Chiriqui, Fortuna, 82°15'W 8°44'N, 19.v.1978 (*O'Brien & Marshall*) (FAMU).

Paratypes. **Panama**: 6 ♂, 3 ♀, data as holotype (FAMU; BMNH).

The relatively complex structure of the paramere closely resembles that of some species of *Mysidia*; the venation of the tegmen, however, and the structure of the aedeagus leave no doubt as to the correct placement of the species in *Pseudomysidia*. It is distinguished by its relatively large size, reddish pigmentation, and by the structure of the male genitalia.

### *Pseudomysidia araguana* Fennah stat. n.

(Figs 43, 59, 75)

*Pseudomysidia fuscovaria* Metcalf ssp. *araguana* Fennah, 1952: 123. Holotype ♀, VENEZUELA (BMNH) [examined].

Male: head 0.48 mm long, 0.53 mm wide; pronotum 1.05 mm wide; tegmen 5.80 mm long; wing 2.80 mm long. Female: tegmen 6.40 mm long.

Length of frons c. 13 times width at apex, 4 times width at base; ocelli small, distinct; clypeus one-fifth longer than frons; rostrum extending to midlength of abdomen. Pronotal width 8 times mid-dorsal length, fronto-lateral carinae distinct; tegula not carinate.

Genae weakly tinged reddish around crimson ocelli; fronto-lateral surfaces of pronotum adjacent to eyes reddish, disc of mesonotum brownish, abdomen broadly crimson along midline. Tegmen and wing whitish hyaline, veins yellowish. Tegmen with cross-veins and forks of veins narrowly edged smoky brown; claval area broadly blackish brown; with an irregular, dark brown, transverse band extending from second fork of claval vein to posterior margin, and another extending from first fork of cubital vein obliquely across

cubital cross-veins; costal area with six faint, evenly spaced, pale brownish bands extending from medial vein to anterior margin. Wing unmarked.

Shaft of aedeagus slender; dorsal surface subapically with four pairs of spine-like processes, those adjacent to midline longest. Paramere slender, apex acute; dorsal process situated somewhat distad of midlength, broad, apex truncate; ventral surface subbasally with long, robust spines.

**MATERIAL EXAMINED**

Holotype ♀, **Venezuela:** Aragua, Rancho Grande, 1949 (*Racenis*) (BMNH).  
**Venezuela:** 1 ♂, nr Maracay (AMNH).

Fennah's description is in error in ascribing to this species only 10 branches to the medial vein of the tegmen the left tegmen of the type, though damaged, shows eleven.

This species is unique in having the claval area of the tegmen darkly pigmented.

***Pseudomysidia palmeri* sp. n.**

(Figs 34, 50, 66)

Male: head 0.54 mm long, 0.54 mm wide; pronotum 1.30 mm wide; tegmen 6.17 mm long; wing 3.48 mm long. Female unknown.

Length of frons *c.* 16 times width at apex, *c.* 3 times width at base; ocelli prominent; clypeus slightly longer than frons; rostrum terminating at level of genital segment. Pronotal width *c.* 8 times mid-dorsal length, fronto-lateral carinae distinct; tegula each with two weak carinae.

Genae ventral to eyes orange, ocelli narrowly edged crimson; fronto-lateral surfaces of pronotum ventral to dorsal margins of eyes orange; abdomen dull reddish. Tegmen and wing very weakly tinged whitish, veins yellow; cross-veins and forks of veins brownish, the latter narrowly edged smoky brown. Wing with posterior margin narrowly edged pale smoky grey.

Shaft of aedeagus slender, weakly expanded subapically; dorsal surface subapically with four pairs of spine-like processes; medial pair long, adjacent pair with apices weakly serrated, next pair strongly curving. Paramere with apex obtusely rounded; dorsal process large, situated at midlength, apex decurved and bearing numerous small spines; dorsal surface subbasally with a row of long, slender spines.

**MATERIAL EXAMINED**

Holotype ♂, **Panama:** Chir. Las Lagunas, 2.5 miles W. El Volcan, 4400 ft (*O'Brien & Marshall*) (FAMU).

This species is distinguished by the reddish pigmentation of the abdomen, the carination of the fronto-lateral surfaces of the pronotum, and by the structure of the male genitalia.

***Pseudomysidia trinidadensis* sp. n.**

(Figs 46, 62, 78)

Male: head 0.46 mm long, 0.57 mm wide; pronotum 1.07 mm wide; tegmen 5.70 mm long; wing 2.77 mm long. Female unknown.

Length of frons *c.* 12 times width at apex, 3.5 times width at base; ocelli small; clypeus *c.* one-third longer than frons; rostrum extending to apex of abdomen. Pronotal width 6.5 times mid-dorsal length; fronto-lateral surfaces and tegula not carinate.

Genae around ocelli and dorsad of eyes pale crimson; fronto-lateral surfaces of pronotum and disc of mesonotum pale orange. Tegmen and wing whitish hyaline, veins and cross-veins pale yellow; cross-veins and forks of veins broadly and irregularly edged very pale brownish. Tegmen with a broad, irregular, faint, brownish transverse band extending from cubital vein to posterior margin at one-quarter length.

Shaft of aedeagus short, broad; dorsal surface subapically with four pairs of spine-like processes, medial pair each with a curving spine at midlength. Paramere slender, apex acute; dorsal process broad, truncate, situated at one-third length.

**MATERIAL EXAMINED**

Holotype ♂, **Trinidad:** Mt Harris (*Withycombe*) (BMNH).

This species is distinguished by the paleness of the markings of the tegmen and wing, and by the structure of the aedeagus.



*Pseudomysidia similis* sp. n.

(Figs 38, 54, 70)

Male: head 0.46 mm long, 0.48 mm wide; pronotum 0.95 mm wide; tegmen 5.40–5.60 mm long; wing 2.60 mm long. Female: tegmen 6.00–6.70 mm long.

Length of frons 14 times width at apex, 4 times width at base; ocelli small, distinct; clypeus slightly longer than frons; rostrum extending to base of subgenital segment. Pronotal width 8 times mid-dorsal length; fronto-lateral surfaces and tegula with carinae obsolete or absent.

Junction of vertex and frons often tinged brownish, ocelli yellowish brown or red. Tegmen and wing whitish hyaline, veins yellowish, cross-veins broadly and irregularly edged smoky brown. Tegmen with pigmentation around cross-veins coalescing to form an irregular transverse band at one-quarter length, and at approximately two-fifths length. Wing with veins narrowly edged smoky brown apically.

Shaft of aedeagus gradually broadening towards apex; dorsal surface subapically with six pairs of spine-like processes, third pair from lateral margins finely serrated. Paramere slender basally; apex broadly rounded; dorsal process situated at midlength, strongly produced posteriorly.

## MATERIAL EXAMINED

Holotype ♂, **Panama**: Barro Colorado, C.Z., 5.vii.1971 (*Wolda*) (FAMU).

Paratype. 1 ♀, same data as holotype (BMNH).

This species is distinguished by the pigmentation of the head and tegmen, and by the structure of the male genitalia.

*Pseudomysidia marshalli* sp. n.

(Figs 44, 60, 76)

Male: head 0.46 mm long, 0.55 mm wide; pronotum 1.07 mm wide; tegmen 5.86–6.03 mm long; wing 3.00 mm long. Female: tegmen 6.70–7.00 mm long.

Length of frons 13 times width at apex, 3.5 times width at base; ocelli small, occasionally obscure; clypeus one-fifth longer than frons; rostrum terminating slightly basad of subgenital segment. Pronotal width c. 7 times mid-dorsal length, fronto-lateral carinae distinct; tegula not carinate.

Genae rarely tinged crimson ventral to eyes; ocelli commonly bright red. Tegmen and wing whitish hyaline, posterior margins broadly hyaline, veins pale; cross-veins and forks of veins darker, broadly edged smoky brown. Tegmen with markings around forks of veins coalescing to form very irregular transverse bands at level of second fork of cubital vein, and at level of each of first, second and third forks of medial vein, the latter two not extending to posterior margin. Wing with a very irregular, pale smoky transverse band at level of radial-medial cross-vein.

Shaft of aedeagus slender; dorsal surface subapically with four pairs of spine-like processes, medial pair trifurcate. Paramere slender, apex acute; dorsal process situated at one-third length, truncate, weakly produced anteriorly; ventral surface over basal half length with long robust spines.

## MATERIAL EXAMINED

Holotype ♂, **Costa Rica**: Turrialba, 21.vi.1974 (*O'Brien & Marshall*) (FAMU).

Paratypes. **Costa Rica**: 1 ♂, 12 ♀ (FAMU; BMNH).

This species is most readily distinguished by the structure of the aedeagus.

*Pseudomysidia hindore* sp. n.

(Figs 39, 55, 71)

Male: head 0.38 mm long, 0.42 mm wide; pronotum 1.05 mm wide; tegmen 5.10–5.70 mm long; wing 2.80 mm long. Female unknown.

Length of frons 12 times width at apex, c. 3 times width at base; ocelli obscure; clypeus c. as long as frons; rostrum extending to apex of abdomen. Pronotal width 8.5 times mid-dorsal length, fronto-lateral carinae distinct; tegula not carinate.

Head and body unmarked. Tegmen and wing whitish hyaline, veins and cross-veins pale yellowish brown; cross-veins irregularly edged pale smoky brown. Tegmen with a weak, irregular, smoky brown, transverse band at one-third length.

Shaft of aedeagus broadly expanded over apical one-half length; dorsal surface subapically with six pairs

of spine-like processes, medial pair apically serrated, lateral pair inclined ventrally. Paramere slender, apex acutely rounded; dorsal process situated at midlength, large, posteriorly produced.

**MATERIAL EXAMINED**

Holotype ♂, **Panama**: Turdi River, San Blas, i.1979 (*Operation Drake Expedition*) (BMNH).

Paratype. **Panama**: 1 ♂, C.Z., 7 km SW. Gatun Lock (FAMU).

Though lacking distinctive pigmentation, this species may be readily distinguished by the structure of the aedeagus.

***Pseudomysidia vestis* sp. n.**

(Figs 45, 61, 77)

Male: head 0.42 mm long, 0.57 mm wide; pronotum 1.10 mm wide; tegmen 6.00 mm long; wing 2.50 mm long. Female unknown.

Length of frons c. 12 times width at apex, 3.5 times width at base; ocelli small, distinct; clypeus one-quarter longer than frons; rostrum extending to base of subgenital plate. Pronotal width c. 9 times mid-dorsal length, fronto-lateral carinae distinct; tegula with carinae obscure.

Head with genae dorsal and ventral to eyes, and lateral margins of clypeus bright scarlet; ocelli scarlet. Tegmen and wing clear hyaline, veins yellowish. Tegmen with an indistinct, irregular, oblique, smoky brown, transverse band at level of each of first, second and third forks of medial vein. Wing with a broad, faint, smoky brown, transverse band at one-third and two-thirds length; apex weakly smoky hyaline.

Shaft of aedeagus robust; with six pairs of spine-like processes, of which the next to lateral pair are longest. Paramere slender; apex narrowly rounded; dorsal process situated at approximately one-third length, apically truncate.

**MATERIAL EXAMINED**

Holotype ♂, **Brazil**: Amazon, Rio Purus, i.1915 (*Roman*) (NR).

Paratype. **Brazil**: 1 ♂, Amazon, S. Gabriel (BMNH).

This species is distinguished by the pigmentation of the head and tegmen, and by the six pairs of processes of the aedeagus.

***Pseudomysidia pallida* sp. n.**

(Figs 14, 30, 42, 58, 74)

Male: head 0.52 mm long, 0.50 mm wide; pronotum 1.06 mm wide; tegmen 5.90–6.12 mm long; wing 2.90 mm long. Female: tegmen 6.20–6.80 mm long.

Length of frons 15 times width at apex, 3 times width at base; ocelli small, distinct; clypeus slightly longer than frons; rostrum terminating c. level with apex of abdomen. Pronotal width 7.5 times mid-dorsal length, fronto-lateral carinae distinct; tegula not carinate.

Genae tinged reddish dorsal to eyes and around ocelli and bases of antennae, lateral surfaces of clypeus reddish brown; fronto-lateral surfaces of pronotum reddish, each with a dark reddish brown spot at level of and adjacent to eye. Tegmen and wing whitish hyaline, veins pale brown. Tegmen with veins and cross-veins broadly and irregularly edged brownish. Wing with radial-medial cross-vein and adjacent fork of medial vein broadly edged smoky hyaline.

Shaft of aedeagus slender, broadening subapically; dorsal surface subapically with four pairs of robust spine-like processes of which the longest pair are apically bifid. Paramere slender, apex acutely rounded; dorsal process situated at one-quarter length, large, truncate, weakly inclined anteriorly.

**MATERIAL EXAMINED**

Holotype ♂, **Ecuador**: Mera, 1–2.ii.1923 (*Williams*) (BMNH).

Paratypes. 13 ♂, 11 ♀, same data as holotype (BMNH; FAMU).

This species is distinguished by the pigmentation of the head and pronotum, and by the structure of the aedeagus.

***Pseudomysidia panamensis* sp. n.**

(Figs 40, 56, 72)

Male: head 0.40 mm long, 0.48 mm wide; pronotum 1.05 mm wide; tegmen 5.00–5.52 mm long; wing 2.40 mm long. Female: tegmen 6.10 mm long.

Length of frons 13 times width at apex, 3.5 times width at base; ocelli small, distinct; clypeus as long as frons; rostrum extending to subgenital plate. Pronotal width 8.5 times mid-dorsal length, fronto-lateral carinae weak; tegula not carinate.

Genae crimson dorsad of eyes and from level of anterior margins of eyes to ventral margins, ocelli red. Fronto-lateral surfaces of pronotum crimson at and ventral to level of eyes; lateral surfaces of mesonotum and metanotum weakly crimson; disc of mesonotum pale brownish; dorsal surface of abdomen dark brown, tinged red. Tegmen and wing whitish hyaline, veins and cross-veins pale brown; cross-veins and branches of veins very broadly edged dark smoky brown. Tegmen with brownish markings coalescing to form a very irregular transverse band at level of first fork of cubital vein, with less distinct bands at level of each of first, second and third forks of medial vein. Wing with an irregular, transverse, smoky brown band at level of radial-medial cross-vein, a weaker band near costal margin at level of first fork of cubital vein; apex faintly tinged smoky brown.

Shaft of aedeagus slender throughout; dorsal surface subapically with three pairs of spine-like processes; medial pair very long and robust, bifurcate from midlength. Paramere basally slender, apex acutely rounded; dorsal process situated slightly basad of midlength, truncate.

#### MATERIAL EXAMINED

Holotype ♂, **Panama**: Cerro Campana, 29.vi.1974 (*O'Brien & Marshall*) (FAMU).

Paratypes. 5 ♂, 1 ♀, same data as holotype (FAMU; BMNH).

This species is most readily distinguished by the structure of the aedeagus.

#### *Pseudomysidia ecuadorensis* sp. n.

(Figs 47, 63, 79)

Male: head 0.46 mm long, 0.57 mm wide; pronotum 1.25 mm wide; tegmen 6.40–6.80 mm long; wing 3.33 mm long. Female unknown.

Length of frons 15 times width at apex; 3.33 times width at base; ocelli very small, distinct; clypeus c. as long as frons; rostrum extending to midlength of genital segment. Pronotal width 7.5 times mid-dorsal length, fronto-lateral carinae weak; tegula not carinate.

Genae pale crimson dorsad to eyes and around ocelli, ocelli crimson; fronto-lateral surfaces of pronotum reddish from level of eyes to ventral margins. Tegmen and wing whitish hyaline, veins and cross-veins yellowish brown; cross-veins and forks of veins irregularly and broadly edged smoky brown. Tegmen with markings coalescing to produce a mottled appearance, forming an oblique, irregular, transverse band at level of second fork of cubital vein and at each of first, second and third forks of medial vein; posterior and apical margins broadly pale smoky brown. Wing with a faint, oblique, smoky brown transverse band at level of radial-medial cross-vein and at one-third length; apex broadly pale smoky brown.

Shaft of aedeagus slender, gradually expanded to apex; dorsal surface subapically with five pairs of spine-like processes. Paramere slender; apex narrowly rounded; dorsal process situated at one-quarter length, truncate, apex antero-laterally directed.

#### MATERIAL EXAMINED

Holotype ♂ **Ecuador**: Tena, 14.ii.1923 (*Williams*) (BMNH).

Paratypes. **Ecuador**: 2 ♂, Tena (BMNH).

This species is distinguished by the dark mottled appearance of the tegmen, and by the structure of the aedeagus.

#### *Pseudomysidia debora* sp. n.

(Figs 37, 53, 69)

Male: head 0.40 mm long, 0.55 mm wide; pronotum 1.13 mm wide; tegmen 6.30 mm long; wing 3.10 mm long. Female: tegmen 7.00–7.30 mm long.

Length of frons 12 times width at apex, 4 times width at base; ocelli small, distinct; clypeus one-quarter longer than frons; rostrum extending to base of subgenital plate. Pronotal width 11 times mid-dorsal length, fronto-lateral carinae very weak; tegula not carinate.

Ocelli narrowly edged crimson. Tegmen and wing whitish hyaline, veins pale yellow; cross-veins and forks of veins brownish, broadly edged smoky brown. Tegmen with a brownish spot on radial cell at level of first fork of medial vein, apex of clavus irregularly pale smoky brown. Wing with posterior and apical margins broadly and irregularly very pale smoky brown.

Shaft of aedeagus slender; dorsal surface subapically with six pairs of spine-like processes, medial pair longest with external surfaces basally serrated. Paramere basally slender, apex acutely rounded; dorsal process situated at approximately midlength, produced dorsally; ventral surface basally with numerous very long, robust, spines.

**MATERIAL EXAMINED**

Holotype ♂, **Costa Rica**: Turrialba, 28.v.1957 (*Cartwright*) (USNM).  
Paratypes. 4 ♀, same data as holotype (USNM; BMNH).

This species is most readily distinguished by the structure of the male genitalia.

***Pseudomysidia lepida* sp. n.**

Female: head 0.53 mm long, 0.59 mm wide; pronotum 1.32 mm wide; tegmen 6.63–6.80 mm long; wing 3.40 mm long. Male unknown.

Length of frons 16 times width at apex, c. 4 times width at base; ocelli small, prominent; clypeus slightly longer than frons; rostrum extending to base of subgenital plate. Pronotal width 8 times mid-dorsal length, fronto-lateral carinae distinct; tegula not carinate.

Genae dorsad and ventral to eyes orange; ocelli crimson. Tegmen and wing whitish hyaline, veins irregularly alternating yellow and dark brown; cross-veins dark brown, these and forks of veins broadly edged dark brownish grey. Tegmen with markings coalescing to form irregular, broad, transverse bands at one-seventh length, at level of first fork of cubital vein, at level of first, second and third forks of medial vein, and at somewhat basad of apical fork of medial vein. Wing with posterior and apical margins broadly dark greyish brown; a broad, irregular, transverse band at three-eighths length and another, oblique band at level of medial-radial cross-vein.

**MATERIAL EXAMINED**

Holotype ♀, **Bolivia**: Beni, Rio Beni, Rurrenábakué, 270 m, 21.vii.1979 (Cooper) (BMNH).  
Paratypes. 1 ♀, same data as holotype (BMNH).

This species is readily distinguished by the very striking markings of the tegmen and wing.

***Pseudomysidia obnubilia* sp. n.**

(Figs 49, 65, 81)

Male: head 0.52 mm long, 0.60 mm wide; pronotum 1.24 mm wide; tegmen 5.70–6.40 mm long; wing 2.84 mm long. Female: tegmen 6.12–6.88 mm long.

Length of frons 14 times width at apex, 3.33 times width at base; ocelli small, prominent; clypeus slightly longer than frons; rostrum extending to apex of abdomen. Pronotal width 6.5 times mid-dorsal length, fronto-lateral carinae distinct; tegula not carinate.

Genae dorsad and ventrad of eyes orange, ocelli crimson; abdomen occasionally red on mid-dorsal line. Tegmen and wing whitish hyaline, veins yellow, cross-veins dark brown. Tegmen with veins and cross-veins broadly and irregularly edged smoky brown, these markings coalescing to form very irregular transverse bands at one-sixth length, at level of first fork of cubital vein, at each of first and second branches of medial vein and at two-fifths length. Wing with posterior and apical margins broadly smoky brown; a broad, irregular, smoky brown, transverse band at two-thirds length.

Shaft of aedeagus slender, with five pairs of long, spine-like processes. Paramere slender, apex acutely rounded; dorsal process situated at one-third length, truncate.

**MATERIAL EXAMINED**

Holotype ♂, **Ecuador**: 18 km S. Tena, 28.iv.1978 (*O'Brien & Marshall*) (FAMU).  
Paratypes. 3 ♂, 4 ♀, same data as holotype (FAMU; BMNH).

Externally very similar to *delicata*, this species is readily distinguished by the male genitalia.

***Pseudomysidia delicata* sp. n.**

(Figs 48, 64, 80)

Male: head 0.52 mm long, 0.55 mm wide; pronotum 1.10 mm wide; tegmen 5.60–6.40 mm long; wing 2.80 mm long. Female: tegmen 5.85–6.40 mm long.

Length of frons 12 times width at apex, 2.75 times width at base; ocelli small, distinct; clypeus

one-quarter longer than frons; rostrum extending to base of genital segment. Pronotal width *c.* 7 times mid-dorsal length, fronto-lateral carinae distinct; tegula not carinate.

Genae crimson dorsal to eyes and from level of anterior margins of eyes to ventral margins; clypeus with lateral margins often pale crimson or brown; ocelli red. Tegmen and wing whitish hyaline, veins pale; cross-veins and bases of branches of veins dark brown, irregularly broadly edged smoky brown; posterior and apical margins broadly pale brownish. Tegmen with dark markings coalescing to form irregular transverse bands at each of first, second and third branches of medial vein. Wing with an irregular, oblique, transverse, smoky brown band at level of medial-cubital cross-vein and at one-third length; apex broadly smoky brown.

Shaft of aedeagus slender, slightly expanded subapically; dorsal surface subapically with five pairs of robust, spine-like processes. Paramere basally slender, apex obtusely rounded; dorsal process situated at one-third length, truncate.

#### MATERIAL EXAMINED

Holotype ♂, Ecuador: Tena, 4.iii.1923 (*Williams*) (BMNH).

Paratypes. 10 ♂, 21 ♀, same locality as holotype (BMNH).

Though externally similar to *obnubilia*, this species is readily distinguished by the structure of the aedeagus.

### *DYSIMIA* Muir

*Dysimia* Muir, 1924: 462. Type-species: *Dysimia maculata* Muir, by monotypy.

Head in dorsal aspect one-quarter to two-thirds wider than long. Lateral margins of vertex strongly converging from base to level of anterior margins of eyes, then subparallel to apex, carinae very prominent, extending beyond anterior margins of eyes for one-quarter to one-third length; basal margin very deeply incised; junction with frons broadly rounded. Frons 6–9 times as long as wide at apex, 1.5–2.0 times width at base; lateral margins strongly and regularly diverging from apex to base. Genae extending anterior to eyes for one-third to two-thirds horizontal diameter of eye. Antenna with second segment club-shaped, twice as long as broad; apex transverse; flagellum arising medially. Ocelli small, usually distinct; occasionally obscure or obsolete. Clypeus short, broad; length from three-quarters of to equal that of frons, from *c.* equal to up to one-half greater than width at base; medial carina obsolete or absent; lateral carinae usually obsolete or absent, occasionally weak and extending over basal *c.* one-third length. Rostrum usually terminating at level of posterior surfaces of hind coxae, occasionally slightly shorter.

Pronotal width 8–12 times mid-dorsal length; fronto-lateral surfaces each with a single, distinct, occasionally prominent carina extending horizontally from adjacent to eye to lateral margin. Tegula rarely carinate. Disc of mesonotum *c.* as long as wide; medial carina percurrent, often weak or obsolete, rarely prominent; lateral carinae commonly obsolete or absent, rarely distinct.

Tegmen commonly 3.20–4.40 mm long, rarely more than 6.00 mm long. Medial vein separating from fused subcostal and radial veins at *c.* one-quarter length; subcostal and radial veins separating at somewhat basad of midlength. Radial vein with two branches extending to apical margin. Medial vein with seven branches extending to apical and posterior margins; with cross-veins between first and second and second and third branches. Cubital vein with three branches extending to posterior margin; anterior branch linked by a cross-vein to first medial vein at *c.* midlength (Fig. 9.)

Length of wing greater than one-half that of tegmen. Subcostal and radial veins fused over rather more than basal one-half length. Radial vein unbranched. Medial vein distinct from base, unbranched, linked to radial vein by a cross-vein at *c.* two-thirds length. Cubital vein with three branches extending to posterior margin, linked to medial vein by a cross-vein at slightly distad of midlength.

Head and body pale, yellowish or brownish. Genae frequently each with a brown band extending horizontally from level of dorsal margin of eye to anterior margin, a similar band at level of ventral margin of eye, rarely unmarked; area around ocelli occasionally tinged brownish. Frons and clypeus rarely with dark markings. Fronto-lateral surfaces of pronotum usually each with a broad brown band extending horizontally from adjacent to eye to lateral margin. Tegmen and wing whitish hyaline; veins pale yellow; cross-veins and forks of veins brownish, often broadly edged smoky brown; apical and posterior marginal veins often crimson, or flecked with red. Tegmen with a large, often prominent, black or brownish, roughly circular spot at one-fifth to one-third length over first branch of cubital vein; often with smaller but equally distinct spots between cubital vein and clavus, adjacent to point of separation of subcostal and radial veins and around apical fork of medial vein. Wing often with a large, prominent, circular, dark brown spot between cubital vein and clavus at *c.* one-third length; where marking is absent, often with a pale brown transverse band at one-third length.

Male genitalia with shaft of aedeagus horizontal, slender, cylindrical, usually symmetrical; dorsal surface subapically with a pair of large, anteriorly directed, flap-like processes, often bearing from one to three pairs of large, curving, anteriorly or antero-laterally directed spines; ventral surface unarmed. Paramere commonly slender, rarely very robust; apex frequently acutely rounded and directed towards midline; basal apodeme not more than one-third total length; dorsal process situated at or distad to midlength, usually well developed with apex strongly produced posteriorly; interlocking surfaces usually well developed, situated basally or at midlength, rarely reduced or absent; dorsal surface basad of main process usually with a large, internally directed, secondary process; ventral surface unarmed. Anal tube with posterior margin rounded, more or less strongly produced, often deeply notched at midline.

Female with posterior margin of subgenital plate more or less strongly produced medially, broadly and regularly convex, rarely truncate apically.

The genus is distinguished by the seven branches of the medial vein of the tegmen, the three branches of the cubital vein of the wing and the apical position of the antennal flagellum. This last character and the proportions of the frons and clypeus show a closer affinity to *Pseudomyssidia* than to *Mysidia*, though it is apparently considerably more specialised than the former.

The male genitalia show three possible diverging lines of development within the genus, which allow the postulation of the following species groups.

The *maculata*-group. Species where the shaft of the aedeagus is lacking large spines, with a corresponding increase in the size and armature of the paramere. The group includes *distincta*, *fennahi*, *pseudomaculata* and *telfordi*, and is probably the most highly specialized of the three.

The *astarte*-group. Species where the shaft of the aedeagus bears strong, heavily chitinized, spine-like processes, and the paramere shows a lesser degree of development. This group includes *morrissi*, *muiiri*, *obrieni*, *maculipennis* and *jamaicensis*.

The *numa*-group. This monotypic group shows a separate line of development from the above. The aedeagus is heavily armed with three pairs of long, acute, spine-like processes, and the dorsal process of the paramere is greatly reduced and can have little grasping function.

Due to the absence of males, *fuscoclypeata* and *putilla* are omitted from the above groups.

The genus is distributed from U.S.A. (Florida) through Central America to Ecuador and Venezuela.

### Key to species of *Dysimia* (based on external characters)

*D. putilla* is omitted from this key due to the fragmentary condition of the unique holotype. In some instances the differences between species are slight and, where possible, reference should be made to the structure of the male genitalia.

1	Tegmen exceeding 6 mm. Jamaica .....	<i>jamaicensis</i> (Distant) (p. 91)
-	Tegmen less than 5 mm .....	2
2(1)	Wing with a prominent, dark brown, spot adjacent to cubital vein .....	6
-	Wing lacking a distinct spot adjacent to cubital vein .....	3
3(2)	Genae with dark brown markings adjacent to eye .....	4
-	Genae unmarked, pale brownish throughout. Florida .....	<i>pseudomaculata</i> sp. n. (p. 91)
4(3)	Tegmen with cross-veins and apical veins dark brown. Costa Rica .....	<i>obrieni</i> sp. n. (p. 92)
-	Tegmen with cross-veins and apical veins pale .....	5
5(4)	Male tegmen in excess of 4.00 mm; female with tegmen in excess of 4.50 mm. Tegmen with posterior margin narrowly scarlet. Ecuador .....	<i>morrissi</i> sp. n. (p. 93)
-	Neither sex with tegmen exceeding 4.00 mm. Tegmen with posterior margin pale. Jamaica .....	<i>muiiri</i> sp. n. (p. 92)
6(2)	Clypeus narrowly pale basally, thence dark brown to junction with paraclypeus. Venezuela .....	<i>fuscoclypeata</i> Fennah (p. 90)
-	Clypeus pale throughout .....	7
7(6)	Genae each with one or two dark brown bands extending horizontally from adjacent to eye to anterior margin. Pronotum dorsad of eyes unmarked .....	8
-	Genae unmarked. Pronotum dorsad of base of head with two very pale fuscous, parallel, transverse bands. Cayman Islands .....	<i>numa</i> Fennah (p. 90)
8(7)	Abdomen with a large, dark brown, spot on either side of midline on dorsal surface. Puerto Rico .....	<i>distincta</i> sp. n. (p. 93), <i>fennahi</i> sp. n. (p. 94), <i>telfordi</i> sp. n. (p. 94)
-	Abdomen with dorsal surface unmarked .....	9



adjacent to eye to external margin. Tegmen and wing with bases of branches of veins and cross-veins brownish, cross-veins edged pale smoky brown; posterior and apical margins frequently very narrowly edged scarlet. Tegmen with a large, circular, dark brown spot over first branch of cubital vein at one-third length; a smaller spot between cubital vein and clavus at one-sixth length; another adjacent to and immediately basad of subcostal and fused radial-medial fork; a third small spot, more irregular and less distinct, around fused subcostal-radial-medial vein at one-third length. Wing with a prominent, circular, dark brown spot between cubital vein and clavus at one-quarter length.

Shaft of aedeagus slender, with two pairs of flap-like processes, the external pair each with a small, blunt, spine on ventral surface. Paramere with dorsal process situated slightly distad of midlength, slender, strongly produced postero-dorsally; dorsal surface at one-quarter length with a slender, regularly tapering, secondary process bearing long, robust, spines.

#### MATERIAL EXAMINED

Holotype ♂, **Puerto Rico**: Rio Piedras, viii.1923 (*Wolcott*) (BPBM).

Paratypes. **Puerto Rico**: 26 ♂, 13 ♀, same data as holotype (BMNH); 1 ♂ (USNM).

This species has also been recorded from Haiti (Dozier, 1922). The specimens recorded by Ball (1928) from Florida are the newly described species *pseudomaculata* (p. 00). The two species are readily distinguished by the absence of the dark spot on the wing of *pseudomaculata*, and by the male genitalia.

### *Dysimia fuscoclypeata* Fennah

*Dysimia fuscoclypeata* Fennah, 1952: 124. Holotype ♀, VENEZUELA: Aragua, Rancho Grande, 1100 m, 1.x.1950 (*Yopez*) (lost). NEOTYPE ♀, VENEZUELA, here designated (BMNH) [examined].

Female: head 0.30 mm long, 0.42 mm wide; pronotum 0.86 mm wide; tegmen 4.40 mm long; wing 2.60 mm long. Male unknown.

Length of frons 7 times width at apex, 1.5 times width at base; ocelli distinct; clypeus *c.* as long as frons, 1.5 times width at base. Pronotal width *c.* 8 times mid-dorsal length; tegula weakly carinate.

Frons with apical half somewhat darker than basal half, with a dark brown transverse band at level of dorsal margin of eye and another at midline; genae irregularly reddish brown, with a dull brown band running from level of midline of eye to anterior margin; clypeus with basal quarter whitish, thence brown to junction with pale yellowish paraclypeus. Fronto-lateral surfaces of pronotum each with a broad brown band extending horizontally from adjacent to eye, terminating short of external margin; metanotum with fronto-lateral surfaces at level of clypeus pale brown. Tegmen and wing with cross-veins narrowly edged smoky brown. Tegmen with a very large, prominent, dark brown spot on first branch of cubital vein at one-third length; a much smaller spot adjacent and anterior to medial vein at equi-distance from base; two small spots at one-seventh length, one between fused subcostal, radial and medial veins and costal margin, and the other immediately posterior to cubital vein. Wing with a single, irregular, dark brown spot at two-fifths length, adjacent to and posterior to cubital vein.

#### MATERIAL EXAMINED

Neotype ♀, **Venezuela**: Aragua, Camino, Choroni, 950 m, montane forest, 24.iii.1949 (*Box*) (BMNH).

This is the only specimen available for study. A pin with a label bearing the data of the holotype is in the BMNH, but the specimen is missing. With Dr Fennah's agreement I therefore designate the single paratype as a neotype.

As the name suggests, *fuscoclypeata* is readily distinguished by the dark pigmentation of the clypeus.

### *Dysimia numa* Fennah

(Figs 95, 107, 119)

*Dysimia numa* Fennah, 1971: 324. Holotype ♂, CAYMAN ISLANDS (BMNH) [examined].

Male: head 0.28 mm long, 0.40 mm wide; pronotum 0.72 mm wide; tegmen 3.60–4.20 mm long; wing 2.00 mm long. Female: tegmen 4.00–4.60 mm long.

Length of frons 6 times width at apex, 1.5 times width at base; ocelli small, distinct; clypeus as long as frons. Pronotal width 10 times mid-dorsal length.

Head unmarked; pronotum with a pale fuscous transverse band parallel to posterior margin on dorsal



surface; fronto-lateral surfaces each with a very faint fuscous band extending horizontally from adjacent to dorsal margin of eye to lateral margin. Tegmen and wing with cross-veins and forks of veins faintly edged brownish. Tegmen with a large, prominent, roughly circular, brown spot over first branch of cubital vein at three-fifths length; a smaller, paler, irregular marking over apical fork of medial vein; two smaller spots, one between cubital vein and clavus, the other between point of separation of medial vein from fused subcostal-radial veins and costal margin; an irregular spot over medial and fused subcostal-radial veins at three-eighths length. Wing with a small dark brown spot immediately basad of one-third length, adjacent to cubital vein.

Shaft of aedeagus laterally expanded over apical one-third length, with three pairs of large spine-like processes. Paramere slender; apex acute; dorsal process situated at two-thirds length, greatly reduced, with a posteriorly directed spine on posterior surface at midlength; dorsal surface at one-third length with an apically rounded secondary process.

#### MATERIAL EXAMINED

Holotype ♂, **Grand Cayman**: N. Coast, N. Side, Hut Rd, 15.vii.1938 (*Lewis & Thompson*) (BMNH).

Paratypes. **Cayman Brac**: 38 ♂, 33 ♀, Statae [?] Bay (BMNH).

In his description Fennah erroneously refers to a single pair of spines on the aedeagus; his illustration correctly shows three.

This species is distinguished by the lack of dark pigmentation on the genae and pronotum, and by the structure of the male genitalia.

### *Dysimia jamaicensis* Distant comb. n.

(Figs 103, 115, 127)

*Mysidia jamaicensis* Distant, 1907: 396. LECTOTYPE ♂, JAMAICA (BMNH), here designated [examined].

Male: head 0.38 mm long, 0.59 mm wide; pronotum 1.20 mm wide; tegmen 6.40 mm long; wing 3.50 mm long. Female unknown.

Length of frons 6 times width at apex, twice width at base; ocelli small, distinct; clypeus two-thirds longer than frons. Pronotal width 12 times mid-dorsal length; tegula carinate.

Genae and fronto-lateral surfaces of pronotum at level of eyes brown. Tegmen and wing with veins and cross-veins narrowly and irregularly edged pale brownish, posterior margins between veins broadly smoky brown, posterior marginal veins crimson. Tegmen with a large irregular brown spot over fork of second branch of medial vein; a smaller spot over apical fork of medial vein; another larger spot between first branch of cubital vein and vanal fold at approximately three-quarters length of clavus. Wing with cross-veins brown; an indistinct, broken, pale brownish, transverse band at one-third length.

Shaft of aedeagus bearing a pair of large, flap-like processes, each with an adjacent spine-like process dorsally and a small, apically bifurcate spine laterally. Paramere very slender; apex acute; dorsal process situated at midlength, apex posteriorly directed and reduced.

#### MATERIAL EXAMINED

Lectotype ♂, **Jamaica**: Moneague, 10.ii.1905 (*Nicholl*) (BMNH).

This species is included in *Dysimia* because of the tegminal venation and the proportions of the head. Its relatively large size and long wings, with the reduction in the dorsal process of the paramere and complex armature of the aedeagus, readily distinguish it.

### *Dysimia pseudomaculata* sp. n.

(Figs 97, 109, 121)

[*Dysimia maculata* Muir sensu Ball, 1928: 199. Misidentification.]

Male: head 0.30 mm long, 0.40 mm wide; pronotum 0.84 mm wide; tegmen 3.58–3.78 mm long; wing 2.40 mm long. Female: tegmen 4.20–4.40 mm long.

Length of frons 6 times width at apex, 1.5 times width at base; ocelli small or obsolete; clypeus slightly shorter than frons. Pronotal width 10 times mid-dorsal length.

Head ventral to dorsal margins of eyes brown, genae lacking distinct darker markings. Fronto-lateral surfaces of pronotum ventral to horizontal carinae pale dull brownish. Tegmen and wing with veins and cross-veins predominantly pale brown; marginal veins very narrowly crimson, broadly and irregularly

edged pale smoky brown. Tegmen with a very large, prominent, circular, dark brown spot over first branch of cubital vein immediately basad of level of apex of clavus; a small, dark brown spot between cubital vein and claval suture subbasally; a somewhat smaller spot on costal cell immediately basad of point of separation of fused radial and medial veins; a small, indistinct spot over medial vein at one-third length; an irregular, fainter spot covering apical forks of medial and radial veins; bases of branches of medial vein occasionally dark brown. Wing lacking a dark brown spot between cubital vein and clavus; irregularly tinged pale smoky brown at approximately one-third length, level of cubital fork, and over apical one-quarter length.

Shaft of aedeagus strongly dorsally and laterally expanded subapically, devoid of spines. Paramere slender; apex acute; dorsal process situated at midlength, apex strongly produced posteriorly; dorsal surface slightly basad of one-third length with a secondary process bearing a few long, robust, spines.

#### MATERIAL EXAMINED

Holotype ♂, U.S.A.: Florida, Sanford, 19.xi.1927 (*Ball*) (USNM).

Paratypes. 4 ♂, 3 ♀, same data as holotype (USNM; BMNH).

The genitalic differences are consistent, though not great, but the lack of a prominent dark spot on the wing of *pseudomaculata* renders the species readily distinguishable.

#### *Dysimia muii* sp. n.

(Figs 98, 110, 122)

Male: head 0.24 mm long, 0.41 mm wide; pronotum 0.70 mm wide; tegmen 3.50–3.60 mm long; wing 2.15 mm long. Female: tegmen 3.60–4.00 mm long.

Length of frons 8 times width at apex, twice width at base; ocelli obscure; clypeus slightly shorter than frons. Pronotal width 10 times mid-dorsal length.

Genae each with a horizontal dark brown band extending from adjacent to dorsal margin of eye to anterior margin, a similar band at level of ventral margin of eye; frons occasionally dark brown between lateral carinae; fronto-lateral surfaces of pronotum each with a pale brown horizontal band extending from adjacent to eye to lateral margin. Tegmen and wing with veins and cross-veins prominently edged grey-brown, apical and posterior margins fuscous between veins. Tegmen with a very large, prominent, roughly circular, dark brown spot near posterior margin between first branch of cubital vein and clavus; a smaller, brownish spot on medial vein at equal distance from base. Wing lacking distinct spots.

Shaft of aedeagus slender; apex laterally expanded, devoid of spines or flap-like processes. Paramere slender, apex acutely rounded; dorsal process large, situated at midlength, greatly produced posteriorly; dorsal surface subbasally with a membranous secondary process.

#### MATERIAL EXAMINED

Holotype ♂, Jamaica: Portland, Somerset Falls, 8.xii.1975 (*O'Brien & Marshall*) (FAMU).

Paratypes. 28 ♂, 19 ♀, same data as holotype (FAMU; BMNH).

This species is readily distinguished by the pigmentation of the tegmen, lack of dark spots on the wing, and by the structure of the male genitalia.

#### *Dysimia obrieni* sp. n.

(Figs 102, 114, 126)

Male: head 0.26 mm long, 0.36 mm wide; pronotum 0.70 mm wide; tegmen 3.60 mm long; wing 2.00 mm long. Female: tegmen 3.90–4.00 mm long.

Length of frons 7 times width at apex, c. twice width at base; ocelli obsolete; clypeus slightly shorter than frons. Pronotal width 10 times mid-dorsal length.

Genae each with a dark brown band extending from level of dorsal margin of eye to anterior margin, a similar band level with ventral margin of eye. Tegmen and wing with veins, cross-veins and posterior margins narrowly edged smoky brown; apical cells fuscous; posterior marginal veins very narrowly scarlet. Tegmen with a prominent, roughly circular, dark brown spot on first branch of cubital vein at level of apex of clavus; a smaller spot near base of cubital vein; another immediately basad of point of separation of fused subcostal, radial and medial veins; a fourth at c. midlength. Wing lacking conspicuous spots.

Shaft of aedeagus slightly asymmetrical; with a pair of large, flap-like processes, each bearing a single, large, curving spine; a slender acute spine medially. Paramere very slender; dorsal process situated at midlength, apex produced postero-dorsally; dorsal surface subbasally with a conical secondary process.

## MATERIAL EXAMINED

Holotype ♂, **Costa Rica**: Turialba, 21.vi.1974 (*O'Brien & Marshall*) (FAMU).

Paratypes. 3 ♀, same data as holotype (FAMU; BMNH).

This species is readily distinguished by the prominent brown spot on the first branch of the cubital vein of the tegmen coupled with the absence of a corresponding spot on the wing, and by the structure of the male genitalia.

*Dysimia morrisi* sp. n.

(Figs 104, 116, 128)

Male: head 0.29 mm long, 0.47 mm wide; pronotum 0.88 mm wide; tegmen 4.20–4.30 mm long; wing 2.40 mm long. Female: tegmen 4.50–4.60 mm long.

Length of frons 8 times width at apex, 1.5 times width at base; ocelli indistinct; clypeus slightly shorter than frons. Pronotal width slightly less than 10 times mid-dorsal width.

Genae each with a broad, dark brown band extending horizontally from level of dorsal margin of eye to anterior margin, another at level of ventral margin of eye. Fronto-lateral surfaces of pronotum each with a broad brownish band extending from adjacent to eye to exterior margin. Tegmen and wing with cross veins narrowly edged pale brown, posterior margins very narrowly scarlet. Tegmen with a large, roughly circular, dark brown spot on first branch of cubital vein at level with apex of clavus; a much smaller spot on medial vein at same level; another at two-thirds length of fused subcostal, radial, and medial veins; another of intermediate size between cubital vein and vanal fold at midlength between base and first fork; area around apical fork of medial vein irregularly pale brown. Wing lacking distinct dark spots.

Shaft of aedeagus slightly asymmetrical; a pair of large, flap-like processes, each bearing a single, large, curving spine mid-dorsally. Paramere slender, apex narrowly rounded; dorsal process large, situated at midlength, apex slender, strongly produced posteriorly; dorsal surface at one-quarter length with a large rounded secondary process bearing long robust spines.

## MATERIAL EXAMINED

Holotype ♂, **Ecuador**: Naranjapata, 1850 ft, xii.1922 (*Williams*) (BMNH).

Paratypes. 4 ♂, 4 ♀, same data as holotype (BMNH).

The pigmentation of this species closely resembles that of *obrieni*, but it is distinguished by its larger size and by the structure of the male genitalia.

*Dysimia distincta* sp. n.

(Figs 94, 106, 118)

Male: head 0.30 mm long, 0.44 mm wide; pronotum 0.76 mm wide; tegmen 3.60–3.80 mm long; wing 2.20 mm long. Female unknown.

Length of frons c. 8 times width at apex, twice width at base; ocelli distinct; clypeus c. three-quarters length of frons. Pronotal width c. 9 times mid-dorsal length.

Genae each with a dark brown band extending horizontally from level of dorsal margin of eye to anterior margin; another similar band at level of ventral margin of eye. Fronto-lateral surfaces of pronotum each with a broad brown band extending from adjacent to eye horizontally to exterior margin; tegula with ventral margin narrowly brown; abdomen with a large, circular, dark brown spot on either side of midline subapically on dorsal surface. Tegmen and wing with cross-veins broadly edged very pale brown. Tegmen with anterior and posterior margins very narrowly and intermittently tinged reddish; a large, circular, dark brown spot on cubital vein at one-third length; a somewhat smaller spot on medial vein equidistant from base; an irregular spot over apical fork of medial vein; two smaller spots, one adjacent to fused subcostal, radial and medial veins at one-fifth length, the other posterior to cubital vein equidistant from base. Wing with posterior margin narrowly tinged reddish, a small brown spot immediately posterior to cubital vein at one-third length.

Shaft of aedeagus lacking spine-like processes, laterally somewhat expanded over apical one-half length; dorsal surface subapically with a transverse, membranous, flap-like process, partially overlying a pair of slender, projections situated one on either side of midline. Paramere complex, robust; dorsal process very large, situated immediately distad of mid-length, apex strongly produced posteriorly, bearing a large, robust, internally curving, hook-like process dorsally; dorsal surface basad of midlength with a shallowly bifurcate secondary process.

## MATERIAL EXAMINED

Holotype ♂, **Puerto Rico**: 8 miles E. of Mayaguez, 9.ii.1969 (*O'Brien*) (FAMU).

Paratype. **Puerto Rico**: 1 ♂, Rio Piedras, 4.xii.1968 (*Telford & Medina*) (BMNH).

Although very similar in external characters to *fennahi* and *telfordi*, this species is readily distinguished by the unique development of the paramere, which here reaches a degree of complexity not seen elsewhere during the present study.

*Dysimia fennahi* sp. n.

Male: head 0.29 mm long, 0.42 mm wide; pronotum 0.80 mm wide; tegmen 3.60 mm long; wing 2.00 mm long. Female unknown.

Length of frons c. 8 times width at apex, twice width at base; ocelli obscure; clypeus three-quarters length of frons. Pronotal width slightly less than 8 times mid-dorsal length.

Genae each with a dark brown band running horizontally from level of dorsal margin of eye to anterior margin, another similar parallel band at level of ventral margin of eye. Fronto-lateral surfaces of pronotum each with a broad dark brown band running horizontally from adjacent to eye to exterior margin; tegula with ventral margin broadly dark brown; abdomen with a large, rather irregular, dark brown spot on either side of midline subbasally on dorsal surface. Tegmen and wing with veins and cross-veins narrowly and intermittently edged brownish, anterior and posterior margins very narrowly and irregularly flecked pale reddish. Tegmen with a large, roughly circular, dark brown spot on first branch of cubital vein at approximately one-third length; a somewhat smaller spot on medial vein equidistant from base; an irregularly shaped, brownish marking over apical fork of medial vein; two small, dark brown spots, one adjacent to fused subcostal, radial and medial veins, the other on cubital vein subbasally. Wing with a small, circular, dark brown spot adjacent to cubital vein at one-third length.

Shaft of aedeagus with apical third length weakly expanded dorso-laterally; dorsal surface subapically with a large, transverse, flap-like process and a pair of spine-like processes adjacent to midline. Paramere massive; apex acutely rounded; dorsal process situated at two-thirds length, apex slender and strongly produced postero-dorsally; dorsal surface with a well-developed secondary process slightly basad of midlength.

## MATERIAL EXAMINED

Holotype ♂, **Puerto Rico**: 8 miles E. of Mayaguez, 9.ii.1969 (*O'Brien*) (FAMU).

Externally, this species closely resembles *telfordi*, from which it is most readily distinguished by the structure of the male genitalia, where the reduction in the armature of the aedeagus is accompanied by massive development of the paramere.

*Dysimia telfordi* sp. n.

(Figs 100, 112, 124)

Male: head 0.26 mm long, 0.42 mm wide; pronotum 0.75 mm wide; tegmen 3.40–3.60 mm long; wing 2.16 mm long. Female unknown.

Length of frons 7 times width at apex, twice width at base; ocelli indistinct; clypeus three-quarters length of frons. Pronotal width c. 8 times mid-dorsal length.

Genae each with a dark brown band extending horizontally from adjacent to dorsal margin of eye to anterior margin, a similar band at level of ventral margin of eye, these bands continued over frons; fronto-lateral surfaces of pronotum each with a broad pale brown band extending horizontally from adjacent to eye to lateral margin; tegula with ventral margin dark brown; abdomen with a large, roughly circular, dark brown spot on either side of midline subapically on dorsal surface. Tegmen and wing with cross-veins narrowly edged pale smoky brown. Tegmen with anterior and posterior marginal veins crimson; a large, circular, dark brown spot on first branch of cubital vein at one-third length; a rather similar spot on medial vein equidistant from base; another over apical fork of medial vein; two smaller spots, one immediately anterior to point of separation of fused subcostal, radial and medial veins, the other posterior to cubital vein subbasally. Wing with posterior marginal vein crimson; a small, distinct, circular, brown spot immediately posterior to cubital vein at one-third length.

Shaft of aedeagus weakly expanded over apical two-fifths length; dorsal surface subapically with a transverse, flap-like, membranous projection, partially obscuring a pair of short, blunt, spine-like processes medially. Paramere robust; dorsal process situated at three-quarters length, strongly produced posteriorly; dorsal surface at midlength with an apically bifurcate secondary process.

## MATERIAL EXAMINED

Holotype ♂, **Puerto Rico**: Rio Piedras, 4.xii.1968 (*Telford & Medina*) (FAMU).

Paratypes. 5 ♂, 1 ♀, same data as holotype (FAMU; BMNH).

Closely resembling *fennahi* in external characters, this species may be distinguished by its smaller size; though the structure of the aedeagus differs only slightly, that of the paramere is quite distinct.

*Dysimia astarte* sp. n.

(Figs 105, 117, 129)

Male: head 0.29 mm long, 0.40 mm wide; pronotum 0.74 mm wide; tegmen 3.80–3.95 mm long; wing 2.30 mm long. Female: tegmen 4.10–4.40 mm long.

Length of frons c. 6 times width at base; c. 2.5 times width at base; ocelli large, not prominent; clypeus two-thirds length of frons. Pronotal width 9 times mid-dorsal length.

Genae each bearing an irregular dark brown band adjacent to dorsal margin of eye, this band often extending onto frons, a similar, broader band level with midline of eye; ocelli pale; apices of second antennal segments brownish. Fronto-lateral surfaces of pronotum adjacent to eyes narrowly and irregularly dark brown; mesonotum with a large, irregular, pale brown spot on each side ventro-laterally. Tegmen and wing with cross-veins brownish, narrowly edged pale brown, marginal veins yellowish. Tegmen very faintly and irregularly mottled greyish brown distad of medial-cubital cross-vein; with a small, circular, dark brown spot on subcostal cell, between cubital vein and claval suture at one-sixth length, another over medial vein at slightly basad of one-third length, a fourth, rather larger and more irregular spot over first branch of cubital vein at one-third length. Wing with a small, irregular, brown spot between cubital vein and claval suture at slightly basad of two-fifths length.

Shaft of aedeagus not apically expanded; with a pair of large, flap-like processes extending ventrally over lateral surfaces; a pair of acute, spine-like processes adjacent to midline. Paramere slender; apex acute; dorsal process large, situated at approximately midlength.

## MATERIAL EXAMINED

Holotype ♂, **Venezuela**: San Esteban, Carabobo, 2.ii.1920 (*Williamson & Ditzler*) (USNM).

Paratypes. 3 ♂, 2 ♀, same data as holotype (USNM; BMNH).

This species is readily distinguished by the pigmentation of the fronto-lateral surfaces of the pronotum, and by the structure of the male genitalia.

*Dysimia maculipennis* sp. n.

(Figs 101, 113, 125)

Male: head 0.22 mm long, 0.38 mm wide; pronotum 0.68 mm wide; tegmen 3.20 mm long; wing 1.88 mm long. Female: tegmen 3.80–4.10 mm long.

Length of frons 8 times width at apex, twice width at base; ocelli small, distinct; clypeus two-thirds length of frons. Pronotal width 10 times mid-dorsal length.

Genae at level of eyes each with a broad, horizontal brown band, darkest at upper and lower margins, extending from adjacent to eye to anterior margin and continuing across frons; head dorsad of upper margins of eyes very pale, whitish. Fronto-lateral surfaces of pronotum whitish dorsally, each with a broad, dark brown band extending horizontally from adjacent to eye to external margin. Tegmen and wing with bases of branches and cross-veins pale brown, weakly bordered smoky brown; very narrowly edged crimson on posterior and apical margins. Tegmen with a large, circular, dark brown spot on cubital vein at one-third length; two smaller spots at one-sixth length, one on cubital vein, the other exterior and adjacent to fused subcostal, radial and medial veins; an intermediately sized spot over cross-vein linking second and third branches of medial vein; a small, irregular marking around separation of subcostal and fused radial and medial veins; posterior margin irregularly pale brown; apical margin with semi-circular brown spots between branches of radial and medial veins. Wing with a pale brown spot immediately distad of first fork of cubital vein.

Shaft of aedeagus slender in dorsal aspect; a pair of large, flap-like processes, each bearing a pair of long, robust spines dorso-laterally. Paramere slender; apex narrowly rounded; dorsal process situated at midlength, apex strongly produced posteriorly, dorsal surface at one-quarter length with an irregularly rounded secondary process bearing scattered, robust spines.

## MATERIAL EXAMINED

Holotype ♂, Ecuador, Tena, 4.iii.1923 (*Williams*) (BMNH).

Paratypes. 1 ♂, 2 ♀, same data as holotype (BMNH; BPBM).

The four specimens in the series bear 'paratype' labels similar to those used by Muir, and the series is labelled as '*maculipennis* Muir'; however, a search of the literature reveals no record of this name ever having been published by Muir. The name *maculipennis* is used here to avoid any possible confusion.

This species is distinguished by the pigmentation of the head and tegmen, and by the structure of the male genitalia.

## Nomen dubium

*Dysimia putilla* Fennah

*Dysimia putilla* Fennah, 1952: 124. Holotype ♀, St Lucia (BMNH) [examined].

Female: tegmen 4.40 mm long; wing (damaged) 2+ mm long.

Head lost. Pronotum with fronto-lateral surfaces distinctly carinate.

Tegmen and wing with veins pale brown. Tegmen with a small, circular, brownish spot on medial vein at one-third length; another, slightly larger spot on first fork of cubital vein equidistant from base; another adjacent to apical fork of medial vein; smaller and less distinct pale brownish markings at level of separation of medial from fused radial and subcostal veins, and at midlength of cubital vein. Wing with a small, roughly circular, pale brown spot adjacent to and basad of first fork of cubital vein.

## MATERIAL EXAMINED

Holotype ♀, St. Lucia: Quillesse, mountain forest, 1000 ft, 22.ii.1941 (*Fennah*) (BMNH).

This species was described from a unique female of which only a few fragments stored in alcohol now remain, thus making an adequate re-description impossible. Fennah stressed the similarity of the species to *maculata*, but also the differences in its markings; in his description he stated:

Basad portion of frons, excluding the secretory pits, a single narrow stripe on side of head before eyes, a minute spot on genae above base of antennae, dark fuscous. A broad area on lateral lobes of pronotum, posterior margin of tegulae, and a slight suffusion on mesonotum light sepia-brown to fuscous; abdomen with third segment sublaterally, fourth prominently laterally and with four short antero-posterior stripes between them, fifth with four paler spots, and sixth with two pale submedian spots and two spots laterally fuscous. and [Tegminal] veins interruptedly and diffusely overlain with fuscous.

*The subgenital sternite is figured, and described as:* . . . produced caudad in a subequilaterally triangular lobe with the apex shortly truncate.

**DYSIMIELLA gen. n.**

Type-species: *Dysimiella pennyi* sp. n.

Width of head one-quarter to two-thirds greater than length in dorsal aspect. Vertex *c.* 1.25 times as long as wide; lateral margins strongly and regularly converging from base to level of anterior margins of eyes, thence parallel to junction with frons; extending for *c.* one-third its length beyond anterior margins of eyes; base very deeply incised medially; lateral carinae very prominent. Length of frons 9 times width at apex, *c.* twice width at base; junction with vertex broadly and regularly rounded; lateral margins from apex initially gradually and regularly diverging, then abruptly and strongly diverging to base; carinae very prominent. Genae extending anterior to eyes for *c.* one-third to one-half horizontal diameter of eye. Second antennal segment club shaped, *c.* 1.5 times as long as wide; apex truncate; flagellum arising apically. Ocelli prominent or obsolete. Clypeus short and broad, shorter than frons, as long as basal width; medial carina obsolete; lateral carinae distinct basally. Rostrum not extending beyond hind coxae.

Pronotal width 11–24 times mid-dorsal length, strongly constricted medially; fronto-lateral surfaces each with a single carina curving horizontally from adjacent to midline of eye to lateral margin. Tegula with carina weak or absent. Disc of mesonotum slightly wider than long; medial carina weak; lateral carinae obsolete or absent.

Tegmen short and broad; length 4.00–5.20 mm, little greater than twice width. Cubital vein with four branches extending to posterior margin; first and second, and third and fourth linked by cross-veins.

Medial vein fused with radial and subcostal veins over basal one-fifth length; forking at two-fifths and three-fifths length and apically; with seven branches extending to posterior and apical margins; first fork linked to cubital vein by a short cross-vein subbasally; linked to radial vein by a cross-vein slightly distad of second fork. Radial vein fused to subcostal vein over basal two-fifths length; two branches extending to apical margin; linked to subcostal vein by a cross-vein subapically.

Wing short and broad; length two-thirds that of tegmen, twice maximum width; apex broadly truncate. Cubital vein with three branches extending to posterior margin. Medial vein unbranched, linked to cubital by a cross-vein slightly distad of the second fork of the latter. Radial vein unbranched, linked to medial by a single cross-vein slightly basad of three-quarters length.

Male genitalia with shaft of aedeagus horizontal, cylindrical, symmetrical, heavily armed on dorsal surface subapically. Paramere with dorsal process well developed. Subgenital plate with posterior margin narrowly and prominently produced at midline.

*Dysimiella* is represented in Brazil and Guyana. The venation of the tegmen and the distinctive proportions of the head and pronotum indicate a close relationship to *Dysimia*; the structure of the male genitalia, in particular the subgenital plate, is unique.

### Key to species of *Dysimiella*

- 1 Tegmen and wing with distinct dark transverse bands. Aedeagus with three pairs of spines (Fig. 154)..... *williamsi* sp. n. (p. 97)
- Tegmen and wing without distinct transverse markings. Aedeagus with large flap-like processes and a single pair of long slender spines (Fig. 155)..... *pennyi* sp. n. (p. 97)

#### *Dysimiella williamsi* sp. n.

(Figs 3, 17, 32, 154, 156, 158)

Male: head 0.38 mm long, 0.48 mm wide; pronotum 0.90 mm wide; tegmen 4.00–4.20 mm long; wing 2.65 mm long. Female: tegmen 4.60–4.80 mm long.

Length of frons 9 times width at apex, c. twice width at base; ocelli obsolete; clypeus slightly shorter than frons. Pronotal width c. 11 times mid-dorsal length, fronto-lateral carinae distinct; tegula weakly carinate.

Genae each with a brown band extending horizontally from adjacent to centre of eye to anterior margin. Fronto-lateral surfaces of pronotum each with a brown band extending horizontally from adjacent to midline of eye to lateral margin, and continued over lower surface of tegula. Tegmen and wing whitish hyaline, cross-veins edged dark brown. Tegmen with a broad, irregular, pale brownish, transverse band at one-fifth length; apical fork of medial vein covered by a large, very prominent, dark brown spot; costal and posterior margins very narrowly, regularly intermittently, flecked with crimson. Wing with a distinct, very pale brown, transverse band at one-quarter length, posterior margin very narrowly flecked with crimson.

Shaft of aedeagus slender, with three pairs of strong, curving spines subapically. Paramere robust; dorsal process situated slightly distad of midlength, apex strongly produced postero-dorsally; dorsal surface without a secondary process. Subgenital plate with posterior margin strongly and narrowly produced medially into a very long, slender, apically acute spine.

#### MATERIAL EXAMINED

Holotype ♂, **Brazil**: Para, Jabaty, v.1924 (*Williams*) (BMNH).

Paratypes. **Brazil**: 11 ♂, 17 ♀, same data as holotype; nr Manaus (BMNH; INPA).

This species is readily distinguished by the prominent markings on the tegmen, and by the structure of the male genitalia.

#### *Dysimiella pennyi* sp. n.

(Figs 155, 157, 159, 160)

Male: head 0.34 mm long, 0.55 mm wide; pronotum 1.01 mm wide; tegmen 4.62 mm long; wing 3.15 mm long. Female: tegmen 5.10 mm long.

Length of frons 9 times width at apex, 1.66 times width at base; ocelli large, prominent; clypeus three-fifths as long as frons. Pronotal width 24 times mid-dorsal length, fronto-lateral carinae weak; tegula not carinate.

Head and body pale yellowish brown; lateral carinae of frons, tibiae and tarsi darker brownish. Tegmen and wing hyaline, veins pale. Tegmen with veins and cross-veins narrowly edged pale smoky brown, with a



darker brownish spot over point of separation of fused radial and subcostal veins, another over apical forks of radial and medial veins, apical cells between branches of radial and medial veins each with a slender, longitudinal, brownish stripe medially. Wing unmarked. Female with subgenital plate dark brownish, ventro-lateral angles of adjacent segment brownish black.

Shaft of aedeagus slender, broadening slightly at two-thirds length; a large, rounded, flap-like process medially, bearing on each side posteriorly a very long curving spine; lateral surfaces each produced into an acute, ventrally directed flap. Paramere slender; apex narrowly rounded; dorsal process situated at two-thirds length, dorsally produced but hardly inclined posteriorly; dorsal surface strongly and obtusely produced at midlength, acutely produced subapically. Subgenital plate narrowly produced medially into a long, slender, apically somewhat expanded and deeply and narrowly notched, spine-like process.

#### MATERIAL EXAMINED

Holotype ♂, **Brazil**: Amazonas, P. das Laranjeiras, 28.vii.1981 (*Arias*) (INPA).

Paratypes. 2 ♀, same data as holotype (INPA; BMNH).

This species is readily distinguished by the lack of a distinct transverse band on the tegmen, and by the structure of the male genitalia, including the medial process of the subgenital plate.

### *MYSIDALOIDES* gen. n.

Type-species: *Mysidaloides trinidadensis* sp. n.

Width of head in dorsal aspect greater than 1.5 times length. Vertex hardly extending anterior to eyes; lateral margins weakly carinate, very abruptly converging from base to level of midline of eyes, then gradually and regularly converging to apex; basal margin transverse; junction with frons broadly and regularly rounded. Frons exceeding narrow apically; length greater than 10 times width at apex, less than 3 times width at base; lateral margins strongly carinate, parallel from apex to level of ventral margins of eyes, then strongly diverging to base. Genae extending anterior to eyes for one-eighth horizontal diameter of eye. Eyes extremely large, prominent, almost hemispherical. Antenna cylindrical; second segment more than 5 times as long as wide; flagellum arising at c. two-thirds length; apex acutely rounded. Ocelli very small, not prominent. Rostrum terminating somewhat posterior to hind coxae.

Pronotal width more than 20 times mid-dorsal length; very deeply and regularly constricted medially; fronto-lateral surfaces each with a distinct carina curving horizontally from adjacent to midline of eye to lateral margin. Tegula not carinate. Disc of mesonotum broader than long; not distinctly carinate.

Tegmen 3 times as long as wide. Medial vein separating from fused radial and subcostal veins at one-eighth length; radial and subcostal veins separating slightly distad of one-third length. Radial vein with two branches extending to apical margin, linked to medial vein by a cross-vein at two-thirds length and at level of apical fork. Medial vein forking slightly basad of, and again slightly distad of, midlength; with seven branches extending to apical and posterior margins, second and third, and fourth and fifth linked by cross-veins. Cubital vein with four branches extending to posterior margin, first linked to apex of clavus and to second, second to third, third to fourth, and fourth to first branch of medial vein by cross-veins.

Length of wing slightly greater than one-half of that of tegmen. Radial and subcostal veins fused over c. basal one-third length. Radial vein unbranched, linked to medial vein by a cross-vein at two-thirds length. Medial vein distinct throughout, with two branches extending to apical margin, linked to third branch of cubital vein by a cross-vein slightly distad of midlength. Cubital vein with three branches extending to posterior margin.

Head and body uniformly pale, lacking distinct markings. Tegmen and wing hyaline, also lacking distinct markings.

Male genitalia with shaft of aedeagus horizontal, cylindrical, symmetrical, slender; dorsal surface subapically bearing well-developed flap-like and spine-like processes. Paramere with dorsal process well developed, without a distinct secondary process; ventral surface unarmed. Anal tube little produced posteriorly. Female with posterior margin of subgenital plate not produced posteriorly.

The venation of the tegmen and wing of this genus is similar to that of *Mysidia*, but it differs in head characters, in particular the large size of the eyes, the very slender apical portion of the frons and the extreme length of the antennae. The genus is monotypic and is known from Brazil, Guyana and Trinidad.



*Mysidaloides trinidadensis* sp. n.

(Figs 10, 16, 24, 130, 131, 132)

Male: head 0.38 mm long, 0.65 mm wide; pronotum 1.32 mm wide; tegmen 6.30 mm long; wing 3.40 mm long. Female: tegmen 7.40 mm long.

Length of frons 12 times width at apex, 2.33 times width at base; ocelli indistinct; clypeus as long as frons. Pronotal width 22 times mid-dorsal length, fronto-lateral carinae distinct; tegula without carinae.

Head and body unmarked. Tegmen and wing hyaline, veins pale yellow. Tegmen unmarked except for a very indistinct, pale smoky, transverse band extending from second branch of cubital vein to apex of clavus. Wing with posterior margin between branches of cubital vein and apex of radial vein pale smoky brown, otherwise unmarked.

Shaft of aedeagus somewhat expanded subapically; dorsal surface subapically with a pair of large, flap-like processes extending to midlength, each terminating in an antero-dorsally directed projection at midline; a pair of diverging spines at midlength. Paramere basally slender, apex broadly rounded; dorsal process situated slightly distad of midlength, not greatly produced posteriorly; dorsal surface at approximately one-third length with a low, rounded projection bearing a cluster of robust, internally directed spines.

## MATERIAL EXAMINED

Holotype ♂, **Guyana**: Tumatumari, 19.vii.1923 (*Williams*) (BMNH).

Paratypes. **Guyana**: 1 ♂, same data as holotype (BMNH). **Trinidad**: 1 ♂, Aripo Valley (BMNH). **Brazil**: 9 ♂, Amazonas, Manaus (INPA; BMNH).

*NEOMYSIDIA* gen. n.

Type-species: *Neomysidia willisi* sp. n.

Width of head considerably greater than length in dorsal aspect. Vertex slightly longer than wide at base; extending less than one-quarter its length beyond anterior margins of eyes; lateral carinae low, very gradually converging from base to apex; basal margin very weakly concave; junction with frons broadly and regularly rounded. Frons parallel-sided from apex to immediately above base, thence lateral margins strongly divergent; *c.* 2.5 times as long as width at apex, little longer than width at base. Genae extending beyond anterior margins of eyes for one-third horizontal diameter of eye. Second antennal segment ovate, *c.* twice as long as broad; apex rounded; flagellum arising subapically. Ocelli large and distinct. Clypeus broad, rounded, longer than frons; length one and two-thirds width at base; lacking distinct medial and lateral carinae. Rostrum terminating at level of mid coxae.

Pronotal width slightly greater than 7 times length mid-dorsally; not strongly constricted medially; fronto-lateral surfaces each with a distinct carina curving horizontally from adjacent to eye to lateral margin. Tegula not carinate. Disc of mesonotum *c.* 1.5 times as wide as long; broadly triangular; medial carina distinct only at midlength; lateral carinae absent or obsolete.

Tegmen length *c.* 6 mm, 2.5 times maximum breadth. Medial vein distinct from fused radial and subcostal veins throughout; forking slightly basad and slightly distad of midlength, with seven branches extending to posterior and apical margins. Radial and subcostal veins separating at midlength; radial with two branches extending to apical margin; linked to subcostal vein by a cross-vein subapically, and to medial vein at *c.* two-fifths length. Cubital vein with four branches extending to posterior margin, the first and second, and third and fourth linked by cross-veins (Fig. 6).

Wing almost twice as long as wide, more than half length of tegmen; apex rounded. Subcostal and radial veins fused from base to slightly basad of midlength, unbranched; radial vein linked to medial by a cross-vein slightly distad of midlength. Medial vein with two branches extending to post-apical margin; linked to cubital vein by a cross-vein at *c.* midlength. Cubital vein two branched.

Male genitalia with shaft of aedeagus horizontal, symmetrical; dorsal surface heavily armed subapically. Paramere with dorsal process reduced; dorsal surface with a secondary process subbasally.

This genus is readily distinguished by the proportions of the head; especially the very short and broad frons, the relatively unstricted dorsal surface of the pronotum, and the short, triangular, mesonotal disc.

Known only from Brazil.

*Neomysidia willisi* sp. n.

(Figs 6, 18, 31, 161, 165, 169)

Male: head 0.42 mm long, 0.71 mm wide; pronotum 1.58 mm wide; tegmen 6.20 mm long; wing 3.50 mm long. Female unknown.

Length of frons 2.5 times width at apex, one-quarter greater than width at base; ocelli large, distinct; clypeus one-third longer than frons. Pronotal width 7.5 times mid-dorsal length.

Vertex, genae ventral to eyes, antennae, base of frons, lateral surfaces of clypeus, a small spot on fronto-lateral surfaces of pronotum above each eye, and dorsal margins of tegula dark brown. Tegmen and wing hyaline, veins pale yellowish, cross-veins very narrowly dark brown, posterior and apical margins with dark brown spots over apices of veins. Tegmen with radial, medial and cubital areas basally irregularly mottled dark smoky brown; an irregular dark brown spot immediately distad of apex of clavus; a very dark, almost black spot over apical fork of medial vein. Wing with a short, oblique, irregular, transverse smoky brown band over medial-cubital cross-vein; a broad, indistinct, oblique, pale smoky brown, transverse band at somewhat distad of three-quarters length.

Shaft of aedeagus robust; a pair of massive flap-like processes situated one on either side of midline, each terminating anteriorly in a small acute point. Paramere robust; apex acutely rounded; dorsal process situated at midlength, greatly reduced; present only as a slight projection; dorsal surface subbasally with a curving posteriorly directed, hook-like secondary process; ventral and lateral surfaces subbasally with very numerous, tiny, tooth-like projections.

## MATERIAL EXAMINED

Holotype ♂, **Brazil**: Amazonas, P. das Laranjeiras, 28.vii.1981 (*Arias*) (INPA).

*IPSEMYSIDIA* gen. n.

Type-species: *Ipsemysidia beautifica* sp. n.

Width of head in dorsal aspect greater than 1.5 times length. Vertex little longer than width at base, extending less than one-third its length beyond anterior margins of eyes; lateral margins not highly elevated, very gradually and regularly converging from base; basal margin shallowly concave; junction with frons weakly angulate. Frons c. 3 times as long as width at apex, c. twice width at base; lateral margins weakly diverging from apex to level of midline of eyes, then very strongly diverging to base. Genae extending anterior to eyes for c. half horizontal diameter of eye. Second antennal segment c. 1.5 times as long as broad, rounded; flagellum arising subapically. Ocelli distinct, not prominent. Clypeus short, broadly rounded, little longer than frons; medial and lateral carinae obsolete or absent. Rostrum not extending beyond hind coxae.

Pronotal width less than 10 times mid-dorsal length; dorsal surface little constricted medially; fronto-lateral surfaces each with a somewhat sinuate carina extending horizontally from adjacent to midline of eye to lateral margin. Tegula not carinate. Disc of mesonotum considerably wider than long; medial carinae weak, lateral carinae absent.

Tegmen more than 6 mm long, c. 3 times maximum width. Fused radial and subcostal veins separating at c. midlength. Medial vein distinct from base, forking at c. midlength and two-thirds length, with seven branches extending to posterior and apical margins, first branch linked to cubital vein, second to third by cross-veins. Radial vein with two branches extending to apical margin, linked to medial by a cross-vein slightly distad of two-thirds length. Cubital vein with four branches extending to posterior margin, first and second, and third and fourth linked by cross-veins.

Length of wing more than half that of tegmen, c. twice maximum width; apex acutely rounded. Subcostal and radial veins fused from base to c. midlength, unbranched; radial linked to medial vein by a cross-vein slightly distad of two-thirds length. Medial vein with two branches extending to post-apical margin, linked to cubital by a cross-vein at level of second fork of the latter. Cubital vein with three branches extending to posterior margin.

Male genitalia with shaft of aedeagus symmetrical, horizontal; dorsal surface heavily armed subapically, including a single process at midline. Paramere with dorsal process reduced; a hook-like secondary process on dorsal surface subbasally.

Though resembling *Neomysidia* in the development of the paramere, *Ipsemysidia* is readily distinguished by external and aedeagal characters. It is recorded from Brazil and Panama.

*Ipsemysidia beautifica* sp. n.

(Figs 8, 21, 26, 162, 166, 170)

Male: head 0.42 mm long, 0.65 mm wide; pronotum 1.50 mm wide; tegmen 6.00 mm long; wing 3.60 mm long. Female: tegmen 7.20 mm long.

Length of frons c. 3 times width at apex, c. twice width at base; ocelli distinct; clypeus c. as long as frons; rostrum terminating at level of mid-coxae. Pronotal width 7 times mid-dorsal length, fronto-lateral carinae very prominent; tegula not carinate.

Head unmarked. Fronto-lateral surfaces of pronotum basally reddish; abdomen with a small dark brown spot on either side of mid-dorsal line. Tegmen and wing whitish hyaline, veins yellow, cross-veins and forks of veins dark brown; posterior margin irregularly dark brown. Tegmen with branches of cubital vein and two basal branches of medial vein each with at least one small black tubercule at c. midlength; medial vein with apical forks blackish brown; branches of apical vein each with a small, circular, dark brown spot subapically; posterior branch of radial vein similarly marked; apical cells of radial and medial veins each with an irregular brownish spot medially at two-thirds length; area between radial vein and costal margin irregularly mottled brownish, these markings extending posteriorly over first forks of medial and cubital veins; clavus with a brown spot adjacent to point of fusion of anal veins, another smaller spot subapically. Wing with radial and medial branches each bearing a small black tubercule; medial vein basad of medial-cubital cross-vein with two to four similar tubercules; cubital vein with two tubercules between first and second forks, third branch occasionally with a single tubercule subbasally; a large, irregular, brownish spot between first branch of cubital vein and claval suture somewhat distad of base of former; an irregular, oblique, smoky brown band over radial and medial areas at five-sixths length.

Shaft of aedeagus bearing a pair of large, apically rounded, flap-like processes laterally, and a single, slender, curving, spine-like process medially; ventral surface with a pair of long, closely opposed, flap-like processes subapically. Paramere slender basally, broadly expanded towards regularly rounded apex; dorsal process situated at approximately three-quarters length, very weakly produced postero-dorsally; dorsal surface at one-quarter length with a large, posteriorly directed, hook-like secondary process; ventral surface subbasally with a group of long, robust spines.

## MATERIAL EXAMINED

Holotype ♂, **Brazil**: Rondonia, Porto Vello, 22.ii.1979 (*Campbell*) (INPA).

Paratypes. **Brazil**: 1 ♀, same data as holotype (BMNH). **Panama**: 1 ♂, Tocumen (USNM).

*AMYSIDIELLA* gen. n.

Type-species: *Amysidiella micare* sp. n.

Width of head in dorsal aspect half to three-quarters greater than length. Vertex extending for less than one-quarter its length beyond anterior margins of eyes; lateral margins elevated, gradually converging from base; basal margin transverse, very weakly concave; junction with frons broadly and regularly rounded. Length of frons c. 5 times width at apex, less than twice width at base; lateral margins gradually diverging from apex to level of ocelli, then strongly diverging to base. Genae extending anterior to eyes for less than one-third horizontal diameter of eye. Second antennal segment club-shaped, not longer than twice maximum width; flagellum arising subapically. Ocelli distinct, not prominent. Clypeus, short, broad, rounded; length c. equal to that of frons, 1.5 times width at base; lacking medial and lateral carinae. Rostrum not extending beyond hind-coxae.

Pronotal width 11–14 times mid-dorsal length; fronto-lateral surfaces each with a weak carina extending horizontally from adjacent to eye to lateral margin. Tegula not carinate. Disc of mesonotum c. as wide as long; medial carina weak or obsolete; lateral carinae absent.

Length of tegmen 5.90–7.20 mm, slightly less than 3 times maximum width. Medial vein separating from fused radial and subcostal veins at c. one-sixth length; with seven branches extending to post-apical margin. Radial and subcostal veins fused over c. basal one-third length; radial with two branches extending to apical margin, linked to medial by cross-veins at slightly distad of second fork of the latter, and to subcostal subapically. Cubital vein with four branches extending to posterior margin; first and second, and third and fourth linked by cross-veins.

Length of wing slightly greater than half that of tegmen; apex acutely rounded. Cubital vein with three branches extending to posterior margin, linked by a cross-vein to medial at level of second fork. Medial vein two-branched; linked to unbranched radial vein by a cross-vein at c. two-thirds length.

Head and body yellowish. Frons and genae at level of eyes reddish. Fronto-lateral surfaces of pronotum and ventro-lateral surfaces of mesonotum each with a distinct horizontal reddish band. Tegmen and wing

faintly whitish hyaline, veins pale, lacking prominent pigmentation. Tegmen with a brownish spot adjacent to costal margin subbasally; another darker irregular marking extending anteriorly from claval margin at c. one-third length. Wing either unmarked, or with a very faint, irregular transverse band.

Male genitalia with shaft of aedeagus horizontal, symmetrical, subapically expanded, robust in lateral aspect; dorsal and lateral surfaces with prominent spine-like processes; ventral surfaces unarmed. Paramere with dorsal process reduced to a small, posteriorly directed, hook-like projection subapically. Posterior margin of subgenital plate transverse. Anal tube strongly produced posteriorly, postero-lateral angles expanded.

Female with posterior margin of subgenital plate regularly produced, apically truncate.

*Amysidiella* is distinguished by a combination of the proportions of the head, pronotum, tegmen and wing, and by the structure of the male genitalia, consisting of a very heavily armed aedeagus with a paramere in which the dorsal process is almost obsolete. Recorded from Brazil and Guyana.

### Key to species of *Amysidiella*

- 1 Pronotum with maximum width in excess of 13 times length at mid-dorsal line. Aedeagus with lateral spines short, arising basad of mid-length (Fig. 164)..... *micare* sp. n. (p. 102)
- Pronotum with maximum width less than 12 times length at mid-dorsal line. Aedeagus with lateral spines very long, arising distad of mid-length (Fig. 163)..... *pseudomicare* sp. n. (p. 102)

#### *Amysidiella micare* sp. n.

(Figs 4, 22, 25, 164, 167, 171)

Male: head 0.40 mm long, 0.69 mm wide; pronotum 1.18 mm wide; tegmen 5.95–6.12 mm long; wing 3.40 mm long. Female: tegmen 7.14 mm long.

Length of frons 5.5 times width at apex, 1.5 times width at base; ocelli small, distinct; clypeus as long as frons. Pronotal width 14 times mid-dorsal length.

Frons with a scarlet spot at level of eyes, often extending onto adjacent surfaces of genae. Fronto-lateral surfaces of pronotum each with a narrow scarlet band extending horizontally from level of ventral margin of eye to lateral margin; male with apices of posterior lobes of anal tube dark brown/black. Tegmen with a pale brownish spot between costal margin and point of separation of radial and subcostal veins; another larger, irregular marking at approximately one-third length extending from costal margin over first fork of cubital vein; an irregular band extending from apex of clavus to second branch of cubital vein. Wing with a very weak transverse band at level of medial-cubital cross-vein.

Shaft of aedeagus broadly expanded over apical one-half length; lateral surfaces subapically each with a large, flap-like process terminating apically in a curving spine; dorsal surface at three-quarters length with a pair of small, curving, spines at midline, and laterally at rather over midlength, with a pair of long, slender, curving, spine-like processes. Paramere slender; dorsal process situated at three-fifths length, greatly reduced, consisting of a single, short, posteriorly directed, hooked spine; dorsal surface subbasally with a flap-like process bearing numerous long, robust spines.

#### MATERIAL EXAMINED

Holotype ♂, **Brazil**: Belem, Para, v:1924 (*Williams*) (BMNH).

Paratypes. **Brazil**: 2 ♂, 1 ♀, same data as holotype (BMNH). **Guyana**: 4 ♂, Blairmont (BMNH).

This species is readily distinguished by its pigmentation, especially the dark posterior lobes of the anal tube in the male, and by the reduced armature of the paramere.

#### *Amysidiella pseudomicare* sp. n.

(Figs 163, 168, 172)

Male: head 0.44 mm long, head 0.67 mm wide; pronotum 1.10 mm wide; tegmen 6.00 mm long; wing 3.35 mm long. Female: tegmen 6.60 mm long.

Length of frons c. 5 times width at apex, one and two-thirds width at base; ocelli large, not prominent; clypeus as long as frons. Pronotal width 11 times mid-dorsal length.

Frons pale crimson at level of eyes; fronto-lateral surfaces of pronotum each with a narrow, pale crimson band extending horizontally from adjacent to midline of eye to lateral margin; mesonotum with a similar band dorsad of bases of mid coxae. Tegmen with a small, distinct, brownish spot on costal margin at level of

point of separation of medial and fused radial-subcostal veins; a distinct, irregular, transverse, brownish band extending from costal margin over radial and medial veins at one-third length and terminating at base of third branch of cubital vein; an irregular, pale brownish spot extending from first-second cubital cross-vein to claval margin. Wing usually unmarked; occasionally with an indistinct, pale brownish, transverse band at midlength.

Shaft of aedeagus robust, strongly laterally expanded over apical one-third length; dorsal surface subapically with a pair of short, spine-like processes, a pair of long, slender, curving, processes; lateral surfaces subapically each with a large, dorsally directed, flap-like process, and a very long, slender, spine-like, horizontal process. Paramere very slender; apex acutely rounded; dorsal process situated slightly basad of three-quarters length, reduced to a small, posteriorly directed hook with a low, rounded projection distally; dorsal surface subapically with a large, rounded, secondary process bearing numerous long, robust, spines.

#### MATERIAL EXAMINED

Holotype ♂, **Brazil**: Rio Uapes, 5.iii (*Roman*) (NR).

Paratype. 1 ♀, same data as holotype (BMNH).

This species, though closely related to *micare*, may be distinguished by the greater lateral expansion and the length, position and inclination of the spines of the aedeagus.

### *PARAMYSIDIA* gen. n.

Type-species: *Mysidia mississippiensis* Dozier, by present designation.

Head in dorsal aspect as wide as or up to one-third wider than long. Vertex extending beyond anterior margins of eyes for from one-third to one-half its length; lateral margins gradually converging from base to level of anterior margins of eyes, thence subparallel to apex; lateral carinae very prominent, almost foliaceous apically; basal margin shallowly concave; junction with frons broadly and regularly rounded. Frons c. 4–6 times as long as wide at apex, c. twice width at base; lateral margins subparallel from apex to level of ocelli, then gradually diverging to base, or very gradually and regularly diverging from apex and abruptly curving outwards subbasally. Genae extending beyond eyes for two-fifths to one-half horizontal diameter of eye. Antenna short; second segment club-shaped, c. twice as long as broad; apex weakly stepped; flagellum arising subapically. Ocelli commonly large, distinct; rarely prominent. Clypeus short, broadly rounded; length c. equal to that of frons, twice width at base; medial carina generally obsolete or absent; lateral carinae obsolete, or only distinct subbasally. Rostrum usually terminating immediately posterior to hind coxae, rarely extending to midlength of abdomen.

Pronotal width from 10–13 times mid-dorsal length; fronto-lateral surfaces each with a prominent carina curving horizontally from adjacent to eye to lateral margin. Tegula not carinate, or with carina obsolete. Disc of mesonotum slightly wider than long; medial carina often weak or obsolete, rarely distinct and percurrent; lateral carinae usually absent, rarely distinct.

Tegmen commonly from 5.00–6.50 mm long, rarely exceeding 7.00 mm long. Medial vein distinct from near base, with seven branches extending to posterior and apical margins, second branch linked to third, and fourth to fifth by cross-veins. Fused radial and subcostal veins separating at c. midlength; radial with two branches extending to apical margin, linked to medial by a single cross-vein at two-thirds length. Cubital vein with four branches extending to posterior margin; first and second, and third and fourth linked by cross-veins.

Length of wing from three-fifths to three-quarters that of tegmen. Subcostal and radial veins fused over basal one-third length, unbranched. Radial vein linked to second fork of medial vein by a single cross-vein at two-thirds length. Medial vein with two branches extending to apical margin, linked to cubital vein by a cross-vein at two-thirds length. Cubital vein with three branches.

Head and body predominantly yellowish brown, often very pale; genae adjacent to ocelli often tinged reddish; pronotum with fronto-lateral surfaces often deep yellow over carinae; dorsal surface of abdomen rarely red or dark brown. Tegmen and wing whitish hyaline; veins yellowish or dark brown; cross-veins and forks of veins usually dark brown; veins and cross-veins often edged smoky brown, giving a mottled appearance. Tegmen rarely with an irregular, smoky brown, transverse band. Wing commonly with two weak, very irregular, smoky brown, transverse bands; posterior and apical margins often broadly pale brown.

Male genitalia with shaft of aedeagus slender, horizontal, cylindrical, somewhat laterally expanded subapically; dorsal surface subapically with a pair of very asymmetrical, dorsally directed, longitudinally aligned processes, of which that on the right is flap-like, that on the left commonly slender and spine-like; dorsal surface at c. midlength with a single, usually slender, dorsally directed, apically bifid secondary

apodeme medially; lateral margins often each with an antero-laterally directed apically bifid process at c. midlength; ventral surface unarmed. Paramere commonly with apex broadly rounded; dorsal process situated subapically, greatly reduced; dorsal surface subbasally with a small hook-like secondary process; rarely with apex acute or dorsal process robust. Anal tube not greatly extended, apex commonly notched medially.

Female with posterior margin of subgenital plate frequently produced medially.

*Paramysidia* differs from *Mysidia* as follows: the armature of the aedeagus is strongly asymmetrical and includes a prominent process at midlength on the mid-dorsal line; the development of the dorsal process of the paramere is usually strongly reduced, its function possibly being, at least partially, taken over by the hook-like secondary process.

Distributed from the U.S.A. (Mississippi, Florida, Texas, Louisiana) to Costa Rica, Honduras, El Salvador, Panama, Brazil and Peru. From this distribution it would appear that species of the genus probably reached the U.S.A. via Central America, though it has not been recorded from Mexico. This shows a marked contrast with *Dysimia*, which almost certainly found its way into North America by island-hopping across the Caribbean.

### Key to species of *Paramysidia* (based on external characters)

Due to the extreme external similarity of many species, reference should be made, where possible, to the structure of the male genitalia.

- |      |   |   |   |
|------|---|---|---|
| 1    | Tegmen with cross-veins and forks of veins not distinctly margined smoky brown. South-eastern U.S.A. ....   | <i>mississippiensis</i> (Dozier) (p. 105) | 2 |
| -    | Tegmen with cross-veins and forks of veins broadly margined smoky brown .....   |   | 2 |
| 2(1) | Tegmen with veins yellowish or pale brown .....   |   | 3 |
| -    | Tegmen with veins dark brown .....  |   | 4 |
| 3(2) | Clypeus with length less than that of frons; genae often tinged orange; fronto-lateral surfaces of pronotum with carinae orange. Peru .....       | <i>vulgaris</i> sp. n. (p. 106)           | 5 |
| -    | Clypeus with length equal to that of frons; head and body unmarked. Brazil ....   | <i>felix</i> sp. n. (p. 106)              | 6 |
| 4(2) | Clypeus with length not greater than that of frons; frons with length less than 5 times width at apex .....                                       |   | 5 |
| -    | Clypeus with length one-third greater than that of frons; frons with length almost 6 times width at apex. Honduras, Costa Rica, El Salvador ..... | <i>barbara</i> sp. n. (p. 106)            | 6 |
| 5(4) | Width of pronotum 11 times length at mid-dorsal line .....  |   | 6 |
| -    | Width of pronotum greater than 13 times length at mid-dorsal line. Panama   | <i>boudica</i> sp. n. (p. 107)            | 7 |
| 6(5) | Rostrum extending to mid-length of abdomen. Costa Rica .....  | <i>tessellata</i> sp. n. (p. 107)         | 8 |
| -    | Rostrum terminating immediately posterior to hind coxae. Costa Rica, Panama   | <i>nigropunctata</i> (Metcalf) (p. 105)   | 9 |

### Key to species of *Paramysidia* (based on male genitalia)

- |      |  |   |   |
|------|--|---|---|
| 1    | Paramere with dorsal process strongly reduced .....  |   | 2 |
| -    | Paramere with dorsal process very robust (Fig. 147) .....  | <i>vulgaris</i> sp. n. (p. 106)           | 3 |
| 2(1) | Paramere with apex broadly rounded .....   |   | 3 |
| -    | Paramere with apex acutely rounded (Fig. 148) .....  | <i>felix</i> sp. n. (p. 106)              | 4 |
| 3(2) | Aedeagus with lateral processes .....  |   | 4 |
| -    | Aedeagus lacking lateral processes (Fig. 135) .....  | <i>nigropunctata</i> (Metcalf) (p. 105)   | 5 |
| 4(3) | Aedeagus with right dorsal process slender, distinctly longer than broad .....   |   | 5 |
| -    | Aedeagus with right dorsal process massive, as long as broad (Fig. 143)  | <i>mississippiensis</i> (Dozier) (p. 105) | 6 |
| 5(4) | Aedeagus with right dorsal process distinctly longer than left dorsal process .....  |   | 6 |
| -    | Aedeagus with right dorsal process very short, shorter than left dorsal process (Fig. 144)   | <i>boudica</i> sp. n. (p. 107)            | 7 |
| 6(5) | Paramere with secondary dorsal process apically acute (Fig. 152); aedeagus with right dorsal process apically acute (Fig. 145) .....     | <i>tessellata</i> sp. n. (p. 107)         | 8 |
| -    | Paramere with secondary dorsal process apically serrate (Fig. 153); aedeagus with right dorsal process apically rounded (Fig. 146) ..... | <i>barbara</i> sp. n. (p. 106)            | 9 |

***Paramysidia mississippiensis* (Dozier) comb. n.**

(Figs 20, 27, 136, 143, 150)

*Mysidia mississippiensis* Dozier, 1922: 82. Holotype ♀, U.S.A. (USNM) [examined].

Male: head 0.52 mm long; 0.69 mm wide; pronotum 1.56 mm wide; tegmen 6.00–7.50 mm long; wing 4.42 mm long. Female: tegmen 6.80–7.30 mm long.

Length of frons 4 times width at apex, twice width at base; ocelli large, not prominent; clypeus as long as frons. Pronotal width 11 times mid-dorsal length; tegula weakly carinate.

Genae adjacent to ocelli often with an orange or dull reddish circular spot; fronto-lateral surfaces of pronotum with carinae broadly deep yellow. Tegmen and wings with veins yellowish brown; cross-veins and branches of veins dark brown. Tegmen with cross-veins each surrounded by a roughly circular smoky brown spot; posterior margin narrowly smoky brown; basal three-eighths of length, and costal and radial cells, mottled smoky brown; area between first branch of cubital vein and apex of clavus broadly smoky brown. Wing with area distad of radial-medial cross-vein irregularly mottled smoky brown.

Shaft of aedeagus basally slender, broadly laterally expanded over apical half length; dorsal surface at three-quarters length with a pair of large processes, that on the right of midline massive, hooked, anteriorly directed; lateral processes present, apically bifid; dorsal apodeme situated at three-fifths length, slender, weakly curving. Paramere slender at base, becoming greatly expanded towards obtusely rounded apex; dorsal process situated at rather over two-fifths length, slender, apex posteriorly produced.

**MATERIAL EXAMINED**

Holotype ♀, U.S.A.: Mississippi, Leland, 15.ix.1921 (*Drake*) (USNM).

U.S.A.: 4 ♂, 4 ♀, Mississippi (FAMU; BMNH); 6 ♂, 4 ♀, Louisiana (FAMU; BMNH); 2 ♂, Texas (FAMU; USNM); 2 ♂, Florida (USNM).

This species is most readily distinguished by the pigmentation of the tegmen and wing, and by the structure of the male genitalia.

***Paramysidia nigropunctata* (Metcalf) comb. n.**

(Figs 135, 142, 149)

*Mysidia nigropunctata* Metcalf, 1938: 316. Holotype ♀, PANAMA (MCZ) [examined].

Male: head 0.52 mm long, 0.61 mm wide; pronotum 1.40 mm wide; tegmen 5.60–6.30 mm long; wing 3.55 mm long. Female: tegmen 6.60 mm long.

Length of frons 4 times width at apex, 2.5 times width at base; ocelli large, prominent; clypeus c. as long as frons. Pronotal width 11 times mid-dorsal length.

Genae around ocelli occasionally pale orange; abdomen with dorsal surface usually dark brown. Tegmen and wing with veins and cross-veins dark brown, broadly and irregularly edged brownish. Wing with an obscure, irregular, smoky brown, transverse band over radial-medial cross-vein; another much narrower band over first fork of cubital vein; posterior and apical margins irregularly edged smoky brown.

Shaft of aedeagus somewhat laterally expanded at two-thirds length; dorsal surface with a broad hook-like process on the right side, and a slender spine-like process on the left; ventro-lateral surfaces unarmed; mid-dorsal process slender, curving, situated at midlength. Paramere robust; apex broadly rounded; dorsal process simple, situated at three-quarters length.

**MATERIAL EXAMINED**

Holotype ♀, Panama: C.Z., Barro Colorado, 13.vii.1924 (*Banks*) (MCZ).

Panama: 7 ♂, 6 ♀ (including 2 ♂, 1 ♀ paratypes) (BMNH; FAMU; CAS; MCZ). Costa Rica: 7 ♂, 5 ♀ (BMNH; FAMU; USNM). Nicaragua: 1 ♀ (USNM).

In his description Metcalf refers to the holotype as female; however, a male specimen bears the MCZ 'type' label, while the female is labelled as 'allotype'.

In external characters this species resembles *boudica*, but it is readily distinguished by the structure of the male genitalia.



*Paramysidia vulgaris* sp. n.

(Figs 2, 133, 140, 147)

Male: head 0.46 mm long, 0.59 mm wide; pronotum 1.20 mm wide; tegmen 5.00–6.00 mm long; wing 3.00 mm long. Female: tegmen 6.00–7.25 mm long.

Length of frons c. 5 times width at apex, c. twice width at base; ocelli large, distinct; clypeus slightly shorter than frons. Pronotal width c. 12 times mid-dorsal length.

Genae often orange around ocelli; second antennal segment rarely black apically; fronto-lateral carinae narrowly orange. Tegmen with radial and medial veins pale, other veins and cross-veins brown; cross-veins and forks of veins broadly edged smoky brown to give an irregular mottled appearance; without distinct transverse bands; apical branches of medial vein dark brown at midlength. Wing with veins alternately pale and dark; with a broad, smoky brown, transverse band at midlength, another slightly distad of three-quarters length.

Shaft of aedeagus slender basally, broader from midlength; dorsal surface subapically with a large, apically acute, flap-like process on the right side and a long, slender, acute, spine-like process on the left; lateral surfaces each with a weakly bifurcate process; mid-dorsal process situated at midlength, slender, curving antero-dorsally. Paramere robust; apex obtusely rounded; dorsal process large, situated somewhat distad of midlength, not posteriorly produced.

## MATERIAL EXAMINED

Holotype ♂, **Brazil**: Para, Jabaty, v.1924 (*Williams*) (BMNH).

Paratypes. **Brazil**: 8 ♂, 8 ♀, same data as holotype; Mato Grosso; Bahia Iguassu (BMNH; NR). **Peru**: 63 ♂, 64 ♀, Ivitas, 60 km W. of Pucallpa (BMNH; FAMU).

The structure of the paramere of this species is unique and readily separates it from all others in the genus.

*Paramysidia felix* sp. n.

(Figs 134, 141, 148)

Male: head 0.46 mm long, 0.61 mm wide; pronotum 1.30 mm wide; tegmen 5.30 mm long; wing 3.06 mm long. Female unknown.

Length of frons c. 6 times width at apex, c. twice width at base; ocelli large, not prominent; clypeus as long as frons. Pronotal width c. 10 times mid-dorsal length.

Head and body unmarked. Tegmen and wing with veins and cross-veins pale yellow, broadly and irregularly edged pale brown. Tegmen with markings coalescing to form a broad, indistinct, transverse band over first fork of cubital vein; narrower, very broken, bands at midlength and three-quarters length. Wing with a narrow, pale brownish, transverse band slightly basad of midlength; another broader band over radial-medial cross-vein; posterior and apical margins very faintly and irregularly tinged smoky brown.

Shaft of aedeagus slender, not laterally expanded; dorsal surface with a pair of large flap-like processes, each terminating anteriorly in a long slender spine; lateral surfaces at three-fifths length each with a broad apically bifid process; mid-dorsal process situated at three-fifths length, very broad in lateral aspect, curving, with a large acute spine on posterior surface at midlength. Paramere slender; apex narrowly rounded; dorsal process robust, situated somewhat distad of midlength, posteriorly produced.

## MATERIAL EXAMINED

Holotype ♂, **Brazil**: Jabaty, Para, v.1924 (*Williams*) (BMNH).

Paratype. 1 ♂, same data as holotype (BMNH).

This species is distinguished by its very pale pigmentation, and by the structure of the male genitalia. It is regarded as having the least specialized genitalia in the genus; the shaft of the aedeagus is almost symmetrical, but the presence of the mid-dorsal process confirms its placement; the paramere bears a subbasal, hook-like, secondary process.

*Paramysidia barbara* sp. n.

(Figs 139, 146, 153)

Male: head 0.42 mm long, 0.42 mm wide; pronotum 1.03 mm wide; tegmen 5.60–6.40 mm long; wing 3.15 mm long. Female: tegmen 6.40–6.90 mm long.



Length of frons *c.* 6 times width at apex, *c.* twice width at base; ocelli large, not prominent; clypeus one-third longer than frons. Pronotal width 12 times mid-dorsal length.

Head and body unmarked. Tegmen and wing hyaline; veins and cross-veins dark brown, narrowly and irregularly edged smoky brown. Tegmen with subcostal, radial, medial and cubital areas irregularly mottled smoky brown; posterior margin narrowly smoky brown. Wing with an indistinct, irregular, smoky brown, transverse band immediately distad of radial-medial cross-vein.

Shaft of aedeagus with a large, slightly hooked, flap-like process to the right of mid-dorsal line, and a long, slender, slightly curving, spine-like process to the left; mid-dorsal process situated at two-thirds length, curving, strongly bifurcate apically; lateral surfaces each with a short apically shallowly bifurcate process. Paramere robust; apex very obtusely rounded; dorsal process situated subapically, obsolete.

#### MATERIAL EXAMINED

Holotype ♂, **Honduras**: Santa Barbara, Chumbagua, 26.vii.1966 (*Matta*) (FAMU).

Paratypes. **Honduras**: 7 ♂, 7 ♀, same data as holotype (FAMU; BMNH). **Costa Rica**: 1 ♀, Villa Neilly (FAMU). **El Salvador**: 2 ♂, 4 ♀, San Miguel; San Pedro Perulapan (FAMU; BMNH).

This species is distinguished by the very narrow head, and by the structure of the male genitalia.

#### *Paramysidia boudica* sp. n.

(Figs 137, 144, 151)

Male: head 0.48 mm long, 0.67 mm wide; pronotum 1.40 mm wide; tegmen 6.40 mm long; wing 3.60 mm long. Female unknown.

Length of frons 4.5 times width at apex, 2.5 times width at base; ocelli large, distinct; clypeus slightly shorter than frons. Pronotal width *c.* 13 times mid-dorsal length.

Genae around ocelli and anterior to bases of antennae tinged pale orange. Fronto-lateral surfaces of pronotum with carinae narrowly edged pale orange. Tegmen and wing with veins and cross-veins dark brown, broadly and irregularly edged smoky brown. Tegmen with base narrowly smoky brown. Wing with an irregular, broad, smoky brown band extending transversely from costal margin to apex of clavus at level of first fork of cubital vein; another, very broad band at level of radial-medial cross-vein; posterior and apical margins broadly smoky brown.

Shaft of aedeagus slender; dorsal process to right of midline broad, tapering, hook-like; ventro-lateral surfaces each with an apically bifid, spine-like process at midlength; dorsal apodeme situated slightly dorsad of midlength, sinuate, very slender. Paramere very robust; apex very obtusely rounded; dorsal process situated subapically, strongly reduced; secondary dorsal process situated at approximately one-third length, small, hook-like.

#### MATERIAL EXAMINED

Holotype ♂, **Panama**: 1924 (*Cheeseman*) (BMNH).

This species is readily distinguished by the markings of the tegmen and wing, and by the structure of the male genitalia.

#### *Paramysidia tessellata* sp. n.

(Figs 138, 145, 152)

Male: head 0.46 mm long, 0.57 mm wide; pronotum 1.36 mm wide; tegmen 6.00–6.80 mm long; wing 3.65 mm long. Female unknown.

Length of frons 4 times width at apex, *c.* twice width at base; ocelli large, distinct; clypeus as long as frons. Pronotal width 11 times mid-dorsal length.

Genae often tinged deep yellow around ocelli. Fronto-lateral surfaces of pronotum with carinae broadly deep yellow; abdomen with dorsal surface usually tinged red or brown. Tegmen and wing with veins and cross-veins dark brown, broadly and very irregularly edged smoky brown. Wing with a very faint smoky hyaline transverse band at one-third length, a much more distinct smoky brown band at level of first fork of cubital vein, a third band at level of radial-medial cross-vein; posterior and apical margins irregularly edged smoky brown.

Shaft of aedeagus broad, strongly laterally expanded from midlength to apex; dorsal surface at three-quarters length with right-hand process very robust and hook-like; lateral surfaces each with an apically bifurcate, spine-like process at midlength; dorsal apodeme situated slightly basad of midlength, slender, slightly curving. Paramere robust; apex broadly expanded; dorsal process simple, situated at three-quarters length.

## MATERIAL EXAMINED

Holotype ♂, **Costa Rica**: Guan, 3 km NW. Liberia, 500 ft, 12.vii.1974 (*O'Brien & Marshall*) (FAMU).  
Paratypes. 8 ♂, data as holotype (FAMU; BMNH).

This species is distinguished by the three transverse bands on the wing, the pigmentation of the abdomen, and by the structure of the male genitalia.

**SYMIDIA** Muir

*Symidia* Muir, 1918: 234. Type-species: *Symidia flava* Muir, by monotypy.

Head in dorsal aspect distinctly wider than long. Vertex triangular, extending for one-quarter to one-third its length beyond anterior margins of eyes, lateral carinae very prominent; posterior margin very broadly and deeply incised; junction with frons commonly broadly rounded, rarely acutely angled. Frons extremely narrow, length 18–20 times width at apex, 2–3 times width at base; *c.* parallel-sided from apex to immediately above base, then very abruptly laterally expanded. Genae extending anterior to eyes for one-third to two-fifths horizontal diameter of eye. Second antennal segment club-shaped, *c.* as long as wide; apex truncate, flagellum arising apically. Ocelli very small, usually distinct. Clypeus *c.* as long as frons; medial carina usually distinct over greater part of length from base; lateral carinae usually percurrent. Rostrum extending at least to base of subgenital plate.

Pronotal width 8–16 times mid-dorsal length; fronto-lateral surfaces each with a very highly elevated, foliaceous carina curving horizontally from adjacent to midline of eye to lateral margin, continuing ventrally and internally along lateral and ventral margins to genae at level of base of antenna (Fennah, 1952, refers to this apparent encirclement of the antennal base as an 'antennal fovea'). Tegula not carinate. Disc of mesonotum slightly broader than long; medial and lateral carinae usually distinct; rarely obscure, extending from anterior margin to midlength or almost to hind margin.

Tegmen 4.90–6.00 mm long. Subcostal and radial veins fused from base over *c.* one-third length. Radial vein with three branches extending to apical margin. Medial vein separating from fused radial and subcostal veins at one-sixth length; with six branches extending to apical and posterior margins. Cubital vein with two branches extending to posterior margin, linked to medial vein by a cross-vein at *c.* one-third length (Fig. 5).

Wing not more than *c.* half length of tegmen, often considerably shorter. Radial, medial and cubital veins distinct throughout. Radial and medial veins unbranched, linked by a cross-vein at slightly distad of two-thirds length. Cubital vein two-branched, linked to medial vein by a cross-vein at two-thirds length.

Head and body predominantly pale brownish yellow; abdomen occasionally darker. Genae often with red or orange markings dorsal or ventral to eyes. Tegmen and wing usually pale whitish hyaline, veins pale; often with pale brownish markings which may coalesce to form irregular and indistinct transverse bands.

Male genitalia with shaft of aedeagus horizontal, cylindrical, variably asymmetrical; dorsal surface subapically with three or four pairs of large, anteriorly directed processes; ventral surface usually unarmed. Paramere with dorsal process situated subapically, usually rounded, never greatly produced, interlocking surfaces situated basally, often reduced; ventral surface subbasally with numerous, very small, obtuse spines, or ridged. Anal tube moderately produced posteriorly, somewhat laterally expanded, apically notched or bifurcate. Subgenital plate with posterior margin transverse, or with a small triangular projection medially.

Female with posterior margin of subgenital plate medially produced, occasionally greatly so.

*Symidia* is regarded as being a highly developed off-shoot of the *Mysidiini* because of the reduction of the tegminal and wing venation, the great expansion of the fronto-lateral carinae of the pronotum, the asymmetry of the aedeagus, and the simple form of the dorsal process of the paramere, while still retaining the apical position of the antennal flagellum.

Of the species available for study, *flava* is regarded as the most primitive because of its very extensive range and relatively unspecialized aedeagal development.

The genus is recorded from Trinidad, Guyana, Brazil, Ecuador and Peru.

**Key to species of *Symidia* (based on external characters)**

- |      |  |                                   |
|------|--|-----------------------------------|
| 1    | Junction of vertex and frons acutely angled in lateral aspect .....                | <i>flava</i> Muir (p. 109)        |
| –    | Junction of vertex and frons broadly and regularly rounded in lateral aspect ..... | 2                                 |
| 2(1) | Tegmen with oblique transverse bands dark and prominent .....                      | <i>pintosamia</i> sp. n. (p. 109) |
| –    | Tegmen with oblique transverse bands indistinct .....                              | 3                                 |

- 3(2) Genae ventral to eyes scarlet. Abdomen often dark brown..... *pseudoflava* sp. n. (p. 110)  
 – Genae ventral to eyes occasionally brownish yellow, never distinctly reddish; occasionally pale orange at level of midline of eyes. Abdomen pale..... 4
- 4(3) Wing with distinct, brownish, transverse bands at two-fifths and two-thirds length. Genae extending anterior to eyes for two-thirds horizontal diameter of eye. Female with posterior margin of subgenital plate produced medially beyond apex of abdomen, apex obtusely rounded. Ecuador..... *bucaya* sp. n. (p. 111)  
 – Wing with a very faint, brown, transverse band at one-third length, another much more distinct band at three-quarters length. Genae extending anterior to eyes for only two-fifths horizontal diameter of eye. Female with posterior margin of subgenital plate bearing a small triangular spine medially, not greatly produced posteriorly. Brazil  
*withycombei* sp. n. (p. 110)

**Key to species of *Symidia* (based on male genitalia)**

It has not been possible to examine a male of *pintosamia* which is therefore omitted from this key.

- 1 Shaft of aedeagus with ventral surface unarmed (Fig. 86)..... *pseudoflava* sp. n. (p. 110)  
 – Shaft of aedeagus with ventral surface bearing spine-like processes subapically ..... 2
- 2(1) Paramere with apex obtusely rounded, dorsal process somewhat inclined posteriorly (Fig. 91) ..... *bucaya* sp. n. (p. 111)  
 – Paramere with apex acutely rounded, dorsal process not posteriorly inclined..... 3
- 3(2) Shaft of aedeagus with ventral surface bearing a single, anteriorly directed process, situated to right of midline subapically (Fig. 88)..... *flava* Muir (p. 109)  
 – Shaft of aedeagus with ventral surface bearing three posteriorly directed spine-like processes (Fig. 89)..... *withycombei* sp. n. (p. 110)

***Symidia flava* Muir**

(Figs 5, 19, 28, 84, 88, 92)

*Symidia flava* Muir, 1918: 234. LECTOTYPE ♂, GUYANA (BMNH), here designated [examined].

Male: head 0.38 mm long, 0.53 mm wide; pronotum 1.05 mm wide; tegmen 5.00–5.30 mm long; wing 2.23 mm long. Female: tegmen 5.10–5.50 mm long.

Junction of vertex and frons acutely angled; length of frons 19 times width at apex, c. 3 times width at base; ocelli very small, obscure; clypeus c. as long as frons; rostrum extending to apex of abdomen. Pronotal width 10 times mid-dorsal length.

Genae each with an orange or red band extending horizontally from adjacent to dorsal margin of eye to junction of vertex and frons. Tegmen and wing whitish hyaline, veins pale yellow. Tegmen with pale, smoky brown markings coalescing to form irregular and intermittent transverse bands at one-third, mid- and three-quarters length. Wing with very faint, smoky brownish bands at two-fifths and two-thirds length; apex pale smoky brown.

Shaft of aedeagus broad; dorsal surface subapically with three pairs of processes, the second pair flap-like and strongly hooked apically; ventral surface subapically with a single, slender, flap-like process. Paramere slender, apex narrowly rounded; dorsal process situated slightly basad of three-quarters length, low and rounded; ventral surface subbasally with numerous small tooth-like spines.

**MATERIAL EXAMINED**

Holotype ♂, Guyana: Demerara R., 20.iii.1913 (*Muir*) (BMNH).

Guyana: 21 ♂, 19 ♀ (including 4 ♂, 5 ♀ paratypes) (BMNH). Brazil: 11 ♂, 14 ♀ (BMNH). Trinidad: 9 ♂, 16 ♀ (BMNH). Ecuador: 7 ♂, 4 ♀ (BMNH).

This species is readily distinguished by the acutely angled junction of the vertex and frons, and the adjacent markings on the genae.

***Symidia pintosamia* sp. n.**

Female: head 0.44 mm long, 0.55 mm wide; pronotum 1.20 mm wide; tegmen 5.60–6.00 mm long; wing 2.40 mm long. Male unknown.

Junction of vertex and frons broadly rounded; length of frons 20 times width at apex, 3 times width at

base; ocelli very small, distinct; clypeus as long as frons; rostrum extending well beyond apex of abdomen. Pronotal width 11.5 times mid-dorsal length.

Genae ventral to eyes orange; ocelli reddish. Tegmen and wing almost hyaline, veins yellow. Tegmen with a broad, oblique, brown, transverse band at level of separation of fused subcostal and radial veins, another at level of radial-medial cross-vein; apex broadly smoky brown. Wing with a broad, smoky brown, transverse band at four-fifths length.

**MATERIAL EXAMINED**

Holotype ♀, **Peru**: eastern foothills of Andes, 1 km S. Tingo Maria, 2000 ft, 16.viii.1971 (*Broomfield*) (BMNH).

Paratype. 1 ♀, same data as holotype (BMNH).

This species is distinguished by the prominent dark markings on the tegmen, and by the extreme length of the rostrum.

***Symidia pseudoflava* sp. n.**

(Figs 82, 86, 90)

Male: head 0.40 mm long, 0.50 mm wide; pronotum 1.11 mm wide; tegmen 5.10–5.30 mm long; wing 2.55 mm long. Female: tegmen 5.35–5.95 mm long.

Junction of vertex and frons broadly rounded; length of frons c. 16 times width at apex, 2.33 times width at base; ocelli small, distinct; clypeus as long as frons; rostrum extending to apex of abdomen. Pronotal width 13 times mid-dorsal length.

Genae ventral to eyes scarlet; abdomen often dark brown. Tegmen and wing whitish hyaline, veins very pale. Tegmen with a broad, pale brown, transverse band immediately distad of medial-cubital cross-vein; an ill-defined, oblique, pale brown, transverse band slightly distad of midlength; apical quarter length irregularly mottled pale brownish. Wing with a distinct, pale brown, transverse band at four-fifths length.

Shaft of aedeagus slender; dorsal surface subapically with four pairs of large processes, anterior pair very long and broad, apices hooked; ventral surface unarmed. Paramere with apex very obtusely rounded; dorsal process situated at two-thirds length, large, rounded, with a dorsally aligned, heavily spined ridge on internal surface; ventral surface subbasally with numerous small, tooth-like spines.

**MATERIAL EXAMINED**

Holotype ♂, **Ecuador**: Tena, 29.iii.1923 (*Williams*) (BMNH).

Paratypes. **Ecuador**: 3 ♂, 5 ♀, Tena (BMNH).

This species is distinguished by the scarlet markings on the genae, the pigmentation of the tegmen and wing, and by the structure of the male genitalia.

***Symidia withycombei* sp. n.**

(Figs 85, 89, 93)

Male: head 0.38 mm long, 0.53 mm wide; pronotum 1.18 mm wide; tegmen 5.10 mm long; wing 2.50 mm long. Female: tegmen 5.30–5.70 mm long.

Junction of vertex and frons obtusely rounded; length of frons 18 times width at apex; 3 times width at base; ocelli very small, distinct; clypeus slightly longer than frons; rostrum extending to base of subgenital plate. Pronotal width 14 times mid-dorsal length.

Genae and fronto-lateral surfaces of pronotum pale, ocelli red, genae at level of eyes rarely pale orange. Tegmen and wing whitish hyaline, veins pale yellow. Tegmen broadly and irregularly mottled brownish around cross-veins and forks of veins, these markings coalescing at one-third and two-thirds length to form oblique, intermittent transverse bands. Wing with a distinct, broad, brown, transverse band at three-quarters length, a much fainter band at one-third length not extending to posterior margin.

Shaft of aedeagus slender; dorsal surface subapically with four pairs of processes, fourth pair large, flap-like, apically hooked; single, spine-like process partially obscured by the paired processes; ventral surface subapically with a pair of spine-like processes; at some distance basad of apex, a single spine-like process on left side. Paramere slender, apex acute; dorsal process small, situated at three-quarters length, apex truncate and tuberculose.

**MATERIAL EXAMINED**

Holotype ♂, **Brazil**: Rezende, Estado de Rio, ii.1924 (*Williams*) (BMNH).

Paratypes. 1 ♂, 6 ♀, same data as holotype (BMNH).

This species is distinguished by the lack of reddish pigmentation ventral to the eye, the rounded junction of the vertex and frons, and by the structure of the male genitalia.

*Symidia bucaya* sp. n.

(Figs 83, 87, 91)

Male: head 0.33 mm long, 0.50 mm wide; pronotum 1.05 mm wide; tegmen 4.90–5.10 mm long; wing 2.12 mm long. Female: tegmen 5.40–5.78 mm long.

Junction of vertex and frons obtusely rounded; length of frons 19 times width at apex, 3 times width at base; ocelli very small, distinct; clypeus c. as long as frons; rostrum terminating level with apex of abdomen. Pronotal width 16 times mid-dorsal length.

Genae ventral to eyes, and clypeus brownish yellow; disc of mesonotum and abdomen brownish, the latter occasionally tinged reddish. Tegmen and wing almost hyaline, veins and cross-veins pale yellow. Tegmen with irregular brownish mottlings coalescing to form intermittent, oblique, transverse bands at level of second fork of medial vein and at two-thirds length. Wing with a broad, pale brown, transverse band at two-fifths length, another at two-thirds length.

Shaft of aedeagus subapically bearing four pairs of processes on dorsal surface, fourth pair large, flap-like, apically bifurcate; ventral surface, on the right side only, subapically with a short spine-like process. Paramere with apex obtusely rounded; dorsal process situated at three-quarters length, large, rounded; ventral surface subbasally with numerous small, tooth-like spines.

MATERIAL EXAMINED

Holotype ♂, Ecuador: Bucay, 1000 ft, 7.x.1922 (Williams) (BMNH).

Paratypes. 6 ♂, 9 ♀, same data as holotype (BMNH).

This species is distinguished by the absence of reddish pigmentation on the genae, the markings of the tegmen and wing, and by the structure of the male genitalia.

## References

- Ball, E. D.** 1928. Some new genera and species of N. A. Derbidae with notes on others (Fulgoroidea). *Canadian Entomologist* **60**: 196–201.
- Dozier, H. L.** 1922. A synopsis of the genus *Stenocranus*, and a new species of *Mysidia*. *Ohio Journal of Science* **22**: 69–82.
- 1931. New and interesting West Indian Homoptera. *American Museum Novitates, New York*. no. 510: 1–24.
- Fabricius, J. C.** 1803. *Systema Rhyngotorum* x + 314 pp. Brunsvigae.
- Fennah, R. G.** 1945. The Fulgoroidea, or Lanternflies, of Trinidad and adjacent parts of South America. *Proceedings of the United States National Museum* **95**: 411–520.
- 1952. On the generic classification of Derbidae (Fulgoroidea), with descriptions of new Neotropical species. *Transactions of the Royal Entomological Society of London* **103**: 109–170.
- 1971. Fulgoroidea from the Cayman Islands and adjacent areas. *Journal of Natural History* **5**: 299–342.
- Fowler, W. W.** 1900. *Biologia Centrali-Americana*. Rhynchota **1**: 1–147.
- Germar, E. F.** 1830. *Thon's Entomologisches Archives* **2**: 56. Jena.
- Kirkaldy, G. W.** 1900. Bibliographical and nomenclatorial notes on the Rhynchota (I). *Entomologist* **33**: 242.
- 1906. Leaf hoppers and their natural enemies (IX. Leaf Hoppers, Hemiptera). *Bulletin of the Hawaiian Sugar Planters' Association Experimental Station* **1**: 287–479.
- Kramer, S.** 1950. *The morphology and phylogeny of Auchenorrhynchous Homoptera (Insecta)*. vii + 111 pp. Urbana.
- Metcalf, Z. P.** 1938. The Fulgorina of Barro Colorado and other parts of Panama. *Bulletin of the Museum of Comparative Zoology, Harvard* **82**: 277–423.
- 1945a. Fulgoroidea (Homoptera) of Kartabo, Bartica District, British Guiana. *Zoologica* **30**: 125–143.
- 1945b. *General catalogue of the Homoptera*. Fulgoroidea **4** (4): 1–212.
- Muir, F. E. S.** 1913. On some new species of leaf-hoppers (II). *Bulletin of the Hawaiian Sugar Planters' Association Experimental Station* **3**: 28–91.
- 1917. The Derbidae of the Philippine Islands. *Philippine Journal of Science* **12**: 49–104.

- 1918a. Notes on the Derbidae in the British museum Collection, II, Derbinae. *Entomologists Monthly Magazine* **54**: 228–243.
- 1918b. Homopterous notes (II). *Proceedings of the Hawaiian Entomological Society* **3**: 414–429.
- 1924. New and little known fulgorids from the West Indies (Homoptera). *Proceedings of the Hawaiian Entomological Society* **5**: 461–472.
- Schaum, H. R.** 1850. *Allgemeine Encyclopädie Ersch und Gruber* **51**: 64–69.
- Spinola, M. M.** 1839. Sur les Fulgorelles, sous-tribu de la tribu des Cicadaïres, ordre des Rhyngotes. *Annales de la Société Entomologique de France* **8**: 133–454.
- Westwood, J. O.** 1840. Observations on the genus *Derbe* of Fabricius. *Proceedings of the Linnean Society of London* **1**: 82–85.
- 1842a. Descriptions of some new species of exotic homopterous insects, *Transactions of the Linnean Society of London* **19**: 1–18.
- 1842b. Descriptions of several new homopterous insects belonging to various subgenera of *Derbe* of Fabricius. *Transactions of the Linnean Society of London* **19**: 19–22.

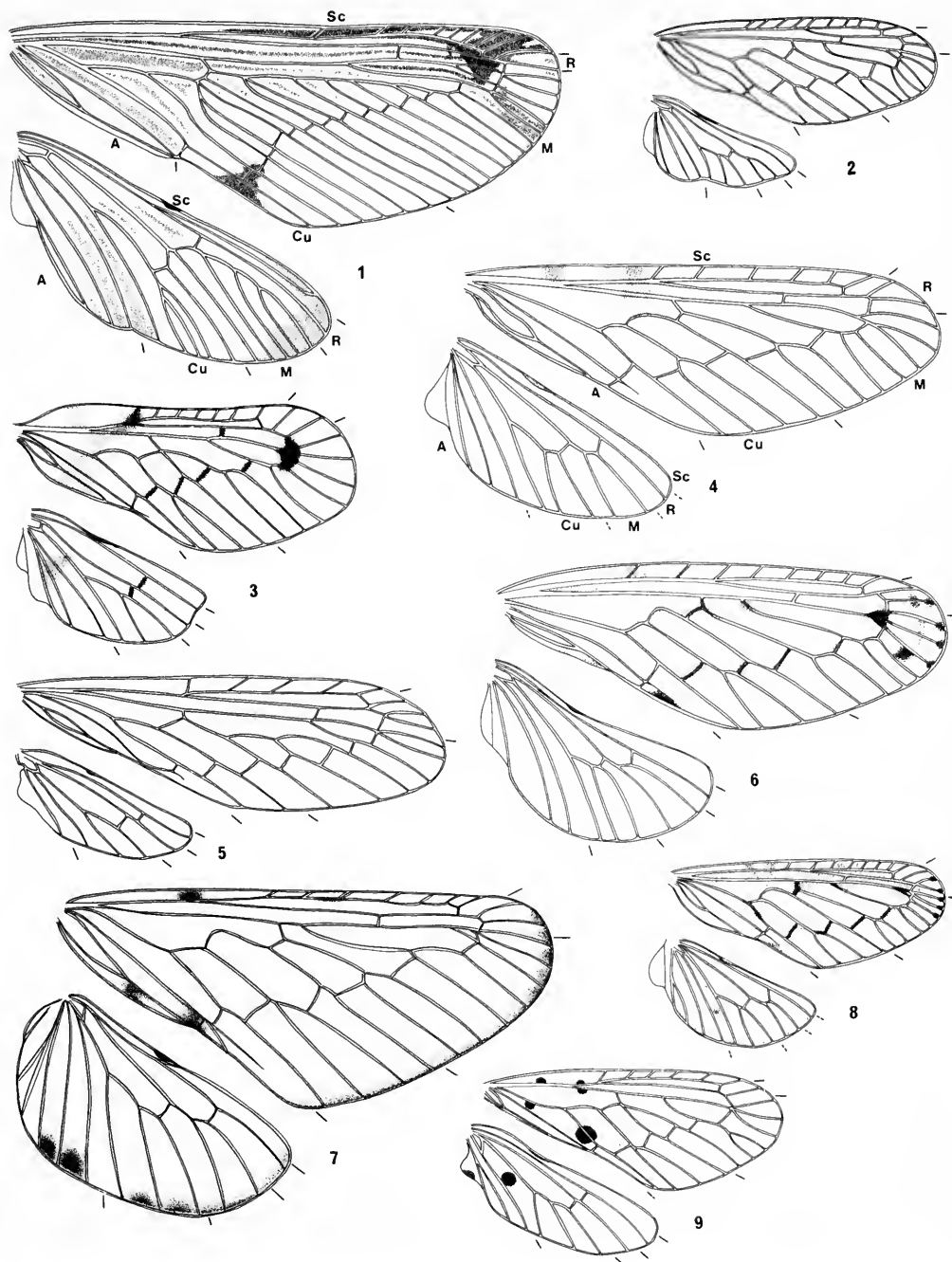

**Figs 1-9** The genera of the Derbinae, tegmen and wing: 1, *Derbe westwoodi*; 2, *Paramysidia vulgaris*; 3, *Dysimiella williamsi*; 4, *Amysidiella micare*; 5, *Symidia flava*; 6, *Neomysidia willisi*; 7, *Mysidia acidaloides*; 8, *Ipsemysidia beautifula*; 9, *Dysimia maculata*. *Derbe*, *Paramysidia*, *Mysidia*, and *Ipsemysidia* are shown to one-half scale. Sc = subcostal area; R = radial area; M = medial area; Cu = cubital area; A = anal area.

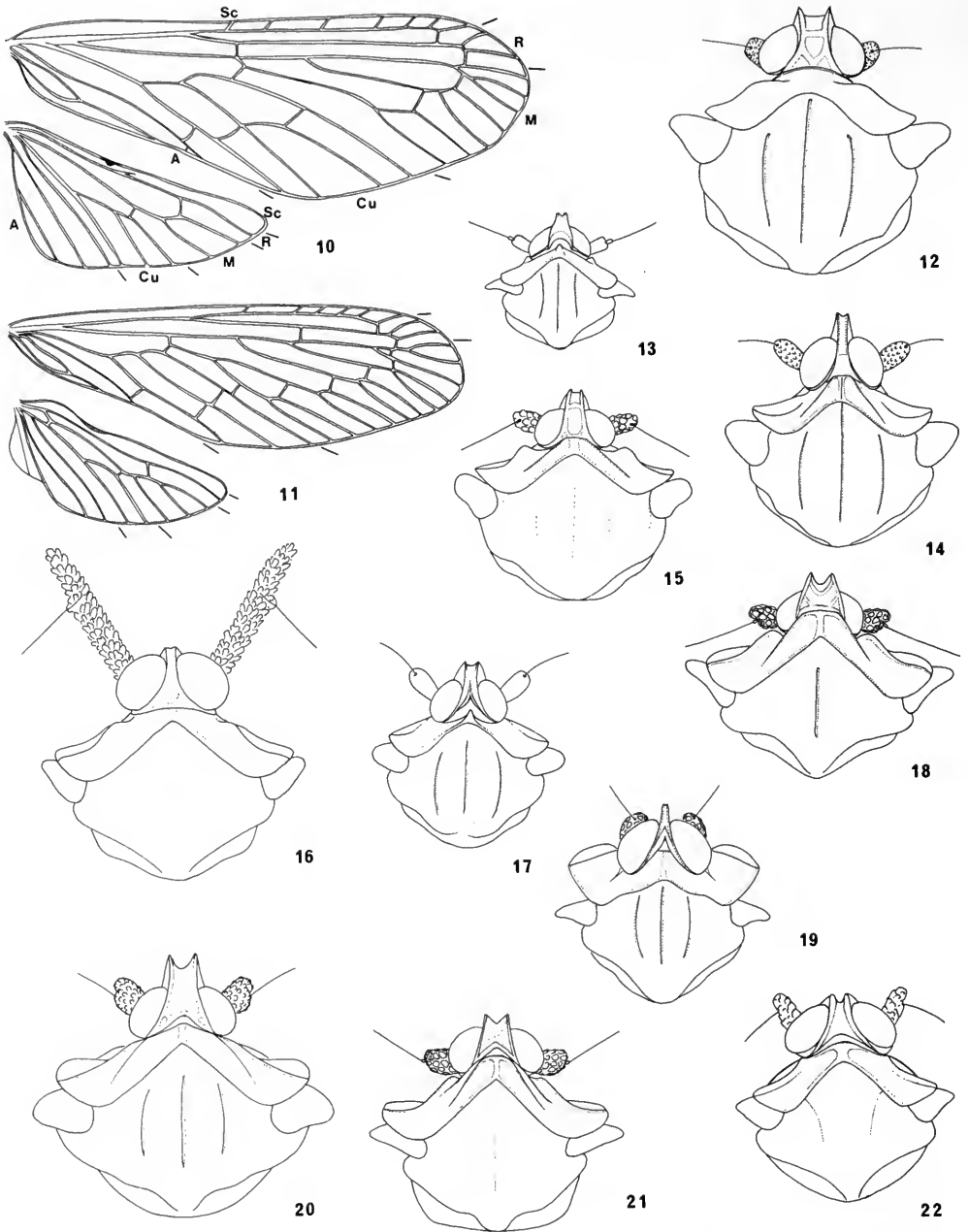

**Figs 10–22** The genera of the Derbinae. 10, 11, tegmen and wing of (10) *Mysidaloides trinidadensis*; (11) *Pseudomysidia fuscovaria*. 12–22, head, pronotum and mesonotum in dorsal aspect of (12) *Derbe westwoodi*; (13) *Dysimia maculata*; (14) *Pseudomysidia pallida*; (15) *Mysidia acidaloides*; (16) *Mysidaloides trinidadensis*; (17) *Dysimiella williamsi*; (18) *Neomysidia willisi*; (19) *Symidia flava*; (20) *Paromysidia mississippiensis*; (21) *Ipemysidia beautifulica*; (22) *Amysidiella micare*. *Derbe* and *Mysidia* are shown to one-half scale.



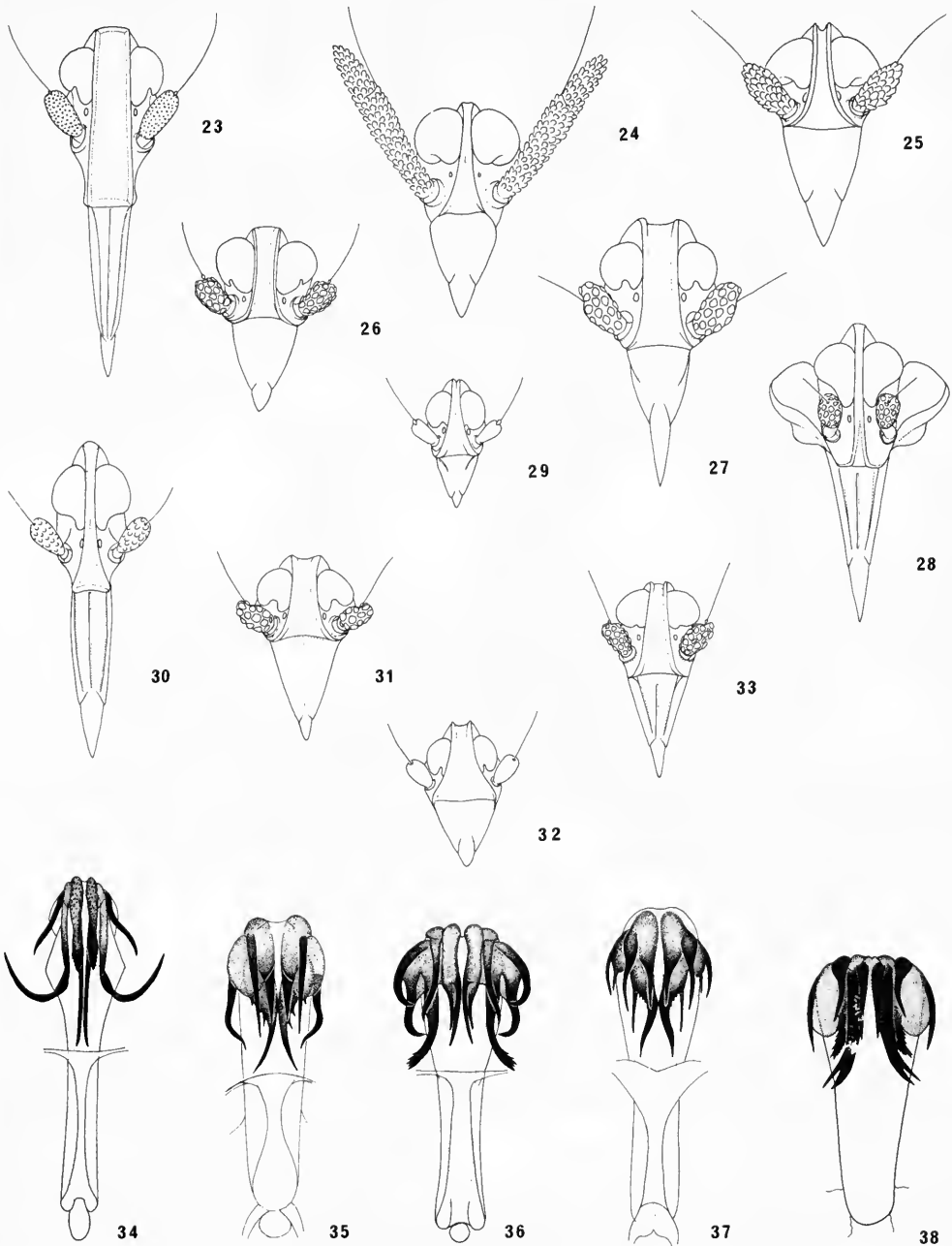

**Figs 23–38** The genera of the Derbinae. 23–33, head in frontal aspect of (23) *Derbe westwoodi*; (24) *Mysidaloides trinidadensis*; (25) *Amysidiella micare*; (26) *Ipsemyssidia beautifca*; (27) *Paramysidia mississippiensis*; (28) *Symidia flava* (including fronto-lateral surfaces of pronotum); (29) *Dysimia maculata*; (30) *Pseudomyssidia pallida*; (31) *Neomyssidia willisi*; (32) *Dysimiella williamsi*; (33) *Mysidia acidaloides*. *Derbe* and *Mysidia* are shown to one-half scale. *Pseudomyssidia* species. 34–38, dorsal view of aedeagus of (34) *palmeri*; (35) *rubidella*; (36) *juliana*; (37) *deborae*; (38) *similis*.

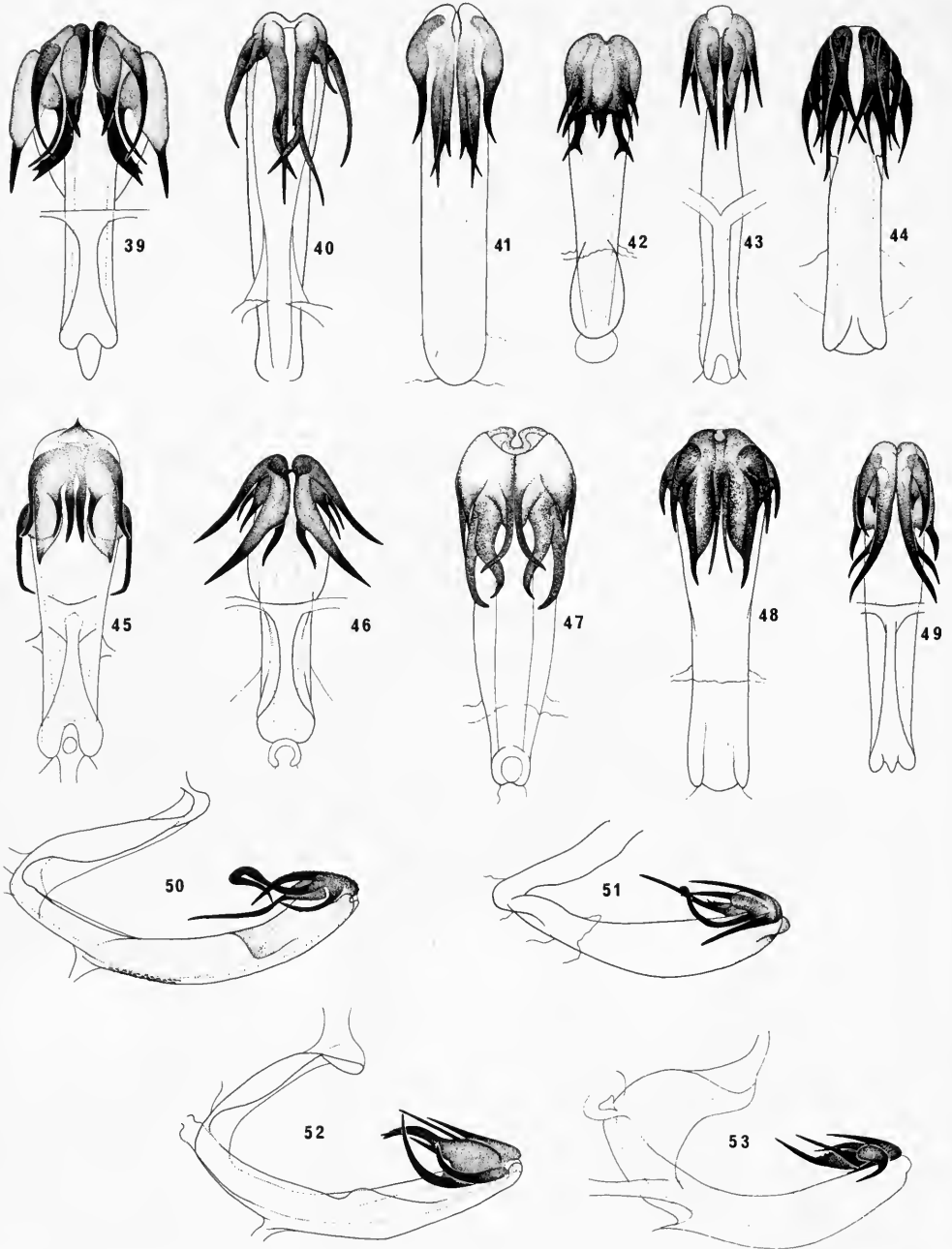

**Figs 39–53** *Pseudomysidia* species. 39–49, dorsal view of aedeagus of (39) *hindore*; (40) *panamensis*; (41) *fuscovaria*; (42) *pallida*; (43) *araguana*; (44) *marshalli*; (45) *vestis*; (46) *trinidadensis*; (47) *ecuadoriensis*; (48) *delicata*; (49) *obnubilata*. 50–53, left lateral view of aedeagus of (50) *palmeri*; (51) *rubidella*; (52) *juliana*; (53) *debora*.

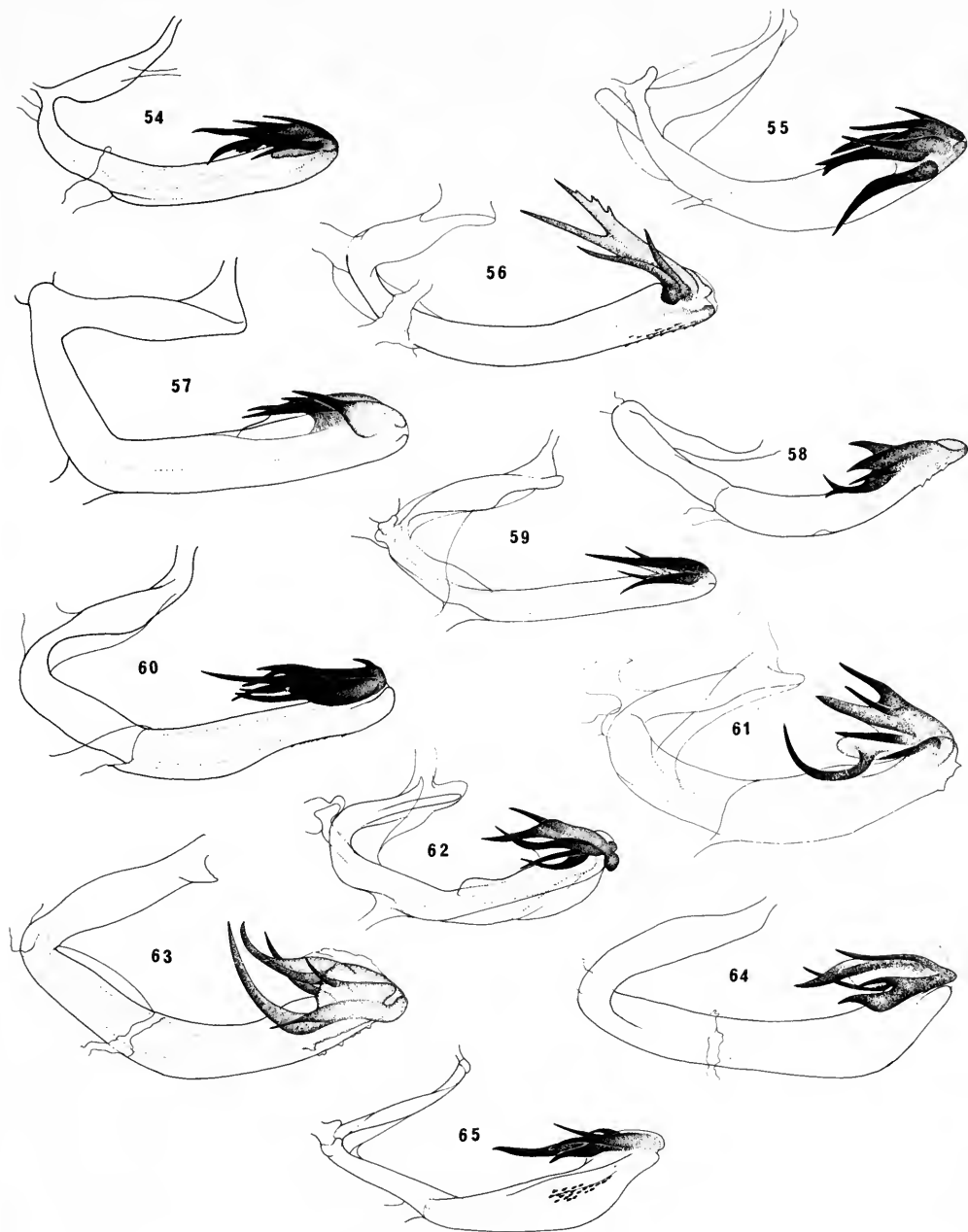

**Figs 54–65** Left lateral view of aedeagus of *Pseudomysidia* species. 54, *similis*; 55, *hindore*; 56, *panamensis*; 57, *fuscovaria*; 58, *pallida*; 59, *araguana*; 60, *marshalli*; 61, *vestis*; 62, *trinidadensis*; 63, *ecuadoriensis*; 64, *delicata*; 65, *obnubilia*.

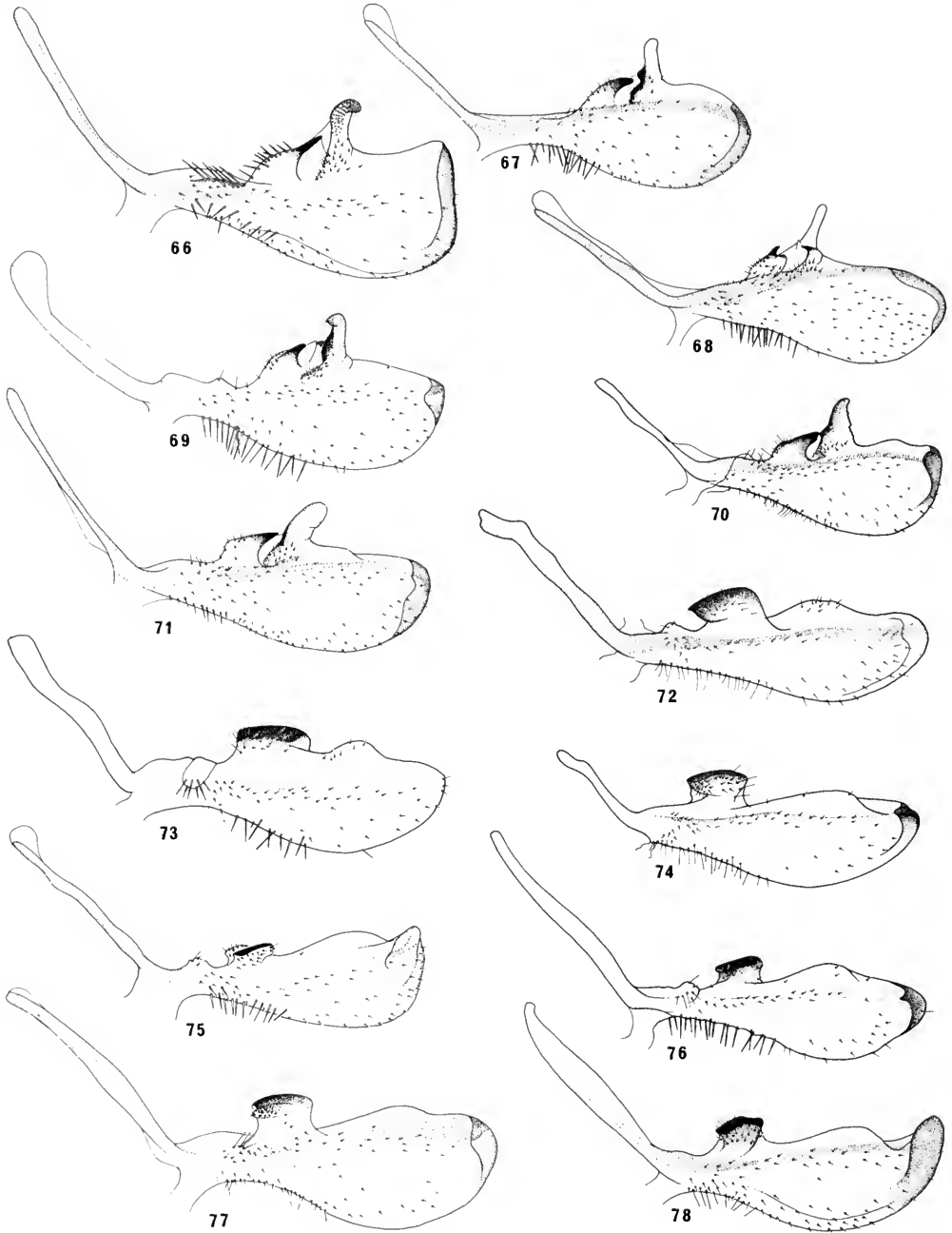

**Figs 66–78** Left lateral view of paramere of *Pseudomyssidia* species. 66, *palmeri*; 67, *rubidella*; 68, *juliana*; 69, *dehora*; 70, *similis*; 71, *hindore*; 72, *panamensis*; 73, *fuscovaria*; 74, *pallida*; 75, *araguana*; 76, *marshalli*; 77, *vestis*; 78, *trinidadensis*.

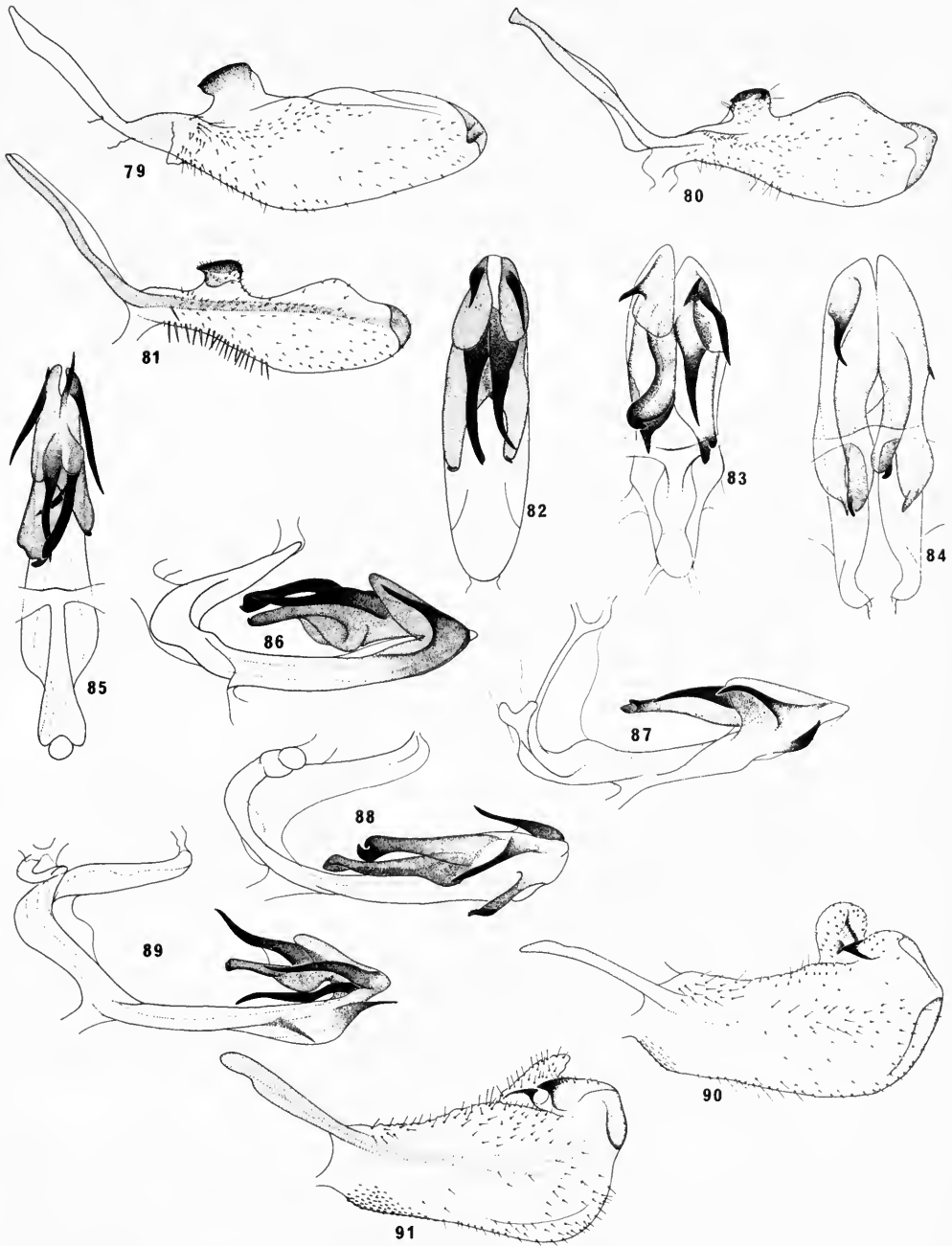

**Figs 79–91** *Pseudomyssidia* species. 79–81, left lateral view of paramere of (79) *ecuadoriensis*; (80) *delicata*; (81) *obnubilia*. 82–91, *Symidia* species. 82–85, dorsal view of aedeagus of (82) *pseudoflava*; (83) *bucaya*; (84) *flava*; (85) *withycombei*. 86–89, left lateral view of aedeagus of (86) *pseudoflava*; (87) *bucaya*; (88) *flava*; (89) *withycombei*. 90, 91, left lateral view of paramere of (90) *pseudoflava*; (91) *bucaya*.

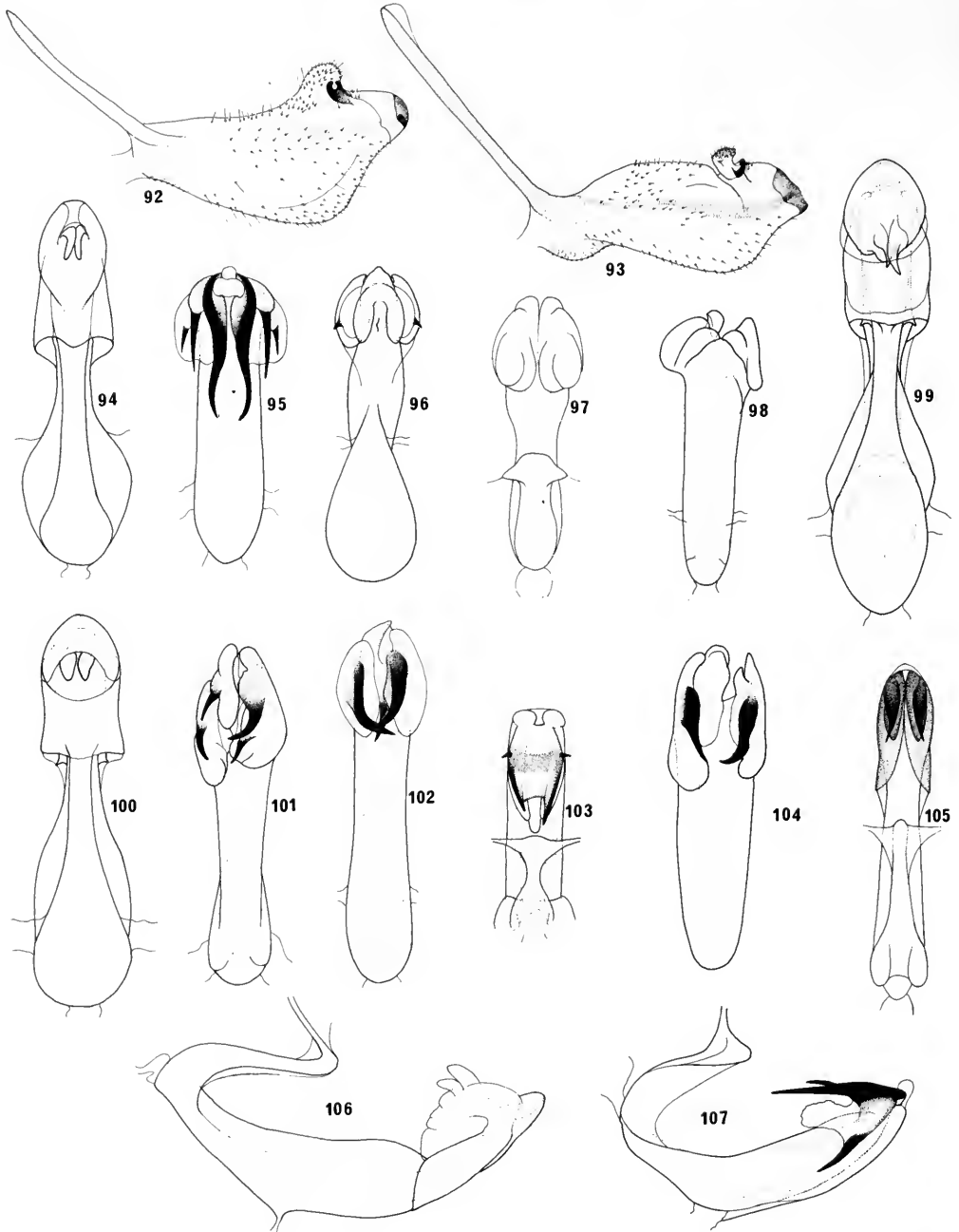

**Figs 92–107** 92, 93, *Symidia* species, left lateral view of paramere of (92) *flava*; (93) *withycombei*. 94–107, *Dysimia* species. 94–105, dorsal view of aedeagus of (94) *distincta*; (95) *numa*; (96) *maculata*; (97) *pseudomaculata*; (98) *muiiri*; (99) *fennahi*; (100) *telfordi*; (101) *maculipennis*; (102) *obrieni*; (103) *jamaicensis*; (104) *morrisi*; (105) *astarte*. 106, 107, left lateral view of aedeagus of (106) *distincta*; (107) *numa*.

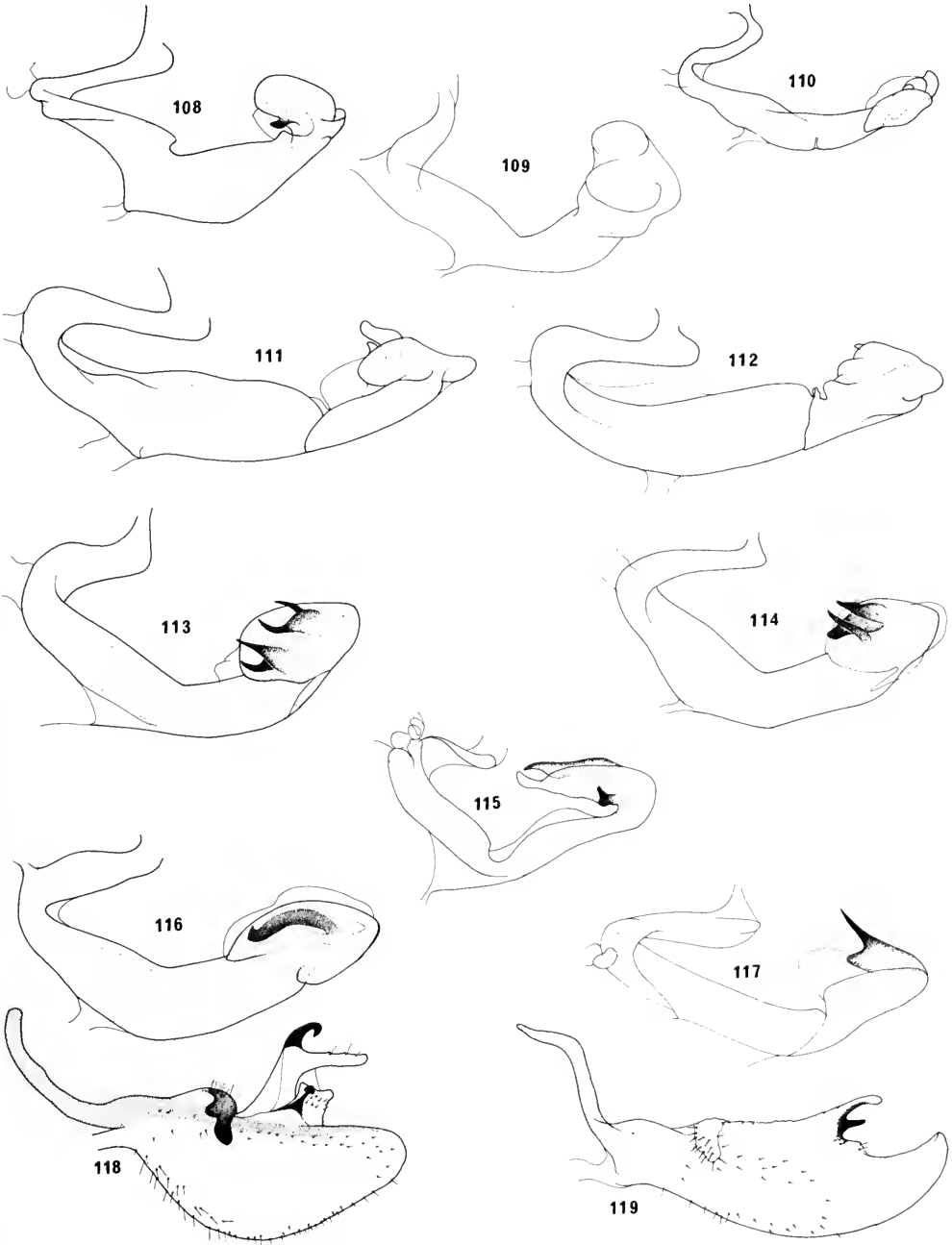

**Figs 108–119** *Dysimia* species. 108–117, left lateral view of aedeagus of (108) *maculata*; (109) *pseudomaculata*; (110) *mui*; (111) *fennahi*; (112) *telfordi*; (113) *maculipennis*; (114) *obrieni*; (115) *jamaicensis*; (116) *morrissi*; (117) *astarte*. 118, 119, left lateral view of paramere of (118) *distincta*; (119) *numa*.

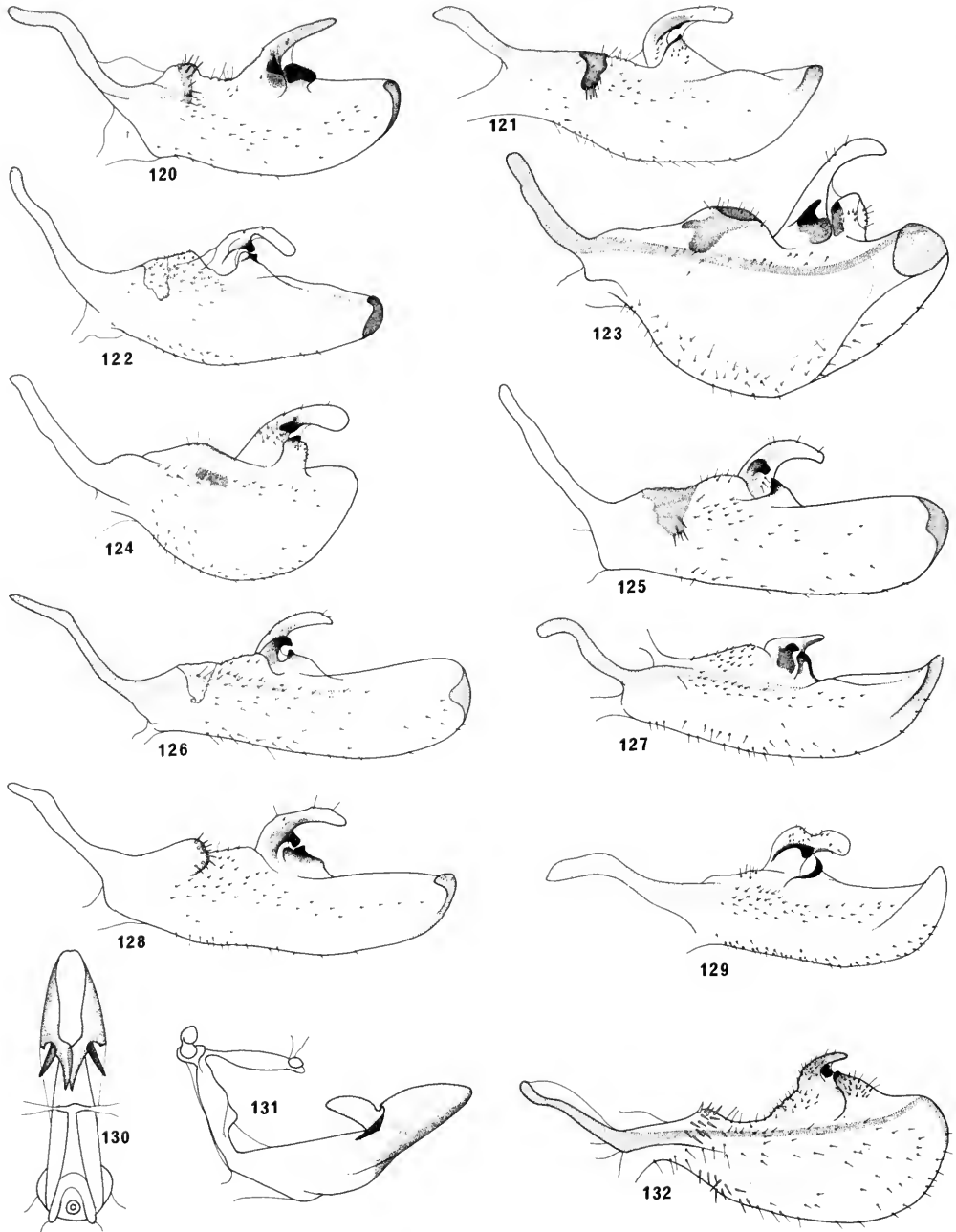

**Figs 120–132** 120–129, *Dysimia* species, left lateral view of paramere of (120) *maculata*; (121) *pseudomaculata*; (122) *muri*; (123) *fennahi*; (124) *telfordi*; (125) *maculipennis*; (126) *obrieni*; (127) *jamaicensis*; (128) *morrissi*; (129) *astarte*. 130–132, *Mysidaloides trinidadensis*. (130) dorsal view of aedeagus; (131) left lateral view of aedeagus; (132) left lateral view of paramere.





**Figs 133–147** *Paramysidia* species. 133–139, dorsal view of aedeagus of (133) *vulgaris*; (134) *felix*; (135) *nigropunctata*; (136) *mississippiensis*; (137) *boudica*; (138) *tessellata*; (139) *barbara*. 140–146, left lateral view of aedeagus: (140) *vulgaris*; (141) *felix*; (142) *nigropunctata*; (143) *mississippiensis*; (144) *boudica*; (145) *tessellata*; (146) *barbara*. 147, left lateral view of paramere of *vulgaris*.

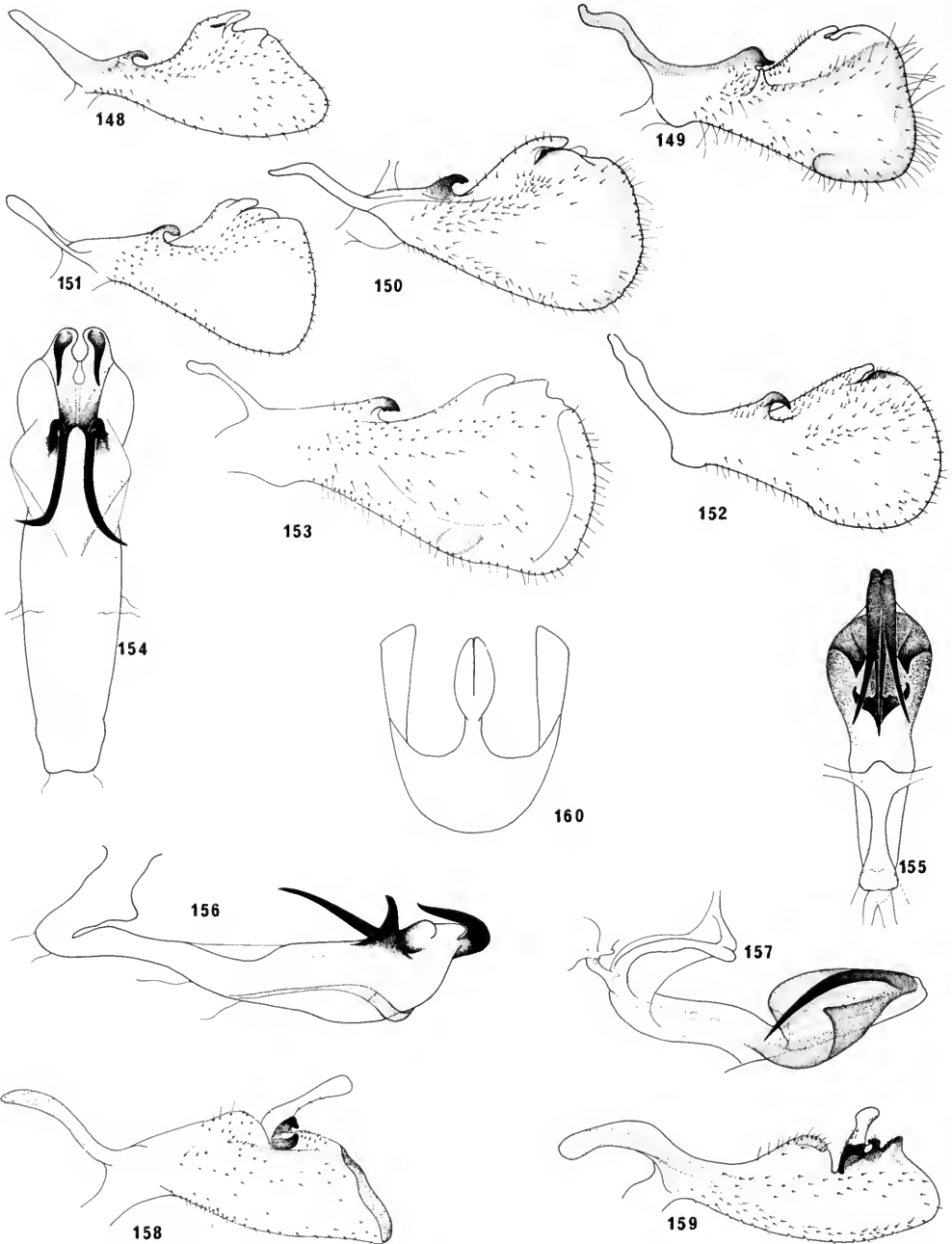

**Figs 148–160** 148–153, *Paramysidia* species, left lateral view of paramere of (148) *felix*; (149) *nigropunctata*; (150) *mississippiensis*; (151) *boudica*; (152) *tessellata*; (153) *barbara*. 154–160, *Dysimiella* species. 154, 155, dorsal view of aedeagus of (154) *williamsi*; (155) *pennyi*. 156, 157, left lateral view of aedeagus of (156) *williamsi*; (157) *pennyi*. 158, 159, left lateral view of paramere of (158) *williamsi*; (159) *pennyi*. 160, ventral view of male subgenital plate of *pennyi*.

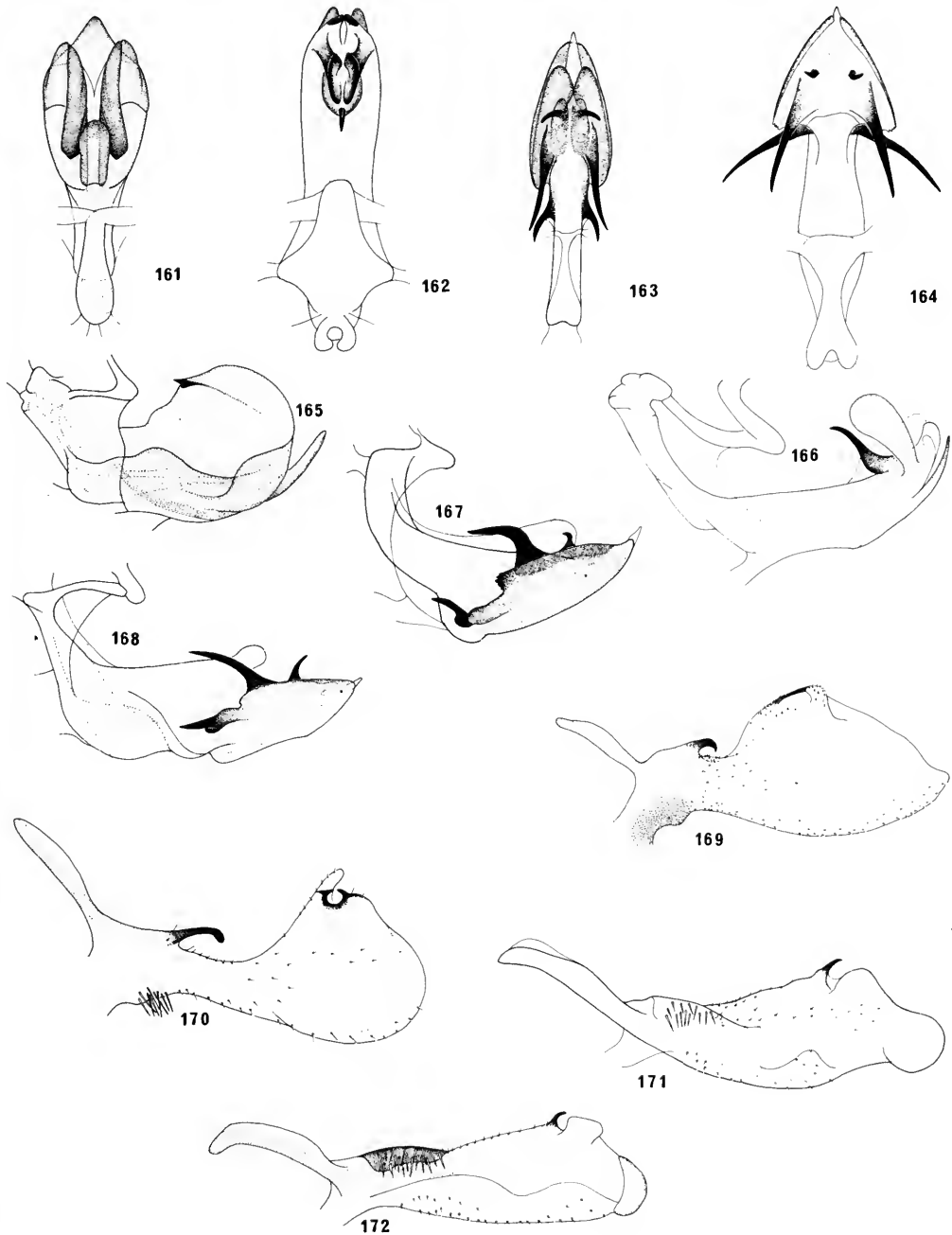

**Figs 161–172** 161–164, dorsal view of aedeagus of (161) *Neomysidia willisi*; (162) *Ipsemysidia beautifulica*; (163) *Amysidiella pseudomicare*; (164) *A. micare*. 165–168, left lateral view of aedeagus of (165) *N. willisi*; (166) *I. beautifulica*; (167) *A. micare*; (168) *A. pseudomicare*. 169–172, left lateral view of paramere of (169) *N. willisi*; (170) *I. beautifulica*; (171) *A. micare*; (172) *A. pseudomicare*.

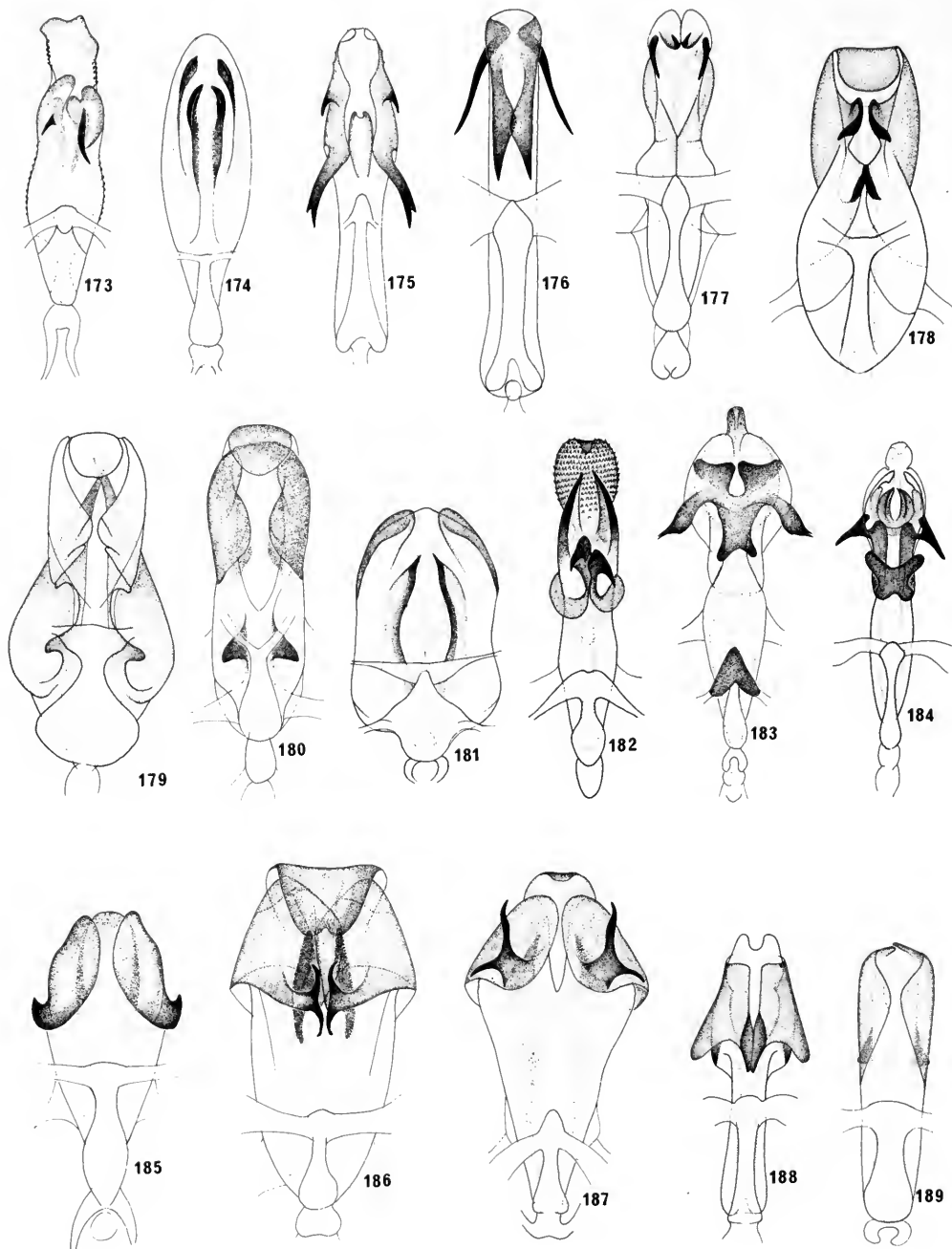

**Figs 173–189** *Mysidia* species, dorsal view of aedeagus. 173, *fowleri*; 174, *distanti*; 175, *claudata*; 176, *pulchella*; 177, *fuscodorsalis*; 178, *douglasi*; 179, *bizzara*; 180, *carosella*; 181, *jamesi*; 182, *peregrina*; 183, *venusta*; 184, *augusta*; 185, *ariasi*; 186, *amazona*; 187, *molesta*; 188, *glauca*; 189, *cinerea*.

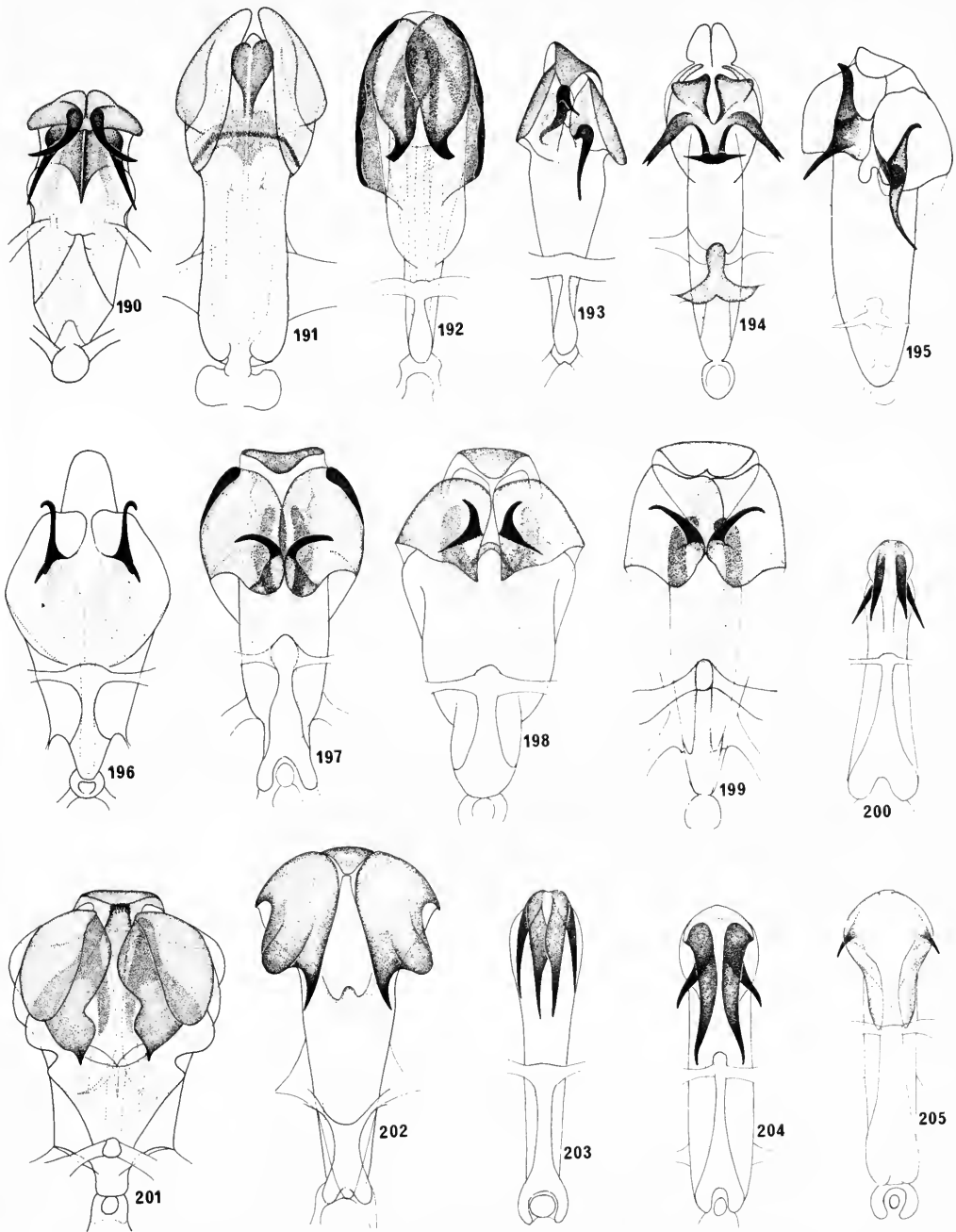

**Figs 190–205** *Mysidia* species, dorsal view of aedeagus. 190, *agilis*; 191, *ecuadoria*; 192, *decora*; 193, *lacteola*; 194, *cheesemani*; 195, *nemorensis*; 196, *polyhymnia*; 197, *limpida*; 198, *nitida*; 199, *amarantha*; 200, *stali*; 201, *erecta*; 202, *pseudoerecta*; 203, *knighti*; 204, *persephone*; 205, *minerva*.

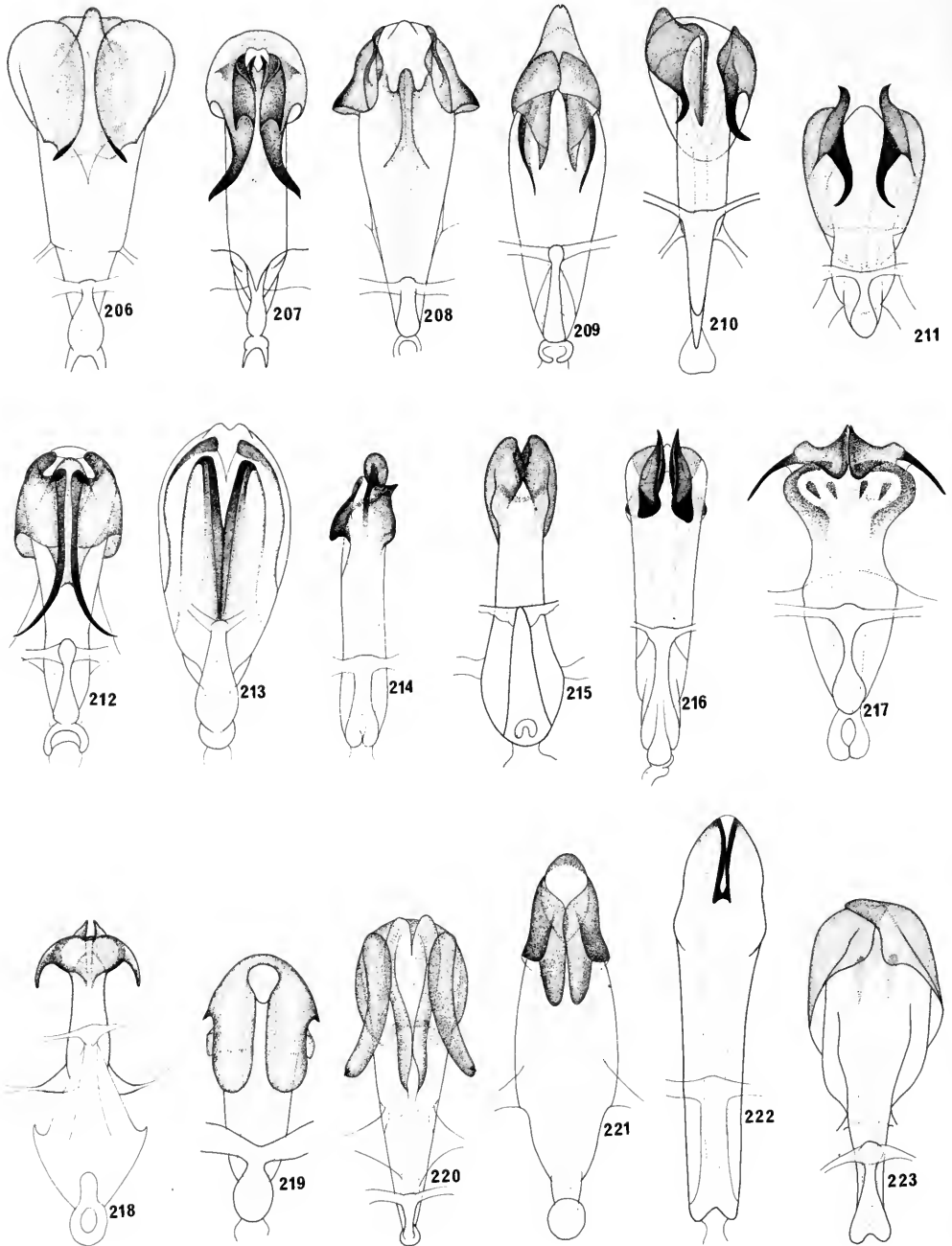

**Figs 206–223** *Mysidia* species, dorsal view of aedeagus. 206, *harmonia*; 207, *bianca*; 208, *pseudocostata*; 209, *bibula*; 210, *panamensis*; 211, *isteria*; 212, *estfarchina*; 213, *insolita*; 214, *athena*; 215, *sanguinea*; 216, *acidaloides*; 217, *adusta*; 218, *havilandi*; 219, *richardsi*; 220, *costata*; 221, *adamare*; 222, *simplicia*; 223, *marshalli*.

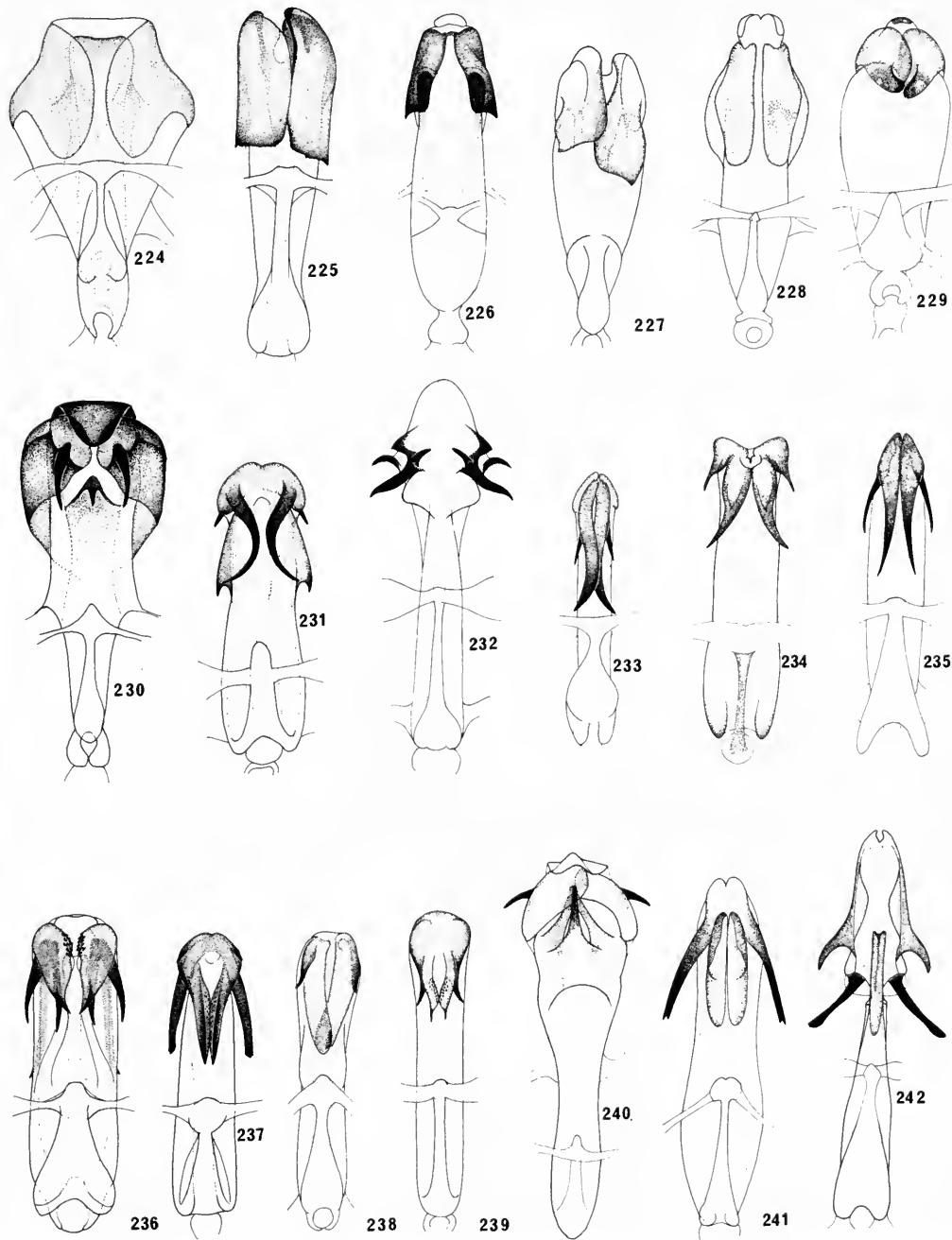

Figs 224–242 *Mysidia* species, dorsal view of aedeagus. 224, *liquida*; 225, *fasciata*; 226, *hyalina*; 227, *diana*; 228, *albipennis*; 229, *bella*; 230, *neonebulosa*; 231, *nigrithorax*; 232, *lucifera*; 233, *infedelis*; 234, *transversa*; 235, *intima*; 236, *caliginosa*; 237, *calypso*; 238, *williamsi*; 239, *albifasciata*; 240, *josianna*; 241, *nigrifrontalis*; 242, *clava*.

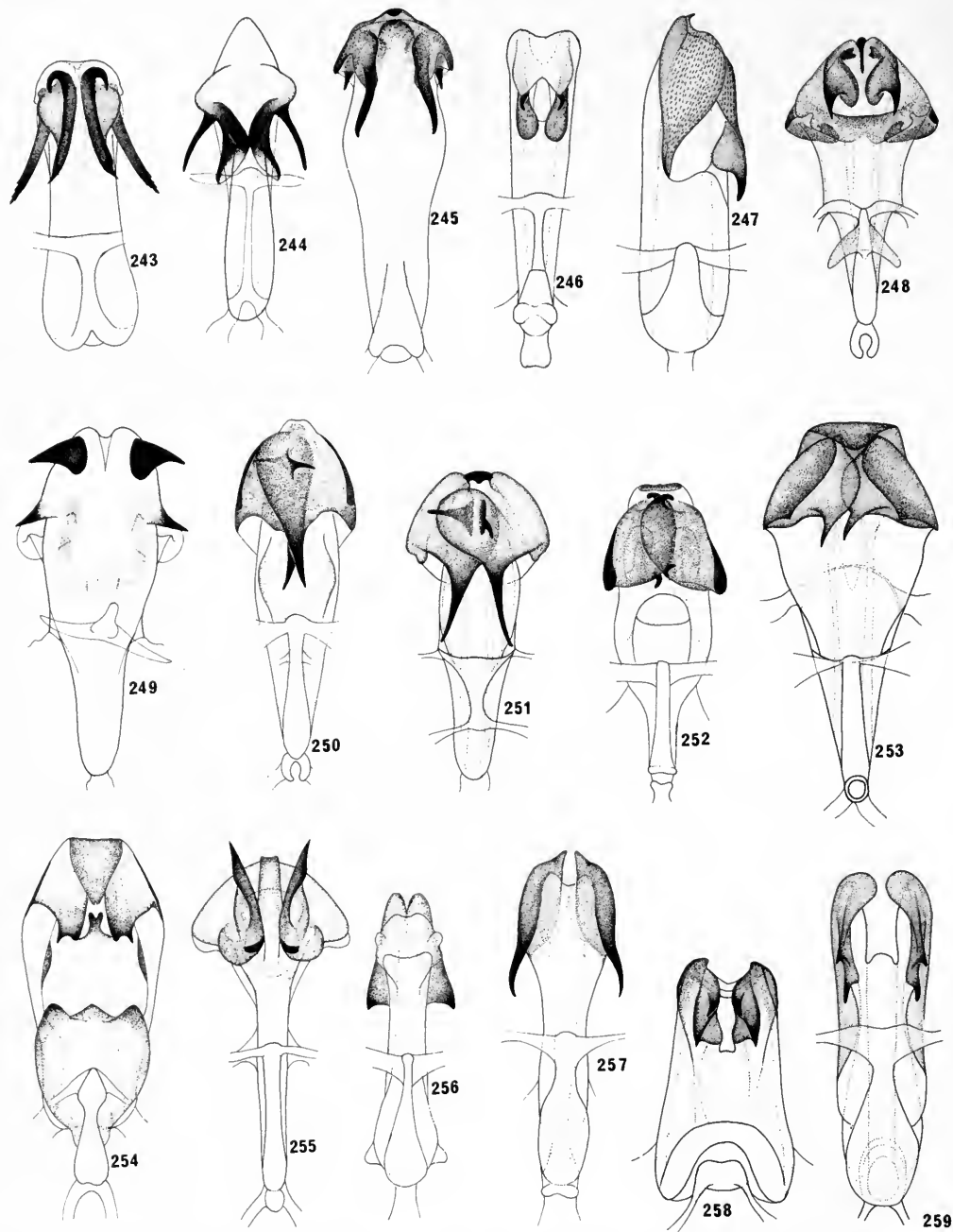

**Figs 243–259** *Mysidia* species, dorsal view of aedeagus. 243, *inquinata*; 244, *gracilis*; 245, *fuscofrontalis*; 246, *formosa*; 247, *cooperi*; 248, *punctum*; 249, *magica*; 250, *boliviana*; 251, *silvana*; 252, *hengist*; 253, *musica*; 254, *etheldreda*; 255, *dollingi*; 256, *diabola*; 257, *neoasinella*; 258, *andes*; 259, *tikalme*.



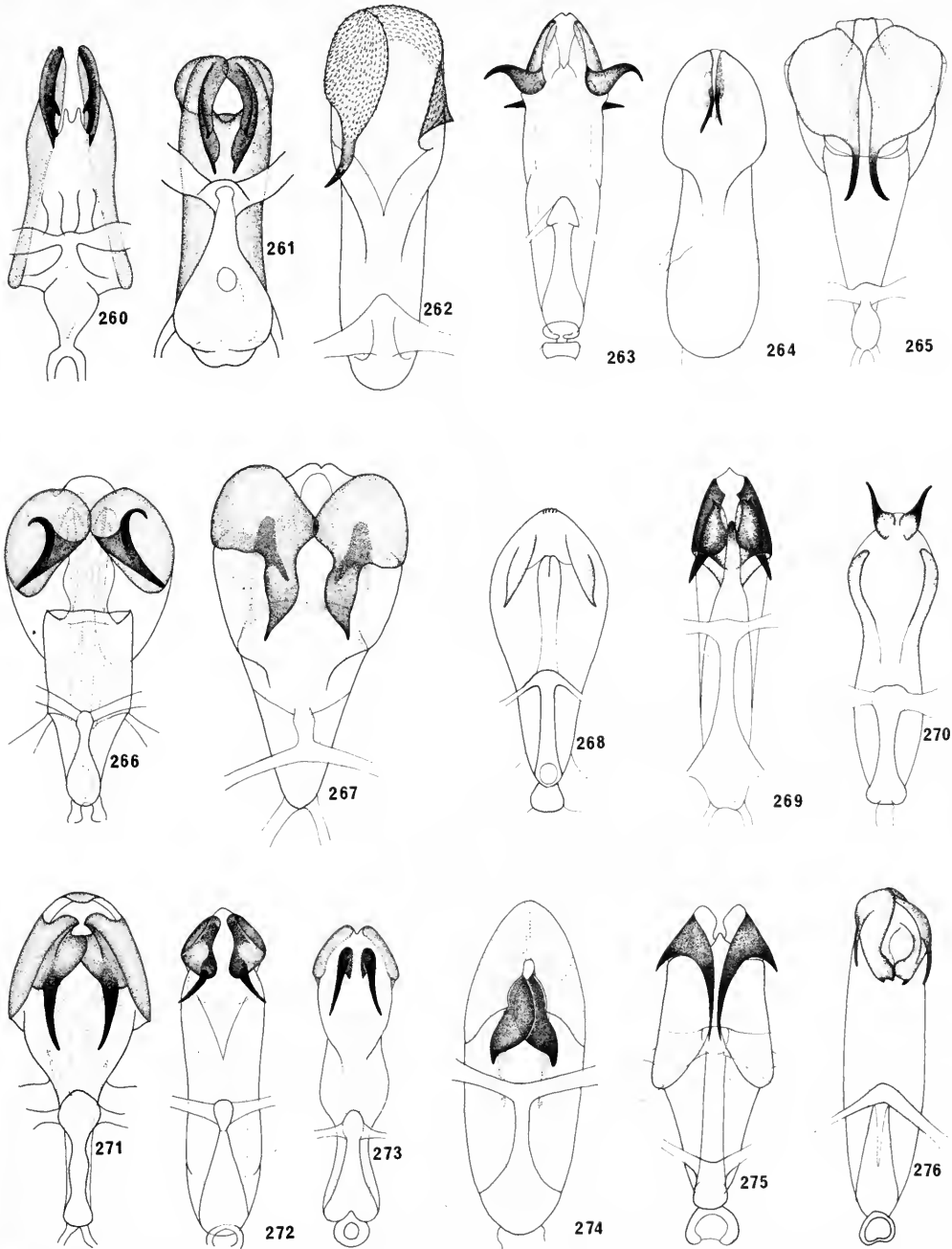

**Figs 260–277** *Mysidia* species, dorsal view of aedeagus. 260, *obscura*; 261, *varia*; 262, *lucianna*; 263, *fuscomaculata*; 264, *lloydi*; 265, *insania*; 266, *nebulosa*; 267, *perspicua*; 268, *flavilla*; 269, *unimaculata*; 270, *maculosa*; 271, *distincta*; 272, *whimperi*; 273, *testacea*; 274, *geoffreyi*; 275, *delicatissima*; 276, *mylesi*.

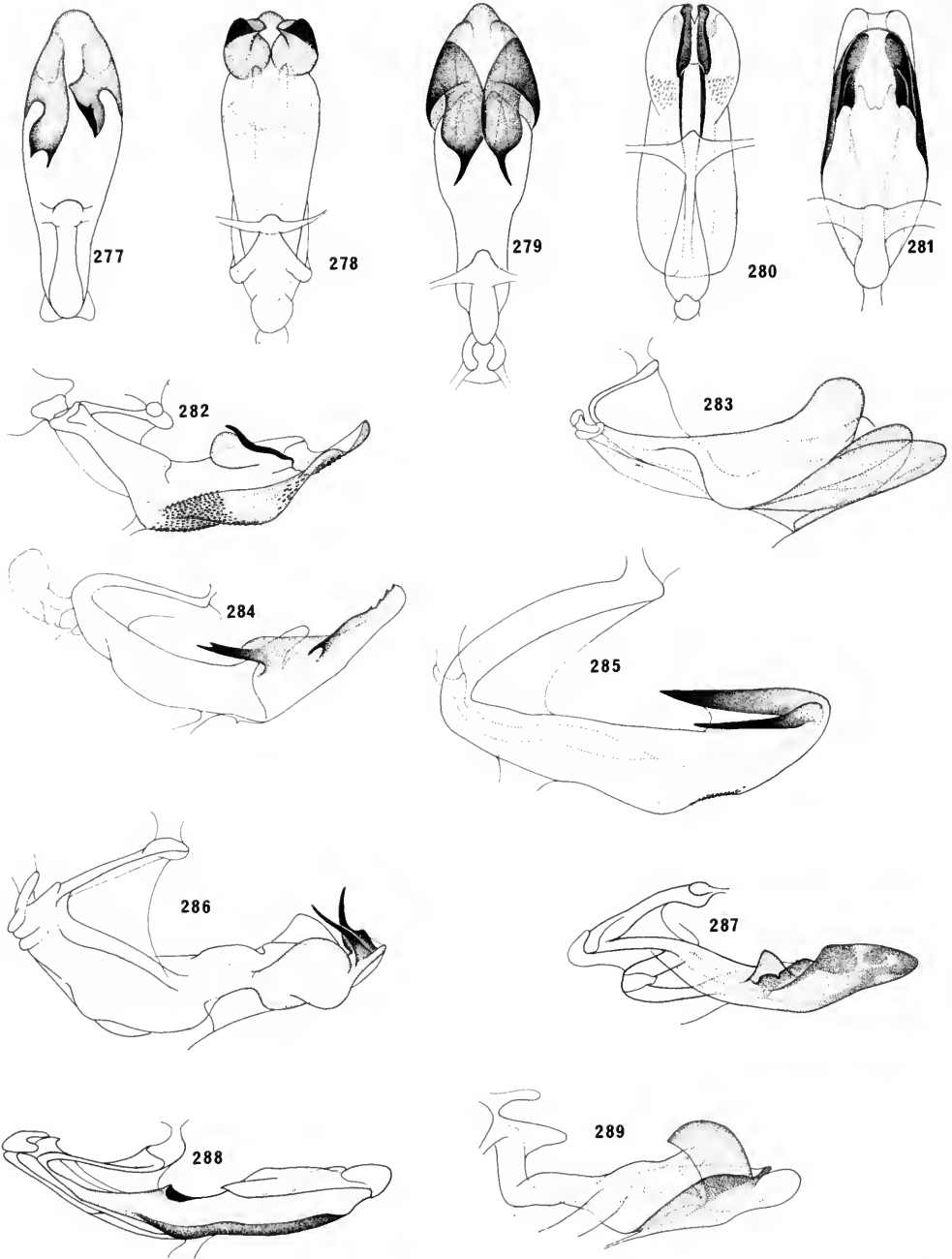

**Figs 277–289** *Mysidia* species. 277–281, dorsal view of aedeagus of (277) *henrietta*; (278) *pseudonebulosa*; (279) *albicans*; (280) *krameri*; (281) *enjebetta*. 282–289, left lateral view of aedeagus of (282) *fowleri*; (283) *distanti*; (284) *claudata*; (285) *pulcella*; (286) *fuscodorsalis*; (287) *douglasi*; (288) *bizzara*; (289) *enjebetta*.

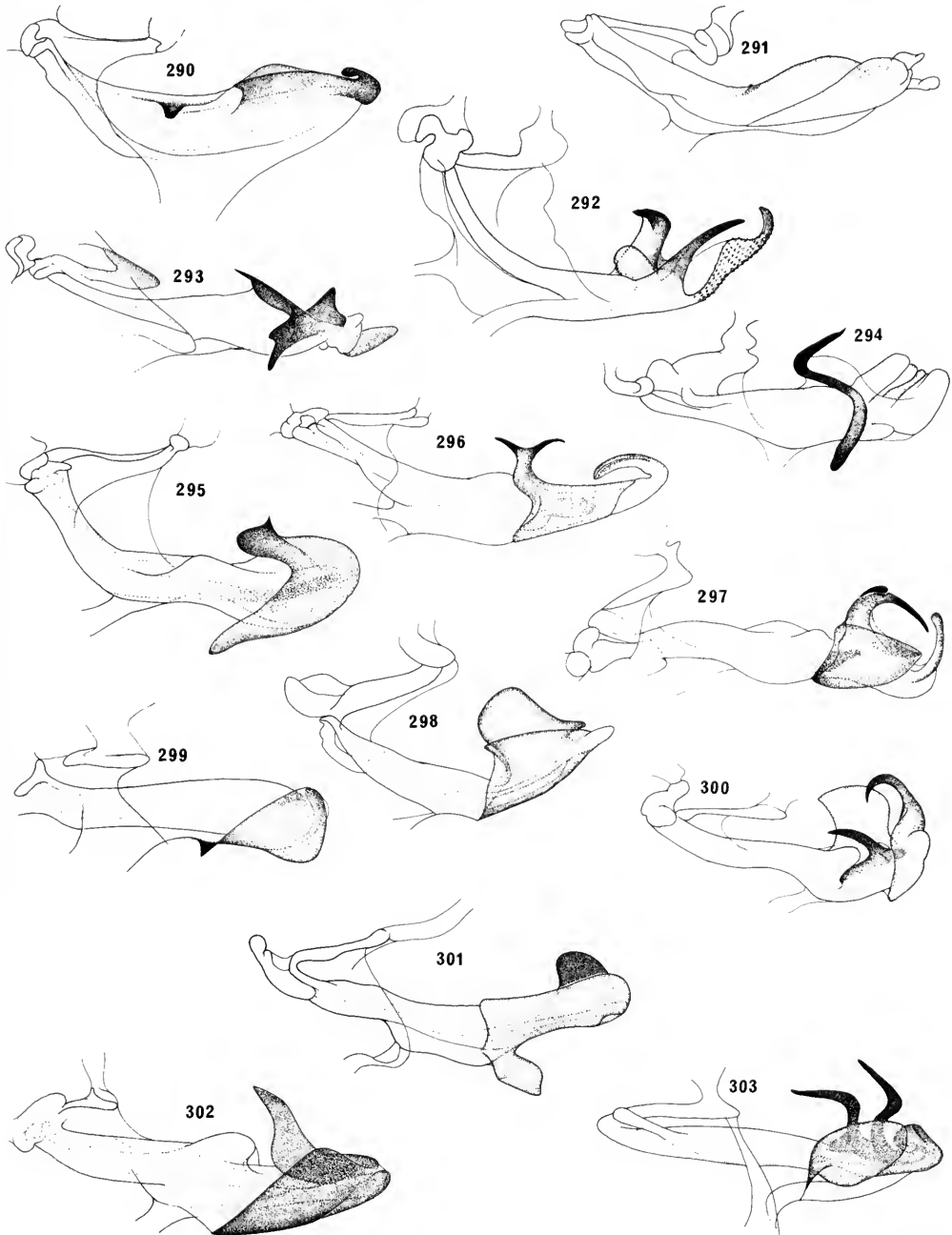

**Figs 290–303** *Mysidia* species, left lateral view of aedeagus. 290, *carosella*; 291, *jamesi*; 292, *peregrina*; 293, *venusta*; 294, *augusta*; 295, *ariasi*; 296, *amazona*; 297, *molesta*; 298, *glauca*; 299, *cinerea*; 300, *agilis*; 301, *ecuadoria*; 302, *decora*; 303, *lacteola*.

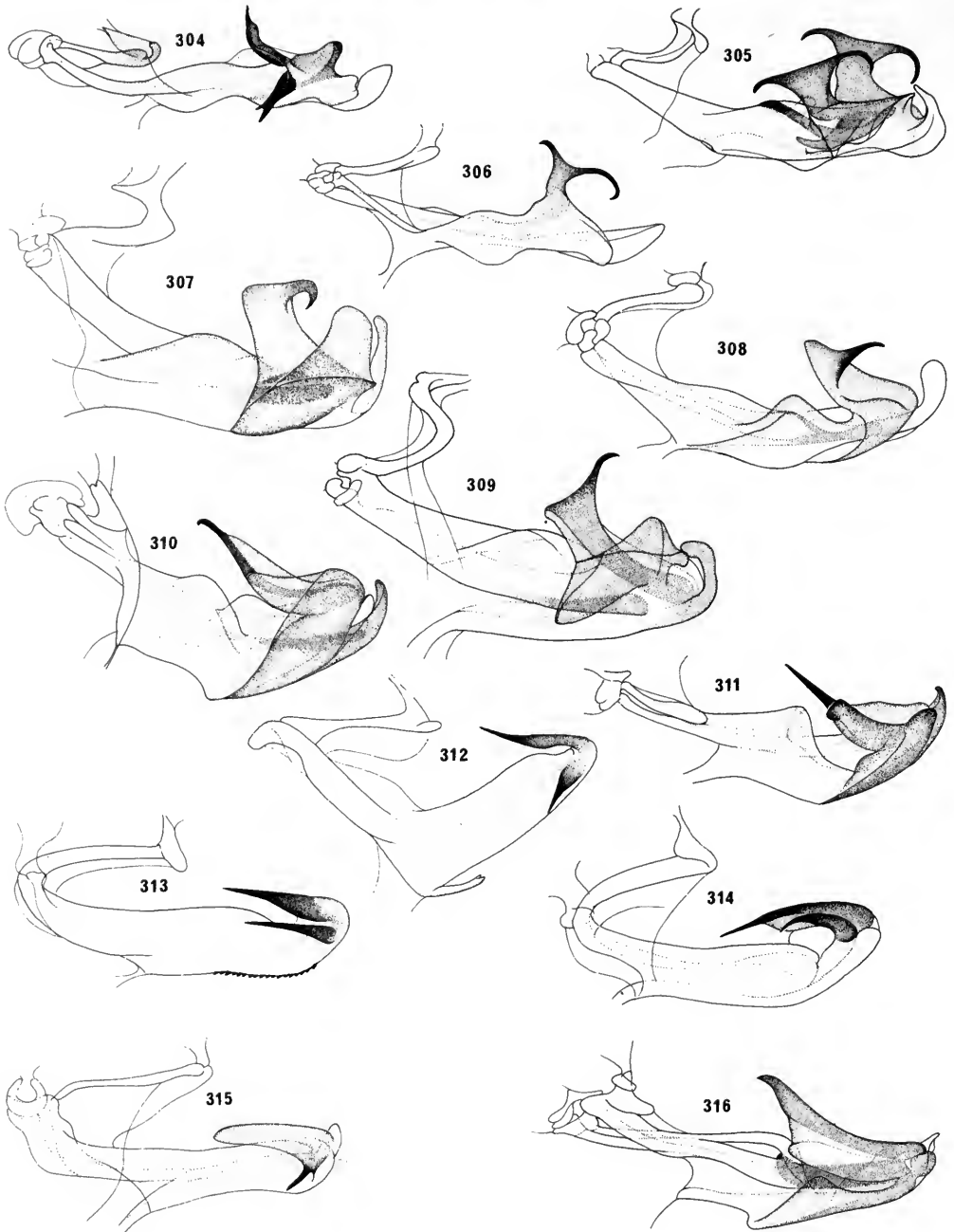

**Figs 304–316** *Mysidia* species, left lateral view of aedeagus. 304, *cheesemani*; 305, *nemorensis*; 306, *polyhymnia*; 307, *limpida*; 308, *nitida*; 309, *amarantha*; 310, *erecta*; 311, *pseudoerecta*; 312, *stali*; 313, *knichti*; 314, *persephone*; 315, *minerva*; 316, *harmonia*.

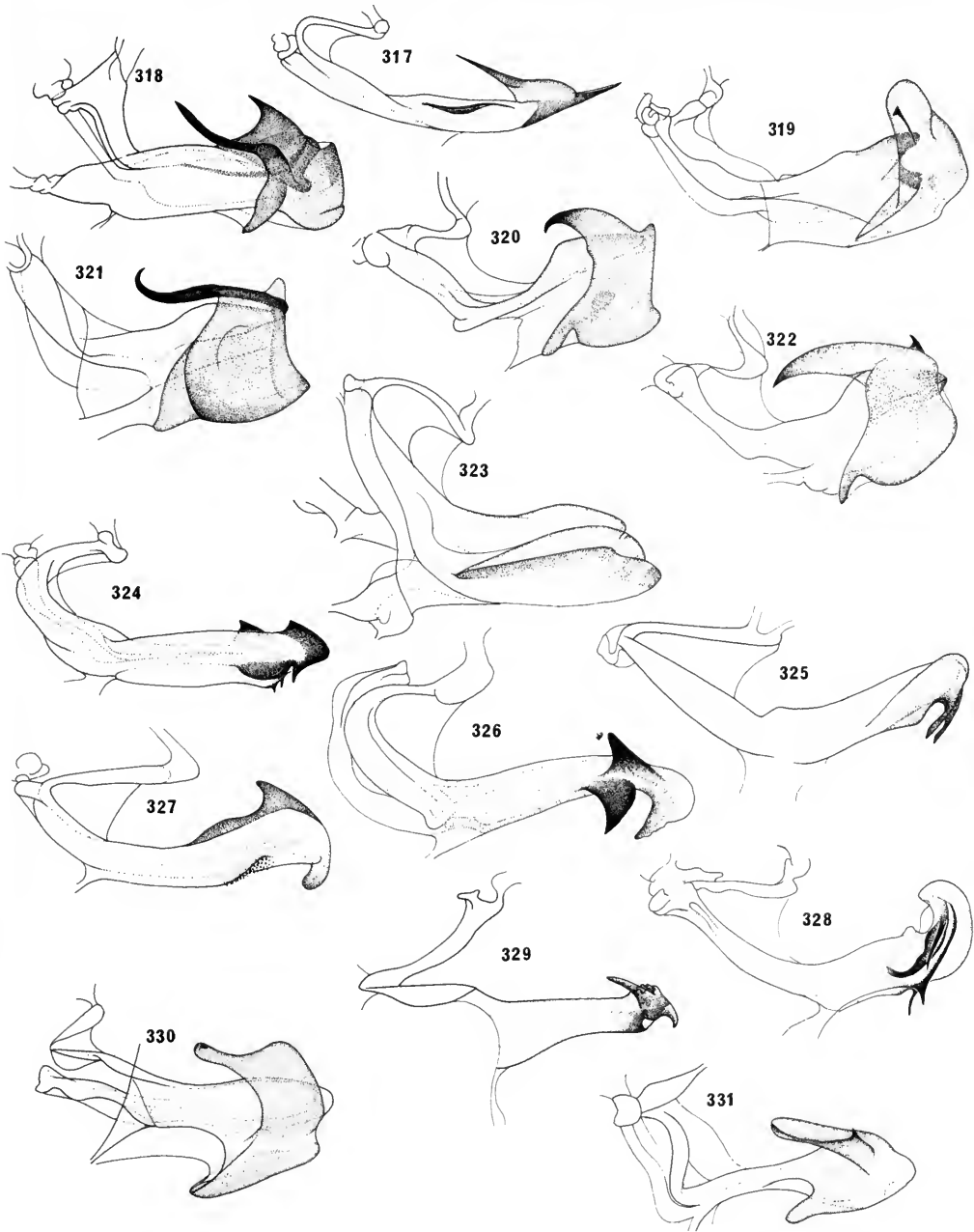

**Figs 317–331** *Mysidia* species, left lateral view of aedeagus. 317, *bibula*; 318, *bianca*; 319, *pseudocostata*; 320, *panamensis*; 321, *isteria*; 322, *estfarchina*; 323, *insolita*; 324, *athena*; 325, *sanguinea*; 326, *acidaloides*; 327, *krameri*; 328, *adusta*; 329, *havilandi*; 330, *costata*; 331, *richardsi*.

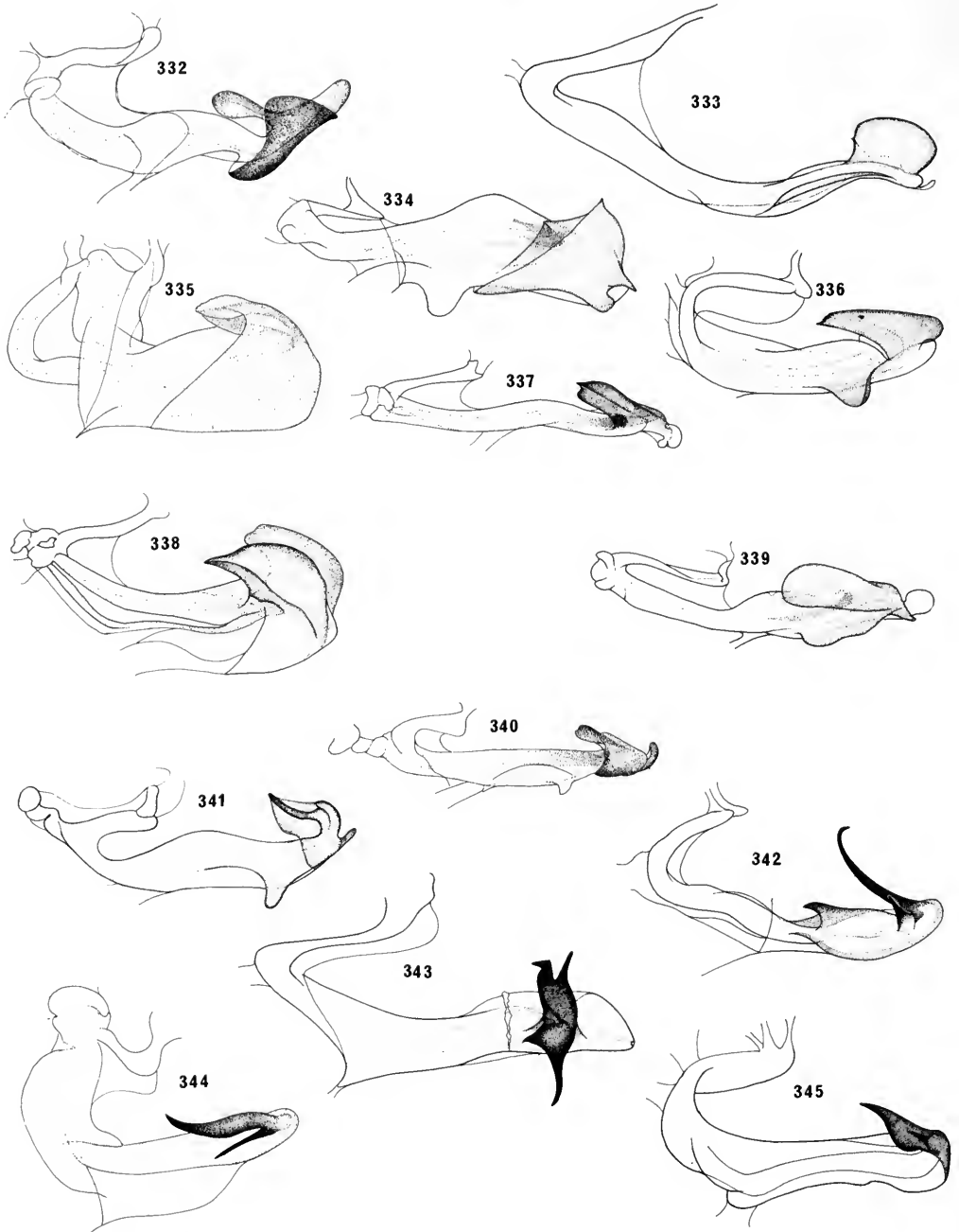

**Figs 332–345** *Mysidia* species, left lateral view of aedeagus. 332, *adamare*; 333, *simpla*; 334, *marshalli*; 335, *liquida*; 336, *fasciata*; 337, *hyalina*; 338, *diana*; 339, *albipennis*; 340, *bella*; 341, *neonebulosa*; 342, *nigrithorax*; 343, *lucifera*; 344, *infedelis*; 345, *transversa*.

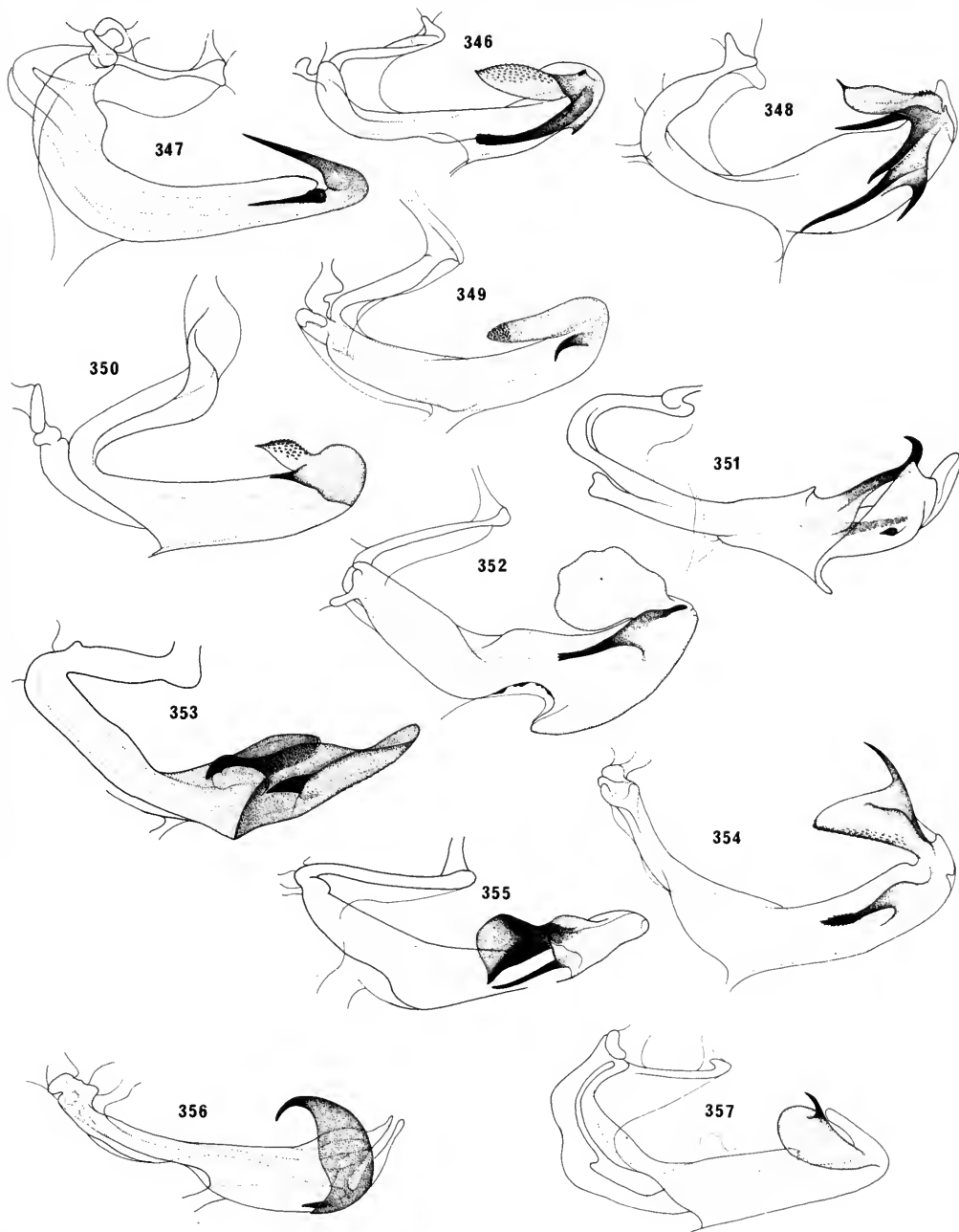

**Figs 346–357** *Mysidia* species, left lateral view of aedeagus. 346, *calypso*; 347, *intima*; 348, *caliginosa*; 349, *williamsi*; 350, *albifasciata*; 351, *josianna*; 352, *nigrifrontalis*; 353, *clava*; 354, *inquinata*; 355, *gracilis*; 356, *fuscofrontalis*; 357, *formosa*.

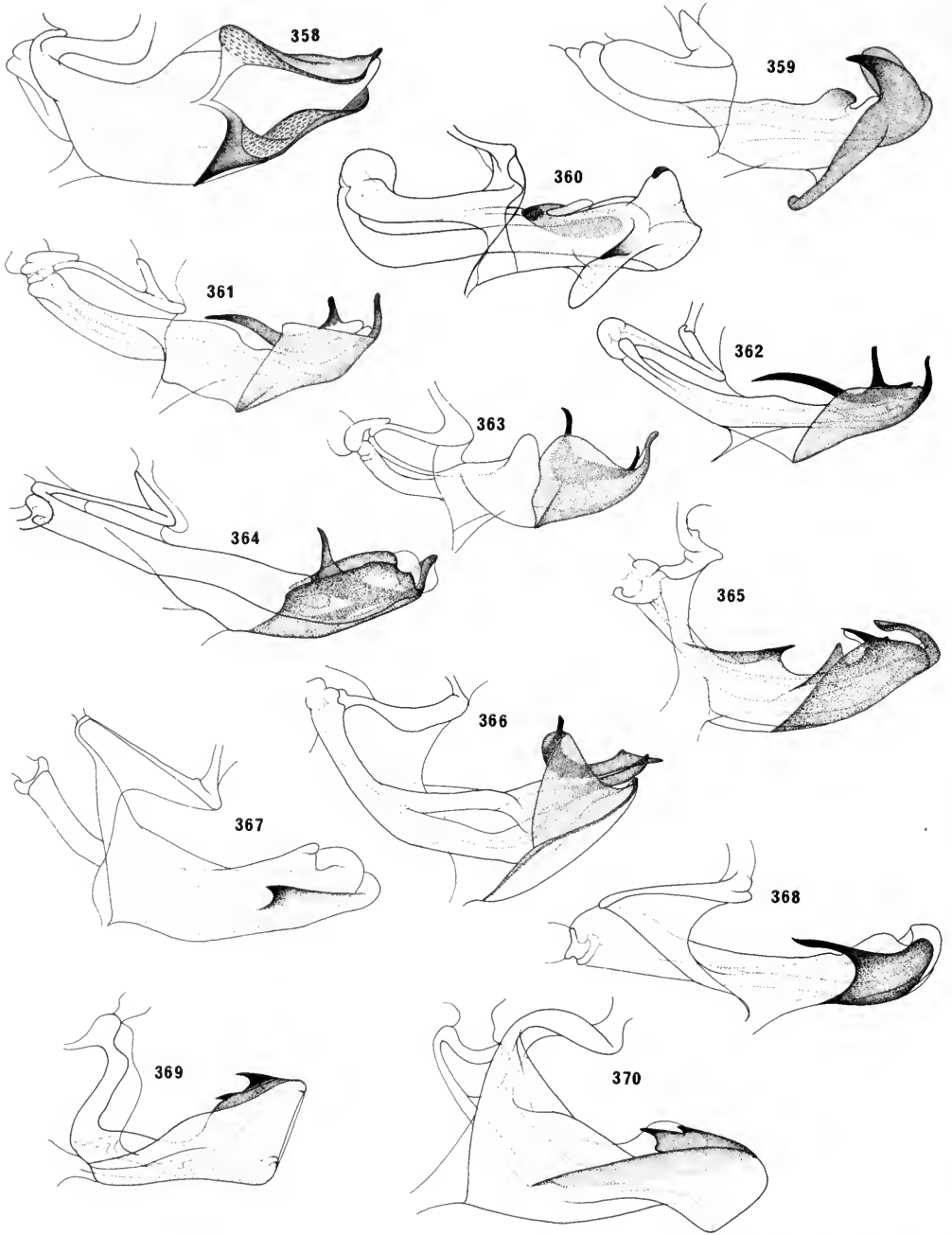

**Figs 358–370** *Mysidia* species, left lateral view of aedeagus. 358, *cooperi*; 359, *punctum*; 360, *magica*; 361, *boliviana*; 362, *silvana*; 363, *hengist*; 364, *musica*; 365, *etheldreda*; 366, *dollingi*; 367, *diabola*; 368, *neosinella*; 369, *andes*; 370, *tikalme*.



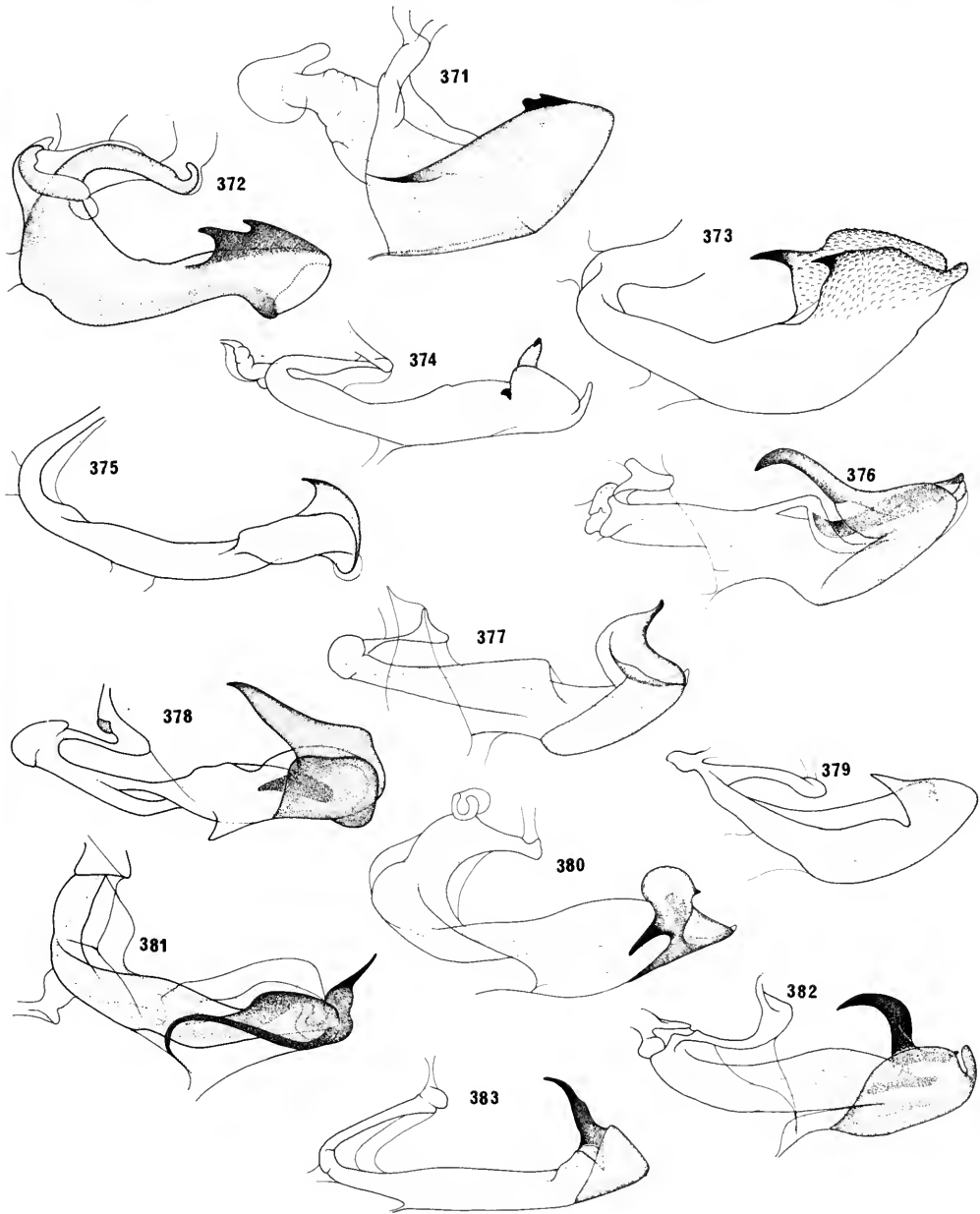

**Figs 371–383** *Mysidia* species, left lateral view of aedeagus. 371, *obscura*; 372, *varia*; 373, *lucianna*; 374, *fuscomaculata*; 375, *lloydi*; 376, *insania*; 377, *nebulosa*; 378, *perspicua*; 379, *flavilla*; 380, *unimaculata*; 381, *maculosa*; 382, *distincta*; 383, *whimper*.

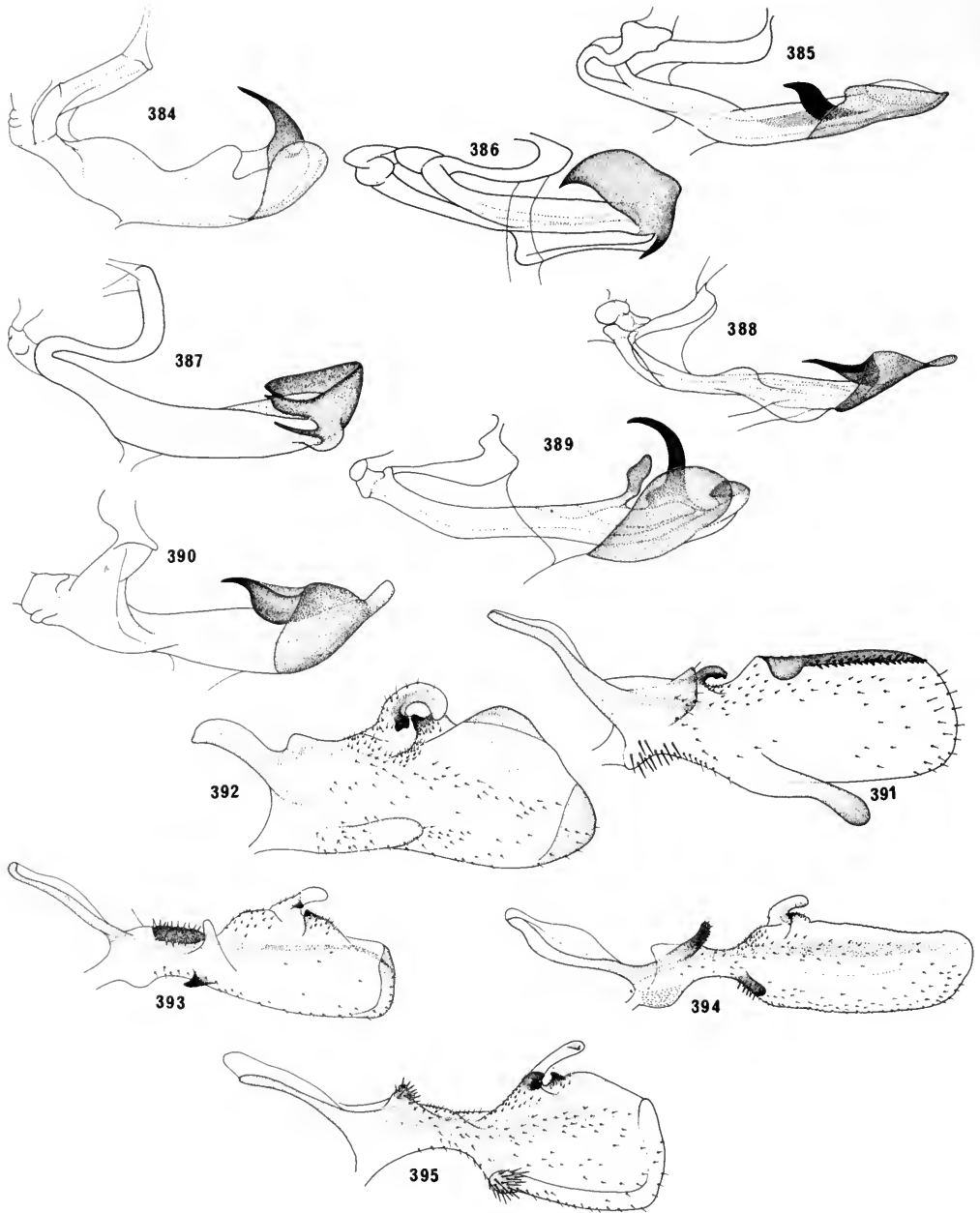

**Figs 384–395** *Mysidia* species. 384–390, left lateral view of aedeagus of (384) *testacea*; (385) *geoffreyi*; (386) *delicatissima*; (387) *mylesi*; (388) *henrietta*; (389) *pseudonebulosa*; (390) *albicans*. 391–395, left lateral view of paramere of (391) *fowleri*; (392) *distanti*; (393) *claudata*; (394) *pulchella*; (395) *fulvodorsalis*.

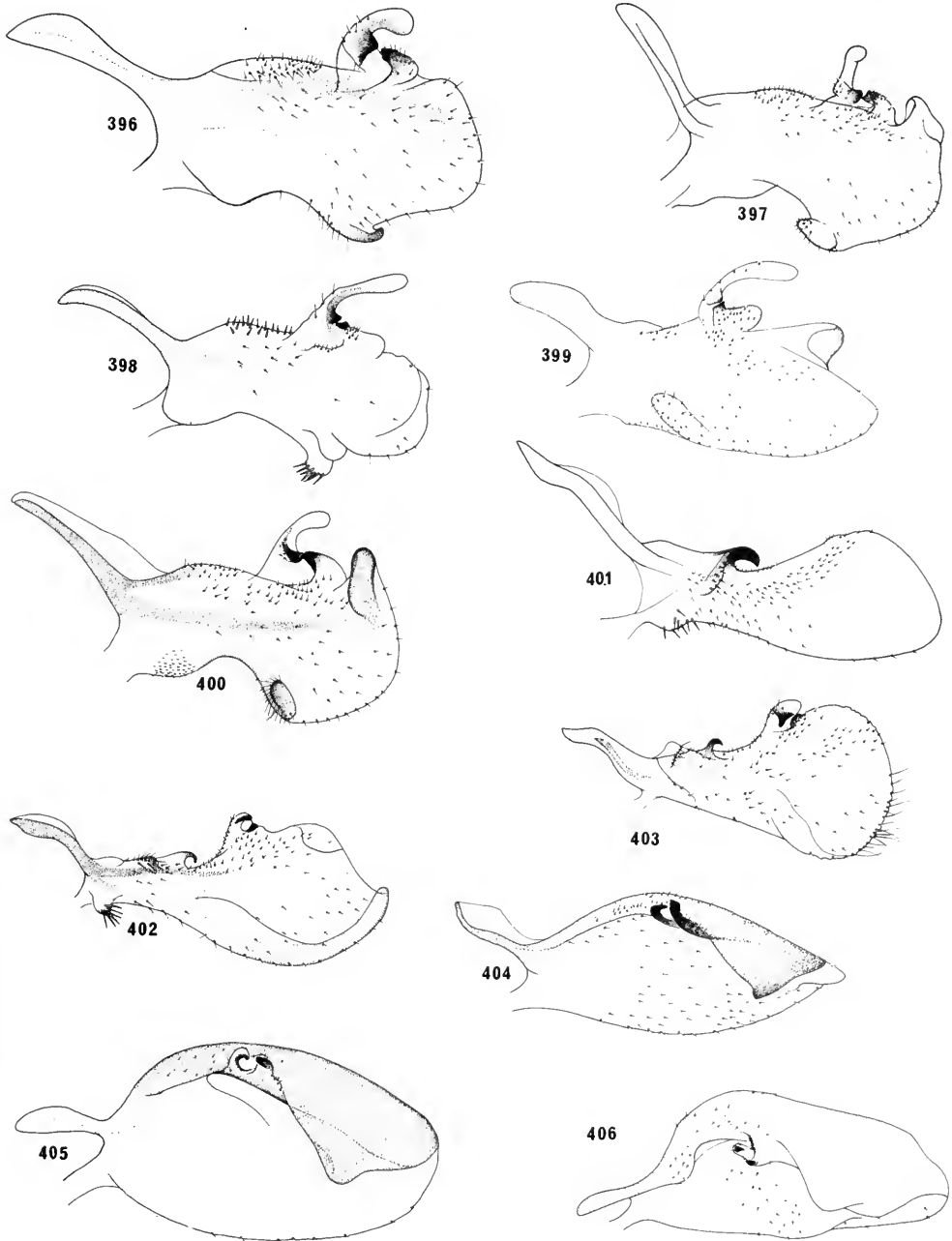

**Figs 396–406** *Mysidia* species, left lateral view of paramere. 396, *douglassi*; 397, *bizzara*; 398, *jamesi*; 399, *enjebeta*; 400, *carosella*; 401, *peregrina*; 402, *venusta*; 403, *augusta*; 404, *ariasi*; 405, *amazona*; 406, *molesta*.

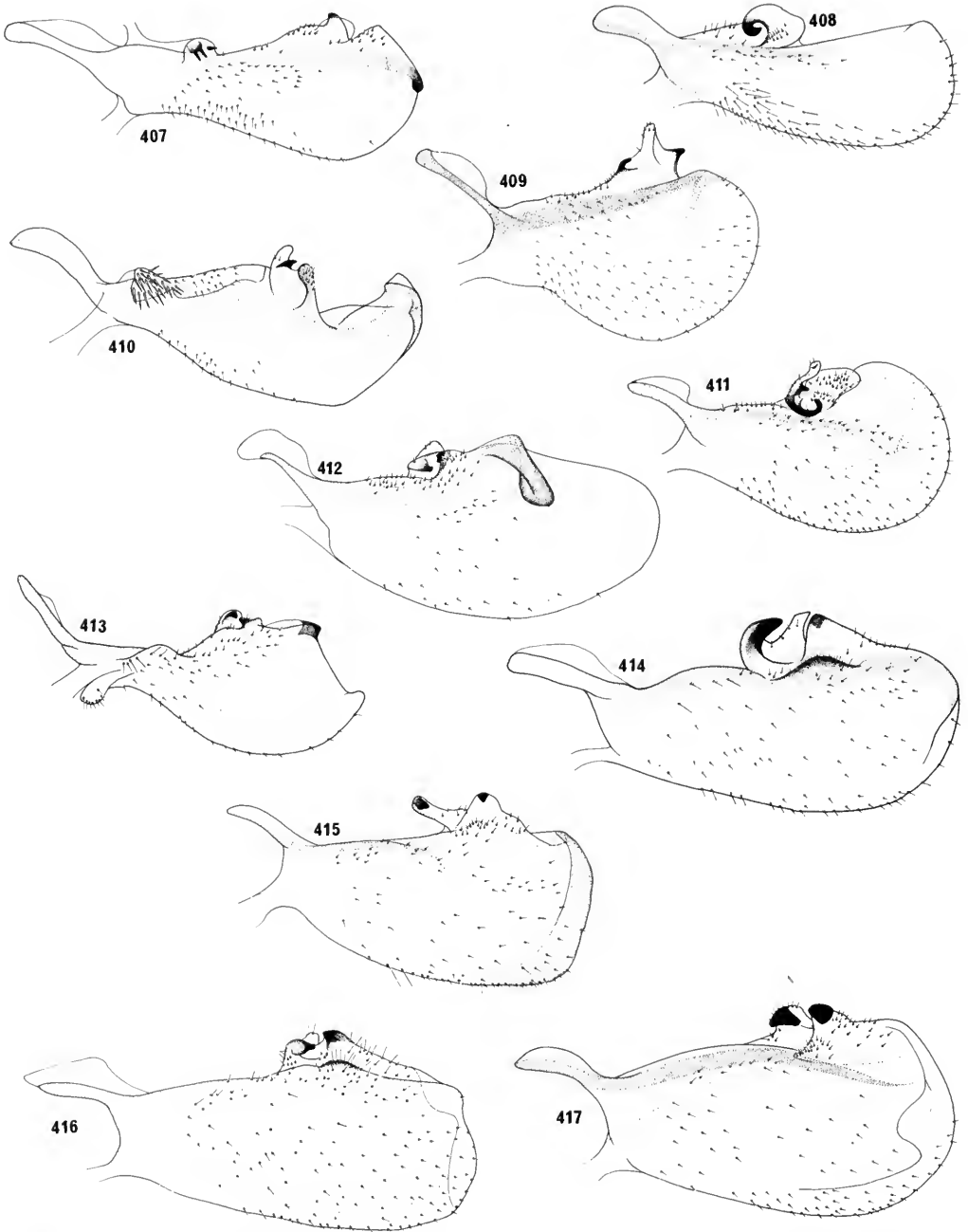

**Figs 407–417** *Mysidia* species, left lateral view of paramere. 407, *glauca*; 408, *cinerea*; 409, *agilis*; 410, *ecuadoria*; 411, *decora*; 412, *lacteola*; 413, *cheesemani*; 414, *nemorensis*; 415, *polyhymnia*; 416, *limpida*; 417, *nitida*.

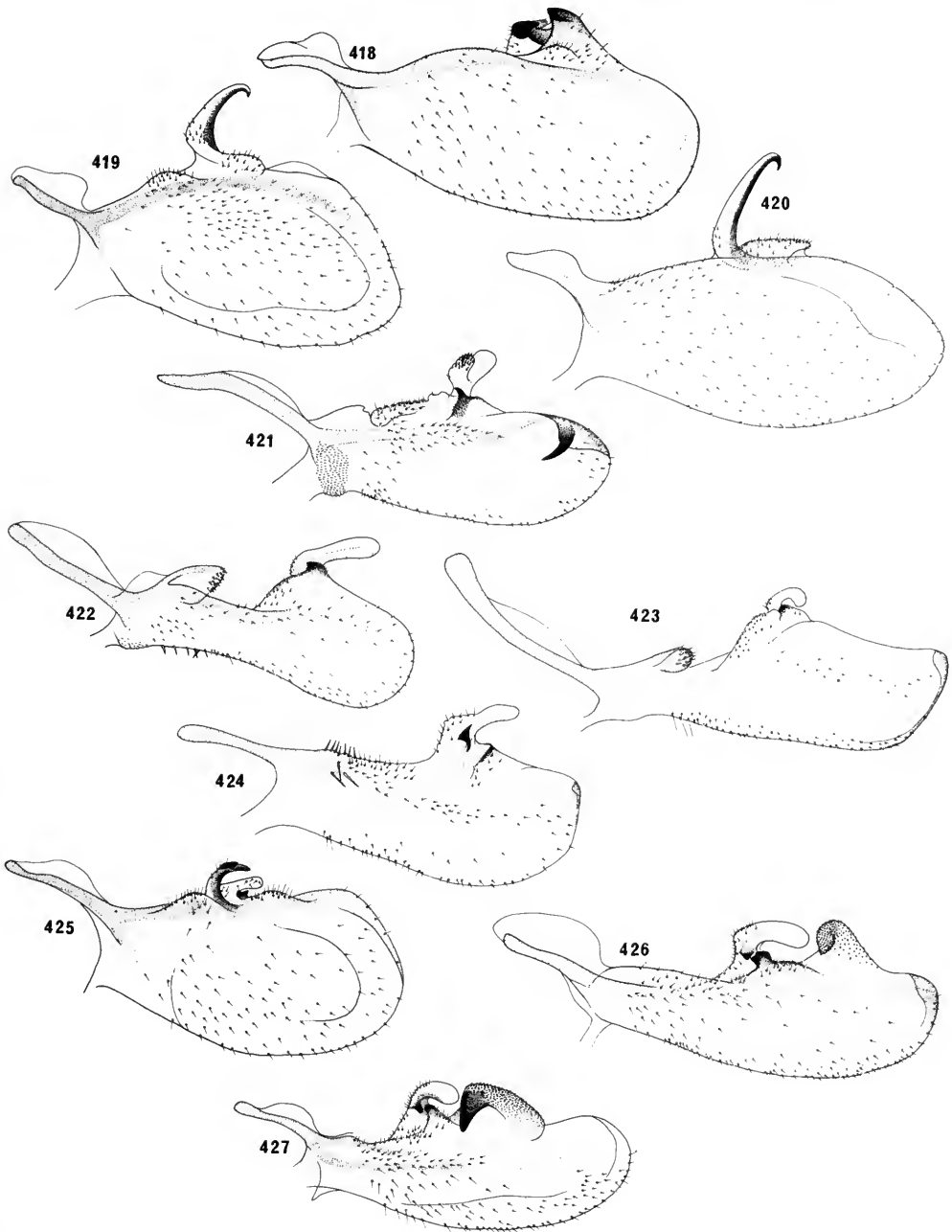

**Figs 418–427** *Mysidia* species, left lateral view of paramere. 418, *amarantha*; 419, *erecta*; 420, *pseudoerecta*; 421, *stali*; 422, *knighti*; 423, *persephone*; 424, *minerva*; 425, *harmonia*; 426, *bianca*; 427, *pseudocostata*.

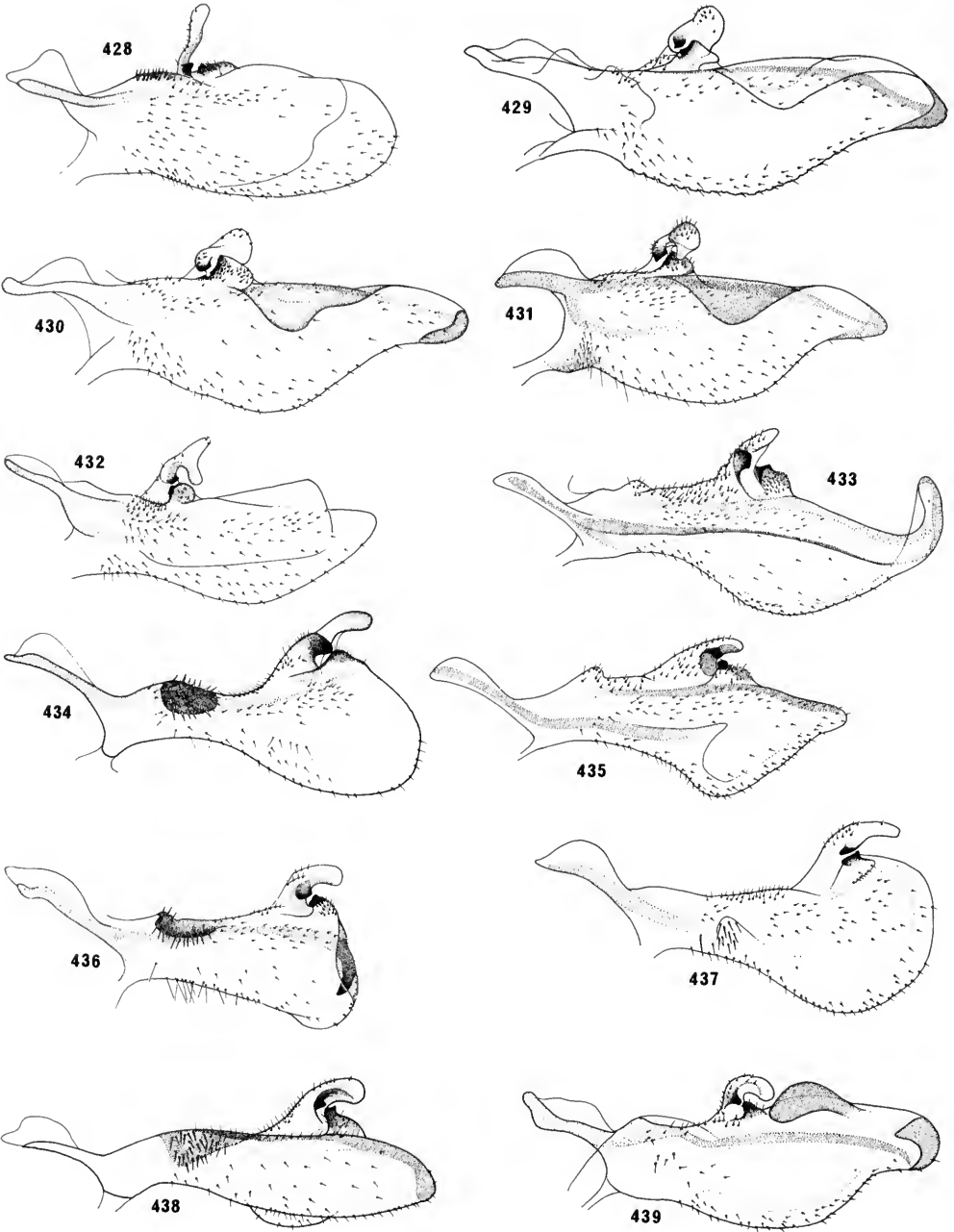

Figs 428–439 *Mysidia* species, left lateral view of paramere. 428, *bibula*; 429, *panamensis*; 430, *isteria*; 431, *estfarchina*; 432, *insolita*; 433, *athena*; 434, *sanguinea*; 435, *acidaloides*; 436, *krameri*; 437, *adusta*; 438, *havilandi*; 439, *richardsi*.

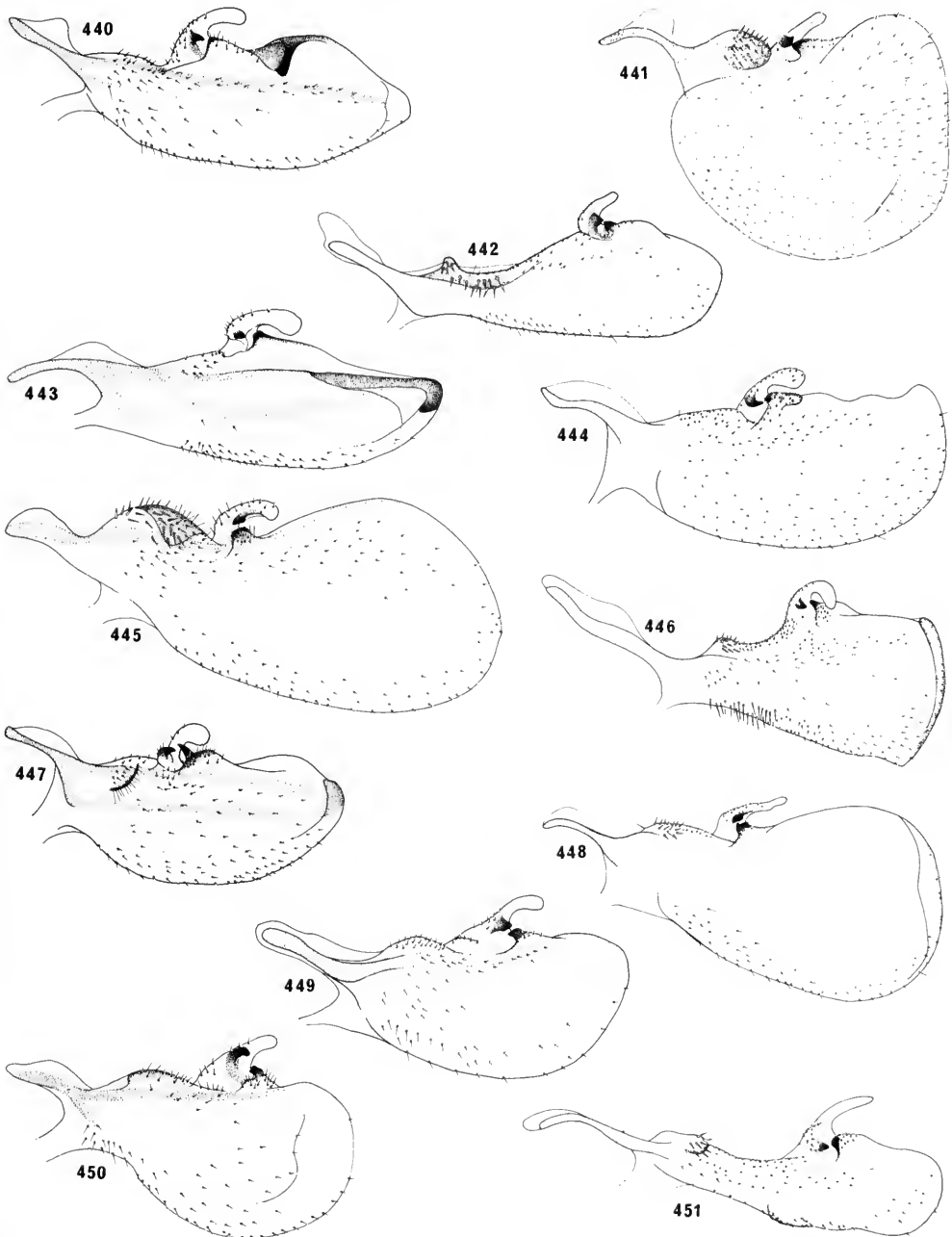

Figs 440–451 *Mysidia* species, left lateral view of paramere. 440, *costata*; 441, *adamare*; 442, *simpla*; 443, *liquida*; 444, *marshalli*; 445, *hyalina*; 446, *fasciata*; 447, *diana*; 448, *albipennis*; 449, *bella*; 450, *neonebulosa*; 451, *nigrithorax*.

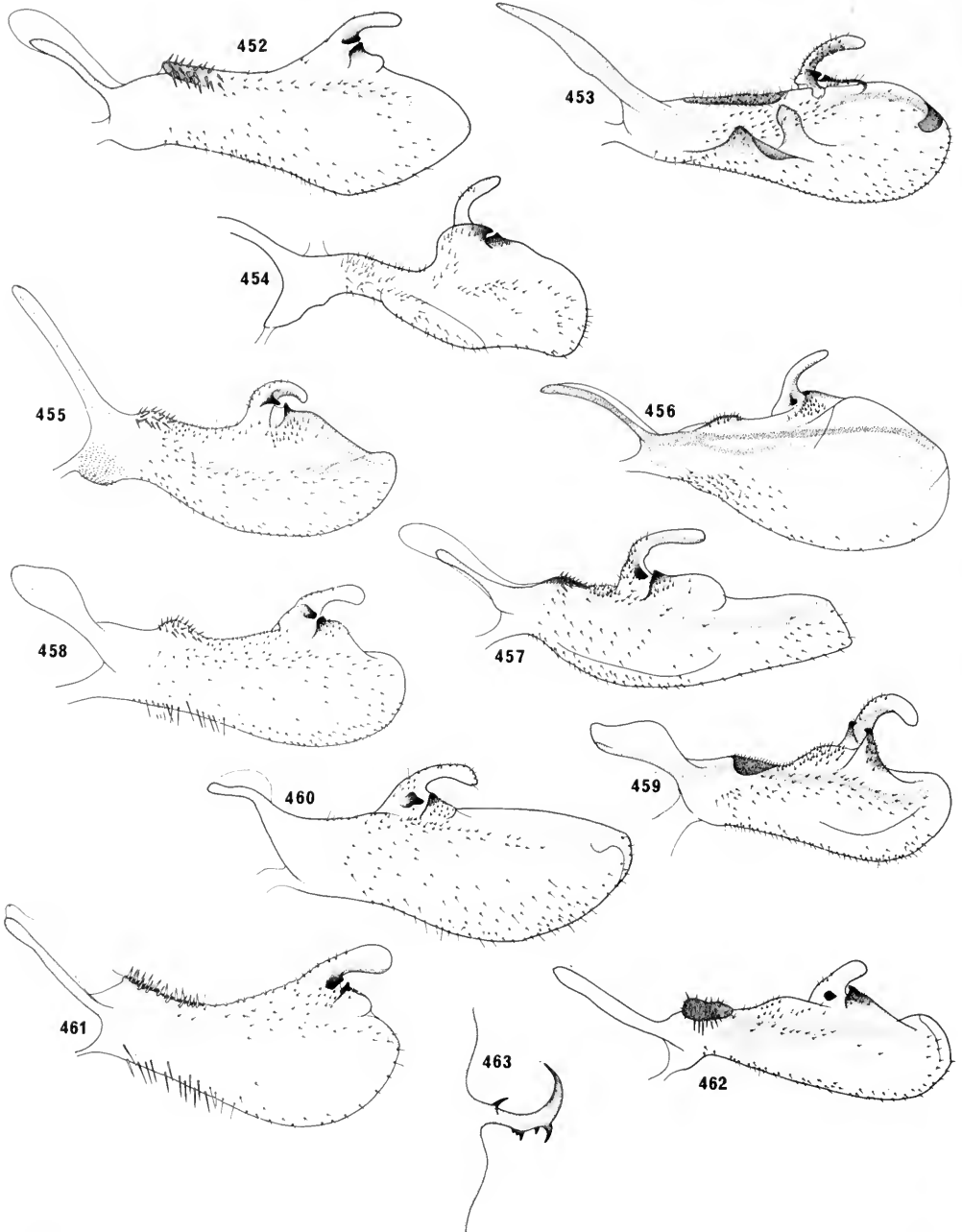

**Figs 452–463** *Mysidia* species. 452–462, left lateral view of paramere of (452), *lucifera*; (453), *infedelis*; (454), *transversa*; (455), *intima*; (456), *caliginosa*; (457), *calypso*; (458), *williamsi*; (459), *albifasciata*; (460), *josianna*; (461), *nigrifrontalis*; (462), *clava*. 463, lateral view of posterior projection of pregenital tergite of male of *caliginosa*.



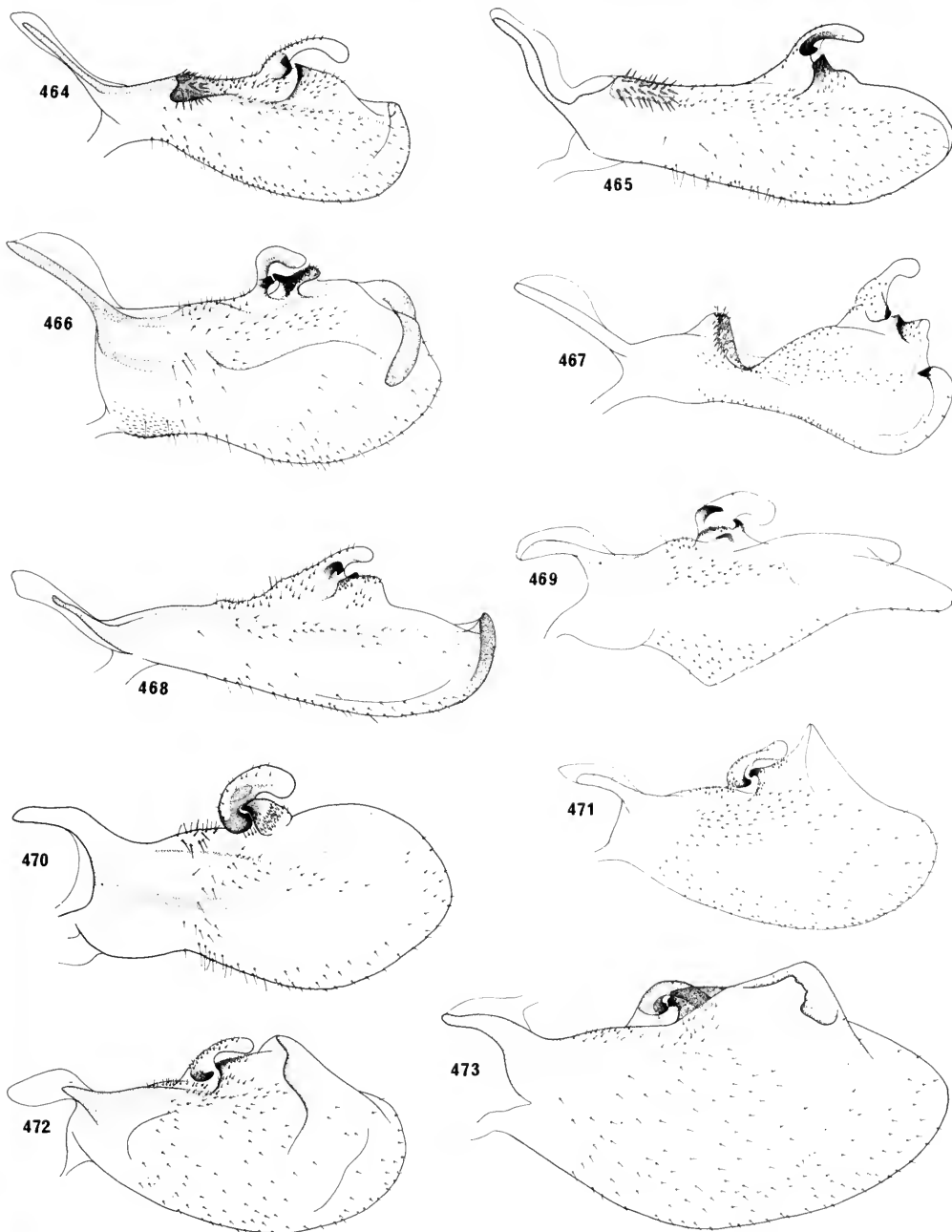

**Figs 464–473** *Mysidia* species, left lateral view of paramere. 464, *inquinata*; 465, *gracilis*; 466, *fuscofrontalis*; 467, *formosa*; 468, *cooperi*; 469, *punctum*; 470, *magica*; 471, *boliviana*; 472, *silvana*; 473, *musica*.

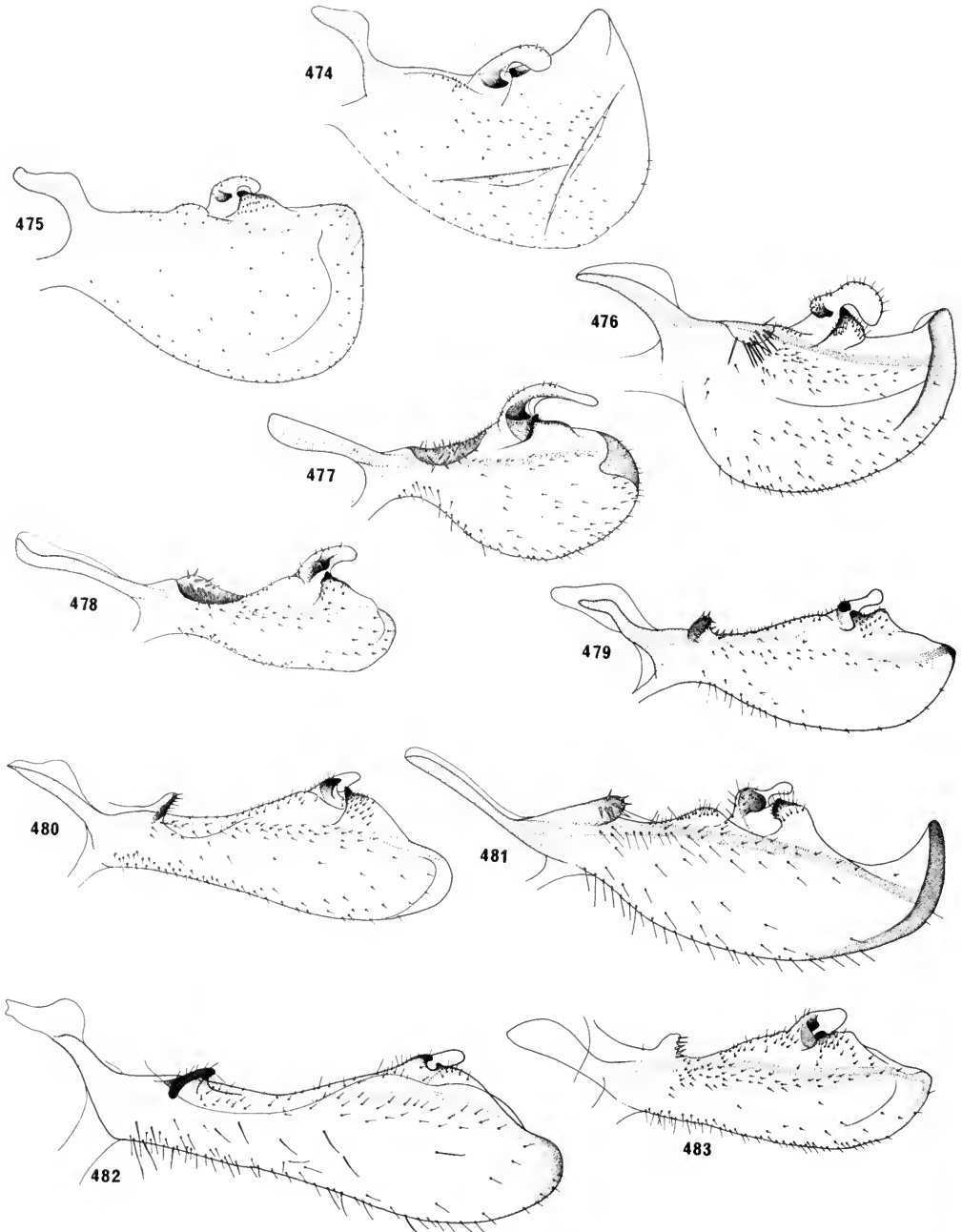

Figs 474–483 *Mysidia* species, left lateral view of paramere. 474, *hengist*; 475, *etheldreda*; 476, *dollingi*; 477, *neasinella*; 478, *diabola*; 479, *andes*; 480, *tikalme*; 481, *lucianna*, 482, *varia*; 483, *obscura*.

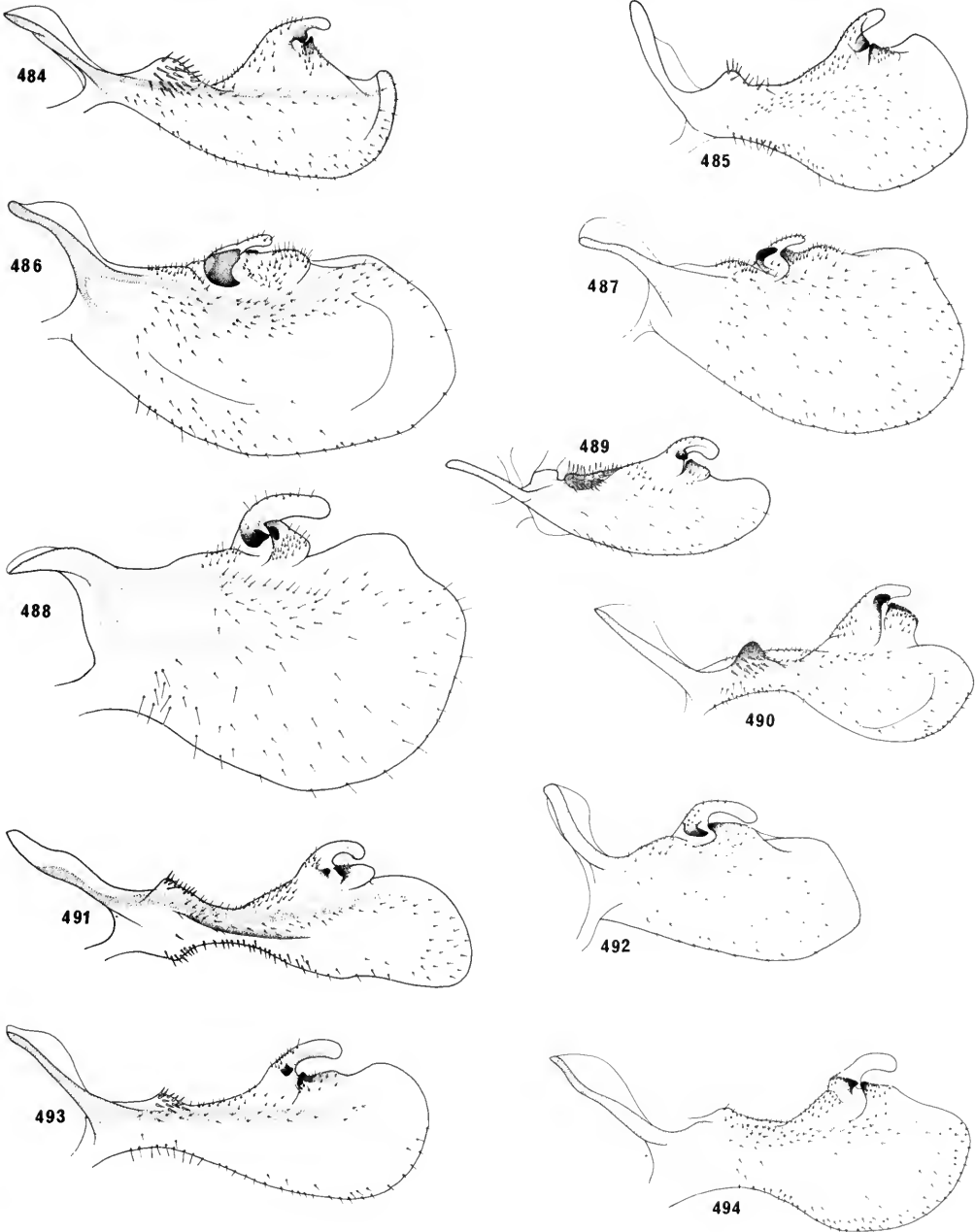

**Figs 484–494** *Mysidia* species, left lateral view of paramere. 484, *fuscomaculata*; 485, *lloydi*; 486, *insania*; 487, *nebulosa*; 488, *perspicua*; 489, *flavilla*; 490, *unimaculata*; 491, *maculosa*; 492, *distincta*; 493, *whimperi*; 494, *testacea*.

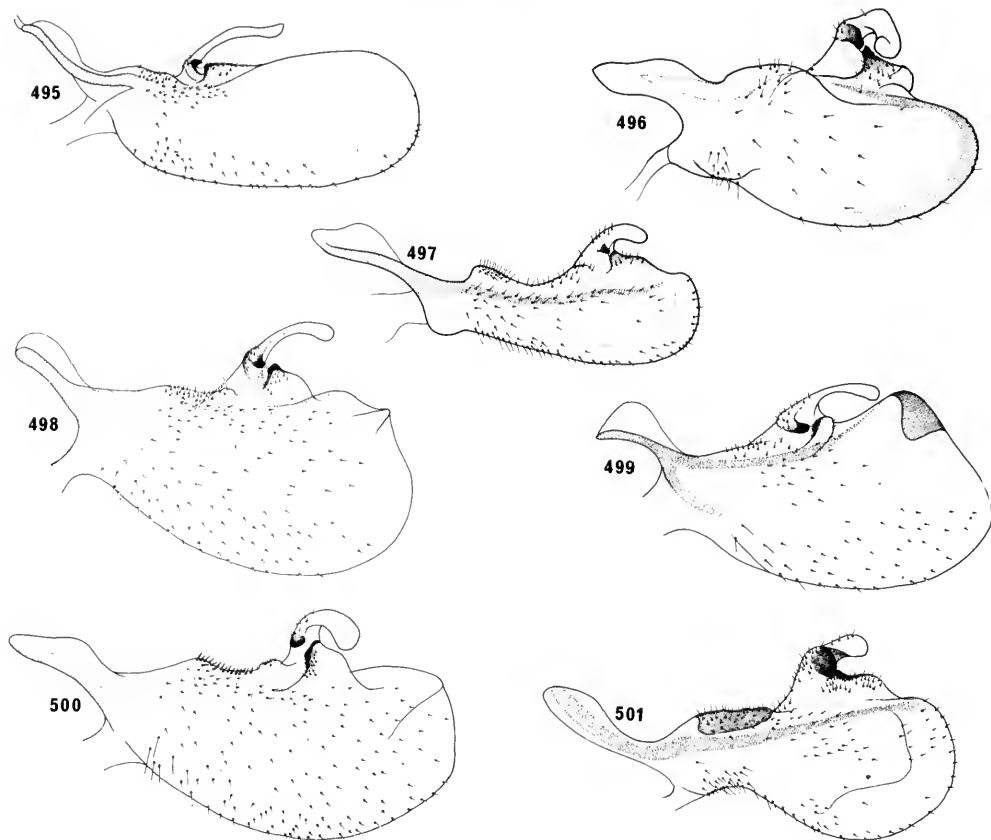

Figs 495–501 *Mysidia* species, left lateral view of paramere. 495, *geoffreyi*; 496, *delicatissima*; 497, *mylesi*; 498, *henrietta*; 499, *pseudonebulosa*; 500, *albicans*; 501, *robusta*.

## Index

Synonyms are in *italics*; page references to descriptions are in **bold**.

- acidaloides **29**  
 adamare **60**  
 adusta **22**  
 agilis **69**  
 albicans **50**  
 albifasciata **31**  
 albigipennis **38**  
 amarantha **26, 72, 74**  
 amazona **26**  
 Amysidiella **4, 101**  
 andes **52**  
 araguana **81**  
 ariasi **37**  
 asinella **22**  
 astarte **95**  
 athena **28, 30**  
 augusta **54**  
  
 barbara **106**  
 beautifica **101**  
 bella **71**  
 bianca **42**  
 bibula **53**  
 bizzara **56**  
 boliviana **72**  
 boudica **105, 107**  
 bucaya **111**  
  
 caliginosa **23, 24**  
 calypso **44**  
 carosella **70**  
 Cenchrea **2**  
 Cenchreinae **2**  
 Cenchreini **2**  
 cheesemani **25, 54**  
 cinerea **76**  
 citrina **57**  
 claudata **69**  
 clava **62**  
 cooperi **42**  
 costata **40, 41**  
  
 debora **85**  
 decora **72**  
 delicata **86**  
 delicatissima **41**  
 Derbe **2**  
 Derbidae **1**  
 Derbinae **2, 3, 4**  
 Derbini **4**  
 diabola **58**  
 diana **43**  
 distanti **49, 51**  
 distincta (Dysimia) **93**  
 distincta (Mysidia) **66**  
 dollingi **43**  
 douglasi **65**  
 Dysimia **3, 5, 87, 104**  
 Dysimiella **3, 5, 96**  
  
 ecuadoria **53**  
 ecuadoriensis **85**  
  
 elatior **77**  
 enjebetta **51**  
 erecta **55, 68**  
 estfarchina **37, 48, 64**  
 etheldreda **36**  
  
 fasciata **65**  
 felix **106**  
 fennahi **94**  
 flava **108, 109**  
 flavilla **29**  
 formosa **61**  
 fowleri **46**  
 fulvodorsalis **32**  
 fuscoclypeata **90**  
 fuscofrontalis **38**  
 fuscomaculata **59**  
 fuscovaria **77, 80, 81**  
  
 geoffreyi **75**  
 glauca **35**  
 gracilis **35**  
 grandis **46**  
  
 harmonia **70**  
 havilandi **36**  
 hengist **67**  
 henrietta **49**  
 Heronax **77**  
 hindore **83**  
 hyalina **28**  
  
 immaculata **27**  
 infedelis **57**  
 inquinata **23, 24**  
 insania **60**  
 insolita **50, 51**  
 intima **56, 73**  
 Ipsemysidia **4, 5, 100**  
 isteria **59**  
  
 jamaicensis **91**  
 jamesi **70**  
 josianna **59, 67**  
 juliana **81**  
  
 Kermesia **2**  
 Kermesiinae **2**  
 knighti **66**  
 krameri **54**  
  
 lacteola **39**  
 lactiflora **39**  
 lepida **86**  
 limpida **25, 72**  
 liquida **37**  
 lloydi **55, 58**  
 lucianna **45**  
 lucifera **35**  
  
 maculata **87, 89**  
  
 maculicosta **48**  
 maculipennis **95**  
 maculosa **55**  
 magica **74**  
 marshalli (Mysidia) **73**  
 marshalli (Pseudomysidia) **83**  
 micare **101, 102, 102**  
 minerva **47**  
 mississippiensis **103, 105**  
 molesta **37, 48**  
 morrisi **93**  
 muiri **92**  
 musica **32**  
 mylesi **33**  
 Mysidaloides **3, 5, 98**  
 Mysidia **2, 4, 9, 104**  
 Mysidiini **1, 4, 5**  
  
 nebulosa **56**  
 nemorensis **51**  
 neoasinella **30**  
 Neocenchrea **77**  
 Neomysidia **3, 99, 100**  
 neonebulosa **74**  
 nigrifrontalis **52**  
 nigrithorax **63**  
 nigropunctata **105**  
 nitida **26, 72**  
 numa **90**  
  
 obnubilia **86, 87**  
 obrieni **92, 93**  
 obscura **49**  
 Otiocerinae **2**  
  
 pallescens **60, 64**  
 pallida (Mysidia) **9, 76**  
 pallida (Pseudomysidia) **84**  
 palmeri **82**  
 panamensis (Mysidia) **59, 61**  
 panamensis (Pseudomysidia) **84**  
 Paramysidia **3, 5, 103**  
 parviceps **38**  
 Patara **2**  
 pennyi **96, 97**  
 peregrina **45**  
 persephone **73**  
 perspicua **68**  
 pintosamia **109**  
 Phenice **2**  
 polyhymnia **23, 24**  
 pseudocostata **41**  
 pseudoerecta **68**  
 pseudoflava **110**  
 pseudomaculata **90, 91**  
 pseudomicare **102**  
 Pseudomysidia **2, 4, 77**  
 pseudonebulosa **75**  
 punctifera **47**  
 pulchella **66**  
 punctum **27**

putilla **96**

quadrifascia **31, 32**

Rhotaninae **2**

richardsi **25**

robusta **26**

rubidella **80**

*rubra*, **23, 24**

sanguinea **44**

Sikaiana **2**

Sikaianini **2, 4**

silvana **71, 73**

similis **83**

simplicata **63, 68**

*spreti* **77**

squamigera **40, 41**

stali **62**

*steinbachi* **27**

stigma **77**

striata **43**

subfasciata **64**

subfusca **64**

Symidia **2, 5, 108**

telfordi **94**

tessellata **107**

testacea **57**

*Thracia* **2**

tikalme **34**

transversa **32**

trinidadensis (*Mysidaloides*) **98, 99**

trinidadensis (*Pseudomysidia*) **82**

unimaculata **28**

varia **34**

venusta **24**

vestis **84**

vista **30**

vulgaris **106**

whimperii **62**

williamsi (*Dysimiella*) **97**

williamsi (*Mysidia*) **33**

willisi **99, 100**

withycombei **110**

Zeugma **2**

Zoraida **2**

Zoraidinae **2, 4**

Zoraidini **2, 4**

## **British Museum (Natural History)**

# **Milkweed butterflies: their cladistics and biology**

**P. R. Ackery & R. I. Vane-Wright**

The Danainae, a subfamily of the Nymphalidae, contains only some 150 species, yet aspects of their biology have stimulated far more attention than can be justified by species numbers alone. In recent years, an expansive literature has grown, considering aspects of their courtship and pre-courtship behaviour, migration, larval hostplant associations, mimicry and genetics. The popularity of danaines among biologists can certainly be attributed to this combination, within one small group, of so many of the factors that make butterflies such an interesting group to study. The obvious need to place this wealth of biological data within an acceptable systematic framework provided the impetus for this volume.

Started eight years ago within the conventions of evolution by natural selection and Hennig's phylogenetic systematics, the book is now largely about natural history (what the animals have and do, where they live and how they develop) and natural groups – as revealed by a form of analysis approaching that practised by the new school of 'transformed cladistics'. The authors have prepared a handbook that will appeal to a wide range of biologists, from museum taxonomists to field ecologists.

**425 pp, 12 pp colour, 73 b/w plates, line and graphic illustrations, maps, extensive bibliography.  
ISBN 0 565 00893 5. 1984. Price £50.**

## **Titles to be published in Volume 50**

**Taxonomy of Neotropical Derbidae in the new tribe Mysidiini (Homoptera).**

By Peter S. Broomfield

**Nymphal taxonomy and systematics of the Psylloidea (Homoptera).**

By I. M. White & I. D. Hodkinson

**The whitefly of New Guinea (Homoptera: Aleyrodidae).**

By J. H. Martin



# Bulletin of the British Museum (Natural History)

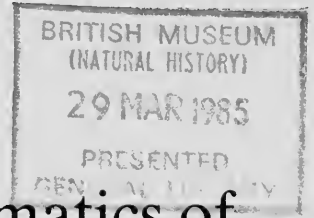

## Nymphal taxonomy and systematics of the Psylloidea (Homoptera)

I. M. White & I. D. Hodkinson

Entomology series  
Vol 50 No 2

28 March 1985

The *Bulletin of the British Museum (Natural History)*, instituted in 1949, is issued in four scientific series, Botany, Entomology, Geology (incorporating Mineralogy) and Zoology, and an Historical series.

Papers in the *Bulletin* are primarily the results of research carried out on the unique and ever-growing collections of the Museum, both by the scientific staff of the Museum and by specialists from elsewhere who make use of the Museum's resources. Many of the papers are works of reference that will remain indispensable for years to come.

Parts are published at irregular intervals as they become ready, each is complete in itself, available separately, and individually priced. Volumes contain about 300 pages and several volumes may appear within a calendar year. Subscriptions may be placed for one or more of the series on either an Annual or Per Volume basis. Prices vary according to the contents of the individual parts. Orders and enquiries should be sent to:

Publications Sales,  
British Museum (Natural History),  
Cromwell Road,  
London SW7 5BD,  
England.

*World List* abbreviation: *Bull. Br. Mus. nat. Hist. (Ent.)*

© Trustees of the British Museum (Natural History), 1985

The Entomology series is produced under the general editorship of the  
Keeper of Entomology: Laurence A. Mound  
Assistant Editor: W. Gerald Tremewan

ISBN 0 565 06009 0  
ISSN 0524-6431

Entomology series  
Vol 50 No 2 pp 153-301

British Museum (Natural History)  
Cromwell Road  
London SW7 5BD

Issued 28 March 1985

# Nymphal taxonomy and systematics of the Psylloidea (Homoptera)

I. M. White

Commonwealth Institute of Entomology, c/o British Museum (Natural History), Cromwell Road, London SW7 5BD

I. D. Hodkinson

Department of Biology, Liverpool Polytechnic, Byrom Street, Liverpool L3 3AF

## Contents

Synopsis.....	153
Introduction .....	154
Methods of illustration .....	157
Material examined .....	157
Morphology of final instar nymphs.....	168
Selection of nymphal characters .....	179
Phenetic analysis of nymphs .....	212
Incorporation of adult characters .....	224
Cladistic analysis .....	228
Host-plant considerations .....	255
Zoogeographic evidence .....	258
Classification and phylogeny .....	261
Nymphal phenetic classification .....	261
General classification .....	263
Possible phylogeny .....	265
Keys.....	275
Key construction .....	275
Artificial key to families .....	275
Keys to subfamilies and genera of Aphalaridae .....	278
Key to genera and species groups of Spondyliaspidae .....	284
Key to subfamilies and genera of Psyllidae .....	285
Key to genera of Calophyidae .....	288
Key to genera of Phacopterionidae .....	288
Key to genera of Homotomidae .....	288
Key to subfamilies of Carsidaridae .....	289
Key to genera of Triozidae .....	289
Acknowledgements .....	290
References .....	291

## Synopsis

The objectives of this study are to form a phenetic classification of Psylloidea using nymphal characters; to compare phenetic relationships suggested by nymphs with relationships suggested by adults; to combine nymphal data with existing adult data and produce a new classification; to devise keys based upon nymphal characters; to produce a predictive model (a cladogram) which describes the probable evolutionary history of the Psylloidea.

Nymphs of 303 species belonging to 94 genera were examined: these represented every existing psyllid family and included material from all zoogeographic regions.

Phenetic analyses were carried out using cluster analysis and ordination. A summary phenetic classification of nymphs is presented which defines four major groups: species with sectasetae (mainly Triozidae); species with lanceolate setae (mainly Aphalaridae); species with capitate setae (most Psyllidae); species without sectasetae, lanceolate setae or capitate setae (some species of each family).

Construction of an evolutionary ground plan for the Psylloidea was aided by the phenetic analyses. A cladogram of 106 psyllid genera and subgenera, based on this ground plan and using adult nymphal characters, is presented. Host-plant and zoogeographic evidence in association with the cladogram suggest that the modern psyllids evolved from an ancestor associated with the plant order Rutales in Gondwanaland.

General trends in the cladogram indicate that the following six families derived from an extinct ancestral group: Triozidae; Carsidaridae; Homotomidae (= Carsidaridae auctt., partim); Phacopteronidae (= Carsidaridae auctt., partim); Calophyidae (= Carsidaridae auctt., partim); Aphalaridae. The Spondyliaspidae and Psyllidae appear to have evolved from a common aphalarid ancestor.

The main contributions made to psyllid systematics are: phenetic groups of nymphs are defined more precisely than they were previously; phenetic and cladistic studies indicate characters of especial value in forming psyllid taxa of rank above the generic category, e.g. tarsal arolium structure; a theory of the origin and evolution of psyllids is proposed incorporating information on nymphal and adult characters plus host-plant and zoogeographic data; a revised classification based on a cladogram incorporating taxa from all zoogeographic regions is presented; keys to genera are produced based on nymphal characters; at the theoretical level the method of cladogram construction is an advancement on that of Hennig (1966); nine new family group taxa are proposed.

## Introduction

Psyllids or jumping plant-lice (Homoptera, Sternorrhyncha, Psylloidea) are small (1–5 mm long) phloem-sucking insects which breed almost exclusively upon perennial dicotyledonous plants (Eastop, 1972; Hodkinson, 1974). A review of psyllid biology is given by Hodkinson (1974).

### Nomenclatural history

The first psyllid described was *Chermes alni* Linnaeus, 1758 (= *Psylla alni*), the type-species of the group. Four years later Geoffroy described *Psylla*, which is the type-genus, *Chermes* Linnaeus, 1758 having been suppressed and *P. alni* designated as the type-species by the International Commission on Zoological Nomenclature (Eastop, 1963 and Opinion 731, *Bull. zool. Nom.* 22: 86–87, 1965). The first major contribution to psyllid systematics was by Förster (1848) who described the genera *Aphalara*, *Euphyllura*, *Rhinocola*, *Spanioneura* and *Trioza*.

Löw (1879) produced the first formalized classification of the psyllids which he regarded as one family, the Psyllidae, comprised of four defined subfamilies: Liviinae (containing the genus *Livia*), Aphalarinae (containing the genera *Aphalara*, *Euphyllura*, *Psyllopsis* and *Rhinocola*), Psyllinae (*Alloeoneura*, *Amblyrhina*, *Arytaina*, *Calophya*, *Diaphorina*, *Floria*, *Homotoma*, *Psylla* and *Spanioneura*) and Triozinae (*Bactericera* and *Trioza*). Subsequently, Scott (1882) erected the subfamily Livillinae (for which he only lists *Creiis*) and the family Prionocnemidae (*Carsidara* and *Tyora*) but neither of these are valid as they are not based on recognised genera. Löw's subfamilies were raised to family status by Edwards (1896) but this was not generally accepted for another 60 years.

Schwarz (1898) erected a further subfamily, the Spondyliaspininae, for the genus *Spondyliaspis*, and several genera, such as *Carsidara*, *Tyora* and *Ciriacremum*, were placed in the subfamily Ciriacreminae by Enderlein (1910). However, Crawford (1911) separated *Ciriacremum* from *Carsidara* and erected a new subfamily, the Carsidarinae, to include such genera as *Carsidara* and *Tyora*. Later, Aulmann (1913) listed six subfamilies: Psyllinae (e.g. *Calophya*, *Diaphorina*, *Mycopsylla*, *Pauropsylla* and *Psylla*), Triozinae (e.g. *Bactericera* and *Trioza*), Aphalarinae (e.g. *Aphalara*, *Cardiaspis* (= *Cardiaspina*), *Euphalerus*, *Euphyllura* and *Phytolyma*), Liviinae, Ciriacreminae (e.g. *Carsidara*, *Ciriacremum* and *Phacopteron*) and Spondyliaspininae.

The classification was further revised by Crawford (1914) who recognised six subfamilies: Liviinae (*Aphalara*, *Aphalaroida*, *Livia* and *Rhinocola*), Pauropsyllinae (*Calophya*, *Heteropsylla*, *Paurocephala* and *Pauropsylla*), Carsidarinae (*Carsidara*, *Epicara*, *Freysuila* sensu Schwarz (= *Mastigimas*) and *Rhinopsylla*), Ciriacreminae (*Ciriacremum* (= *Ciriacremum*)), Triozinae (e.g. *Trioza*) and Psyllinae (e.g. *Euphalerus*, *Euphyllura*, *Pachyopsylla* and *Psylla*). A similar

classification was presented by Pflugfelder (1941) except that Liviinae and Aphalarinae (including *Diaphorina* and *Psyllopsis*) were again separated.

The Spondyliaspinae was first properly defined by Heslop-Harrison who reviewed the subfamily groupings and separated the subfamilies Aphalarinae, Ciriacreminae (including *Bactericera*, *Carsidara*, *Ciriacremum* and *Pauropsylla*), Liviinae, Psyllinae, Spondyliaspinae, and Triozinae in a key (Heslop-Harrison 1949, 1951, 1954, 1958, 1959).

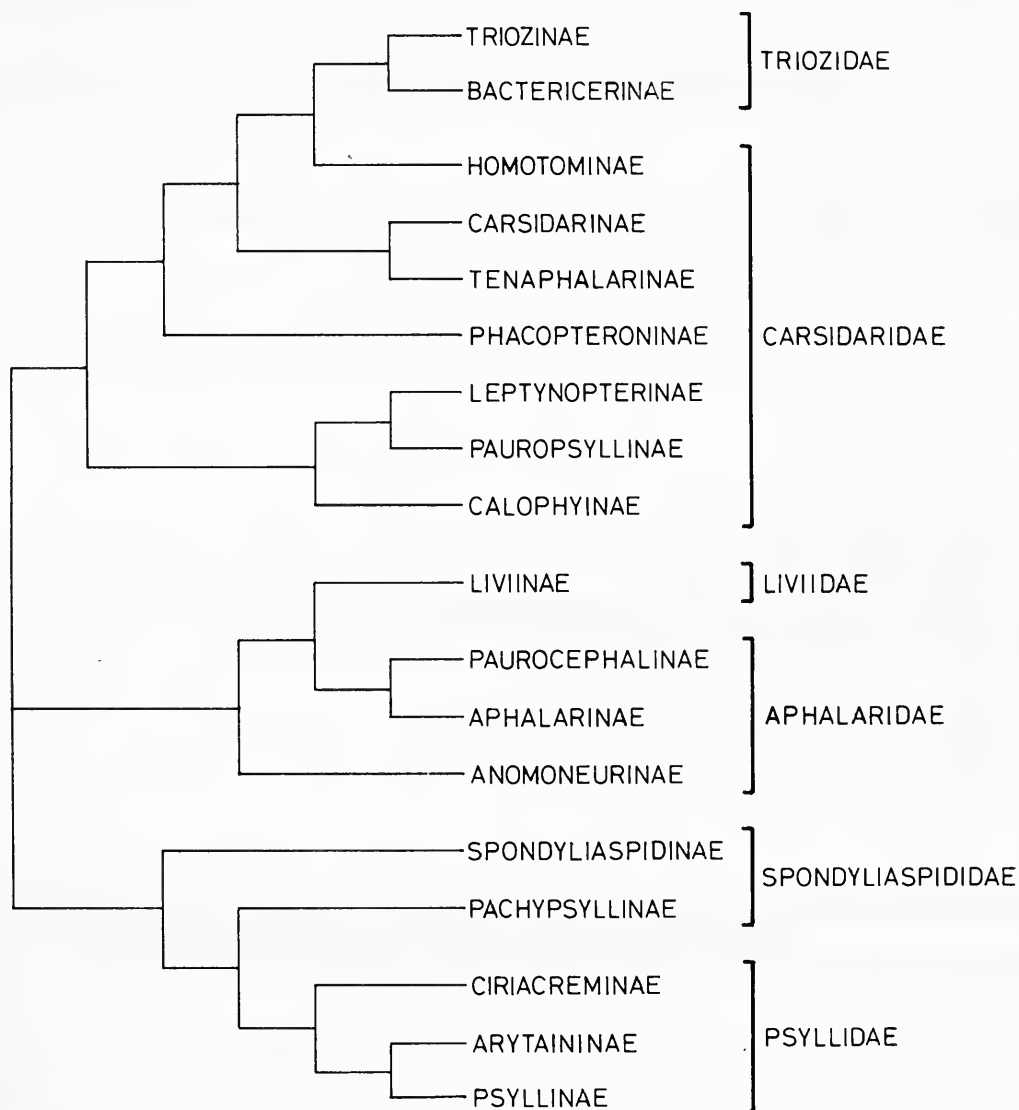

Fig. 1 Cladogram showing the relationships of subfamilies according to Becker-Migdisova (1973).

Superfamily status was given to the psyllids by Handlirsch (1903) and the subfamily units were again promoted to families by Vondracek (1957) who recognised the Aphalaridae (e.g. *Aphalara*, *Paurocephala* and *Pauropsylla*), Carsidaridae, Liviidae, Psyllidae (e.g. *Calophya*, *Ciriacremum*, *Diaphorina*, *Psylla* and *Psyllopsis*), Spondyliaspidae and Triozidae. Vondracek (1963) later replaced the Carsidaridae by the Ciriacremidae (which included *Bactericera*, *Ciriacremum*, *Syndesmophlebia* (= *Klienella*) and *Triozeria*) and expanded the content of Spondyliaspidae to include *Anomalopsylla*, *Phytolyma* and *Tainarys*.

The classification of Klimaszewski (1964) differed from that of Vondracek in certain respects: Bactericerinae (e.g. *Triozamia*) was moved to Triozidae, Anomalopsyllinae (e.g. *Phytolyma* and *Tainarys*) to the Aphalaridae, and *Ciriacremum* to the Psyllidae. Genera such as *Carsidara*, *Homotoma* and *Tenaphalara* were placed in the Carsidaridae. A similar classification for Palaearctic genera is given by Loginova (1964b).

The most recent comprehensive study of psyllid systematics was undertaken by Becker-Migdisova (1973), who produced a classification similar to that of Klimaszewski. Subsequently Loginova (1972, 1973, 1974a, 1974b, 1975, 1976a, 1976b, 1977) has revised several subfamilies and tribes and since completion of this work, has produced a paper on nymphal morphology (Loginova, 1982).

Recently Eastop (1978) presented a classification (attributed to D. Hollis) in which only two families, the Psyllidae (including *Aphalara*, *Calophya*, *Diaphorina*, *Livia*, *Psylla* and *Spondyliaspis*) and the Triozidae (including *Carsidara* and *Trioza*) were proposed.

Contemporary classifications of the Psylloidea (Vondracek, 1957; Klimaszewski, 1964; Becker-Migdisova, 1973) are based on suggested phyletic trees and a summary of the tree of Becker-Migdisova is given in Fig. 1. No attempt has been made to produce cladograms for the Psylloidea as a whole, but they have been constructed for a few genera and tribes, namely *Glycaspis* (Moore, 1970), *Psylla* (Burckhardt, 1979), *Strophingia* (Hodkinson, 1981) and *Ciriacremeni* (Hollis, 1976).

Comprehensive faunal surveys have been made for several temperate and subtropical regions. They include Alaska (Hodkinson, 1978), Australia (Tuthill & Taylor, 1955), central Europe (Haupt, 1935), Czechoslovakia (Vondracek, 1957), European U.S.S.R. (Loginova, 1964a), Great Britain (Hodkinson & White, 1979b; White & Hodkinson, 1982), Mallorca (Hodkinson & Hollis, 1981), New Zealand (Tuthill, 1952), North America (Crawford, 1914; Tuthill, 1943), Poland (Klimaszewski, 1969, 1975), Rumania (Dobreanu & Manolache, 1962), Spain (Gomez, 1956a, 1956b, 1960) and Switzerland (Schaefer, 1949). The only relatively complete faunal surveys of major tropical areas are for India (Mathur, 1975) and Taiwan (Yang, 1984).

Other substantial faunistic papers on psyllids cover Central Africa (Vondracek, 1963), South Africa (Pettey, 1924, 1925, 1933; Capener, 1968, 1970, 1973), Central America (Crawford, 1914; Caldwell, 1944a, 1944b; Tuthill, 1944, 1945, 1950), South America (Crawford, 1914, 1925; Lima, 1942; Tuthill, 1959, 1964a), Borneo (Crawford, 1920), Hawaii (Zimmerman, 1948), Japan (Miyatake, 1963, 1964), Micronesia (Tuthill, 1964b), Philippines (Uichanco, 1921; Miyatake, 1971, 1972) and Puerto Rico (Caldwell & Martorell, 1952). Comprehensive bibliographies of taxonomic literature are available for the Palaearctic (Klimaszewski, 1973) and Neotropical (Hodkinson & White, 1981) regions and the Austro-Oriental, Pacific and Hawaiian regions (Hodkinson, 1983).

### Aims of present study

A classification such as that of Becker-Migdisova (1973) is adequate for studies on temperate psyllid faunas. However, an increasing knowledge of tropical psyllids has brought with it a realisation that a classification which has been largely based on a knowledge of north temperate psyllids is perhaps inappropriate when applied to tropical forms.

This problem cannot be resolved simply by defining more major groups; new information of a suitable nature for incorporation in a systematic study is required. A study of nymphal morphology is one possible source of such information.

The aims of this work were: to investigate the phenetic taxonomic relationships of psyllids as suggested by nymphal data; to compare phenetic relationships based upon nymphal or adult data; to pool nymphal data with existing adult data and produce a new predictive classification, i.e. a classification which has maximal likelihood of predicting unknown character states; to produce a predictive model (a cladogram) against which other forms of data can be compared, and to use this model to derive a theory as to the age, possible origin and ancestral host of the psyllids; to write provisional keys for the nymphs of psyllids.

Over 2000 species of Psylloidea have been described and for nymphal data to be of any value the nymphal stages of a few hundred species, representing as many genera as possible, had to be examined and described. This was facilitated by the use of numerical description and computerised data-handling techniques.

### Use of numerical taxonomic methods

The use of phenetic methods indicates, within the bounds of the characters used, which taxa are most similar to other taxa, without any characters being empirically weighted. They can initiate new ideas, they are resistant to preconceived ideas, and they can help in deciding whether an attribute is ancestral or derived.

The first application of numerical techniques to psyllid taxonomy was a study, based upon inadequate data, of Polish *Triozza* adults (Klimaszewski, 1967). Recently, Hodkinson (1981) used principal component analysis in a study of *Strophingia* adults.

### Previous studies of nymphal psyllids

Many descriptions of nymphal psyllids have been published and these are listed by White (1980). Prior to 1920 these were generally colour descriptions, such as those of Scott (1886a, 1886b, 1886c), although a few authors, such as Löw (1876, 1884, 1886), presented outline drawings. The first descriptions of any taxonomic value were those of Ferris (1923, 1924, 1925, 1926, 1928a, 1928b) who also presented a phenetic classification of the nymphs (Ferris, 1925) which was later expanded by Rahman (1932). There are only three keys to nymphal psyllids: Swedish species of *Psylla* (Ossiannilsson, 1970), subgenera of *Psylla* (Loginova, 1978) and the British Psylloidea (White & Hodkinson, 1982). Good nymphal descriptions of almost half the species known from the Indian subcontinent have been provided by Mathur (1975).

## Methods of illustration

### Nymphal morphology

In whole nymph drawings (Figs 2–4) and in most illustrations of anal pore fields (Figs 97–160) the dorsal view is shown to the left of the body mid-line and the ventral view to the right.

### Minimum spanning networks (MSN)

MSN's use abbreviated generic names with numbers denoting species (Table 1). In Figs 178 and 182 a summary of each MSN is given in which species are only labelled with the initial letter of the family to which they belong in the classification of Becker-Migdisova (1973) (A – Aphalaridae, C – Carsidaridae, L – Liviidae, P – Psyllidae, S – Spondylaspididae, T – Triozidae).

### Phenograms

Phenograms are labelled with the full names of species. Species adjacent in the phenogram but belonging to different Becker-Migdisova families are spaced further apart than species of the same family so as to give a visual impression of which clusters are highly congruent with the families of Becker-Migdisova (congruent clusters appear more tightly packed than incongruent clusters). The initial letter of the family of Becker-Migdisova (1973) to which each species belongs is indicated in the phenogram.

## Material examined

### Taxonomic and zoogeographic coverage

The final instar nymphs of 301 species were examined (Table 1). Two species descriptions (*Tetragonocephala* sp. from Ferris, 1926 and *Togepssylla matsumurana* from Miyatake, 1970) were incorporated from the literature as they were considered valuable additions to the study.

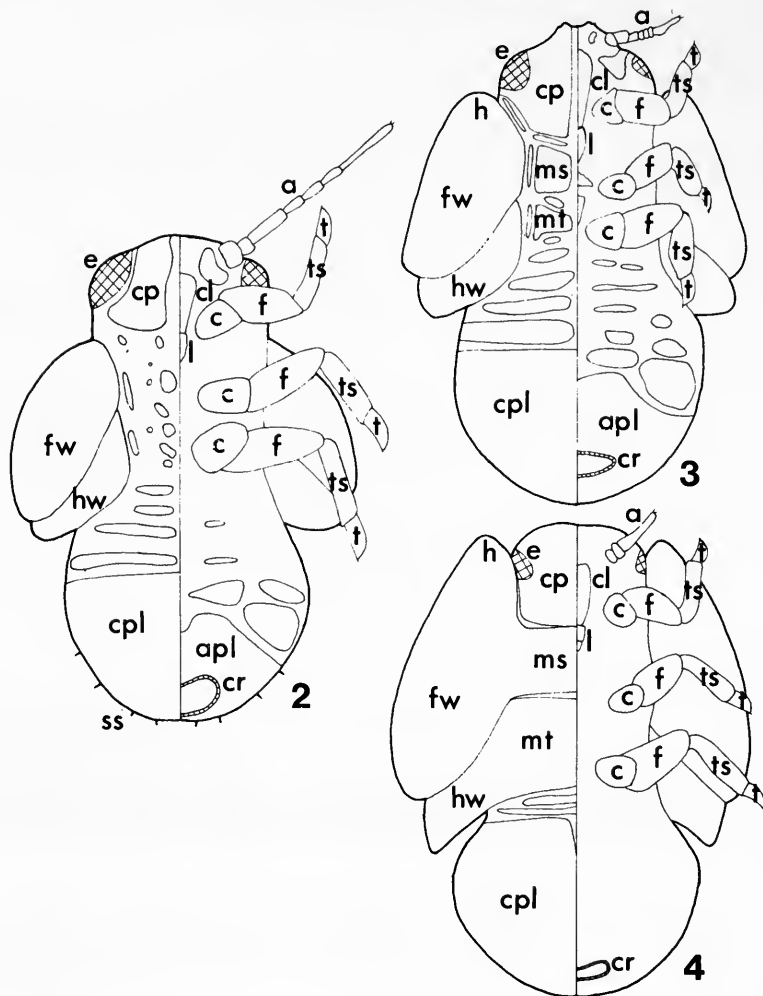

**Figs 2-4** Psylloidea nymphs, morphological features of the three types of nymph defined by Rahman (1932). 2, psylline type nymph; 3, pauropsylline type nymph; 4, triozine type nymph. (a - antenna; apl - anal plate; c - coxa; cl - clypeus; cp - cephaloprothorax; cpl - caudal plate; cr - circum-anal pore ring; e - eye; f - femur; fw - forewing-pad; h - humeral lobe; hw - hindwing-pad; l - labium; ms - mesothoracic sclerites; mt - metathoracic sclerites; ss - setae arranged 4 + 4 on abdomen margin; ts - tibiotarsus; t - tarsal segment II.) Modified from White & Hodkinson (1982).

This represents a total species coverage of approximately 15 per cent and a generic coverage of about 43 per cent.

For purposes of comparison the genera examined are fitted as closely as possible to the phylogenetic tree proposed by Becker-Migdisova (Fig. 1 and Table 1).

The generic and specific representation across each recognised family and each zoogeographic region are given in Tables 2 and 3. The absolute total number of genera and species is not given because taxonomic position and status of many groups is uncertain; the Liviidae, however, contains only one genus.

### Recognition of final instar nymphs

In all cases where the life-cycle of a psyllid has been carefully studied five nymphal instars were recorded (e.g. Mathur, 1975). The most certain method of recognising a fifth instar nymphal



**Table 1** Species examined listed according to the classification of Becker-Migdisova (1973). Type-species of genera and subgenera, when examined, are indicated by an asterisk. Genera not examined by Becker-Migdisova are indicated by †. Abbreviated generic and subgeneric names of up to eight small capital letters are given on the right of each generic and subgeneric name. These abbreviations are used in the minimum spanning network diagrams, in combination with the species numbers. Species numbers are given in parentheses on the right-hand side of the table.

Depositories of material are indicated after each species name. Locality data for each specimen are given by White (1980).

**Abbreviations of depositories**

- BMAG Bolton Museum and Art Gallery, Bolton, Lancs.
- BMNH British Museum (Natural History), London.
- FRI Forest Research Institute, Dehra Dun, India.
- IDH I. D. Hodkinson (private collection), Liverpool.
- LC Loyola College, Madras, India.
- TRL Tasmanian Regional Laboratory, Commonwealth Scientific and Industrial Research Organisation, Hobart, Tasmania, Australia.
- UC University of California, Davies, California, U.S.A.
- USDAC United States Department of Food and Agriculture (California), Sacramento, California, U.S.A.
- USNM United States National Museum of Natural History, Entomological Collection at the Systematic Entomology Laboratory, USDA, Beltsville, Maryland, U.S.A.

APHALARIDAE

Paurocephalinae

Rhinocolini

- Rhinocola* Förster, 1848 RHINCOL
- \**aceris* (Linnaeus, 1758) [BMNH] .
- †*Leurolophus* Tuthill, 1942 LEUROLOP
- \**vittatus* Tuthill, 1942 [USNM]

Euphyllurini

- Euphyllura* Förster, 1848 EUPHYLLU
- ?*aethiopica* Silvestri, 1934 [BMNH] (1)
- olivina* (Costa, 1939) [BMNH] (2)
- \**phillyreae* Förster, 1848 [BMNH] (3)
- †*Neophyllura* Loginova, 1973 NEOPHYLL
- Arbutophila* Loginova, 1973
- \**arbuti* (Schwarz, 1904) [USNM] (1)
- Neophyllura* Loginova, 1973
- \**arctostaphyli* (Schwarz, 1904) [USNM] (2)
- bicolor* (Martin, 1931) [USNM] (3)

Paurocephalini

- Paurocephala* Crawford, 1914 PAUROCEP
- gossypii* Russell, 1943 [BMNH] (1)
- urenae* Russell, 1946 [USNM] (2)
- Strophingia* Enderlein, 1914 STROPHIN
- cinereae* Hodkinson, 1971 [BMNH] (1)
- \**ericae* (Curtis, 1835) [BMNH] (2)
- Agonosцена* Enderlein, 1914 AGONOSCE
- A. sp. (A)* [USNM] (1)
- A. sp. (B)* [BMNH] (2)
- A. sp. (C)* [BMNH] (3)
- Aphalaroida* Crawford, 1914 [USDAC] APHROIDA
- inermis* Crawford, 1914 [USDAC] (1)
- ?near *pithecolobia* Crawford, 1914 [USNM] (2)
- †*Camarotosцена* Haupt, 1935 CAMAROTO
- \**speciosa* (Flor, 1861) [BMNH] (1)
- ?unicolor Loginova & Parfent'ev, 1958 [BMNH] (2)
- †*Moraniella* Loginova, 1972 MORANIEL
- \**calodendri* (Moran, 1968) [BMNH]

† <i>Paraphalaroida</i> Loginova, 1972	PARAPHAL
* <i>fremontiae</i> (Klyver, 1930) [USDAC]	
Aphalarinae	
Aphalarini	
<i>Aphalara</i> Förster, 1848	APHALARA
<i>curta</i> Caldwell, 1937 [USNM]	(1)
<i>exilis</i> (Weber & Mohr, 1804) [BMNH]	(2)
<i>monticola</i> Hodkinson, 1973 [IDH]	(3)
? <i>nubifera</i> Patch, 1912 [USNM]	(4)
<i>persicaria</i> Caldwell, 1937 [USNM]	(5)
<i>polygona</i> Förster, 1848 [BMNH]	(6)
<i>rumicis</i> Mally, 1894 [USNM]	(7)
<i>simila</i> Caldwell, 1937 [USNM]	(8)
<i>Craspedolepta</i> Enderlein, 1921	CRASPEDO
? <i>angustipennis</i> (Crawford, 1911) [USNM]	(1)
* <i>artemisiae</i> (Förster, 1848) [BMNH]	(2)
? <i>vancouverensis</i> (Klyver, 1931) [USNM]	(3)
? <i>constricta</i> (Caldwell, 1936) [USNM]	(4)
<i>furcata</i> (Caldwell, 1936) [USNM]	(5)
<i>minuta</i> (Caldwell, 1938) [USNM]	(6)
<i>minutissima</i> (Crawford, 1914) [USNM]	(7)
<i>nebulosa</i> (Zetterstedt, 1828) [IDH]	(8)
<i>nervosa</i> (Förster, 1848) [BMAG]	(9)
<i>sonchi</i> (Förster, 1848) [IDH]	(10)
<i>suaedae</i> (Crawford, 1914) [USNM]	(11)
<i>subpunctata</i> (Förster, 1848) [BMNH]	(12)
? <i>veaziei</i> (Patch, 1911) [USNM]	(13)
† <i>Gyropsylla</i> Bréthes, 1921	GYROPSYL
<i>ilicis</i> (Ashmead, 1881) [USNM]	(1)
<i>spgazziniana</i> (Lizer, 1917) [USNM]	(2)
Colposceniini	
<i>Colposcencia</i> Enderlein, 1929	COLPOSCE
C. sp. [USNM]	
<i>Crastina</i> Loginova, 1964	CRASTINA
? <i>linavuorii</i> Loginova, 1974 [BMNH]	
Anomalopsyllinae	
Apsyllini	
<i>Apsylla</i> Crawford, 1912	APSYLLA
* <i>cistellata</i> (Buckton, 1896) [LC]	
Anomalopsyllini	
<i>Tainarys</i> Bréthes, 1920	TAINARYS
* <i>schini</i> Bréthes, 1920 [USNM]	
Phytolymini	
<i>Phytolyma</i> Scott, 1882	PHYTOLYM
<i>fusca</i> Alibert, 1947 [BMNH]	(1)
* <i>lata</i> (Walker, 1852) [BMNH]	(2)
<i>minuta</i> (Hollis, 1973) [BMNH]	(3)
CARSIDARIDAE	
Calophyinae	
<i>Calophya</i> Löw, 1878	CALOPHYA
? <i>californica</i> Schwarz, 1904 [USDAC]	(1)
<i>dubia</i> Crawford, 1914 [USNM]	(2)
<i>flavida</i> Schwarz, 1904 [USNM]	(3)
<i>nigripennis</i> Riley, 1883 [USNM]	(4)
* <i>rhois</i> (Löw, 1877) [IDH]	(5)
<i>schini</i> Tuthill, 1959 [USNM]	(6)
<i>triozomima</i> Schwarz, 1904 [USNM]	(7)
<i>rotundipennis</i> White & Hodkinson, 1980 [BMNH]	(8)

Pauropsyllinae		
Microceropsyllini		
<i>Microceropsylla</i> Boselli, 1930		MICROCER
<i>M. sp.</i> [BMNH]		
<i>Pelmatobrachia</i> Enderlein, 1921		PELMATOB
<i>P. sp.</i> [LC]		
Pauropsyllini		
<i>Pauropsylla</i> Rubsaamen, 1899		PAUROPSY
<i>beelsoni</i> Laing, 1930 [BMNH]		(1)
<i>depressa</i> Crawford, 1912 [LC]		(2)
<i>trichaeta</i> Pettey, 1924 [BMNH]		(3)
Leptynopterinae		
<i>Leptynoptera</i> Crawford, 1919		LEPTYNOP
* <i>sulfurea</i> Crawford, 1919 [BMNH]		
Phacopterinae		
Pseudophacopterini		
<i>Pseudophacopteron</i> Enderlein, 1921		PSEUDOPH
<i>floccosa</i> (Crawford, 1915) [USNM]		(1)
sp. (A) [BMNH]		(2)
sp. (B) [BMNH]		(3)
Phacopterini		
<i>Phacopteron</i> Buckton, 1894		PHACOPTE
* <i>lentiginosum</i> Buckton, 1894 [USDAC]		
Tenaphalarinae		
Tenaphalarini		
<i>Protyora</i> Kieffer, 1906		PROTYORA
* <i>sterculiae</i> (Froggatt, 1901) [BMNH]		
<i>Tenaphalara</i> Kuwayama, 1907		TENAPHAL
? <i>acutipennis</i> Kuwayama, 1907 [BMNH]		(1)
<i>malayensis</i> Crawford, 1919 [BMNH]		(2)
sp. [BMNH]		(3)
Togepsyllini		
<i>Togepsylla</i> Kuwayama, 1931		TOGEPESYL
<i>matsumurana</i> Kuwayama, 1949		
[described from Miyatake, 1970]		
Diclidophlebiini		
<i>Diclidophlebia</i> Crawford, 1920		DICLIDOP
? <i>eastopi</i> Vondracek, 1963 [BMNH]		
Mastigmatini		
<i>Mastigimas</i> Enderlein, 1921		MASTIGIM
<i>cedrelae</i> (Schwarz, 1899) [BMNH]		(1)
sp. (A) [IDH]		(2)
sp. (B) [BMNH]		(3)
Carsidarinae		
Mesohomotomini		
<i>Epicarsa</i> Crawford, 1911		EPICARSA
<i>E. sp.</i> [USNM]		
<i>Mesohomotoma</i> Kuwayama, 1907		MESOHOMO
<i>hibisci</i> (Froggatt, 1901) [BMNH]		(1)
<i>tessmanni</i> (Aulmann, 1912) [BMNH]		(2)
<i>Paracarsidara</i> Heslop-Harrison, 1960		PARACARS
<i>dugesii</i> (Löw, 1886) [USNM]		(1)
<i>gigantea</i> (Crawford, 1911) [BMNH]		(2)
sp. [USNM]		(3)
Unplaced		
† <i>Bharatiana</i> Mathur, 1974		BHARATIA
* <i>octospinosa</i> Mathur, 1974 [BMNH]		

## Homotominae

## Synoziini

*Synozia* Enderlein, 1918

SYNOZA

*floccosa* Ferris, 1928 [UC]

(1)

sp. [USNM]

(2)

## Dynopsyllini

*Macrohomotoma* Kuwayama, 1907

MACROHOM

*\*gladiatum* Kuwayama, 1907 [BMNH]

(1)

*striata* Crawford, 1925 [BMNH]

(2)

*Mycopsylla* Froggatt, 1901

MYCOPSYL

*?\*fici* (Tryon, 1895) [BMNH]

(1)

*gardenensis* Bhanotar, Ghosh & Ghosh, 1972 [BMNH]

(2)

†*Pseudoeriopsylla* Newstead, 1911

PSEUDOER

*nyasae* Newstead, 1911 [BMNH]

## Homotomini

*Homotoma* Guérin-Méneville, 1834

HOMOTOMA

*\*ficus* (Linnaeus, 1767) [BMNH]

(1)

*indica* (Mathur, 1975) [FRI]

(2)

## LIVIIDAE

*Livia* Latreille, 1804

LIVIA

*coloradensis* Crawford, 1914 [USNM]

(1)

*crefeldensis* (Mink, 1855) [BMNH]

(2)

*\*juncorum* (Latreille, 1798) [IDH]

(3)

*maculipennis* (Fitch, 1857) [USNM]

(4)

*vernalis* Fitch, 1851 [USNM]

(5)

## PSYLLIDAE

## Ciriacreminae

## Ciriacremini

*Ciriacremum* Enderlein, 1910

CIRIACRE

*capeneri* Hollis, 1976 [BMNH]

(1)

*capense* Enderlein, 1923 [BMNH]

(2)

*harteni* Hollis, 1976 [BMNH]

(3)

*julbernardioides* Hollis, 1976 [BMNH]

(4)

## Anomoneurini

*Anomoneura* Schwarz, 1896

ANOMONEU

*\*mori* Schwarz, 1896 [USNM]

## Arytaininae

## Diaphorini

*Diaphorina* Löw, 1879

DIAPHORI

*albomaculata* Capener, 1970 [BMNH]

(1)

*cardiae* Crawford, 1924 [BMNH]

(2)

*chobauti* Putton, 1898 [BMNH]

(3)

*citri* Kuwayama, 1907 [BMNH]

(4)

*clutiae* Capener, 1970 [IDH]

(5)

*florea* Capener, 1970 [IDH]

(6)

*punctulata* (Petty, 1924) [BMNH]

(7)

*\*putonii* Löw, 1878 [USNM]

(8)

*solani* Capener, 1970 [IDH]

(9)

†*Pennavena* Capener, 1968

PENNAVEN

*\*fabulosa* Capener, 1968 [IDH]

## Arytainini

*Arytaina* Förster, 1848

ARYTAINA

*\*genistae* (Latreille, 1804) [BMAG]†*Acizzia* Heslop-Harrison, 1961

ACIZZIA

*acaciae* (Maskell, 1894) [BMNH]

(1)

*acaciaebaileyanae* (Froggatt, 1901) [BMNH]

(2)

	<i>hakeae</i> (Tuthill, 1952) [BMNH]	(3)
	<i>russellae</i> Webb & Moran, 1974 [BMNH]	(4)
	<i>uncatoides</i> (Ferris & Klyver, 1932) [BMNH]	(5)
†	<i>Amorphicola</i> Heslop-Harrison, 1961	AMORPHIC
	* <i>amorphae</i> (Mally, 1894) [USNM]	
†	<i>Arytainilla</i> Loginova, 1972	ARYNILLA
	<i>cytisi</i> (Puton, 1873) [BMNH]	(1)
	<i>hakani</i> Loginova, 1972 [BMNH]	(2)
	<i>spartiicola</i> (Šulc, 1907) [BMNH]	(3)
	<i>spartiophila</i> (Förster, 1848) [BMNH]	(4)
†	<i>Ceanothia</i> Heslop-Harrison, 1961	CEANOTHI
	<i>aculeata</i> (Crawford, 1914) [USNM]	(1)
	* <i>ceanothi</i> (Crawford, 1914) [USNM]	(2)
†	<i>Euceropysylla</i> Boselli, 1929	EUCEROPS
	<i>cayeyensis</i> (Caldwell, 1942) [USNM]	(1)
	<i>minuticona</i> (Crawford, 1914) [USNM]	(2)
	* <i>russoi</i> Boselli, 1949 [USNM]	(3)
	sp. [USNM]	(4)
†	<i>Euglyptoneura</i> Heslop-Harrison, 1961	EUGLYPTO
	<i>fuscipennis</i> (Crawford, 1914) [USNM]	(1)
	<i>robusta</i> (Crawford, 1914) [USNM]	(2)
	sp. [USNM]	(3)
†	<i>Floria</i> Löw, 1879	FLORIA
	<i>variegata</i> Löw, 1881 [BMNH]	
†	<i>Insnesia</i> Tuthill, 1964	INSNESIA
	<i>glabruscuta</i> (Caldwell, 1942) [USNM]	
†	<i>Purshivora</i> Heslop-Harrison, 1961	PURSHIVO
	<i>chelifera</i> (Crawford, 1914) [USNM]	(1)
	<i>pubescens</i> (Crawford, 1914) [USNM]	(2)
Euphalerini		
	<i>Colophorina</i> Capener, 1973	COLOPHOR
	* <i>cassiae</i> Capener, 1973 [BMNH]	
	<i>Euphalerus</i> Schwarz, 1904	EUPHALER
	<i>gallicolus</i> Ferris, 1928 [UC]	(1)
	<i>jugovenosus</i> Tuthill, 1937 [USNM]	(2)
	<i>nidifex</i> Schwarz, 1904 [USNM]	(3)
	<i>rugipennis</i> Crawford, 1914 [USNM]	(4)
	<i>tanillus</i> Tuthill, 1937 [USNM]	(5)
	<i>vermiculosus</i> Crawford, 1914 [USNM]	(6)
	sp. (A) [BMNH]	(7)
	sp. (B) [BMNH]	(8)
	sp. (C) [LC]	(9)
	sp. (D) [BMNH]	(10)
Psyllopseini		
	<i>Psyllopsis</i> Löw, 1879	PSYLLOPS
	<i>fraxini</i> (Linnaeus, 1761) [BMAG]	(1)
	* <i>fraxinicola</i> (Förster, 1848) [BMNH]	(2)
Psyllinae		
	<i>Psylla</i> Geoffroy, 1862	
	<i>Asphagidella</i> Enderlein, 1921	P-ASPHAG
	* <i>buxi</i> (Linnaeus, 1758) [BMNH]	
	<i>Baeopelma</i> Enderlein, 1926	P-BAEOPE
	<i>foersteri</i> Flor, 1861 [BMNH]	
	<i>Cacopsylla</i> Ossiannilsson, 1970	P-CACOPS
	* <i>mali</i> (Schmidberger, 1836) [IDH]	(1)
	<i>peregrina</i> Förster, 1848 [BMNH]	(2)
	<i>sorbi</i> (Linnaeus, 1758) [IDH]	(3)
	<i>stricklandi</i> (Caldwell, 1939) [USNM]	(4)
	<i>ulmi</i> Förster, 1848 [BMNH]	(5)

<i>Hepatopsylla</i> Ossiannilsson, 1970	P-HEPATO
<i>albagena</i> (Caldwell, 1938) [USNM]	(1)
<i>ambigua</i> Förster, 1848 [IDH]	(2)
<i>brunneipennis</i> Edwards, 1896 [BMNH]	(3)
<i>moscovita</i> Andrianova, 1848 [BMNH]	(4)
<i>myrtilli</i> Wagner, 1847 [IDH]	(5)
* <i>nigrita</i> (Zetterstedt, 1828) [IDH]	(6)
? <i>parallela</i> Crawford, 1914 [USNM]	(7)
<i>palmeni</i> Löw, 1883 [IDH]	(8)
<i>pulchra</i> (Zetterstedt, 1840) [BMNH]	(9)
<i>pyri</i> (Linnaeus, 1758) [USNM]	(10)
<i>pyricola</i> Förster, 1848 [BMNH]	(11)
<i>saliceti</i> Förster, 1848 [BMNH]	(12)
<i>visci</i> Curtis, 1835 [BMNH]	(13)
? <i>Hepatopsylla</i> Ossiannilsson, 1970	
<i>alba</i> Crawford, 1914 [USNM]	(14)
<i>americana</i> Crawford, 1914 [USNM]	(15)
<i>annulata</i> Fitch, 1851 [USNM]	(16)
<i>brevistigmata</i> Patch, 1912 [USNM]	(17)
? <i>coryli</i> Patch, 1912 [USNM]	(18)
<i>hamata</i> Tuthill, 1944 [IDH]	(19)
<i>hirsuta</i> Tuthill, 1938 [USNM]	(20)
<i>magnicauda</i> Crawford, 1914 [USNM]	(21)
<i>minor</i> v. <i>flava</i> Crawford, 1914 [USNM]	(22)
<i>minuta</i> Crawford, 1914 [USNM]	(23)
<i>negundinis</i> Mally, 1895 [USNM]	(24)
<i>rhododendri</i> Puton, 1871 [USNM]	(25)
<i>sinuata</i> Crawford, 1914 [USNM]	(26)
<i>subspiculata</i> Hodkinson, 1976 [IDH]	(27)
<i>Osmopsylla</i> Loginova, 1978	P-OSMOPS
* <i>ribesiae</i> Crawford, 1911 [USNM]	
<i>Psylla</i> Geoffroy, 1862	O-PSYLLA
* <i>alni</i> Linnaeus, 1758 [BMNH]	(1)
<i>betulaenanae</i> Ossiannilsson, 1970 [IDH]	(2)
<i>carpinicola</i> Crawford, 1914 [USNM]	(3)
<i>floccosa</i> Patch, 1909 [USNM]	(4)
<i>galeaformis</i> Patch, 1911 [USNM]	(5)
<i>striata</i> Patch, 1911 [USNM]	(6)
<i>trimaculata</i> Crawford, 1911 [USNM]	(7)
<i>Thamnopsylla</i> Loginova, 1978	P-THAMNO
<i>melanoneura</i> Förster, 1848 [BMNH]	(1)
* <i>pyrisuga</i> Förster, 1848 [BMNH]	(2)
<i>rhamnicola</i> Scott, 1876 [BMAG]	(3)
? <i>Thamnopsylla</i> Loginova, 1978	
<i>magna</i> Crawford, 1914 [USNM]	(4)
<i>media</i> Tuthill, 1943 [USNM]	(5)
<i>pruni</i> (Scopoli, 1763) [IDH]	(6)
sp. near <i>simlae</i> Crawford, 1912 [BMNH]	(7)
subgenus not certain	PSYLLA
<i>phoradendrae</i> Tuthill, 1939 [USNM]	(1)
<i>pulchella</i> Löw, 1878 [BMNH]	(2)
† <i>Spanioneura</i> Förster, 1848	SPANIONE
* <i>fonscolombii</i> Förster, 1848 [BMNH]	
<b>Unplaced</b>	
† <i>Arepuna</i> Tuthill, 1959	AREPUNA
<i>A. sp.</i> [USNM]	
† <i>Epipsylla</i> Kuwayama, 1907	EPIPSYLL
<i>E. sp. (A)</i> [BMNH]	(1)
<i>E. sp. (B)</i> [BMNH]	(2)

† <i>Freysuila</i> Aleman, 1887 <i>F.</i> sp. [USNM]	FREYSUIL
† <i>Heteropsylla</i> Crawford, 1914 <i>incisa</i> (Šulc, 1914) [BMNH] * <i>texana</i> Crawford, 1914 [USDAC]	HETEROPS (1) (2)
† <i>Isogonoceraia</i> Tuthill, 1964 <i>divergipennis</i> White & Hodkinson, 1980 [BMNH]	ISOGONOC
† <i>Mitropsylla</i> Crawford, 1914 ? <i>deserata</i> Caldwell, 1944 [USNM]	MITRAPS
† <i>Neopsyllia</i> Caldwell, 1947 <i>erythrinae</i> (Lizer, 1918) [USNM] sp. [USNM]	NEOPSYLL (1) (2)
† <i>Pexopsylla</i> Jensen, 1957 * <i>cercocarpi</i> Jensen, 1957 [USNM]	PEXOPSYL
† <i>Platycorypha</i> Tuthill, 1945 * <i>princeps</i> Tuthill, 1945 [USNM]	PLATYCOR
† <i>Retroacizzia</i> Heslop-Harrison, 1961 * <i>antennata</i> Heslop-Harrison, 1961 [BMNH]	RETACIZZ
† <i>Trigonon</i> Crawford, 1920 * <i>longicornis</i> (Crawford, 1919) [USNM]	TRIGONON

SPONDYLIASPIDIDAE

Spondyliaspidinae

<i>Spondyliaspis</i> Signoret, 1879 <i>S.</i> sp. [BMNH]	SPONDYLI
† <i>Cardiaspina</i> Crawford, 1911 <i>albitextura</i> Taylor, 1962 [BMNH] <i>densitexta</i> Taylor, 1962 [IDH] <i>squamula</i> Taylor, 1962 [TRL] sp. [TRL]	CARDIASP (1) (2) (3) (4)
† <i>Creiis</i> Scott, 1882 <i>C.</i> sp. [TRL]	CREIIS
† <i>Ctenarytaina</i> Ferris & Klyver, 1932 * <i>eucalypti</i> (Maskell, 1890) [BMNH]	CTENARYT
† <i>Eucalyptolyma</i> Froggatt, 1901 <i>E.</i> sp. [BMNH]	EUCALYPT
† <i>Glycaspis</i> Taylor 1960 <i>baileyi</i> Moore, 1961 [BMNH] <i>imponens</i> Moore, 1961 [BMNH] <i>rivalis</i> Moore, 1961 [BMNH] <i>aggregata</i> Moore, 1961 [BMNH] <i>confecta</i> Moore, 1961 [BMNH] <i>conserta</i> Moore, 1961 [BMNH] <i>cyanoreios</i> Moore, 1961 [BMNH] <i>orientalis</i> Moore, 1961 [BMNH] <i>salebrosa</i> Moore, 1961 [BMNH]	GLYCASPI (1) (2) (3) (4) (5) (6) (7) (8) (9)
† <i>Phellopsylla</i> Taylor 1960 <i>P.</i> sp. [TRL]	PHELLOPS

Pachypsyllinae

<i>Pachypsylla</i> Riley, 1883 ? <i>celtidisgemma</i> Riley, 1883 [USDAC] <i>celtidismamma</i> (Riley, 1876) [USDAC] <i>celtidisvesiculum</i> Riley, 1883 [USDAC] <i>japonica</i> Miyatake, 1968 [USNM] * <i>venusta</i> (Osten-Sacken, 1861) [USDAC]	PACHYPSY (1) (2) (3) (4) (5)
<i>Tetragonocephala</i> Crawford, 1914 <i>T.</i> sp. [described from Ferris, 1926]	TETRAGON

## TRIOZIDAE

Bactericerinae	
Triozamiini	
<i>Triozamia</i> Vondracek, 1963	TRIOZAMI
* <i>lamborni</i> (Newstead, 1913) [BMNH]	
Unplaced	
<i>Neolithus</i> Scott, 1882	NEOLITHU
<i>N.</i> sp. [BMNH]	
Triozinae	
Eutriozini	
<i>Trichohermes</i> Kirkaldy, 1904	TRICHOCH
* <i>walkeri</i> (Förster, 1848) [BMNH]	
Paracomecini	
† <i>Leuronota</i> Crawford, 1914	LEURONOT
<i>michoacana</i> Ferris, 1828 [UC]	
Triozini	
<i>Egeirotria</i> Boselli, 1931	EGEIROTR
* <i>ceardi</i> v. <i>euphratica</i> Boselli, 1931 [BMNH]	(1)
<i>verucifica</i> Loginova, 1965 [BMNH]	(2)
sp. (A) [BMNH]	(3)
sp. (B) [BMNH]	(4)
<i>Paratrioza</i> Crawford, 1911	PARATRIO
<i>arbolensis</i> Crawford, 1910 [USNM]	(1)
<i>cockerelli</i> (Sülc, 1909) [USNM]	(2)
<i>lavatae</i> (Van Duzee, 1925) [USNM]	(3)
<i>maculipennis</i> (Crawford, 1910) [USNM]	(4)
<i>Trioza</i> Förster, 1848	
<i>Bactericera</i> Puton, 1876	T-BACTER
<i>crithmi</i> Löw, 1880 [BMAG]	(1)
? <i>curvatineris</i> Förster, 1848 [BMNH]	(2)
? <i>nigricornis</i> Förster, 1848 [USNM]	(3)
<i>salicivora</i> Reuter, 1876 [USNM]	(4)
? <i>Bactericera</i> Puton, 1876	
<i>atkasookensis</i> Hodkinson, 1978 [IDH]	(5)
<i>aylmeriae</i> Patch, 1912 [USNM]	(6)
<i>frontalis</i> Crawford, 1910 [USNM]	(7)
<i>obtusata</i> Patch, 1911 [IDH]	(8)
<i>tripunctata</i> (Fitch, 1851) [USNM]	(9)
<i>Heterotrioza</i> Dobreanu & Manolache, 1962	T-HETERO
<i>alacris</i> Flor, 1861 [BMNH]	(1)
<i>albiventris</i> Förster, 1848 [BMAG]	(2)
<i>remota</i> Förster, 1848 [IDH]	(3)
<i>chenopodii</i> Reuter, 1876 [BMNH]	(4)
? <i>Heterotrioza</i> Dobreanu & Manolache, 1962	
<i>lobata</i> Crawford, 1914 [USNM]	(5)
<i>magnoliae</i> (Ashmead, 1881) [USNM]	(6)
<i>minuta</i> Crawford, 1910 [USNM]	(7)
<i>obsoleta</i> (Buckton, 1900) [BMNH]	(8)
<i>litseae</i> ?Bordage, 1914 [BMNH]	(9)
<i>Megatrioza</i> Crawford, 1915	T-MEGATR
<i>diospyri</i> (Ashmead, 1881) [USNM]	(1)
<i>hirsuta</i> (Crawford, 1912) [BMNH]	(2)
<i>incidata</i> Tuthill, 1945 [USNM]	(3)
<i>palmicola</i> Crawford, 1918 [USNM]	(4)
<i>vitiensis</i> (Kirkaldy, 1907) [BMNH]	(5)
<i>Trioza</i> Förster, 1848	T-TRIOZA
<i>cinnamomi</i> (Boselli, 1930) [BMNH]	(1)
? <i>marginepunctata</i> Flor, 1861 [USNM]	(2)
* <i>urticae</i> (Linnaeus, 1758) [BMNH]	(3)



? <i>Trioza</i> Förster, 1848	
<i>albifrons</i> Crawford, 1910 [USNM]	(4)
<i>bakeri</i> Crawford, 1910 [USNM]	(5)
<i>beameri</i> Tuthill, 1939 [USNM]	(6)
<i>erytrae</i> (Del Guercio, 1918) [BMNH]	(7)
<i>falcata</i> (Ferris & Klyver, 1932) [BMNH]	(8)
<i>panacis</i> Maskell, 1890 [BMNH]	(9)
<i>phoradendrae</i> Tuthill, 1939 [USNM]	(10)
<i>quadripunctata</i> Crawford, 1910 [USNM]	(11)
<i>vitreoradiata</i> (Maskell, 1879) [BMNH]	(12)
subgenus not certain	TRIOZA
? <i>anceps</i> Tuthill, 1944 [USNM]	(1)
sp. [USNM]	(2)
† <i>Aacanthocnema</i> Tuthill & Taylor, 1955	AACANTHO
*? <i>casuarinae</i> (Froggatt, 1901) [IDH]	
† <i>Ceropsylla</i> Riley, 1884	CEROPSYL
? <i>martorelli</i> Caldwell, 1942 [USNM]	(1)
? <i>sideroxyli</i> Riley, 1883 [UC]	(2)
sp. [USNM]	(3)
† <i>Crawforda</i> Caldwell, 1940	CRAWFORD
<i>triopsyllina</i> Caldwell, 1940 [USNM]	
† <i>Hevaheva</i> Kirkaldy, 1902	HEVAHEVA
<i>swezeyi</i> Crawford, 1928 [USNM]	
† <i>Kuwayama</i> Crawford, 1911	KUWAYAMA
<i>pisonia</i> Caldwell, 1940 [USNM]	
† <i>Swezeyana</i> Caldwell, 1940	SWEZEYAN
<i>elongagena</i> Caldwell, 1940 [USNM]	
† <i>Triozoidea</i> Crawford, 1911	TRIOZOID
<i>silvestris</i> Tuthill, 1959 [USNM]	

**Table 2** Numbers of genera and species examined in each psyllid family.

Family	Genera examined	Species examined
APHALARIDAE	19	51
CARSIDARIDAE	21	43
LIVIIDAE	1	5
PSYLLIDAE	30	119
SPONDYLIASPIDIDAE	9	24
TRIOZIDAE	14	61
TOTAL	94	303

skin was by the presence of a pharate adult within. Such specimens had at least one tarsal segment separate from the tibiotarsus of the hindleg (and usually the fore and midlegs as well). It was therefore assumed that the maximum differentiation of tarsi from the tibia occurred in the final instar. As a further check the size of the final instar nymph was compared with the adult of the same species. With experience the size of the wing-pads relative to the body proved to be a further confirmatory character.

**Table 3** Numbers of species and genera, and total genera recorded from each zoogeographic region.

Region	Species examined	Genera examined	Total recorded genera
AUSTRALASIAN	21	12	27
AUSTRO-ORIENTAL	2	20*	34
ETHIOPIAN	31	28	36
HAWAIIAN	6	6	9
MALAGASIAN	1	4*	4
NEARCTIC	100	24	30
NEOTROPICAL	36	24	52
NEW ZEALAND	4	5	7
ORIENTAL	23	34*	50
PACIFIC	4	10*	17
PALAEARCTIC	75	29	59

\*Figure includes species collected outside the region.

### Morphology of final instar nymphs

Pflugfelder (1941) gives a general account of nymphal morphology. The following account is intended as an explanation of terminology, a discussion of possible homology and an indication of the taxonomic distribution of attributes within the superfamily Psylloidea. Major body parts are shown in Figures 2–4.

#### General form

Nymphal psyllids are generally dorso-ventrally flattened, a condition reaching its maximum expression in pit-gall inhabiting species, e.g. many *Trioza* spp. (Fig. 4). Ferris (1925) defined two morphological types of nymph, i.e. 'psylline' and 'triozine'. This division was made on the basis of wing-pad shape. The 'psylline' type (Fig. 2) does not have the forewing-pad produced anteriorly into a prominent humeral lobe and the apical extremity projects prominently from the contour of the body. In the 'triozine' type there is an anteriorly produced humeral lobe (Fig. 4) to the forewing-pad and the margins of the pads are confluent with the body margin. Rahman (1932) defined a third type of nymph in which the humeral lobe is present but not produced anteriorly and the forewing-pad margin is parallel to the general body contour. He termed this the 'pauropsylline' type (Fig. 3) and gave examples of each of the three nymphal forms, e.g. *Aphalara calthae* and *Pauropsylla depressa* ('pauropsylline'), *Paracarsidara gigantea* and *Psylla alni* ('psylline') plus *Diaphorina citri* and *Trioza urticae* ('triozine'). These descriptions of morphological types were found to be inadequate and emphasis was placed upon the characters described below.

#### Head

The main dorsal sclerite or pair of sclerites generally extend posteriorly so that the hind margin is posterior to the procoxae. This suggests that these sclerites are derived from a fusion of the vertex and part of the pronotum at least. This fusion is least expressed in the Spondyliaspidae, whereas complete fusion is observed in many Carsidaridae and Triozidae, especially those forming pit-galls.

The length, basal position and number of apparent segments of the antennae vary within the group. Free-living forms such as *Psylla alni* have long antennae with many apparent segments and the antennal base is on the margin of the head. Most Triozidae and *Calophya* spp. which inhabit pit-galls have short antennae, often with a total of only one apparent segment, and the

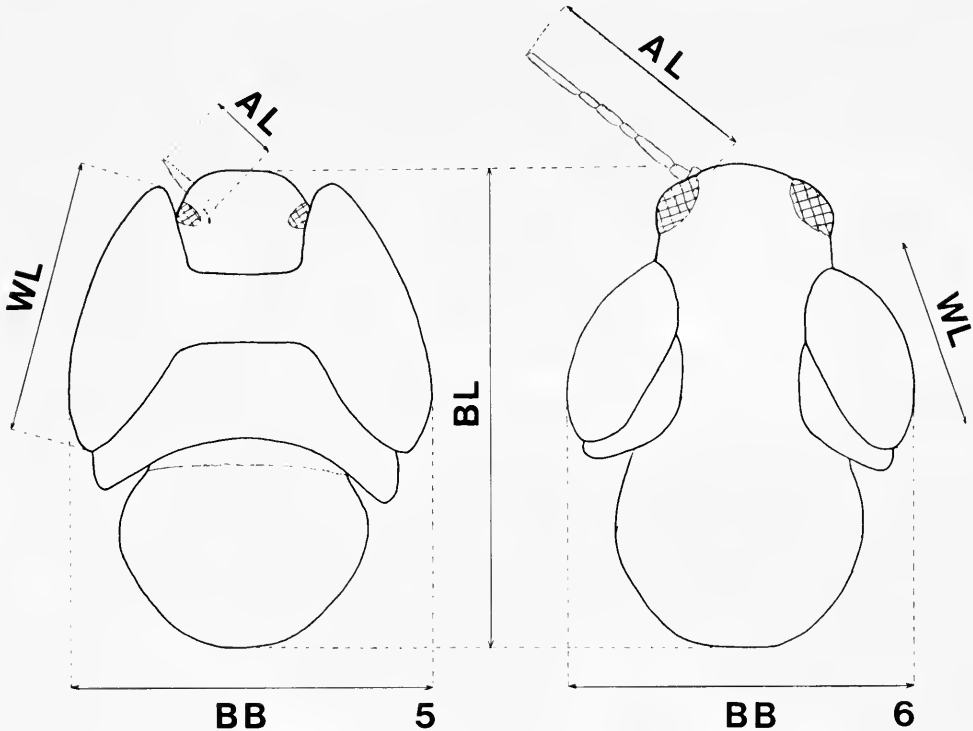

**Figs 5, 6** Body measurements. 5, psylline type nymph; 6, triozine type nymph. (AL – antenna length; BB – body breadth; BL – body length; WL – forewing-pad length.) Modified from White & Hodkinson (1982).

base is usually ventrally placed (Fig. 4). Adults normally have 10 antennal segments with rhinaria or antennal sensoria at the apices of segments IV, VI, VIII and IX. Most nymphs also have four rhinaria which, when 10 antennal segments are present, occur on segments IV, VI, VIII and IX. In those nymphs with fewer than 10 apparent segments fine sutures can sometimes be seen suggesting the positions where further division of the antennae will occur. However, to avoid implication of homology between nymphs and adults, the term ‘division’ will be used and the divisions will be numbered with arabic numerals. Rhinaria positions are assumed to be homologous with those of the adult and the first, second, third and fourth rhinaria are referred to as rhinaria IV, VI, VIII and IX respectively.

Some nymphal Carsidaridae (*Microceropsylla* sp. and *Calophya rotundipennis*) appear to have fewer than four rhinaria. Many adult Aphalaridae have six rhinaria placed singly at the apices of segments IV, V, VI, VII, VIII and IX. However, their nymphs have four, five or six rhinaria, e.g. the adults of *Craspedolepta artemisiae* and *C. angustipennis* have four and five respectively.

The mouthparts are of the normal sternorrhynchous type, i.e. the apex of the clypeus extends to the mesothorax. The labium is two-segmented.

**Thorax**

The prothoracic tergum is assumed to be the area posterior to the eyes and anterior to the thoracic area which is continuous with the dorsal surface of the mesothoracic or forewing-pads. Most of the sclerites are generally fused with the head to form the ‘cephaloprothorax’. The Aphalaridae and Psyllidae normally have at least 2 + 2 sclerites between the mesothorax and cephaloprothorax (Fig. 9) whereas most Triozidae have 1 + 1 (Fig. 10) or no sclerites of the prothorax.

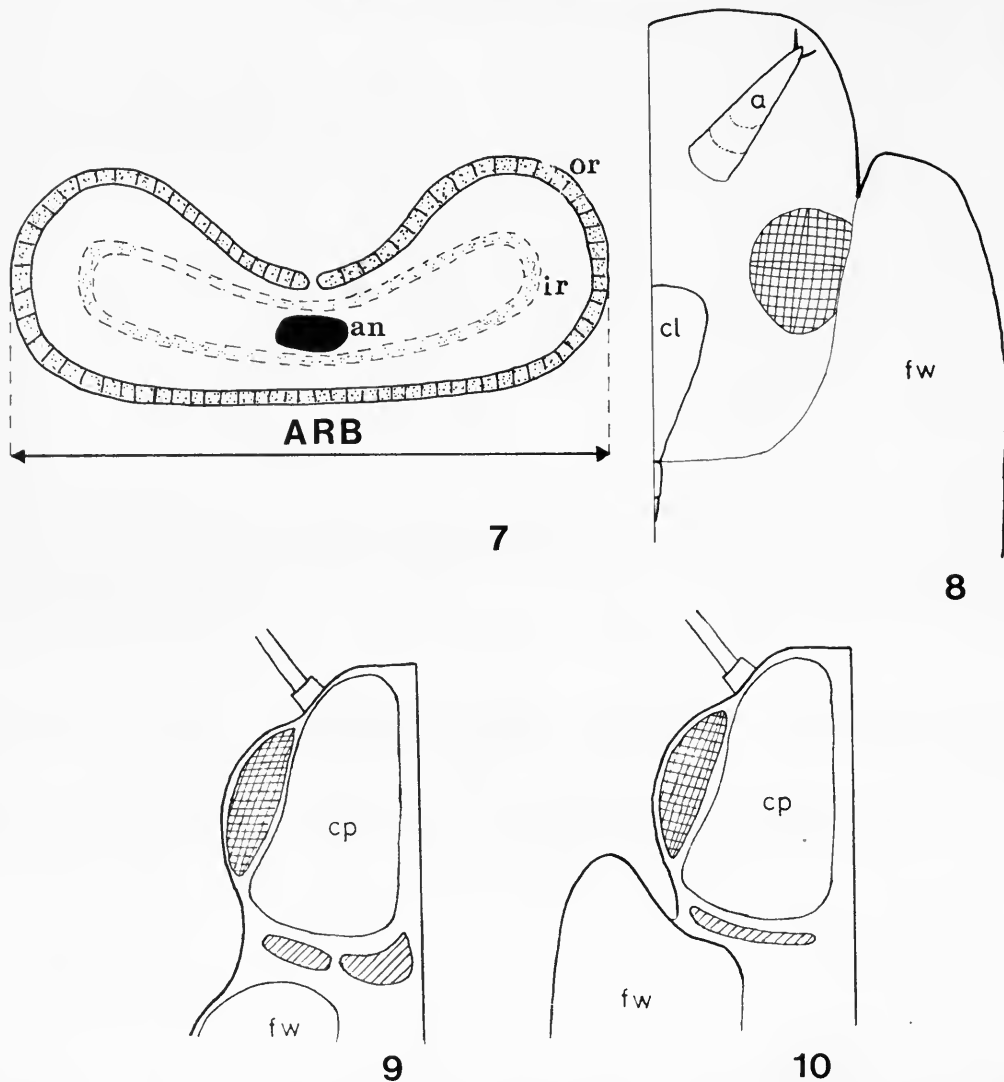

**Figs 7–10** Circum-anal pore rings, antenna and prothorax forms. 7, circum-anal pore ring terminology and measurement; 8, antenna not extending beyond head margin, character N35; 9, 2 + 2 prothoracic sclerites (shaded), character N7; 10, 1 + 1 prothoracic sclerite (shaded), character N7. (a – antenna; an – anus; cl – clypeus; cp – cephaloprothorax; fw – forewing-pad; ir – inner circum-anal pore ring; or – outer circum-anal pore ring.) Fig. 7 from White & Hodkinson (1982).

The mesothoracic tergum is taken to be the area between the lines of attachment of the forewing-pads with the body. The sclerites are completely fused in many Triozidae, especially those forming pit-galls. Some species of *Euphalerus* and *Pachypsylla* have large numbers of very small sclerites. In general the sclerites may be divided into laterals and medials. Nymphs of most Psyllidae and Spondylaspididae have small laterals and small medial sclerites (Fig. 11). The nymphs of *Aphalara* and *Diaphorina* have elongate small lateral sclerites and at least 2 + 2 enlarged medials (Fig. 12) and *Paurocephala* have no laterals but at least 2 + 2 large medials (Fig. 13). *Egeirotioza* and *Homotoma* have 1 + 1 medial sclerites only (Fig. 14). The metathoracic tergum is assumed to be the area between the lines of attachment with the hindwing-pads with the body. The sclerites of the metathoracic tergum take the same form as those of the mesothoracic tergum.

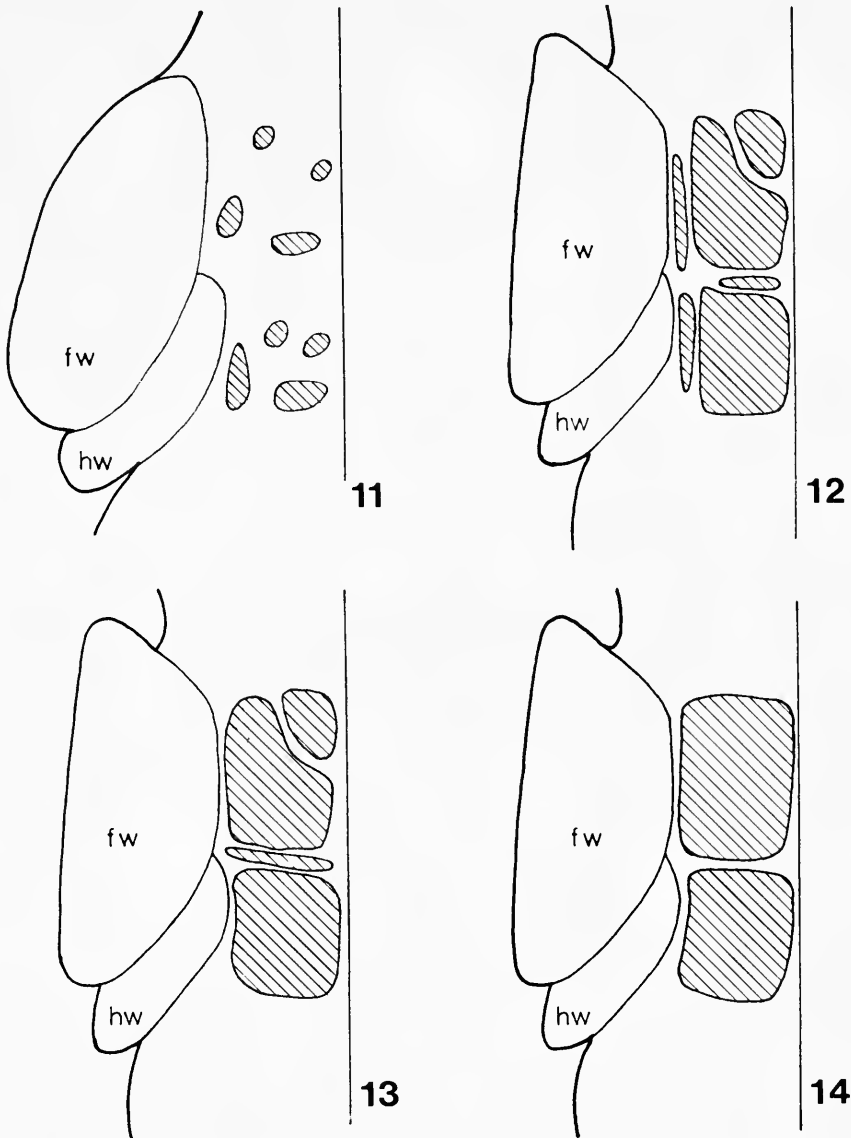

**Figs 11–14** Thoracic morphology, character N8. 11, small lateral and small medial sclerites (shaded); 12, elongate lateral (adjacent to wing-pad) and 2 + 2 large medial sclerites on both meso- and metathorax; 13, no lateral and 2 + 2 large medial sclerites on both meso- and metathorax; 14, no lateral and 1 + 1 large medial sclerite on both meso- and metathorax. (fw – forewing-pad; hw – hindwing-pad.)

Many species have paired depressions on each thoracic tergite. These are very well developed on the meso- and metathoracic tergites of *Acanthocnema casuarinae*. The dorsal thoracic and abdominal areas of some *Calophya* spp. are covered in long processes (Fig. 144) while other species of the genus have apparent ‘perforations’ in their dorsal sclerites.

The forewing-pad is extended anteriorly as a humeral lobe in many Aphalaridae, Carsidaridae, *Diaphorina* and Triozidae. In *Aphalara* and *Diaphorina* the humeral angle is normally placed away from the head margin (Fig. 17) while in Triozidae the humeral lobe may be adjacent to the eye (Fig. 19). In most species the apical (posterior) angle of the forewing-pad is adjacent or exterior to the margin of the hindwing-pad (Fig. 20). However, in some *Calophya* spp. and Triozidae the apical angle is interior to the hindwing-pad margin, and the margins of the

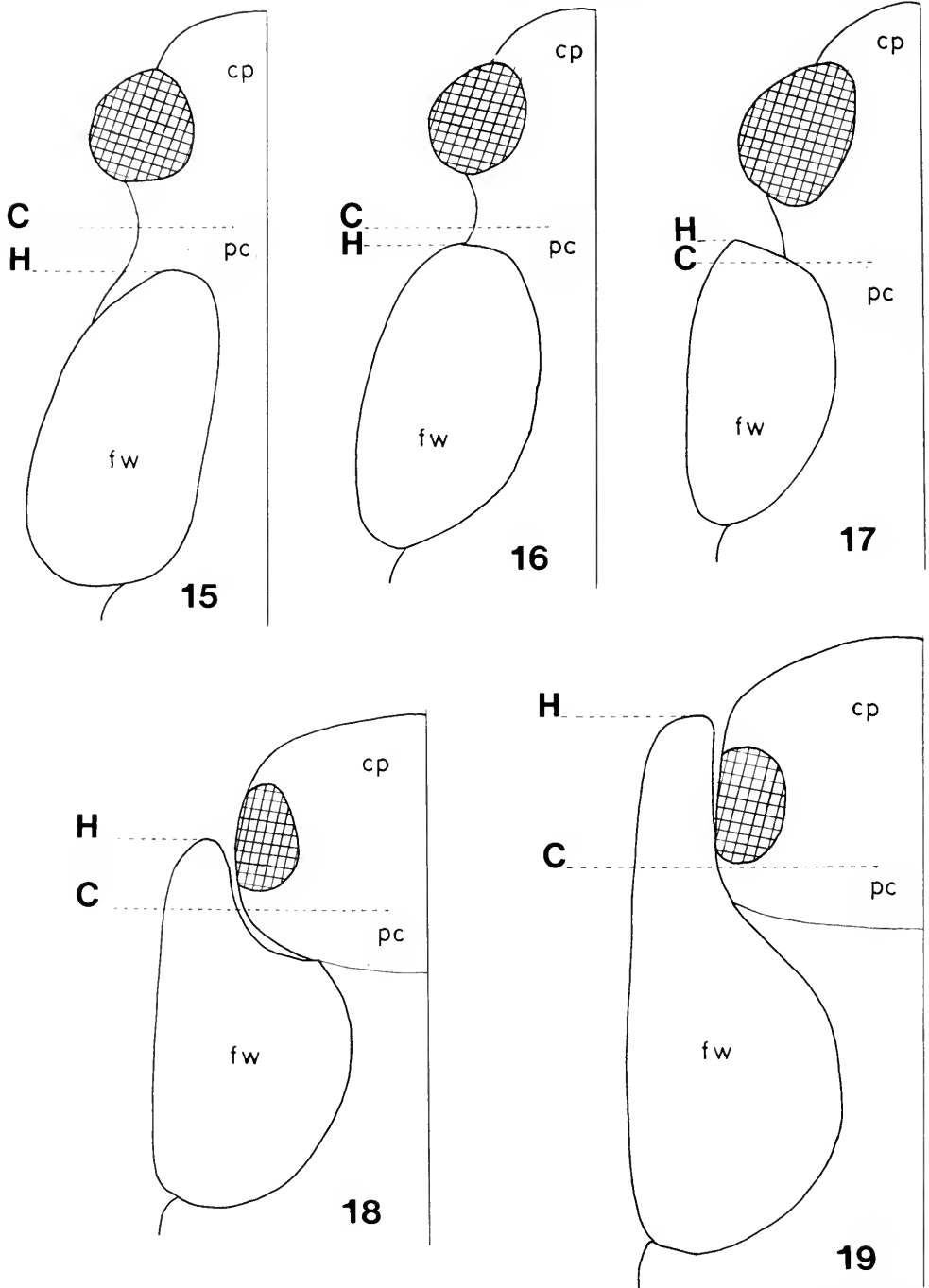

**Figs 15–19** Humeral lobe development, character N1. 15, forewing-pad without a humeral lobe; 16, humeral lobe present, but not extending anterior to procoxa; 17, humeral lobe anterior to procoxa; 18, humeral lobe anterior to posterior margin of eye; 19, humeral lobe anterior to eye. (C – level of anterior margin of procoxa; cp – cephaloprothorax; fw – forewing-pad; H – level of humerus; pc – procoxa.)

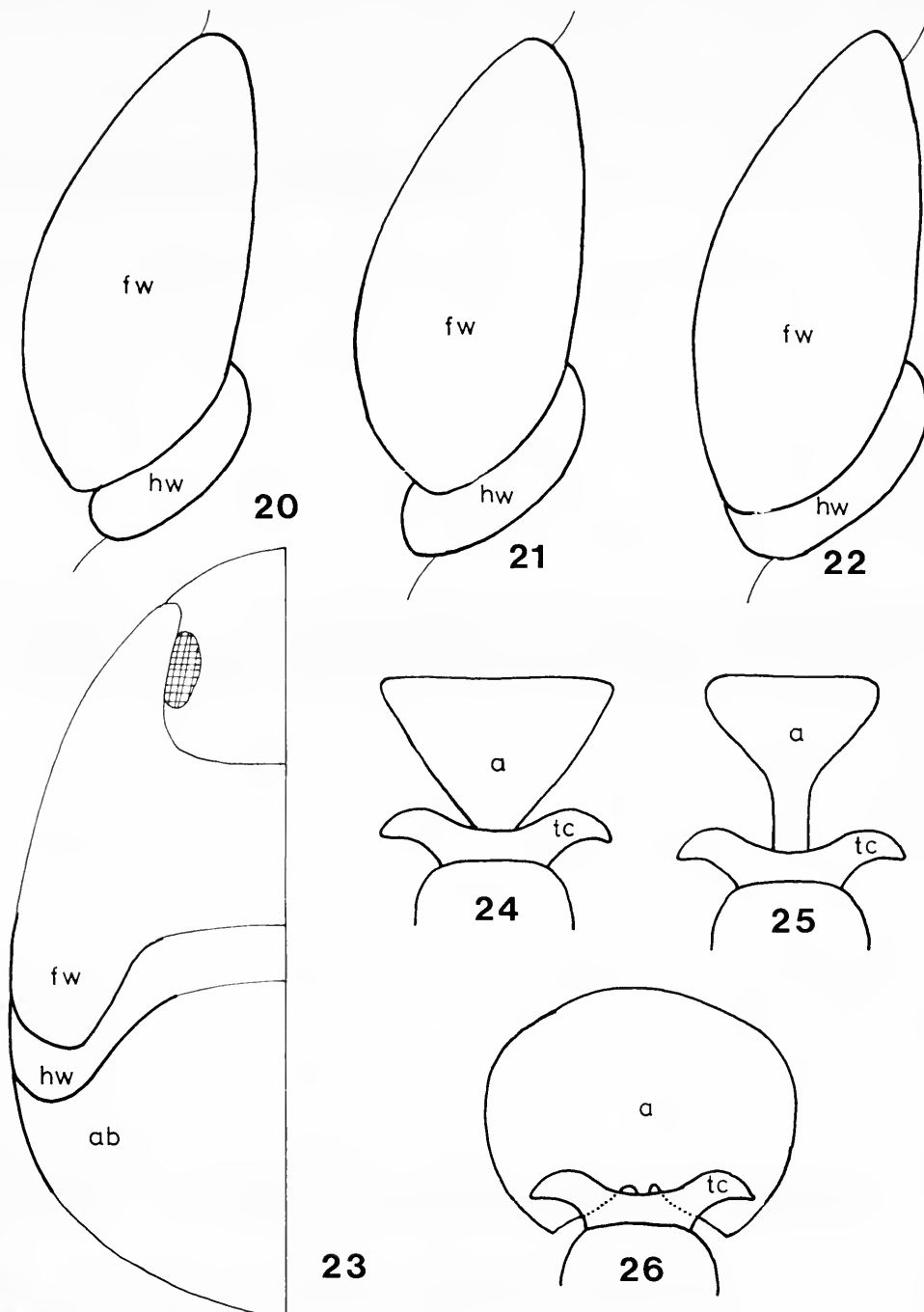

**Figs 20–26** Wing-pad and tarsal arolium forms. 20, apex of forewing-pad exterior to margin of hindwing-pad, character N2; 21, apex of forewing-pad interior to margin of hindwing-pad, but apex of hindwing-pad external to abdomen margin, characters N2 and N3; 22, apex of forewing-pad adjacent to margin of hindwing-pad and wing-pad margins confluent, character N2; 23, apex of forewing-pad interior to margin of hindwing-pad, apex of hindwing-pad interior to margin of abdomen and all margins confluent, characters N2 and N3; 24, triangular tarsal arolium, character N41; 25, triangular and petiolate arolium, character N4; 26, almost circular arolium, character N5. (a – arolium; ab – abdomen; fw – forewing-pad; hw – hindwing-pad; tc – tarsal claw.)

forewing-pad and hindwing-pad are confluent (Fig. 22). Furthermore, the hindwing-pad margin may also be confluent with the abdominal margin (Fig. 23). These features are especially well developed in species which form pit-galls. Adults of *Leptynoptera sulfurea* and *Trioza diospyri* have very reduced hindwings and thus the nymphs have reduced hindwing-pads (Fig. 48). Wing-pad tracheation is sometimes observed just before adult moult and Heslop-Harrison (1951) illustrates this for *Psylla* sp. and *Trioza* sp.

Psyllid nymphal legs lack such elaborate features as meracanthi, genual spurs, metatibial spines and metabasitarsal spines which are seen in the adult. Of the nymphs studies only two, i.e. *Paraphalaroida fremontiae* and *Togepssylla matsumurana*, appear to have articulate tarsi, as in the adult (Fig. 55). *Pachypssylla celtididisgemma* and *Pelmatobrachia* sp. also have two-segmented tarsi but they appear non articulate (Fig. 52). Most species have a single apparent tarsal segment on each leg. This appears to be homologous with segment II of the adult because the apparent 'tibia' is often constricted sub-apically at a point assumed to represent the division line between the tibia and segment I (Fig. 53). The division line is often marked by simple setae. Because this division line is not always visible the apparent tibia and tarsus will hereafter be called the tibiotarsus and the one apparent tarsal segment will be called a division. Most species have a pad between the tarsal claws. Ferris (1923, 1925, 1926), Ferris & Hyatt (1923) and Rahman (1932) term this a pulvillus. Ferris (1928*a*, 1928*b*) uses the word empodium and Lal (1937) was inconsistent. However, the correct term is arolium (Imms, 1957; Chapman, 1971). Arolia are very reduced, or absent, in some Carsidaridae, while in many Triozidae they are at least semicircular (Fig. 26) and in most Psyllidae the arolia are petiolate (Fig. 25).

## Abdomen

The abdomen is assumed to be any body part posterior to the join of the metathoracic tergum and hindwing-pads. Any short broad free sclerites near the base of the abdomen are discounted when describing the sclerites of the abdomen as they may equally well be of thoracic origin. In most species free sclerites and transverse rows of setae indicate the segments. In these species the sclerites are arranged at least 1 + 1 per segment but in the apical area the individual sclerites are often fused to form a caudal plate (Figs 2-4). Some Carsidaridae have completely membranous abdomens while in many Triozidae the caudal plate covers the whole abdomen (Fig. 4). With this confusing set of possibilities no attempt has been made to homologise the abdominal sclerites. The ventral abdominal surface of most species has 2 + 2 sclerites on each segment anterior to the anal plate. The anal plate is formed by a fusion of the individual sclerites in the apical area. The most lateral free sclerites surround the spiracles. Because the true base of the abdomen is poorly defined and spiracles can 'migrate' or 'float' (Heslop-Harrison, 1952*a*) or be reduced in number (Matsuda, 1976) the possible homology of the spiracles was not studied.

The abdomen of *Paurocephala* spp. has large apical tubercles (Fig. 114) and many Spondyliaspidae have lateral bulges, coincident with each apparent segment (Fig. 28). Some species have apical 'teeth' (Fig. 122). In most *Pachypssylla* spp. the central 'tooth' or 'teeth' are larger than the most lateral 'teeth' (Fig. 125) while in *Euphalerus gallicolus* the most lateral 'teeth' are enlarged (Fig. 120).

Some species of each family have the anal opening posterior (i.e. apical) while others have a ventral anal opening. In many species the sex of the final instar nymphs can be determined by the shape of the suture which extends anteriorly from the anus (Ball & Jensen, 1966; Ossiannilsson, 1970; Hodkinson, 1973).

Most species have an anal pore-field which usually surrounds the anus as a ring (Figs 7, 130-142). This ring, which is often double, is called the circum-anal pore ring by Ferris (1928*a*). The following types of anal pore-fields have been observed.

- (i) Circum-anal ring only (Fig. 111).
- (ii) Circum-anal ring plus two additional rings placed laterally to it (Fig. 110).
- (iii) Two rings each lateral to the anus and no circum-anal ring (Fig. 150).
- (iv) Four rings and no circum-anal ring (Fig. 120).



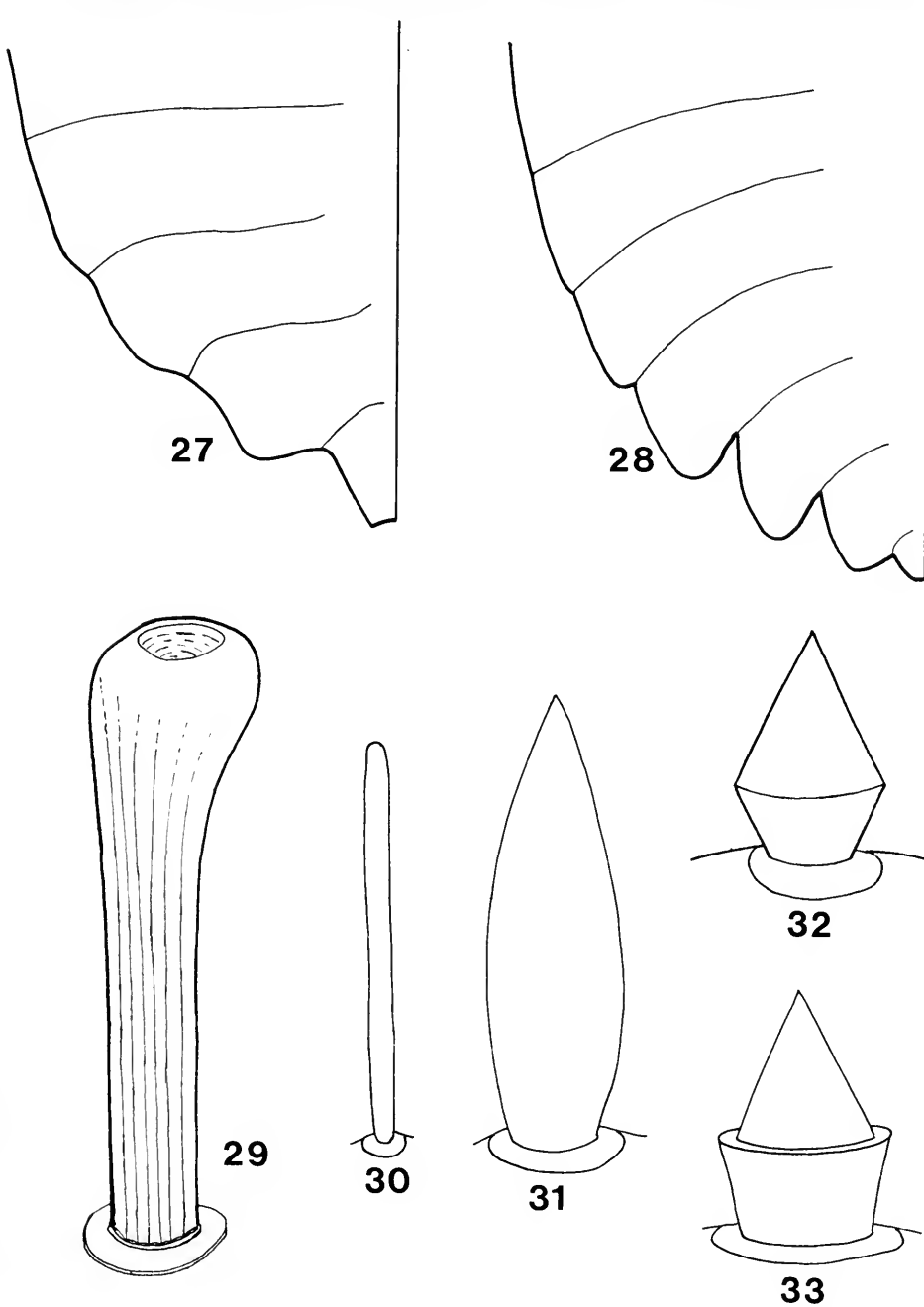

**Figs 27–33** Abdomen shapes and setal types. 27, abdomen margin with lateral bulges, character N44; 28, abdomen margin serrate (typical of many Spondylaspididae), character N44; 29, capitate seta, showing hollow structure (as observed with a scanning electron microscope); 30, rod seta; 31, lanceolate seta; 32, sectaseta, pointed and without a ring; 33, sectaseta, pointed and with a ring.

- (v) Outer circum-anal ring broken at two or more places (Fig. 97).
- (vi) Circum-anal ring very small and remainder of pore-field arranged as bands (Fig. 155).
- (vii) Circum-anal ring absent – otherwise as (vi).
- (viii) Circum-anal ring plus round or ovoid groups of pores which are probably derived from an outer ring (Fig. 99).
- (ix) Small groups of pores (Fig. 154).
- (x) Individual or grouped pores arranged in rings (Fig. 123) or broken rings (Fig. 119).
- (xi) Small groups of pores dispersed in anal region, no circum-anal ring (Fig. 129).

Ferris (1928a) discussed the homology of the anal pore-field. He concluded that the pore rings of *Euphalerus gallicolus* (iv) were not homologous with the circum-anal ring. However, species were observed whose circum-anal rings were constricted, suggesting a tendency to break into separate rings, e.g. *Livia* spp. feeding on *Carex* (Fig. 111) and *Macrohomotoma gladiatum* (Fig. 148). This breakage of the circum-anal ring is complete in *Livia* spp. feeding on *Juncus* (Fig. 110) and in *M. striata* (Fig. 149). This suggests that the pore rings of *E. gallicolus* (Fig. 120) may be of similar origin, i.e. homologous with the circum-anal ring. Groups of pores (type x) may represent a reduction of pore rings (of type ii, iii or iv) as in *Eucalyptolyta* sp. (Fig. 119). Further breakdown may result in isolated pore groups (type xi) as in many Spondylaspidinae (Fig. 129). The homology of pore bands (type vi & vii), e.g. *Mesohomotoma hibisci* (Fig. 155), remains uncertain although they may derive from the outer circum-anal ring.

### Setal types and chaetotaxy

*Simple setae*, including the ring-based setae of Lal (1937), are simple articulated hairs showing a general distribution over many body parts in all major groups. It may be possible to homologue the positions of some of these setae within a few groups. Because this study is concerned with formation of, and the relationships between higher groups, these setae are not further considered.

*Capitate setae* (Ossiannilsson, 1970) or spatulate setae (Klyver, 1931; Lal, 1937) are defined as any seta which is apically dilated. Under the SEM the apex appears to be 'cup-like' (Fig. 29) and broken setae reveal a hollow structure. Capitate setae are found on the head, dorsal surface of the thorax, wing-pads, tibia and abdomen of many Psyllidae. These setae are also found singly or in pairs at the tarsal apices of many psyllids and they are best developed in most Spondylaspidinae (Fig. 38).

*Clavate setae* (Ferris, 1923) are very short setae with a narrow base broadening gradually to maximum breadth just prior to the blunt apex (Fig. 172). Clavate setae are observed in *Arepuna* sp., many *Diaphorina* spp. and some Triozidae. In some individual species of *Diaphorina* they occur together with lanceolate setae while in some Triozidae they occur together with sectasetae or scales. Clavate setae are very small and difficult to observe. In reality they may be modified lanceolate setae, sectasetae or scales.

*Sectasetae* (Ferris, 1923; Boselli, 1929; Lal, 1937). These include dagger-shaped and spear-shaped setae (Lal, 1937), and dagger-like setae (Klyver, 1931). Sectasetae are defined as setae having an angle (Fig. 32) or ring (Figs 33, 34), around their circumference, in the basal third which is visible under phase contrast. Sectasetae arranged in the 1 + 1, 2 + 2, 3 + 3 and 4 + 4 pattern, spaced from the next by more than their own length (Fig. 37), along the abdomen margin occur in two forms. In *Ciriactremum* spp., *Euceropysylla* spp., *Insnesia glabruscuta* and *Isogonoceraia divergipennis* they are tubular. However, these sectasetae are pointed in other Psyllidae. Species with this precise arrangement of abdomen margin sectasetae normally lack sectasetae on other body areas. The only exceptions are *Neopsyllia* spp. and *Platycorypha princeps* each of which have a single sectaseta on the hindwing-pad margin.

Pointed sectasetae (Figs 32–33) arranged in large numbers on many body areas are a feature of some Aphalaridae, some Carsidaridae and some Triozidae. However, on most Triozidae the

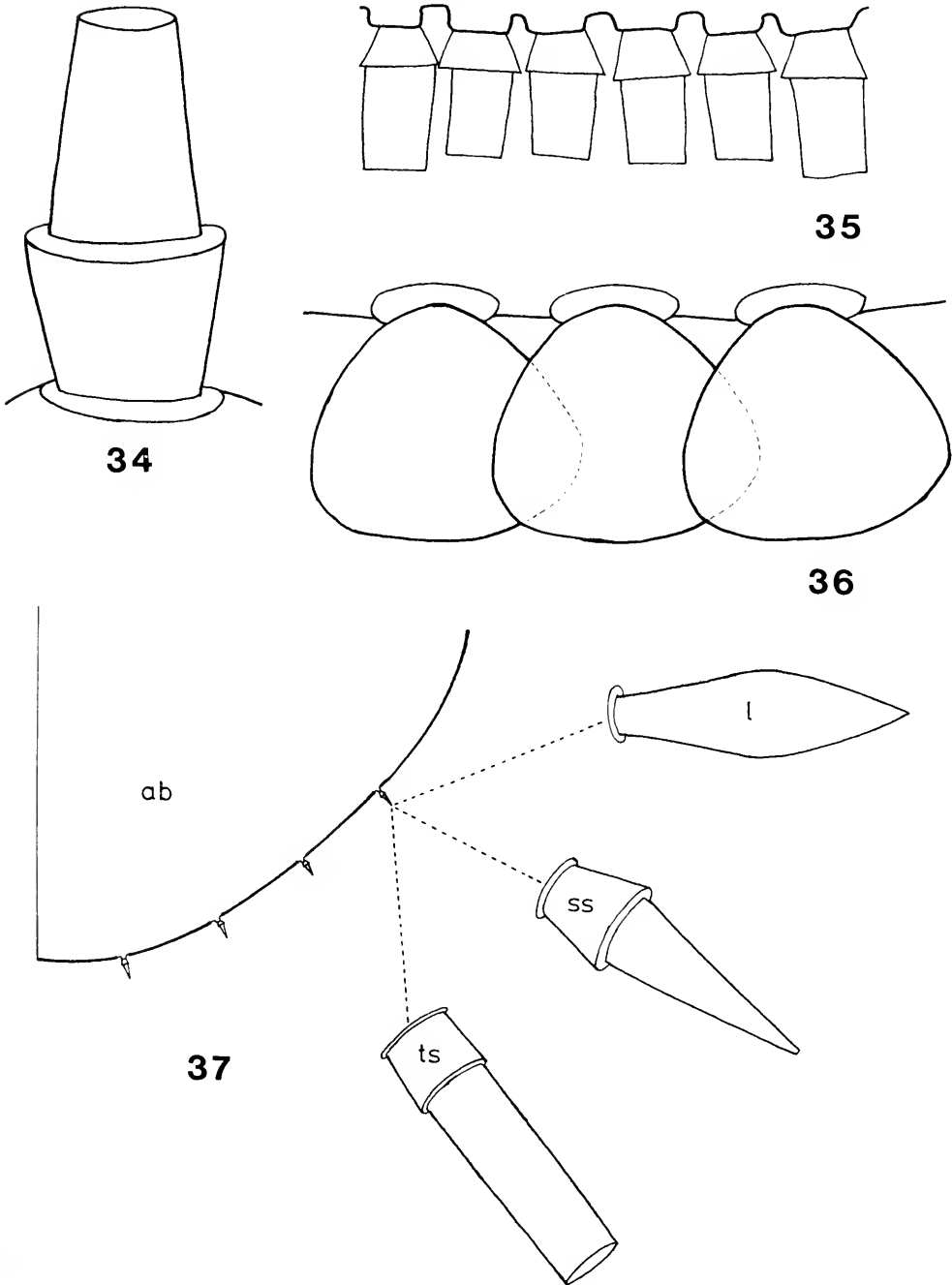

**Figs 34–37** Setal types and chaetotactic arrangements. 34, sectaseta, truncate and with a ring; 35, truncate sectasetae on a body margin, adjacent to each other, character N25; 36, scales on a body margin (typical of many Hawaiian Triozidae); 37, the positions in which up to 4 + 4 setae are placed on the abdomen margin of many Psyllidae, and the three types of setae which occupy these positions, namely lanceolate (e.g. *Mitrapsylla deserata*), pointed sectaseta (e.g. many *Psylla* spp.) and the tubular shaped truncate sectaseta of *Ciriacremum* spp. (ab – abdomen; l – lanceolate seta; ss – sectaseta; ts – tubular sectaseta).

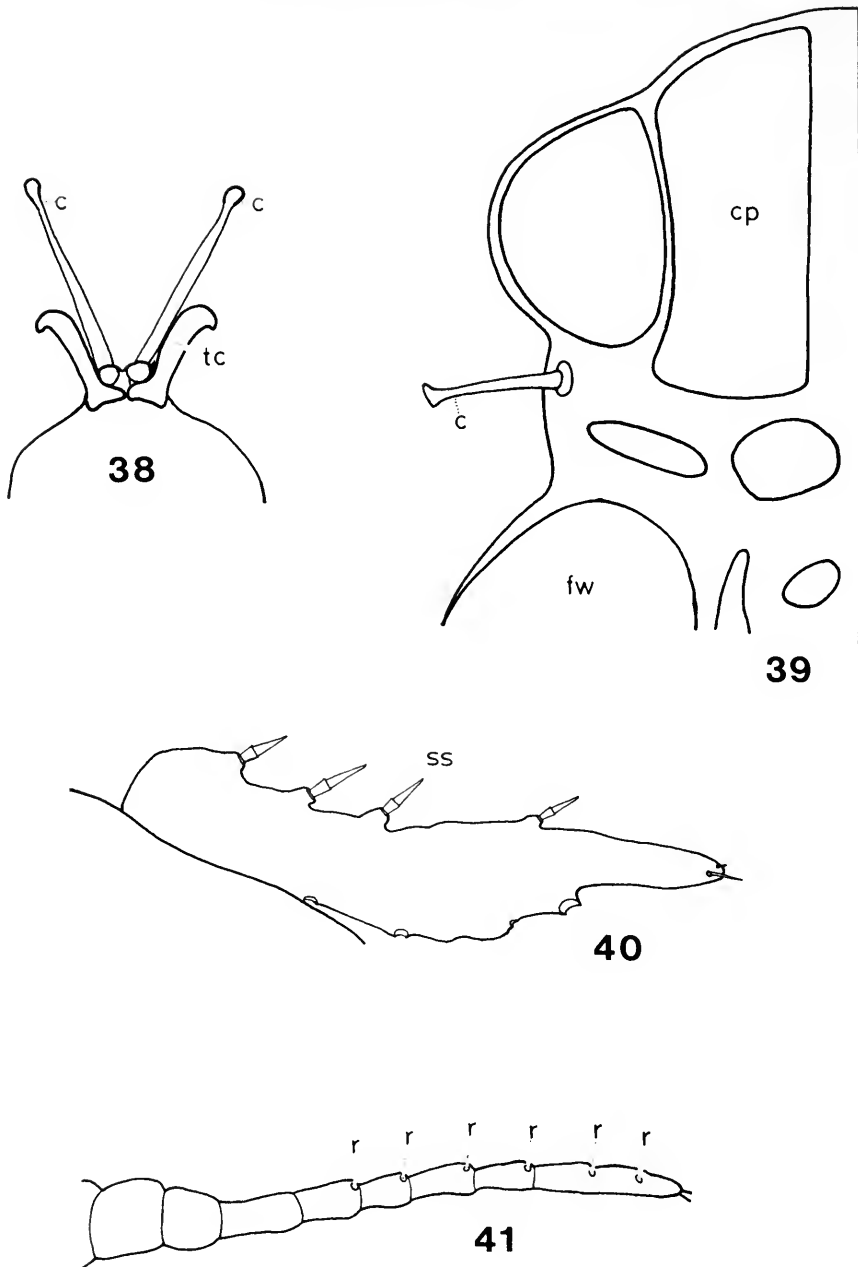

**Figs 38–41** Chaetotactic arrangements and antennae. 38, a pair of capitate setae at the apex of a tarsus (these setae are especially well developed in many Spondyliaspidae), characters N20–N22; 39, a capitate seta placed behind the eye, character N13. Antennae. 40, *Calophya californica*; 41, *Gyropsylla spegazziniana*. (c – capitate seta; cp – cephaloprothorax; fw – forewing-pad; r – rhinaria; ss – sectaseta; tc – tarsal claw.)

sectasetae are truncate (Fig. 34). Three distribution patterns of sectasetae could be recognised on the antennae. One row on the opposite side to the rhinaria occurs in many *Calophya* spp. (Fig. 40) while one row adjacent to the rhinaria occurs in *Diclidophlebia eastopi*. Species with more than one row (Fig. 45) are *Moraniella calodendri*, *Paraphalaroida fremontiae*, *Paurocephala* spp. and *Togepsylla matsumurana*.

*Lanceolate setae* (Ferris, 1923; Boselli, 1929; Rahman, 1932; Lal, 1937) are defined as stout setae with a convex profile and a constricted base (Fig. 31). The maximum breadth of the seta is normally in the basal two-thirds. Lanceolate setae are a feature of most Aphalaridae, Diaphorini and *Psyllopsis* spp. They are also observed in a few Carsidaridae (e.g. *Epicarsa* sp., *Mycopsylla fici* and *Pseudophacopteron floccosa*) and some Spondyliaspidae (*Ctenarytaina eucalypti*, *Eucalyptolyma* sp. and *Phellopsylla* sp.). *Homotoma ficus* has lanceolate setae based upon tall tubercles (Fig. 171).

*Heteropsylla* spp. have lanceolate setae arranged 3 + 3 in positions resembling the similarly placed sectasetae in many species of Psyllidae (Fig. 37). These lanceolate setae are treated as homologous with similarly placed sectasetae and not with other lanceolate setae.

*Scales* are defined as broad, apparently flat setae with a narrow base (Fig. 36) which are placed marginally on some New World and Hawaiian Triozidae.

*Rod setae* are long, parallel or subparallel-sided, with a constricted base (Fig. 30), and they are found covering the bodies of *Aphalaroida pithecolobia*, *Euglyptoneura robusta*, *Pexopsylla cercocarp*i and *Psylla ulmi*.

All attempts to recognise homology of setal positions across the whole of the Psylloidea failed except in one case, i.e. a single capitate seta placed laterally or sublaterally behind each eye (Fig. 39). In general the specialised setae occur in large numbers in any one body area. It is assumed that at least some of the setae in one body area of one species are homologous with some of the same type of seta in the same body area in any other species. The only exception to this rule is the sectasetae and lanceolate setae on the margin of the abdomen. Two arrangements of these setae were recognised: a set of one to four pairs spaced well apart (Fig. 37) and secondly much larger numbers with no obvious individual positions.

### Selection of nymphal characters

A set of 88 ordered multistate and two-state characters were initially defined. From these characters those most likely to be of value in forming major groups were selected for a detailed series of analyses.

For character selection the ordered multistate characters were recoded into 120 additive two-state characters (Sneath & Sokal, 1973). Characters which correlated with large numbers of other characters were identified by the SUMRAT information statistic (Legendre & Rogers, 1972). Only those characters having a SUMRAT value in excess of the mean value were accepted (Baum, 1977). Characters selected by this method were almost identical with those selected by an examination of character eigenvector values in a principal component analysis, carried out on the original character covariance matrix (see Davies & Boratynski, 1979 for method).

After these initial analyses, 45 selected two-state characters remained and these were combined to form 34 ordered multistate and two-state characters (Table 4). Rejected characters are summarised in Table 5.

Once the number of characters has been reduced to 34, many species are identical as defined by the selected character set. Forty-eight species groups were formed, and one representative species was chosen from each (Table 6). The 134 species which remain distinct are also listed in Table 6, making a total of 182 selected species. All subsequent phenetic analyses are conducted using the 34 selected characters and the 182 selected species.

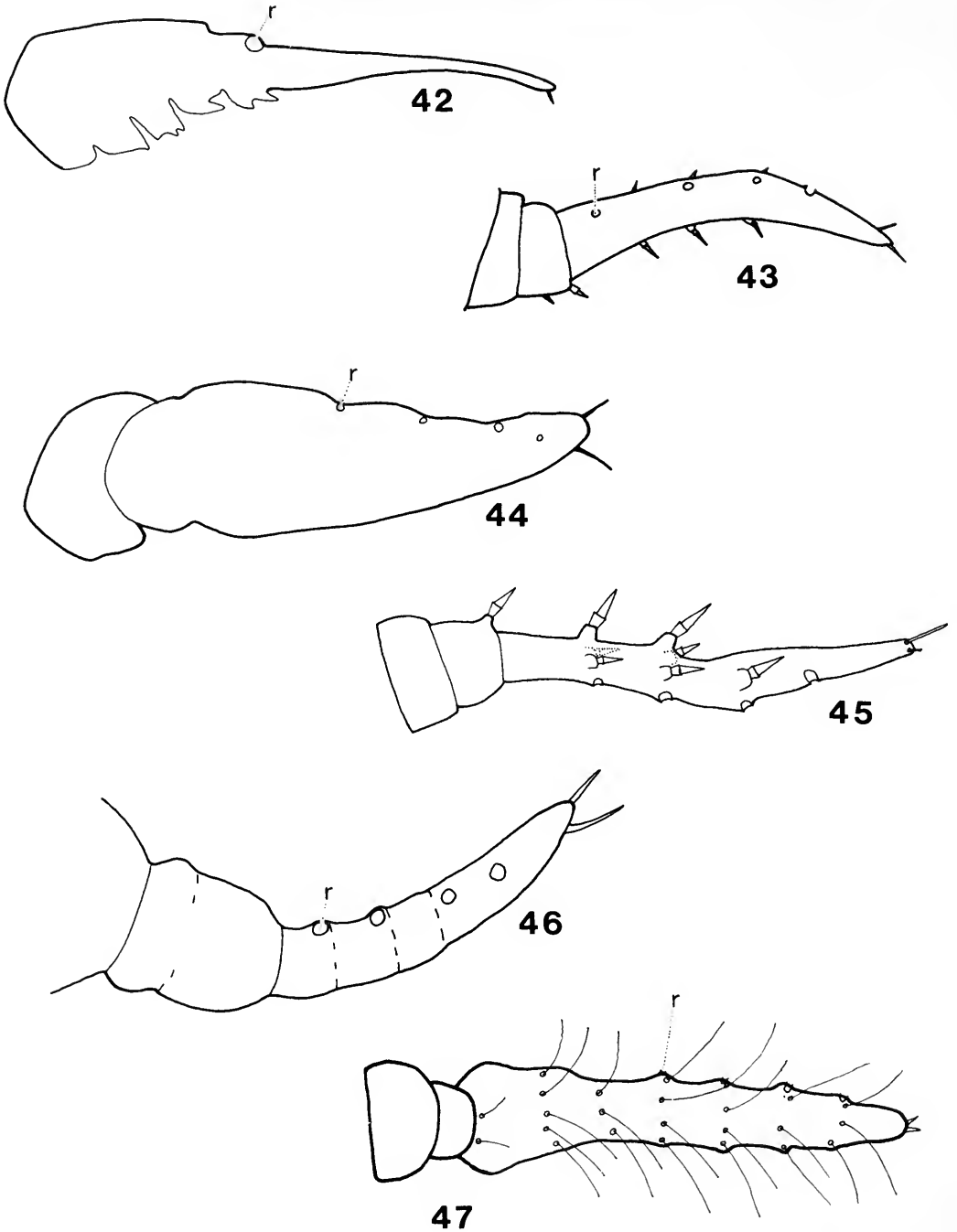

Figs 42-47 Antennae. 42, *Microceropsylla* sp.; 43, *Moraniella calodendri*; 44, *Mycopssylla gardenensis*; 45, *Paurocephala gossypii*; 46, *Pauropsylla depressa*; 47, *Phacopteron lentiginosum*. (r - rhinaria.)

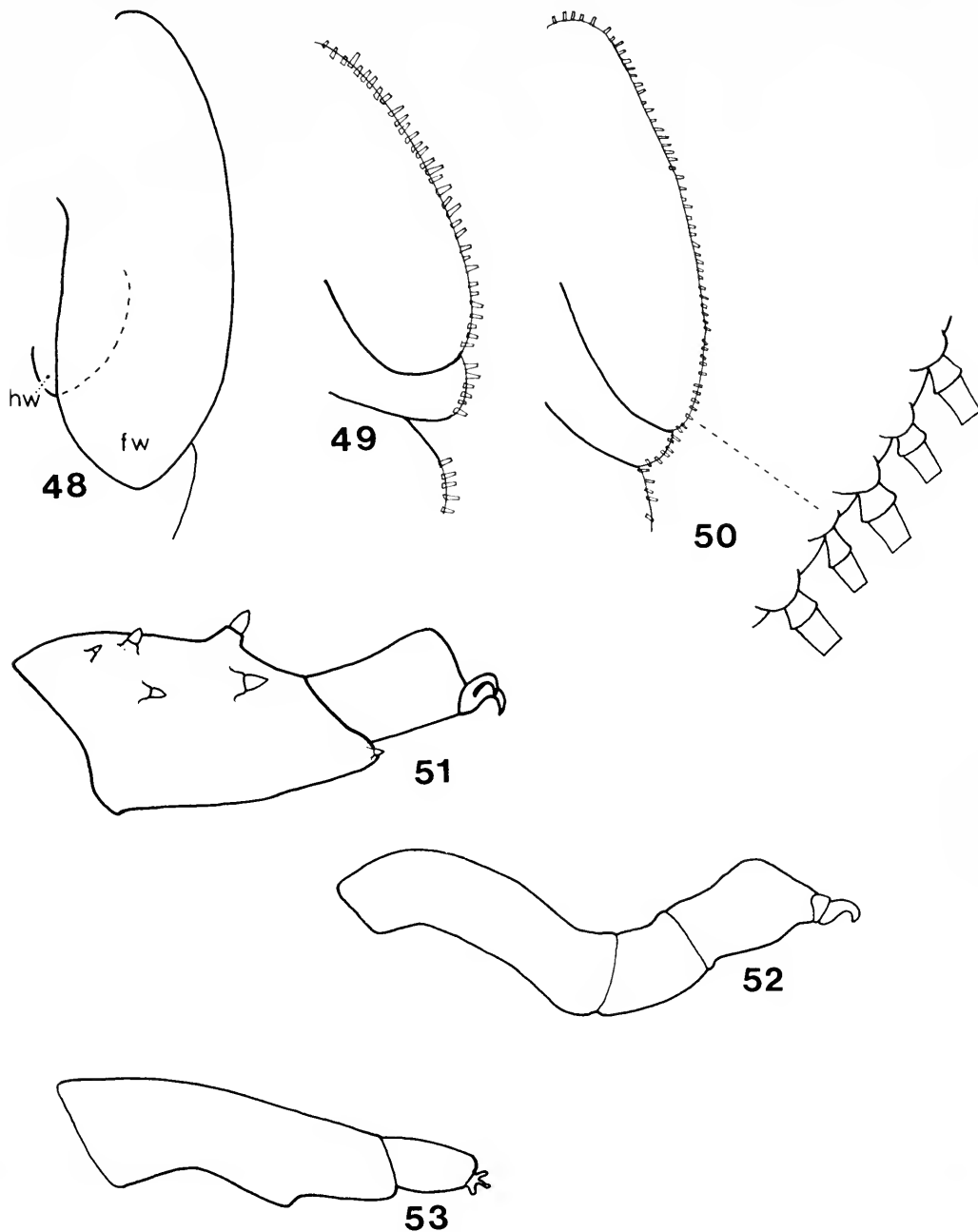

**Figs 48–53** Wing-pads, hind tibia and tarsi. 48, *Leptynoptera sulfurea* wing pads, showing reduced hindwing-pad corresponding to the dipterous adult. Wing-pads and chaetotaxy, 49, *Pauropsylla trichaeta*; 50, *Trioza chenopodii*. Hind tibia and tarsi, 51, *Camarotoscena unicolor* showing tibiotarsus (tibia + tarsal segment I) and the differentiated tarsal segment II; 52, *Pelmatobrachia* sp. showing the tibia and both tarsal segments differentiated; 53, *Phytolyma fusca* showing tibiotarsus and tarsal segment II. (fw – forewing-pad; hw – hindwing-pad.)

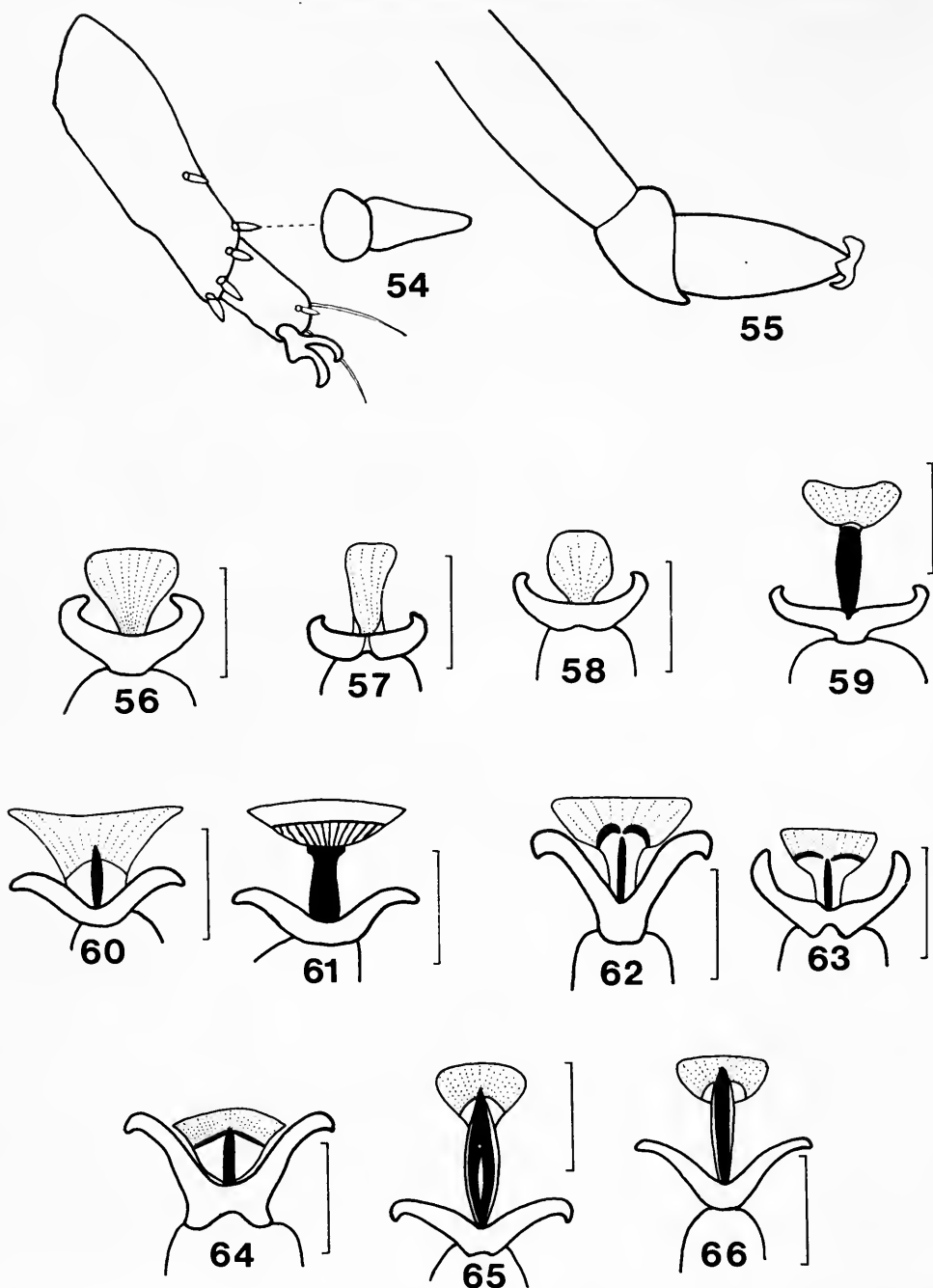

**Figs 54–66** Hind tibia and tarsi, and tarsal arolia (uniguitractor shown in black). Hind tibia and tarsi, 54, *?Pseudophacopteron floccosa* (*?Chineura* sp.) showing tibiotarsus, tarsal segment II and associated setae; 55, *Togepssylla* sp. showing both tarsal segments separate to tibia. Tarsal arolia of Aphalarinae: 56, *Aphalara persicaria*; 57, *Colposcena* sp.; 58, *Gyropsylla ilicis*. Tarsal arolium of Aphalaroidinae: 59, *Aphalaroida ? pithecolobia*. Tarsal arolium of Diaphorininae: 60, *Diaphorina solani*; 61, *Psyllopsis fraxinicola*. Tarsal arolium of Euphyllurini: 62, *Euphyllura ? aethiopica*; 63, *Neophyllura (Arbutophila) arbuti*; 64, *N. (N.) arctostaphyli*. Tarsal arolium of Paraphalaroidini: 65, *Diclidophlebia eastopi*; 66, *Paraphalaroida fremontiae*. Scale line represents 0.05 mm.



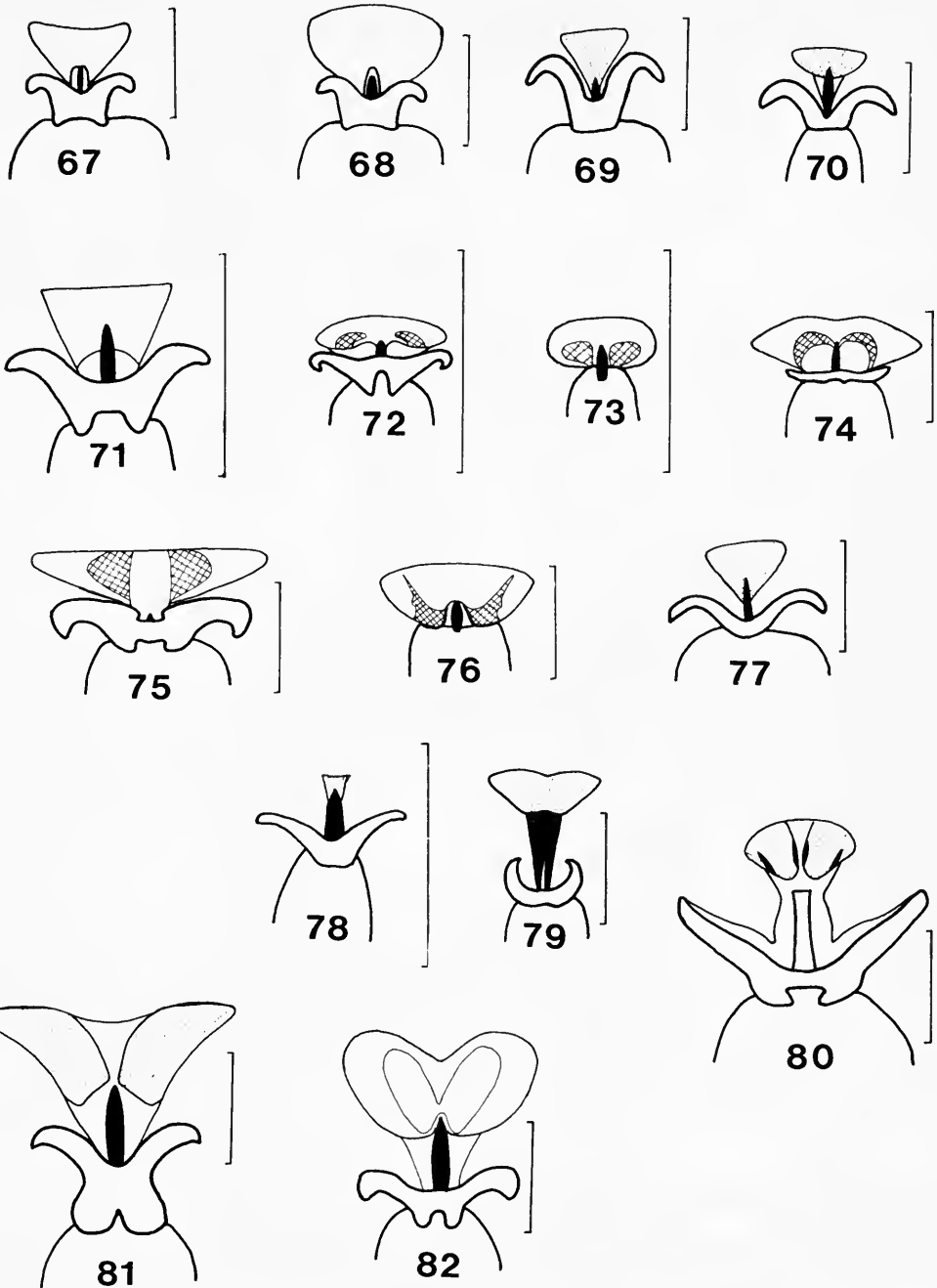

**Figs 67–82** Tarsal arolia (unguitractor shown in black). Liviinae: 67, *Livia maculipennis*; 68, *L. vernalis*. Paurocephalinae: 69, *Camarotoscena unicolor*; 70, *Paurocephala urenae*. Strophingiinae: 71, *Strophingia ericae*. Rhinocolinae: 72, *Agonoscena* sp. (A); 73, *Leurolophus vittatus*; 74, *Moraniella calodendri*; 75, *Rhinocola aceris*; 76, *Tainarys schini*. Euphalerinae: 77, *Euphalerus nidifex*; 78, *Retroacizzia antennata*. Psyllidae: 79, *Acizzia acaciaebaileyanae*; 80, *A. uncatoides*; 81, *Anomoneura mori*; 82, *Ciriactremum julbernardioides*. Scale line represents 0.05 mm.

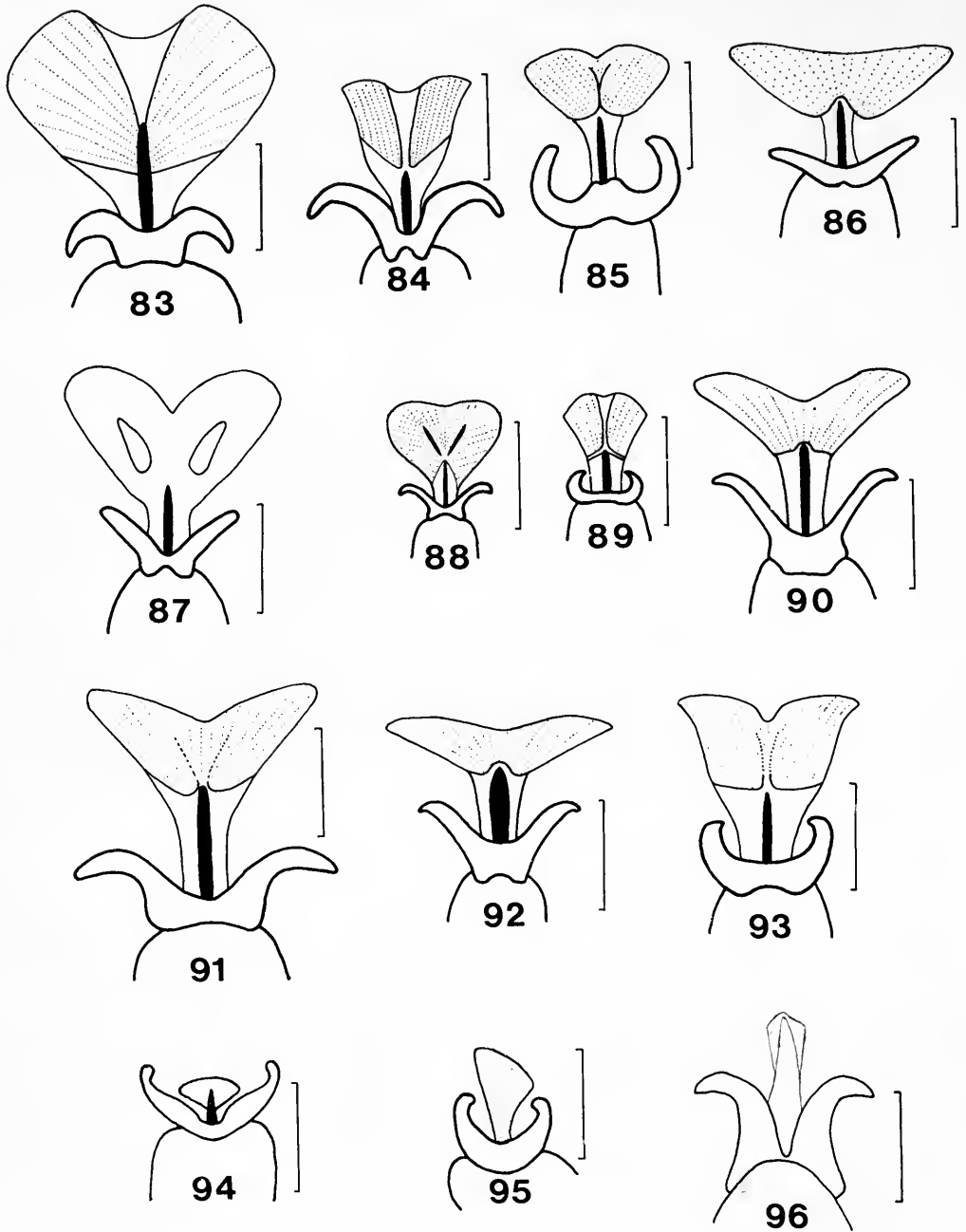

**Figs 83–96** Tarsal arolia (uniguitractor shown in black). Psyllidae: 83, *Epipsylla* sp. (A); 84, *Epipsylla* sp. (B); 85, *Euceropsylla cayeyensis*; 86, *Freysuila* sp.; 87, *Insnesia disjuncta*; 88, *Isogonoceraia* sp.; 89, *Mitrapssylla deserata*; 90, *Neopsyllia erythinae*; 91, *Platycorypha princeps*; 92, *Psylla parallela*; 93, *Trigonon longicornis*. Phacopterionidae: 94, *Pseudophacopteron* sp. (A). Triozidae: 95, *Egeirotrioza* sp. (A); 96, *Trioza hirsuta*. Scale line represents 0.05 mm.

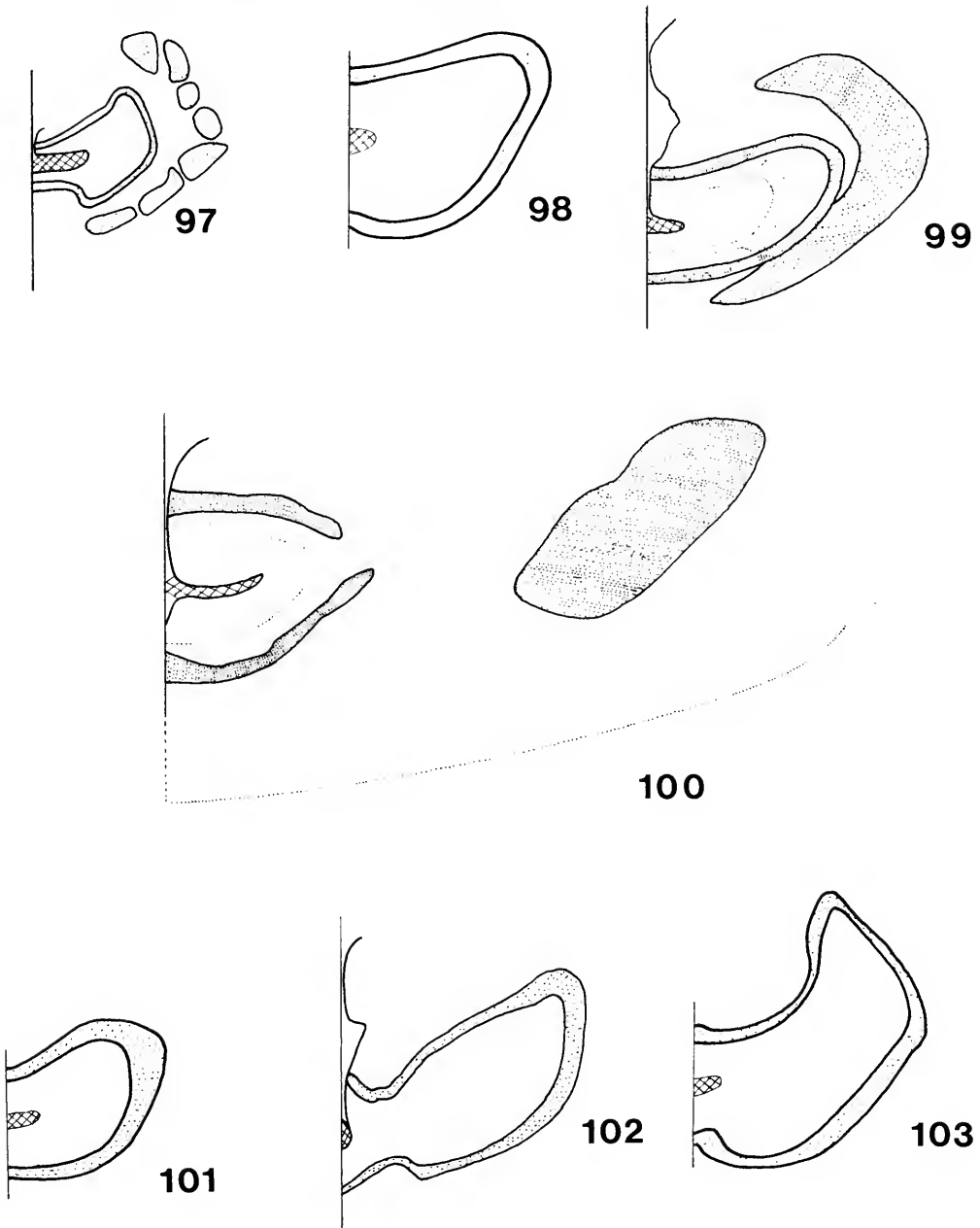

**Figs 97–103** Anal pore-fields of Aparidae. 97, *Agonoscena* sp. (A); 98, *Aphalara polygoni*; 99, *Camarotoscena speciosa*; 100, *C. unicolor* (broken line indicates position of abdomen margin); 101, *Craspedolepta nebulosa*; 102, *C. suaedae*; 103, *C. subpunctata*.

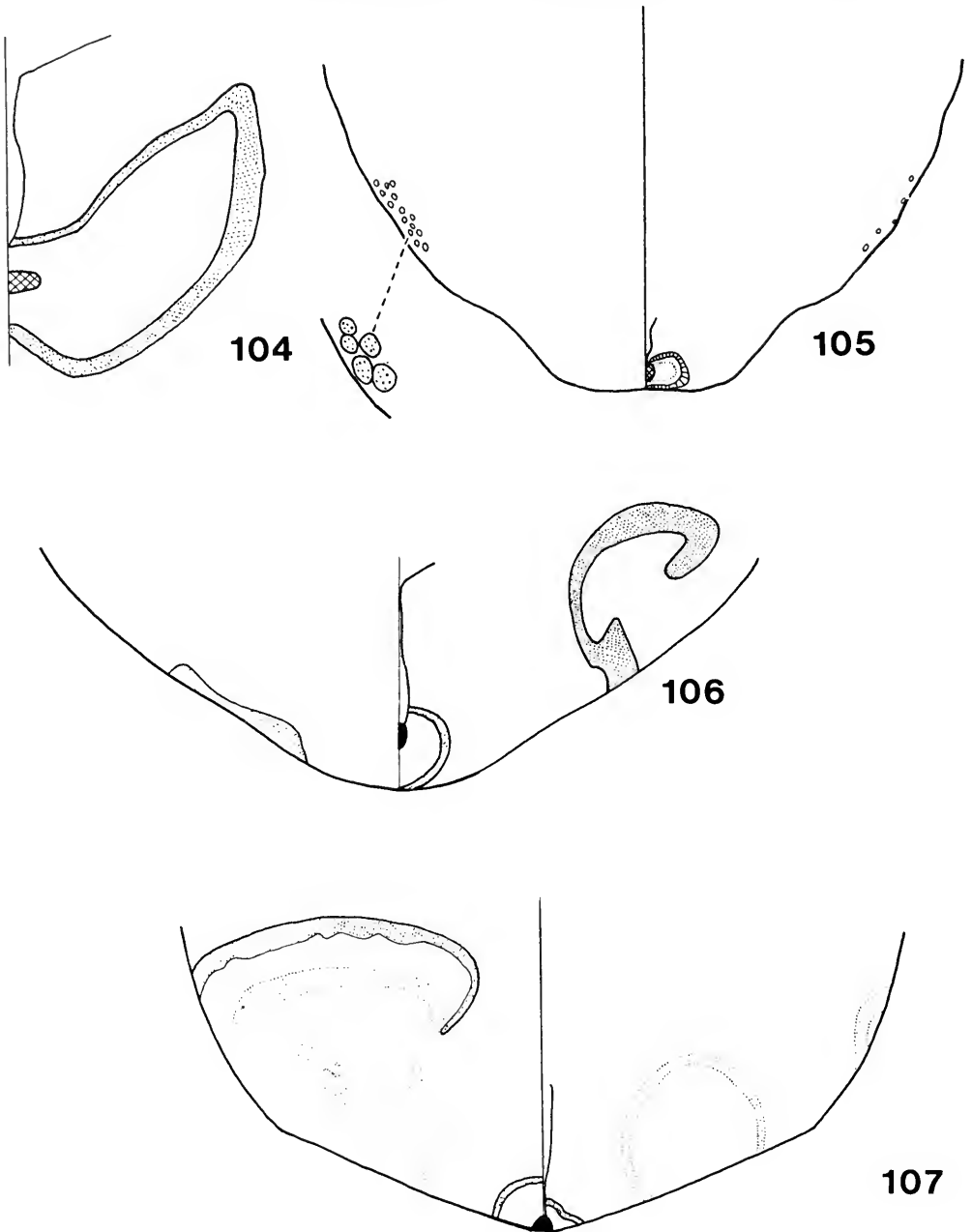

**Figs 104–107** Anal pore-fields of Aphalaridae. 104, *Craspedolepta* ? *vancouverensis*; 105, *Ctenarytaina eucalypti* (inset shows detail of pore-field); 106, *Diclidophlebia* ? *eastopi*; 107, *Euphyllura* ? *aethiopica*.

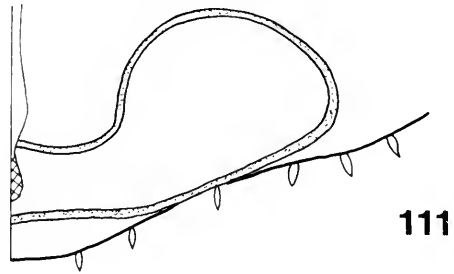
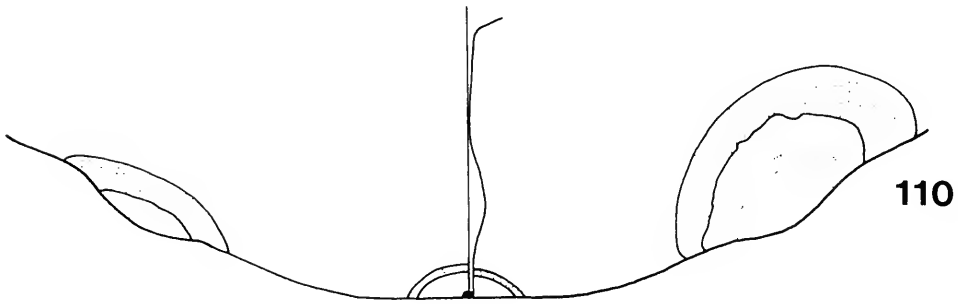
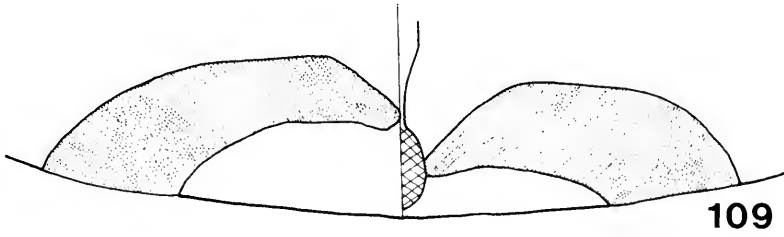
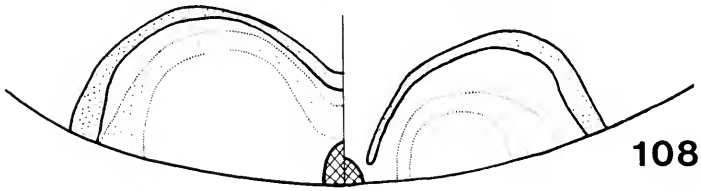

**Figs 108–111** Anal pore-fields of Aphalaridae. 108, *Gyropsylla ilicis*; 109, *Leurolophus vittatus*; 110, *Livia maculipennis*; 111, *L. vernalis*.

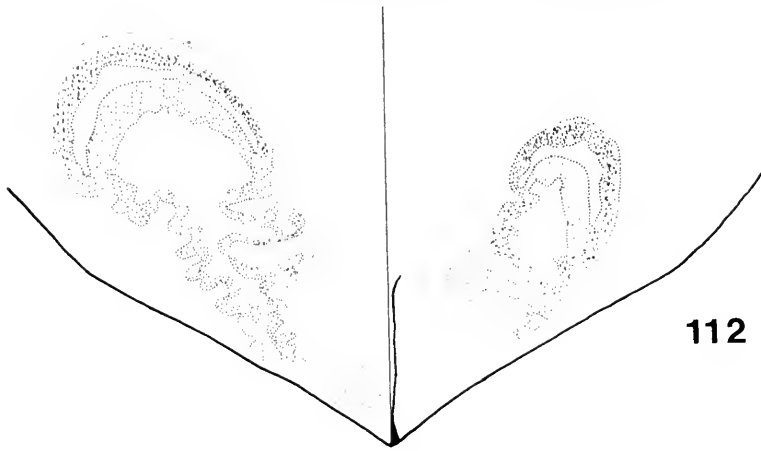

112

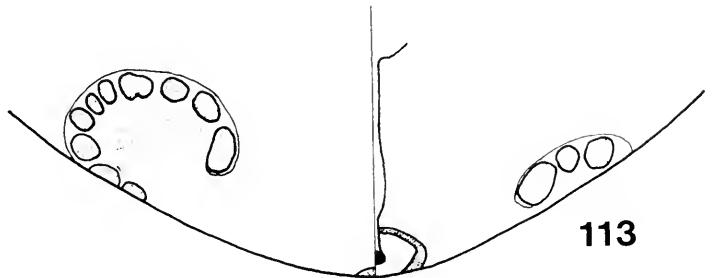

113

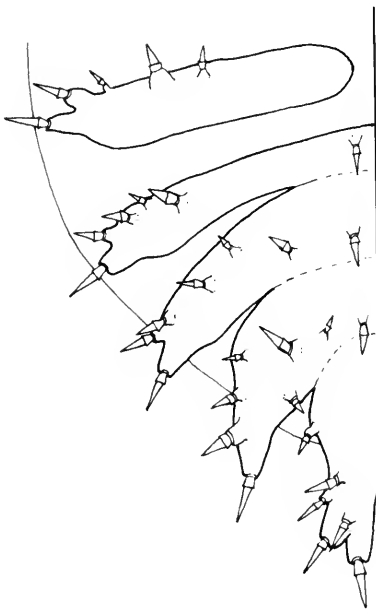

114

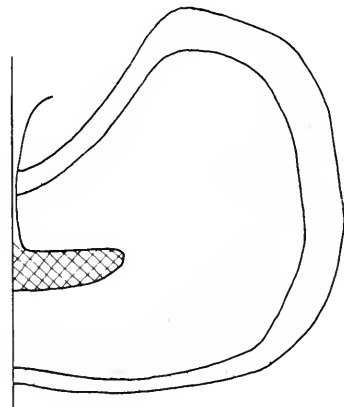

115

**Figs 112–115** Anal pore-fields of Aphalaridae. 112, *Neophyllura bicolor*; 113, *Paraphalaroida fremontiae*; 114, *Paurocephala gossypii*; 115, *Psyllopsis fraxinicola*.

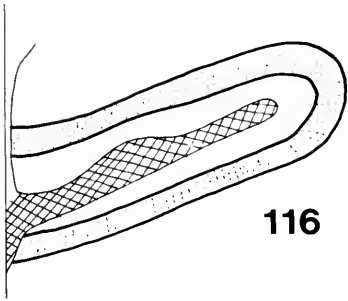

116

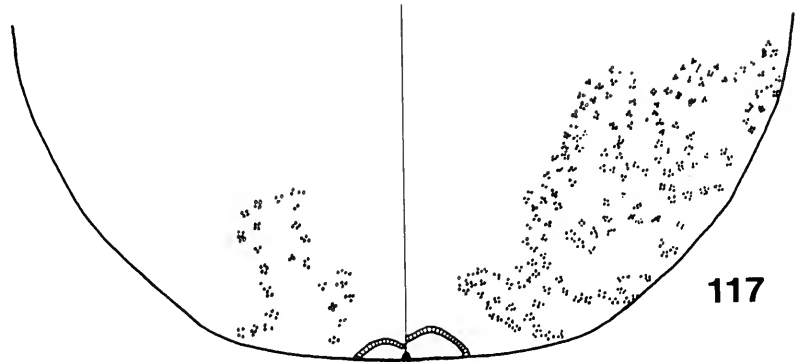

117

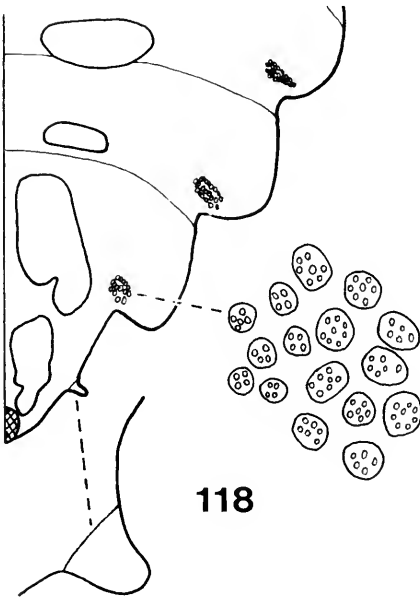

118

**Figs 116–118** Anal pore-fields. Aphalaridae: 116, *Strophingia cinereae*. Spondylaspididae: 117, *Colophorina cassiae*; 118, *Creiis* sp. (insets show pore details and 'tooth' at apex of abdomen).

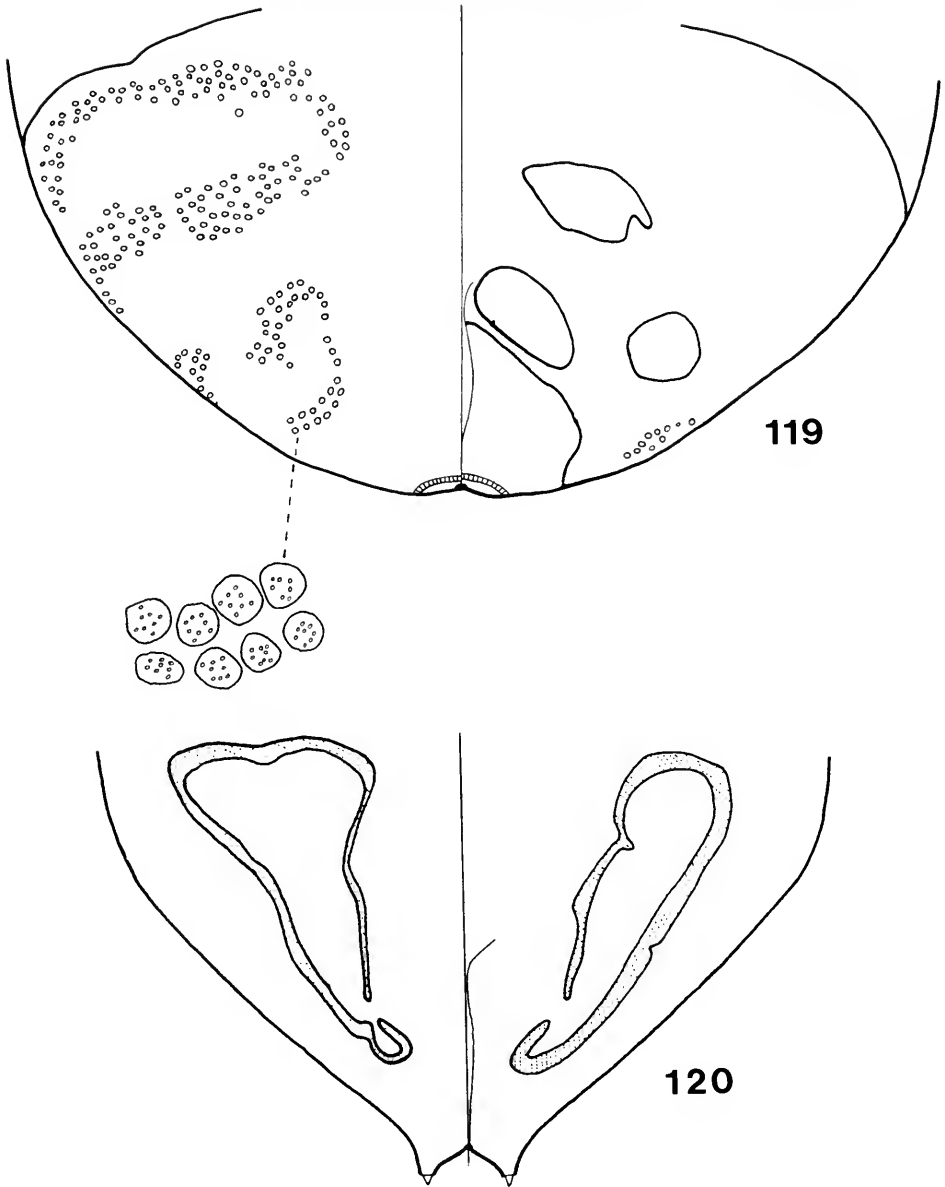

**Figs 119, 120** Anal pore-fields. Aphalaridae: 119, *'Eucalyptolyma'* sp. (inset shows detail of pore field).  
Spondyliaspidae: 120, *Euphalerus gallicolus*.



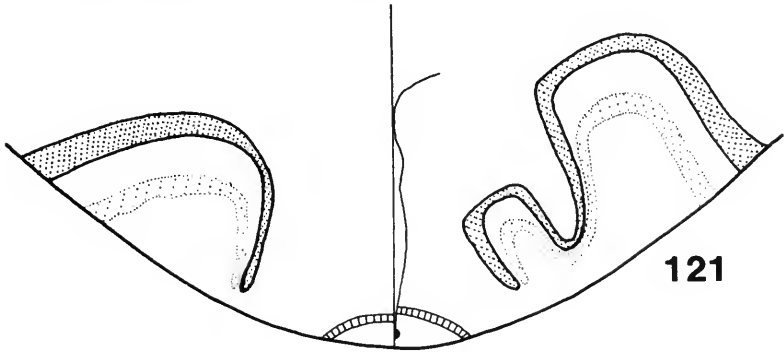

121

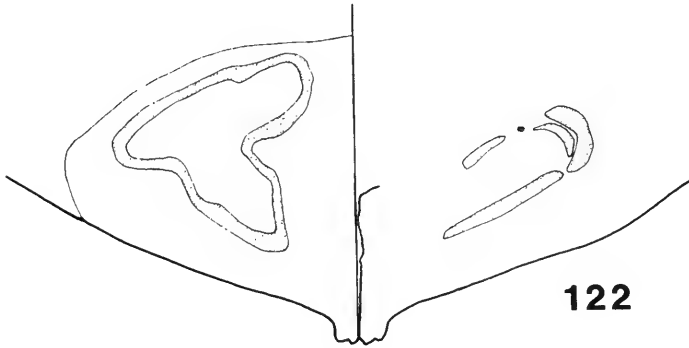

122

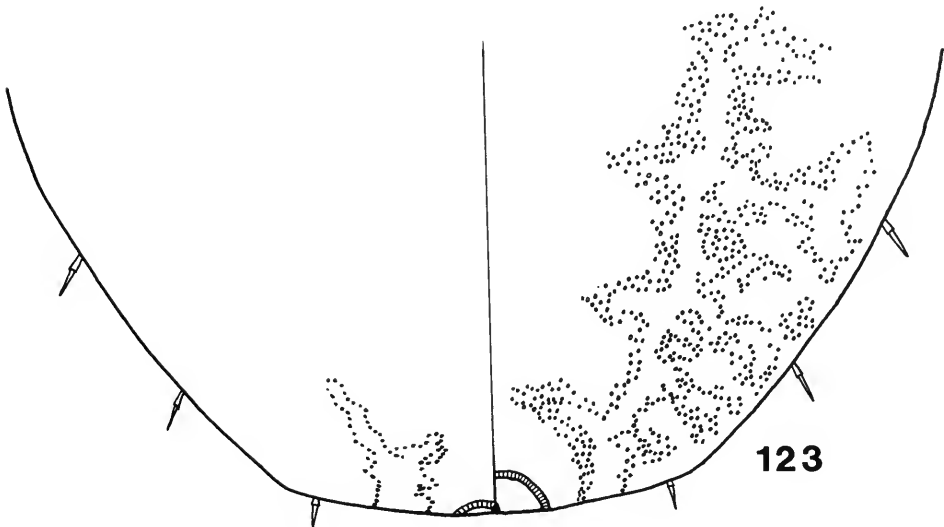

123

**Figs 121–123** Anal pore-fields of Spondyliaspidae. 121, *Euphalerus jugovenosus*; 122, *E. nidifex*; 123, *Euphalerus* sp. (A).

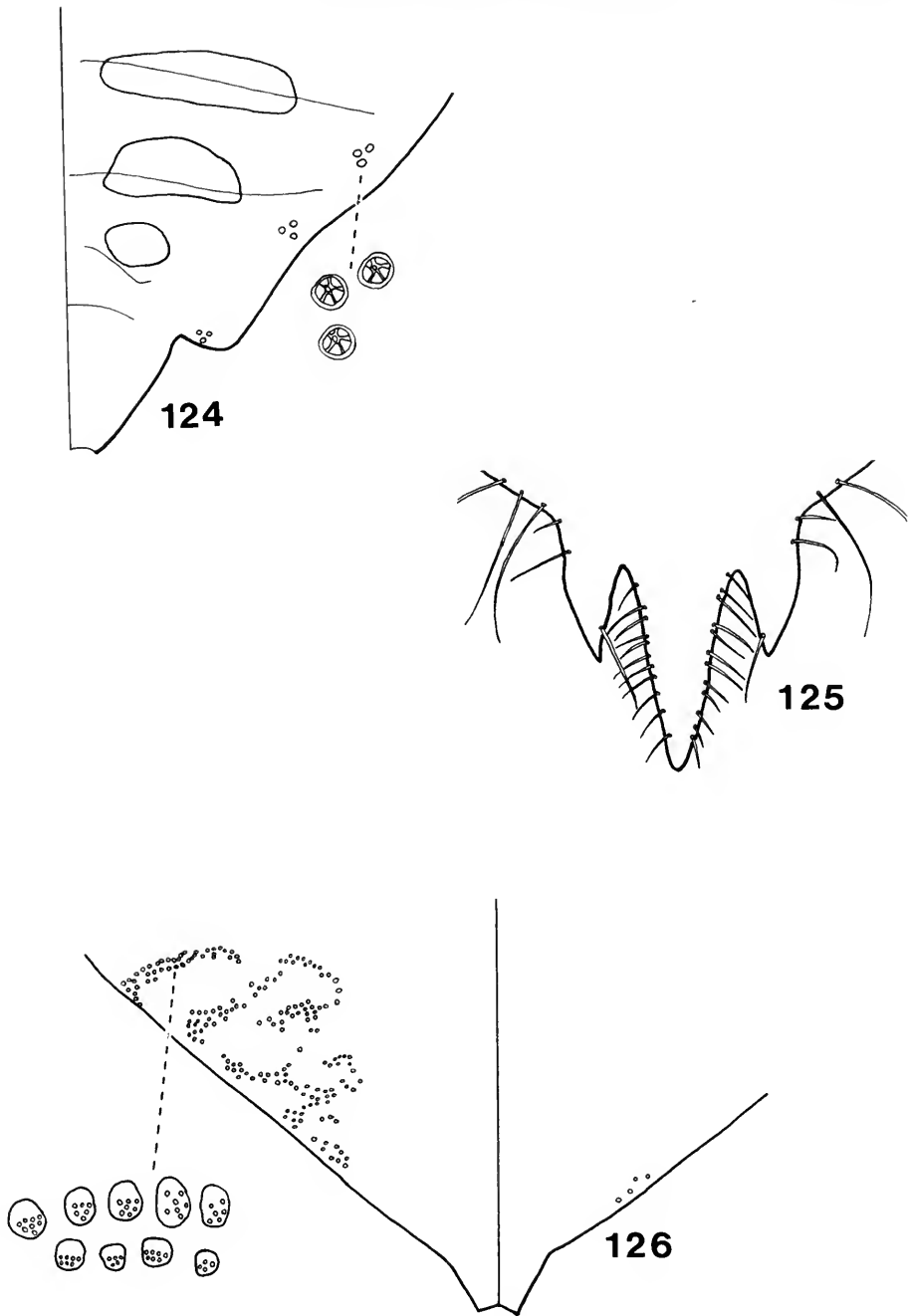

**Figs 124–126** Anal pore-fields and abdomen apex shapes of Spondyliaspidae. 124, *Glycaspis baileyi* (inset shows detail of pore-field); 125, *Pachypsylla celtidismamma*, which lacks a pore-field; 126, *P. japonica* (inset shows detail of pore-field).

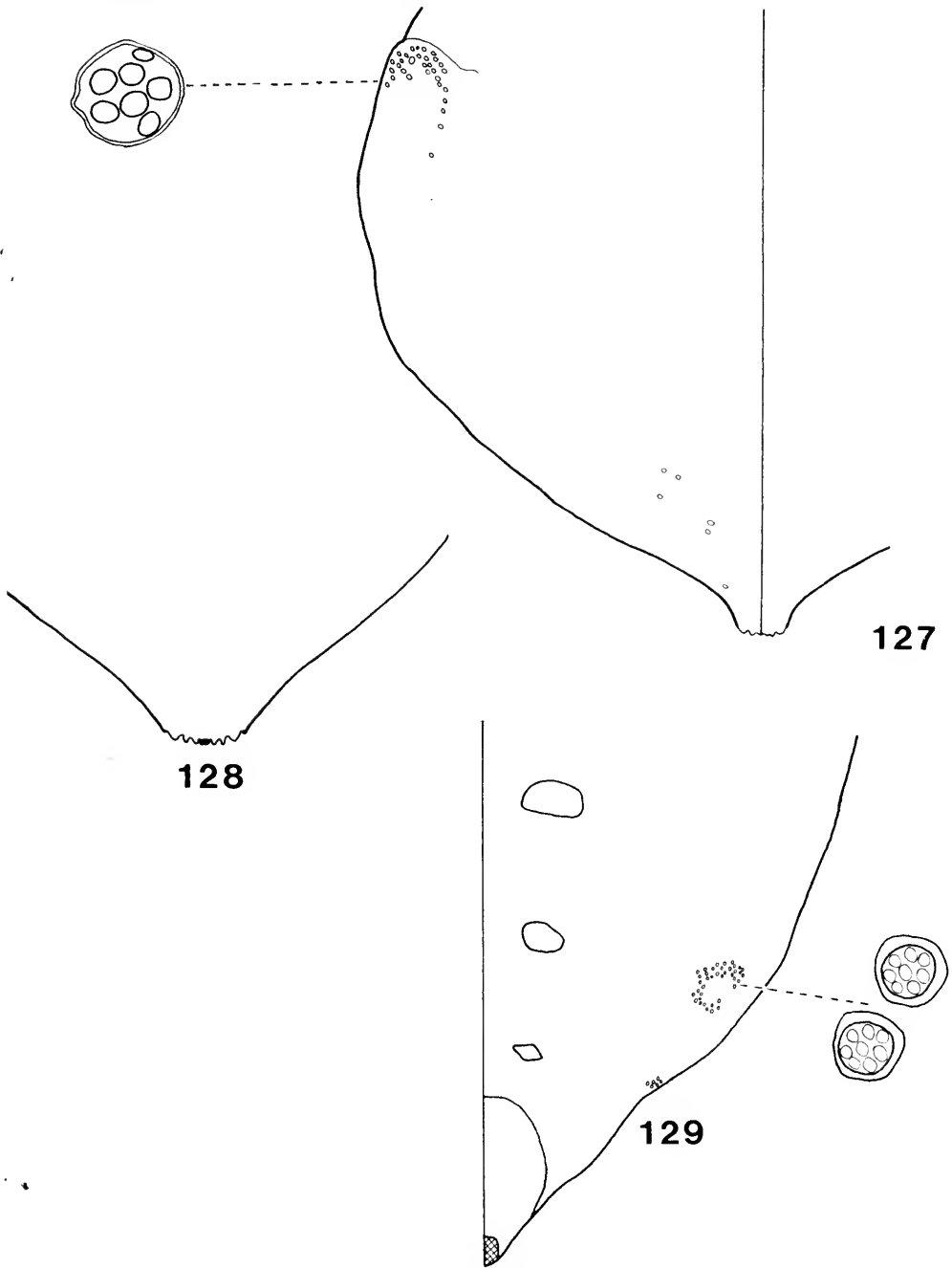

**Figs 127–129** Anal pore-fields and abdomen apex shapes of Spondyliaspidae. 127, *Phellopsylla* sp. (inset shows detail of a pore group); 128, *Retroacizzia antennata*, which lacks a pore-field; 129, *Spondyliaspis* sp. (inset shows detail of two of the pore groups).

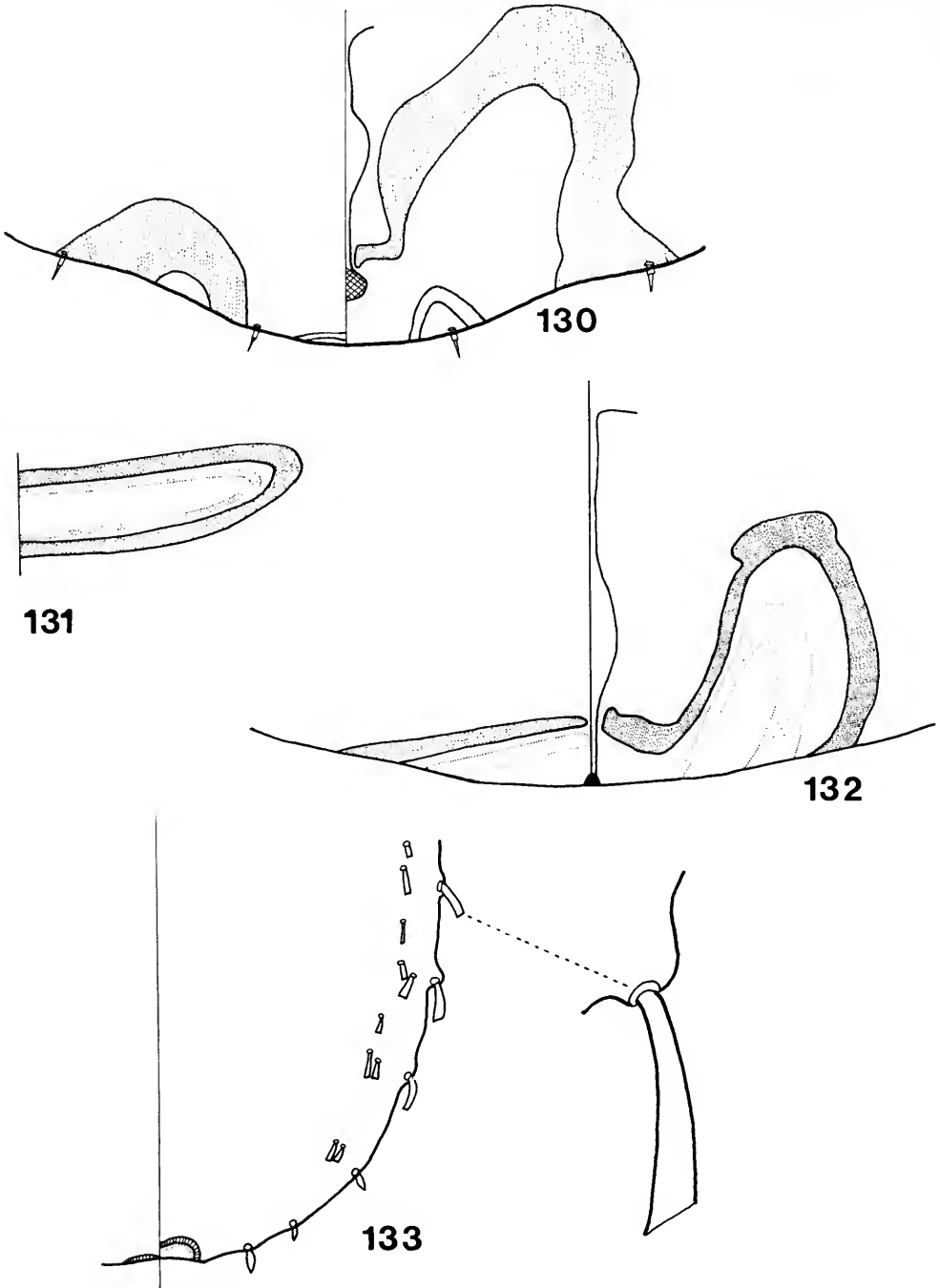

**Figs 130–133** Anal pore-fields and abdomen chaetotaxy of Psyllidae. 130, *Anomoneura mori*; 131, '*Euphalerus*' sp. (C); 132, *Euglyptoneura fuscipennis*; 133, *Mitrapsylla deserata* (inset shows detail of funnel setae).

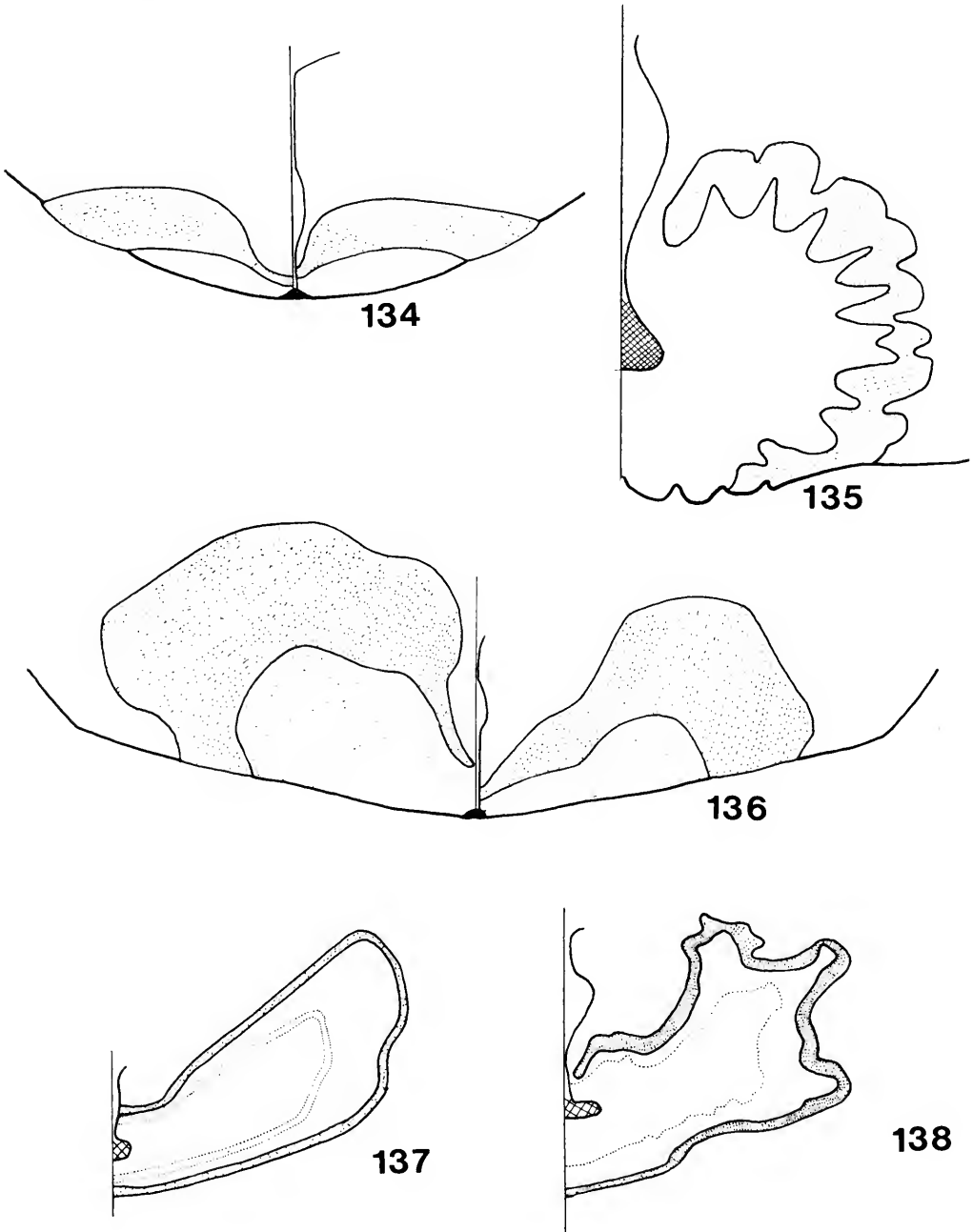

**Figs 134–138** Anal pore-fields of Psyllidae. 134, *Psylla buxi*; 135, *P. foersteri*; 136, *P. galeaformis*; 137, *P. phoradendrae*; 138, *P. pulchella*.

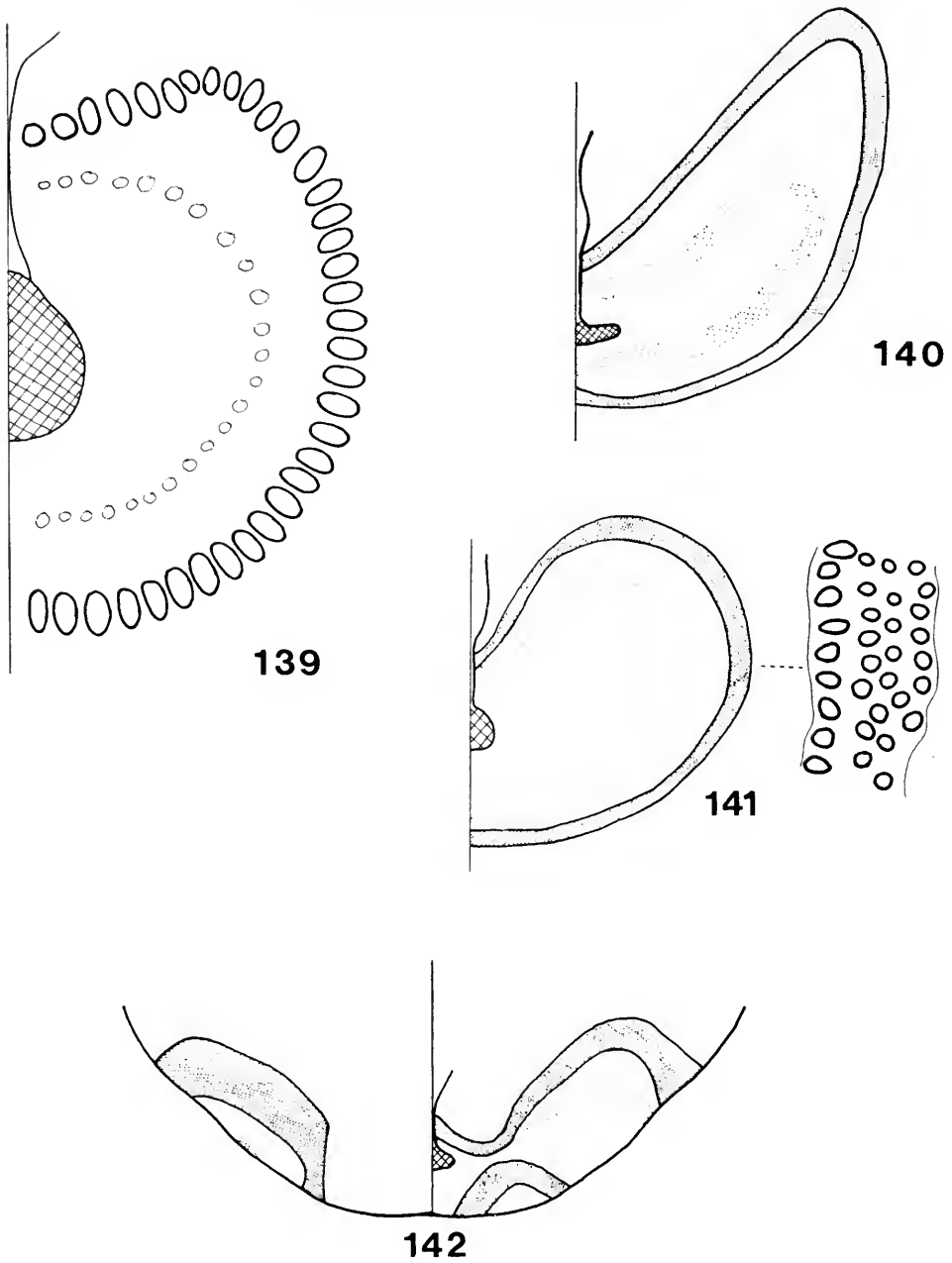

**Figs 139–142** Anal pore-fields of Psyllidae. 139, *Psylla saliceti*; 140, *P. simlae*; 141, *P. sorbi* (inset shows pore structure of part of outer circum-anal ring); 142. *Spanioneura fonscolombii*.

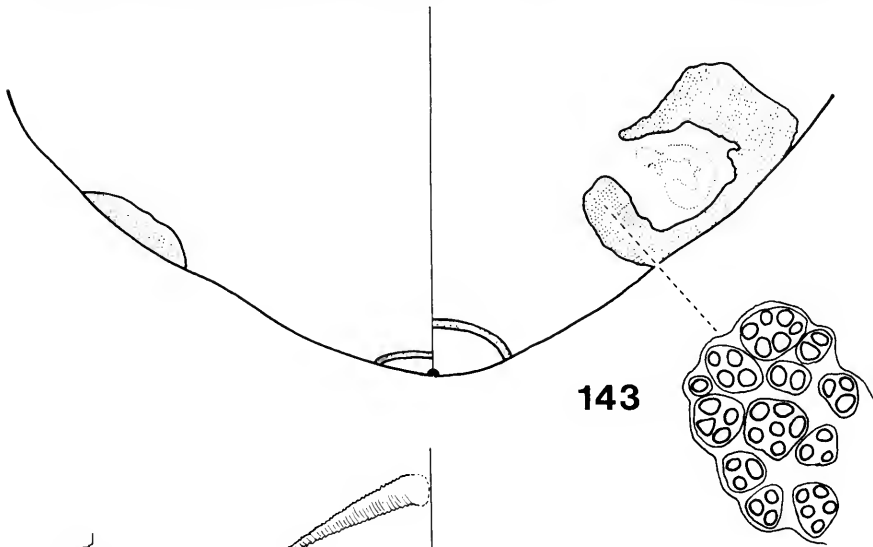

143

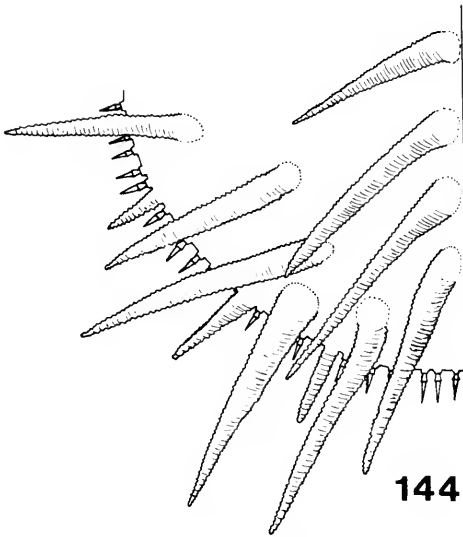

144

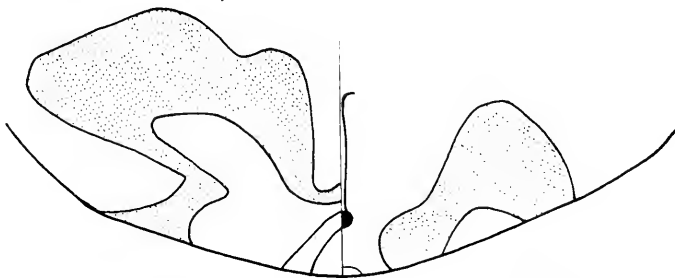

145

**Figs 143–145** Anal pore-fields and abdominal structures of Calophyidae and Phacopteronidae. Calophyidae: 143, *Apsylla cistellata* (inset shows pore structure of parts of the pore-field which is outside the circum-anal rings); 144, *Calophya californica*, showing the long processes which cover the dorsal surfaces of the abdomen and thorax. Phacopteronidae: 145, *Bharatiana octospinosa*.

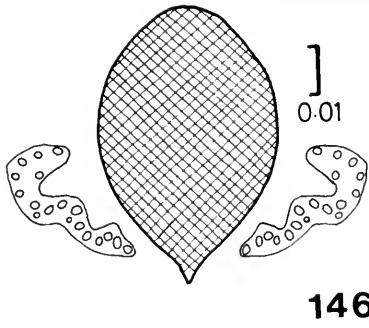

146

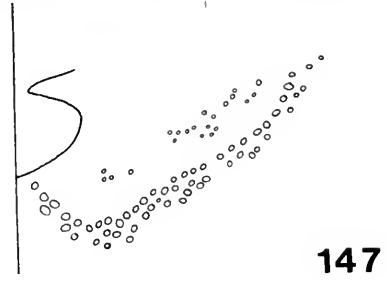

147

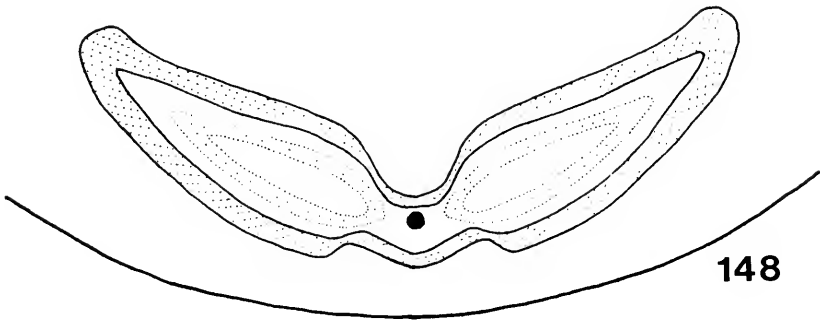

148

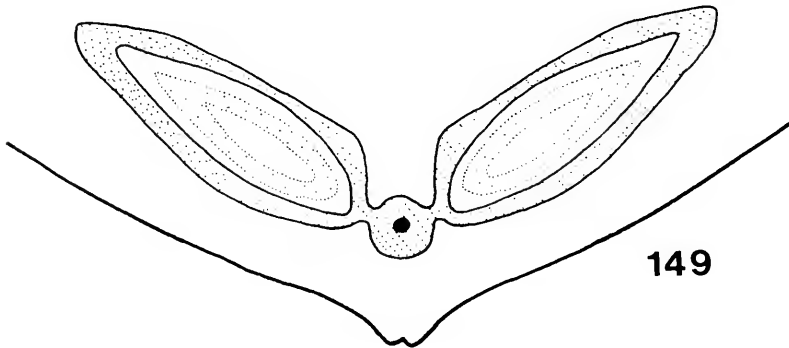

149

Figs 146–149 Anal pore-fields. Phacopteronidae: 146, *Phacopteron lentiginosum* (anus crosshatched); 147, *Pseudophacopteron* sp. (B). Homotomidae: 148, *Macrohomotoma gladiatum*; 149, *M. striatum*.



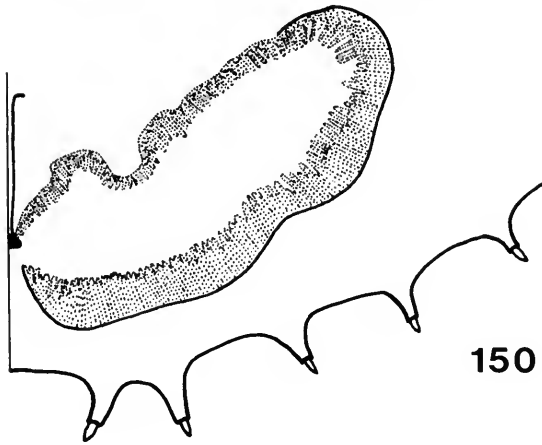

150

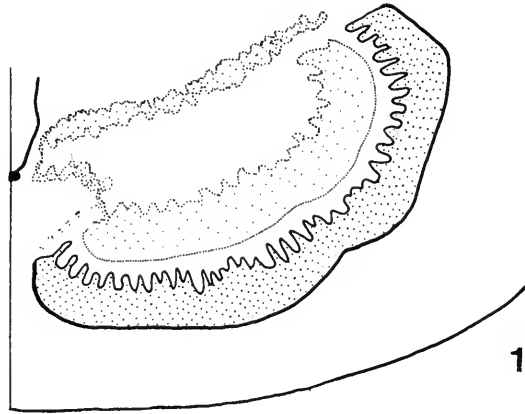

151

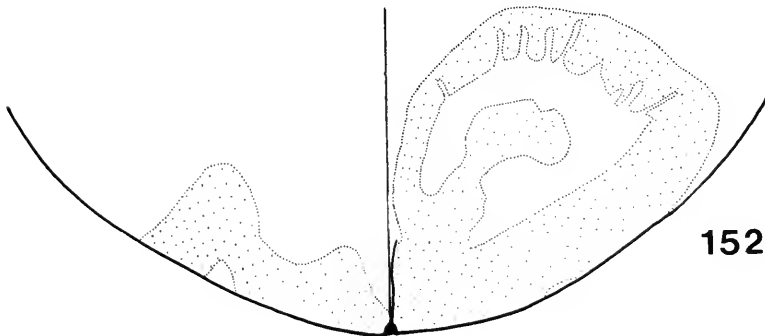

152

**Figs 150–152** Anal pore-fields of Homotomidae. 150, *Mycopsylla ? fici*; 151, *M. gardenensis*; 152, *Pseudoeriopsylla nyasae*.

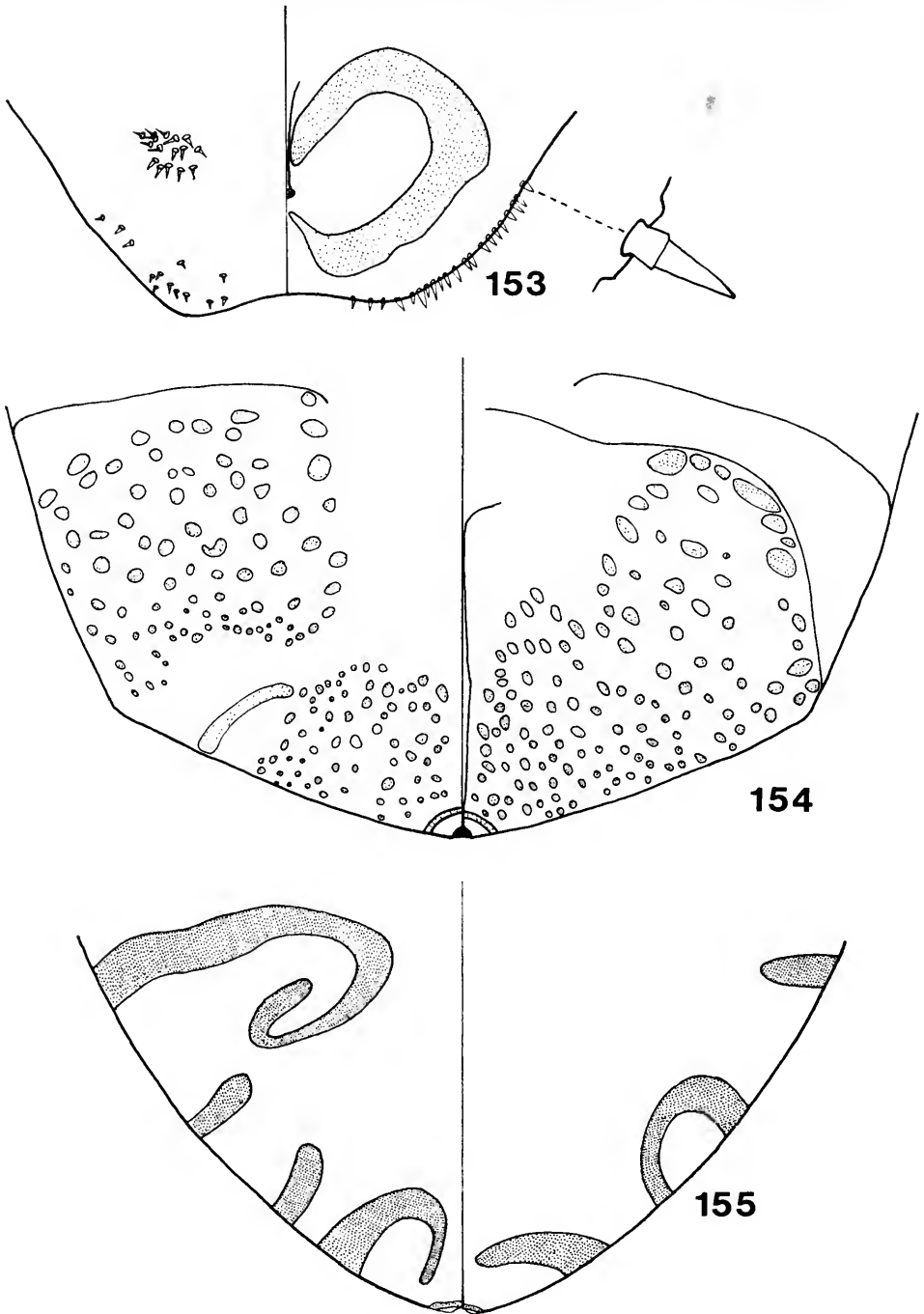

**Figs 153–155** Anal pore-fields and abdomen chaetotaxy. Homotomidae: 153, *Synozia floccosa* (inset shows abdomen margin sectaseta). Carsidaridae: 154, *Mastigimas cedrelae*; 155, *Mesohomotoma hibisci*.

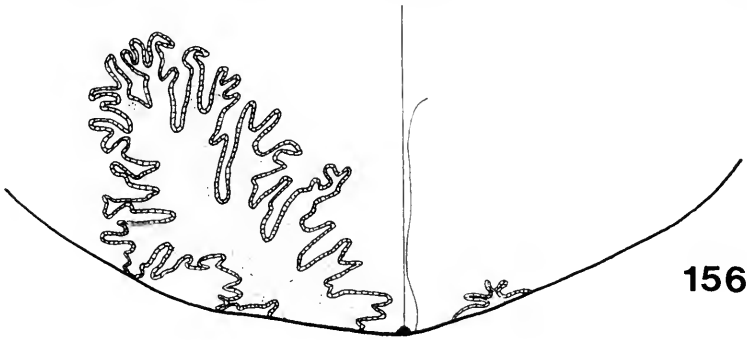

156

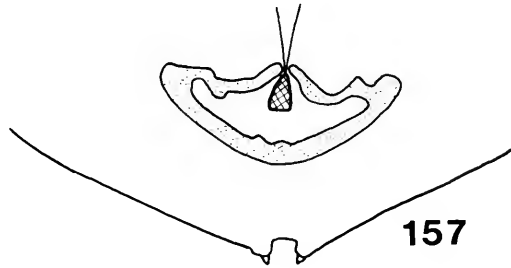

157

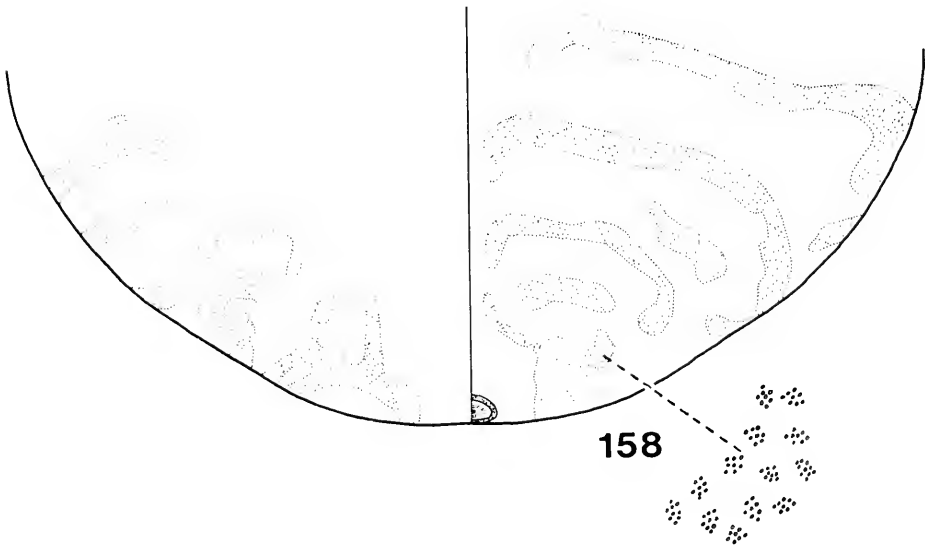

158

**Figs 156–158** Anal pore-fields and abdomen margin shapes of Triozidae. 156, *Leuronota michoacana*; 157, *Neolithus* sp., showing shape of abdomen apex; 158, *Tiozamia lamborni* (inset shows detail of a pore area).

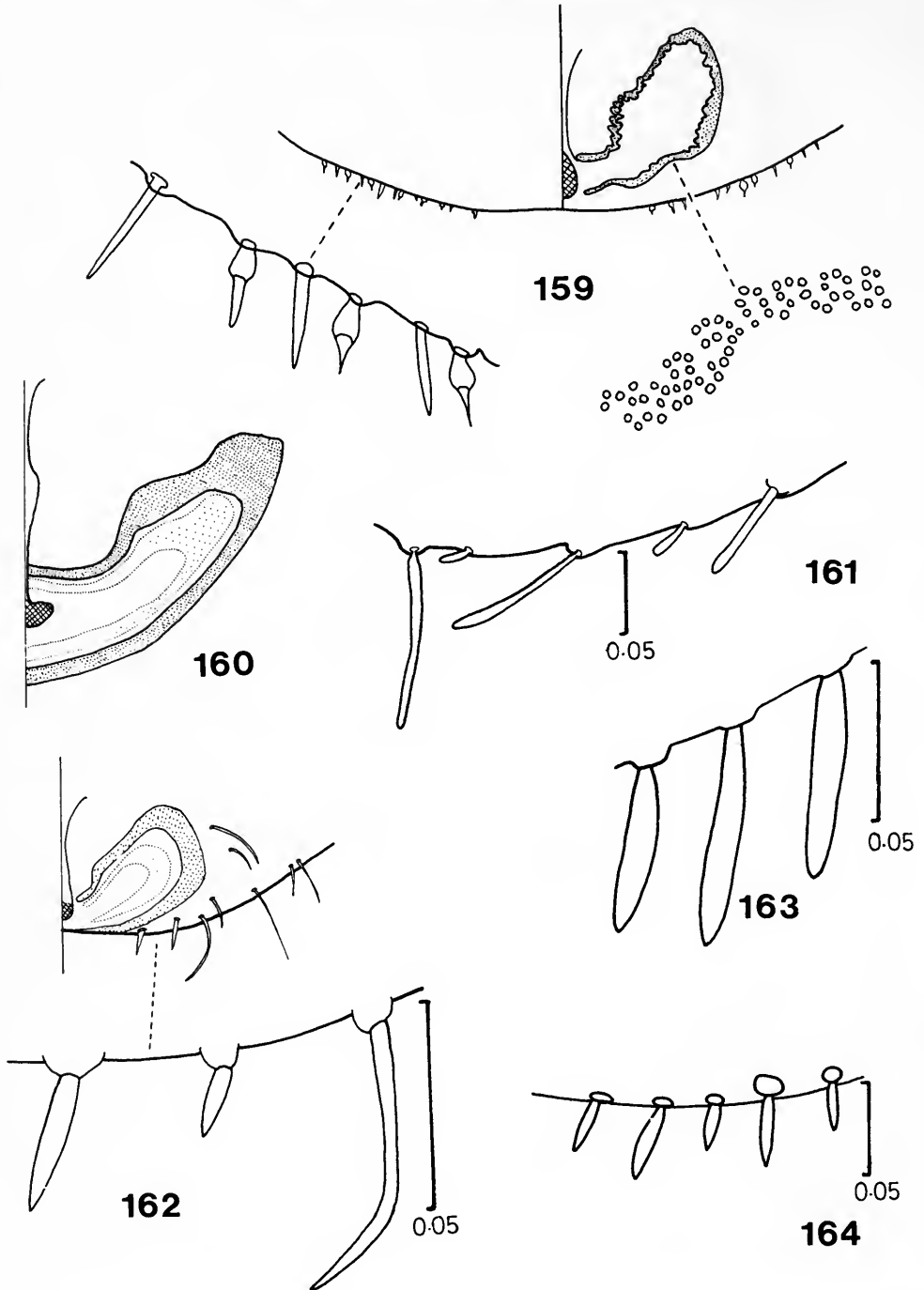

**Figs 159–164** Anal pore-fields and chaetotaxy. Triozidae: 159, *Trioza alacris*, with details of circum-anal pore ring and abdomen margin setae; 160, *Triozoida silvestris*, circum-anal pore rings. Aphalaridae: 161, *Aphalaroida pithecolobia*, abdomen margin rod setae; 162, *Phytolyma minuta*, circum-anal pore rings and abdomen margin lanceolate setae; 163, *Crastina linavuorii*, abdomen margin lanceolate setae; 164, *Aphalara persicaria*, abdomen margin lanceolate setae.



165

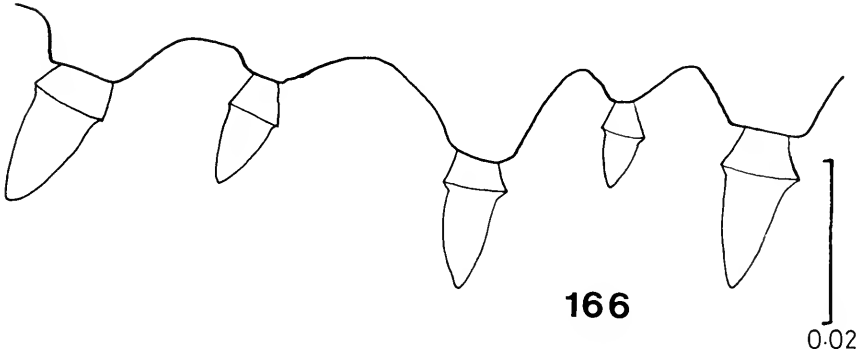

166

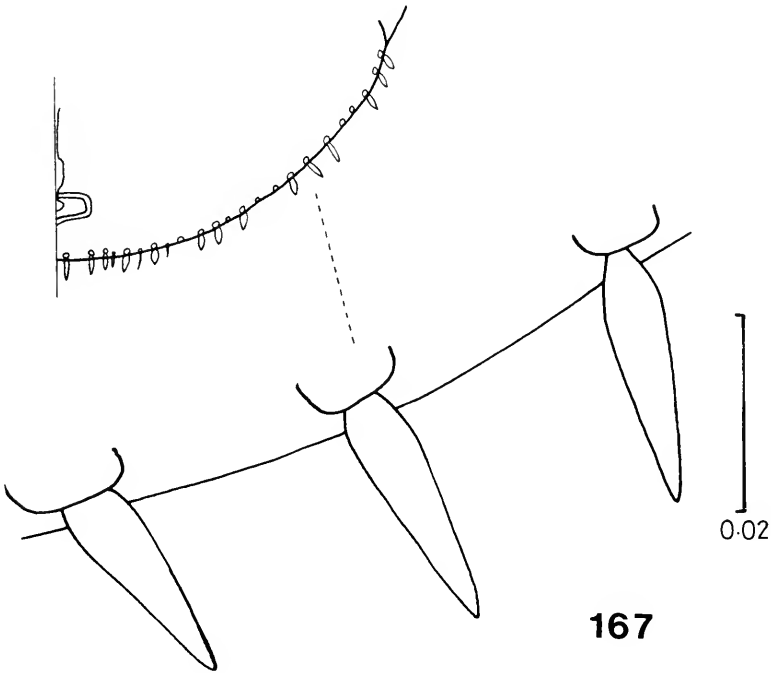

167

**Figs 165–167** Chaetotaxy of Aphalaridae. 165, *Diaphorina putonii*, abdomen margin lanceolate setae; 166, *Moraniella calodendri*, forewing-pad margin sectasetae; 167, *Tainarys schini*, abdomen margin lanceolate setae.

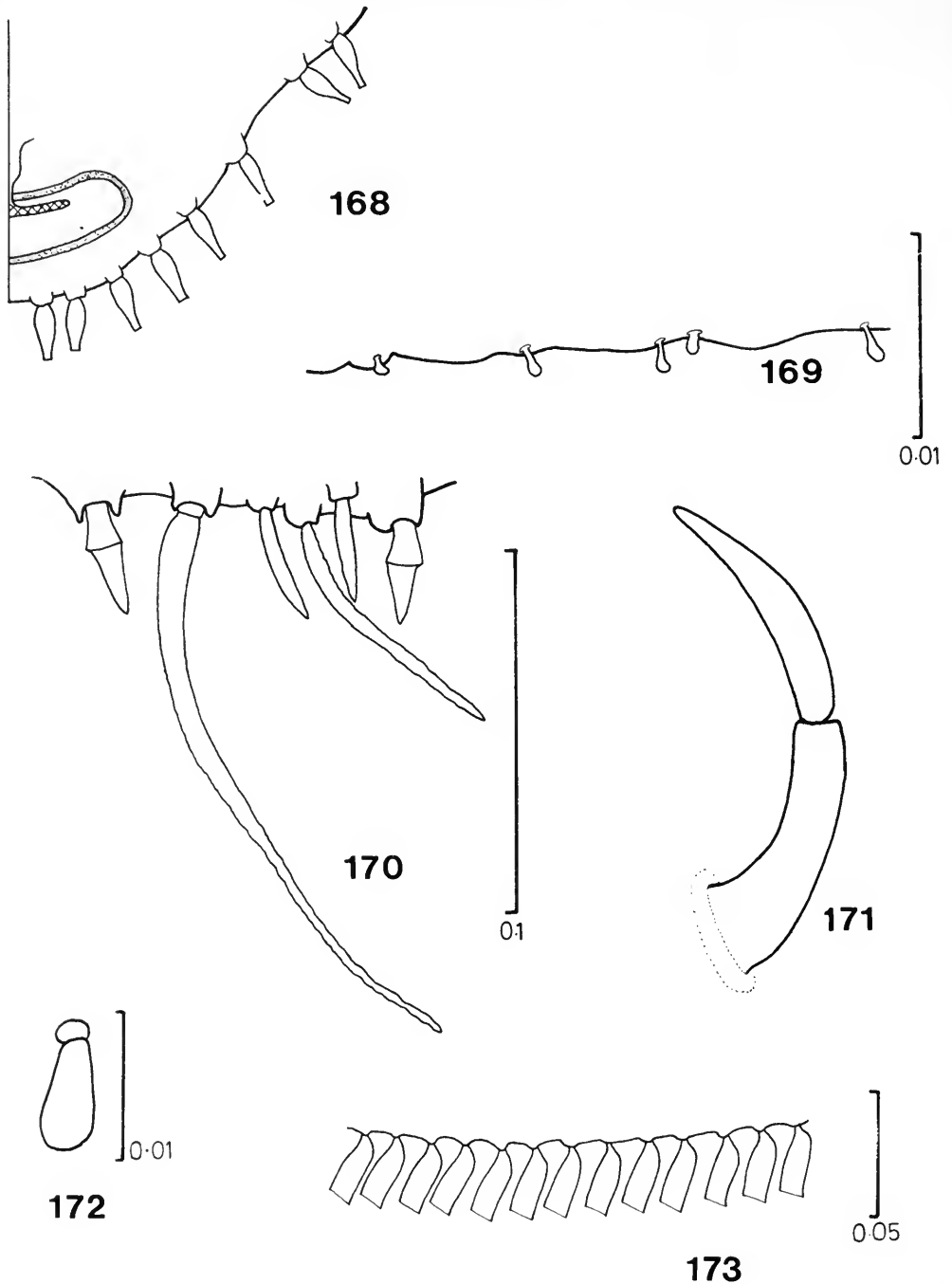

**Figs 168–173** Chaetotaxy. Aphalaridae: 168, *Rhinocola aceris*, abdomen margin with truncate lanceolate setae. Spondyliaspidae: 169, *Arepuna* sp., abdomen margin clavate setae. Psyllidae: 170, *Pexopsylla cercocarpi*, abdomen margin rod and sectasetae. Homotomidae: 171, *Homotoma ficus*, lanceolate seta mounted on a tubercle. Triozidae: 172, *Crawforda triopsyllina*, forewing-pad dorsal surface clavate seta; 173, *Hevaheva swezeyi*, abdomen margin scales.



174

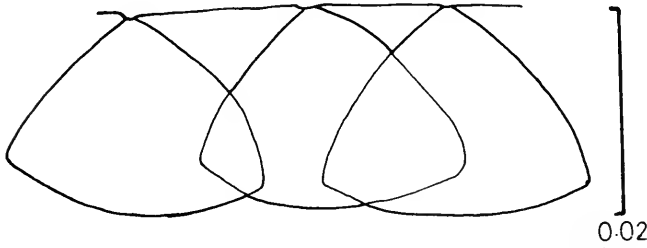

175

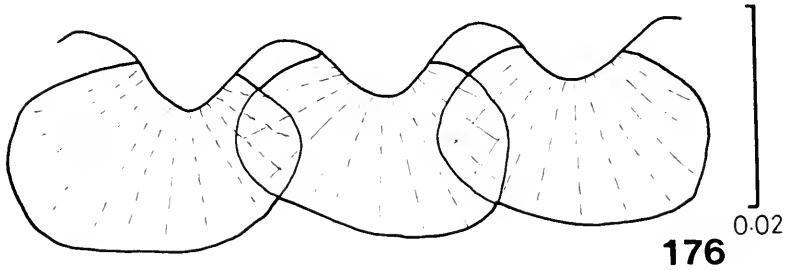

176

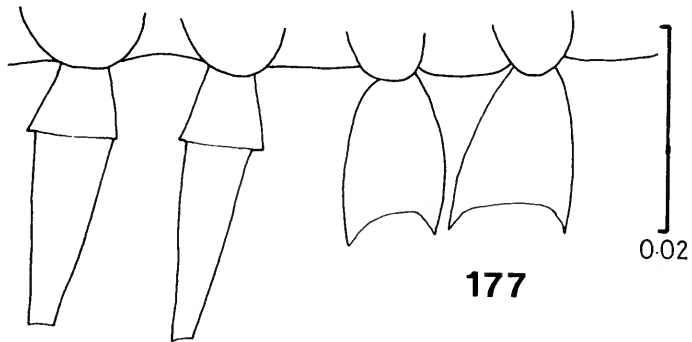

177

Figs 174–177 Abdomen margin scales of Triozidae. 174, *Ceropsylla sideroxyli*; 175, *Kuwayama pisonia*; 176, *Swezeyana elongagena*; 177, *Trioza palmicola*, showing both scales and sectasetae.

**Table 4** Selected nymphal characters.

Selected characters are numbered N1–N34. All the character states in the original list of 88 characters are tabulated. However, some character states became combined by the selection procedure and, hence, in some characters two consecutive states are marked with the same value.

*Characters describing shape and position*

- N1. Humeral lobe (in the case of variability the code chosen was the highest observed).  
 No humeral lobe (Fig. 15). = 0  
 Humeral lobe present, anterior margin of forewing-pad not extending anterior to procoxa (Fig. 16). = 1  
 Humeral lobe present, anterior margin of forewing-pad anterior to procoxa and posterior to eye (Fig. 17). = 2  
 Humeral lobe present, anterior margin of forewing-pad anterior to posterior of eye and posterior to anterior of eye (Fig. 18). = 3  
 Humeral lobe present, anterior margin of forewing-pad anterior to eye (Fig. 19). = 4
- N2. Forewing-pad; position of apex.  
 Apex exterior to margin of hindwing-pad (Fig. 20). = 0  
 Apex adjacent or interior to margin of hindwing-pad, margin of forewing-pad not confluent with margin of hindwing-pad (Fig. 21). = 0  
 Apex adjacent or interior to margin of hindwing-pad, margin of forewing-pad confluent with margin of hindwing-pad (Fig. 22). = 1
- N3. Hindwing-pad; position of apex.  
 Apex exterior to margin of abdomen (Fig. 21). = 0  
 Apex adjacent or interior to margin of abdomen, margin of hindwing-pad not confluent with margin of abdomen (Fig. 22). = 0  
 Apex adjacent or interior to margin of abdomen, margin of hindwing-pad confluent with margin of abdomen (Fig. 23). = 1
- N4–N5. Form of tarsal arolium (clarifying characters of N41).
- N4. Triangular and petiolate (Fig. 25).  
 No = 0 Yes = 1
- N5. Disc-like or more than semicircular (Fig. 26).  
 No = 0 Yes = 1
- N6. Anal opening ventral.  
 No = 0 Yes = 1

*Characters of sclerite fusion*

- N7. Prothorax dorsal sclerites. Extent of fusion with head.  
 Prothorax dorsal sclerites completely separate from head. = 0  
 Prothorax dorsal sclerites partly fused with head. At least 2 + 2 sclerites of prothorax separate to cephaloprothorax (Fig. 9). = 0  
 Prothorax dorsal sclerites fused with head. 1 + 1 sclerite of prothorax separate to cephaloprothorax (Fig. 10). = 1  
 Prothorax dorsal sclerites fused with head. = 2
- N8. Mesothorax and metathorax dorsal surface sclerite arrangement (species which are membranous or completely sclerotized, i.e., the separate sclerites are undifferentiated, are coded zero).  
 Medial sclerites (more than 1 + 1) small. Lateral sclerites small (Fig. 11). = 0  
 Medial sclerites (more than 1 + 1) large. Lateral sclerites small (Fig. 12). = 1  
 Medial sclerites (more than 1 + 1) large. Lateral sclerites absent (Fig. 13). = 1  
 Medial sclerite (1 + 1) large. Lateral sclerites absent (Fig. 14). = 1
- N9. Abdomen dorsal surface with many free sclerites. Caudal plate, if present, covering less than whole abdomen (small transverse sclerites at base of abdomen are discounted) (Fig. 2).  
 No = 0 Yes = 1
- N10. Abdomen dorsal surface heavily sclerotized (caudal plate). At most with a few small transverse sclerites at the base of the abdomen (Fig. 4).  
 No = 0 Yes = 1



*Chaetotaxy characters*

Twelve following characters (N11–N22). Capitulate setae present.

No = 0    Yes = 1

- N11. Head margin capitulate setae.
- N12. Antenna with capitulate setae close to rhinaria IV and VI.
- N13. Capitulate seta placed laterally or sublaterally behind eye (Fig. 39).
- N14. Thorax dorsal capitulate setae.
- N15. Forewing-pad dorsal capitulate setae.
- N16. Forewing-pad margin capitulate setae.
- N17. Hindwing-pad margin capitulate setae.
- N18. Abdomen dorsal capitulate setae.
- N19. Abdomen margin capitulate setae.
- N20–N22. Tarsal apex with 2 capitulate setae (Fig. 38).
- N20. Foretarsi.
- N21. Midtarsi.
- N22. Hindtarsi.

Three following characters (N23–N25). Lanceolate setae present.

No = 0    Yes = 1

- N23. Forewing-pad margin lanceolate setae.
- N24. Hindwing-pad margin lanceolate setae.
- N25. Abdomen margin lanceolate setae present, numbering more than 4 + 4, or if fewer than 5 + 5 they are separated by less than their own length.

Eight following characters (N26–N33).

Sectasetae. Up to three ‘present’ states were recognised in the initial coding.

Absent.

= 0

Present and pointed (Figs 32, 33).

= 1

Present and truncate (Fig. 34).

= 2

Present, truncate and each seta adjacent to the next or separated by less than one-quarter its maximum breadth from the next seta (Fig. 35).

= 3

- N26. Head margin sectasetae.  
Absent = 0; Pointed = 1; Truncate = 2; Adjacent = 2
- N27. Head dorsal sectasetae.  
Absent = 0; Pointed = 1.
- N28. Mesothoracic and metathoracic dorsal sectasetae.  
Absent = 0; Pointed = 1; Truncate = 2.
- N29. Forewing-pad dorsal sectasetae.  
Absent = 0; Pointed = 1; Truncate = 2.
- N30. Forewing-pad margin sectasetae.  
Absent = 0; Pointed = 1; Truncate = 2; Adjacent = 2.
- N31. Hindwing-pad margin sectasetae.  
Absent = 0; Pointed = 1; Truncate = 2; Adjacent = 2.
- N32. Abdomen dorsal surface sectasetae.  
Absent = 0; Pointed = 1; Truncate = 2.
- N33. Abdomen margin sectasetae numbering more than 4 + 4, or if less than 5 + 5 they are each separated from the next by less than their own length.  
Absent = 0; Pointed = 1; Truncate = 2; Adjacent = 2.
- N34. Abdomen margin sectasetae or lanceolate setae present and numbering 1 + 1, 2 + 2, 3 + 3, or 4 + 4 and each separated by more than their own length (Fig. 37).  
No = 0    Yes = 1

**Table 5** Rejected nymphal characters.

Rejected characters are numbered N35–N88. Values are not given against the states, which are separated by a '/'.

*Characters describing shape and position*

- N35. Antenna base position. On head margin, or if ventral antenna apex extends beyond head margin (Fig. 4)/Ventral, antenna apex not extending beyond margin of head (Fig. 8).
- N36. Antenna with one rhinarium (Fig. 42). No/Yes.
- N37. Antenna with five rhinaria. No/Yes.
- N38. Antenna with six rhinaria. No/Yes.
- N39. Thorax with pairs of large depressed areas on each segment. No/Yes.
- N40. Hindwing-pad very small (Fig. 48). No/Yes.
- N41. Tarsal arolia. Very reduced or apparently absent/triangular (Figs 24, 25) or disc-like (Fig. 26).
- N42. Thoracic and abdominal dorsal sclerites with large 'perforations'. No/Yes.
- N43. Thoracic and abdominal dorsal surfaces with cuticular processes (Fig. 144). No/Yes.
- N44. Abdominal segments laterally bulging or serrate. No. Margin evenly shaped/Lateral bulges (Fig. 27)/Serrate (Fig. 28).
- N45. Apical margin of abdomen with 'tooth-like' processes. No/Yes (plus the two following clarifying characters).
- N46. No medial 'tooth' (Figs 120, 122). No/Yes.
- N47. Medial 'tooth' present (Fig. 125). No/Yes.
- N48. Anal pore-field present (in any form). No/Yes (plus 6 following clarifying characters).
- N49. Circum-anal ring with two additional rings placed laterally to it (Fig. 121). No/Yes.
- N50. Two rings each lateral to the anus, no circum-anal ring (Fig. 150). No/Yes.
- N51. Four rings, no circum-anal ring (Fig. 120). No/Yes.
- N52. Outer circum-anal ring broken at two or more places. No/Yes, but remaining in form of a circum-anal ring (Fig. 97)/Bands dispersed. Not forming a circum-anal ring. A small circum-anal ring may remain which is assumed to derive from an inner ring (Fig. 155)/Bands dispersed and broken. Not forming a circum-anal ring. A small circum-anal ring may remain which is assumed to derive from an inner ring (Fig. 154).
- N53. As N52 but describing absence of small circum-anal ring. Present/Absent.
- N54. Outer circum-anal ring broken into single pores or small groups of pores. No/Yes, pores or groups of pores in the form of rings (Fig. 117)/Yes, pores or groups of pores dispersed (Fig. 129).

*Characters of sclerite fusion*

- N55. Mesothorax and metathorax dorsal surface. Numerous very small sclerites. No/Yes.

Three following characters (N56–N58):

Tibio-tarsal fusion of each leg. Two tarsal segments free, articulate (Fig. 55)/Two tarsal segments free, not articulate (Fig. 52)/One tarsal segment free, (segment II) not articulate (Fig. 51)/No tarsal segment free.

- N56. Foreleg (as above).
- N57. Midleg (as above).
- N58. Hindleg (as above).
- N59. Abdomen dorsal surface membraneous. No/Yes.

*Chaetotaxy characters*

- N60. Head dorsal capitate setae present. No/Yes.
- N61. Antenna segment I inner apical angle capitate seta present. No/Yes.
- N62. Abdomen ventral capitate setae present. No/Yes.
- N63. Rod setae on body surface present. No/Yes.

Nine following characters (N64–N72). Clavate setae present. No/Yes.

- N64. Head margin clavate setae.
- N65. Head dorsal clavate setae.
- N66. Antenna segment I inner apical angle clavate seta.
- N67. Thorax dorsal clavate setae.
- N68. Forewing-pad dorsal clavate setae.
- N69. Forewing-pad margin clavate setae.
- N70. Hindwing-pad margin clavate setae.
- N71. Abdomen dorsal clavate setae.
- N72. Abdomen margin clavate setae.

Six following characters (N73–N78). Lanceolate setae present. No/Yes.

- N73. Head margin lanceolate setae.
- N74. Head dorsal lanceolate setae.
- N75. Antenna segment II with lanceolate setae.
- N76. Thorax dorsal lanceolate setae.
- N77. Forewing-pad dorsal lanceolate setae.
- N78. Abdomen dorsal lanceolate setae.
- N79. Lanceolate setae present and placed on tall tubercles (Fig. 171). No/Yes.
- N80. Antenna with one row of sectasetae located on the opposite margin of the antenna to the rhinaria (Fig. 40). No/Yes.
- N81. Antenna with more than one row of sectasetae (Fig. 45). No/Yes.
- N82. Antenna with one row of sectasetae located on the same margin as the rhinaria. No/Yes.
- N83. Tibia with stout setae (Fig. 51). No/Yes.
- N84. Abdomen margin sectasetae present and based on large clustered tubercles (Fig. 114). No/Yes.
- N85. Scales present on body margin (Fig. 36). No/Yes.

Three clarifying characters of N34.

- N86. Sectasetae (of N34 type) tubular. No/Yes.
- N87. Lanceolate setae (of N34 type) present. No/Yes.
- N88. Sectasetae (of N34 type) pointed. No/Yes.

**Table 6** Groups of species identical with the selected nymphal characters. The species chosen to represent the group is named at the top of each list.

- |   |   |
|---|---|
| 1. <i>Acanthocnema casuarinae</i><br><i>Ceropsylla matorelli</i>  | 6. <i>Calophya trioanomima</i><br><i>Calophya dubia</i>   |
| 2. <i>Acizzia acaciae</i><br><i>Acizzia acaciaebaileyanae</i><br><i>Psylla phoradendrae</i>   | 7. <i>Ceanothia ceanothi</i><br><i>Euphalerus tantillus</i><br><i>Psylla simlae</i>   |
| 3. <i>Agonosцена</i> sp. (C).<br><i>Agonosцена</i> sp. (B).<br><i>Strophingia cinerea</i>   | 8. <i>Colophorina cassiae</i><br><i>Epipsylla</i> sp. (B).  |
| 4. <i>Apsylla cistellata</i><br><i>Mastigimas cedrelae</i><br><i>M.</i> sp. (B)<br><i>Mesohomotoma tessmanni</i><br><i>Tenaphalara malayensis</i> | 9. <i>Colopscenia</i> sp.<br><i>Craspedolepta minuta</i><br><i>C. minutissima</i><br><i>Diaphorina cardiaea</i><br><i>D. chobauti</i> |
| 5. <i>Calophya nigripennis</i><br><i>Calophya flavida</i>   | 10. <i>Creiis</i> sp.<br><i>Livia coloradensis</i><br><i>L. maculipennis</i>  |

11. *Ctenarytaina eucalypti*  
*Craspedolepta subpunctata*
12. *Diaphorina citri*  
*Craspedolepta constricta*  
*Diaphorina florea*
13. *Diaphorina putonii*  
*Diaphorina clutiae*  
*D. punctulata*
14. *Euceropsylla russoi*  
*Ciriacremum capense*  
*Euceropsylla minuticonica*  
*E. sp.*
15. *Euphalerus jugovenosus*  
*E. rugipennis*  
*E. vermiculosus*  
*Psylla betulaenanae*  
*P. carpinicola*  
*P. floccosa*  
*P. galeaformis*  
*P. striata*  
*P. trimaculata*
16. *Glycaspis baileyi*  
*Cardiaspina albitextura*  
*C. sp.*  
*C. squamula*  
*Glycaspis spp.*
17. *Gyropsylla ilicis*  
*Gyropsylla spgazziniana*
18. *Insnesia glabruscuta*  
*Mitropsylla deserata*
19. *Mycopsylla fici*  
*Macrohometoma gladiatum*  
*Mycopsylla gardenensis*
20. *Neophyllura arctostaphyli*  
*Neophyllura arbuti*
21. *Neopsyllia erythrinae*  
*Euglyptoneura sp.*  
*Neopsyllia sp.*  
*Platycorypha princeps*
22. *Pachyopsylla venusta*  
*Pachyopsylla spp.*  
*Tetragonocephala sp.*
23. *Paracarsidara gigantea*  
*Bharatiana octospinosa*  
*Mastigimas sp. (A)*  
*Mesohometoma hibisci*  
*Paracarsidara spp.*  
*Tenaphalara acutipennis*
24. *Paratrioza cockerelli*  
*Paratrioza arbolensis*  
*P. maculipennis*  
*Trioza curvatineris*  
*T. minuta*  
*T. salicivora*
25. *Paurocephala gossypii*  
*Paurocephala urenae*
26. *Pennavena fabulosa*  
*Craspedolepta furcata*  
*C. nervosa*
27. *Psylla alba*  
*Psylla sinuata*
28. *Psylla alni*  
*Psylla buxi*  
*Spanioneura fonscolombii*
29. *Psylla brevistigmata*  
*Psylla minuta*  
*P. parallela*
30. *Psylla brunneipennis*  
*Psylla coryli*  
*P. hirsuta*  
*P. moscovita*  
*Purshivora chelifera*
31. *Psylla mali*  
*Euglyptoneura robusta*  
*Pexopsylla cercocarpi*  
*Psylla ribesiae*
32. *Psylla media*  
*Arytainilla hakani*
33. *Psylla minor*  
*Psylla magnicauda*
34. *Psylla nigrita*  
*Psylla saliceti*
35. *Psylla pulchra*  
*Psylla hamata*
36. *Psylla pyricola*  
*Psylla myrtilli*  
*P. visci*
37. *Psylla pyrisuga*  
*Arytainilla cytisi*  
*Psylla melanoneura*
38. *Psyllopsis fraxinicola*  
*Aphalaroida pithecolobia*  
*Psyllopsis fraxini*
39. *Spondylaspis sp.*  
*Cardiaspina densitexta*
40. *Strophingia ericae*  
*Aphalara curta*  
*A. nubifera*  
*A. polygona*  
*A. simila*  
*Craspedolepta augustipennis*  
*C. artemisiae*  
*C. sonchi*  
*C. suaedae*  
*C. vancouverensis*  
*C. veaziei*  
*Tainarys schini*
41. *Swezeyana elongata*  
*Trioza palmicola*
42. *Trichohermes walkeri*  
*Trioza phoradendrae*
43. *Trioza albifrons*  
*Paratrioza lavaterae*  
*Trioza beameri*  
*T. quadripunctata*
44. *Trioza albiventris*  
*Trioza atkasookensis*  
*T. crithmi*

45. *Trioza chenopodii*  
*Trioza litseae*  
 46. *Trioza diospyri*  
*Trioza bakeri*  
*T. frontalis*

47. *Trioza incidata*  
*Trioza tripunctata*  
 48. *Trioza marginepunctata*  
*Trioza vitiensis*  
*T. sp.*

The following species have unique descriptions:

*Acizzia hakeae*  
*A. russellae*  
*A. uncatoides*  
*Agonosцена sp. (A)*  
*Amorphicola amorphae*  
*Anomoneura mori*  
*Aphalara exilis*  
*A. monticola*  
*A. persicaria*  
*A. rumicis*  
*Aphalaroida inermis*  
*Arepuna sp.*  
*Arytaina genistae*  
*Arytainilla spartiicola*  
*A. spartiophila*  
*Calophya californica*  
*C. rhois*  
*C. schini*  
*C. rotundipennis*  
*C. sp.*  
*Camarotoscena spp.*  
*Ceanothia aculeata*  
*Ceropsylla sideroxyli*  
*C. sp.*  
*Ciriacremum capeneri*  
*C. harteni*  
*C. julbernardioides*  
*Craspedolepta nebulosa*  
*Crastina linavuorii*  
*Crawforda triopsyllina*  
*Diaphorina albomaculata*  
*D. solani*  
*Diclidophlebia eastopi*  
*Egeirotrioza spp.*  
*Epicarsa sp.*  
*Epipsylla sp. (A)*  
*Eucalyptolyma sp.*  
*Euceropsylla cayeyensis*  
*Euglyptoneura fuscipennis*  
*Euphalera gallicolus*  
*E. nidifex*  
*E. sp. (A).*  
*E. sp. (B).*  
*E. sp. (C).*  
*E. sp. (D).*  
*Euphyllura spp.*  
*Floria variegata*  
*Freysuila sp.*  
*Heteropsylla spp.*  
*Hevaheva swezeyi*  
*Homotoma spp.*

*Isogonoceraia divergipennis*  
*Kuwayama pisonia*  
*Leptynoptera sulfurea*  
*Leurolophus vittatus*  
*Leuronota michoacana*  
*Livia crefeldensis*  
*L. juncorum*  
*L. vernalis*  
*Macrohomotoma striata*  
*Microceropsylla sp.*  
*Moraniella calodendri*  
*Neolithus sp.*  
*Neophyllura bicolor*  
*Paraphalaroida fremontiae*  
*Pauropsylla spp.*  
*Pelmatobrachia sp.*  
*Phacopteron lentiginosum*  
*Phellopsylla sp.*  
*Phytolyma spp.*  
*Protyora sterculiae*  
*Pseudoeriopsylla nyasae*  
*Pseudophacopteron spp.*  
*Psylla albagena*  
*P. ambigua*  
*P. americana*  
*P. annulata*  
*P. foersteri*  
*P. magna*  
*P. negundinis*  
*P. palmeni*  
*P. peregrina*  
*P. pruni*  
*P. pulchella*  
*P. pyri*  
*P. rhamnicola*  
*P. rhododendri*  
*P. stricklandi*  
*P. sorbi*  
*P. subspiculata*  
*P. ulmi*  
*Purshivora pubescens*  
*Retroacizzia antennata*  
*Rhinocola aceris*  
*Synozia spp.*  
*Tenaphalara sp.*  
*Togepsylla matsumurana*  
*Trigonon longicornis*  
*Trioza alacris*  
*T. aylmeriae*  
*T. anceps*  
*T. cinnamomi*

*T. erytreae*  
*T. falcata*  
*T. hirsuta*  
*T. lobata*  
*T. magnoliae*  
*T. nigricornis*  
*T. obsoleta*  
*T. obtusa*  
*T. panacis*

*T. remota*  
*T. urticae*  
*T. vitreoradiata*  
*Triozamia lamborni*  
*Triozoida silvestris*  
 indet. (A).  
 indet. (B).  
 indet. (C).

### Phenetic analysis of nymphs

The selected characters are used for these analyses of 182 selected species and resemblance was measured using the mean character difference (Cain & Harrison, 1958).

#### Minimum spanning network (MSN)

The MSN (Fig. 178) was constructed using an algorithm given by Farris (1970). In a MSN a set of taxa are joined by the shortest possible set of linkages (numbering  $t - 1$ ) and it indicates which species are phenetically most similar to each other. The main features of the MSN relative to the Becker-Migdisova (1973) families are as follows.

1. The following genera of Psyllidae form one group (Fig. 178a): *Acizzia*, *Amorphicola*, *Anomoneura*, *Arepuna*, *Arytaina*, *Arytainilla*, *Ceanothia*, *Ciriactremum*, *Colophorina*, *Eucercopsylla*, *Euglyptoneura*, *Floria*, *Freysulla*, *Heteropsylla*, *Insnesia*, *Isogonoceraia*, *Mitropsylla*, *Neopsyllia*, *Pexopsylla*, *Platycorypha*, *Psylla*, *Purshivora*, *Retroacizzia*, *Spanioneura* and *Trigonon* plus *Epipsylla* sp. (B) and many *Euphalerus* spp. Genera of Psyllidae not included in this group are: *Diaphorina*, *Pennavena* and *Psyllopsis* plus *Epipsylla* sp. (A)., *Euphalerus gallicolus*, *E. nidifex* and *E. sp.* (A).
2. The following genera of Triozidae form one group (Fig. 178c): *Aacanthocnema*, *Ceropsylla*, *Crawforda*, *Hevaheva*, *Kuwayama*, *Paratrioza*, *Swezeyana*, *Trichochemes*, *Trioza* (minus 2 spp.) and *Triozoida*. Genera of Triozidae not included in this group are: *Egeirotrioza*, *Leuronota*, *Neolithus* and *Triozamia* plus *Trioza alacris* and *T. hirsuta*.
3. All members of the Liviidae form one group; however, two are included with *Creiis* sp. (Fig. 178b).
4. The following genera of Aphalaridae form one group (Fig. 178b): *Agonoscena*, *Aphalara*, *Colposcena*, *Craspedolepta*, *Crastina*, *Euphyllura* (minus *E. phillyreae*), *Leurolophus*, *Neophyllura*, *Rhinocola*, *Strophingia* and *Tainarys* plus *Aphalaroida pithecolobia* and *Camarotoscena speciosa*. Genera of Aphalaridae not included in this group are: *Apsylla*, *Gyropsylla*, *Moraniella*, *Paraphalaroida*, *Paurocephala* and *Phytolyma* plus *Aphalaroida inermis*, *Camarotoscena unicolor* and *Euphyllura phillyreae*.
5. The following genera of Spondyliaspidae form one group (Fig. 178c): *Cardiaspina*, *Eucalyptolyma*, *Glycaspis* and *Spondyliaspis*.
6. A second group of Spondyliaspidae consists of the genera (Fig. 178b) *Creiis*, *Pachypsylla*, *Phellopsylla* and *Tetragonocephala*.
7. The Carsidaridae failed to form as one major group.

In the MSN many genera and species are not placed with the majority of their family. The main discordant features are as follows.

1. *Aphalaroida inermis* and *Paraphalaroida* (Aphalaridae), and *Diclidophlebia* (Carsidaridae) are placed with the Psyllidae (Fig. 178a) because they share the feature of a petiolate tarsal arolium.
2. *Calophya schini*, *Calophya rotundipennis* and *Microceropsylla* (Carsidaridae) are placed with the Triozidae (Fig. 178c). These species have a well-developed humeral lobe of the

fore-wing pad like most Triozidae. *Calophya schini* is surrounded by pointed sectasetae like *Crawforda* to which it is linked, whereas *Calophya rotundipennis* and *Microceropsylla* lack sectasetae like *Kuwayama pisonia* to which they link.

3. *Creiis* (Spondyliaspidae) is identical to some species of *Livia* (Liviidae), as defined by the selected characters. This is because these species have almost entirely zero character states. *Euphalerus* sp. (A) (Psyllidae) also links to *Livia*.

4. *Diaphorina*, *Pennavena* and *Psyllopsis* (Psyllidae), *Ctenarytaina* (Spondyliaspidae) plus *Epicara*, *Homotoma ficus*, *Phacopteron* and *Pseudophacopteron floccosa* (Carsidaridae) are placed with most Aphalaridae (Fig. 178b). Group 4 is a collection of species with lanceolate setae.

5. *Euphalerus nidifex* (Psyllidae) is linked with *Glycaspis* (Spondyliaspidae).

6. *Euphalerus gallicolus* (Psyllidae) is linked with *Creiis* (Spondyliaspidae).

7. Most taxa with pointed sectasetae form one group (Fig. 178b): most *Calophya* spp., *Camarotoscena unicolor*, most *Egeirotrioza* spp., *Homotoma indica*, *Leuronota*, *Moraniella*, *Paurocephala*, *Synoza floccosa* and *Trioza alacris*.

The remaining genera and species lack specialised chaetotaxy. They are placed near to the centre of the minimum spanning network and the distinct groups branch from them.

### Average linkage phenogram (AL)

Further insight into the resemblances between nymphs is provided by a hierarchical representation of data as provided by an average linkage phenogram.

An average linkage phenogram was constructed using the 'weighted pair group method with arithmetic averages' (Fig. 179) which was computed by the 'JOIN' algorithm of Hartigan (1975).

Most of the groups formed in the minimum spanning network were also recognised by average linkage. Three major clusters were formed (Figs 179b–d).

Cluster 1 (Fig. 179b). This includes members of the family Psyllidae which have capitate setae: *Acizzia hakeae*, *A. uncatoides*, *Amorphicola*, *Arytaina*, *Arytainilla*, *Ceanothia*, *Ciriactremum*, *Euceropsylla*, *Euphalerus tantillus*, *E. sp. (B).*, *E. sp. (C).*, *Floria*, *Freysuila*, *Heteropsylla*, *Insnesia*, *Isogonoceraia*, *Mitrapsylla*, *Psylla* (minus subgen. *Asphagidella*, subgen. *Psylla*, *P. annulata*, *P. mali*, *P. phoradendrae* & *P. ribesiae*), *Purshivora* and *Trigonon*. The remaining Psyllidae are in cluster 3 (except *Retroacizzia*).

Cluster 2 (Fig. 179c). This contains taxa with sectasetae. It also includes *Retroacizzia*: *Camarotoscena unicolor*, *Moraniella*, *Paraphalaroida* and *Paurocephala* (Aphalaridae), *Calophya*, *Diclidophlebia*, *Homotoma*, *Leptynoptera*, *Microceropsylla*, *Pauropsylla depressa*, *P. trichaeta*, *Synoza floccosa* and *Togepsylla* (Carsidaridae), *Retroacizzia* (Psyllidae), *Aacanthocnema*, *Ceropsylla*, *Crawforda*, *Egeirotrioza*, *Hevaheva*, *Kuwayama*, *Leuronota*, *Neolithus*, *Paratrioza*, *Swezeyana*, *Trichohermes*, *Trioza* (minus *T. hirsuta*), *Triozoida* and indet. sp. (A). (Triozidae).

Cluster 3 (Fig. 179d,e). This includes taxa with lanceolate setae plus most taxa which lack capitate setae and sectasetae: *Agonoscena*, *Aphalara*, *Aphalaroida*, *Apsylla*, *Camarotoscena speciosa*, *Colposcena*, *Craspedolepta*, *Crastina*, *Euphyllura*, *Gyropsylla*, *Leurolophus*, *Neophyllura*, *Phytolyma*, *Rhinocola*, *Strophingia* and *Tainarys* (Aphalaridae), *Bharatiana*, *Epicara*, *Macrohomotoma*, *Mastigimas*, *Mesohomotoma*, *Mycopssylla*, *Paracarsidara*, *Pauropsylla beelsoni*, *Pelmatobranchia*, *Phacopteron*, *Protyora*, *Pseudoeriopsylla*, *Pseudophacopteron*, *Synoza* sp. and *Tenaphalara* (Carsidaridae), *Livia* (Liviidae), *Acizzia acaciae*, *A. acaciaebaileyanae*, *A. russellae*, *Anomoneura*, *Arepuna*, *Diaphorina*, *Diaphorina*, *Epipsylla*, *Euglyptoneura*, *Euphalerus gallicolus*, *E. jugovenosus*, *E. nidifex*, *E. rugipennis*, *E. vermiculosus*, *E. sp. (A).*, *E. sp. (D).*, *Neopsyllia*, *Pennavena*, *Pexopsylla*, *Platycorpha*, some *Psylla* spp. (subgen. *Asphagidella*, subgen. *Psylla*, *P. annulata*, *P. mali*, *P. phoradendrae* and *P. ribesiae*) and *Psyllopsis* (Psyllidae), *Cardiaspina*, *Creiis*, *Ctenarytaina*, *Eucalyptolyma*, *Glycaspis*, *Pachypssylla*, *Phellopsylla*, *Spondyliaspis* and *Tetragonocephala* (Spondyliaspidae).

Cluster 3 (Fig. 179d) is clearly least congruent with the classification of Becker-Migdisova (1973). Capitate setae (N 11 – N 19) and sectasetae (N 26 – N 33) are described by nine and eight

selected characters respectively. However, lanceolate setae (N 23–N 25) are only described by three selected characters and therefore contribute less weight to the classification than either capitate setae or sectasetae. Hence most taxa which lack any of these three major setal types are phenetically closer to taxa with lanceolate setae than to taxa with capitate setae or sectasetae and cluster 3 is produced.

Detailed analysis of the characters which are responsible for groups is more easily performed using principal component analysis.

**Principal component analysis (PC)**

Principal component analysis, like other forms of ordination, aims to transform a data matrix, whose variance is in many dimensions, into a matrix with most of the variance explained by a

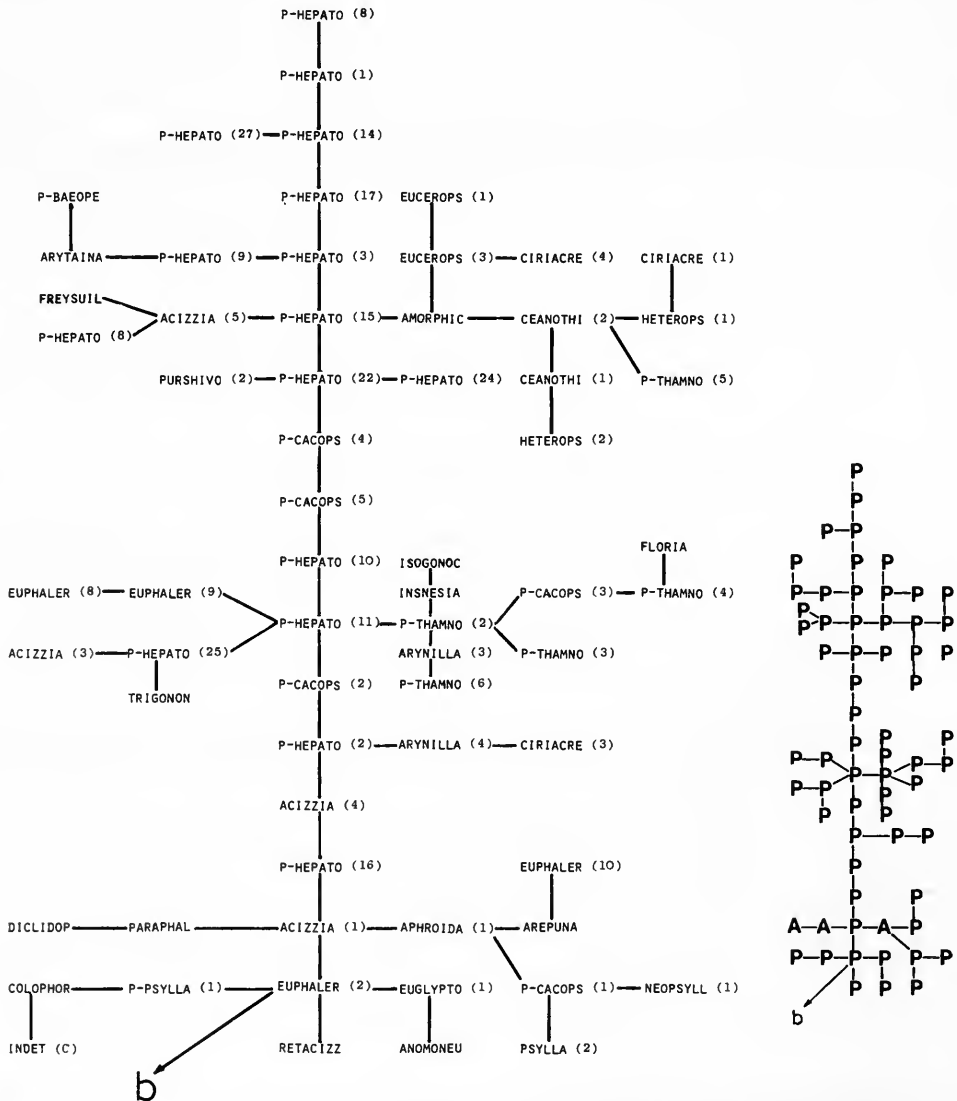

**Fig 178a** Part of a minimum spanning network of 182 selected species with 34 nymphal characters. Internode lengths are not drawn in proportion to taxonomic distance and for convenience the network is divided into 3 sections. Continued in Figs 178b–c.



very few dimensions. In this case 34 dimensions (because there are 34 characters) would be needed to illustrate the spatial relationships of 182 species. However, when principal component analysis was carried out almost 60% (58.2%) of the variance was accounted for by just three dimensions, i.e. a three dimensional figure of spatial relationships of the species could illustrate more than half of the variance in the data. Other forms of ordination, such as principal coordinate analysis, tend to yield very similar results (Boratynski & Davies, 1971) and are not practical when the number of taxa is large and in excess of the number of characters (Rohlf, 1972).

For this analysis data were scaled by ranging and eigenvectors were extracted from correlation and covariance matrices for the first 10 principal components, which accounted for most of the variance (82.8% when extracted from a correlation matrix and 83.7% from a covariance

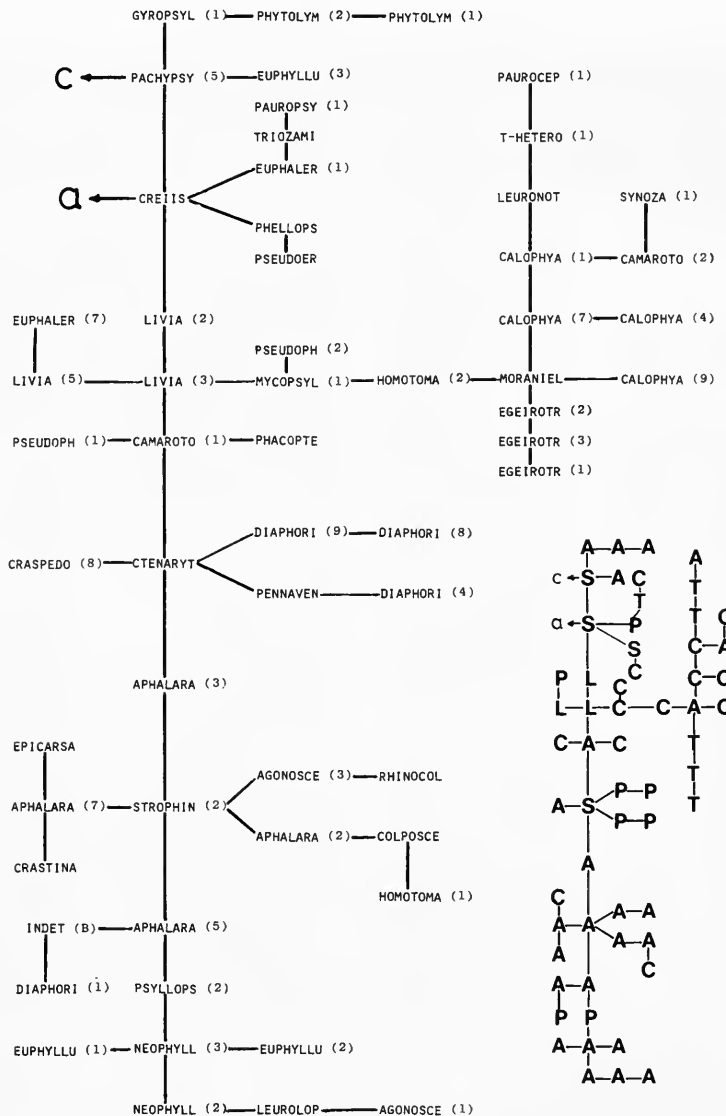
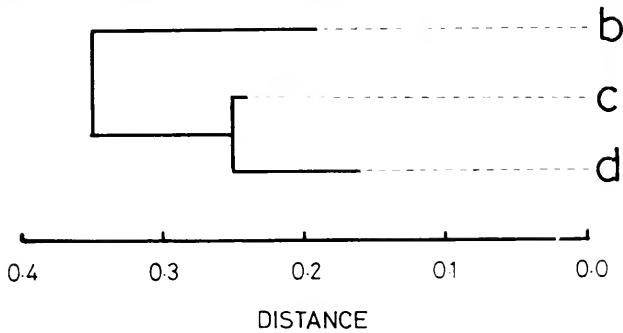
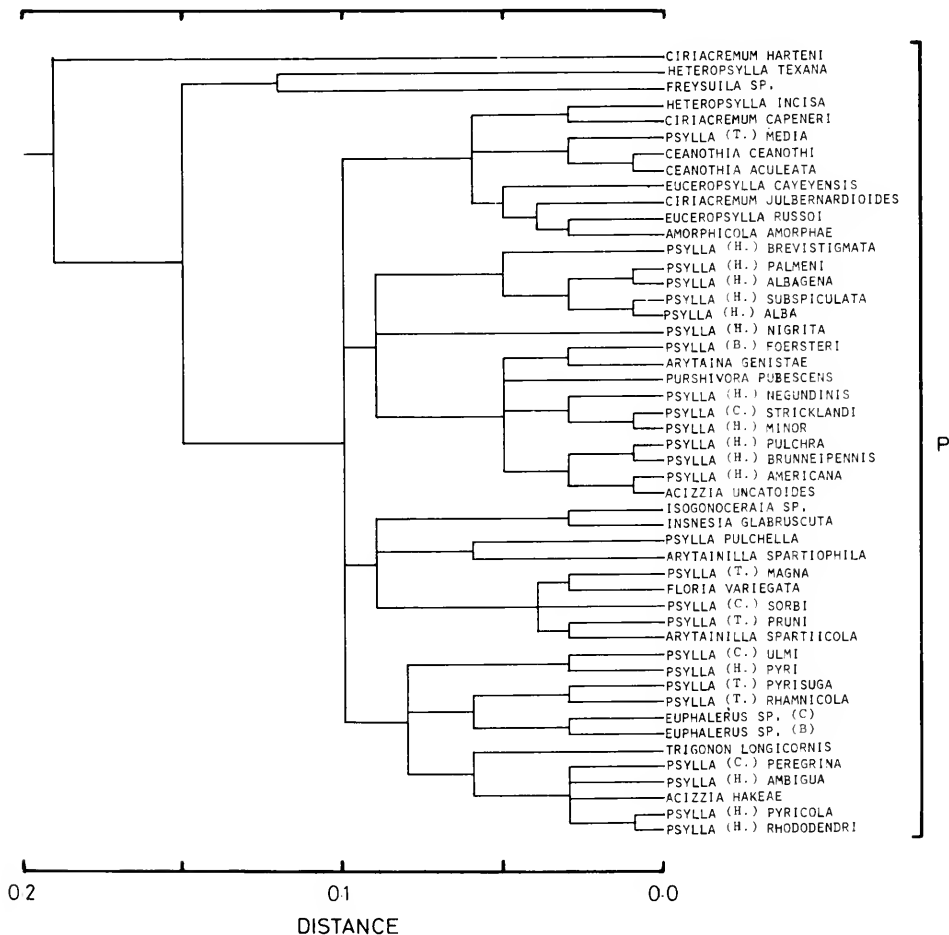

Fig. 178b Part of a minimum spanning network of 182 species; continued in Figs 178a and 178c.





**Fig. 179a** Average linkage phenogram of 182 selected species with 34 nymphal characters; key diagram showing linkages to Figs 179b-d.



**Fig. 179b** Part of a phenogram of 182 species; continued from Fig. 179a.

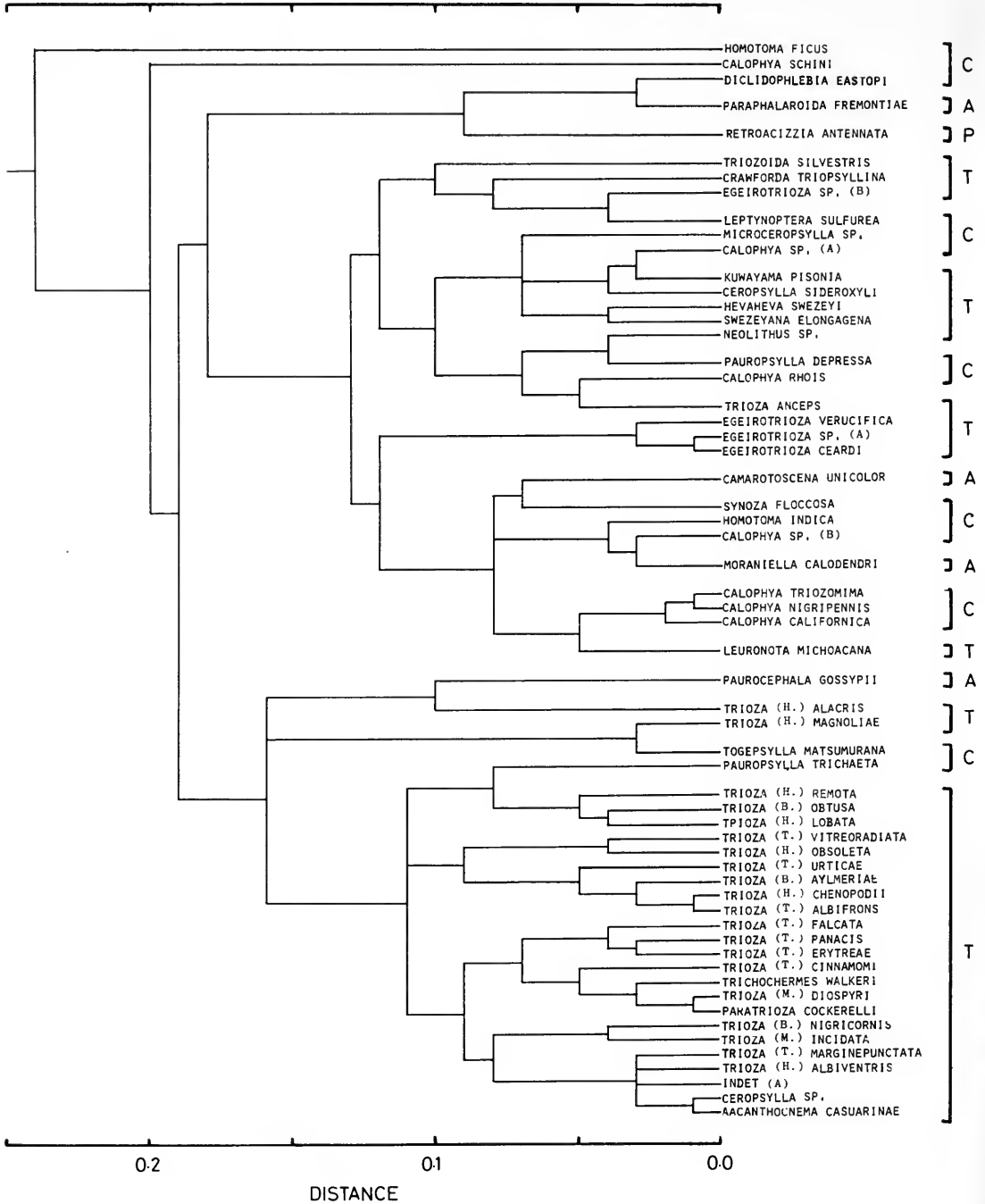

Fig. 179c Part of a phenogram of 182 species; continued from Fig. 179a.

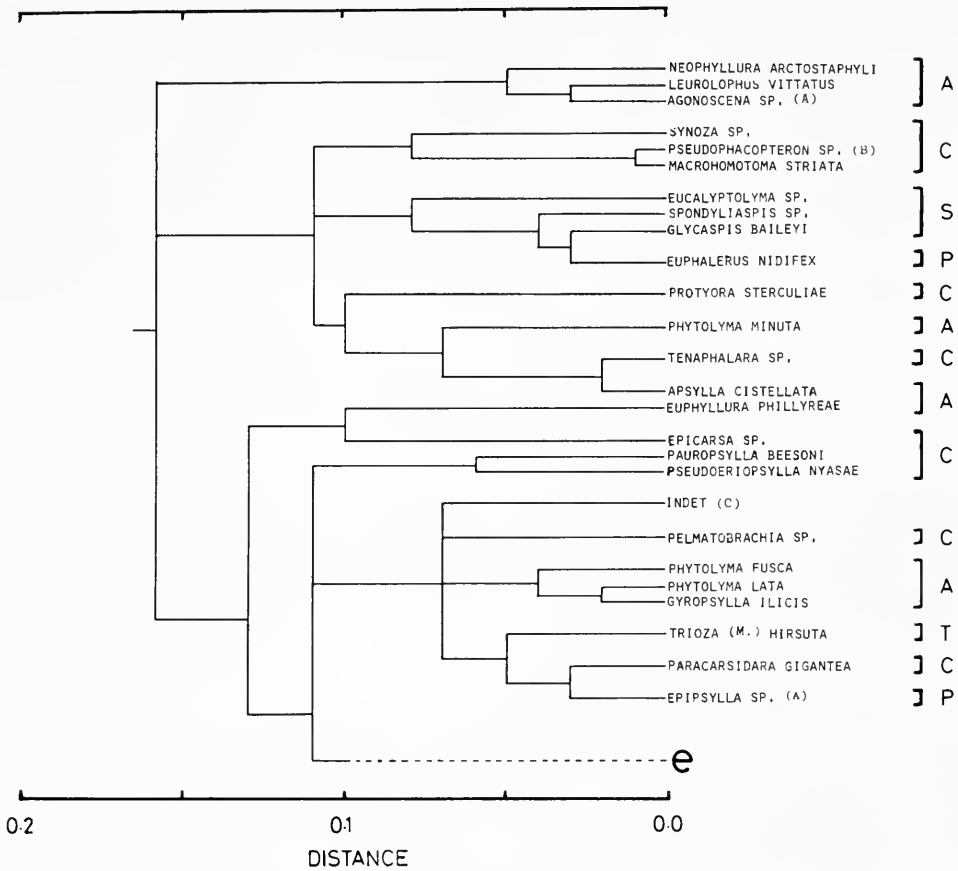

Fig. 179d Part of a phenogram of 182 species; continued in Fig. 179e and from Fig. 179a.

*Epicarsa*. The Carsidaridae and Aphalaridae placed with Triozidae have sectasetae, e.g. *Pauropsylla trichaeta* and *Paurocephala* spp. However, the major advantage of principal component analysis is that it permits the analysis of characters that are responsible for the formation of major groupings.

Characters with absolute eigenvector values on PCs I to III of at least the mean eigenvector value (0.17) are listed in Table 7. These are the characters which largely control the placing of species on PCs I to III.

On PC I (Table 7) the positive eigenvectors account for sectasetae (other than N 34) and shape (N 7) while the large negative values correspond to the petiolate tarsal arolium and capitate setae. The present states of those characters are mainly associated with Triozidae (positive values) and Psyllidae (negative values). On PC II the positive values are those applying to Triozidae and Psyllidae while the negative ones relate to the Aphalaridae (plus Diaphorini and *Psyllopsis*). PC III has a very high positive value for anus position, while other characters with positive values apply to Aphalaridae (plus Diaphorini and *Psyllopsis*). The remaining negative value is a shape character which relates to the Triozidae.

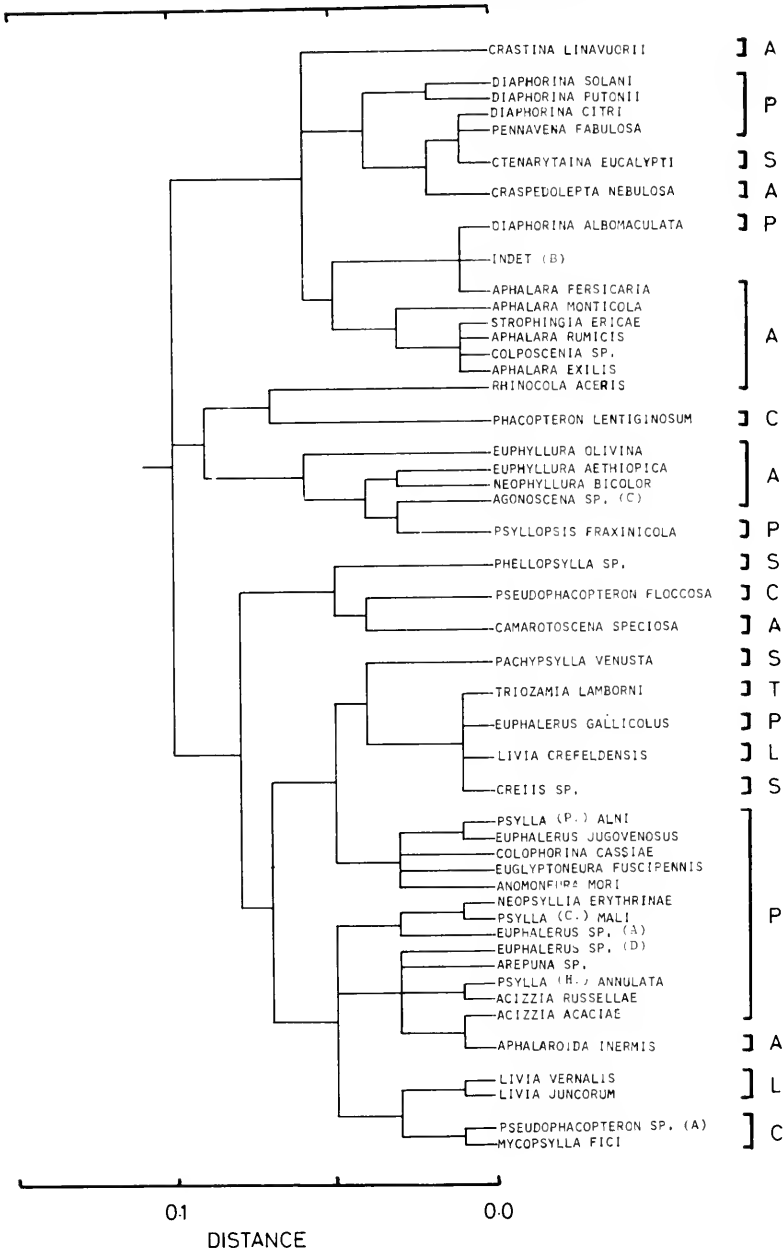
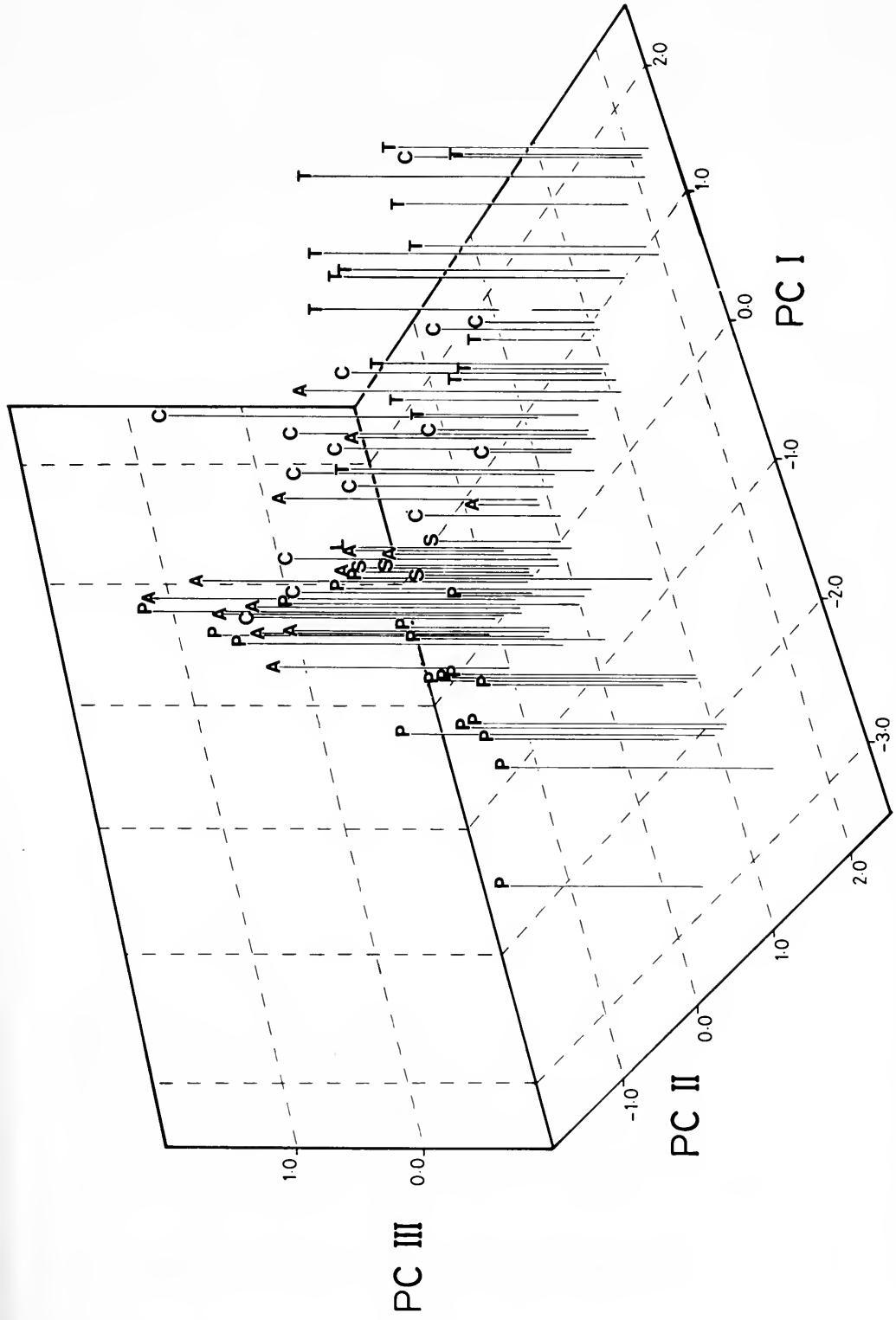

Fig. 179e Part of a phenogram of 182 species; continued from Fig. 179d.



**Fig. 180** Principal component analysis of 182 selected species with 34 nymphal characters. For practical illustration 68 species were chosen, each representing a cluster at the 0.2 phenon level of an average linkage cluster analysis performed on the first 10 principal components. The figure shows the 68 species, each marked by the initial letter of the Becker-Migdisova (1973) family to which it belongs, plotted on the first three principal components.

**Table 7** Absolute eigenvector values in excess of the mean on principal component I, II and III.

Character	PC I	PC II	PC III
N3			-0.21
N4	-0.30		
N6		0.18	0.47
N7	0.27	0.24	
N8		-0.22	0.33
N9			0.44
N11	-0.22		
N13	-0.27	0.17	
N14	-0.18		
N16	-0.31	0.18	
N17	-0.31	0.18	
N18	-0.22		
N19	-0.32	0.18	
N23		-0.19	0.22
N24		-0.22	0.21
N25		-0.28	0.32
N26	0.19	0.28	
N30	0.19	0.28	
N31	0.20	0.27	
N33	0.20	0.27	

When the eigenvector values (EVs) of the 34 selected characters are plotted in three dimensions they form eight major groups (Fig. 181).

1. Characters N7, N26, N30, N31 and N33 describe the fusion of the head and prothorax and marginal positions of setasetae. These characters have positive states for most Trioziidae.
2. Characters N1, N2, N3, N5, N10, N27, N28, N29, and N32 describe the humeral lobe position, position of wing-pad apices, disc-like tarsal arolium, sclerotization of dorsal surface of abdomen and dorsal positions of setasetae. The taxonomic distribution of positive states of these characters is similar to those in group 1.
3. Character N6 refers to the position of the anus. The extreme lack of compatibility of this character with most other characters causes it to be placed alone. All previously recognised major taxa have some species with each state of this character.
4. Characters N11, N12, N13, N14, N15, N16, N17, N18, N19 and N34 are positions of capitate setae and positioned abdominal margin lanceolate setae/setasetae. These are exclusively features of the Psyllidae. As with the setasetae the dorsal surface setal positions fall nearer the zero eigenvector values than the marginal setal positions.
5. Character N4 described the presence or absence of a petiole on the tarsal arolium. This feature is present in most Psyllidae as well as a few other groups.
6. Characters N20, N21 and N22 refer to the pair of tarsal capitate setae which are best developed in the Spondyliaspinae.
7. Characters N8, N23, N24 and N25 refer to the large thoracic sclerites and marginal lanceolate setae typical of the Aphalaridae.

Character groups 1, 2 and 3, groups 4 and 5, plus groups 6 and 7 each form one of three 'arms' of a trifurcate scatter (Fig. 181). Group 8 however, consisting only of characters N9 (free dorsal sclerites on abdomen), does not fit this trifurcate scatter because it is a feature of both Aphalaridae and Psyllidae.

Overall, the scatter of characters shown in Fig. 181 mirrors the trifurcate scatter of species (Fig. 180). This is because only the data matrix is required to transform the character eigenvector values to principal component values.



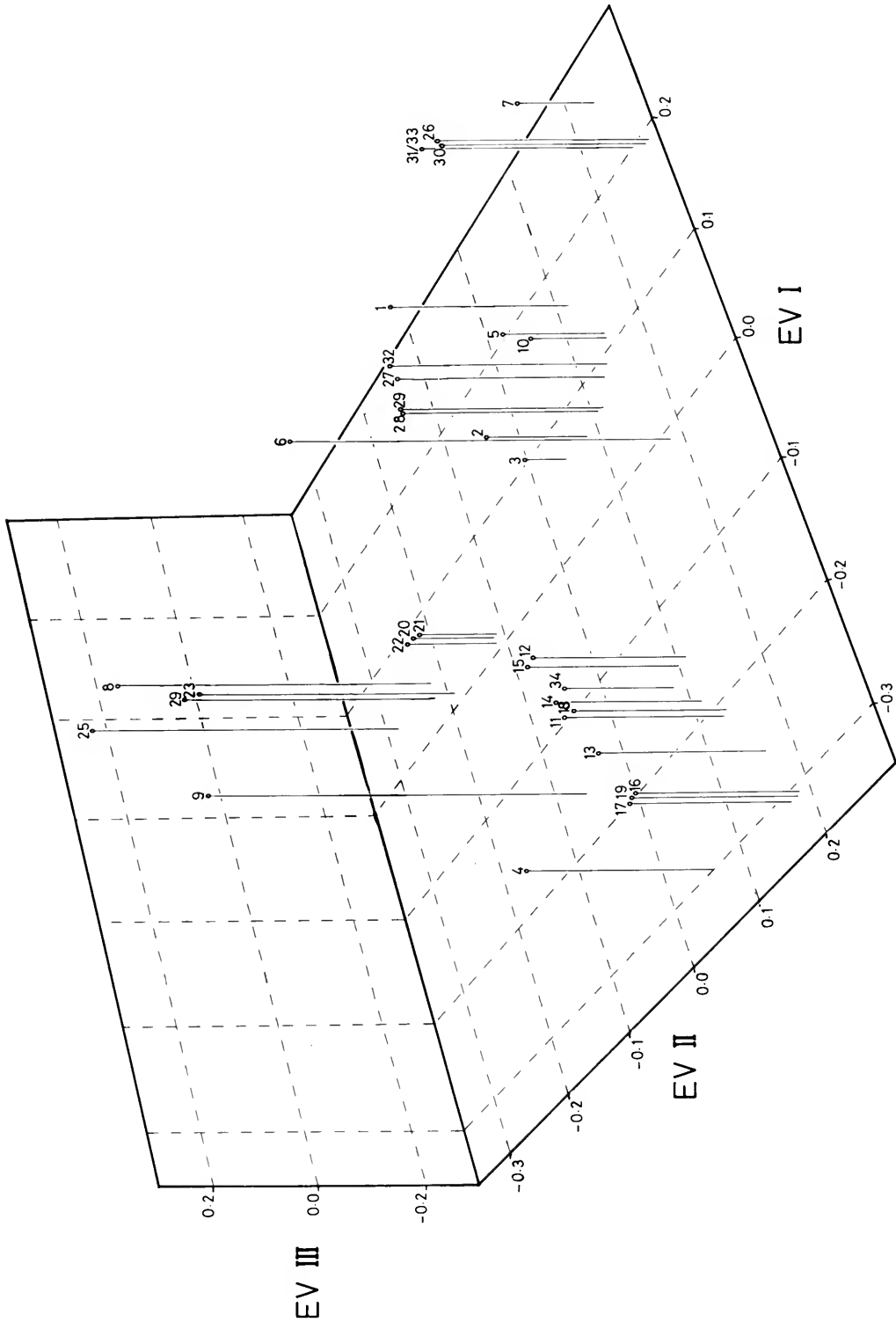

**Fig. 181** Principal component analysis of 182 selected species with 34 nymphal characters. The figure shows the 34 characters plotted against their eigenvector values on the first three principal components.

## Incorporation of adult characters

### Selection of characters

Examination of the adults of the species studied was beyond the scope of this work. However, it was desirable to study adult characters as the interpretation of possible cladistic relationships requires the incorporation of characters controlled by different selection pressures. Characters selected from two rather than one life cycle stages are more likely to meet this criterion. Furthermore, such a study should provide insight into the underlying causes of the partial congruence between the nymphal phenetic relationships and the classification of Becker-Migdisova (1973), which was based almost exclusively upon adult data.

Twenty-seven adult characters were coded largely from the literature (Tables 8, 9). Major sources of information included those of Crawford (1914), Eastop (1958), Heslop-Harrison (1959), Hodkinson & White (1979*b*), Klimaszewski (1964), Loginova (1964*a*, 1972), Mathur (1975), Tuthill (1943, 1959, 1964*a*), Tuthill & Taylor (1955) and Zimmerman (1948). When descriptions are coded in this way several problems occur (Young & Watson, 1970). The greatest problem was the lack of consistency in the conventional approach to description which often made it impossible to distinguish between a genuine absence and mere failure to record the state of the character concerned. The least recorded characters are marked by an asterisk in the character listings (Tables 8, 9). In several cases the states of characters were deduced from family or tribal descriptions.

The 27 characters were coded identically for all species within each genus except for *Euphalerus* and *Pauropsylla*. These genera are variable intra-generically and the species were grouped as follows.

*Euphalerus* spp. received four different group descriptions:

- a. *E. nidifex*, *E. tantillus*, *E. sp.* (A), *E. sp.* (B) and *E. sp.* (D).
- b. *E. gallicolus*
- c. *E. jugovenosus*, *E. rugipennis* and *E. vermiculosus*
- d. *E. sp.* (C)

*Pauropsylla* spp. received two different group descriptions:

- a. *P. beelsoni*
- b. *P. depressa* and *P. trichaeta*

The 27 adult characters were combined with the original 88 nymphal characters (Tables 4, 5) and the ordered multistate characters were recoded into additive two-state code to give 33 adult and 120 nymphal characters. The SUMRAT information statistic was applied and 18 adult and 40 nymphal two-state characters were selected. These were then combined to form 14 adult (Table 8) and 30 nymphal (Table 10) multistate and two-state characters.

Several groups of species were identical with respect to the selected adult plus nymphal characters. Forty-seven species groups were formed and one representative species was chosen from each (Table 11). A further 161 species remained distinct (Table 11) making a total of 208 'taxa' available for further analysis.

### Cluster analysis of combined adult and nymphal data

A MSN was generated across the data (Fig. 182). It was not possible to place an average linkage (AL) phenogram across the combined data because the required computing time was in excess of that available. Instead, as the first 10 principal components (PCs), extracted from a between character covariance matrix, explain most of the variance (79%), an AL phenogram calculated across them should approximate an AL phenogram using the untreated combined data. Such an AL phenogram using average distance is given in Fig. 183.

Five major clusters are formed by the AL.

- 1 (Fig. 183*b*). The members of the family Psyllidae whose nymphs have capitate setae.
- 2 (Fig. 183*c*). The members of the families Trioizidae and Carsidaridae which are typified by adult 'trioizine' wing venation (Character A6) and nymphal sectasetae.



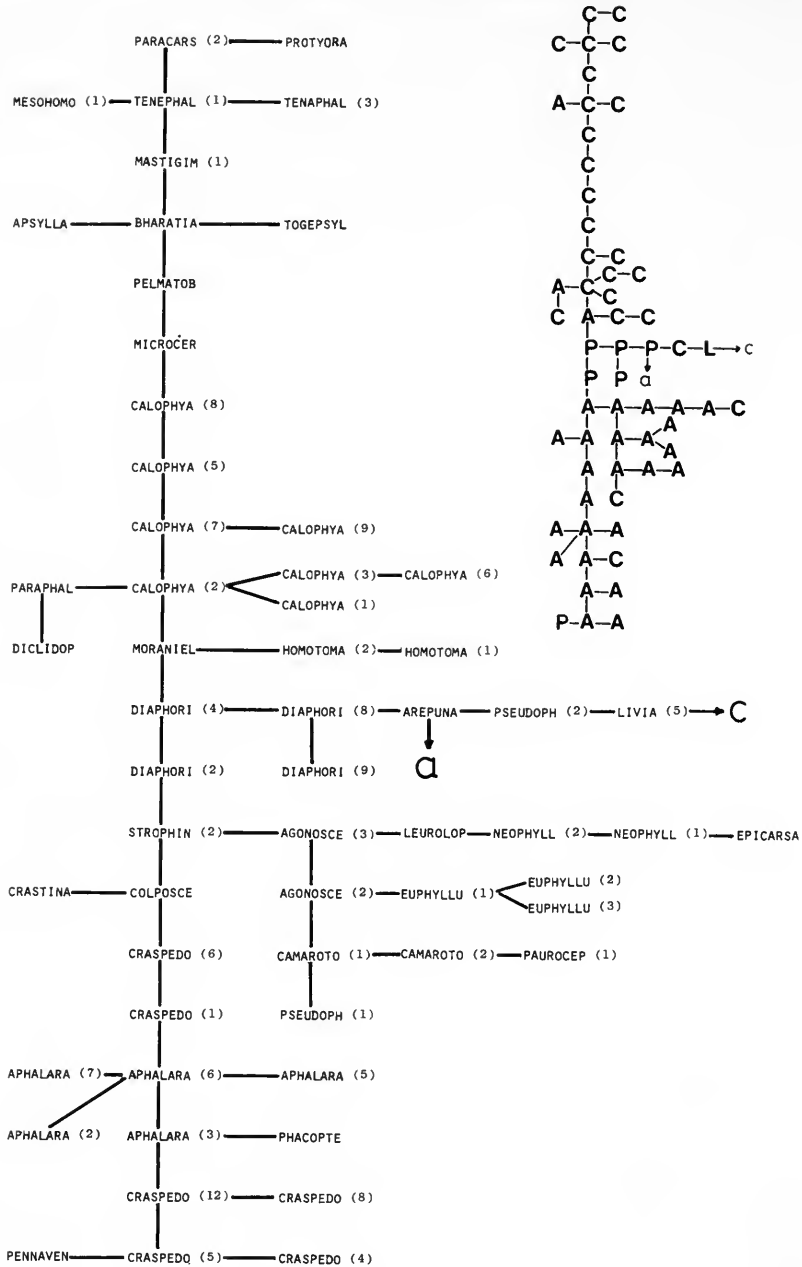

Fig. 182b Part of a minimum spanning network of 208 species; continued in Figs 182a and 182c.

3 (Fig. 183d). The members of this cluster are typified by numerous adult metatibial spines, usually with a lack of pronounced adult genal cones and the presence of nymphal lanceolate setae. It includes many Aphalaridae, all Liviidae, some Carsidaridae (many Homotominae and Phacopterinae) and a few Psyllidae (Diaphorini and *Psyllopsis*).

4 (Fig. 183e). This cluster contains species whose nymphs have pointed sectasetae together with those lacking capitate setae, lanceolate setae and truncate sectasetae. The incorporated taxa are Aphalaridae (e.g. *Paraphalaroida*) and Carsidaridae (e.g. *Calophya*) whose nymphs have

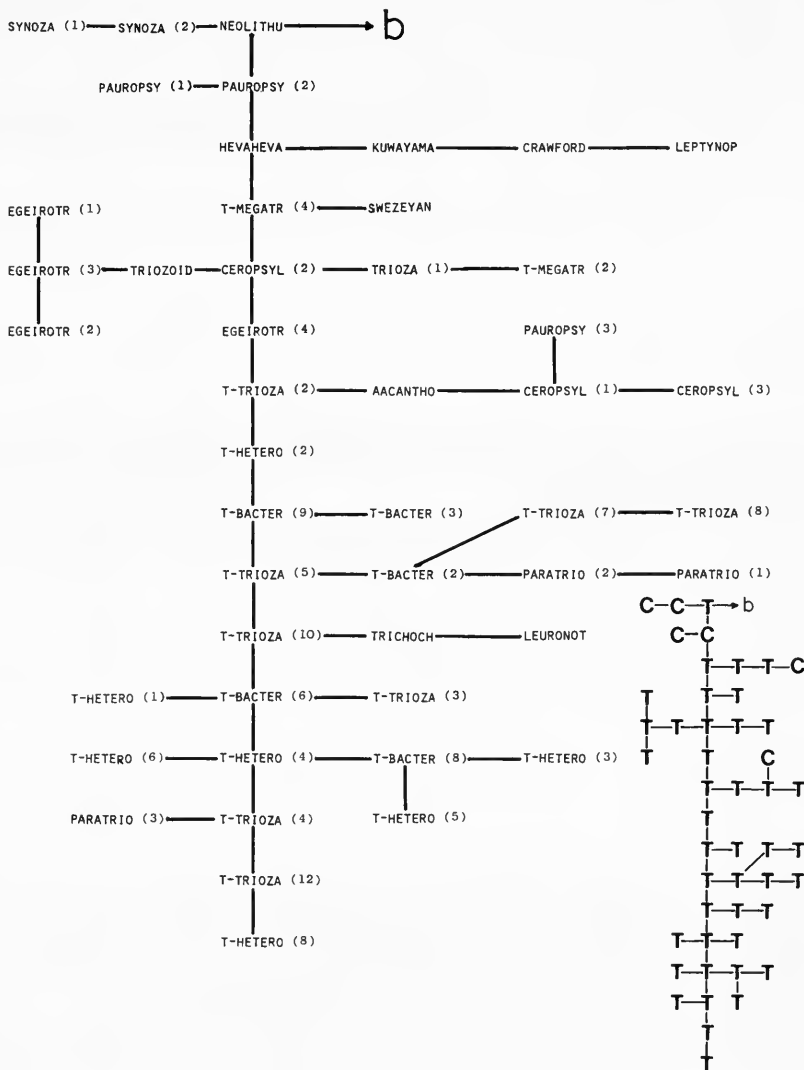

Fig. 182c Part of a minimum spanning network of 208 species; continued in Figs 182a–b.

pointed sectasetae, Psyllidae lacking capitate setae (e.g. *Acizzia acaciae*) and species with no specialised setae belonging to the families Carsidaridae (e.g. *Tenaphalara*) and Spondyliaspidiidae (e.g. *Glycaspis*). The genera *Ctenarytaina*, *Eucalyptolyma* and *Phellopsylla* (all Spondyliaspidiidae) are exceptional in that their nymphs do have lanceolate setae).

5 (Fig. 183a). This cluster is the genus *Euglyptoneura* which is a long distance from other species and hence are not included in any larger hierarchical cluster. However, in the MSN this genus is joined to *Psylla*.

In general, these clusters are very similar to those formed by analysis of nymphal data only.

The incorporation of adult data now enables observations to be made of the causes of congruence and incongruence between adult and nymphal resemblances.

A between character correlation matrix was generated across the selected adult plus nymphal data. The high correlations ( $r$  greater than 0.5) were as follows.

1. *Triozidae* attributes of adults and nymphs correlate (A3, A5, A6 and A12 with N1, N7, N10, N26, N30, N31 and N33), e.g. the adult wing venation and nymphal sectasetae.

2. *Aphalaridae* attributes of adults and nymphs correlate (A11 with N8, N23, N24 and N25), i.e. large numbers of adult metatibial spines with, for example, nymphal lanceolate setae.

3. *Psyllinae* attributes of adults and nymphs correlate (A4 with N4, N16, N17 and N19), i.e. a diagonal suture between the epimeron and episternum of the adult with, on the nymph, a petiolate tarsal arolium and capitate setae.

These correlated sets of characters, whose positive states roughly define currently recognised higher taxa, are the characters which weight the analyses towards complete congruence with the existing classification.

One observed form of incongruence is that groups of species that are regarded as genera on the basis of adult morphology often fail to cluster when nymphal data are analysed. In the minimum spanning network (MSN) (Fig. 182) 11 genera failed to cluster. These were *Acizzia*, *Aphalaroida*, *Ceropsylla*, *Ciriactremum*, *Craspedolepta*, *Egeirotrioza*, *Euphalerus*, *Paratrioza*, *Pauropsylla*, *Pseudophacopteron* and *Trioza*. A total of 21 other genera, of which more than one species was examined, are clustered. It is tentatively concluded that nymphal dissimilarity within a genus does not usually outweigh adult similarity.

## Cladistic analysis

### Ground plan construction

Prior to carrying out a cladistic analysis a ground plan was formed, i.e. a description of the hypothetical ancestor to present day Psylloidea. Various 'directional arguments' have been proposed for deducing which character states are primitive and therefore belong to the ground plan, and the methods are reviewed by de Jong (1980) and Arnold (1981). The favoured technique is known as OUT-GROUP COMPARISON, i.e. a character state that is not restricted to a single monophyletic group is likely to be ancestral. To apply the out-group criterion a previously suggested phylogeny is needed. Watrous & Wheeler (1981) noted that there could be circularity involved in forming monophyletic groups from directional arguments based upon monophyletic groups. Instead a previous classification can be used and in this study directional arguments were based on the results of the phenetic analyses presented earlier. For example, pointed sectasetae are present in many clusters in any given phenogram and so they appear to be an ancestral

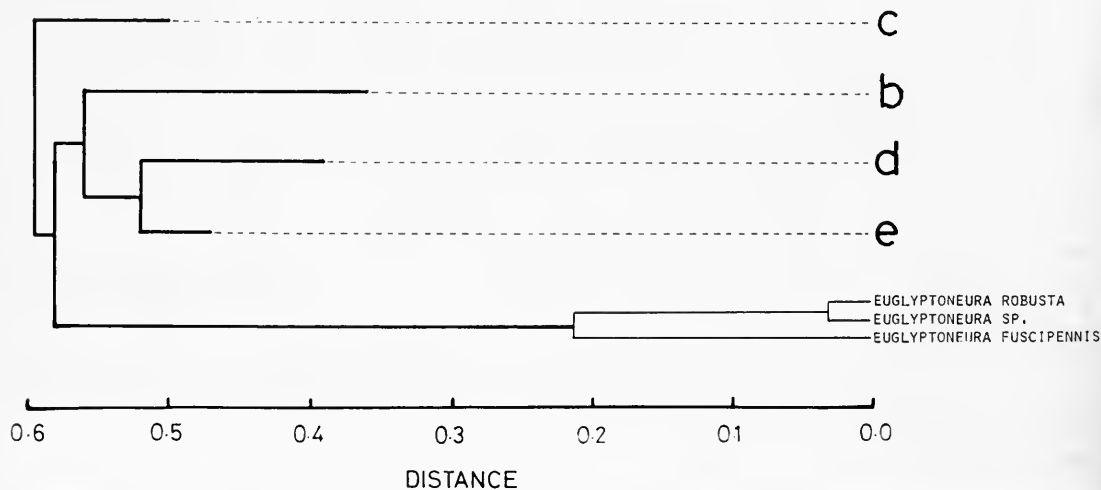

**Fig. 183a** Average linkage phenogram of 208 selected species. Distances were calculated from the first 10 principal components derived from 14 adult and 30 nymphal characters; key diagram showing linkages to Figs 183d–e.

feature. Conversely, truncate sectasetae, capitate setae and lanceolate setae each occur in a single large cluster and are therefore assumed to be derived features.

A summary of the ground plan is as follows.

ADULT

Head rounded. Genal cones absent. Anteoccipital lobes present. Antenna with narrow flagellar segments and rhinaria on segments III, IV, V, VI, VII, VIII, IX.

Suture between epimeron and episternum vertical. Forewing: coriaceous, rhomboidal in shape, costal break present, pterostigma present, nodal line present and veins *Cu+M* with a common stalk after the branching of *R* from the *R+M+Cu* stalk. Hind leg: meracanthus well developed, genual spine present, apex of tibia with a crown of many (c. 12) spines and apex of tarsal segment I with two spines.

Proctiger of male bipartite.

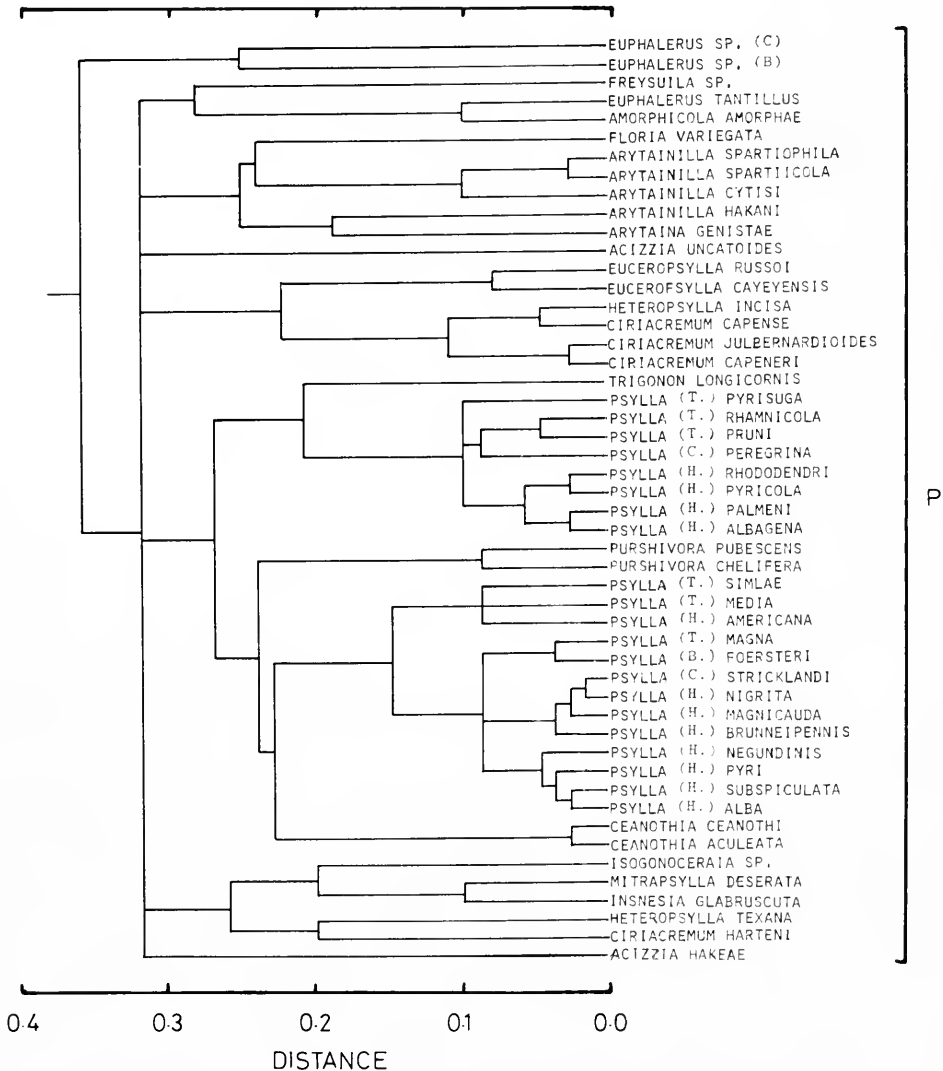

Fig. 183b Part of a phenogram of 208 species; continued from Fig. 183a.

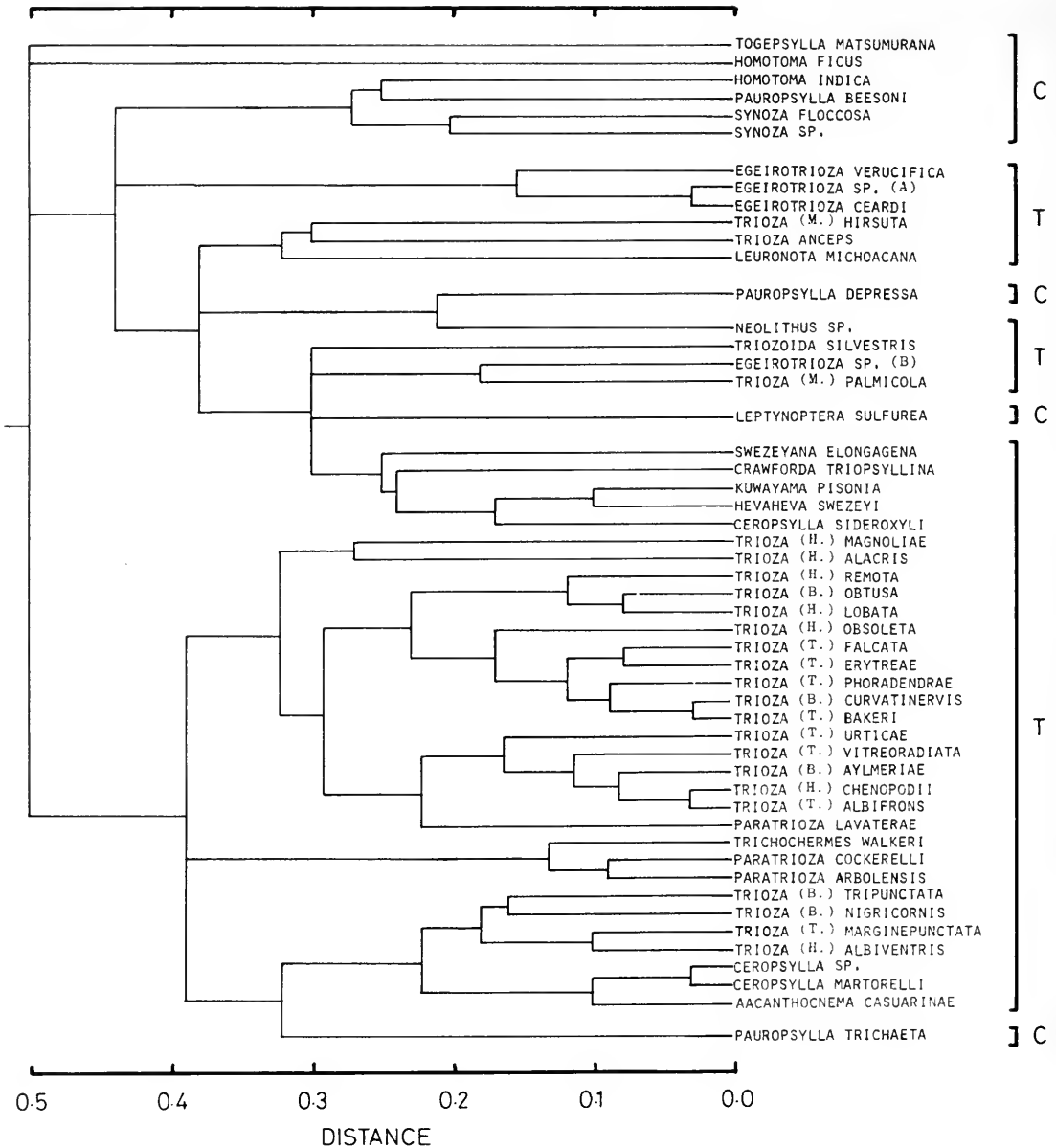

Fig. 183c Part of a phenogram of 208 species; continued from Fig. 183a.



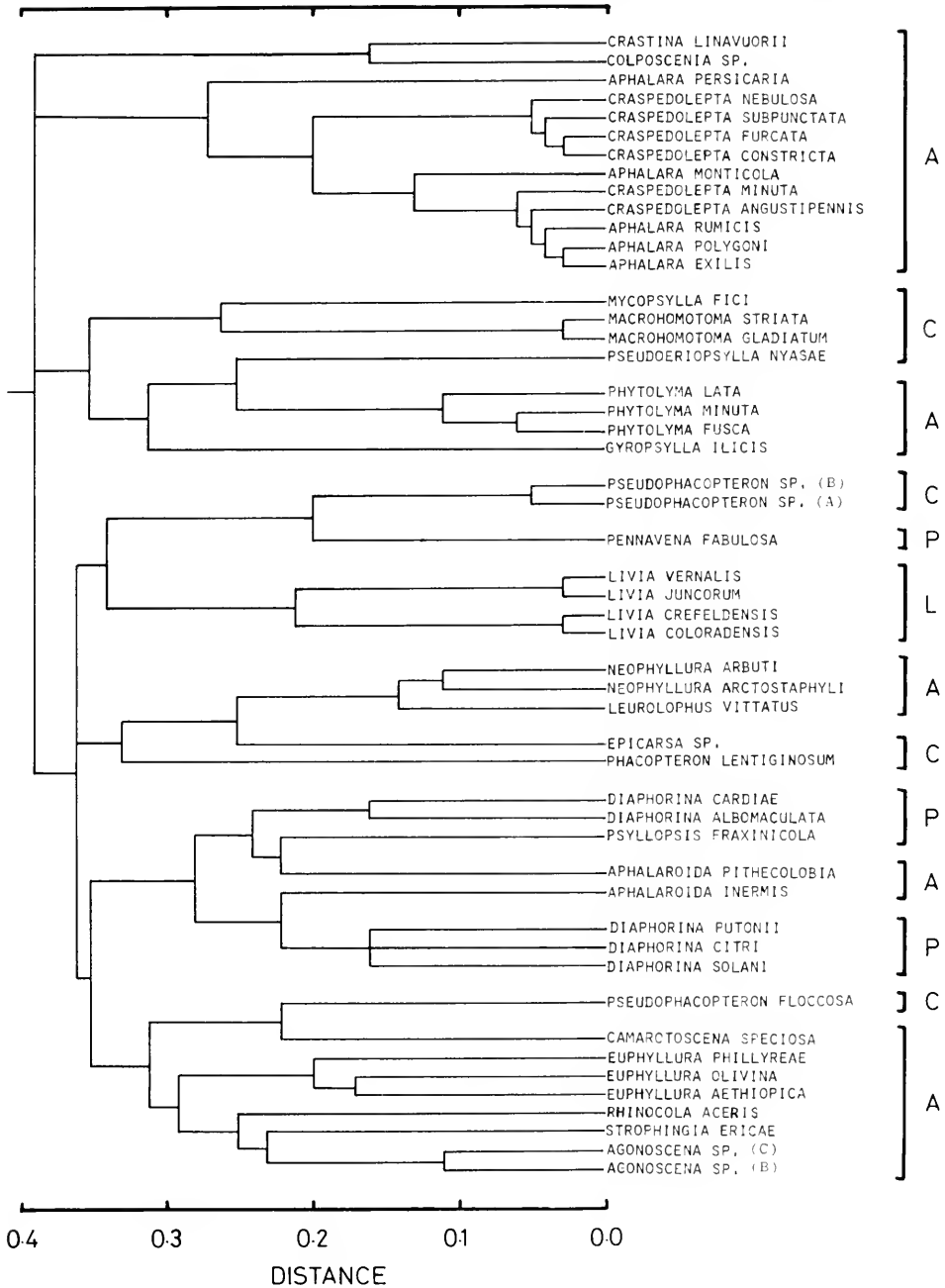

Fig. 183d Part of a phenogram of 208 species; continued from Fig. 183a.

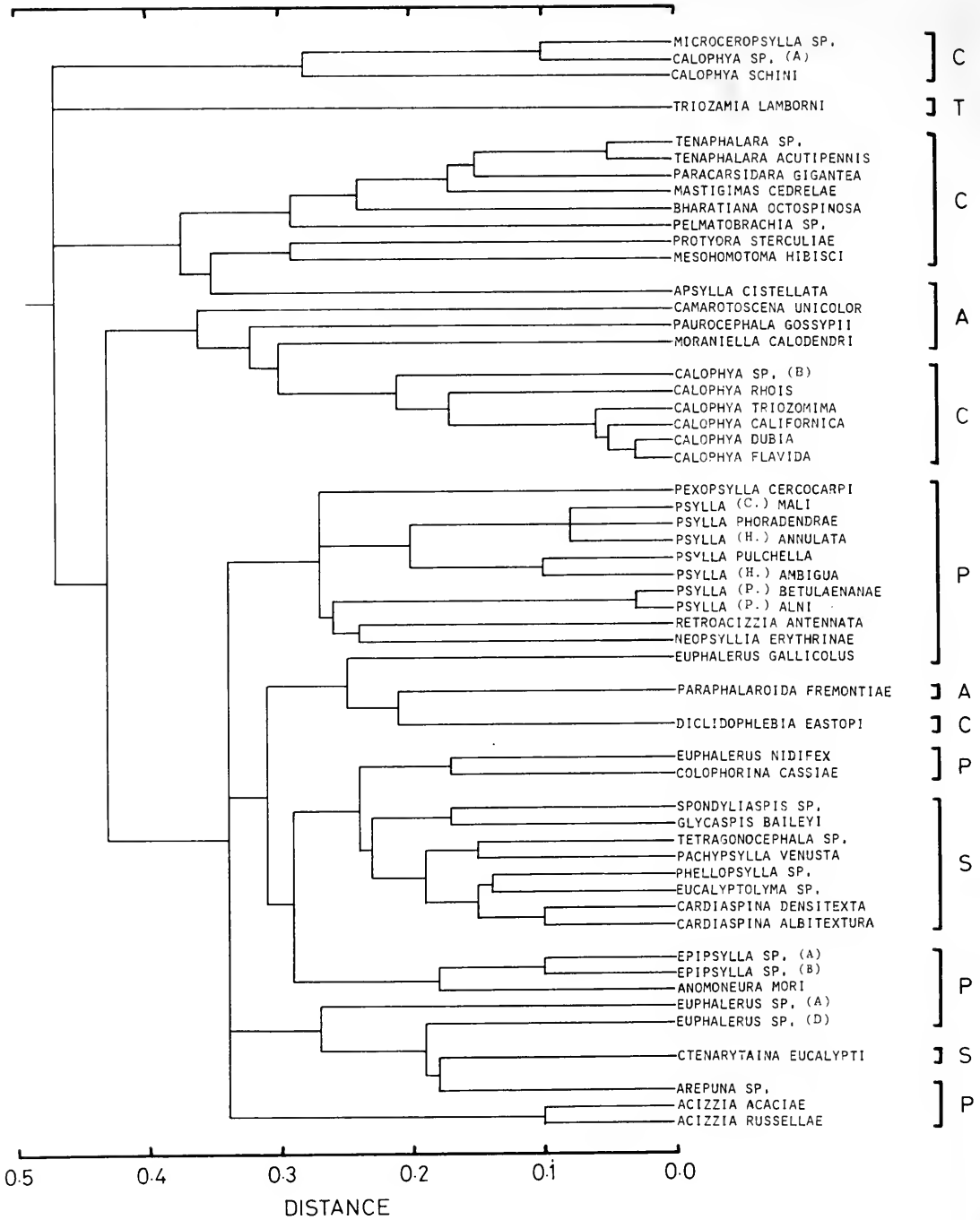

Fig. 183e Part of a phenogram of 208 species; continued from Fig. 183a.

**Table 8** Selected adult characters.

Selected characters are numbered A1–A14. All the character states in the original list of 27 characters are tabulated. However, some character states become combined by the selection procedure and, hence, in some characters two consecutive states are marked with the same value. An asterisk indicates a character which was poorly recorded in the literature.

*Head characters*

- A1. Form of genae.
  - Genae not swollen = 0
  - Genae swollen but not conical = 1
  - Genae conical, frons not enveloped by genae = 2
  - Genae conical, frons enveloped by genae = 3
- \*A2. Antenna with rhinaria on following segments.
  - III, IV, V, VI, VII, VIII, IX = 0
  - IV, V, VI, VII, VIII, IX = 0
  - IV, V, VI, VIII, IX = 1
  - IV, VI, VIII, IX = 2
  - III, VI, VIII, IX = 2

*Thorax characters*

- \*A3. Pronotum vertically or subvertically inclined, and laterally constricted. Often completely or partly concealed by head.
  - No = 0    Yes = 1
- \*A4. Suture between epimeron and episternum.
  - Horizontal = 0
  - Vertical (dorsally terminating at mid point of pronotal lateral margin) = 0
  - Diagonal (dorsally terminating at posterior of pronotal lateral margin) = 1

*Forewing characters*

- A5. Forewing with apex acute or acutely rounded. Costal margin curved.  $M_{1+2}$  terminating at or anterior to apex.
  - No = 0    Yes = 1
- A6.  $Cu+M+R$  or  $M+R$  common stalk present.
  - No = 0    Yes = 1
- \*A7. Costal break absent.
  - No = 0    Yes = 1
- A8. Pterostigma absent.
  - No = 0    Yes = 1
- A9.  $Cu_2$  not terminating adjacent to  $Cu_{1b}$ 
  - No = 0    Yes = 1

*Hind-leg characters*

- \*A10. Metatibia with basal (genual) spine present.
  - No = 0    Yes = 1
- \*A11. Metatibial apical spines or platellae numbering more than five.
  - No = 0    Yes = 1
- \*A12. Metatarsal spines.
  - Absent = 0
  - One present = 1
  - Two present = 2

*Male genitalia characters*

- A13. Male proctiger unipartite.
  - No = 0    Yes = 1
- A14. Male proctiger with long caudal lobes present in at least some species of the genus.
  - No = 0    Yes = 1

**Table 9** Rejected adult characters.

Rejected characters are numbered A15–A27. Values are not given against the states, which are separated by a '/'. An asterisk indicates a character which was poorly recorded in the literature.

*Head characters*

- A15. Vertex with cleft and antennae based upon apices of blunt vertex lobes. No/Yes.  
 A16. Vertex produced into lobes and enveloping genae. No/Yes.  
 A17. Preoccipital lobes present. No/Yes.  
 A18. Preocular tubercles present: No/Yes.  
 A19. Antenna segment II greatly enlarged. No/Yes.  
 A20. Apical antennal spines longer than antennal segment III. No/Yes.  
 A21. Clypeus long and cylindrical, projecting to anterior margin of head. No/Yes.

*Forewing characters*

- A22. Forewing with apex acute or acutely rounded. Costal margin curved.  $M_{1+2}$  terminating posterior to apex. No/Yes.  
 A23. Nodal line absent. No/Yes.  
 A24.  $R-M_{1+2}$  cross vein or anastomosis present. No/Yes.  
 A25.  $R-M$  (bifurcation of  $M_{1+2}$  and  $M_{3+4}$ ) cross vein present. No/Yes.

*Hind-leg characters*

- \*A26. Meracanthus reduced or absent. No/Yes.

*Male genitalia characters*

- A27. Male subgenital plate with hypovalves. No/Yes.

**Table 10** Nymphal characters selected after incorporation of adult characters.

Characters previously selected and now reselected: N1, N3, N4, N5, N6, N7, N8, N9, N10, N11, N13, N14, N15, N16, N17, N18, N19, N23, N24, N25, N26, N27, N28, N30, N31, N32, N33 and N34. Two further characters were selected, as follows.

- Outer circum-anal pore ring broken at two or more places (modified N52).  
     No = 0      Yes = 1
- Forewing-pad dorsal surface sectasetae (modified N29).  
     Absent = 0      Pointed = 1      Truncate = 1

**Table 11** Groups of species identical with the selected adult plus nymphal characters. The species chosen to represent the group is named at the top of each list.

- |  |  |
|--|--|
| 1. <i>Acizzia acaciae</i><br><i>Acizzia acaciaebaileyanae</i>  | 8. <i>Craspedolepta furcata</i><br><i>Craspedolepta nervosa</i>  |
| 2. <i>Agonosцена</i> sp. (B).<br><i>Agonosцена</i> sp. (A).  | 9. <i>Craspedolepta minuta</i><br><i>Craspedolepta minutissima</i>   |
| 3. <i>Agonosцена</i> sp. (C).<br><i>Strophingia cinerea</i>  | 10. <i>Diaphorina cardiae</i><br><i>Diaphorina chobauti</i>  |
| 4. <i>Aphalara polygona</i><br><i>Aphalara curta</i><br><i>A. nubifera</i><br><i>A. simila</i>   | 11. <i>Diaphorina citri</i><br><i>Diaphorina florea</i>  |
| 5. <i>Calophya flavida</i><br><i>Calophya nigripennis</i>  | 12. <i>Diaphorina putonii</i><br><i>Diaphorina clutiae</i><br><i>D. punctulata</i>                               |
| 6. <i>Cardiaspina albitextura</i><br><i>Cardiaspina spinifera</i><br><i>C. squamula</i><br><i>Creiis</i> sp.   | 13. <i>Euceropsylla russoi</i><br><i>Euceropsylla minuticonica</i><br><i>E. sp.</i>                              |
| 7. <i>Craspedolepta augustipennis</i><br><i>Craspedolepta artemisiae</i><br><i>C. sonchi</i><br><i>C. suaedae</i><br><i>C. vancouverensis</i><br><i>C. veaziei</i> | 14. <i>Euphalerus nidifex</i><br><i>Euphalerus jugovenosus</i><br><i>E. rugipennis</i><br><i>E. vermiculosus</i> |
|  | 15. <i>Glycaspis baileyi</i><br><i>Glycaspis</i> spp.  |
|  | 16. <i>Gyropsylla ilicis</i><br><i>Gyropsylla</i> spp.   |

- |   |  |
|---|--|
| <p>17. <i>Livia coloradensis</i><br/> <i>Livia maculipennis</i></p> <p>18. <i>Mastigimas cedrelae</i><br/> <i>Mastigimas</i> spp.</p> <p>19. <i>Mesohomotoma hibisci</i><br/> <i>Mesohomotoma</i> spp.</p> <p>20. <i>Mycopsylla fici</i><br/> <i>Mycopsylla</i> spp.</p> <p>21. <i>Neophyllura arctostaphyli</i><br/> <i>Neophyllura bicolor</i></p> <p>22. <i>Neopsyllia erythrinae</i><br/> <i>Neopsyllia</i> spp.<br/> <i>Platycorypha princeps</i></p> <p>23. <i>Pachypsylla venusta</i><br/> <i>Pachypsylla</i> spp.</p> <p>24. <i>Paracarsidara gigantea</i><br/> <i>Paracarsidara</i> spp.</p> <p>25. <i>Paratrioza cockerelli</i><br/> <i>Paratrioza maculipennis</i></p> <p>26. <i>Paurocephala gossypii</i><br/> <i>Paurocephala urenae</i></p> <p>27. <i>Psylla alba</i><br/> <i>Psylla sinuata</i></p> <p>28. <i>Psylla alni</i><br/> <i>Psylla buxi</i><br/> <i>Spanioneura fonscolombii</i></p> <p>29. <i>Psylla betulaenanae</i><br/> <i>Psylla carpinicola</i><br/> <i>P. floccosa</i><br/> <i>P. galeaformis</i><br/> <i>P. striata</i><br/> <i>P. trimaculata</i></p> <p>30. <i>Psylla brunneipennis</i><br/> <i>Psylla brevistigmata</i><br/> <i>P. coryli</i><br/> <i>P. hamata</i><br/> <i>P. hirsuta</i><br/> <i>P. minuta</i><br/> <i>P. moscovita</i><br/> <i>P. parallela</i><br/> <i>P. pulchra</i></p> | <p>31. <i>Psylla magnicauda</i><br/> <i>Psylla minor</i></p> <p>32. <i>Psylla mali</i><br/> <i>Psylla ribesiae</i></p> <p>33. <i>Psylla nigrita</i><br/> <i>Psylla saliceti</i></p> <p>34. <i>Psylla pyri</i><br/> <i>Psylla ulmi</i></p> <p>35. <i>Psylla pyricola</i><br/> <i>Psylla myrtilli</i><br/> <i>P. visci</i></p> <p>36. <i>Psylla pyrisuga</i><br/> <i>Psylla melanoneura</i><br/> <i>P. sorbi</i></p> <p>37. <i>Psyllopsis fraxinicola</i><br/> <i>Psyllopsis</i> spp.</p> <p>38. <i>Strophiingia ericae</i><br/> <i>Tainarys schini</i></p> <p>39. <i>Tenaphalara acutipennis</i><br/> <i>Tenaphalara malayensis</i></p> <p>40. <i>Trioza albifrons</i><br/> <i>Trioza beameri</i><br/> <i>T. quadripunctata</i></p> <p>41. <i>Trioza albiventris</i><br/> <i>Trioza atkasookensis</i><br/> <i>T. crithmi</i></p> <p>42. <i>Trioza bakeri</i><br/> <i>Trioza cinnamomi</i><br/> <i>T. diospyri</i><br/> <i>T. frontalis</i></p> <p>43. <i>Trioza chenopodii</i><br/> <i>Trioza litseae</i></p> <p>44. <i>Trioza curvatinervis</i><br/> <i>Trioza minuta</i><br/> <i>T. salicivora</i></p> <p>45. <i>Trioza erytreae</i><br/> <i>Trioza panacis</i></p> <p>46. <i>Trioza marginepunctata</i><br/> <i>Trioza vitiensis</i><br/> <i>T. sp.</i></p> <p>47. <i>Trioza tripunctata</i><br/> <i>Trioza incidata</i></p> |
|---|--|

The following species have unique descriptions:

- |   |  |
|---|--|
| <p><i>Aacanthocnema casuarina</i></p> <p><i>Acizzia hakeae</i></p> <p><i>A. russellae</i></p> <p><i>A. uncatoides</i></p> <p><i>Amorphicola amorphae</i></p> <p><i>Anomoneura mori</i></p> <p><i>Aphalara exilis</i></p> <p><i>A. monticola</i></p> <p><i>A. persicaria</i></p> <p><i>A. rumicis</i></p> <p><i>Aphalaroida</i> spp.</p> <p><i>Apsylla cistellata</i></p> <p><i>Arepuna</i> sp.</p> <p><i>Arytaina genistae</i></p> <p><i>Arytainilla</i> spp.</p> | <p><i>Bharatiana octospinosa</i></p> <p><i>Calophya californica</i></p> <p><i>C. dubia</i></p> <p><i>C. rhois</i></p> <p><i>C. schini</i></p> <p><i>C. triozomima</i></p> <p><i>C. rotundipennis</i></p> <p><i>C. sp.</i></p> <p><i>Camarotoscena</i> spp.</p> <p><i>Cardiaspina densitexta</i></p> <p><i>Ceanothia</i> spp.</p> <p><i>Ceropsylla</i> spp.</p> <p><i>Ciriacremum</i> spp.</p> <p><i>Colophorina cassiae</i></p> <p><i>Colposcena</i> sp.</p> |
|---|--|

*Craspedolepta constricta*  
*C. nebulosa*  
*C. subpunctata*  
*Crastina linavuorii*  
*Crawforda triopsyllina*  
*Ctenarytaina eucalypti*  
*Diaphorina albomaculata*  
*D. solani*  
*Diclidophlebia eastopi*  
*Egeirotrioza* spp.  
*Epicarsa* sp.  
*Epipsylla* spp.  
*Eucalyptolyma* sp.  
*Euceropsylla cayeyensis*  
*Euglyptoneura* spp.  
*Euphalerus gallicolus*  
*E. tantillus*  
*E. sp. (A).*  
*E. sp. (B).*  
*E. sp. (C).*  
*E. sp. (D).*  
*Euphyllura* spp.  
*Floria variegata*  
*Freysuila* sp.  
*Heteropsylla* spp.  
*Hevaheva swezeyi*  
*Homotoma* spp.  
*Insnesia glabruscuta*  
*Isogonoceraia divergipennis*  
*Kuwayama pisonia*  
*Leptynoptera sulfurea*  
*Leurolophus vittatus*  
*Leuronota michoacana*  
*Livia crefeldensis*  
*L. juncorum*  
*L. vernalis*  
*Macrohomotoma* spp.  
*Microceropsylla* sp.  
*Mitropsylla deserata*  
*Moraniella calodendri*  
*Neolithus* sp.  
*Neophyllura arbuti*  
*Paraphalaroida fremontiae*  
*Paratrioza arbolensis*  
*P. lavaterae*  
*Pauropsylla* spp.  
*Pelmatobrachia* sp.  
*Pennavena fabulosa*  
*Pexopsylla cercocarp*  
*Phacopteron lentiginosum*  
*Phellopsylla* sp.

*Phytolyma* spp.  
*Protyora sterculiae*  
*Pseudoeriopsylla nyasae*  
*Pseudophacopteron* spp.  
*Psylla albigena*  
*P. ambigua*  
*P. americana*  
*P. annulata*  
*P. foersteri*  
*P. magna*  
*P. media*  
*P. negundinis*  
*P. palmeni*  
*P. peregrina*  
*P. phoradendrae*  
*P. pruni*  
*P. pulchella*  
*P. rhamnicola*  
*P. rhododendri*  
*P. simlae*  
*P. stricklandi*  
*P. subspiculata*  
*Purshivora* spp.  
*Retroacizzia antennata*  
*Rhinocola aceris*  
*Spondyliaspis* sp.  
*Swezeyana elongagena*  
*Synozia* spp.  
*Tenaphalara* sp.  
*Tetragonocephala* sp.  
*Togepsylla matsumurana*  
*Trichohermes walkeri*  
*Trigonon longicornis*  
*Trioza alacris*  
*T. anceps*  
*T. aylmeriae*  
*T. falcata*  
*T. hirsuta*  
*T. lobata*  
*T. magnoliae*  
*T. nigricornis*  
*T. obsoleta*  
*T. obtusa*  
*T. palmicola*  
*T. phoradendrae*  
*T. remota*  
*T. urticae*  
*T. vitreoradiata*  
*Triozamia lamborni*  
*Triozoida silvestris*

#### NYMPH

Prothorax completely separate to head. Mesothorax and metathorax with well-defined medial and lateral sclerites. Abdomen with well-defined sclerites and a small caudal plate. Anus ventral and surrounded by a pore field of uncertain form.

Whole body (dorsal, margin, including wing-pads, and antennae) covered in pointed sectasetae and simple setae.

It is interesting to note that pointed sectasetae appear to be an ancestral attribute. However, Becker-Migdisova (1973) believed the ancestral nymph lacked sectasetae and was similar to *Tenaphalara*. This would imply that sectasetae, which are a highly complex structure, must have evolved several times. Becker-Migdisova fails to explain this unparsimonious assumption.

#### Wagner tree

An attempt was made to analyse cladistic relationships by constructing a Wagner tree (Farris, 1970). Characters were selected by phyletic weighting (Cain & Harrison, 1960), so that only one character out of a set of characters that might be functionally or ecologically correlated was used in the analysis. This weighting left only 17 characters, which were inadequate for meaningful analysis (White, 1980). However, this analysis did indicate a need to re-examine the structure of the tarsal arolium.

#### Reanalysis of tarsal arolium structure

One large branch of the Wagner tree was initially defined by the presence of a petiolate tarsal arolium in the nymph and the branch included all the Psyllidae except Diaphorini and *Psyllopsis*. Furthermore, the presence or absence of a petiolate tarsal arolium in the nymph, received very high eigenvector and SUMRAT values in previous analyses, and the presence state appears to be largely confined to the Psyllidae. However, it was also recorded as present in a few Aphalaridae (*Aphalara persicaria* and *Paurocephala*) and Triozidae (*Trioza hirsuta*). Upon re-examination the finer structure of the arolium became apparent. Most species have a sclerotized 'rod' or 'rods' running longitudinally from the base of the arolium (shown black in Figs 59–94). The homology of this structure is uncertain, but it will be referred to as an unguitractor. Some species lack any visible arolium (most Spondyliaspidae), while others lack any visible unguitractor (Aphalarinae (Aphalaridae) and *Egeirotrioza* (Triozidae)) (Fig. 95). A short unguitractor is probably the ancestral state (Fig. 67). It is greatly elongated in almost all the Psyllidae, *Diclidophlebia* (Carsidaridae), *Aphalaroida*, *Camartoscena*, Euphyllurini, *Paraphalaroida* and *Paurocephala* (Aphalaridae) (Figs 59, 62–66, 69, 70, 79–93). Some species have retained a membrane adjacent to the long unguitractor: Diaphorini (Fig. 60) and Euphyllurini (Figs 62–64) while in others it is lost (Fig. 59). Careful analysis of arolium form was found to be of great value in cladistic analysis of species which otherwise differ little from the ground plan.

#### Cladistic method

The Wagner tree analysis indicated that a method of cladogram construction was needed which used all of the available characters. To overcome the problem of GAIN characters being of greater value than LOSS characters a two-phase method of cladogram construction was devised.

A GAIN character is here defined as one whose derived state is the presence of an attribute. A LOSS character is defined as one whose derived state is the absence of an attribute. Loss characters should be accorded low weight because a structure could be lost in many distantly related phyletic lines (Mayr, 1969). When a high proportion of characters are of the loss type certain modifications to the cladistic principles of Camin & Sokal (1965) and Hennig (1966) must be applied.

A total of 159 adult and nymphal characters was divided into two sets (Table 12): 1, gain characters and, 2, loss characters. Using gain characters only, the most parsimonious cladogram was formed. The loss characters were then added to the cladogram such that each group of taxa

which was divided by loss characters only had maximum parsimony. However, the loss characters were not most parsimonious over the entire tree.

When a section of the tree could only be structured by loss characters and many equally parsimonious solutions were possible, the characters were weighted and added to the tree in order of decreasing weight. The weights were the sum of the mutual information (Legendre & Rogers, 1972) values for each character with all other characters in the section of tree under study. This method is similar in principle to using the compatibility method of Le Quesne (1969).

In the illustration of the cladogram (Figs 184–196) the following convention was adopted.

1. Gain characters are marked by squares; black for derived and white for ancestral.
2. Loss characters are marked by circles; black for derived and white for ancestral. This enables clades which are only defined by loss characters to be instantly recognisable.
3. Each ancestor is numbered, e.g. the ancestral psyllid is number one. All descendants are said to belong to clade one. There are 94 ancestors giving rise to 106 taxa of generic, subgeneric and in some cases species level groupings.

### Formation of initial branches in the cladogram (Fig. 185)

A few of the characters used by Schlee (1969) and Szelegiewicz (1971) are included at the base of the cladogram, to define both the Psylloidea and their supposed sister clade the Aleyrodoidea (Fig. 184).

Certain major clades (2, 6, 13, 15, 17, 32, 37 and 39) are defined by complex gain characters. *Apsylla*, *Bharatiana*, *Livia*, *Mastigimas* and *Strophingia* are separated from the ground plan almost entirely by loss characters and are not easily placed.

*Apsylla* adults have very long apical antennal spines, which is a gain character ancestral to clade 39 (Fig. 190), e.g. *Calophya*, although *Pseudophacopteron* (clade 37, Fig. 189) also has this attribute. *Apsylla* is therefore placed as a sister group to clade 39 (clade 10 is formed). *Bharatiana* adults have a fairly large clypeus and large lateral ocelli, though not as pronounced as in clade 37, e.g. *Phacopteron*. With hesitation, *Bharatiana* is placed as a sister group to clade 37 (clade 8 is formed). *Mastigimas* nymphs have broken bands of anal pores, a feature which could be derived from bands of anal pores, an attribute which is ancestral to clade 32, e.g. *Paracarsidara* (Fig. 187). Although anal pore bands also occur in *Epicarsa*, *Mastigimas* is placed as a sister group to clade 32 (clade 4 is formed). *Livia* and *Strophingia* are only separated from the ground plan by loss characters and cannot be placed with any clade so far formed.

The ten-way furcation from the ground plan (to clades 2, 4, 6, 8, 10, 13, 15 and 17 plus *Livia* and *Strophingia*) was resolved using weighting and the resulting branches are shown in Fig. 185.

Becker-Migdisova (1973) proposed that the ancestral psyllid gave rise to three separate lines (a *Carsidara/Trioza* line, an *Aphalara* line and a *Psylla* line). However, Klimaszewski (1964) proposed a bifurcation into a *Carsidara/Trioza* line and an *Aphalara/Psylla* line. Furthermore, Vondracek (1957) suggests a *Spondylaspis/Carsidara/Trioza* line and a *Calophya/Psylla/Aphalara* line. The present cladogram agrees with a line typified by *Trioza* and *Carsidara* (cf. *Paracarsidara*) and includes some of the groups which these authors have referred to *Carsidaridae*, such as *Calophya*, *Phacopteron* and *Homotoma*. However, the present cladogram provides no justification for the *Aphalaridae*, except as a collection of groups phenetically close to the ground plan from which other clades can be derived. The *Psyllidae* arise from one such group (clade 17).

### Clade descriptions

Clade 2 (Fig. 186) corresponds with the *Triozidae* plus the *Leptynopterinae* and *Pauropsyllini* of Becker-Migdisova (1973). However, this is not the *Pauropsyllini* of Loginova (1972), many of which are placed in clade 17, e.g. *Paurocephala* (Figs. 193–196). The genera *Leptynoptera* and *Pauropsylla* have a typical *Trioza* type adult pronotum, wing venation and sometimes nymphal form. They are placed in clade 18 with other genera possessing these features. The pronotal structure of *Trioza* is also found, to a lesser extent of development, in *Homotoma* (clade 6,



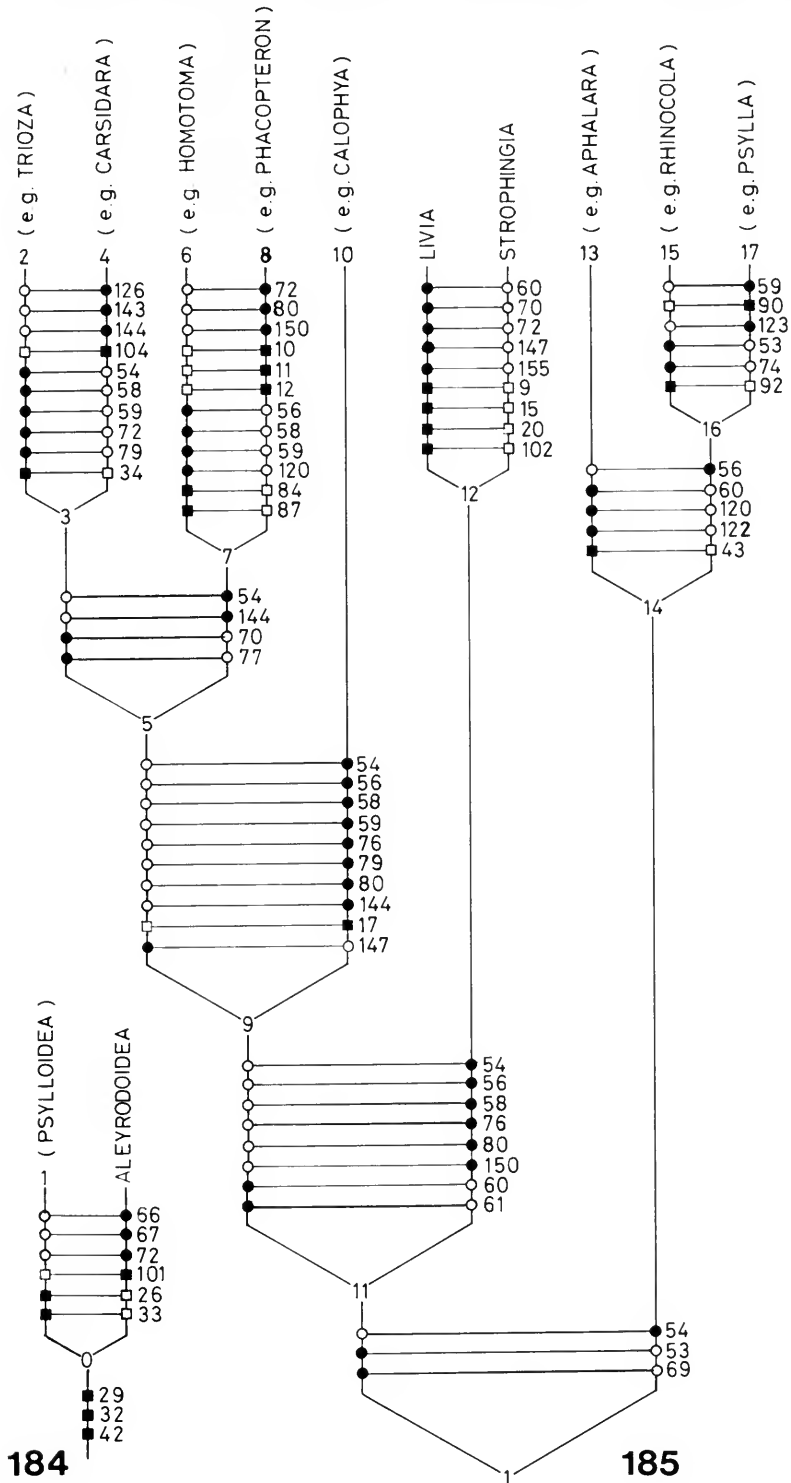

**Figs 184, 185** Clades 0 and 1. 184, clade 0, including the Psylloidea (clade 1) and Aleyrodoidea; 185, clade 1, the Psylloidea. Details of clades 2, 4, 6, 8, 10, 13, 15 and 17 are illustrated in Figs 186–196.

Fig. 188) and *Microceropsylla* (clade 10, Fig. 190). Clade 2 can be divided into three major sections.

(i) Clade 2 (minus clade 18) (Fig. 186a), e.g. *Trichohermes* includes those genera which lack the *Trioza* type adult pronotum and the fusion of the dorsal surface of the nymphal abdomen.

(ii) Clade 18 (minus clade 23) (Fig. 186b) contains genera in which the nymphs are fairly elongate, the hindwing-pad margin is not confluent with the abdomen margin and the marginal setae are normally well spaced apart.

(iii) Clade 23 (Fig. 186c) contains genera which have 'disc'-shaped nymphs, often with marginal scales, dorsal clavate setae or closely spaced marginal setae.

Clade 4 (Fig. 187) is equivalent to the Carsidarinae and Tenaphalarinae of Becker-Migdisova (1973) and Klimaszewski (1964). Clade 32 is defined by the presence of a cross-vein in the adult forewing. This is subdivided into *Tenaphalara* (with an extra cross vein) and clade 31 (with a deeply cleft adult head).

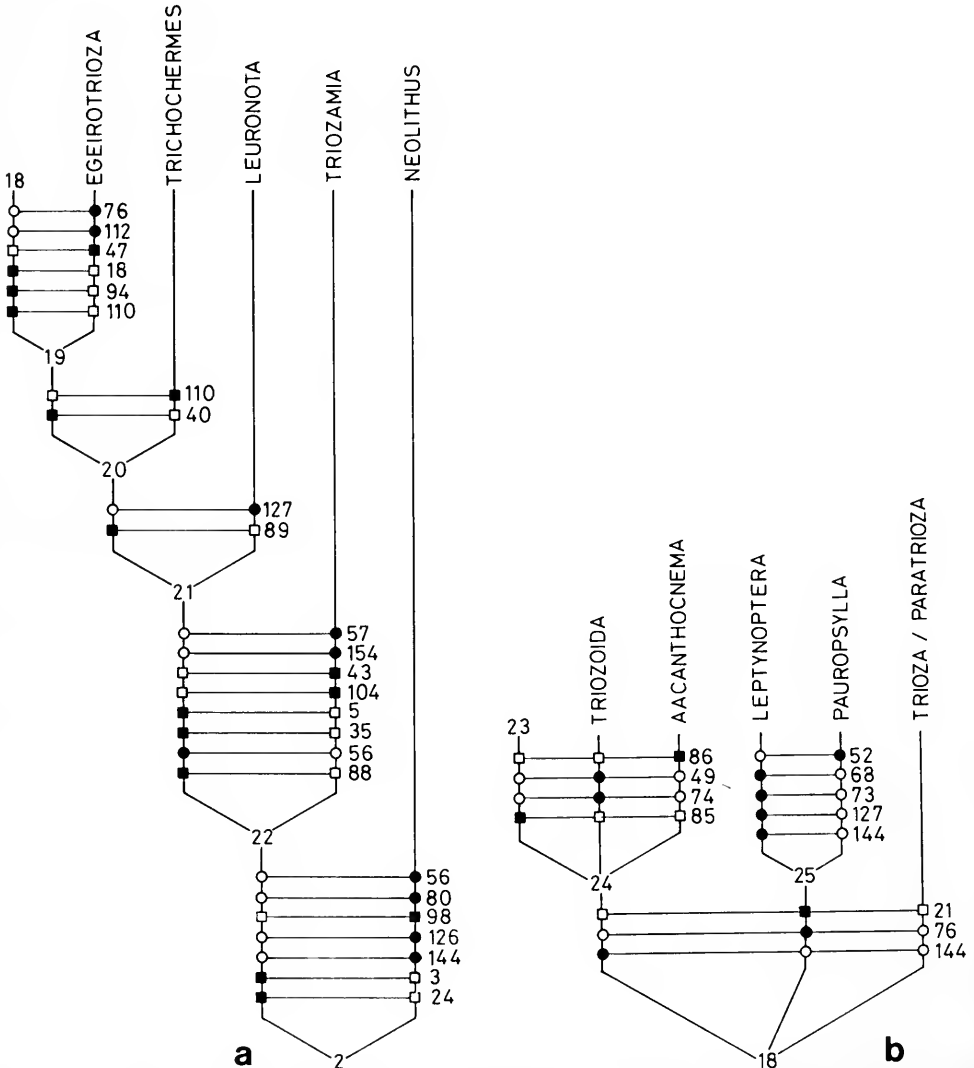

**Figs 186a, b** Clades 2 and 18. 186a, clade 2, continued in Figs 186b, c; 186b, clade 18, continued in Fig. 186c and from Fig. 186a.

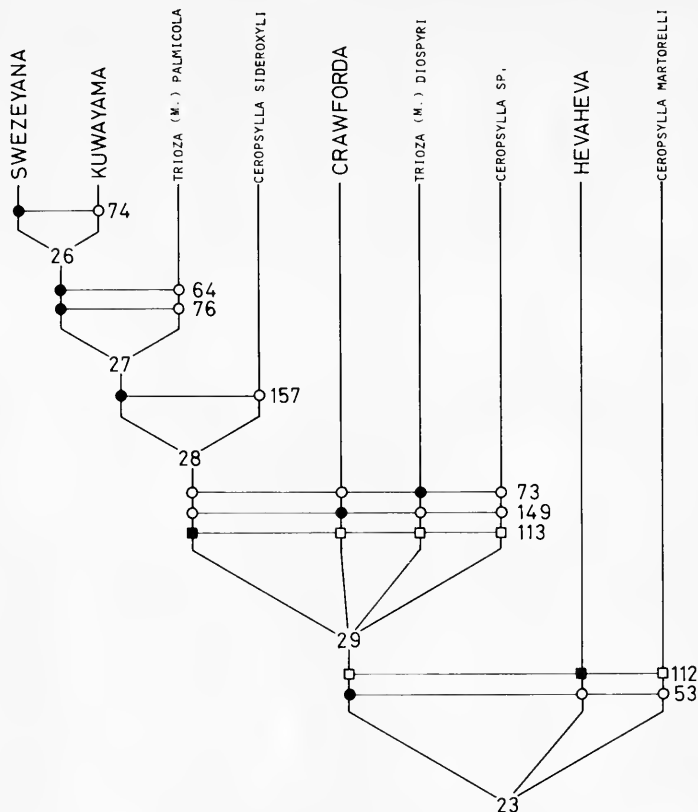
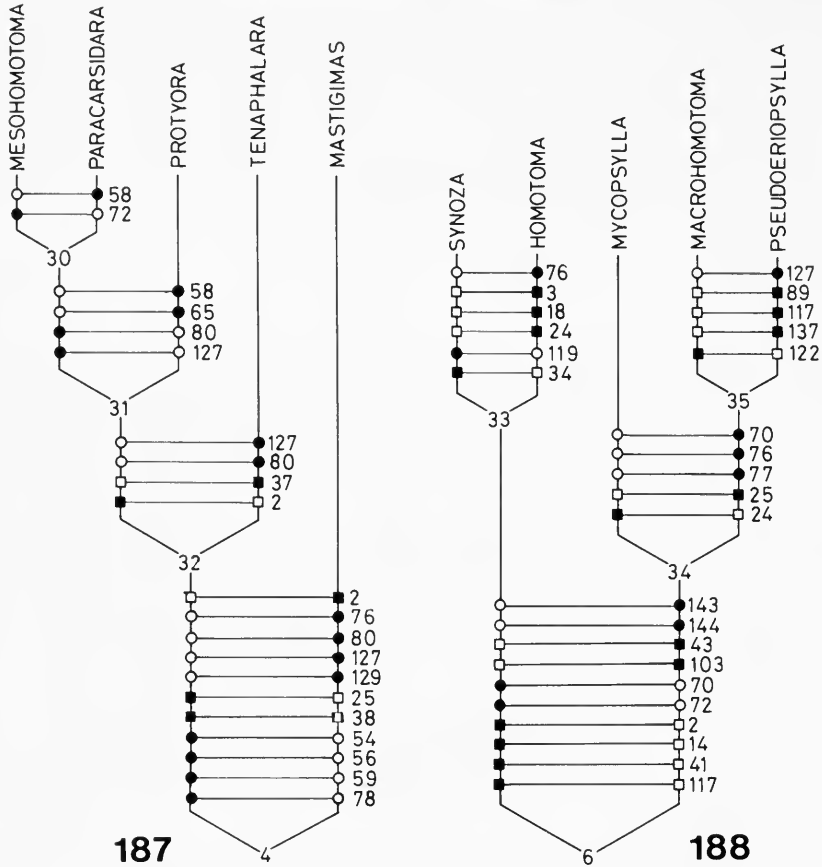

Fig. 186c Clade 23; continued from Fig. 186b.

Clade 6 (Fig. 188) is the Homotominae of Becker-Migdisova (1973). Clade 33 represents a group in need of some revision, for some *Homotoma* spp. not examined in this study may be placed with *Synoza* in the present cladogram, e.g. *H. gressitti* Miyatake has no *M + Cu* vein in the wing. Miyatake (1974) revised some *Homotoma* spp. but overlooked *Synoza* and was unaware of undescribed African species of the group (in coll. British Museum (Natural History)).

Clade 8 (Fig. 189) is the Phacopterinae of Becker-Migdisova (1973) plus ?*Epicarsa* and *Bharatiana*. The latter is only tentatively placed. The nymph examined of the former was labelled as being found with an adult close to *Epicarsa*, from Brazil. The adult characters in the present cladogram are largely those given by Crawford (1911); Ferris (1928*b*) described an *Epicarsa* from Mexico, but there is some doubt about its true identity. Lima & Guitton (1962) described another Brazilian member of clade 37 (*Phacosemoides sicki*). The Pacific genus *Chineura* Tuthill should also be placed here. In the cladogram *Pseudophacopteron* nymphs are described as having lanceolate setae. This only applies to material labelled as ?*P. floccosa* from Guam: these setae are lost in other *Pseudophacopteron* spp. examined. *P. floccosa* is a Sri Lanka species which is unlikely to occur on Guam. Since wing form in this group is distinct it is assumed that the material from Guam is a member of clade 37. Guam is the type locality of *Chineura paucivena* Tuthill which may have been confused with *Pseudophacopteron*.

Clade 10 (Fig. 190) includes *Calophya* plus some genera referred to Pauropsyllinae: Microceropsyllini and Anomalopsyllinae: Apsyllini by Becker-Migdisova (1973). Loginova (1972) places *Microceropsylla* and *Pelmatobrachia* in the Pauropsyllini. The genus *Calophya* itself is referred to the Carsidaridae by Becker-Migdisova (1973), the Pauropsyllinae by Crawford (1914), and the Psyllidae by many authors (Klimaszewski, 1964; Dobreanu & Manolache, 1962; Hodkinson & White, 1979*b*). Several species which probably belong within clade 34 are still



Figs 187, 188 Clades 4 and 6. 187, clade 4; 188, clade 6.

placed in *Pauropsylla*, e.g. *P. longispiculata* Mathur, *P. maculata* Mathur and *P. verrucosa* Mathur. There is little apparent difference in general form between some *Calophya* s.str., *Neocalophya* Miyatake (a subgenus of *Calophya*), *Paracalophya* Tuthill and *Holotrioza* Bréthes. The entire group is in urgent need of revision as indicated by Miyatake (1971).

*Livia* and *Strophingia* (Fig. 185) must be regarded as morphologically primitive genera, although it is not intended to imply that they are very ancient. They have retained the ground plan facies and have no gain characters in common with other clades and their true cladistic relations are uncertain. Cladistic relations within the genus *Strophingia* are postulated by Hodkinson (1981).

Clade 13 (Fig. 191) contains species with 'Aphalarid' facies, i.e. species which are phenetically close to the ground plan but possess a caudal lobe on the adult male proctiger. The caudal lobe also occurs in clade 83 and it is possible that it has evolved more than once among the species in clade 13. Although clade 13 may not be a monophyletic group, clade 41 is partly defined by the unique feature of a 'tooth', lobe or hook-like structure on the ventral edge of the caudal lobe. Hence, only the position of *Phytolyma* is dubious. *Phytolyma* has in the past been assigned to many different groups. Heslop-Harrison (1952b) placed it near *Rhinocola* (clade 15), but later he (Heslop-Harrison, 1958) added it to the Pauropsyllini. Both Vondracek (1963) and Becker-Migdisova (1973) referred it to the Anomalopsyllinae, though the former regarded that subfamily as belonging to the Spondyliaspidae, while the latter placed it in the Aphalaridae. In reality *Phytolyma* is probably a relic genus retaining many features of the ground plan, a bipartite male proctiger and preoccipital lobes in the adult. Hollis (1973) stated that the tropical

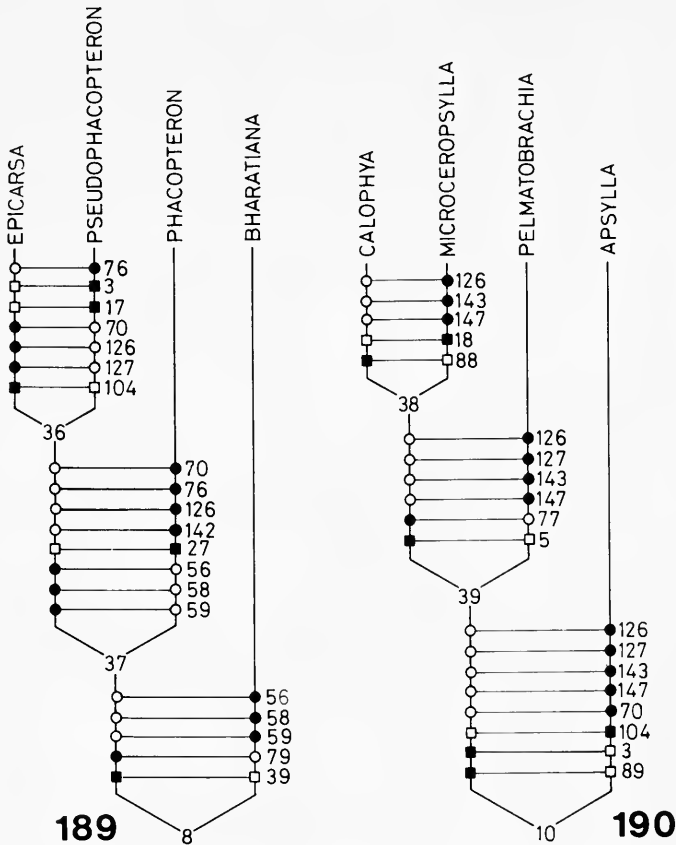

**Figs 189, 190** Clades 8 and 10. 189, clade 8; 190, clade 10.

components of this group are poorly known; they probably derived from basic psyllid stock earlier than temperate forms, and are difficult to place in the existing classification.

Clade 43 is defined by the diagonal suture between the adult epimeron and episternum. Clade 42 is the tribe Stigmaphalarini of Vondracek (1957) and Colposceniini of Becker-Migdisova (1973). Clade 40 is the Aphalarini of most authors.

Clade 15 (Fig. 192) contains species which have retained many ground plan features: *Moraniella* nymphs are surrounded by pointed sectasetae and adult males of *Tainarys* have a bipartite proctiger. However, the form of the tarsal arolium which defines clade 15 is unique. Nevertheless, the branching within the clade is based on loss characters only, and weights were applied.

Clade 17 (Figs 193–196) contains over half of the species studied and it is defined by the elongation of the unguitractor in the tarsal arolium of the nymph. The major division is into clades 48 and 53 (Fig. 193).

Clade 53 is defined by nymphal capitate setae, but excludes those species where the nymph has retained numerous sectasetae or where the sectasetae are reduced to lanceolate setae. Clade 48 is formed by adult loss characters, which are in common to all of these morphologically more primitive species. It is further divided into clades 47 and 50.

Clade 47 (Fig. 194), defined by the presence of 1 + 1 pore rings (or a derivable feature) on the nymphal abdomen, is divided into clades 60 and 62. Clade 62 contains the genera *Diclidophlebia* and *Paraphalaroida*. *Paraphalaroida* contains one species (*P. fremontiae*) which, prior to the revision of Loginova (1972), was regarded as a *Paurocephala* sp. *Diclidophlebia* was referred to the Carsidaridae: Tenaphalarinae, Diclidophlebiini by Becker-Migdisova (1973). The genus

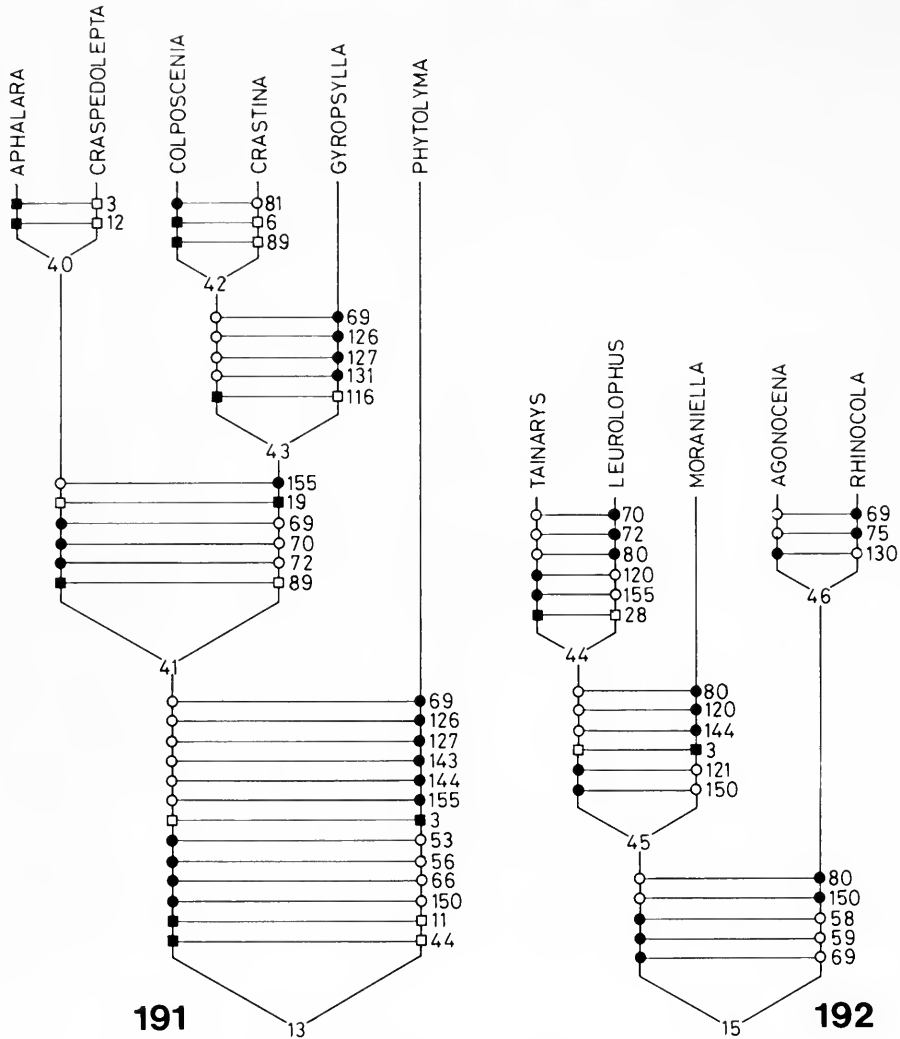

Figs 191, 192 Clades 13 and 15. 191, clade 13; 192, clade 15.

*Togepsylla* (omitted from this cladogram due to lack of information on certain character states, e.g. the form of the tarsal arolium) may belong to clade 62 because its adult head structure is similar to *Diclidophlebia* (Becker-Migdisova, 1973). Certain species still referred to the genus *Paurocephala*, such as *P. tuxtlaensis* Conconi from Mexico and *P. menoni* Mathur from India, probably belong to clade 62.

Clade 60 is divided into clades 59 and 61 by the development of adult vertex lobes as opposed to genal cones and elongated wing cells. Clade 59 is the Euphyllurini of Loginova (1973) and part of the Euphyllurini of Becker-Migdisova (1973).

Clade 61 is referred to the Spondyliaspidae by most authors (Becker-Migdisova, 1973; Hodkinson & White, 1979b; the Spondyliaspidae by Heslop-Harrison, 1954). Unlike the nymphs of other Spondyliaspidae (clade 55, Fig. 195) examined, *Ctenarytaina* and *Eucalyptolyma* have marginal lanceolate setae and, therefore, fit the cladogram outside of clade 56. Both are characterised by the reduction or absence of tarsal arolia and if they do belong to clade 17 this must represent a secondary loss. The pore field on the nymphal abdomen of *Eucalyptolyma* sp. and *Ctenarytaina eucalypti* may be derived from 1 + 1 pore rings, the defining character of clade

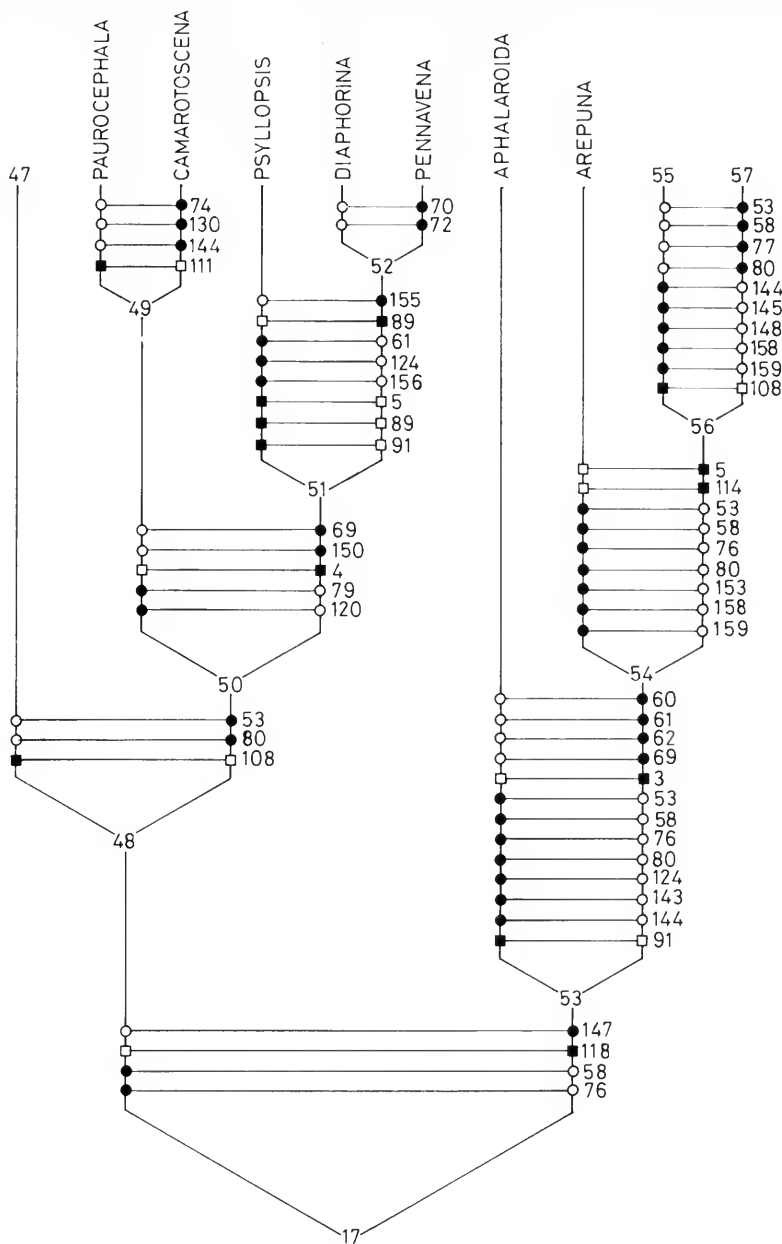

Fig. 193 Clade 17, giving rise to clades 47, 55 and 56 which are illustrated by Figs 194, 195 and 196 respectively.

47, and hence clade 61 is placed in a position of maximum parsimony. Nymphs of *Ctenarytaina thysanura* Ferris & Klyver, which we have subsequently seen, lack the abdominal pore field. The position of *Eucalyptolyma* requires further investigation since recently acquired material of *E. fuscipennis* Froggatt nymphs are of a structure concordant with clade 61 while those of *E. maideni* Froggatt are structurally close to clade 68. Two Indian species (*Euphyllura caudata* Mathur and *E. concolor* Mathur) may also belong to clade 61 on the basis of the pore field of the nymphal abdomen and the structure of the adult female proctiger.

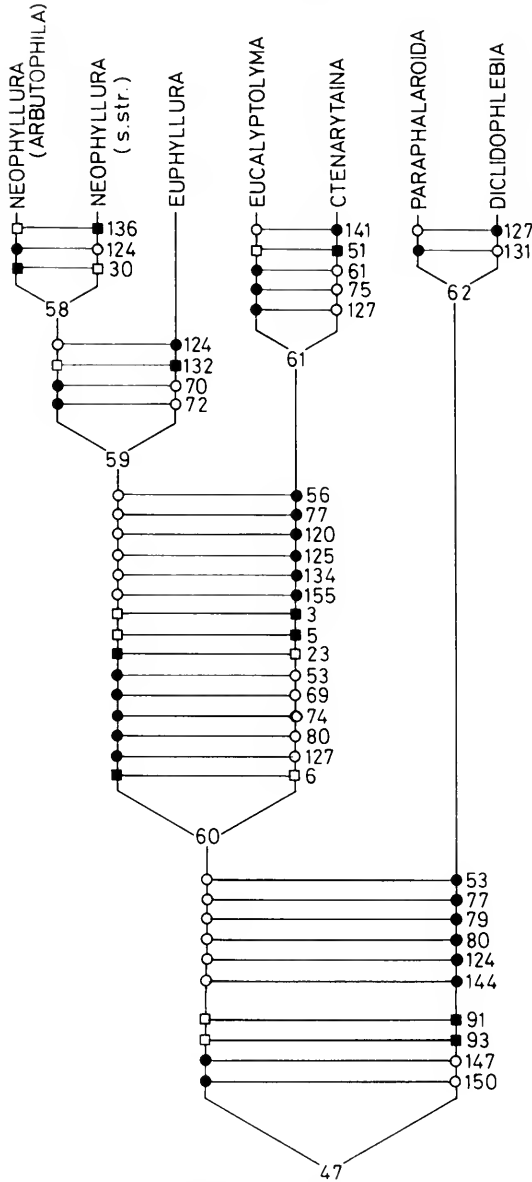

Fig. 194 Clade 47.

Clade 50 (Fig. 193) is a maximum parsimony collection, based on loss characters, of genera belonging to clade 17 but not clades 47 or 53. It is divided into clades 49 and 51. Clade 51 is defined by the presence of genal cones, a feature which occurs many times in the cladogram, and clade 49 is only formed by loss characters.

Clade 49 (Fig. 193) contains the genera *Camarotoscena* and *Paurocephala*, the former of which was regarded as a subgenus of *Paurocephala* by Vondracek (1957). Most authors have placed these genera in the tribe Paurocephalini of the Aphalaridae: Paurocephalinae (Becker-Migdisova, 1973; Klimaszewski, 1964). Because the general facies of the adult head is similar to *Pauropsylla* (clade 25, Fig. 186b) many authors placed *Paurocephala* in the Pauropsyllinae (Crawford, 1914; Loginova, 1972; Mathur, 1975).



Clade 51 (Fig. 193) is the Psyllidae: Arytaininae, Diaphorinini of Vondracek (1957), Dobreanu & Manolache (1962) and Klimaszewski (1975). Becker-Migdisova (1973) placed *Psyllopsis* in the Psyllidae: Arytaininae, Psyllopseini. Pflugfelder (1941) placed *Diaphorina* and *Psyllopsis* in the Aphalaridae, and Löw (1879) placed them in the Psyllidae and Aphalaridae respectively. The nymphs of *Psyllopsis*, *Diaphorina* and *Pennavena* have an 'Aphalara' facies and are surrounded by marginal lanceolate setae. The long unguitactor of the nymphal arolium suggests that these genera belong in clade 17. However, the presence of lanceolate setae excludes these genera from clade 56 where most former authors have placed them. Furthermore, the adults retain a crown of about 10 spines at the apex of the metatibia, a feature always reduced in clade 57 (Fig. 196).

Clade 53 (Figs 193–196) begins with a major transition between members of clade 17 with 'Aphalara' and 'Psylla' type facies. The nymph of *Aphalaroida* is in many respects similar to *Euphalerus* or *Acizzia* while the adult is phenetically similar to *Strophingia*. The nymph of *Aphalaroida pithecolobia* is covered by rod setae, similar to *Euglyptoneura robusta* and *Pexopsylla cercocarpi* (both Clade 56, Fig. 193). The position of *E. robusta* (clade 82, Fig. 196e) suggests that rod setae are modified capitate setae and therefore, in the cladogram, rod setae are not differentiated from capitate setae.

The adult of *Arepuna* has a wing of a *Euphalerus* type and the nymph is surrounded by clavate setae. These could be very reduced sectasetae, which would place *Arepuna* outside of clade 56, or reduced capitate setae, which would place it anywhere in clade 53. A larger number of losses must be proposed if *Arepuna* is to be placed within clade 56 rather than as a sister group to it.

Clade 55 (Fig. 195) is initially defined by the presence, in the nymph, of 1 + 1 pore rings additional to the circum-anal ring. It is assumed that these rings become split to form the 2 + 2 rings which initially define clade 66. Even without this assumption the contents of clades 64 and 66 would still arise from close to the start of clade 56 (Fig. 193). In clade 63 the preoccipital lobes are lost and the 1 + 1 pore rings become areas of separated pores. Although nymphal capitate setae are regarded as lost in clade 55, they may be retained in some species, such as *Psylla bengalensis* Mathur, which were not examined but appear to belong to clade 64.

Clade 66 is initially defined both by the presence of 2 + 2 nymphal pore rings and a serrate apex to the nymphal abdomen. Clade 65 is a collection of species in which the serrate apex to the abdomen is retained but the pore rings are often lost or reduced to small groups of pores. This reduction could be derived from 1 + 1 or 2 + 2 pore rings and species which belong to clade 55, but are excluded from clades 64 and 67, are grouped for convenience into clade 65. Clade 65 consists of the following taxa: clade 72, *Euphalerus nidifex*, *Pachypsylla* spp. (other than *P. japonica*), *Phellopsylla* and *Retroacizzia* all of which are only separated from ancestor 65 by loss characters. The details of clade 65 were constructed by weighting. *Phellopsylla* belongs to the Spondyliaspidae of all authors, clade 73 to the Spondyliaspidae: Pachypsyllinae of Becker-Migdisova (1973) and clade 74 to the Psyllidae.

Ancestor 67 (Fig. 195a) marks a transition. Clade 67 is initially defined by having enlarged outer teeth on the serrate apex of the nymphal abdomen, as in *Euphalerus gallicolus*. Clade 68 is a collection of species with a pointed cauda in the nymph: *Creiis* has both a pointed cauda and 1 + 1 tooth-like structures near the apex of the abdomen. These are treated as being homologous with the enlarged outer teeth in *E. gallicolus*. Further evidence for the inclusion of clade 68 in 66 is provided by the fact that lerp-forming species are confined to clades 65 and 68.

Nymphs of species in clade 68 have weakly sclerotized abdomens and the caudal plate is rudimentary. This implies either that a large caudal plate has been derived separately in several branches, or that a reversal to separate segments has occurred. This appears to contradict Dollo's Law. However, the genotype must contain coding for all abdominal segments since they occur in the adult, i.e. Dollo's Law is not broken at the level of the genotype.

Clade 57 (Fig. 196) is defined by loss characters only and contains genera which belong within clade 56 but not 55. With the exception of clade 51 (Fig. 193), and some *Euphalerus* spp. (including the type-species of the genus, *E. nidifex*) and *Retroacizzia* which have been assigned to clade 55 (Fig. 195), it is the Psyllidae of most authors.

Certain clades (78, 82 and 85) are defined by gain characters leaving the genera *Acizzia*,

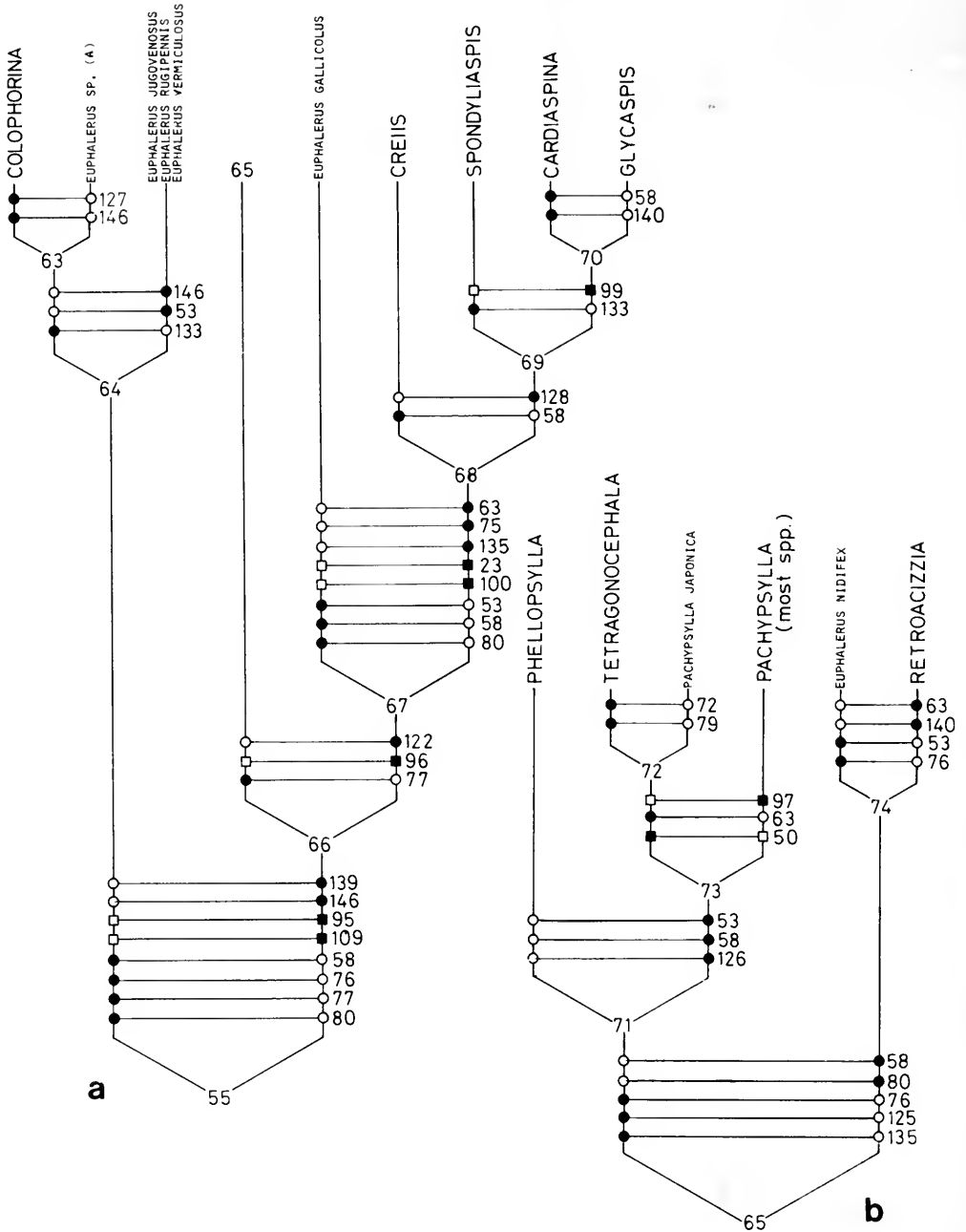

**Figs 195a, b** Clades 55 and 65. 195a, clade 55, continued in Fig. 195b; 195b, clade 65, continued from Fig. 195a.

*Amorphicola*, *Anomoneura*, *Arytaina*, *Arytainilla*, *Epipsylla*, *Floria*, *Mitrapsylla*, *Trigonon* and a few species referred to the genus *Euphalerus* unplaced. Character 43 (caudal lobe on adult male proctiger) was incompatible with character 1 (very broad head) and was initially ignored because it occurs in other apparently unrelated groups such as *Aphalara* and may also have evolved many times within clade 57. Character 13 (position of antennal insertions) was also omitted initially since a tendency for the antennal bases to move back not only occurs in all of

clade 82 (Fig. 196e), *Arytaina*, *Arytainilla* and *Floria* but also in a few species of other clades, such as *Ciriacremum nigripes* Hollis. Character 106 (broad anal ring) is also ignored since this occurs in *Psylla* s.str. (clade 82) as well as in *Anomoneura* and *Epipsylla*, and its derivation is uncertain. The details of clade 57 were then constructed by weighting to form five major clades (75, 76, 78, 80 and 82); characters 43, 13 and 106 were then replaced.

Clade 75 (Fig. 196b): the first branch, from the general line in clade 57, forms clade 75. The largest genus in this clade is *Acizzia*, some species of which, such as the type-species (*A. acaciae*), differ from the description used in the cladogram in that they have lost one spine from the apex of adult basal metatarsus. Furthermore, there is a very high diversity of nymphal form in the genus. *Neopsyllia* and *Platycorypha*, two genera which apparently differ only in the relative length of the caudal lobes of the adult male proctiger, are the only taxa in clade 57 to retain nymphal sectasetae on the hindwing-pad margins. *Freysuila* is placed as a sister group to *Neopsyllia* and *Platycorypha* on the basis of the very broad adult head and, therefore, a secondary loss of the caudal lobes is assumed to occur in *Freysuila*. *Mitrapssylla deserata* nymphs have lanceolate setae on the dorsal surface indicating the retention of dorsal sectasetae, or the derivative lanceolate setae, well into clade 57. The abdomen margin sectasetae (character 114) are reduced to lanceolate setae in *M. deserata*, a feature known elsewhere only in *Heteropsylla* (clade 78). In the remainder of clade 57 (clade 77) the only remaining sectasetae are (up to 4 + 4 in number) on the abdomen margin (character 114).

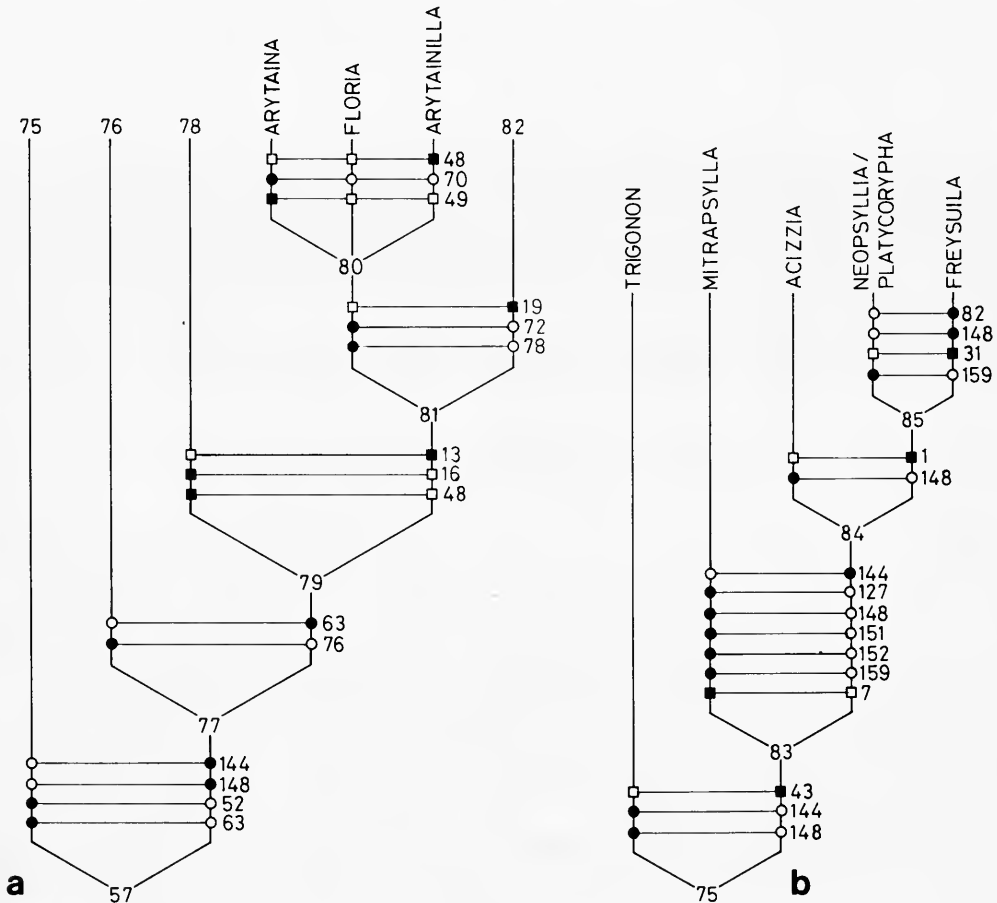

**Figs 196a, b** Clades 57 and 75. 196a, clade 57, continued in Figs 196b–e; 196b, clade 75, continued from Fig. 196a.

Clade 76 (Fig. 196c). In the character weighting procedure character 76 (loss of genual spine) received the greatest weight and defined clade 76, which includes *Amorphicola*, *Anomoneura*, *Epipsylla* and some species referred to the genus *Euphalerus*. *Euphalerus* spp. are placed in both major branches of clade 56 (Fig. 193) and these separate groups may only be recognisable in the nymphal stages. Some species at present referred to the genus *Psylla*, such as *P. hyalina* Mathur and *P. oblonga* Mathur, probably belong to clade 76. Adults of *Anomoneura* and *Epipsylla* are radically different in facies due to such characters as the presence of forewing cross veins in the former and very long genal cones in the latter. The nymphs, however, differ only in the presence of abdominal sectasetae in *A. mori*.

Clade 78 (Fig. 196d) is defined initially by the shape of the adult male paramere (character 46) and by the fact that antenna segment III is not the longest. Both these characters are subsequently lost by many species. There is also a tendency for the base of the pterostigma to be broader than the length of the vein *R* between the *R/Rs* fork and the *R*/pterostigma base positions. This feature reaches its maximum development in certain *Kleiniella* spp. (Hollis, 1976). The African genus *Kleiniella* Aulmann is one of several genera which probably belong to clade 90 but whose nymphs are unknown; others being *Delina* Blanchard (South America), *Palmapenna* Hollis (Africa) and *Panisopelma* Enderlein (South America). Clade 89 is defined by tubular abdominal sectasetae (character 115) on the nymphs. The adults of *Eucero-psylla* and *Heteropsylla* differ only in the development of the genae, despite radically different nymphs. An absence of genal cones in *Heteropsylla* has previously caused it to be referred to the Pauropsyllinae by many authors, who also include *Paurocephala* in that group. There is also a tendency for the genal cones to be reduced in *Ciriacre-mum*, though only in some species. Contrary to the opinion of Becker-Migdisova (1973) *Ciriacre-mum* spp. have neither rudimentary genal cones nor a bipartite male proctiger. Further details of the cladistic relations of clade 90 are given by Hollis (1976). Many Neotropical species at present referred to the genus *Psylla*, such as *P. forcipata* Tuthill, *P. fuscinodulus* Enderlein and *P. ingae* Tuthill, probably belong close to

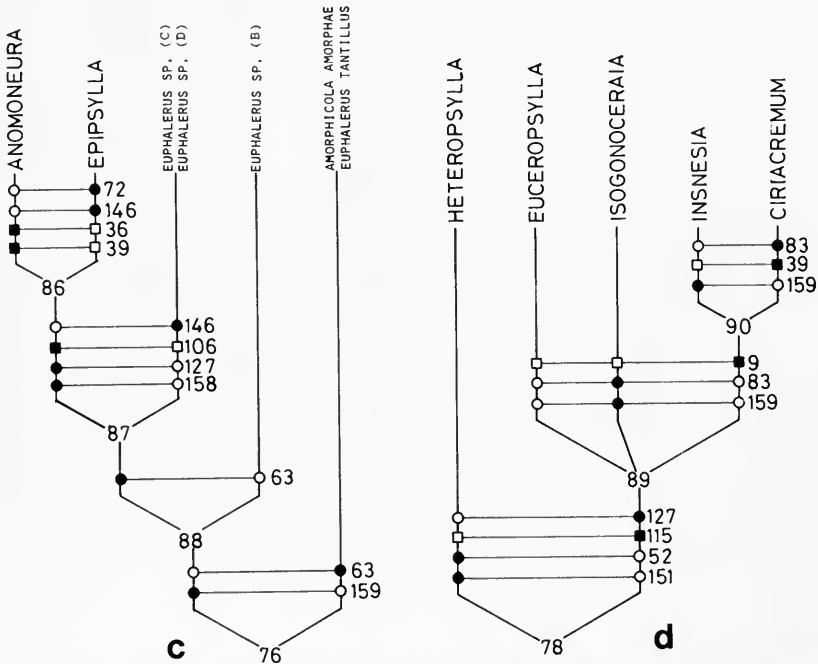

Figs 196c, d Clades 76 and 78. 196c, clade 76, continued from Fig. 196a; 196d, clade 78, continued from Fig. 196a.

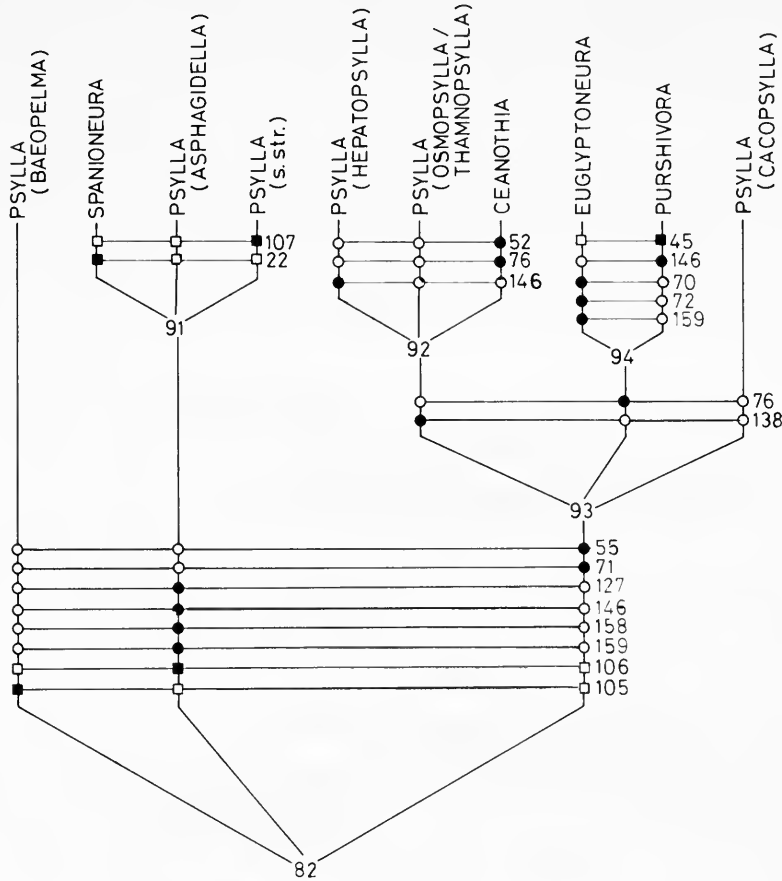

Fig. 196e Clade 82; continued from Fig. 196a.

*Euceropsylla* in clade 78. Many of the described species of *Euceropsylla* are very similar and a full revision is required. The genus *Arytaina* may contain some Pacific species belonging close to *Insnesia* or *Isogonoceraia*.

Clade 81 (Fig. 196a) is formed by replacing character 13 (antennal base position) which was omitted in the initial weighted analysis of clade 57 and is divided into clades 80 and 82.

Clade 80 (Fig. 196a) is the Arytainini of Becker-Migdisova (1973). Loginova (1976a, 1977) divided the Arytaininae into the tribes Arytainini (containing *Arytaina* and *Floria*) and the Cymophilini (containing *Arytainilla*, plus *Acizzia* of clade 75 and *Amorphicola* of clade 76). The character used to separate the tribes was the absence and presence of the costal break in the forewing, respectively. However, this character is variable in the type-species of *Floria* (Hodkinson & White, 1979a) and is therefore a poor character on which to base tribal groups. Heslop-Harrison (1961) included within the Arytainini, *Amorphicola* (clade 76), *Ceanothia*, *Euglyptoneura* and *Purshivora* (all clade 82) together with *Acizzia* (clade 75) and clade 80.

Nymphs of *Amblyrhina torifrons* Löw which we recently collected are, within the bounds of the characters used in the cladogram, identical to *Arytaina*. Other genera which probably fit clade 80 are *Allooneura* Löw and *Livilla* Curtis.

Clade 82 (Fig. 196e) is the genus *Psylla* s.l. (minus species which have already been referred to other clades) plus *Spanioneura* and three North American genera, *Ceanothia*, *Euglyptoneura* and *Purshivora*, placed in the Arytainini by Heslop-Harrison (1961). Additional information, on the number of gonads, is available for a few of the subgenera of *Psylla* shown in clade 82 and

**Table 12** Characters used in the cladogram.

There are four categories of characters used in the cladogram: 50 adult gain, 32 adult loss, 35 nymphal gain and 41 nymphal loss. In some cases shape changes could not easily be categorized as gain or loss. In general, such characters were described as gains, especially if of a complex nature. However, when a shape change was lacking in compatibility with complex type gain characters, i.e. liable to be multiply derived, it was listed with the loss type characters. Only the derived state of each character is given in the following tabulation.

*Adult 'gain' characters*

1. Head, with eyes, more than six times as broad as vertex is long.
2. Vertex deeply cleft and antennae based upon apices of blunt vertex lobes.
3. Genae swollen.
4. Genae formed into cones which are in the same plane as the vertex.
5. Genae formed into cones which are deflected ventrally from plane of vertex.
6. Vertex produced into lobes and enveloping genae.
7. Vertex mid-line paralleled by closely proximal ridges.
9. Preocular tubercles present.
10. Lateral ocelli at extreme posterior margin of head and very prominent.
11. Clypeus large.
12. Clypeus produced anteriorly.
13. Antennal insertions high on vertex, not on front vertex/genal area.
14. Antennal flageller segments (III-X) as broad as basal two segments.
15. Antennal segment II greatly enlarged.
16. Antennal segment VIII longer than segment III.
17. Antennal apical spines very long (at least as long as segments IX and X together or segment III and often almost as long as whole antenna).
18. Pronotum vertically or subvertically inclined, and laterally constricted. Often completely or partly concealed by head.
19. Suture between episternum and epimeron diagonal (dorsally terminating at posterior of pronotal lateral margin).
20. Suture between episternum and epimeron horizontal.
21. Wing very broad subapically (*Pauropsylla* shape).
22. Wing of *Spanioneura* shape.
23. Wing very elongate with veins straight and almost parallel.
24. Forewing with apex acute or acutely rounded. Costal margin curved.  $M_{1+2}$  terminating at or anterior to apex.
25. Forewing with apex acute or acutely rounded. Costal margin curved.  $M_{1+2}$  terminating posterior to apex.
26. Wing thick or coriaceous, not membranous. Shape rhomboidal.
27. Wing veins broad.
28. Costa broad.
29. Lenticula costal field.
30. Veins  $R_s$  and  $M$  sinuate (*Neophyllura* subgenus *Arbutophila*).
31. Cells  $cu_1$  and  $m_2$  very elongate. Wing fairly broad (*Auchmerina*, *Caradocia*, *Freysuila*, *Geijerolyma* and *Macrocorsa* wing forms).
32. Subcosta and costa coalesced.
33. Veins  $R$ ,  $M$  and  $Cu_1$  with a common stem.
34. Veins  $R$ ,  $M$  and  $Cu_1$  separated from common stem at one point or veins  $R$  and  $M$  with a common stalk after the branching of  $Cu_1$ .
35.  $Cu_2$  terminating at a point well separated from  $Cu_{1b}$ , and often closer to the wing base (this separation occurs in many clades but is only well expressed in clade 22, e.g. *Trioza*).
36. Cross veins: pterostigma- $R_s$ .
37. Cross vein:  $R-R_s$ .
38. Cross vein:  $R-M$  (bifurcation of  $M_{1+2}$  and  $M_{3+4}$ ) cross vein.
39. Cross vein:  $R-M_{1+2}$  (or anastomosis of  $R$  and  $M_{1+2}$ ).
40. Well-developed radular spinules.
41. Mid tibia with a dark heavily sclerotized band around apex.
42. Sperm pump of form common to Psylloidea and Aleyrodoidea.
43. Male proctiger expanded posteriorly to form caudal lobes.

44. 'Tooth'-like armature placed ventrally in basal half of caudal lobe.
45. Paramere with inner spiniform process (*Purshivora*).
46. Paramere bifid when viewed posteriorly (e.g. *Heteropsylla*).
47. Paramere bifid when viewed laterally (*Egeirotioza*).
48. Long thin paramere (*Arytainilla*).
49. Stout paramere with a heavily sclerotized and thickened blunt apex (*Arytaina*).
50. Female dorsal valve short, rounded down and densely covered by long thin setae (*Pachypsylla japonica* and *Tetragonocephala* sp.).
51. Female dorsal valve (proctiger) with lanceolate setae arranged along margin (*Ctenarytaina*, *Euphyllura caudata* and *E. concolor*).

#### Adult 'loss' characters

52. Genal cones greatly reduced or lost (derived from character 5).
53. Anteoccipital lobes absent.
54. Antenna without very narrow (*Mastigimas* type) flagellum (segments III to X).
55. Antenna less than twice as long as head breadth (a character of secondary loss which is only applied to clade 82, e.g. *Psylla*).
56. Rhinarium absent from segment III.
57. Rhinarium absent from segment IV.
58. Rhinarium absent from segment V.
59. Rhinarium absent from segment VII.
60. Wing apex rounded, remaining coriaceous (unless combined with character 61) (derived from character 26).
61. Wing membranous (derived from characters 26 or 60).
62. Euphalerine wing (derived from character 26). Generally maculate.
63. Wing apex rounded (derived from character 62).
64. Wing apex rounded (derived from character 24).
65. Wing apex rounded (derived from character 25).
66. Branches of *M* and *Cu* reduced.
67. Cell *cu*<sub>2</sub> (claval field) and anal vein absent.
68. Cell *cu*<sub>1</sub> absent.
69. Nodal (fold) line absent.
70. Costal break absent.
71. Pterostigma reduced (only applied to clade 82, e.g. *Psylla*).
72. Pterostigma absent or very reduced.
73. Hind wing very reduced or absent.
74. Meracanthus very small.
75. Meracanthus absent.
76. Metatibia basal (genual) spine absent.
77. Fewer than six spines at apex of metatibia.
78. Metatarsus segment I with one apical spine.
79. Metatarsus segment I with no apical spines.
80. Male proctiger not bipartite (segment X and XI of abdomen fused to produced a unipartite proctiger).
81. 'Tooth'-like armature in basal half of caudal lobe absent. (Applies only to clade 41. Secondary loss of character 44.)
82. Caudal lobe absent (secondary loss of character 43).
83. Paramere of bifid form (character 46) secondarily lost.

#### Nymphal 'gain' characters

84. General body form broader than long (*Homotoma*, *Macrohomotoma*, *Mycopsylla* and *Pseudoeriopsylla*).
85. General body form rounded (facies of e.g. *Ceropsylla*).
86. General body form very elongate (facies of *Aacanthocnema*).
87. Antenna short and narrowed evenly to apex (Fig. 44).
88. Head and prothorax completely fused dorsally.
89. Humeral lobe of forewing-pad anteriorly produced to an extreme which is anterior to the procoxa (Figs 17-19).
90. Unguitractor long (Figs 77-94).
91. Arolium with a long petiole (Figs 65, 66).

92. Arolium broader than long, without petiole and with a pair of darkened areas (Figs 72–76).
93. Arolium base/petiole apex with a semicircular membranous area (Fig. 65).
94. Abdomen with all dorsal sclerites fused with caudal plate.
95. Abdominal apex serrate (Fig. 122).
96. Abdominal apex with large 'teeth' at lateral extremities of serrate area (follows from character 95) (Figs 118, 120).
97. Abdominal apex with large medial 'teeth' (Fig. 125) (from character 95).
98. Abdominal apex with a pair of apical 'teeth'.
99. Abdominal segments produced laterally as rounded or 'tooth' like projections (Fig. 118).
100. Cauda pointed (Fig. 118).
101. Lingula present.
102. Circum-anal ring constricted either side of anus (Fig. 111) or broken into three rings (*Livia*) (Fig. 110).
103. Circum-anal ring constricted either side of anus (Fig. 148) or broken into three rings (Fig. 149).
104. Anal pore-field arranged as bands (Fig. 155).
105. Specialised circum-anal ring (subgenus *Baeopelma* of *Psylla*) present (Fig. 135).
106. Broad circum-anal ring present (Figs 134, 136, 142).
107. Specialised shape of broad circum-anal ring (Fig. 136).
108. Anal pore-field (other than circum-anal ring) arranged as 1 + 1 rings or of derivable form (discount characters 102 and 103). Rings placed ventrally or dorso-ventrally, i.e. each ring is partly dorsal and partly ventral) (Figs 106, 107, 112, 113, 117, 119, 121).
109. Anal pore field (other than circum-anal ring) arranged as 2 + 2 rings or of derivable form. The rings are arranged ventrally 1 + 1 and dorsally 1 + 1 (Fig. 120).
110. Sectasetae (marginal and dorsal) truncate (Fig. 34).
111. Abdominal sectasetae arranged on large tubercles (Fig. 114).
112. Body margin surrounded by long scales (probably derived from sectasetae) (Fig. 173).
113. Body margin surrounded by broad scales (probably derived from sectasetae) (Figs 174–176).
114. Most abdominal margin sectasetae lost, leaving a distinct arrangement (treated as a gain character because of complexity) of up to 4 + 4 sectasetae. Secondary loss may reduce this number to 3 + 3, 2 + 2 or 1 + 1 (Fig. 37).
115. Sectasetae of character 114 type truncated to form tubes which are normally based on slight tubercles (Fig. 37 [ts]).
116. Lanceolate setae (marginal) greatly elongated.
117. Very thin lanceolate setae (assumed to derive from thickened simple setae) present.
118. Capitae setae present on body plus wing-pad margins and dorsal surfaces (Fig. 29).

#### *Nymphal 'loss' characters*

119. General body form not broader than long (secondary loss of character 84).
120. Thorax dorsal surface with distinct sclerites (at least medials); lateral sclerites small or absent (Figs 12–14).
121. Tarsal claws absent.
122. Unguitractor not visible with optical microscope. Arolium present (Figs 56–58).
123. Basal area of arolium reduced to a thin membrane (Figs 60, 64).
124. Basal membrane of arolium absent (derived from character 123) (Fig. 59) (or reduced; Fig. 62).
125. Unguitractor and arolium not visible with optical microscope.
126. Dorsal surface of abdomen lacking distinct sclerites (membrane only anterior to caudal plate area).
127. Anus at posterior of abdomen, not on ventral surface.
128. Abdominal apical teeth absent (secondary loss of 95 and 96).
129. Anal pore-field bands broken into round areas of pores (derived from 104) (Fig. 154).
130. Broad outer area of circum-anal ring broken into round or ovoid areas of pores (Figs 97, 99, 100).
131. Anal pore-field of type described by character 108 broken into round areas of pores (Fig. 113).
132. Anal pore-field of type described by character 108 reduced to narrow bands (Fig. 107).
133. Anal pore-field of type described by character 108 with pores reduced as in Fig. 117.
134. Small groups of pores in abdominal areas such that a reduction of rings as described by character 108 may have occurred (used in clades containing character 108 but not 109) (Fig. 119).
135. Small groups of pores in abdominal areas such that a reduction of rings as described by character 108 may have occurred (used in clades containing characters 108 and 109) (Fig. 129).
136. Anal pore-field in broken rings, probably derived from character 108, as in Fig. 112.
137. Circum-anal pore ring of type described by character 103 with pores widely separated.
138. Outer circum-anal pore ring reduced to a single row of pores (only applied to clade 82) (Fig. 139).



139. Circum-anal pore ring absent.
  140. Anal pore-field absent.
  141. Anal pore-field of 1 + 1 rings very reduced (derived from character 134), or absent.
  142. Circum-anal pore ring reduced to a few large pores (Fig. 146).
  143. Body margin without sectasetae or derivable structures.
  144. Body dorsal surface without sectasetae or derivable structures.
  145. Body margin (other than abdomen) without sectasetae except for a small number around the hindwing-pad.
  146. Abdomen margin without sectasetae (derived from 114).
  147. Antennae without sectasetae or derivable structures.
  148. Hindwing-pad without marginal sectasetae (derived from character 145).
  149. Pointed sectasetae (derived from character 110).
  150. Body and wing-pad surfaces (antennae, dorsal body surface and body margin) with lanceolate setae (assumed to derive from reduced sectasetae).
  151. Abdominal 4 + 4 (or fewer) sectasetae positions with lanceolate setae (assumed to derive from character 114) (Fig. 37).
  152. Dorsal surface of body and wing-pads with lanceolate setae (assumed to derive from reduced sectasetae). Character only applied when other sectasetae characters are in a derived state.
  153. Clavate setae present on body (probably very small sectasetae or lanceolate setae and therefore regarded as a loss character).
  154. Body margin lanceolate setae absent (derived from character 150).
  155. Dorsal surface of body without lanceolate setae (derived from character 150).
  156. Antennae without lanceolate setae (derived from character 150).
  157. Clavate setae absent (derived from character 153).
  158. Body margin without capitate setae (except in some species which retain one seta behind each eye) (derived from character 118).
  159. Body dorsal surface without capitate setae (derived from character 118).
- 

this has been incorporated in a cladogram of these subgenera by Burckhardt (1979). The details of clade 82 are largely governed by loss characters and it is very unlikely that any cladogram of the subgenera of *Psylla*, based upon present knowledge, will approximate its true cladistic history.

### Host-plant considerations

Psyllids are monophagous or narrowly polyphagous and breed almost exclusively upon angiosperms. Eastop (1972) considered the plant family level relations of 847 species of Psylloidea, of which only 8 were associated with the Monocotyledoneae and the remainder (99%) with the Dicotyledoneae. In this study the probable hosts of 298 of the 303 species examined were known. Of these, only five species of *Livia*, on *Juncus* and *Carex* in the Holarctic region, and *Trioza palmicola*, on an endemic Hawaiian palm, were associated with monocotyledons, and very few species are associated with annual or biennial herbs.

Closely related psyllid species usually occur on closely related host-plants, i.e. psyllid clades are usually restricted to definite angiosperm taxa (Table 13) (Hodkinson, 1974). Individual species of Psylloidea usually occur on host-plants of only one genus and almost exclusively of one family. Examples of psyllids breeding on host-plants in separate families are rare.

Empirical observation suggests that certain psyllid taxa have a narrow taxonomic distribution of host-plants while others have a broad distribution. It is instructive to examine the taxonomic distribution of host-plants, for certain psyllid clades, across the 28 plant orders of relevance to this study. Such an analysis was performed for clades in which at least one terminal taxon descends directly from the ancestor of the clade. The null hypothesis is as follows:

$$\frac{a}{b} = \frac{c}{d}$$

where

- a = no. psyllid species in clade x associated with plant order y;
- b = no. psyllids in all clades associated with plant order y;
- c = no. psyllids in clade x;
- d = no. psyllids in all clades.

The deviation from the regular distribution was measured by the Kolmogorov-Smirnov two-sample test (with two tails of significance). This was converted to a  $\chi^2$  value, by an approximation, with two degrees of freedom (Siegel, 1956). It is expected that  $\chi^2$  is underestimated for any clade with less than 40 species, that is all except 2 and 53, which makes the test conservative (Siegel, 1956), i.e. the significance level may be underestimated. This test (Table 14) indicates that most clades have a taxonomic distribution of host-plants which is significantly non-regular. The variance ( $s^2$ ) and the mean ( $\bar{x}$ ) number of psyllid species in each of the 28 host-plant orders were calculated for each clade shown to depart significantly from a regular distribution. These values were expressed as a ratio (Table 14) which is a measure of dispersion, such that the greater the value the more *clumped* the host-plant distribution. Clades with very small variance-mean ratios, and with large sample sizes (more than 10 psyllid species) are clade 51, e.g. *Diaphorina*, and clade 2, e.g. *Trioza*. The clade with the most clumped, that is most restricted host distribution, is clade 53, e.g. *Psylla*.

This does not imply that genera such as *Trioza* lack distinct groups feeding upon related groups of plants; for example one subgroup of *Trioza* is exclusively associated with the plant genus *Salix* (Salicaceae). Taxa such as clade 53, e.g. *Psylla*, of which 49% feed on Rosales, and most of those on Fabaceae, differ from taxa such as clade 2 (e.g. *Trioza*) in that distinct host associations exist at a suprageneric rather than subgeneric level. If the cladogram roughly represents the true cladistic history of the Psylloidea, then in clade 53 (e.g. *Psylla*) morphological divergence exceeds host-plant choice divergence. However, in clade 2 (e.g. *Trioza*) host-plant choice has undergone more evolutionary changes than morphological form.

The cladogram was assumed to be a true record of the cladistic history of the Psylloidea and an attempt was made to find the most parsimonious fit of the host relationships to the cladogram.

Clade 2 (Fig. 186) (e.g. *Trioza*) is a large highly polyphagous taxon. Widely separate branch tips feed on plant taxa such as Annonales, Moraceae and Salicaceae. At this stage no hypothesis can be made about the ancestral host of clade 2.

Clade 4 (Fig. 187) is associated with Malvales (e.g. *Paracarsidara*) and Rutales: Meliaceae (*Mastigimas*). Either of these plant groups could represent the ancestral host of clade 4.

Clade 6 (Fig. 188) is associated exclusively with *Ficus* (Moraceae), the most likely ancestral host of clade 6.

Clade 8 (Fig. 189) is associated with two families of Rutales, i.e. Burseraceae and Meliaceae. The host of *Epicarsa*, however, is unknown.

Clade 10 (Fig. 190) is associated with the Rutales (mainly Anacardiaceae, plus Burseraceae and Rutaceae), e.g. *Calophya*.

It is now reasonable to suggest that Rutales-feeding is an ancestral feature retained by disjunct groups of the above clades and, by the parsimony criterion, is the most likely ancestral host of clade 9. The association with *Ficus* evolved with clade 6, with Malvales in clade 32 and the ancestral host of clade 2 remains unknown. In the remaining branches of the cladogram *Livia* and *Strophingia* are associated with Commelinales (Cyperaceae and Juncaceae) and Ericaceae respectively; none feeds on Rutales.

Clade 13 (Fig. 191) contains several groups with distinct host relations: *Phytolyma* on Moraceae, *Gyropsylla* on *Ilex* (Aquifoliaceae) and *Nectandra* (Lauraceae), clade 42 on *Tamarix* and *Myricaria* (Tamaricaceae) and clade 40 on herbs. Clade 40 (*Aphalara* and *Craspedolepta*) has several distinct groups of species restricted to certain families or genera of plants. *Aphalara* live on Brassicaceae, Polygonaceae and Ranunculaceae, while *Craspedolepta* are associated

**Table 13** Psyllid taxa which, in the present study, are restricted to specified taxa of angiosperms. An asterisk marks entries which are known to occur on other angiosperm taxa, when psyllid species not covered in the present survey are considered.

i. Psyllid taxa restricted to plant orders.

TAXON	HOST ORDER
Clades 8, 15	Rutales
Clade 32	Malvales
<i>Livia</i>	Commelinales

ii. Psyllid taxa restricted to plant families.

TAXON	HOST FAMILY	HOST ORDER
Clade 58	Ericaceae	Ericales
Clade 62*	Sterculiaceae	Malvales
Clades 63, 74, 78*, 80	Fabaceae	Rosales
<i>Epipsylla</i> , <i>Neopsyllia</i>	Fabaceae	Rosales
<i>Euphyllura</i>	Oleaceae	Santalales
<i>Paurocephala</i> *	Malvaceae	Malvales
<i>Phytolyma</i>	Moraceae	Urticales
<i>Pseudophacopteron</i>	Meliaceae	Rutales
<i>Strophingia</i> , <i>Neophyllura</i>	Ericaceae	Ericales
<i>Tenaphalara</i>	Bombacaceae	Malvales

iii. Psyllid taxa restricted to plant genera

TAXON	HOST GENUS	HOST FAMILY	HOST ORDER
Clade 6	<i>Ficus</i>	Moraceae	Urticales
Clade 42*	<i>Tamarix</i>	Tamaricaceae	Tamaricales
Clades 61*, 68	<i>Eucalyptus</i>	Myrtaceae	Myrtales
Clade 73	<i>Celtis</i>	Ulmaceae	Urticales
<i>Agonoscena</i> *	<i>Pistacia</i>	Anacardiaceae	Rutales
<i>Aphalaroida</i> *	<i>Prosopis</i>	Fabaceae	Rosales
<i>Camarotoscena</i> , <i>Egeirotrioza</i>	<i>Populus</i>	Salicaceae	Salicales
<i>Euglyptoneura</i>	<i>Ceanothus</i>	Rhamnaceae	Rhamnales
<i>Gyropsylla</i> *	<i>Ilex</i>	Aquifoliaceae	Theales
<i>Psyllopsis</i>	<i>Fraxinus</i>	Oleaceae	Santalales
<i>Purshivora</i>	<i>Purshia</i>	Rosaceae	Rosales

with Asteraceae, Chenopodiaceae and Onagraceae. The ancestral host of clade 13 is uncertain and none feeds on Rutales.

Species in clade 15 (Fig. 192) feed exclusively on Rutales and the ancestral host is assumed to be a species of Rutales.

Clade 17 (Fig. 192) is divided into two major taxa; clades 48 and 53.

Clade 8 (Fig. 193) has a high diversity of host relationships; clade 58 on Ericaceae, *Euphyllura* on Oleaceae, clade 61 on Myrtaceae, Onagraceae and Rutaceae, clade 62 on Sterculiaceae and Melastomataceae, *Paurocephala* on Malvaceae and Moraceae, *Camarotoscena* on Salicaceae, *Psyllopsis* on Oleaceae, *Diaphorina* on several families (e.g. Rutaceae and Solanaceae), and *Pennavena* on Loganiaceae. The ancestral host is most likely to be a plant taxon associated with more than one branch tip, i.e. Malvales (Malvaceae and Sterculiaceae), Oleaceae or Rutales (Rutaceae).

Clade 53 (Fig. 193) is associated with Rosales except for: *Arepuna* (Solanaceae), *Euphalerus jugovenosus* group (p. 224) (Rhamnaceae), *Phellopsylla* (Myrtaceae), clade 73 (Ulmaceae), *E. gallicolus* (Rhamnaceae), clade 68 (Myrtaceae), *Trigonon* (host unknown), *Freysuila* sp. (Solanaceae), one *Acizzia* sp. (*A. hakeae*, Proteaceae), *Anomoneura* (Moraceae), some *Insnesia* spp. (Euphorbiaceae), and many species in clade 82 (e.g. Betulaceae, Rhamnaceae and Salicaceae). Of those species on Rosales, most (63%) are associated with Fabaceae.

**Table 14** Values of  $\chi^2$  approximation to Kolmogorov-Smirnov test, variance/mean ratio, and most favoured host-plant order, of selected clades. Significance levels: \*\*\*  $P < 0.001$ , \*\*  $P < 0.01$  & \*  $P < 0.05$ .

Clade	$\chi^2$	$s^2/\bar{x}$	Favoured host order
2	10.71**	4.11	Salicales
4	7.38*	7.48	Malvales
8	10.25**	6.00	Rutales
10	20.10***	13.00	Rutales
12	18.85***	5.04	Commelinales
13	28.59***	6.81	Asterales
33	5.13	—	Urticales
34	6.39*	5.00	Urticales
45	5.18	—	Rutales
46	6.88*	4.00	Rutales
49	4.27	—	Malvales/Salicales
51	12.84**	2.56	Santalales
53	27.77***	34.26	Rosales
59	13.95***	3.89	Ericales/Santalales
61	1.91	—	Myrtales
62	0.72	—	Malvales

Only *Euphalerus tantillus* (Rosaceae) and most members of clade 82 (Buxaceae, Rosaceae and Saxifragaceae) are not. It is assumed that Fabaceae-feeding is ancestral to clade 53. No species occur on Rutales. From Fabaceae host changes to Myrtaceae, Rhamnaceae, Rosaceae and Solanaceae must have occurred more than once. The evidence suggests that this has occurred repeatedly in different zoogeographic regions.

Among the remaining clades, Rutales-feeding occurs exclusively in clade 15 and may also be the ancestral host of clade 48. Rutales-feeding therefore occurs commonly in disjunct clades throughout the cladogram, and application of the parsimony criterion suggests that the ancestral Psylloidea are associated with plants of the order Rutales or a direct ancestral group to the Rutales.

There is evidence, based on a belief that the Rutaceae and Anacardiaceae appeared early enough for direct migration to Australia, that the Rutales evolved at least 95 million years ago (Raven & Axelrod, 1974). If angiosperm-feeding in psyllids evolved only once then initially this was most likely to have been in conjunction with primitive Rutales, possibly prior to differentiation of the host-plant families Aceraceae, Anacardiaceae, Burseraceae, Meliaceae and Rutaceae. Much of the primary differentiation of the Rutales seems to have taken place in Africa-South America, with long standing connections to Eurasia (Raven & Axelrod, 1974).

The clades which are restricted to a single plant taxon other than Rutales are as follows: clade 3 (e.g. *Carsidara*) on Malvales and clade 6 (e.g. *Homotoma*) on *Ficus*. Examples of large clades on a diverse range of plants are: clade 2 (e.g. *Trioza*), clade 13 (e.g. *Aphalara*) and clade 17 (e.g. *Paurocephala*, *Spondyliaspis* and *Psylla*).

### Zoogeographic evidence

A vicariance approach (Platnick & Nelson, 1978) was applied to fit zoogeographic evidence to the cladogram. The model was restricted to the time period since the earliest appearance of the angiosperms (125 million years before present or 125 m.y.B.P.; Raven & Axelrod, 1974), and it was assumed that the modern psyllids have evolved since the splitting of Pangea into Laurasia and Gondwanaland (180 m.y.B.P.). Therefore any track or distribution which includes areas of both Laurasia and Gondwanaland is assumed to have been caused by a dispersal event. Furthermore, dispersal is also assumed to account for the presence of psyllids on oceanic islands as this is a more tenable explanation of such tracks than the assumption of an as yet unknown vicariance event (Cracraft, 1975). Additionally some Nearctic-Palaeartic tracks may be better

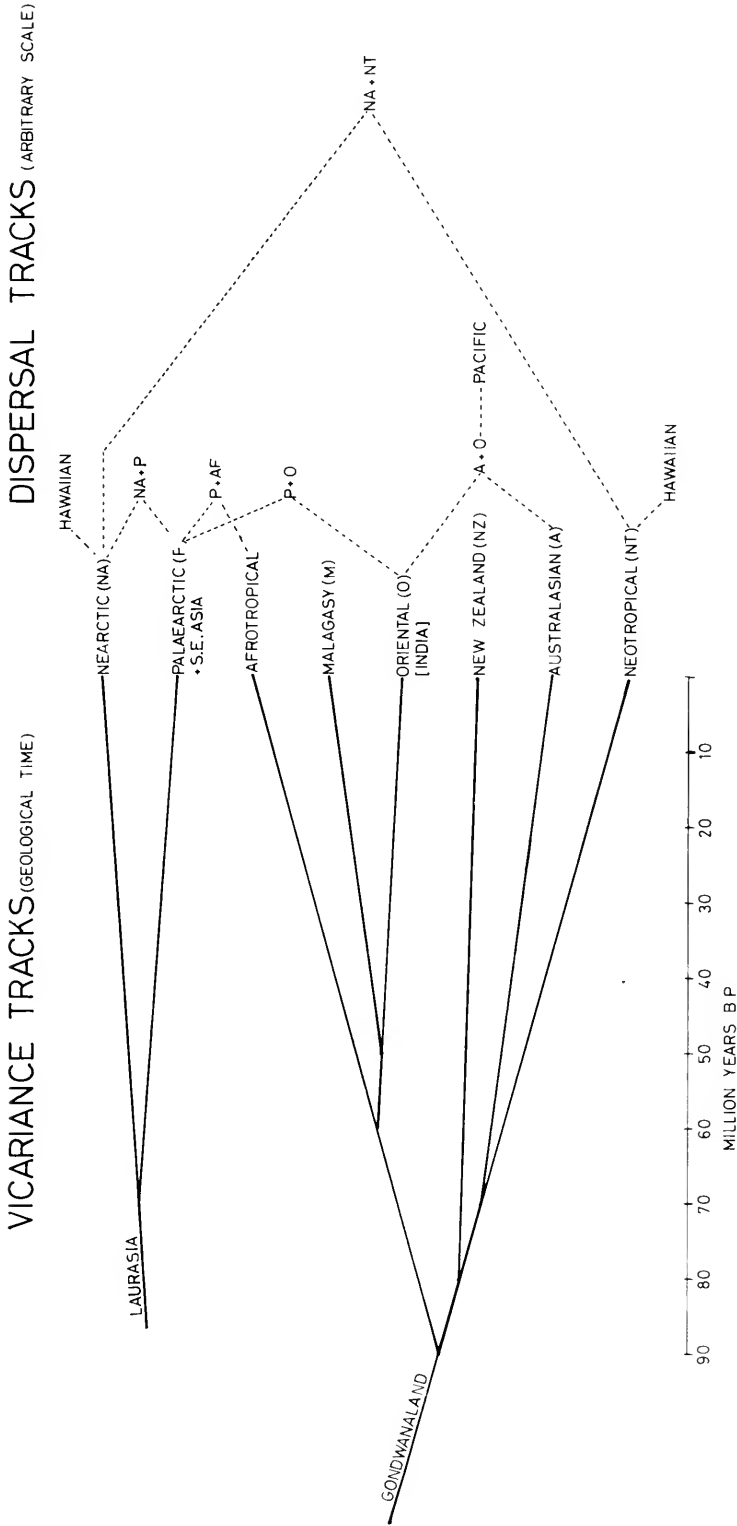

**Fig. 197** Reduced geological area cladogram of the splitting of Laurasia and Gondwanaland. Probable dispersal tracks are also shown (broken lines).

explained by dispersal across Beringia than by vicariance of Laurasia (Hodkinson, 1980). The vicariance/dispersal tracks are shown as a reduced geological area cladogram, based on Rosen (1978) (Fig. 197).

Each section of the psyllid cladogram (Figs 185–196) was compared to the geological area cladogram (Fig. 197). As an example of the reasoning applied, consider a hypothetical clade occurring in the Afrotropical, Malagasy, Oriental, Austro-Oriental and Palaeartic regions. The Palaeartic is not joined by a vicariance track in Fig. 197 to any of these other regions. Dispersal to the Palaeartic is proposed. The Austro-Oriental region must also be reached by dispersal. The Afrotropical, Malagasy and Oriental regions can be seen to have originated from one biota (Fig. 197). The ancestral species of this hypothetical clade is, therefore, assumed to have been distributed in the Afrotropical-Malagasy-Oriental biota, i.e. this is the ancestral track and distribution. Other solutions are less parsimonious.

Extinctions must occasionally be proposed to explain disjunct patterns of distribution. However, 'not yet discovered' may be the correct interpretation in many cases. The full analysis for each major clade is given by White (1980).

The general conclusions to be drawn from this analysis are as follows:

1. Most major clades probably had a Gondwanaland origin, i.e. clade 2 (Fig. 186) (e.g. *Trioza*), clade 4 (Fig. 187) (e.g. *Paracarsidara*), clade 6 (Fig. 188) (e.g. *Homotoma*), clade 8 (Fig. 189) (e.g. *Phacopteron*), clade 10 (Fig. 190) (e.g. *Calophya*), clade 13 (Fig. 191) (e.g. *Gyropsylla*), clade 15 (Fig. 192) (e.g. *Tainarys*) and clade 17 (Fig. 193) (e.g. *Paurocephala* and *Euphalerus*).
2. The ancestor of the Psylloidea probably had a Gondwanaland track. This is consistent with the host-plant evidence, i.e. that the ancestral host was a species of Rutales and that this group of plants must have been distributed throughout Gondwanaland prior to its breakup.

In the geological area cladogram no allowance was made for the possibility of dispersal across the South Atlantic between the Afrotropical and Neotropical regions. Raven & Axelrod (1974) review the evidence for such a dispersal between the two continents, as they are thought to have remained in near contact until at least 90 m.y.B.P. This dispersal route existed before the breakup of the Australian-Antarctic-South American continent (45 m.y.B.P.). Any taxon present in both the Afro-Oriental biota and the Neotropical region could be explained by dispersal across the Atlantic or by vicariance of a Gondwanaland track followed by extinction in New Zealand and Australia. Because of this choice of explanations the vicariance model was adhered to purely as a convention. Australia was probably quite humid at a time when it was still joined to South America (Frakes & Kemp, 1974), and the subsequent lowering of humidity may account for many extinctions.

As the distribution patterns of most clades can be explained largely by vicariance events occurring during the breakup of Gondwanaland, the minimum, and sometimes maximum, age of many of the major clades can be determined from the estimated dates of vicariance events.

Clade 4 (Fig. 187) (e.g. *Paracarsidara*) had a Gondwanaland ancestor (90–180 m.y.B.P.). The initial host was a species of Rutales. Ancestors 30, 31 and 32 also appeared to have evolved during this time in association with Malvales. The origin of the Malvales seems uncertain. Raven & Axelrod (1974) state that the primary radiation of Malvales probably took place in Africa and South America in Maastrichtian time (65–70 m.y.B.P.) or earlier. There are, however, some doubtful Upper Cretaceous (65–110 m.y.B.P.) macrofossils of Malvaceae (Raven & Axelrod, 1974). The origin of clade 32 remains uncertain.

Clade 6 (Fig. 188) (e.g. *Homotoma*) also appears to have originated in Gondwanaland and these taxa are all associated with *Ficus* (Moraceae). Raven & Axelrod (1974) say that Moraceae were probably in existence early enough to have been dispersed more or less directly between Africa and South America. Ancestor 6 may have had an Afro-Indian range and been dispersed to South America (*Synozia*) and later from India to Australia (*Mycopsylla*) by island hopping. Whichever route was taken ancestor 6 must have existed at least 90 m.y.B.P.

Clades 8, 10 and 15 (Figs 189, 190, 192) are all associated with the Rutales and all appear to have a Gondwanaland distributed ancestor. These groups must each have been distinct by 90 m.y.B.P.

Ancestors 13 and 17 (Figs 191, 193) are of unknown host relations and each probably had a Gondwanaland distribution. These groups must also have been distinct by 90 m.y.B.P. In clade 17 the major host preference is for Rosales, especially Fabaceae (clade 53). However, Raven & Axelrod (1974) imply that the Fabaceae were of later origin (c. 65 m.y.B.P.) although the Rosales probably existed much earlier.

Despite several problems a number of major conclusions can be drawn. Firstly that most major clades have a distribution which is consistent with a southern ancestry, probably prior to the breakup of Gondwanaland (90 m.y.B.P.). Furthermore, the flowering plants, typified by Annonales, probably evolved about 125 m.y.B.P. (as indicated by data reviewed by Raven & Axelrod, 1974). The modern psyllids probably evolved with the Rutales (p. 258) and, therefore, later than 125 m.y.B.P. but earlier than 90 m.y.B.P. (although *Togepsylla*, a morphologically very primitive psyllid associated with Annonales, may be a relic member of a group antedating ancestor 1).

Conversely, the following major groups probably evolved from ancestors in the northern land mass of Laurasia: *Livia*, *Strophingia* in the Palaearctic, clade 40 (e.g. *Aphalara*), clade 81 (e.g. *Psylla*) and clade 73 (e.g. *Pachypsylla*). This is assuming that their ancestors dispersed to Laurasia from Gondwanaland. An alternative hypothesis is available if a pure vicariance model is adopted, i.e. that the ancestral psyllid was distributed throughout Pangea. If this were the case then we must accept that modern psyllids diversified before angiosperms evolved and psyllids therefore moved onto angiosperm hosts on several separate occasions, remarkably, often onto the same group of plants, namely the Rutales. On balance, our initial hypothesis that modern psyllids only evolved since the appearance of the angiosperms, and therefore since the splitting of Pangea into the southern Gondwanaland and northern Laurasia, seems more tenable.

## Classification and phylogeny

### Nymphal phenetic classification

Several phenetic classifications have been presented which provide different summaries of the resemblances between taxa. It now becomes necessary to identify the common factors and produce a SUMMARY classification.

Analyses based upon character resemblance, such as principal component and SUMRAT information statistic, indicated the characters of greatest importance in forming a phenetic classification of nymphs. The species groups defined by the presence of each of these 'important' characters coincide with the major groups formed in the minimum spanning networks, phenograms and principal component analyses. Therefore the listing of these species groups forms a summary phenetic classification.

The relationships of the phenetic groups, as defined by the 'important' characters, are shown in Fig. 198 and the approximate positions of the groups and subgroups, of the summary classification, are shown relative to principal components I and II (Fig. 199). This provides a visual representation of the between group relationships. A list of the species in each group, together with the initial letter of the family to which the taxon belongs in the classification of Becker-Migdisova (1973): Aphalaridae (A), Carsidaridae (C), Liviidae (L), Psyllidae (P), Spondyliaspidae (S) and Triozidae (T), is given in Table 15.

Previous phenetic classifications of psyllid nymphs (Ferris, 1925; Rahman, 1932) were based on wing-pad shape. The only similarity between these and the above classification is that the 'truncate sectasetae' subgroup roughly corresponds to the 'triozine' group of Ferris and Rahman.

The percentage of species examined from each of the Becker-Migdisova (1973) families, relative to the new summary classification, is shown in Table 16. The most highly congruent group is 3 (capitate setae) plus subgroups 1.ii (truncate sectasetae) and 4.i (petiolate arolium). These groups are defined by gain characters and correspond to some Psyllidae, Triozidae and the remaining Psyllidae respectively. By contrast, group 2 (lanceolate setae) and subgroup 4.ii (remainder) are characterised by loss characters. Such characters would be expected to form

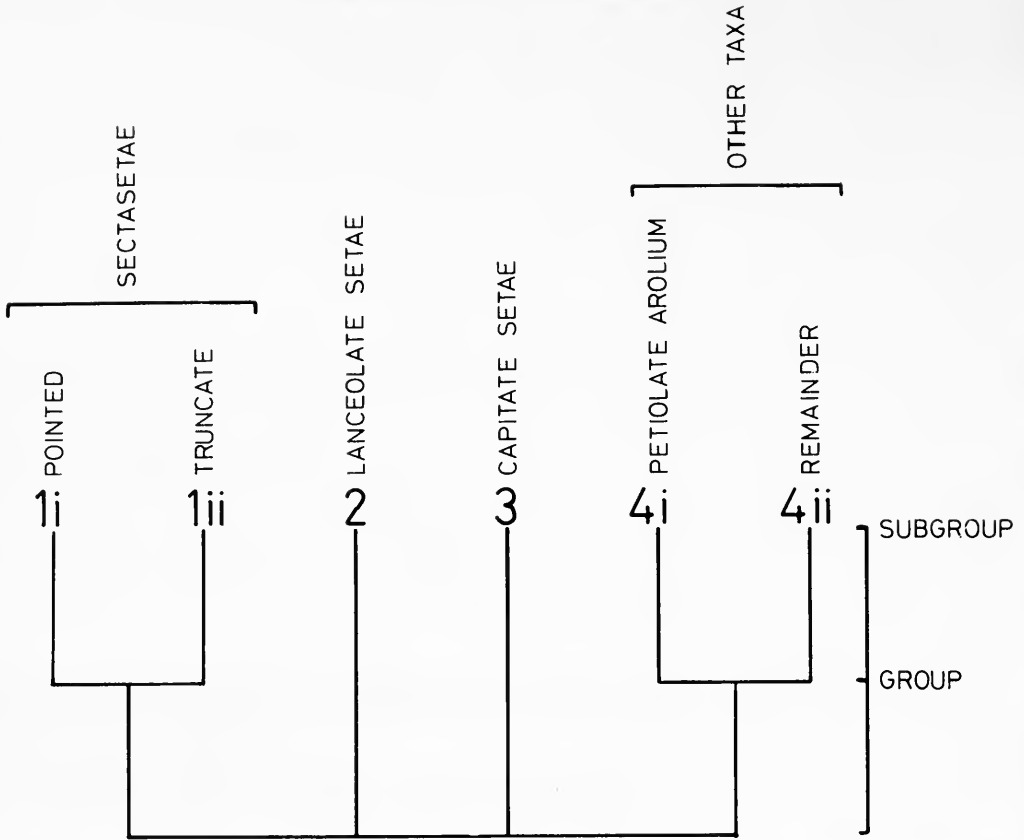
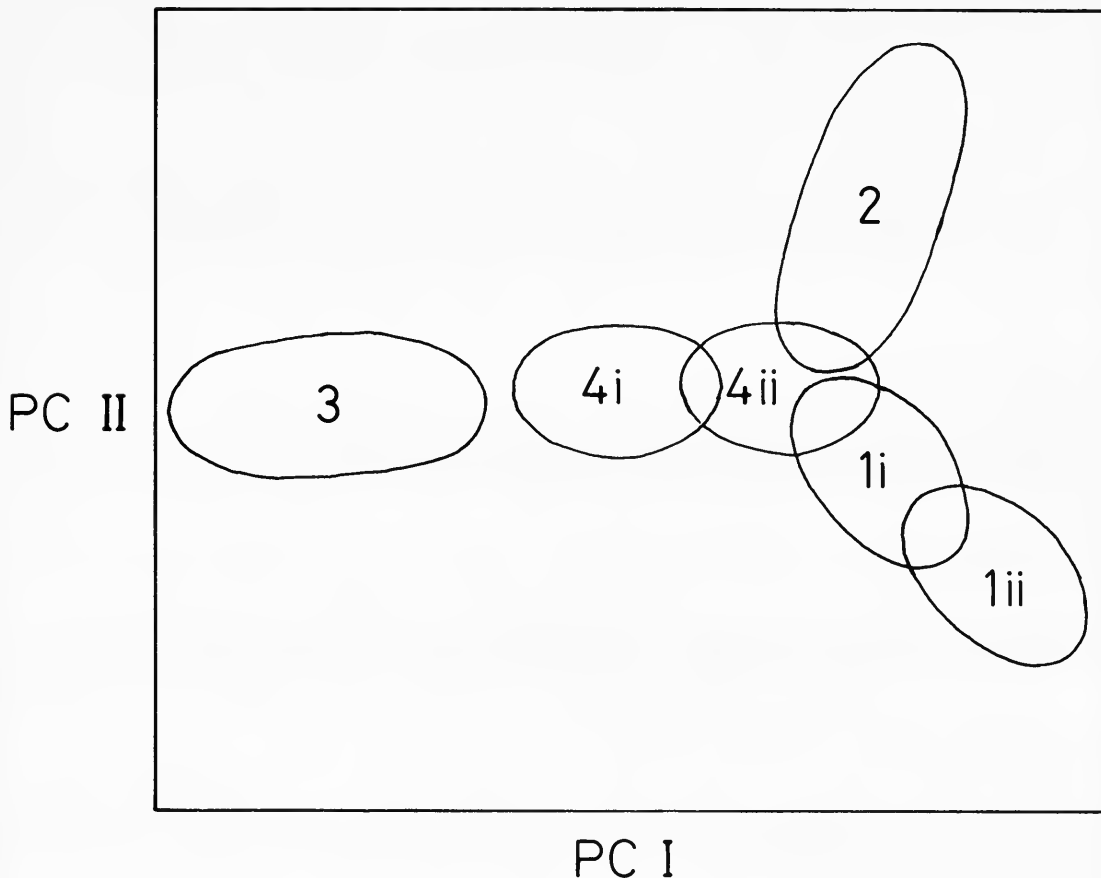

Fig. 198 Phenogram of groups and subgroups of species defined by the summary phenetic classification, based on nymphal characters.

evolutionary convergent clusters. Group 2 and subgroups 4.ii and 1.i (pointed sectasetae) are least congruent with the families of Becker-Migdisova. Pointed sectasetae are probably the ancestral character state and, therefore, subgroup 1.i contains those species which have retained an ancestral feature.

Empirical taxonomic studies of psyllid classification have failed to find stable positions for certain genera; for instance, the suggested relationships between *Paurocephala* and *Pauropsylla* are radically different in the classifications of Crawford (1914), Becker-Migdisova (1973) and Loginova (1972). In this study, these problematical groups again tended to cluster in different positions in different analyses. The most stable groups in each analysis, group 3 (species with capitae setae) and subgroup 1.ii (species with truncate sectasetae), are highly congruent with the most stable families recognised by empirical taxonomy, that is the Psyllidae and Triozidae respectively. Numerical phenetic methods were, therefore, of little direct value in the placement of problem groups in a new general classification. However, such methods did indicate nymphal groupings which might not be predicted from the existing empirical adult classifications. Furthermore, numerical phenetics were particularly relevant to ground plan construction for cladistic analysis and for the recognition of characters with the greatest classificatory power such as the form of the nymphal tarsal arolium. This was found to have far greater power than had been empirically expected and upon re-examination was found to be one of the most useful characters for later cladistic analysis.





**Fig. 199** Groups and subgroups in the summary classification, placed relative to principal components I and II.

### General classification

The most convincing argument in favour of cladistic analysis as a basis for a general reference classification is provided by Mickevich (1978), who compared congruence of phenetic versus cladistic classifications. The latter were found to have greater stability, probably because they were less sensitive to the adverse effects of heterogeneity in the evolutionary rates of characters and, furthermore, they were the most predictive (Platnick, 1978). However, a truly predictive classification, based upon a cladogram, may be impractical if the taxon (clade) to which a species belongs can only be determined from a life-cycle stage which may be unavailable. Therefore, as the nymphs of most species are unknown and many clades are defined by attributes of one life-cycle stage only, it is necessary to produce a compromise 'practical-predictive' classification. For example, clade 13 (Fig. 191, p. 224) (e.g. *Aphalara*) and clade 15 (Fig. 192) (e.g. *Rhinocola*) are defined by an adult and a nymphal attribute and are impracticable in a nymphal and an adult classification respectively. If predictability is to be retained some impractical groups have to be tolerated. However, for practical reasons more emphasis has occasionally been placed on adult rather than nymphal characters in finally deciding the position of a taxon.

In deriving the general classification monophyletic groups were preferred. No polyphyletic groups, in the sense of Hennig (1966) or Farris (1974), were formed and paraphyletic groups, of Hennig (1966) and Farris (1974), were allowed if they increased practicality in identifying adults.

This combination of both cladistic and phenetic information is, in general principle, the 'evolutionary' method of Mayr (1969).

The suggested classification (Table 17) includes eight families of which three are new. The probable positions of some taxa not examined are included and these are marked by an asterisk. A major source of information for the inclusion of these additional taxa was Loginova (1964*b*). The probable family or subfamily to which the residual genera belong are listed in Table 18.

#### Aphalaridae

This is probably a paraphyletic group, in the sense of Hennig (1966) and Farris (1974), but polyphyletic according to Nelson (1971). It comprises species which are phenetically close to the ground plan of the Psylloidea: clade 1 (Fig. 185) minus clades 9 (Fig. 185) and 54 (Fig. 193). It would be impractical to make each whole clade a separate monophyletic family because most are defined only by derived nymphal attributes and adults could only be assigned to such families when accompanied by nymphs of the same species. This is still a problem at the subfamily level and only polyphyletic subfamily groupings within Aphalaridae would form a practical classification.

The content of the family is similar to the Aphalaridae of Becker-Migdisova (1973) but with the addition of the Diaphorininae (from Psyllidae of Becker-Migdisova), Ctenarytainini (from Spondyliaspidae) and Liviinae (formerly Liviidae). The Diaphorininae and Ctenarytainini are included in the Aphalaridae largely on the basis of nymphal features. Phenetically the Liviinae are distant from other Aphalaridae but the relationship of the single genus *Livia* is best illustrated by placing it within the family.

#### Spondyliaspidae

This family is probably a paraphyletic group (in all senses) (clade 54 (Fig. 193) minus clade 57). However, it is only the genus *Arepuna* which falls outside of a probable monophyletic grouping (clade 55, Fig. 195). *Arepuna* spp. have a '*Euphalerus*' adult facies and it would, therefore, be impractical to place this genus in a separate family to the genus *Euphalerus*.

#### Psyllidae

This is a probable monophyletic group (clade 57, Fig. 196). Five subfamilies are tentatively proposed, based upon clades which could only be defined by loss characters. This family is the Psyllidae of Becker-Migdisova (1973) minus the Diaphorinini and Psyllopseini which are now placed in the Aphalaridae: Diaphorininae, and the Euphalerini which are now in the Spondyliaspidae.

Loginova (1976*a*, 1977) proposed a tribe Cyamophilini, which includes *Amorphicola*. Nymphs of *Cyamophila*, the type-genus, were not examined and it is possible that *Cyamophila* belongs close to *Amorphicola* in the cladogram. Therefore, no name is proposed for a tribe containing *Amorphicola*.

#### Calophyidae

This family is a possible monophyletic group (clade 10, Fig. 190), although *Apsylla* is only tentatively included. All other genera belong to the subfamily Calophyinae (clade 39). Many species at present referred to the genus *Pauropsylla* probably belong to the Calophyinae (p. 241).

#### Phacopteronidae

A family which is a possible monophyletic group (clade 8, Fig. 189). *Bharatiana* is only provisionally included and all other genera belong to the subfamily Phacopteroninae (clade 37).

#### Homotomidae

This is the subfamily Homotominae of Becker-Migdisova (1973) and a probable monophyletic group (clade 6, Fig. 188).

#### Carsidaridae

This family is not the Carsidaridae of Becker-Migdisova (1973) as the following genera have been placed elsewhere in the present classification: *Diclidophlebia* and *Togepsylla* (Aphalaridae), *Calophya*, *Microceropsylla* and *Pelmatobrachia* (Calophyidae), *Homotoma*, *Macro-*

*homotoma*, *Mycopsylla*, *Pseudoeriopsylla* and *Synoza* (Homotomidae), *Bharatiana*, *Epicarsa*, *Phacopteron* and *Pseudophacopteron* (Phacopteronidae) plus *Leptynoptera* and *Pauropsylla* (Triozidae). As now defined, the Carsidaridae is a probable monophyletic group (clade 4, Fig. 187). The genus *Mastigimas*, however, is only tentatively included and all other genera form the Carsidarinae (clade 32). Unfortunately, nymphs of the type-genus, *Carsidara*, were not included in the study but the predictive properties of the cladogram suggest that the nymph of *Carsidara* should be of the type found in clade 4 which is thus referred to the existing family Carsidaridae.

**Triozidae**

This is a probable monophyletic group (clade 2, Fig. 186) which is the Triozidae of Becker-Migdisova (1973) plus *Leptynoptera* and *Pauropsylla* from her Carsidaridae. The tribe Triozini is probably a paraphyletic group (clade 21 minus clade 25) which requires much further study of generic limits before the classification can be improved.

**Possible phylogeny**

It is conventional to illustrate a phylogeny as a lateral view of a tree diagram (Fig. 200). The ancestral group is extinct and in the absence of fossil evidence the information required to make more than a tentative estimate of the branching sequence is unavailable.

It is more informative to illustrate a terminal cross section of the phyletic tree as an unresolved BUSH PHYLOGENY (Thorne, 1976) (Fig. 201). Such a phylogeny is said to be unresolved, as no attempt is made to show the exact sequence of branching.

The Ancestral Group comprises extinct species which probably had a Gondwanaland distribution, fed on Rutales and evolved 90–125 million years before present. A southern ancestry for the psyllids has also been suggested by Eastop (1978) and Hodkinson (1980). Klimaszewski (1964), however, believed that psyllids evolved in South East Asia which, according to Takhtajan (1969), is the ‘cradle of the angiosperms’. South East Asia (the Austro-Oriental region) only came into existence in the Miocene with the arrival of the Australian plate in the vicinity of Asia, and angiosperms could not have originated there (Raven & Axelrod, 1974) and, by the same logic, neither could the psyllids. Unfortunately most of the fossils of insects resembling psyllids, as reviewed by Szelegiewicz (1971), antedate the angiosperms. Furthermore, their morphology suggests that they were not on the direct line of descent to the modern Psylloidea. However, there are a few genera which may be as closely related to the ancestral group as they are to any other extant taxa. They include *Apsylla* (Calophyidae), *Bharatiana* (Phacopteronidae), *Mastigimas* (Carsidaridae) and *Strophingia* (Aphalaridae) and, with the exception of *Strophingia* (on Ericales), they are all Rutales-feeders. The most primitive (Cronquist, 1968; Takhtajan, 1969; Thorne, 1976) and thereby the probable ancestral group of angiosperms (Takhtajan, 1969) are thought to be the Annonales. *Togepsylla* (Aphalaridae), which feeds on Lauraceae (Annonales), may possibly be a relic genus of a psyllid group which antedates the Rutales-feeders.

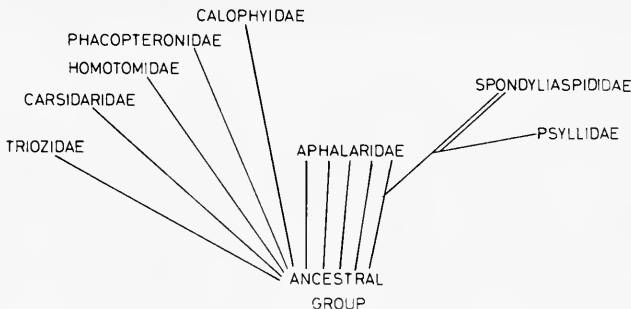

**Fig. 200** Suggested phylogenetic relationships of the families of Psylloidea; as a tree with more than one line leading to the paraphyletic families Aphalaridae and Spondylaspididae.

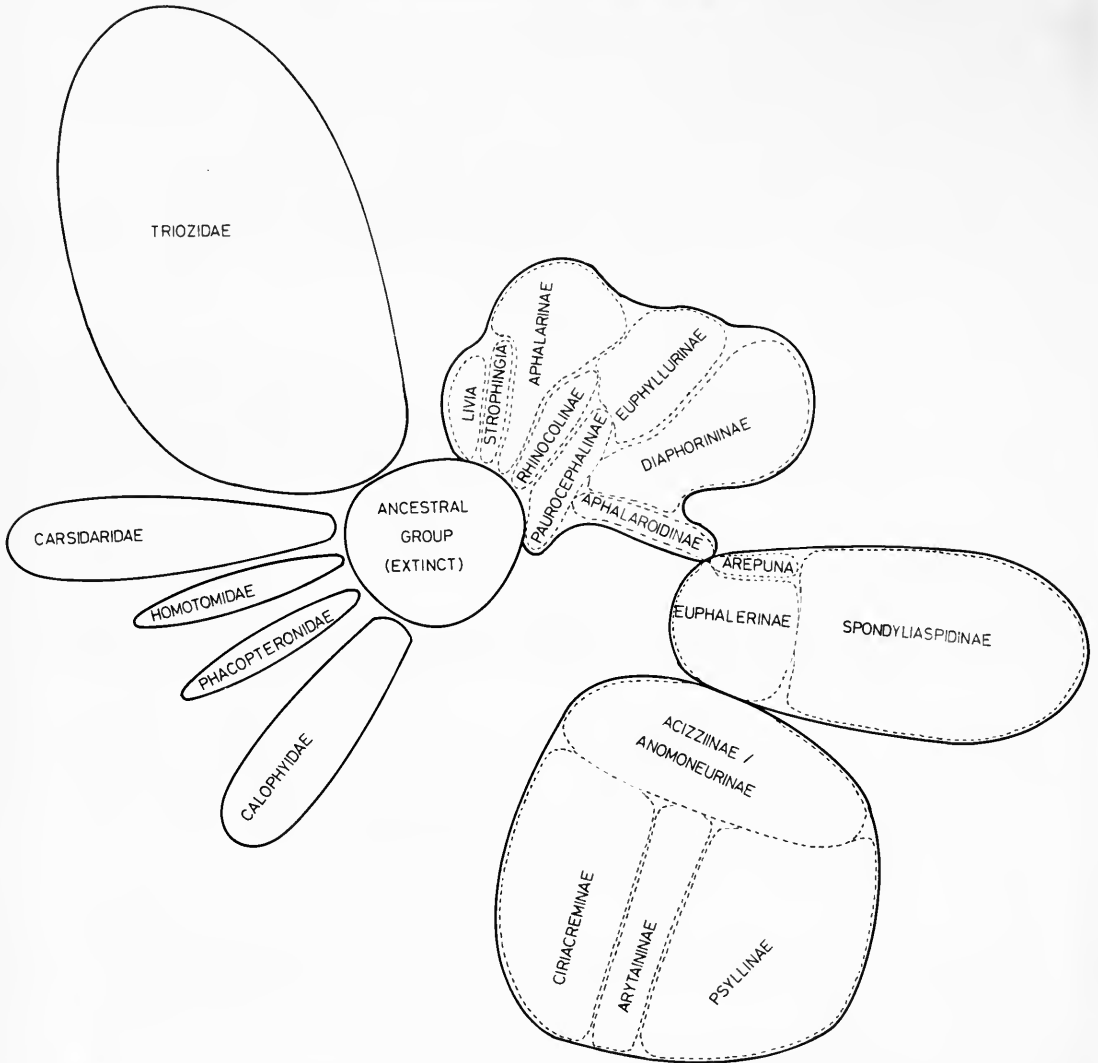

**Fig. 201** Suggested phylogenetic relationships of the families of Psylloidea; a cross section of the unresolved bush phylogeny, in which each family (solid border) and subfamily (broken border) is shown covering an area roughly in proportion to the number of species it contains.

The Aphalaridae is a collection of five phyletic lines, Strophingiinae, Liviinae, Aphalarinae, Rhinocolinae and Paurocephalinae which originate from close to the probable ancestor. The Strophingiinae are only separated from the ground plan by loss characters. The Liviinae probably had a Laurasian ancestor associated with the Commelinales but further evidence suggesting the origin of the group is unavailable. The Aphalarinae, by contrast, were most likely to have had a Gondwanaland ancestor, although the greatest diversification of species and genera has occurred in northern regions. However, their host-plants are diverse and do not include Rutales. It is conceivable that if Annonales-feeding antedates Rutales-feeding, the ancestor of Aphalarinae was an Annonales-feeder. At least one extant member of the family, *Gyropsylla cannella* (Crawford) on Lauraceae, is associated with Annonales.

The Rhinocolinae probably had an ancestor with a Gondwanaland distribution. All members of the subfamily examined feed on Rutales.

**Table 15** Nymphal summary classification

1. Sectasetae group.

Taxa with pointed or truncate sectasetae (characters N26 to N33, Table 4, p. 207). The forewing-pad generally has a well-formed humeral lobe (N1) and the tarsal arolia are very rarely petiolate (N4). There are two subgroups.

i. Pointed sectasetae subgroup.

Taxa with pointed sectasetae (characters N26 to N33)

<i>Calophya</i> (most spp.)	C
<i>Camartoscena unicolor</i>	A
<i>Crawforda triopsyllina</i>	T
<i>Diclidophlebia eastopi</i>	C
<i>Egeirotrioza</i> spp.	T
<i>Homotoma</i> spp.	C
<i>Leptynoptera sulfurea</i>	C
<i>Leuronota michoacana</i>	T
<i>Moraniella calodendri</i>	A
<i>Paraphalaroida fremontiae</i>	A
<i>Paurocephala</i> spp.	A
<i>Synozia pulchra</i>	C
<i>Trioza alacris</i>	T
<i>Triozoidea silvestris</i>	T

ii. Truncate sectasetae subgroup.

Taxa with truncate sectasetae (characters N26 to N33).

<i>Acanthocnema casuarinae</i>	T
<i>Ceropsylla martorelli</i>	T
<i>Paratrioza</i> spp.	T
<i>Pauropsylla trichaeta</i>	C
<i>Togepsylla matsumurana</i>	C
<i>Trichohermes walkeri</i>	T
<i>Trioza</i> (most spp.)	T

2. Lanceolate setae group.

Taxa with lanceolate setae (characters N23 to N25). There is often a humeral lobe (N1) and the tarsal arolia are rarely petiolate (N4).

<i>Agonosцена</i> spp.	A
<i>Aphalara</i> spp.	A
<i>Bharatiana octopsinosa</i>	C
<i>Camartoscena speciosa</i>	A
<i>Colposcena</i> sp.	A
<i>Craspedolepta</i> spp.	A
<i>Crastina linavuorii</i>	A
<i>Ctenarytaina eucalypti</i>	S
<i>Diaphorina</i> spp.	P
<i>Epicarsa</i> sp.	C
<i>Eucalyptolyma</i> sp.	S
<i>Euphyllura</i> spp.	A
<i>Leurolophus vittatus</i>	A
<i>Livia crefeldensis</i>	L
<i>L. vernalis</i>	L
<i>Neophyllura</i> spp.	A
<i>Pennavena fabulosa</i>	P
<i>Phacopteron lentiginosum</i>	C
<i>Phellopsylla</i> sp.	S
<i>Phytolyma</i> (most spp.)	A
<i>Pseudoeriopsylla nyasae</i>	C
<i>Pseudophacopteron floccosa</i>	C
<i>Psyllopsis</i> spp.	P

<i>Rhinocola aceris</i>	A
<i>Strophiingia</i> spp.	A
<i>Tainarys schini</i>	A

## 3. Capitulate setae group.

Taxa with capitulate setae (N11 to N19). All of these species also have a petiolate tarsal arolium (N4).

<i>Acizzia hakeae</i>	P
<i>A. russellae</i>	P
<i>A. uncatoides</i>	P
<i>Amorphicola amorphae</i>	P
<i>Arytaina genistae</i>	P
<i>Arytainilla</i> spp.	P
<i>Ceanothia</i> spp.	P
<i>Ciriacremum</i> spp.	P
<i>Euceropsylla</i> spp.	P
<i>Euphalerus tantillus</i>	P
<i>E. sp. (B)</i> .	P
<i>Floria variegata</i>	P
<i>Freysuila</i> sp.	P
<i>Heteropsylla</i> spp.	P
<i>Insnesia glabruscuta</i>	P
<i>Isogonoceraia divergipennis</i>	P
<i>Mitropsylla deserata</i>	P
<i>Psylla</i> (most spp.)	P
<i>Purshivora</i> spp.	P
<i>Trigonon longicornis</i>	P

## 4. Other taxa.

Taxa which lack sectasetae (characters N26 to N33), lanceolate setae (N23 to N25) and capitulate setae (N11 to N19). Two subgroups may, however, be recognised by the presence or absence of the petiolate tarsal arolium, a character which received high eigenvector and SUMRAT values.

## i. Petiolate arolium subgroup.

The following taxa have a petiolate tarsal arolium.

<i>Acizzia acaciae</i>	P
<i>A. acaciaebaileyanae</i>	P
<i>Anomoneura mori</i>	P
<i>Aphalaroida</i> spp.	A
<i>Arepuna</i> sp.	P
<i>Colophorina cassiae</i>	P
<i>Epipsylla</i> spp.	P
<i>Euglyptoneura</i> spp.	P
<i>Euphalerus</i> (most spp.)	P
<i>Neopsyllia</i> spp.	P
<i>Pexopsylla cercocarpi</i>	P
<i>Platycorpha princeps</i>	P
<i>Psylla betulaenanae</i>	P
<i>P. carpinicola</i>	P
<i>P. floccosa</i>	P
<i>P. galeaformis</i>	P
<i>P. mali</i>	P
<i>P. phoradendrae</i>	P
<i>P. ribesiae</i>	P
<i>P. striata</i>	P
<i>P. trimaculata</i>	P
<i>Retroacizzia antennata</i>	P
<i>Spanioneura fonscolombii</i>	P

## ii. Remainder.

<i>Apsylla cistellata</i>	A
---------------------------	---

<i>Calophya rhois</i>	C
<i>C. rotundipennis</i>	C
<i>Cardiaspina</i> spp.	S
<i>Ceropsylla sideroxyli</i>	T
<i>Creiis</i> sp.	S
<i>Euphalerus gallicolus</i>	P
<i>Glycaspis</i> spp.	S
<i>Gyropsylla</i> spp.	A
<i>Hevaheva swezeyi</i>	T
<i>Kuwayama pisonia</i>	T
<i>Livia</i> (most spp.)	L
<i>Macrohomotoma</i> spp.	C
<i>Mastigimas</i> spp.	C
<i>Mesohomotoma</i> spp.	C
<i>Microceropsylla</i> sp.	C
<i>Mycopsylla</i> sp.	C
<i>Neolithus</i> sp.	T
<i>Pachypsylla</i> spp.	S
<i>Paracarsidara</i> spp.	C
<i>Pauropsylla</i> (most spp.)	C
<i>Pelmatobrachia</i> sp.	C
<i>Phytolyma lata</i>	A
<i>Protyora sterculiae</i>	C
<i>Pseudophacopteron</i> (most spp.)	C
<i>Spondylaspis</i> sp.	S
<i>Swezeyana elongagena</i>	T
<i>Synoza</i> sp.	C
<i>Tenaphalara</i> spp.	C
<i>Tetragonocephala</i> sp.	S
<i>Triozza anceps</i>	T
<i>T. hirsuta</i>	T
<i>T. palmicola</i>	T
<i>Triozamia lamborni</i>	T

There are four remaining subfamilies of Aphalaridae; Paurocephalinae, Euphyllurinae, Diaphorininae and Aphalaroidinae. The Paurocephalinae are morphologically most primitive and, hence, this subfamily is illustrated (Fig. 201) as deriving from the ancestral group and giving rise to the other three subfamilies. The Paurocephalinae, Euphyllurinae and Diaphorininae probably had Gondwanaland origins associated with unknown hosts.

The ancestor of the extant Aphalaroidinae was most likely to have had a Gondwanaland distribution, associated with Fabaceae. From such an ancestor the present day Nearctic genus *Aphalaroida* evolved together with the ancestor of the Spondyliaepididae.

**Table 16** Percentage of species in each family of Becker-Migdisova (1973) in each group or subgroup of the nymphal summary classification (rows total 100%).

	Group or subgroup					
	1.i.	1.ii.	2.	3.	4.i.	4.ii.
APHALARIDAE	10	0	80	0	4	6
CARSIDARIDAE	28	5	9	0	0	58
LIVIIDAE	0	0	40	0	0	60
PSYLLIDAE	0	0	10	64	25	1
SPONDYLIASPIDIDAE	0	0	13	0	0	87
TRIOZIDAE	13	72	0	0	0	15

**Table 17** A general classification of the Psylloidea.

The following classification includes eight families. An asterisk indicates the probable position in the classification of some taxa not examined.

## Psylloidea Löw

- Aphalaridae Löw
  - Togepssyllinae Becker-Migdisova
    - Togepssylla* Kuwayama\*
  - Strophinginae **subfam. n.** (type-genus: *Strophingia* Enderlein)
    - Strophingia* Enderlein
  - Liviinae Löw
    - Livia* Latreille
- Aphalarinae Löw
  - Phytolymini Becker-Migdisova
    - Phytolyma* Scott
  - Gyropsyllini **trib. n.** (type-genus: *Gyropsylla* Bréthes)
    - Gyropsylla* Bréthes
  - Colposceniini Becker-Migdisova
    - Colposcencia* Enderlein
    - Crastina* Loginova
  - Aphalarini Löw
    - Aphalara* Förster
    - Craspedolepta* Enderlein
    - Brachystetha* Loginova\*
    - Epheloscyta* Loginova\*
    - Xanioptera* Enderlein\*
  - Caillardiini Loginova\*
    - Caillardia* Bergevin\*
    - Eumetoecus* Loginova\*
    - Rhodochlanis* Loginova\*
    - Rhombaphalara* Loginova\*
  - Xenaphalarini Loginova\*
    - Eurotica* Loginova\*
    - Xenaphalara* Loginova\*
- Rhinocolinae Becker-Migdisova
  - Rhinocolini Becker-Migdisova
    - Tainarys* Bréthes
    - Leurolophus* Tuthill
    - Moraniella* Loginova
    - Rhinocola* Förster
    - Agonosцена* Enderlein
    - Aphorma* Hodkinson\*
    - Lisronia* Loginova\*
    - Rhachistoneura* Hodkinson & Hollis\*
  - Pachypsylloidini Loginova\*
    - Acaerus* Loginova\*
    - Eremopsylloides* Loginova\*
    - Pachypsylloides* Bergevin\*
- Paurocephalinae Becker-Migdisova
  - Camarotoscena* Haupt
  - Paurocephala* Crawford
- Euphyllurinae Becker-Migdisova
  - Diclidophlebiini Becker-Migdisova
    - Diclidophlebia* Crawford
    - Paraphalaroida* Loginova
    - Haplaphalara* Uichanco\*
  - Euphyllurini Becker-Migdisova
    - Euphyllura* Förster



- Neophyllura* Loginova
- Katecephala* Crawford\*
- Ligustrinia* Loginova\*
- Syntomoza* Enderlein\*
- Syringilla* Loginova\*
- Ctenarytainini **trib. n.** (type-genus: *Ctenarytaina* Ferris & Klyver)
  - Ctenarytaina* Ferris & Klyver
  - (some spp. referred to *Eucalyptolyma*)
  - Eurhinocola* Crawford\*
  - Syncarpiolyma* Froggatt\*
- Diaphorininae Vondracek
  - Diaphorinini Vondracek
    - Diaphorina* Löw
    - Pennavena* Capener
    - Eudiaphorina* Loginova\*
  - Psyllopseini Vondracek
    - Psyllopsis* Löw
- Aphalaroidinae Loginova
  - Aphalaroida* Crawford
- Spondylaspididae Schwarz
  - Arepuniinae **subfam. n.** (type-genus: *Arepuna* Tuthill)
    - Arepuna* Tuthill
  - Euphalerinae Becker-Migdisova
    - Euphalerus* Schwarz
    - Retroacizzia* Heslop-Harrison
    - ?*Pachyparia* Loginova\*
    - Phellopsylla* Taylor
    - Colophorina* Capener
    - Cometopsylla* Froggatt\*
  - Pachypsyllinae Becker-Migdisova
    - Pachypsylla* Riley
    - Tetragonocephala* Crawford
- Spondylaspidinae
  - Spondylaspis* Signoret
  - Creiis* Scott
  - Cardiaspina* Crawford
  - Glycaspis* Taylor
  - Australopsylla* Tuthill & Taylor\*
  - Eucalyptolyma* Froggatt\* (not including species examined in this study)
  - Hyalinaspis* Taylor\*
  - Lasiopsylla* Froggatt\*
- Psyllidae Löw
  - Acizziinae **subfam. n.** (type-genus: *Acizzia* Heslop-Harrison)
    - Acizziini **trib. n.** (type-genus: *Acizzia* Heslop-Harrison)
      - Trigonon* Crawford
      - Mitrapsylla* Crawford
      - Acizzia* Heslop-Harrison
      - Platycorypha* Tuthill
      - Neopsyllia* Caldwell
      - Freysuila* Aleman
    - Macrocorsini Becker-Migdisova\*
      - Auchmerina* Enderlein\*
      - Caradocia* Laing\*
      - Geijerolyma* Froggatt\*
      - Macrocorsa* Vondracek\*
  - Anomoneurinae Becker-Migdisova
    - Anomoneurini Becker-Migdisova
      - Anomoneura* Schwarz
      - Epipsylla* Kuwayama

- Tribe – unnamed (may be Cyamophilini Loginova)  
*Amorphicola* Heslop-Harrison  
 (many species referred to *Euphalerus*)  
 ?*Cyamophila* Loginova\*
- Ciriacreminae Enderlein  
 Ciriacremini Enderlein  
*Euceropsylla* Boselli  
*Heteropsylla* Crawford  
*Insnesia* Tuthill  
*Isogonoceraia* Tuthill  
*Ciriacremum* Enderlein  
*Aremica* Tuthill\*  
*Delina* Blanchard\*  
*Kleiniella* Aulmann\*  
*Palmapenna* Hollis\*  
*Panisopelma* Enderlein\*  
*Russelliana* Tuthill\*
- Arytaininae Crawford  
*Arytaina* Förster  
*Floria* Löw  
*Arytainilla* Loginova  
*Alloeoneura* Löw\*  
*Amblyrhina* Löw\*  
*Livilla* Curtis\*
- Psyllinae Löw  
*Psylla* Geoffroy sensu lato (including all subgenera)  
*Spanioneura* Förster  
*Ceanothia* Heslop-Harrison  
*Euglyptoneura* Heslop-Harrison  
*Purshivora* Heslop-Harrison
- Calophyidae Vondracek **stat. n.**  
 Apsyllinae Becker-Migdisova  
*Apsylla* Crawford
- Calophyinae Vondracek  
*Pelmatobrachia* Enderlein  
*Microceropsylla* Boselli  
*Calophya* Löw  
*Holotrioza* Bréthes\*  
*Paracalophya* Tuthill\*
- Phacopteronidae Becker-Migdisova **stat. n.**  
 Bharatianinae **subfam. n.** (type-genus: *Bharatiana* Mathur)  
*Bharatiana* Mathur
- Phacopteroninae Becker-Migdisova  
*Phacopteron* Buckton  
*Pseudophacopteron* Enderlein  
*Epicarsa* Crawford  
*Chineura* Tuthill\*  
*Phacosemoides* Lima & Guitton\*
- Homotomidae Heslop-Harrison **stat. n.**  
 Homotominae Heslop-Harrison  
*Homotoma* Guérin-Méneville  
*Synozia* Enderlein
- Macrohomotominae **subfam. n.** (type-genus: *Macrohomotoma* Kuwayama)  
 Mycopsyllini **trib. n.** (type-genus: *Mycopsylla* Froggatt)  
*Mycopsylla* Froggatt
- Macrohomotomini **trib. n.** (type-genus: *Macrohomotoma* Kuwayama)  
*Macrohomotoma* Kuwayama  
*Pseudoeropsylla* Newstead

- Carsidaridae Crawford  
  Mastigimatinae Becker-Migdisova  
    *Mastigimas* Enderlein  
  Carsidarinae Crawford  
    Tenaphalarini Heslop-Harrison  
      *Tenaphalara* Kuwayama  
    Carsidarini Crawford  
      *Protyora* Kieffer  
      *Mesohomotoma* Kuwayama  
      *Paracarsidara* Heslop-Harrison  
      *Carsidara* Walker\*
- Triozidae Löw  
  Neolithinae **subfam. n.** (type-genus: *Neolithus* Scott)  
    *Neolithus* Scott  
    *Schedoneolithus* Tuthill\*
- Triozamiinae Becker-Migdisova  
    *Triozamia* Vondracek
- Triozinae Löw  
    Triozini Löw  
      *Leuronota* Crawford  
      *Trichohermes* Kirkaldy  
      *Egeirotrioza* Boselli  
      *Aacanthocnema* Tuthill & Taylor  
      *Triozoida* Crawford  
      *Triozia* Förster  
      *Paratriozia* Crawford  
      *Kuwayama* Crawford  
      *Ceropsylla* Riley  
      *Swezeyana* Caldwell  
      *Crawforda* Caldwell  
      *Hevaheva* Kirkaldy  
      *Anomocephala* Tuthill\*  
      *Bactericera* Puton\*  
      *Calinda* Blanchard\*  
      *Epitrioza* Kuwayama\*  
      *Eutrioza* Loginova\*  
      *Hemischizocranium* Tuthill\*  
      *Hemitrioza* Crawford\*  
      *Izpania* Klimaszewski\*  
      *Metatriozia* Tuthill\*  
      *Myrmecephala* Tuthill\*  
      *Neotrioza* Kieffer\*  
      *Neotriozella* Crawford\*  
      *Ozotrioza* Kieffer\*  
      *Paracomeca* Laing\*  
      *Pseudotrioza* Miyatake\*  
      *Rhegmoza* Enderlein\*  
      *Schedotrioza* Tuthill & Taylor\*  
      *Stenopsylla* Kuwayama\*
- Pauropsyllini Crawford  
      *Pauropsylla* Rübsaamen  
      *Leptynoptera* Crawford  
      *Sympauropsylla* Enderlein\*
-

**Table 18** Genera not examined in this study, and the family or subfamily to which they probably belong.

<i>Aconopsylla</i> Tuthill & Taylor	Carsidarinae
<i>Anomalopsylla</i> Tuthill	Aphalaridae
<i>Astragilita</i> Loginova	Psyllidae
<i>Atmetocranium</i> Tuthill	Aphalaridae
<i>Brachyopsylla</i> Froggatt	Psyllidae
<i>Carsidaroida</i> Crawford	Carsidarinae
<i>Cecidopsylla</i> Kieffer	Phacopteronidae
<i>Cecidotrioza</i> Kieffer	Triozidae
<i>Cerotrioza</i> Crawford	Triozidae
<i>Diceraopsylla</i> Crawford	Aphalaridae
<i>Dynopsylla</i> Crawford	Homotomidae
<i>Engyatoneura</i> Loginova	Triozidae
<i>Eriopsylla</i> Froggatt	Psyllidae
<i>Jensiella</i> Tuthill	Aphalaridae
<i>Labicria</i> Enderlein	Psyllidae
<i>Lanthanaphalara</i> Tuthill	Aphalaridae
<i>Leptotrioza</i> Miyatake	Triozidae
<i>Levidea</i> Tuthill	Triozidae
<i>Lindbergiella</i> Heslop-Harrison	Psyllidae
<i>Megadicrania</i> Loginova	Aphalaridae
<i>Metapsylla</i> Kuwayama	Spondyliaspidae
<i>Nesiopie</i> Kirkaldy	Carsidarinae
<i>Optomopsylla</i> Caldwell	Triozidae
<i>Paurotriozana</i> Caldwell	Triozidae
<i>Pexopsylla</i> Jensen	Psyllidae
<i>Pseudacanthopsylla</i> Samy	Psyllidae
<i>Rhinopsylla</i> Riley	Triozidae
<i>Sphingocladia</i> Enderlein	Homotomidae
<i>Sphinia</i> Blanchard	Aphalaridae
<i>Tyora</i> Walker	Carsidarinae

The Spondyliaspidae probably derived from a Gondwanaland ancestor associated with Fabaceae. However, the largest group, the Spondyliaspinae, is associated with the genus *Eucalyptus* (Myrtaceae).

It is most likely that the Psyllidae shared a common ancestor with the Spondyliaspidae (minus *Arepuniinae*) in Gondwanaland in association with the Fabaceae. Present day psyllids are largely associated with Fabaceae and Rosaceae (Rosales). The morphologically most primitive, and probably oldest, subfamilies of Psyllidae are the *Acizziinae* and *Anomoneurinae*, most species of which retain the habit of Fabaceae-feeding. The *Ciriacreminae* have a Gondwanaland distribution suggesting that they are also an old group. The *Arytaininae* (as here defined) are probably a more recent group, restricted to the Palaearctic, but like most *Ciriacreminae*, retaining the habit of Fabaceae-feeding. The *Psyllinae* live on a variety of host-plants, particularly the Rosaceae, a north temperate family (Good, 1974). They are largely Holarctic and may have had a Laurasian ancestor.

The Calophyidae and Phacopteronidae have retained the habit of Rutales-feeding and probably had Gondwanaland origins. However, the families of Rutales with which most species of these families are associated differ; Calophyidae feed on Anacardiaceae and Phacopteronidae feed on Meliaceae.

The family Homotomidae probably had a Gondwanaland origin in association with *Ficus* (Moraceae). With the exception of a few Indian species on Santalaceae (Mathur, 1975) they feed on *Ficus*.

Once again, the most probable origin of the Carsidaridae was in Gondwanaland. The genus *Mastigimas*, which is only tentatively assigned to this family, has retained the habit of

Rutales-feeding, the remaining genera are placed in the subfamily Carsidarinae, which feed on Malvales.

The Triozidae is a cosmopolitan group for which a Gondwanaland origin appears most likely. There is no indication of the ancestral host relationship and, unlike other families, host-plant diversity appears to exceed morphological diversity (p. 256).

## Keys

### Key construction

These keys are intended to place most psyllid nymphs in the correct subfamily, tribe or in some cases genus. The keys are an application of the predictive properties of the new classification and, hence, they should work for the majority of species not examined by this study as well as the 15% of species which were. To maintain practicality it was sometimes necessary to artificially split some polythetic taxa. For example, the family Triozidae is keyed out in 11 sections in the key to families. In many polythetic taxa no morphological features of the nymphs could be used to separate subordinate taxa. In such cases host-plant differences were often of more practical value than morphological attributes and, hence, some key couplets contain host-plant characters.

Confirmatory data are given after most couplets. Nomomeristic and metric (Figs 5–7) characters are also given as confirmatory data; with the following abbreviations.

#### Nomomeristic characters

- A = Number of antenna divisions (i.e. apparent segments).
- R = Antennal divisions upon which rhinaria occur.

#### Metric characters (lengths)

- AL = Antenna length (Figs. 5, 6).
- ARB = Circum-anal pore ring breadth (Fig. 7).
- BL = Body length (Figs 5, 6).
- WL = Forewing-pad length (Figs 5, 6).

#### Metric characters (ratios)

- AWL = Antenna length to forewing-pad length ratio.
- BBBL = Body breadth (Figs 5, 6) to body length ratio.

Scale lines are given on drawings of structures whose dimensions are not indicated in the text.

### Artificial key to families

The phenetic groups which are usually monothetic, that are most congruent with the classification, are separated first. In this way, the key should have maximum reliability for species which 'key-out' prior to couplet 39. Many of the characters used in the key were shown to have high classificatory power, as indicated by high values of the SUMRAT information statistic and principal component eigenvectors. The key to families of White & Hodkinson (1982) should be used as an additional check on identity when Holarctic material is being examined.

### Artificial key to families of Psylloidea

- 1 Truncate sectasetae present on margin of forewing-pad (Fig. 50). [Sectasetae not present on antenna. Forewing-pad usually anteriorly produced as a humeral lobe]
  - Sectasetae usually absent from margin of forewing-pad; if present they are pointed (except *Togepssylla matsumurana* Kuwayama which has two rows of truncate sectasetae on the antenna) ..... 2
- 2 Scales present on body margin (Figs 173–176)
  - Scales not present on body margin ..... 3
- 3 Sectasetae (pointed or truncate) present on abdomen margin and numbering more than 4 + 4.. 4
  - Sectasetae usually absent from abdomen margin; if present then numbering at most 4 + 4..... 12

**TRIOZIDAE** (most species)(p. 289)

**TRIOZIDAE** (many Hawaiian and tropical New World species)(p. 289)

- 4 Tarsal arolium without a visible unguitactor (Fig. 95). [Palaeartic and Oriental. On *Populus* spp.] ..... **TRIOZIDAE** (*Egeirotrioza*) (p. 289)
- Tarsal arolium with a distinctly visible unguitactor (Figs 65, 66, 69–71, 74) ..... 5
- 5 Clavate setae present on dorsal surface of abdomen (Fig. 172). [Forewing-pad anteriorly produced as a humeral lobe which extends anterior to eye. Hawaii. On *Tetraplasandra*] ..... **TRIOZIDAE** (*Crawforda*) (p. 289)
- Clavate setae absent from dorsal surface of abdomen ..... 6
- 6 Setae present on antenna (Figs 40, 43, 45) ..... 7
- Setae absent from antenna ..... 8
- 7 Antenna length to forewing-pad length ratio 0.18–0.47. On Rutales, especially Anacardiaceae. Antennal setae arranged in one row, opposite rhinaria (Fig. 40). ..... **CALOPHYIDAE** (most New World spp.) (p. 288)
- Antenna length to forewing-pad length ratio 0.52–1.62. Usually not on Rutales, not known on Anacardiaceae. Antennal setae usually in more than one row (Fig. 45). [On Malvales, Melastomataceae, Moraceae and Rutaceae.] ..... **APHALARIDAE** (*Paurocephala* and other genera often confused with *Paurocephala*) (p. 278)
- 8 Apex of abdomen inwardly emarginate (Fig. 153). [Neotropical. On *Ficus*.] ..... **HOMOTOMIDAE** (*Synozia*) (p. 288)
- Apex of abdomen not inwardly emarginate ..... 9
- 9 Tarsal arolium with an unguitactor which forms a petiole (Fig. 69). [Palaeartic. On *Populus*.] ..... **APHALARIDAE** (*Camartoscena*) (p. 278)
- Tarsal arolium with a short unguitactor and no petiole ..... 10
- 10 Hindwing-pad very reduced, its apex interior to margin of abdomen (Fig. 48). [Austro-Oriental and Pacific. On *Calophyllum*.] ..... **TRIOZIDAE** (*Leptynoptera*) (p. 289)
- Hindwing-pad of normal proportions, its apex exterior to margin of abdomen ..... 11
- 11 General body form very broad; body breadth more than 0.75 times body length. [Old World. On *Ficus*.] ..... **HOMOTOMIDAE** (p. 288)
- General body form elongate; body breadth less than 0.70 times body length ..... **TRIOZIDAE** (some spp.) (p. 289)
- 12 Lanceolate setae present on abdomen margin and numbering 3 + 3 or 4 + 4. Capitate setae (sometimes modified into tubular structures, Fig. 133; *Mitrapsylla deserata* Caldwell) present on abdomen margin and/or dorsal surface. [Tropical and warm temperate New World. On Fabaceae.] ..... **PSYLLIDAE** (*Heteropsylla* and *Mitrapsylla*) (p. 285)
- Lanceolate setae usually absent from abdomen margin; if present, then capitate setae absent from body and wing-pads ..... 13
- 13 Lanceolate setae present on abdomen margin and/or forewing-pad margin (Figs 162, 165, 167, 168) ..... 14
- Lanceolate setae absent from abdomen and forewing-pad margins ..... 22
- 14 Circum-anal pore ring reduced to a few large pores (Fig. 146). [Oriental. On Burseraceae.] ..... **PHACOPTERONIDAE** (*Phacopteron*) (p. 288)
- Circum-anal pore ring not reduced to a few large pores ..... 15
- 15 Tibia each with a row of stout setae on outer edge (Figs 51, 54) ..... 16
- Tibia without a row of stout setae on outer edge ..... 17
- 16 Tarsal arolium with a long unguitactor which forms a petiole (Fig. 69). [Palaeartic. On *Populus*.] ..... **APHALARIDAE** (*Camartoscena*) (p. 278)
- Tarsal arolium very reduced (not or hardly visible). [Tropical Old World. On Meliaceae.] ..... **PHACOPTERONIDAE** (*Chineura*) (p. 288)
- 17 Anal pore-field arranged as bands (similar to Fig. 155). Antenna with 10 divisions. [Neotropical.] ..... **PHACOPTERONIDAE** (*Epicarsa*) (p. 288)
- Anal pore-field usually not arranged as bands; or if arranged as bands then antenna with at most 8 divisions ..... 18
- 18 Anal pore-field arranged as 2 rings which are each placed to one side of the anus (Figs 150–152). [Tropical Old World. On *Ficus*.] ..... **HOMOTOMIDAE** (some Macrohomotominae) (p. 288)
- Anal pore-field not arranged as 2 rings which are each placed to one side of the anus ..... 19
- 19 On Anacardiaceae. Antenna with 3 divisions. Small (BL = 0.93–1.20 mm). ..... **CALOPHYIDAE** (*Calophya rhois*) (p. 288)
- Usually not on Anacardiaceae; or if on Anacardiaceae, antenna with 7 or 8 divisions (some Rhinocolinae) or larger (some *Diaphorina*, BL = 1.34–2.13 mm) ..... 20
- 20 Apical margin of abdomen truncate-acuminate (Fig. 127). Anal pore-field not arranged as a

circum-anal ring, pores concentrated at antero-lateral angle of caudal plate (Fig. 127); pores not visible on anal plate. [Australia. On *Eucalyptus*.]

- SPONDYLIASPIDIDAE** (*Phellopsylla*) (p. 284)
- Apical margin of abdomen not truncate-acuminate. Anal pore-field usually comprised of a circum-anal ring only; if pores present on caudal plate then they also occur on the anal plate.. 21
- 21 Circum-anal pore ring partly on caudal plate, broad and convoluted (Fig. 145). [Oriental. On *Toona*.] ..... **PHACOPTERONIDAE** (*Bharatiana*) (p. 288)
- Circum-anal pore ring usually confined to anal plate; if partly on caudal plate then usually not convoluted (Fig. 108), or if convoluted then pores in a narrow row (Fig. 112)
- APHALARIDAE** (most species) (p. 278)
- 22 Anal pore-field (excluding circum-anal ring) arranged as 1 + 1 (Fig. 121) or 2 + 2 (Figs 120, 122) rings, which are slightly convoluted. [Tarsal arolium usually with a long unguitactor which forms a petiole (Fig. 77); except *Euphalerus gallicolus*. On Fabaceae and Rhamnaceae.] ..... **SPONDYLIASPIDIDAE** (*Euphalerus*) (p. 284)
- Anal pore-field (excluding circum-anal ring) usually not arranged as 1 + 1 or 2 + 2 rings; if arranged as 1 + 1 rings then rings not convoluted (Figs 110, 149) ..... 23
- 23 Apical margin of abdomen serrate-acuminate (Figs 125, 126, 128). Circum-anal pore ring absent. Anus posterior. [Anal pore-field, if present, comprised of small groups of pores, most of which occur on the caudal plate. On *Celtis* and *Colophospermum*.]
- SPONDYLIASPIDIDAE** (*Pachypsyllinae* and *Retroacizzia*) (p. 284)
- Apical margin of abdomen usually not serrate-acuminate; or if serrate-acuminate (Figs 149, 157) circum-anal pore ring present and anus ventral ..... 24
- 24 Caudal plate pointed (Figs 118, 124). [Abdomen segments usually laterally bulging (Fig. 27). Anal pore-field, if present, comprised of small groups of pores placed ventrally (Figs 118, 124, 129). Anus posterior. Tarsal apical setae usually strongly capitate (Fig. 38). Australia. On *Eucalyptus*.] ..... **SPONDYLIASPIDIDAE** (Spondyliaspidae) (p. 284)
- Caudal plate (if developed) not pointed ..... 25
- 25 Abdomen margin with 1 + 1, 2 + 2, 3 + 3 or 4 + 4 sectasetae .... **PSYLLIDAE** (many spp.) (p. 285)
- Abdomen margin without sectasetae ..... 26
- 26 Abdomen margin with capitate setae ..... **PSYLLIDAE** (many spp.) (p. 285)
- Abdomen margin without capitate setae ..... 27
- 27 Tarsal arolium with a petiole. Arolium pad usually large relative to tarsal claws (Figs 59, 80–93); if pad small (Fig. 179) then host-plant is a species of Fabaceae (some *Acizzia* spp.) .... 28
- Tarsal arolium usually without a petiole; if with a petiole then arolium pad small and host-plant is a species of Meliaceae (some *Pseudophacopteron* spp., Fig. 94) or *Terminalia* (*Triozia hirsuta*, Fig. 96) ..... 31
- 28 Abdomen margin with rod setae (Fig. 161) ..... 29
- Abdomen margin without rod setae ..... 30
- 29 Tarsal arolium with a very long petiole (Fig. 59). Antenna with 7 divisions. New World. On Fabaceae ..... **APHALARIDAE** (*Aphalaroida pithecolobia*) (p. 278)
- Tarsal arolium with a short petiole (similar to Fig. 92). Antenna with 7 or 8 divisions. Palearctic. On *Ulmus* ..... **PSYLLIDAE** (*Psylla ulmi*) (p. 285)
- 30 Tarsal arolium with a very long petiole (Fig. 59). [New World. On Fabaceae.]
- APHALARIDAE** (*Aphalaroida inermis*) (p. 278)
- Tarsal arolium with a short petiole (Figs 79–93) ..... **PSYLLIDAE** (many spp.) (p. 285)
- 31 Abdomen margin with clavate setae (Fig. 169). [Neotropical. On Solanaceae.]
- SPONDYLIASPIDIDAE** (*Arepuna*) (p. 284)
- Abdomen margin without clavate setae ..... 32
- 32 Anal pore-field with 1 + 1 incomplete rings in addition to circum-anal pore rings (Fig. 143). Host-plant is *Mangifera indica*. [Oriental.] ..... **CALOPHYIDAE** (*Apsylla*) (p. 288)
- Anal pore-field usually comprised of circum-anal rings only; if 1 + 1 additional rings present they are complete and the host-plant is *Juncus* (some *Livia* spp., Fig. 110) or *Ficus* (*Macrohomotoma striata*, Fig. 149) ..... 33
- 33 Anal pore-field comprised of circum-anal rings plus bands of pores which cover a more extensive area of the anal plate than of the caudal plate (Fig. 158). [Aftrotropical. On *Antiaria*.] ..... **TRIOZIDAE** (*Triozamia*) (p. 289)
- Anal pore-field usually comprised of circum-anal pore rings only; if pore bands present then they are more extensive on the caudal plate than on the anal plate (Fig. 155) ..... 34
- 34 Anal pore-field (excluding circum-anal ring which may be present or absent) comprised of pore

- bands (Fig. 155) or a single band plus numerous ovoid pore areas (Fig. 154). [On Meliaceae and Malvales.] ..... **CARSIDARIDAE** (p. 289)
- Anal pore-field (excluding circum-anal pore ring which is present) usually absent; if present then comprised of 1 + 1 rings (Figs 110, 149) ..... 35
- 35 Apical margin of abdomen notched and with 1 + 1 stout setae (Fig. 157). [Neotropical. On Euphorbiaceae, Myrtaceae and Solanaceae.] ..... **TRIOZIDAE** (*Neolithus*) (p. 289)
- Apical margin of abdomen not notched and without 1 + 1 stout setae ..... 36
- 36 Anal pore-field comprised of a circum-anal ring plus 1 + 1 additional rings each of which is separated from the circum-anal ring (Fig. 110). [Holarctic and northern Oriental. On *Juncus*.] ..... **APHALARIDAE** (some *Livia* spp.) (p. 278)
- Anal pore-field usually comprised of circum-anal pore rings only; if 1 + 1 additional rings present then they are adjacent to the circum-anal pore ring (Fig. 149) ..... 37
- 37 Anal pore-field comprised of circum-anal pore rings plus 1 + 1 additional rings (Fig. 149). [Austro-Oriental and Oriental. On *Ficus*.] ..... **HOMOTOMIDAE** (*Macrohomotoma*) (p. 288)
- Anal pore-field comprised of circum-anal pore rings only (which may occasionally be incomplete, Figs 150, 151; *Mycopsylla*) ..... 38
- 38 Circum-anal pore rings broken and with a convoluted inner margin to the outer ring (Figs 150, 151). [BBBL more than 0.83. Australasian, Austro-Oriental and Oriental. On *Ficus*.] ..... **HOMOTOMIDAE** (*Mycopsylla*) (p. 288)
- Circum-anal pore rings usually not broken; if broken (Fig. 147) then inner margin of outer ring not convoluted ..... 39
- 39 Antenna with 1 division. [On Rutales.] ..... **CALOPHYIDAE** (*Calophya rotundipennis* and *Microceropsylla*) (p. 288)
- Antenna with more than 1 division ..... 40
- 40 Antenna with 2 divisions. [Oriental. On *Ficus*.] ..... **TRIOZIDAE** (*Pauropsylla depressa*) (p. 289)
- Antenna with more than 2 divisions ..... 41
- 41 Antenna with 3 divisions ..... 42
- Antenna with more than 3 divisions ..... 43
- 42 Tarsus with 2 segments (Fig. 52). [Oriental. On Anacardiaceae.] ..... **CALOPHYIDAE** (*Pelmatobrachia*) (p. 288)
- Tarsus with 1 segment separate from the tibiotarsus (Fig. 53). [Afrotropical and Palaearctic. On Moraceae and *Tamarix*.] ..... **APHALARIDAE** (*Phytolyma* and some *Colposceniini*) (p. 278)
- 43 General form broad (BBBL more than 0.90). [Austro-Oriental and Oriental. On *Ficus*.] ..... **HOMOTOMIDAE** (*Macrohomotoma*) (p. 288)
- General form elongate (BBBL less than 0.85) ..... 44
- 44 Antenna with 5 or 6 divisions. [On Lauraceae.] ..... **TRIOZIDAE** (*Pauropsylla beelsoni* and *Trioza anceps*) (p. 289)
- Antenna with 8, 9 or 10 divisions ..... 45
- 45 General form broad (BBBL more than 0.77). Antenna with 6 rhinaria (Fig. 41; often difficult to see). [Tarsal arolium without a visible unguitactor (Fig. 58). New Zealand and New World. On *Ilex* and *Nectandra*.] ..... **APHALARIDAE** (*Gyropsylla*) (p. 278)
- General form elongate (BBBL less than 0.76). Antenna with 4 rhinaria ..... 46
- 46 Tarsal arolium usually not visible; if visible then very small relative to claws, with a short petiole and a well-developed pad (Fig. 94). [Old World tropics. On Meliaceae.] ..... **PHACOPTERONIDAE** (*Pseudophacopteron*) (p. 288)
- Tarsal arolium large relative to claws, with a stout petiole and a very reduced pad (Fig. 96). [Oriental. On *Terminalia*.] ..... **TRIOZIDAE** (*Trioza hirsuta*) (p. 289)

### Keys to subfamilies and genera of Aphalaridae

Many subfamilies are largely characterised by the form of the tarsal arolium, which is often difficult to observe. Because of this two keys to subfamilies are provided: (1) a key which follows the classification as closely as possible and (2) a much simplified artificial key. Material of *Togepsylla* sp. was not available for the analyses described earlier in this paper. However, material has since become available and the genus is tentatively included in the following keys (material in British Museum (Natural History); from New Guinea).



**Key to subfamilies of Aphalaridae**

- 1 Tarsus without an arolium, but with a pair of pulvilli (each situated beneath a claw). [Austro-Oriental, Oriental and Palearctic. On Lauraceae.] ..... **TOGEPHYLLINAE** (p. 281)
- Tarsus usually with a well-developed arolium; or if without a visible arolium, pulvilli also absent ..... 2
- 2 Tarsal arolium not visible ..... 3
- Tarsal arolium well developed and visible ..... 4
- 3 Abdomen margin with short lanceolate setae (similar in proportion to those in Fig. 164). [Anal pore-field usually comprised of groups of pores on the caudal plate in addition to the circum-anal ring (Fig. 105). Australasian, Oriental, Pacific, New Zealand and introduced to other areas on cultivated *Eucalyptus*. On Myrtaceae, Onagraceae and Rutaceae.] ..... **EUPHYLLURINAE** (Ctenarytainini) (p. 282)
- Abdomen margin usually with long simple setae; exceptionally slightly lanceolate (Fig. 162; *Phytolyma minuta*). [Anal pore-field comprised of circum-anal pore rings only (Fig. 162). Afrotropical. On Moraceae.] ..... **APHALARINAE** (*Phytolyma*) (p. 281)
- 4 Tarsal arolium without a visible unguitactor (Figs 56–58). ..... **APHALARINAE** (minus *Phytolyma*) (p. 281)
- Tarsal arolium with a well-developed unguitactor (Figs 59–76) ..... 5
- 5 Anal pore-field comprised of circum-anal pore rings plus 1 + 1 incomplete rings (Figs 106, 107, 112, 113) ..... **EUPHYLLURINAE** (minus Ctenarytainini) (p. 282)
- Anal pore-field usually comprised of circum-anal rings only; or if additional pore areas present they form ovoid areas (Figs 97, 99, 100) or complete rings (Fig. 110) ..... 6
- 6 Unguitactor less than half as long as whole arolium and not forming a petiole (Figs 67, 68, 71–76) ..... 7
- Unguitactor usually more than half as long as whole arolium (Figs 59–61, 69, 70); if less than half as long as whole arolium then arolium petiolate (Fig. 69) ..... 9
- 7 Tarsal arolium pad longer than broad (Fig. 71). [Palearctic. On Ericaceae.] ..... **STROPHINGIINAE** (p. 281)
- Tarsal arolium pad broader than long (Figs 67, 68, 72–76) ..... 8
- 8 Tarsal arolium pad more than 2.0 times as broad as long and with a pair of sclerotized areas (Figs 72–76). [On Rurales.] ..... **RHINOCOLINAE** (Rhinocolini) (p. 282)
- Tarsal arolium pad less than 1.5 times as broad as long and without sclerotized areas (Figs 67, 68). [Holarctic and Oriental. On *Carex* and *Juncus*.] ..... **LIVIINAE** (p. 281)
- 9 Abdomen margin with lanceolate setae. Anal pore-field comprised of circum-anal rings only. Tarsal arolium as in Figs 60, 61 ..... **DIAPHORININAE** (p. 283)
- Abdomen margin usually without lanceolate setae; or if with lanceolate setae anal pore-field comprised of circum-anal rings plus ovoid pore areas (Figs 97, 99, 100). Tarsal arolium petiolate (Figs 59, 69, 70) ..... 10
- 10 Abdomen margin with sectasetae or lanceolate setae. Petiole of tarsal arolium short relative to extension of claws (Figs 69, 70). [On *Populus*, Malvales and Urticales.] ..... **PAUROCEPHALINAE** (p. 283)
- Abdomen margin without sectasetae or lanceolate setae. Petiole of tarsal arolium long relative to extension of claws (Fig. 59). [New World. On Fabaceae.] ..... **APHALAROIDINAE** (p. 283)

**Simplified key to subfamilies of Aphalaridae**

- 1 Abdomen margin with rod setae. [Tarsal arolium with a very long petiole (Fig. 59). New World. On Fabaceae.] ..... **APHALAROIDINAE** (*Aphalaroida piuhecolobia*) (p. 283)
- Abdomen margin without rod setae ..... 2
- 2 On Moraceae (*Clorophora* and *Ficus*). [Abdomen margin with long setae, which may be slightly lanceolate (Fig. 162). Anus posterior. Tarsal arolium not visible. Afrotropical.] ..... **APHALARINAE** (*Phytolyma*) (p. 281)
- Not on Moraceae ..... 3
- 3 Abdomen margin with sectasetae ..... 4
- Abdomen margin without sectasetae ..... 9
- 4 Antenna without sectasetae ..... 5
- Antenna with sectasetae ..... 6

- 5 Anal pore-field comprised of circum-anal rings plus ovoid pore areas (Figs 99, 100). Tarsal arolium petiolate (Fig. 69). On *Populus* [Palaeartic.]  
**PAUROCEPHALINAE** (*Camarotoscena*) (p. 283)
- Anal pore-field comprised of circum-anal rings only. Tarsal arolium not petiolate (Fig. 71). On Ericaceae (*Calluna* and *Erica*). [Palaeartic.] ..... **STROPHINGIINAE** (p. 281)
- 6 Anal pore-field comprised of circum-anal rings plus additional broken rings (Figs 106, 113)  
**EUPHYLLURINAE** (Diclidophlebiini) (p. 282)
- Anal pore-field comprised of circum-anal rings only ..... 7
- 7 Abdomen margin setae based upon large clustered tubercles (Fig. 114). Tarsal arolium petiolate (Fig. 70). [On Malvales and possibly Urticales.]  
**PAUROCEPHALINAE** (*Paurocephala*) (p. 283)
- Abdomen margin setae not based upon clustered tubercles. Tarsal arolium, if present, not petiolate ..... 8
- 8 Abdomen, wing-pads and antennal setae truncate. On Lauraceae (*Lindera* and *Litsea*). Tarsal arolium absent. Paired pulvilli present, one under each claw. [Austro-Oriental, Oriental & Palaeartic.] ..... **TOGEPHYLLINAE** (p. 281)
- Abdomen, wing-pads and antennal setae pointed. On Rutaceae (*Calodendrum*). Tarsal arolium present (Fig. 74). Pulvilli absent. [Afrotropical.] **RHINOCOLINAE** (*Moraniella*) (p. 282)
- 9 Abdomen margin usually with lanceolate setae; if abdomen margin without lanceolate setae then forewing-pad margin with lanceolate setae ..... 10
- Abdomen margin and forewing-pad margin without lanceolate setae ..... 21
- 10 On *Carex*. [Circum-anal pore rings as in Fig. 111. Tarsal arolium as in Fig. 68. Holarctic.]  
**LIVIINAE** (some spp.) (p. 281)
- On Dicotyledoneae ..... 11
- 11 On Tamaricaceae. Lanceolate setae on abdomen and/or forewing-pad margin more than 6 times as long as broad (Fig. 163). Tarsal arolium without a visible unguitactor (Fig. 57). [Afrotropical, Oriental and Palaeartic.] ..... **APHALARINAE** (Colposceniini) (p. 281)
- Usually not on Tamaricaceae; if on Tamaricaceae then lanceolate setae less than 4 times as long as broad and tarsal arolium with a distinct unguitactor (Fig. 71) ..... 12
- 12 On *Calluna* or *Erica*. [Anal pore-field comprised of circum-anal rings only (Fig. 116). Tarsal arolium as in Fig. 71. Palaeartic.] ..... **STROPHINGIINAE** (p. 281)
- Not on *Calluna* or *Erica* ..... 13
- 13 On *Acer*. [Tarsal arolium as in Fig. 75. Palaeartic.] ..... **RHINOCOLINAE** (*Rhinocola*) (p. 282)
- Not on *Acer* ..... 14
- 14 Anal pore-field comprised of circum-anal rings (which may be very faint, Fig. 112) plus additional broken rings (Figs 107, 112. On *Arbutus*, *Arctostaphylos*, *Olea* and *Phillyrea*. [Tarsal arolium as in Figs 62–64. Holarctic.] ..... **EUPHYLLURINAE** (Euphyllurini) (p. 282)
- Anal pore-field usually comprised of circum-anal rings only; if additional pore areas present then they are in ovoid groups (Figs 97, 99, 100, 105) and the hosts are *Populus* (*Camarotoscena*), Rutales (*Agonoscena* and *Ctenarytaina*), Myrtaceae or Onagraceae (*Ctenarytaina*) ..... 15
- 15 Anal pore-field comprised of circum-anal rings plus adjacent ovoid groups of pores (Figs 97, 99, 100) ..... 16
- Anal pore-field usually comprised of circum-anal rings only; or if with ovoid groups of pores then these are situated some distance from the outer circum-anal ring (Fig. 105) ..... 17
- 16 On *Populus*. Tarsal arolium narrow (Fig. 69). [Palaeartic.]  
**PAUROCEPHALINAE** (*Camarotoscena*) (p. 283)
- On *Ruta* or *Pistacia*. Tarsal arolium broad (Fig. 72) ..... **RHINOCOLINAE** (*Agonoscena*) (p. 282)
- 17 On Anacardiaceae in the New World. [Tarsal arolium as in Figs 73, 76.]  
**RHINOCOLINAE** (*Leurolophus* and *Tainarys*) (p. 282)
- Usually not on Anacardiaceae; if on Anacardiaceae then Old World ..... 18
- 18 On *Fraxinus*. Tarsal arolium with a very long petiole (Fig. 61)  
**DIAPHORININAE** (*Psyllopsis*) (p. 283)
- Not on *Fraxinus*. Tarsal arolium, if visible, without a long petiole ..... 19
- 19 Antenna with 8 or 9 divisions. Tarsal arolium not visible. Abdomen margin usually sinuate before apex (Fig. 105). Anal pore-field sometimes with groups of pores in addition to circum-anal pore rings (Fig. 105). [On Myrtaceae, Onagraceae and Rutaceae.]  
**EUPHYLLURINAE** (*Ctenarytaina*) (p. 282)
- Antenna usually with less than 8 divisions; if with 8 divisions then tarsal arolium clearly visible.

- Abdomen margin not sinuate before apex and anal pore-field comprised of circum-anal rings only ..... 20
- 20 Abdomen margin lanceolate setae at least 4 times as long as broad (Fig. 164). Tarsal arolium without a visible unguitactor (Fig. 56). Antenna usually with 5 or 6 rhinaria, sometimes 4. Humeral lobe of forewing-pad not usually extended anterior to the posterior margin of the eye. [Cool temperate Holarctic and Oriental. On Asteraceae, Brassicaceae, Chenopodiaceae, Onagraceae, Polygonaceae and Ranunculaceae.] **APHALARINAE** (Aphalarini) (p. 281)
- Abdomen margin lanceolate setae less than 4 times as long as broad (Fig. 165). Tarsal arolium with a long unguitactor (Fig. 60). Antenna with 4 rhinaria. Humeral lobe of forewing-pad usually extended anterior to the posterior margin of the eye. [Warm temperate and tropical Afrotropical, Oriental and Palaearctic. On numerous hosts.]
- DIAPHORININAE** (Diaphorinini) (p. 283)
- 21 Anal pore-field comprised of a circum-anal ring plus 1 + 1 additional rings (Fig. 110). Tarsal arolium with a distinct unguitactor but not petiolate (Fig. 67). [Holarctic. On *Juncus*.]
- LIVIINAE** (some spp.) (p. 281)
- Anal pore-field comprised of circum-anal rings only. Tarsal arolium without a distinct unguitactor (Figs 57, 58) or, if with an unguitactor then petiolate (Fig. 59)..... 22
- 22 Tarsal arolium with a long petiole (Fig. 59). On Fabaceae. [New World.]
- APHALAROIDINAE** (*Aphalaroida inermis*) (p. 283)
- Tarsal arolium without a long petiole (Figs 57, 58). On *Ilex*, *Nectandra* or *Tamarix*
- APHALARINAE** (Colposceniini and *Gyropsylla*) (p. 281)

**Confirmatory characters of Togepsyllinae**

Body, antenna and wing-pads with truncate sectasetae. Tarsus with paired pulvilli, one under each claw. BL = 0.93–1.27 mm, WL = 0.35–0.46 mm, ARB = 0.08 mm, AWL = 0.89–1.12, BBBL = 0.40–0.51, A = 7, R = 3456. Austro-oriental, Oriental and eastern Palaearctic. On Lauraceae ..... **TOGEPSYLLA**

**Key to species groups of Liviinae**

One genus only: *Livia*. Species formerly referred to *Diraphia* Waga can be separated from other species of *Livia*, as follows.

- 1 Anal pore-field comprised of circum-anal pore rings plus 1 + 1 additional rings (Fig. 110). Tarsal arolium pad with angles acutely rounded (Fig. 67). On *Juncus*. [BL = 1.44–2.45 mm, WL = 0.65–0.83 mm, ARB = 0.06–0.08 mm, AWL = 0.49–0.75, BBBL = 0.48–0.71, A = 3 or 7, R = 3333 or 3577.]..... **LIVIA** (minus species formerly referred to *Diraphia*)
- Anal pore-field comprised of circum-anal rings only (Fig. 111). Tarsal arolium pad with angles broadly rounded (Fig. 68). On *Carex*. [BL = 1.75–2.63 mm, WL = 0.80–0.92 mm, ARB = 0.47–0.60 mm, AWL = 0.55–0.76, BBBL = 0.51–0.75, A = 7 or 10, R = 4677 or 4689.]
- LIVIA** (formerly *Diraphia* spp.)

**Confirmatory characters of Strophingiinae**

Abdomen and wing-pad margins with lanceolate setae or pointed sectasetae. Tarsal arolium as in Fig. 71. BL = 1.11–1.58 mm, WL = 0.46–0.60 mm, ARB = 0.09–0.13 mm, AWL = 0.41–0.56, BBBL = 0.72–0.86, A = 3, R = 3333. Palaearctic. On *Calluna* and *Erica*

**STROPHINGIA**

**Key to genera of Aphalarinae**

- 1 Each tarsus without a visible arolium. On Moraceae. [Longest seta on abdomen margin simple, others at most only slightly lanceolate (Fig. 162). Anus posterior, Fig. 162. BL = 1.72–2.47 mm, WL = 0.72–1.11 mm, ARB = 0.31–0.69 mm, AWL = 0.60–0.78, BBBL = 0.82–1.11, A = 3, R = 3333. Afrotropical. On *Clorophora* and *Ficus*.] ..... **PHYTOLYMA**
- Each tarsus with a visible and well-developed arolium (Figs 56–58). Not on Moraceae..... 2
- 2 Anus posterior. Circum-anal pore ring more than 0.35 mm broad and without sharp angles (Fig. 108). [Body and wing-pads without lanceolate setae. Antenna with 6 rhinaria (may be very difficult to see) (Fig. 41). BL = 1.52–1.87 mm, WL = 0.74–0.79 mm, ARB = 0.36–0.39 mm, AWL = 0.65–0.87, BBBL = 0.78–0.81, A = 8 or 10, R = 456788 or 456789. New World and New Zealand. On *Ilex* and *Nectandra*.]..... **GYROPSYLLA**

- Anus ventral. Circum-anal pore ring usually less than 0.35 mm broad; if more than 0.35 mm broad (some *Craspedolepta* spp.) then ring with some sharp angles (Figs 102, 103) ..... 3
- 3 On Tamaricaceae. Lanceolate setae often absent; or if present they are more than 6 times as long as broad (Fig. 163). Forewing-pad margin sometimes with a deep oblique notch ..... 4
- Not on Tamaricaceae. Lanceolate setae present and less than 6 times as long as broad (Fig. 164). Forewing-pad margin without a deep oblique notch ..... 5
- 4 General form broad (BBBL more than 0.83). [Forewing-pad usually with a humeral lobe. BL = 0.95–1.07 mm, WL = 0.37–0.43 mm, ARB = 0.09–0.11 mm, AWL = 0.38–0.43, BBBL = 0.91–0.95, A = 3, R = 3333. Afrotropical, Oriental and Palearctic. On *Tamarix*.] **COLPOSCENIA**
- General form elongate (BBBL less than 0.83). [Forewing-pad without a humeral lobe. BL = 1.84 mm, WL = 0.64 mm, ARB = 0.14 mm, AWL = 0.47, BBBL = 0.75, A = 3, R = 333333. Afrotropical and Palearctic. On *Tamarix* and *Myricaria*.] ..... **CRASTINA**
- 5 On *Caltha*, *Polygonum*, *Rumex* or *Sisymbrium*. [Antenna usually with 7 divisions, rarely 3 or 8. BL = 1.65–2.46 mm, WL = 0.70–0.93 mm, ARB = 0.16–0.31 mm, AWL = 0.40–0.62, BBBL = 0.55–0.80, R = 333333, 3577, 34577, 345677 or 456788. Holarctic and Mexico.] **APHALARA**
- On Asteraceae or Onagraceae. [Antenna usually with 3 divisions, rarely 7. BL = 1.58–2.80 mm, WL = 0.60–1.15 mm, ARB = 0.10–0.38 mm, AWL = 0.34–0.66, BBBL = 0.52–0.91, R = 3333, 33333, 333333, 3577, 35677 or 345677. Holarctic and Mexico.] **CRASPEDOLEPTA**

#### Key to genera of Rhinocolinae: Rhinocolini

- 1 Forewing-pad and abdomen margins with sectasetae (Fig. 166). [Tarsal arolium as in Fig. 74. BL = 1.41–1.59 mm, WL = 0.60–0.68 mm, ARB = 0.14–0.16 mm, AWL = 0.52–0.58, BBBL = 0.74–0.79, A = 3, R = 3333. Afrotropical. On *Calodendrum*.] .. **MORANIELLA** 2
- Forewing-pad and abdomen margins without sectasetae ..... 2
- 2 Anal pore-field comprised of circum-anal rings plus adjacent ovoid groups of pores (Fig. 97). [Tarsal arolium as in Fig. 72. BL = 0.91–1.30 mm, WL = 0.34–0.42 mm, ARB = 0.12–0.18 mm, AWL = 0.76–1.17, BBBL = 0.71–0.78, A = 7, R = 3577. Afrotropical, Oriental and Palearctic. On *Pistacia* and *Ruta*.]..... **AGONOSCENA** 3
- Anal pore-field comprised of circum-anal rings only ..... 3
- 3 Anus posterior or nearly so. Outer circum-anal pore ring comprised of multiple rows of pores (Fig. 109). Antenna with 8 divisions. [Tarsal arolium as in Fig. 73. BL = 1.05–1.16 mm, WL = 0.42–0.50 mm, ARB = 0.19 mm, AWL = 0.70–0.76, BBBL = 0.68–0.76, R = 3577. Nearctic. On *Rhus*.]..... **LEUROLOPHUS** 4
- Anus ventral. Outer circum-anal pore ring comprised of a single row of pores (Fig. 168). Antenna with 7 divisions ..... 4
- 4 Lanceolate setae on the head, wing-pads and abdomen truncate (Fig. 168). Antenna with lanceolate setae. [Tarsal arolium as in Fig. 75. BL = 1.56–2.20 mm, WL = 0.53–0.68 mm, ARB = 0.13–0.19 mm, AWL = 0.61–0.91, BBBL = 0.55–0.70, R = 3577. Palearctic. On *Acer*.]..... **RHINOCOLA**
- Lanceolate setae on the head, wing-pads and abdomen pointed (Fig. 167). Antenna without lanceolate setae. [Tarsal arolium as in Fig. 76. BL = 1.61 mm, WL = 0.58 mm, ARB = 0.09 mm, AWL = 0.57, BBBL = 0.78, R = 3577. Neotropical. On *Schinus*.] **TAINARYS**

#### Key to genera and subgenera of Euphyllurinae

- 1 Abdomen margin with sectasetae ..... 2
- Abdomen margin with lanceolate or stout simple setae ..... 3
- 2 Anal pore-field (other than circum-anal rings) comprised of unbroken bands (Fig. 106). [Tarsal arolium as in Fig. 65. BL = 2.25–2.75 mm, WL = 0.68–0.72 mm, ARB = 0.08–0.09 mm, AWL = 1.24–1.37, BBBL = 0.58–0.60, A = 9, R = 3578. Old World tropics. On Sterculiaceae.] ..... **DICLIDOPHLEBIA**
- Anal pore-field (other than circum-anal rings) comprised of broken bands (Fig. 113). [Tarsal arolium as in Fig. 66. BL = 1.34–1.53 mm, WL = 0.59–0.68 mm, ARB = 0.07–0.10 mm, AWL = 1.44–1.62, BBBL = 0.79–0.85, A = 9, R = 3577. Tropical. On Melastomataceae, Sterculiaceae and Tiliaceae.]..... **PARAPHALAROIDA**
- 3 Tarsal arolium visible and well developed (Figs 62–64) ..... 4

- Tarsal arolium not visible ..... 6
- 4 Anal pore-field comprised of circum-anal pore rings, pore bands and ovoid pore groups (Fig. 107). [Tarsal arolium as in Fig. 62. BL = 1.22–2.00 mm, WL = 0.51–0.75 mm, ARB = 0.08–0.12 mm, AWL = 0.72–0.89, BBBL = 0.71–0.92, A = 8–9, R = 3578. Afrotropical, Oriental and Palaearctic. On *Olea* and *Phillyrea*.] ..... **EUPHYLLURA**
- Anal pore-field comprised of convoluted rings (Fig. 112)..... 5
- 5 Tarsal arolium not petiolate (Fig. 64). On *Arctostaphylos*. [BL = 1.90–2.37 mm, WL = 0.74–1.10 mm, AWL = 0.75–1.10 mm, BBBL = 0.71–0.76, A = 7, R = 3577. Nearctic.]..... **NEOPHYLLURA (NEOPHYLLURA)**
- Tarsal arolium petiolate (Fig. 63). On *Arbutus*. [BL = 2.15–2.65 mm, WL = 0.53–0.80 mm, AWL = 0.80–1.02, BBBL = 0.66–0.68, A = 7, R = 3577. Nearctic.]  
**NEOPHYLLURA (ARBUTOPHILA)**
- 6 Anal pore-field comprised of circum-anal rings only, or circum-anal rings plus ovoid groups of pores which are confined to the lateral areas of the abdomen (Fig. 105). [BL = 1.18–1.38 mm, WL = 0.48–0.60 mm, ARB = 0.07–0.09 mm, AWL = 0.68–0.78, BBBL = 0.58–0.70, A = 8, R = 3577. Australia, New Zealand and Pacific. On *Eucalyptus*, *Fuchsia* and *Boronia*. Introduced to Afrotropical and Palaearctic on cultivated *Eucalyptus*.]  
**CTENARYTAINA**
- Anal pore-field comprised of circum-anal rings plus broken bands of pore groups which are predominantly dorsal in position (Fig. 119). [BL = 1.51–2.00 mm, WL = 0.55–0.64 mm, AWL = 0.67–0.73, BBBL = 0.50–0.56, A = 9, R = 3578. Australia and Oriental. On *Eucalyptus* and other Myrtaceae.]..... **'EUCALYPTOLYMA', 'EUPHYLLURA'**  
(some species currently referred, but excluding the type-species)

**Key to genera of Paurocephalinae**

- 1 Abdomen margin with sectasetae based upon large clustered tubercles (Fig. 114). Antenna with sectasetae (Fig. 45). Anal pore-field comprised of circum-anal rings only. On Malvales and Moraceae. [Tarsal arolium as in Fig. 70. BL = 0.97–1.41 mm, WL = 0.40–0.53 mm, ARB = 0.13–0.16 mm, AWL = 0.81–1.00, BBBL = 0.74–0.92, A = 3, R = 3333. Old World.]..... **PAUROCEPHALA**
- Abdomen margin usually with lanceolate setae; if with sectasetae, then they are not based upon large clustered tubercles. Antenna without sectasetae. Anal pore-field comprised of circum-anal rings plus adjacent crescent-shaped (Fig. 99) or ovoid (Fig. 100) pore areas. On *Populus*. [Tarsal arolium as in Fig. 69. BL = 1.04–1.98 mm, WL = 0.44–0.71 mm, ARB = 0.05–0.23 mm, AWL = 0.70–0.84, BBBL = 0.76–0.85, A = 7, R = 3577. Palaearctic.]  
**CAMAROTOSCENA**

**Key to genera of Diaphorininae**

- 1 Tarsal arolium with a long petiole (Fig. 61). Antenna with 8 divisions and very long (AL = 0.79–0.87 mm, AWL = 0.91–1.23). On *Fraxinus*. Forewing-pad at most slightly extended anteriorly as a humeral lobe, which does not extend anterior to procoxa. [BL = 1.52–2.57 mm, WL = 0.64–0.89 mm, ARB = 0.16–0.27 mm, BBBL = 0.64–0.81, R = 3578. Palaearctic and Oriental. Introduced to Nearctic.] ..... **PSYLLOPSIS**
- Tarsal arolium without a long petiole (Fig. 60). Antenna with 3 divisions and short (AL = 0.29–0.45 mm, AWL = 0.26–0.54). Not on *Fraxinus*. Forewing-pad usually extended anteriorly as a humeral lobe, which extends anterior to procoxa ..... 2
- 2 Body and wing-pads broad (BBBL = 0.78–0.93). [BL = 1.34–2.13 mm, WL = 0.75–1.24 mm, ARB = 0.11–0.24 mm, AWL = 0.26–0.54, R = 3333. Afrotropical, Oriental and Palaearctic. Introduced to Neotropical. On a wide variety of host-plants.]..... **DIAPHORINA**
- Body and wing-pads narrow (BBBL = 0.73–0.75). [BL = 1.91–2.06 mm, WL = 0.87–0.88 mm, ARB = 0.28 mm, AWL = 0.38–0.43, R = 3333. Afrotropical. On *Strychnos*.]  
**PENNAVENA**

**Confirmatory characters of Aphalaroidinae**

- Tarsal arolium with a very long petiole (Fig. 59). BL = 1.51–1.75 mm, WL = 0.59–0.66 mm, ARB = 0.07–0.09 mm, AWL = 0.63–0.77, BBBL = 0.71–0.76, A = 7, R = 3577. New World. On Fabaceae ..... **APHALAROIDA**

## Key to genera and species groups of Spondyliaspidae

- 1 Caudal plate pointed (Figs 118, 124), without apical 'teeth' ..... 2
- Caudal plate not pointed (Fig. 121), with apical 'teeth' (Figs 122, 125, 127, 128) ..... 5
- 2 Margin of abdomen with 'teeth' placed 1 + 1 either side of caudal plate area (Fig. 118). [BL = 3.35-3.91 mm, WL = 1.03-1.18 mm, AWL = 0.83-0.90, BBBL = 0.53-0.30, A = 10, R = 4689. Australia. On *Eucalyptus*.] ..... **CREIIS**
- Margin of abdomen without 'teeth' placed 1 + 1 either side of caudal plate area (Figs 124, 129) ..... 3
- 3 Anal pore-field absent. Antenna short relative to forewing-pad (AWL = 0.57-0.79). [BL = 1.61-2.89 mm, WL = 0.68-0.92 mm, BBBL = 0.54-0.78, A = 9 or 10, R = 3578 or 4689. Australia. On *Eucalyptus*.] ..... **CARDIASPINA**
- Anal pore-field comprised of scattered pore groups (Figs 124-129) ..... 4
- 4 Antenna with 10 divisions and about twice as long as forewing-pad (AWL = 2.02). [BL = 2.44 mm, WL = 0.61 mm, BBBL = 0.55, R = 4689. Australia. On *Eucalyptus*.] ..... **SPONDYLIASPIS**
- Antenna with 9 divisions and about as long as forewing-pad (AWL = 0.87-1.14). [BL = 1.41-2.15 mm, WL = 0.66-0.89 mm, BBBL = 0.67-0.84, R = 3578 or 34578. Australia. On *Eucalyptus*.] ..... **GLYCASPIS**
- 5 Apical margin of abdomen with 'tooth-like' processes (Figs 120, 122, 125) ..... 6
- Apical margin of abdomen without 'tooth-like' processes ..... 13
- 6 Anal pore-field comprised of 1 + 1 ventral and 1 + 1 dorsal rings (Figs 120, 122) ..... 7
- Anal pore-field usually comprised of scattered pore groups (Fig. 126), or absent ..... 8
- 7 Abdomen with large apical 'teeth' arranged 1 + 1 (Fig. 120). Forming galls on Rhamnaceae. [BL = 2.78-2.88 mm, WL = 0.73-0.80 mm, AWL = 1.56-1.68, BBBL = 0.55-0.68, A = 7, R = 3567. New World tropics.] ..... **EUPHALERUS** (*E. gallicolus*)
- Abdomen with about 4 small apical 'teeth' (Fig. 122). Forming lerps on Fabaceae. [BL = 1.15-1.17 mm, WL = 0.44-0.58 mm, AWL = 1.00-1.36, BBBL = 0.85-0.94, A = 9, R = 3578. New World tropics.] ..... **EUPHALERUS** (*E. nidifex*)
- 8 Antenna with 10 divisions. On *Celtis* ..... 9
- Antenna with 8 or 9 divisions. Usually not on *Celtis*, or if on *Celtis* antenna with 8 divisions ..... 11
- 9 Abdomen apical 'teeth' without medial 'tooth' or 'teeth' enlarged (Fig. 126). Lerp forming. [BL = 3.08 mm, WL = 0.84 mm, AWL = 0.99, BBBL = 0.51, R = 4689. Eastern Palaearctic.] ..... **PACHYPSYLLA** (*P. japonica*)
- Abdomen apical 'teeth' with median 'tooth' or 'teeth' enlarged (Fig. 125). Gall forming ..... 10
- 10 Large, body length more than 4.5 mm. Forming galls on stems and leaf petioles. [BL = 4.91 mm, WL = 1.22-1.53 mm, AWL = 0.65-0.75, BBBL = 0.61-0.63, R = 4689. Nearctic.] ..... **PACHYPSYLLA** (*P. venusta*)
- Small, body length less than 4.5 mm. Forming galls on leaves. [BL = 2.03-4.25 mm, WL = 0.69-1.03 mm, AWL = 0.73-1.00, BBBL = 0.48-0.75, R = 4689. Nearctic and Mexico.] ..... **PACHYPSYLLA** (minus *P. japonica* and *P. venusta*)
- 11 Anal pore-field absent. Tarsal arolium petiolate (Fig. 78). [Apical 'teeth' of abdomen as in Fig. 128. BL = 2.20-2.61 mm, WL = 0.76-0.87 mm, AWL = 1.25-1.43, BBBL = 0.67-0.69, A = 8, R = 4688. Afrotropical. Forming lerps on *Colophospermum*.] ..... **RETROACIZZIA**
- Anal pore-field comprised of scattered pore groups (Fig. 127). Tarsal arolium not visible ..... 12
- 12 Abdomen margin with lanceolate setae. Antenna with 9 divisions. [BL = 2.18-2.66 mm, WL = 0.70-0.71 mm, AWL = 1.08-1.21, BBBL = 0.59-0.66, R = 3578. Australia. In discarded lerps of Spondyliaspidae on *Eucalyptus*.] ..... **PHELLOPSYLLA**
- Abdomen margin without lanceolate setae. Antenna with 8 divisions. [BL = 3 mm, WL = 1.1 mm, AWL = 0.9, BBBL = 0.7, R = 4688, all estimated from Ferris (1926). Nearctic and Mexico. Forming lerps on *Celtis*.] ..... **TETRAGONOCEPHALA**
- 13 Anal pore-field comprised of circum-anal rings only. Abdomen and wing-pad margins with clavate setae (Fig. 169). [BL = 1.44 mm, WL = 0.57 mm, ARB = 0.08 mm, AWL = 0.81, BBBL = 0.72, A = 7, R = 3577. Neotropical. On Solanaceae.] ..... **AREPUNA**
- Anal pore-field comprised of circum-anal rings plus pore bands (Fig. 121) or pore groups (Figs 117, 123) arranged as rings. Abdomen and wing-pad margins without clavate setae ..... 14
- 14 Anal pore-field comprised of circum-anal rings plus pore bands (Fig. 121). [BL = 1.56-1.77 mm, WL = 0.53-0.66 mm, AWL = 1.06-1.45, BBBL = 0.60-0.80, A = 7, R = 3577 or 4677. Nearctic. On Rhamnaceae.] ..... **EUPHALERUS** (*E. jugovenosus*, *E. rugipennis* and *E. vermiculosus*, but not the type-species of *Euphalerus*)

- Anal pore-field comprised of circum-anal rings plus pore groups (Figs 117, 123)..... 15
- 15 Abdomen margin with 3 + 3 sectasetae (Fig. 123). [Anal pore-field as in Fig. 123. BL = 1.44–1.72 mm, WL = 0.48–0.53 mm, AWL = 1.13–1.15, BBBL = 0.65–0.66, A = 8, R = 3578. Afrotropical. On Fabaceae.]
  - EUPHALERUS** (some species assigned to the genus, but not the type species)
  - Abdomen margin without sectasetae. [Anal pore-field as in Fig. 117. BL = 1.69 mm, WL = 0.64 mm, ARB = 0.12 mm, AWL = 1.11, BBBL = 0.65, A = 8, R = 3578. Afrotropical. On Fabaceae.]..... **COLOPHORINA**

**Keys to subfamilies and genera of Psyllidae**

**Key to subfamilies of Psyllidae**

- 1 Hindwing-pad margin with a pointed sectaseta. [Neotropical. On Fabaceae.]
  - ACIZZIINAE** (*Neopsyllia* and *Platycorypha*) (p. 285)
  - Hindwing-pad margin without sectasetae ..... 2
- 2 Dorsal surface of abdomen and thorax with lanceolate setae. [Neotropical. On Fabaceae.]
  - ACIZZIINAE** (*Mitrapsylla*) (p. 285)
  - Dorsal surface of abdomen and thorax without lanceolate setae ..... 3
- 3 Abdomen margin with 3 + 3 or 4 + 4 tubular sectasetae (Fig. 37 [ts]) or lanceolate setae (Fig. 37 [l]). [Tropical. On Fabaceae and Euphorbiaceae.]..... **CIRIACREMINAE** (p. 286)
  - Abdomen margin without tubular sectasetae or lanceolate setae ..... 4
- 4 Tarsal arolium pad with two separate spinule-covered areas (Figs 81, 83, 84). Circum-anal pore rings partly on the dorsal surface of the abdomen (Fig. 130). [Tropical Old World and eastern Palaearctic. On Fabaceae and Moraceae.]..... **ANOMONEURINAE** (*Anomoneurini*) (p. 286)
  - Tarsal arolium pad with one spinule-covered area (Figs 79, 80, 86, 92, 93). Circum-anal pore rings usually confined to the ventral surface of the abdomen (the exceptions being some Psyllinae, Figs 132, 134, 136, 142) ..... 5
- 5 Antenna with 9 divisions ..... 6
  - Antenna with less than 9 divisions ..... 7
- 6 On *Cercocarpus*. [Nearctic.] ..... **PSYLLINAE** (*Psylla magna*) (p. 287)
  - On Fabaceae or Proteaceae ..... **ACIZZIINAE** (*Acizzia*) (p. 285)
- 7 Tarsal arolium pad only slightly broader at apex than at base (Fig. 93)
  - ACIZZIINAE** (*Trigonon*) (p. 285)
  - Tarsal arolium pad very much broader at apex than at base (Figs 86, 92) ..... 8
- 8 Antenna with 5 divisions ..... **ANOMONEURINAE** (some species assigned to *Euphalerus* but excluding the type-species) (p. 286)
  - Antenna with 7 or 8 divisions ..... 9
- 9 On *Cercocarpus*. Circum-anal pore ring breadth to antenna length ratio more than 0.3 (0.36–0.40)
  - ANOMONEURINAE** (*Euphalerus tantillus* but not the type-species of *Euphalerus*) (p. 286)
  - Usually not on *Cercocarpus*; or if on *Cercocarpus* then circum-anal pore ring breadth to antenna length ratio less than 0.3 (0.11–0.25) ..... 10
- 10 Not on Fabaceae or Solanaceae ..... **PSYLLINAE** (most species) (p. 287)
  - On Fabaceae or Solanaceae ..... 11
- 11 Circum-anal pore rings convoluted (Fig. 138)..... **PSYLLINAE** (*Psylla pulchella*) (p. 287)
  - Circum-anal pore rings not convoluted ..... 12
- 12 On *Bauhinia* ..... **PSYLLINAE** (*Psylla simlae*) (p. 287)
  - Not on *Bauhinia* ..... 13
- 13 On Genisteae ..... **ARYTAININAE** (p. 287)
  - Not on Genisteae ..... 14
- 14 Ventral surface of abdomen with capitate setae ..... **ACIZZIINAE** (*Freysuila*) (p. 285)
  - Ventral surface of abdomen without capitate setae ..... **ANOMONEURINAE** (some species assigned to *Euphalerus* but excluding the type-species) (p. 286)

**Key to genera of Acizziinae**

- 1 Dorsal surface of thorax and abdomen with lanceolate setae. Abdomen margin with 3 + 3 lanceolate setae and 'funnel' shaped setae (Fig. 133). [Tarsal arolium as in Fig. 89. BL = 1.25

- mm, WL = 0.45 mm, ARB = 0.09 mm, AWL = 1.67, BBBL = 0.67, A = 7, R = 3577. Neotropical. On Mimosoideae.] ..... **MITRAPSYLIA**
- Dorsal surface of thorax and abdomen without lanceolate setae. Abdomen margin without lanceolate setae and 'funnel'-shaped setae ..... 2
- 2 Hindwing-pad margin with a pointed sectaseta. Abdomen margin with 3 + 3 pointed sectasetae ..... 3
- Hindwing-pad margin and abdomen margin without sectasetae ..... 4
- 3 Antenna with 9 divisions. [Tarsal arolium as in Fig. 91. BL = 2.41 mm, WL = 0.82 mm, ARB = 0.14 mm, AWL = 2.68, BBBL = 0.58, R = 3578. Cuba. On *Myroxylon*.] **PLATYCORYPHA**
- Antenna with 10 divisions. [Tarsal arolium as in Fig. 90. BL = 2.11-2.31 mm, WL = 0.84-0.90 mm, ARB = 0.22-0.24 mm, AWL = 1.22-2.11, BBBL = 0.66-0.69, R = 4689. South America. On *Erythrina* and *Tipuana*.] ..... **NEOPSYLLIA**
- 4 Antenna with 7 divisions. Ventral surface of abdomen with capitate setae. [Tarsal arolium as in Fig. 86. BL = 1.54 mm, WL = 0.61 mm, ARB = 0.11 mm, AWL = 1.75, BBBL = 0.71, R = 3577. South America. On Caesalpinoideae and Solanaceae.] ..... **FREYSUILA**
- Antenna with 8 or 9 divisions. Ventral surface of abdomen without capitate setae ..... 5
- 5 Antenna with 8 divisions. Tarsal arolium pad only slightly broader at apex than at base (Fig. 93). [BL = 2.23 mm, WL = 0.64 mm, ARB = 0.25 mm, AWL = 2.77, BBBL = 0.64, R = 3578. Austro-Oriental and Pacific. Introduced to Hawaii.] ..... **TRIGONON**
- Antenna with 9 divisions. Tarsal arolium pad much broader at apex than at base (Fig. 80) or very reduced (Fig. 79). [BL = 0.95-1.66 mm, WL = 0.41-0.61 mm, ARB = 0.07-0.11 mm, AWL = 0.91-1.57, BBBL = 0.63-0.85, R = 3578. An almost cosmopolitan tropical and warm temperate genus. On Mimosoideae and Proteaceae.] ..... **ACIZZIA**

**Key to genera of Anomoneurinae**

The 'unnamed tribe' includes the genus *Amorphicola* and several species which are currently referred to the genus *Euphalerus* (the type-species of which, *E. nidifex*, is here placed in the Spondyliaspidae). It is possible that this tribe should include *Cyamophila* Loginova. However, this is not *Cyamophilini* in the sense in which Loginova (1976a; 1977) defined it. Because of the uncertain status of this tribe it is not further divided in the following key.

- 1 Circum-anal pore rings confined to ventral surface of abdomen. [BL = 1.13-1.98 mm, WL = 0.45-0.68 mm, ARB = 0.11-0.13 mm, AWL = 0.72-0.89, BBBL = 0.60-0.81, A = 5 or 7, R = 3455 or 3577. On Fabaceae and Rhamnaceae.] ..... 'unnamed tribe'
- Circum-anal pore rings partly on the dorsal surface of the abdomen (Fig. 130) ..... 2
- 2 Abdomen margin with 3 + 3 sectasetae. Antenna with 9 divisions. [Tarsal arolium as in Fig. 81. BL = 2.49-3.11 mm, WL = 1.02-1.03 mm, ARB = 0.55-0.65 mm, AWL = 1.63-1.71, BBBL = 0.69-0.75, R = 4689. Oriental and Palaearctic. On *Morus*.] ..... **ANOMONEURA**
- Abdomen margin without sectasetae. Antenna with 7 divisions. [Tarsal arolium as in Figs 83, 84. BL = 2.09-3.38 mm, WL = 1.02-1.03 mm, ARB = 0.33-0.91 mm, AWL = 2.33-2.45, BBBL = 0.56-0.65, R = 3577. Tropical Old World. On Fabaceae.] ..... **EPIPSYLIA**

**Key to genera of Ciriacreminae**

- 1 Abdomen margin with 3 + 3 or 4 + 4 lanceolate setae, without tubular sectasetae (Fig. 37 [l]). [BL = 1.12-1.53 mm, WL = 0.41-0.55 mm, ARB = 0.10-0.18 mm, AWL = 1.59-2.17, BBBL = 0.58-0.74, A = 7-8, R = 3577 or 3578. Tropical and warm temperature New World. On Mimosoideae.] ..... **HETEROPSYLLA**
- Abdomen margin without lanceolate setae but with 3 + 3 or 4 + 4 tubular sectasetae which are usually placed on slightly raised tubercles (Fig. 37 [ts]). [Tropical. Anus posterior.] ..... 2
- 2 Antenna with 9 divisions and abdomen margin with 3 + 3 sectasetae. [Tarsal arolium as in Fig. 88. BL = 1.46 mm, WL = 0.49 mm, ARB = 0.11 mm, AWL = 1.71, BBBL = 0.55, R = 3578. Neotropical and Pacific. On Mimosoideae.] ..... **ISOGONOCERAIA**
- Antenna usually with 7 divisions. If antenna with 9 divisions (*Ciriacremum harteni* and *C. julbernardioides*) then abdomen margin with 4 + 4 sectasetae ..... 3
- 3 Abdomen margin with 4 + 4 tubular sectasetae. Antenna with 7 divisions. [Tarsal arolium as in Fig. 85. BL = 1.57-2.58 mm, WL = 0.62-0.79 mm, ARB = 0.24-0.26 mm, AWL = 1.97-2.53, BBBL = 0.57-0.72, R = 3577. Neotropical. On Mimosoideae.] ..... **EUCEROPSYLLA**



- Abdomen margin usually with 3 + 3 tubular sectasetae. If abdomen margin with 4 + 4 tubular sectasetae antenna with 9 divisions ..... 4
- 4 Forewing-pad dorsal surface without capitate setae. Antenna with 7 divisions. [Tarsal arolium as in Fig. 87. Abdomen margin with 3 + 3 tubular sectasetae. BL = 1.80-2.43 mm, WL = 0.70-0.75 mm, ARB = 0.36-0.40 mm, AWL = 1.90-1.91, BBBL = 0.59-0.69, R = 3577. Pacific. On Caesalpinoideae and Euphorbiaceae.] ..... **INSNESIA**
- Forewing-pad dorsal surface usually with capitate setae. If forewing-pad dorsal surface without capitate setae then antenna with 9 divisions. [Tarsal arolium as in Fig. 82. Abdomen margin with 3 + 3 or 4 + 4 tubular sectasetae. BL = 1.33-2.25 mm, WL = 0.51-0.74 mm, ARB = 0.12-0.34 mm, AWL = 1.54-2.46, BBBL = 0.60-0.71, R = 3577 or 3578.] ..... **CIRIACREMUM**

**Key to genera of Arytaininae**

- 1 Antenna without capitate setae. [Forewing-pad dorsal surface without capitate setae. Abdomen margin with 3 + 3 or 4 + 4 pointed sectasetae. BL = 1.37-2.09 mm, WL = 0.57-0.72 mm, ARB = 0.14-0.28 mm, AWL = 0.93-1.89, BBBL = 0.59-0.98, A = 7, R = 3577. Palearctic. On Genisteae.] ..... **ARYTAINILLA**
- Antenna with a capitate seta positioned close to rhinarium IV ..... 2
- 2 Dorsal surface of forewing-pad with capitate setae. Abdomen margin with up to 3 + 3 (sometimes none) pointed sectasetae. [BL = 1.81-2.62 mm, WL = 0.62-0.73 mm, ARB = 0.19-0.23 mm, AWL = 1.53-1.61, BBBL = 0.53-0.71, A = 7, R = 3577. Palearctic and Oriental. On Genisteae.] ..... **ARYTAINA**
- Dorsal surface of forewing-pad without capitate setae. Abdomen margin with 4 + 4 pointed sectasetae. [BL = 1.91-2.25 mm, WL = 0.62-0.79 mm, ARB = 0.17-0.22 mm, AWL = 1.14-1.37, BBBL = 0.66-0.72, A = 7, R = 3577. Palearctic and Afrotropical. On Genisteae.] ..... **FLORIA**

**Key to genera of Psyllinae**

Keys for the separation of *Psylla* into subgenera have been provided by Ossiannilsson (1970), Loginova (1978) and White & Hodkinson (1982). In the following key to genera no tenable method could be found to distinguish *Purshivora pubescens* (Crawford) from some members of *Psylla* subgenus *Hepatopsylla* Ossiannilsson.

- 1 Circum-anal pore rings extending onto dorsal surface of abdomen and of a convoluted shape (Fig. 142). Antenna with 7 divisions. [BL = 1.34-1.98 mm, WL = 0.68-0.75 mm, ARB = 0.51-0.57 mm, AWL = 0.87-1.18, BBBL = 0.66-0.77, R = 3577. Palearctic. On *Buxus*.] ..... **SPANIONEURA**
- Circum-anal pore rings usually not extending onto dorsal surface of abdomen (Figs 135-141); or if rings convoluted and extending onto dorsal surface of abdomen (Fig. 134), antenna with 9 divisions ..... 2
- 2 Dorsal surface of forewing-pad with capitate or clavate setae. Abdomen margin with 3 + 3 pointed sectasetae. [BL = 1.25-1.62 mm, WL = 0.45-0.52 mm, ARB = 0.11-0.13 mm, AWL = 0.45-1.09, BBBL = 0.60-0.72, A = 7, R = 3577. Nearctic. On *Ceanothus* and *Cercocarpus*.] ..... **CEANOTHIA**
- Dorsal surface of forewing-pad usually without capitate and clavate setae; if dorsal surface of forewing-pad with capitate setae, abdomen with 4 + 4 pointed sectasetae (*Psylla simlae*) ..... 3
- 3 On *Ceanothus*. [Outer circum-anal pore ring multiple (Fig. 132). BL = 1.25-2.16 mm, WL = 0.56-0.75 mm, ARB = 0.11-0.37 mm, AWL = 0.75-1.27, BBBL = 0.69-0.85, A = 7, R = 3577. Nearctic.] ..... **EUGLYPTONEURA**
- Not on *Ceanothus* ..... 4
- 4 On *Purshia*. Outer circum-anal pore ring comprised of a multiple row of pores. [Abdomen margin without sectasetae. BL = 1.27-1.56 mm, WL = 0.43-0.53 mm, ARB = 0.13-0.20 mm, AWL = 1.08-1.27, BBBL = 0.69-0.79, A = 7, R = 3577. Nearctic.] ..... **PURSHIVORA** (*P. chelifera*)
- Usually not on *Purshia*; or if on *Purshia* outer circum-anal pore ring comprised of a single row of pores (similar to Figs 137-139) ..... 5
- 5 On *Purshia*. [Confirmatory characters included with *Purshivora chelifera* and *Psylla* confirmatory descriptions.] ..... **Purshivora pubescens**, **Psylla coryli**, **P. hirsuta**, **P. minuta**

- Not on *Purshia*. [Circum-anal pore rings of various forms (Figs 134–141). BL = 1.31–3.08 mm, WL = 0.46–1.15 mm, ARB = 0.06–0.85 mm, AWL = 0.61–2.20, BBBL = 0.50–1.08, A = 7 or 8, R = 3577 or 3578. Holarctic and northern Oriental. On a wide variety of hosts, especially Betulaceae, Rhamnaceae, Rosaceae and Salicaceae.] **PSYLLA** (most species)

**Key to genera of Calophyidae**

- 1 Anal pore-field comprised of circum-anal pore rings plus 1 + 1 pairs of partial rings (Fig. 143). Antenna with 10 divisions. [BL = 2.22 mm, WL = 0.81 mm, ARB = 0.13 mm, AWL = 1.05, BBBL = 0.80, R = 4689. Oriental. On *Mangifera*.] ..... **APSYLLA**
- Anal pore-field comprised of circum-anal pore rings only, or not discernible. Antenna with 1 to 3 divisions..... 2
- 2 Antenna length to forewing-pad length ratio 0.65–0.73. Humeral lobe of forewing-pad not extended as far forward as eye. [BL = 1.47–1.75 mm, WL = 0.60–0.68 mm, ARB = 0.08 mm, BBBL = 0.83–0.96, R = 3333. Oriental. On *Buchanania*.]..... **PELMATOBRACHIA**
- Antenna length to forewing-pad length ratio 0.18–0.55. Humeral lobe of forewing-pad extended forward beyond the posterior margin of the eye..... 3
- 3 Antenna with one rhinarium. Body breadth with wing-pads to body length ratio 1.23–1.25. Margin of head, wing-pads and abdomen without setae. [BL = 1.15–1.34 mm, WL = 0.64–0.75 mm, ARB = 0.03–0.04 mm, AWL = 0.49–0.53, A = 1. Oriental. On *Mangifera*.] **MICROCEROPSYLLA**
- Antenna with 3 or 4 rhinaria. Body breadth with wing-pads to body length ratio 0.83–1.16. Margin of head, wing-pads and abdomen usually with setae. [BL = 0.93–1.52 mm, WL = 0.49–0.84 mm, ARB = 0.07–0.15 mm, AWL = 0.18–0.56, A = 1, 2 or 3, R = 111, 1111, 2222 or 3333. Tropical and warm temperate areas. On Anacardiaceae, Burseraceae and Rutaceae.]..... **CALOPHYA**

**Key to genera of Phacopteroidae**

- 1 Anal pore-field arranged as bands (similar to Fig. 155). Antenna with 10 divisions. [Abdomen margin with lanceolate setae. BL = 2.20 mm, WL = 0.70 mm, AWL = 2.14, BBBL = 0.68, R = 4689. Neotropical.]..... **?EPICARSA**
- Anal pore-field arranged as circum-anal rings only (Figs 145–147), often very reduced (Fig. 146). Antenna with 3–9 divisions ..... 2
- 2 Outer circum-anal pore ring convoluted and extending onto the dorsal surface of the abdomen (Fig. 145). Antenna longer than forewing-pad length (AWL = 1.20). [Abdomen margin with small lanceolate setae. BL = 3.06 mm, WL = 1.25 mm, ARB = 0.91 mm, BBBL = 0.71, A = 8, R = 3578. Oriental. On *Toona*.]..... **BHARATIANA**
- Outer circum-anal pore ring not convoluted and confined to ventral surface of abdomen. Antenna shorter than forewing-pad length (AWL = 0.50–0.64)..... 3
- 3 Antenna with 3 divisions, the last of which is covered in prominent hairs (Fig. 47). On Burseraceae. [Abdomen margin with short lanceolate setae. Circum-anal pore ring very reduced (Fig. 146). BL = 2.90–4.10 mm, WL = 1.15 mm, AWL = 0.50, BBBL = 0.64, R = 3333. Oriental.] ..... **PHACOPTERON**
- Antenna with more than 3 divisions. On Meliaceae..... 4
- 4 Antenna with 5 divisions. Tibia each with a row of stout setae on outer edge (Fig. 54). Abdomen margin with lanceolate setae. [BL = 1.03 mm, WL = 0.37 mm, ARB = 0.29 mm, AWL = 0.62, BBBL = 0.66, R = 3355. Pacific. On *Aglaiia*.]..... **?CHINEURA**
- Antenna with 8 or 9 divisions. Tibia without stout setae. Abdomen margin without lanceolate setae. [Tarsal arolium often with a short petiole (Fig. 94). Circum-anal pore rings often with separated pores (Fig. 147). BL = 1.78–2.31 mm, WL = 0.61–0.71 mm, ARB = 0.17–0.21 mm, AWL = 0.50–0.64, BBBL = 0.60–0.75, R = 3578 or 4689. Afrotropical. On *Khaya*.] **PSEUDOPHACOPTERON**

**Key to genera of Homotomidae**

- 1 Abdomen margin with setae ..... 2
- Abdomen margin without setae ..... 3
- 2 Dorsal surface of abdomen with pointed setae. Apical margin of abdomen inwardly

- marginate (Fig. 153). General form elongate (BBBL = 0.65–0.81). [BL = 1.97–3.17 mm, WL = 0.75–1.13 mm, ARB = 0.61–0.76 mm, AWL = 1.05–1.48, A = 3, R = 3333. Neotropical. On *Ficus*.] ..... **SYNOZA**
- Dorsal surface of abdomen without pointed setae. Apical margin of abdomen evenly rounded. General form broad (BBBL = 0.83–1.04). [BL = 1.59–2.68 mm, WL = 0.81–1.45 mm, ARB = 0.34–0.46 mm, AWL = 0.48–0.69, A = 2–3, R = 2222 or 3333. Tropical and warm temperate Old World. On *Ficus*.] ..... **HOMOTOMA**
- 3 Inner margin of outer circum-anal pore ring convoluted and pore rings confined to the ventral surface of the abdomen (Figs 150, 151). Antenna with 2 divisions. [BL = 2.33–3.09 mm, WL = 1.13–1.40 mm, AWL = 0.43–0.53, BBBL = 0.87–1.10, R = 2222. Australasian, Austro-Oriental and Oriental. On *Ficus*.] ..... **MYCOPSYLLA**
- Inner margin of outer circum-anal pore ring usually not convoluted (Figs 148, 149); if convoluted then pore rings extending onto the dorsal surface of the abdomen (Fig. 152). Antenna with more than 2 divisions ..... 4
- 4 Circum-anal pore rings extending onto dorsal surface of abdomen (Fig. 152). Antenna with 3 divisions. [BL = 2.31–2.50 mm, WL = 1.20–1.40 mm, AWL = 0.46–0.53, BBBL = 1.61–1.25, R = 3333. Afrotropical. On *Ficus*.] ..... **PSEUDOERIOPSYLLA**
- Circum-anal pore rings confined to ventral surface of abdomen (Figs 148, 149). Antenna with 9 or 10 divisions. [BL = 1.84–2.84 mm, WL = 0.87–1.09 mm, ARB = 0.72–0.93 mm, AWL = 0.70–0.82, BBBL = 0.84–0.98, R = 4578 or 4689. Austro-Oriental and Oriental. On *Ficus*.] ..... **MACROHOMOTOMA**

**Key to subfamilies of Carsidaridae**

- 1 Anal pore-field comprised of numerous pore groups (Fig. 154). On *Cedrela* (Meliaceae). [BL = 1.87–2.71 mm, WL = 0.72–0.82 mm, AWL = 1.80–2.43, BBBL = 0.60–0.77, A = 9–10, R = 3578 or 4689. Neotropical.] ..... **MASTIGIMATINAE** (*Mastigimas*)
- Anal pore-field comprised of pore bands (Fig. 155). On Malvales. [BL = 1.46–3.06 mm, WL = 0.59–0.87 mm, AWL = 1.53–2.73, BBBL = 0.50–0.78, A = 10, R = 4689. Tropical.] ..... **CARSIDARINAE**

**Key to genera of Triozidae**

- 1 Apical margin of abdomen with ‘tooth-like’ processes (Fig. 157). [Head, thorax, abdomen and wing-pads without setae. BL = 2.80–3.02 mm, WL = 1.03–1.13 mm, ARB = 0.24–0.26 mm, AWL = 0.70–0.77, BBBL = 0.58–0.66, A = 6, R = 3355. Neotropical. On Euphorbiaceae, Myrtaceae and Solanaceae.] ..... **NEOLITHUS**
- Apical margin of abdomen without ‘tooth-like’ processes ..... 2
- 2 Anal pore-field comprised of circum-anal pore rings plus small groups of pores arranged as bands (Fig. 158). [Head, thorax, abdomen and wing-pads without setae. BL = 2.50–3.02 mm, WL = 1.15–1.16 mm, ARB = 0.08–0.09 mm, AWL = 1.40–1.46, BBBL = 0.91, A = 10, R = 4689. Afrotropical. On *Antiaria*.] ..... **TRIOZAMIA**
- Anal pore-field comprised of circum-anal pore rings only ..... 3
- 3 Head, abdomen and wing-pad margins with scales (Figs 173–177) ..... 4
- Head, abdomen and wing-pad margins without scales, usually with setae ..... 8
- 4 Marginal scales more than 3 times as long as broad (Fig. 173). [Forewing-pad with a well-developed humeral lobe. Marginal setae absent. BL = 1.46 mm, WL = 0.62 mm, AWL = 0.65, BBBL = 0.76, A = 7, R = 3467. Hawaiian. On *Pelea*.] ..... **HEVAHEVA**
- Marginal scales less than 2 times as long as broad ..... 5
- 5 Dorsal surface of body and wing-pads with clavate setae (similar to Fig. 172). [Forewing-pad with a well-developed humeral lobe. Marginal setae absent. BL = 2.06–2.31 mm, WL = 1.19–1.35 mm, ARB = 0.27–0.36 mm, AWL = 0.18–0.19, BBBL = 0.84–0.88, A = 2, R = 2222. Tropical New World. On *Sideroxylon*.] ..... **CEROPSYLLA** (*C. sideroxyli*)
- Dorsal surface of body and wing-pads without clavate setae ..... 6
- 6 Abdomen margin with setae near abdominal apex, scales only present on basal three-quarters of abdomen margin (Fig. 177). [Forewing-pad with a well-developed humeral lobe. BL = 3.78 mm, WL = 2.18 mm, ARB = 0.43 mm, AWL = 0.16, BBBL = 0.74, A = 2, R = 1222. Hawaiian. On *Pritchardia*.] ..... **TRIOZA** (*T. palmicola*)
- Abdomen margin without setae ..... 7

- 7 Marginal scales ridged (Fig. 176). [Forewing-pad with a well-developed humeral lobe. BL = 3.11 mm, WL = 1.30 mm, ARB = 0.26 mm, AWL = 0.15, BBBL = 0.65, A = 2, R = 2222. Hawaiian. On *Sideroxylon*.] ..... **SWEZEYANA**
- Marginal scales not ridged (Fig. 175). [Forewing-pad with a well-developed humeral lobe. BL = 1.70 mm, WL = 0.95 mm, ARB = 0.21 mm, AWL = 0.20, A = 3, R = 1133. Hawaiian. On *Pisonia*.] ..... **KUWAYAMA** (*K. pisonia*)
- 8 Forewing-pad margin with truncate sectasetae ..... 9
- Forewing-pad margin without truncate sectasetae ..... 12
- 9 General form elongate (BBBL = 0.37–0.46). [BL = 2.59–2.69 mm, WL = 1.00–1.11 mm, ARB = 0.15–0.16 mm, AWL = 0.18–0.24, A = 1, R = 1111. Australasian. On *Casuarina*.] ..... **AACANTHOCNEMA**
- General form broader (BBBL = 0.48–0.87) ..... 10
- 10 Antenna with 8 or 9 divisions. Outer circum-anal pore ring comprised of a multiple row of pores. [BL = 2.59–3.12 mm, WL = 1.26–1.48 mm, ARB = 0.33–0.36 mm, AWL = 0.37–0.40, BBBL = 0.52–0.56, R = 4688 or 4689. Afrotropical, Oriental and Palaearctic. On *Rhamnus*.] ..... **TRICHOCHERMES**
- Antenna with 3–7 divisions. Outer circum-anal pore ring comprised of a single row of pores ..... 11
- 11 On *Ficus*. Forewing-pad hind margin broadly rounded (Fig. 49). [BL = 1.41 mm, WL = 0.64–0.65 mm, ARB = 0.18–0.20 mm, AWL = 0.39–0.40, BBBL = 0.78, A = 4, R = 1244. Tropical Old World.] ..... **PAUROPSYLLA** (*P. trichaeta*)
- Not on *Ficus*. Forewing-pad hind margin usually rounded (Fig. 50). [BL = 1.15–2.95 mm, WL = 0.59–1.67 mm, ARB = 0.16–0.67 mm, AWL = 0.17–1.01, BBBL = 0.58–0.85, A = 3–7.] ..... **TRIOZA** (most species of *Trioza* plus *Paratrioza* and some *Ceropsylla* species)
- 12 Abdomen margin without sectasetae ..... [Several species which form enclosed galls and which cannot be separated by any tenable characters.]
- Abdomen margin with pointed sectasetae ..... 13
- 13 Tarsal arolium without a visible unguitactor (Fig. 95). [Abdomen margin usually with more than a single row of sectasetae. Usually forming enclosed galls. BL = 1.98–3.05 mm, WL = 1.10–1.54 mm, ARB = 0.21–0.43 mm, AWL = 0.21–0.60, BBBL = 0.51–0.79, A = 8 or 10, R = 3578 or 4689. Oriental and Palaearctic. On *Populus*, especially *P. euphratica*.] ..... **EGEIROTIOZA**
- Tarsal arolium with a clearly visible unguitactor ..... 14
- 14 Dorsal surface of abdomen with clavate setae (Fig. 172). [Humeral lobe of forewing-pad extending anterior to eye. BL = 2.77 mm, WL = 1.54 mm, AWL = 0.18, BBBL = 0.87, A = 3, R = 3333. Hawaiian. On *Tetraplasandra*.] ..... **CRAWFORDA**
- Dorsal surface of abdomen without clavate setae ..... 15
- 15 Hindwing-pad very reduced (Fig. 48). [BL = 1.44–1.66 mm, WL = 0.76–0.85 mm, ARB = 0.32–0.35 mm, AWL = 0.46–0.53, BBBL = 0.59–0.67, A = 6, R = 3466. Austro-Oriental and Pacific. On *Calophyllum*.] ..... **LEPTYNOPTERA**
- Hindwing-pad of normal proportions ..... 16
- 16 Dorsal surface of abdomen with pointed sectasetae (Fig. 159). [BL = 1.74–1.98 mm, WL = 0.89–0.97 mm, ARB = 0.34–0.37 mm, AWL = 0.40–0.44, BBBL = 0.62–0.65, A = 6, R = 3466. Palaearctic, introduced to New World. On *Laurus* and *Persea*.] ..... **TRIOZA** (*T. alacris*)
- Dorsal surface of abdomen without sectasetae ..... 17
- 17 Circum-anal pore rings convoluted (Fig. 156). [BL = 1.88 mm, WL = 0.73 mm, AWL = 0.51, BBBL = 0.48, A = 7, R = 3577. Tropical New World and Oriental. On *Celtis* and possibly Fabaceae and *Shorea*.] ..... **LEURONOTA**
- Circum-anal pore rings not convoluted (Fig. 160). [BL = 1.59 mm, WL = 0.77 mm, ARB = 0.29 mm, AWL = 0.44, BBBL = 0.56, A = 1, R = 1111. Neotropical. On *Psidium*.] ..... **TRIOZOIDA**

### Acknowledgements

This study formed the basis of a Ph.D. project by the senior author, supervised by I. D. Hodkinson, Liverpool Polytechnic, and D. Hollis, British Museum (Natural History). Special thanks go to the following colleagues at Liverpool Polytechnic: B. Duncan, M. Forster, J. Higgins, B. Midgeley, J. T. Rasmussen and A. J. K. Walley. I also thank all of the individuals and institutions who donated or lent specimens (listed in Table 1), and the following for reasons too numerous to mention: V. K. Brown and R. G. Davies (Imperial College, London), A. Brockbank (Liverpool School of Tropical Medicine), J. P. Brock (London), D. Burckhardt (Zurich), J. D. Holloway (Commonwealth Institute of Ento-

mology), W. J. LeQuesne (Chesham, Bucks) and A. J. Williams (Software Sciences, Macclesfield). The research was carried out while in receipt of a Liverpool City Council research assistantship to I. D. Hodkinson.

## References

- Arnold, E. N.** 1981. Estimating phylogenies at low levels. *Zeitschrift für zoologische Systematik und Evolutionsforschung* **19**: 1–35.
- Aulmann, G.** 1913. *Psyllidarum Catalogus*. 92 pp. Berlin.
- Ball, J. C. & Jensen, D. D.** 1966. Sexual dimorphism in nymphs of *Psylla pyricola* (Hemiptera: Psyllidae). *Annals of the Entomological Society of America* **59**: 1292–1294.
- Baum, B. R.** 1977. *Oats: wild and cultivated. A monograph of the genus Avena L. (Poaceae)*. Biosystematics Research Institute, Monograph 14, xv + 463 pp. Ottawa.
- Becker-Migdisova, E. E.** 1973. Systematics of the Psylloidea and the position of the group within the order Homoptera. In Narchuk, E. P. (Ed.), *Doklady na dvadzat chetvertom escheghodnom cheni pamyati N.A. Kholodovskogo 1971. Leningrad, 1973*: 90–117. [In Russian, English translation – British Library, Boston Spa.]
- Boratynski, K. L. & Davies, R. G.** 1971. The taxonomic value of male Coccoidea (Homoptera) with an evaluation of some numerical techniques. *Biological Journal of the Linnean Society* **3**: 57–102.
- Boselli, F. B.** 1929. Studi sugli Psyllidi (Homoptera: Psyllidae o Chermidae) I–II. *Bollettino del Laboratorio di zoologia generale e agraria della R. Scuola superiore d'agricoltura* **21**: 218–264.
- Burckhardt, D.** 1979. Phylogenetische Verhältnisse in der Gattung *Psylla* s.l. (Sternorrhyncha, Psylloidea) mit besonderer Berücksichtigung von *Psylla colorata* Löw. *Mitteilungen der Schweizerischen entomologischen Gesellschaft*. **52**: 109–115.
- Cain, A. J. & Harrison, G. A.** 1958. An analysis of the taxonomist's judgement of affinity. *Proceedings of the Zoological Society of London* **131**: 85–98.
- 1960. Phyletic weighting. *Proceedings of the Zoological Society of London* **135**: 1–31.
- Caldwell, J. S.** 1944a. Notes on Mexican and Central American Psyllidae. *Ohio Journal of Science* **44**: 57–64.
- 1944b. Psyllidae from tropical and semitropical America (Homoptera). *Journal of the New York Entomological Society* **52**: 335–340.
- Caldwell, J. S. & Martorell, L. F.** 1952. A brief review of the Psyllidae of Puerto Rico. *Annals of the Entomological Society of America* **44**: 603–613.
- Camin, J. H. & Sokal, R. R.** 1965. A method for deducing branching sequences in phylogeny. *Evolution* **19**: 311–326.
- Capener, A. L.** 1968. A new genus and species of Psyllidae (Homoptera) from South Africa. *Journal of the Entomological Society of Southern Africa* **31**: 361–364.
- 1970. Southern African Psyllidae (Homoptera) – 2: Some new species of *Diaphorina* Löw. *Journal of the Entomological Society of Southern Africa* **33**: 201–226.
- 1973. Southern African Psyllidae (Homoptera) – 3: A new genus and new species of South African Psyllidae. *Journal of the Entomological Society of Southern Africa* **36**: 37–61.
- Chapman, R. F.** 1971. *The insects, structure and function*, 2nd edn, xii + 819 pp. London.
- Cracraft, J.** 1975. Historical biogeography and earth history: perspectives for a future synthesis. *Annals of Missouri Botanical Garden* **62**: 227–250.
- Crawford, D. L.** 1911. American Psyllidae IV (a partial revision of the subfamilies). *Pomona College Journal of Entomology* **3**: 480–503.
- 1914. A monograph of the jumping plant-lice or Psyllidae of the New World. *Bulletin. United States National Museum* **85**: 1–182.
- 1920. The Psyllidae of Borneo. *Philippine Journal of Science* **17**: 353–361.
- 1925. Psyllidae of South America. *Brotéria (Serie Zoológica)* **22**: 56–74.
- Cronquist, A. J.** 1968. *The evolution and classification of flowering plants*. xi + 396 pp. London.
- Davies, R. G. & Boratynski, K. L.** 1979. Character selection in relation to the numerical taxonomy of some male Diaspididae (Homoptera: Coccoidea). *Biological Journal of the Linnean Society* **12**: 95–165.
- Dobreanu, E. & Manolache, C.** 1962. Homoptera Psylloidea. *Fauna Republicii populare române, Insecta* **8**: 1–376.
- Eastop, V. F.** 1958. Some neglected taxonomic characters of Psyllidae (Homoptera). *Entomologist's Monthly Magazine* **94**: 18–19.
- 1963. Proposed validation of *Psylla* Geoffroy, 1762, and suppression of *Chermes* Linnaeus, 1758, under the plenary powers (Insecta, Hemiptera). Z.N. (S.) 1515. *Bulletin of Zoological Nomenclature* **20**: 139–144.

- 1972. Deductions from the present day host plants of aphids and related insects. *Symposia of the Royal Entomological Society of London* 6: 157–178.
- 1978. Diversity of the Sternorrhyncha within major climatic zones. *Symposia of the Royal Entomological Society of London* 9: 71–88.
- Edwards, J.** 1896. *The Hemiptera – Homoptera of the British Islands*: 224–261. London.
- Enderlein, G.** 1910. In Sjöstedt, Y., *Wissenschaftliche Ergebnisse der Schwedischen Zool. Exped. nach dem Kilimandjaro, dem Meru und den umgebenden Massaisieppen Deutsches-Ostafrikas, 1905–1906*. 12 Hemiptera. 8 Psyllidae, pp. 137–144. Stockholm.
- Farris, J. S.** 1970. Methods for computing Wagner trees. *Systematic Zoology* 19: 83–92.
- 1974. Formal definitions of paraphyly and polyphyly. *Systematic Zoology* 23: 548–554.
- Ferris, G. F.** 1923. Observations on the Chermidae (Hemiptera: Homoptera) I. *Canadian Entomologist* 55: 250–256.
- 1924. The nymphs of two species of Chermidae (Hemiptera). *Pan-Pacific Entomologist* 1: 24–28.
- 1925. Observations on the Chermidae (Hemiptera: Homoptera) II. *Canadian Entomologist* 57: 46–50.
- 1926. Observations on the Chermidae (Hemiptera: Homoptera) III. *Canadian Entomologist* 58: 13–20.
- 1928a. Observations on the Chermidae (Hemiptera: Homoptera) IV. *Canadian Entomologist* 60: 109–117.
- 1928b. Observations on the Chermidae (Hemiptera: Homoptera) V. *Canadian Entomologist* 60: 240–245.
- Ferris, G. F. & Hyatt, P.** 1923. The life history of *Euphyllura arbuti* Schwartz (Hemiptera: Chermidae). *Canadian Entomologist* 55: 88–92.
- Förster, A.** 1848. Uebersicht der Gattungen und Arten in der Familie der Psylloden. *Verhandlungen des Naturhistorischen Vereins der Preussischen Rheinlande, Westfalens und des Regierungsbezirks Osnabrück* 5: 65–98.
- Frakes, L. A. & Kemp, E. M.** 1974. Palaeogene continental positions and evolution of climate. In Tarling, D. H. & Runcorn, S. K. (eds), *Implications of continental drift to the earth sciences*. 1: 539–558. London.
- Gomez, C. Ramirez** 1956a. Los psilidos de España. *Boletín de la Real Sociedad española de historia natural* 53: 151–217.
- 1956b. Los psilidos de España. *Boletín de la Real Sociedad española de historia natural* 54: 63–106.
- 1960. Los psilidos de España. *Boletín de la Real Sociedad española de historia natural* 57: 5–87.
- Good, R.** 1974. *The geography of the flowering plants*, 4th edn, xvi + 518 pp. London.
- Handlirsch, A.** 1903. Zur Phylogenie der Hexapoden. *Sitzungsberichte der Akademie der Wissenschaften in Wien* Abt. I. 112: 716–738.
- Hartigan, J. A.** 1975. *Clustering algorithms*. xiii + 351 pp. New York.
- Haupt, H.** 1935. Gleichflügler, Homoptera. *Tierwelt Mitteleuropas* 4: 221–252.
- Hennig, W.** 1966. *Phylogenetic systematics*. xiii + 263 pp. Urbana.
- Heslop-Harrison, G.** 1949. Subfamily separation in the homopterous Psyllidae I. *Annals and Magazine of Natural History* (12)2: 802–810.
- 1951. Subfamily separation in the homopterous Psyllidae II. *Annals and Magazine of Natural History* (12)4: 1–35.
- 1952a. The number and distribution of the spiracles of the adult psyllid. *Annals and Magazine of Natural History* (12)5: 248–260.
- 1952b. The genus *Rhinocola* Förster and associated genera of the Aphalarinae 1. *Annals and Magazine of Natural History* (12)5: 957–974.
- 1954. Contributions to our knowledge of the Psyllidae of Australia and New Zealand, with special reference to Tasmania II. *Annals and Magazine of Natural History* (12)7: 519–530.
- 1958. Subfamily separation in the homopterous Psyllidae III (a–c). *Annals and Magazine of Natural History* (13)1: 561–579.
- 1959. Subfamily separation in the homopterous Psyllidae III (d–e). *Annals and Magazine of Natural History* (13)2: 157–168.
- 1961. The Aryanini of the subfamily Psyllinae, Hemiptera-Homoptera, family Psyllidae-II. *Annals and Magazine of Natural History* (13)3: 417–439.
- Hodkinson, I. D.** 1973. The biology of *Strophingia ericae* (Curtis) (Homoptera-Psyloidea) with notes on its primary parasite *Tetrastichus actis* (Walker) (Hym., Eulophidae). *Norsk entomologisk Tidsskrift* 20: 237–243.
- 1974. The biology of the Psylloidea (Homoptera): a review. *Bulletin of Entomological Research* 64: 325–339.

- 1978. The psyllids (Homoptera-Psyloidea) of Alaska. *Systematic Entomology* **3**: 333–360.
- 1980. Present day distribution patterns of the holarctic Psylloidea (Homoptera-Insecta) with particular reference to the origin of the nearctic fauna. *Journal of Biogeography* **7**: 127–146.
- 1981. Heather-feeding psyllids of the genus *Strophingia* (Homoptera). *Systematic Entomology* **6**: 77–90.
- 1983. The psyllids (Homoptera: Psylloidea) of the Austro-Oriental, Pacific and Hawaiian zoogeographical realms: an annotated check list. *Journal of Natural History* **17**: 341–377.
- Hodkinson, I. D. & Hollis, D.** 1981. The psyllids (Homoptera-Psyloidea) of Mallorca. *Entomologica Scandinavica* **12**: 65–77.
- Hodkinson, I. D. & White, I. M.** 1979a. New psyllids from France with redescriptions of the type species of *Floria* Löw and *Amblyrhina* Löw (Homoptera-Psyloidea). *Entomologica Scandinavica* **10**: 55–63.
- 1979b. Psylloidea (Homoptera). *Handbooks for the Identification of British Insects* (II) **5a**: iv + 1–98.
- 1981. The Neotropical Psylloidea (Homoptera-Insecta): an annotated check list. *Journal of Natural History* **15**: 491–523.
- Hollis, D.** 1973. African gall bugs of the genus *Phytolyma* (Hemiptera, Psylloidea). *Bulletin of Entomological Research* **63**: 143–154.
- 1976. Jumping plant lice of the tribe Ciriacremini (Homoptera-Psyloidea) in the Ethiopian region. *Bulletin of the British Museum (Natural History)* (Entomology) **34**: 1–83.
- Imms, A. D.** 1957. *A general textbook of entomology* 9th edn revised by O. W. Richards and R. G. Davies. x + 886 pp. London.
- Jong, R. de** 1980. Some tools for evolutionary and phylogenetic studies. *Zeitschrift für zoologische Systematik und Evolutionsforschung* **18**: 1–23.
- Klimaszewski, S. M.** 1964. Studia nad układem systematycznym podrzedu Psylloidea. *Annales zoologici* **22**: 81–138. [In Polish, English translation – U.S. Dept. of Commerce, National Technical Information Service, Springfield, Virginia.]
- 1967. Stosunki pokrewienstwa srodkowoeuropejskich gatunkow z rodzaju *Trioza* Forst. (Homoptera, Psylloidea) w swietle badan metodami taksonomii numerycznej. *Annales Universitatis Mariae Curie-Skłodowska* (C) **22**: 1–20.
- 1969. Homoptera-Psyloidea. *Klucze do oznaczania owadów Polski* **17** (3): 1–89.
- 1973. The jumping plant-lice or psyllids (Homoptera-Psyloidea) of the Palaearctic: an annotated check list. *Annales Zoologici* **30**: 155–288.
- 1975. Psylloidea. *Koliszki* (Insecta: Homoptera). *Fauna Polski* **3**: 1–295.
- Klyver, F. D.** 1931. Notes on the Chermidae (Hemiptera: Homoptera). Part II. *Canadian Entomologist* **63**: 111–115.
- Lal, K. B.** 1937. On the immature stages of some Scottish and other Psyllidae. *Proceedings of the Royal Society of Edinburgh* **57**: 305–331.
- Le Quesne, W. J.** 1969. A method of selection of characters in numerical taxonomy. *Systematic Zoology* **18**: 201–205.
- Legendre, P. & Rogers, D. J.** 1972. Characters and clustering in taxonomy: A synthesis of two taximetric procedures. *Taxon* **21**: 567–606.
- Lima, A. M. de Costa** 1942. *Insetos do Brasil: Homopteros* **3**: 1–327. Rio de Janeiro.
- Lima, A. M. de Costa & Guitton, N.** 1962. Novo inseto gálicola, *Phacosemoides sicki*, g.n., sp. n. (Homoptera, Psyllidae, Ciriacreminae). *Memórias do Instituto Oswaldo Cruz* **60**: 219–224.
- Loginova, M. M.** 1964a. Suborder Psyllinea. In G. Ya. Bei. Bienko (ed.), *Keys to the insects of the European part of the U.S.S.R.* **1**: 437–482. Zool. Inst. Akad. Nauk SSR. [English translation: Israeli Programme for Scientific Translations, Jerusalem, 1967.]
- 1964b. New and little-known psyllids from Kazakhstan. Notes on the system of classification of the Psylloidea (Homoptera). *Trudy Zoologicheskogo instituta. Akademiya nauk SSSR* **34**: 52–112. [In Russian–English translation by Israeli programme for Scientific translation in *Collected Articles in Insect Taxonomy*, 114–177, U.S. Dept. of Agriculture and National Science Foundation, 1969.]
- 1972. Revision of the jumping plant lice of the tribe Pauropsyllini Crawf. (Homoptera, Psylloidea, Carsidaridae). *Éntomologicheskoe Obozrenie* **51**: 837–853. [In Russian–English translation: *Entomological Review*, Washington **51**: 497–505.]
- 1973. Taxonomy of the tribe Euphyllurini (Psylloidea, Homoptera). *Zoologicheskii Zhurnal* **52**: 858–869. [In Russian.]
- 1974a. Jumping plant lice of the tribe Stigmaphalarini Vondr. (Psylloidea, Aphalaridae) from arid regions of Palaearctic. *Éntomologicheskoe Obozrenie* **53**: 150–170. [In Russian–English translation: *Entomological Review*, Washington **53**: 106–121.]



- 1974b. Systematics of the family Liviidae (Homoptera: Psylloidea). *Zoologicheskii Zhurnal* **53**: 858–865. [In Russian.]
- 1975. Psyllids of the subfamily Diaphorinae (Psyllidae, Homoptera). *Zoologicheskii Zhurnal* **54**: 543–551. [In Russian.]
- 1976a. Classification of the subfamily Arytaininae Crawf. (Homoptera, Psyllidae). I. A review of the genera of the tribe Arytainini. *Éntomologicheskoe Obozrenie* **55**: 589–601. [In Russian–English translation: *Entomological Review*, Washington **55**: 61–67.]
- 1976b. Psyllids of the tribe Pachypsyllidini. *Zoologicheskii Zhurnal* **55**: 612–614.
- 1977. The classification of the subfamily Arytaininae Crawf. (Homoptera, Psyllidae). II. Review of the tribe Cyamophilini. *Éntomologicheskoe Obozrenie* **56**: 577–587. [In Russian–English translation: *Entomological Review*, Washington **56**: 64–71.]
- 1978. Classification of the genus *Psylla* Geoffr. (Homoptera, Psyllidae). *Éntomologicheskoe Obozrenie* **57**: 808–824. [In Russian–English translation: *Entomological Review*, Washington **57**: 555–566.]
- 1982. Structure and morpho-ecological types of the psyllid nymphs (Homoptera: Psylloidea). *Trudy Zoologicheskogo instituta. Akademiya nauk SSSR* **105** (1981): 20–52.
- Löw, F.** 1876. Zur Biologie und Charakteristik der Psylloden nebst Beschreibung zweier neuer Species der Gattung *Psylla*. *Verhandlungen der zoologisch-botanischen Gesellschaft in Wien* **26**: 187–216.
- 1879. Zur Systematik der Psylloden. *Verhandlungen der zoologisch-botanischen Gesellschaft in Wien* **28**: 585–610.
- 1884. Beiträge zur Kenntnis der Jungenstadien der Psylliden. *Verhandlungen der zoologisch-botanischen Gesellschaft in Wien* **34**: 143–152.
- 1886. Neue Beiträge zur Kenntniss der Psylliden. *Verhandlungen der zoologisch-botanischen Gesellschaft in Wien* **36**: 149–173.
- Mathur, R. N.** 1975. *Psyllidae of the Indian subcontinent*. xii + 429 pp. New Delhi.
- Matsuda, R.** 1976. *Morphology and evolution of the insect abdomen: with special reference to developmental patterns and their bearings upon systematics*. viii + 534 pp. Oxford.
- Mayr, E.** 1969. *Principles of systematic zoology*. x + 428 pp. New York.
- Mickevitch, M. F.** 1978. Taxonomic congruence. *Systematic Zoology* **27**: 143–158.
- Miyatake, Y.** 1963. A revision of the subfamily Psyllinae from Japan. I. (Hemiptera: Psyllidae). *Journal of the Faculty of Agriculture, Kyushu University* **12**: 323–357.
- 1964. A revision of the subfamily Psyllinae from Japan. II. (Hemiptera: Psyllidae). *Journal of the Faculty of Agriculture, Kyushu University* **13**: 1–37.
- 1970. Some taxonomical and biological notes on *Togepssylla matsumurana* Kuwayama, Jr. (Hemiptera: Psyllidae). *Bulletin of the Osaka Museum of Natural History* **23**: 1–10.
- 1971. Studies on the Philippine Psyllidae (Hemiptera: Homoptera). I. *Bulletin of the Osaka Museum of Natural History* **25**: 51–60.
- 1972. Studies on Philippine Psyllidae (Hemiptera: Homoptera). II. *Bulletin of the Osaka Museum of Natural History* **26**: 11–34.
- 1974. A new species of *Homotoma* from NE New Guinea (Homoptera: Psyllidae). *Bulletin of the Osaka Museum of Natural History* **28**: 17–21.
- Moore, K. M.** 1970. Observations on some Australian forest insects. 24. Results from a study of the genus *Glycaspis* (Homoptera: Psyllidae). *Australian Zoologist* **15**: 343–376.
- Nelson, G.** 1971. Paraphyly and polyphyly: redefinitions. *Systematic Zoology* **20**: 471–472.
- Ossiannilsson, F.** 1970. Contributions to the knowledge of Swedish psyllids (Hem., Psylloidea) 1–4. *Entomologica Scandinavica* **1**: 135–144.
- Petty, F. W.** 1924. South African Psyllids. *Entomology Memoirs. Department of Agriculture, Union of South Africa* **2**: 21–30.
- 1925. New South African psyllids. *South African Journal of Natural History* **5**: 125–142.
- 1933. New species of South African psyllids. *Entomology Memoirs. Department of Agriculture, Union of South Africa* **8**: 3–23.
- Pflugfelder, O.** 1941. Psyllina. In Bronns, H. G. (ed.), *Klassen und Ordnungen des Tierreichs*. Volume 5, part 3, book 8. 95 pp. Leipzig.
- Platnick, N. I.** 1978. Gaps and prediction in classification. *Systematic Zoology* **27**: 472–474.
- Platnick, N. I. & Nelson, G.** 1978. A method of analysis for historical biogeography. *Systematic Zoology* **27**: 1–16.
- Rahman, K. A.** 1932. Observations on the immature stages of some Indian Psyllidae (Homoptera: Rhynchota). *Indian Journal of Agricultural Science* **2**: 358–377.
- Raven, P. H. & Axelrod, D. I.** 1974. Angiosperm biogeography and past continental movements. *Annals of Missouri Botanical Garden* **61**: 539–673.



- Rohlf, F. J.** 1972. An empirical comparison of three ordination techniques in numerical taxonomy. *Systematic Zoology* **21**: 271–280.
- Rosen, D. E.** 1978. Vicariant patterns and historical explanation in biogeography. *Systematic Zoology* **27**: 159–188.
- Schaefer, H. A.** 1949. Beiträge zur Kenntnis der Psylliden der Schweiz. *Mitteilungen der Schweizerischen entomologischen Gesellschaft* **22**: 1–96.
- Schlee, D.** 1969. Sperma-Übertragung in ihrer Bedeutung für das phylogenetische System der Sternorrhyncha. Phylogenetische Studien an Hemiptera I. Psylliformes (Psyllina + Aleyrodina) als monophyletische Gruppe. *Zeitschrift für Morphologie und Ökologie der Tiere* **64**: 95–138.
- Schwarz, E. A.** 1898. Notes on the lerp-insects (Psyllidae) of Australia. *Proceedings of the Entomological Society of Washington* **4**: 66–75.
- Scott, J.** 1882. On certain genera and species of the group of Psyllidae in the collection of the British Museum. *Transactions of the Entomological Society of London* **1882**: 449–473.
- 1886a. Description of the nymph of *Psylla mali*, Schmidtberger. *Entomologist's Monthly Magazine* **22**: 281.
- 1886b. Description of the nymph of *Psyllopsis (Psylla, Foerster.) fraxinicola*. *Entomologist's Monthly Magazine* **22**: 281–282.
- 1886c. Note on *Trioxa remota*, Foerster, together with a description of the nymph. *Entomologist's Monthly Magazine* **22**: 282.
- Siegel, S.** 1956. *Nonparametric statistics for the behavioural sciences* xvii + 312 pp. New York.
- Sneath, P. H. A. & Sokal, R. R.** 1973. *Numerical taxonomy* xv + 573 pp. San Francisco.
- Szelegiewicz, H.** 1971. Autapomorphous wing characters in the recent subgroups of Sternorrhyncha (Hemiptera) and their significance in the interpretation of the Paleozoic members of the group. *Annales zoologici* **29**: 15–81. [In Polish, English translation – U.S. Dept. of Commerce, National Technical Information Service, Springfield, Virginia.]
- Takhtajan, A.** 1969. *Flowering plants – origin and dispersal*. x + 310 pp. Edinburgh.
- Thorne, R. F.** 1976. A phylogenetic classification of the Angiospermae. *Evolutionary Biology* **9**: 35–106.
- Tuthill, L. D.** 1943. The psyllids of America north of Mexico (Psyllidae: Homoptera) (subfamilies Psyllinae and Triozinae). *Iowa State College Journal of Science* **17**: 443–660.
- 1944. Contributions to the knowledge of the Psyllidae of Mexico. *Journal of the Kansas Entomological Society* **17**: 143–159.
- 1945. Contributions to the knowledge of the Psyllidae of Mexico. *Journal of the Kansas Entomological Society* **18**: 1–29.
- 1950. Contributions to the knowledge of the Psyllidae of Mexico. (Part II). *Journal of the Kansas Entomological Society* **23**: 52–63.
- 1952. On the Psyllidae of New Zealand (Homoptera). *Pacific Science* **6**: 83–125.
- 1959. Los Psyllidae del Perú Central (Insecta: Homoptera). *Revista peruana de entomologia agricola* **2**: 1–27.
- 1964a. Conocimientos adicionales sobre los Psyllidae (Homoptera) del Perú. *Revista peruana de entomologia agricola* **7**: 25–32.
- 1964b. Homoptera: Psyllidae. *Insects of Micronesia* **6**(6): 353–376.
- Tuthill, L. D. & Taylor, K. L.** 1955. Australian genera of the family Psyllidae (Hemiptera: Homoptera). *Australian Journal of Zoology* **3**: 227–257.
- Uichanco, L. B.** 1921. New records and species of Psyllidae from the Philippine Islands, with descriptions of some preadult stages and habits. *Philippine Journal of Science* **18**: 259–286.
- Vondracek, K.** 1957. Mery Psylloidea. *Fauna ČSR* **9**: 1–431.
- 1963. Jumping plant-lice (Psylloidea-Homoptera) of Central Africa. Part I (Congo). *Sbornik Entomologického oddělení Národního musea v Praze* **35**: 263–290.
- Watrous, L. E. & Wheeler, Q. D.** 1981. The outgroup comparison method of character analysis. *Systematic Zoology* **30**: 1–11.
- White, I. M.** 1980. *Nymphal taxonomy and systematics of the Psylloidea (Insecta: Homoptera)*. xiv + 340, 12, 8, 4, 20, 8, 1 pp. Unpublished C.N.A.A. Ph.D. thesis, Liverpool Polytechnic.
- White, I. M. & Hodkinson, I. D.** 1982. Psylloidea (Homoptera), nymphal stages, *Handbooks for the Identification of British Insects (II)* **5b**: 1–50.
- Yang, C-T.** 1984. Psyllidae of Taiwan. *Taiwan Museum Special Publication Series* no. 3: 1–305.
- Young, D. J. & Watson, L.** 1970. The classification of dicotyledons: a study of the upper levels of the hierarchy. *Australian Journal of Botany* **18**: 387–433.
- Zimmerman, E. C.** 1948. *Insects of Hawaii* **5**: 12–38. Honolulu.

## Index to host plants

- Acer 280, 282  
 Aceraceae 258  
 Aglaia 288  
 Aquifoliaceae 256  
 Anacardiaceae 256, 258, 274, 276,  
 278, 280, 288  
 Annonales 256, 261, 265, 266  
 Antiaria 277, 289  
 Arbutus 280, 283  
 Arctostaphylos 280, 283  
 Asteraceae 257, 281, 282
- Bauhinia 285  
 Betulaceae 257, 288  
 Boronia 283  
 Brassicaceae 256, 281  
 Buchanania 288  
 Burseraceae 256, 258, 276, 288  
 Buxaceae 258  
 Buxus 287
- Caesalpinoideae 286, 287  
 Calluna 280, 281  
 Calodendrum 280, 282  
 Calophyllum 276, 290  
 Caltha 282  
 Carex 176, 255, 279, 280, 281  
 Casuarina 290  
 Ceanothus 287  
 Cedrela 289  
 Celtis 277, 284, 290  
 Cercocarpus 285, 287  
 Chenopodiaceae 257, 281  
 Clorophora 279, 281  
 Colophospermum 277, 284  
 Commelinales 256, 266  
 Cyperaceae 256
- Dicotyledoneae 255, 280
- Erica 280, 281  
 Ericaceae 256, 257, 279, 280  
 Ericales 265  
 Erythrina 286  
 Eucalyptus 274, 277, 279, 283, 284  
 Euphorbiaceae 257, 278, 285, 287,  
 289
- Fabaceae 256, 257, 258, 261, 274,  
 276, 277, 279, 281, 283, 284, 285,  
 286, 290  
 Ficus 256, 274, 276, 277, 278, 279,  
 281, 289, 290  
 Fraxinus 280, 283  
 Fuchsia 283
- Genisteae 285, 287
- Ilex 256, 278, 281
- Juncaceae 256  
 Juncus 176, 255, 277, 278, 279, 281
- Khaya 288
- Lauraceae 256, 265, 266, 278, 279,  
 280, 281  
 Laurus 290  
 Lindera 280  
 Litsea 280  
 Loganiaceae 257
- Malvaceae 257, 260  
 Malvales 256, 257, 258, 260, 275,  
 276, 278, 279, 280, 283, 289  
 Mangifera 288  
 Mangifera indica 277  
 Melastomataceae 257, 276, 282  
 Meliaceae 256, 258, 274, 276, 277,  
 278, 288, 289  
 Mimosoideae 286  
 Monocotyledoneae 255  
 Moraceae 256, 257, 260, 274, 276,  
 278, 279, 281, 283, 285  
 Morus 286  
 Myricaria 256, 282  
 Myroxylon 286  
 Myrtaceae 257, 258, 274, 278, 279,  
 280, 283, 289
- Nectandra 256, 278, 281
- Olea 280, 283  
 Oleaceae 257  
 Onagraceae 257, 279, 280, 281, 282
- Pelea 289  
 Persea 290
- Phillyrea 280, 283  
 Pisonia 290  
 Pistacia 280, 282  
 Polygonaceae 256, 281  
 Polygonum 282  
 Populus 276, 279, 280, 283, 290  
 Populus euphratica 290  
 Pritchardia 289  
 Proteaceae 257, 285, 286  
 Psidium 290  
 Purshia 287, 288
- Ranunculaceae 256, 281  
 Rhamnaceae 257, 258, 277, 284,  
 286, 288  
 Rhamnus 290  
 Rhus 282  
 Rosaceae 258, 274, 288  
 Rosales 256, 257, 261, 274  
 Rumex 282  
 Ruta 280, 282  
 Rutaceae 256, 257, 258, 276, 279,  
 280, 288  
 Rutales 256, 257, 258, 260, 261, 265,  
 266, 274, 275, 276, 278, 279, 280
- Salicaceae 256, 257, 288  
 Salix 256  
 Santalaceae 274  
 Saxifragaceae 258  
 Schinus 282  
 Shorea 290  
 Sideroxylon 289, 290  
 Sisymbrium 282  
 Solanaceae 257, 258, 277, 278, 284,  
 285, 286, 289  
 Sterculiaceae 257, 282  
 Strychnos 283
- Tamaricaceae 256, 280, 282  
 Tamarix 256, 278, 281, 282  
 Terminalia 277, 278  
 Tetraplasandra 276, 290  
 Tiliaceae 282  
 Tipuana 286  
 Toona 277, 288  
 Ulmaceae 257  
 Ulmus 277  
 Urticales 279, 280

## Index

Invalid and misspelt names are in *italics*; keys (pp. 275–290), place in general classification (table 17, p. 270), and other principal references are in **bold**. Names listed in tables 1, 6, 11, 15, 17 and 18 are included.

- Aacanthocnema 167, 171, 209, 212,  
 213, 235, 267, **273**, 290  
 acaciae 162, 209, 213, 227, 234, 249,  
 268  
 acaciaebaileyanae 162, 209, 213,  
 234, 268
- Acaerus **270**  
 aceris 159, 211, 236, 268  
 Acizzia 162, 209, 211, 212, 213, 227,  
 228, 234, 235, 247, **249**, 251, 257,  
 268, **271**, 277, 285, 286  
 Acizziinae **271**, **274**, **285**
- Acizziini **271**  
 Aconopsylla 274  
 aculeata 163, 211  
 acutipennis 161, 210, 235  
 aethiopica 159  
 aggregata 165

- Agonoscena 159, 209, 211, 212, 213,  
234, 267, **270**, 280, 282
- alacris 166, 211, 212, 213, 236, 267,  
290
- alba 164, 210, 235
- albigena 164, 211, 236
- albifrons 167, 210, 235
- albitextura 165, 210, 234
- albiventris 166, 210, 235
- albomaculata 162, 211, 236
- Aleyrodoidea 238
- Alloeoneura 154, 251, **272**
- alni 154, 164, 168, 210, 235
- ambigua 164, 211, 236
- Amblyrhina 154, 251, **272**
- americana 164, 211, 236
- amorphae 163, 211, 235, 268
- Amorphicola 163, 211, 212, 213,  
235, 248, **250**, 251, 264, 268, **272**,  
286
- anceps 167, 211, 236, 269, 278
- angustipennis 160, 169, 210, 234
- annulata 164, 211, 213, 236
- Anomalopsylla 155, 274
- Anomalopsyllinae 156, 160, 241,  
242
- Anomalopsyllini 160
- Anomocephala **273**
- Anomoneura 162, 211, 212, 213,  
235, 248, 249, **250**, 257, 268, **271**,  
286
- Anomoneurinae **271**, **274**, **285**, 286
- Anomoneurini 162, **271**, 285
- antennata 165, 211, 236, 268
- Aphalara 154, 155, 156, 160, 168,  
170, 171, 210, 211, 212, 213, 234,  
235, 237, 238, 247, 248, 256, 258,  
261, 263, 267, **270**, 282
- Aphalaridae 155, 156, 157, 159, 169,  
171, 176, 179, **212**, 213, 216, 219,  
222, 226, **228**, 237, 238, 242, 246,  
247, 261, **264**, 265, **266**, 269, **270**,  
274, 276, 277, **278**, **279**
- Aphalarinae 154, 155, 160, 237, **266**,  
**270**, 279, 280, **281**
- Aphalarini 160, **243**, **270**, 281
- Aphalaroidea 154, 159, 179, 210,  
211, 212, 213, 228, 235, 237, **247**,  
268, 269, **271**, 277, 279, 281, 283
- Aphalaroidinae **269**, **271**, 279, 281,  
**283**
- Aphorma **270**
- Apsylla 160, 209, 212, 213, 235, 238,  
**264**, 265, 268, **272**, 277, 288
- Apsyllinae **272**
- Apsyllini 160, **241**
- arbolensis 166, 210, 236
- arbuti 159, 210, 236
- Arbutophila 159, 283
- arctostaphyli 159, 210, 235
- Aremica **272**
- Arepuna 164, 176, 211, 212, 213,  
235, **247**, 257, **264**, 268, **271**, 277,  
284
- Arepuniinae **271**, 274
- artemisiae 160, 169, 210, 234
- Arytaina 154, 162, 211, 212, 213,  
235, 248, 249, 251, 268, **272**, 287
- Arytainilla 163, 210, 211, 212, 213,  
235, 248, 249, 251, 268, **272**, 287
- Arytaininae 162, 247, 251, **272**, **274**,  
**285**, 287
- Arytainini 162, **251**
- Asphagidella 163, 213
- Astragilita 274
- atkasookensis 166, 210, 235
- Atmetocranium 274
- Auchmerina **271**
- Australopsylla **271**
- aylmeriae 166, 211, 236
- Bactericera 154, 155, 166, **273**
- Bactericerinae 156, 166
- Baeopelma 163
- baileyi 165, 210, 234
- bakeri 167, 211, 235
- beameri 167, 210, 235
- beesoni 161, 213, 224, 278
- bengalensis 247
- betulaenanae 164, 210, 235, 268
- Bharatiana 161, 210, 213, 235, 238,  
241, **264**, 265, 267, **272**, 277, 288
- Bharatianinae **272**
- bicolor 159, 211, 235
- Brachyopsylla 274
- Brachystetha **270**
- brevistigmata 164, 210, 235
- brunneipennis 164, 210, 235
- buxi 163, 210, 235
- Cacopsylla 163
- Caillardia **270**
- Caillardiiini **270**
- californica 160, 211, 235
- Calinda **273**
- calodendri 159, 179, 211, 236, 267
- Calophya 154, 155, 156, 160, 168,  
169, 171, 179, 209, 211, 212, 213,  
226, 234, 235, 238, **241**, 242, 260,  
264, 267, 269, **272**, 276, 278, 288
- Calophyidae **264**, 265, **272**, **274**,  
276, 278, **288**
- Calophyinae 160, 264, **272**
- calthae 168
- Camarotoscena 159, 211, 212, 213,  
235, 237, **246**, 257, 267, **270**, 276,  
280, 283
- cannela 266
- capeneri 162, 211
- capense 162, 210
- Caradocia **271**
- cardiae 162, 209, 234
- Cardiaspina 154, 165, 210, 212, 213,  
234, 235, 269, **271**, 284
- Cardiaspis 154
- carpinicola 164, 210, 235, 268
- Carsidara 154, 155, 156, 238, 258,  
265, **273**
- Carsidaridae 155, 156, 157, 160,  
168, 169, 171, 174, 176, 179, **212**,  
213, 216, 219, **224**, 226, 227, 237,  
238, 241, 243, 261, **264**, 265, **273**,  
**274**, 278, **289**
- Carsidarinae 154, 161, **240**, 265,  
**273**, 274, 275, 289
- Carsidarini **273**
- Carsidaroida 274
- casariae 163, 209, 235, 268
- casuarinae 167, 171, 209, 235, 267
- caudata 245
- cayeyensis 163, 211, 236
- ceanothi 163, 209
- Ceanothia 163, 209, 211, 212, 213,  
235, **251**, 268, **272**, 287
- ceardi 166
- Cecidopsylla 274
- Cecidotrioza 274
- cedrelae 161, 209, 235
- celtidismemma 165, 174
- celtidismamma 165
- celtidisvesiculum 165
- cercocarpis 165, 179, 210, 236, 247,  
268
- Ceriacreminae 154
- Ceriacremum 154
- Ceropsylla 167, 209, 211, 212, 213,  
228, 235, 267, 269, **273**, 289, 290
- Cerotrioza 274
- chelifera 163, 210, 287
- chenopodii 166, 211, 235
- Chermes 154
- Chineura 241, **272**, 276, 288
- chobauti 162, 209, 234
- cinerea 159, 209, 234
- cinnamomi 166, 211, 235
- Ciriacremitidae 155
- Ciriacreminae 154, 155, 162, **272**,  
**274**, **285**, 286
- Ciriacremini 156, 162, **272**
- Ciriacremum 154, 155, 156, 162,  
176, 210, 211, 212, 213, 228, 235,  
249, **250**, 268, **272**, 286, 287
- cistellata 160, 209, 235, 268
- citri 162, 168, 210, 234
- clutiae 162, 210, 234
- cockerelli 166, 210, 235
- Colophorina 163, 209, 212, 213,  
235, 268, **271**, 285
- coloradensis 162, 209, 235
- Colposcena 160, 209, 212, 213, 235,  
**267**, **270**, 282
- Colposceniini 160, **243**, **270**, 278,  
280, 281
- Cometopsylla **271**
- concolor 245
- confecta 165
- conserta 165
- constricta 160, 210, 236
- coryli 164, 210, 235, 287
- Craspedolepta 160, 169, 209, 210,  
211, 212, 213, 228, 234, 236, 256,  
267, **270**, 282
- Crastina 160, 211, 212, 213, 236,  
267, **270**, 282
- Crawforda 167, 211, 212, 213, 236,  
267, **273**, 276, 290
- crefeldensis 162, 211, 236, 267

- Creiis* 154, 165, 209, 212, 213, 234, 247, 269, **271**, 284  
*crithmi* 166, 210, 235  
*Ctenarytaina* 165, 179, 210, 213, 227, 236, 244, 245, 267, **271**, 280, 283  
*Ctenarytainini* **264**, **271**, 279  
*curta* 160, 210, 234  
*curvatinerivis* 166, 210, 235  
*Cyamophila* 264, **272**, 286  
*Cyamophilini* 251, **264**, **272**, 286  
*cyanoreios* 165  
*cytisi* 163, 210
- Delina* 250, **272**  
*densitexta* 165, 210, 235  
*depressa* 161, 168, 213, 224, 278  
*deserata* 165, 210, 236, 249, 268, 276  
*Diaphorina* 154, 155, 156, 162, 168, 170, 171, 176, 209, 210, 211, 212, 213, 216, 234, 236, **247**, 256, 257, 267, **271**, 276, 283  
*Diaphorini* 162, 179, 219, 226, 237 (see also *Diaphorinini*)  
*Diaphorininae* **264**, **269**, **271**, 279, 280, 281, **283**  
*Diaphorinini* **247**, **264**, **271**, 281 (see also *Diaphorini*: Becker-Migdisova)  
*Diceraopsylla* 274  
*Diclidophlebia* 161, 179, 211, 212, 213, 236, 237, **243**, 244, 264, 267, **270**, 282  
*Diclidophlebiini* 161, **243**, **270**, 280  
*diospyri* 166, 174, 211, 235  
*Diraphia* 281  
*divergipennis* 165, 176, 211, 236, 268  
*dubia* 160, 209, 235  
*dugesii* 161  
*Dynopsylla* 274  
*Dynopsyllini* 162
- eastopi* 161, 179, 211, 236, 267  
*Egeirotrioza* 166, 170, 211, 212, 213, 228, 236, 237, 267, **273**, 276, 290  
*elongagena* 167, 210, 236, 269  
*Engyatoneura* 274  
*Epheloscyta* **270**  
*Epicara* 154, 161, 179, 211, 213, 219, 236, 238, 241, 256, 265, 267, **272**, 276, 288  
*Epipsylla* 164, 209, 211, 212, 213, 236, 248, 249, **250**, 268, **271**, 286  
*Epitrioza* **273**  
*Eremopsylloides* **270**  
*ericae* 159, 210, 235  
*Eriopsylla* 274  
*erythrinae* 165, 210, 235  
*erytrae* 167, 212, 235  
*eucalypti* 165, 179, 210, 236, 244, 267  
*Eucalyptolyma* 165, 176, 179, 211, 212, 213, 227, 236, 244, 245, 267, **271**, 283  
*Eucersopsylla* 163, 176, 210, 211, 212, 213, 234, 236, **250**, 251, 268, **272**, 286  
*Eudiaphorina* **271**  
*Euglyptoneura* 163, 179, 210, 211, 212, 213, 227, 236, 247, **251**, 268, **272**, 287  
*Eumetoecus* **270**  
*Euphalerinae* **271**  
*Euphalerini* 163, 264  
*Euphalerus* 154, 163, 170, 174, 176, 209, 210, 211, 212, 213, **224**, 228, 234, 236, **247**, 248, 250, 257, 258, 260, 264, 268, 269, **271**, 272, 277, 284, 285, 286  
*euphratica* 166  
*Euphyllura* 154, 159, 211, 212, 213, 236, 245, 257, 267, **270**, 283  
*Euphyllurinae* **269**, **270**, 279, 280, **282**  
*Euphyllurini* 159, 237, **244**, **270**, 280  
*Eurhinocola* **271**  
*Eurotica* **270**  
*Eutrioza* **273**  
*Eutrizini* 166  
*exilis* 160, 211, 235
- fabulosa* 162, 210, 236, 267  
*falcata* 167, 212, 236  
*fici* 162, 179, 210  
*ficus* 162, 179, 213, 258, 260  
*flava* 164  
*flavida* 160, 209, 234  
*floccosa* (*Pseudophaecopteron*) 161, 179, 213, 241, 267  
*floccosa* (*Psylla*) 164, 210, 235, 268  
*floccosa* (*Synzoa*) 162, 213  
*florea* 162, 210, 234  
*Floria* 154, 163, 211, 212, 213, 236, 248, 249, **251**, 268, **272**, 287  
*foersteri* 163, 211, 236  
*fonscolombii* 164, 210, 235, 268  
*forcipata* 250  
*fraxini* 163, 210  
*fraxinicola* 163, 210, 235  
*fremontiae* 160, 174, 179, 211, 236, 243, 267  
*Freysuila Aleman* 165, 211, 212, 213, 236, **249**, 257, 268, **271**, 285, 286  
*Freysuila* sensu Schwarz 154  
*frontalis* 166, 211, 235  
*furcata* 160, 210, 234  
*fusca* 160  
*fuscinodulus* 250  
*fuscipennis* (*Eucalyptolyma*) 245  
*fuscipennis* (*Euglyptoneura*) 163, 211
- galeaformis* 164, 210, 235, 268  
*gallicolus* 163, 174, 176, 211, 212, 213, 224, 236, 247, 257, 269, 277, 284  
*gardenensis* 162, 210  
*Geijerolyma* **271**  
*genistae* 162, 211, 235, 268  
*gigantea* 161, 168, 210, 235  
*glabruscuta* 163, 176, 210, 236, 268  
*gladiatum* 162, 176, 210  
*Glycaspis* 156, 165, 210, 212, 213, 227, 234, 269, **271**, 284  
*gossypii* 159, 210, 235  
*gressitti* 241  
*Gyropsylla* 160, 210, 212, 213, 234, 256, 260, 266, 269, **270**, 278, 281  
*Gyropsyllini* **270**
- hakani* 163, 210  
*hakeae* 163, 211, 213, 235, 257, 268  
*hamata* 164, 210, 235  
*Haplaphalara* **270**  
*harteni* 162, 211, 286  
*Hemischizocranium* **273**  
*Hemitrioza* **273**  
*Hepatopsylla* 164, 287  
*Heteropsylla* 154, 165, 179, 211, 212, 213, 236, 249, **250**, 268, **272**, 276, 286  
*Heterotrioza* 166  
*Hevaheva* 167, 211, 212, 213, 236, 269, **273**, 289  
*hibisci* 161, 176, 210, 235  
*hirsuta* (*Psylla*) 164, 210, 235, 287  
*hirsuta* (*Trioza*) 166, 212, 213, 236, 237, 269, 277, 278  
*Holotrioza* 242, **272**  
*Homoptera* 154  
*Homotoma* 154, 156, 162, 170, 179, 211, 213, 236, 238, 241, 258, 260, 264, 267, **272**, 289  
*Homotomidae* **264**, 265, **272**, **274**, 276, 278, **288**  
*Homotominae* 162, 226, **241**, 264, **272**  
*Homotomini* 162  
*hyalina* 250  
*Hyalinaspis* **271**
- ilicis* 160, 210, 234  
*imponens* 165  
*incidata* 166, 211, 235  
*incisa* 165  
*indica* 162, 213  
*inermis* 159, 211, 212, 277, 281  
*ingae* 250  
*Insnesia* 163, 176, 210, 212, 213, 236, 251, 257, 268, **272**, 287  
*Isogonoceraia* 165, 176, 211, 212, 213, 236, 251, 268, **272**, 286  
*Izpania* **273**
- japonica* 165, 247, 284  
*Jenseniella* 274  
*jugovenosus* 163, 210, 213, 224, 234, 257, 284  
*julbernardioides* 162, 211, 286  
*juncorum* 162, 211, 236
- Katecephala* **271**  
*Kleiniella* 155, 250, **272**  
*Kuwayama* 167, 211, 212, 213, 236, 269, **273**, 290

- Labicria* 274  
*lamborni* 166, 212, 236, 269  
*Lanthanaphalara* 274  
*Lasiopsylla* 271  
*lata* 160, 269  
*lavaterae* 166, 210, 236  
*lentiginosus* 161, 211, 236, 267  
*Leptotrioza* 274  
*Leptoptera* 161, 174, 211, 213, 236, 238, 265, 267, 273, 276, 290  
*Leptopterinae* 161, 238  
*Leurolophus* 159, 211, 212, 213, 236, 267, 270, 280, 282  
*Leuronota* 166, 211, 212, 213, 236, 267, 273, 290  
*Levidea* 274  
*Ligustrinia* 271  
*linavuorii* 160, 211, 236, 267  
*Lindbergiella* 274  
*Lisronia* 270  
*litseae* 166, 211, 235  
*Livia* 154, 156, 162, 176, 209, 211, 213, 235, 236, 238, 242, 255, 256, 261, 264, 267, 269, 270, 277, 278, 281  
*Liviidae* 155, 157, 158, 162, 212, 213, 226, 261, 264  
*Liviinae* 154, 155, 264, 266, 270, 279, 280, 281  
*Livilla* 251, 272  
*Livillinae* 154  
*lobata* 166, 212, 236  
*longicornis* 165, 211, 236, 268  
*longispiculata* 242  
  
*Macrocorsa* 271  
*Macrocorsini* 271  
*Macrohomotoma* 162, 176, 210, 211, 213, 236, 264, 269, 272, 277, 278, 289  
*Macrohomotominae* 272, 276  
*Macrohomotomini* 272  
*maculata* 242  
*maculipennis* (*Livia*) 162, 209, 235  
*maculipennis* (*Paratrioza*) 166, 210, 235  
*magna* 164, 211, 236, 285  
*magnicauda* 164, 210, 235  
*magnoliae* 166, 212, 236  
*maideni* 245  
*malayensis* 161, 209, 235  
*mali* 163, 210, 213, 235, 268  
*marginepunctata* 166, 211, 235  
*martorelli* 167, 209, 267  
*Mastigimas* 154, 161, 209, 210, 213, 235, 238, 256, 265, 269, 273, 274, 289  
*Mastigimatinae* 273, 289  
*Mastigimatini* 161  
*matsumurana* 157, 161, 174, 179, 211, 236, 267, 275  
*media* 164, 210, 236  
*Megadicrania* 274  
*Megatrioza* 166  
*melanoneura* 164, 210, 235  
*menoni* 244  
  
*Mesohomotoma* 161, 176, 209, 210, 213, 235, 269, 273  
*Mesohomotomini* 161  
*Metapsylla* 274  
*Metatrioza* 273  
*michoacana* 166, 211, 236, 267  
*Microceropsylla* 161, 169, 211, 212, 213, 236, 240, 241, 264, 269, 272, 278, 288  
*Microceropsyllini* 161, 241  
*minor* 164, 210, 235  
*minuta* (*Craspedolepta*) 160, 209, 234  
*minuta* (*Phytolyma*) 160, 279  
*minuta* (*Psylla*) 164, 210, 235, 287  
*minuta* (*Trioza*) 166, 210, 235  
*minuticona* 163, 210, 234  
*minutissima* 160, 209, 234  
*Mitropsylla* 165, 210, 212, 213, 236, 248, 249, 268, 271, 276, 285, 286  
*monticola* 160, 211, 235  
*Moraniella* 159, 179, 211, 212, 213, 236, 243, 267, 270, 280, 282  
*mori* 162, 211, 235, 250, 268  
*moscovita* 164, 210, 235  
*Mycopsylla* 154, 162, 179, 210, 213, 235, 260, 265, 269, 272, 278, 289  
*Mycopsyllini* 272  
*Myrmecephala* 273  
*myrtilli* 164, 210, 235  
  
*nebulosa* 160, 211, 236  
*negundinis* 164, 211, 236  
*Neocalophya* 242  
*Neolithinae* 273  
*Neolithus* 166, 211, 212, 213, 236, 269, 273, 278, 289  
*Neophyllura* 159, 210, 211, 212, 213, 235, 236, 267, 271, 283  
*Neopsyllia* 165, 176, 210, 212, 213, 235, 249, 268, 271, 285, 286  
*Neotrioza* 273  
*Neotriozezza* 273  
*nervosa* 160, 210, 234  
*Nesiope* 274  
*nidifex* 163, 211, 212, 213, 224, 234, 247, 284, 286  
*nigricornis* 166, 212, 236  
*nigripennis* 160, 209, 234  
*nigripes* 249  
*nigrita* 164, 210, 235  
*nubifera* 160, 210, 234  
*nyasae* 162, 211, 236, 267  
  
*oblonga* 250  
*obsoleta* 166, 212, 236  
*obtusa* 166, 212, 236  
*octospinosa* 161, 210, 235, 267  
*olivina* 159  
*Optomopsylla* 274  
*orientalis* 165  
*Osmopsylla* 164  
*Ozotrioza* 273  
  
*Pachyparia* 271  
*Pachyopsylla* 154, 165, 170, 174, 210, 212, 213, 235, 247, 261, 269, 271, 284  
*Pachyopsyllinae* 165, 247, 271, 277  
*Pachyopsylloides* 270  
*Pachyopsylloidini* 270  
*Palmapenna* 250, 272  
*palmeri* 164, 211, 236  
*palmicola* 166, 210, 236, 255, 269, 289  
*panacis* 167, 212, 235  
*Panisopelma* 250, 272  
*Paracalophya* 242, 272  
*Paracarsidara* 161, 168, 210, 213, 235, 238, 256, 260, 269, 273  
*Paracomeca* 273  
*Paracomecini* 166  
*parallela* 164, 210, 235  
*Paraphalaroida* 160, 174, 179, 211, 212, 213, 226, 236, 237, 243, 267, 270, 282  
*Paratrioza* 166, 210, 212, 213, 228, 235, 236, 267, 273, 290  
*paucivena* 241  
*Paurocephala* 155, 159, 170, 174, 179, 210, 212, 213, 219, 235, 237, 238, 243, 244, 246, 250, 257, 258, 260, 262, 267, 270, 276, 280, 283  
*Paurocephalinae* 159, 246, 266, 269, 270, 279, 280, 283  
*Paurocephalini* 159, 246  
*Pauropsylla* 154, 155, 161, 168, 211, 213, 219, 224, 228, 236, 238, 242, 246, 262, 264, 265, 267, 269, 273, 278, 290  
*Pauropsyllinae* 161, 241, 246, 250  
*Pauropsyllini* 161, 238, 241, 242, 273  
*Paurotrioza* 274  
*Pelmatobranchia* 161, 174, 211, 213, 236, 241, 264, 269, 272, 278, 288  
*Pennavena* 162, 210, 212, 213, 236, 247, 257, 267, 271, 283  
*peregrina* 163, 211, 236  
*pescicaria* 160, 211, 235, 237  
*Pexopsylla* 165, 179, 210, 212, 213, 236, 247, 268, 274  
*Phacopterinae* 161, 226, 241 (see also *Phacopterioninae*)  
*Phacopterini* 161  
*Phacopteron* 154, 161, 211, 213, 236, 238, 260, 265, 267, 272, 276, 288  
*Phacopterionidae* 264, 265, 272, 274, 276, 277, 278, 288  
*Phacopterioninae* 264, 272 (see also *Phacopterinae*: Becker-Migdisova)  
*Phacopterionini* (see *Phacopterini*: Becker-Migdisova)  
*Phacosemoides* 241, 272  
*Phellopsylla* 165, 179, 211, 212, 213, 227, 236, 247, 257, 267, 271, 277, 284  
*phillyreae* 159, 212  
*phoradendrae* (*Psylla*) 164, 209, 213, 236, 268  
*phoradendrae* (*Trioza*) 167, 210, 236



- 238**, 261, 262, **265**, **273**, **274**, 275,  
276, 277, 278, **289**  
Triozinae 154, 155, 166, **273**  
Triozini 166, 265, **273**  
Triozoida 167, 212, 213, 236, 267,  
**273**, 290  
triozomima 160, 209, 235  
tripunctata 166, 211, 235  
tuxtlaensis 244  
Tyora 154, 274  
  
ulmi 163, 179, 211, 235, 277  
  
uncatoides 163, 211, 213, 235, 268  
unicolor 159, 212, 213, 267  
urenae 159, 210, 235  
urticae 166, 168, 212, 236  
  
vancouverensis 160, 210, 234  
variegata 163, 211, 236, 268  
veaziei 160, 210, 234  
venusta 165, 210, 235, 284  
vermiculosus 163, 210, 213, 224,  
234, 284  
vernalis 162, 211, 236, 267  
  
verrucosa 242  
verucifica 166  
visci 164, 210, 235  
vitiensis 166, 211, 235  
vitreoradiata 167, 212, 236  
vittatus 159, 211, 236, 267  
  
walkeri 166, 210, 236, 267  
  
**Xanioptera 270**  
**Xenaphalara 270**  
**Xenaphalarini 270**









## **British Museum (Natural History)**

# **Milkweed butterflies: their cladistics and biology**

**P. R. Ackery & R. I. Vane-Wright**

The Danainae, a subfamily of the Nymphalidae, contains only some 150 species, yet aspects of their biology have stimulated far more attention than can be justified by species numbers alone. In recent years, an expansive literature has grown, considering aspects of their courtship and pre-courtship behaviour, migration, larval hostplant associations, mimicry and genetics. The popularity of danaines among biologists can certainly be attributed to this combination, within one small group, of so many of the factors that make butterflies such an interesting group to study. The obvious need to place this wealth of biological data within an acceptable systematic framework provided the impetus for this volume.

Started eight years ago within the conventions of evolution by natural selection and Hennig's phylogenetic systematics, the book is now largely about natural history (what the animals have and do, where they live and how they develop) and natural groups – as revealed by a form of analysis approaching that practised by the new school of 'transformed cladistics'. The authors have prepared a handbook that will appeal to a wide range of biologists, from museum taxonomists to field ecologists.

**425 pp, 12 pp colour, 73 b/w plates, line and graphic illustrations, maps, extensive bibliography.  
ISBN 0 565 00893 5. 1984. Price £50.**

## **Titles to be published in Volume 50**

**Taxonomy of Neotropical Derbidae in the new tribe Mysidiini (Homoptera)**

By Peter S. Broomfield

**Nymphal taxonomy and systematics of the Psylloidea (Homoptera).**

By I. M. White & I. D. Hodkinson

**The whitefly of New Guinea (Homoptera: Aleyrodidae)**

By J. H. Martin

# Bulletin of the British Museum (Natural History)

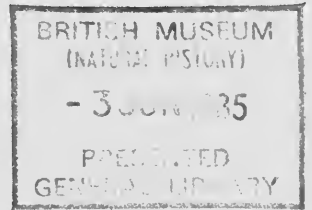

## The whitefly of New Guinea (Homoptera: Aleyrodidae)

J. H. Martin

Entomology series  
Vol 50 No 3

30 May 1985

The *Bulletin of the British Museum (Natural History)*, instituted in 1949, is issued in four scientific series, Botany, Entomology, Geology (incorporating Mineralogy) and Zoology, and an Historical series.

Papers in the *Bulletin* are primarily the results of research carried out on the unique and ever-growing collections of the Museum, both by the scientific staff of the Museum and by specialists from elsewhere who make use of the Museum's resources. Many of the papers are works of reference that will remain indispensable for years to come.

Parts are published at irregular intervals as they become ready, each is complete in itself, available separately, and individually priced. Volumes contain about 300 pages and several volumes may appear within a calendar year. Subscriptions may be placed for one or more of the series on either an Annual or Per Volume basis. Prices vary according to the contents of the individual parts. Orders and enquiries should be sent to:

Publications Sales,  
British Museum (Natural History),  
Cromwell Road,  
London SW7 5BD,  
England.

*World List* abbreviation: *Bull. Br. Mus. nat. Hist. (Ent.)*

© Trustees of the British Museum (Natural History), 1985

The Entomology series is produced under the general editorship of the  
Keeper of Entomology: Laurence A. Mound  
Assistant Editor: W. Gerald Tremewan



ISBN 0 565 06010 4  
ISSN 0524-6431

British Museum (Natural History)  
Cromwell Road  
London SW7 5BD

Entomology series  
Vol 50 No 3 pp 303-351

Issued 30 May 1985

# The whitefly of New Guinea (Homoptera: Aleyrodidae)

J. H. Martin

Department of Entomology, British Museum (Natural History), Cromwell Road, London SW7 5BD

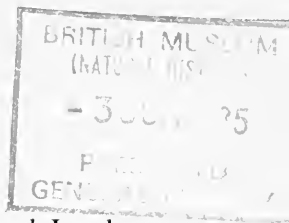

## Contents

Synopsis.....	303
Introduction .....	303
Depositories .....	304
Acknowledgements .....	304
Checklist of New Guinea Aleyrodidae, their hosts in New Guinea, and their depositories .....	304
Key to whitefly subfamilies and genera of New Guinea .....	309
Aleurodicinae .....	311
Aleyrodinae.....	313
References .....	337
Index.....	351

## Synopsis

The whitefly fauna of New Guinea, including Irian Jaya (Indonesian New Guinea) and the smaller island provinces of Papua New Guinea, is reviewed. Fourteen species are described as new, six are newly synonymized, and five new combinations are established. The checklist of whitefly from New Guinea includes host data and depositories and those whitefly not determined to species. Keys to the subfamilies and genera occurring in New Guinea are provided, to the named species of *Aleurocanthus* from New Guinea, and to the described species of *Parabemisia*, *Xenaleyrodes* and tropical Asian *Aleurodicus*.

## Introduction

In their systematic review of the whitefly of the world, Mound & Halsey (1978) listed 1156 described species; only five were recorded from New Guinea, based upon material in the British Museum (Natural History). Four of these species, *Aleurodicus destructor*, *Bemisia tabaci*, *Neomaskellia bergii* and *Trialeurodes vaporariorum*, are widely distributed and well-known pests which had been submitted for identification by agricultural organisations. Previously published records of three species from Papua New Guinea and Irian Jaya (Dumbleton, 1954) were not included in Mound & Halsey's review. In an account of crop pests of Irian Jaya (West Irian), Thomas (1962) lists nine species of whitefly, but careful scrutiny of the introduction to the work indicates that only one (an undetermined *Aleurocanthus*) had actually been recorded from there; the remaining species were from elsewhere in Indonesia, and from 'Territory of Papua and New Guinea' (Dumbleton, 1954). Dumbleton (1961a; 1961b) specifically stated that the whitefly fauna of New Guinea was practically unknown, and no publication has appeared since to change the situation.

In 1979 the author joined the expedition 'Operation Drake' at its scientific base camp at Buso (7° 25'S, 147° 15'E) on the Morobe Province coast of Papua New Guinea, some 80 km south-east of Lae. In the vicinity of Buso, whitefly specimens were collected from angiosperm hosts representing over 60 genera in 35 families, as well as from a number of unidentified hosts; the 780 slide-mounted specimens almost certainly comprise the first significant collection of the group to have been made in New Guinea, over 80 whitefly species being represented as a result of three months collecting in the area. This figure may be compared with 30 records of described species from Australia, 31 from New Caledonia and 11 from New Zealand, the whitefly faunas of these

areas being relatively well studied (Mound & Halsey, 1978). The Buso collection forms the basis of this paper, which also includes other New Guinea records.

The taxonomy of whitefly is based upon the exuviae of the final (fourth) instar larvae, usually referred to as the 'pupal cases'. Mound (1963) has demonstrated by host-transfer experiments with *Bemisia tabaci* (Gennadius) that some whitefly species are polyphagous and morphologically variable. As in *B. tabaci*, this has undoubtedly led to different names being applied to variants within many species, and consequently only 14 of the more distinctive species are described here as new, bringing the total of named species to 37, although over 90 are known to occur. The checklist includes partially identified material examined from New Guinea, their host data and depositories; of the 54 undetermined species, it is probable that the majority are undescribed.

The descriptions which follow use the standard whitefly terminology, which is here illustrated with a schematic diagram (Fig. 48), and is similarly visually explained by Cohic (1966), David & Subramaniam (1976) and Bink-Moenen (1983); Russell (1943) also clarifies a number of terms used in whitefly descriptions.

### Depositories

BMNH	British Museum (Natural History), London
BPBM	Bernice P. Bishop Museum, Honolulu
CSIRO	Central Scientific & Industrial Research Organisation, Canberra
DPIQ	Department of Primary Industry, Indooroopilly, Queensland
DSIR	Department of Scientific & Industrial Research, Auckland
HDA	Department of Agriculture, Honolulu
TARI	Taiwan Agricultural Research Institute, Taipei
UMO	University Museum, Oxford
USNM	United States National Museum of Natural History, Washington DC

### Acknowledgments

The author is particularly indebted to the organisers of 'Operation Drake', and to all those involved with the Buso scientific camp, without whose support the collection of most of the material referred to in this paper would not have been possible. Thanks, too, are due to Ted Henty and his staff at the Lae Herbarium (Papua New Guinea Department of Primary Industry), and to those botanists who worked at Buso, for their help in establishing the identities of many of the host plants. The help of CSIRO, Canberra, the Bernice P. Bishop Museum, Honolulu and DSIR, Auckland (who all loaned material for study) is also acknowledged with thanks.

### Checklist of New Guinea Aleyrodidae, their hosts in New Guinea, and their depositories

\* denotes discussion of undetermined species in main text

ALEYRODIDAE	HOST FAMILY	HOST GENUS/SPECIES	DEPOSITORY
<b>ALEURODICINAE</b>			
<i>ALEURODICUS</i> Douglas, 1892			
<i>destructor</i> Mackie, 1912	Lauraceae	<i>Cinnamomum</i>	BMNH
	Moraceae	<i>Ficus microcarpa</i> var. <i>naumannii</i>	BMNH
	Palmae	<i>Cocos nucifera</i>	BMNH
	?Xanthophyllaceae	? <i>Xanthophyllum</i>	BMNH
<i>holmesii</i> (Maskell, 1895)	Sapindaceae	<i>Guioa</i>	BMNH
<b>ALEYRODINAE</b>			
<b>ALEUROCANTHUS</b>			
Quaintance & Baker, 1914			
<i>cocois</i> Corbett, 1927	Sterculiaceae	indet.	BMNH
<i>esakii</i> Takahashi, 1936	Sapindaceae	<i>Pometia pinnata</i>	BMNH



\* denotes discussion of undetermined species in main text

ALEYRODIDAE	HOST FAMILY	HOST GENUS/SPECIES	DEPOSITORY
<i>luteus</i> sp. n.	Euphorbiaceae	<i>Macaranga</i>	BMNH
<i>papuanus</i> sp. n.	Xanthophyllaceae	<i>Xanthophyllum</i> <i>papuanum</i>	BMNH;USNM
<i>pendleburyi</i> Corbett, 1935a	Sapindaceae Lauraceae Piperaceae indet.	<i>Guioa</i> <i>Persea americana</i> <i>Piper</i>	BMNH BMNH BMNH BMNH;BPBM
<i>spiniferus</i> (Quaintance, 1903)	Apocynaceae	<i>Plumeria rubra</i> c.v.	BMNH
<i>woglumi</i> Ashby, 1915	Malvaceae	<i>Hibiscus</i>	BMNH
sp. 1*	Rutaceae	<i>Citrus</i>	BMNH;BPBM
sp. 2*	Celastraceae	<i>Lophopetalum</i>	BMNH
sp. 3*	Myristicaceae	<i>Myristica</i>	BMNH
sp. 4	Sapotaceae	<i>Planchonella</i>	BMNH
sp. 5*	Myrtaceae	<i>Syzygium</i>	BMNH
sp. 6*	indet.		BMNH
sp. 7	Lauraceae	<i>Cinnamomum</i>	BMNH
<b>ALEUROCYBOTUS</b>	Myrsinaceae	indet.	BMNH;BPBM
Quaintance & Baker, 1917			
<i>setiferus</i> Quaintance & Baker, 1917	Gramineae	<i>Imperata cylindrica</i>	BMNH
<b>ALEUROLOBUS</b>			
Quaintance & Baker, 1914			
<i>niloticus</i> Priesner & Hosny, 1934	Verbenaceae	<i>Gmelina</i>	BMNH
<i>selangorensis</i> Corbett, 1935a	Apocynaceae Erythroxylaceae Leguminosae Naucleaceae Rhizophoraceae	<i>Cerbera ?manghas</i> <i>Erythroxylum</i> <i>Dalbergia</i> <i>Neonauclea</i> <i>Rhizophora ?stylosa</i>	BMNH BMNH BMNH BMNH BMNH
<b>ALEUROMARGINATUS</b>			
Corbett, 1935b			
<i>corbettiaformis</i> sp. n.	Leguminosae	<i>Desmodium umbellatum</i>	BMNH;USNM
<i>littoralis</i> sp. n.	Leguminosae	? <i>Derris trifoliata</i>	BMNH;USNM
sp. 1*	Leguminosae	<i>Dalbergia</i>	BMNH
<b>ALEUROPLATUS</b>			
Quaintance & Baker, 1914			
sp. 1*	Goodeniaceae Potaliaceae Rhizophoraceae	<i>Scaevola ?taccada</i> <i>Fagraea</i> <i>Rhizophora</i>	BMNH BMNH BMNH
sp. 2	?Guttiferae Myristicaceae Myrtaceae	? <i>Calophyllum</i> <i>Myristica</i> <i>Decaspermum</i> <i>Eugenia</i> <i>Syzygium</i>	BMNH BMNH BMNH BMNH BMNH
? sp. 3	Piperaceae	<i>Piper</i>	BMNH
sp. 4	Myrtaceae	<i>Syzygium</i>	BMNH
sp. 5*	Rhizophoraceae	<i>Rhizophora ?stylosa</i>	BMNH
<b>ALEUROTRACHELUS</b>	Fagaceae	<i>Nothofagus pullei</i>	CSIRO
Quaintance & Baker, 1914			
sp. 1*	Linaceae	<i>Durandea</i>	BMNH
<b>ALEUROTUBERCULATUS</b>	Ulmaceae	<i>Celtis philippinensis</i>	BMNH
Takahashi, 1932			

\* denotes discussion of undetermined species in main text

ALEYRODIDAE	HOST FAMILY	HOST GENUS/SPECIES	DEPOSITORY
<i>neolitsea</i> Takahashi, 1934	Dipterocarpaceae	<i>Anisoptera thurifera polyandra</i>	BMNH
	Ebenaceae	<i>Diospyros</i>	BMNH
	Guttiferae	<i>Calophyllum</i>	BMNH
	Magnoliaceae	<i>Elmerrillea papuana</i>	BMNH
	Myristicaceae	<i>Gymnacranthera</i>	BMNH
	Myrtaceae	<i>Eugenia</i>	BMNH
		<i>Myrtella</i>	BMNH
	Ochnaceae	<i>Schuermansia henningsii</i>	BMNH
	Xanthophyllaceae	<i>Xanthophyllum papuanum</i>	BMNH
sp. 1	Rubiaceae	<i>Canthium</i>	BMNH
sp. 2*	indet. vine		BMNH
sp. 3	indet. vine		BMNH
sp. 4*	Euphorbiaceae	<i>Macaranga</i>	BMNH
<b>ALEUROTULUS</b>			
Quaintance & Baker, 1914			
<i>arundinacea</i> Singh, 1931	Gramineae	indet. bamboo	BMNH
<b>ASIALEYRODES</b> Corbett, 1935a			
sp. 1*	Euphorbiaceae	<i>Pimelodendron emboinicum</i>	BMNH
? sp. 2*	Celastraceae	<i>Salacia</i>	BMNH
<b>BEMISIA</b> Quaintance & Baker, 1914			
<i>afer</i> (Priesner & Hosny, 1934)	Leguminosae	<i>Pterocarpus ?indicus</i>	BMNH
<i>leakii</i> (Peal, 1903)	Araceae	<i>Colocasia</i> c.v.	BMNH
<i>pongamiae</i> Takahashi, 1931	Leguminosae	<i>Derris</i>	BMNH
<i>tabaci</i> (Gennadius, 1889)	Convolvulaceae	<i>Ipomoea batatas</i>	BMNH
	Euphorbiaceae	<i>Manihot esculenta</i> c.v. & <i>utilissima</i>	BMNH
	Leguminosae	<i>Sophora tomentosa</i>	BMNH
sp. 1	Leguminosae	<i>Dalbergia</i>	BMNH
<b>CRENIDORSUM</b> Russell, 1945			
<i>lasangensis</i> sp. n.	Musaceae	<i>Musa</i>	BMNH
<i>morobensis</i> sp. n.	Myrtaceae	<i>Decaspermum</i>	BMNH
		<i>Myrtella</i>	BMNH
sp. 1*	?Araliaceae	? <i>Schefflera</i>	BMNH
<b>DIALEURODES</b> (Cockerell, 1902)			
<i>decaspermi</i> sp. n.	Myrtaceae	<i>Decaspermum</i>	BMNH; USNM
<i>kirkaldyi</i> (Kotinsky, 1907)	Oleaceae	<i>Jasminum</i>	BMNH; BPBM
<i>psidii</i> Corbett, 1935a	Celastraceae	<i>Lophopetalum</i>	BMNH
	Dipterocarpaceae	<i>Anisoptera thurifera polyandra</i>	BMNH
	Ebenaceae	<i>Diospyros</i>	BMNH
	Euphorbiaceae	<i>Macaranga</i>	BMNH
	Gyrocarpaceae	<i>Gyrocarpus</i>	BMNH
	Moraceae	<i>Ficus</i>	BMNH
	Myrtaceae	<i>Decaspermum</i>	BMNH
		<i>Myrtella</i>	BMNH
	Naucleaceae	<i>Neonauclea</i>	BMNH; BPBM
	Rutaceae	<i>Euodea</i>	BMNH

\* denotes discussion of undetermined species in main text

ALEYRODIDAE	HOST FAMILY	HOST GENUS/SPECIES	DEPOSITORY	
sp. 1*	Ulmaceae	<i>Celtis</i>	BMNH	
	Verbenaceae	<i>Premna</i>	BMNH	
	Xanthophyllaceae	<i>Xanthophyllum papuanum</i>	BMNH	
	Burseraceae	<i>Canarium</i>	BMNH	
	?Dipterocarpaceae	? <i>Anisoptera</i>	BMNH	
	Linaceae	<i>Durandea</i>	BMNH	
	Moraceae	<i>Ficus</i>	BMNH	
	Ochnaceae	<i>Schuurmansia henningsii</i>	BMNH	
	Rutaceae	<i>Euodea</i>	BMNH	
	Verbenaceae	<i>Gmelina</i>	BMNH	
sp. 2*	Xanthophyllaceae	<i>Xanthophyllum papuanum</i>	BMNH	
	?Guttiferae	? <i>Garcinia</i>	BMNH	
	Myrtaceae	<i>Eugenia</i>	BMNH	
sp. 3	?Guttiferae	? <i>Garcinia</i>	BMNH	
	Gyrocarpaceae	<i>Gyrocarpus</i>	BMNH	
	Potaliaceae	<i>Fagraea</i>	BMNH	
sp. 4	Verbenaceae	<i>Gmelina</i>	BMNH	
	Lauraceae	<i>Cryptocarya</i>	BMNH	
sp. 5	Myristicaceae	<i>Gymnacranthera</i>	BMNH	
		<i>Myristica</i>	BMNH	
sp. 6*	Verbenaceae	<i>Premna</i>	BMNH	
	Myrtaceae	<i>Eugenia</i>	BMNH	
sp. 7	Myrtaceae	<i>Syzygium</i>	BMNH	
sp. 8	Myrtaceae	<i>Decaspermum</i>	BMNH	
<b>DIALEUROPORA</b>				
(Quaintance & Baker, 1917)				
<b>decempuncta</b> (Quaintance & Baker, 1917)	Araceae	<i>Colocasia c.v.</i>	BMNH	
	Dilleniaceae	<i>Tetracera</i>	BMNH	
	Euphorbiaceae	<i>Breynia</i>	BMNH	
		<i>Glochidion</i>	BMNH	
		<i>Macaranga</i>	BMNH	
	Leguminosae	<i>Pterocarpus ?indicus</i>	BMNH	
	Rhamnaceae	<i>Alphitonia</i>	BMNH	
	Sapindaceae	<i>Pometia pinnata</i>	BMNH	
	sp. 1*	Magnoliaceae	<i>Elmerrillea</i>	BMNH
<b>INDOALEYRODES</b> David & Subramaniam, 1973				
<b>pseudoculatus</b> sp. n.	Myrtaceae	<i>Syzygium</i>	BMNH	
	Ulmaceae	<i>Celtis philippinensis</i>	BMNH	
	indet.		BMNH	
<b>NEOMASKELLIA</b>				
Quaintance & Baker, 1913				
<b>bergii</b> (Signoret, 1868)	Gramineae	<i>Cenchrus ciliaris</i>	BMNH	
		<i>Saccharum officinarum</i>	BMNH;BPBM	
<b>ORCHAMOPLATUS</b> Russell, 1958				
<b>niuginii</b> sp. n.	Guttiferae	<i>Calophyllum inophyllum</i>	BMNH;USNM	
	Linaceae	<i>Durandea</i>	BMNH	
	?Celastraceae	? <i>Lophopetalum</i>	BMNH	
<b>PARABEMISIA</b> Takahashi, 1952				
<b>jawani</b> sp. n.	indet.		BMNH	
	Dipterocarpaceae	<i>Anisoptera</i>	BMNH	

\* denotes discussion of undetermined species in main text

ALEYRODIDAE	HOST FAMILY	HOST GENUS/SPECIES	DEPOSITORY
	Euphorbiaceae	<i>Macaranga</i>	BMNH
	Lauraceae	<i>Cryptocarya</i>	BMNH
	Rosaceae	<i>Prunus</i>	BMNH;USNM
<b>PEALIUS</b> Quaintance & Baker, 1914			
group, sp. 1	?Araliaceae	? <i>Schefflera</i>	BMNH
group, sp. 2	Dipterocarpaceae	<i>Anisoptera thurifera</i> <i>polyandra</i>	BMNH
	Moraceae	<i>Ficus</i>	BMNH
group, sp. 3	Ulmaceae	<i>Celtis philippinensis</i>	BMNH
group, sp. 4	Moraceae	<i>Ficus</i>	BMNH
group, sp. 5	Sapindaceae	<i>Guioa</i>	BMNH
	Moraceae	<i>Ficus</i>	BMNH;BPBM
<b>RHACHISPHORA</b> (Quaintance & Baker, 1917)			
<b>ardisiae</b> (Takahashi, 1935)	indet.		BMNH
sp. 1*	Araliaceae	<i>Schefflera</i>	BMNH
? sp. 2*	indet.		BMNH
<b>TETRALEURODES</b> (Cockerell, 1902)			
group, sp. 1	?Araliaceae	? <i>Schefflera</i>	BMNH
group, sp. 2	Dipterocarpaceae	<i>Anisoptera thurifera</i> <i>polyandra</i>	BMNH
	Euphorbiaceae	<i>Glochidion</i>	BMNH
	Myrtaceae	<i>Decaspermum</i>	BMNH
		<i>Myrtella</i>	BMNH
group, sp. 3	Lauraceae	<i>Cinnamomum</i>	BMNH
group, sp. 4	Myristicaceae	<i>Horsfieldia</i>	BMNH
	Ochnaceae	<i>Schuurmansia</i> <i>henningsii</i>	BMNH
group, sp. 5	Rubiaceae	<i>Timonius</i>	BMNH
group, sp. 6	Lauraceae	<i>Litsea</i>	BMNH
	Moraceae	<i>Ficus</i>	BPBM
group, sp. 7	Myristicaceae	<i>Gymnacranthera</i>	BMNH
	Myrtaceae	? <i>Syzygium</i>	BMNH
	Potaliaceae	<i>Fagraea</i>	BMNH
group, sp. 8	Myrtaceae	<i>Eucalyptus</i>	BMNH
group, sp. 9	Gramineae	indet. bamboo	BMNH
<b>TRIALEURODES</b> Cockerell, 1902			
<b>vaporarium</b> (Westwood, 1856)	Cucurbitaceae	'squash' ( <i>Cucurbita</i> )	BMNH;BPBM
	Solanaceae	<i>Solanum lycopersicon</i> , <i>S. tuberosum</i>	BMNH
<b>XENALEYRODES</b> Takahashi, 1936			
<b>artocarp</b> Takahashi, 1936	Verbenaceae	<i>Premna</i>	BMNH
	?Myrtaceae	? <i>Decaspermum</i>	BMNH
<b>broughae</b> sp. n.	Rutaceae	<i>Citrus</i>	BMNH;USNM
<b>irianicus</b> sp. n.	indet.		BMNH;BPBM
<b>timonii</b> sp. n.	Rubiaceae	<i>Timonius</i>	BMNH;USNM
sp. 1*	indet.		BMNH
genus indet. 1	Myrtaceae	<i>Syzygium</i>	BMNH
genus indet. 2	Goodeniaceae	<i>Scaevola ?taccada</i>	BMNH
genus indet. 3	Myrtaceae	<i>Myrtella</i>	BMNH

\* denotes discussion of undetermined species in main text

ALEYRODIDAE	HOST FAMILY	HOST GENUS/SPECIES	DEPOSITORY
genus indet. 4, <i>Indoaleyrodes/Dialeurodes</i> group	Myrtaceae	<i>Decaspermum</i>	BMNH

### Key to whitefly subfamilies and genera of New Guinea

The taxonomy of whitefly at the generic level is in such a poor state that keys like those of Sampson & Drews (1956) and David & Subramaniam (1976) frequently give misleading results when species somewhat atypical of their allotted genera are encountered. The tendency for many such species to be placed in new, monobasic genera has done nothing to clarify generic concepts. The key below will enable genera known from New Guinea to be identified, but, in cases where the described species within a particular genus are so variable as to make the genus difficult to define, some are keyed out at species level.

#### Pupal cases

- 1 Subdorsum with large, ornate, compound pores, often with central spatulate processes, 4–6 pairs on abdomen and 1 cephalic pair; lingula large and excluded from vasiform orifice, bearing 4 hairs (**ALEURODICINAE**) ..... **ALEURODICUS** (p. 311)
- Subdorsum without large, ornate, compound pores (although it may possess 5 pairs of large, simple pores); lingula not as above (**ALEYRODINAE**) ..... 2
- 2 Vasiform orifice transversely elliptical, elevated, usually appearing wider than long in slide-mounted specimens.  
Outer submargin with a single row of about 16 pairs of long hairs (Fig. 38); cuticle pale to brown. Dense, ant-attended colonies on blades of Gramineae ..... **NEOMASKELLIA** (p. 329)
- If vasiform orifice elevated, then at least as long as wide ..... 3
- 3 Submargin with a row of dentate glands (Fig. 22).  
Margin weakly crenulate to finely toothed, but thoracic and caudal tracheal teeth always strongly differentiated from remainder of margin (Fig. 23) ..... **ORCHAMOPLATUS** (p. 329)
- Submargin without dentate glands ..... 4
- 4 Inner submargin, and often also much of dorsal disc, with long, stout spines which have pointed, lacinate or rounded apices.  
Vasiform orifice often elevated ..... 5
- Inner submargin without row of long, stout spines, although short, lanceolate setae sometimes present in outer submargin ..... 6
- 5 Stout spines restricted to a single submarginal ring only; spines tubiform, much thicker in basal two-thirds and narrowing rather suddenly before apical third; spines may be angled sharply at constriction (Fig. 35); true margin curled downwards, usually concealed by dorsum in slide-mounted specimens ..... **XENALEYRODES** (p. 334)
- In addition to submarginal ring, stout spines often occurring on dorsal disc (Figs 1, 41, 44, 45), even if only one or two such additional pairs of spines present (as in Fig. 3); true margin often not curled downwards ..... **ALEUROCANTHUS** (p. 313)
- 6 Margin rather irregular, somewhat crenulate; without, or with only slight differentiation of margin at thoracic tracheal openings. Vasiform orifice triangular, sometimes sinuate laterally, with apex leading into a pronounced caudal furrow; operculum occupying basal half of orifice, with triangular to elongate-oval head of lingula occupying most of remainder. Posterior margin of case normally indented, but often without obvious differentiation. Outer submargin without a row of hairs. Pupal cases pale, not noticeably waxy in life  
**BEMISIA** (Fig. 10) (p. 321)
- Combination of characters not as above ..... 7
- 7 Margin differentiated at caudal and/or thoracic tracheal areas: margin may be indented as a 'pore'; or a 'comb' of teeth distinct from remainder of margin may be present, this comb standing proud, or indented. Tracheal folds often marked on venter, running mesad from margin (as in Figs 8, 20) ..... 13
- Margin undifferentiated at areas of tracheal openings (as in Figs 7, 14) ..... 8
- 8 Dorsal disc completely separated from rather wide submarginal area by a distinct line or fold concentric with margin.  
Pupal cases black ..... **TETRALEURODES**-group (p. 333)

- Dorsal disc not so separated from submarginal area ..... 9
- 9 A longitudinal furrow present on each side of submedian area of dorsal disc in thoracic, and sometimes also anterior abdominal, area (as in Figs 12, 15) ..... 10
- A longitudinal furrow not present on each side of submedian area of dorsal disc ..... 11
- 10 Margin complex: cuticular markings in outer submargin usually give margin the appearance of having a double row of teeth. Pupal cases usually dark brown or black  
*ALEUROTACHELUS* (p. 320)
- Marginal teeth simple (Figs 13, 16). Pupal cases of New Guinea species pale  
*CRENIDORSUM* (p. 323)
- 11 Submargin either with long setae (minimally 3 pairs), or with a row of short, stout, lanceolate setae; margin weakly crenulate, not coarsely toothed ..... 12
- Submargin without long, simple setae and without short, lanceolate setae; margin (high power detail) apparently double: one row of shallow crenulations and one row of more obvious regular teeth (Figs 7, 8) ..... *ALEUROMARGINATUS* (p. 318)
- 12 Pupal case elongate, parallel-sided and slightly squared anteriorly and posteriorly; rather variable number of long submarginal setae present, minimally 1 anterior and 2 posterior pairs; lingula excluded from vasiform orifice; on bamboo  
*ALEUROTULUS* (*arundinacea* Singh) (p. 321)
- Pupal case elongate-oval; submargin with even row of 16 pairs of short, broad, lanceolate setae (Fig. 39); lingula exposed but included within vasiform orifice; on blades of Gramineae, usually in dense, ant-attended colonies  
*ALEUROCYBOTUS* (*setiferus* Quaintance & Baker) (p. 317)
- 13 Dorsal disc separated from rather wide submarginal area by a distinct line or fold concentric with margin ..... 14
- Dorsal disc not so separated from submarginal area ..... 15
- 14 Vasiform orifice triangular, longer than wide, lingula included and often obscured by operculum, caudal furrow pronounced (Fig. 46); differentiation of margin at thoracic and caudal tracheal openings rather variable between species, often most apparent caudally. Pupal cases black, often with a white waxy fringe in life ..... *ALEUROLOBUS* (p. 317)
- Vasiform orifice small and subcircular, hardly longer than wide; thoracic and caudal tracheal openings at margin marked by small indentations ('pores'). Pupal cases pale to dusky ..... *ASIALEYRODES* (p. 321)
- 15 Almost always with 5 pairs of large, simple, subdorsal pores (Fig. 40); if pores are absent then outer submargin with a row of about 12 pairs of short, somewhat lanceolate setae.  
Margin irregular. Pupal cases in life often surrounded by small patches of secreted iridescent blue waxy filaments ..... *DIALEUROPORA* (p. 326)
- Without 5 pairs of large, simple pores in subdorsum; if submarginal setae present, then not lanceolate ..... 16
- 16 Inner submargin with a row of stout papillae.  
Dorsal disc often with a few papillae. Knob of lingula about as broad as long, lobulate (Fig. 29) ..... *TRIALEURODES* (p. 333)
- Inner submargin without a row of such papillae ..... 17
- 17 Thoracic and/or caudal tracheal openings at margin either in the form of notches ('pores'), which may themselves be deeply invaginated from the main outline of the margin, or in the form of thickened, smoother breaks in an otherwise toothed margin ..... 18
- Thoracic and/or caudal tracheal openings in the form of differentiated marginal teeth, sometimes only 2 or 3 such modified teeth present, and sometimes several, forming a 'comb'; differentiation often best developed caudally ..... 23
- 18 Submedian area of dorsal disc somewhat elevated above remainder of pupal case, forming a rhachis with a pronounced furrow or crease running into subdorsum from submedian part of each abdominal segment (as Fig. 38) ..... *RHACHISPHORA* (p. 333)
- Rhachis not developed and submedian area not elevated above remainder of pupal case, but segmentation normally marked medially ..... 19
- 19 Tracheal pores invaginated from margin, inset from margin by several times diameter of pore; outer submargin without a ring of hairs which extend beyond margin; vasiform orifice triangular, lingula exposed but included (Fig. 20) ..... *INDOALEYRODES* (p. 327)
- If tracheal pores invaginated from margin, then either outer submargin with a row of hairs which extend beyond margin, or vasiform orifice not both triangular and with lingula exposed ..... 20

- 20 Vasiform orifice about as wide as long, with operculum occupying most of area of orifice; lingula concealed by operculum ..... 21
- Vasiform orifice normally longer than wide; operculum covering only basal half to two-thirds of orifice; lingula exposed but included.  
Outer submargin with a row of hairs which extend beyond the margin ..... 22
- 21 Vasiform orifice relatively small with respect to size of pupal case: inset from posterior margin by 3 or more times its own length. Caudal furrow often rather ornate (Fig. 18)  
*DIALEURODES* (p. 325)
- Vasiform orifice relatively large with respect to size of pupal case: maximally inset from posterior margin by about twice its own length (Fig. 42). Caudal furrow well-marked but often rather plain ..... *ALEUROTUBERCULATUS* (p. 320)
- 22 Vasiform orifice with a subcircular to trapezoidal anterior section which contains both the operculum and the lingula which has a rather wide D-shaped head: orifice continued posteriorly as a cordate to triangular extension which is sculptured on the floor of the depression (Fig. 28) ..... *PEALIUS*-group (p. 332)
- Vasiform orifice normally triangular and without a false posterior edge; lingula exposed, included, its head with a pair of lateral basal tubercles, not so short and D-shaped (Figs 25, 27) ..... *PARABEMISIA* (p. 330)
- 23 Pupal case elongate-oval, 2.0–2.5 times longer than wide, asymmetric in outline (Fig. 8)  
*ALEUROMARGINATUS* (*littoralis* sp. n.) (p. 319)
- Outline of pupal case symmetrical and round to oval, not elongate ..... 24
- 24 Without a row of submarginal hairs; caudal furrow (dorsal) usually little-marked.  
Vasiform orifice cordate to rounded-triangular; thoracic and caudal folds (ventral) often clearly indicated as finely stippled bands running from margin into subdorsal area. Pupal cases black or pale ..... *ALEUROPLATUS* (p. 320)
- Normally with a row of submarginal hairs which extend beyond the margin, and with caudal furrow (dorsal) well-developed ..... 22

## ALEURODICINAE

### *ALEURODICUS* Douglas

*Aleurodicus* Douglas, 1892: 32. Type-species: *Aleurodicus anonae* Morgan, by subsequent designation, Quaintance & Baker, 1908: 8.

#### Key to tropical Asian species of *Aleurodicus*

##### Pupal cases

- 1 With 4 pairs of abdominal compound pores ..... 2
- With 5 or 6 pairs of abdominal compound pores ..... 3
- 2 Margin with regular, coarse, teeth – about 60 on each side of case; central spines of compound pores stout and seta-like, reaching margin of case; case without long submarginal setae. (Sri Lanka) ..... *antidesmae* Corbett
- Margin not regularly and coarsely toothed; central spines of compound pores short and spatulate, dagger-shaped; case with 11 pairs of long, fine submarginal setae, in addition to caudal and posterior marginal pairs.  
Dorsum with a dense pattern of small wax pores.\* ..... *dispersus* Russell
- 3 With 6 pairs of abdominal compound pores ..... 4
- With 5 pairs of abdominal compound pores ..... 5
- 4 All abdominal compound pores subequal in size, usually with central processes not evident, resembling rings with transversely-sculptured rims; submargin with about 12 pairs of long, fine setae (Fig. 47). (Australia, Brunei, Papua New Guinea, Philippines, Sarawak, Solomon Islands, Sulawesi, West Malaysia) ..... *destructor* Mackie (p. 312)
- Posterior two pairs of abdominal compound pores larger than remaining four pairs, each of posterior two pairs with a conspicuous central spine; submargin without long, fine setae. (Fiji, Java, Papua New Guinea, [Sarawak], Sri Lanka, Thailand, West Malaysia)  
*holmesii* (Maskell) (p. 312)

\* Russell (1965) recorded *A. dispersus* from the Caribbean, Central and South America, southern U.S.A. and the Canary Islands. It has since been introduced to the Philippines (Martin & Lucas, 1984), Guam, Marianas Islands and Hawaii (Russell, pers. comm.).

- 5 Cephalic and posterior four pairs of abdominal compound pores subequal in size, with central spines short, not reaching margin of case; only anteriormost pair of abdominal pores smaller than remainder. (Hong Kong, Taiwan) ..... *machili* Takahashi
- Cephalic and posterior two pairs of abdominal compound pores subequal in size, with central spines usually reaching margin of case; anterior three pairs of abdominal pores subequal in size, distinctly smaller than remainder. (West Malaysia) ..... *cinnamomi* Takahashi

### *Aleurodicus destructor* Mackie

(Fig. 47)

*Aleurodicus destructor* Mackie, 1912: 142. Syntype pupal cases, PHILIPPINES (USNM).

DISTRIBUTION. Australia (New South Wales), Brunei, Papua New Guinea, Philippines, Sarawak, Solomon Islands, Sulawesi, West Malaysia.

#### MATERIAL EXAMINED

**Papua New Guinea:** Port Moresby, on *Cocos nucifera* (Palmae) and *Ficus microcarpa* var. *naumannii* (Moraceae); Wewak, on *Cocos nucifera*; Wau, on *Cinnamomum* sp. (Lauraceae); Buso, on ?*Xanthophyllum* sp. (Xanthophyllaceae); New Britain Province, on *Cocos nucifera* (all BMNH).

### *Aleurodicus holmesii* (Maskell)

*Aleurodes holmesii* Maskell, 1895: 435, fig. xxxi–2. Syntype pupal cases, FIJI (DSIR) [examined].

*Aleurodicus holmesii* (Maskell) Cockerell, 1903: 664.

*Aleurodicus malayensis* Takahashi, 1951: 2, fig. 2. Syntype pupal cases, WEST MALAYSIA (BMNH) [examined]. **Syn. n.**

Takahashi separated *malayensis* from other Asian species of *Aleurodicus* because it had pupal cases which were 'narrow and much narrowed cephalad', with the cephalic compound pores appearing very close to the margin. The syntypes of *malayensis* are in a very thick balsam mount, and there is considerable downward curling of the margins of the specimens, particularly in the cephalothoracic region. There is nothing else unusual about the outline of the pupal case, or in the position of the cephalic compound pores with respect to the margin of the case. The only other difference between *malayensis* and *holmesii* was given as the relatively long spines issuing from the cephalic and last two abdominal pairs of compound pores in *malayensis*. The syntypes of *holmesii* have been compared with the syntypes of *malayensis*, as well as with material from Papua New Guinea, Java, Thailand and Sri Lanka. In the syntypes of *holmesii*, all the compound pore central spines are broken, and additional slides were therefore prepared from duplicate dry material from the Maskell collection. From specimens with unbroken spines, it is evident that the compound pore spines of *holmesii* from Maskell's original Fiji material are indeed very short, and do not extend beyond the pupal case margin, in contrast to the syntypes of *malayensis* which have rather longer spines. However, there is variation in the relative lengths of these spines with respect to the pore-to-margin distance in other material present in the BMNH collection. *A. malayensis* is therefore considered a junior synonym of *holmesii*.

DISTRIBUTION. Fiji, Java, Papua New Guinea, (Sarawak), Sri Lanka, Thailand, West Malaysia.

#### MATERIAL EXAMINED

**Fiji:** Syntype pupal cases (of *holmesii*) and duplicate material bearing syntype data, on *Psidium* sp. (Myrtaceae) (BMNH; DSIR). **West Malaysia:** 8 pupal cases (syntypes of *malayensis*), Kuala Lumpur, on undetermined host (BMNH).

**Java:** 5 pupal cases (BMNH). **Papua New Guinea:** 3 pupal cases, 2 adult ♀, Buso, on undetermined tree; 7 pupal cases, Buso, on *Guioa* sp. (Sapindaceae) (BMNH). **Sarawak:** 1 pupal case, Gunung Mulu National Park, on Annonaceae, tentatively identified as *holmesii* (BMNH). **Sri Lanka:** 1 pupal case, Kandy (G. H. Corbett det.) (BMNH). **Thailand:** 4 pupal cases, Pah Meeung Mts (BMNH).



## ALEYRODINAE

*ALEUROCANTHUS* Quaintance & Baker

*Aleurocanthus* Quaintance & Baker, 1914: 102. Type-species: *Aleurodes spinifera* Quaintance, by original designation.

More species of whitefly seen from New Guinea belong to *Aleurocanthus* than to any other genus: five have been identified as previously described species, two are here described as new, and a further seven remain undetermined (p. 305).

Of those which are undetermined, species 1, 2, 3 and 5 resemble *regis* Mound in possessing few, if any, stout spines additional to the submarginal ring (see comments concerning *papuanus*). *Aleurocanthus* sp. 6 is discussed with *esakii* which it closely resembles.

**Key to named New Guinea species of *Aleurocanthus*****Pupal cases**

- |   |   |   |
|---|---|---|
| 1 | Pupal cases pale to slightly dusky; ventral submargin punctuated by band of shallow subcircular tubercles (Fig. 1) .....  | 2                                       |
| – | Pupal cases brown to black; without ventral submarginal band of shallow subcircular tubercles...  | 3                                       |
| 2 | Stout dorsal spines varying markedly in length, longest 0.25–0.30 mm long; submarginal stout spines tend to occur in groups of 3 or 4 in thoracic and anterior abdominal regions (Fig. 1)   |   |
| – | Stout dorsal spines varying less extremely in length, maximally about 0.2 mm long; submarginal stout spines not occurring in groups of 3 or 4 (Fig. 41).....                                | <i>luteus</i> sp. n. (p. 314)           |
| 3 | Stout dorsal spines in a single ring of 12 submarginal pairs with the only additional pair situated on edge of rhachis on abdominal segment V (Fig. 3). Apices of spines expanded, lacinate | <i>cocois</i> Corbett (p. 313)          |
| – | Several pairs of stout dorsal spines present in subdorsal and submedian areas in addition to submarginal ring. Spines with acute apices .....   | <i>papuanus</i> sp. n. (p. 315)         |
| 4 | Marginal teeth very large, only 4–5 occupying 0.1 mm of margin, teeth at least as long as wide at base, blunt.  |   |
| – | Distribution of stout dorsal spines as in Fig. 44 .....   | <i>woglumi</i> Ashby (p. 316)           |
| – | Marginal teeth smaller, more than 7 teeth occupying 0.1 mm of margin .....  | 5                                       |
| 5 | Submargin with 11 or 12 pairs of stout spines evenly spaced around case, but with posterior 3 pairs double, the submarginal ring thus totalling about 30 spines (as in Fig. 45).....        | 6                                       |
| – | Submargin normally with 11 pairs of stout spines, the posterior 3 pairs not being double, submarginal ring thus totalling about 22 spines only.   |   |
| – | Arrangement of abdominal stout spines: submedian pairs on segments I–III & VIII, inner subdorsal pairs on segments II–VII .....   | <i>spiniferus</i> (Quaintance) (p. 316) |
| 6 | Marginal teeth acute-triangular, often somewhat uneven; cephalothorax with 3 submedian pairs of short stout spines (Fig. 45) .....  | <i>pendleburyi</i> Corbett (p. 316)     |
| – | Marginal teeth blunt, rather castellate and somewhat spiky; cephalothorax with only 1 pair of submedian short stout spines .....  | <i>esakii</i> Takahashi (p. 314)        |

***Aleurocanthus cocois* Corbett**

(Fig. 41)

*Aleurocanthus cocois* Corbett, 1927: 24. Syntype pupal case, WEST MALAYSIA (BMNH) [examined].

*Aleurocanthus canangae* Corbett, 1935a: 790. Syntype pupal cases, WEST MALAYSIA (presumed lost).

**Syn. n.**

As stated by Corbett (1935a), *canangae* and *cocois* are only separable by the different lengths of the dorsal spines. Examination of the material listed below, including a syntype of *cocois* and seven specimens identified as *canangae* by Corbett, indicates that the spines vary somewhat in length, but that the pattern of spines does not. Thus *canangae* is here synonymised with *cocois*.

**DISTRIBUTION.** Burma, Cambodia, India, Papua New Guinea, Solomon Islands, Thailand, West Malaysia.

## MATERIAL EXAMINED

**West Malaysia:** 1 syntype pupal case, Batu Gajah, on *Cocos nucifera* (Palmae) (BMNH); 7 pupal cases (identified as *canangae* by Corbett), Kuala Lumpur, on *Kananga* [sic] *odorata* (Annonaceae) (BMNH).

**Papua New Guinea:** numerous pupal cases and larvae, Buso, on undetermined Sterculiaceae; 14 pupal cases, Wasu, on undetermined tree (all BMNH).

**Solomon Islands:** numerous pupal cases, Honiara, on *Cocos nucifera*; 7 pupal cases, Russell Island; 13 pupal cases, Guadalcanal, on *Cocos* (all BMNH).

*Aleurocanthus esakii* Takahashi

*Aleurocanthus esakii* Takahashi, 1936: 111, fig. 1. Syntype pupal cases, PALAU ISLANDS (TARI).

This species is very similar to *pendleburyi*, from which it differs in possessing blunt to castellate marginal teeth, and in having two pairs fewer of short cephalothoracic dorsal spines.

Several pupal cases of *Aleurocanthus* sp. 7 (see p. 305), very similar to *esakii*, were collected on *Cinnamomum* sp. at Wau Ecology Institute, Morobe uplands. These possess marginal teeth identical to those of *esakii*, but have one extra pair of short cephalothoracic dorsal spines; they also differ in the number and form of the fine submarginal capitate setae. These specimens thus have one pair of dorsal spines fewer than *pendleburyi*, and differ further from that species in not possessing acute triangular marginal teeth.

**DISTRIBUTION.** Palau Islands (Caroline group), Papua New Guinea.

## MATERIAL EXAMINED

**Papua New Guinea:** Buso, on single leaf of tree-crown foliage of *Pometia pinnata* (Sapindaceae) (BMNH).

*Aleurocanthus luteus* sp. n.

(Figs 1, 2)

**PUPAL CASE.** Elongate-oval, 0.80–0.90 mm long, 0.47–0.55 mm wide, widest at abdominal segment III. Cuticle pale to yellowish dusky. Margin very slightly flattened at thoracic tracheal openings, but not at anterior or posterior edges of case. Marginal teeth well developed, even, about 9 rounded-castellate teeth occupying 0.1 mm of margin (Fig. 2). Fine anterior and posterior marginal setae present.

**Dorsum.** Dorsal cuticle smooth, not punctuated by pores or sculpturing. Eye spots not marked. Dorsal disc and submargin with about 40 pairs of stout spines, of varying lengths, as shown in Fig. 1; spines smooth, pointed, with the longest (usually 1 cephalothoracic pair, subdorsal pair on abdominal segment III and submedian pair on abdominal segment V) up to 0.35 mm long. Each dorsal spine with a small circular pore near base. About half-way between margin and outermost stout spines is a row of about 8 pairs of submarginal setae about 35  $\mu$ m long, arranged as in Fig. 1. Pair of cephalic setae not evident in specimens seen, but eighth abdominal and caudal setae long: eighth abdominal setae rather stout, up to 0.12 mm long; caudal setae very fine, up to 0.25 mm long. Base of each marginal tooth marked on dorsum by a tubercle-like marking on cuticle. Dorsal disc rhachisiform, with cephalic and posterior abdominal median line raised into a pronounced keel, with the submedian spines on either side of keel. Transverse moulting sutures becoming indistinct in submargin, not apparently reaching margin of case; longitudinal suture reaching anterior edge of case. Meso-/metathoracic suture well marked, but remainder of cephalothoracic segmentation not evident. Vasiform orifice elevated, with vertical lateral 'flanges' which fold down on slide-mounted specimens to partially obscure vasiform orifice characters (Fig. 2). Vasiform orifice opening about 0.14 mm long, 0.13 mm wide; operculum occupying whole of orifice and obscuring setose head of lingula; vasiform orifice almost always distorted in slide-mounted specimens. Caudal furrow not evident.

**Venter.** Submargin punctuated by shallow, subcircular tubercles which run mesad from margin in regular lines (Fig. 1), about 4–5 tubercles in each line, and about 2 marginal teeth to each line of tubercles. Thoracic and caudal tracheal folds only marked as breaks in submarginal band of tubercles. Mesad of submarginal band of tubercles are many rather sparsely distributed dots in outer subdorsum and central part of thoracic area. A minute conical spine present at base of each middle and hind leg. Ventral abdominal setae long, fine.

**Holotype** pupal case, **Papua New Guinea:** Morobe Province coast, Lasanga Island, on *Macaranga* sp. (Euphorbiaceae), 21.x.1979 (J. H. Martin 2746) (BMNH).

**Paratypes.** 9 pupal cases, same data as holotype (BMNH).

COMMENTS. *A. luteus* belongs to a group of species which are characterised by their pale pupal case cuticle and the possession of a ventral submarginal band of shallow tubercles. Species in this group include *strychnosicola* Cohic, *trispina* Mound, *zizyphi* Priesner & Hosny and *mackenziei* Cohic from Africa; *rugosa* Singh from India and West Malaysia; and *cocois* Corbett from the Indian Region, Pacific Region and New Guinea. With its large number of long dorsal spines, *luteus* most closely resembles *trispina* and *mackenziei*, but differs from both species in the distribution and the markedly varying length and thickness of its dorsal spines; *luteus* further differs from *trispina* in having smooth dorsal spines which do not possess tiny lateral spinules. *A. luteus* resembles *cocois* in possessing about 8 pairs of submarginal setae, but the dorsal disc spines are much stouter and longer, and the tendency for submarginal stout spines to occur in groups of 3 or 4 does not occur in *cocois*.

### *Aleurocanthus papuanus* sp. n.

(Figs 3–5)

PUPAL CASE. Dark brown to black, usually requiring only a little bleaching for microscopic examination. Sexually dimorphic, ♀ 1.30–1.45 mm long, 1.30–1.40 times as long as wide, ♂ 1.00–1.07 mm long, 1.40–1.50 times as long as wide; maximum width at abdominal segments II and III. Outline rather characteristic, flattened to shallowly concave posteriorly, slightly indented towards thoracic tracheal areas and faintly pointed anteriorly. Marginal teeth well developed, even, rounded-triangular and distinctly paler than remainder of case, about 6–8 teeth occupying 0.1 mm of margin; teeth modified at thoracic and caudal tracheal openings (Fig. 4), where the line marking the tooth bases is more markedly indented than the margin itself. Fine anterior and posterior marginal setae present.

*Dorsum*. Cuticle of submedian area fairly smooth, evenly pigmented, but subdorsum and inner submargin punctuated by rather regular darker blotches (Fig. 4). Tiny porettes scattered over dorsum. Eye spots not visible. Submargin with a ring of 12 pairs of stout spines which are paler than dorsal cuticle, up to 0.33 mm long in ♀ (proportionately shorter in ♂), with expanded lacinate apices (Fig. 4); fifth cephalothoracic pair further inset from margin than remainder, and one further pair of similar spines present in inner subdorsum on abdominal segment V (Fig. 3). First abdominal setae short and rather spatulate; cephalic and eighth abdominal setae fine and dark, with caudal hairs similar but up to twice as long. A line of tiny submarginal pores present between marginal tooth bases and line of spinal bases (Fig. 4). Transverse moulting sutures only reach outer subdorsum, but longitudinal suture reaches anterior margin. Abdominal segmentation very well marked by thin, pale, suture-like folds which are immediately bordered by slightly darker pigmentation than on remainder of dorsum; these curious folds are continued into outer subdorsum almost perfectly out of phase with the segmentation on the submedian area, forming a rhachis (Fig. 3). Meso-/metathoracic suture well defined, very close to median part of transverse moulting suture, but remaining cephalothoracic segmentation not discernible. Submedian area defined in cephalothorax by suture-like folds similar to those on abdomen, with one lateral branch extending as far as cephalothoracic submargin between spine pairs 3 and 4. Vasiform orifice (Fig. 5) subcircular, outer (upper) internal margin toothed, inner part slightly reticulate as shown. Operculum trapezoidal, unpigmented, almost filling internal area of orifice. Lingula included and covered by operculum, though somewhat visible through operculum. Caudal furrow marked by slight darkening of cuticle (Fig. 4).

*Venter*. Thoracic and caudal tracheal folds each marked only by a pair of fine lines extending mesad to outer subdorsal area, not spinulose or sculptured. Ventral abdominal setae well developed, fine, situated anterior to vasiform orifice.

Holotype pupal case (♀), Papua New Guinea: Morobe Province coast, Buso river bank, on *Xanthophyllum papuanum* (Xanthophyllaceae), 13.ix.1979 (*J. H. Martin* 2557) (BMNH).

Paratype pupal cases. Papua New Guinea: 35 ♀, 22 ♂, same data as holotype; 1 ♀, Lasanga Island, on *Gaioa* sp. (Sapindaceae), 19.ix.1979 (*J. H. Martin* 2590) (BMNH; USNM).

COMMENTS. *A. papuanus* resembles *regis* Mound (1965, Nigeria) in possessing spines which are virtually all in one submarginal ring, and in the form of these spines, but differs in many other characters. In its general outline, shape of the transverse moulting sutures, and tendency towards a dorsal rhachis, *papuanus* appears similar to *hirsutus* (Maskell) and *T-signatus* (Maskell) from Australia (Dumbleton, 1956), and to *brevispinosus* Dumbleton and *spiniithorax* Dumbleton from New Caledonia (Dumbleton, 1961a). The combination of 12 pairs of submarginal spines with expanded apices, only one similar submedian pair, and the marked cepha-

lothoracic and abdominal folds separate *papuanus* from other described species of *Aleurocanthus*.

It is worth noting that *Aleurocanthus* species 1, 2, 3 and 5 (p. 305) also display a lack of dorsal disc spines, but seem to have closer affinities with *regis* than with *papuanus* and the Australian and Pacific species.

The colony on *Xanthophyllum papuanum* was very numerous, but a single specimen was collected from a species of *Guioa*. Pupae were not attended by ants.

***Aleurocanthus pendleburyi* Corbett**

(Fig. 45)

*Aleurocanthus pendleburyi* Corbett, 1935a: 795. Syntype pupal cases, WEST MALAYSIA (presumed lost).

This species differs from *esakii* in possessing pointed marginal teeth and two additional pairs of short cephalothoracic dorsal spines.

DISTRIBUTION. Papua New Guinea, West Malaysia.

MATERIAL EXAMINED

**Papua New Guinea:** Aiyura, on *Piper* sp. (Piperaceae); Goroka, on *Persea americana* (Lauraceae) (BMNH); Nondugl, on undetermined host (BMNH; BPBM). **West Malaysia:** Genting Highlands, on undetermined tree (BMNH).

***Aleurocanthus spiniferus* (Quaintance)**

*Aleurodes spinifera* Quaintance, 1903: 63; Quaintance & Baker, 1917: pl. 38, figs 1–6. Syntype pupal cases, JAVA (USNM; TARI).

*Aleurocanthus spiniferus* (Quaintance) Quaintance & Baker, 1914: 102.

This species is widespread and has hosts recorded from 15 plant families. The material listed below extends its known range into Java, New Guinea and Australia.

DISTRIBUTION. Papua New Guinea, Java, Australia (Queensland), also widely distributed in the Old World tropics; the existence of *spiniferus* in the Neotropical Region is doubtful (Mound & Halsey, 1978).

MATERIAL EXAMINED

**Papua New Guinea:** Port Moresby, on *Plumeria rubra* c.v. (Apocynaceae) and *Hibiscus* sp. (Malvaceae) (BMNH). **Java:** Jakarta, on *Citrus ?limon* (Rutaceae) (BMNH). **Australia:** Queensland, Cairns, on custard apple (Annonaceae) (BMNH; DPIQ).

***Aleurocanthus woglumi* Ashby**

(Fig. 44)

*Aleurocanthus woglumi* Ashby, 1915: 321. Syntype pupal cases, JAMAICA (?USNM).

*Aleurocanthus husaini* Corbett, 1939: 69. Syntype pupal cases, INDIA (depository unknown). **Syn. n.**

Corbett (1939) distinguished *husaini* from *woglumi* on the evidence of certain longer dorsal disc spines in the pupal cases of *husaini*, combined with an apparent difference between the forewings of adults of the two species. The type-material of *husaini* has not been traced, but in view of the variation in spine lengths displayed within some species of *Aleurocanthus* (see discussion of *cocois*), it is considered that this character has little significance. Further, the illustrated forewings appear to be from a male ('*husaini*') and a female ('*woglumi*'), which probably accounts for the difference in shape. The pupal case of *husaini* as described and illustrated by Corbett is considered a variation of *woglumi*.

Mound & Halsey (1978) did not record *woglumi* from New Guinea. The samples (see below) from Irian Jaya and Papua New Guinea (Wewak) were collected in 1959 and 1968 respectively, and were among undetermined material in BPBM, Honolulu.

DISTRIBUTION. Borneo, Irian Jaya, Java, Papua New Guinea, Philippines, Singapore, Sumatra, West Malaysia in Austro-Oriental Region; Hawaii; also widely distributed elsewhere in warmer parts of the world.

MATERIAL EXAMINED

**Irian Jaya:** Cyclops Mts, on *Citrus* sp. (Rutaceae) (BMNH; BPBM). **Papua New Guinea:** Wewak, on *Citrus* sp. (BMNH; BPBM); Zifaseng, on *Citrus* sp. (BMNH); North Solomon Islands Province, 'near Arawa', on *Citrus* sp. (BMNH).

**ALEUROCYBOTUS** Quaintance & Baker

*Aleurocybotus* Quaintance & Baker, 1914: 101. Type-species: *Aleurodes graminicola* Quaintance, by monotypy.

***Aleurocybotus setiferus*** Quaintance & Baker

(Fig. 39)

*Aleurocybotus setiferus* Quaintance & Baker, 1917: 357. Syntype pupal cases, JAVA, SRI LANKA (USNM).

Two colonies of this species were seen at Buso, feeding on blades of the grass *Imperata cylindrica* growing in sand among other strand-line vegetation. Both colonies were vigorously attended by ants: *Iridomyrmex* sp. in one, and *Polyrhachis laciniata* in the other.

DISTRIBUTION. Australia (Queensland), Hong Kong, Java, Papua New Guinea, Philippines, Sri Lanka, Taiwan, Thailand, West Malaysia.

MATERIAL EXAMINED

**Papua New Guinea:** Buso, on *Imperata cylindrica* (Gramineae). **Hong Kong:** New Territories, on 'grass'. **Sri Lanka:** Peradeniya, on *Imperata arundinacea*. **Australia:** Queensland, on *Imperata cylindrica* (all BMNH).

**ALEUROLOBUS** Quaintance & Baker

*Aleurolobus* Quaintance & Baker, 1914: 108. Type-species: *Aleurodes marlatti* Quaintance, by original designation.

***Aleurolobus niloticus*** Priesner & Hosny

*Aleurolobus niloticus* Priesner & Hosny, 1934: 1, (pl. 3). Syntype pupal cases, EGYPT (USNM).

The material from New Guinea and Sarawak, detailed below, extends the distribution given by Mound & Halsey (1978) into the Austro-Oriental Region.

DISTRIBUTION. The Middle East, East and North Africa, India, Pakistan, Sarawak, Papua New Guinea.

MATERIAL EXAMINED

**Papua New Guinea:** Buso, on *Gmelina* sp. (Verbenaceae). **Sarawak:** Gunung Mulu National Park, on undetermined host (all BMNH).

***Aleurolobus selangorensis*** Corbett

(Fig. 46)

*Aleurolobus selangorensis* Corbett, 1935a: 819. Syntype pupal cases, WEST MALAYSIA (presumed lost).

*A. selangorensis* is very similar to *niloticus* but can be distinguished by the presence of conspicuous dots lining the folds which run mesad from the marginal teeth into the submargin.

DISTRIBUTION. Papua New Guinea, West Malaysia.

MATERIAL EXAMINED

**Papua New Guinea:** Buso, on *Erythroxylum* sp. (Erythroxylaceae), *Dalbergia* sp. (Leguminosae), *Rhizophora* cf. *stylosa* (Rhizophoraceae); Lasanga Island, on *Cerbera ?manghas* (Apocynaceae); Kratke Mts, on *Neonauclea* sp. (Naucleaceae) (all BMNH).

**ALEUROMARGINATUS** Corbett

*Aleuromarginatus* Corbett, 1935b: 246. Type-species: *Aleuromarginatus tephrosiae* Corbett, by monotypy.

***Aleuromarginatus corbettiaformis* sp. n.**

(Figs 6, 7)

**PUPAL CASE.** Outline asymmetrically elongate-oval, often rather narrowed cephalad and usually widest at abdominal segments III–IV. Margin sometimes flattened at anterior and posterior ends of case, but rarely concave. Sexually dimorphic: ♀ 1.40–1.55 mm long, 0.65–0.70 mm wide; ♂ 1.10–1.20 mm long, 0.47–0.50 mm wide; on average 2.3 times as long as wide. Margin (Fig. 7) with regular double row of teeth; primary teeth rather coarse and conspicuous, triangular, with only 7–9 occupying 0.1 mm of abdominal margin; secondary row in form of shallow crenulations. Margin not modified at thoracic and caudal tracheal areas. A pair of fine marginal setae present posteriorly but not anteriorly.

**Dorsum.** Cuticle pale, but many specimens with a brown median stripe. Dorsum densely patterned; submargin with an elongate-oval fold at base of each marginal tooth, and immediately mesad is a row of subcircular papillae; lateral margins of submedian area of dorsal disc marked by longitudinal lines of similar papillae (Fig. 6), these lines similar in appearance to those in species of *Corbettia* Dozier; remainder of dorsal disc densely punctuated by subcircular to polygonal markings which are less sharply defined than the papillae (Fig. 7). Dorsum bearing 21 pairs of blunt hairs which are up to 35 µm long and usually much curved; distribution as shown in Fig. 6, caudal pair on abdominal segment VIII situated submarginally. Longitudinal and transverse moulting sutures both reach margin. Pro-/meso- and meso-/metathoracic sutures well defined, unlike cephalic/prothoracic junction. Vasiform orifice subcordate, a little longer than wide, inset from posterior margin by about 3 times its own length in ♀ (Fig. 7) and 2.3–2.6 times in ♂; lateral margins almost straight, anterior and posterior margins rounded; inner edges of lateral margins with a few coarse teeth. Operculum and lingula as shown (Fig. 7), similar to those of *A. littoralis* (following). Dorsal disc with scattered double pores, submargin with line of similar pores just mesad of marginal teeth. An apparent caudal furrow is created by differentiation of some of the dorsal markings.

**Venter.** Thoracic tracheal folds only occasionally indicated, and then only by a pair of faint lines running mesad from margin. Caudal tracheal fold indicated by faint longitudinal folds and scattered spinules. Ventral abdominal setae fine, long, more than half length of vasiform orifice. Anterior abdominal spiracles hook-shaped. A minute conical spine at base of each middle and hind leg. Antennae rather thick, distally roughened and apically pointed, apex reaching to half way between bases of fore and middle legs.

Holotype pupal case ♀, **Papua New Guinea:** Morobe Province coast, Buso, on *Desmodium umbellatum* (Leguminosae), 10.x.1979 (*J. H. Martin* 2680) (BMNH).

Paratype pupal cases. 13 ♀, 9 ♂, same data as holotype (BMNH; USNM); 10 dry specimens on leaf, same data as holotype (BMNH).

**COMMENTS.** The species is known from only one colony, a large, scattered population on the lower surfaces of mature leaves of *Desmodium umbellatum* (Leguminosae). The pupae were not attended by ants. Each individual has a marginal fringe of waxy filaments, apparently each one corresponding to a marginal tooth: the filaments are not dense and not very obvious to the naked eye, although they are about as long as the subdorsum is wide. The dorsal surface is covered by discrete grains of whitish or almost colourless waxy secretion, each grain corresponding to a cuticular marking: this secretion is developed into longitudinal ridges at the edges of the submedian area, corresponding to the lines of tubercles, and the secretion is similarly developed above the line of submarginal tubercles. Each of the dorsal hairs also has an accretion of wax attached to it. This species has a marked preference for feeding sites alongside major leaf veins, which is the usual explanation of asymmetry of outline. The host plant, *Desmodium umbellatum*, is widespread in strand-line vegetation from East Africa and Madagascar through tropical Asia to Taiwan and northern Australia (Verdcourt, 1979).

The density and form of cuticular patterning in *corbettiaformis* is quite unlike that of any of the described species. Despite the differentiated longitudinal line of tubercles at the edge of the dorsal disc, the species displays all the characters of *Aleuromarginatus*, in particular the apparently double row of marginal teeth and 21 pairs of tiny dorsal hairs in a characteristic pattern. In the characteristics of the vasiform orifice, dorsal segmentation and caudal tracheal fold, *corbettiaformis* resembles *littoralis* (see below), but the dorsal patterning, margin of case and appearance in life are quite different.

Two ventrally incomplete pupal cases of *Aleuromarginatus* (sp. 1, p. 305) were collected on a vine, possibly *Dalbergia densa* or *D. candenatus*. These also have lines of papillae differentiated from the remainder of the dorsal markings, but in a more complex pattern involving complete delineation of the submedian area and 8 pairs of radial 'spokes' running into the submargin; the specimens are symmetrical and not narrowed cephalad.

*Aleuromarginatus littoralis* sp. n.

(Figs 8, 9)

**PUPAL CASE.** Shape generally elongate-oval, widest at abdominal segment III, with margin slightly indented anteriorly and posteriorly. Most individuals are asymmetrical, with many being more convex on one side than on the other, and with precise outline being rather variable. Sexually dimorphic: ♀ 1.80–2.00 mm long, 0.75–0.90 mm wide; ♂ 1.30–1.45 mm long, 0.55–0.65 mm wide. Pupal cases of both sexes 2.0–2.5 times as long as wide, on average 2.3 times. Margin (Fig. 8, inset) with regular double row of teeth: primary teeth conspicuous, with 12–13 occupying 0.1 mm of abdominal margin; secondary row in form of shallow crenulations; short parallel lines run mesad from bases of teeth into submargin. Margin shallowly indented in thoracic tracheal region where teeth are smaller and closer-set; posterior marginal teeth at apex of caudal fold similarly differentiated from remainder of marginal teeth. A pair of fine posterior marginal setae present, but anterior pair apparently always absent.

**Dorsum.** Cuticle pale, but with all segmental sutures sharply defined and often emphasised by brownish pigment. Abdominal intersegmental sclerotisation expands at lateral ends of segmental sutures and tends to merge with that of adjacent segments; the abdominal submedian area is thus quite well defined, although not delineated by a suture-like fold or rhachis. Paired submedian depressions present in anterior half of each of abdominal segments I–VI, and on thorax. Dorsum sculptured by a dense but irregular pattern of polygonal to subcircular markings which are darker and better defined nearer submargin, and somewhat variable between specimens (Fig. 8, inset). Dorsum bearing 21 pairs of very short, often much-curved hairs; distribution as in Fig. 8; abdomen with the pairs on segments I and III–VI just inside submedian area, pair on segment II in subdorsum, the remaining 4 pairs on segment VIII, including the subdorsally placed caudal pair which are similar to the remainder. Transverse and longitudinal moulting sutures reach margin. Pro-/meso- and meso-/metathoracic sutures well defined; cephalic/prothoracic junction no more than a slight fold which is angled abruptly anteriorly in its distal half; lengths of thoracic segments subequal. Median length of abdominal segment VII about half that of each of segments I–VI. Median line on abdominal segments I–IV or V somewhat sclerotic, although not normally pigmented. Vasiform orifice (Fig. 9) elongate-cordate, 65–90 µm long, 55–75 µm wide, inset from posterior margin by about 3 times its own length; lateral margins straight to slightly concave, anterior and posterior margins rounded; inner edges of lateral margins toothed. Operculum trapezoidal with rounded lateral margins, occupying about half length of vasiform orifice; lingula with large spinulose head, occupying most of remaining volume of orifice, exposed but included. Dorsal disc with scattered double disc pores; submargin with a line of similar pores just mesad of marginal teeth, one double pore at base of each 4th to 5th tooth.

**Venter.** Caudal tracheal fold rather broad, marked by slight longitudinal folding, and further punctuated by groups of small spinules along two-thirds of its length from margin to vasiform orifice (Fig. 8). Thoracic tracheal folds marked in subdorsum by scattered, very fine stipples, margins of folds often marked by faint lines. Ventral abdominal setae fine, about half as long as vasiform orifice, with bases situated at about half length of, and a little lateral to, orifice. Anterior abdominal spiracles appear hook-like, situated just lateral to submedian area of abdomen which is very faintly stippled. A minute conical spine present at base of each middle and hind leg. Antennae rather long, slender, directed posteriorly, distally roughened, apically pointed, apex reaching half way between bases of fore and middle legs.

Holotype pupal case ♀, **Papua New Guinea:** Morobe Province coast, Lasanga Island, on ?*Derris trifoliata* (Leguminosae), 7.xi.1979 (*J. H. Martin* 2819) (BMNH).

Paratype pupal cases. **Papua New Guinea:** 31 ♀, 22 ♂, same data as holotype; 23 ♀, 21 ♂, Morobe Province coast, Buso, on same host, 10.ix.1979 (*JHM* 2529); 13 ♀, 6 ♂, Buso, on same host, 25.x.1979 (*JHM* 2760) (BMNH; USNM). A number of dry specimens on leaf, with same data as holotype (BMNH).

**COMMENTS.** This species is known from three large, but not dense, colonies. Pupae were not attended by ants. Each pupa is devoid of obvious secretion dorsally, but is surrounded marginally by a broad fringe of translucent waxy strands, apparently one to each marginal tooth. The marginal wax strands corresponding to the thoracic and caudal tracheal areas are denser and more opaque, white. Pupae are scattered, apparently randomly, over the lower surfaces of the smooth mature leaves of the host, with nothing in their positioning to indicate a possible



explanation for their asymmetry. The host, tentatively identified as *Derris trifoliata*, is a shoreline woody climber which in the Buso area was found in sandy, beach-top situations. *D. trifoliata* is widespread in strand-line vegetation in East Africa, Madagascar, tropical and subtropical Asia and Australia (Verdcourt, 1979).

*A. littoralis* is similar to *kallarensis* David & Subramaniam (1976) and *dalbergiae* Cohic (1969) in its marked asymmetry and general appearance. It is also similar to *millettiae* Cohic (1968), differing in the following respects: meso- and metathoracic segments subequal in median lengths; margin flattened to concave anteriorly, posteriorly and at thoracic tracheal areas; most individuals conspicuously asymmetrical. It differs from *kallarensis* and *dalbergiae* as follows: vasiform orifice longer than wide, with lateral margins straight to slightly concave; submedian area of dorsal disc not defined by longitudinal suture-like folds; thoracic tracheal fold normally marked on venter, punctuated by fine stippling in the subdorsal area; thoracic tracheal teeth smaller than remainder of marginal teeth, with margin indented at that point. *A. littoralis* further differs from *dalbergiae* in possessing a pair of dorsal disc hairs on abdominal segment VI, but with no pair on segment VII; *dalbergiae* possesses the pair on segment VII, but not that on VI. Indeed, with *kallarensis* having the same pattern of dorsal hairs on the abdomen as *littoralis*, the only apparent difference between *kallarensis* and *dalbergiae* is this transposition of one pair of hairs (Figs 11 a, b, c).

#### **ALEUROPLATUS** Quaintance & Baker

*Aleuroplatus* Quaintance & Baker, 1914: 98. Type-species: *Aleurodes quercusaquaticae* Quaintance, by original designation.

Five species from the Buso area are regarded as belonging to *Aleuroplatus* (p. 305), although none has been identified to species level. *Aleuroplatus* spp. 1 and 5 are evenly dark and similar in general shape to *bossi* Takahashi; the remaining three species are less typical of the genus.

#### **ALEUROTRACHELUS** Quaintance & Baker

*Aleurotrachelus* Quaintance & Baker, 1914: 103. Type-species: *Aleurodes tracheifer* Quaintance, by original designation.

A single species is assigned to *Aleurotrachelus*, collected at Buso from *Celtis philippinensis* (Ulmaceae), *Durandea* sp. (Linaceae) and undetermined hosts. This species is tentatively assigned to *Aleurotrachelus* and bears similarities in its outline and suture lines to *dryandrae* Solomon from Western Australia.

#### **ALEUROTUBERCULATUS** Takahashi

*Aleurotuberculatus* Takahashi, 1932: 20. Type-species: *Aleurotuberculatus gordoniae* Takahashi, by original designation.

Five species of *Aleurotuberculatus* have been examined from New Guinea, but it has only been possible to name one; of the undetermined species (p. 306), sp. 2 is similar to *melastomae* Takahashi, and sp. 4 is similar to *siamensis* Takahashi and *bauhiniae* Corbett.

#### *Aleurotuberculatus neolitseae* Takahashi

(Fig. 42)

*Aleurotuberculatus neolitseae* Takahashi, 1934: 55. Syntype pupal cases, TAIWAN (TARI).

*A. neolitseae* is a very distinctive species, and is well illustrated by Takahashi (1934) and Corbett (1935a).

DISTRIBUTION. Papua New Guinea, Sarawak, Taiwan, West Malaysia.

#### MATERIAL EXAMINED

**Papua New Guinea:** Buso area, on *Anisoptera thurifera polyandra* (Dipterocarpaceae), *Diospyros* sp. (Ebenaceae), *Calophyllum* sp. (Guttiferae), *Elmerrillea papuana* (Magnoliaceae), *Gymnacranthera* sp.



(Myristicaceae), *Myrtella* sp. (Myrtaceae), *Syzygium* [= *Eugenia*] sp. (Myrtaceae), *Schuermansia heningsii* (Ochnaceae), *Xanthophyllum papuanum* (Xanthophyllaceae). Sarawak: Gunung Mulu National Park, on undetermined host. West Malaysia: Taman Negara National Park, Kuala Tahan, on undetermined woody vine (all BMNH).

### **ALEUROTULUS** Quaintance & Baker

*Aleurotulus* Quaintance & Baker, 1914: 101. Type-species: *Aleurodes nephrolepidis* Quaintance, by original designation.

#### ***Aleurotulus arundinacea*** Singh

*Aleurotulus arundinacea* Singh, 1931: 88, pl. 35. Syntype pupal cases, INDIA (depository unknown).

The eight pupal cases examined from New Guinea are all from a single bamboo clump, yet they exhibit marked variation in the number and distribution of the long submarginal setae. Singh described the species as having just 4 pairs of long submarginal setae, all on the cephalothorax, in addition to the caudal setae. The New Guinea specimens range from those with just one cephalothoracic pair and the caudal pair, to one with 4 cephalothoracic and 5 abdominal pairs. The other characters are as detailed by Singh, although the posterior marginal setae are rather longer.

DISTRIBUTION. India, Papua New Guinea.

#### MATERIAL EXAMINED

**Papua New Guinea:** Buso, on unidentified bamboo (Gramineae) (BMNH).

### **ASIALEYRODES** Corbett

*Asialeyrodes* Corbett, 1935a: 841. Type-species: *Asialeyrodes lumpurensis* Corbett, by original designation.

*Asialeyrodes* sp. 1 (p. 306) is represented by a damaged pupal case; it is very flat and typical of the species described by Corbett and Takahashi, and was collected from *Pimelodendron emboinicum* (Euphorbiaceae) at Buso.

A second species (?*Asialeyrodes*, sp. 2) was collected from a forest-canopy vine, identified as *Salacia* sp. (Celastraceae); it has markedly convex pupae, unlike the described species of *Asialeyrodes*, but with thoracic and caudal tracheal pores present, and with the submargin separated from the subdorsum by a suture-like fold, it is tentatively assigned to *Asialeyrodes*.

### **BEMISIA** Quaintance & Baker

*Bemisia* Quaintance & Baker, 1914: 99. Type-species: *Aleurodes inconspicua* Quaintance, by original designation.

#### ***Bemisia afer/hancocki***-group

*Dialeurodoides afer* Priesner & Hosny, 1934: 6, pl. 4. Syntype pupal cases, EGYPT (USNM; BMNH) [examined].

*Bemisia afer* (Priesner & Hosny) Habib & Farag, 1970: 8.

*Bemisia hancocki* Corbett, 1936: 20, fig. 5. Syntype pupal case, UGANDA (BMNH) [examined]. [Synonymised by Bink-Moenen, 1983.]

*Bemisia hancocki* was described from cotton in Uganda, and variability of African material was discussed by Mound (1965). The species was subsequently synonymised with *afer* by Bink-Moenen (1983). In the BMNH collection, there is a syntype of each of these taxa, that of *afer* being a slide-mount of a badly damaged pupal case which does not display many characters. Furthermore, a second slide preparation of '*hancocki*', which was previously erroneously labelled as the 'type', and bears the same acquisition number as the syntype, displays differences from the syntype. The true situation, even within the African material, is thus by no means clear.

Specimens in the BMNH collection from the Pacific Region and from New Guinea clearly

belong to the *afer/hancocki*-group, but vary much in size, the position of the vasiform orifice with respect to the posterior margin of the pupal case, and the extent of dorsal tubercular sculpturing.

**DISTRIBUTION.** '*afer*' – Egypt; '*hancocki*' – Mediterranean area, Africa, Madagascar, India, Pakistan; *afer/hancocki*-group – Papua New Guinea, Fiji, Tonga.

**MATERIAL EXAMINED**

**Egypt:** 1 pupal case (syntype of *afer*), Ibreem, on *Ficus sycamorus* (Moraceae) (BMNH). **Uganda:** 1 pupal case (syntype of *hancocki*), on cotton (*Gossypium*, Malvaceae), coll. Hancock (BMNH); 1 pupal case, on *Vigna cajanus* (Leguminosae), bearing same acquisition number as syntype of *hancocki* (BMNH). **Papua New Guinea:** 8 pupal cases, Lasanga Island, on *Pterocarpus ?indicus* (Leguminosae) (BMNH).

(?) *Bemisia leakii* (Peal)

*Aleyrodes leakii* Peal, 1903: 87. Syntype pupal cases, INDIA (depository unknown).

*Bemisia leakii* (Peal) Quaintance & Baker, 1914: 100.

Dumbleton (1961b) lists *B. leakii* on *Colocasia* sp. from Tahiti, quoting Cohic (1955), and illustrates the vasiform orifice characters while not indicating the source of the illustrated material. Cohic simply listed the species as one found colonising *Colocasia* ('taro'), and gave no descriptive data apart from a short observation about its feeding habits. Cohic's observation (translated) was 'This aleyroidid lives on the lower surface of the leaves of taro, but never in dense colonies; the whitish nymphs are isolated from each other. Damage is rarely important.' These observations are also true of the specimens found on taro in New Guinea. Two slides identified as '*? leakii*' were loaned to the author by DSIR for comparison. This material was collected by Cohic in Tahiti, and became part of the Dumbleton collection. It is undoubtedly the material cited in the text of Dumbleton's paper, and appears to be the source of the figure also. The vasiform orifice of the New Guinea specimens from taro matches that of Cohic's material and also matches Dumbleton's figure, but none of these matches Peal's (admittedly poor) original figure. The author has not seen any further material identified as *Bemisia leakii*, so the Tahiti and New Guinea records of this species must remain uncertain.

**DISTRIBUTION.** Fiji, India, (Papua New Guinea), (Tahiti).

**MATERIAL EXAMINED**

**Papua New Guinea:** Buso, on *Colocasia* variety ('taro', Araceae) (BMNH). **Tahiti:** on *Colocasia* sp. and *Erythrina* sp. (Leguminosae), F. Cohic coll. (DSIR).

*Bemisia pongamiae* Takahashi

*Bemisia pongamiae* Takahashi, 1931: 223, fig. 5. Syntype pupal cases, TAIWAN (TARI).

**DISTRIBUTION.** Papua New Guinea, Taiwan, West Malaysia.

**MATERIAL EXAMINED**

**Papua New Guinea:** Buso strand-line, on *Derris* sp., small tree (Leguminosae). **West Malaysia:** Tioman Island, Kampung Tekek, on ?Leguminosae (all BMNH).

*Bemisia tabaci* (Gennadius)

(Fig. 10)

*Aleyrodes tabaci* Gennadius, 1889: 1. Syntype pupal cases, GREECE (USNM).

*Bemisia tabaci* (Gennadius) Takahashi, 1936: 110.

Mound & Halsey (1978) list hosts of *B. tabaci* belonging to 63 families, and this whitefly is known from most warmer parts of the world. The records from New Guinea, Sarawak and Java (see below) extend the recorded distribution. The New Guinea record quoted by Mound & Halsey refers to the New Britain Province sample.

**DISTRIBUTION.** Papua New Guinea (including New Britain), Java, Sarawak; also very widely distributed in warmer parts of the world.

## MATERIAL EXAMINED

**Papua New Guinea:** Lae, on *Manihot esculenta* c.v. (Euphorbiaceae); Lasanga Island, on *Manihot utilisima* and *M. esculenta* c.v.; Buso, on *Sophora tomentosa* (Leguminosae); New Britain Province, on *Ipomoea batatas* (Convolvulaceae). **Sarawak:** Gunung Mulu National Park, on *Manihot* c.v. **Java:** Jakarta, on *Manihot* c.v. and undetermined shrub. (All BMNH.)

**CRENIDORSUM** Russell

*Crenidorsum* Russell, 1945: 55. Type-species: *Crenidorsum tuberculatum* Russell, by original designation.

*Crenidorsum* was erected by Russell to accommodate 12 species from the Caribbean area; hitherto no further species have been assigned to the genus. Russell considered *Crenidorsum*, with the following group of characters, to be most closely allied to *Aleuroplatus*, *Aleurotrachelus* and *Aleurotulus*: longitudinal differentiated fold/furrow in inner subdorsum on each side of pupal case; vasiform orifice subcordate to broadly elliptical; operculum nearly filling vasiform orifice; lingula often folded into vasiform orifice, but when extended the appearance is as in Fig. 14; submedian cephalic setae present; submargin not separated from dorsal disc by a complete fold. The two species described below seem, in general appearance, to be closest to *marginale* from the Dominican Republic.

A third New Guinea species (*Crenidorsum* sp. 1 – p. 306) is represented by a damaged specimen from an undetermined host at Buso; it is unique in having the longitudinal subdorsal furrows continued from abdominal segments IV–VII in the form of separate, segmental, comma-shaped creases.

***Crenidorsum lasangensis* sp. n.**

(Figs 12–14)

**PUPAL CASE.** Rather small, 0.74–0.92 mm long, 0.50–0.61 mm wide, about 1.45–1.50 times as long as broad, widest at metathorax. Cuticle pale, colourless. Outline oval, but with margin almost straight for a short distance at thoracic and caudal tracheal areas, although not indented. Margin (Figs 13, 14) with single regular row of teeth, about 13–16 occupying 0.1 mm of abdominal margin. Usual pairs of anterior and posterior marginal setae present, each arising from near apex of a marginal tooth, fine.

**Dorsum.** Whole of cuticle between submedian area of dorsal disc and margin finely rugose (Fig. 13), the rugae running almost parallel to margin, each sculptured by transverse pale markings, so that the rugae resemble banded chromosomes in appearance. Cuticle of submedian area smoother, with well-marked pairs of submedian depressions on abdomen and thorax and very fine spinules medially on abdominal segments. Pair of longitudinal subdorsal furrows present, though not as suture-like as in some other members of the genus; the furrows well-defined on thorax but becoming indistinct towards cephalic and abdominal areas. Median lengths of abdominal segments I–VI subequal, each about twice that of segment VII. Large dorsal disc pores present, each with an adjacent tiny porette, distributed as in Fig. 12; additionally about 32 much smaller pore/porette adjacent pairs in an inner submarginal row (Fig. 13), with others distributed in subdorsum. Longitudinal moulting suture reaching margin of case, transverse moulting sutures terminating in subdorsum. Vasiform orifice (Fig. 14) subcordate, a little wider than long, inset from posterior margin of case by about twice its own length; on average 36  $\mu$ m long, 45  $\mu$ m wide and 70  $\mu$ m from margin. Operculum laterally-rounded trapezoidal, almost filling vasiform orifice. Lingula (Fig. 14) longer than vasiform orifice, expanded apically into a spinulose club with a pair of fine setae, excluded from vasiform orifice if not folded. Thoracic and caudal tracheal areas not differentiated, caudal furrow not evident. Single pairs of cephalic, metathoracic, eighth abdominal and caudal setae present; cephalic and metathoracic pairs up to 0.3 mm long (although often broken), eighth abdominal and caudal pairs about half as long. Bases of caudal setae inset from margin of case by about twice height of marginal teeth.

**Venter.** Caudal tracheal fold not defined. Thoracic tracheal folds defined only by a nebulous patch of fine stipples located between forelegs and margin of case. A minute conical spine present at base of each middle and hind leg, not longer than broad at base. Median area of abdomen minutely roughened in transverse, segmental bands.

Holotype pupal case, **Papua New Guinea:** Morobe Province coast, Lasanga Island, on *Musa* sp. (Musaceae), 18.ix.1979 (*J. H. Martin* 2586) (BMNH).

Paratype pupal cases, **Papua New Guinea:** 12, same data as holotype (BMNH; USNM).

COMMENTS. In the sample collected the pupae were sparsely scattered over the lower surface of a large leaf of *Musa*, the plant growing in a 'garden' clearing. The pupae were not attended by ants, and were not noticeably protected by waxy secretions. No adults were seen. Although nothing further is known about the biology of this insect, the importance of bananas and plantains throughout the tropics makes the description of this species important.

*C. lasangensis* displays many characters associated with *Aleurotulus* species, particularly with regard to the often-excluded lingula and the long dorsal setae. However, the presence of longitudinal subdorsal furrows and the form of the lingula indicate inclusion in *Crenidorsum*.

*C. lasangensis* differs from *differens* Russell in the absence of a submedian pair of mesothoracic setae, and in the absence of median tubercles on abdominal segments II–V; it differs from *marginale* Russell in possessing remarkably long submedian setae, particularly the cephalic and metathoracic pairs, and in the transverse moulting suture extending well beyond the longitudinal subdorsal furrow; the dorsal disc pores in *lasangensis* are much more prominent than in other species of *Crenidorsum*.

### *Crenidorsum morobensis* sp. n.

(Figs 15, 16)

PUPAL CASE. Pale, surrounded by broad mealy border, but without dense dorsal waxy covering. Rather small, 0.64–0.86 mm long, 0.45–0.63 mm wide. Shape oval, about 1.4 times as long as broad, widest at metathorax, margin faintly indented at thoracic and caudal tracheal openings. Margin (Fig. 16) punctuated by well-developed and evenly spaced teeth, about 11–12 occupying 0.1 mm of margin. Cuticle pale, but some specimens dusky brownish in submedian area and in a narrow marginal ring at bases of teeth.

*Dorsum*. Cuticle slightly wrinkled, with irregular folds running mesad from bases of marginal teeth into subdorsum (Fig. 16); median parts of abdominal segments very finely spinulose. A pair of longitudinal subdorsal furrows present, immediately lateral to submedian area and legs, these furrows running from level of cephalic setae to approximately abdominal segment IV, remaining about parallel to margin of case (Fig. 15). Submedian area of dorsal disc somewhat raised and developed into a rhachis, delineated in cephalothoracic and anterior abdominal region by a pair of rather sinuous and less sharply defined longitudinal lines lying mesad of the subdorsal furrows. Posterior abdominal segments with raised lateral folds extending posterolaterad into subdorsum. Median lengths of abdominal segments I–VII subequal. Submargin with single line of about 48 simple pores, inset about a marginal tooth-length from tooth bases; a little further mesad is a line of 9 pairs of minute hairs. Remainder of dorsal disc with evenly scattered pores. Longitudinal moulting suture reaches anterior margin of pupal case, transverse moulting sutures terminate at the subdorsal furrows. Vasiform orifice (Fig. 16) subcordate, slightly elevated, a little wider than long, inset a little more than its own width from posterior margin of pupal case; on average 32  $\mu\text{m}$  long, 37  $\mu\text{m}$  wide and 40  $\mu\text{m}$  from posterior margin. Operculum roundly trapezoidal, almost exactly filling vasiform orifice. Lingula longer than vasiform orifice, but normally folded into orifice and included. Thoracic and caudal tracheal openings at margin only marked by slight marginal indentations, marginal teeth not differentiated, caudal furrow hardly evident. Single pairs of short, pointed setae present on head, metathorax and abdominal segment VIII, shorter than vasiform orifice; caudal setae longer, length about equal to distance from vasiform orifice to margin, setal bases situated half way between orifice and margin.

*Venter*. Caudal tracheal fold not defined; thoracic tracheal folds sometimes marked in submargin by a faint pair of lines running mesad from the slightly indented margin. A minute conical spine present at base of each middle and hind leg, each hardly longer than its own basal width.

Holotype pupal case, Papua New Guinea: Morobe Province coast, Buso, on *Myrtella* sp. (Myrtaceae), 3.x.1979 (J. H. Martin 2655) (BMNH).

Paratype pupal cases. Papua New Guinea: 9, same data as holotype; 2, Buso riverbank, on ?*Decaspermum* sp. (Myrtaceae), 11.ix.1979 (JHM 2531); 1 (third instar larva), Buso, on *Decaspermum* sp., 14.ix.1979 (JHM 2565); 1, Buso riverbank, on undetermined sapling, 12.ix.1979 (JHM 2547); 1, Buso, on undetermined forest-canopy vine, 11.xi.1979 (JHM 2841) (all BMNH).

COMMENTS. Most specimens were found sparsely distributed on leaves of a *Myrtella* species growing on beach-top sand between mangroves and the sea. Further specimens were taken from other hosts (see paratype data), but there is insufficient material generally to enable any conclusions to be drawn on the likely host range of the species. The pupae were not attended by ants.

*C. morobensis* differs markedly from the described species of *Crenidorsum* in possessing a dorsal rhachis.

### ***DIALEURODES* Cockerell**

*Aleyrodes* (*Dialeurodes*) Cockerell, 1902: 283. Type-species: *Aleyrodes citri* Riley & Howard [= *Aleyrodes citri* Ashmead], by original designation.

*Dialeurodes* Cockerell; Quaintance & Baker, 1914: 97 [raised to genus].

In addition to two named species and one here described as new, eight undetermined species of *Dialeurodes* from New Guinea have been examined (p. 307). *Dialeurodes* sp. 1 resembles *ixorae* Singh (1931, figured) in having the submedian area delineated by a line of small papillae, but it differs in other respects; sp. 2 belongs to a group for which Quaintance & Baker (1917) used the subgenus *Rabdostigma*; sp. 6 resembles *subrotunda* Takahashi.

### ***Dialeurodes decaspermi* sp. n.**

(Figs 17–19)

**PUPAL CASE.** Large, of striking appearance, conspicuous against the rather pale leaf underside of the host. Length 1.70–2.55 mm, width 1.40–2.35 mm, broadly oval to almost circular. Margin slightly irregular, but entire, not crenulate or castellate. Anterior and posterior pairs of marginal setae present, fine.

**Dorsum.** Possessing a most remarkable sclerotic pattern (Fig. 17): only the extreme marginal area, cephalothoracic subdorsum, median part of abdomen and a pair of subdorsal abdominal patches pale, the remainder dark brown to black, the resultant pattern resembling a pale anchor on a dark background. Paler marginal area with very fine lines running mesad as far as the darkly pigmented submargin. Pigmented cuticle finely granular in appearance, granulations not apparent in paler areas. Whole of dorsum except paler marginal band bearing many evenly spaced disc pores and many subcircular markings which give the dorsum a 'cobbled' appearance. Longitudinal moulting suture only reaches anteriorly as far as the subdorsal pale zone, transverse moulting sutures terminate above outer edges of hind legs. Vasiform orifice (Fig. 19) subcordate, 50–70  $\mu\text{m}$  long, a little wider than long, situated 5.5–8.0 times its own length from posterior margin of pupal case; posterolateral margin of orifice smooth, dark, much thickened. Operculum trapezoidal, almost filling vasiform orifice. Lingula (Fig. 19) apically setose, with 4 lateral processes, longer than vasiform orifice but apical section usually recurved to appear shorter than orifice. Caudal and thoracic tracheal pores well marked, situated at points of slight marginal indentation. Caudal furrow (Fig. 18) marked in posterior part by longitudinal rugae extending from caudal tracheal pore, and along remainder of its length by denser cuticular markings. Median lengths of abdominal segments I–VII subequal. Minute pairs of cephalic and first and eighth abdominal setae present, capitate, resembling tiny match sticks. A similar pair, the caudal setae, present about half-way between vasiform orifice and posterior margin of case (Fig. 18).

**Venter.** Thoracic and caudal tracheal folds defined by bands of fine stipples. Antennae rather long, almost reaching articulation of middle legs. A fine seta present at base of each middle and hind leg, similar to ventral abdominal setae, although a little shorter.

Holotype pupal case, **Papua New Guinea:** Morobe Province coast, Buso riverbank, on *Decaspermum* sp. (Myrtaceae), 16.x.1979 (*J. H. Martin* 2713) (BMNH).

Paratype pupal cases. 5, same data as holotype; 48, same locality and host, ix–x.1979 (*JHM* 2528, 2621, 2690, 2755) (BMNH; USNM).

**COMMENTS.** The striking pupae of this species were found only on small bushy plants identified as a *Decaspermum* sp. (Myrtaceae) growing in situations alongside the river and on the beach-top at Buso. They were invariably seen on the young leaves near the growing points of the plants. The apparent absence of the species from other plants in the area throughout a three-month period suggests strong host specificity. The pupae were found in shallow concavities on the leaf undersides, thus remaining flush with the leaf surface. There appears to be sexual dimorphism in this species, with two distinct size ranges within the overall size range described above, but no adults were obtained to confirm this. The pupae were not protected by any visible waxy or woolly secretions, and were not attended by ants. Individuals were fairly evenly scattered over the affected leaves.

*D. decaspermi* may be distinguished from other *Dialeurodes* species by its most unusual sclerotic patterning, combined with its large size and distinctively sculptured dorsum.

***Dialeurodes kirkaldyi* (Kotinsky)**

*Aleyrodes kirkaldyi* Kotinsky, 1907: 95, fig. 2. Syntype pupal cases, HAWAII (HDA; USNM).  
*Dialeurodes kirkaldyi* (Kotinsky) Quaintance & Baker, 1914: 98.

DISTRIBUTION. Irian Jaya, and several countries in each zoogeographical region excepting the Malagasy Region.

## MATERIAL EXAMINED

**Irian Jaya:** Sukarnapura, on *Jasminum* sp. (Oleaceae) (BMNH; BPBM).

***Dialeurodes psidii* Corbett**

(Fig. 43)

*Dialeurodes psidii* Corbett, 1935a: 734. Syntype pupal cases, WEST MALAYSIA (presumed lost).  
*Dialeurodes lumpurensis* Corbett, 1935a: 739. Syntype pupal cases, WEST MALAYSIA (presumed lost).

**Syn. n.**

Corbett (1935a) described seven species of *Dialeurodes* in which the longitudinal and transverse moulting sutures are joined by a cephalothoracic suture, giving rise to distinct 'trapdoors' which can become detached as the adult emerges. Corbett's material on which he based his 1935 publication is thought to be destroyed, but specimens from New Guinea vary between samples in the degree of cuticular marking, and even within samples to some degree; it is considered that *psidii* and *lumpurensis* are synonymous, with *psidii* having page priority. Certainly, from Corbett's observations, and from the study of the material seen from New Guinea, it seems that *psidii* has a wide range of hosts, and it may be that other species in this group will prove to be conspecific also.

DISTRIBUTION. Irian Jaya, Papua New Guinea, Sarawak, Thailand, West Malaysia.

## MATERIAL EXAMINED

**Irian Jaya:** Biak, on *Ficus* sp. (Moraceae) (BMNH). **Papua New Guinea:** Buso, on *Anisoptera thurifera polyandra* tree crown (Dipterocarpaceae), *Celtis* sp. (Ulmaceae), *Decaspermum* sp. (Myrtaceae), *Diospyros* sp. (Ebenaceae), *Euodea* sp. (Rutaceae), *Gyrocarpus* sp. (Gyrocarpaceae), *Lophopetalum* sp. (Celastraceae), *Macaranga* sp. (Euphorbiaceae), *Myrtella* sp. (Myrtaceae), *Premna* sp. (Verbenaceae), *Xanthophyllum papuanum* (Xanthophyllaceae), and undetermined hosts; Lasanga Island, on *Euodea* sp. (Rutaceae); Wau Ecology Institute, on *Ficus* sp. (Moraceae) (all BMNH); Kratke Mts, on *Neonauclea* sp. (Naucleaceae) (BMNH; BPBM). **Sarawak:** Gunung Mulu National Park, on undetermined host (BMNH). **West Malaysia:** Taman Negara National Park, on Melastomataceae; Genting Highlands, on undetermined host. (All BMNH.)

**DIALEUROPORA** Quaintance & Baker

*Dialeurodes (Dialeuropora)* Quaintance & Baker, 1917: 434. Type-species: *Dialeurodes (Dialeuropora) decempuncta* Quaintance & Baker, by monotypy.

*Dialeuropora* Quaintance & Baker; Takahashi, 1934: 46 [raised to genus].

Most specimens from New Guinea have been identified as the very common and widespread species *decempuncta*, but one sample (sp. 1, p. 307) from *Elmerrillea* sp. (Magnoliaceae) contains a species resembling *brideliae* (Takahashi), with the vasiform orifice rather small relative to its distance from the posterior margin of the pupal case and an apparent absence of short lanceolate setae around the submargin.

***Dialeuropora decempuncta* (Quaintance & Baker)**

(Fig. 40)

*Dialeurodes (Dialeuropora) decempuncta* Quaintance & Baker, 1917: 434. Syntype pupal cases, SRI LANKA, PAKISTAN (USNM).

*Dialeuropora decempuncta* (Quaintance & Baker) Takahashi, 1934: 46.

*Dialeuropora perseae* (Corbett), 1935a: 749. Syntype pupal cases, WEST MALAYSIA (presumed lost). **Syn. n.**

Mound & Halsey (1978) concluded that *D. decempuncta* varies considerably, particularly in the precise form and size of the submarginal setae, and accordingly synonymised *setigerus* (Takahashi, 1934) and *dothioensis* (Dumbleton, 1961a) with *decempuncta*. *Dialeuropora perseae* (Corbett, 1935a) was described as differing from *setigerus* only in the presence of 'a ring of small submarginal pores around the case, and of similar-sized pores distributed throughout the dorsum'. The BMNH paratype of *dothioensis* possesses these pores, in common with many other specimens of *decempuncta*. Importantly, several samples contain both individuals with obvious small pores and those with such small pores not evident, and *D. perseae* is regarded as a junior synonym of *decempuncta*.

The samples of *decempuncta* from *Breynia* in New Guinea exhibit a further variation, which is very confusing when encountered in its most extreme form – a tendency to lose the 5 pairs of large simple subdorsal pores which are the principal diagnostic feature of the genus. One sample each from Lasanga Island and Buso contains individuals which vary from those lacking the 5 pairs of pores to those with the pores all present but small, and individuals from two further Buso samples all lack pores. The remainder of the morphological characters, particularly the short lanceolate setae in the submargin and the shape and size of the vasiform orifice and lingula, are typical.

The samples from ?*Breynia* (Wau) and *Glochidion* (Buso) have normally developed large pores and submarginal setae, but have unusually long first and eighth abdominal, caudal and cephalic setae – longer than the width of the vasiform orifice.

Material from Tonga (BMNH), identified as *decempuncta* and listed in Mound & Halsey, does not match even the variants described here and should be regarded as belonging to an unidentified species of *Dialeuropora*.

**DISTRIBUTION.** Austro-Oriental Region: Java, Papua New Guinea, Sarawak, Singapore, West Malaysia. Oriental Region: Cambodia, India, Pakistan, Sri Lanka, Taiwan, Thailand. Pacific Region: New Caledonia. Australasian Region: Northern Territory.

#### MATERIAL EXAMINED

**Papua New Guinea:** Buso, on *Alphitonia* sp. (Rhamnaceae), *Breynia* sp. (Euphorbiaceae), *Colocasia* c.v. (Araceae), *Glochidion* (Euphorbiaceae), *Macaranga* sp. (Euphorbiaceae), *Pometia pinnata* tree crown (Sapindaceae), *Tetracera* sp. (Dilleniaceae) and undetermined host; Lasanga Island, on *Breynia* sp., *Macaranga* sp., *Pterocarpus ?indicus* (Leguminosae) and ?Leguminosae; Wau Ecology Institute, on ?*Breynia* sp. (all BMNH). **Java:** Jakarta, on *Musa* sp. (Musaceae) and *Psidium guajava* (Myrtaceae) (BMNH). **Sarawak:** Gunung Mulu National Park, on ?*Millettia* sp. (Leguminosae) and undetermined hosts (all BMNH). **Singapore:** on ?*Eugenia* sp. (Myrtaceae) (BMNH). **West Malaysia:** Taman Negara National Park, Kuala Tahan, on *Flemingia macrophylla* (Leguminosae) and undetermined hosts; Tioman Island, on *Bauhinia* sp. vine (Leguminosae) and ?Leguminosae (all BMNH). **New Caledonia:** Dothio River bridge (paratypes of *Dialeurodes dothioensis* Dumbleton, F. Cohic. coll., synonymised by Mound & Halsey, 1978), on undetermined host (BMNH). **Australia:** Northern Territory, on *Eucalyptus* sp. (Myrtaceae) (BMNH).

#### **INDOALEYRODES** David & Subramaniam

*Indoaleyrodes* David & Subramaniam, in Krishnamurthy, Raman & David, 1973: 75. Type-species:

*Indoaleyrodes pustulatus* David & Subramaniam, by monotypy.

*Indoaleyrodes* David & Subramaniam, 1976: 199.

The name *Indoaleyrodes pustulatus* was first published in an account of the feeding damage to leaves of *Morinda tinctoria* (Rubiaceae) (Krishnamurthy, Raman & David, 1973, quoting David & Subramaniam, 1972). The 1972 reference was given as 'Studies on some Indian Aleyrodidae (in press), *Mem. zool. Surv. India, Calcutta*' which in fact appeared, in a different journal, in 1976. Although a description of the work of an animal constitutes an 'indication' for the purposes of Article 25 of the Code, the definitive description of *I. pustulatus* appears in David & Subramaniam (1976), and the 'holotype' and 'paratypes' must properly be regarded as syntypes (3 in BMNH [examined]).

*I. pustulatus* is considered a junior synonym (syn. n.) of *Dialeurodes laos* Takahashi (1942), and *laos* is here included in *Indoaleyrodes* (comb. n.).



*Indoaleyrodes* differs from *Dialeurodes* primarily in its deeply indented thoracic and caudal tracheal pores, combined with a triangular vasiform orifice in which the operculum does not occupy most of its area as in *Dialeurodes*.

In addition to *laos* and *pseudoculatus* (see below), it is clear that *Parabemisia reticulata* Dumbleton (1961a) should also be included in *Indoaleyrodes* (comb. n.).

***Indoaleyrodes pseudoculatus* sp. n.**

(Figs 20, 21)

**PUPAL CASE.** Outline almost circular, only 1.15–1.25 times longer than wide, widest opposite hind legs, margin indented slightly at thoracic and caudal tracheal openings, but with actual tracheal pores inset from main marginal outline by about 3 times pore diameter (Fig. 20). Apparently sexually dimorphic, with dimensions in the ranges 1.34–1.41 mm by 1.15–1.21 mm and 1.03–1.09 mm by 0.86–0.90 mm. Margin smooth and slightly irregular, with single pairs of short, fine anterior and posterior marginal setae. Cuticle pale, transparent.

**Dorsum.** Closely set parallel lines run mesad from margin into outer subdorsum, length of these lines a little greater than distance from main marginal outline to tracheal pores (Fig. 20, inset). Thorax bearing a pair of very prominent oval glandular areas with polygonal reticulate pattern, resembling compound eyes; each patch situated about mid-way between thoracic tracheal pore and legs, and a little longer than vasiform orifice. A pair of comma-shaped patches of similar appearance adjacent to vasiform orifice, similar in length to orifice (Fig. 21). Remainder of dorsal surface smooth, with a few scattered tiny disc pores. Moulting sutures rather faint, not apparently reaching margin. Median length of abdominal segment VII about half that of segment VI. Dorsal disc not defined. Only 3 pairs of dorsal setae present, all fine and rather short, cephalic and caudal pairs hardly longer than diameter of tracheal pore: cephalic setae placed at level of apices of front legs; eighth abdominal setae lateral to anterior edge of vasiform orifice; caudal setae slightly anterolateral of caudal tracheal pore. Vasiform orifice (Fig. 21) large, triangular, 1.15–1.25 times longer than wide, inset from posterior margin of case by about 1.5–2.0 times its own length; posterior part of internal margin of vasiform orifice produced into a squared process with width similar to diameter of head of lingula. Caudal furrow not marked. Operculum rounded-trapezoidal, occupying basal half of vasiform orifice. Lingula long and stout, head developed into a spinulose club with a pair of basal lateral lobes and an apical pair of long spines which overlap apex of vasiform orifice; lingula exposed but included within vasiform orifice.

**Venter.** Caudal and thoracic tracheal folds marked by small groups of coarse spinules running mesad in widening bands from the pores (Fig. 20); caudal fold achieving width of vasiform orifice at level of posterior abdominal spiracle, and thoracic folds achieving similar maximum width. A short spine present at base of each middle and hind leg. Mouthparts well developed, with distinct aphid-like ultimate rostral segment of similar length (longitudinal axis) to operculum. Ventral abdominal setae similar to dorsal eighth abdominal setae.

Holotype pupal case, **Papua New Guinea:** Morobe Province coast, Buso, on tree-crown foliage of *Syzygium* sp. (Myrtaceae), 8.x.1979 (J. H. Martin 2674) (BMNH).

Paratypes. 13 pupal cases, 1 larva, same data as holotype (BMNH).

**COMMENTS.** This species is known from a single collection from young crown leaves of a 26-metre high tree of a *Syzygium* sp., reached from a walkway in the forest canopy. The pupae were not attended by ants, and no adults were found. The genus *Indoaleyrodes* is very little known, so no speculation may be made about the likely host range of this remarkable new species. At least two of the specimens were parasitized.

*I. pseudoculatus* is at once separated from the other described species by the remarkable glandular areas on the cephalothorax, which resemble compound eyes, and by the comma-shaped glandular areas on each side of the vasiform orifice.

Two pupal cases which closely resemble *pseudoculatus* are present in the BMNH collection (*Indoaleyrodes* sp. 2, p. 307). One is incomplete and the second evidently damaged by a fungus before it was collected. They differ from *pseudoculatus* in having the abdominal glandular areas fused to form a U-shape, which starts anterior to the vasiform orifice and crosses the caudal furrow half-way between the orifice and the caudal pore; they also differ in the shape and position of the vasiform orifice. They were collected from an undetermined host at 6,000 ft in the Kampere Barola Divide.



Another species of *Indoaleyrodes* (sp. 1, p. 307) is represented by a single pupal case from *Celtis philippinensis* (Ulmaceae), but this possesses neither cephalothoracic nor abdominal glandular areas.

### **NEOMASKELLIA** Quaintance & Baker

*Neomaskellia* Quaintance & Baker, 1913: 91. Type-species: *Aleurodes comata* Maskell, by monotypy.

#### ***Neomaskellia bergii*** (Signoret)

(Fig. 38)

*Aleurodes bergii* Signoret, 1868: 395. Syntype pupal cases, MAURITIUS (depository unknown).

*Neomaskellia bergii* (Signoret) Quaintance & Baker, 1914: 104.

**DISTRIBUTION.** Papua New Guinea; also widely distributed throughout Africa, the Orient, South East Asia and the Pacific Region.

#### **MATERIAL EXAMINED**

**Papua New Guinea:** Lasanga Island, on *Saccharum officinarum* (Gramineae), attended by ants (*Oecophylla smaragdina*); Bubia (Lae), on *Saccharum officinarum* and *Cenchrus ciliaris* (Gramineae); Pig Island (Madang), on *Saccharum officinarum*; Amax mining camp (Hessen Bay, Morobe Province), on undetermined grass (all BMNH); Wau, on undetermined grass (BMNH; BPBM); Laloki, on undetermined grass (BMNH; BPBM); 'Papua', on *Saccharum* sp. (BPBM).

### **ORCHAMOPLATUS** Russell

*Aleuroplatus (Orchamus)* Quaintance & Baker, 1917: 400. Type-species: *Aleuroplatus (Orchamus) mammaeferus* Quaintance & Baker, by monotypy. [Homonym of *Orchamus* Stål, 1876: 30 (Orthoptera).]

*Orchamus* Quaintance & Baker; Dumbleton, 1956: 13 [raised to genus].

*Orchamoplatus* Russell, 1958: 390. [Replacement name for *Orchamus* Quaintance & Baker.]

Since Russell (1958) revised the genus, with 10 included species, a further three, *dumbletoni* (Cohic, 1959), *perdentatus* Dumbleton (1961a) and *sudaniensis* Gameel (1968), have been described. As *sudaniensis* does not possess submarginal glands of the dentate type characteristic of *Orchamoplatus*, it should be included in *Neoaleurotrachelus* Takahashi & Mamet [synonymous with *Jeannelaleyrodes* Cohic (Bink-Moenen, 1983)] (**comb. n.**); this opinion was expressed to Gameel by Mound (pers. comm., 1967) prior to publication of the description.

#### ***Orchamoplatus niuginii* sp. n.**

(Figs 22, 23)

**PUPAL CASE.** Completely pale to slightly dusky, ovoid, rather large: 0.85–1.25 mm long, 0.59–0.87 mm wide, mostly 1.4–1.5 times as long as wide, widest at abdominal segment II. Margin irregularly crenulate, about 13–15 small, rounded crenulations to 0.1 mm of abdominal margin, with fine folds running mesad for a short distance from the bases of the crenulations (Fig. 23). Margin much indented at regions of thoracic and caudal tracheal openings, marginal crenulations very strongly differentiated to form thoracic and caudal tracheal combs. Usual pairs of anterior and posterior marginal setae present.

**Dorsum.** Submargin with single row of evenly spaced dentate glands (the term 'gland' used by Russell, 1958), 50–70 pairs in total, with 16–20 pairs anterior to thoracic combs and 38–50 pairs posteriorly (Fig. 22); structure of glands as in Fig. 23. Row of submarginal dentate glands mostly inset from margin by 3–4 times length of gland crown, although row of glands and margin converge at tracheal regions. Dentate glands adjacent to thoracic and caudal combs not different to remaining glands, not reaching margin. Thoracic and caudal tracheal combs well developed, set in deep marginal concavities, with fluted areas at the tooth bases extending mesad of the line of dentate glands; thoracic combs normally with 10 or 11 teeth, caudal comb with 8–10 teeth, combs evidently arched dorsally. Seven pairs of tiny submarginal setae present, 3 cephalic, 2 thoracic and 2 mid-abdominal; the line of these setae completed by minute, evenly spaced porettes. Most specimens with pronounced cephalothoracic fold parallel to margin between submargin and subdorsum, fold extending posteriorly half-way to thoracic combs and then fading gradually. Longitudinal moulting suture not reaching margin of pupal case, terminating at cephalothoracic fold; transverse

moulting sutures terminating in outer subdorsum. Dorsal cuticle mesad of dentate glands virtually smooth, punctuated only by very fine transverse lines of spinulose sculpturing on median part of abdominal segments II–VII, by coarser spinulose corrugations on median part of abdominal segment VIII (Fig. 23), and by an evenly spinulose patch on abdominal segment I (Fig. 22). Single pairs of cephalic, first and eighth abdominal setae present; cephalic and eighth abdominal pairs fine, cephalic pair the shorter; pair of setae on abdominal segment I in form of thick, chitinous spatulas which are often lost in preparation for slide-mounting. Disc pores well developed, about 12 pairs distributed as shown in Fig. 22. Vasiform orifice (Fig. 23) elevated and thus liable to distortion in slide-mounted specimens, subcircular, inner walls vertical with parallel vertical ridges; orifice about 60  $\mu\text{m}$  in diameter, usually appearing slightly wider than long, and inset a little more than its own length from posterior margin of pupal case (measured from apex of caudal tracheal comb). Operculum subtrapezoidal, almost filling cross-sectional area of vasiform orifice. Lingula shorter than vasiform orifice, head obscured by operculum, apparently rather square and densely spinulose. Caudal setae very long and fine, up to 0.21 mm long, bases situated just mesad of line of dentate glands, on inner border of caudal comb area. Caudal furrow not marked.

*Venter.* Thoracic and caudal tracheal folds virtually unmarked. A minute conical spine present at base of each middle and hind leg. Median parts of abdominal segments II–VIII very finely spinulose. Bases of ventral abdominal setae near anterior edge of vasiform orifice. Rostral base setae tiny, smaller than leg-base spines.

Holotype pupal case, **Papua New Guinea**: Morobe Province coast, Lasanga Island, on *Calophyllum inophyllum* (Guttiferae), 18.ix.1979 (J. H. Martin 2581) (BMNH).

Paratypes. **Papua New Guinea**: 47 pupal cases, 1 larva, same data as holotype; 30 pupal cases, Morobe Province coast, Buso, same host, 30.ix.1979 (JHM 2643); 19 pupal cases, 3 larvae, Lasanga Island, same host, 7.xi.1979 (JHM 2816); 3 pupal cases, 1 larva, Buso, on *Durandea* sp. (Linaceae) at canopy level, 8.x.1979 (JHM 2676) (BMNH; USNM).

COMMENTS. The species occurs in very dense colonies on the underside of mature leaves of littoral *Calophyllum inophyllum* (Guttiferae), and is not attended by ants. These dense aggregations of pupae and larvae are covered with a glassy, translucent secretion which becomes hard when specimens are stored dry; folding the leaf then causes flakes of secretion to peel away with the insects embedded in it. The earlier larval exuviae often remain attached to the dorsa of the later stages, and sometimes all instars are represented in a stack. No adults were found and there was no sign of empty cases from which adults had emerged. A few specimens were also taken from a leaf of a species of *Durandea* vine in the forest canopy, but this provides the only firm evidence of oligophagy.

*O. niuginii* is similar to *mammaeferus* (Quaintance & Baker) and *montanus* (Dumbleton), but differs from both in the following characteristics: submarginal dentate glands further inset from margin (3–4 times length of gland crown, compared with up to twice); dentate glands adjacent to both thoracic and caudal combs not larger than remainder of glands, not reaching margin of case; generally a larger species, pupal cases mostly over 1.0 mm long. *O. niuginii* further differs from *mammaeferus* in the possession of a pair of cephalic setae. *O. niuginii* bears no close resemblance to *calophylli* Russell, which was described from a species of *Calophyllum* in Tonga.

A further colony of *Orchamoplatus* at Buso was taken from a tree-crown leaf, possibly belonging to a species of *Lophopetalum* (Celastraceae). The mounted specimens agree with *niuginii* in most respects, but differ in the apparent shape of the vasiform orifice, and in possessing less-indented thoracic and caudal tracheal areas (apices of centre teeth in combs stand proud of margin of case). A field note states that all were parasitised, appearing black, and the venters failed to detach from the leaf. The mounted specimens, with parasites removed, are pale but ventrally incomplete; they are possibly morphologically modified by the parasites and are tentatively determined as *niuginii*.

### PARABEMISIA Takahashi

*Parabemisia* Takahashi, 1952: 21. Type-species: *Parabemisia maculata* Takahashi, by original designation.

Takahashi (1952) erected *Parabemisia* to accommodate his new species *maculata*, *Bemisia aceris* Takahashi and *Bemisia myricae* Kuwana.

Dumbleton (1961a) assigned his species *reticulata* to *Parabemisia* on the basis of its laterally

bilobed lingula head, while noting that other characters were not typical of the genus; *reticulata* is here transferred to *Indoaleyrodes* David & Subramaniam (1973) (comb. n.).

The five species currently placed in *Parabemisia* are keyed below, in a modified version of Takahashi's original key.

### Key to species of *Parabemisia*

#### Pupal cases

- 1 Submarginal setae very short, sometimes hardly recognisable, numbering 11 pairs (excluding anterior and posterior marginal pairs and caudal pair). Head of lingula rather triangular, evenly tapering from near its base ..... 2
- Submarginal setae long and conspicuous, subequal in length to vasiform orifice and caudal setae, normally numbering 11 or 13 pairs (excluding anterior and posterior marginal pairs and caudal pair). Head of lingula rather ovoid, not tapering evenly from near its base ..... 3
- 2 Head of lingula slender, over twice as long as wide; vasiform orifice elongated, caudal furrow distinct and slender; tracheal folds (ventral) with fine dots..... *aceris* (Takahashi)
- Head of lingula not slender, rather abruptly tapering; vasiform orifice not elongated, caudal furrow not well defined, but wider; tracheal folds without fine dots..... *maculata* Takahashi
- 3 Submargin normally with 11 pairs of setae (excluding caudal pair). Dorsum bearing many large, tubercular pores, each of which is about half as wide as operculum ..... *jawani* sp. n. (p. 331)
- Submargin normally with 13 pairs of setae (excluding caudal pair). Dorsum not bearing large, tubercular pores ..... 4
- 4 Usually entirely pale, very occasionally with slight duskiness. Vasiform orifice with lateral margins straight or slightly concave ..... *myrica* (Kuwana)
- Never entirely pale, always with submargin and subdorsum brown. Vasiform orifice subcordate, lateral margins markedly convex, thickened ..... *myrmecophila* sp. n. (p. 332)

### *Parabemisia jawani* sp. n.

(Figs 24, 25)

**PUPAL CASE.** Pale, oval, 0.8–1.1 mm long, broadest at abdominal segment III, 1.2–1.4 times as long as wide. Posterior margin flattened but hardly indented, without marginal indentation towards thoracic tracheal areas. Margin bluntly and rather unevenly crenulate, with about 12 teeth occupying 0.1 mm of margin. Thoracic and caudal tracheal openings each marked by a simple notch which is hardly wider than one marginal tooth (Fig. 25). Posterior marginal setae present, but anterior pair apparently lacking.

**Dorsum.** Twelve pairs of submarginal setae present, 6 on cephalothorax and 6 on abdomen, including caudal pair; setae fine, a little longer than vasiform orifice, their bases situated just mesad of marginal teeth. A pair of tiny hairs present on each of abdominal segments I and VIII, but cephalic pair absent. Dorsum punctuated by evenly distributed, large, circular tubercular pores, each about half of opercular width in diameter, and with a paler central opening in stained specimens (Fig. 24). Median line of abdomen devoid of these pores, with evenly staining cuticle. Remainder of dorsal cuticle smooth, but staining picks out variations in sclerotisation which appear as irregular polygonal plates delineated by paler lines. Median lengths of abdominal segments I–VI subequal, but that of segment VII much reduced. Median lengths of meso- and metathoracic segments also subequal. Both transverse and longitudinal moulting sutures reaching margin, the dorsal halves of cephalothorax easily becoming detached. Vasiform orifice (Fig. 25) rounded-triangular to trapezoidal, with posterior margin abruptly truncated although not marked by a sharp line; orifice inset from posterior margin by about 3 times its own length; internal walls of orifice smooth, not notched. Operculum laterally-rounded trapezoidal, occupying about two-thirds of vasiform orifice. Lingula exposed, only just included in orifice; head dark, finely spinulose, with a pronounced pair of lateral processes; apical setae not apparent. Caudal furrow well marked by a line of darkly staining spots.

**Venter.** Caudal and thoracic tracheal folds marked by bands of fine dots running mesad from margin, reaching vasiform orifice and outer edges of legs respectively (Fig. 25). A minute conical spine present at base of each middle and hind leg. Ventral abdominal setae long, fine, about as long as vasiform orifice. Abdominal spiracles close to ventral abdominal setae, appearing claw-like.

Holotype pupal case, **Papua New Guinea:** Morobe Province coast, Jawani Island, on undetermined woody host, 2.xi.1979 (*J. H. Martin* 2789) (BMNH).

Paratype pupal cases. 16, same data as holotype (BMNH).

COMMENTS. Nothing is known about the biology of this insect, which was encountered only once feeding on an undetermined woody host alongside mangroves on a small offshore island. The pupae were not attended by ants.

*P. jawani* is very distinctive with its large dorsal tubercular pores, and can be separated by the characters given in the key.

***Parabemisia myrmecophila* sp. n.**

(Figs 26, 27)

PUPAL CASE. Outline rather pear-shaped, 0.65–0.90 mm long, 0.45–0.62 mm wide, broadest at abdominal segment III, mostly 1.4–1.5 times as long as wide. Brown, with variable median area pale, ranging from individuals which are almost evenly brown to those with whole of submedian area of dorsal disc pale; pale area widest on cephalothorax (Fig. 26). Margin (Fig. 27) evenly crenulate, with about 20 rounded-triangular teeth occupying 0.1 mm of margin. Margin very gently indented towards thoracic area at point where a tracheal comb is slightly differentiated from remainder of marginal teeth; posterior margin of case rounded or flattened, but not indented.

*Dorsum*. A row of 14 pairs of submarginal setae present, including caudal pair, setal bases situated just mesad of marginal teeth; submarginal setae fine, similar in length to the single pairs of cephalic and first and eighth abdominal setae, subequal to length of vasiform orifice. Dorsal disc pores similar in size to setal bases, scattered evenly, with 4–5 pairs on each of abdominal segments III–VIII, and about 30 pairs on cephalothorax. Tiny disc pores also present. Cuticle slightly wrinkled, with a few darker granular markings on the brown areas. Median length of abdominal segment VII much less than half that of segment VI, abdomen appearing 7-segmented along median line. Longitudinal and transverse moulting sutures reaching margin of case. Vasiform orifice (Fig. 27) rather large, nearly 0.1 times length of case, subcordate, posterolaterally much thickened with toothed inner margin, posterior margin rather flattened; orifice 60–80  $\mu\text{m}$  long and wide, situated 65–100  $\mu\text{m}$  from posterior margin of case. Operculum trapezoidal, only about half filling orifice. Lingula shorter than vasiform orifice, exposed but included; lingula head spinulose, with an apical pair of setae which are longer than lingula head, bearing a pair of small lateral lobes at base of head, each lobe with a short seta. Caudal furrow discernible in most specimens, although marked to a rather variable degree.

*Venter*. Caudal and thoracic tracheal folds not defined. A minute conical spine at base of each middle and hind leg, hardly longer than its own basal width. Ventral abdominal setae fine, similar to posterior marginal setae, but situated under vasiform orifice and thus not easy to see. Rostral base setae relatively large, over half length of anterior marginal setae, fine.

Holotype pupal case, **Papua New Guinea**: Morobe Province coast, Buso, on *Cryptocarya* sp. (Lauraceae), 27.ix.1979 (*J. H. Martin* 2629) (BMNH).

Paratypes. **Papua New Guinea**: 48 pupal cases, same data as holotype; 11 pupal cases, 7 larvae, Buso, on *Anisoptera* sp. (Dipterocarpaceae), 27.ix.1979 (*JHM* 2626); 44 pupal cases, 4 larvae, Buso, on *Macaranga* sp. (Euphorbiaceae), 27.ix.1979 (*JHM* 2627); 44 pupal cases, 1 larva, Buso, on *Prunus* sp. (Rosaceae), 26.ix.1979 (*JHM* 2622) (BMNH; USNM).

COMMENTS. This species was always found in very dense colonies on undersides of young leaves of small woody saplings growing on the forest floor. In each case, the colony was vigorously attended by ants, *Rhoptromyrmex melleus* (Emery). In one case, adults were observed emerging and then congregating in groups on the very youngest leaves of the same plant, *Cryptocarya* sp. It seems likely that in this way the colony can keep pace with the growth of the plant while it remains suitable for colonisation.

*P. myrmecophila* may be distinguished from other described species of *Parabemisia* by characters given in the key.

**PEALIUS** Quaintance & Baker

*Pealius* Quaintance & Baker, 1914: 99. Type-species: *Aleyrodes maskelli* Bemis, by original designation.

There are currently 28 species assigned to *Pealius*, and the genus is particularly difficult to define; typically, the vasiform orifice has a 'false' posterior margin, continuing posteriorly as a shallow depression which is distinct from the caudal furrow (Fig. 28).

Five species from New Guinea are assigned to the *Pealius*-group, and are listed with host data on p. 308.

**RHACHISPHORA** Quaintance & Baker

*Dialeurodes (Rhachisphora)* Quaintance & Baker, 1917: 430. Type-species: *Dialeurodes (Rhachisphora) trilobitoides* Quaintance & Baker, by original designation.

*Rhachisphora* Quaintance & Baker; Takahashi, 1952: 22 [raised to genus].

In addition to the specimen tentatively identified as *R. ardisiae* (see below), two further samples have been studied from New Guinea (p. 308). *Rhachisphora* sp. 1 has an oval pupal case similar to *ardisiae* and some other species, differing markedly from the anteriorly flattened species of the *trilobitoides*-group; this sample was collected from tree-crown leaves of a *Schefflera* sp. (Araliaceae) in Buso forest. The second sample (*Rhachisphora?*, sp. 2) contains pupal cases which are almost circular and markedly convex: the rather wide submedian area is smooth and brownish; the submargin and outer subdorsum are pale; the inner subdorsal area comprises 2 lateral, arcuate, imbricate zones which stain very deeply and which have about 20 radial 'spokes' leading into the submargin, forming a pronounced though highly unusual rhachis.

**(?) *Rhachisphora ardisiae* (Takahashi) comb. n.**

*Dialeurodes ardisiae* Takahashi, 1935: 50, fig. 35. Syntype pupal cases, TAIWAN (TARI).

This record is based upon a single specimen which has not been compared with the type-material; accordingly, the record should be regarded as tentative, but from the description it is clear that *ardisiae* should be placed in *Rhachisphora*, rather than in *Dialeurodes*.

DISTRIBUTION. (Papua New Guinea), Taiwan.

## MATERIAL EXAMINED

**Papua New Guinea:** Buso, on undetermined host (BMNH).

**TETRALEURODES** Cockerell

*Aleyrodes (Tetraleurodes)* Cockerell, 1902: 283. Type-species: *Aleyrodes perileuca* Cockerell, by original designation.

*Tetraleurodes* Cockerell; Quaintance & Baker, 1914: 107 [raised to genus].

Fifty-seven species of whitefly are currently placed in *Tetraleurodes*, which is a difficult genus to define. Those from New Guinea that are assigned to the *Tetraleurodes*-group all have dark brown to black pupal cases, lack thoracic and caudal tracheal differentiation, and have the submarginal and subdorsal regions separated by a suture-like fold.

The 9 species from New Guinea are listed with host data on p. 308.

**TRIALEURODES** Cockerell

*Aleyrodes (Trialeurodes)* Cockerell, 1902: 283. Type-species: *Aleyrodes pergandei* Quaintance, by original designation.

*Trialeurodes* Cockerell; Quaintance & Baker, 1915: xi [raised to genus].

***Trialeurodes vaporariorum* (Westwood)**

(Fig. 29)

*Aleyrodes vaporariorum* Westwood, 1856: 852. Syntype pupal cases, adults, GREAT BRITAIN: England (Westwood collection, thought to be part of type series, BMNH; UMO) [examined].

*Trialeurodes vaporariorum* (Westwood) Quaintance & Baker, 1914: 105.

DISTRIBUTION. Papua New Guinea; also very widely distributed throughout the world, although Oriental, Austro-Oriental and Australasian records are rather sparse.

## MATERIAL EXAMINED

**Papua New Guinea:** Goroka, on 'squash' (Cucurbitaceae) (BMNH; BPBM); Aiyura, on *Solanum lycopersicon* (Solanaceae) (BMNH); Chimbu, on English potato (Solanaceae) (BMNH). **Great Britain:** no data, part of Westwood series (BMNH).

**XENALEYRODES** Takahashi

*Xenaleyrodes* Takahashi, 1936: 113. Type-species: *Xenaleyrodes artocarpi* Takahashi, by monotypy.

Takahashi (1936) erected *Xenaleyrodes* for *artocarpi* from the Palau Islands (Caroline group). The genus is distinguished from *Aleurocanthus* by the characteristic tubiform submarginal spines which are much thicker in the basal two-thirds, by the absence of similar spines elsewhere on the pupal case and by the deflexed margin (see generic key, p. 309). From a study of the original description, and of material in the BMNH, it is clear that *Neomaskellia eucalypti* Dumbleton (1956) from Australia should also be placed in *Xenaleyrodes* (comb. n.).

A key to the pupal cases of the five species currently placed in *Xenaleyrodes* is given below.

**Key to species of *Xenaleyrodes*****Pupal cases**

- |   |   |                                     |
|---|---|-------------------------------------|
| 1 | Submarginal tubiform spines distinctly curved in apical third, often abruptly angled through 90° (Fig. 35). Comb of differentiated teeth present at position of thoracic tracheal openings near margin (Fig. 36).....                                   | 2                                   |
| - | Submarginal tubiform spines much narrowed in apical third, but generally straight (Figs 31, 33). No differentiated teeth in thoracic tracheal area.   |                                     |
|   | Posteriorly with a single pair of very long, stout setae 0.3–0.4 mm long .....  | 4                                   |
| 2 | Second cephalothoracic pair of submarginal tubiform spines set much closer to 1st pair than to 3rd pair. Thoracic tracheal combs normally with about 8 teeth .....  | 3                                   |
| - | All cephalothoracic submarginal tubiform spines evenly spaced. Thoracic tracheal combs normally with 4 teeth .....  | <i>timonii</i> sp. n. (p. 336)      |
| 3 | Dorsal cuticle rather rough, reticulate-granular; posterior margin of vasiform orifice produced into a pointed process with a median notch; all abdominal submarginal tubiform spines evenly spaced.....  | <i>artocarpi</i> Takahashi (p. 334) |
| - | Dorsal cuticle smooth; posterior margin of vasiform orifice smoothly rounded, not produced into a pointed process; posterior two pairs of abdominal submarginal tubiform spines set closer together than remaining 4 pairs. (Australia, Victoria) ..... | <i>eucalypti</i> (Dumbleton)        |
| 4 | Submargin with single row of about 30 pairs of shorter (90 µm) tubiform spines, interspersed with about 9 pairs of fine hairs up to 0.25 mm long (Fig. 30).....   | <i>broughae</i> sp. n. (p. 334)     |
| - | Submargin with single row of 11 pairs of longer (up to 0.12 mm) tubiform spines, interspersed with 7 pairs of short, lanciform, spines 25–40 µm long (Fig. 33) .....  | <i>iranicus</i> sp. n. (p. 335)     |

***Xenaleyrodes artocarpi* Takahashi**

*Xenaleyrodes artocarpi* Takahashi, 1936: 113, fig. 2. Syntype pupal cases, PALAU ISLANDS (TARI).

DISTRIBUTION. Palau Islands (Caroline group), Papua New Guinea.

**MATERIAL EXAMINED**

**Papua New Guinea:** Buso, on *Premna* sp. (Verbenaceae) and ?*Decaspermum* sp. (Myrtaceae) (BMNH).

***Xenaleyrodes broughae* sp. n.**

(Figs 30–32)

**PUPAL CASE.** Jet black, opaque, with an agglomeration of white wax (see comments). Evenly oval, 1.40–1.50 mm long, 1.00–1.10 mm wide, widest at abdominal segments I & II. Cases rather deep, with margin mostly deflexed under dorsum in slide-mounted specimens: apparent margin is thus merely part of submarginal dorsum and is smooth. Region of true margin complex: true margin serrate-toothed, with venter having another 'false margin' of rounded crenulations of about 3 times width of true marginal teeth (Fig. 32).

**Dorsum.** Dorsal surface almost smooth, and in evenly bleached specimens only slight mottling evident, even median abdominal segmentation little marked. Immediately mesad of (dorsal to) true margin is a line of small tubercles which appear paler than rest of cuticle; inset a little further is a ring of about 30 pairs of short, stout, tubiform spines with expanded apices, interspersed with about 9 pairs of very long fine hairs, including caudal pair (Fig. 30). Tubiform spines about 90 µm long, with basal two-thirds markedly swollen; fine submarginal hairs up to 0.25 mm long, the ring of spines and hairs appearing marginal owing to deflexing of true margin. Adjacent to caudal hairs, with bases a little further inset than submarginal ring of

tubiform spines, is a pair of remarkably stout setae, up to 0.4 mm long and much darker than dusky tubiform spines: it seems likely that these are modified tubiform spines. Single pairs of cephalic, first and eighth abdominal setae also present, as detailed in Fig. 30. Thoracic and abdominal tracheal openings not discernible. Small eyespots present, best seen in untreated specimens. Transverse moulting sutures reaching apparent margin, joined distally to longitudinal suture by a variably defined cephalothoracic fold running concentric to margin. Each thoracic segment with a single pair of subcircular depressions in cuticle. Vasiform orifice elevated, oval, with operculum occupying whole area of orifice and obscuring lingula; orifice inset from apparent margin by a little more than its own length; eighth abdominal setae arising from lateral extensions of vasiform orifice elevation.

*Venter.* Thoracic and caudal tracheal folds not marked. Entire venter smooth, not stippled or otherwise punctuated. Usual ventral spiracles, setae, legs and antennae present.

Holotype pupal case, **Papua New Guinea:** Southern Highlands Province, Eraue, on *Citrus* sp. (Rutaceae), 21.vii.1983 (*E. J. Brough* E630) (BMNH).

Paratype pupal cases. **Papua New Guinea:** 40, same data as holotype (BMNH; USNM). Spirit-stored material with same data as holotype (BMNH).

**COMMENTS.** Known from a single collection from the Southern Highlands Province of Papua New Guinea, where it occurred as a densely populated colony on a few leaves of a mature orange tree growing in a coffee nursery. Each pupa has a thin plate of wax covering the median and subdorsal areas, the wax thickening into dense white curls which extend from the submarginal area to well beyond the edge of the pupa, obscuring the ring of tubiform spines and hairs. The pupae are apparently attached to the leaf by the part of the venter inside the crenulate 'false margin', with a ring of white wax separating the outer ring of the venter from the leaf lamella. The colony was not apparently attended by ants.

The pupal cases were exceptionally resistant to bleaching, and could only be bleached successfully by using a mixture of 880-volume ammonia and approximately 20-volume hydrogen peroxide. With this reagent, bleaching to an acceptable level occurs in only a few minutes, without use of heat.

*X. broughae* can be distinguished from the other described species of *Xenaleyrodes* by the characters given in the key.

### *Xenaleyrodes irianicus* sp. n.

(Fig. 33)

**PUPAL CASE.** Jet black, opaque, in groups under leaves of host. Oval, up to 1.05 mm long, 0.85 mm wide, widest at abdominal segment I. Cases deep, margin deflexed, obscured by dorsum in slide-mounted specimens. True margin crenulate, with about 12 teeth to 0.1 mm of margin; a row of tubercles of similar size immediately mesad of true margin gives margin the appearance of being double in some preparations.

*Dorsum.* Smooth, unicolourous to slightly mottled in slide-mounted bleached specimens; abdominal and thoracic segmentation only faintly marked. Submarginal (apparently marginal, owing to deflexion of true margin) ring of about 11 pairs of tubiform spines up to 0.12 mm long, interspersed with 6 or 7 pairs of lanceolate spines about 25–40  $\mu$ m long, distributed as shown in Fig. 33. Caudally a pair of very long, stout spines (probably modified tubiform spines) up to 0.3 mm long, and a pair of fine caudal hairs about 0.15 mm long. Single pairs of cephalic, first and eighth abdominal setae present, as detailed in figure. Thoracic and abdominal tracheal openings not discernible. Eyespots present. Transverse moulting sutures reaching apparent margin, longitudinal suture not so. Vasiform orifice elevated, oval, with operculum completely obscuring lingula. Eighth abdominal setae arising from lateral extensions of vasiform orifice elevation. Whole of caudal and vasiform orifice area strikingly similar to that of *X. broughae*.

*Venter.* Ventral characters entirely as in *X. broughae*, with the exception of characteristics of true margin.

Holotype pupal case, **Irian Jaya:** Biak, on undetermined tree, 23.v.1959 (*T. C. Maa*) (BPBM).

Paratype pupal cases. 14, same data as holotype (BMNH; BPBM); dry material on leaf, same data as holotype (BPBM).

**COMMENTS.** Each pupa of *X. irianicus* is surrounded and covered by a secretion which, in dried specimens at least, is translucent and glassy, not the more usual white wax. Exuviae of the earlier instars do not appear to remain attached to the dorsum of the pupa.

*X. irianicus* is similar to *broughae* in having the submarginal ring of tubiform spines inter-



spersed with a smaller number of simple hairs/spines. However, the tubiform spines are fewer and longer, and the simple spines are fewer and shorter in *irianicus*.

A further species, *Xenaleyrodes* sp. 1 (p. 308), is represented by three damaged pupal cases from an unidentified host from near Lake Trist, Kuper Range, Papua New Guinea – this appears to be most similar to *irianicus*, but the submarginal tubiform spines do not appear to be interspersed with lanceolate spines, and the posteriormost pair are not as long and stout as in *irianicus*, although longer than the remainder.

### *Xenaleyrodes timonii* sp. n.

(Figs 34–37)

**PUPAL CASE.** Jet black, opaque, with little waxy secretion evident. Pupal cases oval, up to 0.95 mm long, 0.65 mm wide, widest at thoraco-abdominal suture. Cases rather deep, with submargin deflexed, folded under remainder of dorsum in slide-mounted specimens; the apparent margin is thus merely a part of the submarginal dorsum, and is smooth to irregular. True margin, at junction of dorsum and venter, smooth: apparent crenulate to serrate appearance in most specimens is due to an adjacent line of tiny tubercles (Fig. 36), precise appearance dependent upon angle of tubercles to viewing axis.

**Dorsum.** Cuticle almost completely smooth, punctuated only by one row of tiny tubercles just mesad of (i.e. vertically above, in unmounted specimens) true margin, and by disc porettes, a row just mesad of submarginal tubiform spines, a few subdorsally, and also scattered between tubiform spines and true margin. Submargin with single row of 12 pairs of evenly spaced, very prominent tubiform spines (Figs 34–37); tubiform spines of specimens *in situ* on leaf with basal half to two-thirds (about 70  $\mu$ m) horizontal, the apical part much narrower and angled downwards (see comments) through 90°, apices expanded, lacinate. Single pairs of cephalic and first and eighth abdominal setae present; first abdominal pair rather variable, with the extremes shown in Fig. 34. Caudal setae very long, fine, longer than other dorsal setae, sometimes as long as 0.2 mm. Eye spots not marked. Thoracic and abdominal tracheal furrows not marked, but combs distinct; thoracic combs (Fig. 36) normally with 4 rounded teeth, occasionally with 3 or 5, set distinctly mesad of (above) true margin, each tooth about half as wide as base of a submarginal tubiform spine; caudal comb similar, with about 6 teeth. Longitudinal and transverse moulting sutures not reaching true margin; transverse sutures reaching apparent margin, transverse and longitudinal sutures joined distally by a cephalothoracic suture. Vasiform orifice (Fig. 37) oval, elevated, produced posteriorly into a blunt process; orifice toothed posterolaterally on internal walls, a little longer than wide, inset from posterior margin of case by about half its own length, about 65–80  $\mu$ m long, 60–70  $\mu$ m wide, about 30–50  $\mu$ m from margin. Width of dorsal opening of orifice dependent upon degree of flattening in slide-mounted specimens, but evidently less than maximum internal width of orifice (Fig. 37), and often measuring less than width of operculum. Operculum rather small, trapezoidal, occupying only about half of internal cross-sectional area of vasiform orifice. Lingula short, finger-shaped, finely spinulose, exposed but included within vasiform orifice.

**Venter.** Thoracic and caudal tracheal folds not marked. Most of venter densely stippled, stipples most marked in submargin, only absent from median area of thorax. Abdominal segmentation evident. Minute conical seta present at base of each middle and hind leg. A group of 5–7 short, 2- or 3-pointed anchor spines present near anterior edge of venter, presumably to aid adhesion to leaf.

**Holotype pupal case, Papua New Guinea:** Morobe Province coast, Buso, on *Timonius* sp. (Rubiaceae), 10.ix.1979 (J. H. Martin 2527) (BMNH).

**Paratype pupal cases, Papua New Guinea:** (all from same general locality and same host species) 26, same data as holotype; 19, riverside, 13.ix.1979 (JHM 2552, 2556); 28, riverside, 13.x.1979 (JHM 2691, 2696); 5, beach-top, 12.x.1979 (JHM 2687A); 25, beach-top, 6.ix.1979 (JHM 2500) (BMNH; USNM).

**COMMENTS.** Known from seven samples, always from leaves of a species of *Timonius* growing on gravel bars between meanders of the fast-flowing Buso river, or in beach-top sand. The pupae occur in dense groups and are not attended by ants. The larval exuviae often remain attached to the dorsa of later stages, sometimes with all stages present in a stack. The species was never encountered on other hosts, and the name *timonii* appears appropriate. No adults were seen.

*X. timonii* may be distinguished from other *Xenaleyrodes* species by characters given in the key.

In Takahashi's original description of *X. artocarpi* (1936), the submarginal tubular spines are described as being 'eminently curved upward on the distal part'. It has not been possible to examine type-material of *artocarpi*, but specimens from New Guinea, identified as *artocarpi* by



the author, clearly have down-curved spines as in *timonii*, and Takahashi's statement is, in all probability, an error of visual interpretation.

## References

- Ashby, S. F. 1915. Notes on diseases of cultivated crops observed in 1913–1914. *Bulletin of the Department of Agriculture, Jamaica* 2: 299–327.
- Bink, F. A. 1979. Methods for mounting Aleyrodidae specimens. *Entomologische Berichten, Amsterdam* 39: 158–160.
- Bink-Moenen, R. M. 1983. Revision of the African Whiteflies (Aleyrodidae). *Monografiën van de Nederlandse Entomologische Vereniging* no. 10: 1–210.
- Cockerell, T. D. A. 1902. The classification of the Aleyrodidae. *Proceedings of the Academy of Natural Sciences of Philadelphia* 54: 279–283.
- 1903. The whitefly (*Aleyrodes citri*) and its allies. Pp. 662–666. In Gossard, H. A., Whitefly (*Aleyrodes citri*). *Bulletin. Florida Agricultural Experiment Station, Gainesville* 67: 599–666.
- Cohic, F. 1959. Contribution à l'étude des aleurodes de Nouvelle-Calédonie. *Orchamus dumbletoni* n. sp. *Bulletin de la Société entomologique de France* 64: 130–136.
- 1966. Contribution à l'étude des aleurodes africains (1<sup>e</sup> note). *Cahiers de l'office de la Recherche scientifique et technique Outre-Mer, Paris (Biologie)* 1: 3–59.
- 1968. Contribution à l'étude des aleurodes africains (3<sup>e</sup> note). *Cahiers de l'office de la Recherche scientifique et technique Outre-Mer, Paris (Biologie)* 6: 3–61.
- 1969. Contribution à l'étude des aleurodes africains (5<sup>e</sup> note). *Annales de l'Université d'Abidjan (série E: Ecologie)* 2 (2): 1–156.
- Corbett, G. H. 1927. Three new aleyrodids on coconut in Malaya. *Malayan Agricultural Journal* 15: 24–25.
- 1935a. Malayan Aleurodidae. *Journal of the Federated Malay States Museums* 17: 722–852.
- 1935b. On new Aleurodidae. *Annals and Magazine of Natural History* (10) 16: 240–252.
- 1936. New Aleurodidae. *Proceedings of the Royal Entomological Society of London (B)* 5: 18–22.
- 1939. A new species of Aleurodidae from India. *Indian Journal of Entomology* 1: 69–70.
- David, B. V. & Subramaniam, T. R. 1976. Studies on some Indian Aleyrodidae. *Record of the Zoological Survey of India* 70: 133–233.
- Douglas, J. W. 1892. Footnote to p. 32. In Morgan, A. C. F., A new genus and species of Aleurodidae. *Entomologist's Monthly Magazine* 28: 29–33.
- Dumbleton, L. J. 1954. A list of insect pests recorded in South Pacific territories. *South Pacific Commission Technical Paper* no. 79: 36.
- 1956. The Australian Aleyrodidae. *Proceedings of the Linnean Society of New South Wales* 81: 159–183.
- 1961a. The Aleyrodidae of New Caledonia. *Pacific Science, Honolulu* 15: 114–136.
- 1961b. Aleyrodidae from the South Pacific. *New Zealand Journal of Science* 4: 770–774.
- Gameel, O. I. 1968. Three new species of Aleyrodidae from the Sudan. *Proceedings of the Royal Entomological Society of London (B)* 37: 149–155.
- Gennadius, P. 1889. Disease of tobacco plantations in the Trikonja. The aleurodid of tobacco. [In Greek.] *Ellenike Georgia* 5: 1–3.
- Habib, A. & Farag, F. A. 1970. Studies on nine common aleurodids of Egypt. *Bulletin. Société Entomologique d'Egypte* 54: 1–41.
- Kotinsky, J. 1907. Aleyrodidae of Hawaii and Fiji with descriptions of new species. *Bulletin. Board of Commissioners of Agriculture and Forestry, Hawaii, Division of Entomology* 2: 93–102.
- Krishnamurthy, K. V., Raman, A. & David, B. V. 1973. Foliar pit-galls of *Morinda tinctoria* Roxb. *Cecidologia Indica. Bulletin of the Cecidological Society of India* 8: 75–77.
- Mackie, D. B. 1912. A new coconut pest. *Philippine Agricultural Review* 5: 142–143.
- Martin, J. H. & Lucas, G. R. 1984. *Aleurodicus dispersus* Russell, a whitefly species new to Asia. *The Philippine Scientist* 21: 168–171.
- Maskell, W. M. 1895. Contributions towards a monograph of the Aleurodidae, a family of Hemiptera-Homoptera. *Transactions and Proceedings of the New Zealand Institute* 28: 411–449.
- Mound, L. A. 1963. Host-correlated variation in *Bemisia tabaci* (Gennadius) (Homoptera: Aleyrodidae). *Proceedings of the Royal Entomological Society of London (A)* 38: 171–180.
- 1965. An introduction to the Aleyrodidae of western Africa. *Bulletin of the British Museum (Natural History) (Entomology)* 17: 113–160.
- 1966. A revision of the British Aleyrodidae. *Bulletin of the British Museum (Natural History) (Entomology)* 17: 397–428.

- Mound, L. A. & Halsey, S. H.** 1978. *Whitefly of the World*. 340 pp. Chichester.
- Peal, H. W.** 1903. Contribution towards a monograph of the oriental Aleurodidae. *Journal of the Asiatic Society of Bengal* **72**: 61–98.
- Priesner, H. & Hosny, M.** 1934. Contributions to a knowledge of the whiteflies (Aleurodidae) of Egypt (II). *Bulletin. Ministry of Agriculture, Egypt. Technical and Scientific Service* **145**: 1–11.
- Quaintance, A. L.** 1903. New oriental Aleurodidae. *Canadian Entomologist* **35**: 61–64.
- 1908. Homoptera, Family Aleyrodidae. In Wytzman, P., *Genera Insectorum* **87**: 1–11.
- Quaintance, A. L. & Baker, A. C.** 1913. Classification of the Aleyrodidae Part I. *Technical Series. Bureau of Entomology, United States Department of Agriculture* **27**: 1–93.
- 1914. Classification of the Aleyrodidae Part II. *Technical Series. Bureau of Entomology, United States Department of Agriculture* **27**: 95–109.
- 1915. Classification of the Aleyrodidae – Contents and Index. *Technical Series. Bureau of Entomology, United States Department of Agriculture* **27**: i–xi, 111–114.
- 1917. A contribution to our knowledge of the whiteflies of the subfamily Aleurodinae. *Proceedings of the United States National Museum* **51**: 335–445.
- Russell, L. M.** 1943. A new genus and four new species of whiteflies from the West Indies (Homoptera, Aleyrodidae). *Proceedings of the Entomological Society of Washington* **45**: 131–141.
- 1945. A new genus and twelve new species of Neotropical whiteflies. *Journal of the Washington Academy of Sciences* **35**: 55–65.
- 1958. *Orchamoplatus*, an Australasian genus (Homoptera: Aleyrodidae). *Proceedings of the Hawaiian Entomological Society* **16**: 389–410.
- 1965. A new species of *Aleurodicus* Douglas and two close relatives (Homoptera: Aleyrodidae). *Florida Entomologist* **48**: 47–55.
- Sampson, W. W. & Drews, E. A.** 1956. Keys to the genera of the Aleyrodidae and notes on certain genera. *Annals and Magazine of Natural History* (12) **9**: 689–697.
- Signoret, V.** 1868. Essai monographique sur les aleurodes. *Annales de la Société Entomologique de France* (4) **8**: 369–402.
- Singh, K.** 1931. A contribution towards our knowledge of the Aleyrodidae (whitefly) of India. *Memoirs of the Department of Agriculture in India* **12** (1): 1–98.
- Stål, C.** 1876. Observations Orthoptérologiques 2. Les genres des Acridoidées de la faune européenne. *Bihang till Kongl. Svenska Vetenskaps Akademiens Handlingar, Stockholm* **4** (5): 30.
- Takahashi, R.** 1931. Some Formosan whiteflies. *Journal of the Society of Tropical Agriculture, Taiwan* **3**: 218–223.
- 1932. Aleyrodidae of Formosa Part I. *Report. Department of Agriculture. Government Research Institute, Formosa* **59**: 1–57.
- 1934. Aleyrodidae of Formosa Part III. *Report. Department of Agriculture. Government Research Institute, Formosa* **63**: 39–71.
- 1935. Aleyrodidae of Formosa Part IV. *Report. Department of Agriculture. Government Research Institute, Formosa* **66**: 39–65.
- 1936. Some Aleyrodidae, Aphididae, Coccidae and Thysanoptera from Micronesia. *Tenthredo. Acta Entomologica* **1**: 109–120.
- 1942. Some foreign Aleyrodidae IX. Species from Thailand and French Indo-China. *Transactions of the Natural History Society of Formosa* **32**: 327–335.
- 1951. Descriptions of six interesting species of Aleyrodidae from Malaya. *Kontyû* **19**: 1–8.
- 1952. *Aleurotuberculatus* and *Parabemisia* of Japan (Aleyrodidae, Homoptera). *Miscellaneous Reports of the Research Institute for Natural Resources, Tokyo* **25**: 17–24.
- Thomas, R. T. S.** 1962. Checklist of pests on some crops in West Irian. *Mededelingen van Economische Zaken, Landbouwkundige Serie* no. 1: 99.
- Verdcourt, B.** 1979. A manual of New Guinea legumes. *Botany Bulletin* no. 11, *Office of Forests, Division of Botany, Lae, Papua New Guinea*.
- Westwood, J. O.** 1856. The new Aleyrodes of the greenhouse. *Gardeners' Chronicle* **1856**: 852.

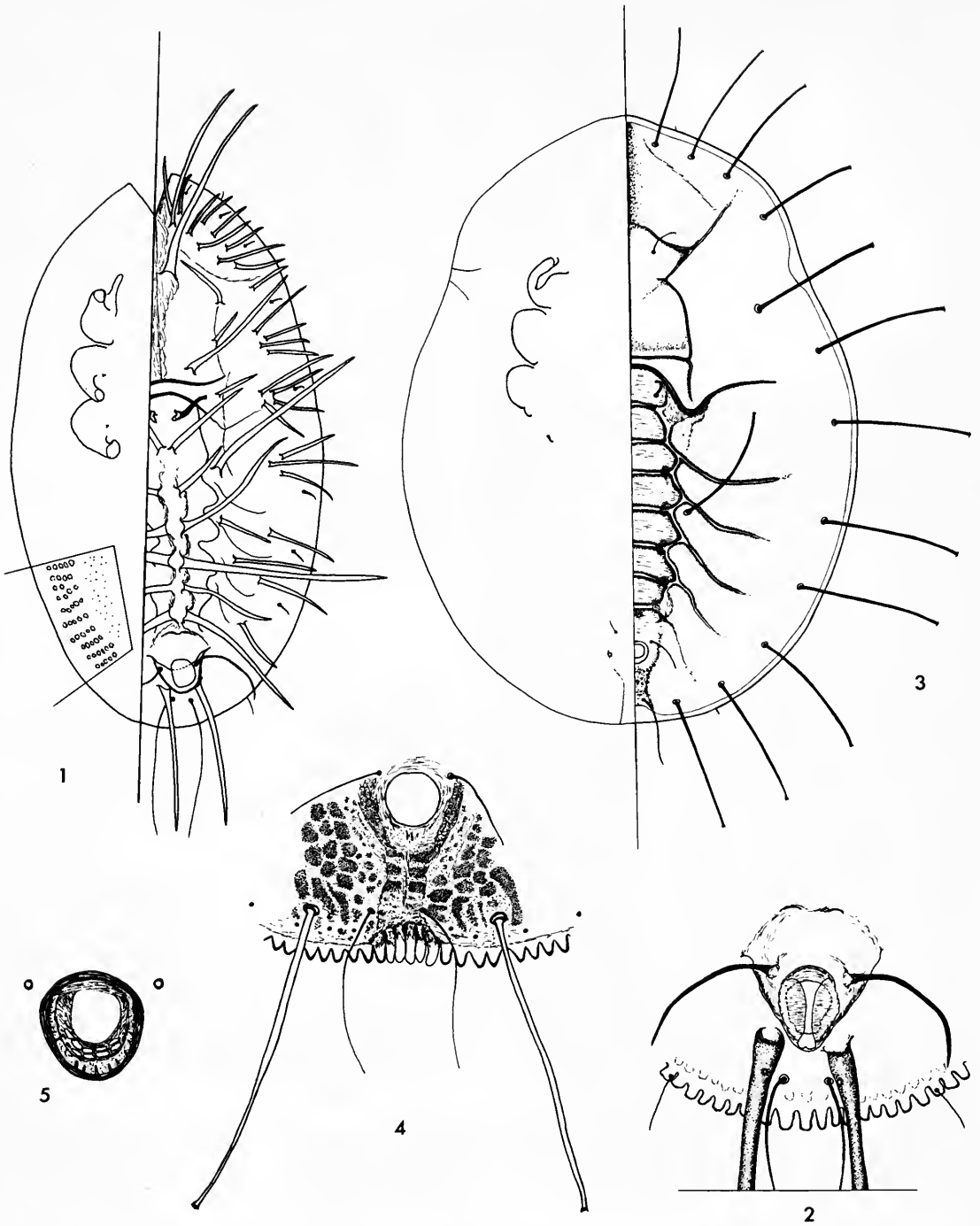

**Figs 1-5** *Aleurocanthus* species. 1, 2, *A. luteus*: (1) pupal case; (2) posterior dorsal detail of pupal case. 3-5, *A. papuanus*: (3) pupal case; (4) posterior dorsal detail of pupal case; (5) vasiform orifice detail with operculum removed for clarity.

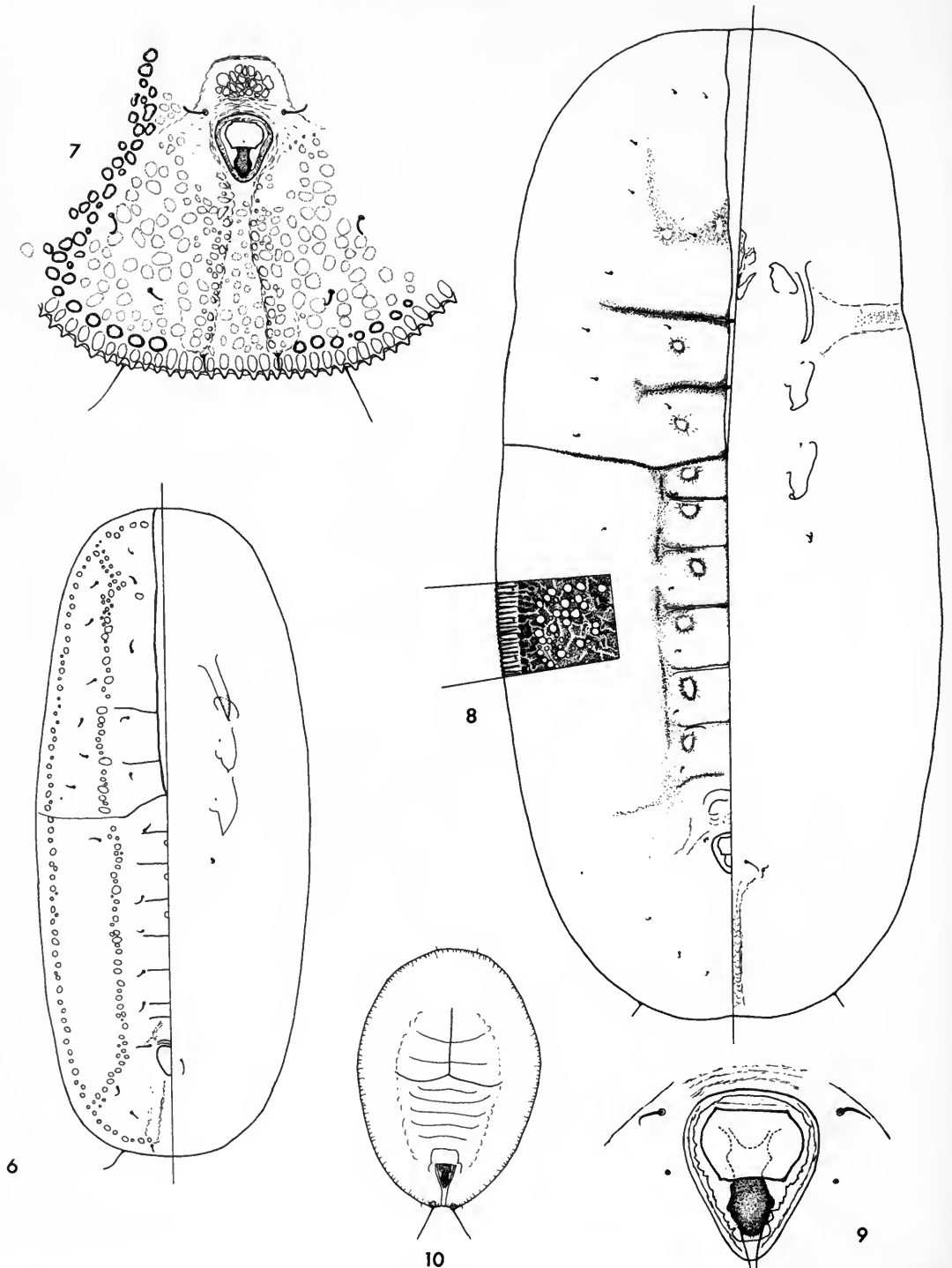

**Figs 6–10** 6, 7, *Aleuromarginatus corbettiaformis*: (6) pupal case; (7) posterior dorsal detail of pupal case. 8, 9, *Aleuromarginatus littoralis*: (8) pupal case, with inset showing fine detail of dorsal cuticle; (9) vasiform orifice. 10, *Bemisia tabaci*, pupal case.

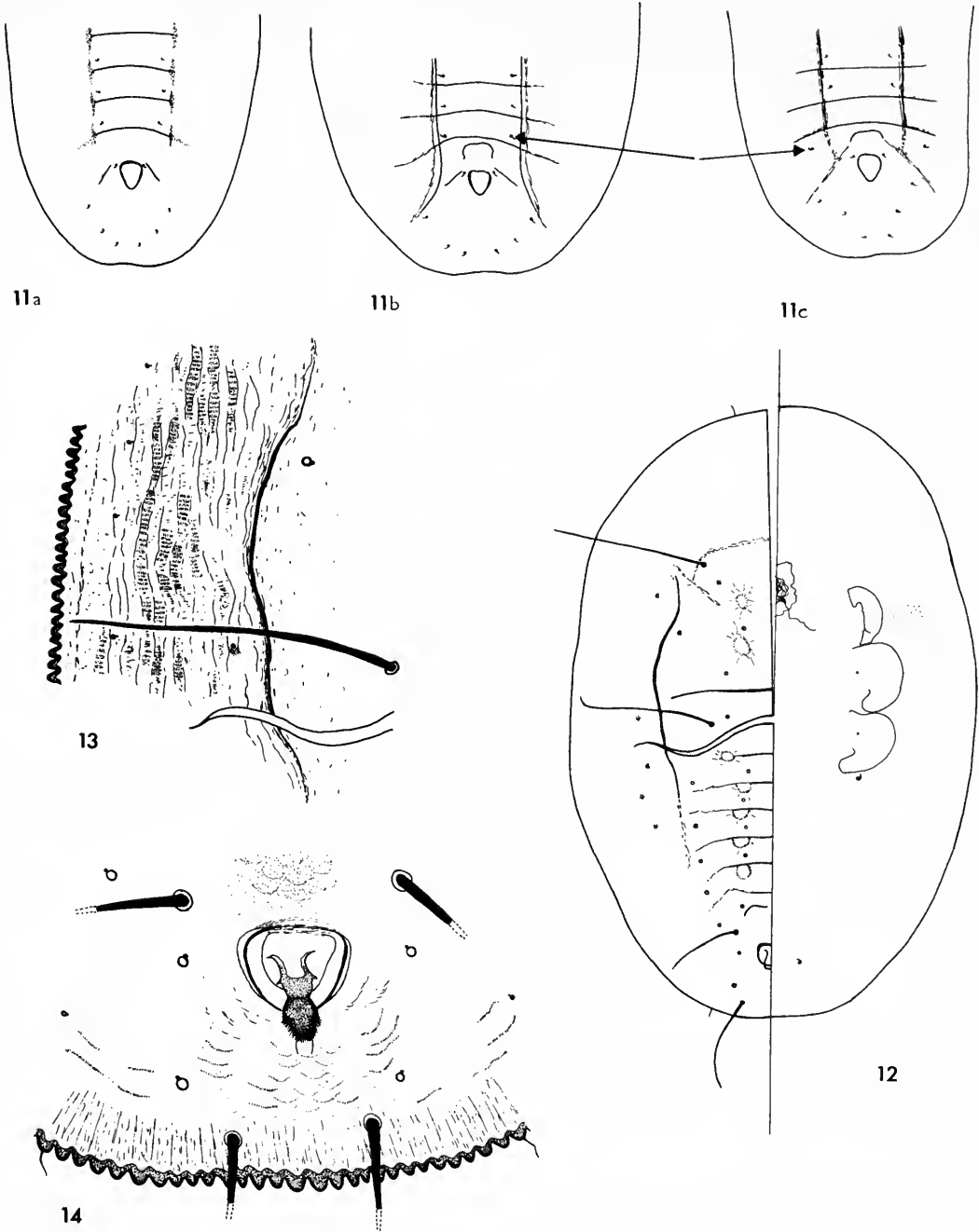

**Figs 11–14** 11, *Aleuromarginatus* species, posterior dorsal detail of: (11a) *A. littoralis*; (11b) *A. kallarensis*; (11c) *A. dalbergiae* – transposition of abdominal hairs arrowed. 12–14, *Crenidorsum lasangensis*: (12) pupal case; (13) dorsal submarginal detail of thoracic region; (14) posterior dorsal detail of pupal case.

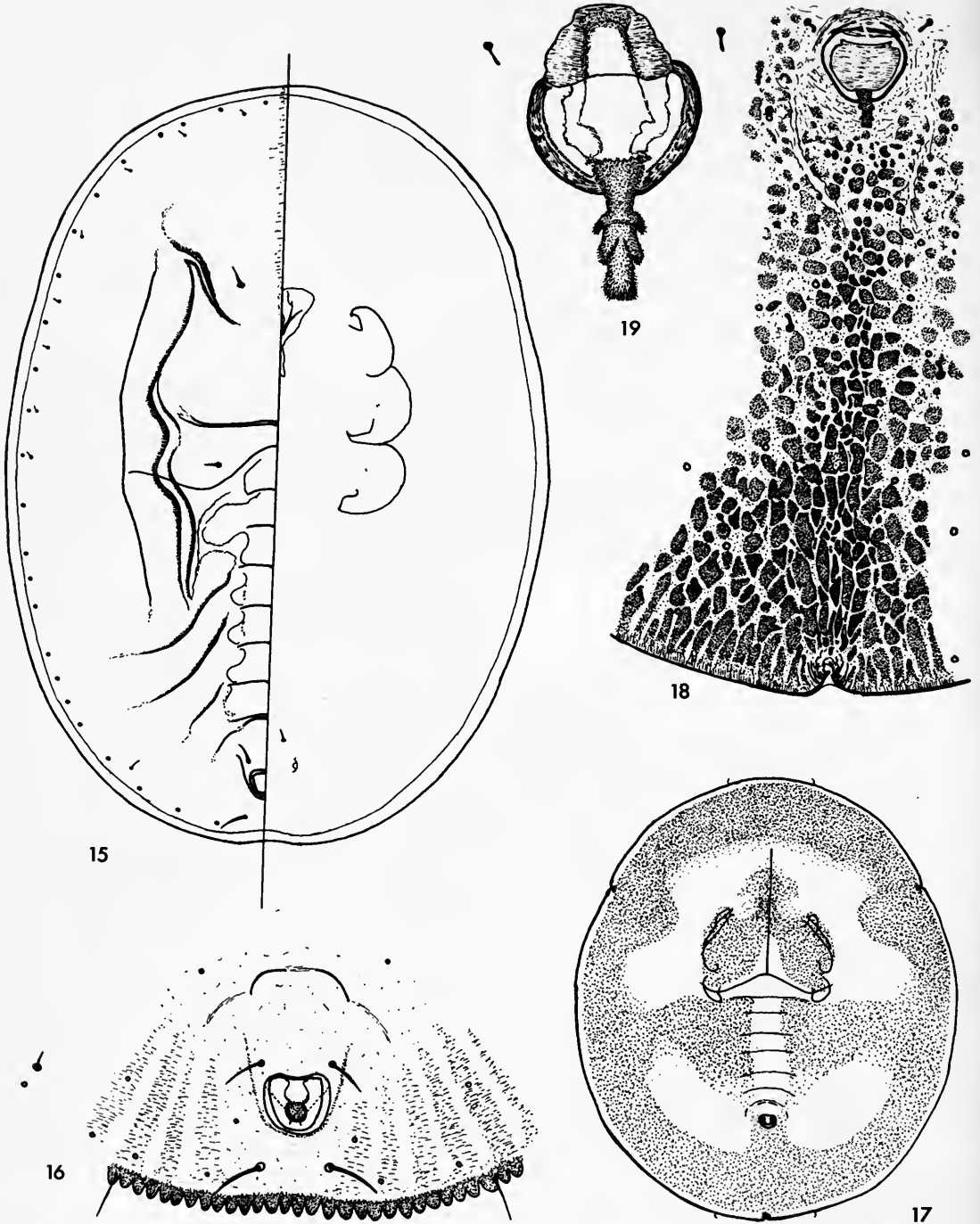

Figs 15-19 15, 16, *Crenidorsum morobensis*: (15) pupal case; (16) posterior dorsal detail of pupal case. 17-19, *Dialeurodes decaspermi*: (17) pupal case, with detail of pigmentation; (18) vasiform orifice and caudal furrow; (19) detail of vasiform orifice, operculum folded upwards.

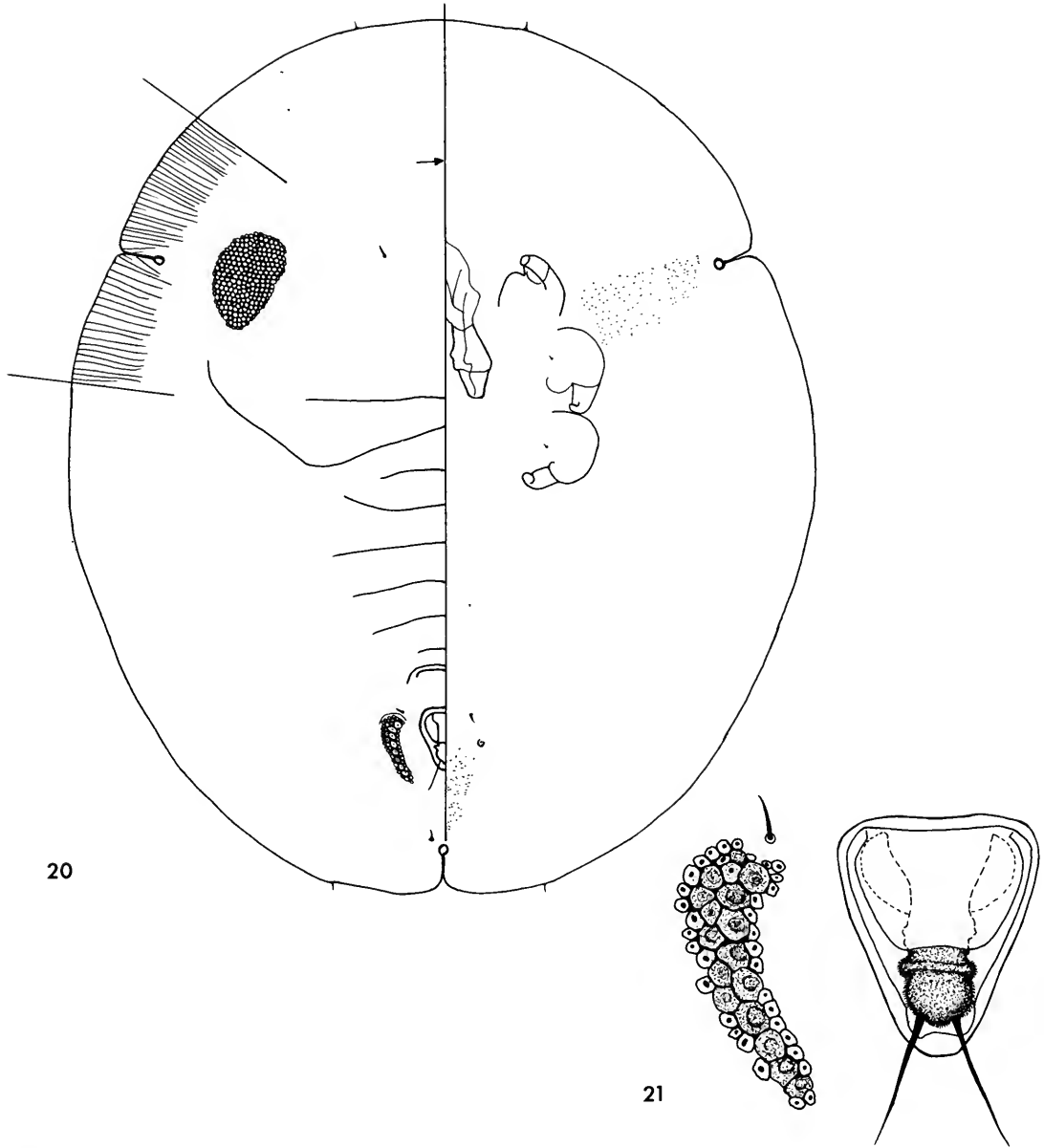

**Figs 20, 21** *Indoaleyrodes pseudoculatus*: 20, pupal case, extremity of longitudinal moulting suture arrowed; 21, vasiform orifice and one lateral dorsal abdominal glandular patch.

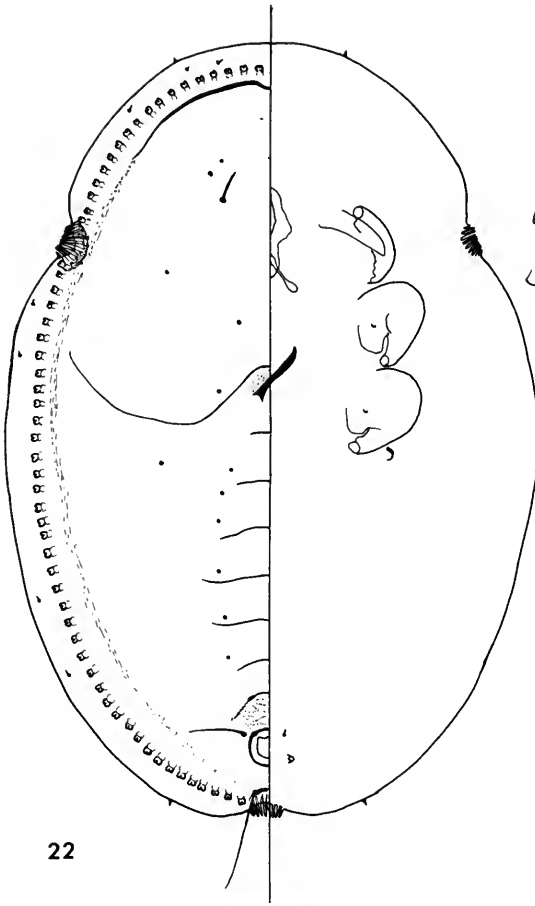

22

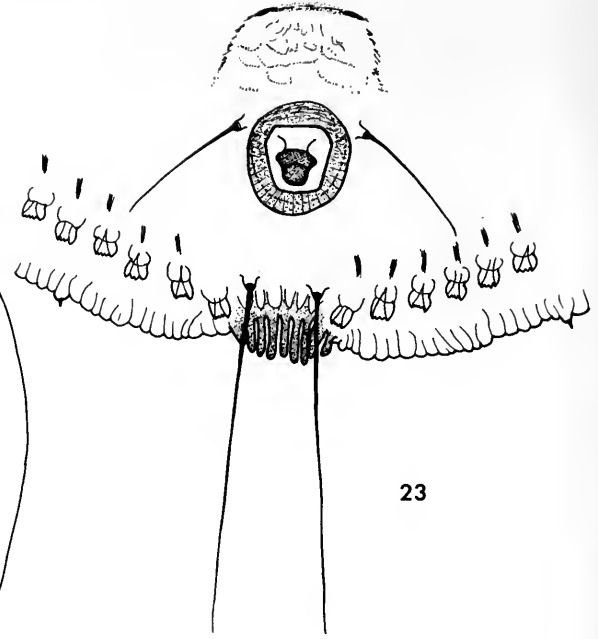

23

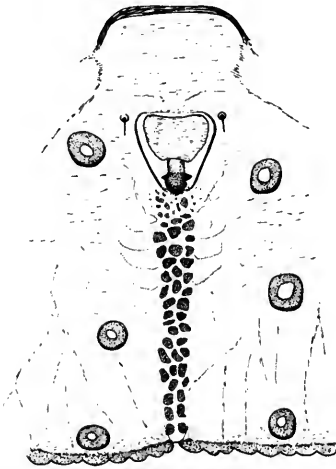

25

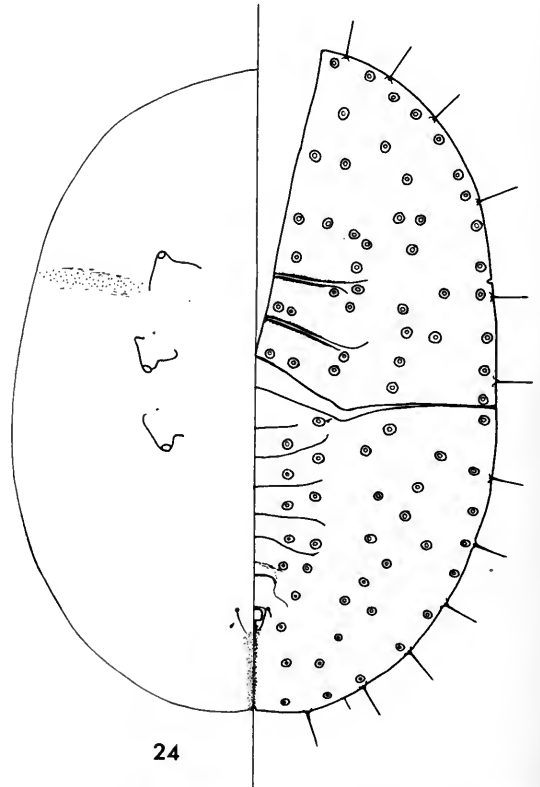

24

**Figs 22–25** 22, 23, *Orhamoplatus niuginii*: (22) pupal case; (23) posterior dorsal detail of pupal case, operculum removed. 24, 25, *Parabemisia jawani*: (24) pupal case; (25) posterior dorsal detail of pupal case.



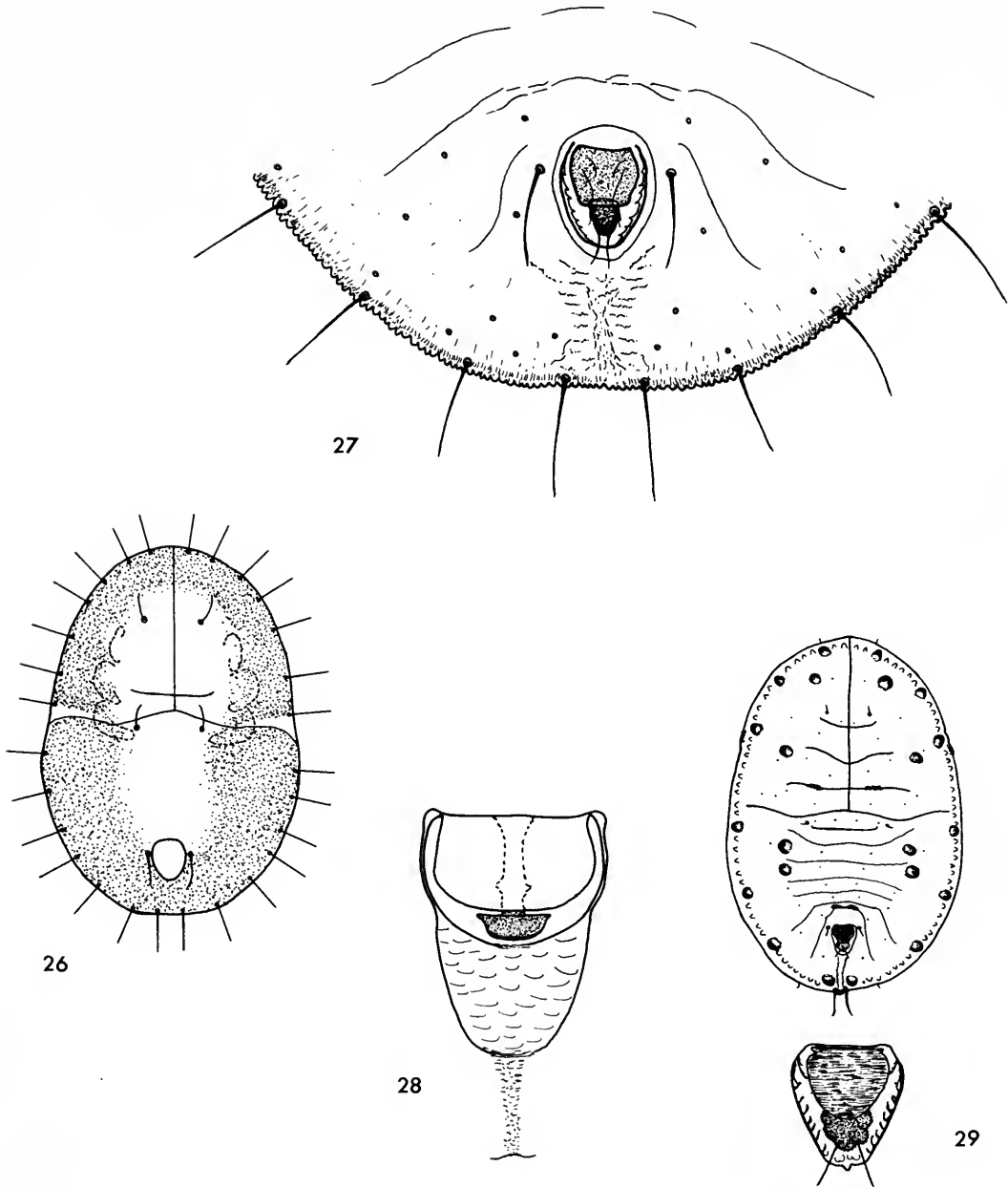

**Figs 26–29** 26, 27, *Parabemisia myrmecophila*: (26) pupal case, with detail of pigmentation; (27) posterior dorsal detail of pupal case. 28, stylised vasiform orifice typical of the *Pealius* genus-group. 29, *Trialeurodes vaporariorum*, pupal case, with enlargement of vasiform orifice.

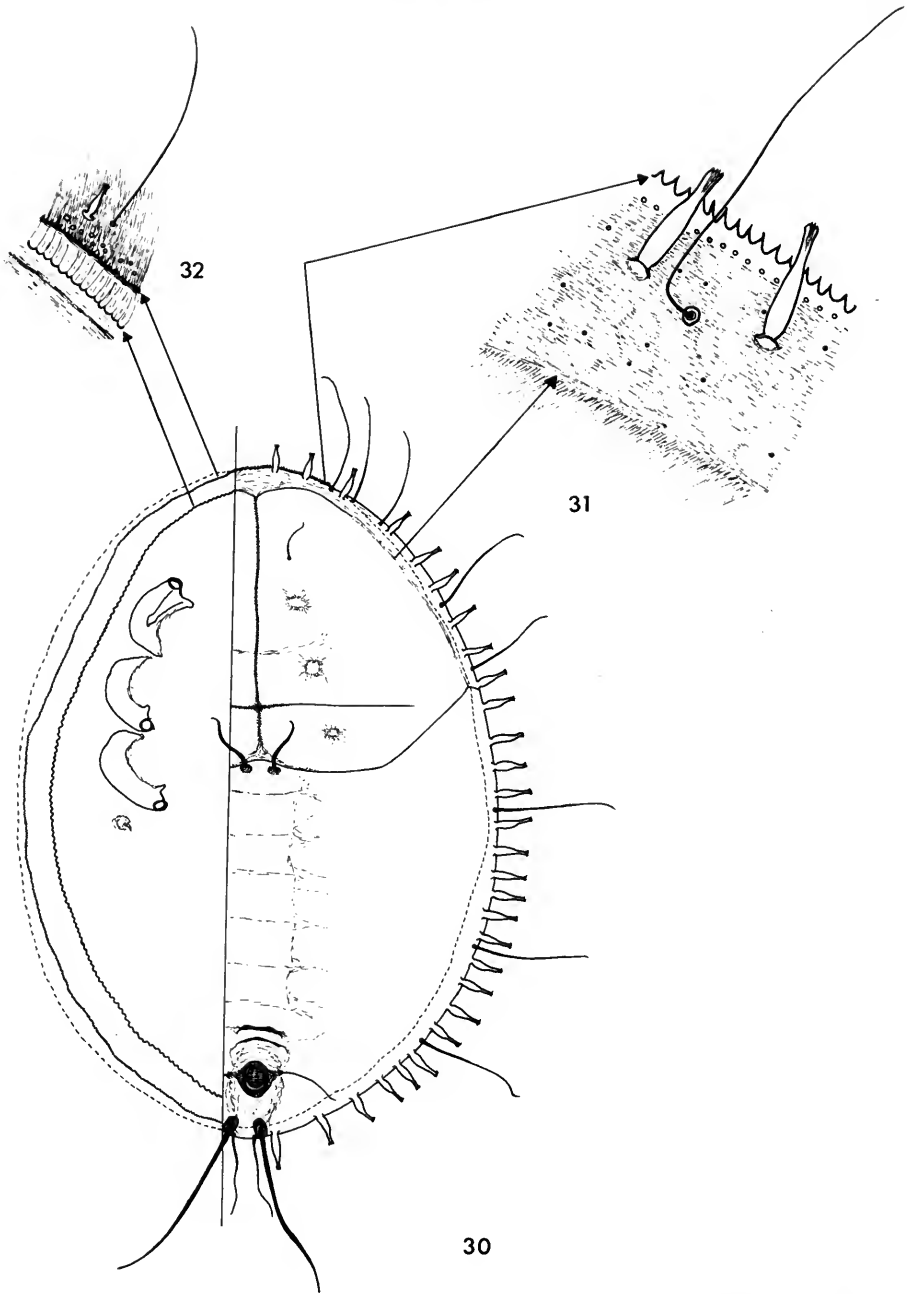

Figs 30-32 *Xenaleyrodes broughae*: 30, pupal case; 31, dorsal submarginal detail and true margin; 32, true margin, ventral 'false margin', and dorsal submarginal detail.

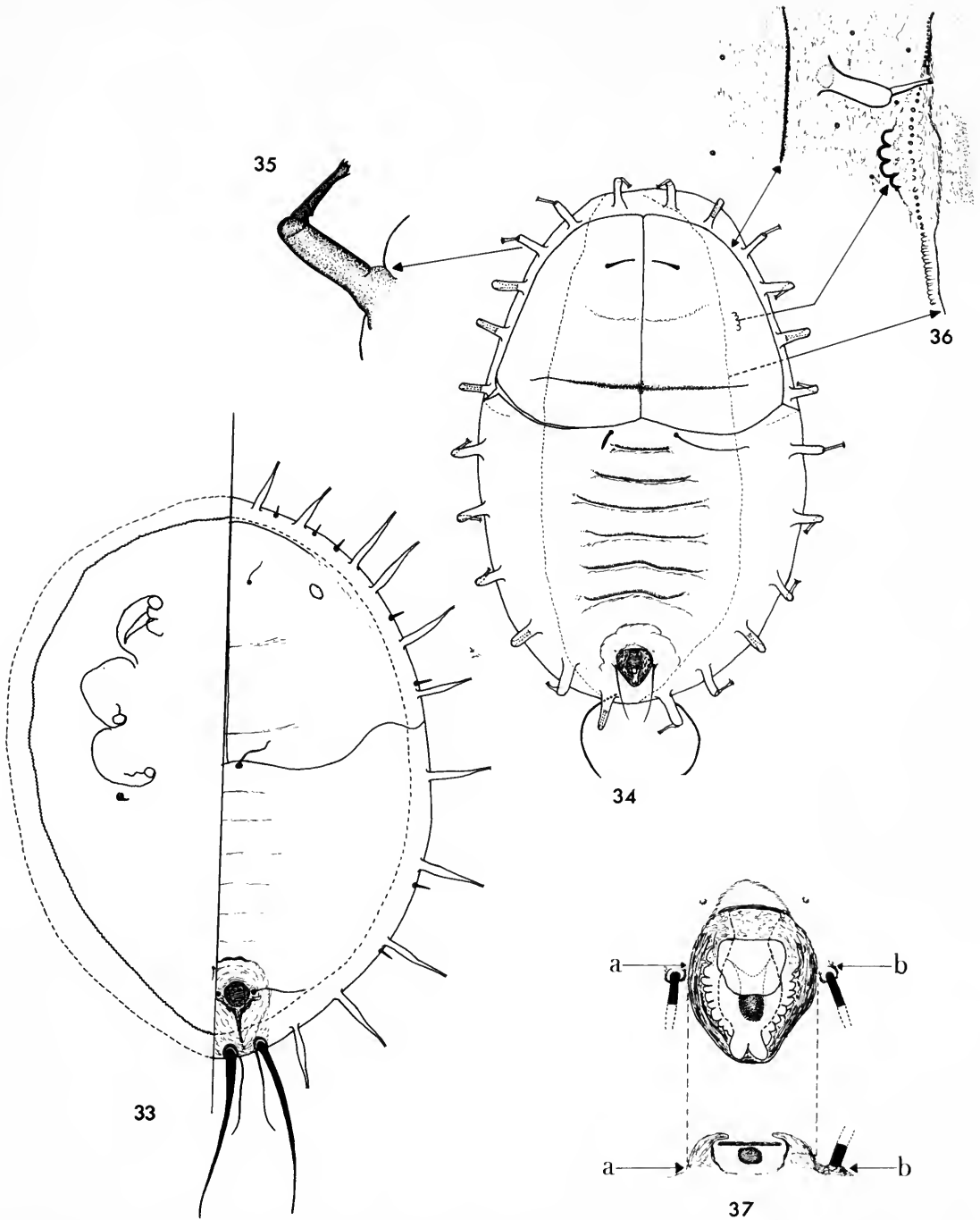

**Figs 33–37** *Xenaleyrodes* species. 33, *X. irianicus*, pupal case. 34–37, *X. timonii*: (34) pupal case, dorsal detail; (35) submarginal tubiform spine; (36) detail of margin at thoracic tracheal area; (37) vasiform orifice, with stylised transverse section.

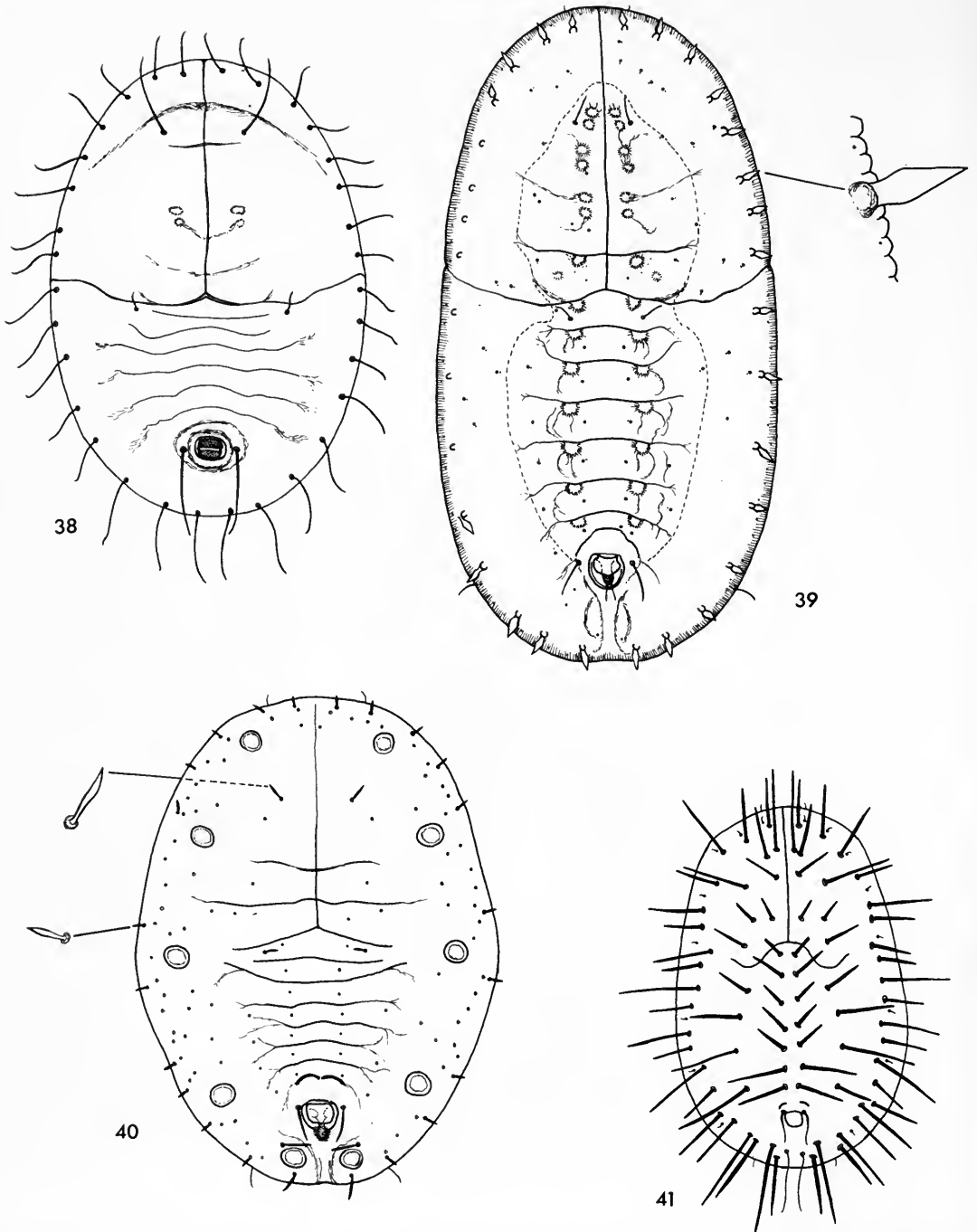

**Figs 38–41** 38, *Neomaskellia bergii*, pupal case ex *Saccharum*, New Guinea. 39, *Aleurocybotus setiferus*, pupal case ex *Imperata*, New Guinea; dotted line indicates border of submedian pigmentation. 40, *Dialeuropora decempuncta*, pupal case ex *Colocasia*, New Guinea. 41, *Aleurocanthus cocois*, pattern of dorsal setae and stout spines.

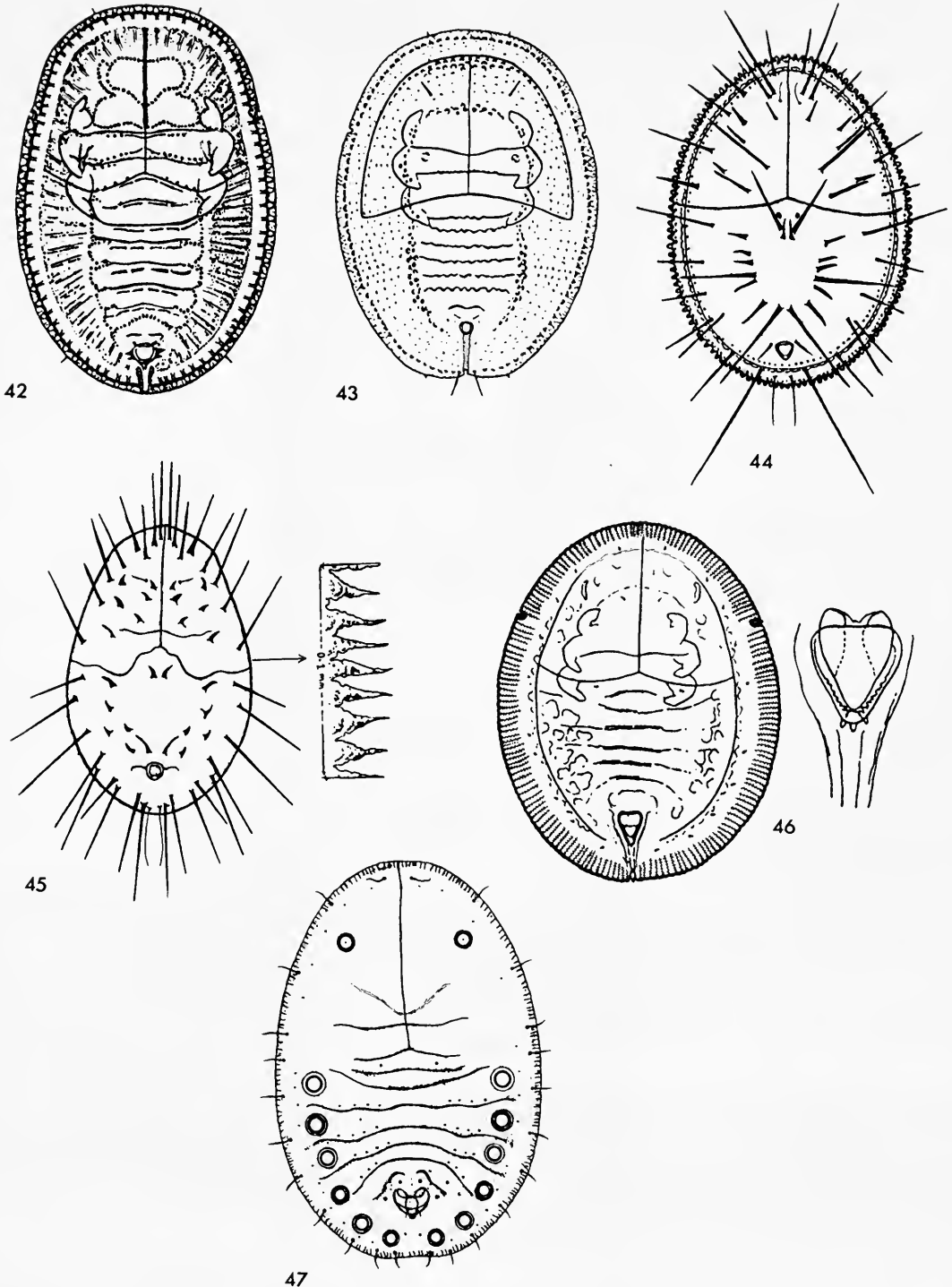

Figs 42–47 (after Corbett, 1935a) 42, *Alerotuberculatus neolitiseae*, pupal case. 43, *Dialeurodes psidii*, pupal case. 44, *Aleurocanthus woglumi*, pupal case with marginal detail. 45, *Aleurocanthus pendleburyi*, pupal case with marginal detail. 46, *Aleurolobus selangorensis*, pupal case with vasiform orifice detail. 47, *Aleurodicus destructor*, pupal case.

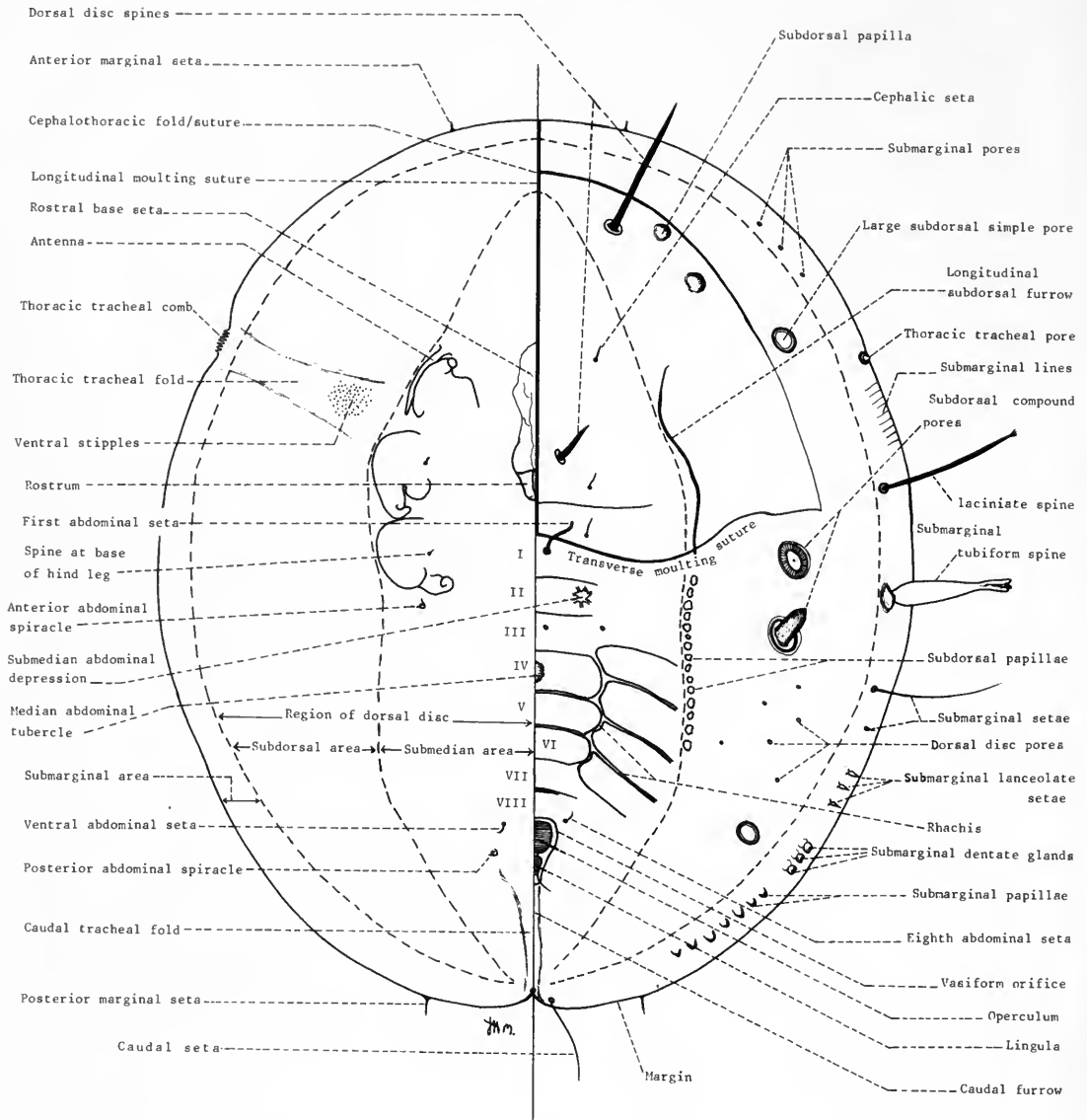

Fig. 48 Annotated schematic diagram of whitefly pupal case.

## Addendum

While this manuscript was in press four samples of *Orchamoplatus mammaeferus* (Quaintance & Baker, 1917: 400), collected in New Guinea, were received. *O. mammaeferus* is similar to *niuginii*, and the differences between the two species are discussed on p. 330.

### MATERIAL EXAMINED

**Papua New Guinea:** near Laiagam and near Wabag, on *Phaseolus vulgaris* (Leguminosae); Wau, on *Croton* sp. (Euphorbiaceae); Mt Hagen, on sweet potato (Convolvulaceae) (all BMNH).

This brings the total of named species (p. 304) to 38.

## Index

Principal page references are in **bold**; page references to figures are in *italics*; invalid names are in *italics*.

- aceris 330, 331  
 afer 306, **321–322**  
 Aleurocanthus 303, 304, 309,  
**313–17**, 334, 339, 348, 349  
 Aleurocybotus 305, 310, **317**, 348  
 Aleurodes 312, 316, 317, 320, 321,  
 322, 329, 333  
 Aleurodicinae 304, 309, **311–12**  
 Aleurodicus 303, 304, 309, **311–12**,  
 349  
 Aleurolobus 305, 310, **317**, 349  
 Aleuromarginatus 305, 310, 311,  
**318–320**, 340, 341  
 Aleuroplatus 305–311, **320**, 323, 329  
 Aleurotrachelus 305, 310, **320**, 323  
 Aleurotuberculatus 305, 311,  
**320–321**, 349  
 Aleurotulus 306, 310, **321**, 323, 324  
 Aleyrodes 322, 325, 326, 332, 333  
 Aleyrodinae 304, 309, **313–337**  
*anoniae* 311  
 antidesmae 311  
 ardisiae 308, **333**  
 artocarpi 308, **334**, 336  
 arundinacea 306, 310, **321**  
 Asialeyrodes 306, 310, **321**
- bauhiniiae 320  
 Bemisia 303, 304, 306, 309,  
**321–323**, 330, 340  
 bergii 303, 307, **329**, 348  
 bossi 320  
 brevispinosus 315  
 brideliae 326  
 broughae 308, **334–335**, 346
- calophylli 330  
*canangae* 313, 314  
 cinnamomi 312  
 citri Ashmead 325  
*citri* Riley & Howard 325  
 cocois 304, **313–314**, 315, 316, 348  
 comata 329  
 corbettiaformis 305, **318–319**, 340  
 Crenidorsum 306, 310, **323–325**,  
 341, 342
- dalbergiae 320, 341  
 decaspermi 306, **325**, 342  
 decempuncta 307, **326–327**, 348  
 destructor 303, 304, 311, **312**, 349  
 Dialeurodes 306, 311, **325–326**, 327,  
 328, 333, 342, 349  
*Dialeurodoides* 321  
 Dialeuropora 307, 310, **326–327**,  
 348  
 differens 324
- dispersus 311  
*dothioensis* 327  
 dryandrae 320  
 dumbletoni 329
- esakii 304, 313, **314**, 316  
 eucalypti 334
- gordoniae 320  
 graminicola 317
- hancocki* **321–322**  
 hirsutus 315  
 holmesii 304, 311, **312**  
*husaini* 316
- inconspicua* 321  
 Indoaleyrodes 307, 310, **327–329**,  
 331, 343  
 irianicus 308, 334, **335–336**, 347  
 ixorae 325
- jawani 307, **331–332**, 344  
*Jeannelaleyrodes* 329
- kallarensis 320, 341  
 kirkaldyi 306, 326
- laos 327, 328  
 lasangensis 306, **323–324**, 341  
 leakii 306, **322**  
 littoralis 305, 311, 318, **319–320**,  
 340, 341  
 lumpurensis, Asialeyrodes 321  
*lumpurensis*, Dialeurodes 326  
 luteus 305, 313, **314–315**, 339
- machili 312  
 mackenziei 315  
 maculata 330, 331  
*malayensis* 312  
 mammaeferus 329, 330, **350**  
 marginale 323, 324  
 marlatti 317  
 maskelli 332  
 melastomae 320  
 millettiae 320  
 montanus 330  
 morobensis 306, **324–325**, 342  
 myricae 330, 331  
 myrmecophila 307, 331, **332**, 345
- Neoaleurotrachelus 329  
 neolitsea 306, **320–321**, 349  
 Neomaskellia 303, 307, 309, **329**,  
 334, 348  
 nephrolepidis 321  
 niloticus 305, 317
- niuginii 307, **329–330**, 344
- Orchamoplatus 307, 309, **329–330**,  
 344, 350  
 Orchamus 329
- papuanus 305, 313, **315–316**, 339  
 Parabemisia 307, 311, 328, **330–332**,  
 344, 345  
 Pealius 308, 311, **332**, 345  
 pendleburyi 305, 313, 314, **316**, 349  
 perdentatus 329  
 pergandei 333  
 perileuca 333  
*perseae* 326, 327  
 pongamiae 306, **322**  
 pseudoculatus 307, **328**, 343  
 psidii 306, **326**, 349  
*pustulatus* 327
- quercusaquatica 320
- Rabdostigma 325  
 regis 313, 315, 316  
 reticulata 328, 330, 331  
 Rhachisphora 308, 310, **333**  
 rugosa 315
- selangorensis 305, **317**, 349  
 setiferus 305, 310, **317**, 348  
*setigerus* 327  
 siamensis 320  
 spinifera 316  
 spiniferus 305, 313, **316**  
 spinithorax 315  
 strychnosicola 315  
 subrotunda 325  
 sudaniensis 329
- tabaci 303, 304, 306, **322–323**, 340  
 tephrosiae 318  
 Tetraleurodes 308, 309, **333**  
 timonii 308, 334, **336–337**, 347  
 tracheifer 320  
 Trialeurodes 303, 308, 310, **333**, 345  
 trilobitoides **333**  
 trispina 315  
 T-signatus 315  
 tuberculatum 323
- vaporariorum 303, 308, **333**, 345
- woglumi 305, 313, **316–317**, 349
- Xenaleyrodes 308, 309, **334–337**,  
 346, 347
- zizyphi 315









## **British Museum (Natural History)**

# **Catalogue of the Diptera of the Afrotropical Region**

*Editor:* R. W. Crosskey. *Assistant editors:* B. H. Cogan, P. Freeman, A. C. Pont, K. G. V. Smith and the late H. Oldroyd. British Museum (Natural History). 1980, 1437 pp. £55.00

The Diptera or two-winged flies are probably the most important insects that affect man. Although most flies are harmless, some have become transmitters of dangerous diseases to man and his domestic animals, and others are important pests of agricultural crops. Some flies are beneficial because they destroy large numbers of plant-feeding insects through their parasitic or predacious habits.

Nowhere is their socio-economic and medical impact more sharply felt than in tropical Africa, where fly-borne diseases are not only a direct health hazard but can prevent or hinder development of the land. The control of such diseases as sleeping sickness and onchocerciasis depends in great measure upon controlling the flies that carry them. This in turn requires a thorough appreciation of all that is known about the insect vectors, including their basic taxonomy, so that they can be correctly identified and their geographical ranges accurately established.

This catalogue synthesizes the scattered basic taxonomic work on the Diptera of tropical Africa and its islands by listing the known 16,500 species with their synonyms and known geographical ranges within a comprehensive classification. A short introduction is given to each family and a bibliography of 4,700 titles provides references to the primary literature. Such a task has never before been attempted for the region and its completion should greatly stimulate taxonomic research. The *Catalogue* represents ten years' careful work by a team of forty specialists, under the editorship of six dipterists on the staff of the Natural History Museum, themselves contributors with considerable expertise in the African fauna.

The *Catalogue* should serve for a long time as an indispensable tool to the taxonomist and an essential source-work to anyone concerned with African flies in the fields of medical, agricultural and veterinary science.

## **Titles to be published in Volume 50**

**Taxonomy of Neotropical Derbidae in the new tribe Mysidiini (Homoptera)**

By Peter S. Broomfield

**Nymphal taxonomy and systematics of the Psylloidea (Homoptera)**

By I. M. White & I. D. Hodkinson

**The whitefly of New Guinea (Homoptera: Aleyrodidae)**

By J. H. Martin





BOUND  
15 DEC 1987

