





1000

1000

*E
S
Fishes
1-2*

Division of Fishes,
U. S. National Museum

DEPARTMENT OF COMMERCE

BULLETIN
OF THE
UNITED STATES
BUREAU OF FISHERIES

VOL. XXXIV
1914

HUGH M. SMITH
COMMISSIONER



WASHINGTON
GOVERNMENT PRINTING OFFICE
1916

BUREAU OF FISHERIES
UNITED STATES
BULLETIN

VOL. XXXIV
1914

HUGH M. SMITH
COMMISSIONER



WASHINGTON
GOVERNMENT PRINTING OFFICE

CONTENTS

	Page.
THE FUR SEALS AND OTHER LIFE OF THE PRIBILOF ISLANDS, ALASKA, IN 1914. By Wilfred H. Osgood, Edward A. Preble, and George H. Parker. (Document 820, issued June 19, 1915).	1-172
CHANGES IN SHADE, COLOR, AND PATTERN IN FISHES, AND THEIR BEARING ON THE PROBLEMS OF ADAPTATION AND BEHAVIOR, WITH ESPECIAL REFERENCE TO THE FLOUNDERS PARALICHTHYS AND ANCYLOPSETTA. By S. O. Mast. (Document 821, issued April 10, 1916).	173-238
THE SHARKS AND RAYS OF BEAUFORT, NORTH CAROLINA. By Lewis Radcliffe. (Document 822, issued April 6, 1916).	239-284
THE STRUCTURE AND GROWTH OF THE SCALES OF THE SQUETEAGUE AND THE PIGFISH AS INDICATIVE OF LIFE HISTORY. By Harden F. Taylor. (Document 823, issued September 23, 1916).	285-330
COPEPOD PARASITES OF FRESH-WATER FISHES AND THEIR ECONOMIC RELATIONS TO MUSSEL GLOCHIDIA. By Charles Branch Wilson. (Document 824, issued June 28, 1916).	331-374
THE FISHES OF THE STREAMS TRIBUTARY TO TOMALES BAY, CALIFORNIA. By John Otterbein Snyder. (Document 825, issued June 2, 1916).	375-382
THE FAIRPORT FISHERIES BIOLOGICAL STATION: ITS EQUIPMENT, ORGANIZATION, AND FUNCTIONS. By Robert E. Coker. (Document 829, issued July 7, 1916).	383-406
NOTES ON THE EMBRYOLOGY AND LARVAL DEVELOPMENT OF FIVE SPECIES OF TELEOSTEAN FISHES. By Albert Kuntz. (Document 831, issued August 3, 1916).	407-430
NOTES ON THE FISHES OF EAST TENNESSEE. By Barton Warren Evermann and Samuel F. Hildebrand. (Document 832, issued September 21, 1916).	431-452
GENERAL INDEX.	453

THE FUR SEALS AND OTHER LIFE OF THE PRIBILOF
ISLANDS, ALASKA, IN 1914



By Wilfred H. Osgood, Edward A. Preble, and George H. Parker



CONTENTS.



	Page.
LETTERS OF TRANSMITTAL.....	11
LETTER OF SUBMITTAL.....	12
INTRODUCTION.....	13
Personnel and instructions.....	13
Investigations by Canada and Japan.....	15
Itinerary.....	15
Impartial nature of the investigation.....	16
Acknowledgments.....	16
THE PRIBILOF ISLANDS.....	17
General description.....	17
Vegetation.....	18
Climate.....	18
CHARACTER AND HABITS OF THE FUR SEAL IN BRIEF.....	18
General characteristics.....	18
Range.....	18
Breeding habits.....	19
Habits of bachelors.....	20
Age of seals.....	20
SEALING HISTORY IN BRIEF.....	21
Russian management.....	21
American occupation and the leasing system.....	21
The growth of pelagic sealing.....	22
The Paris Tribunal and the modus vivendi.....	22
Special investigations.....	23
Sealing under Government management.....	24
The law of 1910.....	24
The treaty suspending pelagic sealing.....	24
The law of 1912.....	24
Revenue from fur seals.....	25
THE CENSUS OF THE HERD IN 1914.....	25
The nature of the census.....	25
The count of harems.....	25
Preliminary counts.....	26
Height of season counts.....	26
Harem charts.....	27
The count of idle and young bulls.....	28
The count of half bulls.....	28
The count of bachelors.....	28
The count of pups.....	29
Importance of the count.....	29
The method of counting pups.....	30
The count of dead pups.....	31
Participants in the count, and results.....	31
The estimates.....	32
Yearlings.....	33
Two-year-olds.....	33

THE CENSUS OF THE HERD IN 1914—Continued.	
The estimates—Continued.	Page.
Three-year-old males.....	34
Four-year-old males.....	36
Five-year-old males.....	36
Summary of estimates of nonbreeding seals.....	36
The complete census of 1914.....	38
RESULTS OF THE CENSUS.....	38
Independent results.....	38
Comparative results.....	39
Comparison of harems and idle bulls.....	39
Comparison of nonbreeding seals.....	41
Comparison of cows and pups.....	41
The census in the future.....	45
THE BREEDING OR HAREM BULLS.....	45
Strength and vigor.....	45
Senile bulls.....	46
Adolescent harem bulls.....	47
Fighting of old bulls.....	47
Significance of the increase of harem bulls.....	49
The ideal proportion of harem bulls.....	49
IDLE AND YOUNG BULLS.....	50
Age and character.....	50
Irregular distribution.....	52
Idle bulls as a desirable breeding element.....	52
Idle bulls as a menace to the herd.....	53
The ideal proportion of idle bulls.....	54
The utilization of surplus bulls.....	55
THE AVERAGE HAREM.....	56
Value of the average harem.....	56
Variation of average harems.....	56
The average harem as a criterion of the capacity of bulls.....	57
DISTINCTIONS BETWEEN THE CLASSES OF SEALS.....	58
General distinctions.....	59
Special methods applied in 1914.....	59
The yearlings.....	60
Definition.....	60
Limited knowledge of yearlings.....	60
Records of yearlings.....	61
Movements of yearlings.....	64
The 2-year-olds.....	65
Two-year-old males.....	65
Two-year-old females.....	66
The 3-year-old bachelors.....	67
The 4-year-old bachelors.....	69
Summary of measurements.....	70
MORTALITY OF SEALS.....	70
Death of pups on land.....	70
Death of young seals at sea.....	72
Death of adult seals.....	73
THE EFFECT OF PELAGIC SEALING.....	74
Losses due to pelagic sealing.....	74
Information to be gained from the cessation of pelagic sealing.....	74
Effect of pelagic sealing still evident.....	75
Pelagic sealing indirect cause of close land killing.....	76

CONTENTS.

5

	Page.
THE EFFECT OF LAND SEALING	76
THE MANAGEMENT OF THE HERD	77
The general policy.....	77
The nature and extent of the property.....	78
Management based on principles employed with domestic animals.....	78
Requirements of a reserving system.....	79
Confinement of killing and reserving to one class.....	79
The method of marking reserves.....	80
The proportion of males to be reserved.....	80
METHODS OF DRIVING, KILLING, AND CURING SKINS	85
Need for shorter drives.....	85
Killing.....	86
Females and old seals in drives.....	86
The sealing season.....	88
Skinning.....	89
Curing of skins.....	89
Need of competent supervision.....	90
Measurements versus weights.....	90
Tagging of skins.....	92
PRACTICAL IMPROVEMENTS NEEDED	92
Present unimproved condition of plant.....	92
Reforms contemplated by lessees.....	93
Better methods of transportation needed.....	93
Roads and trails.....	93
Supply ship.....	94
Cold-storage plants.....	95
Rookery improvements.....	95
Marked rocks.....	95
Observation stations.....	95
Improvement of ground.....	96
THE EFFECT OF EXISTING LAWS	96
The law effective for longer than intended.....	97
As a beneficial measure the law has served its purpose.....	97
Evils of leasing system not possible under Government management.....	98
Flexible regulations desirable.....	98
Reserves unduly large.....	99
Matters for special discretionary power.....	100
Emergency action.....	100
Annual sale of skins.....	101
Specimens for scientific purposes.....	101
Effect of restricted sealing on the fox herd.....	101
The treaty.....	102
Early solution of practical problems important.....	103
Gradual development of efficiency necessary.....	103
Conclusions.....	104
THE FOXES	105
General considerations.....	105
Former abundance.....	106
Decline from lack of food.....	106
Diseases.....	108
Food.....	108
Seal meat.....	108
Birds and eggs.....	108
Miscellaneous food.....	109

THE FOXES—Continued.	
Food—Continued.	Page.
Needs of foxes according to season.....	110
History of special feeding.....	110
Breeding habits.....	111
Methods of capturing.....	112
Recommendations.....	113
Feeding and method of capturing.....	113
Reserves for breeding.....	114
Elimination of white foxes.....	114
Care of skins.....	115
Sale for breeding.....	115
Experiments in domesticating foxes.....	116
THE REINDEER.....	117
Introduction and growth of herd.....	117
Limited capacity of the islands.....	118
Indifference of natives regarding reindeer.....	118
Use and value of the herd.....	119
THE SEA LIONS.....	119
Early abundance and uses.....	119
Breeding habits.....	120
Numbers killed in former years.....	120
Measures for preservation.....	121
THE BIRDS.....	121
Murres.....	122
Gulls.....	122
Auklets.....	123
Ducks and geese.....	123
Shore birds.....	123
Cormorants.....	124
Measures for protection.....	124
FISHING.....	125
INTRODUCTION OF NEW ANIMALS.....	126
Domestic animals.....	127
Horses and mules.....	127
Cattle.....	127
Sheep.....	127
Swine.....	128
Cats.....	128
Poultry.....	128
Wild animals.....	128
Hares and rabbits.....	128
Ground squirrels.....	129
Muskrats.....	129
Sea otter.....	130
Mink and otter.....	131
Lemmings and other small mammals.....	131
Ptarmigan.....	131
THE NATIVES.....	132
Origin and early history.....	132
Relation to lessees.....	132
Conditions under Government management.....	134
Present system of support.....	134
Population.....	139
Practical ability of natives.....	139

CONTENTS.

7

	Page.
THE NATIVES—Continued.	
Knowledge of seals overestimated.....	140
Proposed removal of natives impractical.....	140
Present appropriation inadequate.....	141
Food requirements.....	142
Housing.....	142
Hygiene and sanitation.....	143
Morals.....	145
Religion.....	145
Education.....	145
Conclusions.....	147
SUMMARY.....	147
Existing conditions.....	147
Conclusions.....	148
BIBLIOGRAPHY.....	149
DESCRIPTION OF MAPS.....	168
INDEX.....	x

TABLES AND NUMERICAL RECORDS.

	Page.
Early count of harems, St. George Island.....	26
Harems and idle bulls at height of season, 1914.....	27
Bachelors on land at one time.....	29
Count of pups, Pribilof Islands, 1914.....	32
Comparison of actual counts of pups with estimates based on an average harem.....	34
Estimate of nonbreeding seals, 1914.....	37
Complete census of fur seals, 1914.....	38
General comparison of recent censuses.....	39
Comparison of harems and idle bulls, 1912-1914.....	41
Demonstration of probable abnormal mortality of old cows, 1913-1914.....	43
Number of pups and percentages of decrease or increase in 1913 and in 1914 compared with the year before.....	44
Percentage of idle bulls on different rookeries, 1914.....	52
Mortality in relation to idle bulls.....	54
Prices received for skins of large seals.....	55
Comparison of average harems, 1912-1914.....	57
Branded yearlings seen on St. Paul Island, 1913.....	62
Branded yearlings seen on St. George Island, 1913.....	63
Measurements and weights of male yearlings, St. George Island.....	63
Measurements and weights of two-year-old males.....	66
Measurements and weights of two-year-old females.....	67
Measurements of three-year-old males, with weights of skins, St. Paul Island, July 1, 1914.....	69
Measurements of four-year-old males, with weights of skins, 1914.....	69
Condensed measurements of young males.....	70
Mortality of pups, summer of 1914.....	71
Estimated minimum number of females, 1914-1926.....	81
Estimated maximum number of females, 1914-1926.....	81
Estimated mean number of bearing and virgin cows, 1914-1926.....	81
Estimated minimum number of males, 1914-1926, under operation of law of 1912.....	82
Harem and idle bulls and annual increments required under various estimates at ratio of one bull to thirty-five cows.....	82
Comparison of results of present law, and of a reserving system based on an estimated mean rate of increase of cows.....	82
Bulls provided by law in excess of requirements of maximum, minimum, and mean estimates of cows.....	83
Extracts from St. Paul log regarding cows in drives.....	87
Number of foxes taken on Pribilof Islands, 1890-1913.....	107
Sea lions killed on St. Paul Island, 1870-1890.....	120
Number and size of households on Pribilof Islands, 1914.....	143

PLATES.

	Facing page.
PLATE I. Old bull in prime condition awaiting arrival of cows, Kitovi Rookery, June 22, 1914..	18
II. 1. Cow and pup sleeping, Kitovi Rookery, August 23, 1914.....	22
2. Cow nursing pup, Tolstoi Rookery, August 25, 1914.....	22
III. Bachelors sleeping on Tolstoi sands, August 25, 1914.....	26
IV. 1. Fur-seal pups on Tolstoi Rookery, August 25, 1914.....	30
2. Fur-seal pup on Gorbach Rookery, August 19, 1914.....	30
V. Old bul! showing usual emaciation at close of breeding season.....	34
VI. Roving bachelors on front of Kitovi Rookery, August 23, 1914.....	38
VII. Tolstoi flat after disorganization of the harems, August 23, 1914.....	50
VIII. Old cows in front of Gorbach Rookery, August 13, 1914.....	54
IX. Skulls of male seals showing changes due to growth and age: 1. Two-year-old. 2.	
Three-year-old. 3. Four-year-old.....	66
X. Skulls of male seals showing changes due to growth and age: 1. Five-year-old. 2.	
Six-year-old. 3. Old male of about 12 years.....	68
XI. Cows and pups swimming, Vostochni Rookery, August 17, 1914.....	74
XII. Branded cow, probably 12 years of age, Kitovi Rookery, August 23, 1914.....	78
XIII. Young seals hauled on Tolstoi Beach, St. Paul Island, August 25, 1914.....	80
XIV. Driving and podding seals for a food killing, St. Paul Island, August 8, 1914.....	86
XV. Sea Lion Rookery at Northeast Point, St. Paul Island, June 28, 1914.....	120
XVI. Murres or arries on Walrus Island, July 16, 1914.....	122
XVII. Natives' dwelling houses with seal meat drying, St. Paul Island, July 9, 1914.....	142
XVIII. Native laborers moving hospital building, St. Paul Island, August 24, 1914.....	144

LIST OF MAPS.

(Following index.)

ROOKERIES, SHOWING NUMBER AND LOCATION OF HAREMS AT HEIGHT OF SEASON, 1914.

<i>St. Paul Island.</i>	<i>St. Paul Island—Continued.</i>	<i>St. George Island.</i>
1. Kitovi.	9. Zapadni.	17. North.
2. Lukanin.	10. Little Zapadni.	18. Staraya Artel.
3. Gorbach.	11. Zapadni Reef.	19. Zapadni.
4. Ardiguen.	12. Polovina.	20. Little East.
5. Reef.	13. Polovina Cliffs.	21. East Reef.
6. Sivutch.	14. Little Polovina.	22. East Cliffs.
7. Lagoon.	15. Morjovi.	
8. Tolstoi.	16. Vostochni.	

GENERAL MAPS.

- 23. St. Paul Island, with Otter Island and Sea Lion Rock.
- 24. St. George Island.

LETTERS OF TRANSMITTAL.^a

DEPARTMENT OF COMMERCE,
OFFICE OF THE SECRETARY,
Washington, February 17, 1915.

MY DEAR SENATOR FLETCHER: I transmit herewith a report of Wilfred H. Osgood, Edward A. Preble, and George H. Parker, scientific assistants of the Bureau of Fisheries, on the fur seals and other life on the Pribilof Islands in 1914, and request that you obtain the consent of the Senate to have the report printed as a congressional document.

When the present Administration took charge it found in full force and vigor the existing law providing for a closed season for the seal herd belonging to the United States on the Pribilof Islands. This law was approved August 24, 1912, effective immediately, and will expire by its own limitation August 24, 1917.

The Department has felt that it had two duties in this important matter. The first was to enforce the law in letter and in spirit, and this has been done. The second was to ascertain from unprejudiced and dispassionate sources the effects of the law and to inform Congress about them as fully as possible. This is now done.

In view of the sharp controversy that has existed on the subject of the fur-seal herd it was deemed necessary that the persons selected by the Bureau of Fisheries as scientific assistants to study this problem should be persons who were free from all previous connection with the subject, but who were qualified by training and experience to determine and present the facts. It was required also that they should be severally qualified to carry on as separate individuals the particular lines of scientific study necessary to a full understanding of the problem.

Under these circumstances the president of the National Academy of Sciences, the Secretary of the Smithsonian Institution, and the Secretary of Agriculture were requested to make nominations of persons who might be temporarily employed for the purpose. The National Academy of Sciences nominated Prof. George H. Parker, of Harvard University, Cambridge, Mass.; the Secretary of the Smithsonian Institution nominated Mr. Wilfred H. Osgood, of the Field Museum of Natural History, Chicago, Ill.; and the Secretary of Agriculture nominated Mr. Edward A. Preble, of the Bureau of Biological Survey, Department of Agriculture. The three persons named were selected by the Department of Commerce and employed by the Bureau of Fisheries as temporary scientific assistants, and were instructed to proceed to the Pribilof Islands, there to ascertain the facts and to submit them to the Department for transmission to Congress. Full details are found in the attached report.

As Great Britain, through the Dominion of Canada, and Japan are financially interested in the American seal herd under the terms of the treaty abolishing pelagic sealing, these countries also of their own motion arranged to send representatives to the Pribilof Islands in 1914, and two experts from Canada and one from Japan visited the islands while our own inquiry was progressing. The facts concerning this matter appear in full in the report.

^a This report was originally printed as Senate Document No. 980, 63d Congress, 3d session.

LETTER OF SUBMITTAL.

The report is accompanied by three large traced maps of the Pribilof Islands, of which blue prints have been taken for the records of the Department, and by 21 smaller maps illustrating the report in detail.

The purpose of the Department has been to provide Congress with an unbiased statement of the actual facts to assist it in the preparation of such further legislation, if any, as it may deem wise to enact. It is my earnest hope that this has been accomplished.

Yours, very truly,

WILLIAM C. REDFIELD, *Secretary.*

Hon. DUNCAN U. FLETCHER,
Chairman Committee on Printing,
U. S. Senate, Washington, D. C.

DEPARTMENT OF COMMERCE,
BUREAU OF FISHERIES,
Washington, January 25, 1915.

SIR: There is transmitted herewith, for the information of the department, a report entitled "The Fur Seals and Other Life of the Pribilof Islands in 1914," by Wilfred H. Osgood, Edward A. Preble, and George H. Parker, special assistants whom the department engaged to visit the Pribilof Islands and investigate the conditions thereon during the sealing season of 1914. The report is accompanied by a limited number of photographs illustrating important phases of the subject and a series of maps showing the location and extent of the seal rookeries.

In view of the comprehensive scope of the report, the purpose of the investigation on which it is based, and the large economic interests involved I beg leave to recommend that the report be submitted to Congress with a view to its publication and distribution.

Respectfully,

H. M. SMITH, *Commissioner.*

The SECRETARY OF COMMERCE.



LETTER OF SUBMITTAL.



DEPARTMENT OF COMMERCE,
BUREAU OF FISHERIES,
Washington, January 23, 1915.

SIR: We have the honor to submit a report entitled "The Fur Seals and Other Life of the Pribilof Islands in 1914," being the result of investigations carried out in response to instructions received from the Secretary of Commerce under date of May 26, 1914.

Very respectfully,

WILFRED H. OSGOOD.
EDWARD A. PREBLE.
GEORGE H. PARKER.

Dr. HUGH M. SMITH,
Commissioner of Fisheries.

THE FUR SEALS AND OTHER LIFE OF THE PRIBILOF ISLANDS, ALASKA, IN 1914.



By WILFRED H. OSGOOD, EDWARD A. PREBLE, and GEORGE H. PARKER.



INTRODUCTION.

PERSONNEL AND INSTRUCTIONS.

In the spring of 1914, at the instance of the Secretary of Commerce, steps were taken to send three investigators to the Pribilof Islands to examine and report on the condition of the fur-seal herd. To this end the president of the National Academy of Sciences, the Secretary of the Smithsonian Institution, and the Secretary of the Department of Agriculture were requested to make nominations. The only restriction imposed was that the nominees should have had no previous connection with the fur-seal question, in order that they might approach the subject uninfluenced by the controversies which have for some time beset the subject. The nominations were as follows: George H. Parker, of Harvard University, Cambridge, Mass., by the National Academy of Sciences; Wilfred H. Osgood, of the Field Museum of Natural History, Chicago, Ill., by the Secretary of the Smithsonian Institution; and Edward A. Preble, of the Bureau of Biological Survey, Department of Agriculture, by the Secretary of Agriculture. All having accepted, a conference was held in Washington on April 20, and tentative plans were formulated. In due time the nominees were appointed as temporary special assistants of the Bureau of Fisheries, and detailed individual letters of instructions were issued to them. The nature of these instructions is indicated by the following letter which was addressed to G. H. Parker, and which is essentially like those sent to the others:

DEPARTMENT OF COMMERCE,
OFFICE OF THE SECRETARY,
Washington, May 26, 1914.

DEAR SIR: You have been engaged as a temporary special assistant of the Department of Commerce, Bureau of Fisheries, beginning June 1, 1914, and you are assigned to an investigation of the Alaskan fur seals and various questions connected therewith, in cooperation with Mr. Wilfred H. Osgood and Mr. Edward A. Preble, in accordance with the instructions which are contained herein or which may hereafter be issued.

You will arrange to sail for the Pribilof Islands from Seattle on or about June 8, on the revenue cutter *McCulloch*, which is under orders from the Treasury Department to carry your party to the seal islands. Your return trip from the seal islands to a point where a regular passenger steamer is available will likewise be made on a revenue cutter which will be detailed for the purpose.

The time of your sojourn on the islands is left to your discretion. It is hoped, however, that you will remain as long as it is possible to obtain information of value bearing on the special object of your visit.

You have been selected for this service because, not having previously been identified with or in any way concerned with fur seals or the fur-seal controversy, it is expected that your observations and conclusions will be uninfluenced by past contentions but will depend wholly on the existing conditions. It is desired that you confine yourself to the facts that may be established by your inquiries, and not become involved with profitless discussion or controversy over previous conditions.

The main purpose of your investigation is to ascertain the actual state of the Alaskan seal herd in 1914, and to make that condition known to the department, with recommendations touching all important administrative matters growing out of the international, economic, and biological relations of the seal herd. Incidentally, it will be necessary for you to consider (1) the welfare of the native inhabitants of the islands and the duty of the Government thereto as related to the conservation and utilization of the seal life; and (2) the foxes, reindeer, birds, and other animals of the islands, and their proper treatment with reference to the best interests of the Government and the natives.

Without assuming to restrict your investigations in any way whatever, I will indicate the following subjects as among those requiring special attention:

1. A census of each rookery and hauling ground, so that the numerical strength of each component of the herd may be known. Especially valuable will be the actual enumeration of the pups before they have taken to the water, because this affords the only accurate knowledge of the number of breeding females present. The census requires much time and care, and should be participated in jointly and be certified to by the members of your party and the available members of the staff on the islands.

2. The adequacy of the various components of the herd with regard to the reestablishment of the herd, and especially the sufficiency of male life in view of the recent apparent marked increase in the number of mature females as a result of the suspension of pelagic sealing.

3. The strength of the surplus male life in relation to the close-time provisions of existing law and to treaty obligations.

4. The quota of seals of specified ages that should be taken for the food and other purposes of the natives, in view of the provisions of law and of the condition of the herd. As soon as practicable after your arrival on the islands and after full consideration of the needs of the natives, the department desires a telegraphic recommendation to cover the food killings during the height of the season and a supplementary recommendation prior to your departure from the islands.

5. The general and special effects of the suspension of pelagic sealing on the size and condition of the herd.

6. The propriety of the methods of driving, killing, and skinning now practiced; the presence of female seals in the drives; the probability of the killing of immature females regularly or accidentally through inability to distinguish them from the bachelors.

7. Natural mortality among young and old seals on the islands, especially that due to disease.

8. Evidences of injury to the herd from fighting and trampling among surplus bulls, resulting from the operation of existing law.

It is desired that there be obtained a full photographic record of the rookeries, hauling grounds, etc., and that the historical series of rookery views be continued as far as possible. Furthermore, as a part of the general publicity plans of the department, there should be taken a typical set of motion-picture photographs illustrating the various phases of seal and native life on the islands.

So far as your other duties will permit, I am particularly desirous that you should give attention to the native inhabitants and determine what changes, if any, should be made in the relations of the Government to their social, educational, sanitary, business, and other interests.

The regular employees of the bureau on the seal islands will be instructed to accord you every facility and assistance in your work, and you will have access to and full use of all the official records on the islands and in Washington.

As soon as practicable after your return, and preferably before December 1, I desire to have a full report embodying the results of your investigations, and recommendations based thereon.

Very truly, yours,

(Signed) WILLIAM C. REDFIELD,
Secretary.

Prof. GEORGE H. PARKER,
Harvard University, Cambridge, Mass.

INVESTIGATIONS BY CANADA AND JAPAN.

Canada and Japan, being interested financially in the American seal herd by the terms of the treaty abolishing pelagic sealing, also arranged to send representatives to the Pribilof Islands in 1914. A few days before the date assigned the American investigators for leaving for the Pribilof Islands, the State Department received from the British and Japanese ambassadors the following communication, which was referred to the Department of Commerce:

NOTE VERBALE.

During the past 25 years naturalists of unquestioned ability and integrity have been at great pains to acquire a fuller knowledge of the life of the fur seals frequenting the North Pacific Ocean. They have devoted much attention to the subject and have made a close personal study thereof on the seal islands. Whilst these studies have resulted in a consensus of opinion on many aspects of seal life, it appears that there is still some divergence of view, for instance as to the best course to rehabilitate the herd.

In view of the importance of the matter to Canada and Japan, as well as to the United States, a suggestion has been made that the present time calls for the appointment of a committee of experts for these three countries to visit the Pribilof Islands during the summer, and after a thorough investigation into the conditions there prevailing, to submit a joint report and recommendations, if they can agree on such, for the consideration of the United States Government.

It is desired to know what view the United States Government take of this proposal, and as the experts should be on the islands by the month of July, it is hoped that the United States Government will be able to give the matter their early consideration.

MAY 29, 1914.

To this request the Department of Commerce replied through the Department of State, expressing the belief that, on account of the late date, it would be impracticable to secure the necessary authority to enter into the formal joint investigation proposed, but that arrangements to send three expert assistants to the islands had already been made; that the department would welcome the representatives of Canada and Japan to the seal islands, and would afford them every possible facility for making their investigations, and through its assistants would cooperate with them so far as possible. To this end, the agents on the islands and the special assistants were instructed to extend to the foreign visitors all possible courtesy and assistance.

With this understanding, two experts from Canada and one from Japan visited the islands during the investigation. The representatives of Canada were Mr. James M. Macoun, naturalist of the Geological Survey of Canada, and Mr. B. W. Harmon, of the Dominion Department of Marine and Fisheries. The representative of Japan was Dr. T. Kitahara, biologist of the Imperial Japanese Fisheries Bureau. The American and foreign representatives worked cooperatively during the season, and though nothing of a deliberative nature was done jointly, the observation of fact and particularly the enumerations of seals, were matters of joint labor by both Americans and foreigners.

ITINERARY.

Pursuant to instructions the three assistants assembled at Seattle, Wash., on the evening of June 8. Upon the arrival of the Canadian representatives, the combined party went on board the revenue cutter *McCulloch*, Capt. P. H. Uberroth commanding, and left for the Pribilof Islands on June 11. St. Paul Island was reached in the late afternoon of June 21, and the party was hospitably received by the officials in charge.

The investigators remained on St. Paul Island until July 10 when they went to St. George Island on the Bureau of Fisheries steamship *Albatross*, Lieut. L. B. Porterfield commanding. Here they remained until July 15, when they were taken back to St. Paul on the revenue cutter *Tahoma*, Capt. R. O. Crisp commanding. The next day, July 16, a trip to Walrus Island was made on the same vessel, and an opportunity for observing its extensive bird rookeries was afforded.

On July 24, Dr. T. Kitahara, the Japanese representative, arrived on St. Paul Island on the United States revenue cutter *Manning*.

A visit to Otter Island, formerly the site of an extensive hauling ground, was made on July 27 on the *Tahoma*. On August 3 the entire party—Americans, Canadians, and Japanese—having finished the count of the seal pups on St. Paul, went to St. George on the *Tahoma* to make a similar count there. This work was finished on the morning of August 5, and in the afternoon of that day all returned to St. Paul.

On August 6, Mr. Parker, Mr. Kitahara, and Mr. Harmon left St. Paul for Seattle and their respective homes. Messrs. Macoun, Osgood, and Preble continued to make further observations until August 30, when, through the courtesy of Capt. W. E. Reynolds, in command of the Bering Sea fleet, they left on the revenue cutter *Manning*, Capt. F. G. Dodge commanding. The party arrived at Seward, Alaska, via Unalaska, on September 6, and left Seward on the steamship *Alameda* on September 9, arriving in Seattle on September 17.

IMPARTIAL NATURE OF THE INVESTIGATION.

In accordance with the desire of the Secretary of Commerce, the observations and inquiries of 1914 were conducted, so far as possible, without reference to previous opinions. The entire subject was approached without prejudice and with the desire only to ascertain the actual conditions. Nothing was taken for granted, and whenever it was found necessary to refer to previous conditions all points concerned were subjected to scrutiny and verification by actual observation. The same policy has been pursued in the preparation of the report, and though conclusions of others have been consulted freely they have not been accepted unless confirmed by observations in 1914. In the treatment of special subjects, it has sometimes been necessary, for the sake of clearness, to repeat in part under one subject matter which may be found in full under another.

The preparation of the report has been carried out mainly by Mr. Osgood and Mr. Preble. Owing to the press of other duties, Mr. Parker has been unable to give continuous active assistance, but he has prepared certain sections, revised others, and critically examined the entire manuscript. Therefore the complete report, both as to detailed statement and general conclusions, is subscribed to by each of the co-authors.

ACKNOWLEDGMENTS.

In the course of the investigations material aid was received from many persons, to all of whom grateful acknowledgment is made. Special thanks are due the officers of the Revenue-Cutter Service, who were ready to aid at all times—the necessity of moving back and forth between the two main islands in order to make particular observations at certain times rendered this ready cooperation invaluable. The agents and other employees of the Bureau of Fisheries on the islands and elsewhere, and the operators of the naval radio stations freely rendered service whenever required. Thanks

for various courtesies are due also to the representatives of Canada and Japan, with whom the most cordial relations were maintained during daily association.

Finally, it should be stated that certain of the suggestions made in the present report have been previously urged, some of them repeatedly. To former observers in the field and to many others who in the past have been more or less directly concerned with the activities on the islands, acknowledgment is made for such ideas and facts found in their printed reports as were confirmed by observations in 1914. To give credit in each case is impracticable, but passing acknowledgment is made in various instances in the body of the report.

THE PRIBILOF ISLANDS.

GENERAL DESCRIPTION.

The Pribilof Islands are situated in Bering Sea in latitude 57° north and longitude 170° west, and are of volcanic origin. The nearest land is Unalaska Island, 214 miles to the southward; the next nearest is St. Matthew Island, 220 miles to the north. The distance from the mainland of Alaska is a little over 300 miles. The group comprises five islands, St. Paul and St. George, lying about 40 miles apart, being the principal ones. The others are Otter Island, Walrus Island, and Sea Lion Rock, which lie close to the shores of St. Paul.

St. Paul is about $13\frac{1}{2}$ miles long and $7\frac{2}{3}$ miles wide and has a shore line of about 45 miles, composed of alternate stretches of sand and broken rock, in some cases backed by cliffs, the highest of which attain an elevation of nearly 400 feet. Several cinder cones are distributed over the island, the highest being Rush Hill, which is 665 feet above mean high tide. Much of the surface is very rough in character but extensive stretches of comparatively smooth ground, clothed with lichens and herbaceous plants, occupy many of the valleys and low plateaus. There are many fresh water ponds, the largest about 2 miles in length, but all are very shallow.

St. George Island is about 12 miles long and $4\frac{1}{2}$ miles wide and has a coast line of about 30 miles. It is bordered mainly by abrupt cliffs, the highest of which rise nearly a thousand feet sharply from the water. There are several hills in the interior of the island, the highest of which is 946 feet above sea level. Various shallow ponds and many marshes, from which a few small streams descend to the sea, distinguish St. George from its larger companion, which is devoid of running water.

Otter Island, 6 miles south of St. Paul, is only three-fourths of a mile in length; its shore is mostly precipitous, rising in one place to a height of 300 feet. The other islets, Walrus Island and Sea Lion Rock, also near St. Paul, are merely ledges of rock scarcely elevated above the wash of the sea.

On the shores of the two larger islands the fur seals have most of their breeding rookeries and hauling grounds. The seals when breeding choose rocky beaches or boulder-strewn ledges. The rookeries are usually separated from each other by stretches of sand or by abrupt cliffs, or in some cases by sections which have been abandoned. The breeding masses usually extend back from the water's edge but a short distance.

Sea Lion Rock has a breeding rookery, and Otter Island formerly had a hauling ground, and once, in 1896, a single harem, but so far as known was not resorted to by

seals during 1914. All the islands are the breeding resorts of myriads of sea birds. Their great numbers and the protection which they enjoy during the breeding season make them fearless and confiding, and they afford an exhibition of bird life which can scarcely be surpassed anywhere in the world.

VEGETATION.

The three larger islands are remarkable for the abundance and beauty of their floral display. The flowering plants include a great variety of subarctic species, which from early June until late August beautify the grassy slopes and plains. There are also many ferns and mosses and lichens, and a variety of grasses. No trees whatever grow on the islands, and the shrubs are represented only by a few creeping willows and dwarfed heath-like plants. The two smaller islands are devoid of vegetation with the exception of a few grasses and one or two insignificant herbs.

CLIMATE.

The range in temperature is very slight, the thermometer seldom rising above 50° F. in summer, and in winter ranging usually between 20° and 25° and rarely falling lower than 12°. There is much precipitation, usually falling in the form of drizzly rains or light snows. Chilly fogs are of almost constant occurrence during summer and the winds are at other seasons sometimes very violent. In winter the pack ice from the Arctic frequently closes in about the shores.

CHARACTER AND HABITS OF THE FUR SEAL IN BRIEF.

GENERAL CHARACTERISTICS.

The Alaska fur seal (*Callorhinus alascanus*), although similar in general appearance, has certain characters by which it is recognized by naturalists as distinct from the seals inhabiting the Russian and Japanese islands lying near the coast of Asia. It has a range peculiar to itself and is not associated at any season of the year with the other species of fur seals. With a few allied species, it is remarkable among large animals for its highly gregarious and polygamous nature and its habit of performing a long annual migration. It comes to land only in summer for the purpose of breeding and rearing its young; the remainder of the year is spent entirely at sea. It is an animal of exceedingly strong instincts and relatively small intelligence. The disparity in size between the sexes is very great, the adult male being nearly or quite five times as heavy as the female. Moreover, the male matures more slowly than the female, and thus it results that seals of different ages and sexes are different in appearance and to some extent in habit. The names by which the different ages and classes of seals have come to be known, therefore, are somewhat peculiar. The breeding males are bulls, the females are cows, while the young are pups. The males just approaching full maturity are called half-bulls, while the younger males are termed bachelors. The breeding ground is a rookery, and the place resorted to by the bachelors is a hauling ground.

RANGE.

Practically all the individuals of the herd during some part of the season from May until December make the Pribilof Islands their home. The winter and early



Old bull in prime condition awaiting arrival of cows, Kitovi Rookery, June 22, 1914.



spring months are spent entirely at sea. The migration route in general is southward to the passes of the Aleutian Islands, then eastward and southeastward along the coast of Alaska, British Columbia, and the United States to the latitude of southern California. The adult males remain farthest north, wintering south of the Aleutian Chain and in the Gulf of Alaska. The younger males go somewhat farther and the females the farthest of all. Returning from their winter resort, the seals reach the islands in general according to their age, the older animals first and the youngest last. The adult males begin to reach the Pribilof Islands about the 1st of May; the adult females and the older bachelors arrive there mainly in June; the 2-year-olds mainly in July; and the yearlings in the latter part of August and early September.

BREEDING HABITS.

On reaching the islands the old bulls at once take their places on the rookery ground, in many cases, perhaps in most, choosing the same spot occupied in former years. They remain on the place selected throughout the entire breeding season without eating. Once the place is chosen they can scarcely be forced by any means to forsake it, and display the most extraordinary courage and persistence in maintaining their position against the assaults of their rivals or the efforts of man. During May and June the numbers on the rookery increase, each bull on arriving taking such place as he can obtain, sometimes by dispossessing another, but as a rule by selecting an unoccupied spot. Thus the late comers settle about the ends or the rear of the breeding ground. Shortly after the 1st of June the females of 3 years and over begin to arrive. Each is pregnant, and is impelled by her condition to seek a place to give birth to her pup. The females on arrival at once land and join a bull, and within a few days, sometimes a few hours, they give birth. Each day other cows arrive, and the harems grow rapidly. The arriving cows show a tendency to join the larger groups, and consequently there is an uneven growth, some bulls securing large harems early in the season, while others near by, apparently equally strong and vigorous, may still have no cows. Early in the season, before the arrival of the cows, there is some display of rivalry among the bulls, and late arrivals attempting to gain a place near the center of the rookery are frequently subject to the joint attack of several bulls already in place. In general, however, the stationed bulls spend much of this time in sleeping, and incoming ones gradually fill in the unoccupied territory. As the height of the season approaches and cows come in heat in large numbers, the bulls become continuously alert and active. Those at the rear that have not obtained cows attempt to abduct some from the large harems, and some fighting ensues. When bulls are in abundance, a certain number are unable to secure harems and are known as idle bulls, though the observer finds them far from idle. In 1914 there were comparatively few of this class of bulls. The number of cows to a harem varies greatly, frequently being more than 50 and occasionally exceeding 100, while in many cases it is very small—from 2 or 3 to a dozen. The large harems are clearly due more to advantage of position than to fighting prowess of the bulls in charge of them.

A few pups are born as early as June 10, but the majority between June 20 and July 20. After the latter date the births decrease, but many occur during the last 10 days of July and a few during the first week in August. An occasional birth occurs as late as August 10 or 15, and one on August 27 is recorded. Each female bears one

pup and one only, and of the total number born approximately half are males and half females. The weight of the pup at birth is about 12 pounds. Within a few days after giving birth the female is impregnated; it therefore follows that the period of gestation is a few days short of one year. In the interval she nurses her pup, but otherwise shows comparatively little parental solicitude. After impregnation the mother seal, being free to go and come, takes the first of a series of journeys to sea for the purpose of feeding, going from 50 to 100 miles or more, and, after gorging on fish, remains in the water until digestion has taken place. While their mothers are at sea the pups form small "pods" by themselves outside the harems. On returning, the cow finds her pup among the thousands which now throng the rookeries, and stays with it a short time, the pup partaking freely of the abundant store of milk. These journeys to and from the feeding grounds are kept up until November, when old and young leave the islands.

The decline in the number of pups born marks the end of the breeding season. The old bulls, grown thin and relatively weak from their long fast and protracted harem service, leave the rookeries and after a short rest go to sea to feed and recuperate. Even before the bulls leave, during the last week in July, they relax the strict discipline which they have maintained earlier in the season and the cows come and go at will, and idle bulls and eager young bachelors throng the grounds they dared not enter previously. At this time also the 2-year-old virgin females come ashore for their first impregnation. After this "break-up" there is more or less mingling of all classes of seals. The great majority of the cows continue to frequent the breeding grounds and the bachelors mostly resort to the hauling grounds, but cows often wander among the bachelors and bachelors play among the cows. During the first week in August a few pups begin to play in the water and to make short excursions from shore. By the latter part of August pups may be seen swimming and frolicking along the shores at considerable distances from the rookeries. They continue to come ashore to nurse, however, and leave with the majority of the cows and bachelors in November. During August and later months yearlings are frequently seen playing among the pups.

HABITS OF BACHELORS.

The bachelors or younger males remain during the summer mainly by themselves, hauling out in large bands in the vicinity of the breeding rookeries on separate areas known as hauling grounds. Unlike the breeding males, they make frequent excursions to sea to feed and remain fat the entire summer. While on land they pass much of the time sleeping and playing with each other, and until late in the season are kept from the breeding grounds by the old bulls. It is from these hauling grounds that the drives for killing are made. Some of the bachelors remain until December, and an occasional few are observed during the winter.

AGE OF SEALS.

The male seal is capable of breeding at the age of 5 years or even 4, but does not normally breed until 6 or 7. The female is normally impregnated as a 2-year-old and gives birth to her first pup at the age of 3 years. Males and females, however, have approximately the same length of life, from 12 to 14 years. Fortunately the data regarding this important matter are fairly conclusive. Numerous females branded as pups not later than 1902 were seen in 1914, showing that many cows live at least 12

years. One cow observed in 1914 bore a large T brand consisting of a transverse bar across the shoulder and a longitudinal mark leading from it down the back. This brand is believed to have been made in 1899, and if this be true the cow still bearing it must have been 15 years old in 1914. She was in good condition and bore a healthy pup. The age attained by the bulls is attested by scattered records of animals which have been recognized from year to year by various peculiarities or special marks. It is also evidenced by the disappearance within a limited time of the large surplus of bulls produced by the lack of regular killing during the *modus vivendi*.

SEALING HISTORY IN BRIEF.

RUSSIAN MANAGEMENT.

When the Pribilof Islands were discovered by the Russians, in 1786, they were uninhabited, but a number of small colonies of natives from the Aleutians were at once established. In 1799 the islands passed into the control of the Russian-American Co., which remained in charge until the purchase of Alaska by the United States in 1867. The records of their early operations are imperfect, but so far as available they indicate that some 1,821,639 seals were taken between 1786 and 1834. The catch consisted largely of young ones of the year, and both males and females were taken, and by 1835 the herd had become so reduced that restrictive measures were recognized as necessary. From 1835 to 1867, when the killing was more restricted and females were spared, the herd gradually increased. During this period at least 608,000 seals were taken. At the time of the purchase of Alaska in 1867, the herd contained, according to various estimates, from two to five million animals.

AMERICAN OCCUPATION AND THE LEASING SYSTEM.

In 1868 and 1869 about 242,000 and 87,000 seals, respectively, were taken on the Pribilof Islands by various independent parties. On July 1, 1870, a law was enacted providing for the leasing of the sealing privilege for a term of 20 years, at an annual rental of not less than \$50,000 and a tax of \$2 on each skin taken. Under the terms of this act, a lease was entered into with the Alaska Commercial Co., a corporation including some of the American sealers who had operated on the islands in 1868 and 1869. This company agreed to pay an annual rental of \$55,000 and a tax of \$2.62½ on each skin taken. Certain concessions were made to the natives and the right to make further rules and regulations governing the industry was vested in the Secretary of the Treasury. Under the lease the company took a quota of about 100,000 seals annually until 1889. The total number of skins taken on the islands during the 20-year period was 1,977,377 and the revenue to the Government was \$6,020,152. Upon the expiration of the first lease the Secretary of the Treasury advertised for bids for the lease of the sealing privilege for a further period of 20 years. Although the Alaska Commercial Co. made an effort to secure a renewal of the lease, a more favorable bid was received from another corporation, the North American Commercial Co., to whom the contract was awarded on March 12, 1890. The new lease provided for a rental of \$60,000 per annum, and a tax of \$9.62½ on each skin taken. More liberal provisions were made for the care of the natives, and the number of seals to be killed annually was placed at the discretion of the Secretary of the Treasury. For the first year the number was 60,000. During the

20 years of its incumbency the North American Commercial Co. took on the Pribilof Islands a total of 342,651 skins. The revenue to the Government was \$3,453,844. The leasing system was discontinued in 1910.

THE GROWTH OF PELAGIC SEALING.

Until 1889 the Alaska Commercial Co. had little difficulty in getting its annual quota of 100,000 skins. For some years previously an additional catch was obtained by independent operators who killed seals at sea during their migrations and feeding excursions to and from the islands. These pelagic sealers originally comprised chiefly Canadians and Americans, but in later years many Japanese engaged in the business. Beginning to operate extensively about 1879 they rapidly increased in number and in 1889 their recorded catch was 29,858 seals. In addition, as became evident from later investigations, they killed many seals which could not be retrieved, and still more important, from 60 to 80 per cent of their catch were females whose death involved the loss of their unborn pups, or the starvation of newborn ones left on land, or both. During the period from 1868 to 1878, inclusive, the recorded pelagic catch totaled 72,134. From 1879 to 1911, inclusive, the total catch was 904,506. The largest recorded catch, 59,568 skins, occurred in 1891.

THE PARIS TRIBUNAL AND THE MODUS VIVENDI.

Recognizing that the brutal and wasteful killing at sea was greatly against the interests of the herd, the United States sought to establish jurisdiction in Bering Sea as a closed sea and seized a number of Canadian sealing vessels found operating there. This led to a controversy with Great Britain, which resulted in a treaty concluded February 29, 1892, consigning the whole matter to the deliberation of a tribunal of arbitration which met at Paris in the summer of 1893. Pending this treaty and the result of the deliberations of the tribunal, an agreement between the United States and Great Britain was entered into in June, 1891, by which the latter country prohibited British subjects from sealing in the eastern part of Bering Sea, and the United States prohibited all killing whatever by its citizens excepting that of 7,500 seals annually for the food of the natives of the Pribilofs. Though originally effective for only one year, this agreement, now known as the "Modus vivendi," was renewed in 1892 and 1893.

Among the results of the work of the Paris tribunal was a set of regulations closing to pelagic sealing a zone of 60 miles in radius about the Pribilof Islands, and prohibiting it entirely between May 1 and July 1. These regulations went into effect in the summer of 1894, and of course affected only the citizens of the United States and Great Britain. They were subject to reexamination at intervals of five years. The experience of a single season showed that the result was ineffective, since the catch from pelagic sealing increased, and the seal herd continued to decline. The United States, therefore, requested Great Britain to consider the revision of the regulations. This request was declined, and in 1896 this country accepted the proposal of Great Britain that the two countries institute independent scientific investigations of the entire matter at the close of the five-year trial period. These investigations were made in 1896 and 1897 and a voluminous report on the work of the American investigators was published in 1898. In the meantime, on December 29, 1897, Congress had enacted a law forbidding American citizens from engaging in pelagic sealing at any time or place.



1. Cow and pup sleeping, Kitovi Rookery, August 23, 1914.



2. Cow nursing pup, Tolstoi Rookery, August 25, 1914.

SPECIAL INVESTIGATIONS.

On the acquisition of Alaska by the United States it became evident that the fur seals of the Pribilofs represented a source of revenue concerning which very little was known. In the spring of 1872 Henry W. Elliott was sent to the islands by the Secretaries of the Smithsonian Institution and the Treasury. He remained until the spring of 1873 and later published a report which has appeared in several forms and which still remains the principal source of information regarding the early history of the islands and their activities. Mr. Elliott was on the islands also in the summers of 1874 and 1876. In the summer of 1890, as a special agent of the Treasury Department, he again visited the Pribilofs. With him at this time was associated William Palmer, a naturalist in the employment of the United States National Museum.

In the summer of 1891 a joint commission representing Great Britain and the United States visited the Pribilof Islands. The members for the United States were C. Hart Merriam and Thomas C. Mendenhall, and for Great Britain George S. Baden-Powell and George M. Dawson. A brief joint report was submitted by the commission in March, 1892, and detailed reports to their respective countries by the representatives of the United States and Great Britain were published later.

The appointment of a second joint commission representing Great Britain and the United States to reconsider the result of the work of the Paris tribunal has already been referred to. This commission consisted of David Starr Jordan, Jefferson F. Moser, Leonhard Stejneger, Frederic A. Lucas, Charles H. Townsend, George A. Clark, and Joseph Murray, representing the United States. Those representing Great Britain were D'Arcy W. Thompson, Gerald E. H. Barrett-Hamilton, James M. Macoun, and Andrew Halkett. Investigations were made by this commission in the summer and autumn of 1896 and again during the same season in 1897. Several assistants accompanied the American commission to do special work under its direction.

In the spring and summer of 1892 Barton W. Evermann, as a special commissioner under the State Department, made extensive studies regarding pelagic sealing in the North Pacific. In the course of his investigations he visited the Pribilof Islands.

Frederick W. True, of the United States National Museum, visited the Pribilofs for the purpose of studying the fur seals in the summer of 1895.

Charles H. Townsend made important studies of the fur seals on the Pribilof Islands during some nine seasons, in 1885, 1892 to 1896, inclusive, and in 1898 and 1900.

In the summer of 1906 Edwin W. Sims, of the Department of Commerce and Labor, investigated the fur seals of the Pribilofs.

As a special investigator to perform the naturalist's duties, Harold Heath spent the season of 1910 on the islands and made a census of the herd and certain special studies.

In the summer of 1913 H. W. Elliott and A. F. Gallagher went to the Pribilof Islands as special agents of the House Committee on Expenditures in the Department of Commerce.

George A. Clark, secretary to the American commission of 1896 and 1897, visited the Pribilofs in 1909, 1912, and 1913 as a special agent of the Bureau of Fisheries and made detailed studies of the seal herd.

In addition to the results obtained by special investigators, valuable additions to the knowledge of fur seals have been made by certain of the regular employees on the islands, among whom Naturalists W. L. Hahn and M. C. Marsh and Agent W. I. Lembkey may be specially mentioned.

SEALING UNDER GOVERNMENT MANAGEMENT.

During the period of leasing the sealing privilege the work of the Government on the Pribilofs was confined mainly to keeping a check on the operations of the lessees and in the management of the affairs of the natives. But under a law which provided for the abandoning of the leasing system the Government assumed direct charge of all the activities on the islands in 1910.

The law of 1910.—Toward the close of the term of incumbency of the North American Commercial Co., it was decided to abandon the system of leasing. The act authorizing this was passed on April 21, 1910. It provided that all sealing should be done under the authority of the Secretary of Commerce and Labor through agents and officers whose employment it authorized; the natives were to be employed and their wants provided for; the sealskins were to be sold to the best advantage of the Government; the purchase of the plant of the former lessees was authorized; and authority was given the department to furnish and maintain on the islands stores of necessary supplies. The lease having expired on May 1, 1910, the supplies were purchased and shipped to the islands, the plant of the retiring company was purchased for \$60,541.48, and sealskins to the number of 12,920 were taken during the first season. These skins yielded a net revenue to the Government of \$403,964.94.

During the year 1911 the operations on the islands were conducted in much the same way as in 1910. The sealskins taken were 12,002 in number; the net receipts therefrom were \$385,862.28.

The treaty suspending pelagic sealing.—On December 15, 1911, a treaty became effective between the United States, Great Britain, Russia, and Japan, abolishing sealing on the high seas for a period of 15 years. By its provisions the United States and Russia, as owners or guardians of the seal herds, agreed to pay to Great Britain and Japan, for the relinquishment of their interest in pelagic sealing, a percentage, 15 per cent to each, of the product of the land sealing to be conducted by each of the two nations. In like manner Japan agreed to pay to the United States, Great Britain, and Russia, respectively, 10 per cent of the land catch from the small but growing herd under her jurisdiction.

The law of 1912.—On August 24, 1912, the Congress of the United States passed a law prohibiting all killing of fur seals on the Pribilof Islands for a period of five years except the number needed as food for the natives, and providing for a breeding reserve of not less than 5,000 3-year-old males annually during the life of the treaty suspending pelagic sealing.

Under the operation of this law, only the skins of seals taken for food have been handled. These, including 9 skins carried over from the previous season, numbered 3,773 in 1912. The net proceeds were \$130,640.57.

In 1913, 2,296 sealskins were taken. With the exception of 400, which were withdrawn from immediate sale, these were sold and the net proceeds were about \$50,000. The sealskins taken in 1914, reported as 2,896 in number, have not been sold.

Revenue from fur seals.—During the three years of Government management the net revenue from the sale of sealskins has amounted to a total of approximately \$970,468. As elsewhere stated, \$6,020,152 was derived during the period of the first lease of the sealing privilege and \$3,453,844 during the second lease. Since the acquisition of Alaska by the United States in 1867, therefore, the direct revenue to the Government from the fur seal has amounted to approximately \$10,444,464. Considerable additional revenue has accrued to the Government from the importation of dressed skins from foreign countries.

Fox skins taken since the leasing system was discontinued have yielded net revenues as follows: In 1911, \$15,096.58; in 1912, \$20,505.17; and in 1913, about \$17,000. The fox skins taken in the winter of 1913-14, and numbering 280, are still on hand.

THE CENSUS OF THE HERD IN 1914.

THE NATURE OF THE CENSUS.

The natural desire for complete figures has led most investigators in the past to attempt a full census of all classes of seals, although it has never been possible to make such a census absolutely accurate. The total number of seals living is, of course, a general measure of the state of the herd, but certain classes are more important than others. It is still impossible to make a full census without some proportion of estimate, but the cessation of pelagic sealing has provided opportunity for actual counts of the breeding elements of the herd, the old males and females and the young of the year. With these elements positively known and killing records complete for several years, the nonbreeding seals can be estimated by making use of the number supposed to die from natural causes. At present the rate of mortality must be inferred, and herein lies the only element of uncertainty in the census. The census of 1914 has the advantage of known birth rates for the two preceding years in addition to the absence of killing at sea, and to this extent it is open to less objection than the figures obtained for previous years.

The classes of seals actually counted for the census are the breeding or harem bulls in active service, the idle bulls found on the breeding ground, and the young pups of the season. Actual counts were made also of half bulls and bachelors, but gave only partial results of value chiefly as a check upon the estimates.

The classes estimated are the yearlings and 2-year-olds of both sexes, and the bachelors from 3 to 5 years of age. The number of breeding cows was directly inferred from the number of pups.

THE COUNT OF HAREMS.

Since 1896 counts have been made annually of the actual number of harems or breeding families in the herd. The number of bulls having harems gradually increases from the time the cows begin to arrive in June until the middle of July, when, at the so-called "height of the season," the number reaches a maximum and thereafter rapidly declines. The harem count, therefore, is always made at the height of the season, from July 10 to July 20, and the results obtained from year to year are thus fairly comparable. Bulls having but one cow at the time the count is made are, of course, included as harem bulls, and since the number of such bulls must vary even from hour to hour, this con-

stitutes a slight element of unavoidable uncertainty. It is plain also that the more idle bulls there are the more single cow harems may be expected. The maximum development of the different rookeries is not strictly contemporaneous, and this also adds a variable feature to the harem counts. Such irregularities are probably compensated in the results from year to year, and in any event the total number of harems and idle bulls is not affected.

The method of counting is simple and reliable. The rookeries are mostly extended along the shore in linear formation frequently beneath low cliffs from which the observer can look over them with ease. In the present condition of the herd the number of bulls in tier formation between the shore and the back of the rookery does not often exceed five, and marked rocks and natural prominences are sufficient for all necessary subdivision of rookery space into areas for successive counting. A few of the massed sections, as the flat under Hutchinson Hill and certain parts of Reef Rookery, offer difficulties which will increase as the herd grows and which could be overcome by simple devices. In such places repeated counts were made by four individuals until complete agreement was reached. The large relative size of the bull makes him conspicuous even at a considerable distance, and except when fully recumbent in a heavily massed area, he can not possibly be overlooked.

Preliminary counts.—In order to overcome the lack of previous experience and to make general preliminary observations, numerous counts of harems and various classes of seals were made before the height of the season. In this way counts were made at least once for every rookery on St. Paul Island and some rookeries were counted from three to six times. In addition, weekly counts were made of all the rookeries on St. George Island in late June and early July by Mr. G. Dallas Hanna. Therefore, when the height of the season arrived those engaging in the count were familiar with the peculiarities of each rookery and all were agreed as to the method to be employed. As early as June 29, the total number of bulls in position on St. Paul Island was 1,060.

Owing to exigencies of transportation, it was necessary to make the count of harems on St. George Island on July 13-14, 1914, a few days earlier than desirable. On these dates, 219 harems and 12 idle and young bulls were found as follows:

Early count of harems, St. George Island.

Rookery.	Harems.	Idle bulls.
North.....	85	3
Staraya Artel.....	46	7
Zapadni.....	15	1
Little East.....	1	0
East Reef.....	14	1
East Cliffs.....	58	0
Total.....	219	12

Height of season counts.—The height of season counts on St. Paul Island were made July 17, 18, and 19. Sea Lion Rock, or Sivutch, was counted July 20. The counts were made jointly by Messrs. Osgood, Parker, Preble, and Harmon except that of Sea Lion Rock which was counted by Parker and Harmon only. The early count made on St. George Island being obviously unsatisfactory, arrangements were made for a

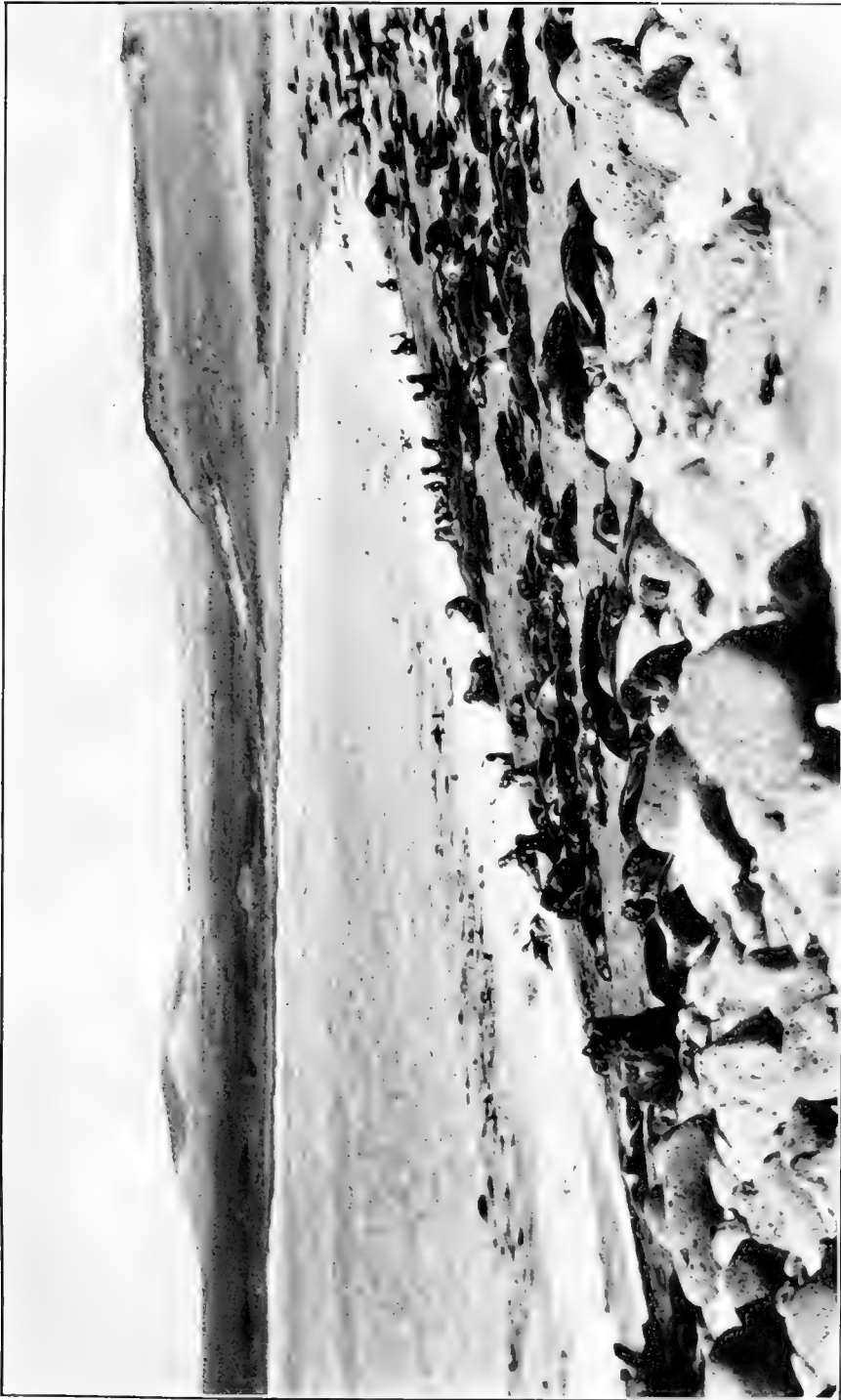

Bachelors sleeping on Tolstoi sands, August 25, 1914.

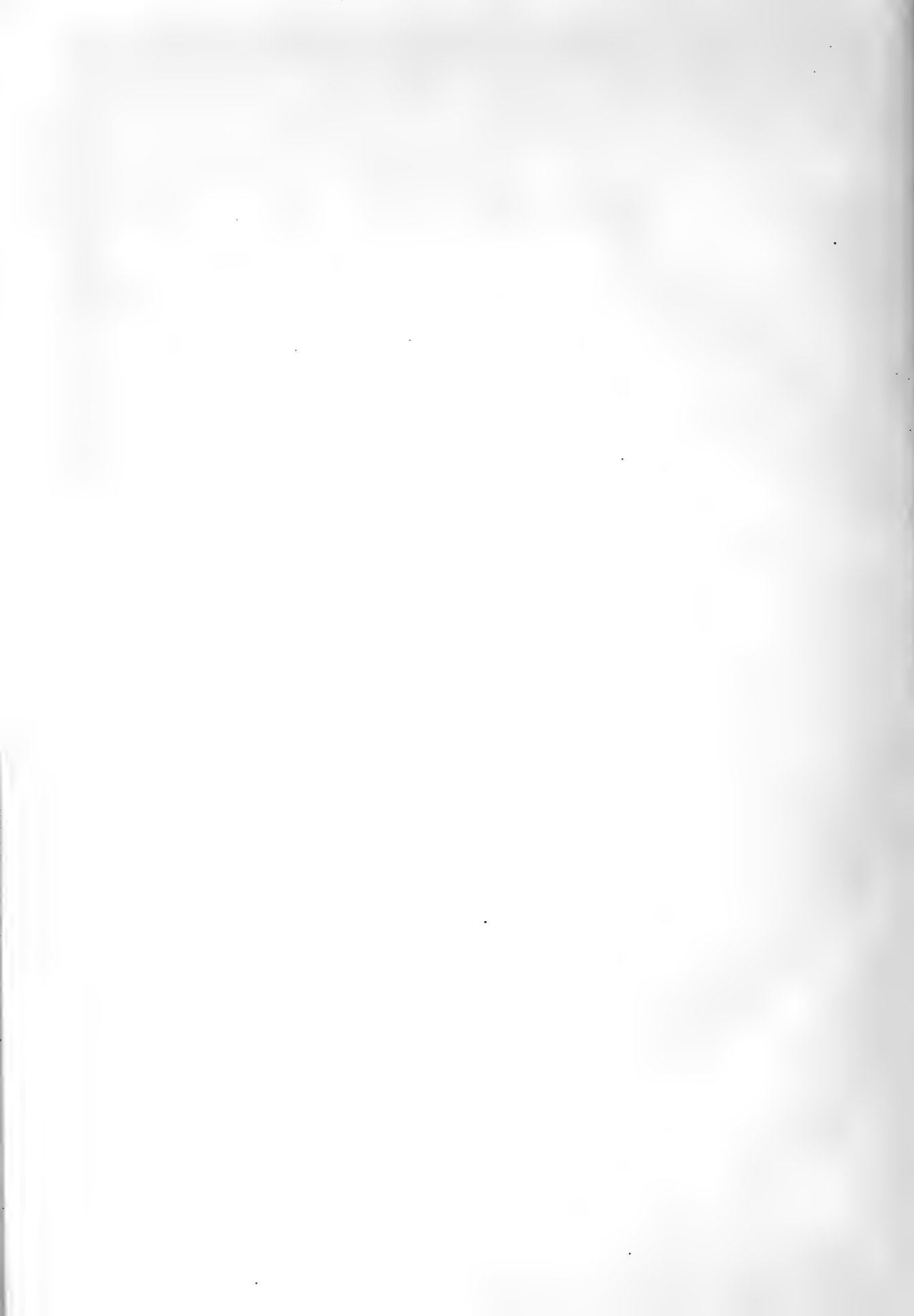

recount July 19-20 by G. Dallas Hanna, school-teacher on St. George Island. Mr. Hanna's figures, therefore, are used in making up the totals, which are as follows:

Harems and idle bulls at height of season, 1914.

Rookery.	Date of count.	Harems.	Idle bulls.
ST. PAUL ISLAND.			
Kitovi	July 17	58	5
Lukanin	do.	39	1
Corbatch	do.	122	9
Ardiguen	do.	15	0
Reef	do.	193	26
Sivutch	July 20	91	10
Lagoon	July 18	8	2
Tolstoi	do.	161	38
Zapadni	do.	114	24
Little Zapadni	do.	90	10
Zapadni Reef	do.	3	1
Polovina	July 19	58	3
Polovina Cliffs	do.	22	0
Little Polovina	do.	18	0
Morjovi	do.	43	4
Vostochni	do.	291	20
Total, St. Paul Island		1,316	159
ST. GEORGE ISLAND.			
North	July 20	94	4
Staraya Artel	do.	63	4
Zapadni	July 19	14	0
Little East	July 20	1	0
East Reef	do.	14	3
East Cliffs	do.	57	2
Total, St. George Island		243	13
Total, St. Paul Island		1,316	159
Total, St. George Island		243	13
Total, both islands		1,559	172

Harem charts.—Graphic representation of the size and extent of the fur-seal herd has usually consisted in the coloring or shading of the areas occupied and in distinguishing, so far as possible, the breeding areas from the hauling grounds. For various reasons, this has proved unsatisfactory as an accurate measure of the herd, although for general comparisons it has been valuable. All such devices, to be of permanent value, should be based upon data which can be stated in exact terms and which utilizes fixed marks or natural features that can be identified by future observers.

Before the investigation of 1914 was begun it was found that unpublished charts showing the number and approximate position of the harems on each rookery had been made in 1912 and again in 1913 by Special Investigator G. A. Clark. These charts showed the contours of the topography as surveyed by the United States Coast and Geodetic Survey and also indicated the position of the rocks on which conspicuous numbers were painted at the time of the survey. These charts were so obviously based upon sound method and their comparative value was so evident that their use was continued in 1914. Blank copies were carried to the rookeries while the harem counts were being made and the position of the harems with reference to the marked rocks was roughly indicated by pencil notes. Immediately thereafter duplicate copies were made transcribing the notes in uniform style for all the rookeries. The field charts thus made have been the basis of the charts published with the present report. The scale is necessarily too small to show the exact position of each harem, but the number and approximately the arrangement of harems between any two numbered rocks is according to the facts.

THE COUNT OF IDLE AND YOUNG BULLS.

The idle and young bulls were counted at the same time as the harem bulls. They include only bulls that were on the breeding ground at that time obviously waiting for opportunity to obtain harems. During preliminary counting an attempt was made to distinguish between those that stood their ground and those commonly called "quitters" because they retreat from man. But as the season advanced some of the quitters were observed to pass into the category of harem bulls, so when the height of the season counts were made all bulls about the back and sides of the rookeries were regarded as idle bulls unless plainly less than 6 years of age. Certain others stationed at the water's edge in front of the rookeries were by mutual agreement regarded as idle bulls. Young bulls on the hauling grounds were not considered at this time. The result of the count of idle bulls is included in the statement of the harem count on a preceding page.

THE COUNT OF HALF BULLS.

The half bulls of 5 and 6 years of age are roving much of the time, sometimes being about the breeding areas, at other times on the hauling grounds, while at all times a considerable proportion are undoubtedly at sea. Their well-developed "wig" or mane readily distinguishes them from bachelors of 4 years and under, while their smaller size prevents confusion with the old bulls. The number on land at any one time can be counted with a great degree of accuracy. They were counted on St. Paul Island on July 28, the count being made practically simultaneously by different observers stationed for the purpose on different rookeries. A few days later a similar count was made on St. George Island by G. D. Hanna. The total result showed 748 half bulls for the whole herd, and although it may have included a few previously engaged in harem service, and of course takes no account of those at sea, it furnishes some measure of the strength of this class of seals, which is obviously greater than it has been for a number of years.

THE COUNT OF BACHELORS.

Counting bachelors may be compared to counting a swarm of bees, part of which is in the hive and the remainder out gathering honey. The full number can not be determined with accuracy although various devices are available as the basis of estimates. Those on land at a given time may be closely approximated by a process of combined counting and estimating. After some experience, results may be obtained in this way which, as minimum figures, are wholly reliable. It is often possible to find a herd of bachelors practically all of which are lying asleep, so an observer in an elevated position with a good field glass can count them with considerable accuracy. Conditions for counting in this manner are particularly favorable on St. George Island. A large herd of bachelors in which all or many individuals are in motion can only be estimated by counting those on a certain space and correlating the number obtained with the total space occupied. At times the bachelors on a given hauling ground may be driven back a short distance and divided into small pods which are successively counted as they form in an irregular line to return to the sea. Taking all data of this sort into consideration, the observer spending an entire season on the islands is in no doubt as to the approximate number of bachelors usually found on each hauling ground. Since the bachelors move about to a certain extent from one hauling ground to another and even pass

back and forth with some frequency between St. Paul and St. George Islands, the whole number hauled at a given time can only be determined by simultaneous observations on all the hauling grounds. The party on the islands in 1914 was large enough for such observations and accordingly they were made on St. Paul on July 28. A count on St. George Island was made a few days later by G. D. Hanna. The half bulls of 5 and 6 years were distinguished from the remainder, which consisted of 2, 3, and 4 year olds. No yearlings were seen, although it is possible a very small number may have been present. The results of the so-called "one-day" count are as follows:

Bachelors on land at one time.

Rookery and island.	2, 3, and 4 year olds.	Half bulls.
St. Paul Island, July 28, 1914:		
Krovina ^a	220	26
Lukanin ^a	175	11
Gorbatch ^a	500	39
Reef ^a	1,500	69
Sivutch ^b	500	30
Tolstoi ^c	534	38
Zapadni ^c	1,290	30
Little Zapadni ^c	251	30
Zapadni Reef ^c	3	1
Polovina ^d	500	50
Polovina Cliffs ^d	45	2
Little Polovina ^d	45	2
Morjovi ^e	300	41
Vostochni ^e	3,150	161
Total, St. Paul Island.....	9,013	530
St. George Island, July 30-Aug. 2, 1914:^f		
North.....	441	64
Staraya Artel.....	611	43
Zapadni.....	252	24
East Reef.....	131	44
East Cliffs.....	751	43
Total, St. George Island.....	2,186	218
Total, St. Paul Island.....	9,013	530
Total, both islands.....	11,199	748

^a Counted by B. W. Harmon and A. G. Whitney.

^b Estimated from distant view but supported by better observations at other times.

^c Counted by G. H. Parker and T. Kitahara.

^d Counted by W. H. Osgood, E. A. Preble, and J. M. Macoun.

^e Counted by W. H. Osgood and E. A. Preble.

^f Counted by G. D. Hanna.

THE COUNT OF PUPS.

Importance of the count.—Since 1897, when it was discovered that the number of pups greatly exceeds the number of cows on land at any one time, the importance of an enumeration of the pups has been apparent. Unlike the other classes of seals, all the pups for a time are on land at once, and the only obstacle in the way of exact knowledge of their number is that of actual enumeration. Until the abolition of pelagic sealing, however, a complete count of pups was not attempted, since it involved driving the cows into the sea and exposing them to the sealing fleet. In 1912 and 1913, with this danger past, complete counts of pups were made. The results of these counts were of the utmost importance, for they not only gave a measure of the new generation in the herd, but also furnished an accurate index of the number of breeding cows, since each cow gives birth annually to one pup. In 1914, therefore, another complete count of pups was made.

The method of counting pups.—At first glance it would seem impossible to count a mass of closely packed, squirming fur-seal pups as they are found on the rookeries. A little study and experiment, however, soon convinces that it can be done very satisfactorily by the method employed in 1912 and 1913. This consists in gradually driving the pups off in small groups, or pods, and successively counting these pods until all have passed in review. About August 1 practically all the pups have been born, and the majority are several weeks old, strong, active little fellows, able to tumble about the rocks and to progress on favorable ground in a somewhat jerky lope, which takes them along at a rate almost equal to that of a man walking. Although able to swim and although they do so voluntarily about a week later, they will not take to the water at this time unless very hard pressed.

At the same time the adults are present on the rookeries in reduced numbers. Many of the old bulls have gone, and those that remain, with some notable exceptions, have lost their former stubbornness and pugnacity. The cows, no longer held by the bulls, flee in a body to the sea, leaving only the pups and a few surly bulls on land. The counting squad then advances and by prodding with long poles urges the bulls into the water or isolates them from the pups in case they prove too recalcitrant. The pups huddle together in large pods or scurry into holes and crevices in the rocks. Beginning at one end of the rookery, or at a runway near the middle if two squads are working, the counters start a small pod of pups back toward the unoccupied space. The first pod moved is generally a small one sometimes started with a little difficulty and counted as a whole, if necessary. After this it becomes easy to induce successive pods to cross the open space and join those already counted. As soon as one pup, stronger or more venturesome than his fellows, starts across others follow in rapid succession, and so they go like sheep, one at a time, two abreast, and three abreast, galloping past the counters, who stand at one side, notebook in hand. In case the file widens beyond the possibility of accurate counting, assistants stationed on either side and somewhat behind the advancing line close in and either cut off the pod completely or bring it to proper attenuation by causing the pups in advance to move faster and those behind to reduce their speed. Now and then pups start back toward their original positions or some of those uncounted move in an undesired direction, but confusion from such moves is prevented by native assistants whose duty is to hold the line between the counted and the uncounted. As each section of rookery space is cleared, the counters search all the crevices and small caverns in the rocks in which pups may be concealed. On some rookeries such places are very numerous, and to make sure that none are overlooked it is necessary to pull out the pups one by one and drive them back to space previously surveyed. This is usually quite laborious and requires much time and patience. No less than 84 pups were extracted in this way from a single cavern under Polovina Cliffs. That some were overlooked in such places is, of course, not impossible, but the work was so thoroughly done in all cases that the number must be exceedingly small. The fur-seal pup at this time is an animal of 15 to 20 pounds in weight and about 2 feet in length, including the hind flippers. Therefore, one is not likely to be missed, except by accident.

It is undeniable that counting pups creates a great disturbance of the rookeries. It literally moves each rookery a short distance along the shore, causing every seal to change position and bringing about a general commotion which to one unacquainted with



1. Fur-seal pups on Tolstoi Rookery, August 25, 1914.



2. Fur-seal pup on Gorbach Rookery, August 19, 1914.

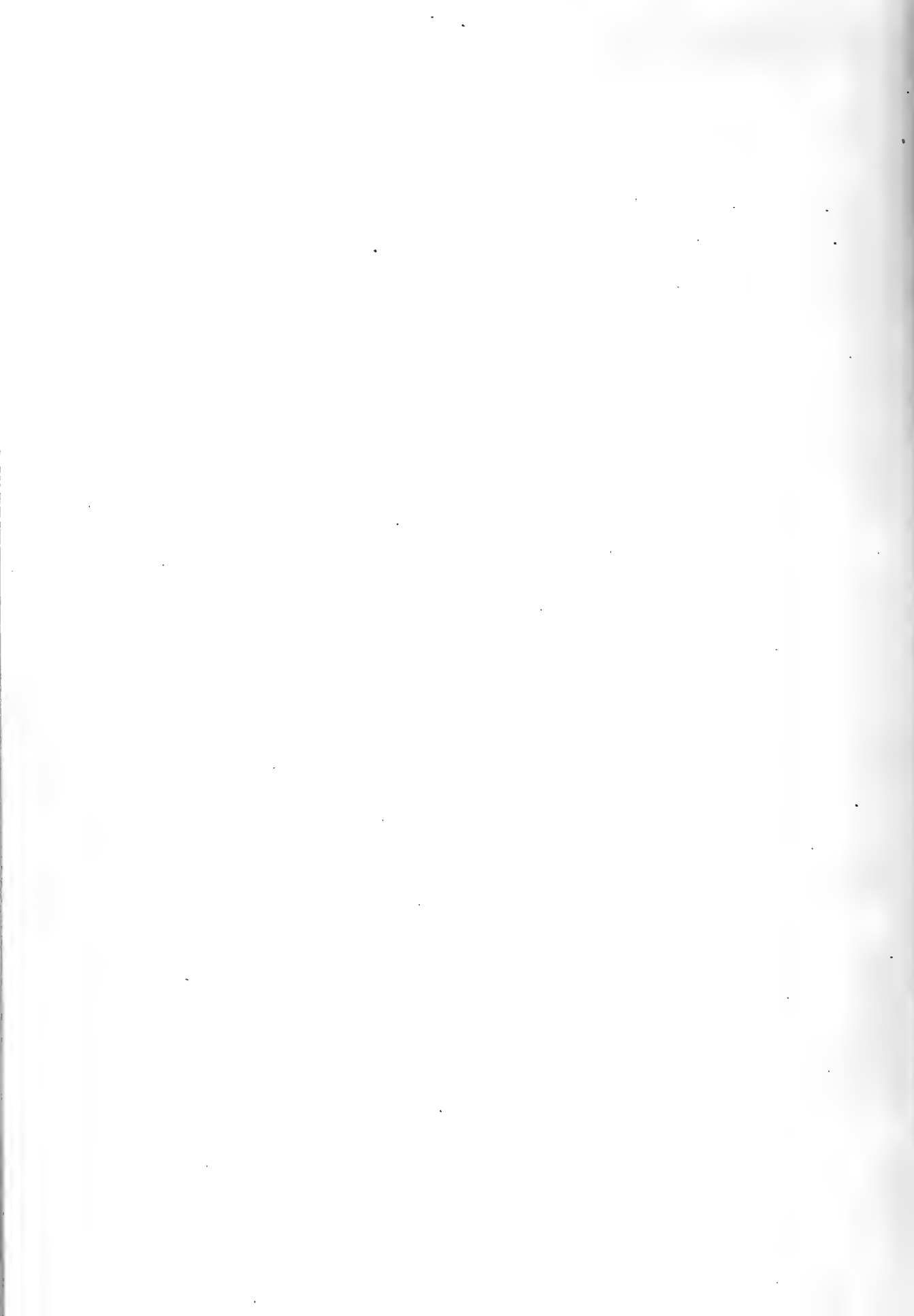

the nature of fur seals might seem calculated to cause harm. That it really has no serious result is evident by the ease and rapidity with which normal conditions are resumed. The seals, particularly the bulls, have a powerful instinct for location, and their ability to recover their relative positions after great disturbance seems little short of miraculous. While counting is still going on at one end of a rookery the space just passed over is rapidly being repopulated, and within a half hour after the count is finished one finds the whole rookery as if nothing had happened, the cows peacefully sleeping or nursing their pups and the pups whose mothers are at sea gathered in pods playing or sleeping.

In the course of the count considerable adroitness is required to avoid crowding the pups into large pods, in which the weaker ones are exposed to the possibility of being smothered by others which heap themselves over them. Out of the 93,000 pups counted in 1914 only 22 came to death in this way. This loss was due partly to overzealous assistants and partly to the difficulty of directing assistants in the continual clamor; but when it is considered that perhaps not more than one-third of the pups so killed would have reached maturity, the actual loss to the herd is seen to be so small that it is scarcely worth a second thought.

As the count must be made before any of the pups have learned to swim, the few that are born after this time can not be enumerated. This number is very small, however, and only serves to make it more evident that the totals accepted are minimum figures. The only further factor of uncertainty is the impossibility of securing an exact total for the dead pups, some having been carried away by the foxes and others having disintegrated or been trampled out of sight before the count is made. These are the only reasonable objections to stating that the pup count gives exact results, and they only serve to strengthen the conviction that the totals accepted can not by any possibility be too large. For, considering the welfare of the herd, the results are minimum figures and therefore absolutely safe.

The count of dead pups.—The dead pups are recorded as they are found during the process of counting the live ones. They are scattered over the rookeries with considerable regularity, and the percentage found on the different rookeries varies but little. They lie in various stages of decomposition, sometimes stretched out on the sand and sometimes nearly hidden from view in crevices between the rocks. As successive sections of rookery space are cleared in the counting of the live pups one member of the counting squad makes it his special duty to pace the ground and record all the dead pups, while as the work progresses other members of the party from time to time call his attention to dead pups noted in obscure places. After a given breeding area is finished the adjacent hauling grounds also are searched for dead pups, and so far as possible identifiable remains are noted when strewn about fox dens encountered in going to and from the rookeries. It is evident therefore that practically all dead pups are enumerated.

Participants in the count, and results.—The count of pups was made from July 29 to August 5. The Canadian and Japanese experts were invited to join with the Americans and the services were enlisted also of Mr. A. G. Whitney, school-teacher, on St. Paul Island, and of Mr. A. H. Proctor, agent, and Mr. G. Dallas Hanna, school-teacher, on St. George Island. The count, therefore, was conducted and subscribed to by the following persons: W. H. Osgood, G. H. Parker, E. A. Preble, G. D. Hanna, A. H. Proctor,

and A. G. Whitney, Americans; J. M. Macoun and B. W. Harmon, Canadians, and T. Kitahara, Japanese. The help of Mr. Whitney, who had assisted in the count in 1913, was most valuable. The party was divided into two squads, making it possible to do the work expeditiously and finish before the pups were ready to take to the water. On St. Paul Island, Kitovi, Ardiguen, and the Zapadnis were counted by Parker, Kitahara, and Harmon; Lukanin, Tolstoi, Lagoon, and Morjovi by Osgood, Preble, and Whitney, assisted by Macoun, except on Lagoon; Gorbatch, Reef, the Polovinas, and Vostochni were counted jointly, Parker, Kitahara, and Harmon forming one squad and Osgood, Preble, Macoun, and Whitney another. On St. George Island, Zapadni was counted by Osgood, Preble, and Hanna; Staraya Artel and North by Parker, Kitahara, Harmon, and Proctor, and East rookeries by Parker, Preble, Kitahara, Harmon, and Proctor. It is thus seen that no less than three individuals of three different nationalities participated in practically every count. All members of the party expressed themselves as convinced of the thoroughness of the method and the reliability of the results. The error in counting is only that limiting any human act, and in this case is almost negligible, and certainly on the side of conservatism.

Following is the result of the count:

Count of pups, Pribilof Islands, 1914.

Rookery.	Date of count.	Living pups.	Dead pups.	Total.
ST. PAUL ISLAND.				
Kitovi.....	July 31	2,072	47	2,119
Lukanin.....	do.....	1,761	73	1,834
Gorbatch.....	July 30	6,067	85	6,152
Ardiguen.....	July 31	645	11	656
Reef.....	do.....	13,353	206	13,559
Sivutch.....	July 30	3,984	68	4,052
Lagoon.....	Aug. 1	373	2	375
Tolstoi.....	do.....	9,760	174	9,934
Zapadni.....	do.....	7,599	126	7,725
Little Zapadni.....	do.....	4,810	79	4,919
Zapadni Reef.....	do.....	203	3	206
Polovina.....	July 29	3,484	71	3,555
Polovina Cliffs.....	do.....	1,432	18	1,449
Little Polovina.....	do.....	910	17	927
Morjovi.....	Aug. 2	2,268	44	2,312
Vostochni.....	do.....	19,210	499	19,709
Total.....		77,860	1,523	79,383
ST. GEORGE ISLAND.				
North.....	Aug. 4	5,189	112	5,301
Staraya Artel.....	do.....	4,215	63	4,278
Zapadni.....	do.....	1,015	8	1,023
Little East.....	Aug. 5	25	1	26
East Reef.....	do.....	576	5	581
East Cliffs.....	do.....	2,627	31	2,658
Total.....		13,647	220	13,867
Total, St. Paul Island.....		77,860	1,523	79,383
Total, St. George Island.....		13,647	220	13,867
Grand total, both islands.....		91,507	1,743	93,250

THE ESTIMATES.

If all the bachelor seals came to land at any one time, it would be possible to count them with a fair degree of accuracy by driving and podding as in the case of the pups. But, although approximately the same number is found on each hauling ground for considerable periods, there is always a large and indeterminate number in the sea, moving

from place to place, going far out to feed, passing from one hauling ground to another, and crossing between St. Paul and St. George Islands. Moreover, it is highly probable that a considerable proportion of the yearlings do not come to land at all. Therefore no complete enumeration of nonbreeding seals is possible.

Since it is from this class of seals that the output of salable skins is derived, a knowledge of their numbers is of the highest importance and it is a lack of such knowledge that has caused much loss to the Government in the past. The fortunate condition which under proper authorization will make it possible to obtain a large part of this knowledge in the future has been discussed in another place (p. 103). For the census of 1914, however, only estimates are possible, and they can not be regarded as more than carefully considered approximations. It is with some reluctance that they are put forth, although all conclusions drawn from them are supported by convictions derived from actual observation. Every effort has been made to make them conservative and in no case are they less so than those of previous investigators.

The basis of the estimates in most cases has been the birth rate. Fixed percentages for assumed natural mortality in successive years plus the number of seals killed have been subtracted from the number born, the remainder being the supposed number surviving. The assumed percentages of natural loss are 50 per cent for the first year, 15 per cent for the second, 10 per cent for the third, and 5 per cent for the fourth. So far as the percentages have a definite numerical basis, it is that of the quotas which the lessees found it possible to secure during commercial killing. They are the percentages which seemed to prevail during pelagic sealing and therefore are ultraconservative when applied to present conditions.

Producing but one young annually and subjected to constant killing for more than 100 years, the fur seal still maintains itself in numbers which, although reduced, are by no means small. It has made ready recuperative response to every partial suspension of killing and its present condition as shown by observations in the past season is unmistakably one of rapid increase. Therefore, it is evident that these percentages give results much more likely to be underestimates than otherwise. An underestimate tends to the conservation of the herd by fostering limited killing. All that can be said against it is that it may involve some money loss to the Government. An overestimate, on the other hand, would endanger the herd, and while it might lead to action productive of immediate revenue, it would in the end also cause money loss.

Yearlings.—These are estimated as one-half the pups known to have been born in 1913, as determined by the full count made by special investigator G. A. Clark. The theory that 50 per cent of each year's pups are lost during the first season is not as yet definitely proved but may be accepted as closely approximating the truth and as furnishing a basis for fair comparison with former estimates. Whatever may be the truth, it is believed that the first year's mortality is less than 50 per cent rather than more, so the estimate may be regarded as a moderate one. This loss, of course, includes the pups that die on the islands as well as those lost at sea. The deaths before the migration amount, under present conditions, to from 2 to 3 per cent of the pups born.

The total of pups counted in 1913 was 92,269; therefore the yearlings alive in 1914 are estimated as 46,135.

Two-year-olds.—These were born in 1912 and were included in the full count of that year which totaled 81,984. On the basis of 50 per cent first year's mortality there

should have been 40,992 of them as yearlings in 1913. As none of them were killed, they should have returned the next year in numbers undiminished except from natural causes. As a matter of fact they appeared in 1914 in large numbers, constituting in the latter part of the season at least two-fifths of the bachelors found on the hauling grounds. Exact enumeration of them is impossible since all are not present at any one time. In 1912, 5,529 of these seals were branded as pups and a considerable number of these were found throughout the season of 1914, but this furnishes no criterion of the total number of surviving 2-year-olds. The only feasible method of estimating them is by subtracting a fixed percentage from the number estimated as yearlings the preceding year. This percentage has been rather arbitrarily determined as 15 per cent, but from experience during commercial killing in past years it is evident that the result obtained in this way is a conservative one. That is, in former years with the herd approximately the same size as now and in spite of the drain of both land and pelagic killing, the lessees found it possible to obtain a quota of 2-year-olds as large or larger than the number estimated in this way. Deducting 15 per cent from 40,992, the number of yearlings estimated for 1913, gives 34,844 as the number of 2-year-olds in 1914, half of these being males and half females.

Three-year-old males.—These were born in 1911, a year for which only very incomplete data are available. No count of pups was made in that year, nor any determination of the average harem even for a single rookery. The count of harems was made, however, and this combined with knowledge of the conditions in 1910 and 1912 furnish practically the only data for estimating the number born in 1911. There are two methods of making such an estimate, one by deductions drawn from the average harem on a single rookery known for 1910 and 1912, the other from the count of pups in 1912 and the relative effect of pelagic sealing.

The average harem method may be considered first. During pelagic sealing or in all years previous to 1912, the birth rate for a given year was estimated by counting the pups on one or several rookeries only and determining the average number of pups to a harem for these rookeries, after which this average harem was multiplied by the total number of harems, the result being the supposed total number of pups, and by inference, the number of cows. Applying this method to the years 1912, 1913, and 1914, for which we have actual counts, it is apparent that the estimates for former years must be greatly below the facts. This is shown by the following tabulation:

Comparison of actual counts of pups with estimates based on an average harem.

Year.....	1909	1910	1911	1912	1913	1914
Total number of harems.....	1,387	1,381	1,369	1,358	1,403	1,559
Pups counted on Kitovi.....	1,979	1,966	1,975	1,855	2,119
Average harem on Kitovi.....	36.0	31.7	^a 34.5	37.3	42.2	36.5
Estimate of pups, entire herd, under average harem method.....	49,932	43,777	47,230	50,653	59,206	56,903
Actual count of pups.....	81,984	92,269	93,250
Percentage of underestimate.....	38.2	35.8	38.9

^a Mean between figures for 1910 and 1912.

The inference is thus very strong that the estimates for 1909 and 1910 are less than two-thirds of the actual number and that a similar estimate for 1911 would be proportionately small. Since the total number of harems (actually counted) for 1911 falls



Old bull showing usual emaciation at close of breeding season.



between the numbers for 1910 and 1912, we may assume that the average harem does the same. This gives 34.5 as the estimated average harem on Kitovi in 1911, and multiplying this by 1,369, the total number of harems, gives 47,230 as the estimated total of pups. Assuming that this is two-thirds of the actual number gives 70,845, total pups in 1911, the best result that can be obtained with the data available.

Considering now the other method, we find that a very reasonable argument may be advanced that, since the herd was in a declining condition, the number of pups born in 1911 would not be smaller than the number born in 1912. The treaty abolishing pelagic sealing went into effect December 15, 1911. Therefore pelagic sealing was going on in 1911 only slightly less than in 1910. There is little doubt that from 10,000 to 15,000 cows were lost to the herd in 1911 through this means. Since we know that in spite of this drain the cows of 1911 produced 81,984 pups in 1912, it is reasonable to suppose that the cows of 1910, having been subjected with the whole herd to one season less of pelagic sealing, would produce at least as many pups as those of 1911. From this reasoning, therefore, the assumed births in 1911 might be stated in round numbers as 82,000. It is evident, however, that pelagic sealing created many abnormal conditions in the herd, and in view of the pup count of 1914 showing practically no increase over that of 1913, as well as various figures obtained by the Japanese on Robben Island, it is unsafe to assume fixed rates of annual increase or decrease. There are too many factors involved to make it possible to say with certainty that such an estimate is a conservative one.

Taking both estimates into consideration, the one of 70,845 and the other of 82,000, it may be concluded that the number born in 1911 was between 70,000 and 80,000. For our purposes, and keeping on the side of conservatism, 75,000 may be taken as a number open to no serious objections. Taking off 50 per cent for first year's mortality and 15 per cent for the second year, leaves 31,875 2-year-olds in 1913, of which half, or 15,937, were males.

It is necessary next to deduct the number of 2-year-old males killed in 1913. The only basis for determining this is the weight of the skins, and, although this is known to be unreliable, it furnishes the best approximation of the truth that can be obtained. The food killings in 1913 were mostly intended to include only 3-year-olds, but a number of skins weighing less than $5\frac{3}{4}$ pounds were taken. For purposes of an estimate made before a thorough study of the subject of weights and ages, it may be assumed that skins weighing under $5\frac{3}{4}$ pounds were those of 2-year-olds. Of 2,399 seals killed in the calendar year 1913 there are records of weights of the skins of 2,357, of which 515 were, on this basis, 2-year-olds. Subtracting this from 15,937 leaves 15,422 as the estimated number of 2-year-old males at the close of the year 1913. Although it is probably too high, 10 per cent less may be assumed for the next year in order to keep the estimate on the safe side. This gives us 13,880 as the number of 3-year-old males in 1914. This is purely an estimate, but in the light of past experience in the killing of large quotas it can not be regarded as excessive. Three-year-olds were seen in large numbers on all the hauling grounds and in all the food drives. On August 8 1,572 bachelors were driven from Reef hauling ground and 447 were killed. At least 411 of these, or 26 per cent of those driven, on the basis of the weight of the skins, were 3-year-olds. This result might be applied in various more or less unsatisfactory ways to estimate the total number of 3-year-olds, but it is of value principally as proof that seals of this class

were present in large numbers. The estimate of 3-year-old males at the beginning of 1914, therefore, is 13,880.

Four-year-old males.—The 4-year-olds living in 1914 were born in the summer of 1910. There was no count of pups in that year but an estimate was made by the average harem method discussed under the estimate of 3-year-olds (p. 34). Using this method, the average harem on Kitovi, which was 31.7, was multiplied by the total number of harems, giving as a result 43,777. The estimated error in the method requires an addition of 21,888 which gives 65,665 as the probable increase for 1910. Reducing this by 50 per cent for the first year's mortality and 15 per cent for the second leaves 27,907 of both sexes or 13,954 2-year-old males in 1912. Although the killings in 1912 were supposed to include a considerable number of 2-year-olds, the records show only 541 yielding skins that weighed less than $5\frac{3}{4}$ pounds and these, therefore, are all that can safely be assumed as 2-year-olds. Deducting these and in addition 10 per cent for natural deaths in the third year, reduces the total to 12,072 3-year-olds at the opening of the season of 1913. Of these, 1,610 were killed having skins weighing from $5\frac{3}{4}$ to 8 pounds, inclusive, and therefore 10,462 were left. The natural mortality in the fourth year is believed to be very small, perhaps negligible, but it may be granted for the sake of conservatism that it is as much as 5 per cent. Therefore the estimated number of 4-year-olds in 1914 is 10,462 less 523, or 9,939. Although no exact count was possible, the number of 4-year-olds observed on the hauling grounds in the season of 1914 was sufficient to make it reasonably certain that this estimate is not beyond the facts. They were seen on all the hauling grounds and in some cases constituted fully 25 per cent of the bachelors present at a given time.

Five-year-old males.—The 5-year-olds of 1914 are of the generation of 1909 and were subjected to both land and pelagic sealing as 2-year-olds. The best method of estimating their present numbers is based on the breeding reserve of 1912. In that year, before killing began, 2,005 bachelors supposed to be 3-year-olds were given a temporary brand and reserved as breeders, exempt from killing for at least one season. In 1913, they became 4-year-olds and if we allow 5 per cent for possible deaths during the winter, they then numbered 1,905. Since killing in 1913 was restricted largely to 3-year-olds, the reserve of the previous year was subjected to no more than a slight decrease. According to the records, 247 skins weighing over 8 pounds and under 12 pounds were taken in 1913, and at least the majority of these were probably 4-year-olds. This leaves 1,658, and since the loss in the fifth year is doubtless too small to be taken into account, it is safe to say there were 1,658 5-year-old males living in 1914. About one-third of them were to be seen on land at any time during the season of 1914. A count of half bulls made practically simultaneously on all the hauling grounds in 1914 showed 748 present, and of these it can be said that 5-year-olds constituted 80 per cent or more. It is probable also that more than 2,000 escaped in 1912 and 1913, since the killings in those years were confined to a few hauling grounds and since the records of weights show that no very large number of 2-year-olds was killed on land in 1911. It is evident, therefore, that the estimate of 5-year-olds is well within the facts. Next year, there should be from 1,500 to 2,000 lusty 6-year-olds ready if necessary for harem duty.

Summary of estimates of nonbreeding seals.—The following table shows the number of nonbreeding seals estimated to be present in 1914, and the method of making the estimate:

Estimate of nonbreeding seals, 1914.

Yearlings:	
Pups born in 1913 and actually counted.....	92,269
Deduction for natural mortality in first year, 50 per cent.....	46,134
Yearlings of both sexes in 1914.....	46,135
Two-year-olds:	
Pups born in 1912 and actually counted.....	81,984
Deduction for natural mortality in first year, 50 per cent.....	40,992
Yearlings in 1913.....	40,992
Deduction for natural mortality in second year, 15 per cent.....	6,148
Two-year-olds of both sexes in 1914.....	34,844
Three-year-old males:	
Pups born in 1911, on the basis of the estimated average harem on one rookery, Kitovi.....	47,230
Addition for probable error in method.....	23,615
Estimated number of pups born in 1911, by average harem method.....	70,845
Estimated number of pups born in 1911, by inference from number counted in 1912.....	82,000
Conservative mean between the results of the two methods.....	75,000
Deduction for first year's mortality, 50 per cent.....	37,500
Yearlings in 1912.....	37,500
Deduction for second year's mortality, 15 per cent.....	5,625
Two-year-olds of both sexes in 1913.....	31,875
Deduction for females, 50 per cent.....	15,938
Two-year-old males in 1913.....	15,937
Two-year-old males killed in 1913.....	515
Two-year-old males at close of 1913.....	15,422
Deduction for mortality in third year, 10 per cent.....	1,542
Three-year-old males at beginning of 1914.....	13,880
Four-year-old males:	
Estimate of number born in 1910, based on average harem of Kitovi.....	43,777
Addition for estimated error in method.....	21,888
Estimated pups born in 1910.....	65,665
Deduction for assumed natural mortality in first year, 50 per cent.....	32,833
Yearlings, both sexes, in 1911.....	32,832
Deduction for natural mortality in second year, 15 per cent.....	4,925
Two-year-olds, both sexes, in 1912.....	27,907
Deduction for females, 50 per cent.....	13,953
Two-year-old males in 1912.....	13,954
Killed as two-year-olds in 1912.....	541
Two-year-old males at close of 1912.....	13,413
Deduction for natural mortality in third year, 10 per cent.....	1,341
Three-year-old males in 1913.....	12,072
Killed as three-year-olds in 1913.....	1,610
Three-year-olds at close of 1913.....	10,462
Deduction for mortality in fourth year, 5 per cent.....	523
Four-year-old males in 1914.....	9,939

Five-year-old males:

Reserved in 1912 as 3-year-olds.....	2,005
Deduction for possible mortality in fifth year, 5 per cent.....	100
Four-year-olds in 1913.....	1,905
Killed as four-year-olds in 1913.....	247
Five-year-old males in 1914.....	1,658
Total estimate of nonbreeding seals.....	106,456

THE COMPLETE CENSUS OF 1914.

Following is a summary of the results of the counts and estimates. Discussion of the methods used in obtaining the figures may be found elsewhere.

Complete census of fur seals, 1914.

Pups (actual count).....	^a 93,250
Bearing cows (inferred from number of pups, including dead).....	93,250
Yearlings of both sexes (based on known birth rate in 1913).....	46,135
2-year-olds of both sexes (based on known birth rate in 1912).....	34,844
3-year-old males (based on assumed birth rate in 1911).....	13,880
4-year-old males (based on estimated birth rate in 1910).....	9,939
5-year-old males (based on known reserve of 1912).....	1,658
Idle bulls (actual count).....	172
Harem bulls (actual count).....	1,559
Total.....	294,687
Total, exclusive of pups.....	201,439

RESULTS OF THE CENSUS.

INDEPENDENT RESULTS.

Whatever past conditions may have been, the census of 1914 shows the fur-seal herd to contain upward of 294,000 animals, by no means a small number. The relative proportions of the different classes of seals, while not yet wholly ideal, are such as to indicate clearly that they can be made so in another year. Furthermore, they are such as to forecast a rapid expansion of the herd in the near future. There are not less than 93,250 mature breeding cows and by conservative estimate about 17,000 virgin cows, or a total stock of approximately 110,000 breeding females. There are 1,559 harem bulls and 172 idle bulls, and although this may not be as many as desirable it is gratifying to note that there are at least 1,600 half bulls of five years of age which may have effected some service in the season of 1914 and which will undoubtedly participate in the harem life of 1915. With allowance for probable natural deaths, there will be on the islands in 1915 not less than 3,000 bulls of 6 years of age and over. A reasonable calculation of the cows to be served next year would be 99,000 adults and 18,500 virgin 2-year-olds, a total of 118,500. The 3,000 bulls, therefore, if evenly distributed, would have 39 to 40 cows each, a number which is certainly not greater than their capacity. Thus all apprehension as to insufficiency of male life will cease in 1915.

^a This includes 1,743 pups already dead at the time of the count, but for comparative purposes this is desirable, the same method having been followed in 1912 and 1913. Since a large percentage of the pups will not survive the first winter, they form at best a variable element so far as the total seals of all classes is concerned. The strength of the herd at the opening of the season of 1914 is shown by the total, exclusive of pups.



Roving bachelors on front of Kitovi Rookery, August 23, 1914.

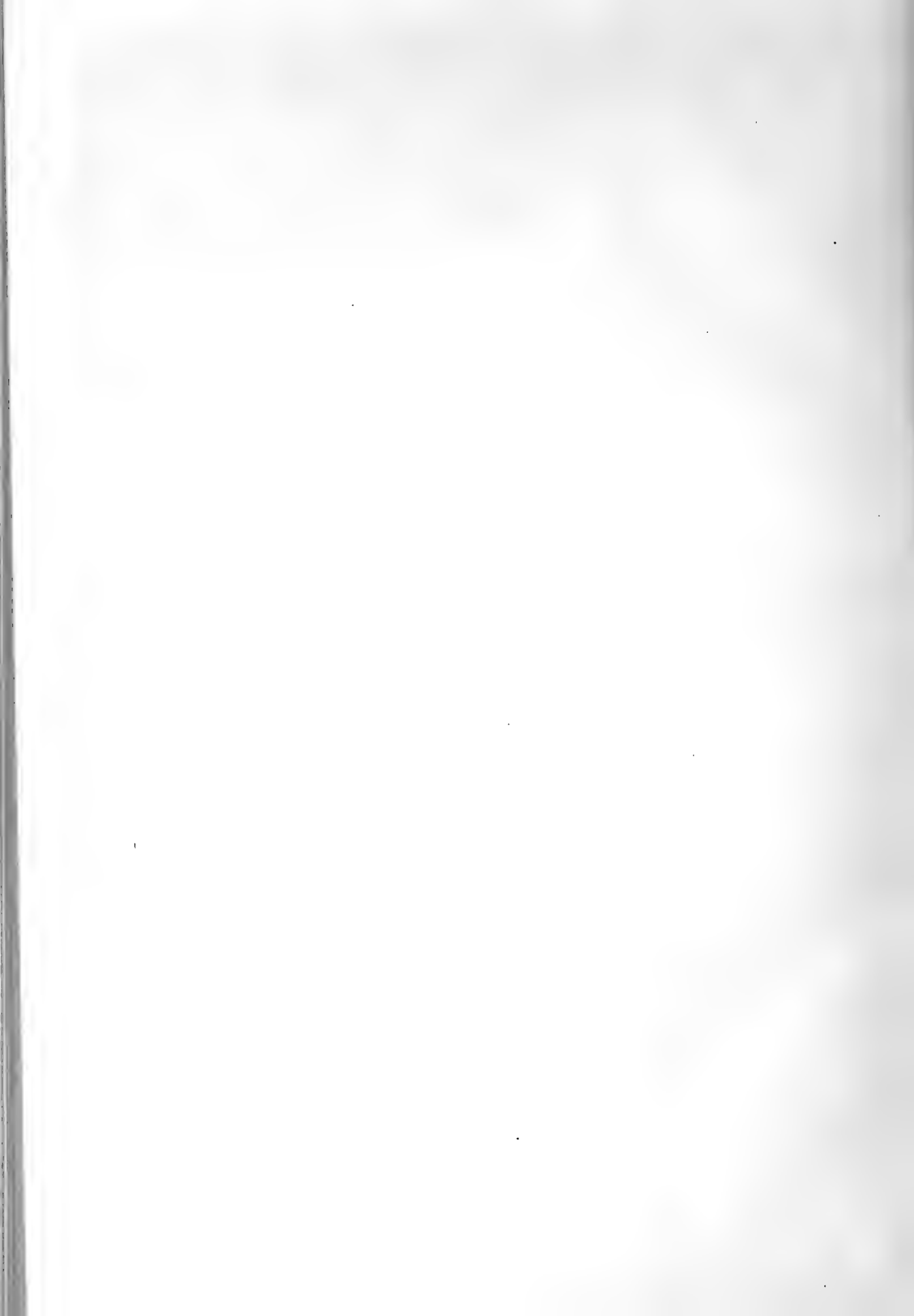

The hauling grounds in 1914 are teeming with bachelor seals of 4 years of age and under. There are nearly 10,000 4-year-old bachelors and upward of 13,000 3-year-olds, so male life for the future is more than assured. The 9,000 to 10,000 4-year-olds living in 1914 will, if wholly spared, undoubtedly create an overstock of males, and this constitutes the principal undesirable feature of the herd as found in 1914. The welfare of the herd demands that some of them should be killed in 1915. By so doing and by killing a sufficient number of 4-year-olds and 3-year-olds at the same time the relative proportions of the different classes of seals would be adjusted to a basis as nearly ideal as our knowledge permits. No matter what course is pursued, the important question will always be what proportion of young males may be killed with safety. The proportion is the same now that it always will be, and nothing is gained by delay. Whether the proportion be small or large, it is obviously safe to take it now as well as in future years.

COMPARATIVE RESULTS.

Comparing the results of the census of 1914 with those of 1912 and 1913, made in much the same manner and at the same stage of the season,^a we find various informing features. Although there is a general increase, it is not evenly distributed and it is evident that various imperfectly understood effects of land and pelagic sealing in previous years are involved. The general comparative results of the three censuses are shown in the following table:

General comparison of recent censuses.

Class of seals.	1912 ^a	1913 ^a	1914
Breeding bulls.....	1,358	1,403	1,559
Breeding cows.....	81,984	92,269	93,250
Idle bulls.....	113	105	172
Young bulls (chiefly 5-year-olds).....	199	259	1,058
4-year-old bachelors.....	100	2,000	9,939
3-year-old bachelors.....	2,000	10,000	13,880
2-year-old bachelors.....	11,000	15,000	17,422
Yearling bachelors.....	13,000	20,000	23,068
2-year-old cows.....	11,000	15,000	17,422
Yearling cows.....	13,000	20,000	23,067
Pups.....	81,984	92,269	93,250
Total.....	215,738	268,305	294,687

^a See Clark, Science, N. S., XXXVIII, p. 919, Dec. 26, 1913; also Bur. Fisheries Doc. 780, p. 97, 1913; and Hearings Comm. Exp. Dept. Commr., H. R., No. 2, 63rd Cong., 2nd sess., pp. 494-499, 1914.

Comparison of harems and idle bulls.—In 1912 there were only 1,358 harems, the smallest number during American ownership, and the number had been less than 1,400 in every year since 1906. In 1913 there was a slight increase to 1,403, and in 1914 there were as many as 1,559, showing the most marked increase and in fact the only important one since that following the modus vivendi some 20 years ago.

With few exceptions, the harem bulls of 1914 were at least 6 years old, and therefore were killable seals of 2 and 3 years, respectively, in 1910 and 1911, when land killing was practically undiminished. Moreover, 200 skins (8-12 pounds) were taken in 1912, which were mostly of 4-year-olds. Therefore the increase in harem bulls in 1914 can not have been due to the limitation of land killing unless it is assumed that with former

^a Fair comparison is not possible with the census made by Mr. H. W. Elliott in 1913, since it was made some two weeks earlier in the season when a large number of pups were still unborn.

conditions prevailing a larger number would have been killed as 4-year-olds in 1912, the first year of the suspension of commercial killing. This is scarcely probable, so it is plainly evident that the increase was accomplished in spite of land killing and was wholly due to the cessation of pelagic sealing, the toll of which was reduced in 1911 and entirely cut off in 1912 and 1913. Considering both harem bulls and idle bulls, the total stock of breeding males has grown from 1,471 in 1912 to 1,505 in 1913 and to 1,741 in 1914, irrespective of land killing.

The increased number of harems in 1914 also shows that the number of young bulls counted in 1912 and 1913 did not include all that were living. The total of harem bulls, idle bulls, and young bulls in the census of 1913 was 1,767. These classes furnished the harem bulls and idle bulls for 1914 to the number of 1,731, which makes it necessary to assume a mortality between seasons of only 36, a number much too small, since the evidence is clear that approximately one-sixth of the harem bulls die annually. The difference between 1912 and 1913 is 162, which indicates a smaller discrepancy but still a discrepancy. Both cases illustrate what is evident throughout the study of fur seals, namely, that the numbers of nonbreeding seals are almost invariably underestimated.

Although the increase in harem bulls is not evenly distributed, the great majority of the rookeries show at least a little increase. The only ones on St. Paul Island failing to do so are Zapadni Reef, Little Polovina, and Vostochni, and of these Zapadni Reef remains unchanged, while the decrease on Little Polovina and Vostochni is insignificant, amounting to only five harems in all. Notwithstanding the great increase on St. Paul Island, there is shown a general decrease on St. George Island, the only rookery having an increase being Staraya Artel, which shows four harems more than in 1913. The total number of harems on St. George in 1914 is 243, as against 261 in 1913 and 281 in 1912. The most obvious explanation of this condition is that it is due to the gregarious instinct and the tendency for the larger herd to recruit itself from the smaller one. Whether or not this be a wholly sufficient explanation, it is of interest to note that the same principle does not seem to be effective in all cases when applied to the different rookeries on St. Paul Island. Thus some of the smaller rookeries show large percentages of gain, while Vostochni, the largest of all, is one of the very few showing an actual loss. Moreover, St. George, while having a decrease of bulls, has an increase of cows, so the cause, if there be any definite one, is evidently peculiar.

The total number of idle bulls in 1914 is 172, and although this is not a large number it should be noted that the rate of increase over 1913 is over 60 per cent. The distribution of idle bulls is somewhat irregular, and although they seem most numerous about large rookeries and massed sections, this is not always the case. For example, East Cliffs, a rookery of 57 harems, had only two idle bulls, while Lagoon, with 8 harems, had the same number, and Zapadni Reef, with 3 harems, had 1 idle bull. In general, the increase in idle bulls seems to be largest on rookeries having a large increase of harems, as Zapadni and Tolstoi.

Comparison of harems and idle bulls, 1912-1914.

Rookery.	1912 ^a			1913 ^a			1914		
	Harem bulls.	Idle bulls.	Total bulls.	Harem bulls.	Idle bulls.	Total bulls.	Harem bulls.	Idle bulls.	Total bulls.
St. Paul Island:									
Kitovi.....	53	2	55	44	7	51	58	5	63
Lukanin.....	38	6	44	33	3	36	39	1	40
Gorbatch.....	109	9	118	106	3	109	112	9	121
Ardiguen.....	11	0	11	11	1	12	15	0	15
Reef.....	179	12	191	171	17	188	193	26	219
Sivutch.....	57	5	62	67	1	68	91	10	101
Lagoon.....	8	0	8	6	0	6	8	2	10
Tolstoi.....	103	10	113	120	9	129	161	38	199
Zapadni.....	105	9	114	106	6	112	114	24	138
Little Zapadni.....	61	5	66	58	7	65	90	10	100
Zapadni Reef.....	3	0	3	3	0	3	3	1	4
Polovina.....	44	4	48	44	2	46	58	3	61
Polovina Cliffs.....	21	1	22	19	0	19	22	6	28
Little Polovina.....	11	0	11	21	0	21	18	0	18
Morjovi.....	37	4	41	40	3	43	43	4	47
Vostochni.....	237	26	263	293	18	311	291	20	311
Total.....	1,077	93	1,170	1,142	77	1,219	1,316	159	1,475
St. George Island:									
North.....	117	7	124	104	5	109	94	4	98
Staraya Artel.....	52	4	56	59	3	62	63	4	67
Zapadni.....	32	2	34	21	1	22	14	0	14
Little East.....	1	0	1	2	0	2	1	0	1
East Reef.....	23	6	29	17	6	23	14	3	17
East Cliffs.....	56	1	57	58	10	68	57	2	59
Total St. George Island.....	281	20	301	261	25+3	286	243	13	256
Total St. Paul Island.....	1,077	93	1,170	1,142	77	1,219	1,316	159	1,475
Total both islands.....	1,358	113	1,471	1,403	105	1,505	1,559	172	1,731

^a From the unpublished records of G. A. Clark.

^b Addition for later count, the first count having been made slightly before the height of the season.

Comparison of nonbreeding seals.—A general increase in all classes of nonbreeding seals is perhaps the most obvious comparative result of the census. The total increase of all classes from 1913 to 1914 is 25,959, and of this only 1,204 are breeding seals, leaving 24,755 as the increment of nonbreeding animals. The classes showing the greatest gains are the 4 and 5 year old males, which have more than quadrupled. In the case of the 5-year-olds, the number is still not far from ideal, but the number of 4-year-olds is unquestionably excessive and disproportionate. It is obviously the result of the limited killings of 1913 and 1914. That it provides conditions for an overstock of males in 1915 and 1916 is so clear that there is no room for argument. Two and 3 year old males also show a steady increase since 1912 and are now living in numbers beyond all possible future need for breeding purposes. The subsequent effect of these large numbers of surplus males is more fully discussed elsewhere. A tabular comparison of the estimates of nonbreeding seals is found on another page (p. 37).

Comparison of cows and pups.—A somewhat unexpected result of the census is the very small increase shown in the number of breeding cows and pups. In 1913 there were 92,269 pups and in 1914 there were 93,250, an increase of only 981. It is inconceivable that such a small increment could have been possible unless the herd was in abnormal condition. Any idea that the figures are wrong may be dismissed immediately, for the testimony of nine men who counted in 1914, as well as that of several others who counted in 1912 and 1913, is that the method of counting is sound and the results reliable. Abnormal conditions, therefore, must furnish the explanation. These

conditions might be due to one or more of three causes: (1) disease, (2) effects of land killing, and (3) effects of pelagic sealing. If disease is in any way responsible, the nature of it is wholly unknown and no direct evidence of its existence in the past or at present is available. Disease, then, can not be considered.

Taking up the possible effects of land killing, we find room for considerable argument. That land killing may have reduced male life to numbers insufficient for breeding purposes is certainly not impossible, for there must be some stage of depletion of males at which cows will begin to escape service. Whether or not a shortage of males existed, land killing can be blamed only in so far as it supplemented pelagic killing. To the effect of land killing was added that of pelagic killing, and the two combined to reduce the stock of breeding males. That land killing alone was not responsible is shown by the increase of harem bulls in 1913 and 1914, which were exposed to the full measure of land killing but had a partial respite from pelagic killing.

If all the cows were not served in 1913, this would be evident in 1914 only by a reduced number of births, or by a small increase, since cows without pups might easily come and go undetected. There was only a very small increase of births in 1914, so, regardless of land killing, it is necessary to determine so far as possible whether or not the supply of males in 1913 was inadequate from any cause whatever. In 1913 there were 1,403 harem bulls, 105 idle bulls, and 259^a young or half bulls, a total of 1,767 possible breeders. These bulls had the responsibility of 92,269 adult cows and 15,000 virgins or nubile, a total of 107,269 cows, making an average of 60.6 cows to each bull. If the half bulls are not included, the average is increased to 71. These undoubtedly are high averages, much higher than desirable, but that they are so high as to allow cows to go unserved is difficult to prove. Such conditions may be detrimental in the long run, but that the bulls, at least for a time, are equal to such emergencies can not be questioned. Even when bulls are in superabundance, harems of more than 60 cows are voluntarily cared for with great frequency, and there is unlimited evidence that every healthy bull is capable of serving 60 to 70 cows whenever opportunity permits or necessity requires. Granting the capacity of the bulls, it remains to inquire what their opportunities were and whether the average is fairly applied. In 1913, as in 1914 and other seasons, there were doubtless many harems of small size, some in fact consisting of only one cow. Therefore, if all cows are served, some of the bulls must care for a number considerably above the average, and when the elements of time and varying rookery conditions are considered the possibility that at least a few cows may have gone unserved is greatly increased. This possibility could scarcely be admitted if numerous idle bulls were present. At best, however, it can only be regarded as a bare possibility, for the reduced number of males in 1913 can not be wholly responsible for the small increase of cows and pups in 1914, because the same relative number of males was present in 1912 and a large increase of cows and pups followed in 1913. The results of insufficient male life should have been as apparent in 1913 as in 1914. This makes it clear that other causes than a shortage of bulls must be sought for the small increment of 1914.

This brings us to further consideration of pelagic sealing which affected not only males but females. It was stopped in 1911, so no direct loss of females since that time

^a As shown on a preceding page, this number is too small, but since it is not certain that all of this class normally breed, this need not be considered here.

can be laid at its door. But its indirect ramifying effects can not cease until an entire regeneration of the herd has taken place. In a normal herd the cows would consist of evenly graded proportions of young and old, and approximately one-tenth would drop out each year through natural termination of life. The indiscriminate slaughter of pelagic sealing probably destroyed these proportions, causing the death rate at present to be abnormal. Although it is known that pelagic sealers secured large numbers of old cows, it is also to be remembered that the young cows spend more time at sea than the old ones and therefore must have been more exposed to the sealer. It naturally follows that the cessation of pelagic sealing may have left the herd in 1911 with a preponderance of aged cows. If this be the case, the number of deaths from old age in the succeeding years would be abnormal and disproportionate, perhaps very few in 1912 and very many in 1913. An increase in young male life is plainly evident in 1914, making it reasonable to infer a similar increase of young females, and thus the supposition is favored that the small total of females is due to losses among those advanced in years. Therefore it is not improbable that the number of old cows dying in 1913-14 was almost equal to the number of young ones bearing pups for the first time, and if so the total number of cows and pups in 1914 is explained. The result would have been accomplished by a death rate among old cows only $3\frac{1}{2}$ per cent above the normal. This is shown by the following statement:

Demonstration of probable abnormal mortality of old cows, 1913-14.

Old cows in 1913.....	92,269
Normal death rate of old cows, 10 per cent ^a	9,226
<hr/>	
Normal expectation of old cows in 1914.....	83,043
Virgin cows in 1913 less 10 per cent probable mortality.....	13,500
<hr/>	
Total normal expectation of cows in 1914.....	96,543
Actual number of cows in 1914.....	93,250
<hr/>	
Deficiency of cows in 1914.....	3,293
Normal deaths of old cows, 1913-14.....	9,226
<hr/>	
Possible total deaths of old cows, 1913-14.....	12,519
<hr/>	
Percentage of possible deaths of old cows, 1913-1914.....	135
Normal death rate of old cows.....	100
<hr/>	
Supposed percentage of excessive mortality, 1913-1914.....	35

That pelagic sealing may have disturbed the death rate to the extent of $3\frac{1}{2}$ per cent is not an unreasonable assumption, and in the absence of any other sufficient explanation this may be accepted as the principal reason for the lack of a substantial increase of cows and pups in 1914.

Comparison of the number of pups found on the various rookeries in the three successive censuses shows certain points of interest, but conclusions drawn from them

^a This is the rate due solely to old age, based on the knowledge that the average breeding life of the cow is about 10 years. Some mortality of adults from other causes should be added for absolute accuracy, but it can not be ascertained, and is doubtless too small to affect a calculation of this kind.

are subject to possible unknown factors involved in the operation of pelagic sealing. The comparison of counts is as follows:

Number of pups and percentages of decrease or increase in 1913 and in 1914, as compared with the year before.

	1912		1913		1914		
	Total pups. ^a	Total pups. ^a	Percent- age of decrease from 1912.	Percent- age of increase over 1912.	Total pups.	Percent- age of decrease from 1913.	Percent- age of increase over 1913.
St Paul Island:							
Kitovi.....	1,975	1,855	6	2,119	14.2
Lukanin.....	1,787	1,661	6.4	1,834	10.4
Gorbatch.....	6,435	6,368	1	6,152	3.4
Ardiguen.....	417	475	13.9	656	38.1
Reef.....	13,014	13,984	7.4	13,559	3
Sivutch.....	2,787	3,495	25.4	4,052	15.7
Lagoon.....	521	527	1.1	375	28.8
Tolstoi.....	9,074	10,026	10.4	9,934	.9
Zapadni.....	7,364	7,953	7.9	7,625	4.1
Little Zapadni.....	4,436	4,596	3.6	4,919	7
Zapadni Reef.....	186	197	5.9	206	4.5
Polovina.....	2,736	3,680	34.7	3,555	3.3
Polovina Cliffs.....	1,083	1,320	21.8	1,449	9.7
Little Polovina.....	841	1,050	24.8	927	11.7
Morjovi.....	2,400	2,812	17.1	2,312	17.7
Vostochni.....	14,979	19,459	29.8	19,709	1.2
Total.....	70,035	79,458	13.4	79,383	.094
St. George Island:							
North.....	4,227	4,319	2.1	5,301	22.7
Staraya Artel.....	3,607	3,778	4.7	4,278	13.2
Zapadni.....	1,246	1,408	13	1,023	27.3
Little East.....	26	25	3.8	26	4
East Reef.....	536	444	17.1	581	30.8
East Cliffs.....	2,307	2,837	23.9	2,658	6.1
Total.....	11,949	12,811	7.2	13,867	8.24
St. Paul Island.....	70,035	79,458	13.4	79,383	.094
St. George Island.....	11,949	12,811	7.2	13,867	8.24
Total, both islands.....	81,984	92,269	12.4	93,250	1.06

^a From the unpublished records of G. A. Clark.

The increase in 1913 was very general, 17 rookeries showing an increase and only 5 a decrease. The increases on different rookeries ranged from 1 per cent to 34.7 per cent and the total increase was 12.4 per cent. In 1914 there were increases on 12 rookeries and decreases on 10, with a total increase of only 1.06 per cent. The range of variation is greater than in the previous year, running from a decrease of 28.8 per cent to an increase of 38.1 per cent. Some rookeries which showed an increase in 1913 show a decrease in 1914 and vice versa. Kitovi, which decreased 6 per cent in 1913, increased as much as 14.2 per cent in 1914 and nearly the same was true of Lukanin. Polovina, which showed the remarkable increase of 34.7 per cent in 1913, has 3.3 per cent decrease in 1914, while various other rookeries show similar irregularities. The most consistent large increase is that of Sivutch or Sea Lion Rock, where there was a gain of 25.4 per cent in 1913 and 15.7 per cent in 1914. Ardiguen also increased well in both seasons, but its small size magnifies slight change as expressed in percentages. In the two years since 1912 most of the rookeries show increase, but Gorbatch, Lagoon, and Morjovi on St. Paul Island, and Zapadni on St. George had fewer pups in 1914 than in 1912.

On the whole, the comparison of the counts on the various rookeries shows nothing more clearly than that great irregularity prevailed. There is nothing to indicate that

increases took place on rookeries of any particular type more than another nor that decreases were due to any general cause unless it were excessive mortality of old cows produced by pelagic sealing. A point of possible significance is seen in the fact that the increases or decreases in cows on a given rookery have no definite relation to the number of bulls. In a number of instances a decrease in cows was shown on rookeries which had an increased number of bulls. Thus, Tolstoi had 120 harem bulls in 1913 and 161 in 1914. The 120 bulls of 1913 had the management of 10,026 cows, whereas the 161 bulls of 1914 had only 9,934 cows, from which it is evident that the number of cows on a given rookery is not wholly dependent upon the number of bulls that are there to receive them.

THE CENSUS IN THE FUTURE.

The great element of uncertainty in all censuses thus far made is our imperfect knowledge of the percentage of young seals that naturally survive to the age of three years. Such information as we now have regarding this important matter is derived from data obtained largely in the days of pelagic sealing when unnatural conditions prevailed, making wholly reliable conclusions impossible. Under proper authority this percentage of survival can be so definitely ascertained in 1915 that the full strength of the herd may be estimated with a degree of accuracy sufficient for all practical purposes. With this knowledge in hand, differences of opinion as to the actual size of the herd should be reduced to a negligible minimum.

Until every possible influence of past sealing on both land and sea has disappeared and until all uncertainty is relieved regarding rates of increase and numerical proportions, it will be advisable to make an annual census. That this time has not yet arrived is evident from the results gained in 1914, particularly the count of pups. The more regularly and carefully censuses are made now while the herd is still relatively small the less necessity there will be for such work in the future when the size of the herd will render the task more difficult and more expensive. Another census, therefore, will be required for 1915 and probably another for 1916. For later years, partial counts may suffice and perhaps the counting of pups may be discontinued.

As the herd grows counts will be made with increasing labor and expense, but although all future conditions can not be predicted, it is probable that the difficulties of counting harems and pups will never be quite insuperable. To continue the harem counts when the herd has reached large proportions will require improved facilities not now available, and to make pup counts at that time will involve the employment of a corps of capable men, but if necessary the work can be done.

THE BREEDING OR HAREM BULLS.

STRENGTH AND VIGOR.

The 1,559 harem bulls of 1914 showed every indication of full strength and vigor. So far as outward appearance and actions are concerned, they were normal animals in good condition as were all other classes of seals. The strain which they undergo without food during some six weeks of almost constant physical exertion and sustained sexual excitement is scarcely paralleled among animals. It is such that any weakness would be likely to manifest itself at once, and when no such weakness can be detected it must be concluded that none exists.

The increased number of bulls, while having some effect on the average size of the harems, did not preclude the formation and successful management of some exceptionally large harems, and it is evident that an unlimited increment of bulls would not do so. Harems of large size were noted under various conditions, on large rookeries as well as smaller ones, and where idle bulls were present as well as where there were none. The bulls holding such harems, while magnificent animals, possibly superior to the average, were in no respect superior to many others in nearby positions having harems of moderate size. Harems of at least 80 cows were observed in numbers, in fact on practically every rookery. The largest single harem was noted on Zapadni rookery on St. George Island. This harem on July 13 contained 106 cows, and there was no doubt this was not the full total. At the close of the season the bull in charge of it was much reduced in weight, but still jealously guarded a few cows not yet served and proved so vigorous and belligerent that he could not be dislodged from his position during the counting of pups. That this bull served more than 100 cows and finished the season in relatively good condition is scarcely open to question. A similar case was noted on Gorbatch. The first harem formed here contained 6 cows on June 22 and 22 on June 26, and rapidly increased to not less than 80 on June 30. A few cows had already gone out to feed, so the total number of cows belonging to this harem was doubtless nearly 100 even at this early date. Later in the season it grew still larger, but became so merged with surrounding harems that an exact count of cows was not possible. That it was successfully conducted is evident from the fact that the bull in charge of it was observed covering one of the few remaining cows on July 23. At this date a few bulls from other localities had concluded their labors and were sleeping in the grass behind the rookeries. These instances are sufficient evidence of the sexual capacity of the bulls. In addition, and corroborative of observations of former investigators, a single bull was noted to copulate twice within an hour and three times within 24 hours.

Further and even more conclusive evidence of the sexual capacity of the bulls is found in the average size of the harems. The 93,250 pups of 1914 were sired by the 1,403 harem bulls, the 105 idle bulls, and perhaps to a limited extent by the half bulls of 1913. Assuming that the number sired by half bulls is at least offset by the cows which died during the winter, it may be concluded that 1,508 harem bulls and idle bulls in 1913 sired the 93,250 pups born in 1914, or an average of 61.8 for each bull. The question of average harems is discussed more fully elsewhere (p. 56), but when it is considered that numerous single-cow harems are always present it is plain that many bulls must have impregnated more cows than the average. It is safe to say, therefore, that a normal bull is capable of serving 75 to 100 cows in a single season.

SENILE BULLS.

Only two cases of undoubted senility were observed. One of these bulls, when first noted on North Rookery, St. George Island, was in possession of two cows near the edge of the water and some distance from the main part of the rookery. He was relatively thin, lacking in vigor, and plainly very advanced in years. He retreated on our approach like an inexperienced "quitter," and his general cowed demeanor, as well as his poor physical condition, indicated that he would not be able to maintain his position. A few hours later he was found dispossessed and dejectedly eyeing a small 5-year-old half bull

that was actively guarding the two cows. The following day he had disappeared. The second bull of this kind, showing similar characteristics, was observed on Sea Lion Rock July 20. Among the active harem bulls a certain proportion can be distinguished as relatively old, but all maintain themselves with vigor, and it is apparent that, with rare exceptions like the ones noted above, practically all bulls with strength enough to return to the islands are still competent for harem service.

ADOLESCENT HAREM BULLS.

Many bulls not over 6 years old and a few not over 5 years conducted harems in the season of 1914. The 6-year-olds could not always be distinguished with certainty, but it was evident that practically the entire stock of this class of seals was divided between harem bulls and idle bulls. Five-year-olds with harems were comparatively few on St. Paul Island, but on St. George Island at least three were noted on East Cliffs and two on North Rookery as early as July 13. There are some observations to indicate that even 4-year-olds may be sexually capable and there is little doubt that all 5-year-olds are. But for such animals to do harem service is scarcely desirable. Under normal conditions 5-year-old half bulls could not obtain cows until the end of the season and the break up of the harems. Their participation in the harem system early in the season can hardly be regarded as anything but an indication of a scarcity of old bulls. This, however, is not proof that the old bulls had more cows than they were capable of serving for there were old bulls with comparatively small harems not far from harems held by the young bulls. The varying character of the breeding grounds makes it impossible for a bull to move far from his original position without losing whatever advantage he may have, so cows that for any reason haul beyond the working range of the established harem bulls are subject to capture by any unoccupied bulls. Under natural conditions such cows would immediately be appropriated by the idle bulls. In the absence of idle bulls, it is evident they fall to the lot of the 5-year-olds, and so far as known are effectively served by them.

Thus, whether or not it will affect the number of pups to be born, there was in 1914 a shortage of old bulls sufficient to permit a limited number of 5-year old half bulls to serve as harem masters.

FIGHTING OF OLD BULLS.

The conditions in 1914 were such as to favor a minimum of fighting. Practically all the old bulls were able to obtain at least small harems, and the idle bulls were not numerous. Moreover, the idle bulls were mostly only 6 years of age and, although fairly large and strong, lacked confidence and experience, so they were rather easily intimidated by the older animals. Early in the season before the cows arrived there was some fighting, which did comparatively little harm and which was doubtless not proportionately greater than it would be under any circumstances. On June 22 a bull was noted on Kitovi that had recently suffered the loss of one eye, and others with cuts and slashes were occasionally seen. Later, on the same rookery, an idle bull was seen to take charge of a harem while the original possessor sought to retrieve a fleeing cow, and in the onslaught which followed the interloper narrowly escaped castration.

Contrary to general popular impression, no fighting of consequence occurs over the incoming cows. The bull fights to maintain his position and only in this indirect

way can be said to fight for the acquisition of cows at the time when they are arriving. Idle bulls are constantly to be seen wholly indifferent to the arrival of cows in near-by harems. Bulls in possession of harems not uncommonly attempt to welcome new cows, but in such cases the cows are very apt to return to the sea in apparent fright. In many cases, cows were observed to come quietly into a harem while its lord and master was lying asleep and blissfully ignorant of any addition to his seraglio. During the formation of the harems, the dominant instinct of every bull is not to dispossess his neighbor but to maintain his own position at all costs; and a relatively poor place is valued as highly as the more favored ones. When the height of the season arrives, with practically all cows accounted for and many of them in heat at the same time, the procreative instinct becomes stronger and bulls which find themselves without cows will then attempt to secure them wherever possible. It is evident that the majority of the bulls return each season to the same or approximately the same position as that occupied the previous year. In general, it is true also that the older bulls arrive early. Thus it follows that the less advantageous positions are left for the younger bulls. Such bulls about the rear and ends of the rookeries are constantly being menaced by the harem bulls, whether actual fighting takes place or not, and this always causes commotion. When an idle bull makes a move which is deliberately or apparently threatening, the nearest harem bull starts toward him, perhaps from the other side of his harem, and plows ruthlessly through passive cows and over struggling pups until he is near enough to cause the idle bull to retire. In the majority of cases there is no real conflict, but since neighboring harem bulls are apt to start up at the same time, the general mêlée may result in two bulls coming into such close proximity that the "bluffing" tactics are abandoned and real blows struck. Similar trouble ensues from the approach of idle bulls and bachelors at the water's edge. The large number of 3 and 4 year old bachelors in 1914 was the source of considerable disorder of this kind, and it is evident that even a moderate breeding reserve of these classes of males would be sufficient to haunt all the rookery fronts and rouse the antagonism of the harem bulls. Time after time a harem bull will rush through his cows merely to roar and puff at a young bachelor which has hauled partly out of the water and looked with apparent curiosity in his direction.

Even with fighting at a minimum, as at present, there is considerable unavoidable commotion on the rookeries. A particularly fruitful source is the departure of the cows to feed. When the first cows begin to go out, the harems are large, the cows closely packed, and births and copulations in progress. The bulls seem to become greatly exercised at the idea that a cow may get away without service and as soon as one makes a move, whether from a real intent to go to sea or not, the bull hastily rushes over any intervening cows and either quiets the restless one or in some way satisfies himself that she has been served. Sometimes the bull will even interrupt the service of one cow to restrain another which seems about to leave, and will do so likewise to threaten an inquisitive young bachelor. Such actions while the pups are still young and while births are underway doubtless cause some mortality of pups. One wonders that it does not cause much more than is found upon investigation, but it is evident from this as well as from general observation that the pups are fitted to withstand an incredible amount of rough treatment. Except at the time of birth and for a few hours thereafter they may be battered about, trampled, and pushed into crevices without serious

injury so far as the great majority of cases are concerned. Although the bulls sometimes seemed conscious of the helpless young ones and appeared to avoid trampling them, innumerable instances were noted in which they passed directly over small pups without harming them. In one case a copulation was observed during which a pup was imprisoned beneath a bull and subjected to continued mauling for nearly 15 minutes, after which the little fellow wriggled out apparently none the worse. It is plain, therefore, that considerable commotion is unavoidably connected with the harem system whether idle bulls are present or not; and although much of it is comparatively harmless, some fatalities are bound to result under the best of circumstances.

SIGNIFICANCE OF THE INCREASE OF HAREM BULLS.

The increase of harem bulls from 1,358 in 1912 to 1,403 in 1913 and again to 1,559 in 1914 shows clearly that the reduced state of male life in 1912 and preceding years was at most only partly due to the killing of males on land. As stated elsewhere, the accessions of harem bulls in 1914 consisted of animals that escaped the undiminished land killings of 1910 and 1911 when they were 2 and 3 years old, respectively. Their continued survival in larger numbers than formerly is thus due to the fact that their later years were free from the effect of pelagic sealing. To some extent this justifies the belief frequently expressed that with the closest land killing possible a certain number of males would always escape and come to maturity. It can not be said, however, that it justifies land killing now at the former rate, for with pelagic sealing stopped, the increase in the number of cows would be proportionately larger than formerly.

The increase in harems in 1914 without a corresponding increase in cows shows that the number of harem bulls in immediately preceding years, if not insufficient, was at least abnormally small. That the bulls are fully capable of meeting such emergencies may not be doubted, but it is nevertheless clear that when more bulls are present the average number of cows per bull is immediately reduced. The number of cows in 1913 was almost equal to the number in 1914, but in 1913 they were divided among 1,403 bulls and in 1914 among 1,559 bulls. It is evident, therefore, that had 1,559 bulls been present in 1913, all or practically all of them would have been able to obtain harems. It is apparent also that a continued increase of bulls will cause the size of the average harem to decline from year to year until it reaches a minimum beyond which no increment of bulls can reduce it.

THE IDEAL PROPORTION OF HAREM BULLS.

It may well be doubted whether it would be wise to permit such an increase of bulls as would insure a minimum average harem, for other considerations are involved; but a safe course of procedure in the management of the herd would seem to demand that the average number of cows per bull be kept as near such a minimum as possible without causing injury to the herd. Such a course may be modified as more complete knowledge is obtained in future years, but at present a prudent policy of approximating natural conditions recommends itself.

To accomplish a reduction of the average harem to the proportions of former years will require the preservation of a relatively small number of males and large numbers may still be killed without the slightest apprehension. This is evident when it is considered that an annual increment of only 2,000 bulls would provide for the maintenance

of 12,000 bulis in service, and if these had an average of only 40 cows each provision would be made for a total of 480,000 cows, a number scarcely exceeded in the history of the herd.

The average number of cows per bull under approximately natural conditions can not be stated exactly, but the best evidence available indicates that it was not less than 30 nor more than 40. In the early days of American ownership it was not known that all the cows are not on land at one time, so underestimates were the rule. H. W. Elliott, writing of conditions from 1872 to 1874, says:^a

I found it an exceedingly difficult matter to satisfy myself as to a fair general average number of cows to each bull on the rookery; but, after protracted study, I think it will be nearly correct when I assign to each male a general ratio of from 15 to 20 females at the stations nearest the water, and for those back in order from that line to the rear, from 5 to 12; but there are so many exceptional cases, so many instances where 45 and 50 females are all under the charge of 1 male, and then, again, where there are 2 or 3 females only, that this question was and is not entirely satisfactory in its settlement to my mind.

Charles Bryant, writing of the same period, says simply, "In the average there are about 15 females to one beach master."^b

More detailed data are available for the years 1896 and 1897, during which the herd was considerably reduced in size, but was supplied with an excessive number of bulls, due to the suspension of killing during the *modus vivendi* of 1891 to 1893. In 1897, when fairly complete counts were made, there were 4,418 harems by count and 172,288 cows by corrected estimate,^c making an average harem of 38.9. At this time idle bulls were practically equal to harem bulls, and obviously excessive in number, so it is evident the average harem was reduced to a low figure. In view of these facts, and the knowledge that the extreme capacity of the bulls is very much greater, it is safe to say that a supply of harem bulls which provides 1 to every 40 cows is amply sufficient. The number in 1914 was approximately 1 to every 60 cows, and close observation revealed no evidence that all were not efficient. To have produced an average harem of 40 in 1914 would have required only 772 more harems than were found, so it is apparent that no large reserves are necessary to bring about ideal conditions in the immediate future. If it should be found in practice that the average harem can not be greatly reduced without the accompaniment of a great excess of idle bulls, action will necessarily be governed according to circumstances as they develop; but if an intelligent and continued effort is made to provide harem bulls in the approximate proportion of 1 to 40 cows the result is certain to fulfill all the demands of a policy of conservation.

IDLE AND YOUNG BULLS.

AGE AND CHARACTER.

The so-called idle bulls were in the majority of cases bulls believed to be only 6 years of age. A few 7-year-olds also were unable to obtain harems, but only in exceptional circumstances. It is evident that in a well-balanced herd the idle bulls would largely consist of animals relatively young. During a great excess of bulls a variable number of all ages might be found in the class of idle bulls, but the natural course

^a Monogr. Seal Islands of Alaska, p. 36, 1882.

^b In Allen, N. Am. Pinnipeds, p. 385, 1830.

^c Obtained by multiplying the average harem of one rookery by the total number of harems and adding one-half for error in method. See this report, p. 34, and Jordan and Clark, Fur-Seal Invest., 1896-97, Vol. I, p. 97, 1898.



Tolstoi flat after disorganization of the harems, August 23, 1914.

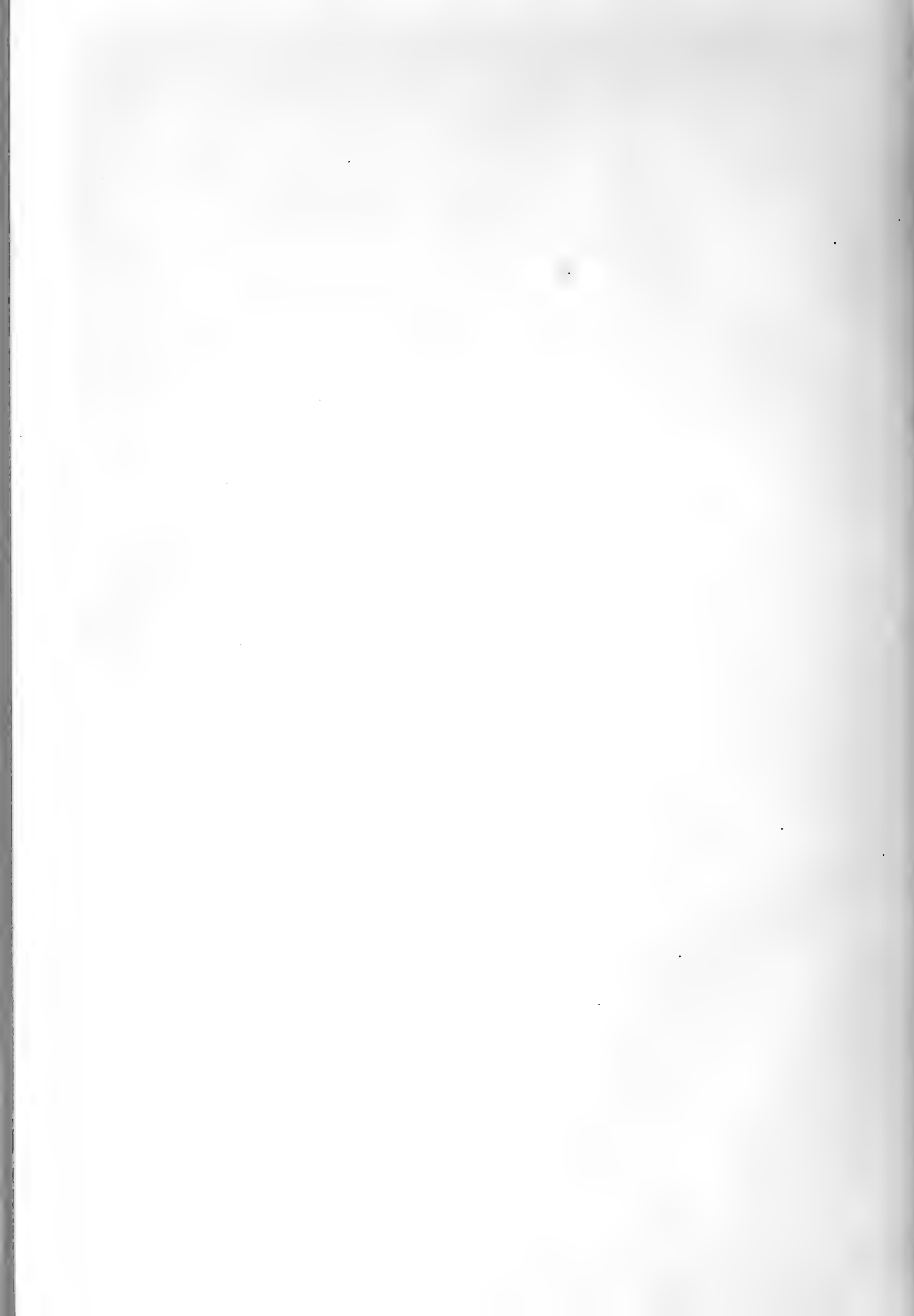

of events brings the younger animals to the less advantageous positions. The older bulls as a class are doubtless stronger and better fighters than their juniors, but their success in all cases may not be due to this so much as to their early arrival and their predilection for places previously occupied. The young bull seeking his first harem is guided mainly by an instinct to secure some sort of a position on the breeding ground and wait for cows to come to him. Arriving a little late, he finds most of the good positions occupied, and unless he stumbles into a place vacant through the death of its previous occupant, he is content to take a relatively poor position and guard it as hopefully as if it were the best. Late in the season he discovers his error and attempts to get cows wherever he can find them. The old bull, on the other hand, comes early and seeks the place occupied the previous year or a similar one and is not satisfied with any other. This, with the exception of circumstances, is the general procedure which operates to make the idle bulls as a class relatively young.

Certain of the idle bulls are as tenacious of their positions as the harem bulls are and will charge at a man who comes near them with just as much ferocity and determination; others will roar at a man and grudgingly give ground as he approaches, perhaps finally retreating to the water and sitting partly submerged while they continue to puff and glower; still others take fright at sight of a man and rush pell-mell to the sea and swim off. Especially to this last class the term "quitter" has been applied and an attempt has sometimes been made to distinguish "quitters" and idle bulls. As observed in 1914, there was every gradation from the undoubted "quitter" to the determined idle bull, and a large number were neither the one nor the other. Moreover, some of the most timid quitters were found continually returning to their positions and in some cases their demeanor changed as the season advanced, while a few of them actually obtained harems. It was evident that all such bulls were ready to secure harems and competent to care for them whenever opportunity permitted. Their enumeration as idle bulls, therefore, was fully justified.

Other bulls, apparently at least 6 years of age, were irregular in their movements, some being on the hauling grounds, some in the bachelor runways and at the extreme ends of the rookeries, while at all times an indeterminate number were in the water, appearing and reappearing along the rookery fronts to haunt and harass the harem masters nearest the sea. Such bulls can not be fully enumerated and, though doubtless quite as effective reserves as the idle bulls in fixed positions, they can only be taken into account collectively with the "young bulls" or half-bulls, all of which are never on land at one time. With these exceptions, the "young bulls" consist of the 5-year-olds, the majority of which spend the early part of the season with the young bachelors. Toward the height of the season they are seen in increasing numbers about the rookery fronts, and at the first sign of relaxation of harem discipline they swarm over the breeding area. As the exodus of old bulls progresses the idle bulls and the smaller half-bulls practically take possession of the breeding ground. At this time the virgin cows appear in greatest numbers and it is assumed that they are largely served by these idle and young bulls. The young bulls, half-bulls, or 5-year-olds, are wholly unable to cope with the idle bulls, and, although in 1914 they occupied most of the space after the break-up, it is plain that they would not have been permitted to do so had a larger number of idle bulls been present.

IRREGULAR DISTRIBUTION.

As in the case of other classes of seals, the presence of a larger or a smaller number of idle bulls on a given rookery is doubtless governed by a variety of circumstances, only a few of which can be recognized. At least it is obvious that the distribution of idle bulls is very irregular, and a considerable number may be present about one rookery while scarcely any are found on another. It may be possible also, as observed in 1914, for idle bulls to be present at one end of a rookery while harems are held by half-bulls at the other end. The fact that the herd as a whole includes a number of idle bulls, therefore, is not inconsistent with their complete absence and an actual shortage of harem bulls on certain rookeries. This being the case, it can not be safely assumed that no shortage of harem bulls exists unless there be idle bulls on every rookery. To this extent at least it is apparent that a certain number of idle bulls are desirable and necessary.

In 1914 there were several rookeries having no idle bulls whatever and the range of variation from rookery to rookery was very great, as shown by the subjoined table:

Percentage of idle bulls on different rookeries, 1914.

Rookery and island.	Harems.	Idle bulls.	Percentage of idle bulls.
St. Paul Island:			
Kitovi.....	58	5	8.6
Lukanin.....	39	1	2.6
Gorbach.....	112	9	8
Ardiguen.....	15	0	0
Reef.....	193	26	13.5
Sivutch.....	91	10	10.9
Lagoon.....	8	2	25
Tolstoi.....	161	38	23.6
Zapadni.....	114	24	21
Little Zapadni.....	90	10	11.1
Zapadni Reef.....	3	1	33.3
Polovina.....	58	3	5.1
Polovina Cliffs.....	22	6	27.2
Little Polovina.....	18	0	0
Morjovi.....	43	4	9.3
Vostochni.....	291	20	6.8
Total, St. Paul Island.....	1,316	159	12
St. George Island:			
North.....	94	4	4.2
Staraya Artel.....	63	4	6.3
Zapadni.....	14	0	0
Little East.....	1	0	0
East Reef.....	14	3	21.4
East Cliffs.....	57	2	3.5
Total, St. George Island.....	243	13	5.3
St. Paul Island.....	1,316	159	12
St. George Island.....	243	13	5.3
Total, both islands.....	1,559	172	11

IDLE BULLS AS A DESIRABLE BREEDING ELEMENT.

The idea that the idle bull is literally a surplus or superfluous bull, only valuable as a reserve or as an indication of a sufficiency of harem bulls, seems open to serious doubt. It is quite conceivable that a moderate number of idle bulls may be an actual necessity for normal breeding. When a sufficient number of idle bulls are present, it is apparent that they are the principal, if not practically the only, agents for the service of the virgin

cows. In the absence of idle bulls, these cows must be served either by the old bulls or by the 5-year-old half-bulls. It can not be said that any such cows ever have escaped service, but it is plain that an absence of idle bulls would be the first condition favoring its possibility. A number of idle bulls proportionate to the number of virgin cows, therefore, would be the safest guaranty that all such cows would be impregnated.

The virgin cows do not appear on the rookeries until relatively late in the season and remain on land but a short time. Apparently they come in greatest numbers at about the time the regular harems are breaking up and the old bulls retiring from the breeding areas. Although some of them are doubtless served by the old bulls, this is exceptional, for the majority of the old bulls leave each season at approximately the same time whether idle bulls are present or not. This leaves the young half-bulls free to take possession of the young cows unless prevented by the idle bulls. In 1914, the idle bulls were sufficiently numerous to secure many of these cows, but a much greater number were seen under the care of the half-bulls. So far as known, the half-bulls are sexually as potent as the older animals, but since they would not do service under natural conditions, some doubt attaches to the advisability of an artificial condition which permits them to act as sires. It may therefore be concluded that idle bulls as a class have a definite function in the breeding economy and that unless in excessive numbers they are a benefit to the herd.

IDLE BULLS AS A MENACE TO THE HERD.

In recent years there has been no opportunity to observe the effect of numerous idle bulls, but there can be no doubt that a large supply of idle males, including animals of 7 years of age and over, would cause increased fighting and disturbance. The extent to which this would entail increased loss of life is to a considerable degree a matter of opinion. If left to itself, the herd would undoubtedly develop an excess of bulls beyond all possible needs and one which might serve as a distinct disadvantage. It may readily be believed that superabundant male life was a factor in maintaining an equilibrium before the advent of man, but in spite of this a considerable proportion of idle bulls may not be seriously detrimental. Under present conditions the massed sections of the larger rookeries are at the height of the season as thickly packed with seals as seems possible. The harems merge one with another to such an extent that those toward the center of a given area are thoroughly shielded from any disturbances except those originating within themselves. On the flat and adjoining beach under Hutchinson Hill there were in 1914 more than 100 contiguous harems and 6,000 to 8,000 closely packed cows. Numerous idle bulls, if present in such a place, would have caused some extra commotion around the outskirts of this breeding ground, but the great central mass would have been practically unaffected. In a large herd a few bulls and a certain number of cows undoubtedly come to death through fighting, and a considerable number of pups are trampled and smothered, but there is no conclusive evidence that the number is appreciably more than proportionate to the size of the herd, regardless of a considerable number of idle bulls. In 1896, when idle bulls were present in great numbers, 131 dead cows and 28 dead bulls were noted, and a full count of pups was made on at least one rookery, Kitovi. So far as these figures can be compared with those of recent years, when both harem bulls and idle bulls have been at a minimum,

no important change in the death rate is indicated. This is shown by the following table:

Mortality in relation to idle bulls.

Year.	1896	1912	1913	1914
Harems.....	4,932	1,358	1,403	1,559
Idle bulls.....	^a 3,000	113	105	172
Total bulls.....	7,932	1,471	1,508	1,731
Total cows.....	^b 209,873	81,984	92,269	93,250
Dead cows.....	131	27	30	18
Per cent of dead cows in relation to total number of bulls.....	1.7	1.7	1.9	1.0
Per cent of dead cows in relation to total number of cows.....	.079	.037	.032	.019
Dead bulls.....	28	3	6	1
Per cent of dead bulls in relation to total number of bulls.....	.380	.204	.390	.057
Total pups on Kitovi.....	6,049	1,975	1,855	2,119
Dead pups on Kitovi.....	^c 109	37	22	47
Per cent of dead pups on Kitovi.....	1.8	1.8	1.1	2.2

^a Estimated; see Rept. Fur-Seal Investigations, 1896-97, vol. 1, p. 98.

^b One-half more than formerly estimated.

^c Including only those which died prior to August 10 to make the figures comparable with those of later years.

The above table is somewhat unsatisfactory, since pelagic sealing was going on in 1896 and the counts were made then by methods not exactly the same as those used in 1912-1914. Moreover, it is not possible to state what percentage of the dead was due to trampling and fighting, so it is necessary to compare those dead from all causes. Notwithstanding that the figures are less extensive than desirable, several points of considerable interest are to be noted. The percentage of dead cows in relation to the total number of cows was greater in 1896 than in the years when idle bulls were few. In all other respects there is nothing in the figures to indicate that the percentage of death from all causes during the breeding season was any greater in 1896 than in the later years. The percentage of dead pups on Kitovi was exactly the same in 1896 as in 1912, and even less than in 1914. Likewise the percentage of dead cows in relation to the total number of bulls was the same in 1896 as in 1912 and less than in 1913. In 1914, with an increase of bulls, there were fewer deaths of bulls and cows than in 1912 and 1913.

The imperfection of the data precludes absolute proof, but so far as any conclusion is indicated by these figures it is that a considerable number of idle bulls does not produce an excessive death rate. If, in spite of these figures, it is held that an increased mortality must necessarily follow even a moderate increase of idle bulls, the most that can be maintained is that it is likely to be relatively small and not of itself sufficient to justify apprehension. Fighting and commotion must always be a part of rookery life, and if the idle bulls have any legitimate function it need not be very great to offset the harm they may do and justify their preservation in reasonable numbers.

THE IDEAL PROPORTION OF IDLE BULLS.

What has been said in the preceding paragraphs indicates that while a great excess of idle bulls is highly undesirable, an entire lack of them is equally so and for the maintenance of a well-balanced herd a definite proportion of them is necessary. This proportion should be large enough to insure the distribution of idle bulls on all the rookeries in numbers sufficient to serve all the virgin cows. The number of virgin cows at a given



Old cows in front of Gorbach Rookery, August 13, 1914.

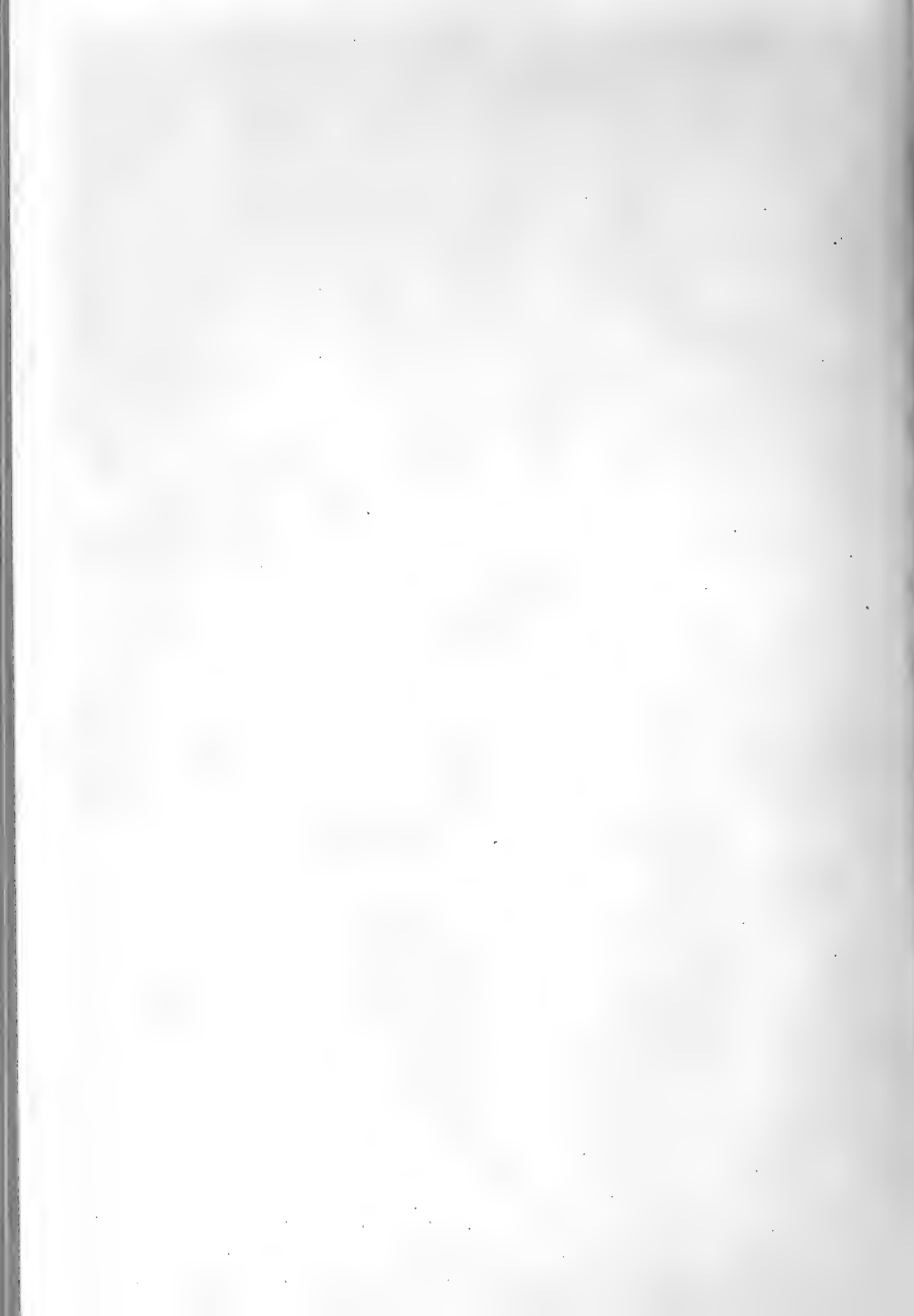

time would normally be about one-fifth as many as the number of old cows. This would indicate that one idle bull to every five harem bulls would not be an excessive number. Although but little data are available, it seems probable that most of the virgin cows are served between July 15 and August 5, a period somewhat shorter than that during which the old cows are held in the harems. Therefore, it may not be unfair to allow a smaller number to each bull than in the case of the old cows, and one idle bull to every four harem bulls therefore may be suggested as a theoretically ideal proportion. Reference to the table (p. 52) of the distribution of idle bulls in 1914 shows that this proportion has nearly or quite been reached on some rookeries without effectively reducing the average size of the harems of the old bulls so it is evident that in practice it may not be possible to secure ideal proportions either of idle bulls or harem bulls. However this may be, there can be no question of the importance of striving to maintain proportions as near a theoretical ideal as circumstances will permit.

THE UTILIZATION OF SURPLUS BULLS.

To prevent financial loss, business principles demand that no large increment of idle bulls be permitted, but it is inevitable that excess may occur from time to time either as the result of well meaning restrictive legislation or on account of the liberal allowances for contingencies necessary in a carefully considered system of reserving young males. It is true that after the fourth year the pelt of the male fur seal becomes coarser and of less value than formerly, but it can not be said that it loses all its value. During the early years of the leasing system all furs were much cheaper than at present and the great abundance of seals made it natural that only the choicest should be taken for market. In later years, when the Government restricted the quota, the lessees were of course inclined to follow a similar policy guaranteeing them the largest possible profit. Therefore it is probable that they fostered the belief that skins of "wiggged" males were of no value. The pelagic sealers, however, took seals of all classes and the records of sales in London show that "wigs" were by no means without value. Although their condition as pelagic skins was variable and doubtless below what might be expected of land-taken skins, they were often sold for good prices in lots including other grades. The best examples of lots consisting exclusively or almost exclusively of wigs in recent years are found on the sales sheet of C. M. Lampson & Co. for 1909 and 1911, as follows:

Prices received for skins of large seals.

Lot number.	Classification.	Average price.
Sale of Dec. 17, 1909:		
168.....	{ 31 wigs.....	} 110 (\$26.76)
	{ 5 wigs (cut).....	
175.....	{ 16 wigs.....	} 108 (\$26.28)
	{ 4 wigs (cut).....	
338.....	{ 10 wigs, pt. cut, etc.....	} 86 (\$20.92)
	{ 1 middling.....	
Sale of Dec. 15, 1911:		
190.....	{ 20 wigs.....	} 66 (\$16.06)
	{ 6 wigs (cut).....	
250.....	{ 12 wigs.....	} 52 (\$12.65)
	{ 3 middlings.....	
268.....	{ 32 wigs.....	} 44 (\$10.70)
	{ 14 wigs (cut).....	

The average price received for land-taken skins in 1909 was \$34.68, so in general terms it may be said that wigs in that year brought at least two-thirds as much as 2 and 3 year olds. In view of these figures, it is obvious that prime skins of 5 and 6 year old fur seals would always command a price that would compensate for a considerable proportion of the revenue which might have accrued if they had been taken as 3-year-olds. Even if no figures were available, it would still be evident that the skins of young bulls must have a substantial value. The observer, seeing these fine young animals in prime condition, and knowing the growing demand for fur of all kinds and the wide range of uses to which it may be put, can not fail to conclude that the skins of young bulls would find a ready market and bring profitable prices. Therefore, while failure to kill at the proper time causes a financial loss, it does not cause a total loss. In emergencies, such as will exist in 1915 when nearly 10,000 5-year-olds will be present, it would be possible to derive at least a moderate revenue from seals of this class.

THE AVERAGE HAREM.

VALUE OF THE AVERAGE HAREM.

The average harem, as commonly considered, is the average number of old cows held in harems by old bulls in a given season. It is calculated by dividing the total number of pups (equivalent to cows) by the total number of harems, and may be obtained for a single rookery or for the whole herd. During pelagic sealing, when full counts of pups were not feasible, the average harem was used as a means of estimating the total number of cows and pups by counting pups on one or several rookeries and applying the average thus obtained to all the rookeries. Estimates made in this way, as shown by recent full counts of pups, were apparently from 30 per cent to 40 per cent too small (see this report, p. 34), but their comparative value is nevertheless very great. For this reason it is highly important that this information be obtained whenever it is not possible to make a full count of pups.

The average harem is of value also as an indication of the relative strength of the breeding males. Thus in 1914 an increase in harem bulls without a proportionate increase in bearing cows caused a reduction of the size of the average harem. Further reduction may be expected with further increment of bulls and regulation of the size of the average harem may be accomplished by increasing or decreasing the number of bulls.

VARIATION OF AVERAGE HAREMS.

Variation of average harems is of two kinds, that of seasons, from one to another, and that of different rookeries in the same season. From season to season the average harem of the total herd has varied in recent years within relatively small limits. Thus in 1912 it was 60.4, in 1913 it rose to 65.8, and in 1914 dropped to 59.8. During the same period it showed a net decline for St. Paul Island and a continuous rise for St. George Island. Variation on the different rookeries from year to year keeps within moderate limits in most cases, and this may be taken as some indication that, unless unduly influenced, the same set of animals repairs each year to the same rookery. In other cases, the average harem shows sudden and pronounced ups or downs which are sometimes obviously due to well-known abnormal conditions and are sometimes wholly inexplicable. A summary of average harem data follows:

Comparison of average harems, 1912-1914.

Rookery and island.	1912 ^a			1913 ^a			1914		
	Bulls.	Cows.	Average harems.	Bulls.	Cows.	Average harems.	Bulls.	Cows.	Average harems.
St. Paul Island:									
Kitovi.....	53	1,975	37.3	44	1,855	42.2	53	2,119	36.5
Lukanin.....	38	1,787	47	33	1,661	50.3	39	1,834	47
Gorbatch.....	109	6,435	59	106	6,368	60.1	112	6,152	54.9
Ardiguen.....	11	477	37.9	11	475	43.2	15	656	43.7
Reef.....	179	13,014	72.7	171	13,084	81.8	193	13,559	70.3
Sivutch.....	57	2,787	48.9	67	3,495	52.2	91	4,052	44.5
Lagoon.....	8	521	65.1	6	527	87.8	8	375	46.9
Tolstoi.....	103	9,074	88.1	120	10,026	80.4	161	9,934	61.7
Zapadni.....	105	7,364	70.1	106	7,953	75	114	7,625	66.9
Little Zapadni.....	61	4,436	72.7	58	4,596	79.2	90	4,919	54.7
Zapadni Reef.....	3	156	62	3	197	65.7	3	206	68.7
Polovina.....	44	2,736	62.2	44	3,680	83.6	58	3,555	61.3
Polovina Cliffs.....	21	1,083	51.6	19	1,320	69.4	22	1,449	65.9
Little Polovina.....	11	841	76.5	21	1,050	50	18	927	51.5
Morjovi.....	37	2,400	64.9	40	2,812	70.3	43	2,312	53.8
Vostochni.....	237	14,979	63.2	293	19,459	66.4	291	19,709	67.7
Total and average.....	1,077	70,035	65	1,142	79,458	69.6	1,316	79,383	60.3
St. George Island:									
North.....	117	4,227	36.1	104	4,319	41.5	94	5,301	56.4
Staraya Artel.....	52	3,607	69.4	59	3,778	64	63	4,278	67.9
Zapadni.....	32	1,246	38.9	21	1,403	67	14	1,023	73.1
Little East.....	1	26	26	2	25	12.5	1	26	26
East Reef.....	23	536	23.3	17	444	26.1	14	581	41.5
East Cliffs.....	56	2,307	41.2	58	2,837	48.9	57	2,658	46.6
Total and average.....	281	11,949	42.5	261	12,811	49.1	243	13,867	57.1
St. Paul, total and average....	1,077	70,035	65	1,142	79,458	69.6	1,316	79,383	60.3
St. George, total and average..	281	11,949	42.5	261	12,811	49.1	243	13,867	57.1
Grand total and average.	1,358	81,984	60.4	1,403	92,269	65.8	1,559	93,250	59.8

^a From the unpublished records of G. A. Clark.

The most obvious general condition revealed by this table is the marked difference between St. Paul and St. George Island. Although only four rookeries on St. Paul show an increased average harem since 1912, the conditions on St. George are reversed and five out of the six show an increase. This accords with field observations which make it very clear that there was a scarcity of bulls on St. George in 1914. For the whole herd the average harem falls since 1912 on 12 rookeries, rises on 8 rookeries, and remains unchanged on 2.

The variation in the averages of different rookeries in the season of 1914 ranged from 36.5 on Kitovi, St. Paul Island, to 73.1 on Zapadni, St. George Island.^a Nine rookeries have an average of over 60, 8 of under 50, and 5 between 50 and 60. Some of this variation is doubtless due to past conditions, especially raiding and pelagic sealing, but it is probable that conditions never have been and never will be such as to produce more than approximate uniformity in the average size of the harems on the different rookeries.

THE AVERAGE HAREM AS A CRITERION OF THE CAPACITY OF THE BULLS.

The nature of an average forbids its use as a criterion of extremes unless certain reservations are made. In some cases, an average may be the mean between only slightly divergent extremes, and thus is fairly representative; but the average harem is based upon the total number of harem bulls, including many with but one cow

^a Little East, with its single harem of 26, not considered.

and others with more than a hundred. If the bulls are of equal strength, one is as capable of caring for a large harem as another, and it must be concluded that all bulls have the ability to serve the maximum number of cows. This maximum number is known to be more than 100, and although an exact figure can not be stated it is not necessary for practical purposes that it should be. The average harem for the whole herd or for certain of the larger rookeries is of value in this connection chiefly because it substantiates the general conclusion that the maximum harem is very large. To obtain the average harem of 59.8 in 1914, it is obvious that harems much larger than the average must have been included. The maximum average harem of some of the larger rookeries furnishes a further indication of the same sort. Thus, in 1912 the average harem of Tolstoi, a rookery of 9,074 cows, was 88.1; in 1913 the average harem of Reef, with 13,984 cows, was 81.8; in 1914 Reef had 13,559 cows and an average harem of 70.3. Such figures can not possibly be interpreted otherwise than that the capacity of the bulls is far beyond their average opportunities even under present conditions.

In addition to the bearing cows, which are the only ones included in the average harem, the harem bulls have the further responsibility of at least a small proportion of the virgin cows; exactly how many can not be ascertained. If a sufficient number of idle bulls were present to insure the exclusion of the half-bulls from the breeding, the total of harem and idle bulls might be proportioned to the total of young and old cows served by each bull. Under these conditions an average might be obtained by considering the bulls of one year as sires of pups of the next, and to this extent the effectiveness of the bulls would be demonstrated wholly beyond cavil. Thus there were in 1913, according to count, 1,403 harem bulls, 105 idle bulls, and 259 young bulls, making a total of 1,767 bulls and young bulls as the sires of the 93,250 pups born the following year, in 1914. The average number of cows per bull on this basis therefore was 52.8 in 1913. Two objections may be made to this result, (1) the number of young bulls counted did not include the full stock of that class (see p. 40), and (2) at least 10 per cent of the old cows must have died between seasons. One of these objections practically offsets the other, and it would be hypercritical to dissent from the conclusion that an average of not less than 50 young and old cows was served by the combined harem bulls, idle bulls, and young bulls in 1913.

Considering all the data on the subject of average harems, it is evident that while they fail to show the maximum capacity of the bulls they demonstrate most conclusively that the maximum is very high and that in practice it has rarely or never been reached. If any bad result has come through the reduced number of bulls on the islands in recent years, it has not been because of lack of sexual power. Possible harm through lack of opportunity by the old bulls and through participation of adolescent males in the breeding has been discussed elsewhere (see p. 47).

DISTINCTIONS BETWEEN THE CLASSES OF SEALS.

The so-called classes of seals are the natural divisions which may be made according to age and sex. For practical purposes there are seven classes of male seals and four classes of females. The classes of males are the pups, the yearlings, the 2-year-old bachelors, the 3-year-old bachelors, the 4-year-old bachelors, the 5 and 6 year olds or half-bulls,

and the bulls or males of 7 years and over. The classes of females are the pups, the yearlings, the virgin cows or 2-year olds, and the bearing cows or cows of 3 years and over. The distinction of these various classes is a matter of great importance in the study of the seals and in the practical management of the herd. It is especially important to distinguish the bachelors of 2, 3, and 4 years since these are the classes most similar in general appearance and the ones from which quotas and reserves must be taken. The other classes are mostly so easily distinguished as to require no special discussion.

GENERAL DISTINCTIONS.

Certain obvious general distinctions have long been recognized. Thus, the males after the third year are so much larger than any female that no confusion is possible. Males and females of 2 and 3 years, although distinguishable by a combination of minor characteristics which are apparent to the experienced observer, have a general similarity in size and color, but they are so completely segregated during the killing season prior to August 1 that no attempt at careful examination of individuals is necessary. The cows keep strictly to the breeding areas during the early part of the season and the bachelors to the hauling grounds with such rare exceptions that they need not be considered. Pups or yearlings of both sexes, so far as known, are identical in general appearance, but the males and females can be readily distinguished when handled. The skinner is always aware of the sex of any seal of any age the moment he takes it in hand to make the opening cuts. Cows or bulls of advanced age are easily distinguished from those of the early years of maturity, but the exact age of a given individual can not be known except in a few cases, and it is of no practical importance that it should be. Pups in their first season are distinctly characterized by color, though, as noted elsewhere, they may become so fat at 3 months of age as to weigh quite as much or more than yearlings. Bachelors in the fifth year develop the "wig" or mane, which serves as a mark of recognition in addition to increased size. The bachelors of 2, 3, and 4 years, however, are very similar in all general respects, and can be distinguished only by size.

SPECIAL METHODS APPLIED IN 1914.

Heretofore bachelors of certain average size have been regarded as 2-year-olds, those of the next size as 3-year-olds, and those of the next as 4-year-olds. Certain seals actually or apparently intermediate between the more or less vague standards have been classified as "long 2-year-olds," "short threes," or by similar terms. The actual age of any particular seal was never known with certainty, since no seals had been marked at birth and subsequently measured as they reached different ages. In 1914 it was possible for the first time to measure seals positively known to be 2-year-olds, since a number of that age were present bearing distinctive brands placed upon them as pups in 1912. With these 2-year-olds as a standard of comparison it was possible to determine the characteristics of the 3-year-olds and the 4-year-olds. As a further and very important check upon the conclusions a large number of skulls were preserved, furnishing unmistakable evidence of the relative age of different individuals. Furthermore, the standard of distinction adopted has been the one subject to the least variation, namely, the total length of the animal. It has long been recognized by zoologists and students of classification and variation that the total length measurement of mammals is the most constant and reliable one that can be taken. This dimension is not affected

by any temporary condition of the animal causing it to be fat or lean, but is mainly dependent upon the length of the vertebral column, which varies only within very narrow limits. As shown beyond, especially under the discussion of 3-year-olds, the use of this measurement makes it possible to classify bachelor seals with a high degree of accuracy.

THE YEARLINGS.

Definition.—A yearling seal has been defined as an animal which has attained its second summer, or one which has completed its first migration. The great majority of the pups are born in July, but some are born as early as the middle of June and a very few as late as the middle of August. The seals of any one generation, therefore, can vary in actual age but little more than 8 weeks, and for all practical purposes this variation may be disregarded. Seals found on the islands the year following that of their birth are and in fact must in practice be regarded as yearlings during the whole of that year or from the time they arrive at the islands on the return from their first migration until they leave to begin their second journey. The same principle applies to the other classes of young seals, each simply representing one generation in the herd. It is true that a provision of the law of 1910, which fails to use the word yearling, conditionally prohibits the killing of "any seal less than 1 year old." But this prohibition is expressly stated to be subject to the "authority of the Secretary of Commerce" and to the needs of the natives for food. Moreover, the subsequent law of 1912 provides that male seals without restriction as to age may be killed as food for the natives. Therefore it is a matter of no practical importance whether the actual age of any given yearling be slightly more or slightly less than 12 months.

It is, of course, impossible to determine the exact age of individual seals, but the limited period in which births take place affords a means of approximation. Births occur in greatest numbers from the 10th to the 20th of July. After that date they rapidly decrease, and although a few usually occur during the first week of August, they represent the merest fraction of the total number. Births as late as August 10 are of very rare occurrence. Among the very few records of such cases which have been found, one on August 14 and another on August 27 may be noted.^a In 1914 the latest copulation recorded was on August 21, the cow engaged being an old one and her pup apparently but a few days old. It is evident, therefore, that yearling seals found in July may be slightly more or slightly less than 12 months of age, that those found early in August are mostly more than that age, while of those found after August 10 the chances are thousands to one that their age exceeds the exact year.

Limited knowledge of yearlings.—During early observations of seals, it was natural to expect that the yearlings, having but little sexual instinct and being but poorly prepared to defend themselves in the rough-and-tumble of the hauling and breeding grounds, would have little reason or desire to come to land early in the season. It was also evident from the variation in the size of the pups in the fall and from the probable vicissitudes of the first migration that yearlings would be likely to present a wider variation in size than seals of older classes. These conditions have been recognized by most students of fur seals in the past and with some corroborative observations of the yearlings themselves, it has generally been regarded as true that the yearlings come late to

^a Report Fur Seal Investigation, 1896-97, pt. 3, p. 43, 1899.

the islands in no large numbers and associate with the pups rather than with the older seals. But exact information as to their size and characteristics has been very limited. It is probable that 2-year-olds, especially 2-year-old females, have been mistaken frequently for yearlings not only by the agents and other white men but by the natives, who have been regarded usually as expert in distinguishing the classes of seals. An incident early in the season of 1914 indicates that this may have been the case. During a killing on July 1, the chief of the natives, John Stepetin, in charge of the clubbers, was asked if any yearlings were likely to appear, and upon his replying in the affirmative he was requested to point them out. A few minutes later, a small pod of seals was driven up and the native chief announced that it contained one yearling. Through misunderstanding a motion made by the chief in pointing out this seal, one of the clubbers struck it a blow and killed it. Therefore it was carefully measured and its skull was preserved. Subsequent study and examination proved conclusively that it was a 2-year-old and not a yearling. It was, however, approximately as small as any seal in the drive or as any on the islands at that time or for several weeks later. Neither the agents nor the natives pay much attention to seals during the few weeks just following the killing season when the yearlings really appear, so it is not unlikely that they have sometimes assumed that the smallest seals present in June and July were yearlings.

Knowledge of the movements of yearlings and of their size and weight has been based largely on assumptions which, however justified by observation and logical probabilities, have not been demonstrated beyond the possibility of doubt by definite experiment and exact record.

Records of yearlings.—In conformity with the spirit of the law, no yearlings were killed in 1914, but records and notes made in 1913 and not as yet published were found to include much valuable data. With the object of securing exact information in regard to yearlings, 5,529 pups were carefully branded in the fall of 1912 by direction of Special Investigator George A. Clark. In 1913 Mr. Clark searched for examples of these branded animals to determine the yearling type, but up to the time of his departure from the islands (August 9), he records the examination of only one, on July 24. Later in the season, the agents and school-teachers on both islands continued to search for branded yearlings and found them only in very small numbers. Since these branded animals were the only undoubted yearlings upon which observations ever were made, the notes of the agents and school-teachers in the fall of 1913 are highly important. Prior to the month of August, as shown by the field notes of G. A. Clark, only one clearly branded yearling had been seen, on July 24, and between that date and November 11 only nine more were recorded on St. Paul Island. The very small number found led to the contention that many of the pups of 1912 must have succumbed to the branding. Although this may have been a matter of uncertainty in 1913, the large number of branded 2-year-olds which appeared in 1914 shows conclusively that it was not founded in fact. As indicating the thoroughness of the search for branded yearlings in 1913, the following notes of Mr. A. G. Whitney, school-teacher on St. Paul, are of interest:

August 10. Spent an hour in the afternoon watching the seals at Kitovi from fox cairn at Rock 8. Many cows and pups hauled back to edge of grass, and a hundred or more bachelors on the knoll at Rock 10. A yearling, with a perfect T brand, playing with the pups and scampering about among the dozing cows. This yearling, scarcely larger than the huskiest pups, and although slenderer and more alert and agile, apparently no heavier than they.

August 16. Hatton reported three branded yearlings in the food drive made to-day.

August 27. Went out to Gorbatch (Rock 14) just before dark to observe the mass of seals there. Noted a number of very small seals, undoubtedly yearlings, among the cows and pups at upper edge of herd.

September 9. One branded yearling seen on Kitovi.

October 13. After closing school, I spent an hour and a half with Hatton searching for branded yearlings on Gorbatch, Ardiguén, and Reef, without success.

October 14. This being a school holiday, I spent all day hunting for branded yearlings. Hatton and two natives accompanied me. With glasses we thoroughly scanned every foot of rookery on Gorbatch, Ardiguén, Reef, Kitovi, Lukanin, and Tolstoi. Observed but one branded yearling (at Rock 2, Gorbatch), which we were unable to catch.

October 17. After school, searched until dark for branded yearlings with Hatton and two natives on Gorbatch, Ardiguén, and Reef. The natives insisted that the yearlings are to be found among the bachelors, and never among the cows and pups. Although I knew better, we decided to cull over the bachelor herd (about 200) on Reef. A few possible yearlings were among them, but no brands. With our glasses we carefully worked over every bunch of seals along the rookery fronts.

October 18. As it was Saturday, Hatton and I spent the whole afternoon looking for branded yearlings. Hunted over Gorbatch, Ardiguén, and Reef carefully. Found but one brand, at Rock 2, Gorbatch, the same place where the one was seen October 14.

October 19. Spent half a day with a native searching for branded yearlings on Gorbatch, Ardiguén, and Reef, and then Kitovi and Lukanin. Found but one, at Lukanin, which we tried to snare, but he got away from us. This one was hauled up among a mass of cows and pups, and frisking about, as usual.

October 24. Spent the late afternoon on Reef Peninsula. Found a finely-branded yearling just in front of "Old John Rock" on Gorbatch, among the cows and pups.

November 4. Took charge of a "food-drive" at Northeast Point and attempted to procure branded yearlings. In a drive of 386 seals from a herd of a thousand or more near Sea Lion Point, there were no branded yearlings and scarcely any seals small enough to have been yearlings.

After the killing this morning, I took two natives and returned to the rookeries to search again for yearlings. Only 50 bachelors hauled out where we drove from last evening and these all three-year-olds or older. Went to bluff at front of Hutchinson Hill and looked over the big mass of cows and pups there for half an hour. Saw no branded yearlings, but a dozen or more very small seals that I am sure were yearlings scattered along the edges of the herd, mostly on the sandy area just in front of the bluff.

November 10. A drive was made from Reef, but it contained no branded yearlings, out of a total of 400 seals driven.

November 11. While on a trip after the reindeer, Hatton saw one branded yearling at Polovina Rookery.

The total number of branded yearlings noted in 1913 on St. Paul Island may be summarized as follows:

Branded yearlings seen on St. Paul Island, 1913.

Date.	Rookery.	Number seen.	Observers.
July 24	Reef.....	1	G. A. Clark, W. I. Lembkey, and A. G. Whitney.
Aug. 10	Kitovi.....	1	Mr. and Mrs. A. G. Whitney.
16	Reef.....	3	P. R. E. Hatton.
Oct. 14	Gorbatch.....	1	A. G. Whitney and P. R. E. Hatton.
18	do.....	1	Do.
19	Lukanin.....	1	A. G. Whitney.
24	Gorbatch.....	1	Do.
Nov. 11	Polovina.....	1	P. R. E. Hatton.
	Total.....	10	

On St. George Island, a much larger number was seen, the total being 74, but here, as well as on St. Paul, it was impossible to be certain that some animals had not been counted more than once, so the total is a maximum. The observations on St. George Island, as shown by the notes of Messrs. Proctor and Hanna, were as follows:

Branded yearlings seen on St. George Island, 1913.

Date.	Rookery.	Number seen.	Observer.
Aug. 16	Staraya Artel.....	2	A. H. Proctor.
26	North.....	2	G. D. Hanna.
30	Staraya Artel.....	2	Do.
Sept. 4	North.....	2	Do.
4	Staraya Artel.....	1	Do.
6	do.....	2	Do.
13	North.....	1	Do.
Oct. 11	do.....	3	Do.
18	Staraya Artel.....	5	Do.
21	North.....	4	A. H. Proctor.
26	do.....	3	G. D. Hanna.
Nov. 5	Staraya Artel.....	10	A. H. Proctor.
10	North.....	12	Do.
25	do.....	25	Do.
	Total St. George Island.	74	

Efforts to obtain specimens of branded yearlings and records of weights and measurements on St. Paul Island were unsuccessful, but on St. George three of the animals were secured and two others obviously of the same age, but unbranded. These were measured and weighed in the presence of Agent Proctor by Mr. Hanna, who is an experienced zoological collector accustomed to measuring animals. The data obtained and certified to by Messrs. Hanna and Proctor follow:

Measurements and weights of male yearlings, St. George Island.^a

Date.	Length. ^b	Weight of animal.	Weight of skin.	
1913.	<i>Inches.</i>	<i>Lbs. oz.</i>	<i>Lbs. oz.</i>	
Aug. 16	37	39 4	4 6	Branded.
16	35 ³ / ₄	37 8	3 13	Do.
Nov. 5	36	41 12	6 5 11	Do.
Oct. 21	34 ¹ / ₂	39 15	6 5 2	Not branded.
21	35 ³ / ₄	33 10	6 4 13	Do.

^a Since these were taken after Aug. 10, the assumption is justified that they were from a few days to several weeks more than 12 months of age.

^b Length of animal from tip of nose to root of tail, taken with tapeline before skinning.

^c This weight is inclusive of the skin of the head; the other weights are of skins prepared in the usual manner, without the head skin or "mask."

Although yearlings may have been recognized and measured in the past, these figures are the first and only available ones based on the examination of seals of positively known age. The weights of the two skins taken in the usual manner are well below 5 pounds, the minimum prescribed by the Government regulations for killings in past years. The others weighed somewhat more, owing to the inclusion of the head-skin or "mask," which is ordinarily left on the carcass. Such a mask from a skin of only 3 pounds 8³/₄ ounces total weight was weighed August 18, 1914, and found to weigh 3³/₄ ounces, or 6.2 per cent of the total weight. With allowance for this extra weight it is seen that even the skin taken November 5, and therefore from an animal of some 15 months of age, only slightly exceeded 5 pounds, and all the others were less than that.

The total body weights of these yearlings, taken immediately after killing and before bleeding or skinning, are interesting in comparison with weights of pups taken late in the season. They indicate that after the pups leave the islands, fattened by an easy life and ample nourishment from their mother's milk, they lose weight, and many of them may actually return to the islands the following summer weighing less than when they left. Under instructions to weigh six of the smallest pups and six of the largest to be found on November 17, 1914, Agent Fassett submitted the following results: Average of smallest four weighed $25\frac{9}{10}$ pounds; average of next smallest four, $33\frac{2}{10}$ pounds; average of largest four, $48\frac{8}{10}$ pounds. Individual weights, recorded in pounds, were as follows: $24\frac{3}{4}$, $25\frac{1}{2}$, $25\frac{3}{4}$, $27\frac{3}{4}$, $42\frac{3}{4}$, $43\frac{1}{2}$, $49\frac{1}{4}$, $51\frac{3}{4}$. The average weight of the four smallest and the four largest is 37.3 pounds, which may be taken as a fair average for November pups; this is only slightly less than that of the yearlings. The great variation in the weight of gray pups is doubtless due in part to early or late birth, but it is evident that this is largely compensated during the first long hard winter at sea, when the weaklings succumb and general vigor rather than mere weight determines survival, so that on the return to the islands the yearlings as a class show comparative uniformity.

Movements of yearlings.—The observations of branded yearlings in 1913, particularly those of Mr. A. G. Whitney, who has kindly submitted his notes for examination, show that yearlings first appear in very small numbers late in July, and that they are seen in greater numbers in August and later months. They are seldom found on the hauling grounds with the bachelors, but prefer the areas occupied by the cows and pups, being found most frequently near the shore engaged in play with the pups, which they do not greatly exceed in size. All specimens taken were of the male sex. Observations made in 1914 confirm those of 1913 in all important respects. Although no branded yearlings were present in 1914, the identification of seals of this class was rendered comparatively certain by the knowledge of the observations made the previous year, and especially by the presence of known 2-year-olds with distinctive brands, which were practically always available for comparison. During the entire month of July the hauling grounds were repeatedly scrutinized for yearlings, but at no time were any seals seen that were smaller than the known branded 2-year-olds. In the same way all food drives from July 1 to August 18, in which seals to the total number of 5,105 were passed in review in small pods under close examination, showed nothing smaller than 2-year-olds. The first yearlings were observed August 17, and after that date others were seen frequently. Of those seen, however, only two were among the bachelors, and even these may have been frightened away from the margin of a breeding area by the natives in rounding up the bachelors. In view of these facts it seems highly improbable that yearlings ever resort to the hauling grounds in numbers, and it is practically conclusive that during the killing season, which ends July 31, they seldom come to land at all.

Observations of yearlings made in 1914 are indicated by the following extracts from the field notes of W. H. Osgood:

August 17. Started at 7.15 a. m. for Northeast Point with Preble, Macoun, Hanna, Ball, and four natives. Macoun stopped to botanize at Polovina. Went out (on Vostochni Rookery) and drove bachelors for branded 2-year-olds and clipped 31; also saw one St. Paul return and one St. George return. Counted pods to a total of 2,945, and fully 1,000 got away into the water and elsewhere, and

were not driven. Not the least doubt that there were over 4,000 bachelors hauled; many were in with the cows and could not be herded. In all this number of seals only two were seen that by any possibility could have been yearlings. These Hanna thinks undoubtedly were yearlings, and he was the only one of the party that ever had seen any before. I was well enough convinced of it, for they were obviously smaller than the 2-year-olds, the size of which is, of course, very well fixed in our minds after all the branded ones we have observed during the summer. Only two in a drive of practically 3,000 seals, however, shows that they are on land in very small numbers, and I am positive we have not seen any earlier in the season.

August 20: Went to Tolstoi and watched seals. * * * Saw two seals (among the cows) that appeared to be yearlings.

August 21: This afternoon went to Gorbatch for a short time and found many bachelors on the "Parade Ground," perhaps eight or nine hundred, including a number that were hauled out on the plateau extending between Gorbatch and Reef. Was rather surprised to note a copulation near Rock 14. The bull was an old harem master and the cow not very young. Her pup was quite small, evidently only a few days old. Saw a couple seals I think were no doubt yearlings (near Rock 14).

August 23: On Lukanin, saw a very small yearling not much larger than one of the largest pups.

August 24: With a little search, yearlings can be found on any of the rookeries now.

August 25: Went to Kitovi. * * * Saw a number of yearlings (15 or 20) along the edge of the water playing with the pups and with each other. Went to Tolstoi again in the afternoon. Large hauling of bachelors on beach. Saw a branded 2-year-old cow among them and photographed her at short range with a 3-year-old bachelor that was paying her attention. Saw two or three yearlings near the water's edge with the pups. Preble tells me he saw at least a dozen among some pups at the edge of the water at Zapadni to-day. I don't believe they associate with the bachelors much more than the pups do.

August 28: Went over Reef, Ardiguen, and Gorbatch looking especially for yearlings and cross-branded 5-year-olds. * * * Saw a couple yearlings on Gorbatch and a half-dozen on Reef, in both cases associated with the cows.

THE 2-YEAR-OLDS.

Two-year-old males.—Early in the season of 1914 seals began to be noted in the food drives having the clearly marked T brand on the top of the head. These were animals branded as pups in 1912 and therefore were undoubtedly 2-year-olds in 1914. As yearlings they had been noted in 1913 in small numbers and only late in the season, but as 2-year-olds in 1914 they appeared as early as June 12, and soon became fairly common. As many as 32 were recorded in a single food drive of only 566 bachelors on July 25 on St. George Island. Throughout the period from June 22 to August 28 failure to find at least several of these branded 2-year-olds on any hauling ground was a rare occurrence. The brands were clear and distinct and easily recognized, making it possible by the use of field glasses to note branded animals at a distance of 100 yards or more and to compare them with the other bachelors hauled without any disturbance of the herd. Allowing the usual deductions for natural mortality, not over 1,200 males of the total branding of 5,529 pups of both sexes should have survived to the age of 2 years. Therefore it was not to be expected that any large number of them would be seen at any one time or place. However, an effort was made to keep a definite record of those which appeared. In order that none should be counted twice, the branded animals were caught and marked by clipping the hair from one side of the head and no record was kept of any except those so marked. Owing to pressure of other matters, it was not possible to make more than two special drives for this purpose, so the seals marked and recorded were for the most part limited to those appearing in the food drives. Moreover, through misunderstanding of instructions, the work was not continued through August and September by the agent and was not resumed until late in October and

November, when a large proportion of the herd had left the islands. Nevertheless, a total of 315 was recorded, and it is evident that many more were present at times when no enumeration was made.

During the season, 13 branded 2-year-old males were killed at food killings and subjected to special examination. Three others taken in November have been reported upon by Agent Fassett. The data obtained from these examples are given below:

Measurements and weights of 2-year-old males.

Date.	Length of body. ^a	Length of skull. ^b	Weight of skin.	Remarks.
1914.	<i>Inches.</i>	<i>Millimeters.</i>	<i>Lbs. Oz.</i>	
July 1	c 39½	173	St. Paul Island.
1	c 38½	176	Do.
1	c 41	173	Do.
1	c 36¾	174	Do.
9	d 42	e 5 7	St. George Island. (Live weight 57 pounds 12 ounces.)
21	c 42	5 6½	St. Paul Island.
21	c 41¾	176	4 9¾	Do.
21	c 42¾	180	5 8	Do.
21	c 41¾	178	5 9¾	Do.
Aug. 1	c 41½	173	4 13	Do.
18	c 38½	170	4 8	Do.
18	c 41	181	5 12	Do.
18	c 41	175	4 11¾	Do.
Nov. 17	f 41½	5	Do.
17	f 45¾	5 7	Do.
18	f 43½	5 12½	Do.
Average.	g 40½	175½	h 5 ½	

^a From tip of nose to root of tail.

^b Condylbasal length.

^c Measured by W. H. Osgood, G. H. Parker, and E. A. Preble.

^d Measured by G. D. Hanna and A. H. Proctor.

^e Including skin of head.

^f Measured by H. C. Fassett.

^g Exclusive of November examples.

^h Eight skins taken July 21-August 18.

Two-year-old females.—The 2-year-old females begin to land at about the height of the season or just before the harems of old cows have broken up. They become more numerous after the break-up but are never seen in large numbers. Some of them join the regular harems and remain for perhaps two or three days, but as a rule they do not stay long in one place. In a few cases, small harems composed exclusively of 2-year-olds may be seen but this is exceptional. Probably many of them are served near the water and never reach the rookery ground beyond. Although not always distinguishable with certainty from young cows of three or perhaps four years, they have certain characteristics which would doubtless be recognized by an experienced observer in practically all cases. They are generally very fat and sleek and seem relatively short-bodied with short front flippers, very light-colored breasts, and short dark whiskers. These characters are not absolutely distinctive, but when combined with observation of the general appearance and actions and the indifference to the pups, they serve to make the identification of the 2-year-old female fairly certain. These females enter the rookery ground with obvious hesitancy; their whole demeanor is that of inexperience and coyness, and they take flight at the slightest alarm. A few of them occasionally stray to the hauling grounds, and when once there sometimes persist in remaining until literally driven into the sea by the unwelcome attentions of the younger bachelors. During the season of 1914, with one exception, the only females found in drives were 2-year-olds.



1. Two-year-old male.
(No. 199294, U. S. National Museum.)

Three-year-old male.
(No. 199293, U. S. National Museum.)
Skulls of Pribilof Island fur seals.

(Reduced to same scale, about one-half natural size.)

3. Four-year-old male.
(No. 199295, U. S. National Museum.)

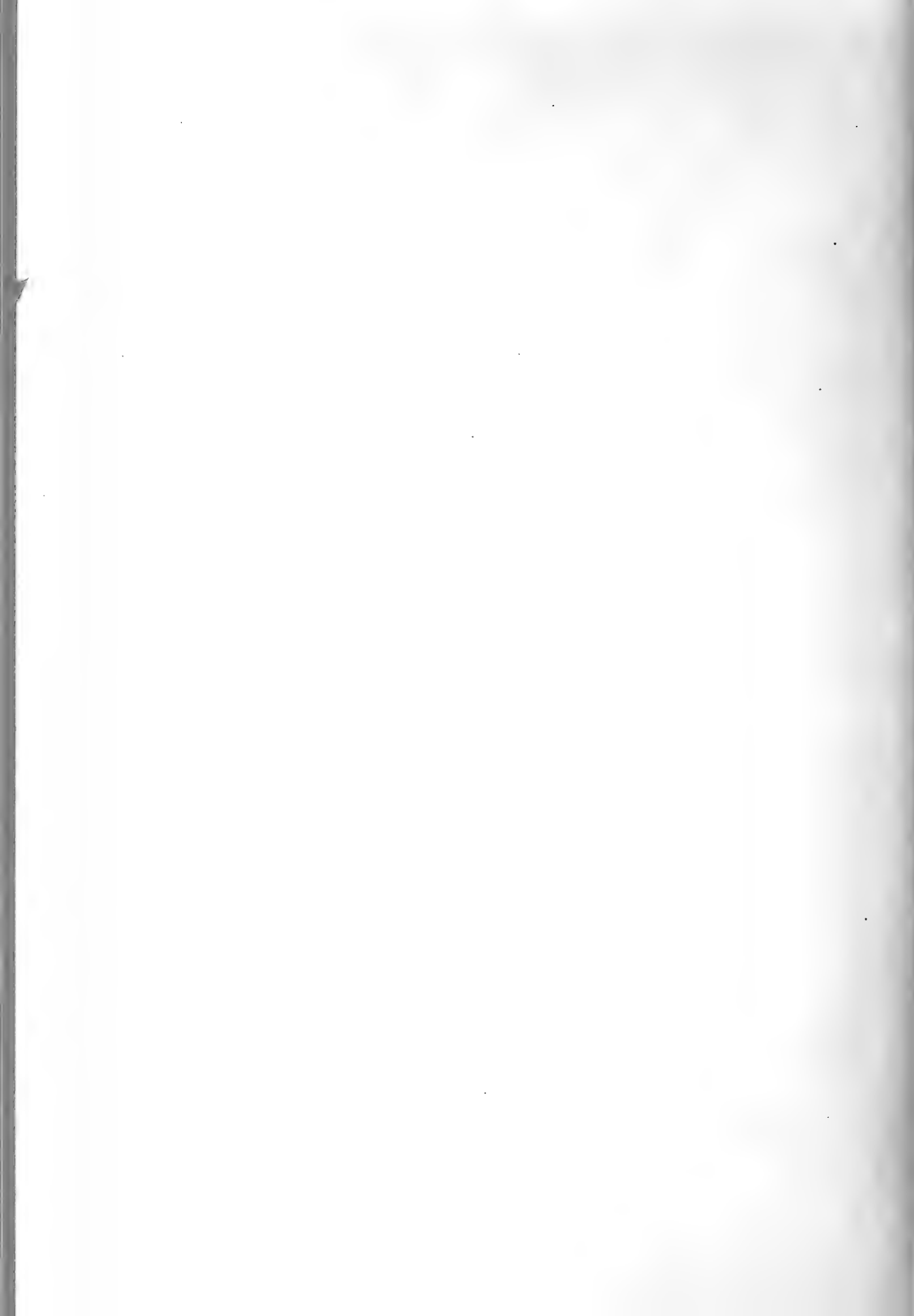

Although branded 2-year-old males were seen in numbers in 1914, females with brands were observed in only 10 instances, probably because the females remain on land but a short time. The first branded females were seen on Polovina on July 19. In company with some 20 others apparently of the same age, three of these branded animals were observed on a gravel beach beneath a low bluff at the north end of the rookery. They were in charge of a small 5-year-old bull who made a futile effort to hold them and then followed as they all rushed into the sea. During the next 10 days a few females, believed to be 2-year-olds, were seen but none branded. On August 1, in a drive from Reef rookery, a branded female was accidentally killed. On August 11 a branded female was noted near Rock 14 on Gorbatch wandering over the breeding ground obviously unattached to any particular place. Another seen on Reef August 13 was among some older cows apparently held by an old bull, but, as the old cows made for the water, the bull followed and a young bull quickly made advances to the 2-year-old cow which remained. On the Tolstoi sands August 25 a branded cow was found among the bachelors being harassed by a 3-year-old whose attentions were vigorously resented, the cow tumbling about plainly seeking a place where she might be undisturbed. Still later, on August 28, two branded cows were seen playing together in the irregular mass of cows, pups, and roving bachelors on the breeding ground of Reef Rookery. Late in the season, on November 17, as reported by telegraph, a branded 2-year-old female was accidentally killed in a food drive from Tolstoi rookery. The sizes and weights of the 2-year-old females which died through overheating or by accident in drives in 1914 are as follows:

Measurements and weights of 2-year-old females.

Date.	Length.	Weight of skin.	Live weight.	Remarks.
1914.	<i>Inches.</i>	<i>Lbs. oz.</i>	<i>Lbs. oz.</i>	
Aug. 1	38¾	3 14	Branded.
18	39	Unbranded. ^a
18	38	3 5	b 29 12	Do. ^a
Nov. 17 ^c	41½	4 13¾	Branded.

^a The determination of the age of the unbranded animals is made positive by examination of the skulls which were preserved and compared with those of the branded animals.

^b Although no other weights of 2-year-old females were obtained, it was evident that this was an exceptionally small example; until its skull was examined it was thought to be a yearling.

^c Measured and weighed by H. C. Fassett.

THE 3-YEAR-OLD BACHELORS.

The presence of numerous branded 2-year-olds of known age in 1914 made the identification of the 3-year-olds comparatively certain. Owing to the importance of this class as the one from which killings and reserves are taken, a special effort was made to determine its characteristics. With this end in view, a large number of supposed 3-year-olds killed for food were carefully measured and their skins weighed. In addition the complete skull of each was preserved and tagged with a number corresponding to the number attached to the skin. These skulls were then brought to the National Museum and there prepared for study. In the same way, skulls were preserved of the branded 2-year-olds taken and of a small number regarded by the natives as 4-year-olds, 5-year-olds, and 6-year-olds. Using these skulls as a check on the measurements taken in the field, it was possible to determine with a high degree of

accuracy the age of any particular seal, to test the judgment of the natives, and to learn the range of variation in size among seals of a given class. Thus, if a supposed 3-year-old showed a small body measurement it was possible to examine its skull and compare it with that of a known 2-year-old and so learn whether it was in reality a small 3-year-old or a 2-year-old mistaken for a 3-year-old. As the combined result of field observations and measurements and the study of skulls and teeth, it was found that the total length of 3-year-old bachelors is subject to but little variation, and that the natives are able to distinguish seals of this class with a very small percentage of error.

During a food killing on July 1, 1914, at which the native clubbers were instructed to proceed as usual and kill only 3-year-olds, 37 seals taken at random as they were killed were carefully measured with a steel tape and their skulls tagged and preserved. Thirty-five of these proved to be undoubted 3-year-olds, one was a 2-year-old, and one was larger than the others and may have been a small 4-year-old. The total length varied from 45 to 52 inches and in 71 per cent of cases it was from 46 to 48 inches. At a later killing on August 10, 61 seals were measured in similar manner, using calipers instead of tape, which gave a slightly smaller result in each case but the same relative uniformity prevailed. One of the 61 proved to be a 2-year-old and the remaining 60 were undoubted 3-year-olds. The length measurement varied from 42½ to 51 inches and in 93 per cent of cases was from 44 to 49½ inches. Such uniformity is not found in the weight of the animals, which may be fat or lean, nor in the weights of the skins, which vary according to the amount of blubber removed. It is found in the skulls, however, and these serve to corroborate the accuracy and significance of the length measurements. The seals of any two generations differ from each other as a class by not less than 10 months in age, and since in the males there is a rapid growth from 2 until 6 years of age, it is evident that differences due to age are likely to be more pronounced than those due to individual variation. A study of skulls proves this to be the case, and with rare exceptions the age of any given skull may be determined upon the basis of growth characters familiar to students of osteology. With the skull, as with the animal, the length measurement is the principal reliance, although other characters are considered. The skull of a newly born pup is short with a broad flattened braincase having no bony ridges or prominences; the facial part of the skull is relatively undeveloped and the teeth are just beginning to appear. In the 2-year male these conditions in general still prevail, although the bone has thickened and the skull become more lengthened. In the 3-year-old a more definite lengthening has taken place, the braincase is higher and relatively narrower, and ridges and prominences begin to show. This process is carried farther in the 4-year-old and in succeeding years until in the old male the skull which began smooth and flat becomes relatively high with various prominences and a high bony ridge extending lengthwise over the top of the braincase. (See pl. ix and x.)

The data obtained from the 3-year-olds measured on July 1, 1914, of which all the skulls were preserved, are as follows:

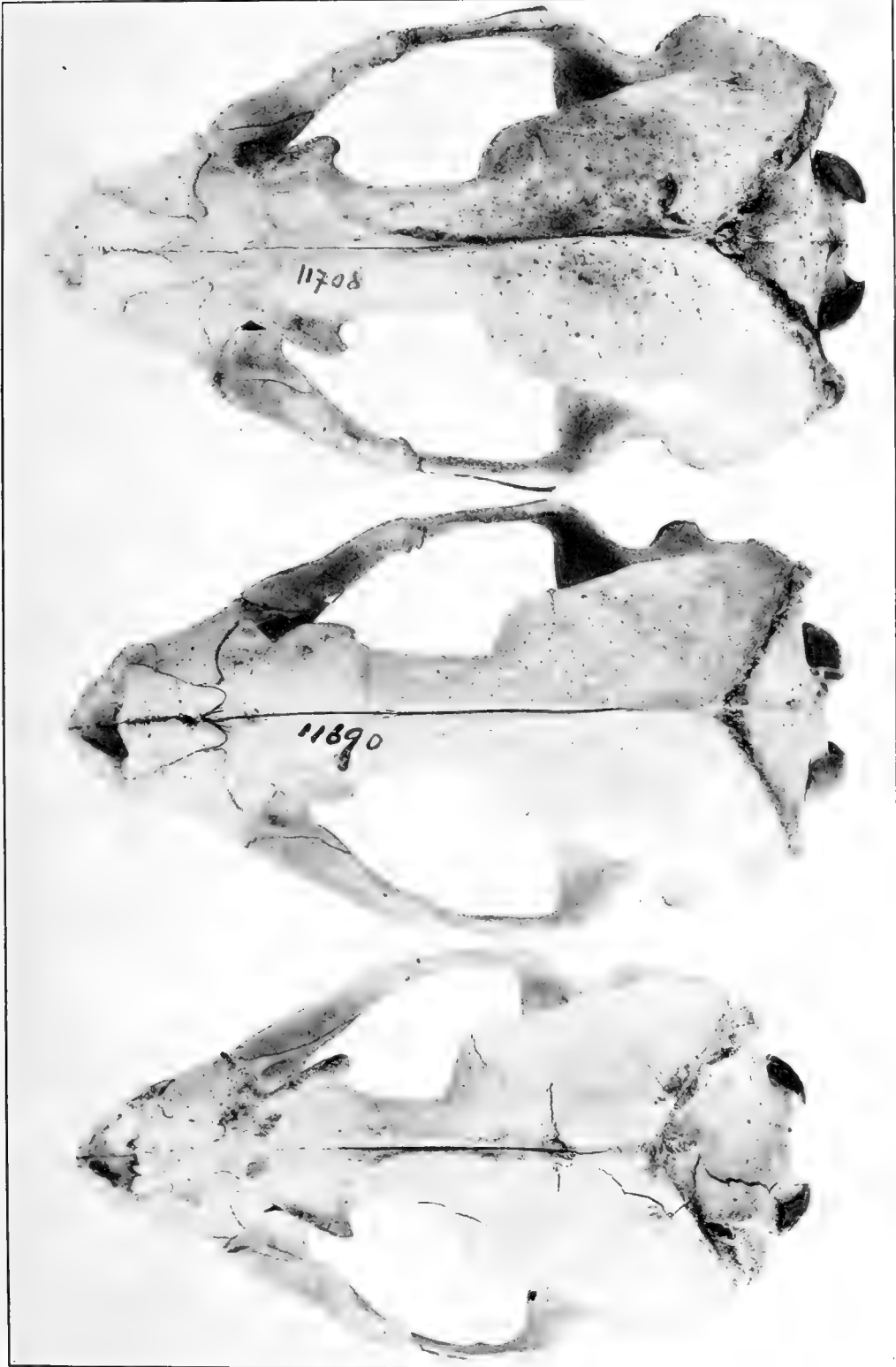

1. Five-year-old male.
(No. 199295, U. S. National Museum.)

2. Six-year-old male.
(No. 11890, U. S. National Museum.)
Skulls of Pribilof Island fur seals.
(Reduced to same scale, about one-half natural size.)

3. Old male of about 12 years.
(No. 11708, U. S. National Museum.)

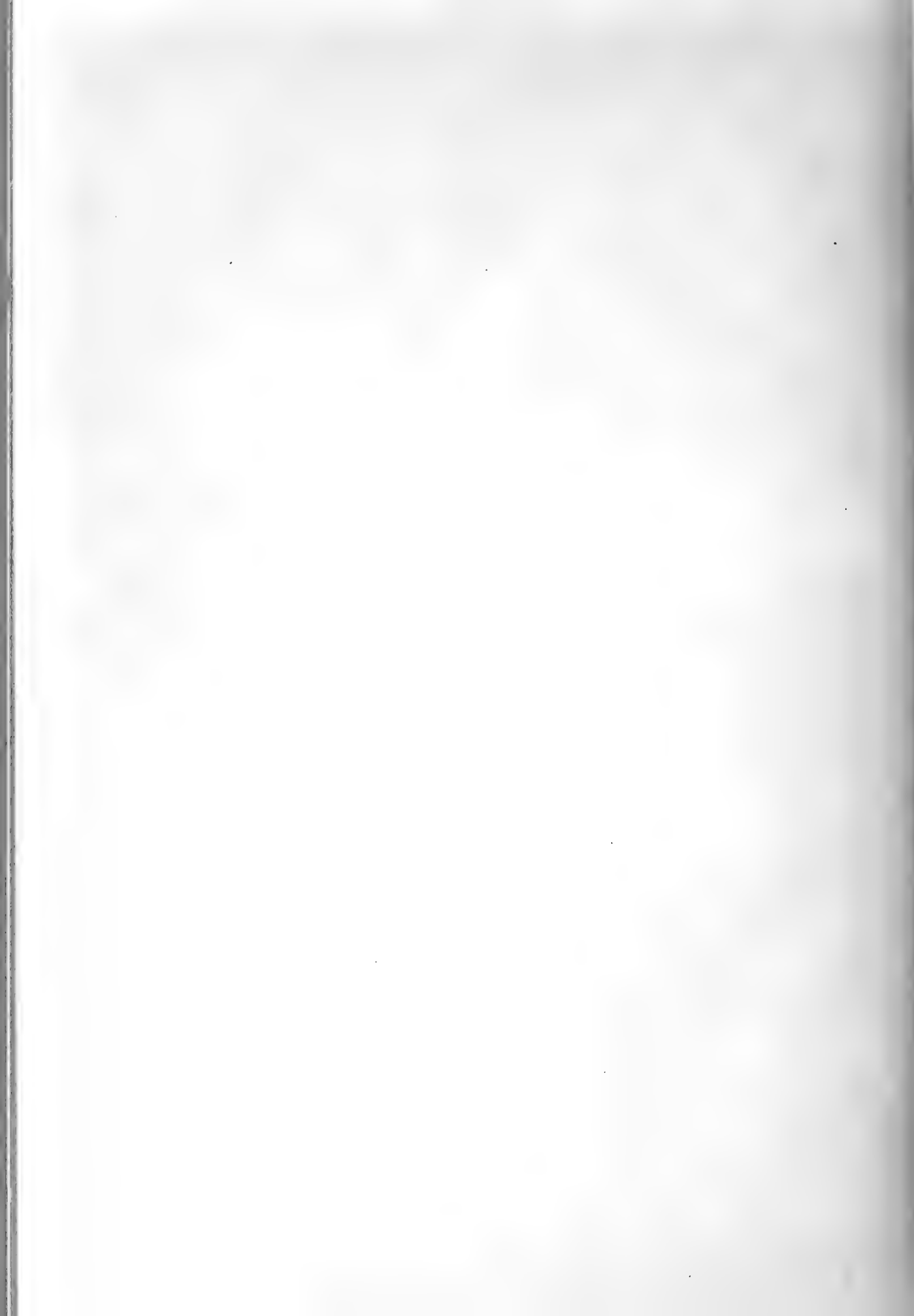

Measurements of 3-year-old males, with weights of skins, St. Paul Island, July 1, 1914.

Tag No.	Length of body in inches. ^a	Length of skull in millimeters.	Weight of skin.	
			Lbs.	Oz.
5576.....	47	185	6	4½
5578.....	46	182	6	15¾
5579.....	47½	188	6	12¾
5581.....	45½	186	5	11¾
5582.....	48	194	7	3½
5585.....	51¼	197	8	6
5587.....	47	192	6	10¾
5588.....	46	189	6	7¾
5589.....	46	185	6	7½
5590.....	46½	184	7	10½
5592.....	46½	185	7	5½
5593.....	50	198	7	11
5594.....	49	189	6	1
5595.....	46	187	6	2¾
5596.....	46	189	6	4¾
5597.....	48¾	191	7	4
5598.....	48½	188	6	7
5599.....	49¾	197	6	13½
5600.....	48¾	188	6	5½
5601.....	46	184	5	14½
5602.....	48½	186	7	2½
5603.....	51	197	6	11¾
5604.....	48½	192	7	3
5605.....	52¼	194	7	1¾
5606.....	47¼	186	6	½
5607.....	50¼	196
5608.....	50¼	194	6	11¾
5609.....	48¾	196
5610.....	46¼	193	6	4¾
5612.....	47	188	7	2½
5613.....	48½	195	6	4
5614.....	47½	190	6	11¾
5615.....	47½	183	6	3
5616.....	47¾	187	5	4
5617.....	49	182	6	2¾
Average.....	48	192	6	11

^a These measurements were taken with a steel tape stretched over the back of the animal from the tip of nose to the root of tail. Measurements taken with calipers give slightly smaller figures.

THE 4-YEAR OLD BACHELORS.

The 4-year-olds associate with the younger bachelors on the hauling grounds, and though some of them may be distinguished by their dark breasts and occasionally by an incipient "wig," as a class they differ from the 3-year-olds mainly in slightly increased size.

Only a few 4-year-olds were killed in 1914, and most of these had their skulls so badly shattered that they were not preserved. The data as to 4-year-olds, therefore, are somewhat meager. In the case of five examples they are as follows:

Measurements of 4-year-old males, with weights of skins, 1914.

Tag No.	Length of animal in inches.	Length of skull in millimeters.	Weight of skin.	
			Lbs.	Oz.
5802.....	58	202	8	13¾
5803.....	53½	205	8	¾
5804.....	57¼	208	9	5
5807.....	56¼	207	8	4¼
5808.....	52	204	8	8¾

SUMMARY OF MEASUREMENTS.

In view of the foregoing, it is evident that bachelor seals of various ages can be distinguished with a high degree of accuracy; that the difference between them is best expressed in the total length of the animal taken before it is skinned; and that weights, either of animals or of skins carrying varying amounts of blubber, are unreliable as a criterion for age. As stated elsewhere, therefore, it is desirable that the classification of seals killed be made upon the basis of measurement rather than weight. It should be said, also, that the native clubbers are able to distinguish seals of different ages with very few exceptions, and that a system of measurement in the field would tend to increase their efficiency and reduce their mistakes to a minimum. The measurements made in 1914 may be subject to slight revision with further experience and practice, but in general it seems safe to state that, with possible rare exceptions, yearlings have a body length between 34 and 37 inches; 2-year-olds between 37 and 43 inches; 3-year-olds between 43 and 52 inches, and 4-year-olds between 52 and 59 inches. The data on the several classes are summarized below:

Condensed measurements of young males.

Age.	Average body length in inches.	Extremes of body length in inches.	Average length of skull in millimeters.	Extremes of length of skull in millimeters.	Number measured.
Yearlings.....	35 $\frac{5}{8}$	34 $\frac{1}{2}$ -37	5
2-year-olds.....	40 $\frac{3}{4}$	36 $\frac{1}{2}$ -42 $\frac{1}{2}$	175.3	170-181	13
3-year-olds.....	48	45 $\frac{1}{2}$ -52 $\frac{1}{2}$	192	182-198	35
4-year-olds.....	55 $\frac{1}{2}$	52-58	205.2	202-208	5

MORTALITY OF SEALS.

DEATH OF PUPS ON LAND.

In making the pup count between July 29 and August 5, the number of dead pups, as well as of live ones, was regularly recorded. When the rookeries were on a narrow stretch of beach, the dead pups were enumerated as they were passed over in counting the live ones. Where the rookeries spread out over extensive areas, however, these areas were examined for dead pups after the live ones had been counted. In the following table are given the total numbers of pups, the numbers of dead pups, and the percentages of dead pups in 1914 for each rookery on the two islands as ascertained at the time of the count of pups, July 29 to August 5.

Mortality of pups, summer of 1914.

Rookeries.	Total of pups.	Dead pups.	Percentage dead.
St. Paul Island:			
Kitovi.....	2, 119	47	2.2
Lukanin.....	1, 834	73	3.9
Gorbatch.....	6, 152	85	1.3
Ardiguen.....	656	11	1.6
Reef.....	13, 559	206	1.5
Sivutch.....	4, 052	68	1.6
Lagoon.....	375	2	.5
Tolstoi.....	9, 934	174	1.7
Zapadni.....	7, 625	126	1.6
Little Zapadni.....	4, 919	79	1.5
Zapadni Reef.....	206	3	1.4
Polovina.....	3, 555	71	1.9
Polovina Cliffs.....	1, 449	18	1.2
Little Polovina.....	927	17	1.8
Morjovi.....	2, 312	44	1.8
Vostochni.....	19, 709	499	2.5
Total.....	79, 383	1, 523	1.9
St. George Island:			
North.....	5, 301	112	2.1
Staraya Artel.....	4, 278	63	1.4
Zapadni.....	1, 023	8	.7
Little East.....	26	1	3.8
East Reef.....	581	5	.8
East Cliffs.....	2, 658	31	1.1
Total.....	13, 867	220	1.5
Grand total.....	93, 250	1, 743	1.8

It will be seen from this table that the mortality of pups up to about August 5 was 1.8 per cent of the total number born and that no rookery diverged far from this percentage. The highest death rate was on Lukanin, 3.9 per cent, and the lowest on Lagoon, 0.5 per cent. These figures show conclusively that during the season of 1914 there were no noteworthy epidemics of any kind among the pups.

The dead pups were usually found on the rookery grounds, and often gave evidence of having been dead several weeks. Some few, particularly on Reef and on Tolstoi, had been dragged away by the foxes and their remains were found at the mouths of the fox burrows on ground adjacent to the rookeries. As there was no evidence of any epidemic, the dead pups were not especially examined. It is probable, as Marsh has pointed out (*Science*, vol. 36, p. 397, 1912), that starvation, asphyxia neonatorum, and crushing by rocks and landslides are the chief fatal accidents of early life, and that uncinariasis is the principal fatal disease of this period. In a report made by Marsh in 1912 to the Department of Commerce and Labor on the causes of death of 175 pups examined in that year, 81 (46 per cent) were believed to have died of starvation, 24 (14 per cent) of asphyxia neonatorum, 19 (11 per cent) from accidents due to landslides, etc., and 12 (7 per cent) to uncinariasis. These four causes were believed to be the chief occasions of death among the young pups in the season of 1912. Since the death rate in that season was estimated at 1.2 per cent of the total number of pups born, and since in 1914 this rate was much the same, 1.8 per cent, it seems probable that the causes of death already enumerated have continued to act in 1914 as in 1912.

An inspection of the table will show, as already pointed out, considerable uniformity so far as the death rates of the various rookeries are concerned. The chief divergences in the direction of larger numbers are to be seen in Little East Rookery on St. George, and in Lukanin and less so in Vostochni on St. Paul. In Little East Rookery the condition is a mere accident due to the small total number of pups present and in Lukanin,

which shows the most considerable divergence of all, the increase is scarcely noteworthy. In Vostochni a state of affairs was observed which may explain its slight excess.

In this rookery there has always been a very large area between Hutchinson Hill and the sea covered with a relatively enormous aggregation of harems. At the height of the season and later, this area has upon it a dense population of pups. On its sides are extensive hauling grounds for bachelors, with runways leading to the sea. Pups may stray to the ground occupied by the bachelors, become lost, and eventually die of starvation or of mistreatment from the bachelors, for the latter were often seen mauling pups and even attempting to copulate with them. Since not a few of the dead pups recorded for Vostochni were found well within the hauling grounds, some of them bearing the toothmarks of the bachelors, it is highly probable that they met their deaths in the way indicated and thus Vostochni may have suffered in this respect somewhat more than most of the other rookeries. Large numbers of bachelors close to aggregated harems certainly afford, as just indicated, unfavorable conditions for pups, though as a cause for their death, this condition is not to be compared in the number of victims that it claims with such other causes as starvation, asphyxia neonatorum, etc.

DEATH OF YOUNG SEALS AT SEA.

The first year is universally considered as the most fatal in the life of seals, the loss during this period by natural causes, though necessarily unknown, being assumed to be 50 per cent. Since the loss from all causes during the first month or so of life, before the animal has learned to swim, is seen to amount to less than 2 per cent, it follows that other and very potent causes must operate.

During the few weeks following the time the animals have learned to swim, deaths from starvation must continue to form a considerable proportion of the total loss. The young animals now wander farther and farther from the spot where they were born, and by late August may be found in numbers at a distance of a mile or more from any breeding place. It necessarily follows that the mothers, on returning from feeding, must experience increasing difficulty in finding their offspring, and the conclusion is unavoidable that some are never found and are thus deprived of the natural means of subsistence. Little is known regarding the time when the young seals first learn to shift entirely for themselves. Although they may pick up a small amount of food while paddling about the shores in the early autumn, it is not likely that they actually learn to fish until they leave with the older seals on their first migration. The search for dead pups in early fall has always resulted in a considerable addition to the number of dead as taken at the time of the regular count.

While the young pups are still about the islands in autumn many are destroyed by killer whales (*Orca gladiator*), which are frequently observed singly or in small schools cruising about in front of the rookeries and are known to prey especially on the pups. The following actual records of killer whales observed about St. Paul Island in autumn, selected from a large number of observations taken from the island log by the late Dr. Hahn, indicate to some degree the part played by them in the destruction of young seals. A large school of killers was seen near East Landing on October 21, 1875, and five near the same place on September 21, 1891; one seen off Reef Rookery on December 2, 1902, was playing havoc with a band of seals; fragments of both cows and pups, the work of killer whales, were found strewn along the beach at Northeast Point on November 6, 1904. In the autumn of 1907 killers were reported on numerous occasions,

and native watchmen at Northeast Point and Polovina reported considerable destruction. A killer 24 feet long was stranded at Northeast Point on December 16, 1908. On November 1, 1913, G. Dallas Hanna observed three killers close to the reef near the village of St. George preying on the seal pups. Two of these came so close to the bluffs that he was able to hit them with a rifle and killed at least one.

These records indicate that killer whales are by no means uncommon about the Pribilofs. The stomachs of two killers examined by Capt. Bryant contained, respectively, 18 and 24 seal pups,^a and it is certain that the total number of young seals killed by them must be very great.

DEATH OF ADULT SEALS.

Regarding the death of seals at sea from natural causes little is known from actual observation. Deaths from old age usually take place at sea and probably result mainly from the animals being unable because of infirmity to procure food. There is good reason to suppose that a very considerable loss of adults is caused by killer whales. The fact that these destructive animals are frequently observed about the Pribilofs at the time of the arrival of the main body of the seals strongly suggests that they attend the seal herd on its migration. Entries from the St. Paul journal before referred to show that many killers were seen on June 6, 1877, and several seals bearing evidence of having been attacked by them were observed; many were observed between St. Paul and Walrus Island on June 6 and 8, 1881; they were numerous May 15, 1884, and May 19, 1886, and on the latter date both the seals and sea lions were taking to the shore at Northeast Point to escape them; many were seen close to shore on May 28, 1888, and an entry of May 31, 1889, asserts that the natives reported killers more numerous than at any time within their memory. On June 1, 1894, a school of these whales was killing seals at Kitovi and near East Landing, and several were shot with rifles. Other records of killers, in some cases accompanied by the specific statement that they were preying on seals, occurred under the following dates: May 22, 23, and 26, 1900; May 5, 1903; July 18, 1902; and June 6 and 21, 1910. That the old bulls do not suffer much from their attacks is suggested by an entry under date of May 24, 1900, when two killers were observed near the shore, while the bulls rolling about in the water near them were not attacked and showed no fear. On the other hand large seals and even sea lions have been known to take to the land to avoid them. Writers on the habits of killers speak particularly of the destruction waged among seals by these voracious animals. There is, of course, a certain proportion of deaths among the older seals, principally the breeders, while they are on the islands. Deaths of bulls occur rather rarely from fighting, though in the event of a great excess of males this factor might be an important one. Under conditions as observed in 1914 no evidence of any mortality from this cause was found, though several bulls were badly injured by their fellows. In the case of the single bull found dead during the summer no specific cause of death could be ascertained.

Among the cows, deaths during the breeding season are mainly from two causes—from the accidents of birth and from the injuries inflicted by the bulls in contending for supremacy. Mortality from these causes has been elsewhere discussed (p. 54). In general, the condition of the cows found dead at the time of the counting of pups is such that the specific cause of death is not apparent.

^a Rept. Fur-Seal Investigations, 1896-97, pt. 3, p. 93, 1899.

THE EFFECT OF PELAGIC SEALING.

LOSSES DUE TO PELAGIC SEALING.

The effect of pelagic sealing has been the subject of much discussion to which reference is not necessary at present. This form of sealing, insignificant at first, began to be important about 1880 and continued until effectively stopped by international agreement in 1911. The total loss to the herd directly or indirectly due to pelagic sealing can never be known. The records show that in Bering Sea and on the Northwest coast during the period from 1880 to 1911 approximately 900,000 skins were secured and marketed by the pelagic sealers. When it is considered that from three to five seals were killed for every one retrieved and that a large percentage were females whose unborn pups perished with them and whose pups on land were left to starve, it is plain that the total losses ran well into the millions. In every season since 1890 the recorded pelagic catch exceeded the land catch, so that during this period of steady decline of the herd even the primary losses due to pelagic sealing were greater than those of land killing.

INFORMATION TO BE GAINED FROM THE CESSATION OF PELAGIC SEALING.

The present importance of a consideration of the effects of pelagic sealing lies in the contrast between present and former conditions. Now, for the first time during American ownership the herd is increasing and an opportunity is afforded for studying its behavior under approximately natural conditions. In previous times practically all efforts for knowledge of the numbers and movements of various classes of seals, all data as to rates of increase or decrease, and all measures looking toward regulation of killing and reserving of breeders were subject to the unknown and uncontrolled factors contributed by pelagic sealing. With pelagic sealing stopped, the time has arrived for a thorough study of the problems hitherto in question solely or chiefly because of the existence of pelagic sealing. The most important of these relate to the percentage of survival to killable size and to the reserving of males for breeding. After the thorough demonstration of the evils of pelagic sealing and after all the effort expended to abolish it, legislation or regulations which perpetuate some of the very obstacles against which we have been contending should be avoided so far as possible. While the cessation of pelagic sealing is principally a matter of congratulation because it insures the preservation of the herd, it is evident that our immediate practical benefit from it is the opportunity it permits for obtaining information which will be absolutely essential in conducting land operations in the future. Thus far we have only partially taken advantage of this opportunity by obtaining full counts of pups in 1912, 1913, and 1914. The information thus obtained has been of great value, but a further use for it of the highest importance will appear in 1915 and 1916, when it might be applied in connection with liberal killing and reserving to determine the percentage of male seals which naturally survive to killable age. This information in regard to the males could then be applied to the females which doubtless survive in approximately the same proportions. Thus it would be possible at an early date to have for future guidance certain very definite data as to natural death rates and percentages of increase of great importance in the management of the herd.

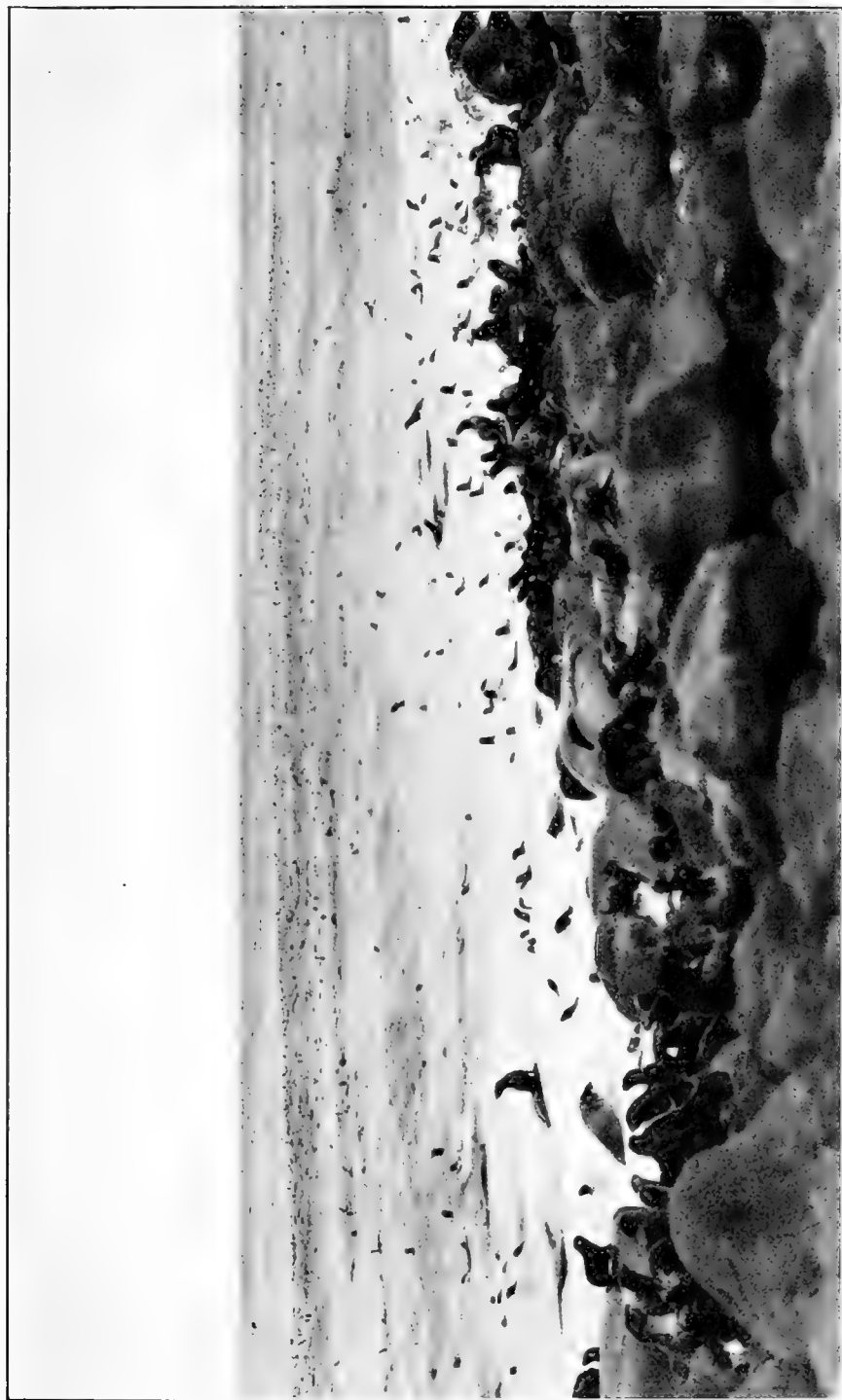

Cows and pups swimming, Vostochni Rookery, St. Paul Island, August 17, 1914.

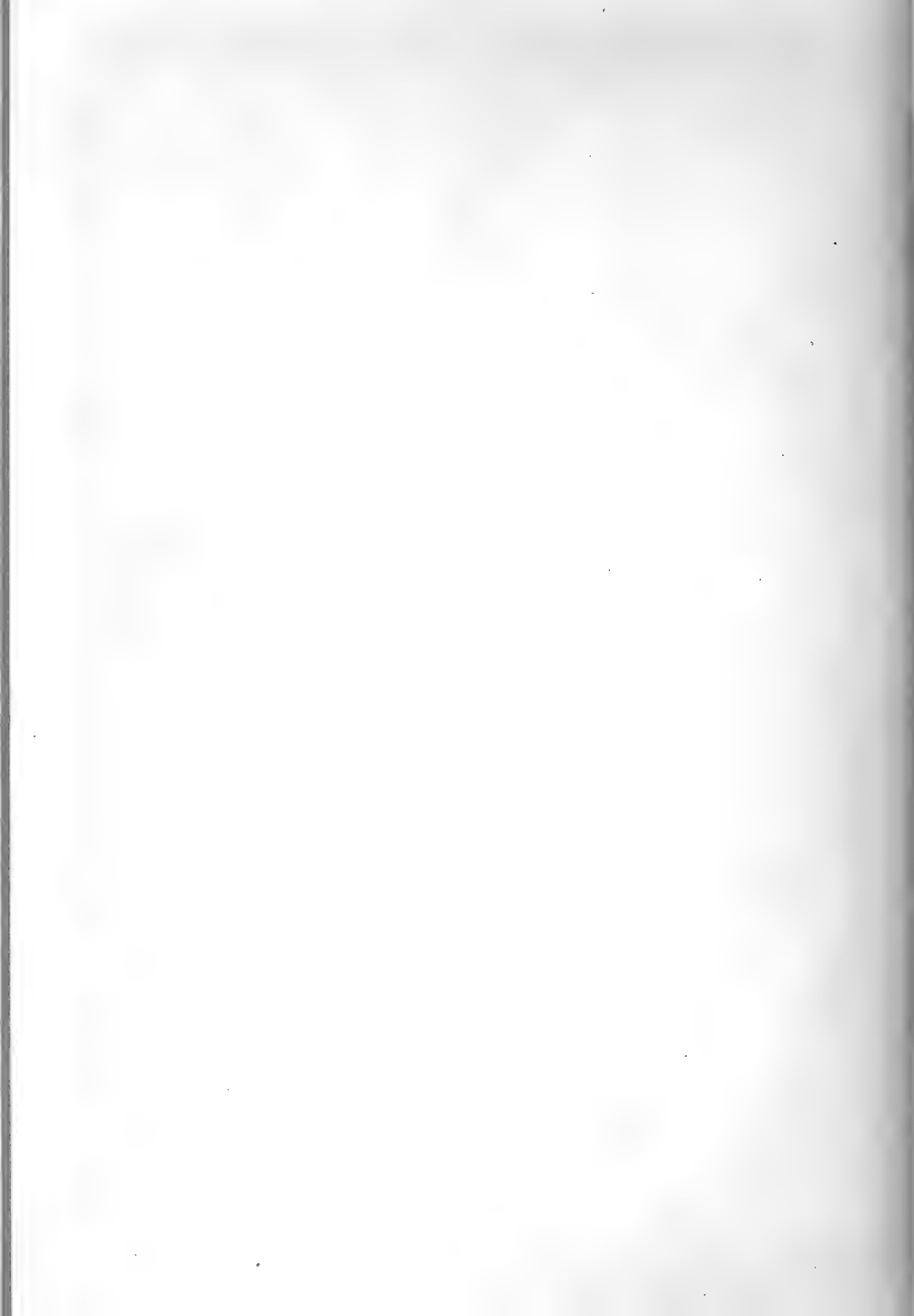

EFFECT OF PELAGIC SEALING STILL EVIDENT.

The treaty abolishing pelagic sealing became effective December 15, 1911. Therefore, killing at sea was going on in the summer of 1911, and although only 14,511 skins were taken, and these may have included animals from the Russian and Japanese herds, the usual failure to retrieve all seals killed and the starvation of pups as the result of the death of their mothers must have made the losses to the herd much greater than the recorded catch. Since 1911 no seals have been taken at sea except the negligible few speared from canoes by natives according to law. The patrol of the fleet of revenue cutters has been continued but no sealers or marauders have been detected. The nature of pelagic sealing was such that it could not fail to leave the herd in a very abnormal condition. The number of seals killed and the proportions of different classes taken at sea were necessarily quite fortuitous. Young cows, old pregnant cows, bachelors, and even old bulls were killed indiscriminately. It is possible that some of the resulting irregular proportions may have had chance compensation from year to year, but there can be little doubt that the cessation of pelagic sealing left the proportions of young and old breeding seals in far from normal condition. The breeding life of the bulls is 7 to 8 years and of the cows 10 to 11 years. This being the case, and other things being equal, about one-sixth of the bulls and about one-tenth of the cows would die each year of old age. The proportion of each age from the youngest to the oldest would be evenly graded and reliable calculations of the general rate of increase could be deducted from the birth rate and the death rate.

It is evident that these proportions can not be reestablished until all the seals subject to pelagic sealing have died and been replaced by others. This will require 12 to 14 years, although approximately natural conditions may be expected somewhat sooner. Seals born in 1911 will be 12 years old in 1923 and the death rate among breeding females will then be practically normal. That abnormal conditions prevail at present is evident from the lack of a substantial increase of breeding cows in 1914 which can not be satisfactorily explained except on the assumption of an excessive death rate among old cows due to pelagic sealing in former years. This has been referred to elsewhere (see p. 43).

Although the effect of pelagic sealing on the breeding herd will linger for years, it can have only a slight and indirect influence on the abundance of young male life. The combined effect of no killing at sea and very limited killing on land in the three seasons since 1911 has already produced an overabundance of young males. The proportion of these that will be needed in later years as breeders is no greater than it would be if there had never been an undue reduction of male life. The preservation of more than this proportion, therefore, is no more justified now than it ever would have been or ever will be. Although the birth rate may fluctuate for some years as the result of irregular mortality of old cows, a reservation of males for breeders based on a regular increase of cows could not fail to be ample since none of the males so reserved would be old enough to go out of service before normal conditions were restored. So far as the effects of pelagic sealing are concerned, therefore, killing and reserving of males need not be postponed.

PELAGIC SEALING INDIRECT CAUSE OF CLOSE LAND KILLING.

Examination of the records and chance interrogation of various individuals formerly connected with sealing make it clear that pelagic sealing, with its reckless and piratical methods, may have indirectly affected the sincerity and morale of land sealing. The conditions were such that it could scarcely be otherwise, and those in charge of the land operations can not be justly criticised for it. If there had been no pelagic sealing, the lessees would have desired to perpetuate the herd quite as much as the Government, but when it was merely a question whether the lessee or the pelagic sealer got the seal, it was to be expected that the lessee would take practically all he could get. As it then appeared, the herd was doomed any way and the preservation of a seal on land was no guarantee that it would not immediately be killed at sea. Thus, even if close killing on land be admitted, it is evident that pelagic sealing was to a considerable extent responsible for it. This form of killing may therefore be credited with even more than its direct drain on the herd. It has been almost the sole cause of trouble. It is inconceivable otherwise that prudent business men, such as constituted the leasing companies, would have allowed their own interests to dwindle by the goose and golden egg method; and of course their agents were thoroughly familiar with at least the main features of the breeding habits of the seals and able to appreciate the futility of efforts at protection on land while wholesale destruction went on at sea.

THE EFFECT OF LAND SEALING.

The effect of land killing is irretrievably involved in that of pelagic sealing. All things considered, it is difficult, if not practically impossible, to show that any land killing during American ownership has been "excessive." The killing of gray pups for food of natives, as practiced to some extent during the period of the first lease, was wasteful, but even this did not include females. The killing of males on land until 1911 has served to reduce the catch at sea and in itself may not have produced any shortage of breeders. The reduction of land killing in 1892 and 1893 produced a surplus of old males in 1896 and 1897, but was accompanied also by a large increase in the pelagic catch, and it is evident that a continued cessation of land killing at that time would only have caused the pelagic sealers to redouble their efforts, and the herd would have continued its decline. In the six years from 1890 to 1895 the number of seals killed on land was 80,482; during the same period pelagic sealers took 295,965 and caused the death of at least several times as many more. In every year thereafter until 1911 the pelagic catch exceeded the land catch. Under such conditions, the effect of any limitation of land killing was problematical. The system of reserving males for breeding purposes inaugurated in 1904 and continued until 1912 had its objectionable features, since certain animals reserved in one season may have been killed the next, but in spite of this it might have been effective but for pelagic sealing. This is evident from the increased number of bulls in 1913 and 1914, due to the reserves of 1910 and 1911. That the reserves of former years did not produce a like number of bulls at the proper time was beyond doubt due to the effect of pelagic sealing. If larger reserves had been made, it is questionable whether they would have accomplished more than an increase in the pelagic catch; certainly a proportionate increase would

have resulted. Therefore, there were no sound economic reasons for making large reserves.

The quotas killed in the decade preceding the abolition of pelagic sealing would not have affected the breeding strength of the herd if they had not been accompanied by the drain of pelagic sealing. It is obvious, therefore, that equally large, or even larger quotas might be permitted in the absence of pelagic sealing with perfect safety. Remembering the great increase of bulls which followed reduced land killing in 1892 and 1893, when pelagic sealing was practically at its height, it is impossible to believe that the reduced killings from 1912 to 1914, with no pelagic sealing whatever, will not produce an overstock of bulls proportionately much greater than that of 1896 and 1897.

So far as the present management of the herd is concerned, land killing in the past only serves to show that relatively large quotas may be taken. With pelagic sealing abolished, uncertainty in many directions ceases, and action should be governed by the number of seals actually found on the islands. The number to be killed or reserved is wholly a matter of proportions, and all the old ideas of fixed quotas and definite numbers should be discarded forever. These proportions are not the same as they would have been during pelagic sealing, and all that can be said is that in working them out under the new conditions, we are likely to find it possible and advisable to kill on land at a higher rate than when land killings were more than duplicated at sea. The effect of the reduced killings of the last three seasons is to be seen on the islands now by the most casual observer. Young male seals of four years and under are filling the hauling grounds again. According to the estimates, which are ultraconservative, the bachelors in 1914 were as follows: Yearlings, 23,067; 2-year-olds, 17,422; 3-year-olds, 13,880; 4-year-olds, 9,939; and 5-year-olds, 1,658; a total of 65,966 young male animals. If only half of them lived, they would provide service for eight years for 989,490 cows at the low ratio of 1 bull to 30 cows. Of course, the cows can not reach such numbers for many years, so it is evident the reduced killing of the last three years has already provided a great excess of males.

THE MANAGEMENT OF THE HERD.

THE GENERAL POLICY.

Since the ratification of a treaty between the United States, Great Britain, Japan, and Russia effecting the complete cessation of pelagic sealing the management of the Pribilof seal herd is no longer to be viewed in the light of past conditions except as they are corroborated by the findings of the present. The way is now clear for the adoption of definite policies, for the acquisition of all necessary information, and for the development of a systematic and businesslike management worthy of and creditable to the Government of the United States.

Although sentiment might prevent the absolute extinction of the fur-seal herd, its preservation is principally possible because of its value as the source of an important commercial product. It is doubtful if it could be preserved at all were it not plain that conservation guarantees infinitely larger profits than immediate destruction. Those interested in the preservation of wild life from scientific or esthetic motives are fortunate when the very ends they desire are supported by strong economic reasons.

In the case of the fur seals it is particularly evident that the only way to insure the growth and continuance of this wonderful display of mammalian life is to advocate a policy involving the taking of life. Scientist, conservationist, sentimentalist, or legislator, therefore, should view the management of the fur-seal herd almost solely from a practical business standpoint.

Laying aside all irrelevant matters of the past and considering the seal herd only as a piece of property to be prudently exploited, we find that simple business principles demand answers to three questions. First, what is the nature and extent of our property? Second, what is the largest annual yield that can be taken from it consistent with absolute safety? Third, what immediate provision should be made for the management of the business?

THE NATURE AND EXTENT OF THE PROPERTY.

This subject involves much of the matter in the present report and requires only brief consideration in this place. To those familiar with the seal herd during periods of expansion, it may seem small at present, but the observer who sees it now for the first time can not fail to be convinced that it is still a large and exceedingly valuable property. It is true that the herd was once vastly larger than at present. It is true also that the past killing of seals at sea was both reckless and disastrous. But the past is gone and the injection of its issues into the present only serves to obscure the real vital matters which need present consideration. Of the present we know that we have a herd of nearly 300,000 seals under practically complete control on both land and sea. This herd includes not less than 93,000 breeding females producing 1 young annually, half the young being males and half females, and at most only 1 male to 35 females being required for breeding. A large supply of males from 2 to 5 years of age is already present and a large revenue from the taking of the surplus is assured. Without attempting an exact calculation, it is evident that the productive capacity of the seal herd is equal to that of an enterprise representing an invested capital of at least ten millions of dollars. As such it is worthy of the highest effort for efficient administration.

MANAGEMENT BASED ON PRINCIPLES EMPLOYED WITH DOMESTIC ANIMALS.

The fur seal is a highly polygamous animal almost wholly controlled by man during the breeding season. It has been subjected to man's disposition for more than a century and shows no tendency to change its habits as a result of his interference. Seals may be driven up, counted, caught and examined, branded, or killed even more easily than range cattle or horses. After being driven they return to their accustomed resorts as if nothing had happened. Except that they have not yet been improved by man, they are scarcely more to be regarded as wild animals than the majority of our domestic species. Their numbers, their breeding, and to some extent their ailments are subject to the control of man. The sexes are born in equal numbers, and a large proportion of the males are superfluous for breeding purposes. It is obvious, therefore, that these superfluous males may be utilized by man just as in the case of domestic animals and that the principles involved are those successfully employed by breeders of live stock.

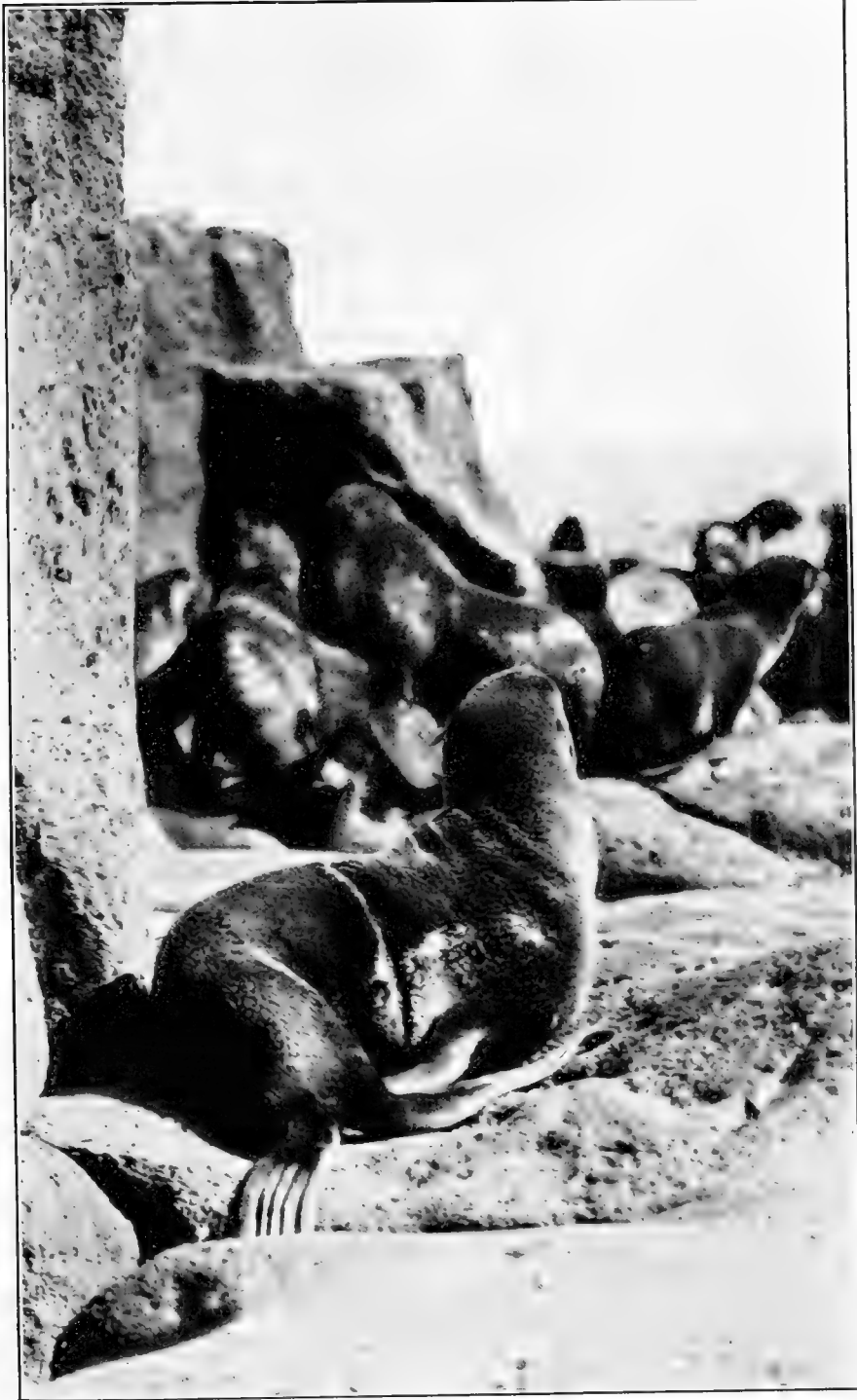

Branded cow, probably 12 years of age, Kitovi Rookery, August 23, 1914.

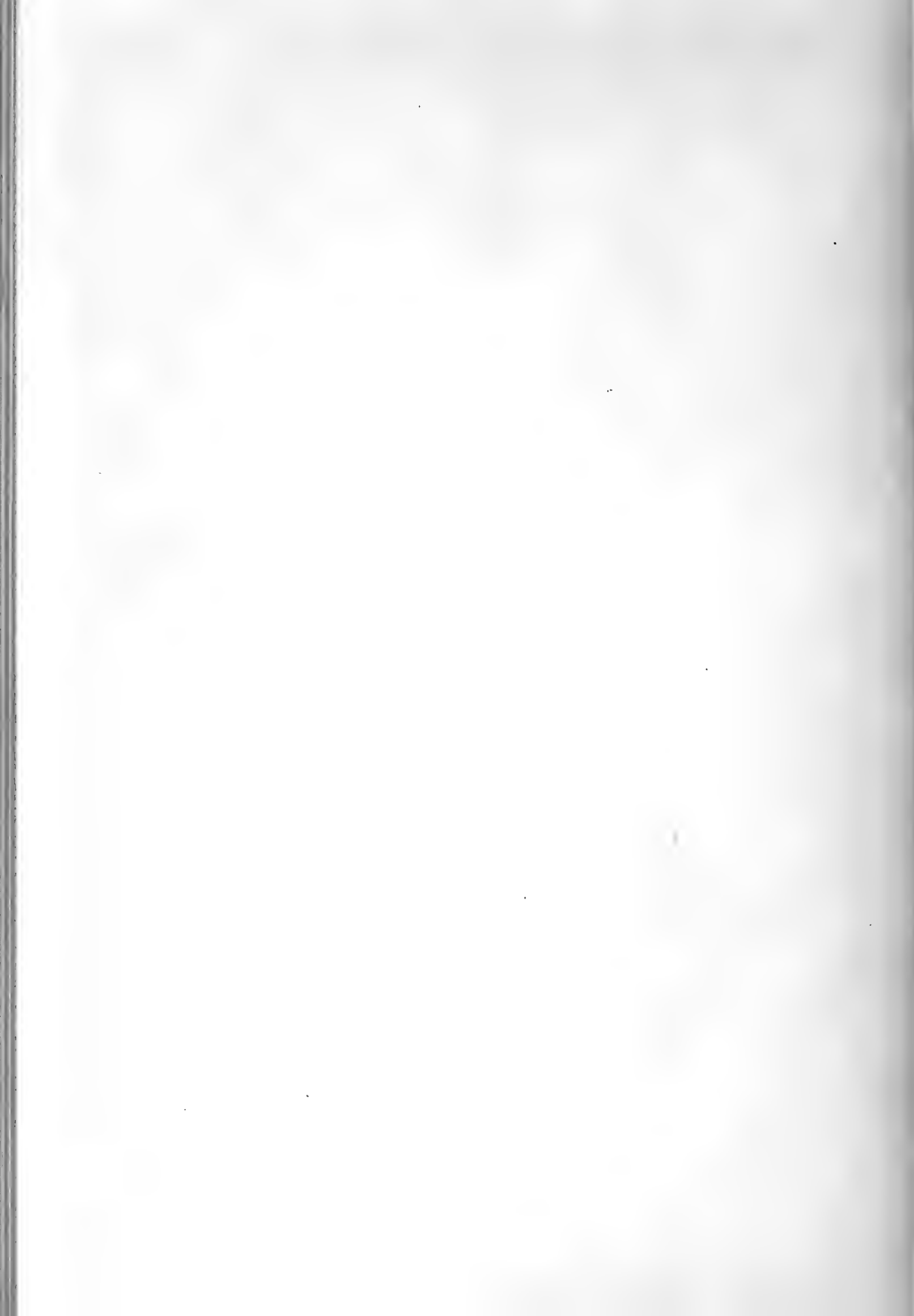

REQUIREMENTS OF A RESERVING SYSTEM.

The requirements of a system of management for the seal herd, therefore, may be stated in their simplest form as only two: (1) The preservation of those males needed as breeders, and (2) the utilization by man of those not needed as breeders. To put these requirements into effect, however, involves the determination of the total number of seals, the proportions of various classes, the death rates from natural causes, the age at which the surplus should be taken, and the method of marking or branding to insure the permanent preservation of the reserves. Some of these matters may be decided upon the basis of data now available, but in regard to others it is still necessary to estimate. The prime requisite for a well-grounded system of reserving males is a better knowledge of the natural rates of increase than we now possess. Liberal allowances for supposed mortality answer the demands of conservatism in estimating the size of the herd and the relative strength of different classes of seals, but, as shown in the discussion of the census of 1914, the estimates are largely based on data obtained during pelagic sealing when natural conditions were greatly disturbed. From one point of view these estimates are entirely safe guides, since they are conservative enough to be well within the facts, but with better data within reach there is no justification for using them longer than necessary. The percentage of survival to the age of 3 years can be determined in a single season by the simple process of setting aside a reserve of 3-year-old males and then killing all the remaining animals of that class. This should be done in 1915, not only because the information is needed as soon as possible, but because the conditions at that time will be particularly favorable. In the first place, the total number will be smaller than in later years and therefore easier to handle. Moreover, the number of pups born in 1912—the 3-year-olds of 1915—is known from an actual enumeration, while some 5,500 of these pups were given permanent brands in 1912 and a record was kept of the few killed as 2-year-olds in 1914. The presence of a certain number of these branded animals, which will be 3-year-olds in 1915, will make it possible to determine with great exactness the characteristics of the 3-year-olds and would greatly facilitate the restriction of killing and reserving to that class. Such favorable conditions will not occur soon again, and even to approximate them in 1918 would require a needless repetition of the branding done in 1912.

CONFINEMENT OF KILLING AND RESERVING TO ONE CLASS.

Various considerations indicate that at present and at least for a few years to come killing and reserving should be mainly confined to one class—the 3-year-olds. In former years the seals taken included those of 2, 3, and 4 years of age. The twos and threes are of practically the same quality, but the threes being larger, usually command a higher price. The fours, although still larger, are not as uniform as to quality, and although they still have good values it is evidently poor economy to allow them to reach that age before being taken. In the past the market has sometimes shown a special demand for the sizes yielded by 2-year-olds, and if it should be found profitable in future to cater to such a demand it may be done at least to a limited extent when our knowledge of proportions and rates of increase is more definite than at present. In general, however, the 3-year-olds yield the skins of highest quality and value, and while the herd is comparatively small and methods are being perfected these only should be taken.

It is obvious that the breeding reserves should be made annually from a single class or generation of seals. They should also be from a class not previously subjected to killing and to one as advanced in years as possible, in order that there may be a short interval between the age of reservation and the age of harem service. The 3-year-olds meet these conditions better than any other class. Furthermore, if 3-year-olds be reserved it will then be possible to take any unbranded 4-year-olds with safety, and thus the chances that any surplus males may come to maturity will be minimized.

THE METHOD OF MARKING RESERVES.

To insure their continued preservation as breeders, it is evident that nothing less than a permanent brand will suffice for marking reserves. The temporary mark used in previous reserves and made by clipping a patch of hair from the head is objectionable because it disappears in a few months, making it impossible to distinguish the reserves when they become 4-year-olds and older. If a permanent brand were given the reserves for a period of years with some slight distinctive variation from year to year, it would soon become possible to determine the relative ages of the stock of harem bulls. The brand should be made on the head or neck with a hot iron or some device for producing the same result. Brands on the body can not be distinguished readily on the killing field, whereas those on the head or neck are easily seen at all times. The practicability of branding on the head and neck has been demonstrated by the branding done in 1912. This consisted of branding on the head some 5,500 pups and about 300 3-year-olds. They were seen in such numbers in 1914 as to indicate that the branding was successful. Although no exact enumeration of them was made, 5-year-olds with brands were seen throughout the season on practically all the rookeries, and when the small number originally branded is considered it is evident that practically all survived. Moreover, it is plain that if young pups survive a brand on the head there can be no risk in placing a similar brand on large vigorous 3-year-olds. Until methods of branding are perfected and the natives instructed in them, branding operations should be conducted by someone experienced in such work. In fact since natives can not be depended upon and since previous branding has been done by persons no longer available, a special employee should be detailed for one or more summer seasons with instructions to investigate the subject of branding thoroughly and establish methods and apparatus for future use.

THE PROPORTION OF MALES TO BE RESERVED.

As shown elsewhere (see p. 49), the ideal number of harem bulls would be such as to provide them in the proportion of 1 to 40 bearing cows, while at the same time idle bulls should be present in the proportion of 1 to 30 virgin cows or approximately 1 idle bull to 4 harem bulls. If these proportions could be maintained, there would never be any question as to the sufficiency of males. It is too much to hope that such exact proportions would in practice be possible, but it is believed that a consistent effort to keep as near as possible to these proportions would serve all practical purposes.

Since reserves must be made at the beginning of the season before the harems are formed and before the size of the herd can be determined, the size of the reserve must depend upon knowledge of conditions the previous year. Furthermore, since the reserves will not enter the stock of bulls for at least three years the size of the reserve in a given season will bear some relation to the reserves of the three preceding years. Therefore the

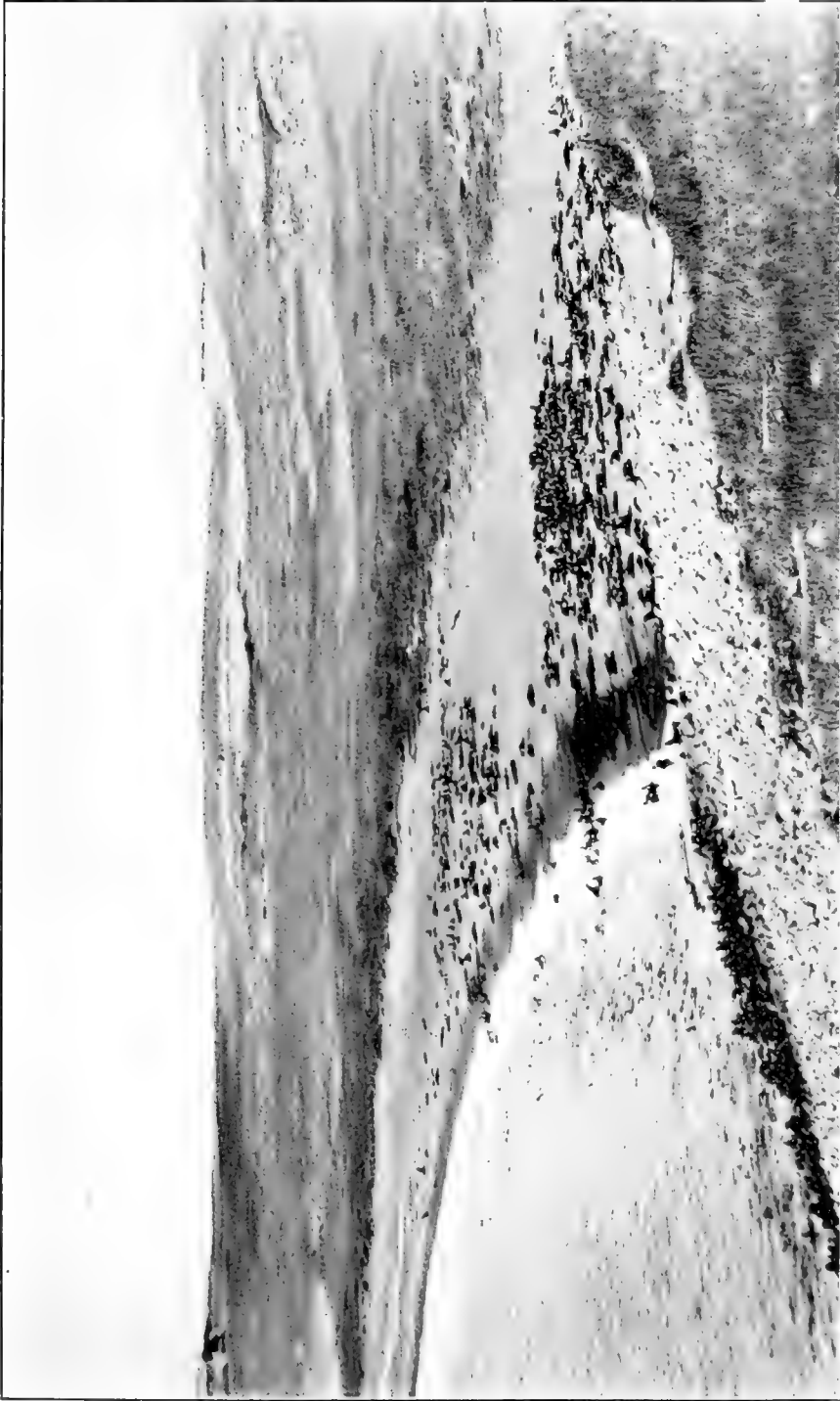

Young seals hauled on Tolstoi Beach, St. Paul Island, August 25, 1914.



size of the reserve should increase from year to year at a rate proportionate to the rate of increase of the cows. After a few years of experimentation this rate could be determined. To indicate our present knowledge of rates of increase and to serve as a guide to be used according to circumstances in making reserves, the following tables have been prepared. Although they furnish a forecast of possible future conditions, this is not their primary purpose, and it is hoped that they will be regarded less as predictions than as demonstrations that whatever the rate of increase the reserve of males should be relatively small.

TABLE NO. 1.—Estimated minimum number of females, 1914-1926.^a

	1914 ^b	1915	1916	1917	1918	1919
Bearing cows.....	93,250	97,740	103,658	109,053	114,660	120,725
Virgin cows.....	17,422	19,607	19,815	20,770	22,027	23,174
Total breeders.....	110,672	117,347	123,473	129,823	136,687	143,899
Yearling females.....	23,068	23,312	24,435	25,914	27,203	28,605
Female pups.....	40,625	48,870	51,829	54,526	57,330	60,303

	1920	1921	1922	1923	1924	1925	1926
Bearing cows.....	127,095	133,773	140,810	148,220	156,019	164,228	172,867
Virgin cows.....	24,365	25,055	27,008	28,427	29,923	31,497	33,154
Total breeders.....	151,468	159,428	167,818	176,647	185,942	195,725	206,021
Yearling females.....	30,182	31,774	33,444	35,203	37,055	39,005	41,057
Female pups.....	63,548	66,887	70,405	74,110	78,009	82,114	86,434

^a Based on assumed mortality of 50 per cent in first year, 15 per cent in second year, 10 per cent in third year, and 12 per cent annually thereafter; annual rate of increase of cows 5 per cent to 6 per cent.

^b Based on actual count of pups.

TABLE NO. 2.—Estimated maximum number of females, 1914-1926.^a

	1914	1915	1916	1917	1918	1919
Bearing cows.....	93,250	105,755	120,093	133,261	148,488	166,064
Virgin cows.....	24,255	27,681	27,975	31,726	36,027	39,978
Total cows.....	117,505	133,436	148,068	164,987	184,515	206,042
Female pups.....	46,625	52,877	60,046	66,630	74,244	83,032

	1920	1921	1922	1923	1924	1925	1926
Bearing cows.....	185,438	206,986	231,125	258,080	288,158	321,746	359,253
Virgin cows.....	44,546	49,819	55,031	62,095	69,337	77,424	86,447
Total cows.....	229,984	256,805	286,756	320,175	357,495	399,170	445,700
Female pups.....	92,719	103,493	115,562	129,040	144,079	160,873	179,626

^a Based on assumed mortality of 40 per cent in first two years and 10 per cent annually thereafter; annual rate of increase of cows 11 per cent to 12 per cent.

TABLE NO. 3.—Estimated mean number of bearing and virgin cows, 1914-1926.^a

Total cows:		Total cows—Continued.
1914.....	^b 114,088	1921..... 195,527
1915.....	123,215	1922..... 211,169
1916.....	133,072	1923..... 228,062
1917.....	143,718	1924..... 246,307
1918.....	155,215	1925..... 266,012
1919.....	167,633	1926..... 287,293
1920.....	181,043	

^a Based on a rate of increase of 8 per cent per annum, this being the approximate mean between the rate of the minimum estimate and the rate of the maximum estimate.

^b Mean between maximum and minimum estimates.

TABLE NO. 4.—Estimated minimum number of males, 1914-1926, under operation of law of 1912.^a

	1914	1915	1916	1917	1918	1919
Male pups.....	46,625	48,870	51,829	54,526	57,330	60,363
Yearlings.....	23,067	23,312	24,435	25,914	27,263	28,665
Two years.....	17,422	19,607	19,815	20,770	22,027	23,174
Three years.....	13,880	15,680	17,645	17,834	18,693	19,824
Four years.....	9,939	8,911	10,620	12,489	12,667	4,750
Five years.....	1,658	9,939	8,911	10,620	12,489	12,667
Six years.....	^b 86	1,658	9,939	8,911	10,620	12,489
Seven years.....	^b 86	86	1,658	9,939	8,911	10,620
Eight years and over.....	1,559	1,427	1,313	2,787	12,336	19,520
Total bulls six years and over.....	1,731	3,171	13,910	21,637	31,867	42,629

	1920	1921	1922	1923	1924	1925	1926
Male pups.....	63,548	66,887	70,405	74,110	78,009	82,114	86,434
Yearlings.....	30,182	31,775	33,444	35,203	37,055	39,005	41,057
Two years.....	24,365	25,655	27,008	28,427	29,923	31,497	33,154
Three years.....	20,856	21,929	23,090	24,307	25,585	26,930	28,347
Four years.....	4,750	4,750	4,750	4,750	4,750	4,750	4,750
Five years.....	4,750	4,750	4,750	4,750	4,750	4,750	4,750
Six years.....	12,667	4,750	4,750	4,750	4,750	4,750	4,750
Seven years.....	12,489	12,667	4,750	4,750	4,750	4,750	4,750
Eight years and over.....	27,407	36,059	43,678	42,313	41,139	40,129	39,261
Total bulls six years and over.....	52,563	53,476	53,178	51,813	50,639	49,629	48,761

^a Based on assumed mortality of 50 per cent in first year, 15 per cent in second, 10 per cent in third, 5 per cent in fourth, and 14 per cent annually after eighth; with allowance also for food killings of 4,500 3-year-olds in 1914, 1915, 1916, and 1917, and reserves of 5,000 per annum after 1917.

^b One-half of idle bulls in 1914.

TABLE NO. 5.—Harem and idle bulls and annual increments required under various estimates at ratio of 1 bull to 35 cows.

	1914	1915	1916	1917	1918	1919
Bulls required for minimum estimate of cows.....	3,162	3,353	3,528	3,709	3,905	4,111
Annual increment of bulls.....			^a 801	715	715	753
Bulls required for maximum estimate of cows.....	3,357	3,812	4,230	4,714	5,272	5,887
Annual increment of bulls.....			^a 1,503	1,077	1,218	1,353
Bulls required for mean estimate of cows.....	3,260	3,520	3,802	4,106	4,435	4,789
Annual increment of bulls.....			^a 1,075	836	904	975

	1920	1921	1922	1923	1924	1925	1926
Bulls required for minimum estimate of cows.....	4,327	4,555	4,795	5,047	5,313	5,592	5,886
Annual increment of bulls.....	792	834	878	924	973	1,023	1,077
Bulls required for maximum estimate of cows.....	6,571	7,337	8,193	9,148	10,214	11,405	12,734
Annual increment of bulls.....	1,508	1,686	1,883	2,105	2,347	2,621	2,926
Bulls required for mean estimate of cows.....	5,173	5,586	6,033	6,516	7,037	7,600	8,208
Annual increment of bulls.....	1,055	1,137	1,229	1,328	1,433	1,548	1,672

^a On the basis of 3,171 bulls which it is estimated will be present in 1915.

TABLE NO. 6.—Comparison of results of present law, and of a reserving system based on an estimated mean rate of increase of cows.

	1914	1915	1916	1917	1918	1919
Seals available for killing and reserving.....		^a 34,530	17,645	17,834	18,693	19,824
Reserve under the law.....		30,030	13,145	13,334	5,000	5,000
Reserve under the estimate.....		^b 2,815	975	1,055	1,137	1,229
Seals killable under the law.....		^c 4,500	^c 4,500	^c 4,500	13,693	14,824
Seals killable under the estimate.....		^d 31,715	16,670	16,779	17,556	18,595
Prospective revenue under the law.....		\$157,500	\$157,500	\$157,500	\$479,255	\$518,840
Prospective revenue under the estimate.....		^e \$932,745	\$583,450	\$587,265	\$614,460	\$650,825
Loss of revenue under the law.....		\$775,245	\$425,950	\$429,765	\$135,205	\$131,985

^a Includes 9,939 5-year-olds, 8,911 4-year-olds, and 15,680 3-year-olds.

^b Includes 1,075 5-year-olds to supply the required increment for 1916, 836 4-year-olds for that of 1917, and 904 3-year-olds for that of 1918.

^c Food requirement only.

^d Assuming that surplus 4 and 5 year olds were killed in 1915 and only 3-year-olds thereafter.

^e Allowing an average price of \$15 for 5-year-olds and \$35 for 3 and 4 year olds.

TABLE NO. 6.—Comparison of results of present law, and of a reserving system based on an estimated mean rate of increase of cows—Continued.

	1920	1921	1922	1923	1924	1925	1926
Seals available for killing and reserving.	20,856	21,929	23,090	24,307	25,585	26,930	28,347
Reserve under the law.....	5,000	5,000	5,000	5,000	5,000	5,000	5,000
Reserve under the estimate.....	1,328	1,433	1,548	1,672	1,806	1,950	2,106
Seals killable under the law.....	15,856	16,929	18,090	19,307	20,585	21,930	23,347
Seals killable under the estimate.....	19,528	20,496	21,542	22,635	23,779	24,980	26,247
Prospective revenue under the law.....	\$554,960	\$592,515	\$633,150	\$675,745	\$720,475	\$767,550	\$817,145
Prospective revenue under the estimate.....	\$683,480	\$717,395	\$753,970	\$792,225	\$832,265	\$874,300	\$918,605
Loss of revenue under the law.....	\$128,520	\$124,880	\$120,820	\$116,480	\$111,790	\$106,750	\$101,500

Remarks: Approximate annual rate of increase of reserve, 8 per cent. Total revenue under the law, \$6,232,135. Total revenue under the estimate, \$8,941,025. Total prospective loss of revenue, \$2,708,890.

TABLE NO. 7.—Bulls provided by law in excess of requirements of maximum, minimum, and mean estimates of cows.

	1914	1915	1916	1917	1918	1919
Minimum number of bulls to be present under law..	1,731	3,171	13,910	21,637	31,867	42,629
Bulls necessary for maximum estimate of cows.....	3,357	3,812	4,230	4,714	5,272	5,887
Excess over requirements of maximum estimate.....	^a 1,626	^a 641	9,680	16,923	26,595	36,742
Bulls necessary for mean estimate of cows.....	3,260	3,520	3,802	4,106	4,435	4,789
Excess over requirements of mean estimate.....	^a 1,529	^a 349	10,108	17,531	27,432	37,840
Bulls necessary for minimum estimate of cows.....	3,162	3,353	3,528	3,709	3,905	4,111
Excess over requirements of minimum estimate.....	^a 1,431	^a 182	10,382	17,928	27,962	38,518

	1920	1921	1922	1923	1924	1925	1926
Minimum number of bulls to be present under law.....	52,563	53,476	53,178	51,813	50,639	49,629	48,761
Bulls necessary for maximum estimate of cows.....	6,571	7,337	8,193	9,148	10,214	11,405	12,734
Excess over requirements of maximum estimate.....	45,992	46,139	44,985	42,665	40,425	38,224	36,027
Bulls necessary for mean estimate of cows.....	5,173	5,586	6,033	6,516	7,037	7,600	8,208
Excess over requirements of mean estimate.....	47,390	47,890	47,145	45,297	43,602	42,029	40,553
Bulls necessary for minimum estimate of cows.....	4,327	4,555	4,795	5,047	5,313	5,592	5,886
Excess over requirements of minimum estimate.....	48,236	48,921	48,383	46,766	45,326	44,037	42,975

^a Deficiencies. These will exist in 1915 under any circumstances and merely indicate the possible extent to which 5-year-olds might participate in the breeding.

Tables Nos. 1, 2, and 3 give minimum, maximum, and mean estimates of cows from 1914 to 1926, using as a basis the actual number of cows and pups found in 1914 and progressively applying a very high death rate for the minimum estimate, a low rate for the maximum, and striking an approximate average for the mean between the maximum and the minimum. Table No. 4 shows primarily the number of young male seals which would be present from 1914 to 1926 under a high death rate and a slow increase of breeding cows. The number of bulls which would result from the operation of the law of 1912 is then obtained by making allowances for food killings of 4,500 three-year-olds per annum until 1917 and for reserves of 5,000 per annum thereafter.

Table No. 5 shows the total number of bulls which would be necessary to provide 1 bull to 35 cows under the various estimates. Thus, under the minimum estimate there would be a total of 123,473 cows in 1916. Dividing this by 35 gives 3,528, the number of bulls to be required in that year. After obtaining the number of bulls required for each year, the increment from year to year is obtained by allowing for deaths of 14

per cent per annum, which is about 2 per cent more than results from natural termination of life. Thus if 3,528 bulls were present in 1916, 86 per cent, or 3,034, would be assumed to survive to 1917, and therefore an increment of 675 bulls in 1917 would be necessary to make the total requirement of 3,709 bulls for that year. From this table it is seen that even for the maximum estimate of cows, only 12,734 bulls would be needed in 1926 and the annual increments would be very small, not exceeding 2,000 until 1923. Under the mean estimate, which is a much more reasonable one, scarcely more than 8,000 bulls would be needed in 1926, and the increment would not exceed 1,500 until 1925. Therefore, no reserve of over 1,500 would be necessary until 1922.

In Table No. 6 is shown the result of a reserving system based on the estimates of the preceding tables and compared with the results to be expected under present law. The results thus indicated are decidedly conservative, and it is highly probable that smaller reserves would suffice, but as a guide for action it is desirable that all reasonable provision be made that the supply of bulls be ample. Therefore, under the system proposed in this table, it is intended that there shall be at least 1 bull to 35 cows. That this can not fail to result is evident when it is noted that this ratio is maintained in a calculation in which the bulls are assumed to increase at a slower rate than the cows. It would be quite fair to state the requirements of the minimum estimate of cows, since the males to be killed represent a minimum, but in order to allow for all possible contingencies the mean estimate of cows is used. The maximum estimate need not be considered, except as an indication that under the most extreme and improbable increase of cows the number of bulls required would still be small as compared with that provided by law.

In order to establish a rational reserving system at once and to prevent loss of revenue, all surplus 5-year-olds and 4-year-olds should be killed in 1915. Thereafter, reserves would be made from the 3-year-olds and would increase from year to year at the rate of 8 per cent. Referring to Table No. 5, it is seen that an increment of 1,075 bulls would be needed in 1916, the increment in that year being relatively large owing to the present shortage as compared with an ample allowance. This increment will be supplied by the 5-year-olds of 1915, of which all but 1,075, therefore, might be killed. In 1917 the increment would be 836 to be supplied from the 4-year-olds of 1915. The following year, 1918, would require 904 new bulls, and this determines the size of the reserve of 3-year-olds in 1915. In 1916 the reserve of 3-year-olds would be 975, and subsequent reserves would increase at the same rate. The size of the reserve in any given season would be 8 per cent larger than the reserve of the previous year or approximately 22 per cent of the number of harem and idle bulls which were present the preceding year.

Table No. 6 shows also the estimated revenue to be derived under the proposed reserving system in comparison with that which might be expected under present law. It is seen that a prospective loss of more than three-fourths of a million dollars is indicated for the year 1915, from which it is apparent that immediate action is necessary. The total loss indicated for the 12 years from 1915 to 1926, inclusive, is \$2,708,890, or an average of \$225,742 per annum. Of this loss only 70 per cent, or \$1,896,223, would be suffered directly by the United States, since 30 per cent, or \$812,667, would fall upon Great Britain and Japan. These losses are computed on the basis of a price of \$35 per skin, which is the approximate average price received during

the last 10 years. It is, of course, impossible to predict the future state of the fur market, but with an annual output of considerably less than 30,000 skins it is more likely that this figure would be exceeded than otherwise.

Table No. 7 makes comparison of the number of bulls of six years and over which would be present under the law and the numbers which would be required for the various estimates of cows. It is seen from this that on the basis of the mean estimate of cows, although there would be a slight deficiency of bulls in 1915, this would suddenly change to a large excess of over 10,000 in 1916, which would increase to a surplus of 47,890 in 1921 and maintain a high excess of over 40,000 until 1926. Even the requirements of the maximum estimate are greatly exceeded by those of the law, the excess of bulls in this case being 9,680 in 1916, 46,139 in 1921, and 36,027 in 1926. If comparison is made with the minimum requirements, the excesses are still greater, and it is evident that the operation of the law provides for an excess over any rational estimate that could be made. Using the minimum estimate of cows, and therefore simply assuming an equal rate of increase of males and females but with allowance for the killing permitted by law, it appears that in 1921 there would be 159,428 cows and 53,476 bulls, or exactly three cows for each bull. It is apparent also that the 53,476 bulls of 1921, at the conservative ratio of 1 to 35, would be sufficient for 1,871,660 cows, or more than seventeen times the number living in 1914. Such an increase of cows is, of course, impossible.

Comparisons need not be multiplied, but it may be repeated that the above tables have not been constructed for the purpose of predicting by exact figures the future growth of the herd, but for demonstrating that the effects of the law and of a limited reserving system, estimated by the same method, are very far apart. It is confidently believed that a reserving system based on the principles above outlined might be undertaken at once with perfect safety. Although the exact percentages shown by the foregoing tables may need alteration as new information is obtained, there is not the slightest danger that any shortage of males would result from their adoption for immediate practice. It is therefore plain that in 1915 all males of 3, 4, and 5 years of age might be taken with the exception of reserves of approximately 1,100 5-year-olds, 850 4-year-olds, and 900 3-year-olds, and that subsequent reserves of 3-year-olds need to increase at no greater rate than 8 per cent per annum.

METHODS OF DRIVING, KILLING, AND CURING SKINS.

The main methods now practiced are the results of the experience of many years. To those studying the matter from a viewpoint free from the restrictions imposed by long custom, however, many improvements suggest themselves, mainly in regard to details which have been handed down from a period when modern transportation methods were unknown and the time of laborers considered of little moment, or those which have been demanded by temporary exigencies no longer existent.

NEED FOR SHORTER DRIVES.

The seals are forced to carry their skins and meat and most of the butchering is done close to the villages, entailing more or less annoyance from the presence of the decaying offal. Furthermore, the seals are driven distances varying from one to several

miles, involving much delay and the possibility of injury from overheating. Under this method no killing can be done on warm or dry days, since the seals can not travel far unless rain or heavy dew is present. It sometimes happens that several days will pass without weather conditions which permit driving. On many other occasions drives have to be abandoned before the killing grounds are reached because of sun or lack of moisture.

The main difficulty opposing the location of killing grounds nearer the rookeries, which would do away with much of the necessity of waiting for favorable weather conditions, is the absence of roads. Although draft animals have been used on St. Paul Island for many years, there is only one road—that connecting Northeast Point with the village. Teams are sometimes driven to Zapadni, but the road is scarcely passable and the journey involves so much discomfort and such flagrant misuse of the animals and vehicles that it is seldom undertaken. Reef Rookery, from which most of the seals killed during the last few years have been taken, though only a mile from the village, is not reached by road nor by trail worthy of the name. The seals are therefore driven by indefinite routes to the killing ground close to the village and thence the meat and skins are hauled by wagon to the storehouses. A road would allow the animals to be killed nearer the hauling ground, and the expenditure of a little more time and energy would permit the transportation of the meat and skins the whole distance by wagon.

KILLING.

It is believed that the present method of killing is effective and as humane as is possible and that no change is necessary or desirable. The seal selected to be killed is stunned by a blow on the head from a heavy club and while unconscious is stabbed in the heart and bled. The method is thus at least as humane as that followed in slaughtering domestic animals for food.

FEMALES AND OLD SEALS IN DRIVES.

In making drives from the vicinity of the breeding rookeries it sometimes happens that a few females are included. These are almost always detected and liberated, but occasionally one is accidentally killed. This may happen from the inability of the clubber to judge of the sex of the animal when only the head is visible or by the animal's receiving a blow intended for another individual. In spite of all care, an occasional accident of this kind in killing thousands of seals is unavoidable. During June and early July cows are seldom included in the drives, but after the last of July, when the vigilance of the harem bulls has become relaxed, the bachelors encroach somewhat on the breeding grounds, and if drives are made then a few cows are likely to be included. About this time, however, the stagey season begins and so many of the skins become worthless that killing is wasteful and should be stopped altogether. July 31 should mark the close of the sealing season.

During June and July in the season of 1914 ten food drives were made on the Pribilof Islands. The only cow which appeared in any of these drives was a virgin female accidentally killed on St. George Island on July 25. After August 1, however, a few cows were noted in almost every drive, and though only three were killed (by accident) several others succumbed to overheating and trampling. The cows, especially the



Driving and poddling seals for a food killing, St. Paul Island, August 8, 1914.

young 2-year-olds, are much less able to withstand the pressure and buffeting of the drive than the bachelors, and they are often detected by their distressed appearance as compared with the males. The presence of cows in the drives has evidently been regarded as a matter of seriousness in past years, for it is noted with considerable regularity in the agents' daily journal or "log." The records are far from complete, but the following compilation of them made by naturalist W. L. Hahn is of considerable interest:

Extracts from St. Paul log regarding cows in drives.

1879. (?)

October 29, first drive of pups was made from Lukanin, among them many females. Orders were given to examine each separately before it was killed. The Government agent believed that formerly pups had been selected on account of size—not sex.

August 28, 2 females killed by accident.

October 7, 2 females killed by accident.

October 20, 10 females killed by accident.

November 13, in a food drive it was found that several—probably 8 or 10—female seals had been killed by accident.

1897.

November 12, 2 cows were accidentally killed in a drive.

1902.

July 24, 13 cows appeared in a drive at Zapadni.

July 29, 6 cows in a drive from Zapadni.

August 9, 18 large and 701 small seals were dismissed from a drive, a large part of them being cows.

1903.

July 24, 1 cow dismissed from drive from Zapadni.

July 27, 2 cows dismissed from drive at N. E. Pt.

July 29, 1 cow dismissed from drive from Tolstoi.

July 30, 2 cows dismissed from drive from Reef.

July 31, 19 cows dismissed from drive from N. E. Pt.

1904.

July 1, 3 yearlings (?) appeared in the drive at N. E. Pt. A large one was knocked down and proved to be a female. It weighed 34 pounds before it was stuck, and the skin weighed $3\frac{1}{8}$ pounds.

August 9, 25 cows appeared in a drive from Reef and Gorbach. A pronounced falling off in the number of cows appearing in drives is noted this summer.

1905.

June 23, 32 pregnant cows were dismissed from a drive of about 600 seals at N. E. Pt.

June 30, 8 cows were dismissed from a drive at N. E. Pt.

July 26, 17 cows were dismissed from a drive at N. E. Pt.

July 28, 75 cows were dismissed from a drive from Zapadni.

July 31, 32 cows were dismissed from drive from Reef.

August 10, 97 cows were dismissed from food drive from Reef.

1906.

July 28, 4 cows were dismissed from drive from Polovina.

1907.

October 31, 40 pups and 116 cows appeared in a food drive from Reef Rookery.

1908.

October 20, few cows in the drive from Reef.

October 29, only a few cows in a drive from Tolstoi.

1909.

July 30, 10 cows dismissed from drive from Zapadni.

July 31, 4 cows in drive from Reef and Gorbach.

October 20, 34 pups and a large number of cows were dismissed from a food drive from Tolstoi.

November 1, 45 cows were dismissed from food drive from Reef.

November 13, 52 cows dismissed from food drive at Northeast Point.

The great majority of these records relate to dates very late in the season; in fact, only three are earlier than July 24. Two of these are June records and undoubtedly refer to drives improperly made from a breeding ground. It is evident that with careful driving prior to August 1 there is little danger to the females, but that later in the season even small food drives are made at considerable risk. If a system of cold storage of meat were installed on the islands and the working force of men trained to high efficiency, all killing might well be confined to the months of June and July.

Owing to the fact that few seals have been killed since 1911, a large number of five and six year old seals now haul out with the younger bachelors and are included in the bands of seals which are driven to the killing grounds. These large seals are a source of considerable delay and annoyance and some danger. It is always possible to eliminate a part of them, as they travel more slowly than the younger animals and may sometimes be left behind. Some, however, refuse to be discarded, and as the younger seals show a tendency to rally around the larger ones, it always happens that some remain with the drive. Since they travel slowly, the speed of the entire company must be accommodated to their gait, and the younger seals are trampled and hampered and fatigued by their unwieldy companions. Some of the larger seals which are thus included in the drives become very vicious. There are instances of sealers being seriously injured by the sudden attack of one of these stubborn animals.

Within the next few years, unless some means are taken to reduce the number of these large seals, they will become so abundant that driving will be a matter of difficulty.

THE SEALING SEASON.

The season during which commercial killing is possible is short. The bachelors are most numerous at the same time that the breeding animals are at their height of abundance—from the last of June to the end of August. The so-called "stagey" season, when the animal is moulting, begins about the 1st of August, and this reduces the effective period of greatest abundance to about one month. In order to take the fullest advantage of the short season it is necessary to begin before the time of greatest abundance. In past years the bulk of the catch was taken between the middle of June and the 20th of July, though a few were killed in late May and a few up to the last of July. This very short season necessitates that every possible facility for effective work be provided. Even under the best conditions days will frequently occur during which it will be impossible to work to advantage, and this emphasizes the need for thorough preparation, so that the favorable days may be utilized to the fullest extent.

SKINNING.

The seals after being killed are laid in rows far enough apart to allow each skinner to work on his subject without impeding the movements of his neighbor. An incision is first made from vent to throat; continuous with this cut, incisions are made around the head in front of the ears, and around the base of the hind flippers; a cut is also made around each fore flipper close to the body. Beginning at the middle of the ventral cut the native then rapidly separates the skin from the body, holding the skin slightly stretched and cutting through the subcutaneous layer of blubber with rapid, sweeping strokes. Each fore flipper is worked out of the circular cut at its base, and the remainder of the skin, after being separated from the body, falls free of head and limbs. The result is an ovate pelt with two circular holes where the fore flippers were removed.

The skin of the head from the ears forward, known as the mask, has customarily been left on the carcass and allowed to waste. It is probable that these masks include enough good fur to give them a substantial value. They are easily removed and preserved and have sometimes been taken as perquisites by the natives, who have sold them for small sums to the natives of Unalaska and to chance visitors to the Pribilofs. The value of these masks should be investigated and if it be found profitable, as seems likely, they should be regularly taken and marketed.

A layer of fat from one-fourth to one-half an inch in thickness is left on the skin. This is allowed to remain and helps to keep the skin in the moist flexible condition desirable for its proper dressing. The process of skinning requires much skill and care. A chance cut greatly reduces the value of the skin; too much blubber may result in imperfect curing and consequent loss; while a dearth of blubber may allow the skin to become dry, which interferes with the process of dressing. Some of the more expert of the natives are able to skin a seal in two minutes, but the average time is longer. To retain the desired degree of skill it is, of course, necessary that the work be kept up. It is evident that the suspension of killing during the past few years has already resulted in considerable loss of skill, even among the experienced men, while the younger men have had practically no opportunity to acquire efficiency.

CURING OF SKINS.

The method of curing the skins has been detailed so often that only a brief description is necessary. After being allowed to cool on the ground so that the animal heat is lost, the skins are taken to the salt house where they are numbered and weighed individually, and recorded. The process of weighing consumes a great deal of time and should be discontinued, as under Government management it serves no useful purpose. A simple system of flesh measurements, as explained beyond, should be substituted. The skins are then laid flat, fur side down, and having been carefully spread to guard against the persistence of folds or wrinkles, are covered with salt. Successive layers of skins, each well salted, are placed in the bins or "kenches" until the entire catch of the day is cared for. In this state they are allowed to remain a week or ten days, when they are shaken clear of salt and are examined critically to make sure that all parts of the skin have been cured. They are then repacked in a compact pile, called the "book," the process being similar to that of the original salting, but less salt being used. Here they remain until such time as they are to be shipped, when they are tied into bundles, each containing

two skins placed flesh to flesh, with a small quantity of salt between to keep the skins moist and pliable. Much of the salt now in the bins or kenches has been in use so long that it has become so coated with dirt and grease that its solubility and consequent curing power is considerably lessened. Unless this old salt can be freed from the foreign matter which accompanies it, much of it should be thrown away. It is believed also that the substitution of a finer grade of salt, which would be more easily soluble, might have advantages. It may be possible to cleanse and reduce to finer grains some of the salt now on hand. This amounts to many tons, and by utilizing the native force, the expense and trouble of actually replacing it may be avoided.

NEED OF COMPETENT SUPERVISION.

It is evident to any one who has observed a gang of the natives at work that they need constant and intelligent supervision. Left to themselves they are rather careless and indifferent. This is in part due to their natural lack of care for detail, and partly to the fact that they have fallen behind in efficiency because of the decline in the amount of sealing. It was noticed that in making drives they allowed the seals to travel in too large bunches, resulting in an excessive amount of trampling. This fact being recognized, a drive made under special direction was managed differently. The seals were drawn out into a long line, only a few abreast, and a much longer drive than usual was made with decidedly less distress and, according to the natives, in the quickest time on record. In some of the illustrations of driving as practiced during the days of extensive killing, the seals are represented as being driven in this way, and it is probable that the carelessness observed in 1914 represents merely a lapse from a method formerly recognized as efficient and proper.

MEASUREMENTS VERSUS WEIGHTS.

It has long been the custom in selecting seals of the proper age for killing, to rely on the weight of the skins as a criterion. Those below a certain weight were considered 2-year-olds; those above this weight and below another higher weight were considered 3-year-olds, and so on. The uncertainty of this method, and the impossibility of confining the killing strictly to certain ages by its application has been amply demonstrated. Measuring the skins also has been found to be very unreliable because of the extreme flexibility of fresh skins. The large amount of variability in the weight and measurements both before and after salting has been demonstrated repeatedly. The fact that neither the weight nor the measurements of a skin can be taken until it is removed and all connection in the minds of the sealers between a particular skin and the seal from whose body it was taken is necessarily lost, must always remain an insuperable argument against its practicability. It should be stated, moreover, that the confinement of killing to particular classes of seals in the past has been due more to the judgment of the clubbers than to the system of weighing skins.

Under complete Government control there can be no temptation to take animals below the prescribed age, and the time-consuming system of individual weighing should be abandoned. Notes made in 1914 show that the process of weighing 100 skins takes two men about one hour. As before stated, this necessarily has to be done at a time when every consideration of economy demands that the skins on hand be placed in the salt as quickly as possible, and thus it interferes greatly with the proper utilization of the services of the working force.

The measurements of the seals of a given age are much more uniform than the size or weight of the skins. The most important measurement and one that is easily taken is the length from the end of the nose to the root of the tail, and the idea was conceived of using this measurement as a standard for judging the age of seals killed. It was found entirely practicable to take this measurement for each one of the seals without delaying the progress of the work as they were laid out in rows preparatory to skinning. The most satisfactory method of measuring is by means of calipers similar to those employed in measuring timber. The one used experimentally was made by fitting a fixed and a movable arm to a rod marked for feet and inches. Even with this improvised instrument it was found practicable to ascertain the length of the animal easily and quickly. As explained elsewhere, a large number of skulls of seals killed in the food drives were preserved. Some of these were of seals branded as pups in 1912. These specimens of known age, studied in connection with the flesh measurements and the weight of the fresh skins, serve as a basis for comparison with the older seals. The specimens include also a large series of 3-year-olds and a few older seals. It was thus possible to ascertain the approximate size of the seals of different ages. Owing to the fact that there is a range of nearly two months in the actual ages of the seals of a given class, and because of the range of individual variation, there is a small percentage of animals whose age can not be absolutely determined even by careful examination. A careful study of the data at hand, however, convinces that this proportion is probably not greater than 1 in 50 and may be regarded as negligible. To show how much greater is the variation in the weight of the skins of seals of a given age, compared with the total length, the data regarding a killing of 61 seals made on August 10 may be briefly discussed. These seals were selected with ordinary care by the natives as being 3-year-olds. Before they were skinned the length of each animal from the tip of the nose to the base of the tail was taken with calipers and this measurement was recorded against the tag number of the skin. Ten skulls selected at random from the lot were saved for examination. Each skin was then weighed before being salted.

Of the 61 seals, 56 ranged from 44 to 49½ inches in length. Of these, 8 measured 44 to 44½ inches; 10, from 45 to 45½ inches; 12, from 46 to 46½ inches; 8, from 47 to 47½ inches; 10, from 48 to 48½ inches; 8, from 49 to 49½ inches. Of the remaining 5 seals, 1 (probably a 2-year-old) measured 41 inches, and the skin though fat weighed only 5 pounds and 1 ounce; one measured 42½ inches, and 2 measured 43 inches; the remaining one measured 51 inches and since its skull was that of a 3-year-old it doubtless represents the maximum size for this class.

Regarding the weight of the skins of the 56 animals ranging in total length from 44 to 49½ inches, every one of which was certainly a 3-year-old, the lightest weighed 5 pounds 6¼ ounces, and the heaviest 9 pounds 10¼ ounces. The variation in measurements was thus only 11 per cent of the maximum, while the variation in the weight of skins was 44 per cent of the maximum. The 12 skins from animals of practically the same length—46 to 46½ inches—ranged in weight from 5 pounds 6¼ ounces to 8 pounds 5¼ ounces.

An incident showing how little dependence can be placed on the weight of skins as a criterion for age occurred on August 6, when a skin weighing 11 pounds 7¾ ounces was noticed to bear an excessive amount of flesh, probably having been skinned by an inexperienced native. After being divested of the superfluous muscle and fat, it was found to weigh 9 pounds 11¾ ounces, a difference of 1¾ pounds.

From a careful study of these and other data, it is believed that the present practice of weighing each skin should be discontinued and that a check complying with all reasonable requirements may be made by the use on the killing field of calipers by means of which the seals may be rapidly measured by the person in charge. Seals between 42 and 51 inches in body length may be considered as 3-year-olds with but little chance for error. If it is found that seals under or over the proper size are being killed, the fact can be immediately and graphically impressed on the minds of the working force. If desirable, skins of seals departing from the standard may be tagged in the field and a record made of the size or weight, but even this does not seem necessary. It is believed that the real object—the securing of skins of a uniform class—will be accomplished by this method with a minimum of effort, with no waste of valuable time, and with much more accuracy than has been possible under the methods formerly in use.

TAGGING OF SKINS.

The affixing of a leather tag bearing a serial number to each sealskin as a mark of authentication, while it affords a help in recording weights or measurements, does not seem necessary. A tag can, of course, be removed at will and either thrown away or attached to another skin, and therefore does not certainly identify any particular one. Furthermore, it is not practicable to dress the skins without removing the tag. It is therefore necessary to replace the leather tag by pricking in the skin a number or symbol which can by no process be obliterated or hidden, and which, while the skin remains intact, must constitute a distinctive mark.

In view of these facts it seems that the small advantage gained by the system of tagging each skin does not justify the expense and trouble involved, especially if the troublesome and misleading process of recording the weight of each skin be abandoned.

The authentication of the Pribilof Island sealskins will be rendered a matter of certainty by pricking on each skin the letters P or G, followed by some number or symbol to express the year of capture; e. g., P-15 or G-15, to express St. Paul or St. George, 1915. This process of pricking can be effected by a single motion with a small hand instrument as the skins are counted into the salt house preparatory to curing, and the mere recording of the number of skins taken at a killing or during a season can be done as readily as under the present laborious system. As before stated, certain skins which for any reason require special marks may be tagged as at present.

PRACTICAL IMPROVEMENTS NEEDED.

PRESENT UNIMPROVED CONDITION OF PLANT.

It is evident to anyone considering the matter from an unprejudiced standpoint that many improvements are needed in order that the work of sealing, the principal business of the islands, may be more effectively accomplished. The Pribilof Islands, with their herds of fur seals greatly surpassing in number and value any others in the world, constitute a plant equivalent to a private business with an investment of millions of dollars. It is plain that such a business deserves to be put on the most efficient working basis possible. The need of a larger administrative force on the islands and of improvements in some of the methods of the actual work of sealing or of the other

industries more or less directly concerned are treated elsewhere. Under the following heads will be considered particularly the needed improvements and changes of a more or less mechanical nature.

REFORMS CONTEMPLATED BY LESSEES.

The desirability of making certain of the improvements recommended in the present report has been repeatedly pointed out in past years, even before the taking over of the sealing business by the Government. Various improvements were contemplated by the later lessees toward the close of their occupation, but the uncertainty of the renewal of the lease prevented active steps for their adoption. Since the abandonment of the system of leasing, little progress has been made in improving the plant or in instituting useful changes. This has been due partly to the death or serious illness of valuable members of the island force and partly to the results of the agitations which have beset the general administration of affairs. The prevailing impression that the seal herd was reduced to very small and unimportant proportions also contributed to inaction.

BETTER METHODS OF TRANSPORTATION NEEDED.

One of the most important of the improvements needed is the installation of better facilities for transportation. These may be considered under two heads: (1) Facilities for traveling and moving supplies on the islands, and (2) the transportation from the United States to the islands of the necessary supplies and the moving of the annual catch of seal and fox skins to market.

Roads and trails.—A pressing need is the establishment of better facilities for reaching Northeast Point from the village. It is believed that the construction of a tramway to be traversed by a small gas engine would prove most satisfactory. It would be about 12 miles in length and would connect some of the most important hauling grounds with the village, where the only feasible landing places are located. A spur road about 4 miles long would reach Zapadni and would thus allow prompt access to all the important parts of the island. In the event of a raid on the rookeries, prompt action would be of the highest importance, while the moral effect inspired by a state of preparedness might go far in preventing such an occurrence. A wagon road, much of which is deep in sand, now connects the extremities of the island, but under present conditions travel by mule team is scarcely faster than progress on foot. In the days of active commercial sealing nearly one-third of the skins from St. Paul Island were taken at Northeast Point, and as the facilities for landing there are very poor, the importance of a ready means of hauling the skins to the village, when sealing is resumed, is apparent. The installation of a tram road would also provide for the prompt delivery of the sealing force at the scene of their labors whenever a killing was planned and the skins secured could be promptly transported to the main salt house and there cared for more economically than at Northeast Point. This road would also serve as an important aid in properly distributing seal meat intended for the foxes or for other purposes.

Whether or not a tram road to Northeast Point is installed, the construction of a number of shorter roads on both islands is important. One from the village of St. Paul to Reef Rookery is highly desirable, as it would permit killing near the rookery and would do away with the killing ground now situated at the edge of the village. Foot

trails to the various rookeries near the village may also be laid out at a trifling expense, and would allow ready access by foot or horseback for purposes of inspection and study.

On St. George Island no draft animals are now used, but the construction of a road connecting Garden Cove with the village seems important. It often happens that a landing can be made at Garden Cove when none other is possible, but this place can not be used for the landing of general supplies because of the lack of any means of transporting the goods to the village, a distance of about 3 miles. Because of this it is sometimes impossible to land urgently needed merchandise. A foot trail now connects these places, and another facilitates travel to Zapadni, 5 miles from the village. There are trails to North and East rookeries also, but they need improvement. A road to Staraya Artel, at present the most important hauling ground on the island, also seems desirable. The seals are now driven to the village, a distance of about $2\frac{1}{2}$ miles, and a road would do away with the necessity for this long drive.

The importance of a better system of transportation in connection with the problem of distributing fox food has been referred to in the account of that animal. The fox herds represent very valuable possibilities, and it is important that their needs be fully considered.

Supply ship.—For the transportation of the supplies needed for the Pribilof Islands the charter of a ship of approximately 1,000 tons is necessary. For the *Homer*, which has been employed for several seasons on this work, the average cost for the past four seasons was a little over \$21,000. The cost of the *Melville Dollar* for the season of 1914 was a little over \$18,000 for 59 days, or slightly over \$300 per day. It would seem that an annual expenditure of this amount would justify the acquisition by the Bureau of Fisheries of a ship to be used chiefly or entirely for the Alaskan service. Two trips to the islands should be made; the first with the opening of navigation and another as late in the autumn as the weather conditions allow.

The landing of cargo on the Pribilof Islands is a matter of considerable difficulty. There are no wharves nor even harbors on either island. A ship must lie at some distance offshore in such place as affords the best shelter under the prevailing condition of the wind. It frequently happens, under stress of weather conditions, that the place most favorable for landing cargo has to be abandoned while the ship weathers out the storm in some more favorable spot. All cargo must be landed in the native boats called bidarras, which are made by stretching a cover of sea-lion skins over a wooden framework. In spite of the increasing difficulty of procuring enough skins suitable for this purpose, the use of the native boats has been continued. They have the distinct advantage of being so constructed that they stand the buffeting against the sides of the ship without injury. They can carry only about 5 tons, however, so that the landing of the cargo of approximately 800 tons necessitates a great many trips, even with the use of two boats. During the season of 1914 the ship was detained 9 days at St. Paul and 12 days at St. George at a cost of \$300 per day in landing the cargo. It is evident, in view both of the growing scarcity of the sea lions and of the objections to the use of the skin boats, that some substitute for the latter must soon be found.

In many places cargoes are landed by means of a car running on a cable which is stretched between the anchored ship and a high point on the shore. Steps should be taken to ascertain whether this or some other efficient method can not be used on the Pribilof Islands.

COLD-STORAGE PLANTS.

With the resumption of sealing on a commercial scale and with better methods of local transportation, it is believed that the establishment on each island of a small cold-storage plant would be a wise and economical project. The great quantities of seal meat, above what can be used by the natives and to support the fox herd, should not be allowed to go to waste. Cold storage would not only provide for preserving the winter supply of meat for the natives and for the fox herd, but would allow the surplus to be economically utilized for other purposes. There are on the Aleutian Islands and elsewhere in northern Alaska many communities of natives which have been reduced to actual want through the cessation of sea-otter hunting, the extirpation or reduction in numbers of other animals formerly relied on, or from the desertion of routes of trade which formerly brought them employment. The partial or entire support of some of these people must eventually be borne by the Government. Unalaska was formerly the center of a prosperous sea-otter trade, and later the scene of much activity by reason of its being a stopping place for vessels bound for northern Alaska, but is now of little importance as a port, and its inhabitants are much reduced in circumstances. To such a community a portion of the seal meat which might be wasted on the Pribilofs, only 200 miles away, would be of the utmost importance. It is also by no means unlikely that a market for a quantity of the surplus meat, which is very nourishing and not unpalatable, might be found among the poorer classes in the cities of the west coast of the United States.

A further important advantage to be gained by the use of cold storage would be found in the possibility of limiting the driving and killing of seals to the season when females are not associated with the young males. The accidental and very undesirable killing of even a few cows might thus be almost entirely avoided.

ROOKERY IMPROVEMENTS.

Some work in improving the ground on several of the breeding rookeries should be done. This is a matter which has been frequently discussed, but very little has been accomplished. The perpetuation of the series of marked rocks to facilitate the taking and recording of observations is also important.

Marked rocks.—On each of the rookeries is a series of rocks marked by numbers put on with white paint, the work of the Coast and Geodetic Survey. These rocks serve as landmarks for locating and recording the harems and the boundaries of hauling grounds. Many of the numbers, from long exposure to the weather, are becoming obliterated and in some cases can no longer be deciphered. Since these marked rocks have figured in the records of observations for several years, it is very important that they be repainted when necessary.

Observation stations.—In some of the more crowded rookeries it is very difficult to count the harems, and as it will be desirable to count them for several years at least, a few observation stands should be built. They may be towers of rock a few feet in height, and in some cases will need to be connected with the rear of the occupied space by lanes protected by walls of rock which afford a safe path through the rookery mass. At present Reef Rookery is most in need of these observation towers. In 1914 it was

difficult to count the harems there, and if the breeding area is increased in future years, as is almost certain, it will be impossible to make an accurate count without their aid. An inclosed station on Gorbatch for the accommodation of visitors to the islands also would serve a useful purpose, since it is now difficult to carry out the regulations in regard to the inspection of the seals by persons landing on the islands for a few hours and desiring to see the seals.

Improvement of ground.—Although the breeding ground preferred by the seals is decidedly uneven in character, some of the occupied areas are so rough that the cows and pups are exposed to considerable discomfort and danger. Small hollows between bowlders afford refuge to the pups and protect them from trampling, but where deep cavities occur pups and occasionally cows may be unable to escape from them and may perish. These cavities are a source of great annoyance also in the work of counting the pups, as it frequently happens that several dozen must be pulled bodily from a cavern before any idea of their number can be gained. Certain stretches on Lukanin, Gorbatch, and Tolstoi are particularly troublesome.

By blocking the entrances to the larger cavities and by filling the smaller ones with loose bowlders the rookery grounds can be greatly improved. A few days' work with a gang of men would give good results. It would be advisable to do as much of this work as possible in the spring before the arrival of the bulls in order that the animals of that season might benefit by the improvement.

On Polovina Rookery there are a number of caves in the soft bank, evidently formed by the action of the waves during the storms of winter, which become packed with the little pups. Nearly a hundred were taken from one of these caves during the pup counting of 1914. As these soft banks are constantly crumbling, there is always danger of some of the little creatures being buried by the slipping of a part of the bank. These places should be inspected each spring, and such portions of the bank as seem dangerous should be cut down. The likelihood of having to pave sandy areas which in the past have been affected with *Uncinaria* should not be lost sight of. While no evidence of this pest was found in 1914, it may recur at any time. Areas which were especially favorable to the spread of the plague have been improved from time to time by being partially covered with rock, and this treatment appears to have borne good results. Close watch should be kept, and at the first evidence of the recurrence of the pest the affected places should be partially or completely paved. The shrinking of the rookery areas in late years has naturally led to the abandonment of some of these affected spots, but with the increase of the herd they will doubtless be reoccupied and may again become serious sources of mortality.

THE EFFECT OF EXISTING LAWS.

Among the matters to which special attention was directed in the instructions for the investigation of 1914 was "The strength of the surplus male life in relation to the close-time provisions of existing law and to treaty obligations."

The most recent law affecting the seal herd, and the one under which it is chiefly administered, became effective August 24, 1912. It provides that all killing of fur seals be suspended for a period of five years, except the limited number of male seals needed as food for the natives. It further provides that not less than 5,000 males shall be reserved for breeding in each year after the resumption of killing until 1926,

and thus prescribes by exact figures the nature of the management of the herd for a period of 14 years, or until the expiration of the international agreement by which pelagic sealing was stopped. The text of the law relating to these important provisions is as follows:

SEC. 11. That from and after the approval of this act all killing of fur seals on the Pribilof Islands, or anywhere within the jurisdiction of the United States in Alaska, shall be suspended for a period of five years, and shall be, and is hereby, declared to be unlawful; and all punishments and penalties heretofore enacted for the illegal killing of fur seals shall be applicable and inflicted upon offenders under this section: *Provided*, That this prohibition shall not apply to the annual killing on the Pribilof Islands of such male seals as are needed to supply food, clothing, and boat skins for the natives on the islands, as is provided for in article eleven of said convention; the skins of all seals so used for food shall be preserved and annually sold by the Government, and proceeds of such annual sales shall be covered into the Treasury of the United States: *Provided further*, That at the expiration of the said five years' suspension of all commercial killing as above provided, said killing may be resumed under authority of the Secretary of Commerce and Labor: *Provided, however*, That the number of three-year-old males selected from among the finest and most perfect seals of that age found on the hauling grounds to be reserved for breeding purposes, in each year ending August first, shall not be fewer than the following: In nineteen hundred and seventeen, and in each year thereafter until nineteen hundred and twenty-six, inclusive, five thousand.

THE LAW EFFECTIVE FOR LONGER THAN INTENDED.

This law, which was introduced in the House of Representatives on February 15, 1912, was pending during the sealing season of 1912, and, in the expectation of its passage at an early date, operations were limited until its final provisions should become known. This did not occur until the season had closed, the result being that although the law was not in force during that season the effect was the same, for only 3,764 seals were killed, a number scarcely sufficient to supply meat for the natives. Thus the close-time provision of the law was in effect increased from five to six years, and in actual practice the law will operate one year in excess of its intent.

AS A BENEFICIAL MEASURE THE LAW HAS SERVED ITS PURPOSE.

At the present time, therefore, commercial killing has been suspended for a period of three seasons, though the law has actually been on the statute books but two years. What has been accomplished in these three seasons is of the highest importance. The law is entitled "An act to give effect to the convention between the Governments of the United States, Great Britain, Japan, and Russia for the preservation and protection of the fur seals and sea otter which frequent the waters of the North Pacific Ocean, concluded at Washington July seventh, nineteen hundred and eleven." Obviously it was a conservation measure, and now, after three years, it may be inquired how far its intent has been fulfilled.

In 1912, when the law was under discussion, conditions were very different from those at present. At that time pelagic sealing had just been stopped, the herd was at a low ebb, male life was greatly reduced, the real or supposed evils of former systems of management were fresh in mind, and conflicting opinions were freely expressed as to the fate of the seals. The ultimate needs of the herd were obscured by the complicated and special nature of the subject and by its long, involved history, in which almost all important points were rendered elusive by the uncertain factors contributed by pelagic sealing. Under these circumstances it was inevitable that the law as finally

passed would be something of a compromise except as to its main feature, which was that the seals receive immediate and practically unqualified protection.

In 1914, after three years without pelagic sealing and without commercial killing on land, the herd is found to be in flourishing condition, the stock of breeding females appreciably increased, an ample supply of breeding males assured, and a large surplus of males immediately impending. To produce such conditions was doubtless the main object of the law, and it is evident that as a purely protective measure the law up to the present time has been successful and beneficial. This improvement in the herd, however, seems to indicate that at least certain provisions of the law no longer accord with its intent.

EVILS OF LEASING SYSTEM NOT POSSIBLE UNDER GOVERNMENT MANAGEMENT.

The herd is now beyond the danger point, and with full governmental control, protection of the seals and conservative management would be assured without special restrictions. Departmental officers having discretionary power, and even agents on the islands, could have no possible incentive for furthering any interests other than those of the Government itself. A law restricting killing does not guard against the cupidity of any private individual or any Government employee, because under the new system no one can gain by excessive killing. Under private leasing, whether or not irregularities existed, it is conceivable that the system might have offered temptation to dishonest parties; but under full governmental administration circumstances can scarcely be imagined in which individual officers could derive personal profit at the expense of the Government's interest. Detailed regulations influenced by real or supposed injurious practices of the past, therefore, are entirely unnecessary at present. The general laws against official misconduct cover practically every possible contingency.

FLEXIBLE REGULATIONS DESIRABLE.

The nature of sealing as a business is such that restrictions of a fixed and absolute character are highly impractical. Living animals subject to the ravages of disease, to the inroads of natural enemies, to the vicissitudes of an unusually stressful existence, and to the varying results of peculiar breeding habits can not be successfully managed under inflexible rules laid down long in advance. The establishment of close seasons for game animals, especially those of the deer family, is quite a different matter from the restriction of killing of fur seals. A comparison of fur seals with American elk, caribou, or prong-horned antelope in this connection would scarcely be made by any one having first-hand knowledge of the nature and habits of the seals as well as of the game animals. If all the elk, caribou, or antelope living came annually to a Government reservation where they could be enumerated and proportioned as to age and sex, there would be no reason to prohibit the killing of males not needed as breeders.

Among wild animals the fur seal is unique in many respects. Although not actually under domestication, it is by nature and habits almost strictly comparable to a domestic animal, and the principles governing its management should unquestionably be those employed by breeders of live stock. Rigid rules of procedure, therefore, are as inadvisable in the case of the seals as they would be with horses, cattle, or sheep. So far as possible, regulations should be sufficiently elastic to take advantage of conditions as they

arise. The number of males which should be killed or reserved can not, in the nature of the case, be absolute. It is not and never can be a fixed number, and the only possible way in which it can be stated in advance is in relative terms. That is, the number to be killed or to be reserved in any given season depends upon the number that are present in that season and upon the relation which the number of males of certain ages bears to the number of females. With pelagic sealing abolished, these numbers and proportions can be determined with all reasonable accuracy. Whether the herd be large or small, diminishing or progressing, good management demands discretionary power in the hands of responsible officers in order that action may be governed by circumstances. Inflexible rules applied to living animals are dangerous under any circumstances and in the case of the seals are no more necessary now than they will ever be. The relative proportions of males and females should be the same in a herd of a thousand seals as in one of a hundred thousand or a million, and in any case it is wholly a matter of proportions, not of fixed numbers.

RESERVES UNDULY LARGE.

The subject of reserving males for breeding has received careful consideration in the present report. It has been recognized that the number of bulls in recent years may have been inadequate, and it has been concluded that in the future a much larger supply would be desirable, even to the point of having somewhat more than the requirements of a most conservative ratio of males to females. But the reserves of the law go far beyond the needs determined by a careful investigation of present conditions.

Aside from the close-time provision of existing law, which in itself provides more males than necessary, the subsequent reserves of 5,000 per annum are excessive. After thorough and unprejudiced investigation it is found impossible by argument or calculation to justify such large reserves. As shown elsewhere (p. 82), the close-time and the later reserves will produce an enormous supply of males unwarranted by any policy, unless it be one of permanent cessation of killing for sentimental reasons. Such a policy is, of course, impractical, for it would mean a return to pelagic sealing, which is brutal in the extreme, whereas land killing is quite as humane as the killing of domestic animals for food. This great excess of males would doubtless cause some increased fighting and consequent mortality detrimental to the herd, but laying this aside as of minor importance, it is evident that a great waste is involved. The money loss alone during the period affected promises to be very large, not less than \$2,700,000 by most conservative estimates.

It should be stated that if these reserves were liberal merely to provide for emergencies or errors in estimates, no objection to them could be urged. But they are much more than liberal, since they provide not twice as many but several times as many as a very conservative ratio of males to females would require. In the end it is believed they would produce a stock of some 50,000 bulls where less than 10,000 would be a liberal allowance. That is, if bulls and cows increase at the same rate, the law provides for a herd in 1921 in which there would be one bull for every three cows, instead of one to forty, the a reasonable ratio.

MATTERS FOR SPECIAL DISCRETIONARY POWER.

Emergency action.—The concurrent action of the law of 1912 and the previous law of April 21, 1910, places such restrictions on the killing of seals that even in cases of urgent necessity action could not legally be taken.

The clauses bearing particularly upon this matter are as follows:

ACT OF APRIL 21, 1910.

SEC. 6. That section nineteen hundred and sixty of the Revised Statutes of the United States and section one hundred and seventy-seven of the act of March third, eighteen hundred and ninety-nine be amended to read as follows:

It shall be unlawful to kill any fur seal upon the Pribilof Islands, or in the waters adjacent thereto, except under the authority of the Secretary of Commerce and Labor, and it shall be unlawful to kill such seals by the use of firearms or by other means tending to drive the seals away from those islands; but the natives of the islands shall have the privilege of killing such young seals as may be necessary for their own food and clothing, and also such old seals as may be required for their own clothing and for the manufacture of boats for their own use; and the killing in such cases shall be limited and controlled by such regulations as may be prescribed by the Secretary of Commerce and Labor.

SEC. 7. That section nineteen hundred and sixty-one of the Revised Statutes of the United States and section one hundred and seventy-eight of the act of March third, eighteen hundred and ninety-nine, be amended to read as follows:

It shall be unlawful to kill any female seal or any seal less than one year old at any season of the year, except as above provided; and it shall also be unlawful to kill any seal in the waters adjacent to the Pribilof Islands, or on the beaches, cliffs, or rocks where they haul up from the sea to remain; and every person who violates the provisions of this or the preceding section shall be punished for each offense by a fine of not less than two hundred dollars nor more than one thousand dollars or by imprisonment not more than six months, or by both such fine and imprisonment; and all vessels, their tackle, apparel, and furniture, whose crews are found engaged in the violation of either this or the preceding section shall be forfeited to the United States.

ACT OF AUGUST 24, 1912.

SEC. 11. That from and after the approval of this act all killing of fur seals on the Pribilof Islands, or anywhere within the jurisdiction of the United States in Alaska, shall be suspended for a period of five years, and shall be, and is hereby, declared to be unlawful; and all punishments and penalties heretofore enacted for the illegal killing of fur seals shall be applicable and inflicted upon offenders under this section: *Provided*, That this prohibition shall not apply to the annual killing on the Pribilof Islands of such male seals as are needed to supply food, clothing, and boat skins for the natives on the islands, as is provided for in article eleven of said convention; * * *

From this it appears that in the event of a sudden epidemic of disease or in any other emergency requiring immediate and perhaps drastic measures, no officer would have authority to kill female seals. The provision against the use of firearms has a similar effect since conditions may arise making it advisable to kill certain animals, as vicious old bulls, which can not be put to death by the usual methods. In addition, ordinary humane action in the case of wounded or injured seals is prohibited. Pups or cubs may be found mortally wounded by the bulls or by falling rocks, but under the law they can not be put out of their misery and must be allowed to suffer a lingering death. Several cases of this kind occurred in the season of 1914. Under present conditions there are no advantages gained by these provisions of the law. The agents are not and can not be under any temptation to permit unnecessary killing of females or young, but even if they should be, the matter could be governed by regulations limiting regular killings to seals from the hauling grounds and to the season ending July 31.

Annual sale of skins.—In section 11 of the law of 1912 it is provided that “the skins of all seals so used for food shall be preserved and *annually* sold by the Government.” A further provision of the same section relating to the disposition of skins obtained from commercial killings and from the Governments of Great Britain and Japan states that “all skins which are or shall become the property of the United States from any source whatsoever shall be sold by the Secretary of Commerce and Labor in such market, at such times, and in such manner as he may deem most advantageous.” Thus at least food skins taken during the five-year period of restricted killing are to be sold annually, and by construing the first provision of the law as governing the second, the same course will be necessary with all skins taken in the future.

Obviously it would be to the interest of the government to be able to take advantage of the best market conditions in all cases. A temporary depression, such as that caused by the European war, would make it advisable to postpone the sale to a more favorable date, but under the present laws this can not be done without special authority from Congress.^a The sale has usually been conducted in December or January. The time between the shipment of the skins and the sale may be so short that conditions are likely to arise making it desirable to postpone the sale for several months. Even slightly depressed market conditions during the restricted period allowed for the sale might cause serious loss.

Specimens for scientific purposes.—The laws make no provision for the preservation of specimens of the fur seal for scientific investigation or for exhibition in public museums. It is altogether probable that in the future management of the herd practical problems will arise which can not be settled except by research involving the killing of certain seals, including some proportion of females and young. Such problems may relate to breeding and reproduction, to ascertaining the cause of disease, or to various other matters. Although of technical nature, they may be of great economic importance, and failure to provide for them may result in large financial loss. During the investigation of 1914, the legal prohibition against killing females proved embarrassing, and certain matters which otherwise might have received attention were therefore disregarded. The preservation of specimens of the fur seal in public museums is surely worthy of consideration because of the educational service to the public. Many of our museums have very few or no specimens of the fur seal, and even in the United States National Museum, where such an important and interesting animal should be well represented, the specimens are old and imperfect. Under the law, even the skins of seals that have died from natural causes and which may have only trifling money value, must be sold like any others.

It is plain, therefore, that a provision which would place the killing of seals for scientific or educational purposes within the discretion of a responsible official would be very desirable.

EFFECT OF RESTRICTED SEALING ON THE FOX HERD.

The blue foxes of the Pribilof Islands constitute an important and valuable asset. Undue restriction of sealing not only causes a reduced revenue from the seals but

^a This was found necessary in December, 1914, when a joint resolution to postpone the sale of food skins for that season was introduced in Congress. Such action would have been unnecessary if the time of sale had been within the discretion of a responsible official.

involves an additional loss through its effect on the foxes. As shown in the special discussion (p. 106), the decline of the output of fox skins has been coincident with the reduction of seal killing and is due to the lack of a sufficient supply of seal carcasses upon which the foxes are dependent. This decline has progressed more rapidly since the limitation of sealing imposed by the law of 1912 until at the present time the fox industry is in a highly undesirable condition, the animals being greatly reduced in number and the stock deteriorated in quality and vigor. The resumption of sealing on a larger scale would provide means for the upbuilding of the fox herd; otherwise prompt measures of some other sort will be necessary. The main problem is one of food supply, and owing to the isolation of the islands and the poor facilities for communication the securing of fox food other than seal meat is beset with difficulties. Therefore it is desirable that seal meat be provided for them at the earliest possible time; that is, as soon as the condition of the seal herd will warrant it. That this time has already arrived is evident from the general results of the investigation of 1914, and while no consideration of the foxes should be permitted to jeopardize the sealing interests it is to be remembered that with the good condition of the seals assured the foxes are capable of producing a revenue not to be ignored.

In former years, without any attempt at careful management, more than 1,000 fox skins were taken annually on St. George Island alone. Such an output, at the prices prevailing in recent years, would have realized a revenue of \$40,000 to \$50,000 per annum. That an equally large or a larger revenue may be obtained in the future is scarcely to be doubted if proper measures be taken now.

THE TREATY.

The treaty effective December 15, 1911, between the United States, Great Britain, Japan, and Russia is essentially an agreement by which the foreign nations relinquish their right to take seals on the high seas in exchange for a share in land sealing to be conducted by the United States. The main assumption of the treaty is that the decline of the herd has been caused by pelagic sealing and not by land sealing, a conclusion formed and agreed upon by the joint conference of British and American experts after the investigation of 1896-97. The Governments of Great Britain and Japan paid large sums to retire their sealing fleets, obviously expecting to be reimbursed in the near future by their 15 per cent share of land sealing. The United States is granted the right to suspend land sealing under two conditions: (1) To protect and preserve the seal herd, and (2) to increase its number. The statements of the treaty in regard to these provisions (Sen. Doc. No. 75, 62d Cong., 1st Sess.) are as follows:

ART. X, page 7, lines 15-22: *Provided, however,* That nothing herein contained shall restrict the right of the United States at any time and from time to time to suspend altogether the taking of sealskins on such islands or shores subject to its jurisdiction, and to impose such restrictions and regulations upon the total number of skins to be taken in any season and the manner and times and places of taking them as may seem necessary *to protect and preserve the seal herd or to increase its number.*

ART. XI, page 8, lines 25-32: If, however, the total number of seals frequenting the United States islands in any year falls below one hundred thousand (100,000), enumerated by official count, then all killing, excepting the inconsiderable supply necessary for the support of the natives as above noted, may be suspended without allowance of skins or payment of money equivalent until the number of such seals again exceeds one hundred thousand (100,000) enumerated in like manner.

Without attempting to interpret these sections of the treaty, it may be stated that a number of American experts and officials, both scientific and legal, have expressed the opinion that the right to suspend land sealing depends upon the need of the herd for protection and that unless this need can be demonstrated land sealing should go on under no limitation except that required for the preservation and growth of the herd. If this opinion be sound, the important question is, Does the herd need protection to the extent of continued suspension of land killing? Even assuming to the full that the herd did need protection when the law of 1912 was enacted, this nevertheless does not relieve us from the obligation of demonstrating that it still needs it now after three seasons without commercial sealing. No such necessity can be demonstrated. The condition of the seal herd in 1914, as set forth in this report, is such that resumption of commercial sealing on a moderate scale in 1915 could be undertaken with confidence that the protection and growth of the herd would not be jeopardized in the slightest degree. The inference is clear, therefore, that unless sealing be resumed agitation will be continued and the integrity of a most desirable treaty endangered.

EARLY SOLUTION OF PRACTICAL PROBLEMS IMPORTANT.

At the time the law of 1912 was enacted, there were certain important practical problems regarding the seals which hitherto had remained unsolved owing to the existence of pelagic sealing. The treaty of 1911 had abolished this form of sealing, opening the way for the solution of these problems. The law, however, was and still is an effectual bar to the elucidation of these vital matters. The principal points to be determined as prerequisites of sound and systematic management relate to distinguishing seals of different ages and to ascertaining the number or proportion of males that naturally survive to the age of 3 years, these forming the class from which both killings and breeding reserves are drawn. As shown elsewhere, the conditions for obtaining this information will be particularly favorable in 1915. The number of pups born in 1912 is known, and certain of these which will appear as 3-year-olds in 1915 carry permanent brands which will greatly facilitate the confining of killing and reserving to that class. Therefore, it would be possible to determine fully the characteristics of the 3-year-olds as a standard for future use; and by setting aside a liberal breeding reserve and killing the remainder the total stock remaining from the pups born in 1912 would be learned. Such favorable conditions could not be obtained again until 1918 and then only by repeating in 1915 the branding of pups which was carried out at considerable labor and expense in 1912. Therefore it is highly desirable that the work be done in 1915.

GRADUAL DEVELOPMENT OF EFFICIENCY NECESSARY.

The long-continued ravages of pelagic sealing and the publicity which they gained during the protracted agitation against it, combined with charges of excessive land killing and the undisputed fact that the seal herd was reduced to a fraction of its former size, produced a general impression that the number of seals remaining was only a mere handful, or in fact that the herd was on the very verge of extinction. The total suspension of commercial killing by the law of 1912 has added to this impression and circumstances have caused an interruption and abandonment of continuous policies, a reduced and partly temporary personnel, and general conditions favoring inaction only

justifiable on the assumption that since there are few seals and but little killing, the requirements of the situation must be few and unimportant. The actual conditions, as disclosed by the investigation of 1914, are quite the contrary. Never during American ownership has the situation demanded more careful consideration, more numerous and capable employees, or more liberal financial support.

The seal herd is small only by comparison. Actually it is large and growing rapidly. The business of managing it will involve the handling of a product yielding an annual income equivalent to that of a business enterprise with an investment of at least ten millions of dollars. Extensive preparation and careful study are necessary to avoid large financial loss not only at present but in the future. The native men who do the sealing are losing their former efficiency. The younger ones, of whom much will be required in the future, are gaining but little experience and training and it is plainly evident that a sudden resumption of killing on a large scale a few years hence would find them unequal to the task. The duties and responsibilities of the agents and officials resident on the islands are of a special nature and they too need time and opportunity to grow with the business. Suitable men to fill these positions can not be had for the asking but must be selected with care and trained by experience. Men with special training also are needed for special purposes—to plan and execute general improvements, to build roads and trails, to provide better housing, sanitation, and education for the 300 natives of the islands, to study the possibilities of new industries and economies, the utilization of by-products, and the development of general efficiency—in short, to provide means by which the Pribilof Islands shall be a source of profit, satisfaction, and pride to the Government.

Failure to undertake many needed reforms and to develop efficient and systematic management is to a considerable extent due to the continued suspension of land sealing and it requires no lengthy argument to show that the sooner the Government resumes land sealing, the principal business of the islands, the sooner will it be possible to institute reforms of all kinds and to provide a basis for permanent efficiency.

CONCLUSIONS.

Conclusions regarding the effect of existing laws, especially the law of 1912, as seen in the light of conditions in 1914, may be summarized as follows:

(1) The law effects a suspension of sealing for six years instead of five and sealing has now been restricted for three years.

(2) The benefits of the law as a protective measure have now been attained, the seal herd being past the danger point.

(3) The law guards almost wholly against practices which may have been possible under the leasing system, but which can not occur under full Government management.

(4) The law is a rigid measure imposing fixed restrictions on the management of living animals subject to natural vicissitudes, whereas in the nature of the case reasonable elasticity is required to meet conditions as they arise.

(5) Under the law, no one has discretion to permit the killing of seals in emergencies or exceptional circumstances to prevent the spread of disease, to avoid suffering, to provide material for scientific study, or to obtain specimens for museums and other educational institutions.

(6) By provision for the annual sale of skins, the law makes it difficult to regulate the time of the sale to market conditions. Moreover, a small output of skins during the suspension of commercial sealing may cause the demand for them to diminish, and a sudden large supply upon the resumption of sealing is likely to meet with reduced prices.

(7) The blue fox industry, capable of yielding \$50,000 or more per annum, is reduced to small proportions through lack of seal meat for food.

(8) The continued suspension of sealing and the subsequent reserves provided by law will create a large excess of males, and failure to take and market their skins at the proper time will cause an estimated minimum loss of \$2,700,000.

(9) A part of this loss falls upon Great Britain and Japan, to each of which we are by treaty bound to deliver 15 per cent of the annual take under commercial sealing.

(10) The suspension of sealing prevents the immediate determination of the proportion of seals which naturally survive to killable age, a most vexed and vital matter, which must be settled before any explicit regulations based on sound principles can be formulated.

(11) The development of general efficiency for the future management of a very large and profitable business, the training of both white and native employees, the installation of modern methods, and the numerous preparations necessary for adaptation to new conditions are largely dependent upon the resumption of active sealing at the earliest possible date.

(12) The law now offers no compensations for its many disadvantages. It has served a purpose as a remedy for a shortage of male life, but though a shortage existed when the law was enacted there is no shortage now, and none is likely to occur in the future, whether the law be in effect or not.

THE FOXES.

GENERAL CONSIDERATIONS.

The foxes of the Pribilof Islands belong to a group ordinarily known from their circumpolar habitat as arctic foxes and considered as forming a genus distinct from other foxes. The animals of these islands have become slightly differentiated by long insular isolation from their relatives inhabiting the other parts of the north, and bear the name *Alopex pribilofensis* (Merriam).

The so-called white and blue foxes are not different species but merely represent two color phases of the same animal, the white being the winter coat of the normal phase, which in summer is characterized by a brown back and shoulders and tawny sides. The blue fox is the abnormal dark color phase, sooty gray in summer, and bluish gray in winter. This sooty phase is found practically throughout the range of the animal, at least in America, but is usually much less abundant than the ordinary phase and in some sections is so rare as to be practically unknown.

On the Pribilof Islands, however, the sooty phase so outnumbered the ordinary phase as to be practically the normal state. According to old accounts, blue foxes only were found on the islands when they were first discovered, and the white ones came (presumably on the ice) a few winters afterwards. This is probably an error, as it is much more likely that the white were present at first but were overlooked until their white winter condition forced itself on the attention of the discoverers. It is undoubtedly true, however, that foxes do occasionally reach the islands from the north on the pack ice,

and as these would probably come from regions where the normal phase predominates it is likely that the majority of such immigrants would be white. Such infrequent arrivals, however, can have had but little effect of any kind on the Pribilof herd within historic times.

Because of the beauty and rarity of the blue fox its value has always been much greater than that of the white. Until very recent years the white skins were worth very little, but the growing scarcity of all kinds of fur has resulted lately in a great increase in their value.

During the continuance of the leasing system the companies paid to the natives a certain price for taking the skins and sold them in the best markets, the Government deriving no benefit from the transaction. Since the discontinuance of this system in 1910 the same methods have been followed by the Government, which now derives a revenue from the animals. The gross proceeds of the catch of the winter of 1910, 371 blue and 20 white skins, were \$16,563.55; the expenses of marketing were \$1,466.92. The net price received was thus about \$40 each for the blue skins and \$6 each for the white. Of the skins taken in 1911, 12 blues netted over \$50 each, and the whites about \$13 each, while an exceptionally fine lot of 31 blue fox skins brought a gross return of \$131 each. Of those taken in 1912, 13 brought slightly less on the average, a little under \$40 each for the blue and about \$11 each for the white. One lot of 6 fine blue skins brought an average gross price of \$158 each. The net proceeds to the Government from the sale of fox skins for 1910-11 were \$15,096.58; for 1911-12, \$20,505.17; and for 1912-13, about \$16,000. It is plain that an industry which even in its present depleted state has yielded this revenue deserves to be brought up to a higher state of efficiency.

FORMER ABUNDANCE.

According to the old records, foxes were present on the Pribilof Islands when they were first visited, but regarding their numbers in early times we know very little. During the period from 1842 to 1860, inclusive, the Russian-American Co. took from the Pribilofs an average annual catch of 1,829 foxes; more than two-thirds of these came from St. George. From 1861 to 1870 the complete figures are not available. From 1871 to 1890 a total of 24,792 skins was taken from both islands; 20,412 of these came from St. George, an annual average of 1,020 skins. During all this time practically no attention was paid to the care of the foxes, which subsisted mainly on the birds and on the bodies of the seals which had been left on the killing fields.

DECLINE FROM LACK OF FOOD.

About 1890 the number of foxes begun to show a marked diminution, undoubtedly due to the smaller quota of seals killed. Within the next few years, during the *modus vivendi*, the catch of seals being limited to the food requirements of the human inhabitants, the foxes suffered further reduction in numbers. During the period from 1891 to 1900 the total catch for both islands was only 6,245 skins. The decline being attributed to over-trapping, no foxes were killed on either island during the winters of 1891-2 and 1894-5, and the season of 1898-9 was marked by a suspension of killing on St. Paul. But the scarcity of food rather than excessive killing gradually becoming recognized as the real cause of the decline, the special feeding of the animals was taken up in 1896,

and has been carried on in a more or less systematic way ever since. This matter is elsewhere discussed.

In marked contrast to the numbers taken on the Pribilof Islands during the middle and latter part of the last century, the lessened number yielded during the last two decades is of interest. The figures have been compiled from various authentic sources.

Number of foxes taken on Pribilof Islands, 1890-1913.

	St. Paul.			St. George.			Pribilof Islands.		
	Blue.	White.	Total.	Blue.	White.	Total.	Blue.	White.	Total.
1890-91.....	^a 525		525	793		793	1,318		1,318
1891-92.....			(^b)			(^b)			
1892-93.....	336	37	373	928		928	1,264	37	1,301
1893-94.....	213	27	240	557	14	571	770	41	811
1894-95.....	^d 8		8			(^b)	8		8
1895-96.....	256	18	274	^c 33		33	^c 289	18	307
1896-97.....	214	9	223	^c 497		497	^c 711	9	720
1897-98.....	149	18	167	^c 346		346	^c 495	18	513
1898-99.....			(^b)	^c 386		386	^c 386		386
1899-1900.....	245	28	273	^c 418		418	^c 663	28	691
1900-1901.....	155	1	156	^c 441		441	^c 596	1	597
1901-2.....	163	7	170	^c 246		246	^c 409	7	416
1902-3.....	228	10	238	^c 511		511	^c 739	10	749
1903-4.....	15	5	20	486	15	501	501	20	521
1904-5.....	31	2	^d 33	262	10	272	293	12	305
1905-6.....			(^b)	468	12	480	468	12	480
1906-7.....			(^b)	366	8	374	366	8	374
1907-8.....			(^b)	438	8	446	438	8	446
1908-9.....			(^b)	367	10	377	367	10	377
1909-10.....	149	36	^e 185	212	10	222	361	46	407
1910-11.....	131	20	151	240	1	241	371	21	392
1911-12.....	109	27	136	275	2	277	384	29	413
1912-13.....	143	30	173	262	1	263	405	31	436
1913-14.....	150	25	175	106	1	107	256	26	282

^a Including 10 pairs blue foxes sold for breeding purposes.
^b No trapping done.
^c Including a few white foxes.

^d From Otter Island; none taken on St. Paul.
^e Including 19 blue and 1 white from Otter Island.

It will be noticed that a few skins have been taken on Otter Island. In former years this island, situated about 6 miles southward from St. Paul, maintained a considerable herd of foxes. In December, 1875, according to the St. Paul records, 60 foxes were taken. In December, 1894, a trapping party took 8 foxes and was supposed to have depopulated the island. No more appear to have been taken there until the winter of 1904-5, when 33 were killed. In December, 1909, 19 blue foxes and 1 white one were taken there.

During our visit to Otter Island in July, 1914, we looked carefully for foxes, but saw no traces. This island has large colonies of breeding birds and would support a good number of foxes during the summer, but the natural supply of food in winter is apparently not sufficient. In former times a few fur seals bred there, and the bachelors hauled out in some numbers. Although none seem to have been killed there, the animals dying from natural causes may have afforded some food, which, added to what was obtainable on the beaches, permitted numbers of the foxes to survive the winter. That they were never in a prosperous condition is indicated by the fact that the skins taken there have always been reported as inferior. Unless seals should again resort to Otter Island in numbers sufficient to warrant killing for the skins, so that winter provision could be supplied, it will probably be unwise to encourage the foxes to increase there. Although there are none there at present, a few are likely to reach there from St. Paul whenever the pack ice occurs in quantity.

On one occasion, on June 11, 1892, a fox was found on Walrus Island. Its activities had prevented the birds from beginning to nest, and it was shot. On June 27, when the island was next visited, a boatload of eggs was gathered.

DISEASES.

The main cause of the decline of the fox herd, lack of food, has been sufficiently discussed. Some diminution due to disease has taken place, but apparently there has never been any serious epidemic. Deaths of occasional individuals occur from tuberculosis, hemorrhage, or other affections of the kidneys, and ulcers of the stomach or intestines. Mange, or a similar disease, has appeared at infrequent intervals, and has undoubtedly caused the death of many. It was prevalent on St. George in 1914.

Under this head cannibalism, although undoubtedly due entirely to lack of proper food, may be considered. It has caused a serious loss on a few occasions, the most notable occurring on St. George in the autumn and winter of 1913-14, when several hundred were estimated to have perished from this cause. At this time the foxes were being supplied plentifully with salted food. This apparently had been imperfectly freshened and was not relished by the animals. It is certain that salt is injurious to foxes, and it is not unlikely that the eating of salted food induced a diseased condition similar in effect to scurvy, and that the craving for fresh meat led to cannibalism. During the spring of 1914 the number of foxes observed was unusually small, and many were in poor physical condition.

FOOD.

Seal meat.—Under the conditions prevailing for many years on the Pribilof Islands, while large numbers of seals were killed every season, the thousands of bodies which were left on the killing fields constituted the main source of food for the foxes. To this abundance the islands owe their eminence as a fox nursery. During the few years immediately following 1890, coincident with a reduced catch of seals, a great diminution in the numbers of foxes on both islands was apparent, and although for several years only a few animals were killed the numbers continued to remain at a low ebb. Although other factors have contributed to their continued scarcity, there is no doubt that the main cause has been the lessened quantity of seal meat available. Formerly no special care was taken to preserve the meat, the bodies being merely left on the killing grounds to be disposed of by natural processes, and the foxes securing their share as best they could. But when it became evident that the diminution in the fox herd was due to the reduced kill of seals, steps were taken to provide the animals with salted food of various kinds, and seal meat was used as far as available. The subject of most effectively utilizing surplus seal meat for fox food is elsewhere discussed.

During the summer and early autumn the bodies of young seals dying from natural causes on the breeding rookeries are eagerly devoured by the foxes being eaten on the spot or dragged to the dens for the young.

Birds and eggs.—The foxes of the Pribilof Islands seem to prefer birds to any other food. The greater abundance of birds on St. George seems to have been the direct cause of the larger number of foxes taken on that island. During the spring and summer the remains of birds, which are found about the burrows of the foxes in large numbers, testify to the fondness of the animals for this food. The foxes are adept climbers and make their way about cliffs which appear absolutely inaccessible to a quadruped. Many gulls,

puffins, murres, and other cliff-nesting species are secured by the foxes in this way. But the bird most commonly eaten is the least auklet, the smallest sea bird found on the islands. These occur literally in millions and are especially numerous on St. George. From the time of their arrival in early May they are pursued relentlessly by the foxes which are easily able to secure them owing to their habit of nesting in large colonies in subterranean cavities on the boulder-covered beaches and ridges. So numerous are the birds, however, that the foxes seem to cause no appreciable diminution in their numbers. During the nesting season the eggs of various birds are eagerly and successfully sought by the foxes. Though it is probable that eggs of practically all the breeding species are secured, those of the murres furnish the bulk of this form of subsistence. The foxes store large numbers by burying them singly in the mossy tundra in the vicinity of the breeding grounds of the birds. These spots are later visited and the eggs are eaten on the spot or carried to the young.

After the departure of the bulk of the birds in the autumn, the foxes derive but little benefit from those remaining. An occasional dead bird or an egg overlooked during the time of abundance, or an unfortunate migrant or winter visitor is picked up, but as a source of food in winter, the birds are of little value. Out of about 40 stomachs of foxes examined by A. G. Whitney at St. Paul village late in November, 1913, feathers or other remains of birds were found in 11 cases, but they probably represented only a small amount of nourishment.

Miscellaneous food.—The various invertebrates and other forms of marine life are of great importance as food during the winter, and are of course utilized to some extent at other seasons. Of about 40 stomachs of foxes examined at St. Paul village in late November, 1913, tunicates were found in five cases, and the remains of a fish in one. Grass or other vegetable matter of little nutritive value, but chiefly indicating that the animals were hard pressed for food, were found in 24 cases, sand or earth in 16, and hair in 9. In the records of stomach contents from other parts of the island, examined and recorded by natives, sea eggs (Echinoderms) were frequently mentioned. These notes relating to a series of stomachs which were examined with some care, accord in a general way the results of stomach examinations made in former years on St. George.

In former times many sea lions were killed for their hides and for human food, and much of this meat was available for the foxes. At present the sea lion herd is much depleted and few are killed. Occasionally a dead sea lion, whale, or walrus is cast up and is utilized. A whale, if cast ashore at a point where a quantity of the blubber can be secured, furnishes a great store of excellent fox food. If obtained during the summer, or if desired for use during more than one season, it must be preserved by salting, and of course should be thoroughly freshened before being fed. Quantities of vegetable substances, including grasses and various herbaceous plants, are eaten by the foxes in times of scarcity, but these have little value as food.

Although lemmings are abundant on St. George, and it has always been assumed that they are devoured by the foxes whenever possible, there seems to be no positive evidence to this effect. Among the contents of large numbers of fox stomachs examined during past years no remains of lemmings seem to have been found. During the autumn of 1913, at a time when lemmings were unusually abundant, no evidence was found that any were eaten. At the same time the stronger foxes were eating

their own kind. It seems scarcely credible that lemmings should never be eaten, but it is plain that they can not form an important element in the food supply.

Needs of foxes according to season.—It is evident from the above discussion of the principal sources of food available even at the present time, when comparatively few seals are being killed, that the relatively small number of foxes now living on the islands do not suffer much from hunger during the summer months. During the early autumn also there is apparently a sufficiency of food, but the young foxes, after being abandoned by their parents in early September and while yet inexperienced in seeking food, undoubtedly have a hard struggle for existence. But the fact that the foxes taken in late November are almost invariably fat shows that they have fared well during the autumn. Conditions during midwinter and early spring, however, are necessarily more severe. Regarding the natural food at this season, the most complete observations seem to be those of Dr. W. L. Hahn. On January 18, 1911, he found indications showing that tunicates formed an important source of food supply. In late January he noted that the common stalked ascidian, together with a colonial form, and a large sessile, potato-like form, constituted a very large part of the food of the foxes. Later he found that a few sea urchins were eaten. About the middle of April ascidians and other invertebrates were being eaten. During the winter, however, he noted that the shore ice prevented the foxes from securing a great deal of food which otherwise would have been available.

As regards food obtained from the sea, St. Paul Island on account of its more extensive beaches offers better resources than St. George, where steep cliffs form a large part of the shore line.

Thus waging a constant struggle against starvation and the rigor of the elements the foxes pass the long winter until the arrival of the hordes of birds marks the beginning of a period of abundance.

History of special feeding.—During the winter of 1894-95 when it began to be evident that the growing scarcity of foxes on St. George was due to lack of food, an effort was made to feed such as came about the village, and many were saved from starvation. In the summer of 1896, James Judge inaugurated the present system of feeding on St. George by salting a large quantity of seal carcasses. During the following winter these bodies which had been more or less perfectly preserved were freshened a few at a time and put out for the foxes. The readiness with which they responded and the preference for this food which they exhibited favored the continuance of the practice, and with various modifications this plan has been followed ever since. The lack of a sufficient supply of seal meat above the actual food requirements of the population, however, has made it necessary to resort to other food. Salted or dried salmon and whale blubber have been fed in large quantities and with greater or less success. The difficulty of properly freshening the salted food, however, is always very great. Sea water does not effectively remove the salt and the supply of fresh water being limited to a few places and usually being not ample nor easily available for this purpose, is further reduced in quantity and availability by freezing at the very time it is most needed. The inevitable result has been that much imperfectly freshened food has been given to the animals, sometimes with disastrous results. The difficulties in the way of properly removing the salt from foods preserved in this way seem to be insurmountable, taking into consideration the necessity for supplying the food at a number of widely separated locations.

On a number of occasions the bodies of seals and the offal from those utilized for food by the inhabitants have been buried in pits. When opened in the winter the meat is sometimes entirely spoiled, but usually a portion is eatable. Meat kept in this way is generally not eaten at once, but eventually is consumed. A quantity of seal carcasses buried in the autumn of 1910 on St. Paul Island were examined about midwinter and found to be in a more or less putrid condition. They were not visited by the foxes to any extent until toward the end of the winter, but were still being eaten as late as May 10, 1911. While it is unlikely that any harm to the foxes results from the eating of putrid or imperfectly cured meat, the great waste involved and the hardship of handling the product forbid the use of this method. It is equally plain that salted food, even when freshened under the most favorable conditions, is unnatural and can not fail to be more or less injurious.

The objections to salted or buried food make it necessary to look for some better method of preservation. It may be borne in mind that it is not necessary for the meat to be preserved perfectly, but only sufficiently to guard against loss and to put it in such shape that it can be handled. In the absence of cold storage the remedy seems to be in the use of dried meat. With the improved methods of transportation absolutely necessary in order that the resources of the islands may be effectively and economically exploited, the bodies of seals killed in the vicinity of the hauling grounds at points accessible to the foxes may be hung in screened shelters and dried. It has been proved by experiment that the meat can be preserved in this way at a very small expense, and that the foxes prefer it to salted meat.

The importance of increasing these valuable herds of foxes justifies the expenditure of more care than has been devoted to the subject. The expense and labor of preserving and distributing an ample supply of seal meat, when killing on a larger scale shall be resumed, will probably not be greater than that involved at present. This subject is discussed at greater length elsewhere.

The fact that the methods now in vogue have failed to accomplish the result sought calls for no criticism of the persons who have been in charge. The failure has been due to circumstances which in most cases have been beyond the control of the agents. The fact remains, however, that in spite of what has been done, the number of the animals and to some extent the quality of the fur have gradually declined since special feeding and the reservation of a part of the stock for breeding purposes were inaugurated. In addition the herd on St. George is not only greatly reduced in number at present, but the animals are in very poor physical condition. It is hoped that the causes resulting in these unfavorable conditions have been stated in sufficient detail. The prospect of removing the main obstacles is good, and the outlook for the ultimate restoration of the herd is by no means dark.

BREEDING HABITS.

According to Judge, who has made more careful observations on the foxes than any other person, they mate in March or early April. New-born young have been found from May 17 to June 6. The young are usually born above ground, and are transferred to underground dens within a few days. The dens are usually in rocky ground, or, when situated in sandy areas, beneath a rock.

Among 22 litters of new-born young observed by Judge, the smallest numbered 5 and the largest 11 pups. A newly-born pup weighed $2\frac{1}{4}$ ounces. He states that the

mortality among the young is large, and is due mainly to lack of nourishment and inclement weather. About the middle of June the young begin to be observed about the mouths of the burrows. While the young are small, the mother, assisted frequently by another fox, which is presumably the male parent, is very assiduous in providing them with food. Birds are the favorite prey at this time, and quantities of feathers and other remains which are scattered about the burrows testify to the skill of the animals as hunters. When the dens are in the vicinity of the seal rookeries, the bodies of many pups which have died are dragged away, and the bones picked clean of flesh may be found about the burrows.

METHODS OF CAPTURING.

Previous to 1890 the usual method of capturing foxes on the Pribilof Islands was by means of steel traps. When, however, the plan of feeding them was inaugurated on St. George, the readiness with which the animals came to the feeding places suggested capturing them in box traps, so that certain ones could be liberated for breeding. This proving successful, the plan was conceived of taking them in larger numbers by means of a larger trap. As finally perfected, this was a cage of woven wire 14 by 10 feet and 8 feet high, provided with a door which could be closed at will. This cage adjoins a house divided into three rooms, used for storing and freshening the food and handling the foxes. This trap, which is the regular feeding place, is usually left open so that the foxes can come and go at will. The animals having become accustomed to the cage, it is only necessary to remain in hiding until a number of them have entered the inclosure and then close the door by means of a rope. The animals are then examined and those to be reserved as breeders are marked by clipping a ring of fur from the tail, the males being marked near the end of the tail, and females near the base. Those left for breeders must be of good color, not too old, and in good physical condition. Males taken in early winter, in good condition, usually range in weight from about 8 to 14 pounds, and females from 7 to 10 pounds. In selecting those to be left for breeding, no males weighing less than 10 pounds are saved and no females less than $7\frac{1}{2}$ pounds.

It was formerly the custom to reserve a preponderance of females, but the fact that the fox is a monogamous animal being recognized, the sexes are now left in approximately equal numbers. For a number of years previous to 1910, approximately 200 pairs were usually released as breeders. Since then the number has usually been less. During the winter of 1913-14, 237 males and 192 females were released, but as before stated, the spring of 1914 found the animals in poor physical condition, so that this number can not be taken as an indication that the herd is in a prosperous condition.

In the annual trapping and handling of as many of the St. George foxes as can be secured, all white ones and all those crippled or diseased are killed. On St. Paul Island the trapping has been almost entirely by means of steel traps, though deadfalls are sometimes used. For many years it has been the custom to allow the natives to shoot all white foxes seen during the trapping season, and during some years for longer periods, but this method has not been very effectual. The reasons will be discussed later.

Of a lot of 1,044 foxes handled on St. George Island during the winter of 1905-6, as recorded by Chichester (Senate Doc. 376, 60th Cong., 1st sess., p. 51, 1908), 497 were

males and 547 were females. Of these 218 males and 245 females were killed. Those released comprised 279 males and 302 females.

Of the entire number of males, 10 weighed from $5\frac{1}{2}$ to 6 pounds, inclusive, and 32 others between 6 and $7\frac{1}{4}$ pounds; 239 fell between $7\frac{1}{2}$ and 10 pounds, the minimum weight required of breeders. Of the remainder, 206 weighed between $10\frac{1}{4}$ and 15 pounds, 7 between $15\frac{1}{2}$ and $17\frac{1}{4}$ pounds; and the other three weighed $17\frac{1}{2}$, 20, and $20\frac{1}{4}$ pounds, respectively.

Of the females handled on this occasion, 4 weighed from 4 to 5 pounds, and 7 others fell below 6 pounds; 280 weighed between 6 and 8 pounds, inclusive; 197 fell between $8\frac{3}{4}$ and 10 pounds; 56 ranged from $10\frac{1}{4}$ to $13\frac{1}{2}$ pounds; and the remaining three weighed, respectively, $14\frac{1}{2}$, 15, and $21\frac{3}{4}$ pounds, the last being the heaviest blue fox on record from the Pribilof Islands.

The largest fox taken on St. Paul Island during the trapping season of 1913, which comprised the last week of November, was a male weighing $19\frac{1}{2}$ pounds.

RECOMMENDATIONS.

Feeding and method of capturing.—With the resumption of commercial killing of seals, an abundance of excellent food for the foxes will be assured. With increased facilities for transportation the killing would be done in the vicinity of the hauling grounds. The principal ones on St. Paul Island are as follows: Northeast Point, Polovina Point, Reef and adjoining points, Tolstoi, Lukanin, and the several hauling grounds at Zapadni. Practically all the foxes on the island live near or at points allowing easy access to these places. Roofed sheds screened from flies and provided with arrangements for hanging quantities of seal bodies should be built for the purpose of drying the meat. These sheds should be so constructed as to keep out the foxes, but a free circulation of air should be allowed. The drying process can be facilitated by slow fires of driftwood; this can be gathered nearby in sufficient quantities for this purpose. The use of a fire will dry the air and also protect the meat against flies. The drying shed could serve also as a storehouse for the meat.

The feeding inclosures, at least preceding and during the annual trapping season, should be trap cages similar to those now used on St. George, but future experience will doubtless suggest some improvements. Such traps have never been used on St. Paul but there is, of course, no reason why they can not be introduced. It will be desirable to avoid the necessity of remaining at watch all night during the trapping season to spring the traps, especially if these trapping stations are established at a number of places. Inclined funnel-shaped entrances have been recommended by G. Dallas Hanna. These or inclined walkways from the end of which the animals can jump down to a tipping shelf can without doubt be devised. A larger feeding trap would prevent the animals from crowding and by allowing the food to be more scattered would insure a share to the weaker animals. If low houses were provided in the corners of the feeding corrals, the foxes on finding themselves trapped would doubtless hide in these and could easily be secured for examination.

In addition to the feeding which should be maintained at these places during the winter season, some judicious scattering of food suitable for the young foxes in certain well-stocked breeding areas would doubtless result in a larger proportion of young reach-

ing the age when they are self-supporting. This seems to be especially desirable at Northeast Point, which is very suitable as a breeding ground for foxes, but which has no important bird rookeries. When the killing of seals on a commercial basis is resumed, the refuse from the killing fields may be sufficient for this purpose. Careful observations regarding the needs of the young foxes during the summer are needed.

On St. George Island the foxes are more numerous and more generally distributed than on St. Paul because of the extensive bird rookeries, which occupy about one-half of the shore line, and the many square miles of the interior where innumerable auklets raise their young; but since the same topographic features which determine the distribution of the birds, and in turn that of the foxes, limit the seals to a few scattered areas, probably not more than half the foxes have their homes near the hauling grounds. Still the comparatively small size of the island makes it possible for most of the animals to reach easily some place where seals might be killed. Owing to the limited number and small size of the hauling grounds and the difficult nature of the ground, it will probably never be feasible to develop as complete a system of transportation on St. George as is necessary for St. Paul, but such improvements should be made as will render Staraya Artel, Zapadni, and East Rookeries more accessible. This will permit arrangements to be installed at these places for the feeding and trapping of foxes. The remaining place where feeding seems to be desirable is Garden Cove. This place is one of the few possible landing places and is often the only one feasible. At present it is connected with St. George village only by a foot trail. If a wagon road were built it would be possible at times to utilize Garden Cove to good advantage as a landing place for supplies, and the food necessary for maintaining a foxing station could be easily transported. Failing the construction of a wagon road, the food could be taken there by boat at some favorable time in the summer.

Reserves for breeding.—With improved methods of feeding and capturing the foxes, enlarged opportunities for selecting and reserving a sufficient number of animals fit for breeders will be possible, since a larger proportion of the entire herd may be handled. The standards governing the selection of animals for reservation, as practiced in the past, seem to call for no criticism, and if the methods of feeding and capturing the foxes be improved and carried into effect on both islands a marked advance in the effective strength of the herds should soon be apparent.

Elimination of white foxes.—As before stated, the blue foxes, though representing an abnormal state, are so predominant on the Pribilof Islands as to be practically the normal condition. Owing to their greater value, it is desirable that they form as large a percentage as possible of the herd, and the elimination of the white element as far as practicable is therefore important. This fact has long been recognized, and ever since selective trapping on St. George Island has been practiced all white ones caught have been killed. The result has been that the number of white ones now found there is almost negligible. During the last 10 years St. George Island has produced 3,560 foxes, only 88 of which have been white; during the last four years out of 888 foxes only 5 have been recorded as white.

On St. Paul, where the attempt to eliminate the white element has been prosecuted only in a half-hearted way during the past five years, the proportion of white is much larger. In the last five years out of 830 foxes taken for fur on St. Paul 148 have been white. The proportion from year to year has not varied greatly.

It is evident that the attempt to eliminate the undesirable white element on St. George Island has been successful and that this success is due to the method of capture. It is also evident that merely allowing the natives to shoot the white ones during a part of the year has met with no success.

There is good reason to believe that continuance of the methods now practiced on St. George will keep the white foxes down to a negligible proportion and perhaps eliminate them entirely. The establishment of similar methods of trapping on St. Paul should eventually achieve the same result. But success will be attained much sooner if the undesirable animals are pursued in other ways. The natives should be encouraged by a reward to shoot the white foxes during the entire hunting season. They are now forbidden to use firearms during the summer, and such a prohibition is desirable for many reasons, but they are and should be allowed to shoot during the fall and winter. Most of the skins of foxes taken during the winter will be salable. The reduction of white foxes by any other method than shooting outside of the regular trapping season is obviously not feasible. The white foxes can be as easily distinguished from the blue when in the summer coat as in the white winter pelage, and they should be vigorously pursued and destroyed at all seasons. It might be best to leave white foxes which were found caring for pups until the latter are large enough to take care of themselves. During this time the animal could be kept under observation and might be destroyed at the close of the summer. But against this is the objection that presumably a part of the litter raised would be white animals also, the destruction of which, together with that of the parent, would be thus left to the chances of the future. This point is one which might well be left to the judgment of those in charge, but in common with many others needs the careful consideration of some one who shall be free to give his attention to such problems.

Animals which are suffering from disease should be killed whenever possible at all seasons. This is especially important at the present time, when the foxes on St. George are in poor condition. The process of raising the herd to a high state of perfection, even under the favoring influence of better food, will be greatly retarded if the pursuit of animals suffering from mange or other diseases can be prosecuted only during the few weeks of the trapping season. The natives should be encouraged to cooperate in this work.

Care of skins.—More care needs to be taken to cleanse the fox skins that they may reach the market in as good condition as possible. Those trapped in steel traps become more or less bedraggled during their efforts to escape, while those taken in cage traps become soiled from contact with the greasy meat and by scrambling over each other. Care should be taken to avoid such soiling as far as possible, and better facilities should be installed for cleaning and drying such as become soiled by blood, grease, or dirt. The skins can best be cleaned when freshly taken from the animal. Washing the soiled skins with soap and water will probably be found the most advantageous method and will probably be sufficient. To facilitate drying the skins, some arrangement for tumbling them could easily be devised, to be used with some absorbent. Stretching the skins in a uniform manner and taking care that they be well shaped and well dried are also important points.

Sale for breeding.—On a few occasions in past years blue foxes have been sold at a nominal price to persons engaged in breeding them, usually to those holding leases of

islands in Alaska for such purposes. In recent years the growing scarcity of the animals and the relatively high price obtainable for the skins have made it inadvisable to dispose of the live animals at a price less than that brought by the skins. The advisability of offering some encouragement to those engaged in the business of propagating foxes being recognized, however, the following announcement was issued by the Secretary of Commerce on July 1, 1913, in connection with the information relative to the leasing of certain islands in Alaska for the purpose of raising foxes:

The Secretary of Commerce will undertake to supply from the Pribilof Islands fox herds a limited number of blue foxes for breeding stock to lessees of any of the islands that may be leased, or to other responsible parties operating fox ranches in Alaska. Such foxes will be sold under competitive bids and will be delivered to the purchasers at Unalaska on a date to be agreed upon.

Later this offer was extended to include persons engaged in raising foxes elsewhere than in Alaska. As a result of this offer a few small lots of foxes have been sold, at a price of about \$100 each. These have been young animals.

In considering the advisability of continuing this practice, it is necessary to bear in mind a variety of peculiar circumstances, particularly the present low state of the fox herds in point of numbers and vitality, and the impossibility of arranging for prompt and uninterrupted carriage of the animals from the islands to their destination. The latter difficulty is likely to lead to undue mortality during transit, resulting in the waste of valuable life and causing dissatisfaction to buyers.

The present unsatisfactory state of the fox herd is an even more serious objection to the disposition of animals for breeding. The herds need the retention of the best blood, and it is of course unwise to allow inferior stock to be used for starting new herds elsewhere.

It seems wise, therefore, to discontinue for the present the sale of animals for breeding purposes. When the herds shall be brought up to a higher state of efficiency as regards numbers and quality, the disposal of a limited number of animals of high quality might well be considered. This could then be done without injury to the herds, and would facilitate greatly the establishment of a legitimate and profitable industry.

Experiments in domesticating foxes.—The readiness shown by the foxes of St. George Island in responding to feeding has resulted in many of them becoming semidomesticated. This has led to the advocacy of experiments being made with a view to improving the fur and the physical condition of the animals by selective breeding. It is thought also that the raising of a larger proportion of the young to maturity might be effected, since it would assure their proper nourishment during the critical period when in a state of nature they are abandoned by their parents. It is thought by some that the eventual domestication of all the foxes of the islands would be profitable. While it is believed that this is impracticable, it is evident that some experiments in raising the animals in inclosures may well be made. The experience thus gained would be of great importance to prospective breeders of the animals and would also help to an understanding of the needs of the wild foxes on the islands.

THE REINDEER.

INTRODUCTION AND GROWTH OF HERD.

For some years the Department of the Interior, in connection with its work on the education of the natives of Alaska, has maintained large herds of domesticated reindeer at various points on the mainland. These herds have prospered and from time to time have been drawn upon to stock other places, including several islands in the Aleutian chain and elsewhere.

In the course of a study of the economic resources of the Pribilof Islands it was seen that they afforded a quantity of food suitable for reindeer and it was believed that utilizing this product to maintain herds of these useful animals would be a wise procedure. Accordingly arrangements were effected with the Department of the Interior for the transfer of enough of the animals to start a herd on each island. By the cooperation of the Revenue-Cutter Service, 40 animals were brought to the islands at the end of August, 1911. Twenty-five of these, 21 does and 4 bucks, were landed on St. Paul on August 31, and the remaining 15—12 does and 3 bucks—were put on St. George on September 1. Practically all the animals were of breeding age. There has been little mortality and both herds have shown a good percentage of increase.

In the spring of 1912 the St. Paul herd produced 17 fawns and had suffered the loss of only 2 of the original herd, a male and a female. In the spring of 1913 18 fawns were born, and in 1914 25 were produced. The mortality has continued to be small, and the herd on St. Paul in the summer of 1914 numbered about 75 animals. All seemed to be healthy with the exception of 2 of the older males, which were lame and seemed to be suffering from some trouble of the feet. This is probably the same disease that has occasionally occurred among the herds on the mainland. The exact nature and cause of this disease does not appear to be well known. The animals are said to recover occasionally, but it would seem best to kill the animals now affected, since they are consuming food which will be needed for the healthy animals and they are not needed for the growth of the herd.

The animals on St. George also are in good condition. In spite of the fact that the oldest buck disappeared soon after the animals were landed, 11 of the 12 females produced fawns in the spring of 1912. In the spring of 1913, according to the report from the island, 15 fawns were born. This would mean that some of the young only 1 year old produced fawns. Of those born, 13 survived the summer. In 1914 21 young were produced, and the herd numbered 58 animals. The total number now on both islands therefore is slightly more than 150.

The reindeer on both islands keep rather closely to the higher, less frequented parts, where they are seldom disturbed and where their favorite food is most abundant. The animals of course require no feeding and no special care except at fawning time, but in order that they may not become too wild to be easily handled, they should be frequently visited and rounded up. In no other way can they be kept under observation and their actual condition be known. At fawning time some special care and attention is necessary to prevent undue loss of the newly born young. On St. Paul the females are driven into a corral for the fawning. This prevents the desertion of the young ones by their mothers, which often occurs during the prevalence of hard storms, and which results in heavy mortality. The newly born young are also in some danger from the old bucks.

LIMITED CAPACITY OF THE ISLANDS.

Although the Pribilof Islands afford a favorable habitat for reindeer it is plain that their relatively small size will not permit an unlimited increase, though larger herds than now exist can undoubtedly be supported. As the summer food is practically unlimited in quantity, the main factor limiting the size of the herd seems to be the quantity of the various lichens which constitute the main source of food in winter. These lichens are not evenly distributed over the islands, but occupy certain fairly extensive areas. Unlike the grasses and herbaceous plants which die down and renew their growth annually, the lichens grow persistently but very slowly, and when once destroyed do not restock a given area for a long time, perhaps as long as 20 years. Detailed study of the habits of the animals in their special haunts, and of the areas drawn upon for their subsistence must precede any definite prediction as to the number that the islands can maintain permanently. It is certain, however, that the herds can be increased considerably over their present numbers. Observations made while this increase is going on should lead to a better understanding of the actual relation of the animals to their present habitat and make it possible to avoid letting them increase beyond the danger point.

Since with a few exceptions none of the animals have been killed, it follows that there is now a considerable number of males in excess of the actual breeding requirements of the herds. A reduction in their number should of course be made as an aid in conserving the food supply. Diseased animals should be killed and the meat utilized for the foxes. Other males should be killed from time to time and utilized to the best advantage.

INDIFFERENCE OF NATIVES REGARDING REINDEER.

Although the reindeer were introduced primarily for the benefit of the natives, they take practically no interest in the animals. For many generations these people have lived and died among the seals and foxes. The direct or indirect results of the exploitation of these animals have formed their sole means of livelihood and have satisfied their every need. It is very difficult therefore for them to realize that these new animals can ever prove of any real benefit to them, especially as no benefit has yet been realized. On each island two natives are paid \$2.50 each per month to care for the reindeer. With only this small reward, unsupported by any natural interest in the animals, it follows that the so-called herders never see the animals they have in charge unless told to look them up, and even when this occurs their observations are more or less inaccurate or misleading and are seldom of much value. This is only one manifestation of the native's inherent lack of interest in any project or occupation apart from sealing. This apathy will be difficult or impossible to overcome, although certain ones among the natives will doubtless show more aptitude than others in this and other new lines of work. But unless natives are found who will take a real interest in the reindeer, their services except for work which is mainly mechanical will be of little use. The animals undoubtedly need closer attention. They should be herded and driven often enough to become accustomed to their attendants so that when it becomes necessary to corral them they may be more readily handled. At present they are scarcely seen from month to month with the natural result that they are more or less wild and intractable and difficult to impound or to observe.

USE AND VALUE OF THE HERD.

It would seem that the reindeer on the Pribilof Islands are destined to be useful mainly as a source of fresh meat for the Government employees on the islands and as a possible source of supply for stocking other places. The training of some for driving has been suggested, but considering the small size of the islands and the rough nature of the ground it does not seem advisable to take this up on an extensive scale. The killing of a large proportion of the young males is desirable, and the meat of these would form a welcome substitute for some of the more costly canned foods which now necessarily form a large percentage of the provisions in the islands during the entire year. At times the meat could be issued to the natives, although it is doubtful if it would be as acceptable to them as that of the seal, which naturally forms their staple meat diet. The skins of the animals killed could be tanned and used for making gloves and other articles of clothing, but it would involve a radical departure from fixed habits on the part of the natives and it is doubtful if much can be hoped for in this regard, especially as the supply of skins will never be large. But by turning into desirable food certain natural resources which would otherwise be wasted it is believed that the reindeer herds will more than justify the expenditure of the comparatively small amount of time and money involved in their introduction and care.

The presence of growing herds of reindeer on the Pribilof Islands seems to afford an excellent opportunity to make detailed studies of great value. Here in a habitat which is favorable and yet is so limited in area as to allow of easy observation, a naturalist can study the diseases and the general relation of the animals to their habitat with comparative ease, and the knowledge thus gained should be of help in realizing to the best advantage the fullest value of the herds, not only on the Pribilofs but in other parts of Alaska.

THE SEA LIONS.

Steller's sea lion (*Eumetopias stelleri*) is a huge animal, the adult male being about three times the bulk of the fur seal and weighing probably as much as 1,500 pounds. The females are rather less than half as large as the males. Such imposing animals occurring in numbers and in such situations as to admit of easy observation excite an interest, especially to the lover of wild life, scarcely second to that created by their smaller and more numerous relatives the fur seals, which they resemble rather closely in habits and beside which they dwell in amicable indifference.

EARLY ABUNDANCE AND USES.

Until comparatively recent times sea lions were found in thousands on both St. Paul and St. George Islands. In the primitive economy of the natives these animals played an important part. In addition to the use made of their skins as covering material for the bidarras, or large boats, the animals furnished to the Aleut material for waterproof clothing and boots and for many lesser articles, while the flesh, especially that of the pups, was particularly relished. But in later years, with the growing tendency of the inhabitants to adopt imported food and clothing, the importance of the animal has dwindled until practically its only economic use is found in the manufacture of the huge bidarras. The adoption of modern methods of managing the business of the islands will undoubtedly demand the discarding of these boats as a means of landing cargo, and with them will vanish the importance of the sea lion as an economic factor.

Considering the relatively small number of the animals remaining on the Pribilof Islands, it is well that they are no longer indispensable. Where formerly there were many thousands of the huge creatures there are at present only a few hundred on both islands.

BREEDING HABITS.

The breeding rookeries are only two in number, at Northeast Point on St. Paul, and near Garden Cove on St. George. In former years they resorted in numbers to both Otter and Walrus Islands, and doubtless do so yet to some extent as they do to Sea Lion Rock. A few are said to have bred on Walrus Island in the days of their abundance, but otherwise the present breeding stations seem to be the only ones ever occupied on the Pribilof Islands.

In general habits they resemble the fur seals. The males take up their stations from about the first to the middle of May and are joined by the females about two weeks later. Young are recorded as having been born as early as May 24, and as with the fur seal the period of pup-bearing extends over several weeks. They grow very rapidly, and when less than three months old are as large as 3-year-old fur seals. The animals when breeding are much more wary and timid than the fur seals. On the approach of man the females forsake their young and take to the water, where they gather in company with the bachelors and the less courageous of the breeding males, and keep up a deafening roaring chorus of rage and defiance.

A few of the largest males hold their ground and in the general excitement wage relentless battle with each other while the pups which are too young to accompany their mothers avoid the intruders as far as possible. The animals remain about the islands the entire year, but appear to be more scattered in winter.

NUMBERS KILLED IN FORMER YEARS.

In early days great numbers of sea lions were taken for the skins and meat. The following table shows approximately the number killed on St. Paul Island from 1870 to 1890 according to the island records, which are probably incomplete. Unless otherwise stated practically all were killed at Northeast Point.

Sea lions killed on St. Paul Island, 1870-1890.

Year.	Number killed.	Remarks.
1870	123	About 500 skins sent to Unalaska spring 1870.
1871	No record of number killed.
1872	200	A quantity of skins shipped probably to Unalaska and Kodiak.
1873	290	160 driven from Northeast Point to Village Sept. 16; 130 driven from Northeast Point to Village Nov. 16.
1874	506	Includes about 300 driven from Northeast Point to Village October and November.
1875	402	Includes 340 driven from Northeast Point to Village during year; 295 skins shipped to Unalaska.
1876	292	Includes 188 driven from Northeast Point to Village in November.
1877	38	Mostly killed at Northeast Point.
1878	300	All driven from Northeast Point to Village in November.
1879	195	Driven from Northeast Point to Village in October.
1880	66	Killed at Northeast Point.
1881	287	20 killed on Walrus Island, remainder driven from Northeast Point to Village in October and November.
1882	214	Includes 100 driven from Northeast Point to Village in November.
1883	139	Killed at Northeast Point.
1884	253	Do.
1885	30	Do.
1886	356	Includes 190 driven from Northeast Point to Village.
1887	138	Killed at Northeast Point.
1888	30	Killed at Northeast Point in spring.
1889	30	Killed at Northeast Point.
1890	41	Do.



Sea Lion Rookery at Northeast Point, St. Paul Island, June 23, 1914.



It will be seen that up to 1882 most of the sea lions killed were driven from Northeast Point to the village. This was done to avoid having to transport the meat and skins. It was necessary to let the huge animals travel very slowly, and from four to six days were required for the journey of 12 miles. After 1882 the animals became scarcer and more wary, and it became difficult to get enough together to make it profitable to conduct drives.

In 1891 a few only were killed, mainly pups taken for food. In 1892 about 50, mainly pups, were taken. In 1893 about 35 were killed; in 1894, 96; in 1895, 17 (bulls); in 1896, 25; in 1897, 22; in 1898, 33 (bulls). From 1899 to 1909 only a few were killed annually to furnish skins for covering the bidarras, but the number had then become so reduced as to lead the agent to believe that it would be advisable not to kill any more for several years. Within the last 10 years the number has slowly decreased. In the summer of 1904 there were on the breeding rookery at Northeast Point about 30 bulls and 200 cows. In the summer of 1914 there were about 20 breeding bulls and somewhat over 100 cows.

On St. George Island the location of the breeding rookery does not readily allow driving, as the animals lie at the foot of bluffs and are difficult to approach. No figures as to the numbers killed are available, but it is known that in former years a great many were taken, probably being driven from the hauling grounds near East Rookery where about 50 were seen in July, 1914. Comparatively few have been killed in recent years. No reliable data as to the number breeding on St. George Island are at hand, but it is thought that there are fewer than on St. Paul.

MEASURES FOR PRESERVATION.

Although the sea lions are no longer of great economic importance to the inhabitants of the Pribilof Islands, it seems desirable to preserve the remnants of the herds now existing there. The species is not of general distribution in the North Pacific, but is confined to certain restricted and widely separated localities. Of these the Pribilof Islands constitute one of the most northerly stations. In most other parts of its range the animals are subjected to persecution and are being rapidly extirpated. On the Pribilof Islands—a Government reservation—the sea-lion herds are protected from indiscriminate killing without special expense or trouble, and an excellent opportunity is afforded to preserve for all time small herds of these highly interesting animals. The herds may be drawn upon from time to time to furnish scientific specimens to museums and a few may be killed for other special purposes, but they should not be exterminated. The presence of these small herds is not detrimental to the more numerous and valuable seals, and their preservation as an example of an imposing and highly interesting form of wild life seems to be highly desirable.

THE BIRDS.

Even to the casual visitor, not especially interested in ornithology, the bird life of the Pribilof Islands affords an experience which never fails to call forth expressions of wonder and admiration, while to the naturalist the teeming hordes are a constant delight. Taken as a whole, the islands present an array of bird life scarcely equaled in the world. Nearly 100 species have been detected on the Pribilofs, and of these about 20 species breed there. With a few exceptions the breeding species exist by tens of thousands and nest in large

colonies, usually on the cliffs and rocky ledges fronting the sea. Besides the breeding birds, there are a larger number which nest on the Alaskan mainland or in other parts of the far North and merely visit the Pribilofs on their journeys to and from their winter homes, which in some cases are as far distant as the Hawaiian Islands. A number of species of Asiatic distribution occur on the island and a few of these breed. In the case of a few species, the specimens taken on the Pribilof Islands constitute the only records for North America. It will be seen, therefore, that apart from their purely economic status, which is the subject of the present account, the birds of the Pribilof Islands are of unusual interest.

The species which are abundant and of economic importance to the human inhabitants fall into six natural groups. Mentioned in the order of their importance these groups are the murre, auklets, gulls, ducks and geese, shorebirds, and cormorants. Some of these groups are important also as furnishing food for the valuable herds of blue foxes. Their value in this regard is discussed in the account dealing with that animal.

MURRES.

With the exception of the least auklet, the murre, or arries as they are usually called, probably outnumber any other birds on the islands. They include two species, the Pallas Murre (*Uria lomvia arra*) and the California Murre (*Uria troile californica*). The first named is slightly larger than the other with the back glossy black, while the California Murre is of slighter build with the back more plumbeous. Both species breed on St. George, Walrus, and Otter Islands. The murre of St. Paul are mainly, if not entirely, the Pallas Murre. The two species are of nearly equal abundance, and for present purposes may be considered together. The size of the birds, nearly equal to the mallard, the ease with which they can be captured, and especially the immense size of the nesting colonies, combine to make them an important economic feature. Many of the birds are shot, especially in the spring, and the eggs are an important article of food. The single egg is very large for the size of the bird, being at least twice the bulk of a hen's egg. Many are taken from the cliffs of the two main islands, but the main source of supply is Walrus Island, about 10 miles from St. Paul. Here the birds nest to the number of many thousands. It is the custom for the natives to go to this island about the middle of June, when the birds have fairly started nesting, and to gather all eggs from a certain area. About a week later the place is revisited and the area lately denuded will be found restocked with fresh eggs. The birds will lay again, even if the second set is removed, and in some cases even a fourth egg may be deposited, but as the breeding ground is seldom revisited more than once in a season, the taking of eggs causes practically no diminution in the species, but merely retards the breeding of a part of the birds a week or two. This is shown by the fact that in spite of the eggs having been gathered in this way for many years, practically all the available space on Walrus Island is still occupied by the breeding hordes, and the various colonies in other parts of the Pribilofs show no appreciable loss. The birds are never killed on the rookeries during the breeding season.

GULLS.

The gulls of economic importance are the Glaucous-winged Gull (*Larus glaucescens*), the Red-legged Kittiwake (*Rissa brevirostris*), and the Pacific or Black-legged Kittiwake (*Rissa t. pollicaris*). The two last named occupy certain areas on all the islands, usually



Murrelets on Walrus Island, July 16, 1914.

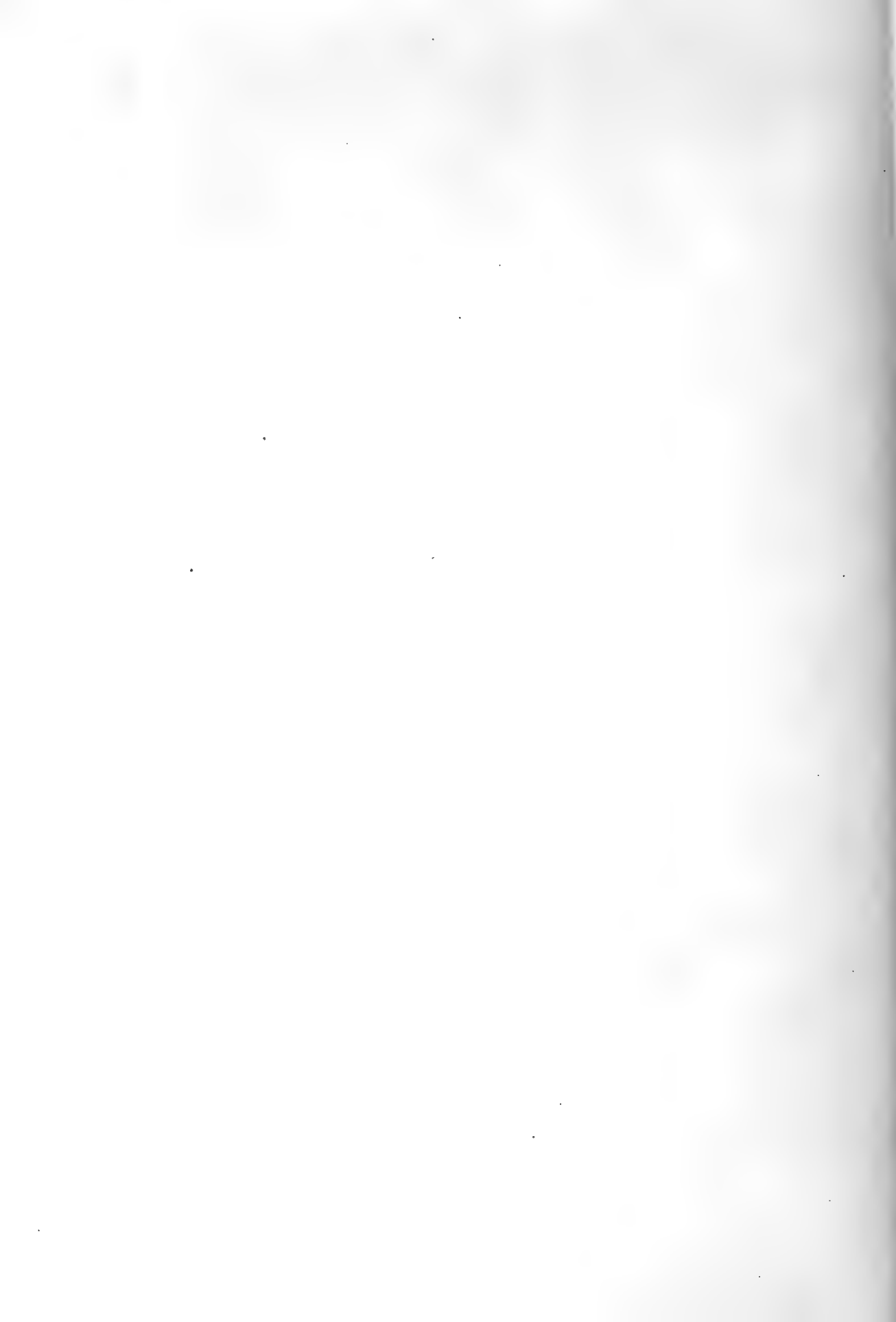

breeding in separate colonies, and are about equally abundant. The Glaucous-winged gull nests mainly or entirely on Walrus Island and Sea Lion Rock, but resorts to St. Paul Island in numbers throughout the summer. It is seldom seen on St. George Island at that season. The eggs are sometimes utilized, and during the colder part of the year the birds are shot for food.

The Kittiwakes are especially relished as food by the natives, and numbers are shot in early autumn as they fly along certain parts of the cliffs or cross from bay to bay over low portions of the islands. Their eggs are small and so difficult to secure that the birds suffer practically no loss in this respect. The continued abundance of the birds seems to be good evidence that the shooting of a few for food has had no serious effect.

AUKLETS.

Of the three species of auklets occurring in numbers on the Pribilof Islands, the only one of economic importance is the Least Auklet (*Aethia pusilla*). This bird is scarcely larger than a robin, but exists in such myriads and is so easy to capture that it is of considerable value as food, and its arrival in April is eagerly awaited. The birds occur commonly on St. Paul, nesting mainly among the boulders on the beaches, while on St. George the numbers are so great as to be almost incredible. On the latter island fewer nest in the boulder-covered beaches, but large areas nearly throughout the island are occupied by nesting colonies. Although the bird lays only one egg, the nesting period extends from late May to mid August, and probably at least two young are raised. Those taken for food by the natives are netted in spring as they fly along the cliffs, and the birds are practically unmolested during the breeding season. Many thousands are destroyed by the foxes throughout the summer, but in spite of the large numbers which meet death from these causes the birds continue to occur in such myriads that it is difficult to conceive of any larger numbers existing.

DUCKS AND GEESE.

Several species of ducks and geese occur in comparatively small numbers on the Pribilof Islands either as scarce breeders or as more or less regular visitors during migration. Several species are of some importance, and of these may be mentioned the eider ducks (the King Eider, *Somateria spectabilis*, being the commonest) and the Emperor Goose (*Philacte canagica*). The latter is taken mainly in autumn. The eiders are more or less numerous during the autumn, winter, and spring, particularly in seasons when the ice packs closely about the islands.

The eiders are birds of wide distribution, and the comparative few which are killed on the Pribilof Islands can not affect the species to any appreciable extent. The Emperor Goose is of rather restricted range, but so few visit the Pribilofs that the destruction there may be considered negligible.

SHORE BIRDS.

The list of shore birds, including sandpipers, turnstones, plovers, curlews, and godwits, is rather extensive, but the only species which need consideration in the present connection are the Pribilof Sandpiper and the Pacific Turnstone.

The Pribilof Sandpiper (*Arquatella pilocnemis*), as far as known, breeds only on these islands and on St. Matthew Island. The breeding season is passed by the birds

mainly on the higher, more barren parts of the islands, where they suffer no harm from man. At the close of nesting, in August, the old and young congregate on the beaches, where they are shot in some numbers by the natives, being highly relished as food. Considering that the bird has such a limited habitat and is of unusual interest from a scientific point of view, it would seem wise to restrict somewhat its killing, especially since no hardship to the natives would result. This subject is discussed at greater length beyond.

The Pacific Turnstone (*Arenaria interpres*) occurs during the spring migration, and in August and September when old and young are on their way to their wintering ground on the Hawaiian Islands. While on the Pribilofs the birds spend most of their time on the killing fields, where they feed on the larvæ of flesh flies in the remains of the slaughtered seals. They become very fat and are much prized as food by the natives, but soon become wary and are not killed in any great numbers.

CORMORANTS.

Cormorants occur as breeders and winter residents on the islands. They are not very abundant, but are easily obtained in winter when other birds are scarce, and are, therefore, welcomed. They raise large broods and appear to have few natural enemies besides man, and seem to maintain their numbers.

MEASURES FOR PROTECTION.

The fact that the Pribilof Islands now constitute a national reservation insures the continued preservation of the hordes of birds which annually go there to rear their young. Ever since the first occupancy of the islands by man, the supply of birds has been drawn upon to furnish large quantities of food for the people who have lived there.

The fact alone that this drain has not resulted in the extirpation of a single species, and as far as known has not caused the appreciable diminution of any, seems to allay apprehension that any of the species are in danger from this cause. As a matter of fact the birds are probably subjected to less persecution now than at any time since the islands were first discovered. The habits of the natives have changed considerably in many respects. They have contracted a liking for imported food, and with this the need and desire for pursuing the birds has waned to a considerable degree. They do not now seek the eggs of the birds to any such extent as formerly; and they are losing their skill in taking birds in nets, by means of which they formerly secured great numbers. The introduction of firearms has, of course, offset this to some extent, but it is believed that fewer birds are killed now than formerly.

Although most of the species are still very abundant and none seem to be in actual danger of extermination, one or two species should perhaps be accorded some measure of protection. The one of most importance is the Pribilof Sandpiper. This species breeds only on the Pribilofs and on St. Matthew Island. Apparently it goes no farther away to winter than the Aleutians, and it has, therefore, a very limited distribution. Its long-continued insular isolation under conditions which seem to be particularly favorable has apparently resulted in the development of a large and strikingly handsome species, and it is very desirable that it be perpetuated. Apparently it has not suffered appreciable diminution as yet, and the prospect of preserving it is therefore excellent. The general interest in the bird because of its restricted habitat and comparative scarcity

causes it to be much desired by museums, and as it is practically impossible to obtain the species elsewhere, the collection of specimens for scientific purposes should be allowed, but it is believed that the killing of unlimited numbers for food should be prohibited.

In the case of this or any species which future investigations may show to be in need of special consideration it would be well for the agent or naturalist to be given authority to prohibit entirely the killing of such species, or to extend to it the benefit of such restrictive measures as would meet the requirements.

FISHING.

Since early times the natives of the Pribilof Islands have obtained a part of their subsistence by fishing. The stormy and inclement weather which obtains during the greater part of the year, and the fog which almost continually enshrouds the islands, have prevented this industry from being prosecuted to the extent that the abundance of fishes probably warrants. Notwithstanding the unfavorable conditions and the lack of systematic effort, however, large quantities of fish have been taken, the aggregate food value of which has been very great.

The species taken are mainly halibut (*Hippoglossus hippoglossus*) which here appears to attain as large a size as is usual in other parts of its range. Examples weighing 100 pounds or over are frequently taken, and one of 350 pounds is recorded. The Alaska cod (*Gadus macrocephalus*) which does not attain a large size, usually not exceeding 10 or 15 pounds, is also taken in large numbers. Sculpins, perhaps of several species, are also abundant, and are frequently caught about both islands. Because of the weather conditions it follows that most of the fishing is done in the summer, but it can be successfully conducted in some seasons as late as the last of October, and in some cases even into December.

So far as known, the best places for fishing have never been searched for systematically, though the places now selected by the natives are of course in accordance with the experience gained in former years. The place usually resorted to by the people of St. Paul is a mile or two off East Landing, where both cod and halibut are taken. Off St. George there are two principal fishing banks, one about 3 miles to the eastward of the village landing, and about half a mile from shore where only cod are taken; the other is 2 miles west of the village, and half a mile from shore, and here the principal catch is halibut. This species is said to be seldom caught here during the winter. It is probable that other fishing banks await discovery. In former years the natives fished largely or entirely from their small skin boats or bidarkas, but they have now entirely abandoned the use of this craft, in the management of which their ancestors were so proficient, and now fish only from large rowboats.

In order to give a clearer idea of the extent of the fishery than it is possible to gain from general statements, it may be well to set forth a few examples of the success which has attended fishing parties in past years. The following entries in the St. Paul Island log are selected from a very large number of records of fishing trips, very few of which were not to some extent successful: Parties were very successful in taking halibut on August 9, 10, 11, and 12, 1876; on August 14, 8 large ones were caught, and on August 23, seven bidarkas took 30 halibut, some of them very large. On August 25, 1880, between 1,000 and 1,500 pounds of halibut were taken, and on August 31, one 6

feet long is noted. A number of halibut taken in September, 1891, weighed from 50 to 100 pounds each. In 1892, many cod were taken during May, the first of the season being caught on May 19. In September, 1901, two natives took 29 halibut in two days. In more recent years, extraordinary catches of halibut are recorded on August 6, 1908, and good catches of cod, halibut, and sculpins, on November 10, 1910. During the summer of 1914 many very fine halibut and some cod were taken off East Landing on several occasions.

As regards St. George Island, fewer records are at hand. The fishing places are more accessible than the St. Paul stations, and being closer to shore the fishermen are less exposed to danger from foggy weather and sudden storms, and the chances for success seem to be rather better than on St. Paul. Mr. G. Dallas Hanna, on June 8, 1914, on a trip which took four hours, including the time consumed in the round trip to the fishing grounds, caught on one hook 90 pounds of cod and 100 pounds of sculpin. On June 20, 1914, on a similar trip of five hours, he took on one hook 120 pounds of cod, 80 pounds of sculpin, and 60 pounds of halibut.

The success which attends the fishing as conducted at present seems to warrant the prediction that with systematic exploitation the fishery will prove of considerable value. The establishment of a cold-storage plant, which is needed for many reasons, would insure the economical utilization of the product. During the year ended June 30, 1914, over 4,000 pounds of canned and salted salmon, in addition to a great quantity of preserved meats, all of which were of course imported, were consumed by the natives of the two islands. There seems reason to believe that this amount can be materially reduced by better utilizing the resources of the sea. Fish is relished by the foxes also, and as it has been proven by experiment that it can be easily dried on the islands, the use of the poorer part of the product for this purpose may prove feasible. All things considered, it seems certain that in the more systematic development of the resources of the islands which is demanded, the fisheries will prove of considerable value.

INTRODUCTION OF NEW ANIMALS.

The occupation of the Pribilof Islands by man early led to the introduction of various domestic animals, the presence of which has been of considerable advantage to the inhabitants. Another class of animals requiring consideration are those intended to furnish food for the foxes. Since the killing of seals has been limited to the number actually necessary for the support of the natives, the resulting hardship to the foxes has led to recommendations regarding the introduction of various small species which it was thought might supplement the reduced food supply of these valuable animals. Some experiments on a small scale have been attempted, but no success has as yet been achieved. It should be noted that in the consideration of the various species which might prove useful for this purpose, the important fact has been overlooked or disregarded that the Pribilof Islands are called upon to support a fox population far in excess of the normal. In a state of nature, a white or blue fox requires several square miles of territory for its support, while on the Pribilof Islands there are many foxes to each square mile. It is plain that any animals introduced here for fox food would need to become exceedingly abundant to be of any material benefit, and that while gaining a foothold they would have to contend against enormous odds. With the full signifi-

cance of these self-evident facts before us, it seems plain that the chances of success attending the introduction of any animals intended to prove of benefit to the foxes are very small. The various species which have been introduced and those which have been recommended for introduction are discussed beyond.

DOMESTIC ANIMALS.

Horses and mules.—Draft animals, usually mules, have been used for many years on St. Paul to haul supplies from the landings to the warehouses, and for transportation to and from the more distant seal rookeries. The animals find abundant pasturage during five or six months of the year and are fed for the remainder of the year on imported food.

It is believed that if the work were undertaken in a systematic way that a sufficient quantity of hay and ensilage could be put up annually to support the small herds of domestic stock during the winter. A coarse beach grass (*Elymus mollis*) is very abundant and grows luxuriantly. Unsuccessful attempts to make ensilage of this grass are reported, but since it is successfully put up on Kodiak Island at a cost of less than \$1 per ton ^a there seems to be no reason why the process should not be successful on the Pribilofs if properly managed. It is practically certain also that hay can be made from some of the grasses which grow abundantly in certain localities. It must be conceded that favorable weather can not be depended on. Even in the best hay regions, however, periods of rainy weather often occur, but with proper management most of the crop can usually be saved. Directions for the proper care of hay under unfavorable weather conditions are given in Bull. 3 of the Alaska Experiment Stations, 1907. Although the conditions on the Pribilofs are perhaps less favorable than at Fort Kenai, to which place this bulletin refers, the drying properties of the air, when precipitation is not actually occurring, are very marked, and it is confidently believed that hay in moderate quantities can be made on the islands.

The animals appear to withstand well the peculiar climate of the islands. They are indispensable since they furnish the only means of transportation at present available.

Cattle.—A few cattle have been maintained on each island for many years, furnishing a supply of milk and occasionally beef for the tables of the employees. Like the horses and mules, the cattle have to be housed and fed during a large part of the year. All things considered, they do very well, but there is little doubt that the effectiveness of the herds would be increased if a breed were selected with reference to fitness for the peculiar climatic conditions. Instances of animals living for several years on the islands without care are on record, and while it is not desirable to adopt this method of treatment, it is plain that a greater measure of efficiency could be secured from a breed especially adapted to the rigorous climate.

Sheep.—Small flocks of sheep, usually composed mainly of ewes, have been brought to the islands from time to time, but no attempt has been made to keep up the supply by breeding, although it is likely that this would be successful if a hardy race were selected. On one or two occasions sheep which have strayed away in the fall have survived the winter. This argues remarkable ability to withstand the severe winter conditions, and suggests that if a breed were selected with this factor in mind the herds might be kept up with less care than is now necessary. The question of attempting

^a Ann. Rept. Alaska Agric. Exp. Stations for 1907, p. 61, 1908.

to maintain small herds of sheep on both islands is one that may well merit careful study.

Swine.—For many years swine have been kept by the natives on both islands. The well-known omnivorous propensities of the animals enable them to pick up an easy living during the summer, as they usually have the run of the villages and the neighboring fields, where they secure a variety of vegetable food. The near-by killing fields are also drawn upon for a part of their subsistence. No prejudice against pork produced from a diet of seal offal seems to have arisen in the minds of the natives, and perhaps has no just grounds for existence.

There seems to be no valid objection to the raising of a limited number of pigs by the natives, but the careless habits of the people and the crowded nature of the villages tend to undesirable conditions with this industry unless there is very strict supervision.

Cats.—These animals were early introduced and have thrived on St. Paul Island. They seem to have been ineffective in reducing the numbers of house mice, which here, as elsewhere, are a great pest. No apparent benefit has resulted from the presence of the felines, nor has any particular harm been apparent, excepting the annoyance which always accompanies the presence of large numbers of cats.

Poultry.—The Government, as well as many native families on both islands, have flocks of fowls which furnish their owners with a fair supply of eggs. Owing to the length and severity of the winter, against which no adequate protection is provided, it follows that the productivity of the fowls during the colder season is very limited. Many of the natives are obliged at this season to house their poultry in the attics of their own crowded homes, with results that may be imagined.

The establishment of a large poultry house to be used by the community has been suggested. The large amount of animal food which will be available when seal killing on a commercial scale is resumed, would greatly simplify the problem of the maintenance of a good sized flock, and with proper arrangements for the care of the fowls and the equitable distribution of the product it is evident that a large stock of poultry could be kept at slight expense. The project seems well worth consideration.

WILD ANIMALS.

Hares and rabbits.—The introduction of hares, jack rabbits, cottontail rabbits and Arctic hares have at various times been recommended as a source of food supply for the foxes. On one occasion several years ago a number of jack rabbits from Kansas were shipped, but they died on the voyage.

It is not believed that the introduction of either hares or rabbits would ever prove of any benefit to the foxes. The great number of foxes would make it very difficult to establish a colony of rabbits of any species. Furthermore, it is not believed that the winter climate of the Pribilofs, coupled with the meager food supply at that season, would favor the existence of any species excepting the Arctic hare. This animal is able to withstand conditions even more severe than those found on the Pribilofs, but even under the most favorable conditions never becomes really abundant, although occasionally a number of individuals, driven by stress of circumstances, may congregate in a particularly favorable place. The Arctic hare requires for its winter food an abundance of willow. Several species of these shrubs occur in a dwarfed condition on the Pribilofs, but the supply is by no means abundant. The cost of procuring a

stock of hares for introduction, owing to the scarcity and wariness of the animal, would be very great; it would be difficult if not impossible to protect these after their introduction, and even in the event of their becoming established, which is scarcely possible, the islands would support only a limited number. The abnormally crowded condition of fox life on the Pribilofs has already been alluded to, and this fact has a sinister bearing on the practicability of adding to their food resources by introducing small mammals among them. The introduction of any species of hares or rabbits, therefore, can not be recommended.

Ground squirrels.—The introduction of ground squirrels has been attempted on two occasions, but neither has proven a success. In 1899 some were brought from Unalaska and liberated on St. Paul, near the village. Their disappearance has been attributed to cats, but whether they were eaten by cats or foxes is immaterial.

In the summer of 1913 the assignment of G. Dallas Hanna for work on St. George Island afforded an opportunity to make another attempt, and 22 ground squirrels, including both sexes and different ages, were captured at Nushagak. Of these, four died from natural causes before their journey was begun. Various circumstances made it impracticable to provide small cages for the animals, and they were shipped in a single large crate. Although plentifully supplied with green food, they preyed on each other, and while this tendency was overcome to some extent by supplying them with meat, the stock of 18 had been reduced to 5 before they reached their destination. These 5, an adult female and 4 young, including both sexes, were liberated near the village on St. George Island in August. At least two survived the winter, and were seen on several occasions in early May, 1914. They are not known to have been observed later; during our visit in early August none were seen, and a careful search disclosed no positive evidence of their presence. It is doubtful if any survived the summer, and in view of the fact that numbers of foxes continually ranged in the vicinity of the spot where they had been observed, the destruction of the squirrels would seem to be inevitable.

Although the two attempts which have been made to introduce ground squirrels have failed, there is little doubt that the animals could be established if brought in larger numbers and liberated in selected places where they could most easily find shelter in small natural rock cavities and where the foxes were least abundant. They are rapid breeders, and once established they might increase. But the fact that they retire in the autumn to deep underground burrows and would thus be unavailable as food during the entire winter and early spring—in other words, during the only part of the year when they would be needed by the foxes—seems to be an insuperable argument against their becoming useful as a source of fox food.

Muskrats.—The project of introducing muskrats on the islands has received considerable consideration and has once been attempted, but without success. In the summer of 1913 G. Dallas Hanna captured seven muskrats near Nushagak for introduction on St. George Island. Unfortunately the animals preyed on each other during transit until only one remained to be liberated, and this is not known to have survived the winter.

Perhaps the most important factor bearing on the chances of survival of this animal is the suitability of the ponds where it must live. Those on St. George are believed to

be so shallow that they freeze to the bottom, and if so, this makes them unsuitable for muskrats. Most of the ponds on St. Paul Island were surveyed by the late Dr. Hahn to ascertain their fitness for muskrats. The majority of those examined were found to be too shallow. The work was never completed, and two ponds which apparently are the best adapted to muskrats of any on the islands were not critically examined. One of these, Antone Lake, appears from a somewhat cursory examination to be suitable for the animals. Webster Lake is also a possibility, but is less likely to be favorable than the other.

There is little doubt that the introduction of muskrats on St. Paul Island can be successfully accomplished, but its advisability is questioned. Muskrats seek their food in winter entirely beneath the ice, and, however abundant, could not be caught at that season by the foxes, while their habits at other times of the year are such as to render them almost immune from the attacks of any land animal. The native boys, however, could increase their earnings by trapping the animals, but it is somewhat doubtful if the number which the limited amount of suitable ground would support would justify the undertaking on this basis. At any rate, a more careful examination of the deeper lakes by some one familiar with the habits of muskrats should precede any further attempt to establish the animals.

Sea otter.—This valuable animal played an important part in the discovery by white men of all the region bordering Bering Sea on the south and east. After its practical extermination from Kamchatka, the Russians in the middle of the eighteenth century gradually uncovered and devastated its haunts on the Aleutians and the neighboring groups until its growing scarcity in the more accessible regions led to its pursuit and virtual extinction in the uttermost parts of its range. At the time of the discovery of the Pribilof Islands, in 1786, sea otters were very abundant there, and as many as 5,000 are said to have been taken from St. Paul during the first year of its occupancy. They were abundant also on St. George. They rapidly declined in numbers, and according to Veniaminoff had become scarce by 1811 and extinct within the next 30 years. Although the species apparently was practically exterminated on the Pribilofs about this time, small numbers remained and single individuals have been reported in a few instances even during recent years. According to the St. Paul log, a sea otter, the first observed for several years, was reported by fishermen on September 23, 1889. One was found dead at Rocky Point, St. Paul, in June, 1896, and in December of the same year a live one was reported close to shore in Southwest Bay. Skulls or other remains, probably of animals long dead, are still occasionally found.

For some time after the commercial extermination of the sea otter on the Pribilofs many of the animals retained a foothold among the Aleutian Islands and in other parts of the North Pacific, but the incessant persecution to which the species was subjected gradually reduced it to the verge of total extinction. Now the pitiful remnant left is protected for a term of years in the hope that the species, which ranks among the most valuable of all fur bearers, may gradually repopulate its former haunts.

It has been suggested that sea otters be restored to the Pribilofs. If the difficulty of securing a stock for this purpose could be overcome, the animals might be induced by protection to remain on or about the islands, but the project is a doubtful one. Otter Island, so named from the former abundance of the sea otter on its shores, seems to be eminently adapted to the peculiar needs of this animal, is uninhabited, and yet is close

enough to St. Paul to render its supervision practicable. It is not well adapted to foxes; the seals no longer resort to it, and even if they should do so, no conflict of interests need result. It is barely possible that an attempt to restore the sea otter to the Pribilofs, where formerly it was so abundant, might be successful.

Mink and otter.—While it is possible that mink might be introduced on the Pribilof Islands, it is not believed that the attempt is advisable. The animals would undoubtedly gain an easy living in summer from the bird rookeries, but the well-known blood-thirsty proclivities of the animals would insure the destruction of such vast numbers of birds that the harm inflicted would be out of all proportion to the benefit gained. The lack of streams with their accompanying food supply, and the dearth of small mammals, would form insuperable obstacles against the maintenance of any number of mink during the winter. In short, the conditions on the Pribilofs are unnatural and on the whole unfavorable for mink, and their introduction can not be recommended.

The objections to mink apply in a great measure to the land otter. The habits of this animal in winter are very similar to those of the mink. While otter live to a considerable extent on islands, their food is gained chiefly from fresh-water lakes and streams, and the absence of these from the Pribilofs is a strong argument against the advisability of attempting their introduction.

Lemmings and other small mammals.—The black-footed lemming (*Lemmus nigripes*) is found on St. George Island only, where it sometimes becomes very abundant. Its introduction on St. Paul, where the conditions are essentially similar, has been advocated. It is said that a number of years ago lemmings from St. George were released on St. Paul on two occasions, but no evidence that they survived was ever noted. There seems to be no good reason, however, why they would not become established if liberated in sufficient numbers. Since, however, there is no evidence that the lemmings have ever been of any particular benefit to the foxes on St. George, the experiment would be interesting chiefly from a zoological standpoint. The species is known only from St. George Island, and its introduction on St. Paul would decrease the danger of its extermination from any chance cause, a fate which frequently overtakes island species, and would afford an opportunity at some future time to study any effect on the species which its new habitat might induce.

For the same reasons the Pribilof shrew (*Sorex pribilofensis*), a tiny animal known only from St. Paul Island, might be transplanted to St. George. Much the same reasoning holds true in regard to meadow mice (*Microtus*), which are not found on the Pribilofs. Certain marshy areas on both islands seem admirably adapted to these animals, and there seems to be no reason why they should not succeed there, since they are abundant on several similar islands in Bering Sea and on some of the Aleutians. These species are in most cases peculiar to the island on which they are found.

House mice were early introduced on St. Paul Island and have long been abundant, and a pest. The presence of so many cats does not seem to have acted as a check on their numbers. Rats seem never to have gained a foothold, although it is altogether likely that occasionally they are landed with cargo.

Ptarmigan.—The introduction of ptarmigan on the Pribilofs has been suggested. While the general conditions as to climate and food are rather favorable than otherwise, it is believed that the great number of foxes would prevent the birds from establishing themselves or from increasing to any extent. It is likely also that the isolation of the

islands from any other land masses would result unfavorably, since it is likely that the birds would attempt to migrate from the new habitat forced upon them, and in that event their loss would be inevitable. Therefore the project does not seem feasible.

THE NATIVES.

ORIGIN AND EARLY HISTORY.

When the eager search for the unknown land resorted to by the fur-seal millions was rewarded by the discovery of St. George Island in 1786, no signs of human occupancy were found. St. Paul was not visited until the following summer, and although the first party which landed there is said to have found the remains of a recent fire, proving that they had been preceded by some chance visitors, no evidence that human beings had previously made the islands their home has ever been discovered.

The exploitation of the mine of wealth thus fallen into the hands of the discoverers demanded the services of laborers—a people accustomed to the peculiar climate and inured to the life of hardship which must become their lot. The Russians turned naturally to the near-by islands, whose inhabitants, already in a state of virtual slavery, offered no opposition to the will of their masters. Unalaska and Atka islands furnished the bulk of the natives, said to be about 140 in number, who constituted the nucleus of the present population. Villages were founded at Staraya Artel (Old Settlement), Zapadni Bay, and Garden Cove on St. George; and on the North Shore, near Big Lake, and at Polovina and Zapadni on St. Paul.

In 1799 the government of the whole region passed into the hands of the Russian-American Co. The various rival traders whose dependents had inhabited the different villages were banished from the islands and all the inhabitants on each island were finally gathered into single settlements, the sites of which are now occupied by the villages of St. George and St. Paul. In the early days the natives were in a state of practical bondage, and were in many respects worse off than slaves. They lived crowded together in semisubterranean huts, subject to the whims of their brutal masters. Scanty fires of driftwood and blubber, which added greasy smoke to the filth which naturally pervaded their hovels, were their only means of cooking and keeping warm. In winter, crowded together in their squalor, neglected and unnoticed, they perished or survived as it happened, and when the sealing season came they slaughtered and skinned the seals for their masters until another winter rolled around. The number necessary for the work was kept up not by natural increase but by annual recruits from other parts of the region, including Sitka and Kodiak. On the heterogeneous mixture naturally resulting from the intermarriage of these diverse native peoples, their Russian masters, and to a less extent people of other nationalities who have since from time to time made the islands their home, have left their impress. The resulting combination is a people having many characteristics in common, yet probably including individuals as different in appearance and character as can be found in any isolated community of this size anywhere in the world.

RELATION TO LESSEES.

In 1870, shortly after the purchase of Alaska by the United States, the Alaska Commercial Co. was formed by the banding of several enterprising traders who had taken advantage of the cessation of Russian monopoly to gain a foothold on the islands.

To this company was given the exclusive right to take sealskins on the Pribilofs for a period of 20 years. The lease was framed with due regard to the moral rights of the native inhabitants. By its terms the Alaska Commercial Co. was required to furnish annually to the natives, free of charge, 25,000 dried salmon and salt and barrels for preserving a supply of meat; a school was to be maintained for eight months of the year on each island, and furnishing any spirituous liquor to the natives was forbidden. By further regulations the natives were to be employed in the work of sealing and were to receive 40 cents for each skin taken, the rate of wages for other work done to be agreed upon between the company and the natives; all provisions and merchandise were to be furnished at prices not higher than retail prices in San Francisco; the natives were to receive free the necessary fuel and oil; all widows and orphans were to be supported; free transportation to the Aleutian Islands was allowed; medicine and the services of a physician were to be supplied free of cost; dwelling houses were to be furnished rent free; no interference in their social or domestic relations or in their religious ceremonies would be allowed, and they were to be accorded kind treatment and aided by precept and example to appreciate the advantages to be gained by proper conduct.

An annual rental of \$55,000, an internal-revenue tax of \$2 for each sealskin taken, and certain other minor taxes were required of the sealing company. To keep a proper check on the operations of the company and to safeguard in all ways the interests of the Government and the rights of the natives, agents of the United States Treasury were stationed on each island.

Thus raised from a life of degradation and misery to a condition of comparative comfort, the natives responded in a manner which is highly creditable to them. Already expert in sealing, the advantages of better food and shelter were soon apparent. The company was able to take its annual quota of 100,000 seals in from 40 to 50 working days. At the same time the natives acquired a taste for many imported foods hitherto unknown to them and adopted the manner of dress of the white inhabitants and gradually began to lose many of the more useful of their primitive habits and handicrafts.

On the expiration of the lease of the Alaska Commercial Co. in 1890 a similar lease was given to the North American Commercial Co. for a further period of 20 years. Its provisions, as far as the privileges accorded the natives are concerned, were substantially the same as those of the previous arrangement, but the rate of compensation for the sealing and other work which the natives were fitted to perform was to be fixed by the Secretary of the Treasury. For several years following the advent of the new company comparatively few seals were killed and the natives were called upon to perform a correspondingly small amount of labor. During the incumbency of the leasing companies a system of compensating the natives was developed which is now impossible of operation, but which has become so ingrained into the minds and customs of the people that it is difficult for them to accept or understand any other. The total sum due the natives for performing the work of sealing was divided into a certain number of shares, a number considerably larger than the number of laborers. The workmen were divided by agreement among themselves, and supposedly according to their ability, into several classes, and from time to time received what was due them according to this arrangement. Some shares went to the church, others to the priest, and others to the widows and orphans. This arrangement did very well under the leasing

system and while a large number of seals were being killed; some of the natives accumulated considerable sums which were deposited with the companies and bore interest. But the diminution in the herd necessitated a reduction in the quota, and during the *modus vivendi* an appropriation was made by the Government for the support of the natives. This continued to be done down to 1911; the annual amount, at least during the later years, was \$19,500.

CONDITIONS UNDER GOVERNMENT MANAGEMENT.

The lease of the North American Commercial Co. having been terminated in 1910, the Government deemed it best to abandon the leasing system and accordingly took charge of all the activities on the Pribilof Islands. The special appropriation of \$19,500 was discontinued, but a part of the general appropriation for Alaskan seal and salmon fisheries was made available for the support of the natives. For this purpose the sum of \$40,000 was set aside, which the natives were supposed to earn by taking the seal and fox skins and by miscellaneous labor. For some of this work the natives received cash, but the greater part was paid in provisions and merchandise drawn in the form of weekly allowances. In 1912 the killing of seals, excepting the number actually needed for food, was prohibited, and the sealing work involved was reduced to a negligible quantity. The consequent necessity of making the natives dependent in a great measure on the bounty of the Government marks a decided backward step in their progress along many important lines. Some of them consider that the Government is bound to support them in any case, and as they can get very little beyond a mere living they do not feel that they should be called upon to do any work not directly concerned with sealing. Others are willing workers, but are dissatisfied because they can not attain a condition superior to that allowed their associates who make no special effort.

PRESENT SYSTEM OF SUPPORT.

The following extract from the report of Walter I. Lembkey, former agent in charge of the islands, as published in Appendix II of the Report of the United States Commissioner of Fisheries for 1913 (Bureau of Fisheries Document No. 797, pp. 141-148) states so clearly the present method of dealing with the natives that it may be quoted:

PROBLEMS IN COMMUNISTIC SYSTEM.

The instructions of the bureau provide that the natives shall be supplied, so far as funds will permit, with the necessaries of life to an amount sufficient to maintain them in comfort, due regard being paid to economy and thrift. To this end various supplies to be used by the natives, as fuel, food, clothing, etc., were purchased in San Francisco at the best wholesale rates obtainable and transported to the islands on the bureau's chartered steamer *Homer*. These supplies upon arrival at the islands were placed in the two general stores (one on each island), where they were marked for issue or sale at a price one-third above wholesale cost, including all discounts except for cash. They were then distributed after the methods hereafter detailed. The increase of one-third over the wholesale cost was made to cover cost of transportation and handling only.

The instructions of the bureau further provided that from the supplies thus taken to the islands merchandise to the amount of \$40,000 be furnished the native inhabitants for their support and maintenance during the fiscal year ending June 30, 1913. These supplies were not to be received by the natives as a gratuity but as a return for services rendered. Services such as might be performed in the taking of sealskins and in the management of the herd in general were considered the main labor for which the natives were to receive this support; but, as the killing of seals was to be greatly curtailed, the natives, in return for their support by the Government, were to be required to perform such other

labor of a nature to benefit the community generally as might become necessary or desirable. Individual natives, however, who were willing to perform such labor of a skilled or unskilled nature as might be necessary to the upkeep of the Government property and the maintenance of the stations in general were to be compensated individually in cash from funds other than the \$40,000 set apart for the community support at the rate of, for skilled labor 25 cents an hour, and for unskilled 15 cents an hour. The skilled labor embraced that of carpenters, engineers, painters, and ironworkers, etc.; the unskilled mere laboring work requiring no special aptitude.

The system involved in the foregoing arrangement for natives' support is one of almost pure communism. The main problem confronting those charged with its conduct was to support the people in such comfort and happiness as the resources would allow and at the same time to minimize those admitted evils of communal existence which, in this case, could easily result in reducing the island inhabitants to a mental condition of stolid apathy, and a physical condition of virtual peonage, if not slavery.

If no labor were required of these people the problem would be simply to give gratuitously to each person supplies sufficient to insure his existence. It is necessary, however, at almost all times of the year to require some of them to perform services for which they receive no specific compensation, but merely a right to participate in the general fund. If all labor required of them were alike in character and amount and if all the natives could perform this labor with a like degree of proficiency, no special difficulty would be encountered. Some of the labor, however, requires aptitude and special training which some natives do not possess; also, some by reason of physical imperfections can perform less work even of a general nature than others, and some no work at all. To support the natives only to the extent that they perform service would be to allow some to suffer and others to starve because of inability to work and therefore to earn.

But if a helpless cripple and his family should not be allowed to starve, on the other hand a man of high efficiency should not be required to expend his best efforts for a compensation no greater than that which the cripple and his family receive for their bare maintenance in return for which they furnish no labor whatever, and which, too, the efficient would receive as a matter of course without rendering any service in return. Then, moreover, the fund for natives support is not large enough to allow special compensation to some and general support to all, but sufficient only to prevent suffering no matter what labor may be required of them.

These and other questions, which perhaps appear trivial to the casual observer, become of vital importance to those managing the natives' affairs. It may be of interest to detail the methods which are used in the distribution of the fund for the support of the natives, all of which methods have been the subject of careful study.

The \$40,000 fund was considered as belonging to the community and to be used for its support without regard to the question whether the person so supported was or was not able to perform service in return. It was therefore divided between the two islands on a strict per capita basis; that is to say, the whole amount was divided into as many parts as there were natives on both islands, and each island was allotted as many of these parts as there were natives on that island. From this fund before distribution, however, coal enough for both islands was paid for. This coal was turned over to the native community, and the community, through its chief men, was allowed to make distribution of it without official interference. No cash was paid from this fund except \$1 apiece to each native man on Christmas and Easter, for church purposes, and a payment to a midwife of \$5 for each baby born.

From the amount remaining after the deduction for coal, a suit of clothes was given to each man and boy, each individual was provided with two pairs of shoes, each family with material enough to make underclothing for the children and women, and each person with a supply of rubber footwear. From the remainder an "emergency fund" of perhaps \$1,500 was set apart. What was left was available for purchase of food and clothing on regular issues. This remainder was divided into 52 equal parts, representing weeks in the year, thus fixing the amount that might be spent weekly for support of the whole population.

The total number of persons to be supported was next ascertained from the census—two children being considered as one adult—and divided into the weekly allotment for the whole island, thus establishing a per capita tentative allowance for each person per week.

The number of individuals in each family was then ascertained, and the per capita amounts combined to give a basis for the expenditure for each family for the week.

It having been demonstrated that a large family under the same roof can live more cheaply per capita than a small one, a readjustment of amounts was made, deducting a certain sum from the large-family allotments and adding it to those of small families. In this way a final adjustment of allotments was reached, giving about \$5 weekly to a family of two, and about \$7.50 weekly to a family of six or seven.

Having thus established the amount which each family may spend weekly, issues of food and such clothing as could be purchased out of the allowance were then made on Saturday of each week to the heads of families, each head being given an order for such supplies as he wished not exceeding his allowance, which order when taken to the store was filled and the merchandise represented thereon given to the person presenting the order.

The emergency fund, already mentioned, was used to meet expenditures not contemplated in the regular allowance, such as occur in cases of death, sickness, marriage, childbirth, etc.

In this way the amount available for support of the natives is expended, not in cash, as stated, but in merchandise itself. The amount is just about enough to support the population without want. It reaches a little more than \$100 per capita. Everything to eat, to wear, and to keep the fires burning has to be transported over 2,000 miles, and the food is mostly in tins. Nothing edible except seal flesh can be obtained locally. It can be realized, therefore, that if the fund for natives' support is barely enough to provide the actual necessities of each person, little can be done toward encouraging and compensating extra effort or otherwise alleviating the objectionable features of communistic life in general.

Where a number of persons share equally in the distribution of a general fund, as these natives do, the natural tendency of each is to take and use the whole of that share without regard to whether it is needed or not. There is no inducement for a native to strive through self-denial to exist upon less than his share from the general fund when such abstention would result simply in increasing the share of his less provident neighbor. The whole tendency of a scheme of this character is to produce an attitude of carelessness in the use of communal resources—in short, to create that attitude of mind which says: "As there is no reward for economy, let's get all we can. The other fellow will get it if we don't."

EXPERIMENTAL PLAN TO INDUCE THRIFT AND SELF-RELIANCE.

This tendency toward shiftlessness, which is an inevitable result of these peculiar circumstances, has long been recognized, and efforts have been made to palliate it at least. In 1911 a plan was put in operation designed to induce the natives to save at least a small portion of their earnings. It was based upon the general principle that by reducing weekly and other issues of supplies to a minimum an unexpended balance would be created, which balance at the year's end was to be distributed in cash among the earners according to their proficiency as workers. If even from a weekly allowance the native saved something, that saving was to be given him in cash at once. It was hoped he could be induced to open savings accounts with cash thus obtained, or at least to use it in purchasing some article not otherwise obtainable that would increase his happiness and comfort.

This scheme was placed in operation on St. George during the winter of 1911-12. The results from a careful following of the plan are interesting. At the end of the first month in which the native men were informed that such savings as they made from their weekly allowances for family supplies would be paid to them in cash more than half the families in the village drew cash savings thus derived, the sums varying from \$1 to as much as \$8 or \$9. They continued to do thus during each remaining month in the year, almost every family saving something out of the amount allowed for its support.

Careful inquiries into the motives governing the making of these savings developed some interesting points. It seemed, on the whole, that the main object of the native was not to hoard the cash thus obtained by saving but, on the other hand, to get possession of the cash itself, which in many instances he at once took to the store to expend for perhaps the very articles he had denied himself in order to make the saving. Some few, of course, used the cash to purchase in San Francisco articles which could not have been issued to them had they not the cash. No savings accounts were created. If any sums were saved, they were secreted in the natives' houses.

Some of the natives who made the largest savings had previously complained that their allowances were too small; those who have always been thrifty, however, redoubled their efforts to save, increasing their hoards regularly every month. But it was found that, to make these monthly savings, in some

cases the children in the family were made to suffer through deprivation of proper clothing and sometimes food.

At the end of the year the sum of \$632.48 was unused from the natives' fund and remained for distribution. This amount was divided among the sealers, the first-class men receiving about \$32 each and the lower grades in proportion. This money was nearly all spent in the store for articles of general use. No portion of it, as stated, was used to create or to increase savings accounts in bank. It is reported, however, that the natives were greatly pleased with the plan as operated and under it many of them came into possession of more money than they ever owned before.

The net result of this one year's experiment is not large. It shows that the natives desire their earnings in cash rather than a mere credit. It shows also that if paid in cash for their labor in taking sealskins, etc., the greater portion, if not nearly all, of their money would be used for the same purpose for which the credit is used, namely, the purchase of the necessaries of life. It shows that under the present communal system the natives are not desirous of creating permanent savings funds because of their inability to profit greatly by the result of the self-denial necessary to create the fund.

It must be stated that conditions were not favorable for carrying the operation of this plan beyond the mere point of inducing the natives to curtail their use of the necessaries of life to a minimum. It was impossible to demonstrate to them that any particular benefit would follow this saving, because there was nothing they might obtain with their savings except the bare necessities of life, of which they had deprived themselves in order to create the savings fund. And, having saved, all they could buy was what they could have had without saving. Under the present system it is not permitted to purchase for island use anything but the barest necessaries of life. Articles from the use of which the average citizen finds enjoyment or benefit, and by means of which he is able to bring his life above the level of mere animal existence, are not allowed to be purchased for sale on the islands. Neither can the native improve his mind and broaden his education by travel, because no means of transportation are available. His clothing is of a certain fixed grade each year; if he desires a better suit or an unusual article of clothing he can not purchase it because it is not in the store; nor can he order it unless through some cumbersome private arrangement almost impossible to make. In short, he is held down to the use of a greatly circumscribed class of merchandise, on an isolated spot of the universe, in which use he must live and die, practically without power to alter the condition.

Why, therefore, should the native save money? Money has no value unless it can be used as a medium of exchange. The mere hoarding of it induces no satisfaction or comfort to any normal person. The reward of self-denial exists in the possibilities for greater enjoyment and greater comfort created as the result of the self-discipline. If the native has no use for his money after saving it, he will not save it; neither will anyone. To carry out successfully any scheme of this character, it is necessary to broaden the possibilities of the native's purchasing power. He must be able to buy desirable and attractive articles at least to the amount of his savings.

Everywhere, except to these people, a prize is offered for thrift. It should be held out to them, too. For example, it should be so arranged that the shiftless must wear poor clothing, but the provident may wear better. The provident, industrious man should be able to obtain better food than his careless and lazy neighbor. Under the present system this is impossible. This situation could be adjusted readily by a private concern, and it should present no more difficulties to the Government.

NEED FOR BROADENED OPPORTUNITY.

Since the killing of seals has been stopped on the islands, except a few for food, and because of the material reduction in the appropriation by Congress for the natives' support, the system of cash payments has, unfortunately, been discontinued after only one year of trial. The building up of the moral and intellectual fiber of a people is a matter of generations, not of years, even under ideal conditions. In the case of these natives, not only should precept and example be afforded, but an intelligent readjustment of conditions on the islands should be made to give point and object to mere academic advice.

It may seem from the foregoing that because no greater results were obtained from this experiment it is useless to attempt to lead the natives to greater self-reliance and thrift. It is believed, however, that such object is not so near an impossibility as supposed. The cause should be sought in the system, not the native. The instinct of self-preservation is as highly developed in these natives as in the more effete races, and this instinct forms the basis of all desire to lay by something of what is in hand to insure

against future want. Under the present system the native expects that his future will be provided for, and has, therefore, no incentive to deny himself and no self-reliance. While no one would be willing to make the existence of these people a matter of doubt, on the other hand, it is thought that it can be so managed that the native would have to depend more upon himself through the removal of certain of the paternalistic offices performed in his behalf by the Government.

As the situation is at present, the native merely has to work and to draw his weekly rations. He might complain in order to get more, but beyond that he has no voice in the disposition of his earnings. All the managing of his resources is done in his behalf by the agent in charge, under departmental instructions, and the only open line of endeavor is to hoodwink the agent into giving him more than his share. This unnatural situation should be remedied by allowing the natives more voice in the management of their domestic financial arrangements. It is believed, contrary to general opinion, that nearly all the native men are capable of handling their earnings in a thrifty and judicious manner, once they understand that it is necessary for them to do so or starve. Under this hypothesis it would be better for the native to receive his earnings, or at least a large portion of them, in cash at the close of each season, with the understanding that this sum must suffice to support him and family for a year; or monthly amounts could be given them with the same understanding.

* * * Should a native be grossly improvident, a stated sum from his earnings should be set apart for use of his children. The Government should arrange to deposit any savings the native might make, or to expend them for such articles as the native may request to be ordered. At present this latter privilege is denied.

In short, the strongly paternalistic attitude of the Government, together with the communal system of living, has robbed these people of all chance of self-improvement by destroying the incentive. Any effort along the lines indicated or others to increase this self-reliance will be salutary. It is conceived that a certain small percentage of receipts from the sale of skins taken by these people, set apart for them, either for their support or as a fund for the improvement of local conditions, or as a sheer bonus to increase efficiency and faithful cooperation, would be a paying investment.

CASH PAYMENTS FOR SUNDRY LABOR.

What has been said in the foregoing concerning natives' earnings relates wholly to the fund earned by the community in general, mainly from the taking of skins. Such work as the natives perform as laborers or skilled workmen in maintaining the station buildings, exclusive of their own residences, is paid in cash monthly. These sums, although small, are welcome as representing the only cash the natives receive, and because this desultory labor is the only means through which the native may get individual results from independent action. Cash thus obtained almost invariably is used to augment the regular allowance of supplies, and the work through which it is obtained is eagerly sought. Not to pay them individually for such work, which is not at all for their benefit, would be to destroy the feature which removes their system of existence from mere peonage. * * *

In the above painstaking account of the manner of caring for the natives several points of vital importance are brought out, some of which may be briefly discussed. (1) The native wishes to be paid in cash for his work even though he may be impelled, either from inclination or necessity, to spend that cash almost at once. This tendency may be observed among native races anywhere as soon as money comes into use as a medium of exchange and is, of course, merely an indication that the native mind has grasped the fundamental idea underlying its use. He has labored and having obtained his reward, he would exchange it for something he needs or wishes. (2) Some of the people desire to accumulate their savings, showing that they possess a measure of thrift. (3) Some wish to exchange the results of their labor for articles other than mere necessities such as food and clothing, but that this is rendered impossible or difficult because the articles are not available on the island, and the delay and other difficulties of sending outside for the desired commodity are discouraging. (4) The opportunities for profiting from the possession of special talents or abilities are too limited,

causing dissatisfaction to those possessed of such abilities and removing in a great degree the incentive which those less favored should have for striving to increase their earning capacity.

Since 1912 less money has been available for cash payments for miscellaneous labor than was contemplated. The necessities of life have been provided the natives, but with the cessation of sealing on a commercial scale they have been receiving their support in return for a minimum of labor. As before stated, the custom of receiving this support in return for the work of sealing has become so fixed in their minds that it is very difficult to make them understand that, in the absence of this work, other labor should be required of them. The fact that miscellaneous work has not always been rewarded, owing to lack of funds, has created much dissatisfaction, some of which is natural and justified.

POPULATION.

The native populations of the islands of St. Paul and of St. George on June 30, 1914, were 192 and 116, respectively. During the preceding year on St. Paul there were 9 births, 1 arrival, and 8 deaths, 3 departures and 1 dropped by marriage, making a reduction of two in the population. During the same period on St. George there were 9 births and 3 deaths, an increase of 6. Of the 192 natives on St. Paul, 94 were males and 98 females; and of the 116 on St. George, 58 were males and 58 females. Although the proportions of sexes are favorable for normal marriages, the regulations of the church forbid marriage within such distant degrees of relationship that in restricted communities such as these recruiting from outside bodies must often be resorted to. Thus the population of Unalaska has frequently been drawn upon.

In addition to the native population, there were on June 30, 1914, on St. Paul Island, 10 white residents, 1 Chinese (cook) and 6 white visitors, and on St. George, 5 white residents and 1 Chinese (cook).

PRACTICAL ABILITY OF NATIVES.

It has become somewhat usual to regard the native inhabitants of the Pribilof Islands as of little intelligence and practical ability, but this is by no means the case. It is true that they have failed to develop along many lines as rapidly as has been hoped, but to those who understand the conditions this is not surprising. That they do not understand the reasons for the various changes in methods of administration is only natural since some of these changes have affected them adversely, and the complex conditions which have given rise to them are to these isolated beings an absolutely unknown quantity. It is true that they are somewhat childish in their methods of reasoning, but this is always true of a semicivilized people having but a limited outlook. One of the most effective means of helping them to broaden their viewpoint will be the more widespread use of the English language. This matter is discussed elsewhere.

Regarding their practical ability along mechanical lines there is much to be said in their favor. There is on the islands a good assortment of tools for working both wood and iron, and many of the natives are proficient in their use. Under intelligent supervision they can do practically any work necessary for the upkeep and enlargement of the station. The steam and gasoline launches are run by natives. The large amount of work done under the direction of James Judge in the autumn of 1911 is a good illus-

tration of their varied ability. This work included the building of a bridge 168 feet long, including approaches; the remodeling, painting, and shingling of a large number of buildings, including dwelling houses, shops and offices; the laying of several concrete floors, pavements, and boat ways; and a great variety of minor jobs of carpentry, such as desks, book shelves, and filing cabinets. The women, under the instruction of the wives of the agents and others, have become expert dressmakers, and make a large part of their own and their childrens' clothing, and some of them do lacework and embroidery of a high order of merit.

It will be necessary in order to put the sealing plant on an efficient basis to do a great deal of work of a varied character during the next few years, and in most of this work the natives may well be employed. After the resumption of commercial sealing most of the available force will be needed during June and July on the actual work of taking the skins, but during the spring and autumn the other work necessary may gradually be accomplished.

During the incumbency of the Alaska Commercial Co. about 75,000 seals were taken annually on St. Paul Island. All the work of driving, killing and skinning this large number was done by about 70 men in from 40 to 50 working days. In late years, owing to the small number of seals killed, the ability of the natives has undeniably lessened, and care will be necessary to restore their old-time skill.

KNOWLEDGE OF SEALS OVERESTIMATED.

The native's knowledge of seals has been greatly exaggerated. It is, of course, undeniable that a native who has lived all his life among these animals acquires a great deal of information, but the average white man similarly situated would learn far more. Much of the lack of definite knowledge which has always prevailed, and which has been the source of a great deal of trouble, is due to the fact that agents and others in charge have been too ready to rely on the statements of the natives instead of ascertaining the real facts for themselves. The belief that he is supposed to know all about the seals gives the average native an exaggerated idea of his value in this regard and causes him to underestimate the true value of exact observation. An instance of this tendency came to our attention in August, 1914. It was wished to make a drive from Reef Rookery, but the natives reported only a very few seals there, and said that it would be impossible to get a sufficient number. Our observations convinced us that this was an error and the drive was ordered, with the result that 1,600 bachelors were easily found. This may have been a case of deception rather than ignorance, or more probably a combination of the two, but it illustrates the fact that in matters requiring exact information it is unwise to rely wholly upon the natives. A white man soon learns to know as much of seals as the average native, and his judgment regarding seals, as of other matters, is greatly superior. For the work of killing, skinning, and curing, however, the services of the natives can not well be spared.

PROPOSED REMOVAL OF NATIVES IMPRACTICAL.

The removal of the inhabitants to a reserve elsewhere has been suggested, but the proposal is subject to numerous objections. These islands constitute the only home that the inhabitants know, and almost without exception each one thinks that the Pribilof group in general, and his own island in particular, is the best place on earth.

The greatest punishment that can be suggested is banishment to some other place. To remove these people would be cruel in the extreme, nor under present conditions would it be justified from any standpoint of expediency or economy. They would have to be supported elsewhere, while here as long as the seal herd endures they will be self-supporting and under proper management will be happy and contented. In the event of their removal it would be necessary to have their work done by temporary employees probably less suited to the peculiar conditions than are these people born and raised on the islands. As far as possible the reforms needed should be put in operation gradually. It should be borne in mind that the ideas and habits of these people have back of them many generations of training under peculiar and somewhat adverse conditions, and that it is impracticable to change these habits abruptly or to settle the problems in regard to their management by transfer to a different and less favorable field.

PRESENT APPROPRIATION INADEQUATE.

The appropriation available for the Pribilof Islands is wholly inadequate to manage the business in an efficient manner. It is not enough that a certain quantity of provisions and other merchandise, varying according to the amount which can be spared for this purpose from a given year's allowance, be landed on the islands and doled out to them in weekly portions in exchange for what work they may that year be called upon to do. Even under present conditions, when no fur seals are taken except for food and when the fox herds are in poor condition, the net receipts from the sale of skins in 1913 were over \$67,000. It would seem no more than reasonable with this amount of revenue actually being turned into the Treasury that the islands be allowed a substantial increase over the \$40,000 now available. The system now followed in paying the natives for their services is merely a legacy from former times, with many of the objectionable features retained and with no improvements added. It does not meet the requirements of the situation, and is unsatisfactory alike to the natives and to the officials of the Government on the islands and elsewhere who have its administration in hand. This subject in its relation to the natives may here be considered briefly.

From a generous appropriation the stores on the islands should be annually stocked with a supply of goods sufficient to last at least one year, and to provide against accidents and emergencies a surplus of the most essential articles should be kept on hand. This stock should include the staple articles of food, clothing, and other merchandise which experience has determined are most suitable for the purpose. Some arrangement should be made for the support of those unable to earn their living—the widows, orphans, and those crippled or otherwise incapacitated. This might be done by issuing rations, and probably it might be well, in view of the impracticability of furnishing them with steady work throughout the year, to issue a minimum ration to all the natives. They should then be paid in cash for all work performed at a fair rate of wage. They themselves have petitioned that they be paid in cash for their work and be allowed to buy their provisions. Most of this cash almost at once will be expended in the store—in other words, will be returned to the Government—and after the first year it or its equivalent may be expended in paying for further labor or in the purchase of provisions.

If the business of the islands were in the hands of a private concern, this is exactly the method which would be followed, and it should be possible for the affairs there to be administered by the Government in a manner equally efficient and simple. The details

of such an arrangement will, of course, need to be worked out. A careful study of the conditions on the islands convinces one that the work necessary to put the plant on an efficient working basis will keep the natives employed for several years during the seasons when outdoor work is possible.

FOOD REQUIREMENTS.

The diminution of the seal herd and the consequent restriction of the killing of seals to the number considered necessary for native food has sometimes led both on St. Paul and St. George to so limited a kill as to be hardly sufficient for the maintenance of the community. As a result the use of large quantities of imported foodstuffs has been necessary. Thus, during the fiscal year ending June 30, 1914, the natives on both islands consumed over 3,000 pounds of canned salmon, about 1,400 pounds salted salmon, 7,500 pounds canned meats, about 6,500 pounds salt beef, and over 1,000 pounds of salt pork. While it would be inadvisable to stop entirely the importation of these articles of food, since the natives have acquired a taste for them and would be dissatisfied if they were withheld, it is plain that the quantity of these costly foods consumed would be greatly reduced if an abundance of seal meat, fresh or properly preserved and which costs nothing, was furnished them.

To ascertain the amount of seal meat really necessary for the natives, a conference was held on St. Paul with the agent in charge, Mr. Hatton, and with the native chief, John Stepetin. It appeared that a family of eight persons would consume in one month 14 fresh seal carcasses or 7 salted ones; hence fresh meat would be eaten at the rate of $1\frac{3}{4}$ carcasses per capita per month and salt meat at half that rate or seven-eighths of a carcass per capita per month.

As fresh seal meat is available for eight months in the year and salt meat must be relied upon for the remaining four months, it follows that the total amount of seal meat needed for one native for a year is 17.5 carcasses. This amounts to not more than one pound of meat free of bone per day for each person. A seal carcass as roughly dressed by the natives and including bone weighs about 35 pounds. St. Paul, with a population of 192 natives, is therefore entitled to 3,360 seal carcasses per year for native food, and St. George, with about half that number of natives, to about half that amount of meat. Scaling these figures to conservative round numbers, it seems not unfair to set the allowance for native food on St. Paul at 3,000 seals and on St. George at 1,500 seals, making a total of 4,500 seals for the native food on the two islands combined. The economical utilization of this meat would be greatly facilitated by the establishment of a cold-storage plant on each island. The natives also consume freely soda biscuits, sweet crackers, preserved fruit, jellies, and condensed milk. Sugar, candies, and sweetened foods of all descriptions have been used in considerable quantities in the home manufacture of an intoxicating drink called quass. Various means of stopping this custom have been attempted, but without complete success, although there is undoubtedly much less intemperance than formerly.

HOUSING.

The natives live in small wooden houses. With few exceptions these houses were built in the first few years of the incumbency of the Alaska Commercial Co. and are, therefore, about 40 years old. At that time the natives were living in their primitive barrabkies, a combination of sod house and burrow, compared with which these neat



Natives' dwelling houses with seal meat drying, St. Paul Island, July 9, 1914.



frame houses, small though they were, seemed like palaces. Even now they make very comfortable dwellings for small families. They are of one story, about 12 feet by 20 feet, usually with an inclosed side hall or "calidor" through which is the single entrance. Windows at the front and back, and sometimes on the side opposite the entrance, light them fairly well. Most of them have been kept in fair repair, but in many instances the floors, sills, or roofs are defective.

The native populations of the two islands are distributed in households of the following numbers:

Number and size of households on Pribilof Islands, 1914.

	Size of household.													Number of households.	Total population.
	1	2	3	4	5	6	7	8	9	10	11	12	13		
On St. Paul.....	2	7	14	14	6	2	4	1	50	192
On St. George.....	1	3	5	4	3	2	3	1	1	1	24	116

It is evident that the houses, even though they are provided with a calidor and divided into two rooms, are too small for many of the families. A few of them have been enlarged and have a third room, but there is still entirely too much crowding for proper considerations of comfort, sanitation, or morals. The most striking instance of overcrowding was met with on St. George, where a house of four rooms, the largest room being 11 by 12 feet, the smallest 7 by 11 feet, contained a man, his wife, and 12 children. The children were 8 girls, aged in years as follows: 18, 16, 9, 7, 6, 4, 2, and 8 months; and 3 boys, aged 12, 10, and 5. This family had been assigned the largest native house in the village, but it was obviously much too small.

The principle of meeting the needs of the various families by assigning to the large ones the larger houses seems to have been carried out with reasonable fullness on both St. Paul and St. George. The Government will, however, be obliged from time to time to undertake rather extensive repairing and rebuilding and it is suggested that under such circumstances greater variety be introduced into the new construction so that families of different sizes can be better accommodated than in the more nearly uniform houses at present available.

HYGIENE AND SANITATION.

The native houses are as a rule overcrowded and filthy, and in all cases they are unprovided with water and are poorly ventilated. They reproduce all the conditions of congested tenements in our worst city slums except that outside their doors there is an unlimited supply of uncontaminated fresh air.

On St. George the water for village use is in part hauled from wells and in part taken in the midst of the village from a pipe which leads by gravity from a pond behind the settlement. On St. Paul the water has heretofore been hauled entirely from wells half a mile from the village. During the past year large storage tanks have been erected on the village hill and spring water is pumped into these by way of the radio station and is to be delivered by pipes at several points in the village. For cooperation in installing and maintaining this system the village is indebted to the Navy Department. At the time of inspection (July, 1914) this system was only partly installed and the water in the tanks was much discolored by the new wood. This state of affairs had brought the system into some disfavor with the natives, but there is no reason to

suppose that when it is in working order it will not prove a decided advantage over that of the past. With water carried in wagons, sledges, or on the back for half a mile it is no wonder that its use is limited and that filthiness is thereby encouraged. Too much emphasis can not be laid on the importance of establishing in each village a good supply of easily available water.

If the water supply of the villages is meager, the means for disposal of waste is absolutely inadequate. Most native houses are provided with a privy, consisting of a pit in the ground covered with a small wooden structure. Many of the privies are filled and receive no further attention. Much of the waste, including that from cooking, is thrown on the ground just outside the houses. The result is that the whole settlement is permeated with filth. If underground drainage can not be provided, it seems that some form of waste collection and disposal ought to be instituted. Privies might be arranged with collecting pans and these, together with receptacles for household waste, ought to be emptied and the contents disposed of once or twice a week as a part of the community work.

As matters are at present the natives find it easy to remain in a condition of much filthiness, but with a reasonably available water supply and a simple but adequate system for the disposal of waste in each village this condition might well be improved. The natives are resistant to all such changes and seem to harbor a deep-seated antipathy, if not a religious one, against having anything to do with community refuse. It is therefore doubtful if they could be induced easily to take these steps in reform. Such measures would have to be enforced, and it would seem impossible to accomplish this without semi-military methods. If the Government provides village water and institutes a system of waste disposal, it might well declare the law of the land to be "Clean up and keep clean or you will be sent away."

The results of the filthiness of both villages are seen in the reports of their respective physicians. At St. Paul about half the native population showed evidence of tubercular trouble, and intestinal disorders were very prevalent. St. George, though not reported in so detailed a manner, seemed to be in much the same condition as St. Paul. In both places the work of the physician was greatly handicapped, if not made entirely ineffective, by the fact that the patient was obliged to stay in a filthy house where little or no attention was given to physicians' directions; a bath, for instance, ordered by the doctor was seldom if ever taken, for the reason that these people rarely bathe and see no relation between health and personal cleanliness. In cases of desperate sickness the priest is usually summoned, and if he declares that death is at hand the doctor's advice is entirely ignored. The invalid is kissed by most of the community and, if death follows, the same kissing is resorted to with the corpse. All these practices have religious significance to the natives, but they are unhygienic and render futile the best efforts of a physician bent on preventive measures. Improvement in these matters could be made by maintaining in each village a small hospital and inculcating through it some idea of clean living. A start in this direction has been made on St. Paul, where during the past season a small hospital building has been fitted up. The need for a hospital on St. Paul was so great that, although no appropriation was available, a fairly serviceable old building was moved and remodeled in 1914 and furnished as well as could be done by utilizing scattered material collected from various sources on the island. The physician in charge, to effect much, should have a semimilitary control over the community.

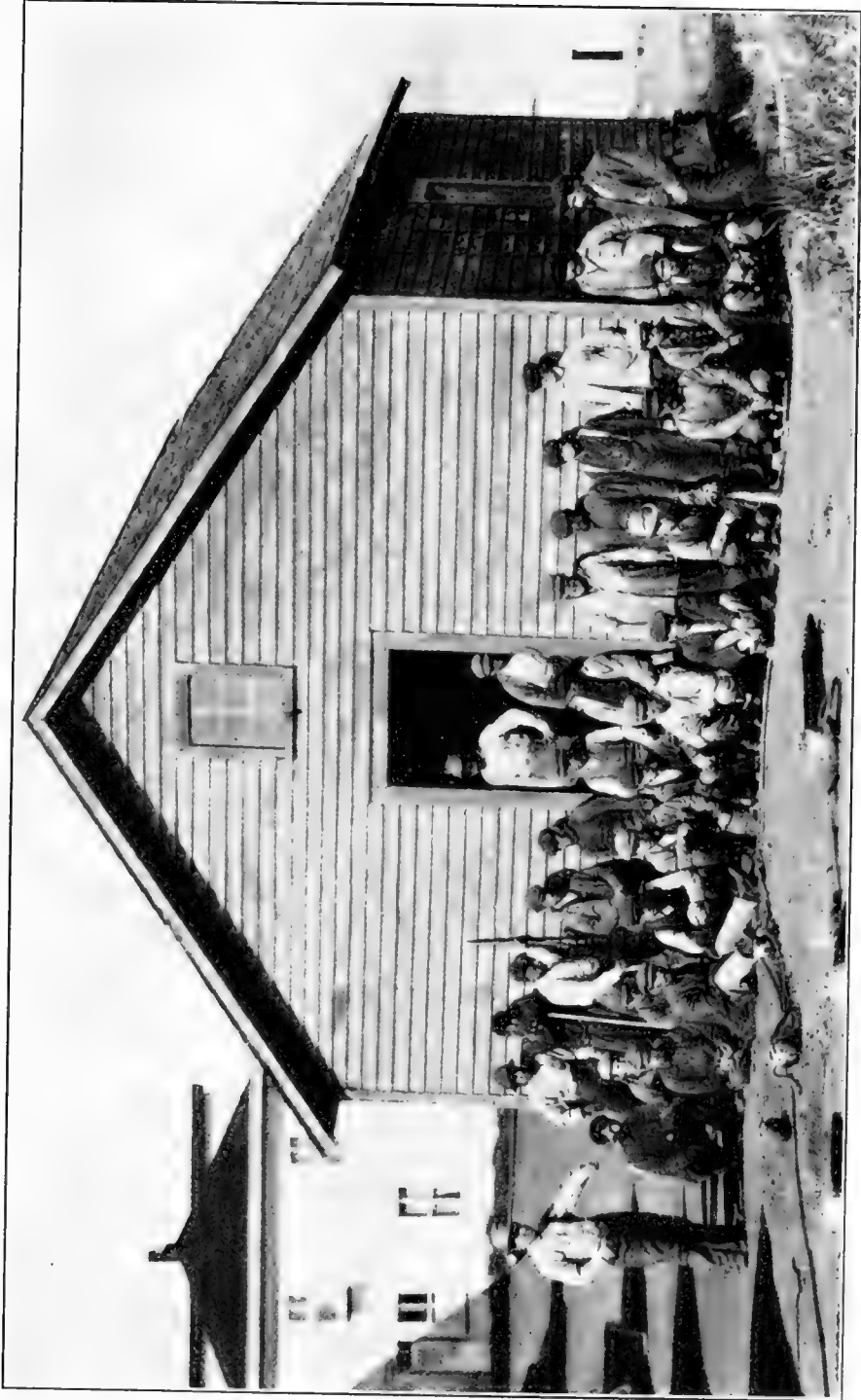

Native laborers moving hospital building, St. Paul Island, August 24, 1914.

MORALS.

The natives give the impression of an honest, docile body of people, devoid of the small vices of the poorer parts of American towns, but addicted to a certain amount of drunkenness and to sexual looseness.

Though not supposed to have access to alcoholic drink, they brew for themselves, from the sugar and other sweets supplied them, an alcoholic beverage known as quass, which is the occasion of most of their drunkenness. From the reports of those whites who have wintered on the islands, it appears that quass debauches are of not infrequent occurrence. This practice could be suppressed only through the action of the natives themselves, and even its partial control presents many difficulties.

Sexual looseness is seen in the considerable number of illegitimate births and in the prevalence of venereal diseases. So far as the natives are concerned, these conditions are due not so much to viciousness as to purely animal habits. In some respects the natives resemble children with the appetites of adults. They are reasonably honest; they are not vicious, but they indulge their appetites almost without control. Changes in these conditions can result only from racial improvement brought about through sanitary surroundings and proper education.

RELIGION.

The natives are members of the Russian Church. On each island there is a church building and priest answerable to the head of the American division of the Greek Church in New York City. The services are usually conducted in Russian with some Aleut interpretation. Each priest maintains with more or less regularity a Russian school which is chiefly concerned with teaching the Russian Church service. The priests have been extremely diverse; some have been self-seeking, deceitful, and cunning; others have been simple, kindly, and benevolent. All seem to be strongly conservative and oppose those steps in the social and educational organization of the islands that from the American standpoint mean progress. It is difficult to see how many needed improvements can be carried out on the islands without the cooperation of the church. If intelligent priests could be obtained and thoroughly sympathetic relations established with them, a most effective avenue for advance would probably be opened up.

EDUCATION.

The education of the natives, as the reports of the several school-teachers on the islands have shown, is not a simple task. School is in session for eight months each year, and the pupils in attendance range from 6 to 16 years of age. In the past year on St. Paul there were 26 boys and 16 girls enrolled, and on St. George 12 boys and 13 girls. The schoolhouses are single-room frame buildings, poorly and inadequately furnished, and in wretched condition, particularly on St. George. While the school on St. George can be managed by one teacher, that on St. Paul requires two, one of whom should be a woman. Some improvement has been accomplished during the present year on St. Paul by the utilization of a smaller building for the younger scholars, thus relieving somewhat the congestion. New school buildings with better equipment, or extensive repairs and enlargement of the old buildings, are urgently needed on both islands. Although the time devoted to school is nominally eight months, this period is considerably reduced by the large number of holidays. The total number of school days in the school year is about

170, but during this period there are $25\frac{1}{2}$ days of vacation, 4 American holidays and $21\frac{1}{2}$ Russian Church holidays. These reduced the school days last year (1913-14) by $18\frac{1}{2}$ days. Besides this many name days fall in the school period, and as these are religiously observed, they cause each child an additional absence once a year. One of the teachers in particular has complained much about these holidays, but they are not more numerous than in German schools, which do not seem to have been seriously affected by them. In one respect the school year might be changed to advantage. The holiday period centers around the Russian Christmas (Jan. 6-14), a time of year when the days are very short and the light poor. A vacation covering these holidays might be given at this period, and the time thus taken might be added to the school year, in part at the beginning and in part at the end, thus increasing the year at periods when the season is more favorable than in the dark winter.

The subject most taught in the schools is English, and the exercises deal with speaking, reading, and writing this language. Besides this, arithmetic, some geography, history, personal hygiene, and a little natural history have been tried. Mr. G. Dallas Hanna, the teacher on St. George, noticed that though the native children could learn with great ease to write after a copy and even spell difficult words, their real understanding of their performances was very slight. They were remarkable imitators, but otherwise of very low intelligence. He therefore spent much time in teaching them words and their uses. But even so simple a matter as this is not easily accomplished. Most schoolbooks are written and illustrated for children who live in a land where tree, river, dog, train, etc., are already things of experience. Not one of these objects is on the Pribilofs, and it is not surprising that a new language about strange things, many absolutely unknown to them, should be troublesome to inculcate. But the matter is rendered still more difficult from the fact that the native child on leaving school for the day hears nothing but Aleut and speaks nothing but Aleut till he returns to school the next morning. The daily speech of the native is Aleut with a few Russian and English words, and to such a native the English school must seem a most impractical and academic affair.

This side of the educational situation was recognized by the teachers on both islands, and instruction in sewing and dressmaking for the girls and in making nets, working ropes, and working and tempering steel for the older boys and men were begun. It would seem that if the educational aim could be made more practical and the English language made incidental to this training, a more secure advance might be made. Certainly the common-school aims and methods in the States are not well adapted to the natives of the Pribilofs.

Some improvement could doubtless be attained by the use of special readers, dealing more generally with objects which are familiar to the native child.

The ability of the natives to use English is quite different on the two islands. On St. Paul about six, mostly old people, can speak no English, but about two-thirds of the total population speak the island's capacity of this tongue. About half the population can answer simple English questions, and five or six speak English well. It is easy to get an English answer on St. Paul; it is rather difficult on St. George. This difference is probably due to the greater frequency with which Government vessels call at St. Paul than at St. George. The native on St. Paul has considerable use for his English as compared with his brother on St. George.

CONCLUSIONS.

It will be seen from the foregoing account that the people of the Pribilof Islands, though not natives, have for so long made the islands their home that they know and recognize no other. They are a people still in a state of semicivilization, and considering their limited environment they seem to be as well able to embrace its advantages and as successful in combating its disadvantages as is usual among such peoples. They constitute a heritage acquired by the United States with the islands and their valuable wild inhabitants, and considerations of economy and of humanity demand that they be accepted as such and managed with all possible wisdom and fairness. Many of the details of the present system of dealing with them are survivals of the past, and the conditions under which they developed are no longer existent. Many changes and improvements have been recommended by the agents and other officials, but in most cases they have not been accomplished, either on account of controversy, sudden and radical changes of régime, or small appropriations. Many changes in the methods of dealing with the natives seem to be necessary. Such changes should be instituted gradually, and in such a way that the natives will be able to perceive their fairness and expediency. In some respects they deserve more liberal treatment; in others they must be dealt with more firmly. In their management a great deal will depend on the personality of the officials in charge.

The changes in methods which seem desirable have been pointed out in the foregoing pages. It is believed that the work necessary to put the sealing plant on an efficient basis and the resumption in the near future of commercial sealing, accompanied by a better system of compensation, and the opportunity of exchanging the reward of their labor according to their desires will help to make the natives self-respecting and gradually lead to their betterment in many directions. By such a course the people of the islands may become an entirely self-supporting, efficient, and happy community.

SUMMARY.

The results of the investigation of 1914 may be summarized under two principal headings, (1) existing conditions and (2) conclusions.

EXISTING CONDITIONS.

The actual conditions on the Pribilof Islands as detailed in the foregoing pages may be stated briefly, as follows:

(1) The herd of fur seals contains approximately 294,000 individuals, of which not less than 93,250 are bearing females.

(2) The stock of adult males is small, and though there is no proof that breeding is thereby diminished, it is evident that adolescent males participate in it to a greater extent than is natural. There is every reason to believe that this condition will cease to exist in 1915.

(3) The supply of idle bulls is small and insufficient for the service of the virgin cows, which must therefore mate either with the old bulls or with the adolescent half-bulls. There are good grounds for believing that this condition also will cease to exist in 1915.

(4) The maintenance of a supply of harem bulls in the ratio of 1 bull to 40 bearing cows meets all possible demands of safety and conservation.

(5) The operation of the law of 1912 has already resulted in a great increase of male seals. The number of young males is very large and increasing rapidly. Of those now living, enough will come to maturity in 1915 to supply the needs of the herd for both harem and idle bulls. The next generation, coming to maturity in 1916, promises to exceed greatly the needs which will then exist and succeeding generations will furnish further excess.

(6) The herd is in excellent physical condition. Seals of all classes appear healthy and robust. Mortality of pups was small and natural and no epidemic of any kind was prevalent.

(7) Yearling seals were not found on the hauling grounds except in exceedingly small numbers and very late in the season. The evidence is practically conclusive that they rarely come to land at all until after the close of the killing season, July 31.

(8) The increase in the number of bearing cows in 1914 was small and is probably due to an abnormal death rate among old cows as a result of former pelagic sealing.

(9) Observation and handling in 1914 of seals branded with hot irons in 1912 shows that the marking of breeding reserves with a permanent brand is practicable.

(10) With more facts available than at any previous time, it is conservatively estimated that when once proper proportions are established in the herd they may be continued by reserving 3-year-old males in numbers increasing at the rate of 8 per cent per annum, the reserve in any given season being 22 per cent of the number of bulls required for the cows of the previous season.

(11) The method of killing seals is not objectionable from the humane standpoint, but shorter drives are desirable.

(12) The system of weighing skins, introduced during the period of leasing, is antiquated, unreliable, and no longer necessary. A more economical and more trustworthy classification can be made by measuring the dead animals before they are skinned.

(13) The condition of the buildings on the islands, the means of local transportation, and many of the methods of work are but little changed since the lessees left. They are the inheritance of obsolete conditions and in many cases unsuited to the demands of modern efficiency.

(14) The fox herd is in poor condition and demands special care and study.

(15) The reindeer herd is increased and in good condition.

(16) The sea lions and certain of the birds need continued protection.

(17) The natives constitute a serious problem demanding careful consideration; their present condition, while far from hopeless, is not creditable to the Government.

(18) The resident employees on the islands have a heavy responsibility divided between the management of the seals and the government of the natives, each presenting special problems requiring a high degree of ability for their solution.

CONCLUSIONS.

As a result of the investigations of 1914, the findings of which are summarized in the preceding section, the following conclusions seem justified:

(1) There are good reasons both from the standpoint of economy and from that of the welfare of the seal herd to resume commercial sealing at once. Commercial sealing

in which the growth and preservation of the herd would be practically guaranteed could be practiced under only two restrictions, namely that females should not be killed for their skins or for food, and that breeding bulls should be maintained in numbers sufficient to supply one to each 40 bearing cows.

(2) The management of the seals and other animals of the Pribilof Islands needs to be placed in charge of a specially qualified officer and the management of the natives and the fiscal affairs might well be conducted by another. The officer in charge of sealing, in addition to physique and general good character, should have a deep interest in the problems he would have to deal with and a desire to make of them practically his life work. These qualifications are most readily found among naturalists, but general fitness for the position is more important than training as a zoologist. The position would have certain disagreeable features that are unavoidable, and in order to attract a man of the necessary ability, he should be well paid, should have certain perquisites, and should be detailed for service in Washington during the winter season so far as possible. The officer in charge of natives and fiscal affairs should be similarly qualified. Each should have at least one competent assistant. Complete division of authority being administratively impossible, the man in charge of sealing should be the senior officer on the islands, but the man in charge of fiscal affairs should have the same degree of freedom in his field that the physician and the school-teacher have in theirs.

(3) The Pribilof seal herd is a property of great value warranting immediate liberal expenditures in preparation for a most promising future. The very prevalent idea that the fur seal is on the verge of extinction is not in accordance with the facts. The present size and condition of the herd is such that its complete rehabilitation may be confidently expected. Provisions commensurate with the needs and importance of the property involved are to be regarded as wise investments and curtailment of operations at this time is not justified by conditions.

BIBLIOGRAPHY.

The following list, though known to be incomplete, is believed to include most of the important titles relating to the fur seals of the Pribilof Islands which have appeared in English since the purchase of Alaska. No attempt has been made to include references to all the minor laws and regulations or resolutions of Congress, and the list is known to be especially lacking in this respect. Articles in magazines and other periodicals of a popular nature have not, as a rule, been included. No bibliography relating to the Pribilof fur seals has ever appeared, and therefore the publication of the present list, despite its limitations, seems justified.

The work of compiling the list has been done almost entirely by Miss Rose M. MacDonald, librarian of the United States Bureau of Fisheries.

1868 Bulkley, Charles S.

St. Paul's Island, Alaska [Report by Charles S. Bulkley and Charles M. Scammon] 1867-1868. Washington, 1868. 16 p. (40th Cong., 2d sess., House Misc. Doc.)

1869 U. S. Congress. House. Committee of Ways and Means.

St. Paul and St. George, Alaska. Letter from Frank N. Wicker to Hon. Robert C. Schenck, with copy of report made to the Solicitor of the Treasury relative to the Islands of St. Paul and St. George, Alaska. Washington, 1869. 3 p. (41st Cong., 2d sess., House Misc. Doc. 11.)

- 1870 Alaska Commercial Co.
 Letter from the Alaska Commercial Company, by N. I. Jeffries, their attorney, to Hon. Nathan F. Dixon, Chairman Committee on Commerce, H. R. 1870. 25 p.
 Dall, William Healey.
 Alaska and its Resources. Boston. 1870. XII, 627 p. illus. pls.
- U. S. Congress. House. Committee of Ways and Means.
 Alaska. Letter from the Secretary of the Treasury, in answer to resolution of the House of December 5 [1869] transmitting a copy of the report of the late special agent [H. H. McIntyre] of his department for Alaska. [Supplementary report concerning the islands of St. Paul and St. George, and the fur seal: p. 11-17.] Washington, 1870. 18 p. (41st Cong., 2d sess., House Ex. Doc. 36.)
- U. S. Congress. House. Committee on Commerce.
 Fur-seal fisheries of Alaska. Letter from the Secretary of the Interior in answer to a resolution of the House, of February 9, 1870, transmitting a copy of a portion of Vincent Colyer's report relating to the fur-seal fisheries of Alaska. Washington, 1870. 12 p. (41st Cong., 2d sess., House Ex. Doc. 144.)
- U. S. War Department.
 Report of Major General George H. Thomas [relative to seal life, natives and military posts on the islands of St. George and St. Paul] September 27, 1869. (*In* Report of the Secretary of War for 1869. Washington 1870. p. 113-121.)
- 1871 U. S. Congress. House. Committee on Commerce.
 Alaska seal fishery lease. Letter from the Secretary of the Treasury, in relation to the leasing of the Alaska seal fishery. Washington, 1871. 24 p. (41st Cong., 3d sess., House Ex. Doc. 108.)
- U. S. Congress. House. Committee on Commerce.
 St. Paul Island, Alaska. Letter from the Secretary of the Treasury, transmitting a report of the special agent [Charles Bryant] of the Treasury Department, stationed at St. Paul Island, Alaska Territory, in charge of the seal fishery. Washington, 1871. 7 p. (41st Cong., 3d sess., House Ex. Doc. 122.)
- U. S. Congress. House. Committee on Commerce.
 Fur-seal fisheries, Alaska. Letter from the Secretary of the Treasury, transmitting copy of report of the special agent [Charles Bryant] in charge of the fur-seal fisheries at the islands of St. Paul and St. George, Alaska. Washington, 1871. 9 p. (42d Cong., 2d sess., House Ex. Doc. 122.)
- 1873 U. S. Treasury Department.
 Report on the Prybilov group, or Seal Islands, of Alaska. By Henry W. Elliott. Washington, 1873. [125] pages. plates. (Date on cover 1875.)
- 1874 Scammon, Charles Mellville.
 The marine mammals of the north-western coast of North America, described and illustrated: together with an account of the American whale-fishery. By Charles M. Scammon . . . New York, 1874. 319, v. p. illus., xxvii pl. (6 double) incl. front.
- 1875 Anti-Monopoly Association of the Pacific Coast.
 A history of the wrongs of Alaska. An appeal to the people and press of America. Printed by order of the Anti-monopoly association of the Pacific coast. San Francisco, 1875. (The operations of Hutchinson, Kohl & Co., and their successors, the Alaska commercial company, in connection with the fur-seal islands.) 43 p.
- U. S. Congress. House.
 Alaska seal fisheries. Letter from the Secretary of the Navy, transmitting a copy of the report by Lieut. Washburn Maynard, U. S. N., on the subject of the Alaska seal fisheries. Washington, 1875. 23 p. (44th Cong., 1st sess., House Ex. Doc. 43.)
- U. S. Congress. Senate. Committee on Territories.
 Letter from the Secretary of War, transmitting a report of the commanding general [O. O. Howard], Department of the Columbia, of his tour in Alaska Territory in June, 1875. Washington, 1875. 33 p. (44th Cong., 1st sess., House Ex. Doc. 12.)

- 1875 U. S. Treasury Department. Special Agents Division.
A report upon the condition of affairs in the Territory of Alaska. By Henry W. Elliott, special agent Treasury Department. Washington, 1875. 277 p. (Published also as part of 44th Cong., 1st sess., House Misc. Doc. 83.)
- 1876 U. S. Congress. House. Committee on Ways and Means.
The Alaska commercial company . . . Report . . . [Relating to the lease made between the United States and the Alaska commercial company, of the right to kill fur seals on the islands of St. George and St. Paul, in Alaska]. Washington, 1876. 143 p. (44th Cong., 1st sess., House Rept. 623.)
- U. S. Congress. House.
. . . Seal-fisheries in Alaska. Letter from the Secretary of the Treasury, transmitting, in response to resolution of the House of Representatives, information relative to the seal-fisheries of Alaska. [Washington, 1876. 478 p.] (44th Cong., 1st sess., House Ex. Doc. 83.) Contains: "A complete list of papers on file in the office of the Secretary of the Treasury, in the Alaska business since the date of the lease of the Alaska Commercial Company, August 3, 1870, to the present date."
- 1880 Allen, Joel Asaph.
History of North American Pinnipeds. A monograph of the walruses, sea-lions, sea-bears, and seals of North America. Washington, 1880. xvi, 785 p. (Department of the Interior. U. S. Geological and Geographical survey of the territories. Misc. pub. no. 12.)
- U. S. Congress. Senate.
Letter from the Secretary of the Treasury, transmitting, in answer to a resolution of the Senate of March 9, 1880, the report of Capt. Bailey upon the number, occupation, and condition of the people of Alaska; the report of the Supervising Surgeon General Marine Hospital Service on the same subject; also report of Special Agent Otis upon the illicit traffic in rum and firearms. Washington, 1880. 7 p. (46th Cong., 2d sess., Senate Ex. Doc. 132.)
- 1881 U. S. Revenue-Cutter Service.
Report of the cruise of the U. S. revenue steamer Corwin in the Arctic Ocean, by Capt. C. L. Hooper . . . Washington, 1881. 71 p. plates, fold. chart, fold. tables.
- Elliott, Henry W.
. . . The history and present condition of the fishery industries . . . The seal-islands of Alaska. Washington, 1881. 176 p. illus., xxix pl. 2 fold. maps. (Tenth Census of the United States.)
- Taylor, W. B.
Letter published in the Wenona (Illinois) Index, October 20, 27, and November 3, 1881; Descriptive of a trip to the seal islands of Alaska. Towards the North Pole. The ocean, the sea, the natives (Alutes). The seal, skins, etc. Wenona Index Extra.
- 1882 Elliott, Henry Wood.
. . . A monograph of the seal islands of Alaska. Reprinted, with additions, from the report on the fishery industries of the tenth census. Washington, 1882. 4 p. l., 3-176 p. illus., xxix pl. 2 fold. maps. (U. S. Commission of Fish and Fisheries. Special bulletin 176.)
- 1883 U. S. Revenue-Cutter Service.
Cruise of the revenue steamer Corwin in Alaska and the N. W. Arctic Ocean in 1881 . . . Notes and memoranda . . . Washington, 1883. 120 p. front. illus., plates (partly col.) [Treasury Dept. Doc. 429.]
- Swan, James G.
Report of investigations at Neah Bay, Wash., respecting the habits of fur seals of that vicinity, and to arrange for procuring specimens of skeletons of Cetacea. (*In* Bulletin of the United States Fish Commission for 1883. Washington, 1883. Vol. III, p. 201-207.)
- 1884 Elliott, Henry Wood.
Report on the seal islands of Alaska, by Henry W. Elliott. (*In* U. S. Census Office. 10th census, 1880. [Census reports] Washington, 1884. [v 8] 2 p. l., 3-188 p. illus., plates, fold. maps.)

- 1886 U. S. Congress. Senate.
Letter from the Secretary of the Treasury, transmitting, in response to Senate resolution of December 13, 1886, report by Agent Tingle on condition of the seal islands of Alaska in 1886. Washington, 1886. 4 p. (49th Cong., 2d sess. Senate Ex. Doc. 7.)
- 1887 U. S. Congress. Senate.
Letter from the Secretary of the Treasury, transmitting, in response to Senate resolution of December 13, 1887, Special Agent G. R. Tingle's report on the condition of the seal islands of Alaska in 1887. Washington, 1887. 12 p. (50th Cong., 1st sess., Senate Ex. Doc. 31.)
- U. S. Revenue-Cutter Service.
. . . Report of the cruise of the revenue marine steamer Corwin in the Arctic Ocean in the year 1885. By Capt. M. A. Healy, U. S. R. M., commander. Washington, 1887. (General report of operations of vessel for the protection of the seal fisheries and sea-otter hunting grounds, by M. A. Healy.) 102 p. plates (partly col.) 2 fold. maps. (49th Cong., 1st sess., House Ex. Doc. 153.)
- Canada.
Correspondence relative to the seizure of British American vessels in Behring Sea by the United States authorities in 1886. Ottawa, 1887. cover-title, 47 p., fold. map.
- 1888 U. S. Congress. Senate. Committee on Indian Affairs.
Letter from the Secretary of the Treasury, transmitting, in response to Senate resolution of December 13, 1888, information about Indians in Alaska. [Report of Geo. R. Tingle, special agent of the Treasury Department, of the operations of the fur-seal islands of Alaska, for the year ending July 31, 1888, p. 2-5.] Washington, 1888. 6 p. (50th Cong., 2d sess., Senate Ex. Doc. 30.)
- 1889 U. S. Congress. House. Committee on Merchant Marine and Fisheries.
. . . Investigation of the fur-seal and other fisheries of Alaska. Report from the Committee on Merchant Marine and Fisheries of the House of Representatives. Washington, 1889. 1, 415 p. pls. charts. (50th Cong., 2d sess., House Rept. 3883.)
- U. S. Revenue-Cutter Service.
. . . Report of the cruise of the revenue marine steamer Corwin in the Arctic Ocean in the year 1884. By Capt. M. A. Healy. Washington, 1889. 128 p., front. plates. (Partly col.) (50th Cong., 1st sess., House Misc. Doc. 602.)
- U. S. Congress. Senate.
Letter from the Secretary of the Treasury transmitting, in response to Senate resolution of January 17, 1889, report of Special Agent George R. Tingle on condition of the seal islands of Alaska in 1889. Washington, 1889. 5 p. (50th Cong., 2d sess., Senate Ex. Doc. 90.)
- U. S. President.
Message from the President of the United States, transmitting, in response to Senate resolution of January 2, 1889, a report upon the seal fisheries in Bering Sea. [Washington, 1889] 281 p. (50th Cong., 2d sess., Senate Ex. Doc. 106.)
- 1890 U. S. Department of State.
Seal fisheries of Behring Sea. Message from the President of the United States transmitting a letter from the Secretary of State, with accompanying papers, touching the subjects in dispute between the Government of Great Britain in the Behring Sea, including all communications since March 4, 1889. Washington, 1890. 96 p., fold. map. (51st Cong., 1st sess., House Ex. Doc. 450.)
- U. S. Department of State.
Seal fisheries of the Behring Sea. Message from the President of the United States transmitting a letter from the Secretary of State submitting the official correspondence between the Government of the United States and the Government of Great Britain touching the seal fisheries of the Behring Sea since the nineteenth of July last. Washington, 1890. 53 p., 2 fold. maps. (51st Cong., 2d sess., House Ex. Doc. 144.)
- 1891 U. S. Congress. Senate.
Letter from the Acting Secretary of the Treasury, transmitting, in response to a resolution of the Senate, reports concerning the condition of seal islands of Alaska. Washington, 1891. 35 p. (51st Cong., 2d sess., Senate Ex. Doc. 49.)

U. S. Department of State.

Great Britain, fur-seal fisheries; *modus vivendi* respecting fur-seal fisheries in Behring Sea. Signed and proclaimed at Washington, June 15, 1891. [Reprint, 1896.] 2 p.

- 1892 Act to amend act to give effect to award rendered by Tribunal of Arbitration at Paris, under treaty between United States and Great Britain, concluded at Washington February 29, 1892, for purpose of submitting to arbitration certain questions concerning preservation of fur seals. (*In Stat. L.*, vol. 28, p. 64.)

Hart, Albert Bushnell.

. . . Extracts from official papers relating to the Bering Sea controversy. 1790-1892. New York, 1892. 26 p. (American history leaflets . . . Ed. by A. B. Hart and E. Channing . . . no. 6.) Caption title.

U. S. President.

Message of the President of the United States, transmitting the convention of February 29, 1892, between the United States and Her Britannic Majesty, submitting to arbitration the questions which have arisen between those Governments concerning the jurisdictional rights of the United States in the waters of Bering Sea, etc.; and also transmitting recent correspondence upon that subject with the British Government. Washington, 1892. 102 p. map. [52 Cong., 1st sess., Senate Ex. Doc. 55.]

- 1893 [Blowitz, H. G. S. A. O. de.]

The Behring Sea arbitration. Letters to the Times by its special correspondent; together with the award. Reprinted by permission of the proprietors. London and Toronto. 1893. 87, [1] p.

Carter, James Coolidge.

Fur-seal arbitration. Oral argument of James C. Carter . . . on behalf of the United States before the Tribunal of Arbitration convened at Paris under the provisions of the treaty between the United States of America and Great Britain, concluded February 29, 1892. Paris, 1893. 379 p.

Elliott, Henry W.

Report on the condition of the fur-seal fisheries of the Pribylov Islands in 1890. Produced on April 4, 1893, by the agent of the United States to the Tribunal of Arbitration convened at Paris. Paris, 1893. xv, 338 p.

Great Britain.

Behring Sea Arbitration . . . London, 1893. Foreign Office. United States. Nos. 1-8, 10-11.)

No. 1.—Case presented on the part of the Government of Her Britannic Majesty to the Tribunal of Arbitration . . . between Her Britannic Majesty and the United States of America. [C. 6918]

No. 2.—Report of the Behring Sea Commissioners of June 21, 1892. (With maps and appendices.) [C. 6919]

No. 3.—Counter case presented on the part of the Government of Her Britannic Majesty to the Tribunal of Arbitration . . . between Her Britannic Majesty and the United States of America. [C. 6920]

No. 4.—Argument presented on the part of the Government of Her Britannic Majesty to the Tribunal of Arbitration . . . between Her Britannic Majesty and the United States of America. [C. 6921]

No. 5.—Map of the northern portion of the north Pacific Ocean, annexed as part of the appendix to the case of Her Majesty's Government. [C. 6922]

No. 6.—The case of the United States, including the reports of the Behring Sea Commission . . . [C. 6949]

No. 7. Counter case of the United States . . . [C. 6950]

No. 8.—Argument of the United States . . . [C- 6951]

No. 10.—Award of the Tribunal of Arbitration. [C. 7107]

No. 11.—Papers relating to the proceedings of the Tribunal of Arbitration. [C. 7161]

Myers, L. W.

Seal catch, 1893. (*In Consular Reports*, 1893, vol. 43, p. 32, 320-321.)

1893 Myers, L. W.

Sealskin industry. (*In* Consular Reports, 1893, vol. 43, p. 164-165.)

United States.

Behring Sea Arbitration. Argument of the United States before the Tribunal of Arbitration, convened at Paris under the provisions of the treaty between the United States of America and Great Britain, concluded February 29, 1892. Presented to both Houses of Parliament by command of Her Majesty. London, 1893. iv p., 327 p. (United States. No. 8, 1893.) Gt. Brit. Parliament. Papers by command. C. 6951.

Bering Sea Tribunal of Arbitration.

. . . Opinions of Mr. Justice Harlan at the conference in Paris of the Bering Sea Tribunal of Arbitration, constituted by the treaty of February 29, 1892, between Her Britannic Majesty and the United States of America . . . Washington, 1893. 228 p.

U. S. Congress. Senate.

. . . Letter from the Secretary of the Treasury, in response to Senate resolution of February 8, 1893, transmitting several reports of special agents to the seal islands. [Washington] 1893. 140 p., 3 pl. (part. fold.) (52d Cong., 2d sess., Senate Ex. Doc. 107.)

Welling, James Clarke.

The Bering Sea Arbitration; or, "Pelagic Sealing," juridically considered according to a particular analogy of municipal law, by James C. Welling . . . Washington, 1893. Cover-title, 18 p. (Columbian University studies.)

Wishart, Andrew.

The Behring Sea question, the arbitration treaty, and the award . . . Edinburgh, 1893. 54 p., front. (fold. map).

1894 U. S. President.

Proclamation (of act to give effect to award of Tribunal of Arbitration at Paris concerning fur seals) April 9, 1894.

Same; with license for sailing vessels on reverse.

Same; *In* Stat. L., vol. 28, p. 1245-1247.

Myers, L. W.

Seal catch for 1893 and prospects for 1894. (*In* Consular reports, 1894, vol. 44, p. 276-279.)

U. S. Congress. House. Committee on Foreign Affairs.

Bering Sea controversy. Letter from the Secretary of State, transmitting, pursuant to House resolution dated December 15, the correspondence touching the Bering Sea controversy. [Washington, 1894.] 11 p. (53d Cong., 3d sess., House Ex. Doc. 132.)

U. S. Department of State.

Agreement between the United States and Russia for *modus vivendi* in relation to fur-seal fisheries in Bering Sea and north Pacific Ocean. Signed, Washington, May 4, April 27, 1894. Proclaimed May 12, 1894. 4 p.

1895 U. S. Bering Sea Tribunal of Arbitration.

. . . Fur-seal arbitration. Proceedings of the Tribunal of Arbitration, convened at Paris, under the treaty between the United States . . . and Great Britain, concluded at Washington, February 29, 1892, for the determination of questions between the two Governments concerning the jurisdictional rights of the United States in the waters of Bering Sea. . . . Washington, 1895. 16 vols. plates, fold. maps, facsims., tables, diags. (U. S. 53d Cong., 2d sess., Senate Ex. Doc. 177, pt. 1-16.)

(Each volume is preceded by the t.-p. and index of "The Executive Documents . . . Senate . . . 1893-94." Vol. 16 has half-title: Facsimiles of documents in the Alaskan archives, Department of State of the United States. To accompany the case and counter-case of the United States as presented to the Tribunal.)

Roberts, W. P.

Seal catch of 1894. (*In* Consular Report, 1895, v. 47, p. 84-87.)

U. S. Bureau of Navigation.

[Laws relating to] seal fisheries. (*In* Navigation Bureau. Laws relating to Navigation and Merchant Marine, 1895. p. 219-226.)

- 1895 U. S. Congress. House. Committee on Ways and Means.
Bering Sea Tribunal. Letter from the Secretary of Treasury, transmitting, pursuant to House resolution dated December 11, 1894, information relating to the Bering Sea Tribunal, convened at Paris in 1893. Washington, 1895. 4 p. (53d Cong., 3d sess., House Ex. Doc. 243.)
- U. S. Congress. House. Committee on Appropriations.
. . . Letter from the Secretary of the Treasury, transmitting a communication from the Secretary of State in regard to an appropriation for the payment by the United States of all claims that may be made by Great Britain arising out of the Bering Sea controversy. Washington, 1895. 2 p. (53d Cong., 3d sess., House Ex. Doc. 310.)
- U. S. Congress. House. Committee on Ways and Means.
Information relating to fur seal in Bering Sea. Letter from the Secretary of the Treasury, transmitting, pursuant to House resolution of the 23d ultimo, additional information relating to fur seal in Bering Sea. Washington, 1895. 5 p. (53d Cong., 3d sess., House Ex. Doc. 306.)
- U. S. Congress. House. Committee on Ways and Means.
Fur-bearing animals in Alaska. . . . Report [to accompany H. R. 8909] (to amend act to prevent the extermination of fur-bearing animals in Alaska, as substitute for H. R. 8633). Washington, 1895. 3 p. (53d Cong., 3d sess., House Rept. 1849.)
- U. S. President.
. . . Message from the President of the United States, in response to Senate resolution of January 8, 1895, transmitting information relating to the enforcement of the regulations respecting fur seals, adopted by the Governments of the United States and Great Britain in accordance with the decision of the Tribunal of Arbitration convened at Paris, with other information called for by said resolution. . . . Washington, 1895. 438 p. 4 fold. pl. (53d Cong., 3d sess., Senate Ex. Doc. 67.)
- U. S. Revenue-Cutter Service.
Regulations governing vessels employed in fur-seal fishing during the season of 1895. Washington, 1895. 10 p. (On verso of t.-p.: Treasury Depart. Doc. 1742. Office of the Secretary. Division Revenue-Cutter Service.)
- U. S. State Department.
Modus vivendi between the United States and Great Britain respecting fur-seal fisheries in Bering Sea June 15, 1891 (printed 1895). 2 p.
- U. S. Treasury Department. Division of Special Agents.
Information respecting pelagic catch of fur seals, April 12, 1895. 2 p. (Dept. circular 75.)
- U. S. Treasury Department. Division of Special Agents.
Amendment to circular giving information respecting pelagic catch of fur seals. September 19, 1895. 1 p. (Dept. circular 154. 1895.)
- 1896 Brice, John J.
Remarks on the movements and breeding grounds of the fur seal, based on observations made while on the United States naval patrol of Bering Sea in 1894. By J. J. Brice. . . . Washington, 1896. p. 573-577. (Appendix 7. Extracted from the Report of the U. S. Commissioner of Fish and Fisheries for 1894.)
- Elliott, Henry Wood.
Letter from the Secretary of the Treasury, transmitting, in response to the House resolution of the 22d instant, a copy of the report of Henry W. Elliott on the condition of the fur-seal fisheries of Alaska, together with all maps and illustrations accompanying said report, January 27, 1896. . . . Ordered to be printed. Washington, 1896. 240 p. 48 pl. 14 maps (partly fold.) (54th Cong., 1st sess. House Doc. 175.)
Found also in U. S. Treasury Dept. Special Agents Division. Seal and salmon fisheries and general resources of Alaska. . . . Washington, 1898.
- Stejneger, Leonhard Hess.
The Russian fur-seal islands. By Leonhard Stejneger . . . Washington, 1896. 148 p., 66 pl. (partly fold.) (Extracted from U. S. Fish Commission Bulletin for 1896.)

- 1896 U. S. Congress. House. Committee on Ways and Means.
Lease of Alaska seal islands, etc. Letter from the Secretary of the Treasury, replying to the House resolution of the 7th ultimo in regard to the lease of the seal islands and the policing of Bering Sea. Washington, 1896. 3 p. (54th Cong., 1st sess., House Doc. 197.)
- U. S. Congress. House. Committee on Ways and Means.
Fur-bearing animals in Alaska . . . Report <to accompany H. R. 3206> (from Committee . . . favoring bill, to amend act to prevent extermination of fur-bearing animals in Alaska [by providing for commission to arrange modus vivendi, and for destruction of herd in default of same]) February 20, 1896. Washington, 1896. 2 p. (54th Cong., 1st sess., House Rept. 451.)
- U. S. Congress. Committee on Ways and Means.
Fur seals. A bill to amend an act entitled "An act to prevent the extermination of fur-bearing animals in Alaska," and for other purposes. Hearing before Committee on Ways and Means . . . Bill under discussion: H. R. 3206. Washington, 1896. 21 p. (54th Cong., 1st sess., House Rept. 3206.)
- U. S. Congress. Senate.
Act [Senate bill 2997 making appropriations for commission] to provide for fulfillment of treaty between United States and Great Britain signed February 8, 1896 [as to Bering Sea controversy], approved May 7, 1896. (*In Stat. L.*, v. 29, p. 115.)
- U. S. Congress. Senate.
. . . Letter from Henry W. Elliott, of Cleveland, Ohio, relative to condition and driving of fur seals on the Pribilof Islands, Bering Sea, Alaska. April 14, 1896. Washington, 1896. 6 p. (54th Cong., 1st sess., Senate Doc. 215.)
- U. S. Congress. Senate.
Joint resolution to authorize scientific investigation of fur-seal fisheries. Approved June 8, 1896. (54th Cong., 1st sess., Senate Doc. 155.) *Also in Stat. L.*, v. 29, p. 475.
- U. S. Congress. Senate.
. . . The Vice President presented the following letter from Acting Secretary of the Treasury, inclosing a communication from N. L. Jeffries, attorney for the North American Commercial Company, lessee of the islands of St. Paul and St. George, Alaska, protesting against the proposition to destroy fur seals by order of the United States, as contemplated by bill 3206, which recently passed the House. [Washington, 1896.] 1 p. (54th Cong., 1st sess., Senate Doc. 162.)
- U. S. Congress. Senate. Committee on Foreign Relations.
Report <to accompany H. R. 3206> (from committee favoring bill to amend "act to prevent extermination of fur-bearing animals in Alaska" [by providing for commission to arrange modus vivendi, and for destruction of herd in default of same]). Washington, 1896. 1 p. (54th Cong., 1st sess., Senate Rept. 402 [pt. 1]).
- U. S. Congress. Senate. Committee on Foreign Relations.
Views of the minority, <to accompany H. R. 3206> (adverse to House bill 3206, to amend "act to prevent extermination of fur-bearing animals in Alaska" [by providing for commission to arrange modus vivendi, and for destruction of herd in default of same]), April 16, 1896. Washington, 1896. 7 p. (54th Cong., 1st sess., Senate Rept. 402, pt. 2.)
- U. S. Congress. House. Committee on Ways and Means.
Fur-seal fisheries . . . Report <to accompany H. Res. 191> [favoring joint resolution to authorize scientific investigation of seal herd]. Washington, 1896. 1 p. (54th Cong., 1st sess., House Rept. 2095.)
- U. S. President.
Proclamation [declaring sec. 1956, Revised Statutes, to be applicable to waters designated in award of Tribunal of Arbitration under treaty between United States and Great Britain concluded Feb. 29, 1892; concerning] fur-seal fisheries, April 14, 1896. Washington, 1896. 2 p.

- 1896 U. S. Treasury Department. Revenue-Cutter Service.
Fur-seal, sea otter, and salmon fisheries. Acts of Congress, President's proclamations, regulations governing U. S. vessels, acts of Parliament, orders in council, pertaining to the fur-seal fisheries in Bering Sea and north Pacific Ocean; sea otter regulations, laws as to salmon fisheries in Alaska. Washington, 1896. 78 p. [Treasury Dept. Doc. 1850. Office of Division of Revenue-Cutter Service.]
- U. S. Treasury Department. Revenue-Cutter Service.
Regulations governing vessels employed in fur-seal fishing during season of 1896. Washington, 1896. 11 p. (Treasury Dept. Doc. 1836.)
- U. S. Treasury Department.
Statistics relating to Bering Sea seal fisheries, being tables W-GG accompanying annual report of Secretary, 1895. [Washington, 1896.] 43 p.
- U. S. Treasury Department.
Reports of agents, officers and persons, acting under the authority of the Secretary of the Treasury in relation to the condition of seal life on the rookeries of the Pribilof Islands, and to pelagic sealing in Bering Sea and the north Pacific Ocean, in the years 1893-1895. Washington, 1896. 2 pts., VIII, 379, 154 p. 23 pls. 11 maps and atlas. (54th Cong., 1st sess., Senate Doc. 137.)
- U. S. Treasury Department. Commission on fur-seal investigation.
Observations on the fur seals of the Pribilof Islands. Preliminary report by David Star. Jordan . . . commissioner in charge of fur-seal investigations for 1896; aided by . . . Leonhard Stejneger and Frederic A. Lucas . . . Jefferson F. Moser . . . Charles H. Townsend . . . George A. Clark . . . Joseph Murray . . . Washington, 1896. 69 p. fold. map. (On verso of t.-p.: Treasury Dept. Doc. 1913. Office of the Secretary.)
- 1897 Macoun, James M.
[Report, by James M. Macoun, to the minister of marine and fisheries, Canada, of an examination of the fur-seal rookeries on the Pribilof Islands in 1896.] Report presented January 12, 1897. (*In* Compilation of Documents. Alaskan seal fisheries. U. S. Bureau of Fisheries.)
- Macoun, James M.
[Report by Mr. James M. Macoun to the Minister of Marine and Fisheries, Canada, of an examination of the fur-seal rookeries on the Pribilof Islands in 1897.] Report presented September 25, 1897. (*In* Compilation of Documents. Alaskan seal fisheries, U. S. Bureau of Fisheries.)
- Thompson, D'Arcy Wentworth.
Report by Professor D'Arcy Thompson on his mission to the Behring Sea in 1896, dated March 4, 1897. [London, 1897.] 39 p. chart.
- United States.
Fur-seal arbitration. In the matter of the claims of Great Britain against the United States of America before the Bering Sea claims commission. Argument for the United States in reply. Washington, 1897. IV, 496, IV p. (Counsel for the United States: Don M. Dickinson, Robert Lansing, C. B. Warren.)
- U. S. Congress. Senate.
Revenue from rental of the seal islands of Alaska. Letter from the Secretary of the Treasury transmitting, in answer to a Senate resolution of January 5, 1897, information relative to the revenue derived from the North American Commercial Company, by the rental of the seal islands of Alaska. Washington, 1897. 12 p. (54th Cong., 2d sess., Senate Doc. 81.)
- U. S. Congress. Senate.
Act [2612] prohibiting killing of fur seals in north Pacific Ocean. Approved December 29, 1897. (*In* Stat. L., vol. 30, p. 227, 229.)
- U. S. President.
. . . Protection of fur seals in Bering Sea. Message from the President of the United States transmitting, in response to resolution of the Senate of May 25, 1897, a report to the Secretary of State, accompanied by copies of correspondence of record in the Department of State, touching the protection of fur seals in Bering Sea and the north Pacific Ocean. Washington, 1897. 67 p. (55th Cong., 2d sess., Senate Doc. 40.)

- 1897 U. S. President.
Protection of fur-seal herd in Alaska. Message from the President of the United States, transmitting, in response to Senate resolution of the 17th instant, a report from the Secretary of State touching the reply of the British Government in regard to failure of the negotiations of the Paris tribunal to protect the fur-seal herd of Alaska. February 20, 1897. [Washington, 1897] 2 p. (54th Cong., 2d sess., Senate Doc. 142.)
- U. S. Department of State.
Agreement between United States and Russia for modus vivendi in relation to fur-seal fisheries in Bering Sea and north Pacific Ocean. Signed Washington $\frac{\text{May 4, 1894}}{\text{April 22, 1894}}$, proclaimed May 12, 1894 [reprint, Washington, 1897]. 4 p. [English and French.]
- U. S. Treasury Department.
Regulations governing vessels employed in fur-seal fishing and sea-otter hunting during season of 1897. Washington, 1897. 12 p. (Treasury Depart. Doc. 1920.)
- U. S. Treasury Department.
Statistical tables. Fur-seal catch, season of 1896. List of vessels engaged, with other statistical information showing total pelagic catches from American and Asiatic herds since 1868 and land catch, Pribilof Islands, since 1870, etc. Washington, 1897. 38 p. (Treasury Depart. Doc. 1932.)
- U. S. Treasury Department.
Prohibition of killing of fur seals in north Pacific Ocean and of importation of fur-seal skins taken in such waters. Dec. 30, 1897. (Treasury Department, Division of Special Agents. Dept. circular 214.)
Same (*In* Treas. Dept. Fur seals, fur-seal islands of north Pacific Ocean, 1898 [1899]. Pt. 1, p. 246-248.)
- U. S. Treasury Department, Revenue-Cutter Service.
Regulations governing vessels employed in fur-seal fishing and sea-otter hunting during the season of 1897. Washington, 1897. 12 p. (Treasury Dept. Doc. 1920.)
- U. S. Treasury Department.
Answer to resolution relative to revenue derived from the North American Commercial Company by rental of seal islands of Alaska. Jan. 23, 1897. 12 p. (54th Cong., 2nd sess. Senate Doc. 81.)
- U. S. Treasury Department, Special Agents Division.
Report on the rookeries of the Commander Islands, season of 1897, by Leonhard Stejneger. Washington, 1897. 17 p. (On verso of t.-p.: Treasury Depart. Doc. 1997. Office of the Secretary, Special Agents Division.)
- 1898 Barrett-Hamilton, Gerald Edwin Hamilton.
Report by Mr. G. E. H. Barrett-Hamilton on his mission to the Russian seal islands in 1897. [London, 1898.] 67 p., map. (Appendices: i. Extract from report of N. C. Waxmuth, acting commander of the Kommandorski Islands, dated August, 1897 (section III). ii. Drives at the Commander Islands in 1897. iii. Memorandum of seals taken on the "Rookeries" by vessels sailing from or putting in to Japanese ports (comp. by H. J. Snow, of Yokohama). iv. Statement of prices obtained at the fur seal-skin sales on the 9th December, 1897 (C. M. Lampson and Co.). v. List of photographs. vi. Map of North Rookery, Bering Island, by Leonhard Stejneger.)
- Great Britain.
Joint Statement of conclusions signed by the British, Canadian, and United States delegates respecting the fur-seal herd frequenting the Pribilof Islands in Bering Sea. London, 1898. 5 p.
- International Bureau of the American Republics.
. . . Alaska. (Handbook No. 84, 1897.) [Washington, 1898] 133 p. front (fold. map). ([U. S.] 55th Cong., 2d sess., Senate Doc. 178, pt. 13.)

1898 Thompson, D'Arcy Wentworth.

Despatch from Prof. D'Arcy Thompson forwarding a report on his mission to Bering Sea in 1897. [London, 1898] 15 p. (U. S. No. 1, 1898.)

U. S. Congress. Senate.

Award of commissioners appointed pursuant to convention of February 8, 1896, between United States and Great Britain for settlement of claims in virtue of convention of February 29, 1892 [on Bering Sea controversy], Washington, 1898. 15 p. (55th Cong., 2d sess., Senate Doc. 59.) [Summary of claims by the Secretary of State and text of convention of February 8, 1896, are included.]

U. S. President.

Seizure of British ships in Bering Sea. Message from the President of the United States, transmitting, in response to the resolution of the Senate of February 1, 1898, a report from the Secretary of State, with accompanying papers, relating to the work of the commission appointed pursuant to the convention of February 6, 1896, between the United States and Great Britain for the settlement of claims presented by Great Britain against the United States by virtue of the convention of February 29, 1892. Washington, 1898. 94 p. (55th Cong., 2d sess., Senate Doc. 164.)

U. S. President.

Bering Sea awards. Message from the President of the United States, transmitting a report from the Secretary of State in regard to the award of the commissioners appointed pursuant to the stipulations of the convention of February 8, 1896, between the United States and Great Britain, providing for the settlement of the claims presented by the latter against the former in virtue of the convention of February 29, 1892. Washington, 1898. 15 p. (55th Cong., 2d sess., Senate Doc. 59.)

U. S. Department of State.

Fur seals in Bering Sea. Letter from the Secretary of State, transmitting a corrected copy of Senate document no. 40, Fifty-fifth Congress, second session, in relation to the protection of fur seals in the Bering Sea, and requesting that the same be reprinted. [Washington, 1898.] 3 p. (55th Cong., 2d sess., Senate Doc. 40, pt. 2.)

U. S. Treasury Department. Commission on fur-seal investigations.

Second preliminary report of the Bering Sea fur-seal investigations by David Starr Jordan, assisted by Leonhard Stejneger, Frederic Augustus Lucas, and George Archibald Clark, 1897. Washington, 1898. 48 p. (Treasury Dept. Doc. 1994.)

U. S. Treasury Department. Special Agents Division.

Seal and salmon fisheries and general resources of Alaska . . . Washington, 1898. 4 vols. illus. plates (partly col., partly fold.) ports, maps, charts. (55th Cong., 1st sess., House Doc. 92, pt. 1-4.)

Contents.—v. 1. Reports on condition of seal life on the Pribilof Islands by special Treasury agents . . . 1868 to 1895 . . . by D. S. Jordan. v. 2. Reports on seal and salmon fisheries . . . and correspondence between the State and Treasury Departments on the Bering Sea question . . . 1895 to . . . 1896, with comments on that portion thereof which relates to pelagic sealing by D. S. Jordan. v. 3. Reports by H. W. Elliott and Lieut. W. Maynard, U. S. N., on the fur-seal fisheries, etc., of the Pribilof Islands, and by Rev. S. Jackson on "Reindeer in Alaska" and "Education in Alaska," with comments on Elliott's and Maynard's report by D. S. Jordan. v. 4. Reports by W. G. Morris, I. Petroff, C. H. Townsend, F. W. True, J. J. Brice, and L. Stejneger on international resources of Alaska and the fur-seal fisheries of the North Pacific Ocean, with comments on the reports of Townsend, True, and Brice by D. S. Jordan.

U. S. Treasury Department. Special Agents Division.

Statistical tables. Fur seal catch. Season of 1897. Washington, 1898. 30 p. (On verso of t.-p.: Treasury Department, Office of the Secretary, Doc. 2009. Division of Special Agents.)

- 1898- U. S. Treasury Department. Commission on fur-seal investigations.
 1899 The fur seal and fur-seal islands of the North Pacific Ocean. By David Starr Jordan . . . commissioner in charge of fur-seal investigations of 1896-97. With the following official associates: Leonhard Stejneger and Frederic Lucas, of the U. S. National Museum. Jefferson F. Moser . . . in command of the U. S. Fish Commission steamer Albatross. Charles H. Townsend, of the U. S. Fish Commission. George A. Clark, secretary and stenographer; Joseph Murray, special agent. With special papers by other contributors. Washington, 1898-99. 4 v. fronts. (v. 1, 3) illus. plates, maps, diags., and atlas of 14 fold., charts (No. 3214-3227).
 Pt. 1-4: Treasury Dept. Doc. 2017.
 Atlas of charts has t.-p.: Report of the fur-seal investigations, 1896-1897. Charts of the islands and fur-seal rookeries of St. Paul and St. George, Pribilof group, Alaska. Prepared by the U. S. Coast and Geodetic Survey from surveys by Will Ward Duffield and party in the summer of 1897. Washington, 1899.
 Contents.—pt. 1. The history, condition, and needs of the herd of fur seals resorting to the Pribilof Islands, by David Starr Jordan and George Archibald Clark . . . pt. II. Observations on the fur seals of the Pribilof Islands, 1872-1897, as extracted from the log of St. Paul Island, and as recorded in the daily journal of the commission of 1896 and 1897. pt. III. Special papers relating to the fur seal and to the natural history of the Pribilof Islands. pt. IV. The Asiatic fur-seal islands and fur-seal industry, by Leonhard Stejneger.
- 1899 Townsend, Charles H.
 The American seal herd and pelagic sealing. (*In* Report of the Commissioner of Fish and Fisheries for 1898. Washington, 1899. p. CLXIV-CLXV.)
 U. S. Treasury Department. Special Agents Division.
 Annual Report of the Supervising Special Agent for the fiscal year ended June 30, 1899. Washington, 1899. (Seal Islands of Alaska, p. 7-8.) 19 p. (On verso of t.-p.: Treasury Depart. Doc. 2158. Special agents.)
- 1900 U. S. Treasury Department. Special Agents Division.
 Annual Report of Supervising Special Agent for fiscal year ended June 30, 1900. Washington, 1900. (Seal fisheries of Alaska, p. 7-9.) 30 p. (Treasury Depart. Doc. 2204.)
 U. S. Treasury Department.
 Regulations governing vessels employed in fur-seal fishing during the season of 1900. Washington, 1900. 6 p.
- 1901 U. S. Treasury Department.
 Regulations governing vessels employed in fur-seal fishing during the season of 1901. Washington, 1901. 6 p.
 U. S. Treasury Department. Special Agents Division.
 Annual Report of the Supervising Special Agent for the fiscal year ending June 30, 1901. Washington, 1901. 30 p. (Treasury Dept. Doc. 2255.)
- 1902 U. S. Congress. Committee on Ways and Means.
 Fur seals of Alaska. Hearing before the Committee on Ways and Means, Fifty-seventh Congress, first session. Statement of Mr. Henry W. Elliott and appendix . . . Washington, 1902. 19 p. (57th Cong., 1st sess., House.)
 U. S. Congress. House. Committee on Ways and Means.
 Fur-bearing animals in Alaska. June 2, 1902. Committed to the Committee of the Whole House on the state of the Union and ordered to be printed . . . Report <to accompany H. R. 13387>. Washington, 1902. 8 p. (57th Cong., 1st sess., House Rept. 2303 [pt. 1]).
 U. S. Congress. House. Committee on Ways and Means.
 Fur-bearing animals in Alaska. June 11, 1902. Referred to the Committee of the Whole House on the state of the Union and ordered to be printed . . . Views of the Minority <to accompany H. R. 13387>. Washington, 1902. 5 p. (57th Cong., 1st sess., House Rept. 2303, pt. 2.)
 U. S. Treasury Department.
 Regulations governing vessels employed in fur-seal fishing during the season of 1902. Washington, 1902. 6 p.

- 1902 U. S. Treasury Department. Special Agents Division.
Annual Report of the Supervising Special Agent for the fiscal year ended June 30, 1902. Washington, 1902. (Seal fisheries of Alaska. p. 7-9.) 29 p. (On verso of t.-p.: Treasury Depart. Doc. 2308. Special agents.)
- 1903 U. S. Department of Commerce and Labor. Navigation Bureau.
Seal and salmon fisheries. (*In* Navigation Bureau. Laws relating to navigation and merchant marine. Washington, 1903. p. 252-263.)
Jordan, David Starr.
Fur seal as an international issue. By D. S. Jordan and George Archibald Clark. (*In* International Quarterly. New York, 1903. vol. 7, p. 220-230.)
- 1904 U. S. Congress. Senate. Committee on Foreign Relations.
To permit action to be commenced by American citizens for vessels seized in Bering Sea. Report from the Committee on Foreign Relations amending S. 3410. Washington, 1904. 6 p. (58th Cong., 2d sess., Senate Rept. 2128.)
U. S. Congress. Senate. Committee on Territories.
. . . Conditions in Alaska. Report of subcommittee of Committee on Territories appointed to investigate conditions in Alaska . . . [and hearings before subcommittee . . .] January 12, 1904.—Ordered to be printed. Washington, 1904. 2 v. in 1. fold. map. (58th Cong., 2d sess., Senate Rept. 282.)
U. S. Congress. House. Committee on Foreign Affairs.
Fur seals. Report [from the Committee on Foreign Affairs amending S. J. R. 61, requesting the President to conclude negotiations with Great Britain for review and revision of rules and regulations which now govern taking of fur seals in north Pacific Ocean and Bering Sea]. Washington, 1904. 1 p. (58th Cong., 2d sess., House Rept. 2076.)
U. S. Congress. House. Committee on Ways and Means.
Fur seals of Alaska. Hearings before the Committee on Ways and Means . . . March 9 and 10, 1904 [on H. J. R. 124, directing the Secretary of Commerce and Labor to suspend killing of fur seals on Pribilof Islands, of Alaska, by the North American Commercial Company]. Washington, 1904. III, 76 p. (58th Cong., 2d sess., House.)
- 1905 U. S. Department of Commerce and Labor.
Regulations and instructions regarding the seal islands of Alaska. Letter from the Secretary of Commerce and Labor, transmitting, in response to a Senate resolution of January 22, 1905, copies of all regulations and instructions regarding the seal islands of Alaska. Washington, 1905. 12 p. (58th Cong., 3d sess., Senate Doc. 114.)
U. S. Congress. Senate. Committee on Foreign Relations.
Alaskan fur-seal herd . . . Letter from Henry W. Elliott, of Lakewood, Ohio, relative to the rules and regulations governing the agents of the Government in charge of the seal islands of Alaska and the condition of the fur-seal herd thereon. Washington, 1905. 78 p. (58th Cong., 3d sess., Senate Doc. 149.)
Townsend, Charles Haskins.
. . . Notes on certain Pinnipeds, with data respecting their present commercial importance. By C. H. Townsend . . . New York, 1905. p. 21-32, illus. (Reprinted from the ninth annual report of the New York Zoological Society.)
- U. S. Department of Commerce and Labor.
. . . Alaskan seal fisheries. Letter from the Secretary of Commerce and Labor, transmitting . . . certain reports . . . [Washington, 1905]. (Preliminary and annual reports for 1903-4 and 1904-5, by W. I. Lembkey, agent. Dated June 7, Aug. 12, Sept. 7, 1904, and June 17, Oct. 26, 1905, respectively.) 115 p. (59th Cong., 1st sess., Senate Doc. 98.)
- 1906 U. S. Department of Commerce and Labor.
. . . Report on the Alaskan fur-seal fisheries, by Edwin W. Sims, Solicitor of the Department of Commerce and Labor, August 31, 1906. Washington, 1906. (Appendices: A. Statistics of the Pribilof fur-seal herd from the discovery of the Pribilof Islands, 1786 to 1906, inclusive. B. Probable increase of the Pribilof fur-seal herd in case there be a total cessation of pelagic sealing and a national land killing; computation by Walter I. Lembkey.) 59 p. (59th Cong., 2d sess., House Doc. 251.)

- 1906 U. S. Congress. Senate.
 Compilation of the acts of Congress and treaties relating to Alaska from March 30, 1867, to March 3, 1905, with indices and references to decisions of the Supreme Court and opinions of the Attorney General. Prepared under the direction of Paul Charlton by . . . Fred F. Barker. Washington, 1906. 496 p. (59th Cong., 1st sess., Senate Doc. 142.)
- U. S. Congress. House. Committee on the Territories.
 Fisheries in Alaska. Hearings before the Committee on the Territories of the House of Representatives, February 16, 1906. Washington, 1906. (Statements of F. W. Cushman, B. W. Evermann, G. M. Bowers, E. W. Sims, and H. M. Kutchin, discussing bill H. R. 13543.) 19 p.
- 1907 U. S. Department of Commerce and Labor. Navigation Bureau.
 Seal hunting and Alaska fisheries [Laws]. (*In* Navigation Bureau report for 1907. pt. 2. p. 255-268.)
- 1908 U. S. Congress. Senate.
 Fur-seal herd, 1868-1908. (60th Cong., 1st sess., Senate Doc. 407 [recalled, as it was confidential].)
- U. S. Congress. Senate. Committee on Foreign Relations.
 To permit action to be commenced by American citizens for vessels seized in Bering Sea. <Report to accompany S. 390>. [Washington, 1908]. 6 p. (60th Cong., 1st sess., Senate Rept. 140.)
- U. S. Department of Commerce and Labor.
 Reports relating to Alaskan seal fisheries. Letter from the Secretary of Commerce and Labor, transmitting, pursuant to Senate resolution of March 2, 1908, certain reports . . . Washington, 1908. (Preliminary and annual reports of W. I. Lembecky, agent in charge, 1906-7.) 120 p. (60th Cong., 1st sess., Senate Doc. 376.)
- 1909 Evermann, Barton Warren.
 Fur seals domesticated. (*In* Science, New York, 1909. n. s., vol. xxxi. p. 34.)
- 1910 Evermann, Barton Warren.
 The Alaska fisheries service. By Barton W. Evermann. [Washington], 1910. cover-title, p. 219-224. (Reprinted from the Transactions of the American Fisheries Society, 1910.)
- Townsend, Charles Haskins.
 Fur seals and the seal fisheries, by Charles H. Townsend . . . Address before the Fourth International Fishery Congress, held at Washington . . . September 22 to 26, 1908. Bulletin of the Bureau of Fisheries, vol. xxviii . . . [Washington, 1910.] p. 315-322. ([U. S.] Bureau of Fisheries Doc. 661.)
- U. S. Laws, statutes, etc.
 . . . Laws and regulations relative to fur-seal fishing . . . Washington, 1910. 7 p. (Bureau of Fisheries Doc. 732.)
- U. S. Congress. Senate. Committee on Foreign Relations.
 Report. To permit action to be commenced by American citizens for vessels seized in Bering Sea [from the Committee on Foreign Relations favoring S. 3916, to confer jurisdiction upon Circuit Court of the United States for 9th Circuit to determine in equity rights of American citizens under award of Bering Sea arbitration of Paris]. Washington, 1910. 6 p. (61st Cong., 2d sess., Senate Rept. 45.)
- U. S. Congress. House. Committee on Judiciary.
 Report. Claims for alleged unlawful seizures in Bering Sea [from Committee on Judiciary amending by substitute S. 3916, to confer jurisdiction upon the Court of Claims to hear and determine claims of American citizens for damages or loss resulting from alleged unlawful seizures in Bering Sea.] Washington, 1910. 2 p. (61st Cong., 2d sess., House Rept. 1270.)
- U. S. Congress.
 An act to protect the seal fisheries of Alaska, and for other purposes. [Washington, 1910.] 3 p. (61st Cong., 2d sess., S. 7242.) [Public No. 146.]

- 1910 U. S. Congress. Senate. Committee on Conservation of National Resources.
Fur-seal fisheries. Hearings before the Committee on Conservation of National Resources on bill (S. 7242) entitled "An act to protect the seal fisheries of Alaska, and for other purposes" . . . Washington, 1910. 32 p., 2 fold., maps., diag. (61st Cong., 2d sess., Senate Doc. 605.)
- U. S. Congress. House. Committee on Ways and Means.
Seal fisheries of Alaska. Hearings before the Committee on Ways and Means of the House of Representatives, 61st Congress, 2d session, on S. 7242, April 2, 1910. (Statements of W. I. Lembkey and Charles Nagel) Washington, 1910. III, 267-278 p.
- U. S. Congress. Senate. Committee on Conservation of National Resources.
Seal fisheries of Alaska . . . Report <To accompany S. 7242> . . . [Washington, 1910.] 6 p. (61st Cong., 2d sess., Senate Rept. 441.) [For law, *see* Statutes at Large, vol. 36, pt. 1, p. 326.]
- U. S. Congress. House. Committee on Ways and Means.
Seal fisheries in Alaska . . . Report <To accompany S. 7242> . . . Washington, 1910. 3 p. (61st Cong., 2d sess., House Rept. 967.) [For law, *see* Statutes at Large, v. 36, pt. 1, p. 326.]
- U. S. Department of Commerce and Labor. Bureau of Fisheries.
The fur-seal fisheries of Alaska in 1909. [By Walter I. Lembkey.] Washington, 1910. 53 p. (Bureau of Fisheries Doc. 735.)
- U. S. President.
Lease of North American Commercial Company. Message from the President of the United States, recommending the repeal of the provisions, authorized in section 1963 of the Revised Statutes, for the renewal of the lease of the North American Commercial Company in the matter of the taking of fur seals on island [islands] of St. Paul and St. George. Washington, 1910. 2 p. (61st Cong., 2d sess., Senate Doc. 430.)
Same (*In* Congressional Record, 1910. v. 45, p. 3190, 3222).
Same (*In* House Journal. 61st Cong., 2d sess., p. 432).
Same (*In* Senate Journal. 61st Cong., 2d sess., p. 219).
- 1911 Great Britain. *Treaties*.
Despatch from His Majesty's ambassador at Washington containing the text of the treaty for the preservation and protection of the fur seals which frequent the waters of the North Pacific Ocean. Signed at Washington, July 7, 1911. Presented to both houses of Parliament by command of His Majesty, December, 1911. London, Pub. by H. M. Stationery off., [1911], 5 p. (Foreign office. Miscellaneous, No. 12 (1911). Parliament. Papers by command. Cd. 6008.)
- Heath, Harold.
Special investigation of the Alaska fur-seal rookeries, 1910. [By Harold Heath] . . . Washington, 1911. 22 p. ([U. S.] Bureau of Fisheries Doc. 748.)
- Smith, Hugh McCormick.
Making the fur seal abundant. (*In* The National Geographic magazine. Washington, 1911. vol. XXII, no. 12., p. 1139.)
- Townsend, Charles Haskins.
The Pribilof fur seal herd and the prospects for its increase. [By C. H. Townsend.] New York, 1911. 3 p. (Read at the forty-first annual meeting of the American Fisheries Society, 1911.) "Reprinted from Science, n. s., vol. xxxiv, p. 568-570."
- Evermann, Barton Warren.
An experiment in fur-seal conservation. By Barton W. Evermann [Washington, 1911, cover-title, p. [227]-234. [Reprinted from Transactions of the American Fisheries Society, 1910.]
- U. S. Congress. Senate. Committee on Conservation of National Resources.
Alaskan seal fisheries. Hearings [Feb. 4, 1911] before the Committee on Conservation of National Resources, United States Senate, on the bill S. 9959, to amend an act entitled "An act to protect the seal fisheries of Alaska, and for other purposes," approved April 21, 1910, No. 1. Washington, 1911. 86 p.

- 1911 U. S. Department of Commerce and Labor. Bureau of Fisheries.
The fur-seal fisheries of Alaska in 1910. [By Walter I. Lembkey.] Washington, 1911. 40 p.
(Bureau of Fisheries Doc. 749.)
- U. S. Department of Commerce and Labor.
Seal islands of Alaska. Letter from the Secretary of Commerce and Labor, transmitting, in response to House resolution No. 73, information relating to the seal islands of Alaska . . . Washington, 1911. 1232 p. [Appendix A to hearing before Committee on Expenditures in the Department of Commerce and Labor, House of Representatives.] (62d Cong., 1st sess., House Doc. 93.) "Copies of all letters, reports, and documents received from agents of the department in charge of the seal islands of Alaska, together with copies of all instructions given to such agents . . . since January 1, 1904, to date."
- U. S. President.
Fur seals. Message from the President of the United States, transmitting a treaty between the United States and Great Britain looking to the preservation and protection of the fur seals, signed at Washington on February 7, 1911. 4 p. (61st Cong., 3d sess., Executive 1.)
- U. S. Treaties.
Convention between the United States and other powers providing for the preservation and protection of fur seals. Signed at Washington July 7, 1911. Washington, 1911. [Ratification advised by the Senate July 24, 1911. Ratified by the President November 24, 1911. Ratified by Great Britain August 25, 1911. Ratified by Japan November 6, 1911. Ratified by Russia {October 22}, 1911. Ratifications exchanged at Washington December 12, 1911. Proclaimed December 14, 1911.] 9 p. (Treaty series No. 564.)
- U. S. Treaties.
Fur seal protection. Message from the President of the United States transmitting a convention looking to the protection and preservation of fur seals and sea otters in a certain defined zone of the North Pacific Ocean, signed by the plenipotentiaries of the United States, Great Britain, Japan, and Russia at Washington on July 7, 1911. Washington, 1911. 9 p. (62d Cong., 1st sess. Confidential. Ex. G.) also 11 p. (62d Cong., 1st sess., Senate Doc. 75.)
- U. S. Treaties.
Treaty between the United States and Great Britain providing for the preservation and protection of fur seals. Signed at Washington February 7, 1911 . . . Washington, 1911. [Ratification advised by the Senate February 15, 1911. Ratified by the President March 6, 1911. Ratified by Great Britain April 20, 1911. Ratifications exchanged at Washington July 7, 1911. Proclaimed December 14, 1911.] 6 p. (Treaty series No. 563.) [Superseded by the Treaty of July 7, 1911.]
- 1912 Clark, George Archibald.
Report of the Seal Commission. (*In Science*. New York. 1912. n. s. vol. xxxv. p. 540-541.)
- Clark, George Archibald.
The fur seal census. (*In Science*. New York. 1912. n. s. vol. xxxvi, p. 894-897.)
- Jordan, David Starr.
Fur seals and their enemies. By D. S. Jordan and Geo. A. Clark. (*In Review of Reviews*. New York. 1912. vol. 45. p. 315-317.)
- Marsh, Millard Caleb.
The fur seal mortality of the Pribilof rookeries in the absence of pelagic sealing. (*In Science*. New York. 1912. n. s. vol. xxxvi. p. 897-898.)
- McLean, Marshall.
Pribilof fur seal herd. (*In Science*. New York. 1912. n. s. vol. xxxvi, p. 183-184.)
- Townsend, Charles Haskins.
Pribilof fur seal herd. By C. H. Townsend and George A. Clark. (*In Science*. New York. 1912. n. s. vol. xxxv. p. 334-338.)

- 1912 U. S. Congress. House. Committee on Foreign Affairs.
 Protection of fur seals and sea otter. Hearing before the Committee on Foreign Affairs of the House of Representatives, January 3 and 4, 1912, on H. R. 16571, a bill to give effect to the convention between the Governments of the United States, Great Britain, Japan, and Russia, for the preservation and protection of the fur seals and sea otter which frequent the waters of the north Pacific Ocean, concluded at Washington, July 7, 1911 [Text of Treaty] . . . Washington, 1912. [Statements of Chandler P. Anderson, Charles Earl, W. I. Lembkey, Barton W. Evermann, Henry Elliott, etc.] 150 p.
- U. S. Congress. House. Committee on Expenditures in Department of Commerce and Labor. Hearings before the Committee on Expenditures in the Department of Commerce and Labor, House of Representatives, on House Resolution No. 73, to investigate the fur-seal industry of Alaska. May 31, 1911-[July 31, 1912], no. 1 [-14], Washington, 1911-1912. 1013, [28] p
- U. S. Congress. House.
 An act to give effect to the convention between the Governments of the United States, Great Britain, Japan, and Russia for the preservation and protection of the fur seals and sea otter which frequent the waters of the north Pacific Ocean, concluded at Washington, July 7, 1911. (Approved August 24, 1912.) [Washington, 1912.] 4 p. (62d Cong., 2d sess., H. R. 16571 [Public 320]). (In Stat. L., vol. 37, pt. 1, p. 499.)
- U. S. Department of Commerce. Bureau of Fisheries.
 Alaska fisheries and fur industries in 1911 [by Barton Warren Evermann], Washington, 1912. 99 p. (Bureau of Fisheries Doc. 766.) (Contents include General administrative report, by B. W. Evermann and The Fur Seal Service by W. I. Lembkey.)
- U. S. President.
 Fur seal convention. Message from the President of the United States, urging the importance of enacting at the earliest possible moment, and at this session of Congress, legislation necessary to enable this Government to make the payments to Great Britain and Japan as required by a convention entered into by the United States with Great Britain, Japan, and Russia on July 7, 1911, and also to fulfill its obligations thereunder in so far as legislation is necessary for that purpose . . . [Washington, 1912.] 3 p. (62d Cong., 2d sess., Senate Doc. 921.)
- U. S. Department of Commerce. Bureau of Fisheries.
 Truth about the fur seals of the Pribilof Islands. [Washington, 1912.] 7 p. (Bureau of Fisheries. Economic circular No. 4.) "Statement of Dr. David Starr Jordan and Mr. George A. Clark."
- U. S. Treaties.
 Fur seal convention . . . Washington [1912] (Signed at Washington July 7, 1911, by representatives of the United States, Great Britain, Japan, and Russia) 13 p. (62d Cong., 2d sess., House Doc. 916.)
- U. S. Congress. House. Committee on Foreign Affairs.
 Protection and regulation of the seal fisheries of Alaska . . . Report <To accompany H. R. 20047> Washington, 1912. 7 p. (62d Cong., 2d sess., House Rept. 321.)
- U. S. Congress. House. Committee on Foreign Affairs.
 The fur seal convention . . . Report. <To accompany H. R. 16571> Washington, 1912. ("Treaty series No. 564. Convention between the United States and other powers providing for the preservation and protection of fur seals. Signed at Washington, July 7, 1911 . . ." p. 21-29.) 29 p. (62d Cong., 2d sess., House Rept. 295.)
- 1913 [Anonymous] Seals of the Pribilof Islands. (*In* Popular Science Monthly. New York. 1913. vol. 82.)
- Clark, George Archibald.
 Conservation of the fur seal. (*In* North American Review. New York. 1913. vol. 197. p. 640-644.)
- Clark, George Archibald.
 Administration of the fur seal service. (*In* Science. New York. 1913. n. s. vol. XXXVII, p. 325-327.)

- 1913 Clark, George Archibald.
The fur-seal census for 1913. (*In Science*. New York. 1913. n. s. vol. xxxviii, p. 918-919.)
- Elliott, Henry Wood.
A statement submitted in re the fur-seal herd of Alaska to the House Committee on Expenditures in the Department of Commerce, by Henry W. Elliott, December 15, 1913, to supplement and complete the report and exhibits of the special agents of the House Committee on Expenditures in the Department of Commerce upon the condition of the fur-seal herd of Alaska and the conduct of the public business on the Pribilof Islands, as ordered by the committee June 20, 1913. Washington, 1913. 261 p. (Included, also, in "Hearings before the Committee on Expenditures in the Department of Commerce . . . October 13, 1913, and January 17, 1914," p. 163-427.)
- Jordan, David Starr.
Fur-seal legislation. By David Starr Jordan and George Archibald Clark. (*In Science*. New York. 1913. n. s. vol. xxxvii, p. 553.)
- U. S. Congress. House. Committee on Expenditures in Department of Commerce.
The report of the special agents of the House Committee on Expenditures in the Department of Commerce upon the condition of the fur-seal herd of Alaska and the conduct of the public business on the Pribilof Islands, as ordered by the committee, June 20, 1913, and made by the said agents, August 31, 1913, to the chairman, Hon. J. H. Rothermel; by Henry W. Elliott and Andrew F. Gallagher . . . Washington, 1913. 139 p. illus. charts (part fold.).
- U. S. Congress. House. Committee on Expenditures in Department of Commerce and Labor.
The fur-seal industry of Alaska . . . Report [Washington, 1913] 19 p. (62d Cong., 3d sess. House Rept. 1425.) At head of title: "House calendar no. 377." Submitted by Mr. Rothermel. Ordered printed January 21, 1913. "Views of the minority" (p. 7-10) submitted by Mr. McGuire. "Statement of the minority as to matters presented to the committee" (p. 11-19) signed: Bird McGuire, Martin B. Madden, Chas. E. Patton.
- U. S. Department of Commerce. Bureau of Fisheries.
Fishery and fur industries of Alaska in 1912. By Barton Warren Evermann. Washington, 1913. 123 p. (Bureau of Fisheries Doc. 780.) (Contents include: General administrative report, B. W. Evermann, and Fur-seal service, by Walter I. Lembkey.)
- U. S. President.
Message of the President of the United States on fur seals. Communicated to the two houses of Congress, Wednesday, January 8, 1913 . . . Washington, 1913. 7 p. (62d Cong., 3d sess., Senate Doc. 997.)
- 1914 Clark, George Archibald.
The new fur-seal investigation. (*In Science*. New York. 1914. n. s. vol. xxxix, p. 871-872.)
- Clark, George Archibald.
Russian versus American sealing. (*In Science*. New York. 1914. n. s. vol. xl, p. 736-739.)
- Osburn, Raymond C.
The fur-seal inquiry, the Congressional committee and the Scientist. (*In Science*. New York. 1914. n. s. vol. xl, p. 557-558.)
- [Editor]
The fur-seal commission. (*In Science*. New York. 1914. n. s. vol. xxxix, p. 529.)
- U. S. Congress. House. Committee on Expenditures in Department of Commerce.
Hearings before the Committee on Expenditures in the Department of Commerce, House of Representatives. Investigation of the fur-seal industry of Alaska. October 13, 1913. . . . [to April 2, 1914] . . . Washington, 1914. 849 p. (63d Cong., 2d sess., House.)
- U. S. Congress. House. Committee on Expenditures in Department of Commerce.
Fur-seal industry of Alaska . . . Report [recommending action by Attorney General to collect bond from North American Commercial Company and to institute civil proceedings against Isaac Liebes and others] Washington, 1914. 8 p. (63d Cong., 2d sess., House Report 500.)

- 1914 U. S. Congress. House. Committee on Expenditures in Department of Commerce.
Fur-seal industry of Alaska . . . Minority report. 22 p. (63d Cong., 2d sess., House Rept. 500, pt. 2.)
- U. S. Department of Commerce. Bureau of Fisheries.
. . . Alaska fisheries and fur industries. [By] Barton Warren Evermann. Appendix II to the Report of the U. S. Commissioner of Fisheries for 1913 . . . Washington, 1914. 78 p. (Bureau of Fisheries Doc. 797.)
- U. S. Treasury Department. Revenue Cutter Service.
[Rules governing vessels designated to protect seal herds and sea otters] 7 p. Approved October 29, 1913.
- U. S. Congress. House.
Appendix. In re fur-seal investigation. Facts of record which show the decline of the fur-seal herd of Alaska and the cause of that destruction of this fine public property. [Washington, 1914] p. 53-260. (63 Cong., 2d sess., House Rept.)

DESCRIPTION OF MAPS.



ROOKERIES, SHOWING NUMBER AND LOCATION OF HAREMS AT HEIGHT OF SEASON, 1914.

ST. PAUL ISLAND.

- | | |
|--------------|----------------------|
| 1. Kitovi. | 9. Zapadni. |
| 2. Lukanin. | 10. Little Zapadni. |
| 3. Gorbatch. | 11. Zapadni Reef. |
| 4. Ardiguen. | 12. Polovina. |
| 5. Reef. | 13. Polovina Cliffs. |
| 6. Sivutch. | 14. Little Polovina. |
| 7. Lagoon. | 15. Morjovi. |
| 8. Tolstoi. | 16. Vostochni. |

ST. GEORGE ISLAND.

- | | |
|--------------------|------------------|
| 17. North. | 20. Little East. |
| 18. Staraya Artel. | 21. East Reef. |
| 19. Zapadni. | 22. East Cliffs. |

GENERAL MAPS.

23. St. Paul Island, with Otter Island and Sea Lion Rock.
24. St. George Island.

KITОВI ROOKERY, ST. PAUL ISLAND.

Nearly a mile northeast of the village and beyond the high cliff known as the Black Bluff, lies Kitovi Rookery. The harems occupy a stretch of broken ledge with numerous irregular features.

On June 25 this rookery contained 46 harem bulls and 24 cows in 17 harems. On June 30 this was increased to 47 bulls and 162 cows in 34 harems. On July 17, 58 harems and 5 idle bulls were counted. The count of pups showed 2,119 born on Kitovi.

The northern end of this rookery, known as the Amphitheater, is frequented by a small and variable number of bachelors. A small number haul also in the vicinity of Rock No. 10. Early in the season the number found in both these places was small, from 50 to 150, but gradually increased and on July 28, 446 were counted.

LUKANIN ROOKERY, ST. PAUL ISLAND.

North of Kitovi Rookery and separated from it only by a short interval of sea-washed cliff, lies Lukanin. A few harems are situated on a limited space at the base of a steep bluff and beyond this a steeply sloping area studded with large boulders is occupied.

On June 25, when Kitovi still had very few cows, a single harem on Lukanin had as many as 18. There were 34 bulls, 19 harems, and 196 cows on June 30 and nearly half the cows were included in a single harem. On July 17, at the height of the season, there were 39 harems and one idle bull. Bachelors hauled at the northern end of Lukanin with great irregularity. In June none were seen except at the water front, but on July 7 about a dozen were found hauled well up the slope and sleeping in the grass, and on July 28 as many as 186 were counted about the rookery. The official count of pups showed 1,834 for Lukanin.

GORBATCH ROOKERY, ST. PAUL ISLAND.

This rookery occupies nearly half a mile of shore on the northwestern side of Reef Peninsula. Its extreme eastern harems are at the foot of abrupt cliffs, its central ones are situated on broadly shelving ledges, while those farther west occupy a boulder beach. Being scarcely half a mile from the village, it is easily accessible and high banks in several places afford excellent observation stations.

On the occasion of the first critical examination of this rookery on June 23 it held about 90 old bulls, 26 of which had small harems aggregating about 60 cows. Many harems contained but one cow, and the largest numbered only 10. About one-fourth of the cows had new-born pups. The next day the cows had increased to about 100 and at least 20 pups were seen.

On June 25 100 old bulls were counted, 43 of which had harems containing in all 143 cows. The pups had then increased to 41. On June 26 the cows had increased to 198 and 79 pups were counted.

Gorbach was next visited on June 30, when 101 harem bulls were counted, 72 of which had harems aggregating about 550 cows and at least 170 pups. On July 3 no detailed count was made, but the number of cows had increased and the number of pups nearly equaled the cows. At this time many of the cows had begun to go to sea to feed. No more counts were made until July 17, when the official harem count showed 112 bulls with harems. The females in these harems were later found to have given birth to 6,152 pups.

A small hauling ground on a grassy hillside at the rear of the middle of the rookery was occupied by a moderate number of bachelors which slowly increased throughout the season. On June 30, this number was slightly less than 100; on June 24, it was not less than 150; on June 26, it was somewhat more than 200; on July 3, by careful count, it was approximately 400; and on July 28, it was 500.

ARDIGUEN ROOKERY, ST. PAUL ISLAND.

Beyond Gorbach Rookery and separated from it by a short stretch of precipitous cliffs is the small rookery known as Ardiguén. It occupies a narrow beach at the foot of a high cliff, from the crest of which one may look almost directly down on the harems. This rookery, when first examined on June 24, was occupied by only 9 bulls, 5 of which had small harems. The number of harems later increased to 14. From 1909 to 1913 this rookery had uniformly held 11 harems. The count of pups showed that 656 pups were born on Ardiguén.

REEF ROOKERY, ST. PAUL ISLAND.

Extending for somewhat over half a mile along the southeastern side of Reef Peninsula is the populous rookery bearing this name. The ground occupied comprises mainly ledges of rock or boulder-covered beaches. The regular nature of the ground and the lack of eminences make observation difficult, as the harems extend some distance back from the shore and access to the front of the rookery mass from the rear is not possible.

On June 24 there were about 165 harem bulls on this rookery. At the time of the official count of harems there were 193 bulls. In these harems were born 13,559 pups.

Near the center of the breeding ground on Reef Rookery is an extensive hauling ground, from which numerous drives were made in 1914. A drive from this place on July 1 contained, by actual count, 780 seals, and these were estimated to constitute about one-fifth of the total number then on the ground.

On August 8, notwithstanding that practically all food killings in recent years have been taken from this place, 1,600 seals were driven from this hauling ground, forming the largest drive that has been made on the islands for a number of years. On July 3 between 2,000 and 2,500 seals were estimated to be hauled out here. On July 28, when a one-day count of all bachelors on St. Paul Island was made, only 1,500 were found on Reef.

SIVUTCH ROOKERY, ST. PAUL ISLAND.

Sea Lion Rock or Sivutch, a small islet lying a few hundred yards off Reef Point, is the site of a populous rookery. When first visited, on June 29, 63 breeding bulls were stationed there; 35 of these had harems, with a total of 364 cows. At the height of the season, there were 91 harem bulls, and 10 idle bulls. The count later showed that 4,052 pups were born there.

Bachelor seals haul out on Sivutch in some numbers. On July 28 at least 500 were present there. This hauling ground is resorted to later in the autumn than any other, and successful drives for food are sometimes made as late as December. A few sea lions are usually found on this island, and many birds breed on its summit.

LAGOON ROOKERY, ST. PAUL ISLAND.

This rookery occupies the front of a wall-like reef composed of rounded boulders which have been forced by the ice from the shallow bay called Village Cove, partially shutting off a lagoon from the sea. Lagoon was once an extensive rookery, but is now almost abandoned.

On June 23, when Lagoon rookery was first inspected, it contained two young and five old bulls, one of which had two cows. Seven bulls were present on July 2 and on July 18 there were eight harem bulls and two young bulls. The count of pups on July 29 showed that 375 pups were born there.

There is at present no hauling ground near Lagoon Rookery.

TOLSTOI ROOKERY, ST. PAUL ISLAND.

This rookery occupies a continuous stretch nearly a mile long on the eastern shore of English Bay. The ground occupied is mainly a rocky beach, but in some places the harems extend part way up the steep slope which flanks the grassy bluffs of Tolstoi Head. At the northern end of the rookery a number of harems occupy a considerable portion of a broad sand flat upon which scattered rocks were placed some years ago. The southern part of the rookery is sometimes distinguished from the northern under the name Tolstoi Cliffs.

At the time of the earliest visit, on June 23, 106 harem bulls were found located on Tolstoi. These were guarding a total of about 100 cows, of which 37 had pups. On June 25, 122 harem bulls were counted and the number of cows had greatly increased.

On July 18, 161 harems and 15 idle bulls were counted. In these harems were born 9,934 pups.

The principal hauling ground is at the northern end of the rookery. On June 23 it was estimated that 800 bachelors were hauled. On July 28, 572 were counted, and after August 1, although no exact counts were made, it was evident that nearly or quite 1,000 were usually present.

ZAPADNI ROOKERY, ST. PAUL ISLAND.

This rookery lies northeast of the extremity of Zapadni Point, the western boundary of English Bay. The harems occupy a stretch of rocky ledges and boulder beaches nearly half a mile in length. When first visited, on June 26, this rookery held 103 bulls, 34 of which had harems with an aggregate of about 100 cows. By July 18, when the official count of harems was made, there were 114 harem bulls and 24 idle bulls. The count of pups on this rookery showed a total of 7,625. On the several hauling grounds of this rookery about 1,300 bachelors were counted on July 28.

LITTLE ZAPADNI, ST PAUL ISLAND.

On the northwest shore of English Bay and separated from Zapadni Rookery by a small sandy beach lies Little Zapadni. It occupies about a half mile of rocky ledge backed by a gently rising slope. The harems extend up this slope in tiers so that in places five or six are in line between the water and the upper limits.

On June 26, when this rookery was first visited, 68 harem bulls, 36 of which already had harems, were located. On July 18, 90 harem bulls and 10 idle bulls were counted. The count of pups later showed that 4,919 had been born. On the hauling ground at the northern end of the rookery 281 bachelors were counted on July 28.

ZAPADNI REEF, ST. PAUL ISLAND.

The remnant of a rookery at one time nearly continuous with Little Zapadni is found on the northern shore of English Bay. The present season it contained 3 harem bulls and 1 idle bull. The count of pups showed that 206 were born. There are no hauling grounds in the vicinity.

POLOVINA ROOKERY, ST. PAUL ISLAND.

This rookery occupies a rocky point about half way between the village and the northeastern extremity of the island. On June 27, when first visited, 36 harem bulls had located, and 7 of these had harems, with a total of about 60 cows. At the height of the season, there were 58 harem bulls and 3 idle bulls. The count later showed that 3,555 pups were born on the rookery.

At the southern end of the rookery is a hauling ground, which on July 28 contained about 550 bachelors.

POLOVINA CLIFFS ROOKERY, ST. PAUL ISLAND.

This rookery consists of several interrupted groups of harems occupying a narrow strip of rough boulder beach at the foot of a line of low cliffs, behind which extends a level mossy plain. On June 27 there were 18 harem bulls in this rookery, 11 of which had a total of 38 cows.

At the height of the season 22 harems and 6 idle bulls were stationed here. The count taken July 29 showed that 1,449 pups were born in these harems.

A very few bachelors haul out in the vicinity of this rookery; on July 28 the number found was 47.

LITTLE POLOVINA ROOKERY, ST. PAUL ISLAND.

Little Polovina lies a short distance north of Polovina Cliffs and is similar in character to Polovina Cliffs. On June 27 it held 11 harem bulls, 6 of which had 28 cows among them. On July 19 the number of harems was 18. The count later showed that 927 pups were born here. On the small hauling ground about 50 bachelors were usually found.

MORJOVI ROOKERY, ST. PAUL ISLAND.

Morjovi is on the eastern side of Northeast Point, and separated from the larger rookery of Vostochni by the breeding herd of sea lions. It consists of two rather compact detached harem masses, with a few scattered outlying ones, and is the remnant of a rookery which formerly extended far down the shore. On June 27 it had 35 breeding bulls, and on July 19 there were 43 harems and 4 idle bulls. On this rookery 2,312 pups were born.

Adjoining Morjovi Rookery are two small hauling grounds, on which about 400 bachelors were usually found.

VOSTOCHNI ROOKERY, ST. PAUL ISLAND.

This rookery, which is nearly continuous over a stretch of rocky shore line more than a mile in length, is the largest rookery of fur seals in the world. When first visited, on June 27, 248 harem bulls were stationed there. At the height of the season, 291 harems and 20 idle bulls were found. The count of pups later showed that 19,709 had been born in these harems.

From the summit of Hutchinson Hill one looks down on a closely packed mass of harems which at the height of the season in 1914 held 106 harem bulls. The count of pups on August 2 showed a total of 9,504 in this mass, which, with their mothers and the harem masters, makes a total of over 19,000 breeding seals in one compact mass. Surrounding this particular breeding area on three sides is a hauling ground usually containing several thousand bachelors. On the various hauling grounds of Vostochni, 3,652 bachelors were counted on July 28. In former years the hauling grounds of Northeast Point were much more populous than at present and furnished nearly one-third of the total quota of skins for St. Paul Island.

On the point near the eastern extremity of this rookery is a breeding rookery of sea lions, the only one on St. Paul Island.

NORTH ROOKERY, ST. GEORGE ISLAND.

North Rookery lies about a mile west of the village and consists of a narrow fringe of harems occupying a strip of rough beach at the foot of low abrupt cliffs. There were 85 harems on July 13, and 94 harems and 4 idle bulls at the time of the official count on July 20. In these harems were born 5,301 pups. About 100 bachelors usually resorted to the small hauling ground.

STARAYA ARTEL, ST. GEORGE ISLAND.

This rookery comprises a compact mass of harems on a hill, one side of which breaks suddenly to the water and another sweeps gradually to the same level.

There were 46 harems here on July 13 and 63 harem bulls and 4 idle bulls on July 20. The count later showed that 4,278 pups were born here. On the hauling ground there were usually from 500 to 600 bachelors.

ZAPADNI ROOKERY, ST. GEORGE ISLAND.

Zapadni Rookery occupies a small patch of rough bowlder beach at the foot of an abrupt cliff, while a few harems extend around the end of the cliff and occupy a small area on its summit.

On July 13 there were 15 harems on Zapadni and on July 19 this number was found to be reduced to 14. The count of pups showed that 1,023 were born here. About 50 bachelors haul on the ground immediately adjacent to the breeding area.

On the shore about a mile east of Zapadni there was in 1914 a small hauling ground. On August 4 a number of bachelors and two old bulls were found there. Among the seals which took to the water no females were distinguished but a single young pup was found, evidence of at least one harem. According to the natives there were three harems at this place in 1913. In former years many seals hauled out here, and it was a regular killing place. Another hauling ground about half a mile west of the rookery was occupied in 1914. On August 1 a total of 276 bachelors was counted on the several hauling grounds near Zapadni Rookery.

LITTLE EAST ROOKERY, ST. GEORGE ISLAND.

This rookery has dwindled in late years, and in 1914 had only one harem, in which 26 pups were born. In 1913 there were two harems with 25 pups, and in 1912 one harem with 26 pups. The rookery is on a beach at the end of the cliffs which extend for about a mile eastward from the village.

EAST REEF ROOKERY, ST. GEORGE ISLAND.

A short distance eastward from Little East Rookery is East Reef, occupying a slightly elevated stretch of ledge covered with large bowlders.

On July 14 there were 14 harems on this rookery, and the same number were counted on July 20. About 175 bachelors were on the hauling ground on July 30. On this rookery 581 pups were born.

EAST CLIFFS ROOKERY, ST. GEORGE ISLAND.

This is the easternmost of the St. George rookeries, and occupies a gradually narrowing rocky beach and rough ascending slope. Back of it is a steep, grassy ascent, which at the eastern end of the rookery becomes an abrupt cliff. The harem bulls on July 14 numbered 54. The count on July 20 showed 57 harems and 2 idle bulls. The pups born on this rookery numbered 2,658.

On the hauling ground at the western end of this rookery about 800 bachelors were counted on July 28.

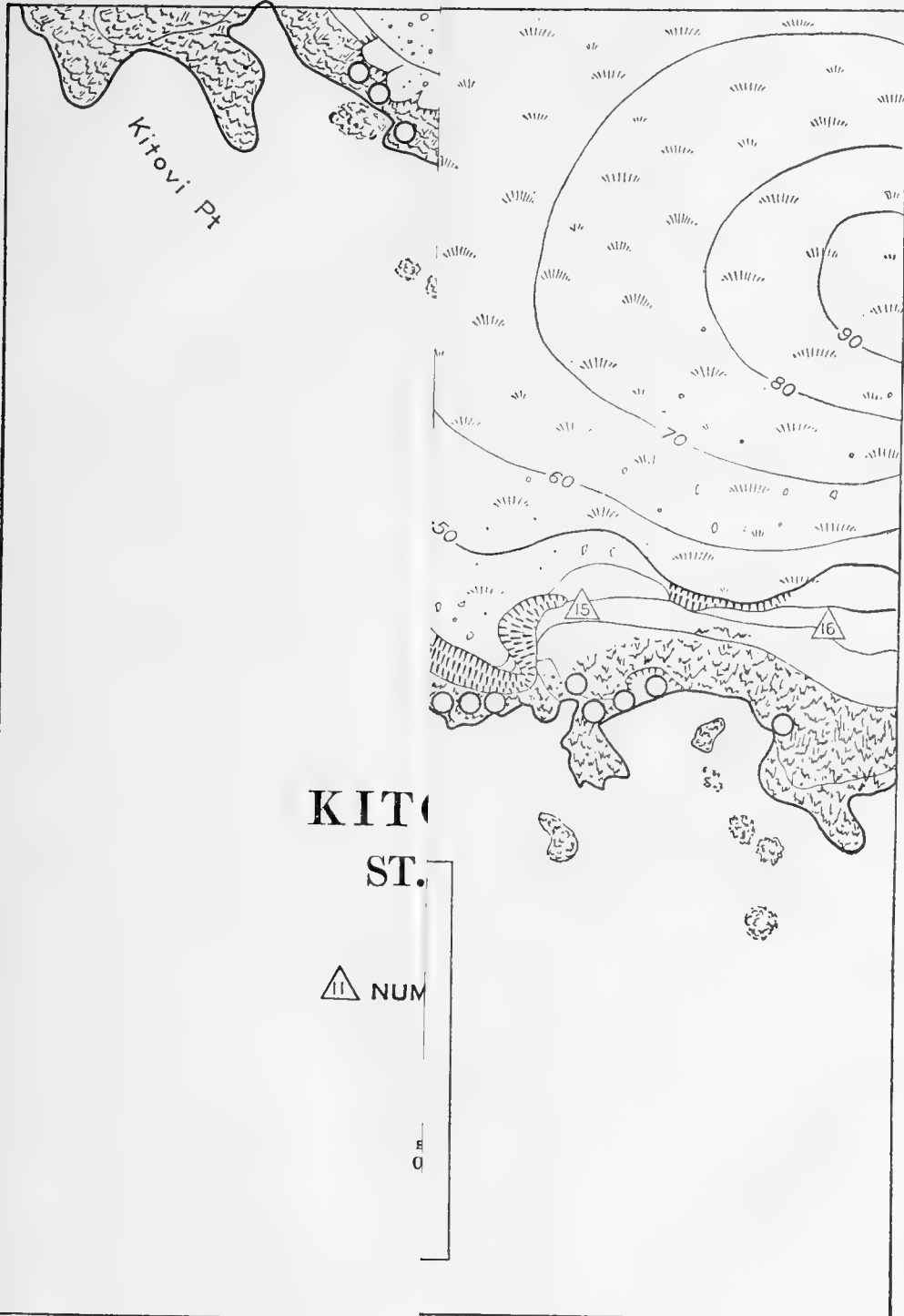

Kitovi Pt

KITO
ST.

△ NUM

5
0

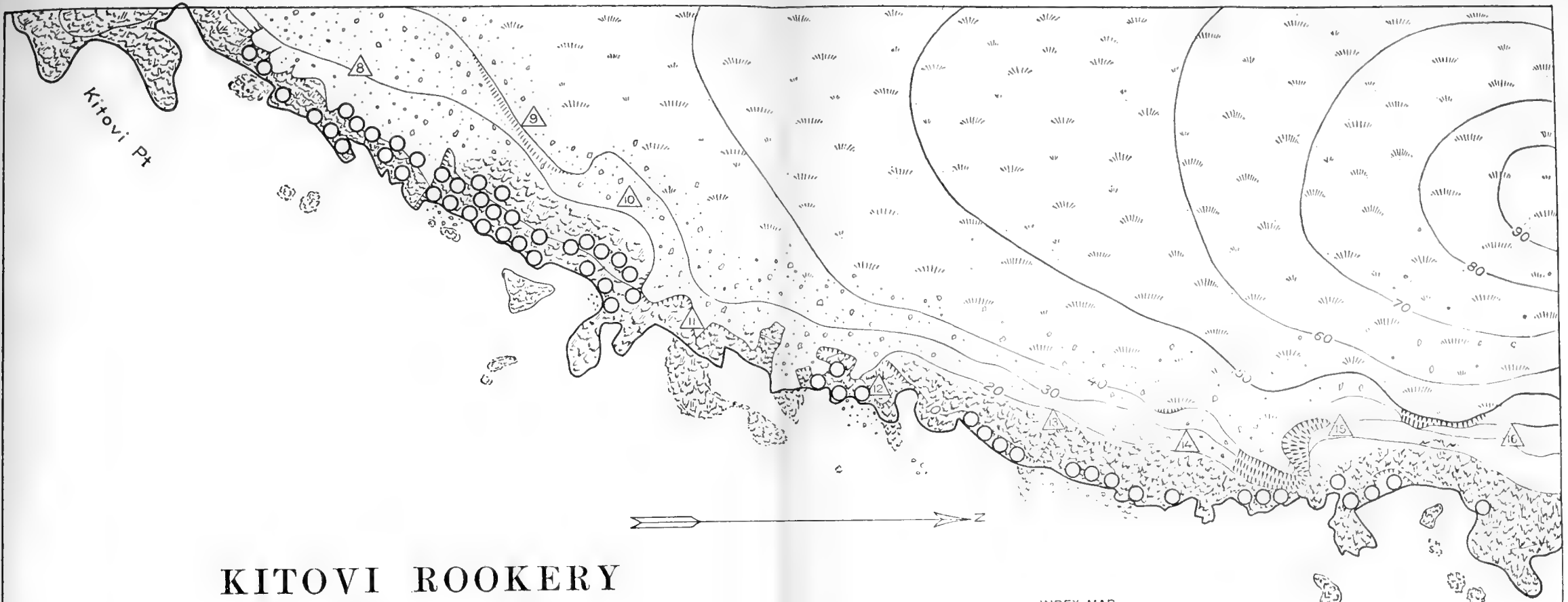

KITОВI ROOKERY ST. PAUL ISLAND

1914

▲ NUMBERED ROCKS ○ HAREMS

NUMBER OF HAREMS 58

JULY 17, 1914

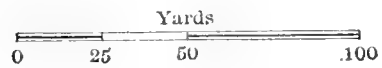

INDEX MAP

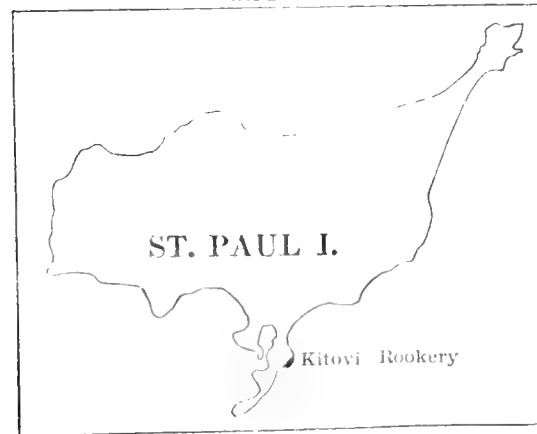

KITOV I BOOKERY
ST. PAUL ISLAND

1914

△ NUMBERED ROCKS ○ HARBOR

NUMBER OF HARBORS 23

JULY 15 1914

LUKANIN ROOKERY ST. PAUL ISLAND

1914

▲ NUMBERED ROCKS ○ HAREMS

NUMBER OF HAREMS 39
JULY 17, 1914



INDEX MAP

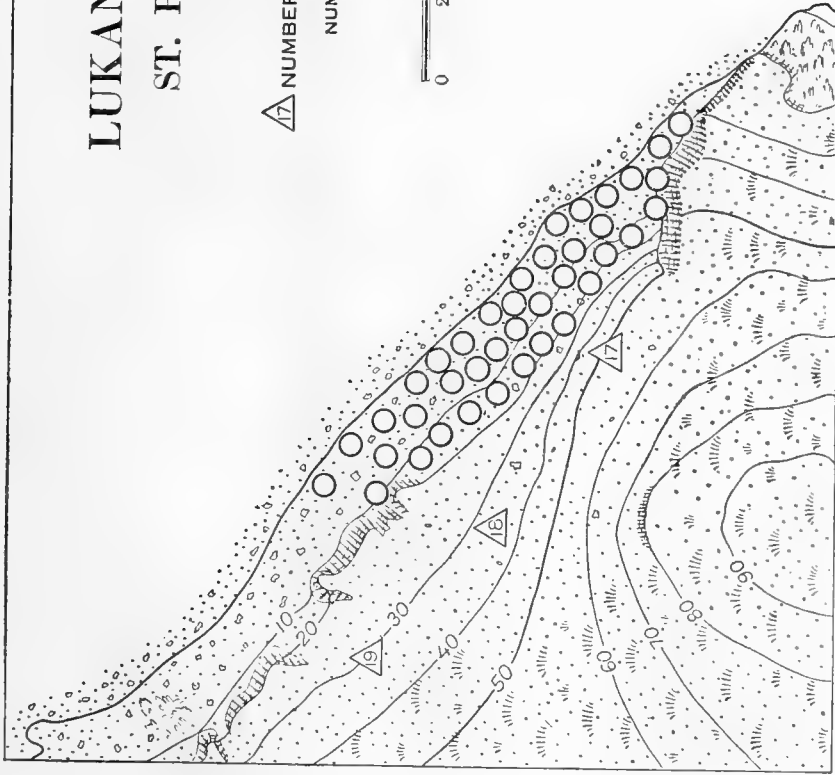
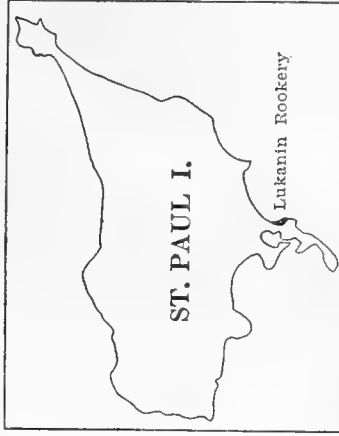

1000000

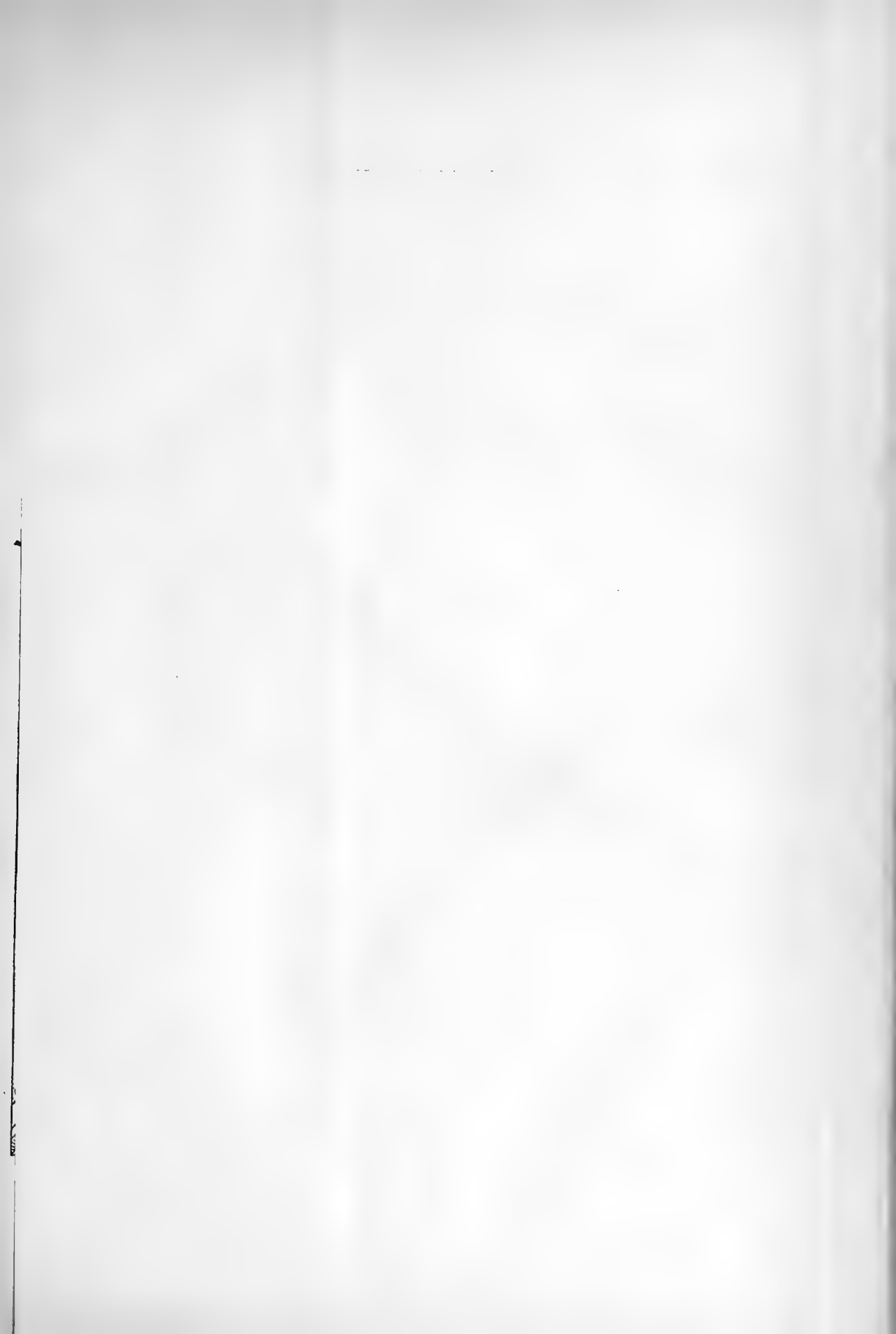



GORBATCH ROOKERY ST. PAUL ISLAND 1914

△ NUMBERED ROCKS ○ HAREMS

NUMBER OF HAREMS 112
JULY 17, 1914

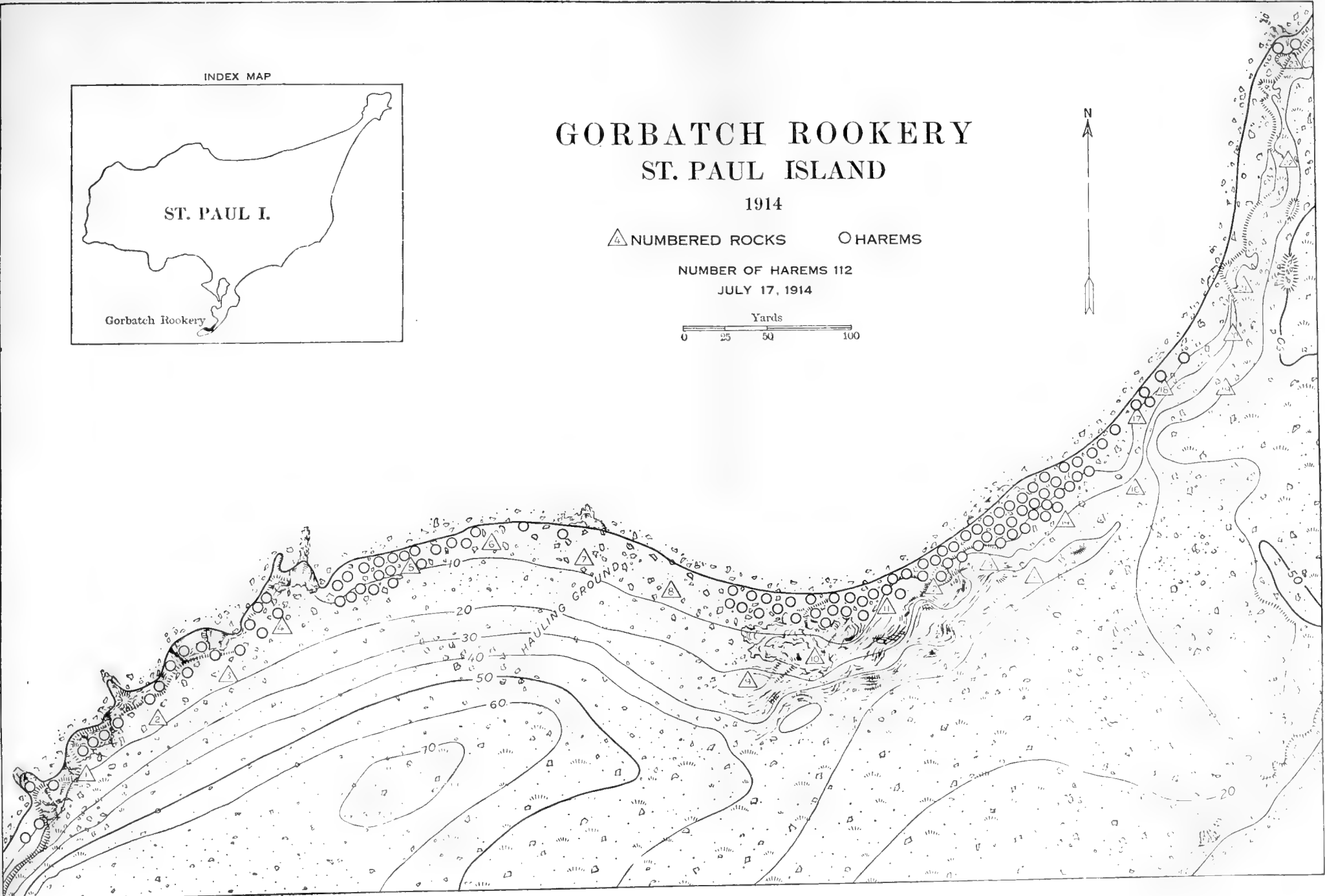
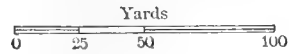

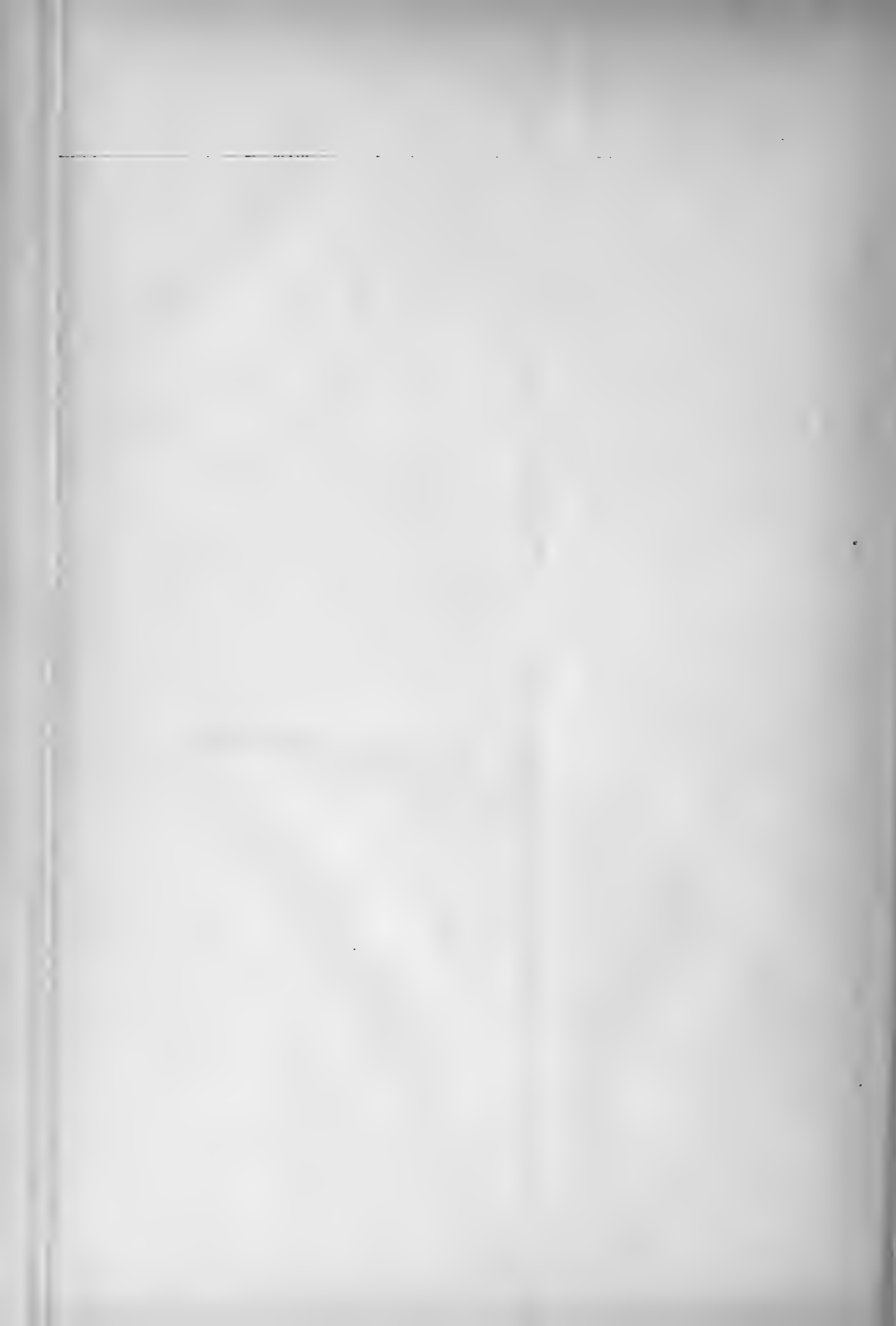

ARDIGUEN ROOKERY ST. PAUL ISLAND 1914

△ NUMBERED ROCKS ○ HAREMS

NUMBER OF HAREMS 15
JULY 17, 1914

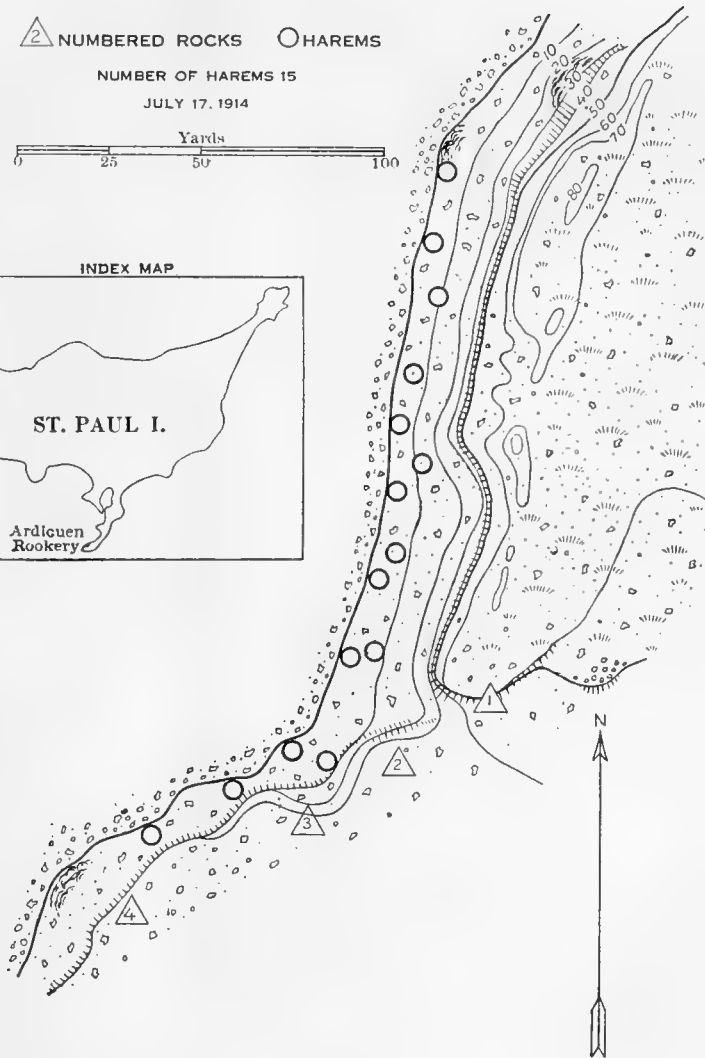
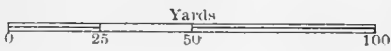

REEF
ST

△ NUMB

20

30

INDEX MAP

ST. PAUL I.

Reef Rookery

HAULING GROUND

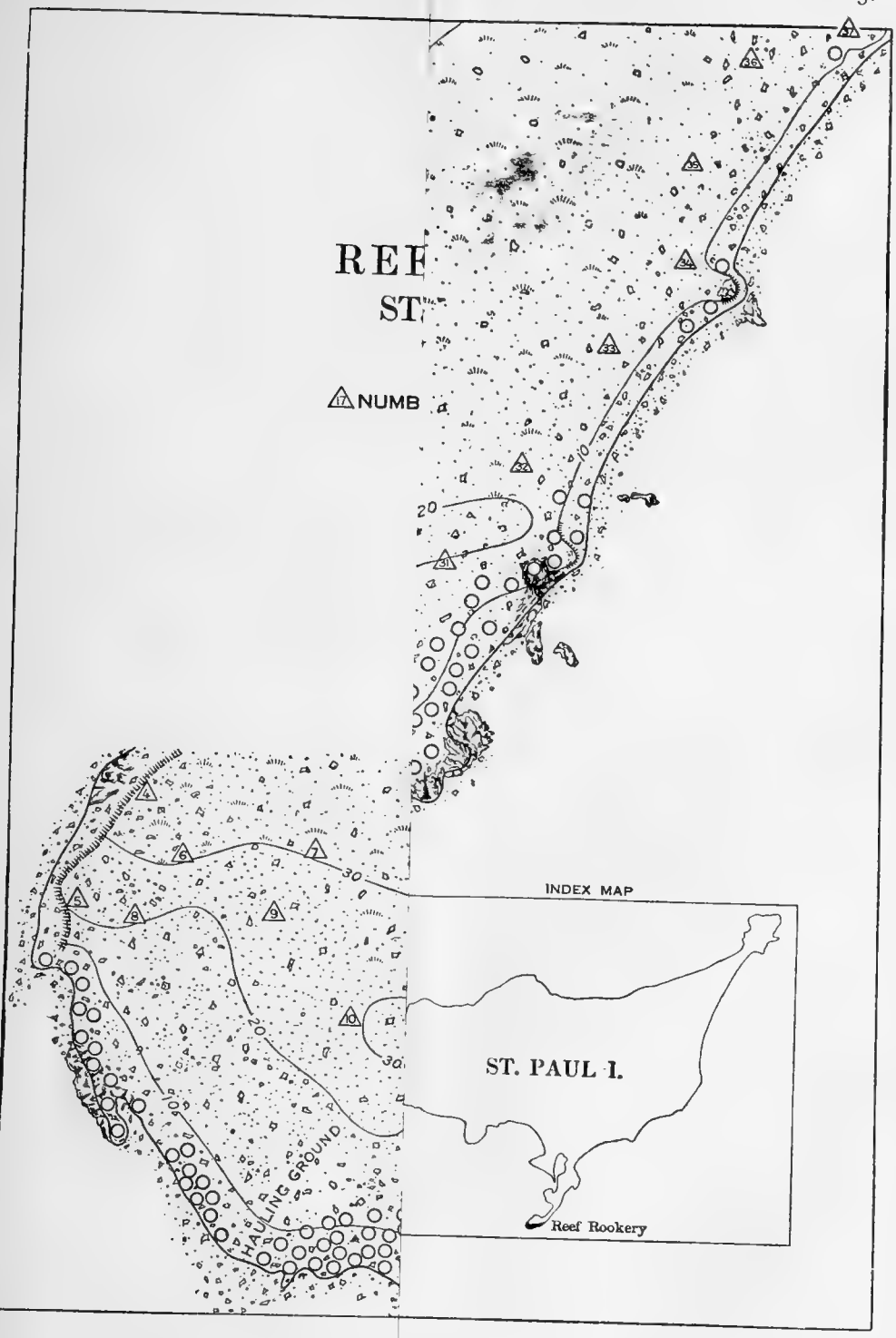

REEF ROOKERY ST. PAUL ISLAND

1914

▲ NUMBERED ROCKS ○ HAREMS

NUMBER OF HAREMS 193
JULY 17, 1914

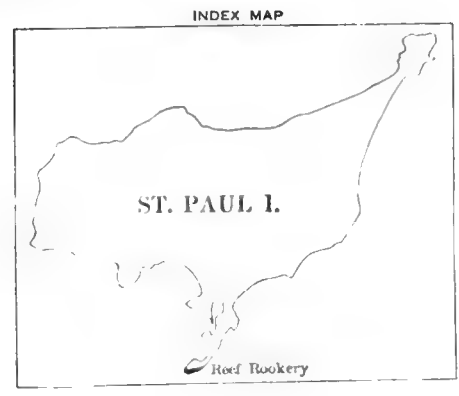
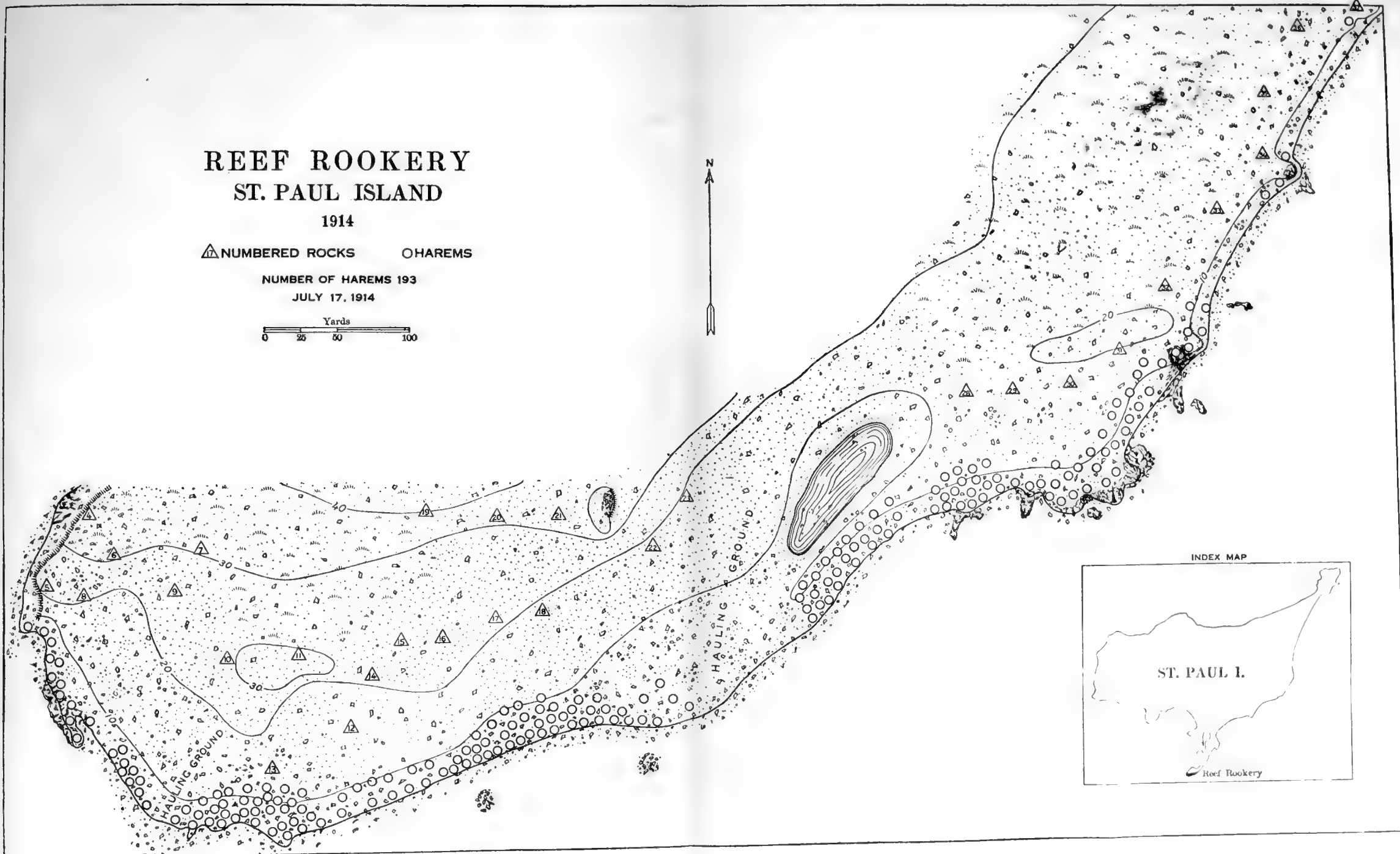

YORKSHIRE TOWN
HALL

1891

THE TOWN COUNCIL

OF YORK

1891

PRINTED BY

W. CLAY

1891

SIVUTCH ROOKERY ST. PAUL ISLAND 1914

○ HAREMS

NUMBER OF HAREMS 91

JULY 20, 1914

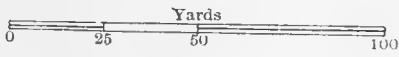

N

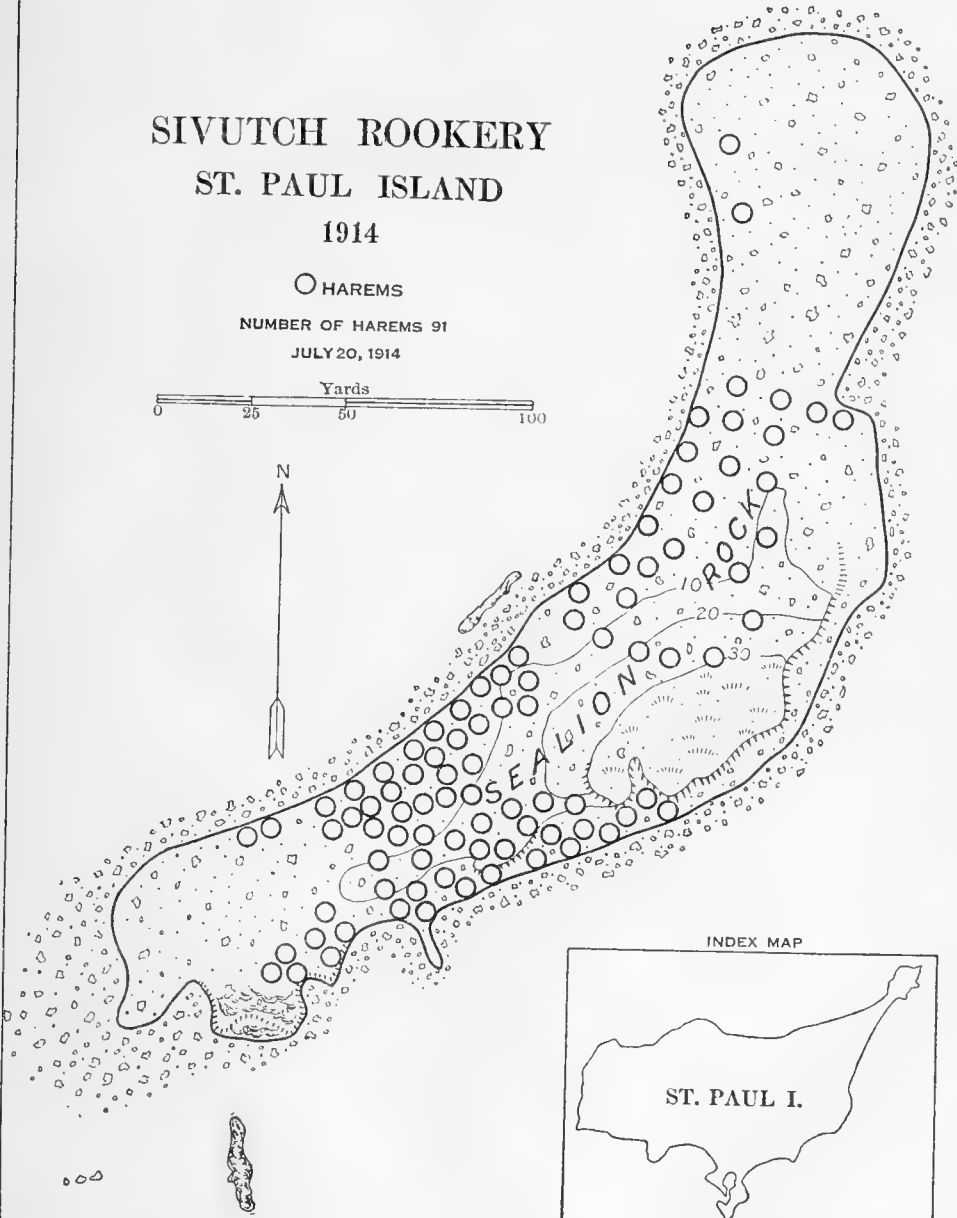

INDEX MAP

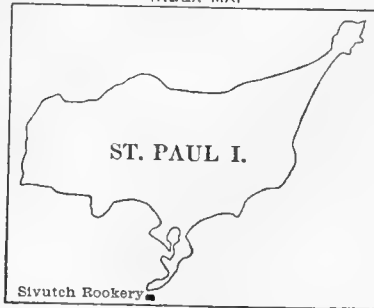

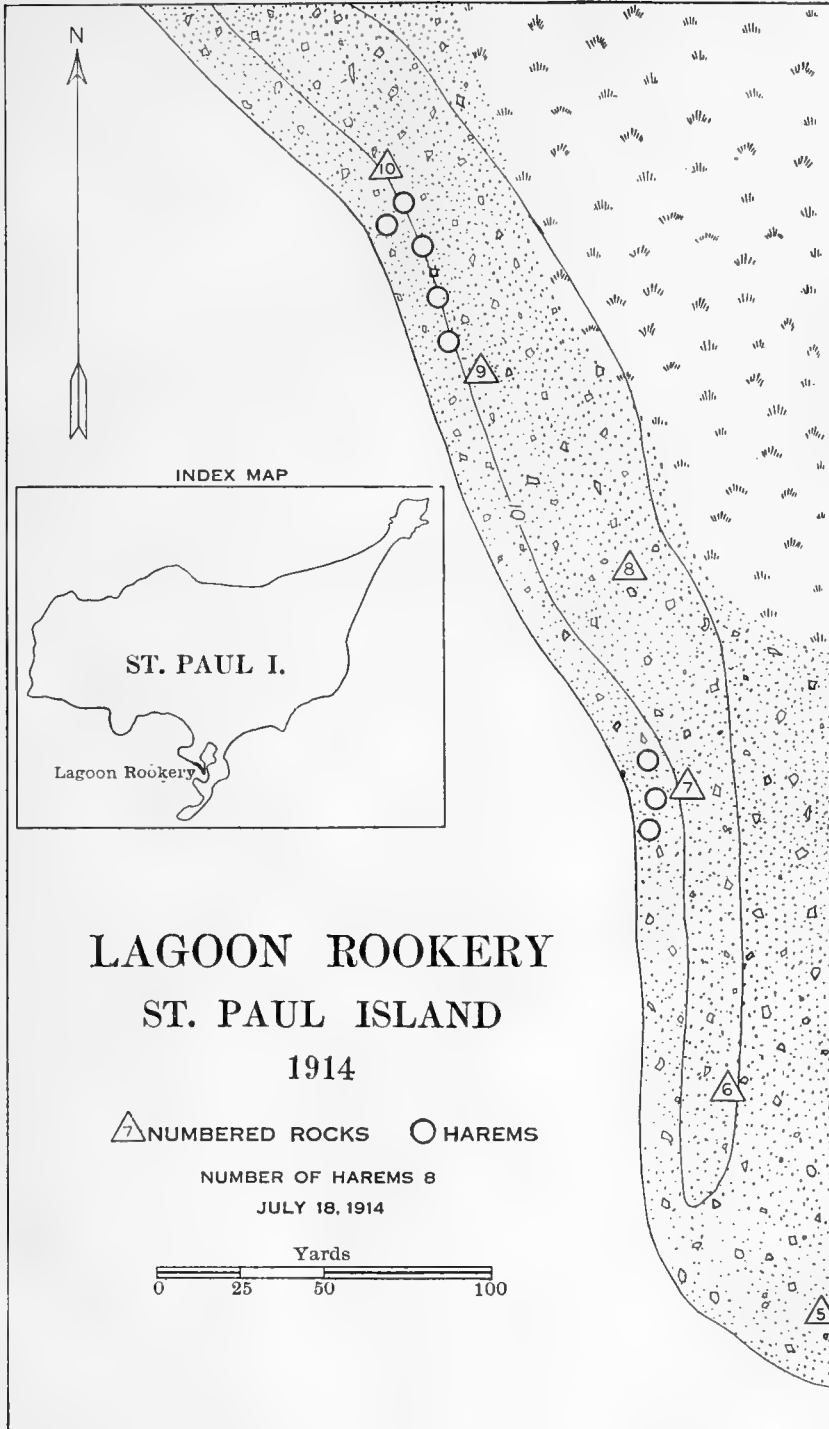

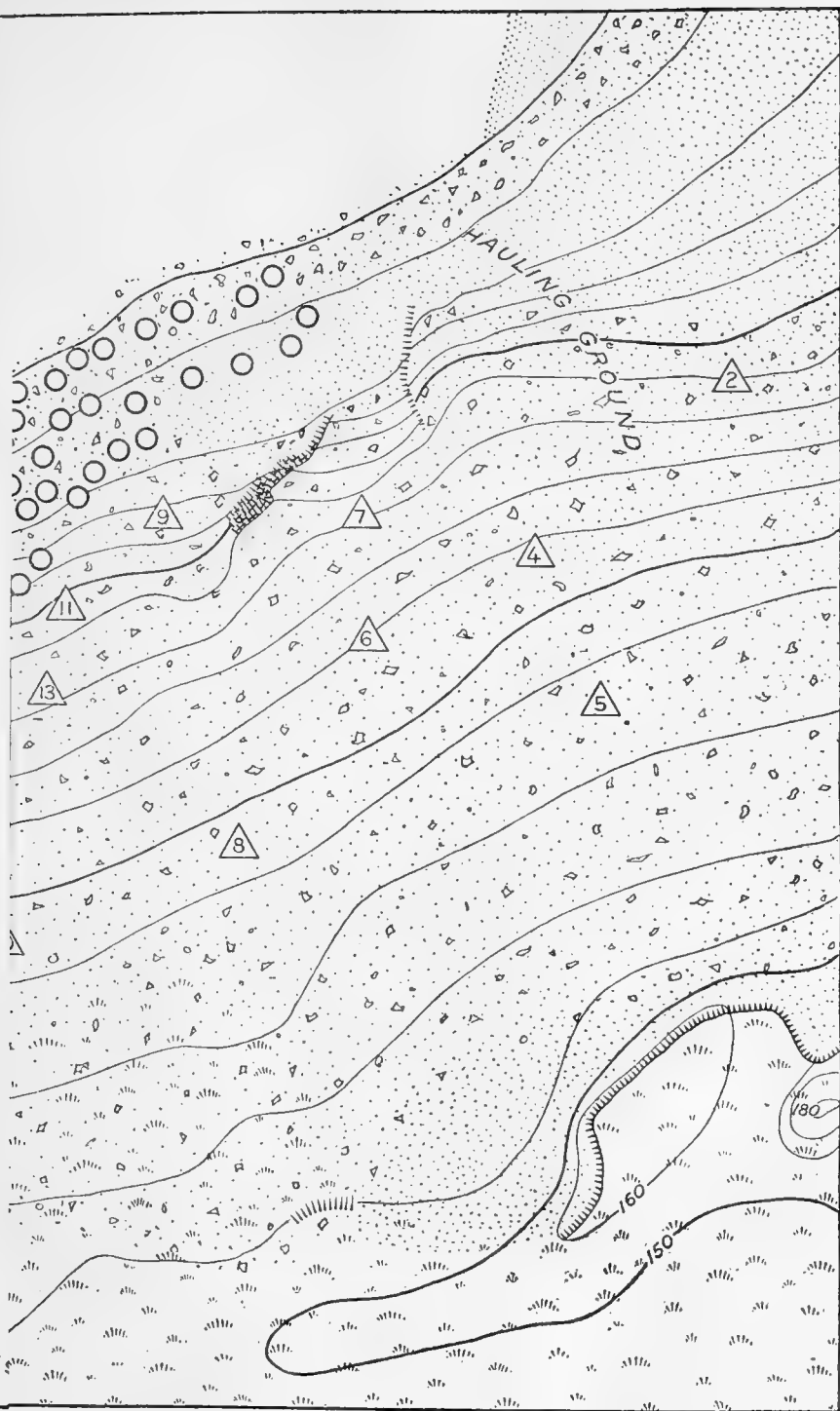

TOLSTOI ROOKERY ST. PAUL ISLAND 1914

▲ NUMBERED ROCKS ○ HAREMS

NUMBER OF HAREMS 161

JULY 18 1914

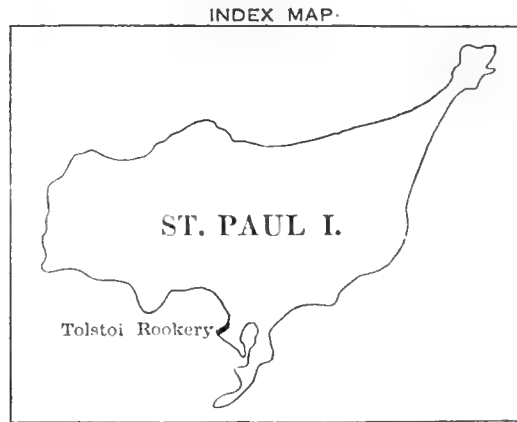
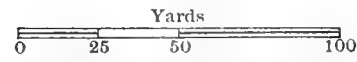

Tolstoi Pt

HAULING
GROUND

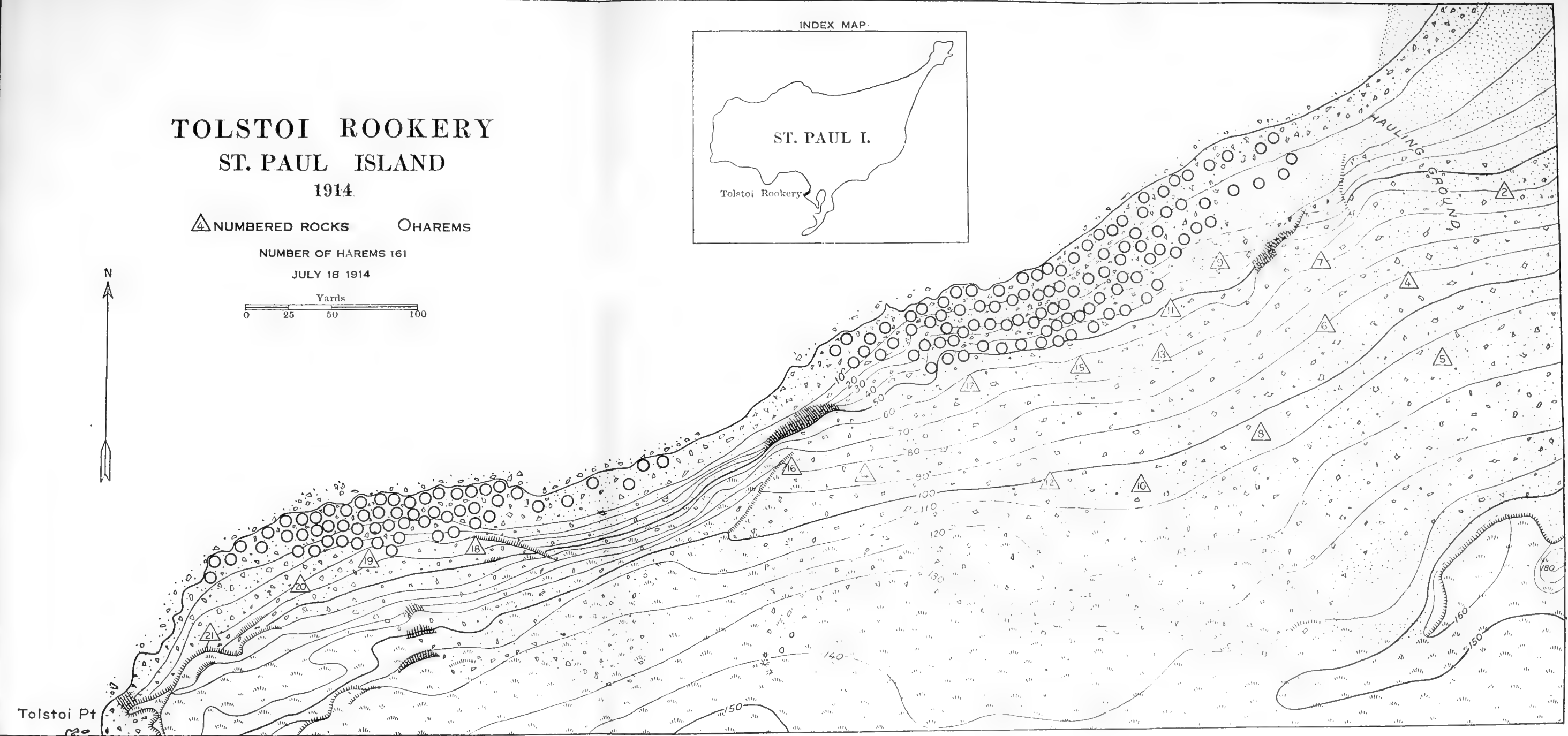

THE JOURNAL OF THE
ROYAL ANTHROPOLOGICAL INSTITUTE

Volume 100, Part 1, 2000

NUMBER OF PAGES 151
JULY 2000



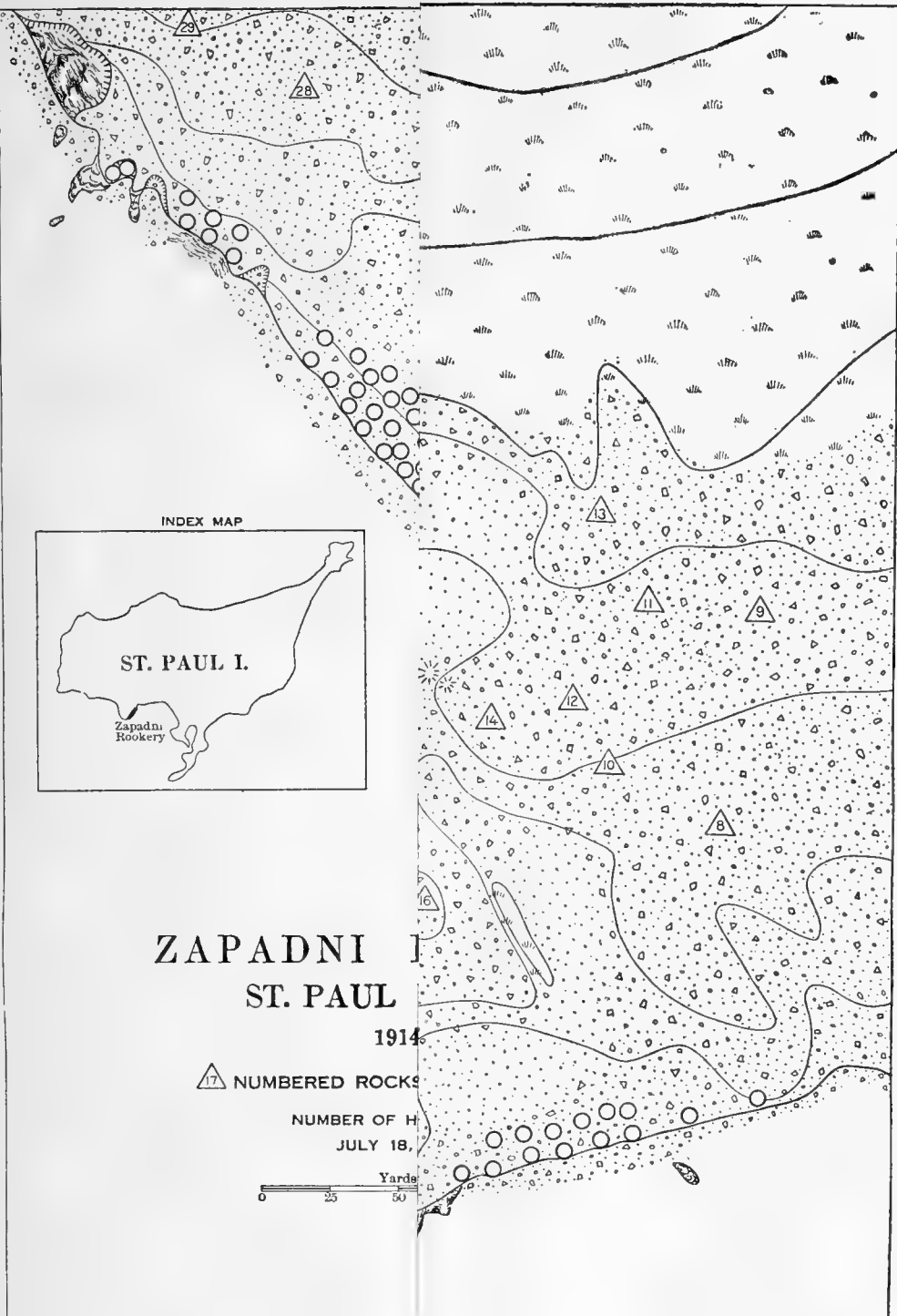

INDEX MAP



ZAPADNI I.
ST. PAUL I.

1914

▲ NUMBERED ROCKS

NUMBER OF H
JULY 18,

Yards
0 25 50

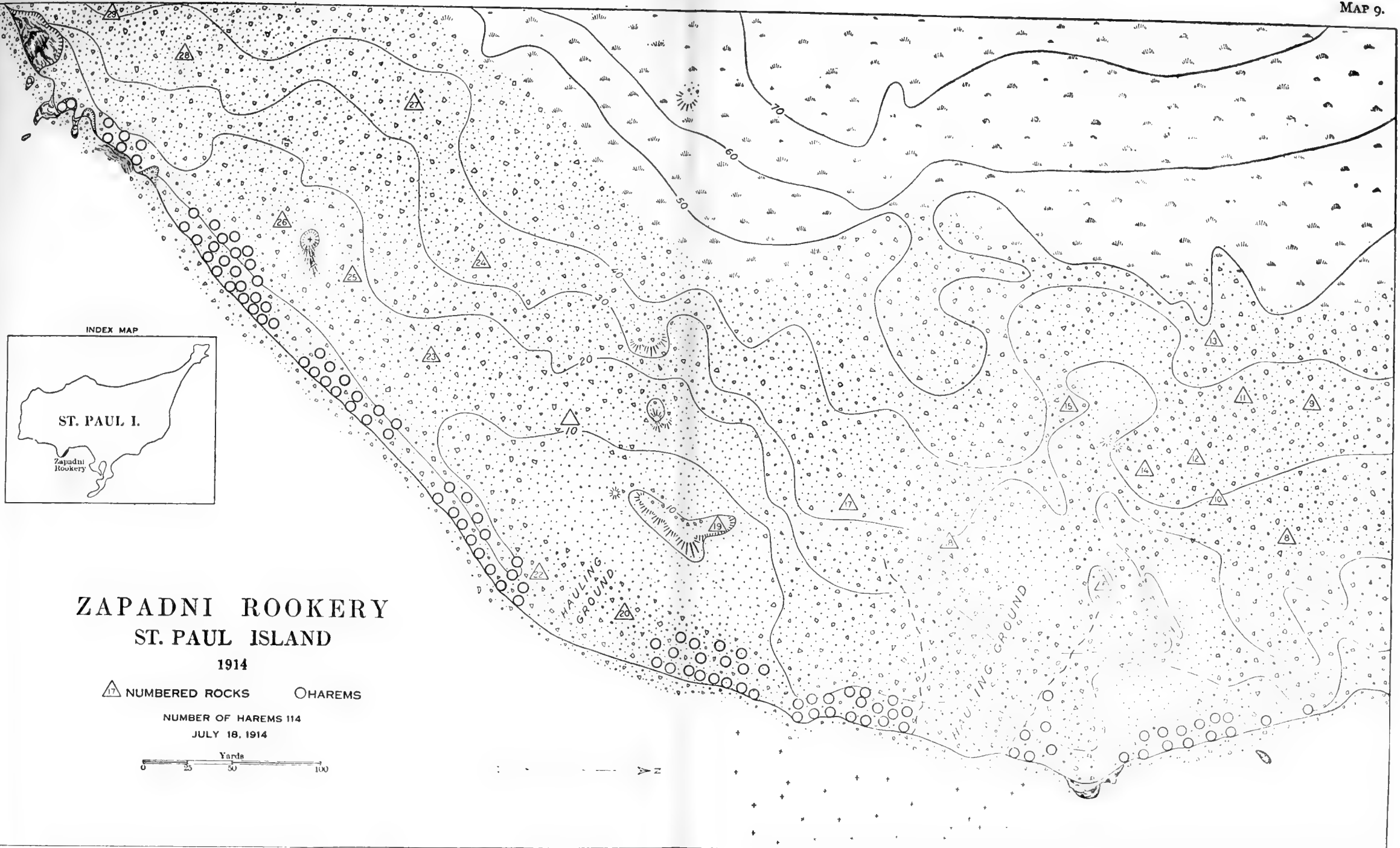

INDEX MAP



ZAPADNI ROOKERY
ST. PAUL ISLAND

1914

▲ NUMBERED ROCKS ○ HAREMS

NUMBER OF HAREMS 114
JULY 18, 1914

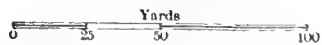

N



BULL.

[Faint, illegible text]

LITTLE ZAPADNI ROOKERY ST. PAUL ISLAND 1914

▲ NUMBERED ROCKS ○ HAREMS

NUMBER OF HAREMS 90

JULY 18, 1914

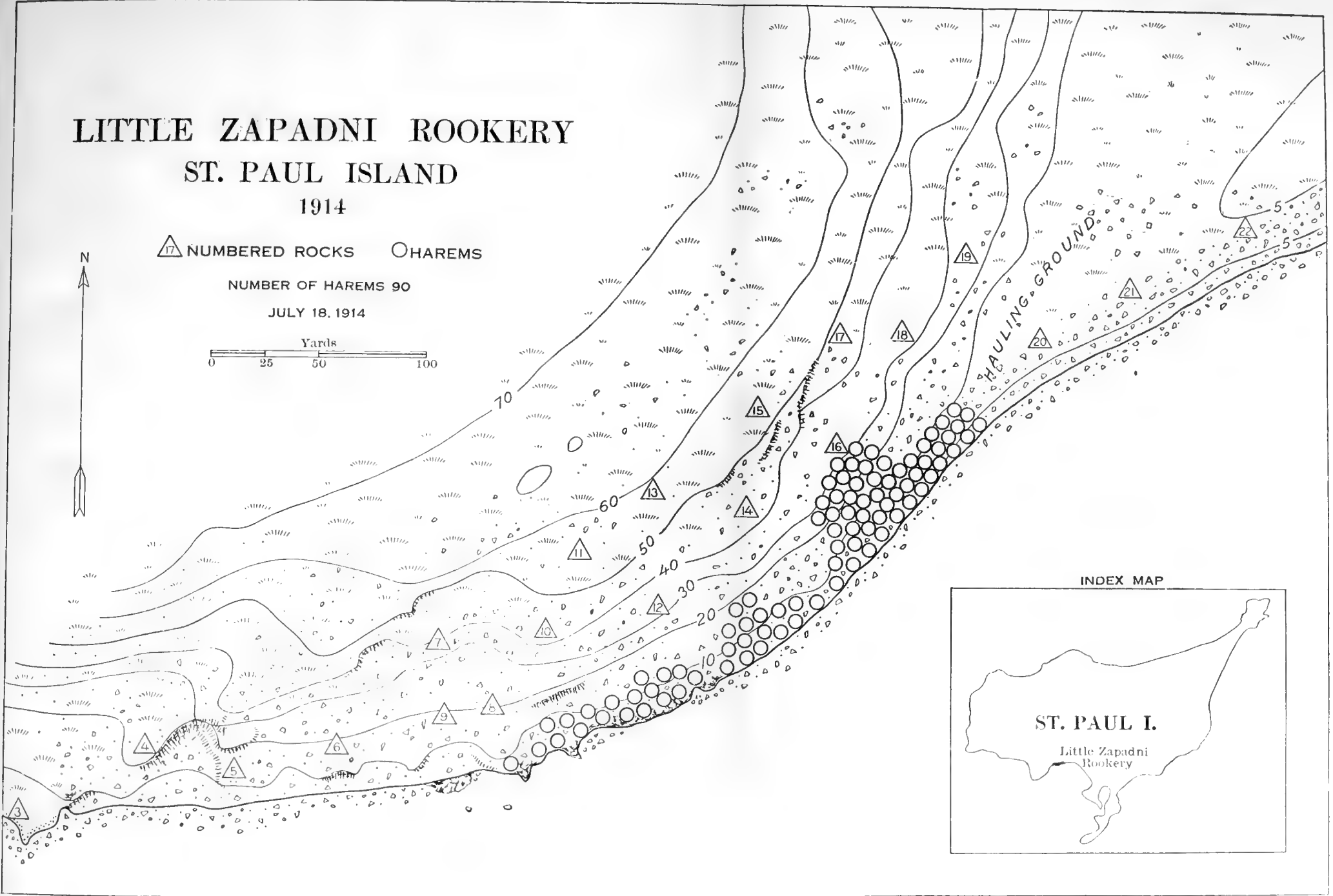
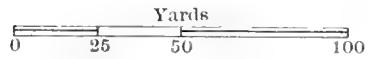

INDEX MAP



ST. PAUL I.
Little Zapadni
Rookery

История древней России

из собрания

№ 100

из собрания по древности

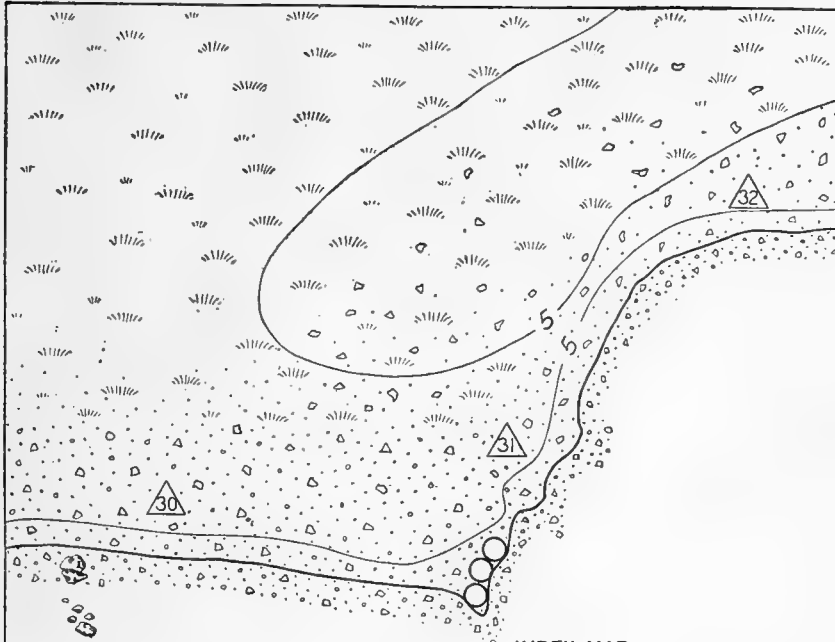

INDEX MAP



ZAPADNI REEF ROOKERY
ST. PAUL ISLAND
1914

 **NUMBERED ROCKS**  **HAREMS**

NUMBER OF HAREMS 3

JULY 18, 1914

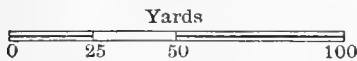

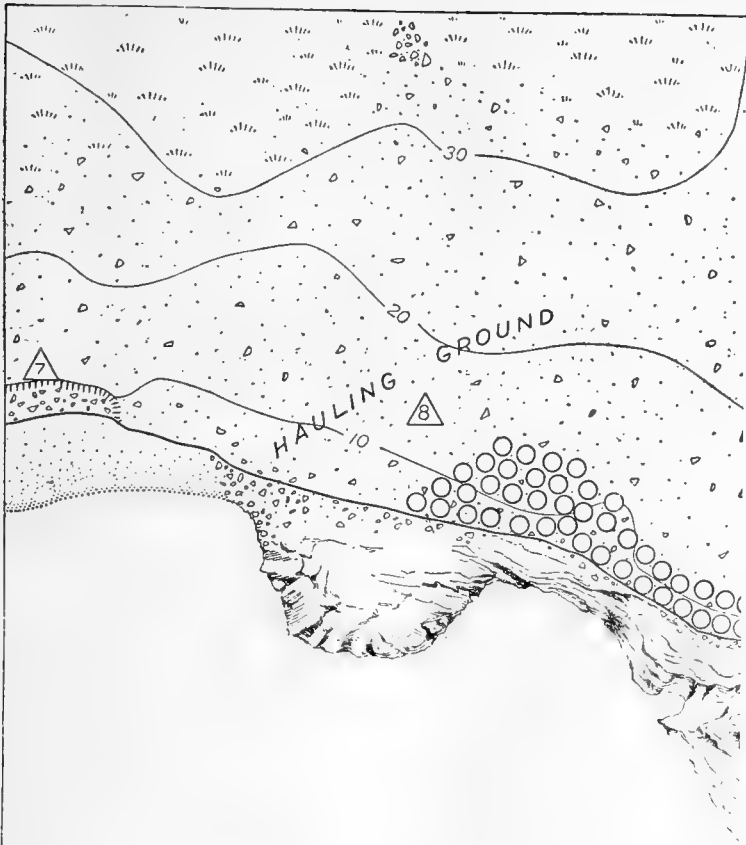

POLOVINA ROOKERY
ST. PAUL ISLAND
1914

△ NUMBERED ROCKS ○ HAREMS

NUMBER OF HAREMS 58

JULY 19, 1914



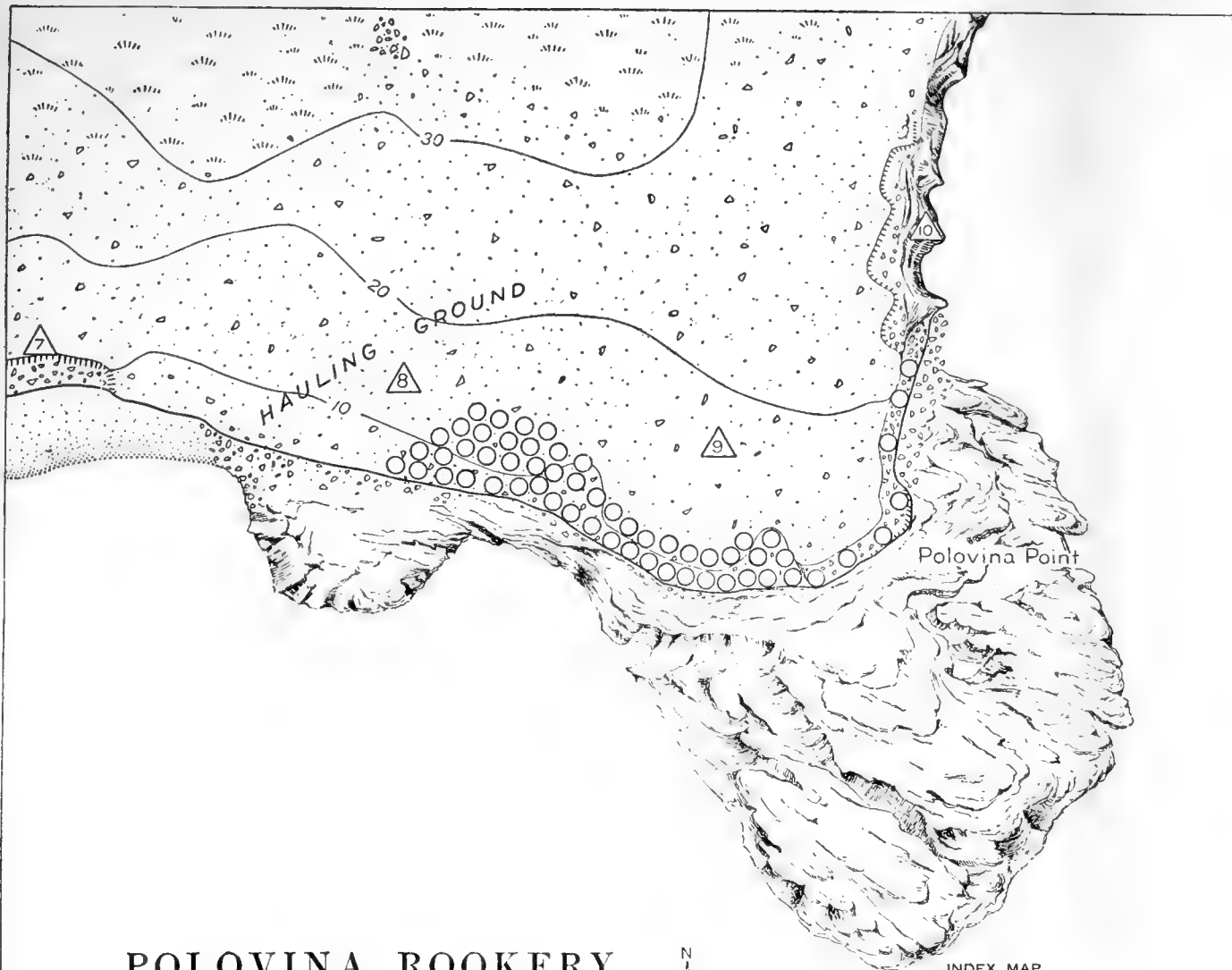

POLOVINA ROOKERY ST. PAUL ISLAND

1914

▲ NUMBERED ROCKS ○ HAREMS

NUMBER OF HAREMS 58

JULY 19, 1914

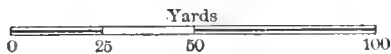

INDEX MAP

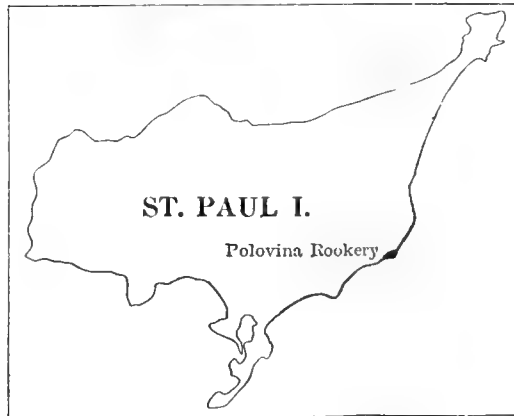

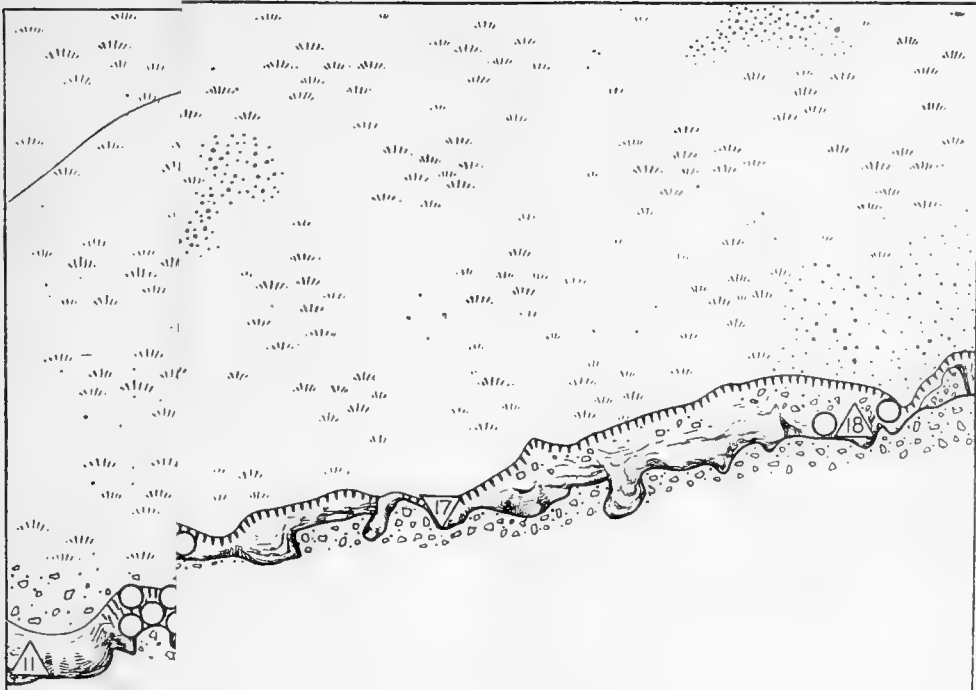

OVINA CLIFFS ROOKERY
ST. PAUL ISLAND
1914

△ NUMBERED ROCKS ○ HAREMS

NUMBER OF HAREMS 22

JULY 19, 1914

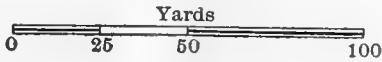

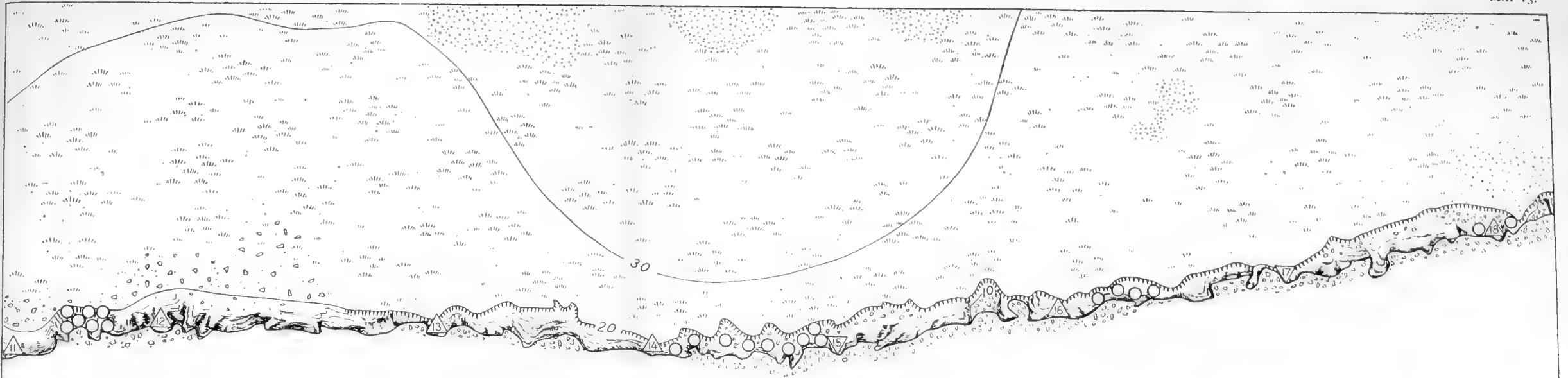

INDEX MAP

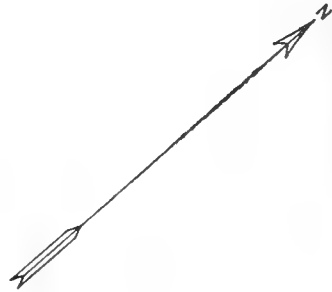

POLOVINA CLIFFS ROOKERY
ST. PAUL ISLAND
1914

▲ NUMBERED ROCKS ○ HAREMS

NUMBER OF HAREMS 22

JULY 19, 1914

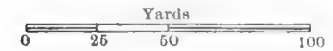

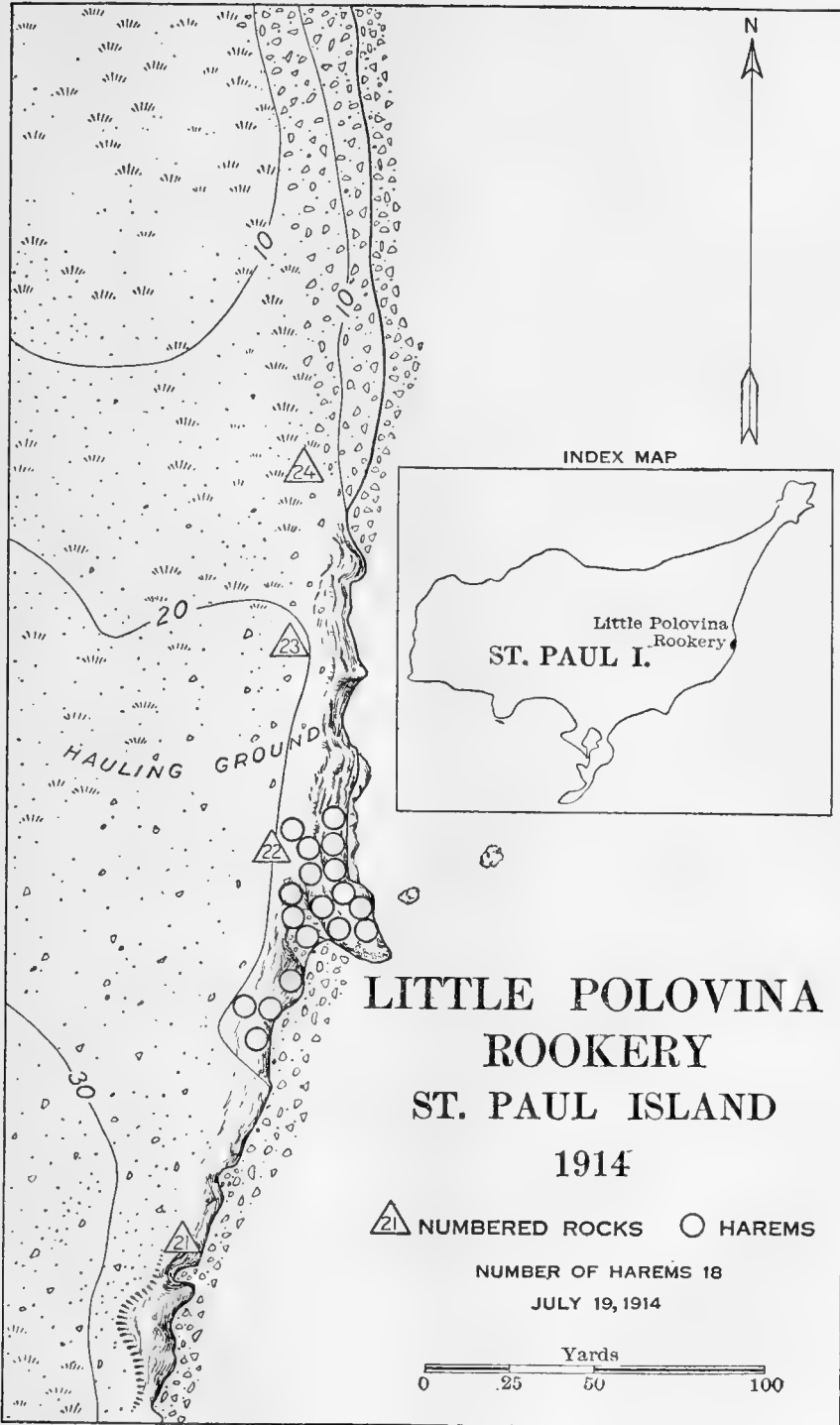

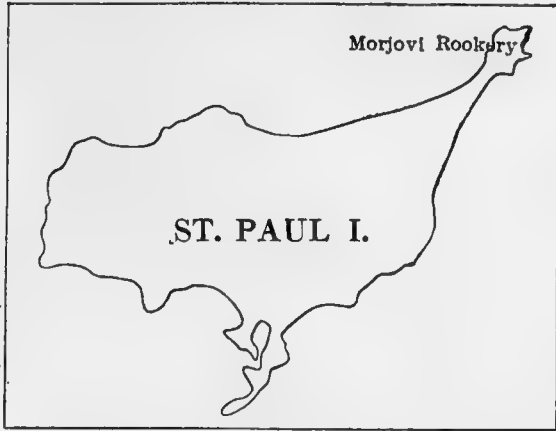

INDEX MAP

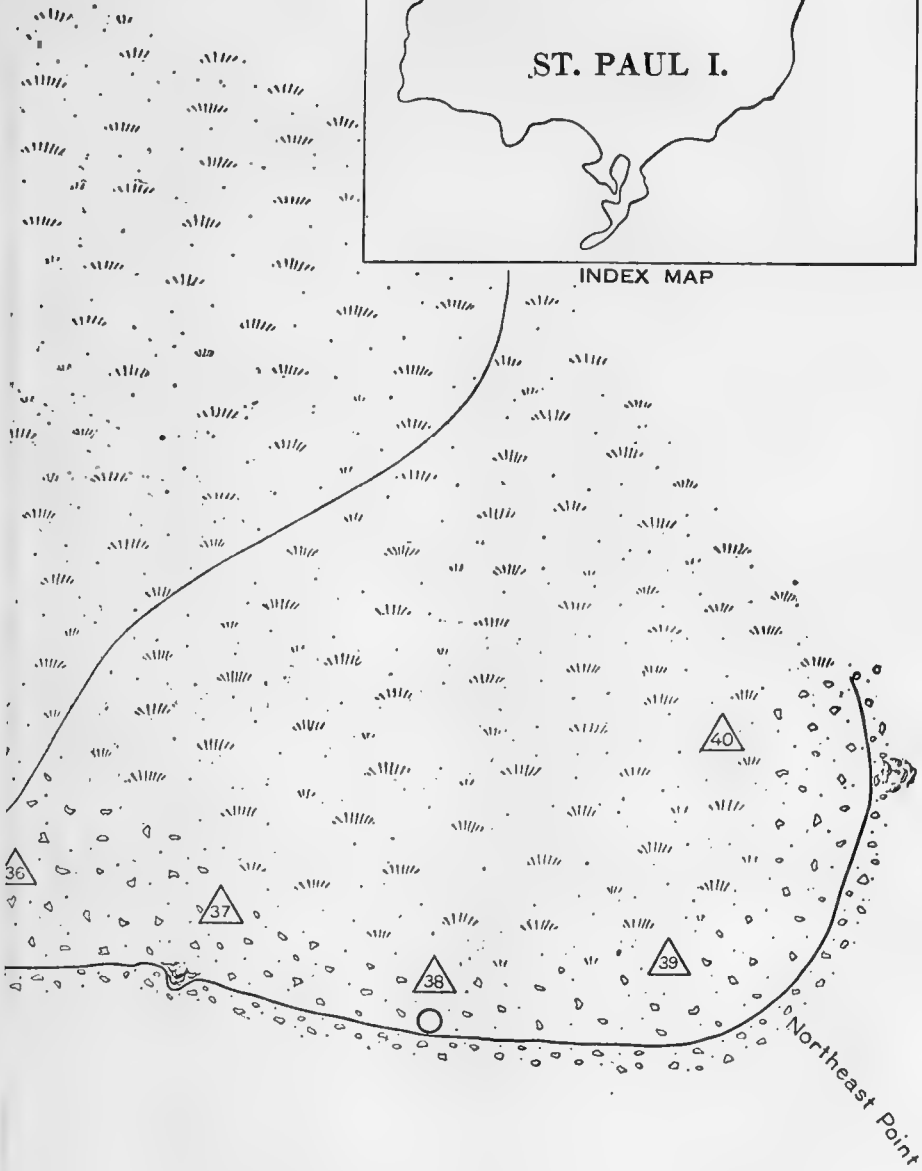

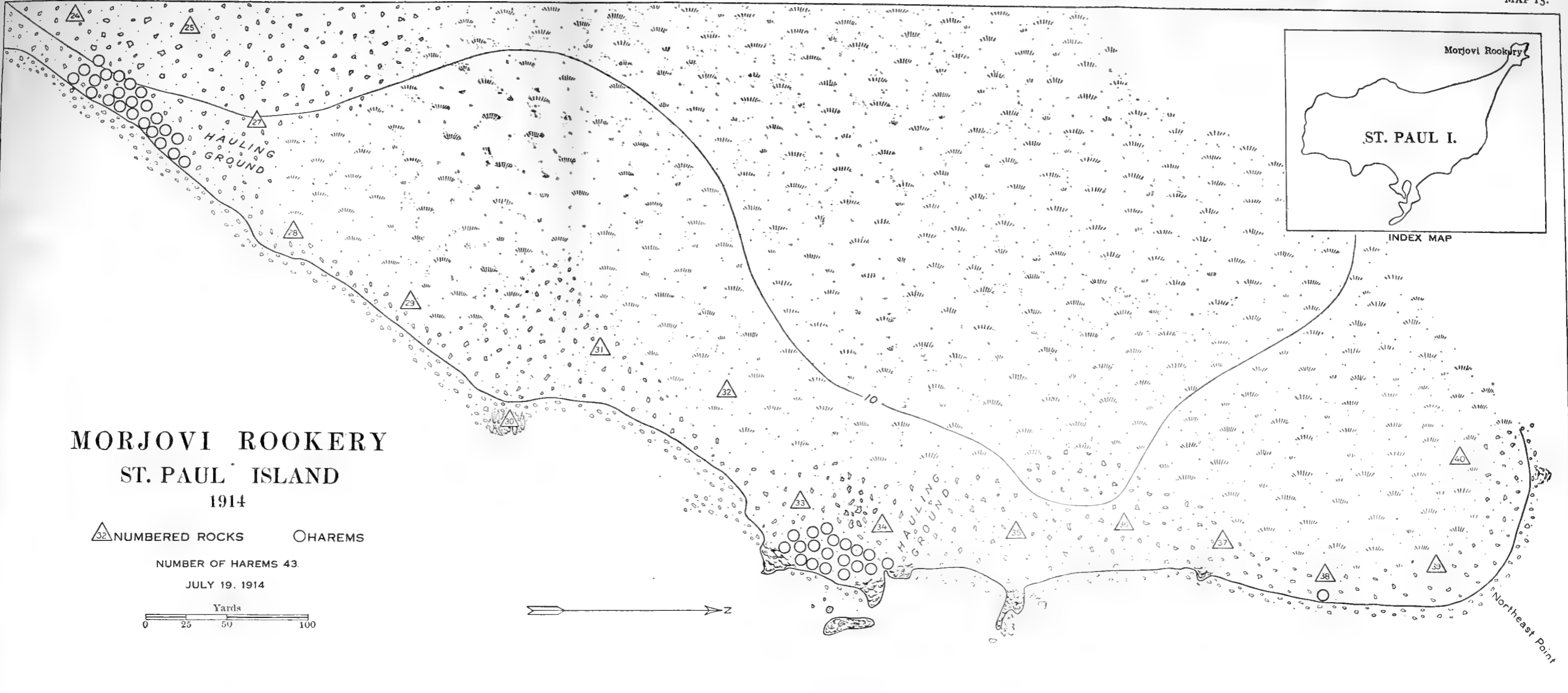

MORJOVI ROOKERY
ST. PAUL ISLAND
 1914

△ NUMBERED ROCKS ○ HAREMS

NUMBER OF HAREMS 43

JULY 19, 1914

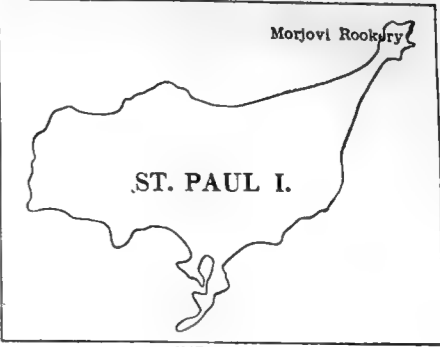
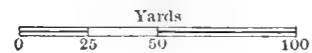

INDEX MAP

Northeast Point

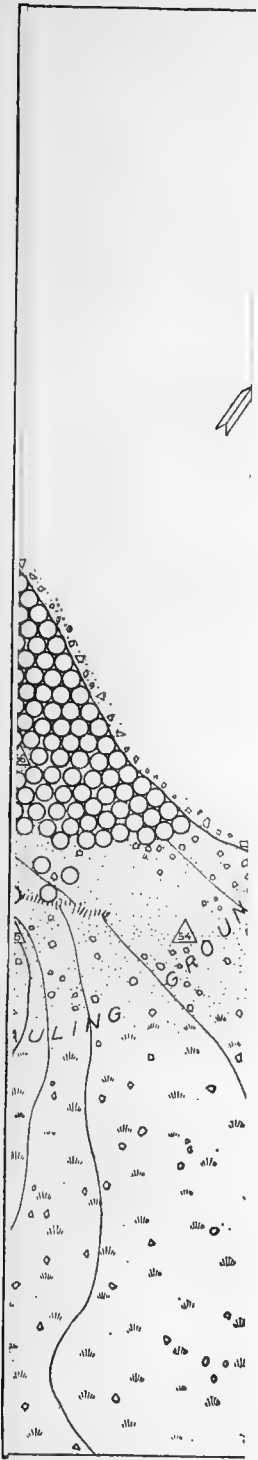

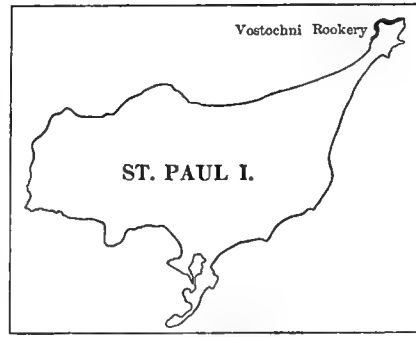

VOSTOCHNI ROOKERY ST. PAUL ISLAND

1914

△NUMBERED ROCKS ○HAREMS

NUMBER OF HAREMS 291
JULY 19, 1914

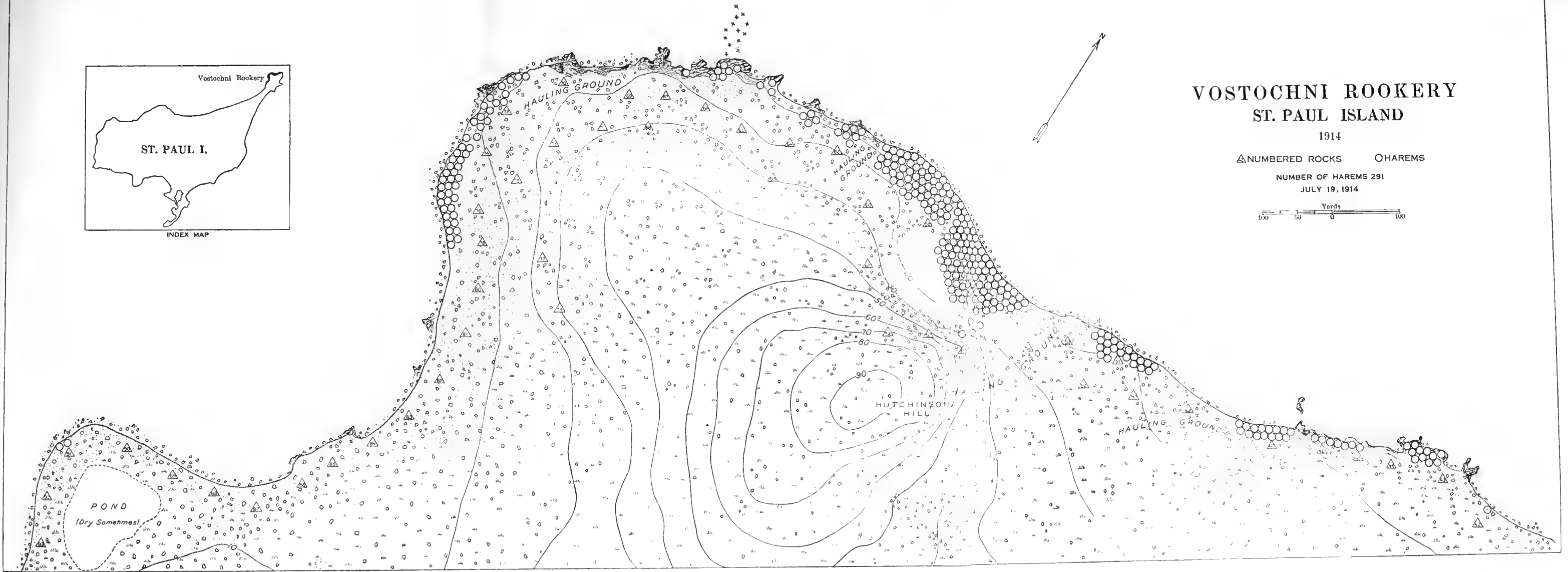
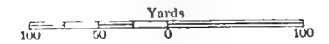

MAP 17.

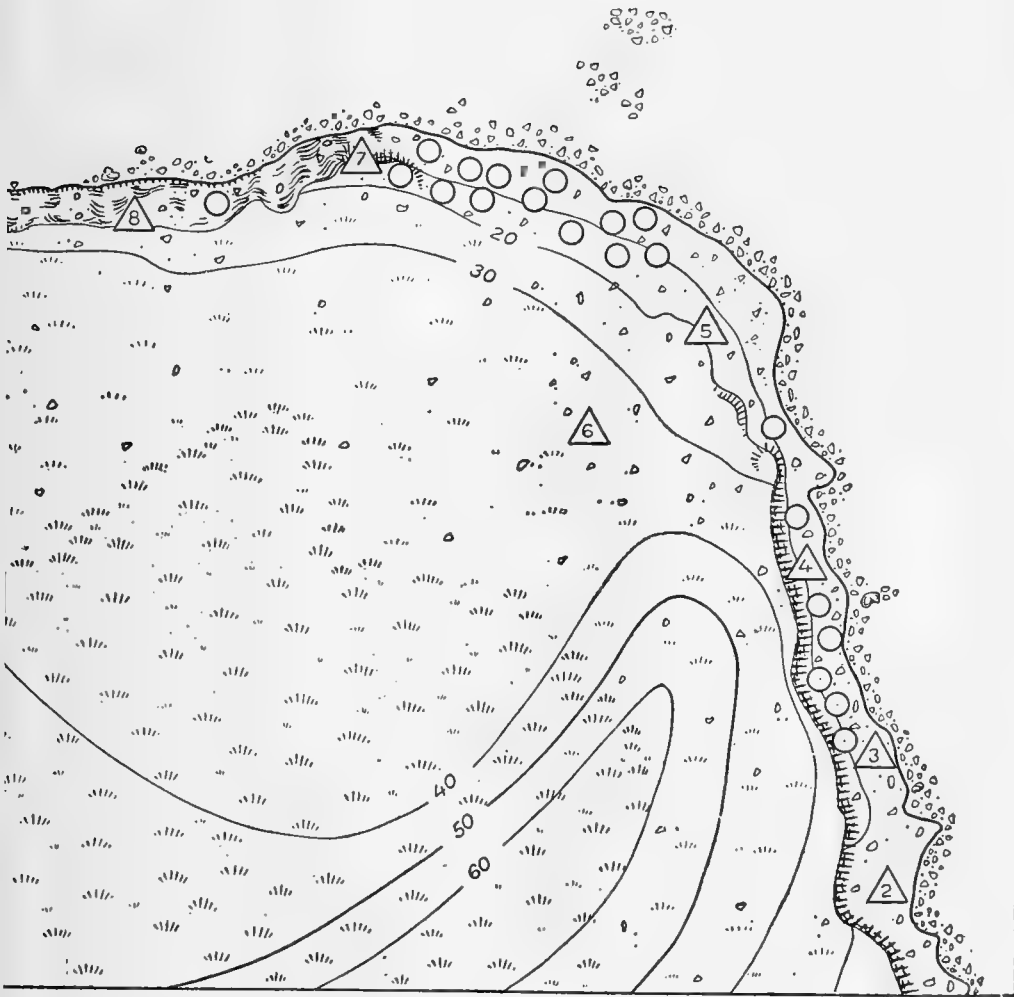
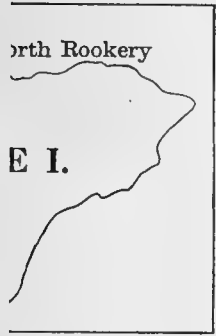

NORTH ROOKERY ST. GEORGE ISLAND 1914

▲ NUMBERED ROCKS ○ HAREMS

NUMBER OF HAREMS 94
JULY 20, 1914

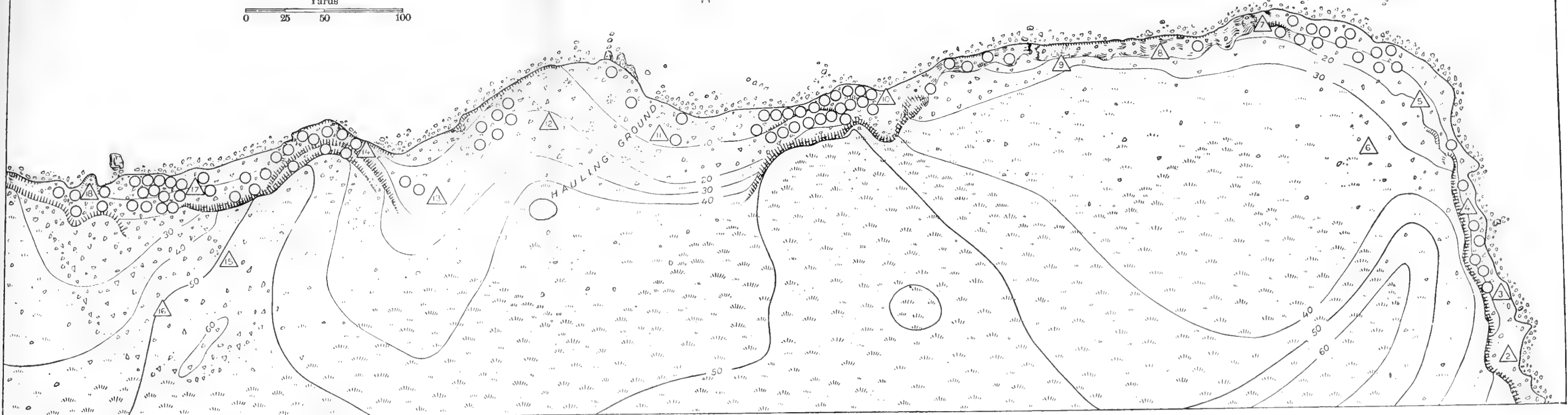
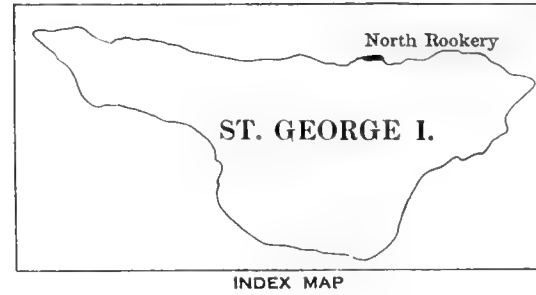

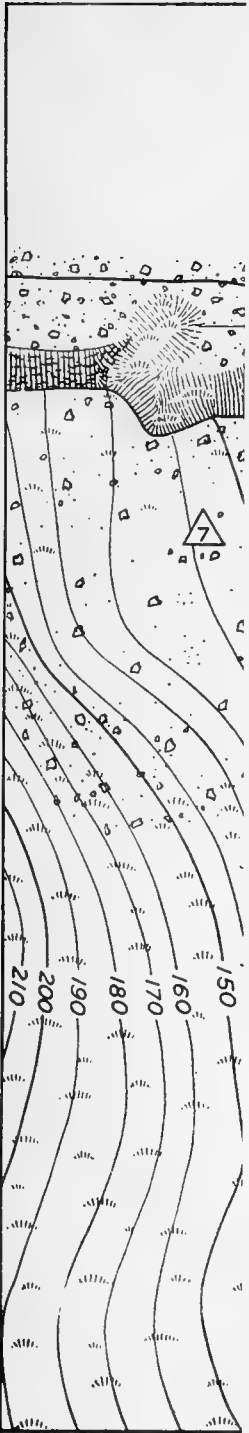

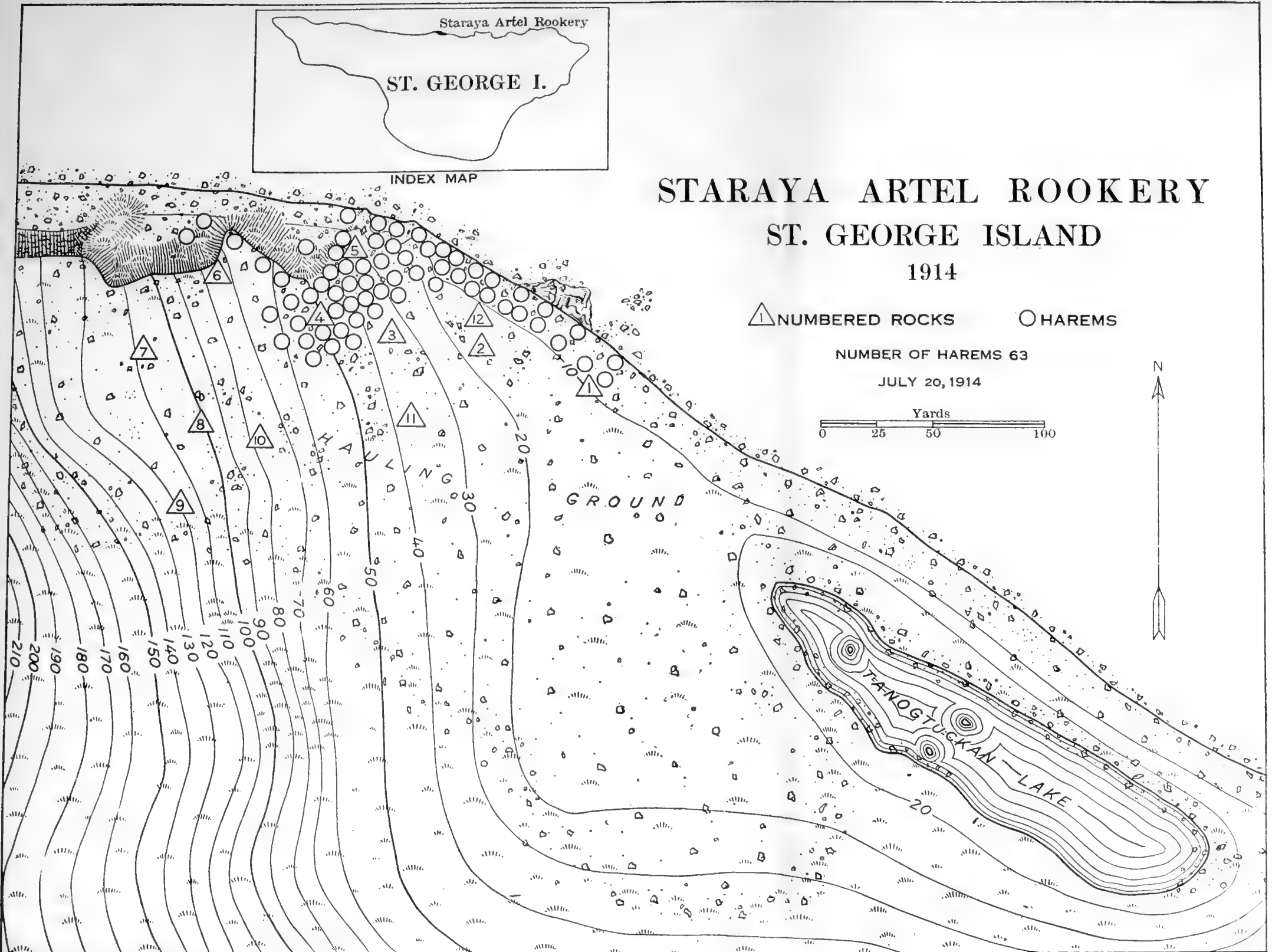

ZAPADNI ROOKERY ST. GEORGE ISLAND 1914

△ NUMBERED ROCKS ○ HAREMS

NUMBER OF HAREMS 14
JULY 19, 1914

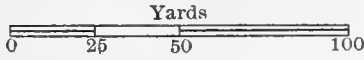

INDEX MAP

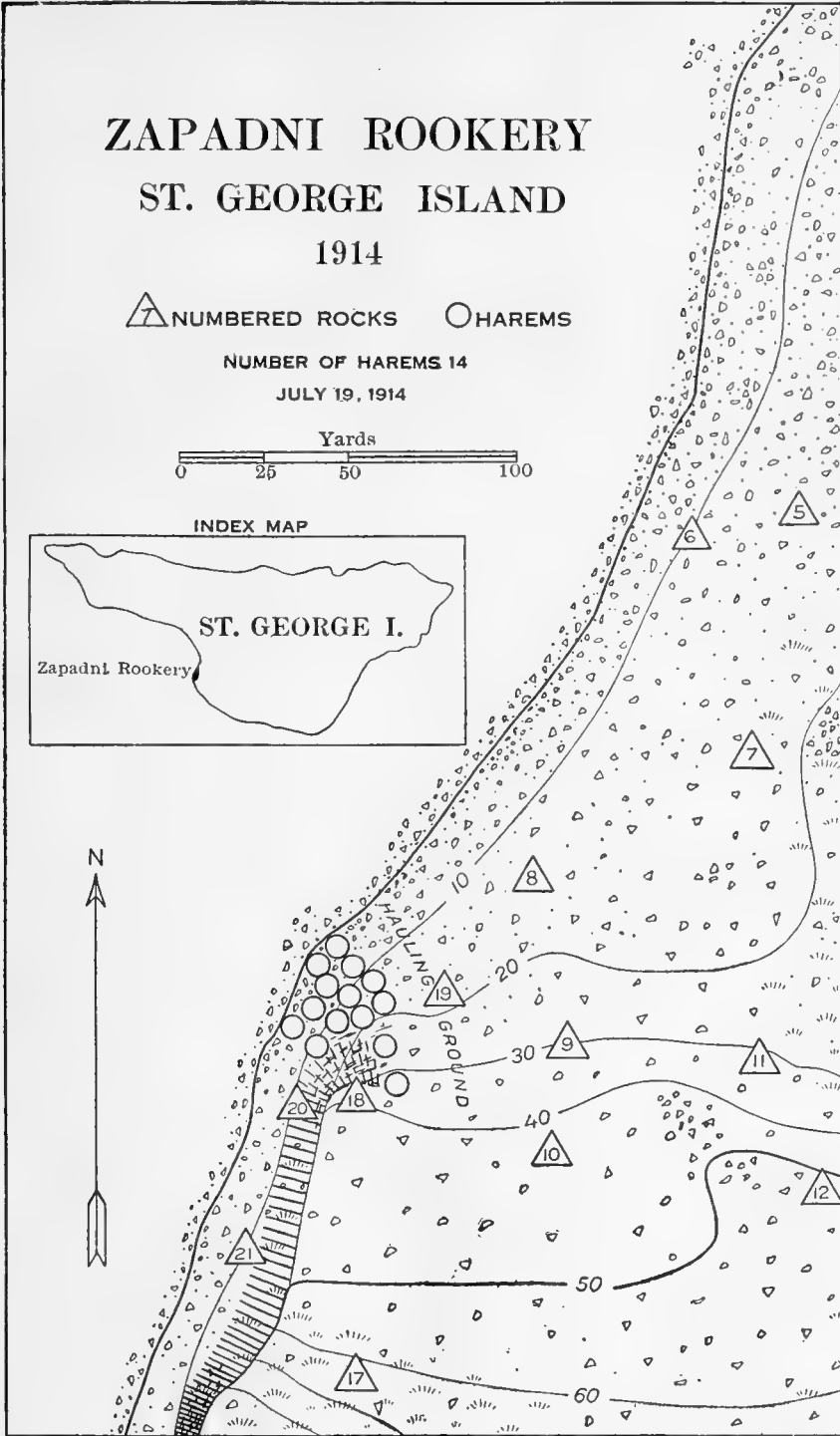
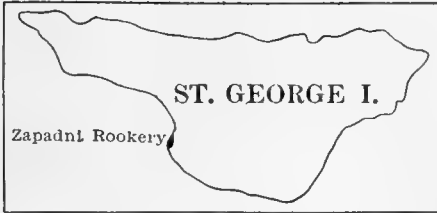

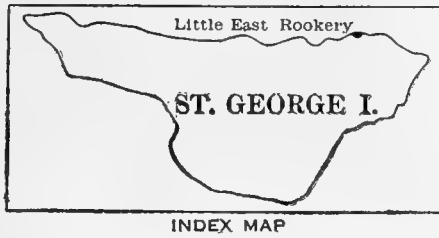

LITTLE EAST ROOKERY

ST. GEORGE ISLAND

1914

△ NUMBERED ROCKS ○ HAREMS

NUMBER OF HAREMS 1
JULY 20, 1914

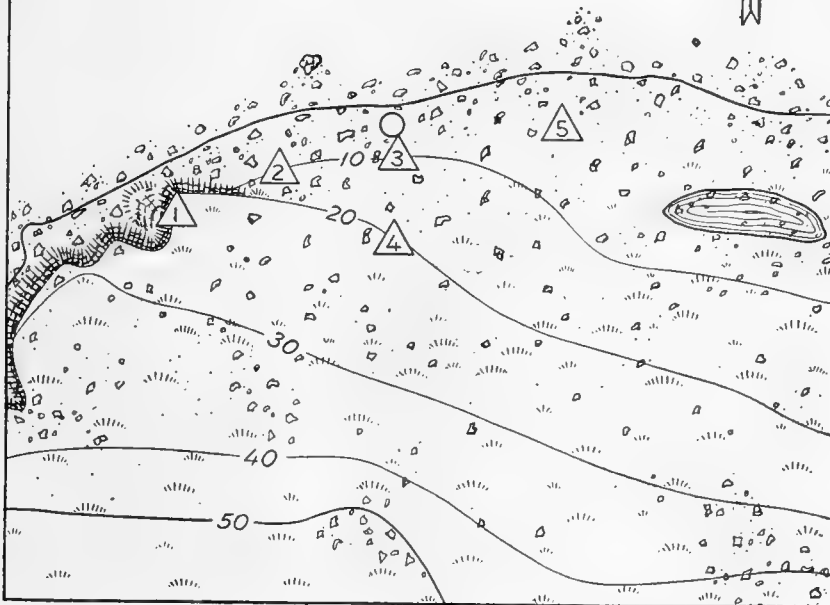
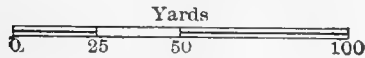

THE NEW YORK PUBLIC LIBRARY

ASTOR LENOX TILDEN FOUNDATION
475 FIFTH AVENUE
NEW YORK, N. Y.

•





INDEX MAP.

EAST REEF ROOKERY ST. GEORGE ISLAND 1914

△ NUMBERED ROCKS ○ HAREMS

NUMBER OF HAREMS 14

JULY 20, 1914

Yards

0 25 50 100

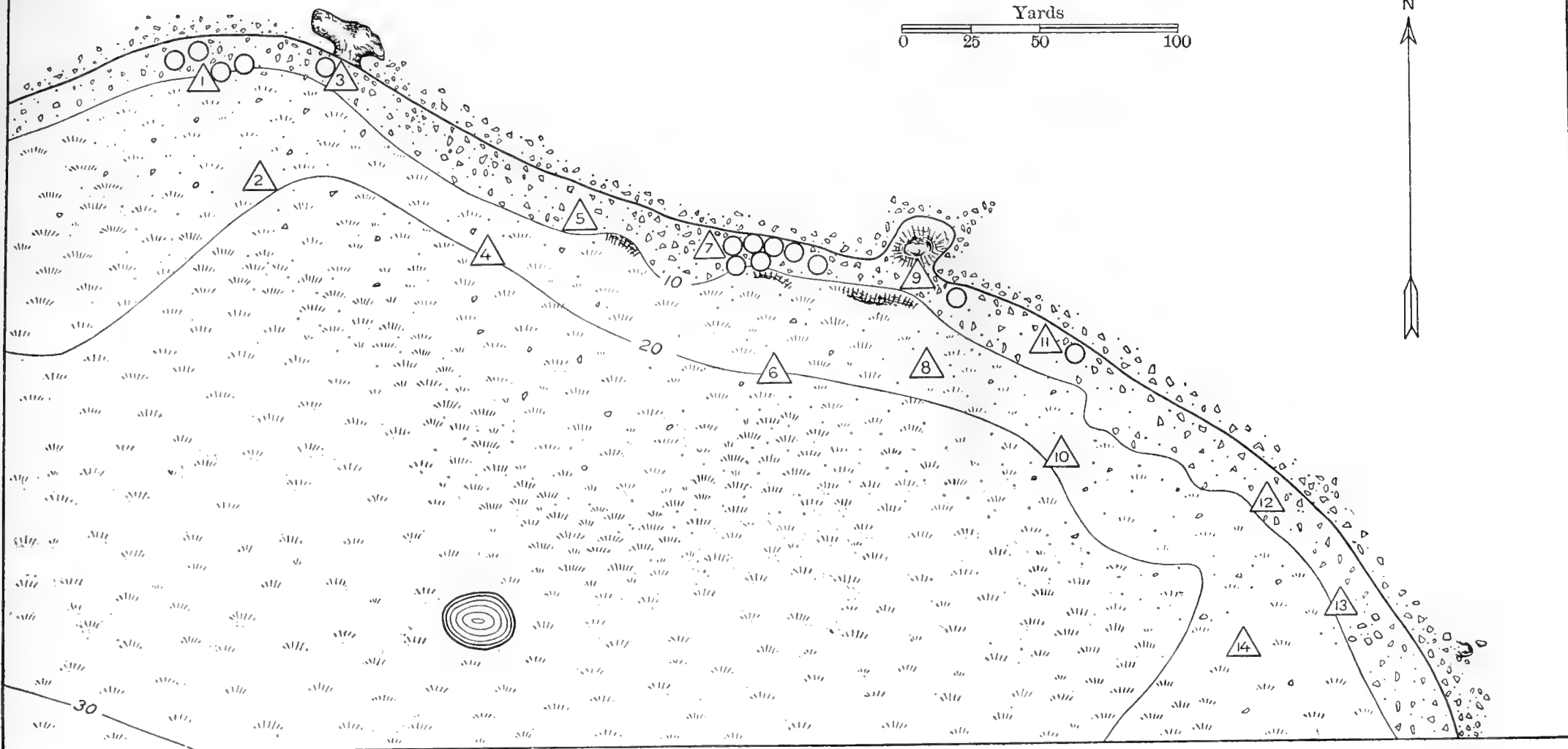

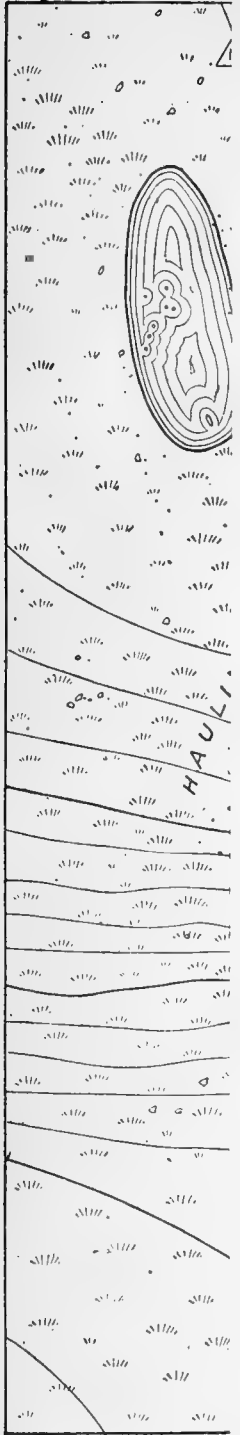

EAST CLIFFS ROOKERY ST. GEORGE ISLAND

1914

▲ NUMBERED ROCKS ○ HAREMS

NUMBER OF HAREMS 57

JULY 20, 1914

Yards

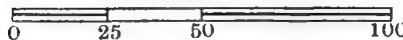

N

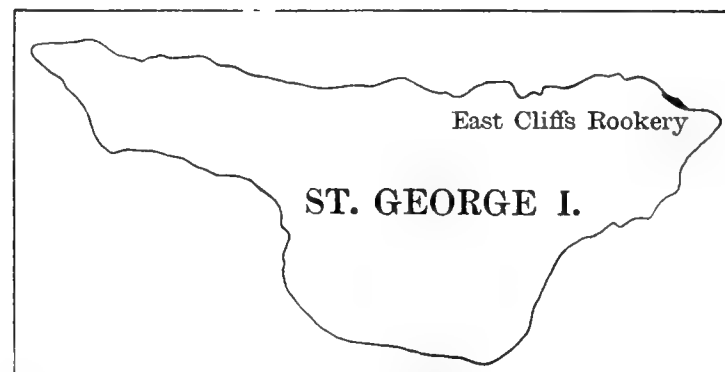
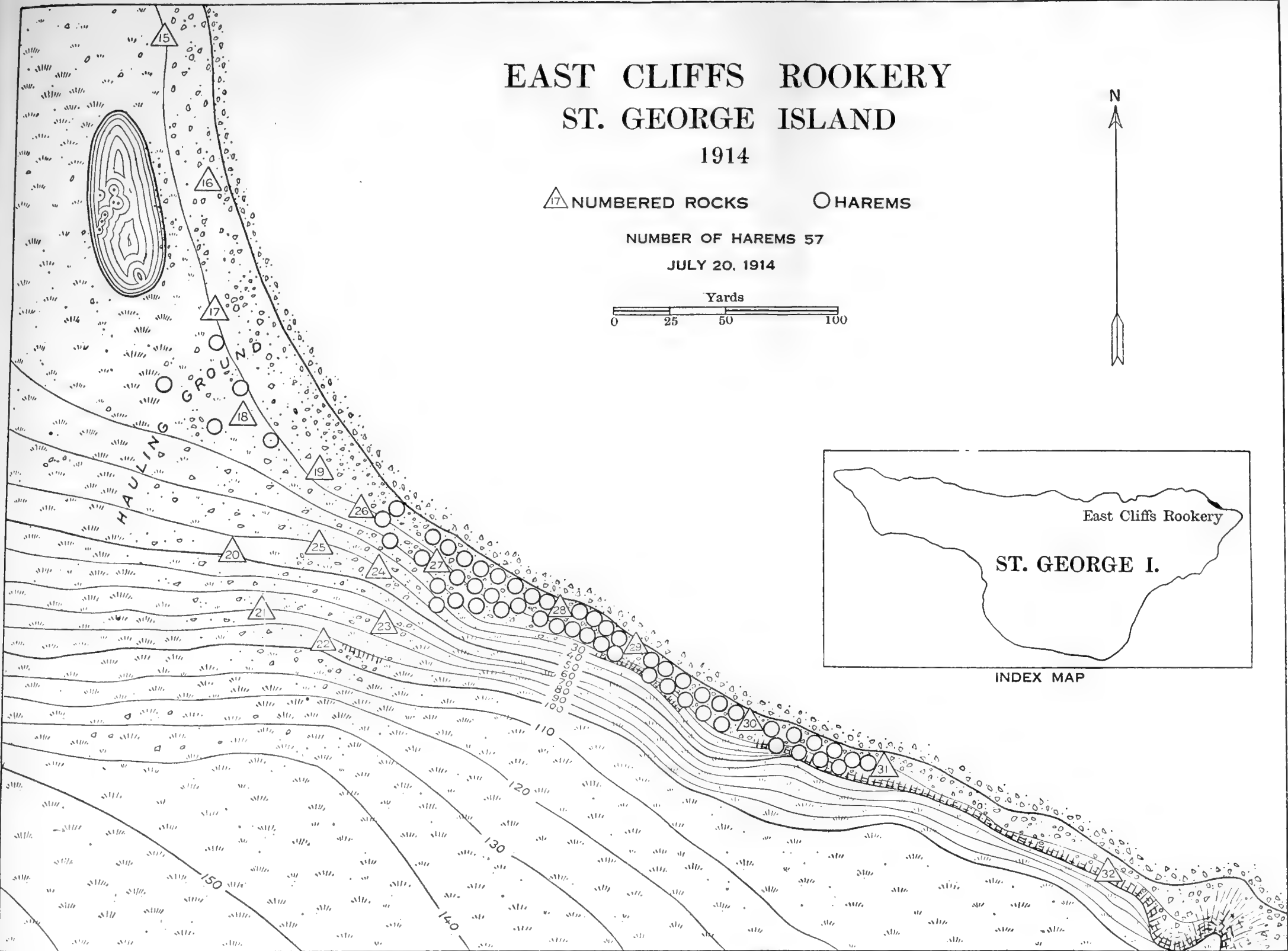

INDEX MAP

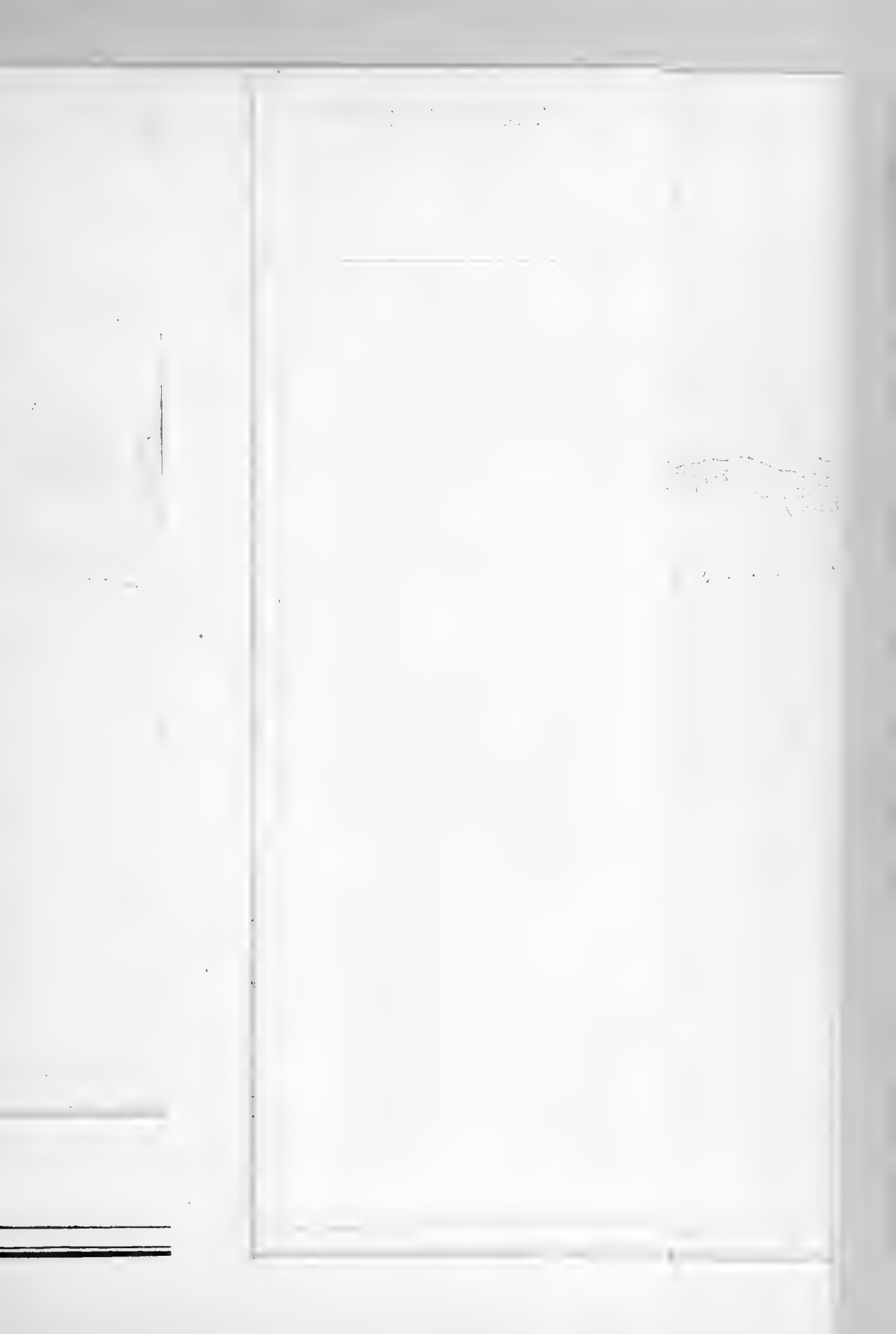



Walrus Island
 CL. 40
 5
 1.5
 57° 1'

Note True position is in longitude 169°56,
 6.26 statute miles due east

170°24'
 Otter Island
 288'

Note True position is in latitude 57°02'45;
 4.61 statute miles due south

ST. PAUL ISLAND
 PRIBILOF GROUP
 ALASKA



1914

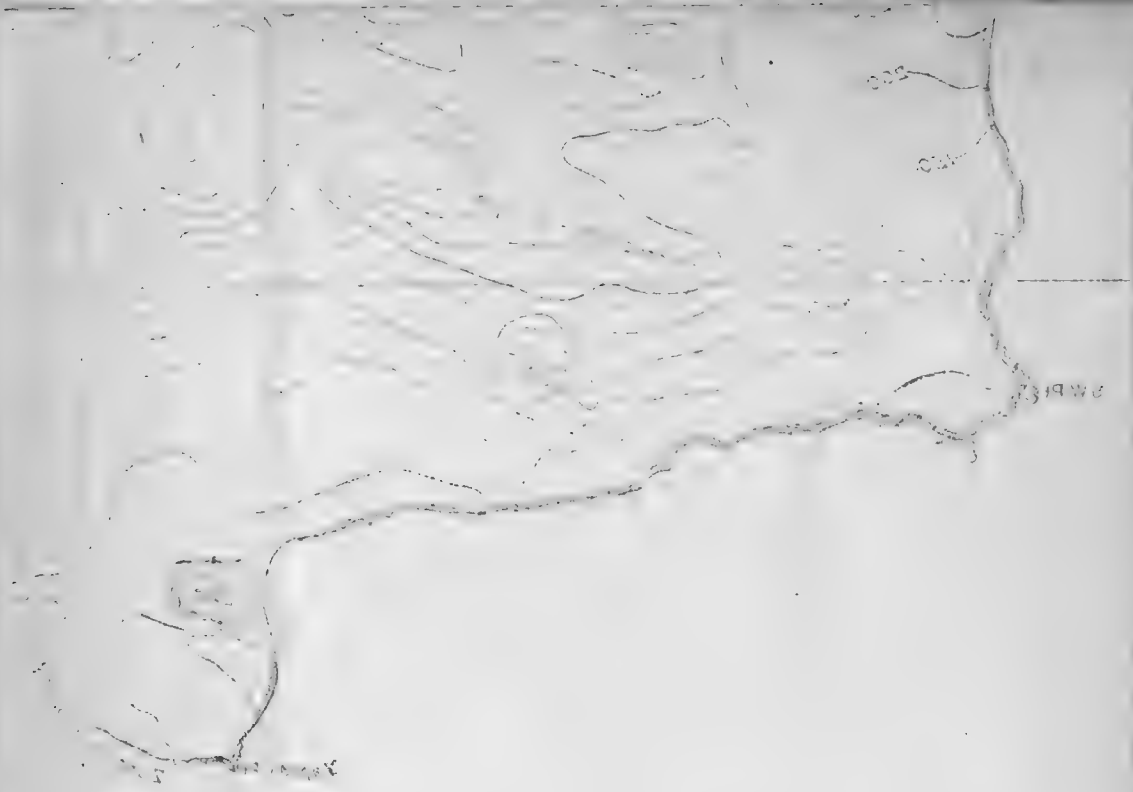

A. Si stote mics que souh
 And there is a small house 20 ft high



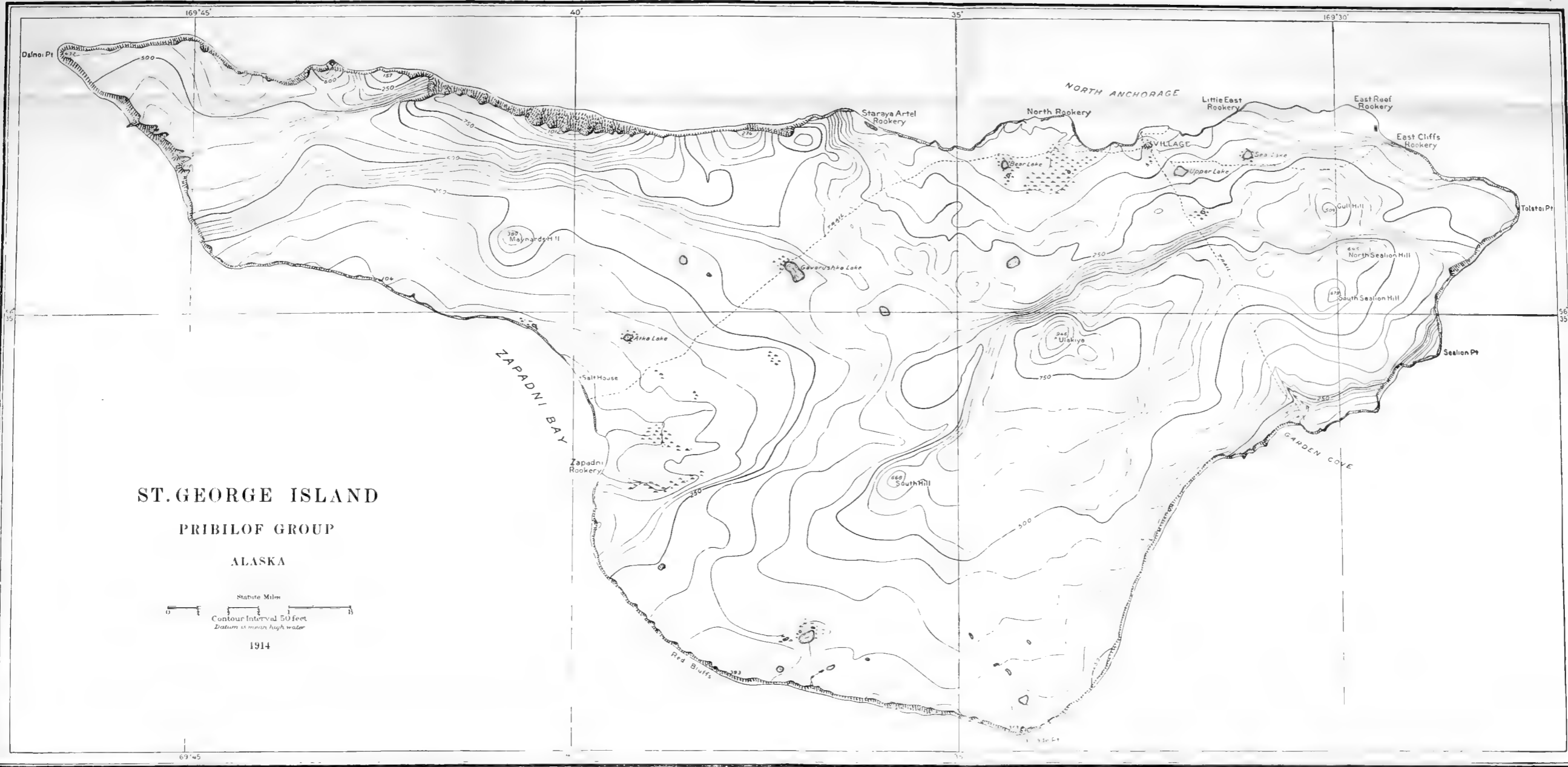

ST. GEORGE ISLAND

PRIBILOF GROUP

ALASKA

Statute Miles
 0 1 2
 Contour Interval 50 feet
 Datum is mean high water
 1914

THE UNIVERSITY OF CHICAGO
LIBRARY OF THE DIVISION OF THE PHYSICAL SCIENCES
CHICAGO, ILLINOIS



CHANGES IN SHADE, COLOR, AND PATTERN IN FISHES, AND
THEIR BEARING ON THE PROBLEMS OF ADAPTATION
AND BEHAVIOR, WITH ESPECIAL REFERENCE TO
THE FLOUNDERS PARALICHTHYS AND
ANCYLOPSETTA



By S. O. Mast



Contribution from the United States Fisheries Biological Station, Beaufort, N. C.,
and the Zoological Laboratory of the Johns Hopkins University

CONTENTS.

	Page.
Introduction	177
General survey of changes in shade, color, and pattern in fishes.	180
Detailed study of changes in shade, color, and pattern in <i>Paralichthys</i> and <i>Ancylopsetta</i>	182
Behavior	182
Adaptive changes in shade, color, and pattern	184
Natural backgrounds	184
Black and white background, artificial.	186
Relation between the pattern in the skin and that in the background.	188
Individuality of the pattern	190
Effect of mechanical and other stimuli on the pattern	191
Colored background, artificial	192
General statements	192
Experiments and results in detail.	193
Conclusions	198
Rate of adaptation to background.	198
Factors involved in the process of adaptation	199
Chromatophores in the skin	199
Eyes, nervous system, and direct action of stimulating agents as factors in adaptation to backgrounds.	200
Extent of distribution of stimuli from either eye	204
Relation between the intensity of light and the reaction of the chromatophores.	205
Light reflection from the skin as a factor in adaptation	206
The direction of the light as a factor in adaptation	207
Experiments (A), light from below relatively stronger than normal.	208
Experiments (B), light from above relatively stronger than normal.	212
Vision	215
Color-vision	215
Vision of motion, size, and form	219
Fusion rate of images on the retina	220
Summary	221
Selection of background	222
Group method	222
Individual method	223
Colored backgrounds.	224
Summary	225
Discussion	227
Bibliography	230
Explanation of plates	233

CHANGES IN SHADE, COLOR, AND PATTERN IN FISHES, AND THEIR BEARING ON THE PROBLEMS OF ADAPTATION AND BEHAVIOR, WITH ESPECIAL REFERENCE TO THE FLOUNDERS *PARALICHTHYS* AND *ANCYLOPSETTA*.

By S. O. MAST.

Contribution from the United States Fisheries Biological Station, Beaufort, N. C., and the Zoological Laboratory of the Johns Hopkins University.

INTRODUCTION.

Color and color patterns in plants and animals have a fascinating interest for almost every one. The layman as well as the artist, the scientist, and the philosopher shares in this. There are not only the questions as to the origin, inheritance, and phylogenetic development of such phenomenal, though relatively permanent, color schemes as are found particularly prominent in many tropical birds and fishes, but also the still more interesting questions regarding the biological significance and the mechanism of changes in such surface characteristics in individuals; not only ontogenetic changes which are more or less permanent, but especially such rapid and reversible changes as are well known to occur in the chameleon and a considerable number of other widely separated species.

The literature on the subject in general is very extensive. In an excellent review covering the more important references bearing only on changes in the color in animals, Van Rynberk (1906) has collected a bibliography consisting of 402 titles, and since the publication of this review many more papers have appeared. But in spite of all the work done, it will be necessary to do much more before the more fundamental problems involved are solved.

This paper, as the title indicates, deals primarily with the reversible changes that occur in the shade, the color, and the pattern in fishes, with especial reference to their extent and biological significance and the factors involved in their production. Considerable space, however, is also devoted to problems in behavior.

That there are marked changes in the appearance of fishes has long since been known. The Romans, Van Rynberk maintains, more than 2,000 years ago were wont to entertain the ladies at dinner with exhibits in changes in the color in fishes, mostly due to injury. In more recent times records show that under various circumstances very striking changes in both pattern and color have been observed by numerous investigators in many different fishes. These changes, in accord with their supposed cause or significance, have been classified as follows: (1) Psychic, (2) sexual, (3) adaptive.

(1) Townsend (1909) and others have observed that many fishes often suddenly change in appearance, sometimes without any apparent external cause, but more often

when mechanically stimulated or when some object, as, e. g., another fish comes within the range of vision. In general, the difference in the shade of the various regions of the skin becomes, under such conditions, much more pronounced. Such changes are usually referred to as psychic. They may possibly be protective by way of warning off enemies.

(2) Many authors have observed that during the breeding season the colors in various fishes, especially the males, become much brighter and the entire surface becomes more conspicuous. These changes are generally supposed to be functional in sexual selection. Hess (1913), however, has recently offered serious objections to this view. He maintains that in some species which spawn at a depth of 60 meters the males become brilliantly colored during the breeding season, and that red and yellow predominate, although at that depth these colors do not exist, for all of the longer waves of light have been absorbed.

(3) It is held by many that fishes simulate the background, not only in shade but also in color. Stark (1830), De Vescovi (1886), Van Rynberk (1906), Frisch (1912), Šečerov (1913), and others have come to this conclusion regarding a considerable number of genera (*Blennius*, *Gobius*, *Labrus*, *Crenilabrus*, *Solea*, *Rhomboidichthys*, *Nemachilus*, *Phoxinus*, etc.). Van Rynberk (1906, p. 549) says that particularly in *Rhomboidichthys* the skin assumes a color strikingly similar to that of the background, "exquisite anpassung an den Farbenton des Bodens," and Frisch is equally positive in asserting that there is color adaptation in *Phoxinus*.

These conclusions, however, have not gone unchallenged. Schöndorff, on the basis of results obtained in experiments on trout of the same species studied by a number of the investigators referred to above, concludes that there are no adaptive color changes in fishes. He writes (1903): "Wenn früher einige Autoren wie z. B. Stark (54) die Behauptung aufstellten, die Farbe der Fische richte sich nach dem Grunde des Gefässess, in dem sie gehalten würden, so beruht dies auf einem Irrthum." Hess is even more positive in his denunciation of the idea of adaptive coloration in fishes, although his criticism is directed primarily toward the work of Frisch. He repeated and extended much of Frisch's work and found no evidence indicating production of color in the skin in harmony with that of the environment. He says (1913, p. 439): "Frisch's Angaben über die Farbenanpassung der Pfrille sind sämtlich unrichtig. Die Farbe des Grundes hat keinen Einfluss auf die Farbung der Pfrille."

Not only has it been maintained that fishes simulate the background in brightness or shade and in color, but it has also been asserted, particularly by Sumner, that the pattern in the skin changes, so as to continually harmonize with that of the background. Sumner found in experiments on some of the flatfishes, especially *Rhomboidichthys*, that the size of the figures in the skin changes to correspond to a most remarkable degree with those in the bottom on which they lie. This is illustrated in his excellent photographs (1911, p. 481-505). A careful study of these photographs shows clearly that if the light and dark areas in the background are small the figures in the skin are also small, and if the areas are large the figures are correspondingly large. But the form of the figures in the skin does not appear to depend upon that of the areas in the background. It is essentially the same in fishes on a bottom containing alternate black and white squares as it is on one containing alternate black and white stripes, or black spots on a white field, or white spots on a black field, or an irregular pattern as is found in nature on gravel bottoms. Sumner says (p. 468): "Squares, crossbands, circles,

etc., were never copied in any true sense by the fishes." But he does maintain (p. 472) "that there may be very specific relations between the distribution of light and shade in the background and the pigment pattern assumed by the fish."

Pitkin, Loeb, and others, however, appear to hold that there is in the skin of these fishes an actual reproduction of the pattern in the background, especially in reference to the spacial interrelationship, form, and size of the light and dark areas. On the basis of this assumption very important conclusions have been formulated.

Pitkin (1912, p. 401) points out that since the eyes of the flatfish are so near the bottom the images on the retina are much foreshortened; that is, an area on the bottom having, e. g., a circular outline produces an image having an elliptical outline. He maintains, however, that in reproducing the pattern of the bottom the fish makes corrections for perspective distortion. He holds that the configuration of the bottom is reproduced in the skin, not as it would appear to an observer with eyes in the position of the eyes of the fish, but as it would appear to one with eyes directly above. Thus, Pitkin ascribes to this simple vertebrate most remarkable abilities.

Loeb (1912), overlooking entirely the question of foreshortening referred to above, holds that the different points stimulated in the retina bear the same spacial interrelation as the different points in the background which produce the image; and on the basis of the assumption that there is in the skin an actual reproduction of the pattern found on the bottom, he maintains that the impulses, as they travel through the nervous system, have the same spacial interrelation as have the different points stimulated in the retina. All this, he asserts, supports the theory of localization in the brain. He says (p. 81): "There exists, therefore, a definite arrangement of the images of the different luminous points of the ground on the retina and a similar arrangement of the images of the luminous points on the skin of the fishes." And from this he concludes that "vision is a kind of telephotography."

Thus the main points of contention concern the question as to the relation between the color of the environment and that of the fish, and the question as to whether or not there is in the skin of the fish an actual reproduction of the pattern of the background.

Regarding the biological significance of changes in the shade, the color, and the pattern in the skin there are various opinions. Some hold that these changes are purely accidental and have no biological value; others maintain that they function as a protection from enemies or in capturing prey; still others assert that they are primarily of value in the process of courtship and mating; a few contend that they function chiefly in regulating the temperature; and some even think they are of use in all of these ways and that they have still other functions. Townsend says (1909, p. 3): "Under natural conditions the changes of color are made chiefly for the purpose of concealment from enemies. They are also used for the capture of prey, for signaling, warning, mimicry, courtship, and other purposes." Unfortunately, however, none of these ideas are supported by experimental evidence. In no case has it ever actually been proved that changes in the appearance of the skin have any value whatsoever.

In regard to the mechanism involved in the phenomenon in question, practically all that is known is that it is largely dependent upon the distribution of pigment in certain cells found in the skin, and that the process of distribution is to a large extent regulated through the sympathetic nervous system. We shall later refer directly to the literature on this phase of the subject.

GENERAL SURVEY OF CHANGES IN SHADE, COLOR, AND PATTERN IN FISHES.

During the summers of 1913 and 1914 a considerable number of different fishes were kept in aquaria about the laboratory at Beaufort, for various purposes, by different investigators. Superficial observations were made from time to time on all of these fishes. No detailed record was kept of these observations, nor were the species recorded, although it may safely be said that there were at least 30. Changes in shade occurred in practically all of the species observed, changes in color in a relatively large number, and changes in pattern in relatively few. In some these changes were slight and insignificant, in others very striking. Some of the changes observed occurred very suddenly and were transient; others proceeded gradually and slowly, requiring hours or even days for complete adjustment. In some species most of the changes occurred without any apparent reference to the environment, the stimulus evidently being internal, and in these there was little evidence of adaptation. In others, nearly all of the changes were clearly due to alterations in the shade, configuration, or color of the background. These animals, in some instances, came to resemble their surroundings to a most remarkable degree.

In a number of the species referred to above the changes in shade, color, and pattern were somewhat more thoroughly studied by putting them successively into different boxes painted on the inside as follows: Black, white, white with black spots, yellow, red, green, and blue. The results of these observations are briefly summarized in table 1.

In judging the effect of a given background, the fishes were frequently put upon a different background ^a and compared with specimens which had been on this long enough to become fully adjusted. In most cases the changes in the skin were so marked that there was not the slightest doubt concerning them. All of those concerning which there was any doubt are indicated in the table by means of a question mark.

By referring to this table it will be seen that all of the species mentioned assumed a light shade on a light bottom and a dark shade on a dark bottom, and that a number changed in color so as to harmonize in this respect with the bottom, but that the skin assumed a pattern similar to that of the bottom in only a few species. These changes were of such a nature that I was fully convinced that whatever the significance may be, they are related to the background in such a way as to make the individuals incon-

^a This precaution is very important, especially in judging the effect of the background on the color, particularly in translucent forms, such as *Menidia*. Enough light passes through these creatures to make them resemble somewhat the background in color, no matter what it may be. It was found, however, in this case that when those which had been in a box of a given color were put into one of a different color, they still showed a predominance of the color of the box from which they had been taken, in spite of the interference of the color reflected from the new background. For example, an individual taken from the green box and put into the yellow box appeared very distinctly green, especially above the eyes and along the sides, while in the individual which had been in the yellow box continuously these same parts appeared yellow and not a trace of green could be seen. In the observations, the results of which are recorded in table 1, similar tests were applied in practically all cases.

spicuous. This is especially marked in *Paralichthys*^a *dentatus* and *P. albiguttus*, and fairly prominent in *Ancylopesetta quadrocellata*. In *Paralichthys*, especially *albiguttus*, the simulation of the background, both in color and pattern, is so accurate that in many instances the animals become almost invisible, as will be shown in detail later.

TABLE I.—DEGREE OF ADAPTATION TO THE BACKGROUND IN VARIOUS FISHES.

Species.	Background.						
	Black.	White.	Spotted.	Yellow.	Red.	Blue.	Green.
<i>Paralichthys albiguttus</i> ...	Very dark...	Very light...	Spotted....	Yellow.....	Reddish brown.	Bluish.....	Greenish.
<i>P. dentatus</i>	do.....	do.....	do.....	do.....	do.....	do.....	Do.
<i>Ancylopesetta quadrocellata</i>	do.....	do.....	do.....	do.....	do.....	Bluish gray.	Greenish gray.
<i>Etropus crossotus</i>	do.....	do.....	Darker but not spotted.	do.....	Brownish.	do.....	Do.
<i>Achirus faciatus</i>	Slightly darker.	Somewhat lighter.	Not spotted.	(?).....	(?).....	(?).....	(?)
<i>Spheroides</i> (puffer, several sp.).....	Dark.....	Very light...	do.....	Yellow.....	Brownish...	(?).....	(?)
<i>Menidia</i> sp.? [?]	Very dark...	do.....	do.....	Distinctly yellow.	Reddish....	Dark blue(?)	Distinctly green.
<i>Synodus foetens</i> (sand pike).....	Dark.....	Light.....	do.....	Yellow.....	Brownish...	Not tested..	Not tested.
<i>Ceratacanthus</i> and <i>Monocanthus</i> (foolfish) sp.? [?]	do.....	Light to very light.	do.....	do.....	(?).....	Purplish...	Strikingly greenish.
<i>Fundulus</i> , two species.....	Very dark...	Very light...	do.....	do.....	Brown.....	Bluish gray.	Greenish gray.
<i>Mugil</i> sp.? [?]	do.....	do.....	do.....	Not tested..	Not tested..	Not tested..	Not tested.
<i>Symphurus plagiusa</i>	Slightly darker.	Somewhat lighter.	do.....	do.....	do.....	do.....	Do.
<i>Dasyatis</i> (sting ray, two sp.).....	Dark.....	Much lighter	do.....	do.....	do.....	do.....	Do.
<i>Pteroplatea maclura</i> (butterfly ray).....	do.....	Very light...	do.....	do.....	do.....	do.....	Do.
<i>Opsanus tau</i> (toadfish).....	do.....	Light.....	do.....	do.....	do.....	do.....	Do.

After having made these rather superficial observations I was fully convinced that, contrary to the opinion implied in the statements of Schöndorff and Hess, quoted above, adaptive color changes in fishes occur not only in a marked degree, but that they are rather widespread. Bearing on the first of these conclusions I hope to present irrefutable evidence. In general, these observations seem to indicate that adaptation in shade is almost, if not quite, universal among fishes; that adaptation in color is much more limited; and that adaptation in pattern is confined to relatively very few species. It was found only in *Paralichthys* and *Ancylopesetta*.

^a The two species of *Paralichthys* mentioned are very nearly alike, both in form and structure, and in the shade, the color, and the marking of the skin. They can, however, be readily distinguished in most cases by the difference in the number of dark oscillated areas present. *Albiguttus* has but three such areas, while *dentatus* has more, the two near the posterior end of the base of the fins being particularly prominent. (Pl. xxxvi, fig. 70; pl. xxxvii.)

DETAILED STUDY OF CHANGES IN SHADE, COLOR, AND PATTERN IN PARALICHTHYS AND ANCYLOPSETTA.

BEHAVIOR.

Observations were made throughout two seasons (July 17 to Sept. 1, 1913, and June 17 to Sept. 23, 1914) on flounders, especially *Paralichthys* and *Ancylopsetta*, with reference to their habitat, activities, character of food, method of feeding, modifiability in reactions, etc. In these observations two methods were followed—direct observations on specimens kept in aquaria, both in the laboratory and outside, and inquiry among fishermen.

Nearly all of the specimens kept in the aquaria were taken in seines on the sandy beaches of the marshes in the immediate neighborhood of the laboratory at Beaufort. They varied in length from about 3 to 33 cm. Most of them were kept in large, shallow, wooden aquaria containing water about 5 cm. deep. These fish are naturally very hardy, and under such conditions they thrived very well with a surprisingly small amount of change of water. This was especially true of the larger ones, 5 cm. long and larger, practically all of which lived the entire season. For a few days after they were put into the aquaria they appeared to be somewhat shy and did not feed, but after that most of them fed freely and nearly all became very tame, so that they could be handled without becoming noticeably excited. A number of individuals became so tame that, if hungry—and they appeared to be hungry nearly all of the time—they would come to the surface of the water whenever anyone came near, apparently looking for food, and if offered they would take it directly from the fingers.

In general, the specimens in the aquaria seemed to prefer living minnows or shrimp, but most of them came to take readily dead specimens either entire or cut. They were usually fed every other day, almost entirely on living menidia and dead anchovies.

In nature and in aquaria containing soil, flounders are usually found partly buried. Oftentimes only the eyes and the mouth are visible. (Fig. 5.) When they are thus buried, or bedded, as it is ordinarily called, it usually requires considerable stimulation to cause them to leave, and after they do leave they usually swim only a short distance and then suddenly bed again. This is accomplished by a series of rapid vibratory movements in different parts of the body, the fins and the tail successively, of such a nature that while the animal remains stationary strong currents of water are produced under it which carry the soil out in all directions. The fish then suddenly comes to rest on the bottom and the soil settles down on it. If it is fine the entire animal usually becomes well covered; if coarse only a portion along the edge. (Pl. XIX, XX.)

In aquaria without soil they give the bedding reaction quite as freely as in those with soil, and they continue to give it for at least several months, but there is some evidence indicating that they give it less frequently and less vigorously. This was particularly noticeable in a few specimens of *P. albiguttus* after they had been in a wooden aquarium for four months.

After completing this section some observations were made which throw considerably more light on the question of modification in behavior. On September 21, 9 a. m., four large specimens of *P. albiguttus* were taken from the aquaria in the laboratory, where they had been for over three months, and set free in a small tide pool. All four immediately came to rest on the bottom, but none of them bedded. This is very unusual. Flounders, under such conditions, ordinarily bed at once. At 10 a. m. each one was still in precisely the place where it came to rest. The tide was at this time ebbing and the water in the pool was rapidly running out. One of the flounders was stimulated with a stick and driven out of the pool. After leaving the pool it swam about 20 meters and came to rest on the sand in about 15 cm. of water, but it did not bed. Another specimen was then stimulated. It swam about 1 meter and came to rest without bedding. It was again stimulated, after which it again swam a short distance, but this time it bedded when it came to rest. The bedding reaction, however, was so feeble that only the edges of the fins became covered with sand. Thereafter this specimen bedded every time that it came to rest, but none of the other specimens gave this response. The water in the tide pool had in the meantime become so low that the remaining two specimens could no longer swim out. Both were caught and carried out. All four specimens were now lying on the sand in shallow water, one bedded and three not. Half an hour later all four were found stranded on the beach. None had moved as the tide ebbed until it was so low that they could not get away. They had so completely forgotten the ways of the sea that all would have perished had they not been rescued. They were carried out and thrown into water about 30 cm. deep and left.

At low tide another observation was made, but only one specimen was found. All of the others had evidently gone out with the tide. This one, however, the only one which had given the bedding reaction, failed to get out and was found dead under a board. It apparently had become so accustomed to stimulation in the aquarium, where it was daily stroked and handled, that it failed to respond when the board sank with the ebbing tide, until it was too late. It had obviously completely forgotten the danger of the tides. These observations show in a striking way that the responses of these animals to given stimuli can be greatly modified.

Flounders in general are relatively quiet, especially during the daytime, when they frequently lie quiet for hours at a time. One specimen, after having been in an aquarium in the laboratory for several days, was observed to remain in a given position, without the slightest noticeable change, from 8 a. m. until nearly 6 p. m. Many others were seen to remain quiet for shorter periods, both in the laboratory and outside. In aquaria which do not contain any soil they tend to huddle together and partly cover each other (pl. xxxvii).

During the night, however, they are much more active. This is true, at least, for specimens kept in captivity. After dark considerable noise usually came from the aquaria. *Ancylosetta* particularly has a tendency to jump out of the water. On several occasions, during the night, specimens jumped out of an aquarium, the sides of which extended 8 inches above the surface of the water.

Fishermen report that flounders often take pieces of meat of various sorts, but that they usually feed on crustacea, mollusks, and minnows; that they usually lie concealed on the bottom until their prey gets within range, then suddenly spring and seize it,

but that they sometimes feed on schools of small fry near the surface, pursuing and capturing them as other fish do.

These reports were confirmed by observations in the laboratory. It was ordinarily found that the latter method prevailed only in case the fish had not been fed for a few days and were presumably hungry. I am of the opinion that this method of feeding was much more common in fish that had been in the laboratory a few weeks than in those recently brought in. It was observed that flounders, especially *Ancylopussetta*, frequently stalk their prey. Specimens were repeatedly seen creeping on the bottom with their fins, toward a minnow hovering above them, just out of reach, so slowly and smoothly that their motion was scarcely perceptible and, when they got within striking distance, spring suddenly upward and forward, capturing their prey. They rarely, if ever, take dead minnows or pieces of meat lying on the bottom motionless, but do not hesitate to take them, even when badly decayed, if they are in motion. In fact, they appear to take decayed food quite as readily as fresh. Thus it would appear that the selection of food depends very largely, if not entirely, upon vision.

After this work was completed I found a blind specimen which learned to capture minnows, showing that vision can be dispensed with in the process of feeding. This specimen lost both eyes on September 1. From this time until September 17 it ate nothing and gave no feeding reaction. On this day, however, it was seen several times to snap at minnows that chanced to come near. On September 19, 15 minnows were put into a rather small inclosure with the blind specimen. In a few minutes it captured and swallowed one of them. After this it fed regularly on living minnows, but it was impossible to make it take dead ones. I am of the opinion that the presence of the minnows was detected only by contact, although I was not able fully to establish this point.

Owing to their peculiar habits and characteristics and their hardiness, *Paralichthys* and *Ancylopussetta* are among the most favorable of fishes for experimental work, especially of the sort described in the following pages.

ADAPTIVE CHANGES IN SHADE, COLOR, AND PATTERN.

NATURAL BACKGROUND.

It is well known that *Paralichthys* and *Ancylopussetta* usually resemble somewhat the bottom on which they lie—those taken on dark bottoms are usually dark and those taken on light bottoms are usually light. Further than this, however, practically nothing is known. Little or nothing is known concerning the nature, the degree, and the function of this resemblance. In trying to solve some of the problems just referred to, observations were made under various conditions on specimens kept on three essentially different sorts of bottoms: (a) Natural background; (b) black and white background, artificial; and (c) colored background, artificial.

In studying the adaptive changes on natural backgrounds, some specimens were placed directly on, and others in glass dishes over, fine gray sand; fine black sand; medium, and very coarse yellowish sand, consisting largely of small shells and fragments of larger ones; broken oyster shells; coarse black cinders; and bluish-gray pebbles.

Nearly all of the specimens used in this experiment had been for some time in a white aquarium and were uniformly very light in shade with little or no color. Very soon after they were put on the different bottoms, in some cases almost immediately, the shade, the color, and the pattern in the skin began to change, and within five minutes a striking difference could be clearly seen between the individuals on the different bottoms, although there was at this time in most cases very little resemblance between the fish and the background. Gradually, however, they came to look more and more like the background until, in the course of several days, in some cases in a few hours, in others a number of weeks, it required more than casual observation to locate the animals. This was particularly true with reference to those on the different kinds of sand. But on all of the bottoms there was a most remarkable similarity between the fish and the background in color as well as in shade and configuration. Some features of this resemblance are well represented in the photographs. (Pl. XIX, XX, fig. 1-7.)

In taking these photographs, as well as all of the others, and also the autochromes,^a referred to later, especial precautions were taken to get the illumination of the object, depth (2 to 3 cm.) and character of the water, and the exposure and treatment of the plates in all cases as nearly alike as possible. The exposures were all made in front of a large window, in strong diffused sunlight.^b In each case, before the exposure was made, the specimen to be photographed was kept for some time in a crystallizing dish or a shallow box in the place in which it was photographed. In these retainers the fish were fed and supplied with running water. (Fig. 1, p. 186.) They were observed frequently and gently touched and stroked until they became thoroughly accustomed to their new environment. As previously stated, however, these creatures are readily tamed and many of them, in a surprisingly short time, can be pushed about the aquarium and even picked up without showing any marked effect. Moreover, the camera was often adjusted and kept in place for some time before making the exposure. In short, the animals were given a preliminary course of training.

Such precautions are of the greatest importance in work of this sort, for the appearance of the skin changes greatly if the animals are disturbed. (Fig. 21, 22.) In animals just brought into the laboratory the slightest movement about the aquarium usually induces such changes; merely directing one's eyes toward them is often sufficient.

No changes, by retouching or otherwise, were made in any of the figures. Standard Orthenon plates were used almost exclusively. Moreover, careful observations were made and recorded in each case at the time the photograph was taken, and in printing these descriptions served as a guide in attempting faithfully to reproduce the various shades and patterns assumed by the fish. Thus the inaccuracies in reproduction were reduced to such an extent that I feel certain they are of no serious consequence, especially in conclusions resting upon a comparison of the skin with the background or of the skin in individuals under different conditions.

By referring to these photographs it will be clearly seen that the light and dark areas in the skin are relatively large in the individuals on coarse-grained bottoms and relatively small in those on the fine-grained bottoms, and that the shade of the skin in general corresponds well with that of the background. But the adaptation in color,

^a The technical work connected with the photographs and autochromes was done by F. H. Harper, to whom I am under great obligations for apparatus as well as for expert service.

^b Some autochromes were later taken in direct sunlight.

not shown in the photographs, was fully as striking as the adaptation in shade and pattern. In the specimens on the shells the skin was very distinctly brownish yellow; in those on the gray sand it was yellowish gray; while in those on the black sand there was no trace of yellow or brown, nothing but black and white. The adaptation in color, however, was more clearly evident in specimens kept in boxes painted on the inside. These experiments we shall consider in detail later.

Thus by changes in the shade and color, and in the pattern in the skin and by partly burying, these animals become very effectively concealed on a variety of different bottoms. But there is still another peculiarity in their reactions that serves this same purpose. When they lie on the bottom the central portion of the body is usually considerably raised in such a way as to form a channel from the lower gill to the posterior end, and while in this position they frequently breathe only through this gill, the exposed gill being closed and perfectly quiet. Thus when buried in sand the water enters the mouth, passes through the lower gill, back under the body and up on either side of the caudal fin (fig. 5), where it can be seen oozing up through the sand, moving the grains slightly. This is the only movement that can be detected, except a very slight and inconspicuous movement in the mouth. As to the function of the concealment we have all sorts of suggestions, but as yet no direct evidence. I hope, however, to deal with this matter experimentally in the near future.

BLACK AND WHITE BACKGROUND, ARTIFICIAL.

While the study of *Paralichthys* and *Ancylopsis* on natural bottoms shows conclusively that the skin tends to assume a pattern such as to make the fish inconspicuous, it shows but little concerning the relation between the pattern assumed and that found in the background. It does not tell us precisely why the pattern in the skin resembles the

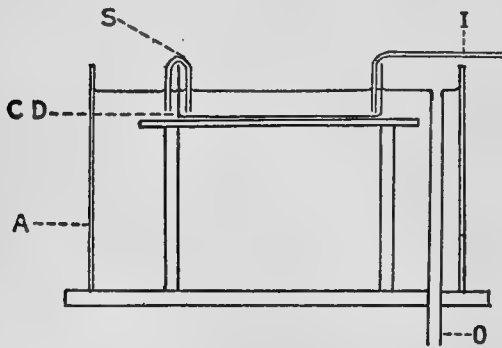

FIG. 1.—Vertical section of apparatus used in studying adaptation to artificial backgrounds. A, aquarium; CD, crystallizing dish; S, siphon; I, inlet for water; O, outlet.

bottom. It gives but little knowledge concerning the degree of accuracy with which the configurations in the bottom are reproduced. For this purpose it is essential to be able to test the effect of figures which can be varied as desired with reference to size, form, and interrelationship. This can readily be done by means of artificial backgrounds. Such backgrounds were made by painting, with india ink, various figures on bristol board.

The fish to be tested were in all cases put into 21 cm. glass crystallizing dishes and these, containing water about 2 cm. deep, were set in water of the same depth on the painted boards, which were always put between two thin clear glass plates so as to protect them against the action of the water. To change the background it was only necessary to remove one board and push under another with a different figure. In every case all bubbles of air were removed from under the dish. This is of the greatest importance, for if not removed there is so much refraction and reflection that the figures may appear much distorted, and if the air is sufficient to form a continuous layer many of them can

not be seen at all when viewed from such a small angle of elevation as the eyes of these animals have.

The fishes were supplied with oxygen by means of a continuous stream of sea water from the storage tank. This water flowed out of the dish through a siphon so arranged as to insure in the dish a constant depth of water. This could be varied as desired by simply raising or lowering the dish. (Text fig. 1, p. 186.)

The different sorts of backgrounds used in these experiments and the general results obtained are summarized in tables II and III and in the photographs reproduced on plates XXI-XXXV.

TABLE II.—RELATION BETWEEN THE PATTERN IN THE SKIN OF THE FISH AND THE FORM, SIZE, AND ARRANGEMENT OF THE FIGURES IN THE BACKGROUND.

Form of figures.	Size.	Relation.		Pattern in skin of fish.
		In size.	In position.	
Square.....	2 cm.....	Equal.....	Alternate.....	Very coarse, large black spots.
Do.....	1 cm.....	do.....	do.....	About the same, but more black spots.
Do.....	5 mm.....	do.....	do.....	Smaller black spots more numerous.
Do.....	2 mm.....	do.....	do.....	Very fine spots much more numerous.
Rectangular.....	5 by 10 mm.....	do.....	do.....	Somewhat coarser than on 5 mm. squares.
Rotated rectangular. ^a	do.....	do.....	do.....	Do.
Stripes.....	10 mm. wide.....	do.....	do.....	More white than on 10 mm. squares.
Do.....	5 mm. wide.....	do.....	do.....	More white than on 5 mm. squares.
Black spots.....	1 square cm.....	Black equals white.....		Same as on 10 mm. squares.
White spots.....	do.....	do.....		Fewer spots than on 10 mm. squares.
Black spots.....	do.....	Black equals 1/2 white.....		Much more white. Fewer black spots, but about same size as on 10 mm. squares.
White spots.....	1/2 square cm.....	Black equals 15 white.....		Much more black. Fewer white areas, but about same size as on 5 mm. squares.
Solid black, no figures.....				Very dark, nearly uniform, save usually a light area near pectoral fin, and in some specimens a number elsewhere.
Solid white, no figures.....				Very light, nearly uniform, usually some light grayish patches.

^a In this test the background was continuously rotated.

TABLE III.—RELATION BETWEEN THE PATTERN IN THE SKIN OF FLOUNDERS AND THE SIZE AND TOTAL RELATIVE AREA OF BLACK CIRCULAR FIGURES ON A WHITE BACKGROUND.

Diameter.	Distance apart both ways.	Percentage of black.	Effect on pattern in fish.
0.5 millimeter.....	Millimeters. 20	0.0535	No effect; same as on all white background.
Do.....	10	.2121	No effect.
Do.....	5	.8484	Do.
Do.....	2.5	3.3936	No effect, except probably slightly grayish, no spots.
1 millimeter.....	20	.1964	No effect.
Do.....	10	.7856	One small black spot.
Do.....	5	3.1424	Three small black spots.
2 millimeters.....	20	.7856	No effect.
Do.....	10	3.1424	Three small black spots.
Do.....	20	1.7175	Do.
3 millimeters.....	10	6.87	Three larger and denser black spots and numerous small ones.
Do.....	20	5.302	Do.
5 millimeters.....	10	21.21	Numerous black spots.

By referring to table II and plates XX-XXXV, it will be seen at once that there is, on artificial backgrounds as on natural bottoms, a tendency in the skin of the fish to assume an appearance somewhat similar to that of the environment. On a white background all of the black areas in the skin disappear; on a black one frequently all of

the white areas except one near the pectoral fin disappear. In general, it may be said that the larger the proportion of the background covered by the black areas the larger the proportion of black in the skin and vice versa, and the smaller the black and white areas in the background the smaller those in the skin. This is well shown in figures 9-17.

These statements hold, however, only within certain limits. If the black areas are small it requires a larger proportion of black, under certain conditions, to produce the same effect than it does if they are larger. This is shown in some of the records in table III and in plates XXXI, XXXII. A background with dots 3 mm. in diameter, 20 mm. apart, produces very nearly as much black in the skin as one with dots 2 mm. in diameter and 10 mm. apart (fig. 52, 54), although in the former there is only 1.71 per cent black while in the latter there is 3.14 per cent black. And if the dots are very small there are no black areas produced in the skin, no matter how great the proportion of the background covered with black (fig. 49). In the specimen used in obtaining the results recorded in table III, dots 0.5 mm. in diameter, 2.5 mm. apart, produced no black spots in the skin, while dots 1 mm. in diameter, 10 mm. apart, did, although in the former case 3.39 per cent of the background was black and in the latter only 0.78 per cent. If the figures are very small the black acts just as it does if uniformly distributed. That is, a background containing numerous very small spots has the same effect as a uniform gray background. This matter was, however, tested only in a single individual.

If the light and dark areas are excessively large the skin also tends to assume a uniform shade; or, at any rate, there is no simulation of the background. The size of the figures required to produce this varies with the size of the fish. The 2 cm. squares represented in figures 11 and 15 are very near if not slightly beyond the limit in size for simulation in specimens of the size, 14 cm. long, shown in these figures; while in smaller specimens, 10 cm. long, represented in figure 18, the limit in size, of the figures simulated is about one-fourth as great. The effect of relatively coarse-grained bottoms like these depends, however, upon the position of the fish. If the fish is held so that the head is on a black area and the edge of the anterior end of the animal is on white, as in figure 15, the skin assumes a much larger proportion of white than it does if the head is held on a white area and the edge is on black. The production of a uniform shade results if the figures are so large compared with the size of the fish, that one eye is ordinarily affected mainly by black and the other mainly by white. We shall consider the cause of this later.

While large specimens come to resemble the background more closely than small ones if it contains relatively large configurations, the opposite is true if the configurations are small. In the smaller specimens, 5-15 cm. long, adaptation also proceeds more rapidly than in the larger ones, 20 cm. and up.

Relation between the pattern in the skin and that in the background.—Our evidence shows conclusively that both on natural and on artificial backgrounds there is a configuration produced in the skin which resembles that of the background. This is clearly shown in the photographs already referred to. This resemblance between the fish and the background was, however, even more remarkable in specimens which had been for several weeks in a variegated dark blue and white granite pan. (Pl. XXVII, XXVIII.) Is this resemblance due to an actual reproduction of the configurations in the back-

ground, as maintained by Pitkin and Loeb, pointed out in the introduction, or is it the result of some other phenomena?

By referring to table II and comparing figures 12, 26, and 27, all reproductions of photographs of the same individual on backgrounds having black and white areas equal in size but different in form, it will be seen that the pattern in the skin of the fish is practically identical in all. The same dark spots and patches are found in all, and they have the same form and relative position, although in the different backgrounds the light and dark areas differ greatly both in form and in spacial interrelationship.

The same will be found to be true in comparing figures 23, 24, and 25. In figure 23 the background was changed every time the fish moved, so as continuously to keep the long axis of the fish parallel with the short axis of the light and dark areas; in figure 24 it was so regulated as to keep this axis parallel with the long axis of these areas; and in figure 25 the background was continuously but very slowly rotated. Thus, in figure 23 the light and dark areas, owing to foreshortening from the flounder's angle of vision, appeared nearly square, in figure 24 very much elongated, and in figure 25 the appearance changed continuously. Yet the pattern produced in the skin by these different backgrounds appeared to be the same, even in details visible only under considerable magnification. This may be seen by comparing with a lens the photographs reproduced in the three figures mentioned above, and even more clearly by studying those reproduced in figures 31-40.

Figures 33 and 34 represent the same individual on different backgrounds. In figure 33 the specimen was in a shallow granite pan which was dark blue speckled with white. The white spots, as shown in the photograph, varied in form and size and were scattered promiscuously over the surface. Figure 34 represents the same individual on an artificial black and white background. The white areas in this background covered about the same proportion of the whole as the white areas did in the granite pan, and they were on an average about the same size on the two backgrounds; but in the former they were regularly arranged and fairly uniform in shape, while in the latter they were irregularly arranged and varied much in form.

By examining these two figures it will be seen, however, that there is a striking similarity in the patterns produced in the skin. On the artificial background there are in the skin a number of light areas which resemble the white spots in the background quite closely in size but not at all in form and arrangement. In the pattern produced in the pan these light areas are all present, moreover they are practically the same in size and form and have precisely the same relative position, respectively, as those in the pattern produced by the artificial background, although the form and arrangement of the white spots in the two backgrounds differ greatly. This is well illustrated in figures 39 and 40, which are photographic enlargements of a small region taken somewhat above the ventral ocellus in figures 33 and 34, respectively. The same characteristic is shown in figures 31 and 32. In figure 32 the white areas in the background are somewhat larger than they are in the pan, represented in figure 31. The white spots in the skin are likewise somewhat larger in the former, but they have precisely the same spacial interrelationship in both. In neither, however, is there any similarity in arrangement between the spots in the skin and those in the background. This is clearly shown in figures 35, 36, 37, and 38. These figures are photographic enlargements of certain areas in figures 31 and 32. The magnification in all is approximately nine diameters. Figures

35 and 38 represent the background and figures 36 and 37 a small portion of the surface of the fish shown in figures 31 and 32, respectively. The section of the skin enlarged in these figures is found in the same relative position as that enlarged in figures 39 and 40.

A glance at these figures shows at once that there is no indication of an actual reproduction of the background. In the granite pan the adaptation of the fishes to the background in color and shade, as well as in pattern, was, as previously stated,^a most remarkable. So closely did they resemble the bottom, in most instances, that strangers rarely saw them until they were pointed out, and yet a comparison of figures 35 and 36 shows conclusively that the configuration of the light and dark areas in the skin is strikingly different from that in the background. The pattern in the skin, on the other hand, is almost identical, even in minute details, with that produced by the artificial background. The different black and white areas in one are practically identical in form and spacial interrelationship with those in the other, although some are considerably larger on the artificial background than they are in the pan. This is especially true of the prominent white spots, two of which are included in the areas enlarged.

The simulation of the background in *Paralichthys*, in so far as the pattern in the skin is concerned, is due merely to the formation in the skin of light and dark areas similar in size to those in the background. On a background with large figures the light and dark areas in the skin become relatively large. On one with small figures the pattern breaks up into small areas, black dots appearing in the larger white areas and white ones in the larger black areas. The location of these dots and their form are morphologically fixed. They are essentially the same in fishes over a background consisting of alternate black and white stripes as they are over one consisting of alternate black and white squares, or one consisting of black spots on a white field, or white spots on a black field, or one consisting of light and dark areas irregular in form and arrangement, as found in granite pans and on natural bottoms.

All our evidence supports the general conclusion of Sumner with reference to *Rhomboidichthys*, stated in the following words (1911, p. 468): "Squares, crossbands, circles, etc., were never copied in any true sense," and contradicts the contention of Pitkin and Loeb that there is an actual reproduction of the figures in the background. It supports only with certain limitations Sumner's contention (p. 472) "that there may be very specific relations between the distribution of light and shade in the background and the pigment pattern assumed by the fish." *The size of the light and dark areas in the background and the relative amount of surface covered by them have a profound effect on the pattern produced in the skin, but the form and arrangement of these areas have, at least within rather wide limits, none.*

Individuality of the pattern.—In some individuals adaptation is very much more precise and is attained much more rapidly than in others. This, however, I think is largely due, as I shall show later, to difference in experience.

The characteristic markings in the skin of different individuals of the same species appear very much alike, provided they are on the same background. This is clearly seen by comparing figures 10, 19, 20, and 30, all photographs of different individuals of the same species on similar backgrounds. In detail, however, there is considerable variation in the patterns of these individuals, as a comparative examination with a lens

^a See the autochrome, fig. 66.

of the same area in the different photographs mentioned will show. In all of the specimens of this species there are three small but prominent black areas, ocelli, which stand out rather conspicuously, especially in animals adapted to a background containing relatively little black. They are well shown in some of the figures on plates xxvi and xxxii, and also in many other figures. In individuals adapted to a white background they are light gray and quite indistinct, but they can still be seen. On backgrounds containing much black, however, these areas become continuous, with larger black patches, and can no longer be distinguished.

Without a lens it can be readily seen that the ventral one of these ocelli is elliptical in outline in figure 9, and in all of the other photographs of this individual in which it can be seen at all (fig. 9-17, 23-29, 49-55). In figure 19, which represents a different individual, this area is, however, very nearly circular, and the posterior border contains a small but conspicuous white spot. These characteristics are seen in all of the photographs of this individual. They are particularly prominent in figures 33 and 34. In figures 31 and 32, photographs of still a different individual, this area has other distinguishing features. Thus any individual could be recognized by the characteristics of this area alone. There is probably quite as much individual difference in every other section of the surface, so that the patterns of different individuals of the same species which superficially appear so nearly alike are, in detail, so different that every individual could be recognized by a thorough examination of any small area of the pigmented surface probably not larger than 0.5 mm. square. This individual variation becomes very evident in a comparison of figures 36 and 37 with figures 39 and 40; the former represent enlargements of a given area of one individual on two different backgrounds, the latter enlargements of the same area of another individual of the same species, *P. albiguttus*, on similar backgrounds. By examining these figures closely it will be seen that while nearly all of the light and the dark areas and spots found in one individual are also found in the other, they differ considerably in form. There is, in fact, more difference in the details of the patterns in the two individuals on the same background (granite pan) than there is in the patterns of the same individuals on the different backgrounds.

Effect of mechanical and other stimuli on the pattern.—If *Paralichthys* or *Ancylopsis* is mechanically stimulated, contrastive patches suddenly appear in the skin. If the fish are adapted to a dark background, numerous white spots appear, and if adapted to a white background numerous black spots appear. In either case the animal becomes very conspicuous. This is especially marked in *Paralichthys*. (Fig. 21, 22.) The degree of stimulation required to produce the reaction varies greatly. In animals that have not been handled much it ordinarily requires only a light touch. Strange objects brought in the field of vision also induce this reaction. Thus, to cause the reaction, it is often only necessary to bend over the aquarium or to bring a strange specimen within a distance of 15 to 30 cm. In such cases the change in the chromatophores is clearly due to stimuli received through the eyes. Similar changes usually occur during the process of feeding. This is particularly marked in specimens adapted to white. No new spots originate in any of these cases. That is, the spots, both black and white, appear in the same relative regions in all specimens and in the same regions in which they appear when they are caused by any other stimulating agents. As to the biological significance of these phenomena, if there really is any, we are quite in the dark.

COLORED BACKGROUND, ARTIFICIAL.

General statements.—Among those who hold that fishes simulate the background in color, Frisch (1912, 1913) has probably presented the most conclusive evidence. He made an extensive study of the reactions to color in *Phoxinus* and *Crenilabrus* and maintains that there is in these forms clearly adaptation to color. (Farbenanpassung.) Hess, however (1913), while admitting that fishes change color, maintains that there is no evidence showing that these changes bear any specific relation to the color of the environment. He asserts that the strongest point Frisch has in favor of his contention is found in his statement that *Phoxinus* on a yellow bottom becomes yellow, but, he concludes, after working on this form one and one-half years, that Frisch is in error. He kept specimens over colored bottoms for several weeks and found no specific effect of the color of the bottom on that assumed by the fish. He says (p. 407): "I did indeed find that after having been over red, yellow, or orange bottoms for a number of hours some of the specimens appeared slightly more yellow than those kept over gray bottoms, but often the opposite was true." And those on blue, he maintains, frequently appeared more yellow than those on red. Hess asserts that his opinion regarding the color of these specimens was confirmed by his colleagues, and he says that one of them even maintained that those on the gray were more yellow than those on the yellow bottom.

After the appearance of the criticism of Hess, Frisch repeated some of his experiments. He tested 22 specimens of *Phoxinus* on yellow, and asserts that 20 became yellowish and 2 did not. One of these, he says, was later found to be sick and the other abnormal, in that it contained only a very small amount of yellow pigment. Frisch states that his judgment concerning the color of these fish was confirmed at the time by his colleagues, Hertwig, Goldschmidt, and Buchner.

While the results recorded in table 1 include neither *Phoxinus* nor *Crenilabrus*, they indicate clearly, as previously stated, that adaptive color changes do occur in some fishes. A thorough study of *Paralichthys* and *Ancylosetta*, on artificial backgrounds variously colored, proves that this conclusion is correct and shows that color-adaptation in these forms, especially in *Paralichthys*, is highly developed and extends over a wide range.

In this study nine wooden boxes, 30 cm. long, 25 cm. wide, and 7.5 cm. deep, were used. Each box was colored on the inside with oil paint ranging from dark red to very dark blue. There were thus nine boxes in all, each differing in color from the rest. The nine different colors represented in these boxes were compared with Bradley's standard colors. The common name of each and that in Bradley's classification with which it most nearly corresponds follows: Maroon (red, shade no. 2), vermilion (orange red), dark brown (orange, shade no. 2), light brown (orange, shade no. 1), chrome yellow (orange yellow), light yellow (yellow, tint no. 2), chrome green (yellow green, shade no. 2), light blue (green blue, tint no. 1), dark blue (blue, shade no. 2).

These boxes were all placed in strong diffused sunlight and so arranged that the water in them was constantly about 4 cm. deep. All of them received a constant supply of sea water from the storage tank. One or more moderately small specimens of *Paralichthys* were put into each box, and one of *Ancylosetta* into the maroon, the chrome yellow, the chrome green, and the dark blue. Under these conditions the fish fed normally and thrived, some being in the boxes more than two months. None were lost except by accident.

When the specimens were put into the boxes, the shade, color, and pattern of the skin were nearly alike in all. Nearly all had been in a white aquarium for some time. No color, save gray of various shades, could be detected in any of them except in *Ancylopselta*, and in these there were only some slightly iridescent patches, and at times a faint trace of brownish color in and around the four conspicuous ocelli, which are responsible for the common name "four spot," by which the members of this genus are known.

Immediately after they were put into the boxes they still appeared alike. There was no evidence whatever that colored light reflected from the sides of the boxes or transmitted through the fish from the bottom affected in any way the appearance of the fish, with the exception of the fins and tail. Within half an hour, however, there was a marked difference. There was much individual variation, but in general those in the yellow boxes were distinctly yellowish; those in the brown, brownish; those in the red, grayish or brownish; and those in the blue and green, grayish.^a The pattern in the skin of all the specimens remained essentially the same throughout the experiment, but the shade and color continued to change greatly in all until, in the course of from a few days to several weeks, the skin in most of them came to resemble the background in color, as well as in shade to a most remarkable degree. This was especially true of those on various shades of yellow and brown, and of those on light and dark blue and chrome green.^b (Pl. XXXIII-XXXV.) It was in general more marked in *Paralichthys* than in *Ancylopselta*.

On red of different shades and dark green, tested in another connection, the fish did not assume a color very much like that of the background, but in each case, including the different shades of brown, red, and yellow, the color of the skin was unquestionably different from that in any other case, and it showed no resemblance to anything obtained on any shade or intensity of white, gray, or black.

Thus the effect of each of the nine different colors tested, ranging from dark red to dark blue, is specific, and since no combination of black and white, regardless of the intensity of the light, produces anything similar in effect, it is evident that this specific effect produced by the different colors can not be accounted for on the basis of differences in the intensity or quantity of light reflected by the various colors, but must be due to differences in the length of the waves. The fact that the light reflected from the colored paint was not monochromatic can affect in no way the validity of this conclusion. Pure colors, so necessary in much of the work on color-vision, are not even essential in work of this sort.

Experiments and results in detail.—These general statements and conclusions are supported by the following details regarding changes in color under different conditions, selected from my notes and by the autochromes^c and photographs reproduced on plates XXXIII-XXXV.

^a The tendency to become gray is particularly marked on those colors which are apparently not readily simulated. On such backgrounds the animals become adapted in shade first and later in color, if at all. The response resulting in a gray shade is undoubtedly, in some way, associated with the quantity of light reflected from the background regardless of its quality, i. e., the length of the waves. The response, on the other hand, which results in the production of color is associated with the quality of the light. There are therefore two mechanisms involved in the process of adjustment on colored backgrounds.

^b After this part was completed the same was found to be true for pink.

^c It is a pleasure to acknowledge my indebtedness to W. P. Hay for his generosity in putting at my command an excellent rapid lens, without which the autochromes would have been practically impossible. Even with this lens the plates, all of which were Lumière, required, under most favorable conditions, an exposure of nearly a minute, and it was often necessary to exercise no small amount of patience to keep the fish quiet that long. After this part was written some exposures were made in direct sunlight and in this way the time necessary was greatly reduced.

The photographs show that the light reflected from the fish had very nearly the same chemical effect on the plates as that reflected by the background, no matter what color it was, indicating that the fish were well adapted with reference to brightness or shade. By examining the autochromes it will be seen at once that the color of the fishes differs greatly. The specimens on the blue appear blue, those on the green appear green, those on the yellow appear yellow, and those on the red appear brownish. This becomes strikingly evident if the plate is covered with the gray sheet fastened to it so as to eliminate the background from view. There can be no question but that the autochromes show a correlation between the color in the background and that in the skin of the fishes, but the correlation seen in these autochromes is not as marked in many respects as it actually was in the living specimens. The blue, the pink, and the green are fairly accurately reproduced; the red and the yellow not so accurately. This may have been due, at least in part, to the action of the water on the light; for in order to prevent the formation of waves by the water forced through the gills in the process of respiration it was necessary to have the water over the fish 1-2 cm. deep.

Autochromes were taken of specimens on all of the nine different colors or shades, a total of nineteen, but those of the two shades of brown could scarcely be distinguished and there was very little difference between them and those of the two shades of yellow. The difference between the vermilion and the maroon was also much greater than the autochromes indicate. In general, there was actually much more difference in the color of the fishes than the reproductions indicate.

The original plates of nine of the autochromes reproduced on plates xxxiii-xxxv were exhibited at the meeting of the American Society of Zoologists held in Philadelphia in January, 1914. There was much surprise expressed at the remarkable contrast in the color of the fishes and the correlation between it and that of the different backgrounds, but in spite of the fact that the autochromes show less difference in color than there actually was in the living specimens and minimize the correlation between their color and that of the background, it seemed inconceivable to many that there could have been even as much as shown; and not a few suggested that the animals must have been translucent so that the background showed through them, or that the color must have been due to the reflection of light from the sides and the bottoms of the boxes.

I shall present evidence showing conclusively that these suggestions are not valid. An autochrome of a specimen of a given color in a box of a different color would have settled this whole matter, but there was so much difficulty in keeping the specimens quiet long enough for the purpose required, without removing them from the box in which they were, that, owing largely to lack of time, this was not attempted.^a Fortunately, however, in one of the autochromes on the green color taken at the close

^a During my second season at Beaufort (1914) after this section of the paper was completed, W. P. Hay very generously took a number of autochromes of flounders of a given color on backgrounds of a different color. Nearly all of these autochromes were taken in direct sunlight. Thus the time of exposure was greatly reduced, and consequently much of the trouble experienced during the preceding season in keeping the animals quiet was eliminated.

Several of these autochromes are reproduced on plates xxxiii-xxxv (fig. 60, 64, 65, 66, 67). Figure 64 represents a specimen autochromed in a green box immediately after it had been taken from a blue box in which it was fully adapted. Figure 65 represents four specimens autochromed in a green box immediately after they had been taken from blue, green, yellow, and pink boxes, respectively. Figure 67 represents the same individuals autochromed on a white background. These three figures show conclusively that the color seen in the autochromes of the fishes is not due to reflection of colored light from the background, and that it therefore must be due to the structure of the skin. I shall not, however, eliminate the other evidence presented in favor of this conclusion, since it is of value in elucidating other characteristics associated with the process of adaptation.

of the season (fig. 62) the specimen had not had time to become fully adapted. This specimen, taken from the dark-blue box, appeared dark blue in color when first put into the green box and, although it had been in this box nearly four days and had changed color considerably, it was still distinctly blue when it was autochromed. This is fairly well seen in the reproduction. A comparison of this figure with figure 61, which represents the same specimen fully adapted to blue, and with figure 63, which represents one fully adapted to yellow, shows fairly conclusively that if the light reflected from the sides of the boxes or transmitted through the animals has any effect at all on their apparent color it is, with the exception of that in the fins and tail, of minor consequence. And even the fins and tail in *Paralichthys* are so nearly opaque that very little light is reflected through them from the bottom, as can be seen clearly by examining the photographs on artificial backgrounds, especially figures 17 and 26.

The best evidence in support of this contention, however, is found in the following detailed account of the changes in color, observed during the process of adaptation in the individuals on the various backgrounds. This account also throws some light on the nature of these changes and on the rate of adaptation. It will be given essentially in the form in which it was written at the time the observations were made.

Light brown.—July 27, *Paralichthys albiguttus*, 15 cm. long, taken from the white aquarium and put into the light-brown box (considerably darker than Bradley's orange, shade no. 1); it rapidly assumed a brownish color. July 31, simulation of background in shade and color, good. August 10, 12.07 p. m., color yellowish brown with numerous small bluish spots, excellent color adaptation as seen from a distance of about 75 cm. Autochromed and photographed; put into dark-blue box and compared with specimen fully adapted to blue, it still appears brown, striking contrast. August 11, bluish gray but not nearly so blue as the specimen fully adapted. At 2 p. m. it jumped into the brown box, changed back to brown almost at once. Returned to the blue box. August 12, more blue than on preceding day. August 19, simulation of background in color and shade remarkably good.

Dark blue.—August 7, a. m., *P. albiguttus*, 19 cm. long, taken from white aquarium and put on dark blue (darker than Bradley's blue, shade no. 2). Became dark gray almost at once. August 8, 10.37 a. m., autochromed. (Fig. 58.) Simulation of background in color and shade excellent. August 11, if any change, somewhat darker and bluer; pattern more nearly uniform. Put into the light-blue box.

August 11, 5 p. m., a specimen of *P. albiguttus* which had been in the green box since July 27 and appeared distinctly green was put into the dark-blue box. In this box it appeared quite as green as it did in the green box. At 6 p. m. it was still distinctly green, showing a marked contrast with the specimen autochromed on the blue. August 12, 2 p. m., much grayer but still has slight greenish tint. August 19, no longer greenish; appears much like specimen autochromed on the blue, which is still in the box. There is no evidence indicating that the color of the fish is due to colored light reflected from sides of box or transmitted through the animals, except in the fins and tails of some specimens.

On August 19 a specimen of *P. albiguttus*, thoroughly adapted in color to a brown, water-soaked, cypress board, was put into the dark-blue box. In this box it appeared as brown as it did when on the cypress board. A bright yellowish-brown stripe about 0.5 mm. wide, extending along the entire margins of the ocular opening in the skin, was

particularly conspicuous. There was no indication of blue. On August 22 it was dark grayish blue, with still some evidence of brown, but not in the stripe bordering the ocular openings. This stripe was now grayish blue. It was put into the green box and compared with specimen adapted to green. Marked contrast between color of the two individuals compared. No indication of green in the specimen adapted to blue. August 27, autochromed. Color about same as August 22, brownish tinge^a still visible, giving the animal a slightly greenish tint not seen in the other specimen on the dark blue.

Dark red.—August 2, *P. dentatus*, 14 cm. long, taken from white aquarium, put into dark red (Bradley's red, shade no. 2). August 12, rich sepia color, not red; there is a tendency to have a row of whitish spots along the fin. Rather prominent white area at the base of the pectoral fin. Three large and several smaller black spots, darker than the rest of the surface and surrounded by yellowish rings, stand out quite conspicuously. This specimen was put into the dark brown and the vermilion boxes and compared with those fully adapted to these colors. It was found to be unquestionably darker than either, but it did not show the slightest indication of any similarity to the color of the skin produced by black. This shows that the relatively long waves of light found in the dark-red color have a specific effect and that the spectrum is probably not shortened at the red end. August 29, color dark rust brown, particularly striking when compared with specimens in boxes of other colors. The pattern was very uniform and inconspicuous, and the tips of fins and tail were yellow. Autochromed and photographed. There was much difficulty in keeping the specimen quiet. It was forcibly held for some time before the autochrome was taken. This caused the skin to become abnormally mottled. The dark patches around the ocelli, shown in figure 70, are due to this.

Green and yellow.—July 27, *P. albiguttus*, 15 cm. long, taken from the white aquarium and put into the light-yellow box (Bradley's yellow, tint no. 2). August 11, adaptation very good, very little contrast in different regions of the skin, but uniformly of a slightly darker shade than background. Autochromed, photographed (fig. 56), and put into the green box. The color in all the autochromes taken on light yellow is so faint it can scarcely be seen.

When first put into the green box there was great contrast in color between this specimen and those adapted to the green. August 12, much darker, color grayish, with distinct greenish tint. In this specimen the green is more pronounced than it is in other specimens in the same box, taken from gray sand several days earlier. August 26, very good simulation of background, color yellowish grayish green. The green in the fish becomes very evident when it is compared with specimens adapted to other colors. Autochromed and photographed; colors very faithfully reproduced. (Fig. 57, 71.)

Vermilion.—July 27, *P. albiguttus*, 19 cm. long, taken from white aquarium and put into vermilion box (slightly darker than Bradley's orange red). July 31, pinkish gray, contrasting strongly with the background. August 12, general appearance when viewed from a distance of 75–100 cm. uniform sepia, contrasting considerably with background. Close examination shows a sort of network consisting of dark-brown stripes about 0.5 mm. wide which surround grayish green areas 1.5 mm. or less in diameter. White patch at the base of the pectoral fin, about 6 mm. in diameter. The three ocelli, characteristic of the species, are dark brown, not black. Put into dark-brown box and compared

^a This can be distinctly seen in the autochrome taken at this time but not reproduced.

with a specimen adapted to this color. It is clearly darker and more reddish. No indication whatever of black in the skin of the specimens in either the brown or the red box, showing clearly that brown or red does not have the same effect as black or gray, and that the color assumed on them is correlated with the length of the waves of light. August 26, general color rich sepia brown, having slightly greenish tint. Scattered all over the surface are small spots varying considerably in size and color; some are brown, others greenish or pinkish, and still others brown with a greenish border or greenish with a brown border. Considerable contrast between the color of the fish and that of the background. Autochromed^a and photographed. (Fig. 59, 72.) August 30, conspicuously reddish brown with slight greenish tinge. My colleagues all remark about the redness of this specimen and the striking contrast it shows when compared with specimens of the same species adapted to other colors.

Two other specimens were kept in the vermilion box with the one referred to above. One of these was of the same species but much smaller (9 cm. long); the other (17 cm. long) was *P. dentatus*. The color in both was very much like that described, but in *dentatus* the markings in the skin were smaller and less conspicuous, and the color and shade more uniform.

Light blue.—August 12, 3 p. m., *P. albiguttus* taken from the dark-blue box and put into the light-blue box (Bradley's green blue, tint no. 1). Half hour later much lighter, grayish blue. August 27, simulation of the background excellent, finely mottled grayish blue. Pattern remarkably uniform, no light or dark areas visible. (Fig. 73.) A number of nemerteans which appear dark are seen in the fins. August 29, autochromed and photographed.

Dark blue.—August 22, *A. quadrocellata*, 17 cm. long, caught in the seine and at once put into the dark-blue box (considerably darker than Bradley's blue, shade no. 2). This specimen changed rapidly to a dark bluish gray, except two large areas which remained very light and somewhat iridescent. August 24, the fish is more bluish; the light areas have a decidedly bluish tint; the tips of fins and tail are bright yellow. August 26, somewhat darker and more bluish. Autochromed and photographed. (Fig. 61, 74.) The colors as they appeared in the fish are fairly faithfully reproduced in the autochrome. There is, however, probably a little too much of a greenish tint in the light areas. This specimen was, at this time, transferred to the green box.

Green.—August 26, *A. quadrocellata*, the same specimen as shown in figure 61, taken from the dark-blue and put into the green box (Bradley's yellow green, shade no. 2). After it was transferred it appeared quite as blue as before. The four ocelli were distinctly blue. There was no indication of a greenish tint in any part of the surface except the fins and the tail, which were somewhat translucent. August 30, still distinctly bluish but has more of a greenish tint. The four ocelli are greenish dark gray surrounded by greenish yellow rings about 1.5 mm. wide. The large light areas have a pinkish cast. The tips of the fins and tail are bright yellow. In general, the specimen is not nearly so intensely green as the *P. albiguttus* shown in figure 57, which is still in the green box. Autochromed and photographed. (Fig. 62, 75.)

Owing to the fact that it was necessary for me to leave Beaufort at this time, this specimen was autochromed after it had been on the green less than four days, not nearly

^a Too much green in autochrome.

long enough to become fully adjusted to the new color. The autochrome shows that the fish was still bluish and does not indicate that there was any marked adaptation to the green. The autochrome is valuable, however, in that it demonstrates fairly conclusively that the color represented in the various autochromes is due to the structure of the skin and not to light reflected from the sides of the boxes or transmitted through the fish from the bottom, as many who have seen them intimated.

Yellow.—July 27, *A. quadrocellata*, 16 cm. long, taken from the white aquarium and put into the chrome-yellow box (slightly darker than Bradley's orange yellow). It became distinctly yellowish within a few hours, as did also a specimen of *P. albiguttus* put in at the same time. Adaptation on yellow occurs much more rapidly than it does on blue, green, or red, and there is no indication of adaptation in shade before adaptation in color occurs, as appears to be true for some of the other colors. August 7, the color of the skin is very much like that in the background except in the two large light areas and in the four ocelli, but as a whole *Ancylopssetta* is much more conspicuous than *Paralichthys*, the color of which is remarkably similar to that of the background and very uniformly distributed, making the animal very inconspicuous. *Ancylopssetta* autochromed and photographed. The colors are quite faithfully reproduced. (Fig. 63, 76.)

On a background consisting of alternate black and yellow squares the skin of *Paralichthys* assumes a conspicuous pattern consisting of black and yellow patches similar in size, form, and arrangement to the black and white patches assumed on a background consisting of alternate black and white squares of the same size.

Conclusions.—The evidence which we have presented leaves no reasonable doubt that in both *Paralichthys* and *Ancylopssetta* the skin simulates the background in color as well as in shade and pattern, and that the colors which are simulated range at least from dark blue to dark red. It shows that adaptation in shade ordinarily occurs more rapidly than adaptation in color and that adaptation to yellow is ordinarily attained in a much shorter time than adaptation to most of the other colors tested. In the case of yellow it may occur in a few minutes, while in the case of the other color it takes days and even weeks.

Thus it is evident that both the quality and the quantity of the light, the length of the waves, and the energy are functional in adaptive processes that occur in the skin. Concerning the question as to how these characteristics of light function and the question as to the process and mechanism involved, we shall have something to say later.

RATE OF ADAPTATION TO BACKGROUND.

The difference in the time required for different individuals of a given species to simulate the background is very great. This has been noted by practically all who have investigated the subject. This great difference is largely due, not to innate individual variation, but to variation in the experience of the individual; to training, if you please. Van Rynberk (1906), Sumner (1911), and others maintain that the reaction time of the chromatophores is much reduced by repetition. Sumner, referring to flatfishes, says (p. 469): "The same fish acquired with practice (if this word may be allowed) the power of changing much more rapidly than before. The time required for a radical change of shade or of pattern ranged from a fraction of a minute to several days."

The results of my observations are in harmony with the statements presented above. The time required to produce adaptive changes in the skin, both in *Paralichthys* and in *Ancylosetta*, varies greatly. Under some conditions changes resulting in maximum adjustment in shade to a given background occur in two minutes or less; under others it requires several days. In general, the time required for adjustment is considerably longer for large specimens than it is for small ones. It is much longer for individuals kept continuously on a given background than it is for those frequently changed from one background to another. That is, the time required for adaptation is greatly reduced by practice. This is clearly shown in the following experiment.

A *P. albiguttus*, 12 cm. long, after having been in a white granite pan continuously for two weeks and long since maximum white, was transferred to a black pan August 18, 2.05 p. m. At 4.30 p. m. it was about one-half maximum black; August 19, 12 m., about three-fourths maximum black; August 22, 10 a. m., nearly maximum black; August 23, 10 a. m., maximum black. This same individual, after having been frequently transferred from white to black and vice versa, from August 23 to August 30, was taken from the white background on which it was maximum white and put into the black pan at 7.27 a. m. One minute later, 7.28, it was already five-sixths maximum black, and after one minute more, 7.29, it was maximum black. The change from black to white, however, was never observed to be so rapid as this; it was never observed to occur in less than an hour. Thus, while it required five days to produce a complete change in the skin from white to black, after continuous sojourn of two weeks on white it required only two minutes, after repeated transfer, to change from one to the other. This is a most remarkable change in the reaction to a given stimulus. Such a change in the reaction of man would undoubtedly be called learning. Are the processes involved in changes in reactions in these widely different organisms fundamentally the same as they are in man?

No specific observations were made on the effect of repetition on the time required for adaptation in pattern and color, but judging from superficial observations on this point made in connection with experiments on the degree of adaptation, it appears probable that repetition has the same, or at least a similar, effect on adaptation to these characteristics as it has on adaptation in shade.

Changes in color require, in general, much more time than changes in shade or changes in pattern. There is, however, much variation regarding this among the different colors. Yellow, for example, is a color that the fish assume much more readily and rapidly than green or blue. This may be due to the fact that yellow ordinarily predominates in their environment. I have seen specimens which had been kept on various black and white backgrounds for weeks, showing no trace of yellow, become almost at once distinctly yellowish when put on a yellow background.

FACTORS INVOLVED IN THE PROCESS OF ADAPTATION.

CHROMATOPHORES IN THE SKIN.

The skin of the fishes contains several different sorts of colored cells or groups of cells known as chromatophores. These cells are much branched, some contain melanin granules, which are brown or black in color, others contain xanthine granules, which vary from yellow to orange, and still others contain iridescent guanin crystals. Ballo-

witz (1913) refers to these cells or groups of cells as melanophores, xanthophores, erythrophores, and guanophores, respectively. The pigment granules in these cells are sometimes found massed together in a small space and at others spread out over a considerable area. The color, the shade, and the pattern in the skin depend mainly upon the relative position of these granules and the guanin crystals.^a Changes in these features consequently depend upon their movements. Some maintain that the cells are ameboid and that the movement of the granules is caused by changes in the state of ameboid processes; others maintain that they are fixed in form and that the granules move through the protoplasm or through fixed canals in it. Hooker (1914) has recently reviewed the literature on this subject. It will, therefore, not be necessary to go into details regarding this matter. I shall, moreover, treat this whole matter in a subsequent paper.

EYES, NERVOUS SYSTEM, AND DIRECT ACTION OF STIMULATING AGENTS AS FACTORS IN ADAPTATION TO BACKGROUNDS.

Ballowitz (1893) and others have shown that the chromatophores are surrounded by a dense network of nerve fibers; and the results of operations on the eyes and the nerves by Pouchet (1876), Šečerov (1909, 1913), Frisch (1912), Sumner (1911), and others indicate that these fibers are part of the sympathetic system and that the adaptive movements of the pigment granules are largely, if not entirely, controlled by stimuli received through the eyes. It has been found by these investigators and others that if the eyes are destroyed, or if the optic nerves or the sympathetic trunks are cut, adaptive changes in the chromatophores of the skin cease.

The results which we obtained by means of operations on the eyes in flounders confirm these conclusions in so far as they refer to the function of the eyes. In *Paralichthys*, it was found that the removal of either eye alone interferes only temporarily with adaptive processes in the skin, but that such processes cease permanently after the removal of both eyes, although blind specimens learn to move about in aquaria without any apparent difficulty, and in some instances they even learn to capture minnows. One such specimen was kept for over three weeks. At the end of this time the wounds had healed, the eye sockets had become pigmented, and the fish appeared to be in perfect condition. Changes in the background, however, had no apparent effect on the appearance of the skin.

There is always some degree of uncertainty as to the cause of negative results after operations. Regarding some of the experiments mentioned above, Sumner (p. 473) and others have raised the question as to whether the effect of the operations on the chromatophores was due to the elimination of the action of the sympathetic system and the eyes, in accord with the conclusions stated above, or to the injury involved in the operation. Moreover, Spaeth (1913), Šečerov (1913), and others maintain that light, temperature, chemicals, and other agents affect the movement of pigment in the chromatophores directly. They found that the chromatophores in small pieces of skin separated from the body still respond to these agents. Thus the question arises

^a Frisch (1913) maintains that in addition to the pigment granules there is in some forms a blue-green substance probably in solution. He says (p. 156) that in *Crenilabrus*, after having been on a blue background for two weeks, pigment in the chromatophores was much condensed thus exposing the blue-green substance, and he also maintains that the flesh in these individuals had a distinct blue-green cast not found in others. This, he holds, indicates that the blue-green substance increases when the fish is on a blue background.

as to what part the direct responses of the chromatophores to the stimulating agents may play in the process of adaptation in normal animals. The results obtained in the following experiments seem to give precise and conclusive answers to some of these, as well as to other questions.

A specimen of *Paralichthys*, 5 cm. long, in which adjustment to a black or a white background occurred rapidly, was put into a glass dish on the stage of a binocular and so arranged that the head was over a black surface and the tail over the opening in the stage. The mirror was then adjusted so as to reflect strong diffused light up through the opening, thus strongly illuminating the tail without affecting the head. The fish was kept in this position an hour, which was much longer than was necessary for marked changes in adjustment to either black or white. It was carefully examined under low magnification from time to time and finally put entirely on a black surface and again examined. No difference whatever was detected in the shade of the two ends of the fish. This experiment was repeated several times with this specimen and also with two others of about the same size. Those which were adapted to black remained uniformly dark throughout the experiment and those which were adapted to white became uniformly dark over the entire surface of the body. There was no indication that the intense reflected light had any direct effect on any of the chromatophores, although many of them, especially those in the fins and the tail, were strongly illuminated and all of them were unquestionably in stronger light than those on the opaque surface, for much light penetrated the tissue even where it was thickest. If light of this intensity does not under normal conditions appreciably affect the movement of the pigment granules directly, there is no probability that light reflected from the bottom will do so. This conclusion, moreover, is supported by the following observations and experiments.

Specimens free in an aquarium, half of which was black and the other half white, were repeatedly seen to come to rest with the head either on the black or on the white and to remain long enough for adaptation to occur. In every instance observed in which there was any response at all the entire fish assumed a shade corresponding to that of the bottom under the head. Thus the posterior end of the animal in every instance stood out in striking contrast against the background, while the anterior end corresponded well with it. In no case was there any evidence of a line of demarcation on the body corresponding with that in the background below. The same was found to be true, no matter what position the fish had with respect to this line. If it was parallel with the dividing line in the background so that one eye was over black and the other over white, the skin assumed a gray shade of equal intensity on both halves of the body. This also occurred if only the tip of the head was on the black or white and in some instances even if the line between black and white was some little distance in front of the anterior end.

These statements are supported by the following detailed account of individual observations and by the photographs reproduced on plate xxx.

On July 3 a specimen of *P. albiguttus*, 11 cm. long, was closely observed for several hours in an aquarium one half of which was white and the other half black. It usually moved about near the bottom very slowly for a period, then came to rest and remained a variable length of time, and then moved away again, repeating this process. Adaptation to black or white occurred remarkably rapidly in this specimen. So rapid were the changes in the skin that in slowly swimming from black to white or vice versa the

animal became almost fully adjusted in the time it required the body to cross the line. As the fish went from the black to the white it appeared as though the black chromatophores were being rapidly buried in a white substance; and, as it returned to the black, as though they were being rapidly uncovered.

At 10.30 a. m. this specimen came to rest with the head on the white and the body and tail on the black, in such a position that the longitudinal axis made an angle of about 30 degrees with the line between the two halves of the aquarium. One eye was 2 cm. from this line and the other farther away. The skin immediately became much lighter. The fish remained in this position until 12.45 p. m. At this time it was much darker than when fully adapted to the white and much lighter than when fully adapted to the black bottom. It was gray, somewhat mottled but not contrastive, and the same over the entire pigmented surface. At 12.45 p. m. the specimen moved forward 15 cm. so that it was entirely on the white. It at once became much whiter, and soon appeared maximum white. At 1.15 p. m. it returned to the black bottom and at once became much darker. At 1.50 p. m., when the observations were closed, it was still on the black bottom and it appeared maximum black, having, as usual when in this condition, a number of conspicuous white spots scattered over the surface.

During the course of these observations, while this specimen was on the white bottom, a large dark four spot, 20 cm. long, several times swam slowly toward it. Each time, as the four spot approached a point approximately 10 cm. from the anterior end of the specimen of *Paralichthys* under observation, this specimen suddenly became much darker. Whether this change in shade was due to the darkness of the four spot and the consequent reduction in reflected light, or the excitement caused by its presence, I am unable to say, but other observations show that dark objects at a distance sometimes do have an effect owing to the reduction of light. Similar phenomena were observed in a considerable number of other specimens. Details in reference to one of these follow:

A specimen of *P. albiguttus* 21 cm. long was kept for several weeks in a large aquarium, one half of which was black and the other half yellowish white. On August 19 and 20 it was frequently transferred from the black to the white bottom and vice versa. Adaptation to black and white, at the end of this period, was found to be rapid. On August 21, 2.30 p. m., it was found on the black bottom fully adapted. It was at once put into water about 4 cm. deep in a glass crystallizing dish 50 cm. in diameter. This dish was placed in water in strong diffused light, on a sheet of bristol board half black and half white, and so adjusted as to continuously keep the anterior half of the animal over the white and the posterior half over the black bottom. The entire surface of the fish became light grayish white almost at once, and it soon appeared to be maximum white. The fish was held in this position until 4.55, photographed (fig. 44), and then rotated until the anterior end was on the black.

At 7 p. m. it was nearly maximum dark. At this time it was set free in the dish and left. At 10 p. m. it was found with the anterior end on the white and the entire surface appeared to be, if anything, whiter than it had been at any time previous, although the light was so weak that during most of this time only that part of the fish which differed in shade from the background could be seen.

The following morning it was still maximum white. At 8 a. m. the anterior end was put and held on black. At 10 a. m. the entire surface was nearly maximum black. It was then turned until the longitudinal axis was parallel with the dividing line in

the background, so that one eye was on the black and the other on the white bottom. The entire surface soon became gray of a shade about halfway between maximum white and maximum black. No further change occurred, although it was held in this position until 11.55 a. m. At this time it was photographed (fig. 45) and then set free in the dish.

The following morning at 6 a. m. it was found, with only the head to a point a trifle over a centimeter back of the eyes, on the white. The specimen appeared nearly if not quite maximum white. It was kept in this position until 9.20 a. m. and then photographed (fig. 46), after which it was rotated until the anterior end was on the black bottom. In this position it was held until 12 m. and then again photographed (fig. 47). This photograph shows several light lines crossing each other in the central part of the surface of the fish. These lines are not normal; they are due to abrasions in the skin and do not show in the other photograph because of the light shade.

The animal was now moved backward until the dividing line in the background was below a point about 1 cm. back of the eyes. The entire surface became distinctly whiter. The fish was then moved forward again, and the entire surface soon became distinctly darker. This was repeated several times with the same results.

The fish was then put entirely on the white with the head directed from the black, and left until it became maximum white. It was then turned through an angle of 180 degrees and moved forward so that the anterior end faced the black and was 2 cm. from the dividing line. In the course of a few minutes the entire surface became distinctly darker. This entire experiment was repeated several times with the same results.

Similar results were also obtained with color. On August 22, I was much surprised to find a specimen of *P. albiguttus* on a black and white checkered background distinctly yellowish. This specimen had been used in experimental work on black and white backgrounds almost continuously since July 22, and at no time before was there any evidence of yellow or any other color in the skin. When this specimen was discovered in the yellow state it was in a crystallizing dish in close contact with the edge. The dish was on an artificial black and white background, which at this point extended 2.5 cm. beyond the edge. Beyond this a brownish-yellow water-soaked cypress board, on which it rested, was exposed. This board, which was somewhat over 2.5 cm. from the eyes of the fish, evidently caused the flounder to become yellowish.

At 3.10 p. m. the dish was moved farther from the exposed part of the board. Fifteen minutes later there was only a trace of yellow left in the skin of the fish, and the following morning there was nothing more to be seen of it. At 9.30 a. m. the fish was so placed that the exposed part of the cypress board was 6 cm. from the anterior end of the fish and directly in front of it. In this position it was held until 10.45 a. m. There was no apparent effect of the yellow color. The fish was then moved forward until it was 5 cm. from the exposed part of the board and held until 12 m. Still there was no visible effect. It was then moved forward 2 cm., i. e., 3 cm. from the board, and held. An hour later, at 1 p. m., the skin of the fish was distinctly yellowish.

These results, without further analysis, show very clearly that under normal conditions the shade and the color in the skin of *Paralichthys* are regulated by the effect of light received by the eyes. There is no evidence whatever indicating that

the simulation of the background, so marvelously developed in these creatures, is in any way influenced or affected to an appreciable extent by any direct action which the stimulating agents in the environment may have on the chromatophores. Consequently if we are ever to obtain an insight into the mechanism of this phenomenon of adaptation it must be through a study of the chromatophores in their relation to the nervous system, the eyes, and the environment. The reaction of isolated chromatophores to various stimulating agents, recently so much studied, can throw but little light on the problems concerning the evolution, the mechanism, and the function of the adaptive processes in question.

EXTENT OF DISTRIBUTION OF STIMULI FROM EITHER EYE.

Sumner asserts (p. 459) that the flatfish *Lophopselta*, with either eye removed, responds normally in reference to adaptation to the background. The results of my experiments on *Paralichthys* with but one eye are in harmony with this contention. In these experiments, which unfortunately were not very extensive and refer only to changes in shade, the responses appeared to be normal both in time and degree. Similar responses have been observed by other investigators in a number of different fishes. There are, however, some species in which the removal of one eye greatly alters the reactions in the skin. Thus while Šečerov (1909) maintains that the chromatophores in *Nemachilus barbatula* with but one functional eye respond normally over the entire surface, and Frisch (1911) holds that the same occurs in *Phoxinus* and in *Carassius*, Pouchet (1876) asserts that in trout, with one eye blinded, only those chromatophores on the opposite side respond normally, and Frisch (1911) confirms this assertion in experiments on "Forellen" and "Cyprinoiden." Semper also maintains that the chromatophores in "Makropoden" and "Teleskopfishen" having but one eye respond differently on opposite sides of the body.

In all of the species in which adaptation to the background is normal after the destruction of one eye, the shade, the pattern, and the color assumed on any given background must be the result of an integration of the stimuli received individually by each of the two eyes. This is clearly shown in reference to shade and pattern for *Paralichthys* in plates XXIX, XXX.

If a *Paralichthys* is held with one eye on a black and the other on a white background the skin assumes a gray shade, much lighter than it does when both eyes are over black and much darker than when both eyes are over white. Obviously, then, the effect of the stimuli received by the chromatophores from one eye is modified by the effect of the stimuli received from the other eye. (Fig. 45.)

The same is true with reference to pattern. If one eye is held over a background with large figures and the other eye over one with small figures, the pattern in the skin becomes intermediate in texture between that produced by the effect of the large figures and that produced by the effect of the small figures acting alone. (Fig. 41, 42, 43.) When the specimen represented in these figures was fully adapted to the background containing the large figures, the skin had relatively large white and black patches. (Fig. 42.) A few minutes later it was so arranged that one eye was on this background and the other was on the background with the small figures. It then could be seen clearly that both the large white and the large black patches were breaking up, dark spots appearing in the former and light spots in the latter. It is consequently evident that a given stimulus in the process of simulation of the background does not have the

same effect when both eyes are functional as it has when but one is functional. In other words, the pattern and the shade assumed are the result of a sort of superimposition of the effects of the stimuli received by each of the two eyes.

RELATION BETWEEN THE INTENSITY OF LIGHT AND THE REACTION OF CHROMATOPHORES.

Keeble and Gamble (1904, p. 353) maintain that the response of the chromatophores in higher crustacea, under normal conditions, is independent of the intensity of the light. They found that specimens in a white porcelain jar covered with black paper "pierced with several pinholes" became just as pale as others of the same species in the same kind of jar uncovered.

Sumner (1911, p. 460) obtained similar results in experiments on the flatfishes, *Rhomboidichthys* and *Lophopsetta*. In these experiments he used two boxes, one painted gray, the other white. To the latter so little light was admitted that the white surface appeared distinctly darker than the gray surface in the other box, and by means of a photographic method it was proved that less light was reflected from the white than from the gray surface. He found, however, that specimens became maximum white on the former and gray on the latter.

I was able to confirm these results in experiments on *Paralichthys*. In addition to tests similar to those described above, numerous observations were made at night, usually about 10 p. m., on animals in various stages of adaptation to backgrounds differing in shade, color, and pattern. In making these observations a strong electric light was momentarily turned on. In all cases in which adaptation was complete the shade, color, and pattern of the skin appeared to be the same as it had been during the preceding evening. If there was any change it consisted in slight contractions of the chromatophores. These statements apply especially to *Paralichthys*.

In those specimens in which adaptation was not complete there were usually marked changes of such a nature as to show that the adaptive process continues in very weak light. This was repeatedly observed in specimens changed from dark to light backgrounds or vice versa late in the evening. Thus, to cite one instance, August 21, a *Paralichthys* very dark in shade was put upon a white background at 7 p. m. At this time it was already so dark that the fish could be seen only against the white background, and later it became still darker. At 10 p. m., however, when the fish was examined in strong electric light, it appeared maximum white.

There is some evidence indicating that the pattern assumed in weak light is not as conspicuous as is that assumed in strong light. This was most evident in specimens on backgrounds containing small black dots, of such a number as to produce relatively few black spots in the skin. For example, *Paralichthys*, individual (B), on a white background containing black dots 2 mm. in diameter and 10 mm. apart, regularly had in the skin a number of distinct black spots (fig. 54), but when examined in artificial light, at 10 p. m. on two different occasions, not a trace of these spots was found.

Ancylosetta becomes much darker at night. This was repeatedly seen in various specimens in the colored boxes. Verrill (1897) observed similar phenomena in other forms. I was unable, however, to see any change in *Paralichthys* in the same boxes with *Ancylosetta*. Moreover, both in *Paralichthys* and in *Ancylosetta*, the shade assumed on any given background is the same in direct as it is in diffused sunlight. It, therefore, seems well established, at least for *Paralichthys*, that the shade assumed by the

animal is independent of the intensity of the light. How is it possible to explain this phenomenon?

LIGHT REFLECTED FROM THE SKIN AS A FACTOR IN ADAPTATION.

Sumner says (1911, p. 463) that to account for adaptation in shade "we are limited to two alternative explanations: Either (1) the fish takes into account the degree of illumination, just as we do, and makes due allowance for this in judging of the paleness or darkness of the background; or (2) it makes a direct visual comparison between its own surface and that of the background and endeavors to bring the former into harmony with the latter."

To test the second hypothesis he made numerous observations on specimens, some of which had an opaque cloth fastened over them so as to conceal all but the eyes, and others had the pigmented surface stained. The results of all of these experiments he considers inconclusive owing to the possible effect of the treatment. He holds, however, that adaptation occurs normally in specimens bedded in sand, and concludes that this comes "very near to refuting the visual hypothesis altogether."

This would no doubt be true if all of the skin within the range of vision were concealed when the animals are bedded, but this does not appear to be the case. While I have not seen *Rhomboidichthys*, the form used by Sumner in his experiments, I have made numerous observations on *Paralichthys*, a similar form, and I have never found one, except for very short periods, in which the skin along the margin of the mouth was not exposed. Moreover, the skin bordering the lower margin of the eye is also usually exposed. Since both of these regions are within the range of vision, the fact that adaptation occurs in flounders after they are bedded does not seem to warrant Sumner's conclusion.

By removing the eye situated near the mouth and by taking special precautions to keep the lower margin of the other eye well covered, I was able to correct the defects in Sumner's method, and I found that after thus totally eliminating all of the skin from the view of the fish, it still simulated the background, and, moreover, simulation was quite as rapid and as extensive as it had been before the skin was covered. This was observed in several different experiments, one of which follows:

On September 3 the ventral eye of a specimen of *P. albiguttus* 27 cm. long was entirely removed. On September 12 the wound was thoroughly healed and the specimen fed and acted normally in every way. It was put into a black aquarium, and after it had become maximum black it was, at 9.40 a. m., suddenly entirely buried with gray sand. The fish soon shook enough sand off to admit of respiration, but the eye remained covered. At this time the sand was washed from the posterior portion of the animal, so as to admit of direct observation of the skin. This was found to be still maximum black, showing that no change occurs when the eye is entirely covered. Soon after this the fish moved slightly and the eye was raised sufficiently to be seen, but it was still covered with a thin layer of sand, and the upper surface was still somewhat below the surface of the sand. The skin, however, began to turn lighter, and half an hour later, 10.40 a. m., it was clearly somewhat lighter. At 11.30 the shade of the skin was considerably lighter and the pattern much broken so as to simulate the sand fairly accurately. During this entire time the eye projected only very little above the surface of the sand. The lower margin of the eye was continuously well covered with sand, as was also all of the rest of the skin within the range of vision. It is consequently evident

that adaptation can occur with the skin entirely concealed and that light reflected from the skin or received by it plays no appreciable part in the process.

THE DIRECTION OF THE LIGHT AS A FACTOR IN ADAPTATION.

The fact that flounders and crustacea become maximum white on a white background and gray on a gray background even if the former, owing to weak illumination, reflects less light than the latter, shows conclusively that the shade assumed by these creatures is not proportional to the absolute amounts of light received from below. Keeble and Gamble (1904, p. 354) maintain, for crustacea, that it bears a specific relation to the ratio between the light received by the eyes direct from above and that received from below after reflection from the background—i. e., the “ratio $\frac{\text{direct}}{\text{reflected}}$ light.” Sumner inclines to the same view with reference to fishes. He holds that adaptation in shade can not be regulated by a “direct visual comparison [by the fish] between its own body surface and the bottom on which it lies” (p. 476); and he further says:

May not, then, the ratio between the light reflected from the near-by surfaces within the tank and the light which enters the latter from above be that factor of the total stimulus which renders possible these accurate adjustments of the shade of the fish's body to that of its background? I think that this is the true solution of the problem.

This hypothesis seems to meet all the requirements of the phenomena in question; but neither Keeble and Gamble nor Sumner succeeded in establishing it experimentally, although Sumner says that he constructed apparatus for this purpose, but was unable to make the necessary tests, owing to lack of material. The following experimental results throw some light on the problem in hand:

If the shade of the animal depends upon the ratio between the amount of light received by the eyes direct from the source above and that received by the reflection

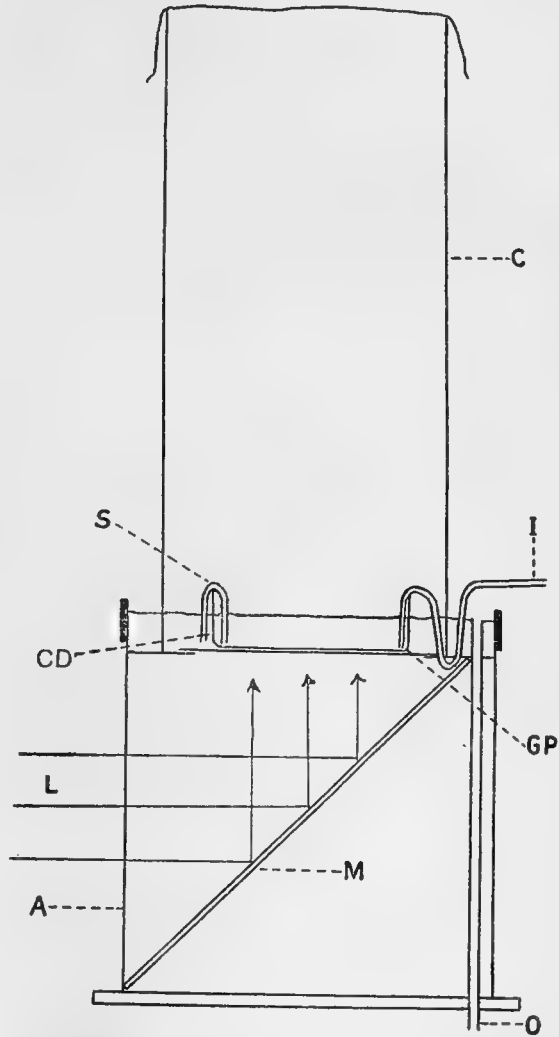

FIG. 2.—Vertical section of apparatus used in testing, in flounders, the effect of abnormally increasing the relative amount of light received by the eyes from below. A, glass aquarium; CD, crystalizing dish; S, siphon; I, inlet for water; O, outlet; GP, glass plate; C, opaque cylinder; M, mirror; L, light.

from the background below, in accord with Keeble and Gamble's hypothesis, then an increase in the amount received from below, without any change or with a decrease in the amount received from above, ought to cause the animals to become abnormally pale, no matter what the shade of the background may be. On a gray background the animals ought to become maximum white. On the other hand, if this hypothesis holds, an increase in the amount of light received from above, without any change or with a decrease in the amount received from below, ought to cause the animals to become abnormally dark. Under these conditions they ought to become gray on a white background.

In the following experiments these conditions of illumination were produced, but not all of the results obtained support the hypothesis in question. It was found that abnormally increasing the reflected light induces the fish to become abnormally pale, but that abnormally decreasing it has no effect. It was also found under the former conditions that black spots in the background affect but little the pattern in the skin and that color in the background is simulated only to a slight degree.

Reference to text figures 2 and 3 (p. 207, 213) will make clear the essential features of the apparatus used in these experiments. We shall refer to the two sets of experiments performed by means of the apparatus represented in these figures as (A) and (B), respectively. In (A) the background was illuminated from below, thus making the "ratio $\frac{\text{direct}}{\text{reflected}}$ light" abnormally small. In (B) the eyes were more highly illuminated from above than was the background, making the reflected light received by them relatively low. Thus the "ratio $\frac{\text{direct}}{\text{reflected}}$ light" became abnormally large.

EXPERIMENTS (A), LIGHT FROM BELOW RELATIVELY STRONGER THAN NORMAL.

1. *White background.*—On August 10, 9 a. m., a specimen of *P. albiguttus* 18 cm. long was taken from a yellowish white aquarium and put into the glass crystallizing dish, over an ordinary sheet of white writing paper 25 cm. square in the apparatus shown in text figure 2. When the specimen was put into the apparatus it was yellowish white. All the air was removed from under the dish, so as to avoid any interference with the light reflected from the mirror below. The black cylinder was then put in place and the upper end closed with a piece of opaque cloth. At 12 m. the specimen was very light gray with a brownish cast. The cloth was then removed, admitting light from above. No appreciable change occurred either in the shade or the color of the fish.

August 11 the cylinder was removed and the light from the mirror intercepted by inserting a piece of bristol board under the dish. The brownish color disappeared, and the fish consequently became slightly paler. These tests were repeated several times under other conditions with different individuals and similar results were obtained. The brownish color was, no doubt, due to the collection of brown sediment on the mirror. The water contained so much solid material, ooze, diatoms, and the like that it required only a very short time to form a perceptible layer on everything submerged. On a white background, then, increase in the relative amount of light from below does not appreciably alter the reactions of the chromatophores.

2. *Gray background.*—On August 16, at 10.30 a. m., the sheet of white paper with black spots was replaced with one which had been made uniformly gray of a medium shade (Ridgway's pale neutral gray). The light from the mirror was intercepted, and the fish was fully illuminated from above. At 1 p. m. the entire surface was fairly uniformly gray, and the fish was quite inconspicuous. At this time the cylinder was put in place and covered and the light from the mirror turned on. The background, as seen from the top of the cylinder, appeared distinctly gray, not white. At 2 p. m. the fish was nearly maximum white. There were no dark spots and the three ocelli were very light gray. The following morning, 6 a. m., the fish was fully as white as it had been at any time on a pure white background. The cylinder was now removed and the light from the mirror intercepted. At 10 a. m. the fish was well adapted to the gray again. The background was now again illuminated from below, and also left exposed to light from above. The fish seemed to turn a shade lighter, although there was some question concerning this. It was left until 3 p. m., then a sheet of gray tracing paper and another sheet of white paper were added to the gray paper under the dish, making the background much darker and nearly opaque. The cylinder was then put in place, covered, and the light from the mirror turned on. The background, as seen from above, appeared nearly black. At 5 p. m. the fish was nearly if not quite maximum white, and the following morning it was unquestionably maximum white.

Thus we see that if the light from above is abnormally low in comparison with that from below, *Paralichthys* may become white on a background which appears dark gray to the human eye. This strongly supports the idea that the shade assumed by the skin in these creatures under normal conditions depends upon the amount of light received by the eyes from above, as well as upon the amount received from below; for under such conditions animals on a gray background always become gray. This idea is also supported by the results obtained in the following experiment, in which the background contained numerous black spots:

3. *White background containing black spots.*—On August 11, 2 p. m., the sheet of white paper under the crystallizing dish in the first experiment was replaced by one of the same kind and size containing dense black dots 5 mm. in diameter. These dots were made with india ink, and they were such a distance apart that they covered one-half of the entire surface. The opaque cylinder was removed and the light from the mirror was not obstructed. Thus the background was illuminated both with light from below and from above, but it appeared much as it did under normal conditions of illumination, the spots being merely relatively somewhat darker. Numerous black spots appeared almost at once in the skin of the fish, just as under normal conditions, except that the spots were slightly more conspicuous. At 2.15 p. m. the cylinder was put in place and closed so as to cut off all light from above. Under these conditions of illumination the spots in the background, as seen from above, were still very prominent. At 2.30 p. m. no change had taken place in the skin. At 8 p. m. all of the black spots except three, the ocelli, had disappeared, and the fish was nearly if not quite as pale as it had been in the preceding test on a pure white background. The three ocelli were, however, somewhat darker. This shows that simulation of the pattern in the background is dependent upon light received from above; and it shows again that decrease in the illumination from above tends to cause the skin of the fish to become abnormally light.

Even if this illumination is only slightly reduced the effect becomes quite evident, as seen in the following observations:

On August 15, 11 a. m., the side wall of the crystallizing dish was covered with black paper, thus forming a black cylinder 6 cm. high in order to slightly reduce the illumination from above. The fish at this time was fully adapted to the spotted background fully illuminated from above and below. It had numerous dark brownish spots and the three ocelli also had a brownish cast. At 5 p. m. the fish in general had become much lighter. The three ocelli were at this time nearly black, but the dark regions around them and the dark spots were much smaller and much less distinct. The light from the mirror was now again intercepted and at 6.30 p. m. the surface was again about the same as it was in the beginning of the experiment. These tests were repeated several times the following day and in general it was found that the fish assumed a lighter shade when the background was illuminated from below in addition to the illumination from above, and in general the pattern in the skin appeared to be less conspicuous, although the spots in the background, as seen from above, appeared much more conspicuous. The ocelli and spots in the skin did not appear quite as large or as dense as they did when adapted to the background illuminated only from above, but the light regions appeared somewhat whiter.

It is consequently evident that a slight reduction of light from above has a marked effect on the reactions in the skin; but the following observations indicate that there is no strict proportionality between these reactions and the amount of light received from above compared with that received from below.

On August 12, 6 a. m., the cylinder was removed, admitting light from above. The skin of the fish immediately became speckled. The three ocelli became black, a row of five conspicuous black spots appeared near the base of the dorsal fin and another row of the same number near that of the ventral; and some spots also appeared in the fins and the tail. When the cylinder was put in place and closed these spots rapidly disappeared again and the ocelli became lighter. This change required less than two minutes. When the cylinder was removed the spots appeared again but not quite so rapidly. With the cylinder open on top, admitting some light from above, the results appeared to be the same as they were when it was closed, admitting no light from above. This was tried several times between 6 and 10 a. m., after which the cylinder was put in place, closed and left. At 11.45 a. m. there was no change; the ocelli were still clearly visible, the rest of the surface was very light gray with a slight brownish cast. There was much reddish sediment on the mirror. This was removed and the entire aquarium cleaned. At 1.15 p. m. the three areas apparently had become somewhat darker and the rest of the surface lighter, the brownish cast having entirely disappeared. After the cylinder had been removed a row of dark spots appeared almost at once along the edge of the body near the fins, and the three ocelli became much darker. The light from the mirror was now intercepted so that the background was illuminated only from above. At 1.22 p. m. the dark spots had become darker and many more had appeared and each of the three ocelli was surrounded by a dark patch fully 1 cm. in diameter. Observations were made from time to time during the afternoon, but no further changes were seen. At 5 p. m. the light from the mirror was again turned on and left. At 6.10 p. m., however, no reduction in the number or the size of the dark spots was detected. This test

was repeated August 14, with essentially the same results, although according to my notes there was a tendency in the fish to become darker with the light from the mirror intercepted. There was little or no difference noted in the shade of the light regions, but the ocelli and spots appeared to become somewhat less dense and brownish when the background was illuminated from below.

4. *Background consisting of direct reflection from the mirror.*—August 13, 5.30 a. m., the cylinder was put in place and covered. The sheet of white paper with black spots was still under the fish. At 8.30 a. m. the three ocelli appeared black and the rest of the surface very light gray. The sheet of paper was then removed, exposing the fish directly to the light from the sky reflected by the mirror. At 9.15 a. m. the ocelli were light grayish and the rest of the surface light reddish gray. The reddish cast was probably due to the reddish sediment on the mirror. The cylinder was now removed, a sheet of white paper put under the dish, and the light from the mirror intercepted. At 2.45 the reddish cast had disappeared and the fish was maximum white. This shows that the effect of illumination from below is in all probability due solely to the increase in the amount of light from the background.

5. *Colored background.*—I have in several places pointed out that when the light from the mirror was colored the skin of the fish also became colored. On August 18, 4.30 p. m., a piece of brown wrapping paper was put under the dish, the cylinder covered and put in place, and the light from the mirror turned on. After the paper became wet it was considerably lighter in shade, but it still appeared distinctly brown as seen through the cylinder. August 19, 3 p. m., the fish was very light gray, probably maximum white, with no indication of a brownish cast.

The brown paper was now replaced by a maroon-colored glass. As seen from the opening at the upper end of the cylinder, the background appeared bright red. August 20, 9 a. m., the fish was maximum white, except the three ocelli and a row of ten spots about 1 mm. in diameter near the base of the fins. All of these were brown, not black or gray, as they had been on the gray and the white and black backgrounds. August 21, 11 a. m., no change could be detected. August 22, 8.30 a. m., it was still the same. At this time the cylinder was removed and the light from the mirror intercepted. The fish very quickly became much darker and assumed a distinct brownish color. So rapid was the change that it could be readily detected within two minutes after the illumination had been altered. No further change occurred during the following three days, except an increase in the density of the shade. The fish became dark brown in color, but it was not so reddish as those which had been on a red background for several weeks. These tests were repeated several times during the following five days with essentially the same results. The brownish ocelli and spots mentioned never failed to appear. These were not seen in any of the tests with a gray background illuminated only from below, no matter how dense it was.

It is therefore evident that the appearance of the brownish ocelli and spots on the red background could not have been due to the quantity of light transmitted by the colored glass, and that it must have been due to the quality of the light—i. e., the length of the waves. But, under normal conditions on a maroon background, with certainly no more colored light striking the eyes from below and none received from above, just as in these tests, the effect of the color is very much greater. The entire

surface becomes reddish brown. This marked difference in effect must be due to the difference in the illumination from above.^a How can this be explained?

Under normal conditions adaptation to a colored background, as demonstrated elsewhere, involves two processes. One results in adaptation in shade, the other in adaptation in color. Adaptation in shade, as the tests with the gray in particular indicate, is, at least to some extent, dependent upon the ratio between the intensity of the direct and the reflected light. A decrease in this ratio causes concentration and an increase causes distribution of the black pigment in the melanophores. The distribution of the guanin crystals may also be affected but in the reverse manner, so that when the dark melanin granules become concentrated the white guanin crystals spread out and cover them over. When the red background was illuminated only from below, this ratio became very small, and therefore adaptation in shade required concentration of the melanin and distribution of the guanin; but adaptation in color required just the reverse, together with distribution of the red and yellow pigment. Thus under the conditions of the tests there was an antagonism between the two processes involved; and this accounts for the resulting limitation of the brown color to the ocelli and dark spots, in which it requires less stimulation than elsewhere to cause an expansion of the melanin. Distribution of the red and yellow pigment was no doubt masked in all other regions by the distribution of the guanin which lies nearer the surface. Hence the extreme whiteness in these regions.

This leads directly to a discussion of the whole question concerning the relation between the different structures in the skin and the production of the different shades, colors, and patterns that have been observed in fishes. This question, however, I hope to treat more fully in a later paper.

EXPERIMENTS (B), LIGHT FROM ABOVE RELATIVELY STRONGER THAN NORMAL.

In these experiments a specimen of *P. albiguttus* 20 cm. long was used. This specimen had previously been transferred frequently from a white to a black background and vice versa; and at the time the experiments were made adaptation in shade to either of these backgrounds occurred very rapidly.

The fish was put into a 22 cm. crystallizing dish on a pure white background and covered with the black cylinder, which was lined with white cloth extending from the bottom to a line several centimeters above the surface of the water. A piece of white wire screen was so bent and adjusted in the glass dish as to prevent the fish from turning. The top of the cylinder was nearly closed with opaque cloth, making the intensity of the light within, so low that the white background appeared decidedly gray. A tube 3 cm. in diameter and 45 cm. long was fastened so as to extend down through an opening in the opaque cloth, directly over the eyes of the fish. Through this tube a beam of light from the sky was reflected, by means of mirrors (fig. 3, p. 213). This tube was so adjusted that the beam of reflected light illuminated the eyes and the skin about them, but not the background, and it was readjusted whenever the fish moved. In

^a The fact that the fish became nearly maximum white on the red background illuminated from below indicates that the melanophores, groups of black pigment-bearing cells, respond to monochromatic light much as they do to white light; that the stimulus which affects these organs bears a definite relation to the quantity of light regardless of the quality. It would be interesting to ascertain whether or not this relation is the same for all colors—that is, if a given amount of light energy has the same stimulating effect regardless of the length of the waves.

some tests a black cork containing two small holes was inserted in the bottom of the tube. These holes were of such a size and were so located that the two beams of light passing through just covered the two eyes.

In all of the tests the light received by the eyes from above, compared with that received from the background, was abnormally intense; and in accord with the hypothesis under consideration the fish should have become abnormally dark. This, however, did not occur. In most of the tests the fish was allowed to become maximum white in the cylinder in low light intensity before the eyes were illuminated from above; but in other tests a piece of black cloth was put under the crystallizing dish and the fish was allowed to become maximum black; then the cloth was removed from under the dish and the light from the tube turned on. In still other tests a piece of bristol board containing black and white 5 mm. squares was put under the glass dish and the fish was allowed to become mottled before turning on the light through the tube. Without going further into details, the results may be summed up by saying that the increase in illumination from above induced no observable change, although the beam of light was directed on the eyes, in some instances, continuously for over two hours, a period much longer than was necessary for a complete change in this individual from black to white or vice versa.

At first thought, these results appear to contradict the idea that the shade assumed by the fish depends upon the ratio between direct and reflected light. The fact, however, that in all of these tests the fish retained the shade it had at the beginning of the increase in illumination from above, no matter whether it was dark or light or mottled, indicates merely that under the conditions of the experiment the chromatophores did not respond at all. The excessive illumination of the eyes from above entirely prevented stimulation by light reflected from the white back-

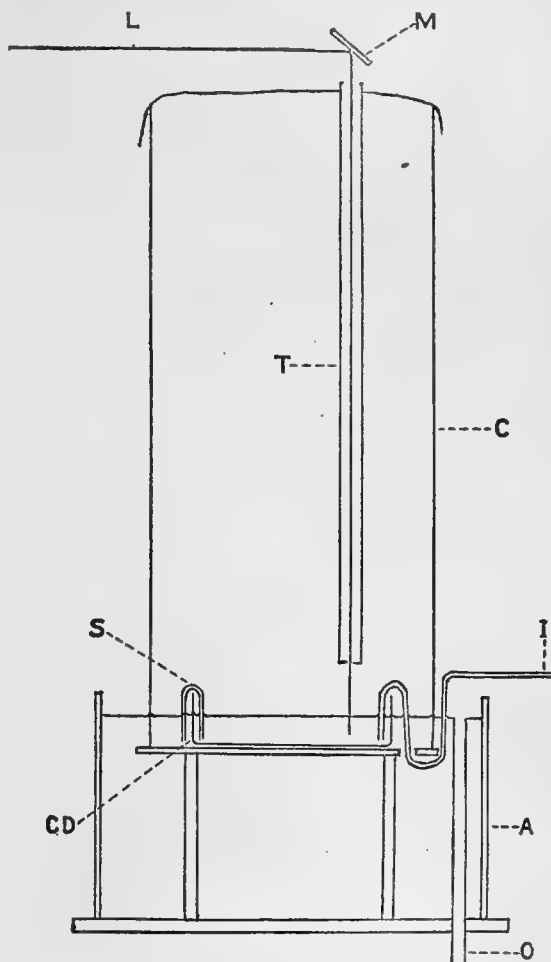

FIG. 3.—Vertical section of apparatus used in testing, in flounders, the effect of abnormally increasing the relative amount of light received by the eyes from above. A, aquarium; CD, crystallizing dish; S, siphon; I, inlet for water; O, outlet; C, opaque cylinder; T, iron tube; M, mirror; L, small beam of light.

ground; for without this illumination the reflected light from a white background always caused the fish to become maximum white.

These experiments were later somewhat modified and repeated with an individual having but one eye. Adaptation in this individual occurred very rapidly. When transferred from a white background to a black, or vice versa, marked changes in shade could be detected at once. In preparation for the experiment the specimen, *P. albiguttus*, 27 cm. long, was put into an aquarium containing gray sand. In a short time it assumed a gray shade very similar to that of the sand. It was in rather low diffused daylight. By means of the apparatus described above and an additional mirror, a vertical beam of direct sunlight 3 mm. in diameter was reflected down into the eye. The beam of light was so small that none of the skin around the eye, except the projected margin over it, became illuminated. The illumination was continued for 30 minutes. During this time the fish did not move and there was but little movement in the eye, which was merely drawn down into the socket occasionally, as it ordinarily is when stimulated by contact. Thus the illumination from above as compared with the reflected light from the background was very much stronger than it normally is and, in accord with Keeble and Gamble's ratio theory, the fish should have become darker, but no change in shade was detected.

The same was, however, also true when the experiment was repeated beginning with the animal adapted to a black background. In this experiment the fish was put into a black aquarium, and after it became adapted it was suddenly and entirely covered with gray sand. The apparatus was previously adjusted, so that as soon as the sand was removed from the eye the beam of light entered it. The posterior portion of the animal was uncovered for observation as in the preceding experiment. The illumination was continued from 11.35 a. m. to 12 m. No appreciable change occurred in the skin. If anything it became somewhat lighter.

At 12 m. the beam of light was intercepted without making any other change. At 12.10 p. m. the fish had clearly become somewhat lighter, and at 1 p. m. much lighter, showing that the absence of changes in the skin under the apparatus was in all probability not due to lack of time.

These experiments were again repeated with the same individual, but with the beam of light entering the eye at an angle of 35 degrees with the horizontal. There was, however, no difference in the results obtained. Moreover, the fish was placed in direct sunlight and a small shadow cast on the eye so as to reduce the light received from above without decreasing that received from the background. Under these conditions, in accord with the Keeble and Gamble's ratio hypothesis, the fish should have become lighter, but, although the shadow was held continuously on the eye for 40 minutes, no appreciable change in the shade of the skin occurred. While these results are not conclusive, they do throw considerable doubt on the validity of this hypothesis. It is, however, certain, as previously demonstrated, that simulation of the background is not controlled solely by light reflected from the bottom; i. e., the effect of the light received from the background must be modified, in some way, by light received from some other source. This modification is, however, in all probability, not so simple as is demanded by the hypothesis in question.

VISION.

COLOR-VISION.

Several investigators have maintained that they have experimentally demonstrated that fishes have color-vision, but in every case the validity of the evidence has been seriously questioned.

Washburn and Bentley (1908, p. 140), working with the creek chub (*Semotilus atromaculatus*), found that it could be trained to distinguish food associated with green from food associated with red of different shades; and Reighard (1908) found, in experiments on feeding, that the gray snapper (*Lutianus griseus*) can distinguish blue as well as green from red, even if the red appears much darker or much brighter than the blue.

The fact that these animals distinguish the blue from red that is brighter, as well as from red that is darker than the blue, shows, the authors maintain, that the selection could not have been solely on the basis of difference of intensity or brightness such as a color-blind person can perceive in the different colors, and that the animals consequently have color-vision. This conclusion is valid, however, only if the brightness at the red end of the spectrum is practically the same for the fishes as it is for man. If this end has a lower stimulating efficiency for fishes, as is found to be true in color-blind persons, it is evident that the red which, to the normal human eye, appeared brighter than the blue may have actually appeared darker to the fishes; and if this is true the discrimination observed may have been made on the basis of brightness.

This idea is in full harmony with the conclusion reached by Hess, who has probably done more work on vision in animals in general than anyone else. In his experiments on fishes (1913) he studied their response in the spectrum as well as their reactions to colored objects. In these experiments he tested *Atherina*, *Phoxinus*, and *Mugil*. Young *Atherinas* are positive in white light of all intensities above the threshold. When they are exposed in a spectrum, Hess maintains, they aggregate in the yellow near the green, but that they aggregate in any other region except the red if it is made more intense than the rest. This, he asserts, is true for light-adapted as well as for dark-adapted specimens, provided the spectrum is sufficiently strong. He holds that they respond just as color-blind organisms would be expected to respond, and, he contends, the same is true in regard to the reactions of adult *Atherina*, *Phoxinus*, and *Mugil* to colored objects, in feeding experiments. In the feeding experiments he used food and other objects colored red, yellow, green, blue, and gray of different shades, in various combinations. He maintains that he found no evidence whatever of discrimination on the basis of color. He asserts that he has demonstrated that the methods of earlier investigators, supporting the idea of color-vision, were inadequate, and concludes that fishes, contrary to other vertebrates, are color-blind. In this conclusion, however, Hess seems to stand practically alone among investigators of this subject.

Bauer (1913), on the basis of results obtained by means of methods similar to those used by Hess, concludes that fishes have color-vision when their eyes are adapted to light but not when they are adapted to darkness. And Frisch is even stronger in his support of color-vision. He bases his conclusion on three lines of evidence—discrimination of food of different colors, change in color during the breeding season, and adaptation in color to the bottom.

He maintains (1912) that *Phoxinus* fed for some time exclusively on yellow meat was able to distinguish between yellow and any one of 24 different shades of gray, some of which were very much darker and others very much lighter than the yellow. This discrimination, he holds, could only have been made on the basis of difference in color. He further contends that it is possible to understand the changes in color during the breeding season, so conspicuous in the males, and adaptation in color to the bottom only on the assumption that fishes have color-vision.

All of this evidence, however, does not convince Hess. He maintains (1913) that some of the fishes, which during the breeding season become most highly colored, red and yellow predominating, live at such a depth that these colors are entirely eliminated by absorption and consequently that they can have no bearing on vision whatever. He repeated and extended Frisch's experiments on feeding and adaptation, using the same species but, he asserts, improved methods, and maintains that he obtained no evidence of discrimination among different colors and no evidence of adaptation in color to the bottom. He concludes (p. 439) that Frisch's statements regarding the behavior of *Phoxinus* are wrong, "sämtlich unrichtig."

In order to answer these charges Frisch extended his feeding and other experiments on *Phoxinus*. He used 50 shades of gray ranging from black to white and also blue, green, yellow, and red. He maintains that the fish distinguished between any of these colors and all the shades of gray, also between any combination of blue, green, and red, but not between yellow and red. He also maintains, as previously stated, that the fish assumed a color similar to that of the bottom; and that, while Hess may be right in his assertion that some species which become highly colored during the breeding season live in water so deep that yellow and red rays do not penetrate, nearly all fishes in which this occurs live in shallow water. Moreover, he holds that the fact that yellow and red at a given depth appear gray to the human eye does not prove that they affect the eye of the fish in the same way.

Unless the results of Frisch's observations, especially those on feeding, can be shown to be erroneous they seem to support strongly the idea of color-vision in fishes. The experiments here made on *Paralichthys* and *Ancylopussetta* support this idea quite as strongly and prove conclusively that *Paralichthys* and *Ancylopussetta* assume a color similar to that of the background, ranging from dark blue to dark red, and that this correlation can not be accounted for on the basis of difference in brightness or energy, and that it is dependent upon the length of the light-waves, and, moreover, that the color assumed is dependent upon stimuli received through the eyes.

Now the essential objective characteristic of color-vision in man consists in the fact that the stimulation resulting in sensation of color is dependent upon the length of the waves and not upon luminous intensity, at least not in certain respects. On the basis of this phenomenon as a criterion it necessarily follows, from the facts stated above, that flounders also have color-vision. It may, however, be contended that this is not a satisfactory criterion of color-vision, and, in a certain sense, this is perfectly true. But is there any criterion that is more satisfactory?

In the process of adaptation in color we have a response dependent upon the quality of light, wave-length, and upon the visual apparatus in the eyes. It is known that the stimuli involved pass through the optic nerves to the brain and that they are distributed

through the spinal cord and the sympathetic nervous system to the cells in the skin, where they induce coordinated responses. It is also known that these responses may be influenced by other stimuli, physiological states, and processes in general. Essentially the same is true, with the exception of the part played by the sympathetic system, regarding every other reaction that has been used as a criterion of color-vision in animals. Nothing is known, in any case, as to what part, if any, the brain may play in the process.

The principal difference between this criterion and that which involves muscular activity is found in the course of transmission of the impulses from the brain to the reacting organs. In the latter this transmission is accomplished through the motor nerves; in the former, at least in part, through the sympathetic nerves. Whether or not both sorts of reactions should be marshaled under the term "color-vision" is, at present, very largely a matter of personal opinion. But whatever conclusion may be reached regarding this, neither criterion throws any light on the question as to whether or not animals have sensations of color similar to those in man, or of any other sort. That is, the term "color-vision" must be used in a purely objective sense regardless of which of these kinds of reaction is meant.

In a study of the question concerning the selection of backgrounds, pursued after the preceding pages were written, results were obtained which have a further bearing on the problem of color-vision. In this study one specimen of *Paralichthys* and one of *Ancylopsetta* were confined for about six weeks in each of four boxes. These boxes were painted on the inside, blue, green, yellow, and red, respectively; the red, however, turned pink in the course of a few weeks. At the close of this period each individual was tested as to the selection of colors on three consecutive days (Sept. 16, 17, and 18) as follows:

Boxes of the same kind as those mentioned above, and previously described in the section on colored backgrounds, were divided crosswise in the center. One half was covered with paint of one of the four colors mentioned and the other half with paint of another color. In this way boxes were prepared to represent all possible pairs of the four colors and one in addition, which was black and white.

In making the tests each specimen was gently placed directly over and parallel with the dividing line in the box. It was then released and the color toward which it turned recorded. Each individual was given 20 trials (10 with the head facing in one direction and 10 with it facing in the opposite direction) in each box that contained the color to which the animal was adapted, and also, on the second and third days, in the black and white box. Thus each individual was given a total of 60 trials in each colored box and 40 trials in the black and white box. The results obtained in these trials are summarized in table IV. The responses of *Paralichthys* and *Ancylopsetta* in each box were essentially the same. They have been added in the table, making a total of 120 tests in each box, except the black and white, for the two individuals adapted to a given color.

By referring to the table it will be seen that the individuals adapted to pink turned, in the red and yellow box, toward the red 50 times and toward the yellow 70 times; in the red and green box, toward red 40 times and the green 80 times; in the red and blue box, toward the red 5 and the blue 115 times; and in the black and white box, toward the black 1 and the white 79 times. Thus they turned toward the color to which they were adapted fewer times than toward any other color.

TABLE IV.—EFFECT OF ADAPTATION TO A GIVEN COLOR ON THE SELECTION OF COLORS.

Adapted to background colored.	Relation in brightness.	Number of times the fish turned toward—					
		Red.	Yellow.	Green.	Blue.	Black.	White.
Red.....	1	50	70				
		40		80			
		5			115		
Yellow.....	4	29	91				
			60	60			
			63		57		
Green.....	2	21		99			
			36	84			
				69	51		
Blue.....	3	5			115		
			11		109		
				27	93		
					1	79	

This was true, however, only for those specimens adapted to pink, and the fact that these specimens were adapted to pink (Ridgway's alizarin pink) and that the test boxes were still the original red (Bradley's red, shade no. 2) may have had something to do with it. The preponderance of turning toward the yellow in individuals adapted to yellow was also insignificant. But in those adapted to green and blue the selection of these colors, respectively, was quite marked, especially the latter. In all the selection of white was practically perfect.

The order of brightness of these four colors, beginning with the darkest, was as follows: Red, green, blue, yellow. Between the red and green and especially between the green and the pink, which was considerably lighter than the red, the difference was not great, but it was marked in reference to the other three colors.

The fact that the individuals adapted to green selected green in preference to red, yellow, or blue, seems to indicate that the selection was not made on the basis of brightness, for the green was lighter than the red and darker than the yellow and the blue. The same argument applies to the reaction of those adapted to blue.

The only way that these reactions could be accounted for, solely on the basis of brightness, would be to assume that the animals were adapted to a color of a given degree of brightness, and they reacted negatively to colors either darker or brighter than the one to which they were adapted. This assumption, however, does not accord well with the results obtained in the black and white box; for it demands that the brighter the color to which the animal is adapted the greater the tendency to turn toward the white. Thus one would expect the greatest relative number of positive reactions to white in individuals adapted to yellow and the least in those adapted to red. This expectation, however, was not realized. These results are not in themselves absolutely conclusive regarding color-vision, but they do seem to lend support to the conclusion reached with reference to the problem in the study of the simulation of colors in the background.

Hess (1913b) holds that the spectrum for certain fishes is shortened at the red end and that the region of maximum brightness is shifted toward the blue. That is, he maintains that the distribution of brightness for these animals is similar to that for color-blind persons. But even if this is true for flounders, the reactions recorded in table IV

can not be accounted for solely on the basis of brightness, nor can they be accounted for on this basis on the assumption that the brightness values for fishes, of the four colors used, differ in any other way from their values in man; for in accord with all such assumptions the reactions in each box should have been the same for all of the individuals tested. The reactions in the blue-green box, e. g., should have been the same for the individuals adapted to blue as they were for those adapted to green. This, however, was not the case; the former were positive to blue, while the latter were positive to green.

VISION OF MOTION, SIZE, AND FORM.

Much more work has been done on color-vision in fishes than on any other phase of the subject. It is well known, however, that many species in securing food regulate their movements by vision and that smell and taste play a minor rôle in the process, if indeed they play any. This is true for *Paralichthys* and *Ancylopsis*. It is also well known that these fishes see other objects, especially such as may be injurious. It is known, moreover, that the movement of the object seen is an essential factor in the process of vision. Very little, however, is known as to what rôle in the process is played by form, size, and surface characteristics.

The following observations throw some light on these questions. A fiddler crab of moderate size was thrown into an aquarium containing a number of hungry specimens of *Paralichthys*. The crab was seized at once, partly swallowed, and then thrown out. It was then taken by another specimen and again rejected. Neither of these specimens nor any of the others in the aquarium was again seen to attack a crab, although during the following few days specimens of various sizes were repeatedly thrown in. Minnows of the same size, however, were invariably taken during this time. Thus it is evident that the crabs were recognized, and this recognition, no doubt, was made on the basis of form.

Size, however, is also a distinguishing characteristic for these animals, as shown by the fact that they rarely attack minnows which are so large that they can not be swallowed. But if the simulation of patterns in the background in *Paralichthys* may be used as a criterion of vision, we have evidence of far greater significance regarding this matter.

By referring to plates xxxi, xxxii, figures 49-55 and the legends accompanying them, it will be seen that dots 0.5 mm. in diameter produce no specific effect, but that those 1 mm. in diameter do. It will also be seen that the effect of dots 2 mm. in diameter differs from that of those 3 mm. in diameter, and that the effect of these dots differs from the effect of those 5 mm. in diameter. These results, as I have shown elsewhere, are due to stimuli received through the eyes, and impulses passed through the brain and the central and sympathetic nervous systems. These responses may be and probably are purely reflex. But, however that may be, they indicate as clearly as any other responses can that these animals recognize the difference between spots 2 mm. and 3 mm. in diameter, and that they do not recognize spots 0.5 mm. in diameter. Regarding subjectivity in these animals, we know next to nothing, if not actually nothing. It is consequently evident that, until this state of affairs is changed, the term recognition should be used strictly in an objective sense.

FUSION RATE OF IMAGES ON THE RETINA.

It is well known that if a disk containing alternate black and white sectors is rotated rapidly enough the sectors become invisible and the disk appears uniformly gray. This is due to the fusion of the images on the retina. If the images on the retina in fishes fuse somewhat as they do in man, a flounder over such a disk, at a certain rate of rotation, ought to become uniformly gray. And if the fusion rate is the same for fishes as it is for man the flounder ought to become, when the disk is rotated fast enough to appear gray to the human eye, as uniformly gray as it does on a stationary gray background. The results of the following experiments show that this actually occurs.

In these experiments a disk, 25 cm. in diameter, was fastened to a vertical shaft and so arranged in a wooden vessel that it rotated immediately under a stationary horizontal glass plate. The shaft extended down through the bottom of the vessel, where a pulley was attached to it. The disk was divided into 32 equal sectors, half of which were painted with white enamel and the rest, alternating with these, with black engine paint. The vessel contained flowing water extending to a point a few centimeters above the glass plate. The specimens to be tested were put on this plate in a glass inclosure of such a form and so arranged that the head was held continuously over the center of the disk. All air bubbles were carefully removed from under the plate. The disk was turned by means of a water motor, the speed of which could be altered as desired.

Four individuals were tested, three *P. albiguttus*, 16, 20, and 27 cm. long, respectively, and one *P. dentatus*, 14 cm. long. The specimen 20 cm. long was more thoroughly studied than any of the others. This specimen had been changed frequently during several weeks from a white to a black aquarium and vice versa until adaptation to these shades occurred moderately rapidly. It was kept over the disk continuously, with the exception of a few short intervals, for five days. During this period the rate of rotation of the disk was changed at intervals varying from a few moments to an hour or more, and the effect on the pattern of the skin was noted and recorded. Without going into details regarding these records the results may be summarized as follows:

When the disk was not rotating the pattern in the skin became very conspicuous. The three ocelli became black and numerous other black spots of about the same size as the ocelli appeared. Numerous larger irregular light and dark patches also appeared, giving the fish a contrastive mottled appearance. Rotations of the disk up to about 50 revolutions per minute did not cause, in strong diffused sunlight, any appreciable alterations in the pattern. If anything, it became more conspicuous. As the rate of revolution increased above this, the pattern became less and less conspicuous until at 200 revolutions, in strong, diffused sunlight, the fish became as nearly uniformly gray as it did on a stationary gray background. Under both conditions the entire surface, with the exception of the ocelli and spots mentioned above, became, in the same length of time, almost uniformly gray. The ocelli and spots were in all cases considerably darker than the rest of the surface but not nearly so dark as they were when the disk rotated more slowly.

Thus, in moderately strong light the images produced on the retina of the fish fused completely when the disk made 200 revolutions a minute, or, since the disk contained 32 sectors, when the images were superimposed at the rate of 6,400 per minute.

In lower light intensity the fusion rate was lower. According to notes taken at 6 p. m. on the third day of the experiment, September 12, the rate was found to be about 4,800 per minute, and the following day the same rate was obtained between 11 a. m. and 1 p. m. by reducing the light intensity by means of an opaque screen. When the screen was removed, without changing the rate of rotation of the disk, the fish could be seen to become almost at once distinctly more conspicuous. When the light was thus increased the dark spots and patches became markedly darker, and when it was again decreased by replacing the screen they rapidly faded again. With full illumination, moderately strong indirect sunlight, the fusion rate was found during this period to be approximately 6,400 per minute.

The fusion rate for the human eye in all of these tests was apparently the same as that for the eye of the fish. At 50 revolutions per minute and below the sectors appeared nearly, if not quite, as black and white as they did when the disk was not rotating, although they appeared considerably narrower. As the rate of rotation increased, the sectors appeared to become narrower and narrower, and to become more and more nearly alike in shade, until they finally merged entirely and the disk assumed a uniformly gray shade. This occurred at about 200 revolutions per minute in strong, diffused light, and at a lower rate in weaker light, just as in the case of the fish. In other words, the disk appeared uniformly gray whenever the fish became maximum gray. Under no circumstances did the fish become maximum gray before the sectors on the disk had entirely disappeared.

The results obtained with the other three specimens were in all essentials like those set forth above. Two of them, however, did not appear to become quite as gray over the disk rotated fast enough to appear uniformly gray to the human eye as they did on a gray bottom. In these individuals, however, the changes in the skin proceeded so slowly that it was exceedingly difficult to detect slight changes which may have occurred in the shade and the pattern. Consequently, there is some doubt concerning these results which, if valid, would indicate that the fusion rate for some specimens may be higher than it is for man.

SUMMARY.

1. The evidence presented above indicates that fishes have color-vision and that the spectrum for them is, objectively, essentially the same as it is for man.

2. It indicates that they do not recognize dots 0.5 mm. in diameter as individuals, but that they do recognize dots 1 mm. in diameter and that they distinguish between dots 2 mm. in diameter and dots 3 mm. in diameter. In this respect vision does not appear to be as keen in fishes as it is in man.

3. It indicates further that fishes recognize differences in form, that the difference in the reaction to a crab and a minnow is on the basis of difference in form.

4. It also indicates that the fusion rate of images on the retina is essentially the same for fishes as it is for man, and consequently, that motion as a factor in vision is approximately the same for both.

SELECTION OF BACKGROUND.

No one has heretofore obtained any evidence indicating that fish show any tendency to select a background which harmonizes with the shade, color, or pattern of the skin. Sumner (1911, p. 443) made a number of tests with *Rhomboidichthys* and obtained negative results. He is very conservative, however, in his conclusion based upon these results, stating merely that they "render it improbable that the fish exercises much selection in respect to the shade of its background." The results here noted of experiments on both *Paralichthys* and *Ancyllopsetta* show very clearly that such selection occurs. They throw but little light, however, on the question as to the extent and the significance of the selection.

In these experiments two methods were pursued. One may be called the group method and the other the individual method.

GROUP METHOD.

In the group method a given number of specimens, usually 10, which had been either on a white or a black background continuously for several days or longer, were released in an aquarium one half of which was black and the other white. Their movements were then studied and their positions at given intervals were recorded. The aquarium used for this purpose was 55 by 70 cm. The bottom of this aquarium was divided lengthwise into four equal areas. Two of these, with the adjoining side walls, were painted white and the other two, alternating with the first, were painted black. In these tests, specimens of *Paralichthys* were exclusively used. They varied in length from 12 to 20 cm. At the close of the first test two new individuals were added. With this exception the same individuals were used throughout the tests. In making these tests the individuals were put into the aquarium and left undisturbed. At intervals of about five minutes their positions were noted and the number on the white and on the black, respectively, was recorded. At the close of each test these numbers were added. The resulting sums appear in table v.

TABLE V.—THE RELATION BETWEEN THE SHADE OF THE SKIN AND THAT OF THE BACKGROUND SELECTED.

Number of test.	Time covered by test.	Number of specimens used.	Shade of background and time on same before tests.	Total number of readings.	Position of specimens at time of readings.	
					On black.	On white.
I	July 14, 10.28 a. m. to 12.49 p. m.	8	Black, 3 days or over.....	30	160	80
II	July 15, 9.47 to 11.58 a. m.....	10do.....	88	616	264
	Total.....				776	344
III	July 18, 2.31 to 5 p. m.....	10	White, 3 days.....	37	139	231
IV	July 20, 11.30 a. m. to 4.15 p. m.	10	White, 5 days.....	67	218	452
	Total.....				357	683
V	July 15, 12.03 to 1.55 p. m....	10	Continuation of test II.....	6	31	29
VI	July 22, 6 to 7.30 a. m.....	10	In a half black and half white aquarium, 2 days.	4	20	20
	Total.....				51	49

INDIVIDUAL METHOD.

A number of specimens of *Paralichthys* and *Ancylopsisella* were kept for several weeks in a shallow wooden aquarium 2.6 meters long and 1.3 meters wide. One half of this aquarium, sides as well as bottom, was painted black and the other half white, with the dividing line extending crosswise.

It was repeatedly noted that most of the specimens in the aquarium persistently remained on the white, but a few tended to remain on the black. When those on the white background were forced over onto the black they almost invariably returned at once, and the same was found to be true for those on the black background, indicating a selection of background in harmony with the shade of their skin.

More detailed results regarding this, however, were obtained as follows: Individuals fully adapted to either white or black were placed on the dividing line in the aquarium in such a position that one eye was over black and the other over white. In this position they were held with the hands until they became quiet, which usually occurred in a very few moments, and then released. In some instances they remained quiet after being released. Whenever this occurred the tip of the tail was touched repeatedly until they started off. The direction in which they turned was then noted and recorded, after which the whole process was repeated. In returning the animal, in about half of the individual tests it was moved across the line to the opposite end of the aquarium and then brought back onto the line so as to counteract any possible influence of the direction of movement before the test, on the direction of turning during the test. The results of nearly all of these tests are summarized in table VI.

TABLE VI.—THE RELATION BETWEEN THE SHADE OF THE SKIN AND THAT OF THE BACKGROUND SELECTED.

Number of test.	Designation of individual used.	Shade of background and time on same before test.	Time tests were made.	Number of times and direction of turning.			
				Ventral surface on black.		Ventral surface on white.	
				Toward black.	Toward white.	Toward black.	Toward white.
1	<i>Paralichthys</i> , 30 cm.	Black, 1 day	July 9, 2.30 p. m.	8	2	7	3
2	do.	Black, 2 days	July 10, 5 p. m.	15	0	12	3
3	do.	Black, nearly 6 days	July 16, 5 p. m.	20	0	15	5
4	<i>Paralichthys</i> , 33 cm.	Black, 1 week or over	July 8, 11.45 a. m.	12	3	14	1
5	do.	Black, over 1 week	July 9, 4.15 p. m.	14	1	11	4
6	do.	White, 1 day	July 10, 5.30 p. m.	5	8	6	7
7	do.	White, 7 days	July 17, a. m.	7	33	7	33
8	<i>Ancylopsisella</i> (A).	Black, 1 week or over	July 9, 3 p. m.	29	0	15	14
9	do.	do.	July 9, 4.45 p. m.	16	0	5	11
10	do.	White, 1 day	July 10	8	5	0	13
11	do.	White, 7 days	July 16, 5.15 p. m.	5	20	3	22
12	do.	White, 8 days	July 17, 3 p. m.	0	15	0	15
13	<i>Ancylopsisella</i> (B).	White, most of time for 1 week.	July 9, 3.30 p. m.	0	8	0	8
14	do.	do.	July 9, 3.40 p. m.	12	0	12	0
15	do.	do.	July 9, 4.30 p. m.	0	6	0	6
16	do.	do.	July 9, 4.40 p. m.	9	0	9	0
17	do.	Black, 1 day	July 10, 4 p. m.	1	13	2	12
18	do.	Black, 6 days	July 16, 5 p. m.	10	0	10	0

These results, without further analysis, show clearly that there is a tendency, both in *Paralichthys* and *Ancylopsisella*, to turn toward that shade to which they are adapted.

The only results which do not support this statement were obtained with *Ancylosetta* (B). This individual, as the table shows, turned frequently and persistently toward a given shade for a considerable period of time and then suddenly stopped and turned as persistently in the opposite direction. The results obtained with all of the other individuals are, however, so consistent that not much weight can be placed on those obtained with this one. The tabulated results also show that, especially in *Ancylosetta*, there is a tendency to turn toward the ventral surface. Thus it is evident that these creatures select, to some degree, that background on which they are least conspicuous. Whether or not this selection has reference to color and pattern as well as to shade remains to be ascertained.

COLORED BACKGROUND.

After this section of the work was completed opportunity presented itself to extend this investigation so as to include color. This study was carried on in the same way as that described above, bearing on the selection of backgrounds on the basis of difference in shade. The details regarding the experiments and the results obtained are presented under color-vision in the section on vision. By referring to table IV in that section, it will be seen that the individuals adapted to blue and to green showed a strong tendency to go toward the background with which they harmonized in color, that those adapted to yellow showed very little of this tendency, and that those adapted to red showed none. Thus it would seem that there is some evidence indicating that color is a factor in the selection of backgrounds. The whole subject, however, is in need of further investigation before hard and fast conclusions can be reached.

SUMMARY.

1. Adaptive changes in shade occur in the skin of practically all of the different fishes found in the region of Beaufort, N. C.; adaptive changes in color occur in many; but adaptive changes in pattern in only a few.

2. The flounders *Paralichthys* and *Ancylosetta* simulate the background over a wider range and more closely than any other forms studied. In nature they resemble the bottom so much that it is difficult to see them, especially when they are partly buried, as they usually are. They are the only forms found in which the skin changes so as to resemble the bottom in pattern as well as in shade and color.

3. Simulation of the background in *Paralichthys* is more extensive and more nearly perfect than in *Ancylosetta*. The range of changes in the skin in members of this genus is most remarkable. On a white background they become almost pure white, on a black background nearly black, and on gray backgrounds of various shades they become gray of very nearly the same shade.

4. On blue, green, yellow, orange, pink, or brown of various hues they assume a color remarkably similar to that of the background. Reds of various tints and shades, however, are not very accurately simulated; but the color produced in the skin by each tint or shade of red is different from that produced by any other color and very different from that produced by gray regardless of the intensity.

5. On bottoms containing black and white squares or circles, the skin breaks up into similar areas both in size and shade, but in no case is there any indication of an actual reproduction of the form of the areas, as maintained by Pitkin and Loeb. Large figures in the background produce a coarse pattern in the skin, and small figures a fine pattern, but squares of a given size produce essentially the same pattern as circles or stripes, or within certain limits any other figures of the same size.

6. The size of the light and dark areas in the background and the relative amount of surface covered by them have a profound effect on the pattern produced in the skin, but the form and arrangement have little or no effect.

7. The large features in the pattern are essentially the same in different individuals of the same species, but the details differ so much that any individual could readily be recognized by a careful study of less than a square millimeter of any portion of the pigmented surface.

8. The time required for adaptation to colors is, in general, much longer than that required for adaptation in shade or pattern. On the reds, greens, and blues adaptive changes still appear to continue after a sojourn on them of between two and three months. On yellows and browns adaptation occurs in much shorter time. This may be due to the predominance of these colors in the normal environment of the flounders.

9. The time required for adaptive changes in shade may be greatly reduced by repetition. In one individual, in the course of a week, it was reduced from five days to less than two minutes by repeated changes from black to white and vice versa.

10. Changes in shade, pattern, and color result from concentration or distribution of pigment granules in groups of cells known as chromatophores, in connection with highly reflective and refractive guanin crystals found in other cells known as guanophores.

11. The pigment granules in some of the chromatophores are black. In others they are yellow, varying from yellowish green to deep orange, depending upon the color of the background.

12. The movement of the granules resulting in adaptation is under the control of stimuli received through the eyes by way of the central and sympathetic nervous system.

13. If there is any direct effect of the stimulating agents in the environment on the adaptive reaction of the chromatophores it is insignificant.

14. Stimuli received through either eye are distributed equally over the entire pigmented surface. The shade, color, and pattern assumed is the result of stimuli received through one eye modified by those received through the other.

15. In *Paralichthys* the shade assumed in low luminous intensity on a given background is practically the same as that assumed in high intensity on the same background. It therefore bears no proportional relation to the amount of light received from the background. *Ancylosetta*, however, assumes a much darker shade in very weak light than it does in strong light.

16. Light reflected from the skin to the eyes plays no part in adaptation to the background. Simulation of the background is not controlled by visual comparison of the skin with the background.

17. On a white background flounders become maximum white and on a gray background maximum gray, even if the conditions of illumination are such that much more light is reflected from the latter than from the former. The action of the light received by the eyes from the background must therefore be modified by light received from above, but the interaction of the light received from the different immediate sources is probably not so simple as is demanded by the ratio hypothesis of Keeble and Gamble.

18. The simulation of the background in color is regulated by stimuli received through the eyes, and it depends upon the length of the light-waves. It can not be accounted for on the basis of differences in the brightness or the intensity of the light. It consequently indicates that these animals have color-vision.

19. This conclusion is, moreover, supported by the fact that flounders adapted to blue or green tend to react positively to these colors when simultaneously subjected to stimuli from one of these and any one of the following colors: Red, green, blue, and yellow, red being the darkest color and the others brighter in the order given.

20. Flounders distinguish differences in size and in form, but the evidence obtained does not indicate that their vision is acute in these respects. The fusion rate of images on the retina, however, is essentially the same in flounders as it is in man, showing that in respect to motions their vision is on a par with human vision.

21. Flounders tend to select a background with which they harmonize in shade and in color.

DISCUSSION.

What sort of mechanism is necessary to account for the reactions of the chromatophores resulting in adaptation in shade, in pattern, and in color? Let us consider this question with reference to these different characteristics in the order given:

Adaptation in shade.—Different shades in the skin of flounders depend upon the degree of concentration of the melanin granules in the melanophores. The movement of these granules, which regulates the degree of concentration, is controlled by stimuli received through the eyes and the nervous system.

If this movement were proportional to the light received by the eyes from the background, and if each melanophore were connected with receptors in only one of the retinas, one could readily account for adaptation in shade, but such is not the case. The movement of the melanin granules is not proportional to the light received from the background, for the degree of concentration of these granules on a background of a given shade is the same, no matter how strong or how weak the light is; and each melanophore is probably connected with receptors in both eyes, for if one eye receives light from a black and the other from a white background the skin assumes an intermediate shade. To account for the regulation of the movement of the granules it is consequently necessary to assume a mechanism, such that the effect of the light reflected from the background on the movement of the melanin, is modified by the action of light received from other sources; and to account for the intermediate shades reproduced when one eye receives stimuli from a background of a given shade and the other from one of a different shade, it seems necessary to assume that the effective stimulus bears a definite relation to the arithmetical means of the light received from the background by each of the two eyes, modified by light received from other sources. It can not be proportional to the summation of the light received by both eyes, for if this were true a greater concentration of the melanin and a more rapid reaction would be expected, under given conditions, if both eyes are functional, than would be if only one is functional. This, however, does not occur; consequently it must be further assumed that the effect on a melanophore of a given amount of light received by a retina from the background modified by light received from other sources is twice as great if only one eye is functional as it is if both are functional.

Without attempting any further analysis, it is evident that to account for the observed phenomena concerning adaptation in shade it is necessary to postulate a rather complex mechanism, the working of which is as yet not altogether clear. The difficulties encountered in attempting to elucidate the physiology of adaptation in this respect, however, are much less perplexing than are those encountered in attempting mechanically to explain adaptation in pattern and color. In these we have to account for all of the phenomena regarding the compromise in the effect of direct and reflected light and in the action of the two eyes and others as well. In other words, adaptation in shade is always present.

Adaptation in color.—The observations on adaptive simulation of colors show that the reactions of the chromatophores depend upon the length of the waves of light regardless of the intensity. Each wave-length, within certain limits, has a specific effect. Thus the red causes extension of the pigment granules in the xanthophores and the melanophores, yellow causes greater extension in the former and less in the latter, etc.

If each chromatophore is connected directly with given cells in the retina, it must be assumed that the impulses which travel through a given nerve fiber from the retina to the skin differ and that the character of each impulse depends upon the length of the waves. Thus adaptation to monochromatic light might be explained, but colors produced by mixtures of light waves of different lengths are also simulated. As a matter of fact, most of the colors tested were not monochromatic. The different shades of brown, e. g., which were very accurately simulated, were produced by mixing red and yellow pigments. These pigments on drying aggregated in such a way as to form small adjoining red and yellow areas, distinctly visible under a magnification of 50 diameters; the brown color, therefore, consisted of a mixture of red and yellow rays. It thus becomes evident that a given reaction of a chromatophore is not necessarily specifically associated with a given length of light-wave. In other words, the effect of light consisting of waves of a given length is modified by the presence of light consisting of waves of a different length, and the modification is different for every wave-length. Where and how this process of modification occurs is unknown, but it seems most natural to refer it to the activity of cells in the brain.

The melanophores, as well as the xanthophores, take part in the production of colors in the skin. Their reactions are consequently dependent upon the length of the waves of light as well as upon the intensity, and to account for this as well as to account for the response of the xanthophores it is necessary to add to the complexity of the mechanism postulated to explain adaptation in shade. The nature of this addition is at present quite obscure.

Adaptation in pattern.—In the case of adaptation in pattern there is an integration of the action of impulses from the two eyes similar to that considered under adaptation in shade. If one eye receives stimuli from a background having a coarse pattern and the other from one having a fine one, the skin assumes a pattern intermediate in texture. Thus it is evident that the stimuli from either eye modify the effect of those from the other eye. With reference to the action of each eye alone it was found that, while the dark and light areas produced in the skin bear to those of the images in the retina a definite relation in size, they bear no such relation in form or in special interrelation. Obviously, then, the regulations of patterns can not be explained on the assumption of a direct and specific nervous connection between the chromatophores in the skin and the cells in the retina. An illuminated spot of a given size and intensity produces the same effect on the chromatophores in the skin, no matter where it may be located or what form, within certain limits, it may have. Different configurations (a, b, c, d, e, f, etc.) in the retina, no matter where they are located, all may result in the same configuration in the skin. Consequently, if the pattern in the skin depends upon the spacial interrelation of the impulses, their interrelation must be reorganized somewhere between the retina and the skin, probably in the brain.

Concerning the details of the processes involved nothing is yet known. Driesch, however, would probably hold that it can not be explained on purely mechanical grounds. It is well known that in man the image of an object may result in the same sensations, no matter from what angle the object is viewed. Thus a dog seen from the side may cause the same sensation as one seen from in front or from any other point of view, although the image on the retina in each case differs greatly from that in any other case. This phenomenon is like that just discussed in fishes. Driesch holds that in man it can not be explained on a purely mechanical basis. We should consequently expect him to maintain the same view for the phenomenon in fishes.

BIBLIOGRAPHY.

BALLOWITZ, Emil.

1893. Die Nervenendigungen der Pigmentzellen, ein Beitrag zur Kenntnis des Zusammenhanges der Endverzweigungen der Nerven mit dem Protoplasma der Zellen. *Zeitschrift für wissenschaftliche Zoologie*, bd. 56, p. 673-706, taf. xxxv-xxxix. Leipzig.
- 1893a. Über die Bewegungserscheinungen der Pigmentzellen. *Biologisches Centralblatt*, bd. 13, p. 625-630. Leipzig.
1912. Über chromatische Organe in der Haut von Knochenfischen. *Anatomischer Anzeiger*, bd. 42, p. 186-190, 2 taf. Jena.
1913. Die chromatischen Organe in der Haut von *Trachinus vipera* Cuv. Ein Beitrag zur Kenntnis der Chromatophoren-Vereinigungen bei Knochenfischen. *Zeitschrift für wissenschaftliche Zoologie*, bd. 104, p. 471-529, 5 taf. Leipzig.
- 1913a. Über schwarze und sternförmige Farbzellenkombinationen in der Haut von Gobiiden. Ein weiterer Beitrag zur Kenntnis der Chromatophoren und Chromatophoren-Vereinigungen bei Knochenfischen. *Zeitschrift für wissenschaftliche Zoologie*, bd. 106, p. 527-593, taf. 5. Leipzig.
- 1913b. Über Erythrophoren besonderer Art in der Haut von Knochenfischen. *Archiv für mikroskopische Anatomie und Entwicklungsgeschichte*, bd. 82, abt. 1, p. 206-219, 1 taf. Bonn.
- 1913c. Über schwarze Doppelzellen und andere eigenartige Vereinigungen heterochromer Farbstoffzellen bei Knochenfischen. *Anatomischer Anzeiger*, bd. 44, p. 81-91. Jena.
- 1913d. Das Verhalten der Zellkerne bei der Pigmentströmung in den Melanophoren der Knochenfische. (Nach Beobachtungen am lebenden Objekt.) *Biologisches Centralblatt*, bd. 33, p. 267-272. Leipzig.

BAUER, V., und DEGNER, E.

1913. Über die allgemein-physiologische Grundlage des Farbenwechsels bei dekapoden Krebsen. *Zeitschrift für allgemeine Physiologie*, bd. 15, p. 363-412. Jena.

BRADLEY, M.

The Bradley educational colored papers, Milton Bradley Co., Springfield, Mass.

BUYTENDIJK, F. J. J.

1911. Ueber die Farbe der Tarbutten nach Exstirpation der Augen. *Biologisches Centralblatt*, bd. 31, p. 593-596. Leipzig.

CUNNINGHAM, J. T.

1890. A treatise on the common sole (*Solea vulgaris*) considered both as an organism and as a commodity. viii+147 p., xviii, pl. Plymouth.
- 1890a. Colour changes in *Cottus bubalis*. *Journal of the Marine Biological Association of the United Kingdom*, vol. 1 (n. s.), p. 458-459. Plymouth.
1895. Researches on the coloration of the skins of flatfishes. *Journal of the Marine Biological Association of the United Kingdom*, vol. III (n. s.), p. 111-118, 1 text fig. Plymouth.

CUNNINGHAM, J. T., and MACMUNN, C. A.

1893. On the coloration of the skin of fishes, especially of the Pleuronectidæ. *Philosophical Transactions of the Royal Society of London*, vol. 184 (B.), p. 765-812, pl. LIII-LV. London.

FRANZ, V.

1908. Die Struktur der Pigmentzelle. *Biologisches Centralblatt*, bd. 28, p. 536-543, 545-548, 13 fig. Leipzig.

FRISCH, KARL V.

1911. Beiträge zur Physiologie der Pigmentzellen in der Fischhaut. *Archiv für die gesammte Physiologie des Menschen und der Tiere*, bd. 138, p. 319-387, 2 taf., 8 fig. Bonn.
1912. Über farbige Anpassung bei Fischen. *Zoologische Jahrbücher*, abt. für allgemeine Zoologie und Physiologie der Tiere, bd. 32, p. 171-230, 4 fig., 2 taf. Jena.

FRISCH, KARL, v.—Continued.

- 1912a. Sind die Fische farbenblind? Zoologische Jahrbücher, abt. für allgemeine Zoologie und Physiologie der Tiere, bd. 33, p. 107-126, 2 fig. Jena.
- 1912b. Über die Farbenanpassung des *Crenilabrus*. Zoologische Jahrbücher, abt. für allgemeine Zoologie und Physiologie der Tiere, bd. 33, p. 151-164. Jena.
1913. Weitere Untersuchungen über den Farbensinn der Fische. Zoologische Jahrbücher, abt. für allgemeine Zoologie und Physiologie der Tiere, bd. 34, p. 43-68. Jena.

GOLOVINE, E.

1907. Etudes sur les cellules pigmentaires des Vertébrés. Annales de l'Institut Pasteur, 21 année, p. 858-881. Paris.

HESS, C.

1911. Experimentelle Untersuchungen zur vergleichenden Physiologie des Gesichtssinnes. Archiv für gesammte Physiologie des Menschen und der Tiere, bd. 142, p. 405-446, 5 fig. Bonn.
1913. Neue Untersuchungen zur vergleichenden Physiologie des Gesichtssinnes. Zoologische Jahrbücher, abt. für allgemeine Zoologie und Physiologie der Tiere, bd. 33, p. 387-440. Jena.
- 1913a. Untersuchungen zur Physiologie des Gesichtssinnes der Fische. Zeitschrift für Biologie, bd. 63, p. 245-274, 12 text fig. München.

HOOKER, D.

1912. The reactions of the melanophores of *Rana fusca* in the absence of nervous control. Zeitschrift für allgemeine Physiologie, bd. 14, p. 93-104, 3 fig. Jena.
1914. Amœboid movement in the corial melanophores of *Rana*. American Journal of Anatomy, vol. 16, no. 2, p. 237-250, 3 fig. Philadelphia.

KAHN, R. H., and LIEBEN, S.

1907. Über die scheinbaren Gestaltänderungen der Pigmentzellen. Archiv für Anatomie und Physiologie, Physiologische abt., p. 104-112, taf. 4, 5. Leipzig.

KEEBLE, F., and GAMBLE, F. W.

1904. The colour-physiology of higher crustacea. Philosophical Transactions of the Royal Society of London, (Sr. B.), vol. 196, p. 295-388, pl. 18-23. London.

LEHMANN, A.

1906. Über sympathische Färbung und die Pigmentbildung bei Barsch und Forelle. Inaug. Dissert., p. 40, 1 taf. Bern.

LODE, A.

1890. Beiträge zur Anatomie und Physiologie des Farbenwechsels der Fische. Sitzungsberichte der Kaiserlichen Akademie der Wissenschaften, Mathematisch-Naturwissenschaftlichen Klasse, bd. 99, abth. 3, p. 130-143, 1 taf. Wien.

LOEB, J.

1912. The mechanistic conception of life: Biological essays. The University of Chicago Press, 232 p., illus. Chicago.

MAYERHOFER, F.

1909. Farbwechselfersuche am Hechte (*Esox lucius* L.). Archiv für Entwicklungsmechanik der Organismen, bd. 28, p. 546-560, 1 taf. Leipzig.

MINKIEWICZ, R.

1912. Recherches sur la formation des habitudes, le sens des couleurs et la mémoire chez les poissons. Annales de l'Institut Océanographique, tome v, fasc. iv, p. 53. Paris.

PITKIN, W. B.

1912. The new realism: Cooperative studies on philosophy, by Edwin B. Holt, Walter T. Marvin, William Pepperrell Montague, Ralph Barton Perry, Walter B. Pitkin, and Edward Gleason Spaulding. Has "Some realistic implication of biology, by W. B. Pitkin," p. 491. New York.

POUCHET, G.

1876. Les changements de coloration sous l'influence des nerfs. Journal de l'Anatomie et de la Physiologie, t. 12, p. 1-90, 113-165. Paris.

- REIGHARD, J.
1908. An experimental field-study of warning coloration in coral-reef fishes. Papers from the Tortugas Laboratory of the Carnegie Institution of Washington, vol. II, p. 257-325, pl. 5. Washington.
- RIDGWAY, R.
1912. Color standards and color nomenclature, p. 44, pl. 53. Washington.
- RYNBERK, G. VAN.
1906. Ueber den durch Chromatophoren bedingten Farbenwechsel der Tiere. Ergebnisse der Physiologie, 5 jahr., p. 347-571. Wiesbaden.
- SCHÖNDORFF, A.
1903. Über den Farbenwechsel bei Forellen. Archiv für Naturgeschichte, 69 jahr., p. 399-426, taf. 22. Berlin.
- ŠEĆEROV, S.
1909. Farbenwechselversuche an der Bartgrundel (*Nemachilus barbatula* L.). Archiv für Entwicklungsmechanik der Organismen, bd. 28, p. 629-660, taf. 22, 23. Leipzig.
1913. Über einige Farbenwechselfragen. Biologisches Centralblatt, bd. 33, p. 473-487. Leipzig.
1913a. Notizen über den Farbenwechsel von *Nemachilus barbatula* L. Zoologischer Anzeiger, bd. XLII, p. 273-276. Leipzig.
- SPAETH, R. A.
1913. The physiology of the chromatophores of fishes. Journal of Experimental Zoology, vol. xv, no. 4, p. 527-585, 4 pl., 3 text figs. Jena.
1913a. The mechanism of the contraction in the melanophores of fishes. Anatomischer Anzeiger, bd. 44, p. 520-524, 3 fig. Jena.
- STARK, J.
1830. On changes observed in the colour of fishes. Edinburgh New Philosophical Journal, vol. 9, no. 18. Edinburgh.
- SUMNER, F. B.
1911. The adjustment of flatfishes to various backgrounds: A study of adaptive color change. Journal of Experimental Zoology, vol. 10, no. 4, p. 409-480, 13 pl. Philadelphia.
- TOWNSEND, C. H.
1909. Observations on instantaneous changes in color among tropical fishes. Thirteenth Annual Report of the New York Zoological Society, p. 28, 12 pl. i. e. 13. New York.
- VERRILL, A. E.
1897. Nocturnal and diurnal changes in the colors of certain fishes and the squid (*Loligo*), with notes on their sleeping habits. American Journal of Science, vol. 3, p. 135, 136. New Haven.
- WASHBURN, M. F. and BENTLEY, M. B.
1906. The establishment of an association involving color discrimination in the creek chub, *Semotilus atromaculatus*. Journal of Comparative Neurology and Psychology, vol. XVI, p. 113-125. Granville.
- ZEYNEK, R. V.
1901. Über den blauen Farbstoff aus den Flossen des *Crenilabrus pavo*. Zeitschrift für Physiologische Chemie, bd. 34, p. 148-152, t. 1. Strassburg.
1902. Über den blauen Farbstoff aus den Flossen des *Crenilabrus pavo*. Zeitschrift für Physiologische Chemie, bd. 36, p. 568-574, t. 1. Strassburg.

EXPLANATION OF PLATES.

All of the figures found in the following plates are reproductions of photographs and autochromes from life, none of which have been retouched, tinted, or altered in any way.

Plates XIX, XX.—Adaptation on natural backgrounds.

PLATE XIX.

FIG. 1. *Paralichthys albiguttus*, 20 cm. long, on fine variegated shells, yellow predominating, partly buried as usually found in nature.

FIG. 2. Same individual two minutes later with the shells removed.

FIG. 3. *P. albiguttus*, 21 cm. long, on coarse shells of the same kind, partly buried, from August 16 to 19.

FIG. 4. Same individual two minutes later with shells removed. Note that the pattern is much coarser than in figure 2 on the fine shells. In both the skin was distinctly yellowish in color.

PLATE XX.

FIG. 5. Same individual as in figure 4 on very fine gray sand, almost entirely covered with sand. From August 19 to 21. Note the two small depressions in the sand at the base of the caudal fin. The lower one is much more prominent than the other. This individual breathed only through the lower gill. The water which entered the mouth passed back under the body and oozed up through the sand, forming the depressions. The animal was very effectively concealed.

FIG. 6. Same individual uncovered. Compare with figure 4 and note what a great change took place in the pattern. The skin also changed very much in color. All the yellow had disappeared and it had assumed a light gray shade.

FIG. 7. *P. albiguttus*, 13 cm. long, in a glass dish over very fine black sand. Note the remarkable similarity between the pattern and the shade in the fish, especially the central part of the body, and those of the sand. The tips of the fins and the tail have no pigment and consequently stand out boldly against the background.

FIG. 8. *P. albiguttus*, 16 and 10 cm. long, on a smooth jet black background. Note the conspicuous white spots. In some instances all of these, except a trace of the one at the base of the pectoral fin, disappeared entirely.

Plates XXI–XXIII.—Adaptation on artificial black and white backgrounds.

PLATE XXI.

FIG. 9. *Paralichthys albiguttus*, 14 cm. long, individual (B), on black and white background (2 mm. squares) from July 29, 11 a. m., to July 30, 3 p. m., after having been adapted to the background shown in figure 10. This individual was extensively used in the study of adaptation on artificial backgrounds. It is represented in many of the following figures. Note that numerous dark spots have appeared in the light areas shown in figure 10, and that the light spots in the dark areas have become more numerous and more conspicuous.

FIG. 10. Individual (B) on black and white background (5 mm. squares) from July 25, 2 p. m., to July 26, 11.30 a. m., after having been adapted to a white background. Note that the three very light gray areas around the ocelli, shown in figure 13, have become much darker and other dark spots have appeared.

FIG. 11. Individual (B) on black and white background (2 cm. squares) from August 1, 9 a. m., to 4.30 p. m., after having been adapted to 1 cm. squares, shown in figure 12. Note that the pattern has changed very little.

FIG. 12. Individual (B) on black and white background (1 cm. squares) from July 31, 11.40 a. m., to August 1, 9 a. m., after having been on (1 sq. cm. circles) from July 30, 3 p. m., to July 31, 11.40 a. m. Note that the dark areas are darker than in figure 10.

PLATE XXII.

FIG. 13. Individual (B) on a smooth white background continuously from July 23, 2 p. m., to July 25, 10 a. m. It was alternately on white and on black about equal time during the preceding seven days. The skin actually appeared much whiter and less mottled and the animal less conspicuous than the photograph indicates. This is partly due to the shadow in the background along the ventral side. In specimens kept continuously on white for two months the skin became much more uniformly white.

FIG. 14. Individual (B) on black and white background (circles 5 mm. in diameter) from August 11, 12 m., to August 13, 1.30 p. m. Note the remarkable difference between the pattern in this figure and that in figures 9 and 13.

FIG. 15. Individual (B) on black and white background 2 cm. squares from August 24, 11 a. m., to August 27, a. m., after having been adapted to white. Note that the light areas are much larger than on figure 15, which shows the same specimen on the same background at a different time. A great variation was observed in the size of these areas during the time the fish was on this background. There is some evidence indicating that the relative amount of black and white produced in the skin depends upon whether the head is over a black square or over a white square. If it is over a white square there is considerably more black near the eyes than white, and if it is over a black square the opposite is true. While in other positions one eye may be influenced mainly by black and the other mainly by white. This no doubt accounts for the variation mentioned. In other words, a fish 14 cm. long can not simulate light and dark areas of this size as accurately as smaller ones, although larger specimens can.

FIG. 16. Individual (B) on black and white background (circles 5 mm. in diameter) from August 15, 10 a. m., to August 16, 9 a. m. This photograph shows one of the most remarkable concealing patterns observed. The fish appeared to contain numerous holes.

PLATE XXIII.

FIG. 17. Individual (B) on black and white background (1 sq. cm. circles) from August 1, 4.30 p. m., to August 2, 11 a. m. Probably not fully adapted.

FIG. 18. *P. albiguttus* (E), 10 cm. long, on black and white background (1 sq. cm. circles) from August 1, 11 a. m., to August 5, 9.40 a. m. On this background the specimen was nearly uniformly gray much of the time, and the simulation of the figures in this background was at no time as good as it was in larger specimens, although on the finer-grained backgrounds it was quite good, showing that the maximum area of figures successfully simulated depends upon the size of the fish.

FIG. 19. *P. albiguttus*, individual (C), 14 cm. long, on black and white background (1 cm. squares) from July 25, 2 p. m., to July 28, 10.30 a. m. Note that the pattern is similar to that in individual (B), figure 12, although specific individual characteristics can readily be found. Compare, e. g., the ventral ocellus in these two figures.

FIG. 20. *P. albiguttus* (E), 10 cm. long, on black and white background (5 mm. squares) from August 6, 12.30 p. m., to August 8, 10 a. m.

Plate XXIV.—Effect of mechanical stimulation on the pattern produced in the fish.

FIG. 21. *P. albiguttus*, 16 cm. long, in shallow bluish-gray mottled granite pan from August 1 to August 4, 10.30 a. m. Excellent simulation of the background on the entire surface except the three ocelli, which are nearly black.

FIG. 22. Same specimen photographed in the granite pan, August 5, 4 p. m., very shortly after mechanical stimulation. Note the contrast due to the enlargement of the regions around the ocelli and the appearance of numerous dark and light spots. These regions and spots were considerably more

pronounced immediately after stimulation. They become less conspicuous rapidly but it usually requires several minutes for them to disappear completely. They usually also appear when the animal is feeding.

Plates XXV, XXVI.—Adaptation on artificial black and white backgrounds, showing that the patterns on them is not actually reproduced in the skin.

PLATE XXV.

FIG. 23. Individual (B) on black and white background (5 by 10 mm. rectangular), long axis of the fish parallel with short axis of rectangles, continuously August 21, from 10 a. m. to 2.30 p. m., and August 22 from 11 to 11.30 a. m. No change in pattern could be detected from that assumed when the fish was free on this background.

FIG. 24. Individual (B) on same background, long axis of fish continuously parallel with long axis of rectangles, August 22 from 3.10 to 5 p. m., and August 23 from 6 to 9.15 a. m.

FIG. 25. Individual (B) on the same background continuously rotated on a disk under the crystallizing dish August 21 from 2.30 to 4.45 p. m. Note that the pattern is essentially the same as that shown in figures 23 and 24, although the apparent forms of the figures were continuously changing from long narrow to short and broad rectangles and vice versa.

FIG. 26. Individual (B) on black and white background (1 sq. cm. circles, area of white equal to that of black) from August 7, 11.30 a. m., to August 8, 10.15 a. m.

PLATE XXVI.

FIG. 27. Individual (B) on black and white background (1 sq. cm. circles, area of black equal to that of white) from July 30, 3 p. m., to July 31, 11.40 a. m.

FIG. 28. Individual (B) on black and white background (stripes 1 cm. wide) from August 4, 5.15 p. m., to August 5, 9.45 a. m.

FIG. 29. Individual (B) on black and white background (stripes 5 mm. wide) from August 5, 4 p. m., to August 6, 4 p. m. Note that the pattern produced by stripes is essentially the same as that produced by white circles on a black field (fig. 26) or black circles on a white field (fig. 27) or square or elongated rectangles, foreshortened in either direction or constantly rotated so as to continuously change the perspective. There is no evidence whatever indicating an actual reproduction in the skin of the figures in the background.

FIG. 30. *P. albiguttus* (A), 15 cm. long, on black and white background (5 mm. square) from July 23, 2 p. m., to July 25, 10 a. m. This specimen was tested on larger and on smaller squares and also on stripes. The pattern produced in the skin was essentially the same as in individual (B), shown in the preceding figures.

Plates XXVII, XXVIII.—Photographs showing more in detail the relation between the pattern in the skin and that in the background.

PLATE XXVII.

FIG. 31. *P. albiguttus* (F), 14 cm. long, in large, shallow granite pan (variegated, dark blue and white) from July 31 to August 14. Note the small white spots shown in irregular rows across the fish.

FIG. 32. Individual (F) on black and white background (dots 2 mm. in diameter) from August 23 to 27, 10 a. m. The white spots in the irregular rows have become more conspicuous, but the pattern is essentially the same, although the spacial interrelationship of the light and dark areas in the background is very different. This is very clearly shown in the enlarged photographs reproduced in figures 35, 36, 38, and 39.

FIG. 33. Individual (C) same specimen shown in figure 19 in the granite pan represented in figure 31 from August 1, 9 a. m., to August 14, after having been on various backgrounds during the preceding week. All the individuals in the granite pan after being fully adjusted were so inconspicuous that it required considerable attention to see them. (See autochrome fig. 66.)

FIG. 34. Individual (C) on black and white background (2 mm. squares) from August 25, 8 a. m., to August 27, 10.18 a. m. Note that the patterns produced by these two very different backgrounds are essentially the same.

PLATE XXVIII.

FIG. 35. A small section of the background shown in figure 31, enlarged. $\times 9$.

FIG. 36. Enlargement of a small section of figure 31 taken slightly above the ventro-anterior ocellus. $\times 9$.

FIG. 37. Enlargement of a section taken from the same relative place in figure 32. $\times 9$.

FIG. 38. A small section of the background shown in figure 32, enlarged. $\times 9$. Note that the details of the pattern in the skin (fig. 36, 37) assumed on these two different backgrounds (fig. 35, 38) are strikingly similar. Practically all of the dark and the light areas found in one are also found in the other, and the forms of these are, respectively, very nearly the same, although in the two backgrounds the dark and the light areas differ greatly, both in form and in spacial arrangement. The same is true with reference to individual (C), figures 33, 34, 39, and 40. On neither background is there any evidence of an actual reproduction in the skin of the configuration in the background.

FIG. 39. Enlargement of a small section of figure 33 located in the same relative position as that reproduced in figures 36 and 37. $\times 9$.

FIG. 40. Enlargement of the same relative section of figure 34. $\times 9$. Note that the patterns shown in figures 39 and 40 are essentially the same, although the backgrounds on which they were produced differ greatly. Note also that the patterns shown in figures 36 and 39 differ considerably in detail, although produced by the same background but in different individuals. While the large features in the pattern of the skin of all individuals of this species are essentially the same, there is sufficient specific individuality in the smaller features to make it possible to recognize every individual by a thorough study of the pattern found on a square millimeter or less of any part of the pigmented surface.

Plates XXIX, XXX.—The photographs on these plates show that simulation of the background is dependent upon stimuli received through the eyes and that the stimuli from each eye are distributed over the entire pigmented surface.

PLATE XXIX.

FIG. 41. Individual (B) (same specimen shown in many other figures), on black and white background (2 mm. squares) from July 29, 11 a. m., to July 30, 3 p. m.

FIG. 42. Individual (B) on black and white background (circles 1 sq. cm.) from July 30, 3 p. m., to July 31, 11.40 a. m.

FIG. 43. Individual (B), one eye continuously on a coarse and the other on a fine-grained background, on August 29, 8 to 11.20 a. m. No further appreciable change occurred in the pattern after 8.30 a. m. Thus it is clear that the fish was fully adapted long before the photograph was taken. This rapid adaptation was no doubt due to the fact that this animal had been used in the study of patterns produced by different backgrounds almost continuously for a month or more. Note that the pattern is the same over the entire surface and that it is intermediate in texture between those shown in figures 41 and 42. It appears to be a sort of superimposition of these two patterns.

PLATE XXX.

FIG. 44. *P. albiguttus* (G), 22 cm. long, head continuously on white and tail on black, on August 21, 2.30 to 4.55 p. m. This specimen was taken from a black aquarium and was fully adapted to black in the beginning of the experiment.

FIG. 45. Individual (G), one eye on white the other on black continuously, on August 22, 10 to 11.55 a. m. The fish was nearly maximum black at 10 a. m.

FIG. 46. Individual (G), continuously with head on white, body on black, on August 23, 6 to 9.20 a. m.

FIG. 47. Individual (G), head on black, body on white, on August 23, 9.20 a. m. to 12 m.

Plates XXXI, XXXII.—Limits of vision, keenness of discrimination, and adaptation to gray background.

PLATE XXXI.

FIG. 48. *P. albiguttus*, 12 cm. long, fully adapted to a very light gray background. This specimen continuously appeared somewhat darker than the background. Note that the three ocelli have almost entirely disappeared:

FIG. 49. Individual (B) (fig. 9), on black and white background (dots 0.5 mm. in diameter) from August 16, 2 p. m., to August 17, 9 a. m. Dots of this size, no matter how numerous, had no effect except perhaps to cause the skin to become uniformly slightly grayer.

FIG. 50. Individual (B) on black and white background (dots 1 mm. in diameter) on August 5, 9.45 a. m. to 4 p. m.; after having been fully adapted to 1 cm. squares. These spots have no appreciable effect on the skin unless they are more numerous than they are in this background.

FIG. 51. Individual (B) on black and white background (dots 1 mm. in diameter) on August 20, 10 a. m. to 4.45 p. m., after having been fully adapted to dots 2 mm. in diameter. Note that the posterior ocellus is much darker than on white, but that the two anterior ones are not.

In the production of a pattern in individuals which are maximum white the posterior ocellus always becomes dark first, then the two anterior ocelli and then a row of ten dark spots appears along the base of the fins. Following this two dark spots appear in the tail and two in the central part of the body, after which others appear in the fins, the tail, and elsewhere.

PLATE XXXII.

FIG. 52. Individual (B), on black and white background (dots 3 mm. in diameter) on August 14, 7 a. m. to 1.30 p. m., after having been fully adapted to white.

FIG. 53. Individual (B), on black and white background (dots 3 mm. in diameter) from August 16, 10 a. m., to August 19, 12 m. The black spots are clearly somewhat larger and denser than those produced on dots 2 mm. in diameter (fig. 54).

FIG. 54. Individual (B), on black and white background (dots 2 mm. in diameter) from August 19, 3 p. m., to August 20, 10 a. m., after having been fully adapted to white. On this background the same number of black spots are produced as on that in figure 52, but the spots are slightly larger and more dense. This statement and all others of a similar nature are based upon a comparative study of a series of prints made from each of the different negatives, and upon descriptions of the effect of the different backgrounds written during the process of the experiments.

FIG. 55. Individual (B), on black and white background (dots 5 mm. in diameter) from August 2, 12 m., to August 3, 1 p. m.; no observable change after 8 a. m. The black spots are practically the same as those produced on dots 2 mm. in diameter, but only half as far apart (fig. 54).

Putting the matter in subjective terms this work shows that these animals do not recognize dots 0.5 mm. in diameter as individuals, but that they do recognize those 1 mm. in diameter and that they distinguish dots 2 mm. in diameter from those 3 mm. in diameter and dots 3 mm. in diameter from those 5 mm. in diameter.

Plates XXXIII-XXXV.—Simulation of colors in the background.

PLATE XXXIII.

For a fuller account of the environment of the specimens autochromed see text.

To compare the color of the different individuals eliminate the background by covering the autochromes with the accompanying gray sheet containing holes. These autochromes prove conclusively that the color in *Paralichthys* and *Ancylosetta* changes within wide limits so as to harmonize fairly accurately with that of the background.

FIG. 56. *P. albiguttus*, 17 cm. long, on chrome yellow from September 1 to 11. The color is only fairly accurately reproduced.

FIG. 57. *P. albiguttus*, 15 cm. long, on green from August 11 to 26.

FIG. 58. *P. albiguttus*, 19 cm. long, on dark blue from August 7 to 8. This specimen became bluish exceptionally rapidly. It remained on dark blue four days longer and became but little more blue than it was when autochromed.

FIG. 59. *P. albiguttus*, 20 cm. long, on vermilion from July 27 to August 26.

PLATE XXXIV.

FIG. 60. *Ancylosetta quadrocellata*, 14 cm. long, on pink (Ridgway's alizarin pink) from August 3 to September 11. Excellent reproduction.

FIG. 61. *A. quadrocellata*, 17 cm. long, on dark blue from August 22 to 26.

FIG. 62. Same specimen on green from August 26, 4 p. m. to August 30, 2.30 p. m. When first transferred, this fish appeared even bluer in the green box than it did when it was in the blue box, and there was no evidence of green whatever. During the following four days the blue became fainter and the fish gradually assumed a greenish tint. But at the end of this time there was still considerable blue in the skin, as the autochrome shows. This demonstrates conclusively that the color of the skin as reproduced in all of the figures on this plate is due to internal structures and not to colored light reflected from the surface or transmitted through the fish, as has been suggested by a number of those who have seen the original autochromes. This is more conclusively demonstrated in the reproduction of autochromes taken later (figs. 64, 65, and 67).

FIG. 63. *A. quadrocellata*, 16 cm. long, on chrome yellow from July 27 to August 26.

PLATE XXXV.

FIG. 64. *P. albiguttus*, 15 cm. long, on blue from August 20 to September 11; autochromed in a green box. This proves that the color shown in the autochromes is due to the structure of the skin and not to light reflected from the background as many who saw the originals maintained.

FIG. 65. Four specimens of *P. albiguttus*, adapted to blue, green, yellow, and pink backgrounds, respectively, autochromed on green. Color in all but the yellow one is quite faithfully reproduced.

FIG. 66. *P. dentatus*, 14 cm. long, in a variegated blue and white granite pan from August 19 to September 10. The brown spots are due to particles of rust. Colors faithfully reproduced.

FIG. 67. *Paralichthys*, same individuals adapted to the same backgrounds as in figure 65. Autochromed on a white background. The color in all but the smallest specimen is fairly faithfully reproduced. The smallest specimen appeared much greener in life and also in another autochrome taken at the same time than it does in this figure.

Plate XXXVI.

FIGS. 68-76. Photographs taken with orthonon plates of specimens adapted to colored backgrounds. Fig. 68, brown; 69, dark blue; 70, maroon; 71, green; 72, vermilion; 73, light blue; 74, dark blue; 75, green; 76, chrome yellow. Note the remarkable simulation of the background in shade and the absence of conspicuous patterns, especially in *Paralichthys*. The conspicuous dark areas and light spots shown in figure 70 were present only after abnormal stimulation.

Plate XXXVII.

FIG. 77. Photograph of a group of *Paralichthys* on a white background containing considerable débris scattered over it. All of the specimens are *albiguttus* except the large one above and to the left, which is *dentatus*. Note that this specimen has five dark areas, two rather inconspicuous ones near the head and three near the posterior end. In some specimens there are several others nearly as conspicuous as these. In *albiguttus* there are but three, the two near the posterior end at the base of the fin being absent.

The difference in shade in the different individuals is largely due to difference in their past experience.



3



4

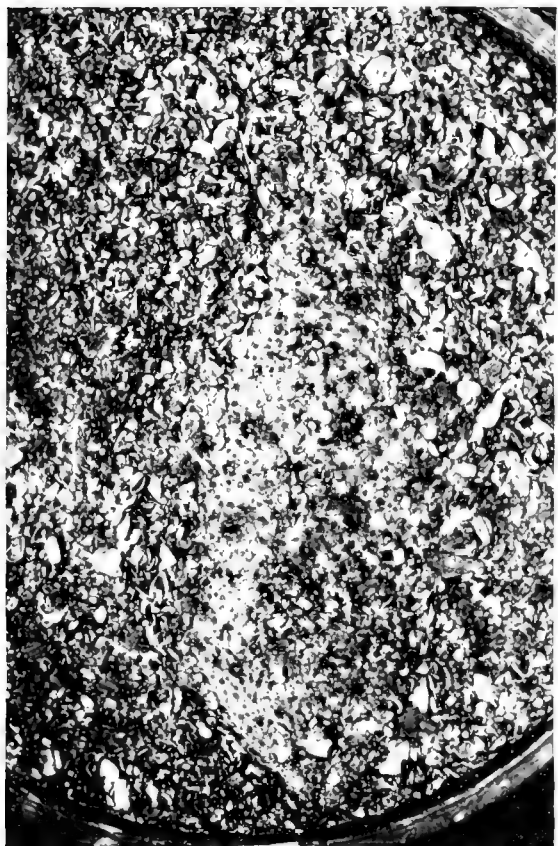

1

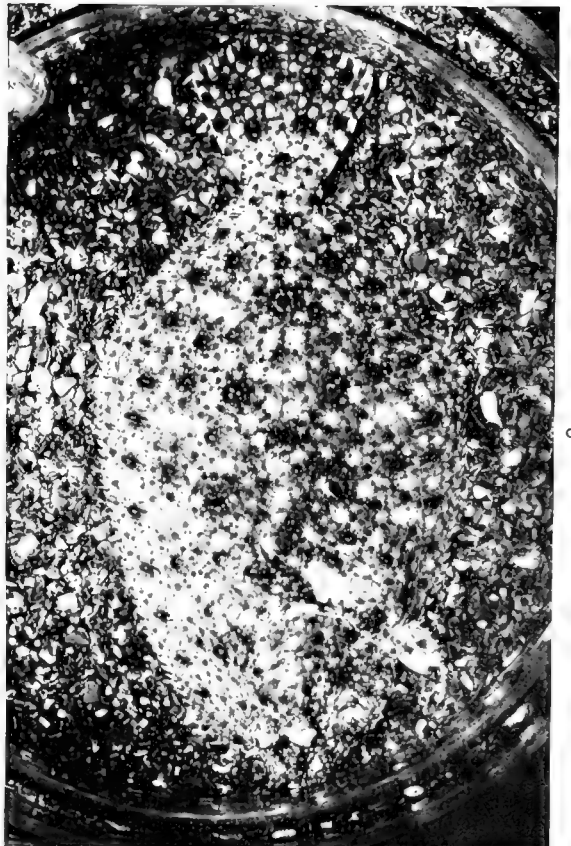

2

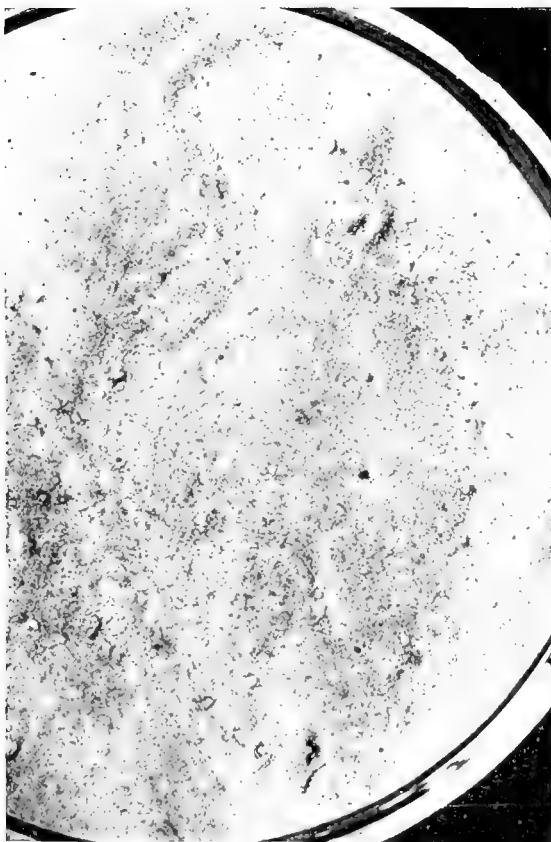

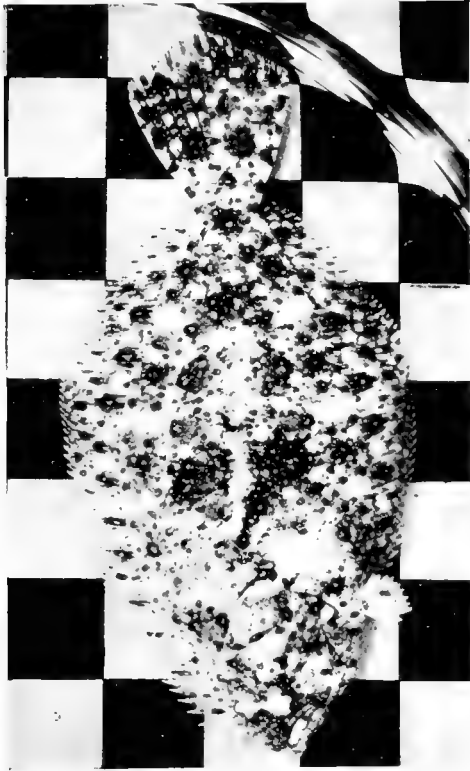

11

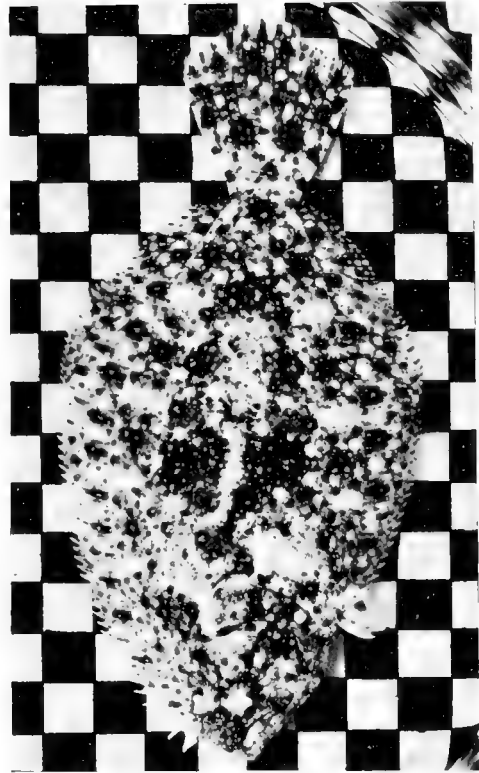

12

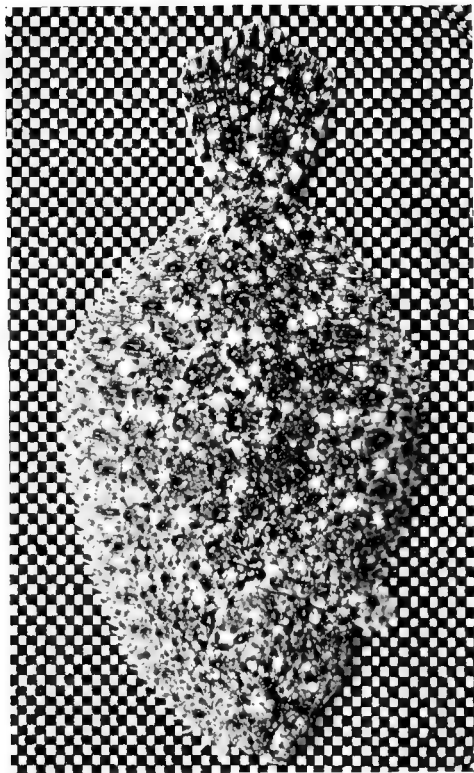

9

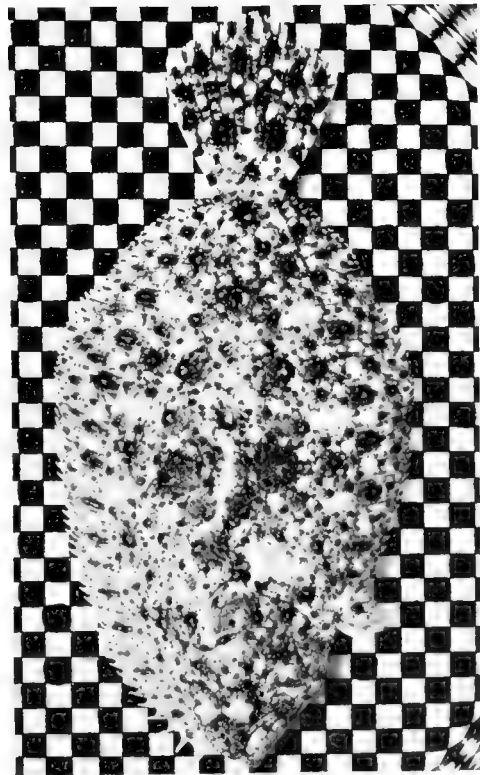

10



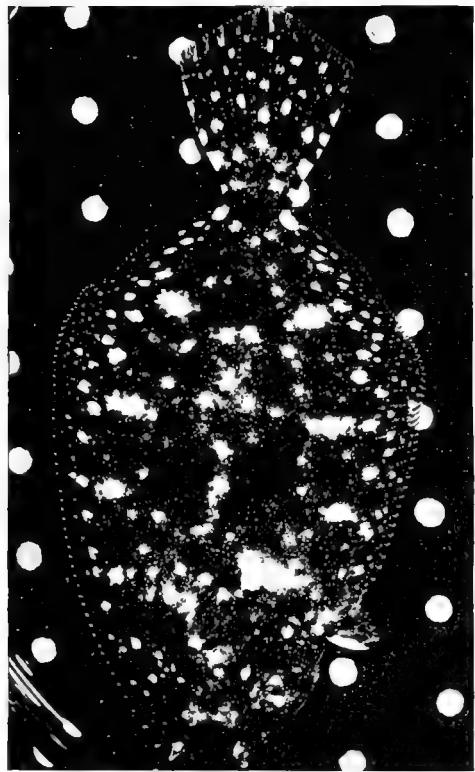
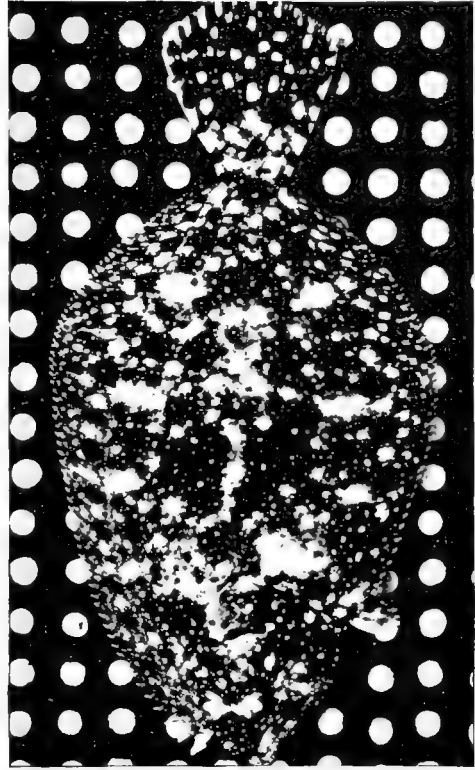
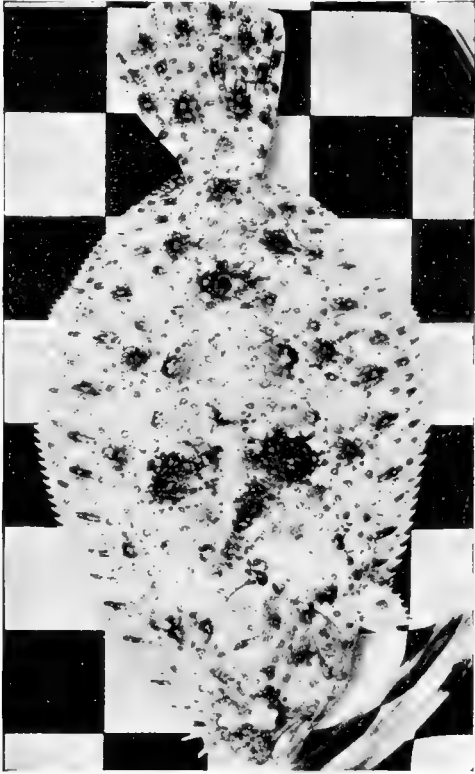

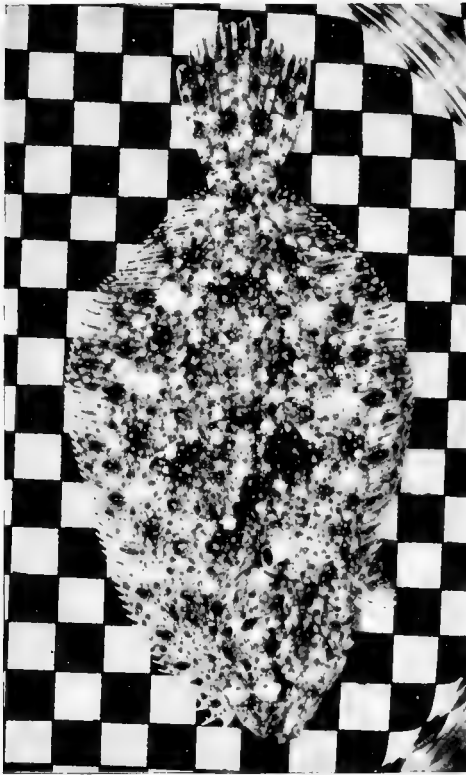

19

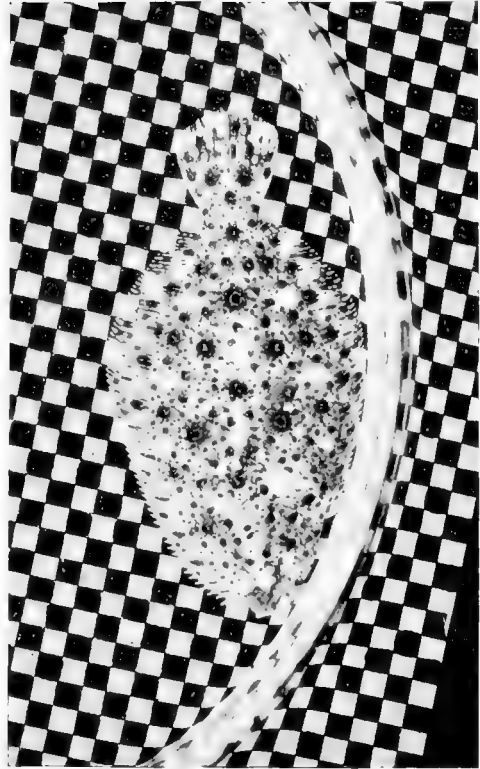

20



17

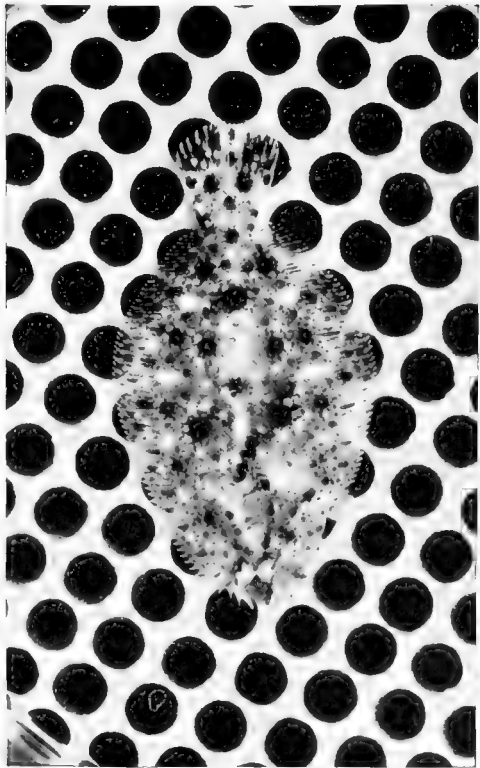

18

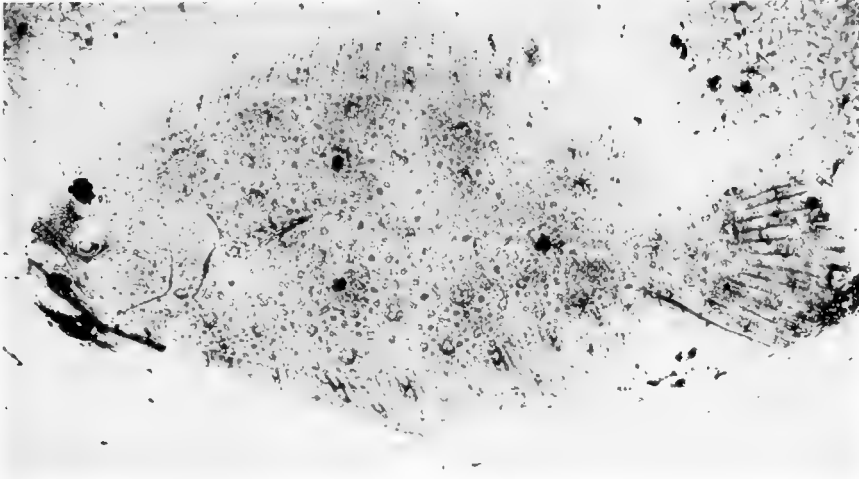

21

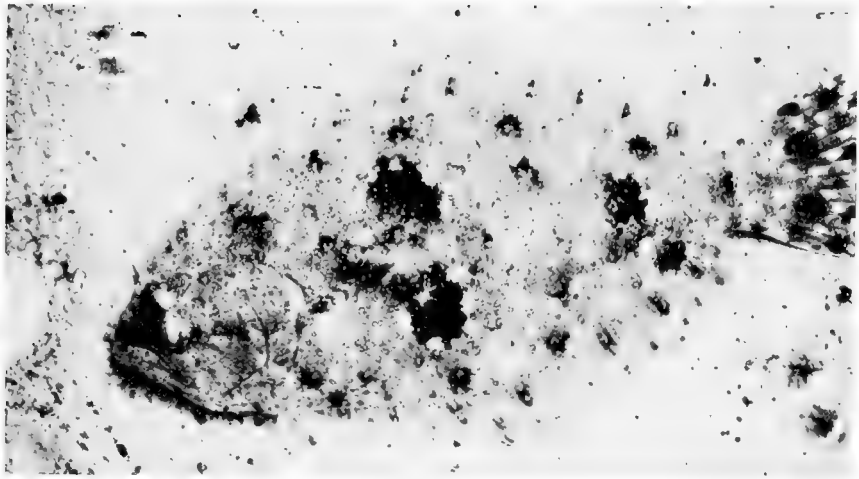

22

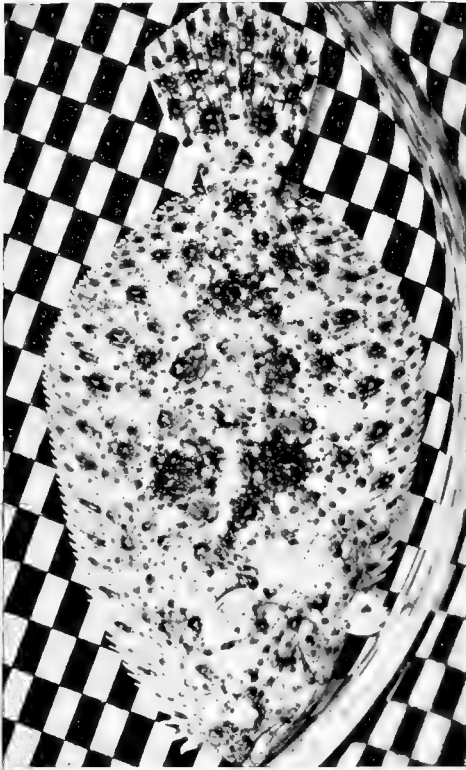

25

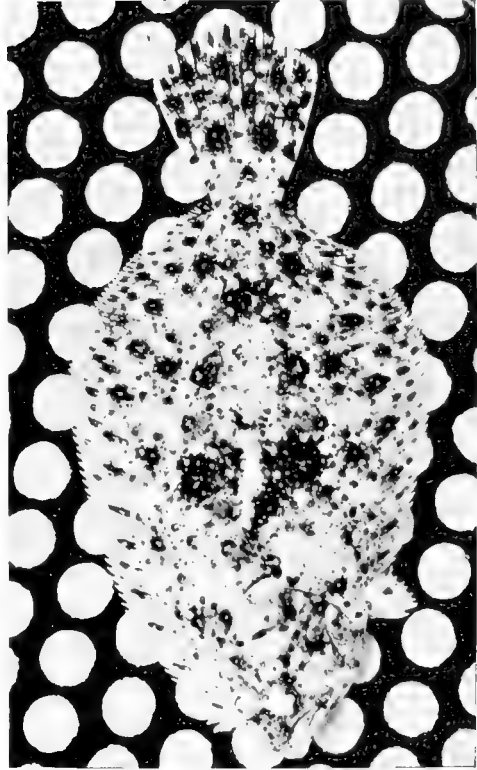

26

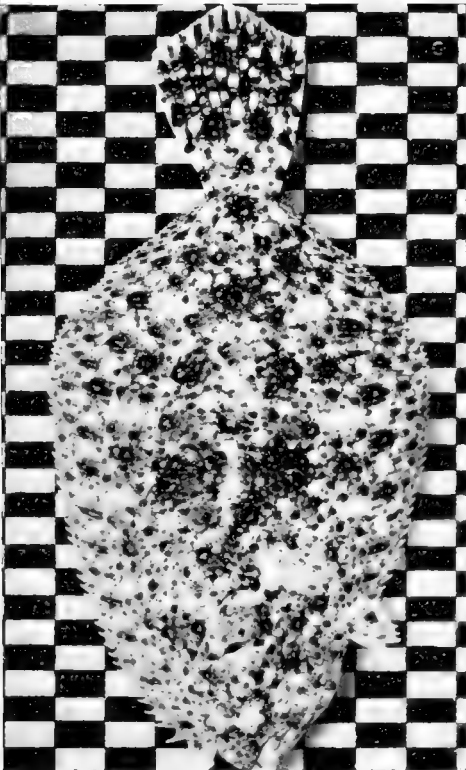

23

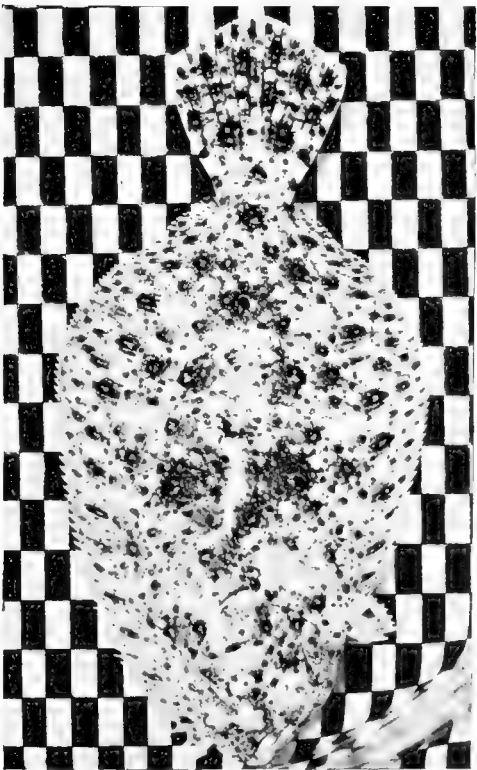

24



29

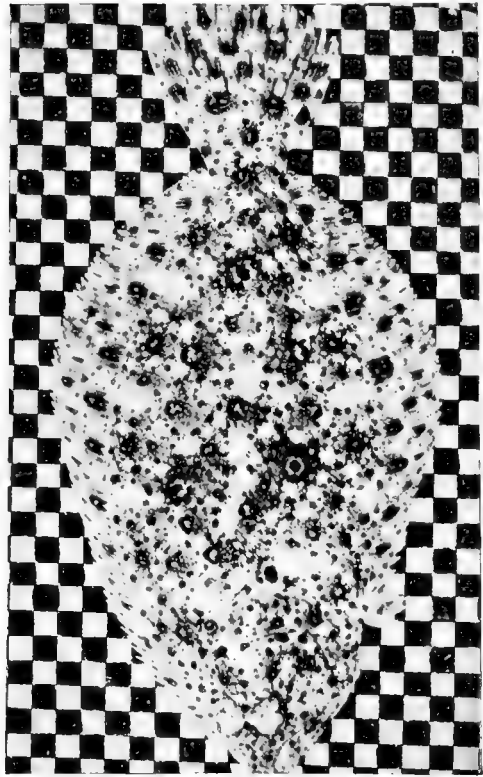

30

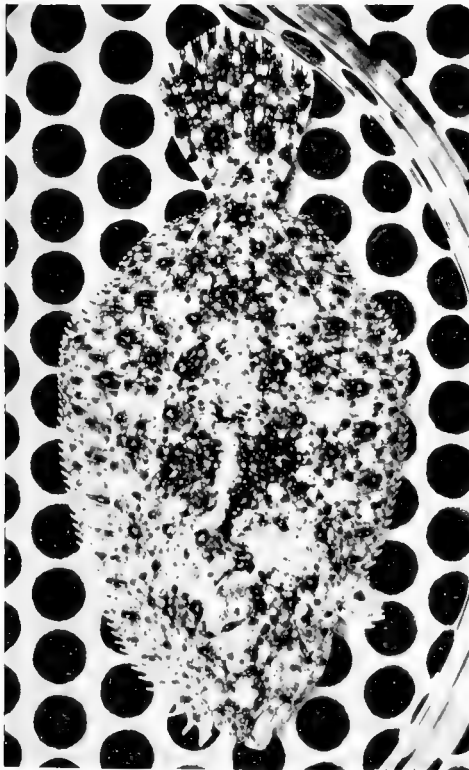

27



28

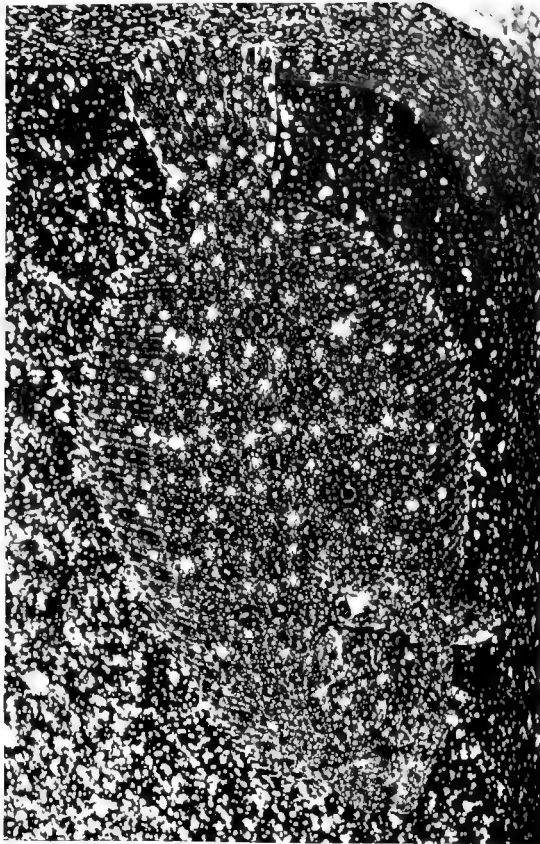

33

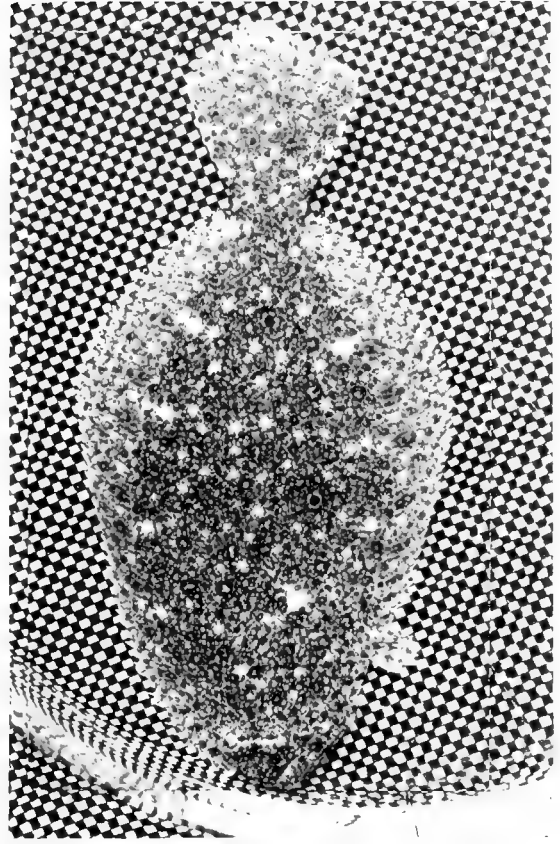

34

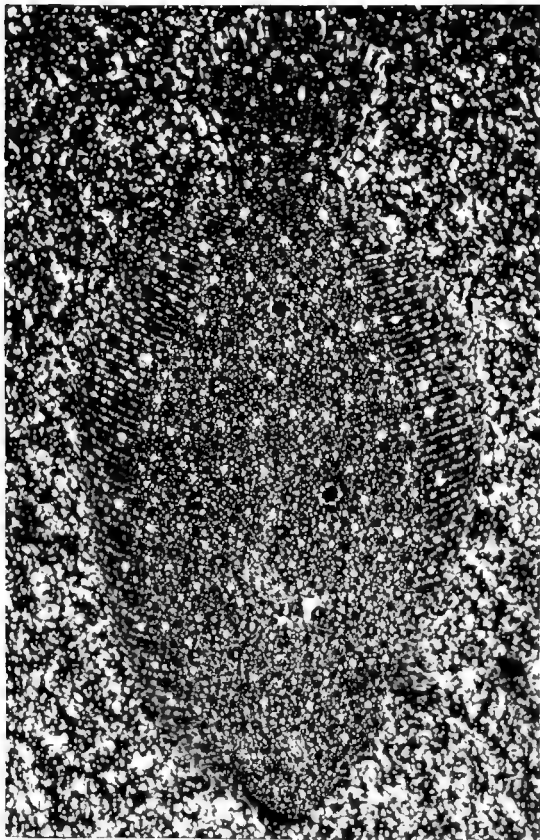

31

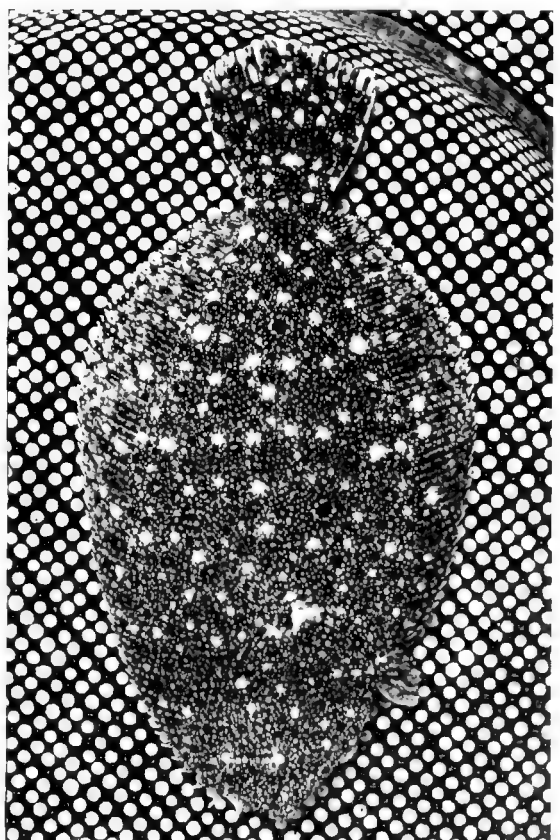

32

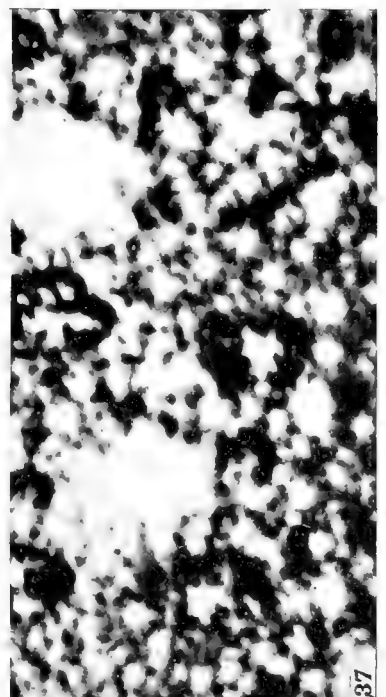
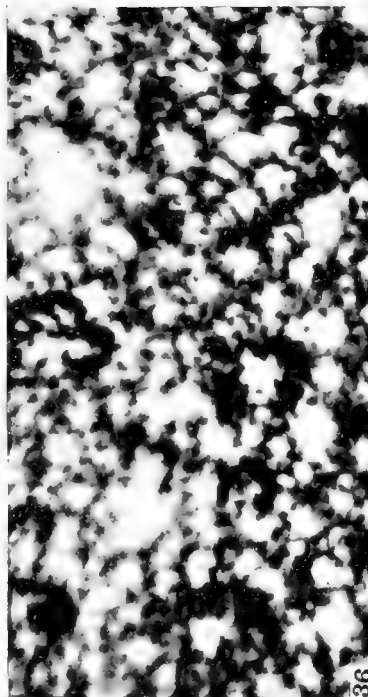
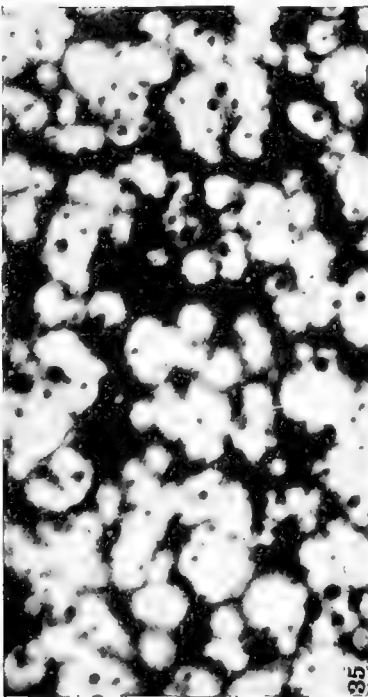
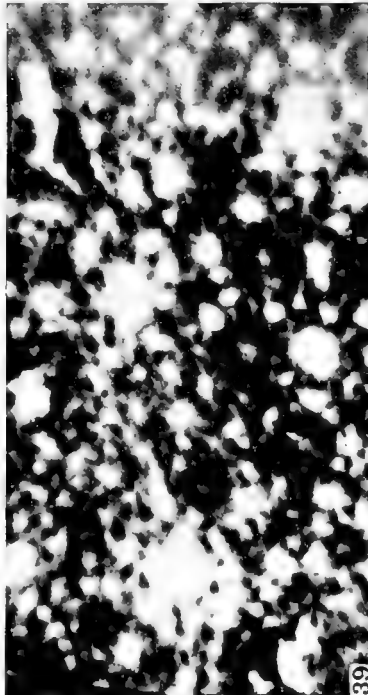
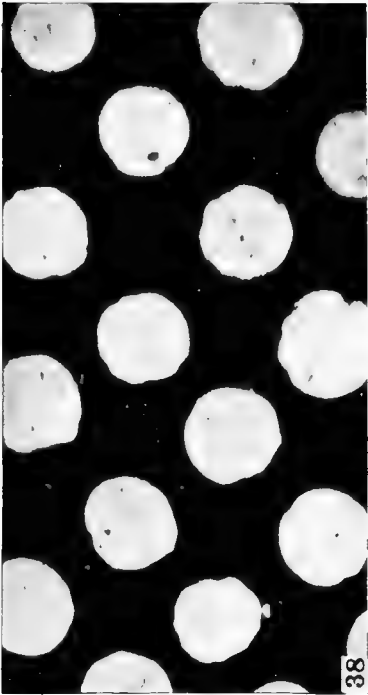

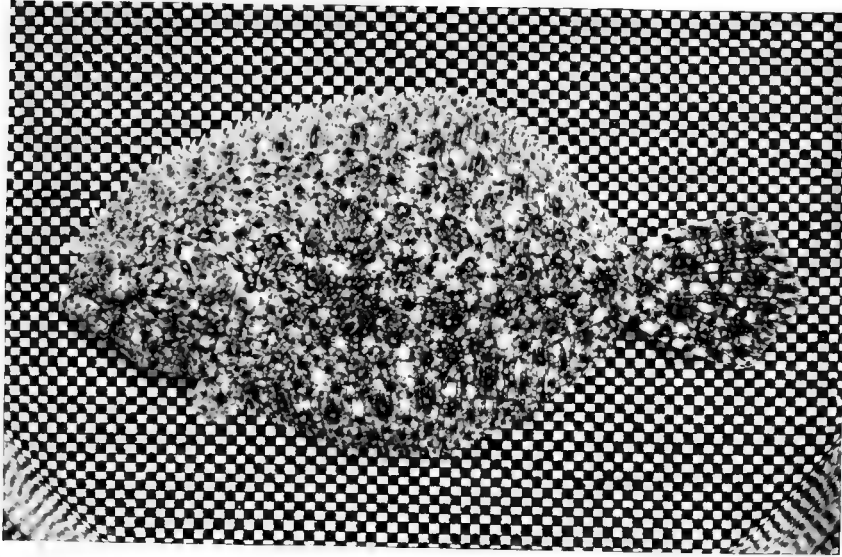

41

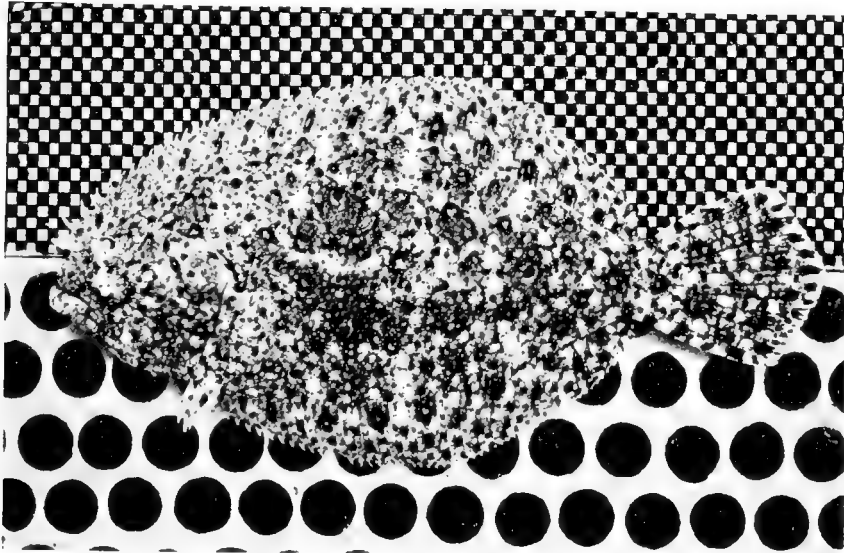

43

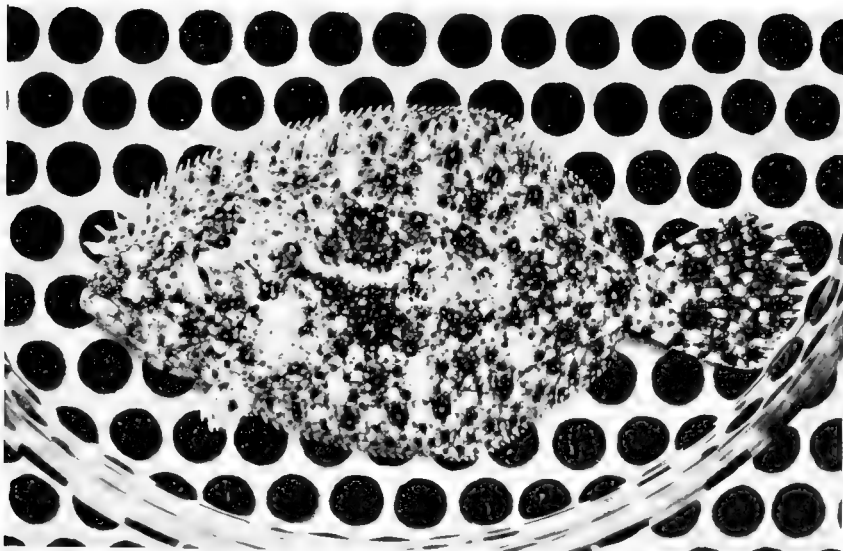

42



46



47



44



45

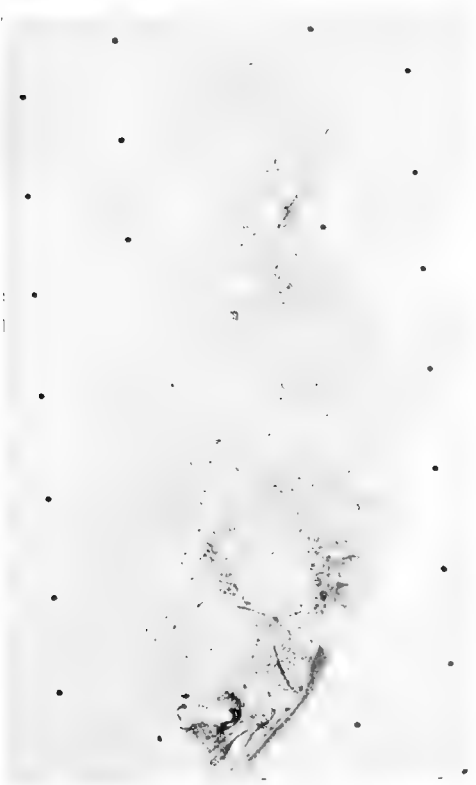

50

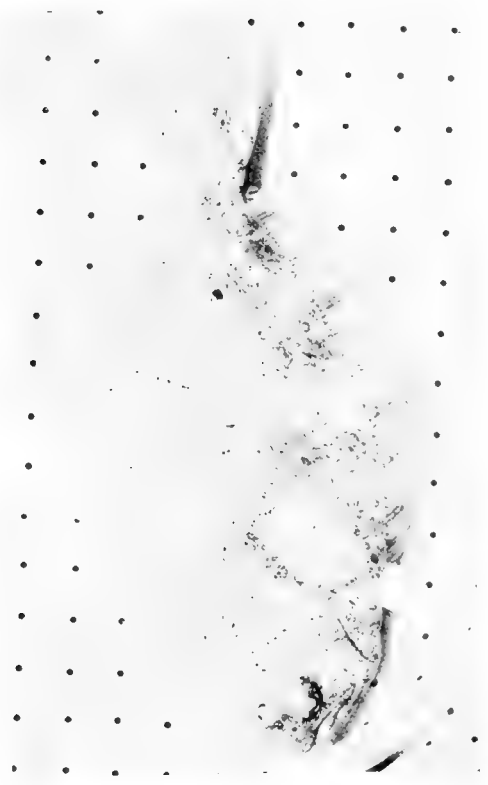

51

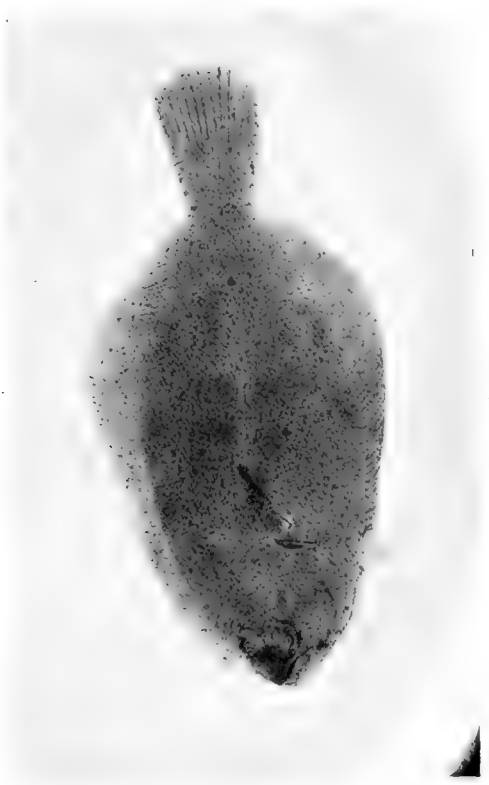

48



49



54



55

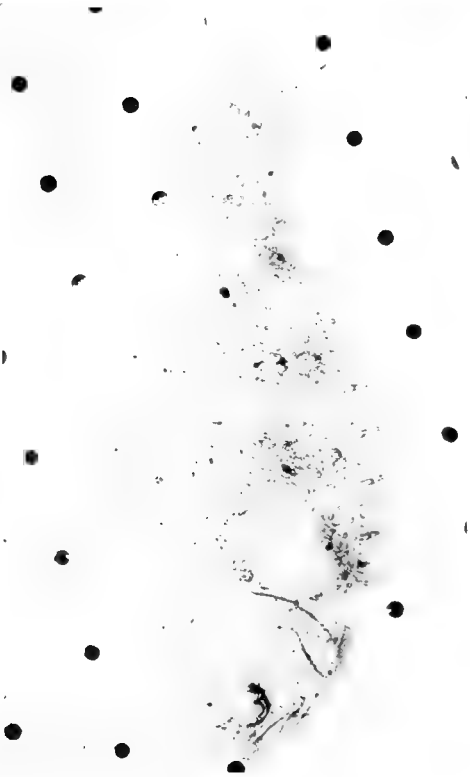

52

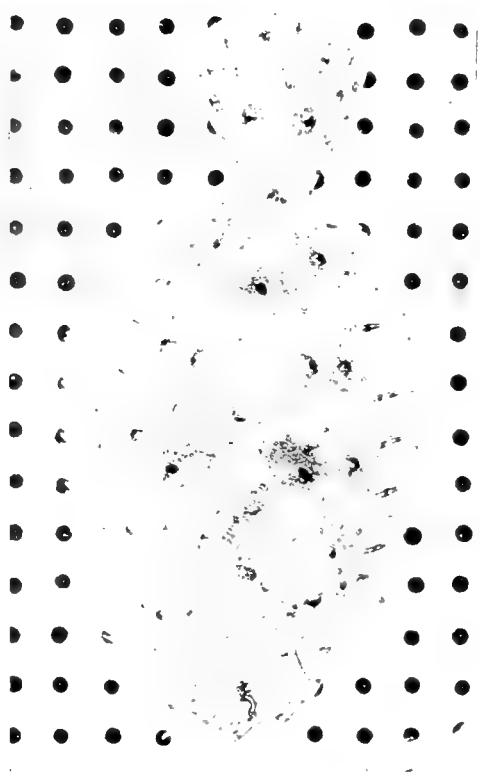

53



58



59

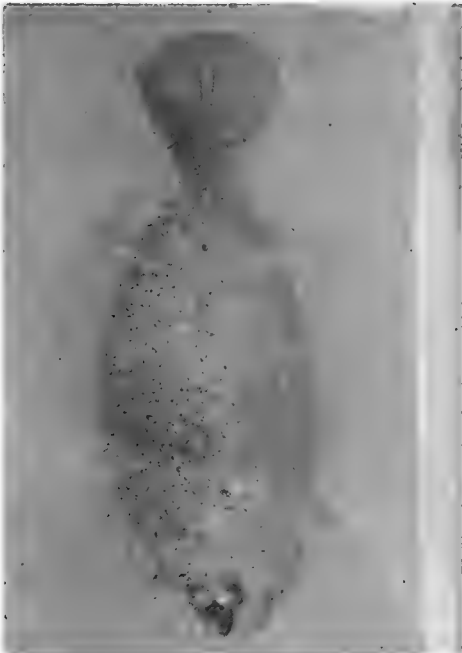

56



57



61

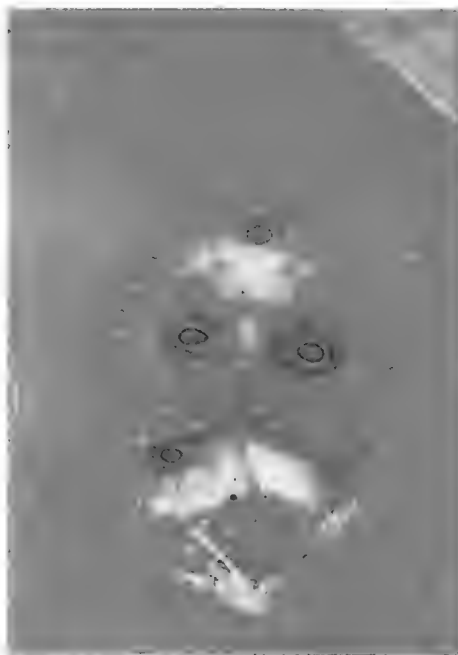

63



60



62

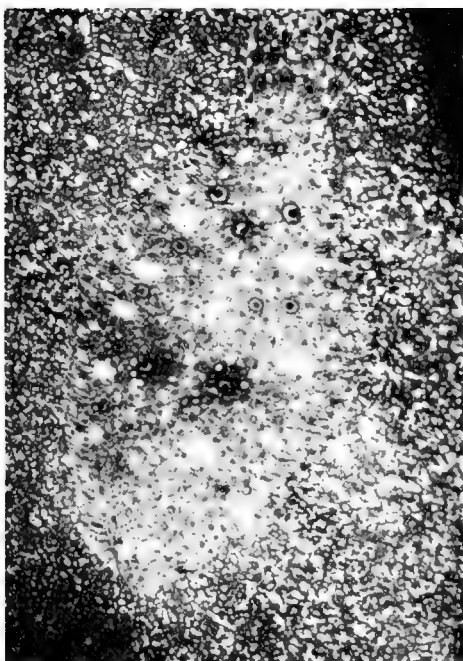

66



65

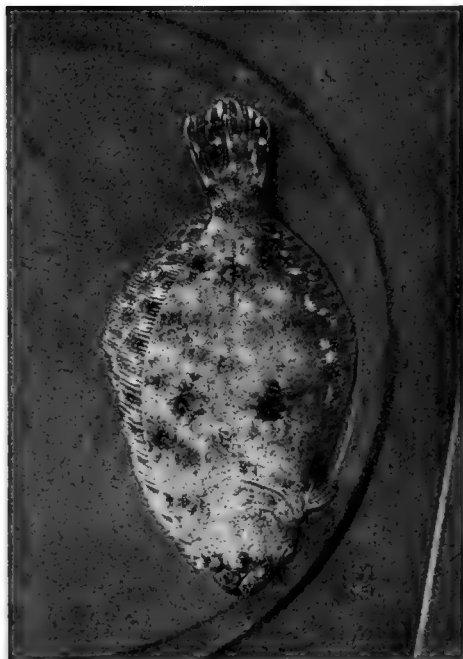

64



67

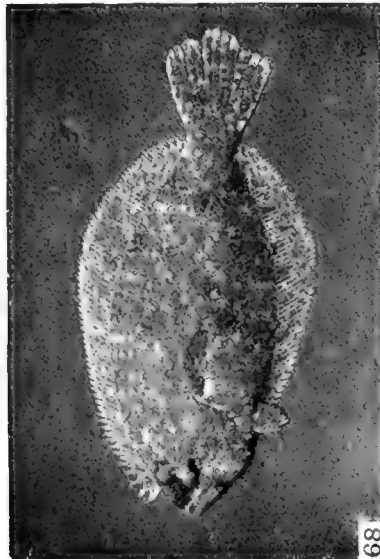
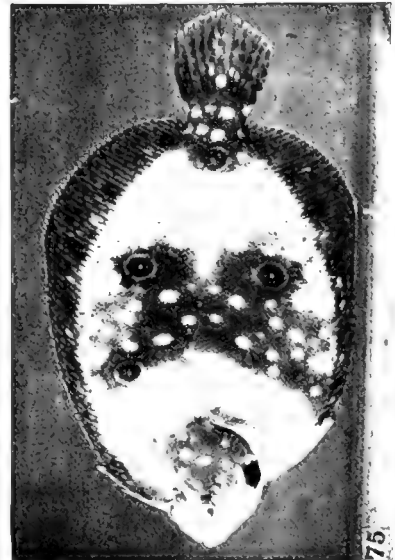
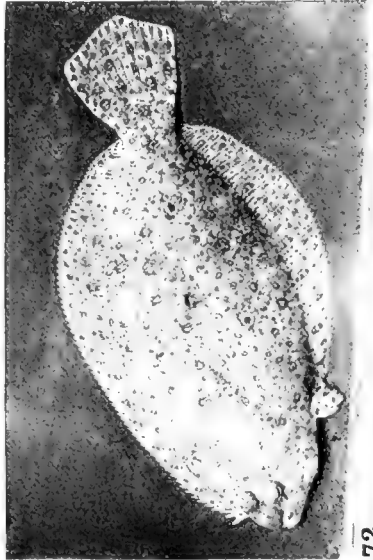
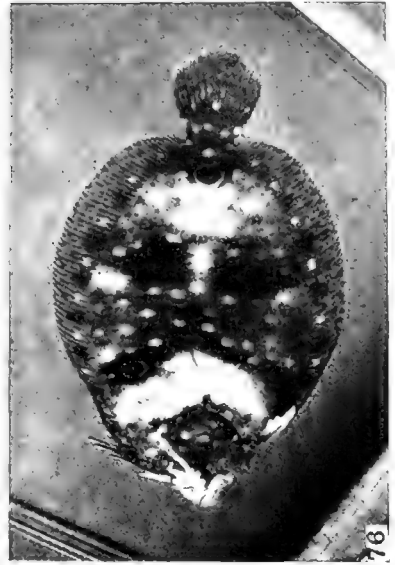
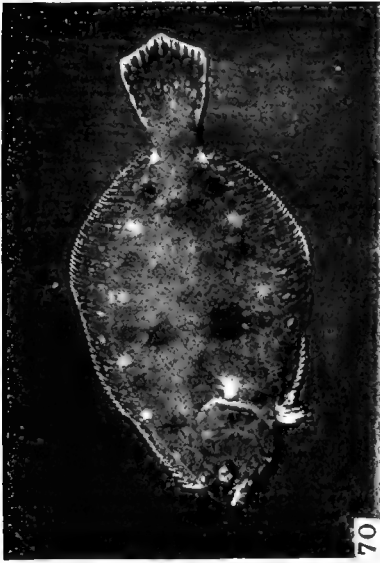

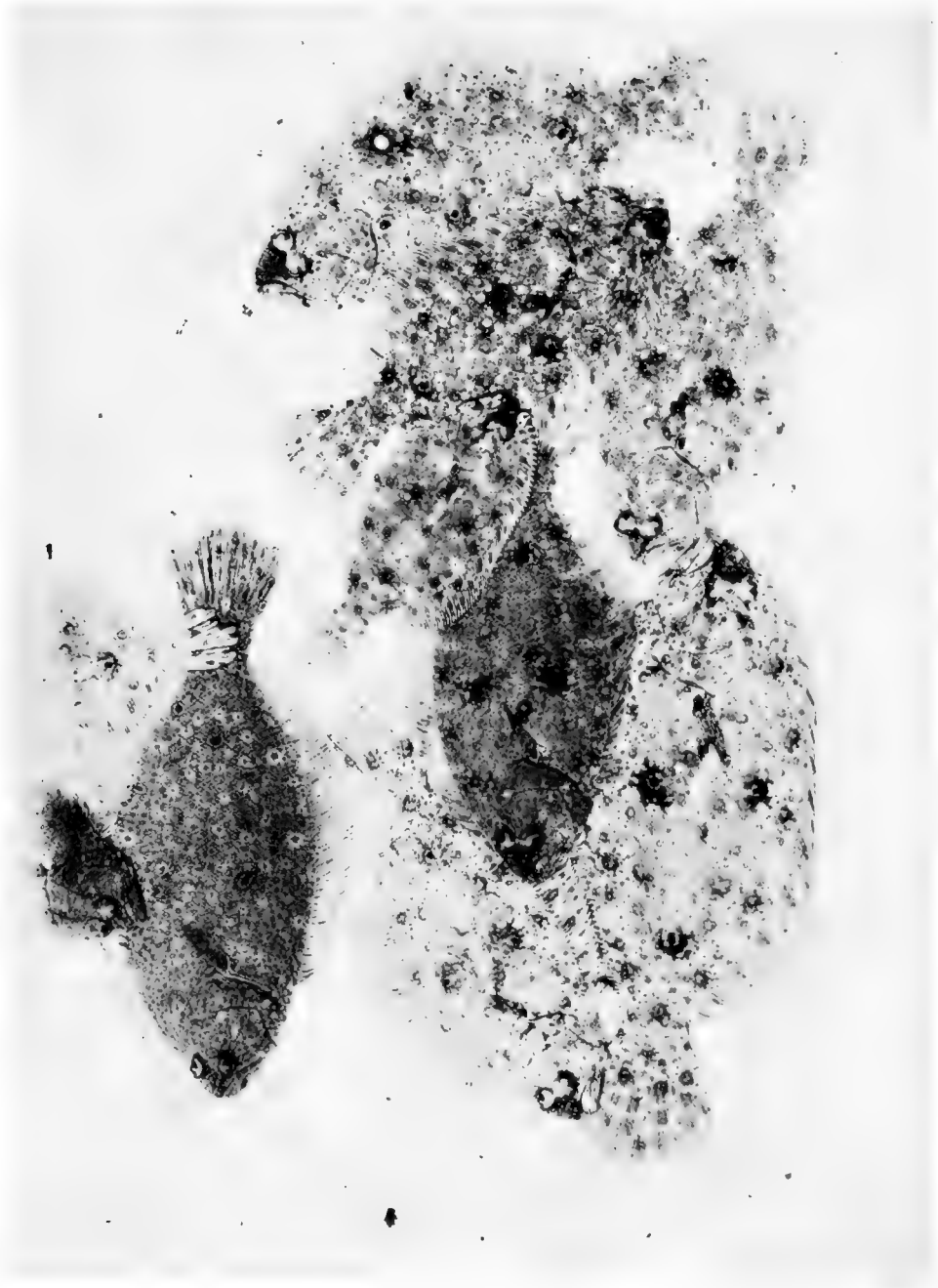

THE SHARKS AND RAYS OF BEAUFORT, NORTH CAROLINA



By Lewis Radcliffe

Scientific Assistant, U. S. Bureau of Fisheries



Contribution from the United States Fisheries Biological Station, Beaufort, N. C.



THE SHARKS AND RAYS OF BEAUFORT, NORTH CAROLINA.

By LEWIS RADCLIFFE,

Scientific Assistant, United States Bureau of Fisheries.

Contribution from the United States Fisheries Biological Station, Beaufort, N. C.

INTRODUCTION.

The present report deals with the species of sharks and rays of the Beaufort region and includes two species from the Gulf Stream near by. It is intended primarily to serve as a laboratory guide to investigators in this field. The demand for a work of this character has been augmented by the addition to the fauna of a number of little-known species not previously reported from the eastern coast of the United States, by lack of adequate descriptions in some instances and inaccessibility of literature in others. The latest descriptive report on the species of the North Carolina coast contains but 18 of the 37 listed herein.

This report was begun at Beaufort in the summer of 1912 and continued intermittently through the summers of 1913 and 1914. It is not the intention to supply complete descriptions for each species, but to furnish data of a character generally lacking in papers on the subject and to make the report of special value as a field manual. For the most part, descriptions and illustrations^a are based on material from this region; for completeness material has been obtained wherever possible. The report contains working keys and aims to include in the synonymy of each species all published references on the subject for this region and no others. The species are arranged in accordance with the classification of Dr. Samuel Garman in "The Plagiostomia" (Memoirs Museum Comparative Zoology, vol. xxxvi, 1913, in two parts), and the nomenclature used in that report has been adopted.

Many of the sharks and rays are too large to preserve or even transport to one's laboratory. The question of what notes should be taken or what is the minimum of material that must be preserved to insure identification of the form often arises. The writer finds that, in addition to the usual field notes, if the jaws and a piece of the shagreen below the first dorsal are preserved, these are all that will be required to identify the sharks. In most species the form and sculpturing of the dermal denticles from a definite body region appear to vary little, if any, with age; in others age differences appear. The amount or extent of variation for all species could not be determined with the limited amount of material obtainable. The denticles from the side of the body below the first dorsal have been used in every case in which they

^a The drawings were made by Mrs. E. Bennett Decker, of Washington, D. C.; the photographs of jaws, embryos, and adults by the author.

were available at the time. With the exception of the two species of hammer-headed sharks, the character of the teeth or denticles, or both, have been of value in identifying the species.

The writer is indebted to the assistants at the Beaufort laboratory who aided in this work; and also to Mr. Barton A. Bean, of the United States National Museum; Mr. Russell J. Coles, of Danville, Va.; Mr. Vinal N. Edwards, of the Woods Hole laboratory; Dr. E. W. Gudger, of Greensboro, N. C.; and Mr. John T. Nichols, of the American Museum of Natural History, for the use of material.

UTILIZATION OF SHARKS AND RAYS.

In the United States there is a prejudice against the use of this class of animals for food that results in waste of what rightfully should be a resource. In England and Wales, for example, 64,996 hundredweight of dogfish, valued at £20,242, were landed in 1913. As the flesh of these small sharks, when properly prepared, is palatable, there appears to be no valid reason against its use. The United States Bureau of Fisheries has been conducting preliminary experiments in the preparation of this meat, and there is good ground for the belief that a demand for the article will be created. Even now sharks are more universally eaten than is generally known. As an instance of this, a letter from Mr. Vinal N. Edwards, of Woods Hole, Mass., states that the trap fishermen of that region ship all of the large species of sharks, with one exception, caught in their traps. Among those shipped are the thresher (*Vulpecula marina*), dusky sharks (*Carcharhinus obscurus* and *milberti*), and the black-finned shark (*Carcharhinus limbatus*), the exception being the sand shark (*Carcharias taurus*). The fishermen remove the head, fins, and tail; the body then looks not unlike a swordfish and is shipped to Boston or New York, where it is sold as deep-water swordfish. The fishermen receive from 3 to 8 cents per pound for this class of food.

There are still other uses to which the sharks and rays might be put. For example, oil may be extracted from the liver, which reaches a very large size in these forms; the skins, which have been used to a limited extent, possess certain characteristics which, it would seem, might be capable of more general use. Stevenson (Report of the United States Commission of Fish and Fisheries for 1902, p. 347-348) says:

The skins of sharks, rays, and dogfish are commonly very rough and studded with numerous horny tuberculous markings or protuberances. Some have small imbricated and triangular scalelike tubercles; others unimbricated and nearly rhomboid, which in one species are ranged near each other in quincunxes, or they may be quite square, compact, and comparatively smooth on top. These protuberances are usually firmly fixed to the skin so that they are not easily separated therefrom. They are rough and hard and take a polish almost equal to stone.

These skins, like those of all cartilaginous fishes, are very durable. A peculiarity, in addition to the markings above noted, is the nonporous character. The pores that are everywhere present in the skins of most mammals, which give the natural grain in the tanned leather, are entirely indiscernible in the skins of these fish. The result is to render them almost proof against water absorption. Although by skillful tanning the fibers of seal and other skins may be plumped and the body of the membrane solidified, yet much water exposure loosens the fiber and gradually permits absorption. Not being of a porous nature, shark skin is naturally free from this defect; but the advantage is also a disadvantage in some respects. The nonporous leather is practically airproof as well as waterproof, and that is a serious defect when its use for footwear is considered. Beyond this, the skins of sharks and similar fishes may be prepared into a very durable, noncracking leather, for which many uses may be found.

Formerly large quantities of these skins were used for polishing wood, ivory, etc., for which they are excellent, owing to their roughness, hardness, and durability; but the great improvements made in preparing emery compositions and sandpapers have resulted in substituting them almost entirely for polishing purposes. However, a small demand yet exists for shark skins for cabinetworkers' use.

The principal uses made of the skins of sharks and allied fishes at the present time are for covering jewel boxes, desk ornaments, cardcases, sword sheaths, sword grips, and a great variety of small articles for which the tuberculous markings peculiarly adapt them. The demand for these purposes, however, is small and restricted, and each producer has to develop his own market. Comparatively few of these skins are prepared in the United States, and diligent search among the tanneries and leather stores will result in the finding of only a few skins. Many, however, are prepared in France, Turkey, and other countries of southern Europe, and also in China and Japan.

A Parisian manufacturer has made quite a reputation tanning the skins of a species of Malabar shark into morocco, and establishments in Turkey make green leather from the skin of the angel shark found in the Mediterranean Sea. The skin of the diamond shark obtained in the North Sea, and so called because of the shape of the markings or protuberances, is used to cover the sword grips of German officers, and for this purpose is not surpassed by any material obtainable. Some parts of the skin of certain varieties of sharks when dried and hardened take a polish equal to that of stone and bear a strong resemblance to the fossil coral porites, and are much used in the manufacture of ornaments and jewelry.

In preparing them for the use of cabinetmakers, shark skins are merely cleaned and not tanned. The hard, dry skins are soaked in lukewarm water for three or four days, shaved on the flesh side to remove surplus flesh and muscular tissue, and then dried. The skins of some species of sharks are so hard that they can not be shaved. The appearance of these skins is improved by bleaching, using chloride of lime and sulphuric acid. The durability of some of them is remarkable, outwearing many sheets of sandpaper of equal area.

In tanning shark skin for leather or ornamental purposes an alum process is generally employed. Each establishment usually has its own particular method, but the general process is much the same, consisting of a preliminary soaking, liming, bating, and fleshing, and then tanning or preserving in an alum compound. The hard skins are first soaked in water four or five days and then in limewater for two to six days, depending on the condition of the texture, temperature of water, etc. The skins are washed free of lime and bated in bran water, then shaved on the flesh side to remove all excess of flesh and the like. The alum solution in which they are immersed is composed of a pound of alum and one-fifth pound of salt to a gallon of water. The skins remain in the solution two or three days, with occasional stirring. On removal they are dried and are then ready for manufacturing.

Class CHONDROPTERYGIA. The sharklike fishes.

Subclass PLAGIOSTOMIA. The sharks, skates, and rays.

KEY TO THE ORDERS AND FAMILIES OF PLAGIOSTOMIA REPRESENTED IN THE BEAUFORT, N. C., REGION.

I. ANTACEA: Body subfusiform; pectorals not attached to the head; gill openings lateral.

a. Body subcylindrical.

b. Anal fin present; two spineless dorsals.

c. Nictitating membrane absent; spiracles present.

d. First dorsal fin inserted more or less in advance of ventrals.

e. Caudal fin not lunate; upper lobe two or more times length of lower, with a notch below toward tip; sides of caudal peduncle not keeled.

f. Last gill slit entirely in front of pectoral fin; teeth long, subulate, with a slender cusp on each side..... Carchariidæ.

ff. Last gill slit above pectoral base; teeth triangular, compressed; caudal longer than body..... Vulpeculidæ.

ee. Caudal fin lunate; caudal peduncle with a keel on each side; last gill opening entirely in front of the pectoral..... Isuridæ.

dd. First dorsal fin over or behind the ventrals; last gill slit above base of pectoral.

- g.* Nostrils confluent with mouth (in species included herein), with a nasoral groove and a cirrus on the anterior nasal valve; first dorsal above ventrals.....Orectolobidæ.
- gg.* Nostrils not confluent with the mouth (in species included herein); cirri absent or rudimentary; first dorsal behind ventrals.....Catulidæ.
- cc.* Nictitating membrane present; spiracles absent or present.
- h.* Teeth more or less compressed, triangular, one or two series functioning.
- i.* Head normal, not expanded across the orbital region.....Carcharhinidæ.
- ii.* Head much expanded across orbital region, hammer-headed or kidney-shaped.....Cestraciontidæ.
- hh.* Teeth depressed, paved, several series functioning.....Galcorhinidæ.
- bb.* Anal fin absent; two dorsals each with a spine; spiracles present; mouth protrusible, with a deep groove at each angle.....Squalidæ.
- aa.* Body and head depressed; no anal fin; pectorals produced but free from the head; two spineless dorsals on the tail.....Rhinidæ.
- II. PLATOSOMIA: Body discoid; pectorals attached to the head; gill openings on ventral surface of disk.
- a.* Tail comparatively thick, with two dorsals and a caudal fin; no serrated caudal spines.
- b.* Nasoral grooves absent; disk narrow and elongate; tail strong.
- c.* Snout sawlike, much produced, flat, armed with strong teeth on each side, set at right angles to its axis; disk small; pectorals not continued forward at side of head.....Pristidæ.
- cc.* Snout more or less produced, not sawlike, toothless; disk moderate; pectorals continued at side of head, not reaching end of snout.....Rhinobatidæ.
- bb.* Nasoral grooves present; disk broad, rounded, or angular; tail moderate to short.
- d.* Disk subcircular; skin smooth; an electric battery at each side of head....Narcaciontidæ.
- dd.* Disk rhomboidal; skin usually rough, with spines or tubercles; no electric battery...Rajidæ.
- aa.* Tail slender, with one or no dorsal fin and usually with one or more serrated spines.
- e.* Pectoral fins uninterrupted, confluent around the snout; teeth small; disk subcircular to rhomboidal.....Dasybatidæ.
- ce.* Head bearing a pair of rostral or cephalic fins, representing a partly or entirely separated section of the pectoral fins; disk very broad and angular.
- f.* Head bearing a pair of rostral fins; teeth broad, molarial.
- g.* A pair of rostral fins joined in front of snout, forming a single lobe....Myliobatidæ.
- gg.* Snout in two separate lobes, the rostral fins not joined in front of the skull and not continuous at the sides of the head with the pectorals.....Rhinopteridæ.
- ff.* Head bearing a cephalic fin, a separate section of the pectorals, extended forward as a hornlike process from each side; teeth small, numerous, in pavement....Mobulidæ.

Family CARCHARIIDÆ. The sand sharks.

Genus CARCHARIAS Rafinesque.

1. *Carcharias taurus* Rafinesque. Sand shark; sand-bar shark.

Eugomphodus littoralis, Yarrow, 1877, p. 217.

Carcharias americanus, Jordan and Gilbert, 1879, p. 387.

Carcharias littoralis, Jordan, 1886, p. 26; Jenkins, 1887, p. 84; Jordan and Livermann, 1868, p. 2748; Smith, 1907, p. 37; Gudger, 1913b, p. 98; Coles, 1914, p. 91.

Teeth.—Teeth slender, in $\frac{45}{39}$ ($\frac{40-46}{36-40}$)^a rows; bases two-rooted, with one or two slender, sharp-pointed denticles at each side of cusp; teeth in front of mouth long, subulate, sinuate, slightly protruding; on the sides of the jaws they are graduated, the length and crookedness of median cusp diminishing, the 10 or 12 rows nearest angles of mouth being tricuspidate, several rows at angles minute; teeth of first row in upper jaw slightly smaller than the second; those of the fourth row in the upper jaw and the first row in the lower jaw much smaller; some of the upper teeth have two small denticles on one or both sides; two rows of functioning teeth.

^a German, *Plagiostomia*, p. 25.

Denticles.—The dermal denticles are relatively large, being about 0.42 mm. long by 0.47 mm. broad in a shark 105 cm. long, very unequal in size, not close set, and not, or only slightly, overlapping; outer surface 3-keeled, keels high, median keel very prominent, with a deep groove on either side, lateral keels resting on a narrow, raised, flattened marginal area, the margin of the latter sometimes curved



FIG. 1.—Denticles, *Carcharias taurus*, about 152 cm. long, from Cape Lookout, N. C.

upward; apical margin with a prominent, obtuse-angled median lobe, and without a deep indentation between tips of median and lateral keels; basal margin trilobed or rounded; pedicel of medium size and height; basal plate small.

MEASUREMENTS OF A MALE, 105 CM. (41 $\frac{3}{8}$ INCHES) LONG FROM WOODS HOLE, MASS.

	cm.		cm.
Tip of snout to—		Base of second dorsal.....	7.2
Origin of first dorsal.....	42.0	Length of outer margin of pectorals.....	13.6
Anterior margin of eye.....	8.1	Length of inner margin of pectorals.....	6.3
First gill slit.....	22.0	Breadth of pectorals.....	10.9
Last gill slit.....	26.0	Axil of pectorals to base of ventrals.....	21.2
Base of pectoral.....	26.0	Length of outer margin of ventrals.....	8.2
Spracle.....	13.3	Length of inner margin of ventrals.....	4.1
Front of mouth.....	5.5	Breadth of distal margin of ventrals.....	8.3
Outer angles of nostrils.....	4.7	Length of claspers.....	3.5
Horizontal diameter of orbit.....	1.4	Length of anterior margin of anal.....	8.6
Vertical diameter of orbit.....	1.2	Length of posterior margin of anal.....	2.7
Distance between nostrils.....	3.2	Length of base of anal.....	6.9
Height of gill apertures (subequal).....	5.2	Distance from posterior base of anal to origin of lower caudal lobe.....	3.1
Length of anterior margin of first dorsal.....	10.5	Length of upper caudal lobe.....	30.0
Length of posterior margin of first dorsal.....	3.6	Length of lower caudal lobe.....	10.7
Base of first dorsal.....	8.0	Distance of notch from tip of caudal.....	7.5
Distance between dorsals.....	10.8	Breadth of lower margin of caudal tip.....	5.5
Length of anterior margin of second dorsal.....	9.5		
Length of posterior margin of second dorsal.....	2.8		

This species is very voracious and is said to be very destructive to fishes; working together in schools, they surround and attack schools of other fish, even those imprisoned in the nets of fishermen. At times it is abundant along the banks, and in the spring wherever the haul seine fishermen operate dead specimens usually are to be found on the beaches. On April 24, 1913, at least a dozen examples, 3 to 5 feet in length, were seen on the beach in the light of Cape Lookout. Coles states that the species is not a regular habitant of this region, but that they occasionally arrive in schools, especially

on Lookout Shoals, where they prove very troublesome to the bluefish fishermen, attacking the fish in the nets, tearing the nets, and liberating the fish. The fishermen sometimes confuse this species with another (*Hypoprion brevirostris*), and some of the large examples reported to be the sand shark were presumably the latter species.

Family VULPECULIDÆ. The thresher sharks.

Genus VULPECULA Valmont.

2. *Vulpecula marina* Valmont.

Vulpecula marina, Radcliffe, 1914, p. 414.

Alopias vulpes, Coles, 1914, p. 91.

Teeth.—Teeth two-rooted, in $\frac{42}{44} \left(\frac{42}{37} \right)^a$ rows, small, compressed, subtriangular; cusps narrow, smooth-edged, sharp-pointed, slightly recurved at tip, anterior margin sinuate, posterior margin concave; bases broad; a minute denticle present on one or both sides of many of the teeth, frequently absent on functioning teeth; teeth in the third row in upper jaw and in the eighth row in the lower jaw smaller; a row of minute teeth on each side of symphysis of lower jaw; teeth at angles of mouth small; outer row and part of the second functioning.

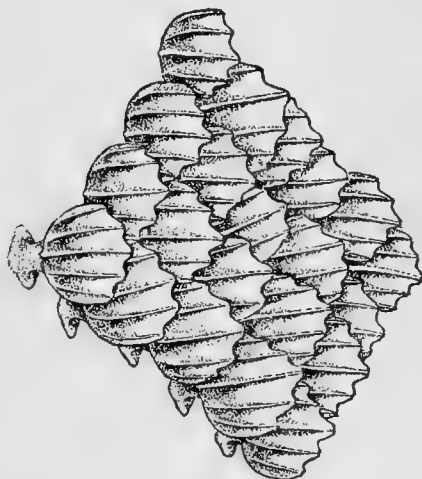

FIG. 2.—Denticles, *Vulpecula marina*, about 458.2 cm. long, from Cape Lookout, N. C.

Denticles.—The dermal denticles are normally five-keeled, very small, being about 0.21 by 0.21 mm. in an example about 458.2 cm. long, thin, subequal, close-set, closely overlapping; outer surface flattened; keels low, distinct, interspaces not deeply grooved; apical margin slightly dentate; basal margin rounded; pedicel small, slender, high; basal plate small, rhomboidal.

The first record of this species for the coast of North Carolina is that of an example found on the beach in the bight of Cape Lookout April 24, 1913. This specimen had evidently become entangled in the nets of the fishermen; the elongate caudal lobe had been severed from the body and

lost. The length of the body to the base of the caudal was about 228.6 cm. (7 feet); estimated total length, 457.2 cm. (15 feet).

Head short, thick, very robust; snout short, subconical, its length less than the distance from its tip to front of mouth; eye large, without nictitating membrane, horizontal diameter 1.25 in vertical diameter, 2.66 in snout; nostrils large, interspace between nostrils about double length of aperture; nasal flap acute-angled, aperture divided; mouth small, its length nearly equal to its width; spiracle small, behind middle of eye, its distance from eye 1.75 in horizontal diameter of eye, aperture one-tenth horizontal diameter of eye.

First dorsal large, as high as long, distal margin concave, lower lobe acute; origin of dorsal over inner angle of pectoral; second dorsal very small, its distal margin straight, produced posteriorly in a long, acuminate lobe; anal small, similar to second dorsal, situated nearer base of caudal than base of ventrals; ventrals short, broad, breadth about equal to length, distal margin sinuous, rather deeply concave mesially; claspers slender, pointed, very elongate, nearly four times length of inner lobe of ventrals, their tips extending beyond origin of anal; pectorals narrow, falcate.

Color of back and sides bluish slate, sides of head below spiracle lighter; region around mouth, thence backward on ventral surface, white; from axil of pectoral to behind base of first dorsal the white coloration of belly extends well up on the sides of the body; behind the ventrals the white coloration again encroaches on the sides of the body.

Coles reports observing one of these sharks feeding in the bight of Cape Lookout late in July, 1914.

^a Garman, *The Plagiostomia*, p. 31.

Family ISURIDÆ. The mackerel sharks.

KEY TO THE GENERA.

- a. Gills without strainers; teeth compressed; one or two series functioning.
 b. Teeth large, triangular, edges serrated, basal denticles absent.....*Carcharodon*.
 bb. Teeth awl-shaped, smooth-edged, with or without basal denticles.....*Isurus*.
 aa. Gills with strainers; teeth small, conical, several series functioning.....*Cetorhinus*.

Genus *CARCHARODON* Smith in Müller and Henle.3. *Carcharodon carcharias* (Linnaeus).

Carcharodon carcharias, Coles, 1914, p. 91.

Teeth.—Teeth in $\frac{26}{24}$ rows, large, erect, triangular, coarsely serrated, cutting edges nearly straight; teeth relatively longer and narrower, without distinct basal shoulders and more uniform in size than in species of *Carcharhinus*; third row on each side of symphysis of upper jaw of slightly smaller teeth than those in the second or fourth rows; teeth in lower jaw similar in form to those in the upper except that they are narrower, edges slightly more concave; a wide toothless space at symphysis of lower jaw;

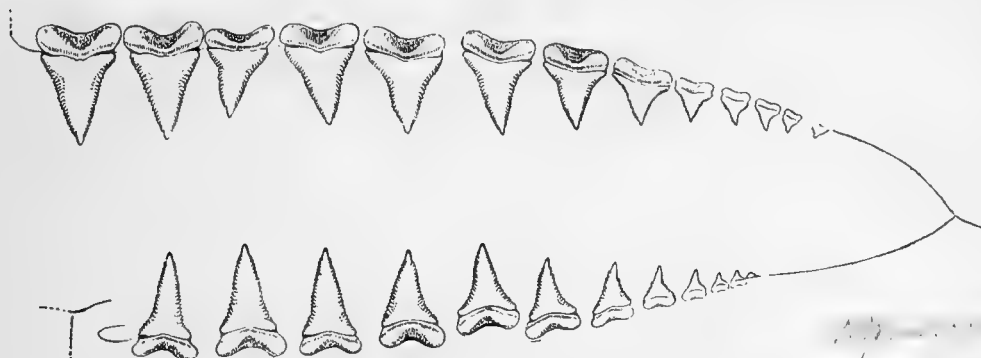

FIG. 3.—Teeth, *Carcharodon carcharias*, from Woods Hole, Mass. (U. S. National Museum no. 11845.)

two rows of small teeth at angles of mouth. (Description of teeth based on a set of jaws in the United States National Museum, from Woods Hole, Mass.)

Dermal denticles.—As figured by Garman (*The Plagiostomia*, pl. 5, fig. 9), the denticles are regular in arrangement, slightly overlapping, three-keeled, keels parallel; lateral keels submarginal; apical margin with three sharp-pointed lobes, median one most prominent; basal margin rounded; pedicel and base small.

In 1905 and again in 1913 Coles observed several very large sharks in the vicinity of Cape Lookout which he believed to be this species. As yet none has been captured on the coast of North Carolina.

Genus *ISURUS* Rafinesque. Mackerel sharks.4. *Isurus tigris* (Atwood).

Isuroopsis dekayi, Yarrow, 1877, p. 217.

Isurus dekayi, 1907, p. 31.

Teeth.—"Teeth smaller than those of *I. oxyrinchus*, similarly without basal denticles, with a sharp, slender curved cusp, and with the third tooth at each side of the middle of the mouth on the upper jaws much smaller than the second or the fourth."^a

Denticles.—No material or description available. Dr. Yarrow states that he saw a skeleton of this species. Although later observers have failed to find examples of it and have not included it in their faunal lists, the species doubtless visits these waters.

^a Garman, *The Plagiostomia*, p. 37.

Genus *CETORHINUS* Blainville. The basking sharks.5. *Cetorhinus maximus* (Gunner).*Cetorhinus maximus*, Coles, 1914, p. 92.

Teeth.—Teeth small, subconical, recurved, numerous, many-rowed, slightly compressed along lateral margins, back of teeth slightly more flattened than the front, apex pointed; teeth arranged in regular rows, five or six teeth in each row functioning; numerous pockets along outer margin of jaw from which teeth have been shed.

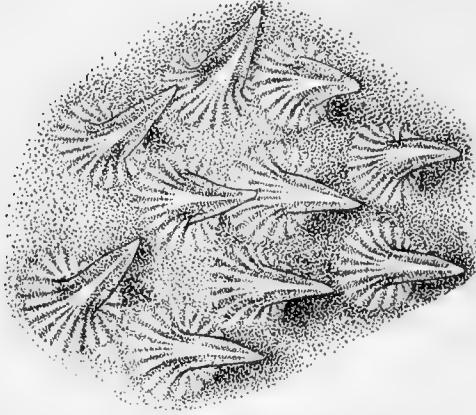

Denticles.—The denticles are small, unequal, suberect, close-set, thornlike, with recurved tips; outer (anterior) surface with a low, corrugated median ridge which broadens out at base with a slight groove along each side on apical portion; base large, circular, corrugated. (Description based on parts of a specimen in the United States National Museum, from Monterey, Cal.)

FIG. 4.—Denticles, *Cetorhinus maximus*, from Monterey, Cal. (U. S. National Museum no. 27024.)

tion of teeth and denticles based on parts of a specimen in the United States National Museum, from Monterey, Cal.)

In July, 1905, Coles observed a huge shark lying motionless on the surface of the water out from Cape Lookout. The size accredited to this specimen by Coles would indicate that it was the basking shark, although no examples have ever been captured on this coast.

Family ORECTOLOBIDÆ. The nurse sharks.

Genus *GINGLYMOSTOMA* Müller and Henle.6. *Ginglymostoma cirratum* (Bonnaterre).*Ginglymostoma cirratum*, Coles, 1914, p. 89.

Teeth.—Teeth in $\frac{36}{31}$ rows, arranged in regular rows both transversely and laterally, about 9 teeth in a transverse row in front of upper jaw and 12 in the lower jaw; each tooth with a prominent, pointed, median cusp and three smaller cusps on each side of it, base broad. At the sides of the jaw the cusps are smaller, slightly curved toward angles of mouth; along anterior edge of the jaw the margin of each tooth is practically smooth, cusps and denticles being worn away. (Description based on a set of jaws of an adult from Pensacola, Fla., now in United States National Museum.)

In an example 26.7 cm. (10.5 inches) long from the American Museum of Natural History, collected in Brazil, the teeth in the front of the mouth have a single cusp; behind these are tricuspid teeth indicating that the form of the teeth changes considerably with age.

Denticles.—The dermal denticles are large, being about 0.41 mm. long by 0.31 mm. broad in a specimen 26.7 cm. long, ovate, leaflike, quite regular in outline and arrangement and of nearly uniform size; sculpturing consists of a short distinct median keel extending along median line of basal half of denticle and normally with a shorter lateral keel on each side, the latter sometimes absent; pedicel high, slender; base short, broad, stellate.

Coles observed a school of these sharks in Lookout Breakers in the summer of 1913 and succeeded in capturing one 273.3 cm. (9 feet) in length.

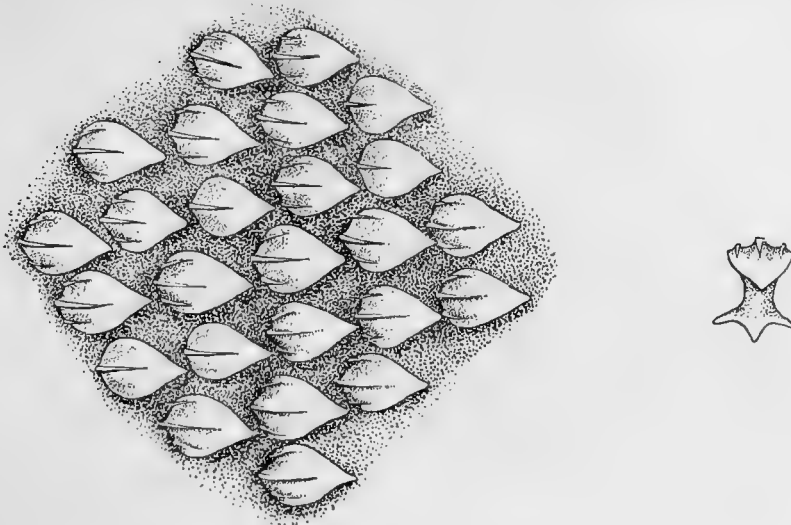

FIG. 5.—Denticles, *Ginglymostoma cirratum*, 26.7 cm. long, from Brazil.

Family CATULIDÆ. The cat sharks.

Genus CATULUS Valmont.

7. *Catulus retifer* (Garman).

Catulus retifer, Smith, 1907, p. 31.

Teeth.—Teeth similar in both jaws, small, suberect, subequal, with a median, lanceolate cusp and normally with two smaller lateral cusps; cusps of lower teeth relatively stouter, more nearly subequal, number of lateral cusps more variable; teeth arranged in quincunx, several teeth in each row functioning.

Denticles.—The denticles are large, unequal, suberect or recurved, not crowded or overlapping; irregular in arrangement, quite similar in form on the different parts of the body. Exposed outer surface of denticle long, narrow, recurved, lanceolate at tip, frequently with one to three lateral serrations, mesial portion hollowed out with a low keel on each side and with or without a low median keel; pedicel short; base very large, rhomboidal. Denticles around mouth and on under side of snout short, depressed, leaflike, without sculpturing; those along dorsal surface of caudal slightly enlarged and more closely set than those on sides of body.

Two examples in the laboratory collections 15.2 and 16.7 cm. in length, dredged by the *Fish Hawk* at station 7315 in 172 fathoms, have the characteristic color pattern of this species. The fins are more rounded at tip than shown in Goode and Bean's illustration (*Oceanic Ichthy.*, 1895, pl. IV, fig. 14), the origin of the first dorsal is about an eye's diameter nearer tip of snout than tip of tail and the caudal is more elongate. In these respects they more closely resemble *C. boa* (Garman, *The Plagiostomia*, p. 77).

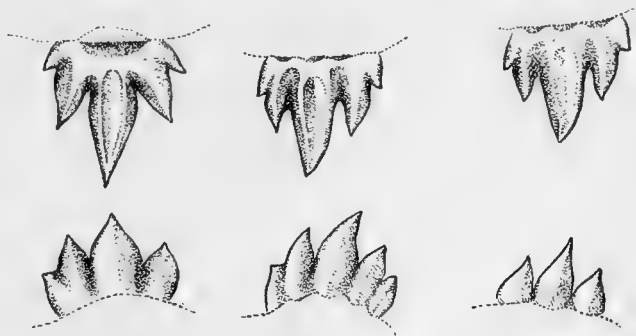

FIG. 6.—Teeth near front of mouth, *Catulus retifer*, 16.7 cm. long, from *Fish Hawk* station 7315, Gulf Stream, off Cape Lookout, N. C.

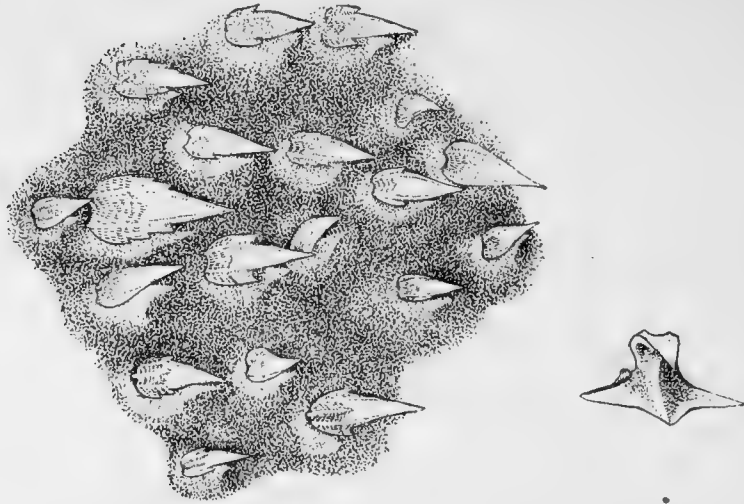

FIG. 7.—Denticles, *Catulus retifer*, 16.7 cm. long, from *Fish Hawk* station 7315, Gulf Stream, off Cape Lookout, N. C.

Family CARCHARHINIDÆ. The requiem sharks.

KEY TO THE GENERA.

- a. Spiracle absent; lower teeth narrower than upper.
- b. Labial folds at angles of mouth well developed, extending along both jaws; teeth entire, oblique, notched *Scoliodon*.
- bb. Labial folds rudimentary; teeth erect and entire or serrated, some or all, on bases and cusps.
- c. Teeth without serrations, slender, erect, sharp-pointed; upper teeth slightly larger. . . *Aprionodon*.
- cc. Teeth of upper jaw serrate on basal shoulders only; lower teeth entire, slenderer, erect. *Hypoprion*.
- ccc. Teeth serrated, some or all, on bases and cusps; teeth in upper jaw in most species more broadly triangular than those in *Aprionodon* or *Hypoprion*. *Carcharhinus*.
- aa. Spiracle present, minute; teeth large, coarsely serrate, alike in both jaws, notched on outer margin; labial folds at angles of mouth well developed. *Galeocerdo*.

Genus SCOLIODON Müller and Henle

8. *Scoliodon terra-novæ* (Richardson). Sharp-nose; sharp-nosed shark; dog shark.

Scoliodon terra-novæ, Jordan and Gilbert, 1879, p. 388; Linton, 1905, p. 342; Smith, 1907, p. 34; Coles, 1914, p. 90.
Carcharhinus terra-novæ, Jordan, 1886, p. 26; Jenkins, 1887, p. 84.
Carcharhinus terra-novæ, Wilson, 1900, p. 355.
Scoliodon terranova, Gudger, 1910, p. 399.

Teeth.—Teeth in $\frac{26}{24}$ rows, oblique, compressed, broad-based, without serrations, each with a single cusp inclined toward the angle of the mouth, and a deep notch on posterior margin below the cusp; teeth at symphysis of each jaw slightly smaller; median row in upper jaw and two rows at symphysis of lower jaw erect; bases of teeth in upper jaw higher and cusps broader than in lower jaw; toward the angles of the mouth the inclination of cusps falls, the anterior margin being almost horizontal in the teeth at the angles; near front of mouth, the tips of the cusps are slightly bent toward symphysis, the anterior margin being slightly concave; this character is more pronounced in teeth of lower jaw; near angles of mouth, anterior margin straight.

Denticles.—The denticles are three-keeled, very small in size, being about 0.17 by 0.17 mm. in a shark 61 cm. long, subequal, slightly overlapping; keels low but distinct, interspaces relatively flat, not deeply concave; lateral keels intramarginal; apical margin of denticle with three acute-angled pro-

jections, corresponding to the keels, median one longest; basal margin rounded, with a slight concavity between the keels; pedicel slender; base small, rhomboidal.

The denticles of this species differ from those of *Carcharias taurus* in being smaller, more uniform in size, closer set, overlapping, more regular in arrangement; interspaces between keels not so deeply concave, lobes on apical margin sharper, incisions between apical lobes deeper, pedicel more slender.

This is one of the most common sharks in the Beaufort region. From the laboratory records it appears that the species is scarce or absent from the harbor during the winter months. The young, 28 to 45 cm. long, are abundant in the harbor during June and July. In the surf along the banks and on the offshore fishing grounds, the species is common and the readiness with which it takes the hook renders it a source of annoyance at times to the line fishermen in these places.

From the ovary of a female 101.6 cm. (40 inches) in length, taken in the surf on Shackelford Bank, August 9, 1912, four embryos, three females and a male, 5.5 to 6 cm. in length, were taken. These were attached to the yolk sac, and still possessed the mass of long, threadlike, external gill filaments. The

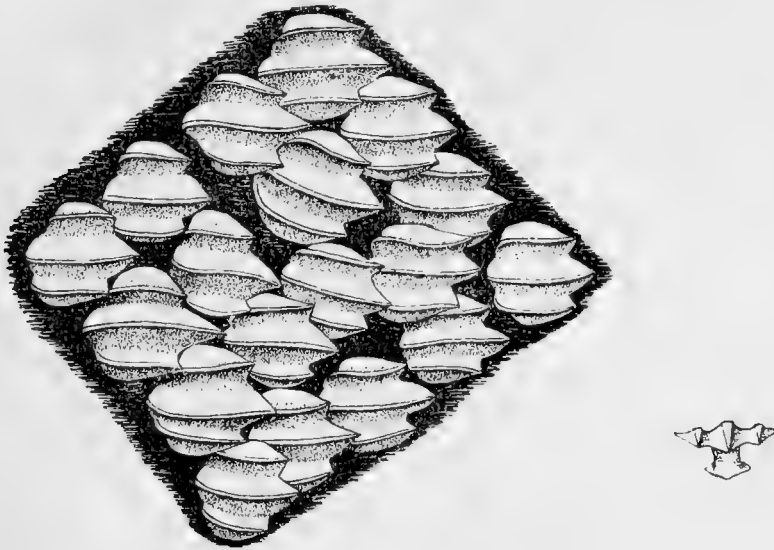

FIG. 8.—Denticles, *Scoliodon terraenovae*, 62.5 cm. long, from Cape Lookout, N. C.

claspers in the male were distinct, reaching posterior margin of ventrals. In addition to the embryos, the ovary contained a number of small eggs.

The stomachs of specimens examined in June and July, 1912-13, contained hogfish, silversides, Irish pompano, shrimp, the feet of mollusks, and other partly digested matter.

TABLE OF LENGTHS AND WEIGHTS OF THESE EXAMPLES.

Month taken.	Length.	Weight.
	Centimeters.	Grams.
June.....	34.9	152
Do.....	36.6	175
Do.....	38.5	154
Do.....	^a 38.4	184
July.....	39.7	184
Do.....	33.0	110
Do.....	37.5	211
Do.....	37.5	241

^a This was a female. All the others were males.

Genus APRIONODON Gill

9. *Aprionodon isodon* (Müller and Henle).

Aprionodon isodon, Radcliffe, 1914, p. 414.

Teeth.—Teeth in $\frac{3}{1}$ rows, small, erect, compressed, without serrations; cusps narrow, sharp-pointed; bases broad, forming a distinct shoulder; three rows of minute teeth at symphysis of upper jaw; a median row of minute teeth at symphysis of lower jaw, a row on either side of it of smaller teeth than those which follow; lower teeth smaller than the upper.

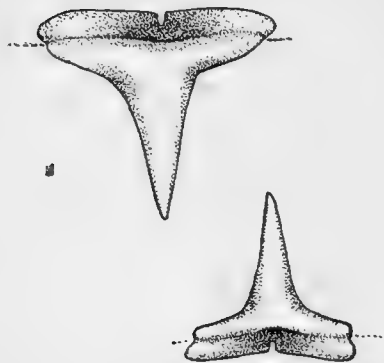

FIG. 9.—Teeth, *Aprionodon isodon*, 50.8 cm. long, in Beaufort collection. (Same specimen as fig. 10.)

Denticles.—The dermal denticles are very thin and small, being about 0.27 mm. long by 0.28 mm. broad in a shark 50.8 cm. in length, three-keeled, imbricated, outer surface relatively flat, keels low, parallel; apical margin normally with three sharp-pointed lobes, the number varying from three to five, median lobe longest, incision between lobes sharp-cut, relatively deep; in many of the denticles these lobes are broken or worn away; basal margin rounded; pedicel short, stout; base large, stellate. The denticles of this species differ from those of *Scoliodon terraenovae* in being more closely imbricated, slightly larger, with weaker keels, lobes of apical margin sharper and longer, three to five in number, pedicel shorter and stouter.

The laboratory collections at Beaufort contain a single example of this species 50.8 cm. (20 inches) in length, for which there is no record as to date or method of capture.

MEASUREMENTS OF THIS EXAMPLE, A FEMALE.

	cm.		cm.
Total length.....	50.8	Length of posterior margin of first dorsal.....	2.2
Tip of snout to—		Base of first dorsal.....	5.0
Origin of dorsal.....	17.0	Distance between dorsals.....	10.0
Anterior margin of eye.....	4.3	Length of anterior margin of second dorsal.....	2.5
First gill slit.....	10.6	Length of posterior margin of second dorsal.....	2.2
Last gill slit.....	12.4	Base of second dorsal.....	2.2
Base of pectoral.....	12.1	Length of outer margin of pectorals.....	7.5
Front of mouth.....	3.8	Length of inner margin of pectorals.....	2.7
Outer angle of nostrils.....	2.5	Breadth of pectoral.....	4.5
Horizontal diameter of orbit.....	1.0	Axil of pectorals to base of ventrals.....	9.5
Vertical diameter of orbit.....	0.8	Length of outer margin of ventrals.....	2.9
Distance between nostrils.....	2.8	Length of inner margin of ventrals.....	2.9
Length of nasal aperture.....	0.75	Breadth of distal margin of ventrals.....	2.7
Distance between angles of mouth.....	4.2	Length of anterior margin of anal.....	3.1
Height of—		Length of posterior margin of anal.....	2.2
First gill slit.....	2.6	Base of anal.....	2.3
Second gill slit.....	2.7	Axil of anal to origin of lower caudal lobe.....	3.7
Third gill slit.....	2.8	Length of upper caudal lobe.....	14.1
Fourth gill slit.....	2.7	Length of lower caudal lobe.....	5.9
Fifth gill slit.....	2.2	Tip of caudal to notch.....	3.8
Length of anterior margin of first dorsal.....	6.2	Breadth of tip of caudal lobe.....	3.3

Snout short, depressed, blunt, its length about equal to breadth of mouth; nostrils small, with a short, rounded, flaplike projection near inner angle, length of aperture equal to vertical diameter of orbit; distance from tip of snout to outer angle of nostrils, one-half distance from angle of nostril to angle of mouth; mouth large, distance from tip of mandible to angle slightly less than distance between angles. An eye diameter behind eye, there is a porelike aperture which resembles a rudimentary spiracle. Gill slits elongate, the third longest, 2.8 times horizontal diameter of eye; fifth shortest, above pectoral base.

First dorsal high, nearer base of pectorals than ventrals, distal margin concave, anterior lobe

rounded, posterior lobe acute-angled; second dorsal small, over anal, posterior lobe elongate, distal margin straight; pectorals larger than first dorsal, inner angle reaching beyond vertical from origin of first dorsal, distal margin slightly concave; ventrals truncate; anal slightly larger than second dorsal, distal margin incised, posterior lobe acute; caudal long, 3.63 in total length; subcaudal lobe deep, rounded, terminal lobe distinct, deep. This rare species, according to Jordan and Evermann, has been recorded from New York, Virginia, and Cuba.

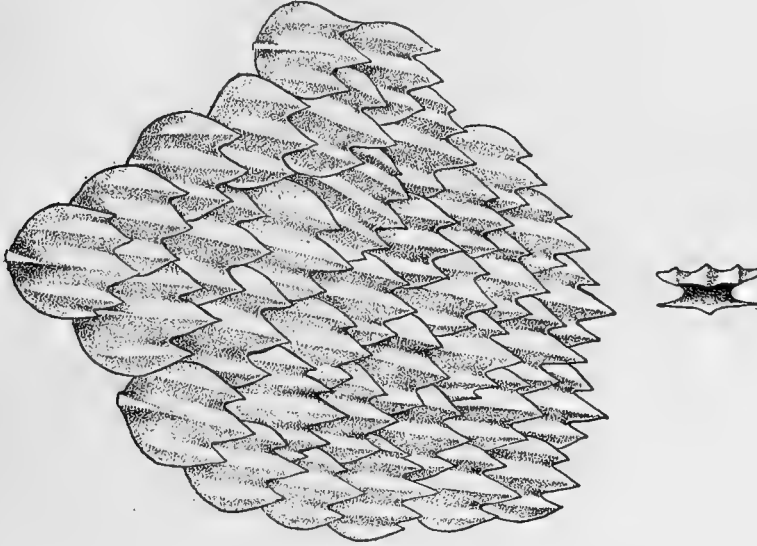

FIG. 10.—Denticles, *Aprionodon isodon*, 50.8 cm. long, in Beaufort collections.

Genus HYPOPRION Müller and Henle.

10. *Hypoprion brevisrostris* Poey. Sand shark.

Carcharhinus obscurus, Linton, 1905, p. 339 (in part); Smith, 1907, p. 33 (after Linton).

Hypoprion brevisrostris, Radcliffe, 1913, p. 396; Coles, 1914, p. 90.

Teeth.—Teeth in $\frac{33-33}{29-31}$ rows, suberect, subulate, narrow-cusped, broad-based, two-rooted; cusps

of lateral teeth in upper jaw slightly inclined toward angles; teeth near angles with a distinct notch; cusps smooth, shoulders distinctly serrate; lower teeth slenderer, without serrations on cusps or shoulders, cusps more nearly erect; three rows of small teeth at symphysis of each jaw. Three rows of teeth at angles of mouth resembling the teeth of *Scoliodon tetræ-novæ*.

Denticles.—The denticles are large, being about 0.4 to 0.62 mm. long by 0.4 to 0.6 mm. wide in a shark 248.9 cm. in length, heavy, normally five-keeled (three to five), unequal, imbricated; median keel very heavy, interspaces rather deeply concave; keels parallel; apical margin usually five-lobed (three to five), median lobe strongest, with a deep incision on each side; basal margin rounded; pedicel reduced to a very short, heavy neck, resting on a large stellate basal plate.

Three large males were caught with a shark hook baited with butterfly rays and toadfish floated out from first jetty on Pivers Island so that the bait hung about 2 feet below surface, as follows: A specimen (no. 1) 228.6 cm. ($7\frac{1}{2}$ feet) long, August 31, 1912; one (no. 2) 205.7 cm. ($6\frac{3}{4}$ feet) long, September 1, 1912; and one (no. 3) 248.9 cm. ($8\frac{1}{8}$ feet) long, August 12, 1913. In each case these were hooked during the night.

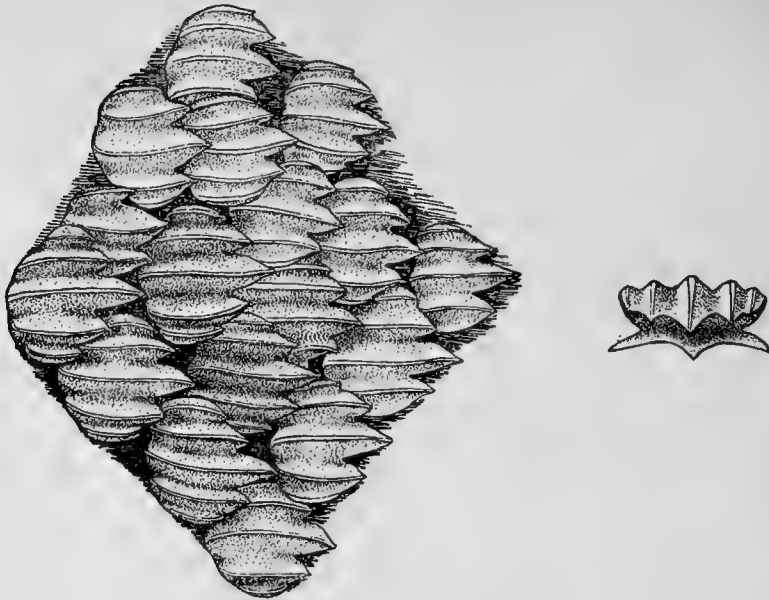

FIG. 11.—Denticles, *Hypoprion brevirostris*, 248.9 cm. long, from Beaufort, N. C.

MEASUREMENTS OF SPECIMENS.

	No. 1.	No. 2.	No. 3.
	cm.	cm.	cm.
Total length.....	228.6	205.7	248.9
Depth at origin of first dorsal.....	32.0	31.0
Tip of snout to—			
Origin of first dorsal.....	78.0	76.0	90.0
Anterior margin of eye.....	15.0	14.9	15.0
First gill slit (upper angle).....	41.0	38.7	43.0
Last gill slit (upper angle).....	50.6
Base of pectoral.....	50.0	49.0
Front of mouth.....	11.0	11.0
Outer angle of nostrils.....	8.4	8.5
Horizontal diameter of orbit.....	2.3	2.2	2.5
Distance between nostrils.....	10.2
Distance between angles of mouth.....	21.0	22.0
Height of—			
First gill slit.....	9.2
Second gill slit.....	9.8
Third gill slit.....	10.2
Fourth gill slit.....	9.5
Fifth gill slit.....	8.8
Length of anterior margin of first dorsal.....	28.0	25.3	31.0
Length of posterior margin of first dorsal.....	10.0	9.1	12.0
Base of first dorsal.....	22.0	19.7	22.0
Distance between dorsals.....	41.0	37.0	48.0
Length of anterior margin of second dorsal.....	22.0	19.4	22.0
Length of posterior margin of second dorsal.....	7.5	7.3	8.0
Base of second dorsal.....	16.0	14.5
Length of anterior margin of pectoral.....	39.5	37.0	42.0
Length of posterior margin of pectoral.....	15.0	12.9
Length of distal margin of pectoral.....	38.0	36.3
Distance from origin of pectorals to base of ventrals.....	65.0	62.0	77.0
Length of anterior margin of ventrals.....	19.0	17.3
Length of base of ventrals.....	13.0	13.7
Length of claspers.....	14.0
Distance from posterior base of ventrals to origin of anal.....	20.0	17.8
Length of anterior margin of anal.....	20.0	19.1
Length of posterior margin of anal.....	6.5	5.2
Length of anal base.....	12.5	12.3
Axil of anal to lower caudal lobe.....	13.0	12.3
Length of upper caudal lobe.....	54.0	50.0	60.0
Length of lower caudal lobe.....	28.0	29.3	27.0
Breadth of tip of caudal lobe.....	14.0	11.8

In the largest example the distal margin of the first dorsal was deeply concave; second dorsal large, similar in shape to the first; pectoral short, broad, distal margin slightly concave; anal similar in form to second dorsal but much smaller. Labial fold short.

In smallest example the liver was very large, more than half the length of the body; 400 cc. of bile in gall bladder; stomach empty except for bait, spiral valve as in *Scoliodon terraenovae*; heart small, ventricle 6.1 cm. from apex to base, width at base 5.7 cm., length from apex to insertion of conus 6.6 cm. The red corpuscles of the blood were 16 μ by 12.4 μ , somewhat irregular in outline, but generally oval; the white corpuscles had an average diameter of 8.8 μ .

Color at death.—Ground color of back dark bluish-gray, lemon-yellow tinge below, shading into white on belly; fins grayish except the anal, which was yellowish edged with gray; claspers white; margins of gill openings white, shading to dark gray, with an intramarginal area above and below white; eye yellow-gray, pupil black; interior of mouth white.

The toadfish (*Opsanus tau*) proves a very effective bait for sharks. If hooked carefully through the jaws it will live for several days, and is immune to attacks from crabs and other fishes.

Among the fishes recorded by Linton (1905, p. 339) is *Carcharhinus obscurus* of which he says:

"These sharks are referred to this species although they do not agree in all diagnostic features with the descriptions published in Jordan and Gilbert's Fishes of North America or Jordan and Evermann's later work. The pectorals do not reach quite to the first dorsal. The second dorsal is larger than the anal. There is not much difference between the upper and lower teeth. They agree rather with *Prionace* in the character of the fins, but the nose is much shorter and broader than in that genus." With the exception of the one caught by Coles on July 26, 1902, these appear to have been examples of *H. brevirostris*. The short pectorals, second dorsal larger than anal, similarity of teeth in each jaw, and the short and broad snout are characters which are more diagnostic of this species than any other found in this region.

From recent data the species appears to be fairly common in the Beaufort region and has undoubtedly been confused with other species by earlier writers. The writer has been unable to obtain an authentic record of the presence of *C. obscurus* in this region.

Genus CARCHARHINUS Blainville.

KEY TO THE SPECIES.

- a. Fins black-tipped; teeth similar in form in both jaws, narrow-cusped, broad-based in $\frac{33-34}{30-31}$ rows; dermal denticles small, imbricated, three-keeled in small examples, five to seven keeled in large ones; snout elongate *limbatus*.
- aa. Fins not black-tipped; teeth in upper jaw triangular, notched or not; cusps of lower teeth narrow, erect.
- b. Dermal denticles three-keeled, not closely imbricated without or with distinct apical lobes; upper teeth narrowly triangular, longer than broad, without distinct basal shoulders, in 29 to 31 rows; lower teeth narrow-cusped in 27 to 30 rows; snout short, broad, blunt, its length slightly greater than distance between angles of mouth; pectorals broad, breadth 1.7 times length, without prominent lower lobe *milberti*.
- bb. Dermal denticles five-keeled, closely imbricated, upper teeth deeply notched or broadly triangular.
- c. Snout elongate, moderately pointed; teeth in $\frac{26}{23-25}$ rows; upper teeth deeply notched; lower teeth short, very narrow-cusped *acronotus*.
- cc. Snout short, broad, blunt, its length less than distance between angles of mouth; teeth in $\frac{27-31}{26-32}$ rows; upper teeth broadly triangular, broader than high; cusps of lower teeth rather broad; pectorals long, narrow, twice as long as broad, with a prominent basal lobe *commersonii*.

11. *Carcharhinus limbatus* (Müller and Henle).

Carcharhinus obscurus, Linton, 1905, p. 339 (in part).

Carcharhinus limbatus, Gudger, 1913a, p. 2; Coles, 1914, p. 90.

Teeth.—Teeth in $\frac{33-34}{30-31}$ rows, erect, subulate, narrow-cusped, broad-based; cusps of upper teeth finely serrate, basal shoulders finely denticulate; cusps of lower teeth normally with small serrations, bases smooth; two to three rows of small teeth at symphysis of each jaw.

The teeth of this species resemble those of *H. brevirostris* more closely than the other species of *Carcharhinus*, the difference being so slight as to suggest the advisability of including the species of that genus under the genus *Carcharhinus*.

Denticles.—The sculpturing of the dermal denticles varies with age. In specimens 60 to 70 cm. in length the denticles are small (0.25 mm. long by 0.28 mm. broad in a 70 cm. specimen), three-keeled,

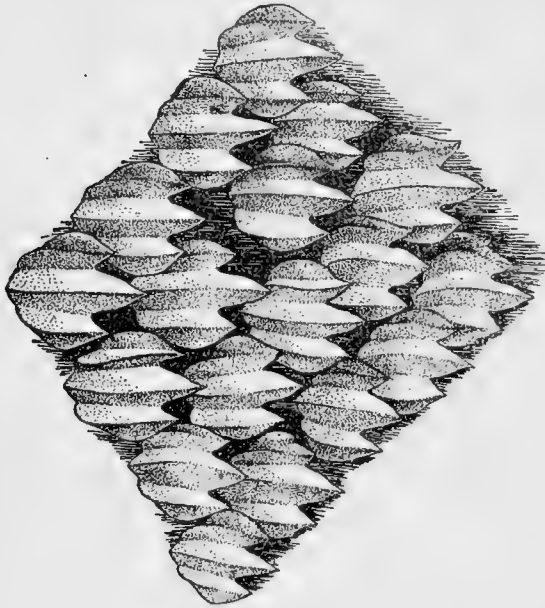

FIG. 12.—Denticles, *Carcharhinus limbatus*, 70 cm. long, from Beaufort, N. C.

subequal, close-set, imbricated; keels low, distinct; apical margin three-lobed, with deep incisions between the lobes; basal margin rounded; pedicel short and stout; basal plate large, rhomboidal.

In two examples 135 and 175 cm. in length, the denticles are five to seven keeled; apical margins relatively smooth, the apical lobes in most cases being worn down. In places where the skin has been abraded and new denticles are being formed, the changes in form may be noted. In the early stages of development, the denticles are usu-

ally smooth, ovate in outline; later a sharp median keel appears, followed by a lateral one on each side; at this stage the apical margin may be entire or deeply three-lobed as in individuals 60 to 70 cm. long. Later one or two additional lateral keels on each side appear.

MEASUREMENTS OF A FEMALE, 70 CM. (27½ INCHES) LONG, TAKEN IN THE POUND NET AUG. 27, 1913.

	cm.		cm.
Total length.....	70.0	Length of posterior margin of first dorsal.....	3.1
Depth at origin of first dorsal.....	10.8	Base of first dorsal.....	7.5
Tip of snout to—		Distance between dorsals.....	13.7
Origin of first dorsal.....	22.4	Length of anterior margin of second dorsal.....	3.4
Anterior margin of eye.....	4.8	Length of posterior margin of second dorsal.....	2.9
Upper angle of first gill slit.....	14.0	Base of second dorsal.....	3.2
Upper angle of fifth gill slit.....	17.9	Length of anterior margin of pectoral.....	12.2
Base of pectoral.....	17.1	Length of posterior margin of pectoral.....	3.4
Front of mouth.....	5.7	Length of distal margin of pectoral.....	8.5
Center of nostrils.....	3.7	Distance from origin of pectorals to base of ventrals.....	18.6
Horizontal diameter of eye.....	1.35	Length of anterior margin of ventrals.....	4.2
Distance between nostrils.....	3.7	Length of posterior margin of ventrals.....	3.8
Distance between angles of mouth.....	6.3	Base of ventrals.....	2.6
Height of—		Distance between ventrals and anal.....	6.6
First gill slit.....	2.5	Length of anterior margin of anal.....	4.0
Second gill slit.....	2.7	Length of posterior margin of anal.....	2.6
Third gill slit.....	2.9	Base of anal.....	3.3
Fourth gill slit.....	2.8	Distance from base of anal to origin of caudal.....	4.0
Fifth gill slit.....	2.3	Length of upper caudal lobe.....	19.6
Length of anterior margin of first dorsal.....	9.6	Length of lower caudal lobe.....	8.4
Height of first dorsal.....	6.5		

This species is easily recognized by the black-tipped fins. It is ferocious, very gamy, and not easily captured when hooked. In the Beaufort region it is not common, although a number, ranging in length from 59 to 175 cm., were taken in the summer of 1914. A male taken in the pound July 10, 1912, 60 cm. in length, weighed 1,280 g. From its stomach a menhaden (*B. tyrannus*) and a butterfish (*P. alepidotus*) were taken. The sting of a sting-ray was found embedded in the skin under the jaw of a female 175 cm. long.

Under *C. obscurus*, Linton (1905, p. 339) lists a specimen captured by Coles, July 26, 1902, 6 feet in length. He says: "It was a much cleaner-cut and more graceful shark than any other seen by me at Beaufort. The tips of the pectorals were black, a character not noted in the others. * * * Mr. Coles stated that the tips of all the fins of his specimen were black when it was first captured. He also said that it was much more voracious and gamy than the others he had taken." These characters agree more closely with *C. limbatus*, the black tips of the fins and game qualities being characteristics of that species.

12. *Carcharhinus milberti* (Müller and Henle).

Carcharhinus milberti, Smith, 1907, p. 34 (in part).

Teeth.—Teeth $\frac{29-31}{27-30}$ rows; upper teeth long, narrowly triangular, with serrate cutting edges; several rows at symphysis erect, cutting edges straight; toward the angles of the mouth the outline of the teeth changes, the anterior margins from straight to convex, posterior margins from straight to concave to slightly notched; teeth without distinct basal shoulder, except those at angles; a row of minute, finely serrated teeth at symphysis; lower teeth erect, narrow cusped, with short but distinct basal shoulders; cusps slender, subulate, finely serrate in small individuals, smooth, or with traces of serrations in larger ones; basal shoulders smooth; a row of minute, unserrated teeth at symphysis.

In an example 182.9 cm. long the teeth in the front of the upper jaw are longer than broad, resembling those of *Carcharodon carcharias*, but more finely serrated.

Denticles.—The dermal denticles vary somewhat in outline with age. In a shark 54.6 cm. in length they are small, 0.2 mm. long by 0.3 mm. broad, three-keeled, unequal in size, not close set and not overlapping; keels low, parallel, interspaces not deeply channeled; apical margin truncate, without or with

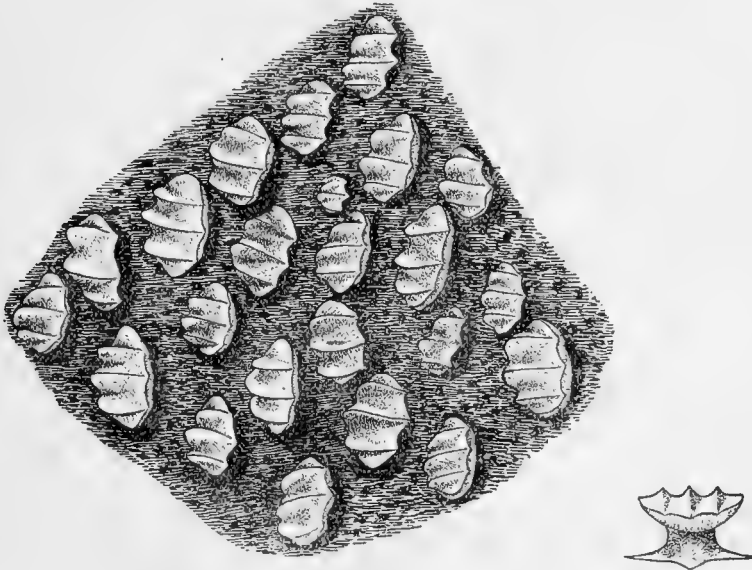

FIG. 13.—Denticles, *Carcharhinus milberti*, 8x cm. long, from Cape Lookout, N. C.

only slightly projecting lobes; pedicel of medium size; base large, stellate.

The extent of the area on sides of body below dorsal having this type of denticle varies in different specimens and with age, being larger in small examples than in large ones. Outside this area the

denticles grade into a form which has three sharp-pointed lobes on the apical margin, with a deep indentation between the lobes, keels high and distinct. These differences may be noted without the aid of a microscope by passing the fingers forward over the surface of the skin, that portion devoid of apical lobes feeling comparatively smooth. In the example 182.9 cm. long, the denticles are closer together, and in nearly all cases the median keel projects slightly, apical margin more rounded. The characteristic form and sculpturing of the denticles in this species have proved to be of marked value in identifying the species.

MEASUREMENTS OF A SPECIMEN (No. 1) 81 CM. (31 $\frac{1}{8}$ INCHES) LONG FROM CAPE LOOKOUT, N. C., AND ONE (No. 2) 182.9 CM. (6 FEET) LONG FROM WOODS HOLE, MASS.

	No. 1.	No. 2.
Total length	81.0	182.9
Tip of snout to—		
Origin of first dorsal	24.0	58.5
Anterior margin of eye	7.8	16.9
First gill slit	16.4	38.5
Last gill slit	19.5	49.5
Base of pectoral	18.7	44.0
Front of mouth	6.9	15.2
Outer angles of nostrils	4.8	9.8
Depth of body at origin of dorsal	11.4
Horizontal diameter of orbit	1.7	2.8
Distance between nostrils	4.9	10.6
Length of nasal aperture	1.4	3.2
Distance between angles of mouth	7.5	16.1
Height of—		
First gill aperture	3.2	5.8
Second gill aperture	2.9	5.9
Third gill aperture	2.9	5.7
Fourth gill aperture	2.7	5.5
Fifth gill aperture	1.8	4.6
Length of anterior margin of first dorsal	2.0	26.1
Length of posterior margin of first dorsal	3.7	9.3
Base of first dorsal	9.6	20.0
Distance between dorsals	18.7
Length of anterior margin of second dorsal	4.0	9.6
Length of posterior margin of second dorsal	3.4	7.4
Base of second dorsal	3.6	8.1
Distance from second dorsal to caudal	14.0
Length of outer margin of pectorals	14.4	36.0
Length of inner margin of pectorals	5.0	11.0
Breadth of pectorals	8.3	20.4
Axil of pectorals to origin of ventrals	15.4
Length of outer margin of ventrals	5.3
Length of inner margin of ventrals	5.0
Breadth of distal margin of ventrals	4.9
Length of claspers	4.1
Length of anterior margin of anal	5.9	12.1
Length of posterior margin of anal	3.4	7.2
Base of anal	4.0	8.1
Axil of anal to lower caudal lobe	6.0	10.0
Length of upper caudal lobe	20.4	48.8
Length of subcaudal lobe	9.0	22.7
Tip of caudal to notch in upper lobe	5.2
Breadth of distal margin of caudal tip	4.3

Snout (in smaller example, a male) short, broad, blunt, its length slightly greater than distance between angles of mouth; nostrils widely separated, distance from outer angle to tip of snout nearly 1.5 in preoral length, aperture less than diameter of eye, valves with a short, pointed lobe.

First dorsal high; upper lobe rounded; posterior lobe produced, acute; distal margin concave, origin over axil of pectoral; second dorsal small, acuminate behind; distal margin very slightly concave; origin of fin in advance of anal; pectorals large, breadth 1.7 in length, distal margin slightly concave; ventrals truncate, claspers small; anal slightly larger than the second dorsal, distal margin deeply concave; caudal large, about one-fourth total length, subcaudal lobe large.

The larger individual agrees in general with the one just described. The nasal aperture is greater than diameter of eye, the first dorsal is more erect and the upper lobe is more pointed, distal margin slightly sinuous, concave posteriorly; second dorsal considerably smaller than the anal; caudal about 3.7 in total length.

Color of upper surface of body and fins smoke gray, ventral surface massicot yellow, dusted with black and gray.

This species appears to be rare in the Beaufort region. Specimens are occasionally taken in the bight of Cape Lookout. On May 6, 1914, two examples 62.2 and 65.4 cm. in length were taken in Newport River. In the Beaufort region it has been confused with *C. commersonii* (see description of that species). It is quite generally confused with *C. obscurus* in regions where both occur; in fact, examples from northern waters, New Jersey and New England, identified as *C. obscurus*, which the writer has examined, have, almost without exception, proved to be *C. milberti*.

13. *Carcharhinus acronotus* (Poey).

Carcharhinus acronotus, Gudger, 1913a, p. 2; Radcliffe, 1913, p. 396; Coles, 1914, p. 90.

Teeth.—Teeth in $\frac{26}{23-25}$ rows; upper teeth broad, oblique, triangular; with a distinct notch on the posterior margin; cusps broad, serrate, inclined toward angles of mouth, anterior margin without distinct basal shoulder, posterior margin with a distinct, coarsely serrated basal shoulder below notch;

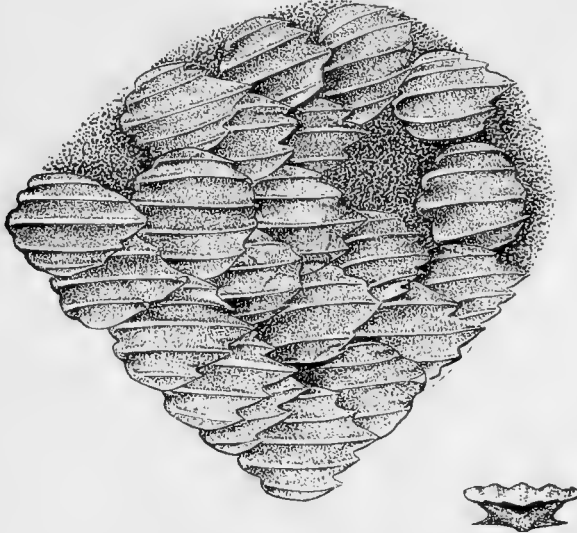

FIG. 14.—Denticles, *Carcharhinus acronotus*, about 60 cm. long, from Cape Lookout, N. C.

one or two rows of small teeth at symphysis, second and third rows on either side slightly larger, graduated; lower teeth smaller than the upper, erect; cusps short, narrow, pointed, very finely serrate, resting on a low, broad base; a median row of minute teeth at symphysis.

Denticles.—The dermal denticles are large, leaflike, closely imbricated, five-keeled; keels low, narrow, parallel, distinct, interspaces not deeply channeled; apical margin in denticles not badly worn, with five small, graduated lobes, corresponding to the keels, median lobe longest; pedicel short, heavy, resting on a large rhomboidal basal plate.

MEASUREMENTS TAKEN FROM A FEMALE 134 CM. ($52\frac{3}{4}$ INCHES) LONG, CAUGHT ON A HOOK BAITED WITH MULLET, IN THE SURF ON SHACKLEFORD BANKS, AUG. 9, 1912.

	cm.		cm.
Tip of snout to—		Origin of first dorsal to origin of second dorsal	42.0
Anterior margin of eye	11.0	Length of anterior margin of pectoral	20.5
First gill slit	25.0	Distance from base of ventrals to anal	17.0
Front of mouth	10.0	Length of caudal	32.5
Base of pectoral	31.5	Length of subcaudal lobe	14.5
Origin of ventrals	69.0		
Origin of dorsal	43.0		

This West Indian species is rare in the Beaufort region, the first example being taken by Coles in the bight of Cape Lookout in July, 1911. In July, 1914, Coles took six additional specimens in the same locality. It may be expected at other points in the South Atlantic States.

14. *Carcharhinus commersonii* Blainville.

Carcharhinus milberti, Linton, 1905, p. 341; Smith, 1907, p. 34 (in part).

Carcharhinus lamia, Gudger, 1913b, p. 97; Coles, 1914, p. 90.

Teeth.—Teeth in $\frac{27-31}{26-32}$ rows; upper teeth erect, very broadly triangular, coarsely serrate; anterior margins straight to slightly convex, posterior margin straight to slightly concave; tips of teeth near angles slightly recurved, those at angles more or less distinctly notched; one or two rows of minute teeth at

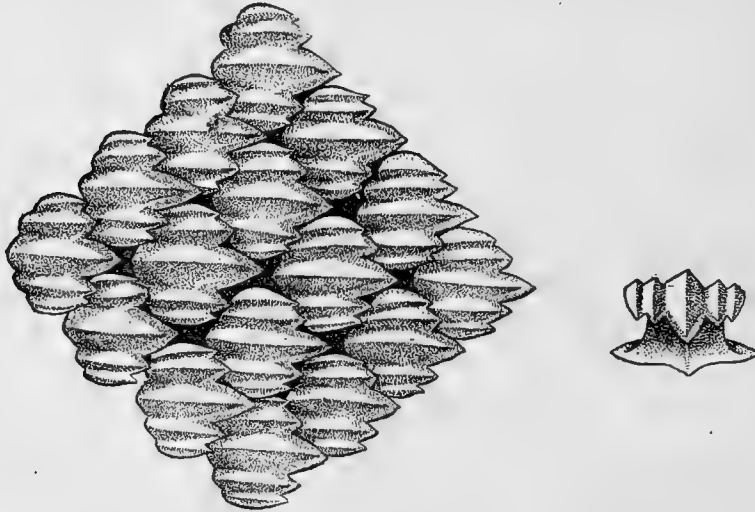

FIG. 15.—Denticles, *Carcharhinus commersonii*, taken from back behind first dorsal, specimen from Cape Lookout, N. C.

symphysis; lower teeth smaller, erect, with relatively short cusps and broad bases, cusps very finely serrate, broader than in related species; two or three rows of minute teeth at symphysis.

The teeth of this species more closely resemble those of *C. milberti* than any other in this region. The upper teeth are shorter and broader, the length of the side of a tooth is more nearly equal to its breadth at base than in *milberti*, serrations coarser, posterior margins of lateral teeth straighter; lower jaw with two or three rows of minute teeth at symphysis instead of one.

Denticles.—The dermal denticles are large (about 0.32 mm. long by 0.42 mm. broad in a shark 2 m. long), closely imbricated, heavy, five-keeled; keels prominent, parallel; apical margin smooth, scalloped or with five distinct pointed lobes, depending upon position and wear they have been subjected to; pedicel low, stout, resting on a large rhomboidal basal plate.

The denticles represented in the drawing were taken from the back behind the first dorsal fin and were the only ones available at the time. Denticles under the dorsal have much less prominent apical lobes, more closely resembling apical margin of *C. acronotus*.

MEASUREMENTS OF A MALE 2 M. (6 FEET 6¾ INCHES) LONG, FROM STATION 10,208 (UNITED STATES COAST SURVEY STEAMER "BACHE"), MAR. 21, 1914.

(Furnished by Mr. W. W. Welsh.)

	cm.		cm.
Total length.....	200.0	Length of anterior pectoral margin.....	47.0
Tip of snout to—		Axil of pectorals to base of ventrals.....	54.0
Origin of first dorsal.....	62.0	Length of ventrals.....	13.0
Anterior margin of eye.....	16.0	Length of claspers.....	18.0
First gill slit.....	33.0	Base of ventrals to origin of anal.....	19.0
Front of mouth.....	14.0	Length of anterior margin of anal.....	13.0
Horizontal diameter of eye.....	2.5	Length of posterior margin of anal.....	9.0
Distance between nostrils.....	12.0	Base of anal.....	7.0
Distance between angles of mouth.....	20.5	Anal to lower caudal lobe.....	12.0
Depth of body at base of first dorsal.....	32.0	Length of upper caudal lobe.....	57.0
Base of first dorsal.....	23.0	Length of lower caudal lobe.....	26.0
Interdorsal space.....	44.0	Caudal notch to tip of fin.....	14.0
Base of second dorsal.....	6.5	Caudal fork to tip of fin.....	50.0
Distance from second dorsal to base of caudal.....	14.0		

First dorsal broad, upper lobe rounded, height of fin greater than length of base, distal margin sinuous, concave near acuminate lower lobe; second dorsal small, similar in form to the first, but more deeply concave, lower lobe relatively longer; pectorals long, narrow, twice as long as broad, with a distinct basal lobe; claspers elongate; anal larger than second dorsal, distal margin deeply incised, anterior lobe rounded, posterior lobe acuminate; caudal large, its length 3.5 in total length of fish; subcaudal lobe nearly one-half length of caudal fin.

Through the courtesy of Mr. Coles, I have been enabled to examine the jaws of the specimen incorrectly identified as *C. milberti* (Linton, 1905, p. 341) and the jaws and denticles of a smaller example. These are *C. commersonii*. Mr. Coles has taken three specimens, the only ones taken on the North Carolina coast.

Genus *GALEOCERDO* Müller and Henle. The tiger sharks.15. *Galeocerdo arcticus* Faber.*Galeocerdo tigrinus*, Coles, 1914, p. 89.

Teeth.—Teeth in $\frac{21-23}{23}$ (21-25)^a rows; upper and lower teeth similar in form; cusps oblique; anterior margins convex, posterior margins incised, with a deep notch and a prominent basal shoulder; tips of

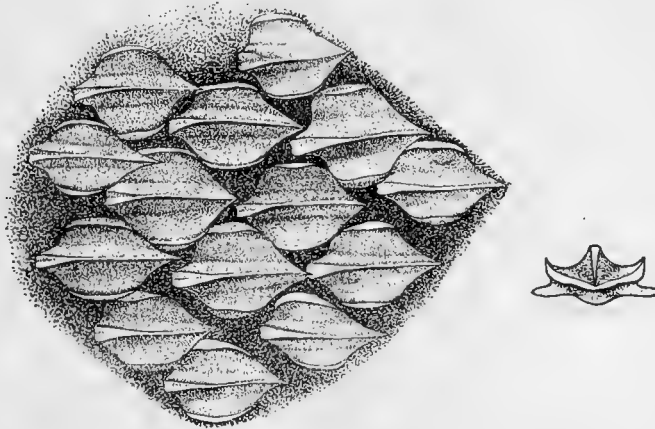
FIG. 16.—Denticles, *Galeocerdo arcticus*, 365.8 cm. long, from Beaufort, N. C.

cusps finely serrate (frequently smooth in functioning teeth), coarsely serrate on basal portion; basal shoulder denticulate, the denticles finely serrate; a median row of smaller, more nearly erect teeth at symphysis of each jaw; the first row and part of the second functioning.

^a Garman, *The Plagiostomia*, p. 148.

Denticles.—The dermal denticles are large, subequal, slightly imbricated, ovate in outline, with a high, arched median keel, and a deep channel on each side of keel; lateral margins curved outward, upturned edges sometimes thickened, keellike, outer edge truncate, or with a narrow basal winglike expansion; apical margin pointed, acute-angled; pedicel broad, little more than a constriction of outer denticle, resting on a large rhomboidal basal plate. Description of specimens 264.2 to 365.8 cm. long. In an example 198.1 cm. long the denticles were smaller, unequal, rather widely separated, without or with only slightly upturned lateral margins.

MEASUREMENTS OF AN EXAMPLE (NO. 1) 198.1 CM. (6½ FEET) LONG FROM MENEMSHA BIGHT MASS., TAKEN AUG. 13, 1913, AND ONE (NO. 2) 279.4 CM. (9 FEET 2 INCHES) LONG FROM BEAUFORT, N. C., TAKEN AUG. 8, 1914.

	No. 1.	No. 2.
Tip of snout to—	cm.	cm.
Base of dorsal.....	56.0	80.0
Anterior margin of eye.....	12.5	21.0
First gill slit (upper angle).....	29.6	48.0
Last gill slit (upper angle).....	37.4
Base of pectoral.....	35.0
Front of mouth.....	8.3	12.0
Outer angle of nostrils.....	7.5
Spiracle.....	17.9
Horizontal diameter of orbit.....	2.7	3.5
Length of aperture of nostrils.....	2.8	4.0
Distance between nostrils.....	8.1
Distance between angles of mouth.....	15.7	23.0
Height of—		
First gill slit.....	4.5
Second.....	4.8
Third.....	5.0
Fourth.....	5.3
Fifth.....	3.9
Length of anterior margin of first dorsal.....	19.0	28.0
Length of posterior margin of first dorsal.....	9.2	16.0
Base of first dorsal.....	14.4	22.0
Distance between dorsals.....	70.0
Anterior margin of second dorsal.....	11.0
Posterior margin of second dorsal.....	13.0
Base of second dorsal.....	12.0
Distance from second dorsal to base of caudal.....	22.0
Length of anterior margin of pectoral.....	24.0	41.0
Length of posterior margin of pectoral.....	8.8	14.0
Breadth of pectorals.....	15.1	25.0
Axil of pectorals to origin of ventrals.....	79.0
Anterior margin of ventrals.....	14.0
Distal margin of ventrals.....	16.5
Posterior margin of ventrals.....	9.0
Distance between axil of ventrals and anal.....	19.0
Anterior margin of anal.....	17.0
Posterior margin of anal.....	10.0
Base of anal.....	17.0
Length of upper caudal lobe.....	55.0	76.0
Length of subcaudal lobe.....	19.5	28.5
Breadth of distal margin of caudal tip.....	2.5
Tip of caudal to notch.....	9.5

Head short, broad, very blunt and robust; snout short, depressed, semicircular; eye large, lateral, above middle of sides of mouth, nictitating membrane present, highest anteriorly; mouth large, nearly semicircular, near tip of snout; angles with a distinct labial fold above and below; distance between angles nearly equal to their distance from tip of snout; nostrils widely separated, length of aperture nearly one-third of their distance apart, anterior margin with a prominent lobe; spiracle small, about an eye diameter behind eye, in line with its upper margin; body slender, tapering posteriorly to a very slender caudal peduncle; a distinct ridge along median line of back between dorsals; caudal peduncle depressed, angled laterally.

Origin of first dorsal above tip of lower pectoral lobe, fin small, high, anterior lobe slightly rounded, posterior lobe long, acuminate; distal margin concave, slightly sinuous; base of fin nearly equal to its height; second dorsal resembling the first, anterior lobe more rounded; pectorals small, falcate, tips barely reaching to posterior base of first dorsal; ventrals truncate; anal origin slightly behind origin of second dorsal, anterior lobe acute, sickle-shaped, posterior lobe acuminate, distal margin very deeply incised; caudal elongate, about 3.7 in total length, upper lobe very narrow, subcaudal lobe narrow, elongate.

Color.—Upper parts silvery gray, lower sides lighter, shading into white of ventral surface; three rows of large spots of darker coloration than the ground color along upper sides and on caudal nearly to tip.

On August 8, 1914, a small school of large tiger sharks appeared in the Fort Macon Channel near the fisheries laboratory and swam around the *Fish Hawk*. A baited shark hook thrown over the side was seized by the largest of the school. The line offered little resistance to this big fellow and he disappeared, taking bait and hook with him. During the time that elapsed while another hook was being secured and baited, the rest of the school came up under the stern of the ship, showing no fear of the men in the cockpit a few feet above them. Apparently the sharks were very hungry and were prepared to grasp anything that might fall to them in the nature of food. When the second hook was thrown over, it was seized by one of the school. This shark, which was killed and brought on deck, was 264.2 cm. (8 $\frac{2}{3}$ feet) in length. For the second time this hook was thrown overboard and soon another specimen, 307.3 cm. (10 $\frac{1}{4}$ feet) in length was captured and hung from the end of the boom with its head out of the water. On the third cast, another, 279.4 cm. (9 $\frac{1}{8}$ feet) in length, was captured. About this time a shark, larger than any of those taken, swam up to the one hanging from the boom, and raising its head partly out of the water, seized the dead shark by the throat. As it did so, the captain of the *Fish Hawk* began shooting at it, with a 32-caliber revolver, as rapidly as he could take aim. The shots seemed only to infuriate the shark, and it shook the dead one so viciously as to make it seem doubtful whether the boom would withstand its onslaught. Finally it tore a very large section of the unfortunate's belly, tearing out and devouring the whole liver, leaving a gaping hole across the entire width of the body large enough to permit a small child to easily enter the body cavity. At this instant one of the bullets struck a vital spot, and after a lively struggle on the part of the launch's crew, a rope was secured around its tail. The four specimens, all females, were brought to the laboratory for examination. The last shark was 365.8 cm. (12 feet) in length, and the liver of the smaller one was still in its stomach, the estimated weight of which was 40 pounds. At the time of capture one of the sharks regurgitated a rat, another a small shark about 61 cm. in length. As this was not saved, its identity was not determined. A shark sucker (*Leptecheneis naucrates*) 26.2 cm. long was also taken with one of the sharks.

Mr. Coles reports the capture of an example of this species by fishermen in the bight of Cape Lookout in 1912.

Family CESTRACIONTIDÆ. The hammer-head sharks.

Genus CESTRACION Klein.

KEY TO THE SPECIES.

- a. Head hammer-shaped; nostril with a well-developed groove extending along front of head. *zygæna*.
 aa. Head kidney-shaped; nostril with frontal groove short or obsolete. *tiburo*.

16. *Cestracion zygæna* (Linnæus). Hammer-head; hammer-headed shark.

Sphyrna zygæna, Yarrow, 1877, p. 217; Jordan and Gilbert, 1879, p. 387; Jordan, 1886, p. 26; Jenkins, 1887, p. 84; Wilson, 1900, p. 355; Smith, 1907, p. 36, fig. 6 (a and b); Gudger, 1907, p. 1005; id., 1913a, p. 10; Coles, 1914, p. 90.

Teeth.—Teeth in $\frac{32-36}{31-34}$ rows, differing in form in different individuals.

In an example 52.3 cm. in length they are oblique, compressed, with a sharp-pointed cusp and a deep notch on the posterior margin, similar in form in both jaws, with no specific differences in form from those of *Scoliodon terræ-novæ*. In a male 124.5 cm. long, the upper teeth are oblique, notched, like those of *S. terræ-novæ*, lower teeth erect, or nearly so, narrow-cusped, several rows of oblique teeth at angle of jaws. In a male 132 cm. long the teeth are low, broad-based, without or with a very short cusp, bases somewhat swollen, not compressed as in the specimens mentioned above. Three rows of small teeth, with a short, erect, pointed cusp, at symphysis of upper jaw; in the teeth adjacent to these, the cusps are slightly bent toward the angles, with a distinct notch on posterior border; this type grades into a cuspless form, five rows at each angle being pavementlike. Lower teeth similar, except that the number of rows with an erect cusp is greater and the transition to the pavement type more abrupt, eight or nine rows of the latter adjacent to angles. The teeth in this species show a transition from the compressed triangular forms of the foregoing species to the pavement teeth of the smooth dogfish.

Through the courtesy of Dr. E. W. Gudger, the writer has examined the jaws of the female hammer-head, 381 cm. (12 feet 6 inches) long, taken in Beaufort Harbor, July 20, 1906. The teeth are oblique

in $\frac{36}{34}$ rows, cusps long, pointed, basal shoulder on posterior margin prominent, cutting edges distinctly serrate; teeth at symphysis erect, or nearly so, with a distinct shoulder on each side of cusp.

Denticles.—The dermal denticles vary in form of sculpturing with age, three-keeled in the young, five-keeled in older examples. In a specimen 52.3 cm. long the denticles are very small, being about 0.17 mm. long by 0.16 mm. broad, closely imbricated, normally three-keeled (3 to 5); apical margin normally five-lobed (3 to 5), lobes long, narrow, sharp-pointed; pedicel short and heavy, resting on a

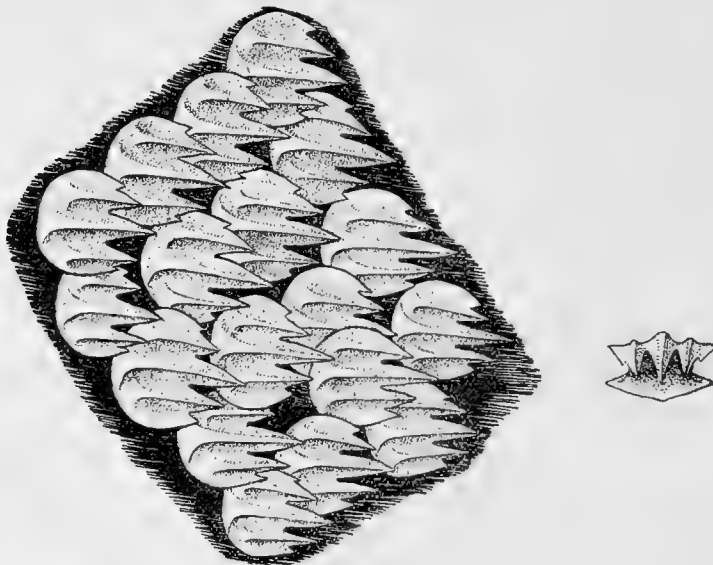

FIG. 17.—Denticles, *Cestracion zygoana*, 52.3 cm. long, from Beaufort, N. C.

large rhomboidal base. In an example 124.5 cm. long they are five-keeled; with or without lobed apical margin.

MEASUREMENTS OF A MALE 124.5 CM. (49 INCHES) LONG, TAKEN IN THE POUND NET, JULY 11, 1914.

	cm.		cm.
Breadth of head.....	35.0	Distance between dorsals.....	29.5
Width of hammer.....	10.0	Length of anterior margin of second dorsal.....	5.0
Tip of snout to—		Length of posterior margin of second dorsal.....	7.5
Origin of first dorsal.....	35.0	Base of second dorsal.....	5.0
First gill slit.....	27.0	Distance from second dorsal to caudal base.....	9.0
Last gill slit.....	28.8	Length of outer margin of pectorals.....	16.5
Base of pectoral.....	26.0	Length of inner margin of pectorals.....	6.5
Front of mouth.....	7.0	Breadth of distal margin of pectorals.....	15.0
Depth of body at origin of first dorsal.....	17.0	Axil of pectorals to origin of ventrals.....	23.5
Horizontal diameter of orbit.....	2.5	Length of outer margin of ventrals.....	9.0
Length of nasal aperture.....	2.5	Length of inner margin of ventrals.....	3.5
Distance between angles of mouth.....	8.5	Breadth of distal margin of ventrals.....	9.0
Height of—		Length of claspers.....	4.5
First gill slit.....	4.0	Distance between base of ventrals and anal.....	10.5
Second gill slit.....	4.0	Length of anterior margin of anal.....	7.0
Third gill slit.....	4.5	Length of posterior margin of anal.....	5.0
Fourth gill slit.....	4.0	Length of base of anal.....	6.5
Fifth gill slit.....	3.0	Posterior base of anal to caudal.....	9.0
Length of anterior margin of first dorsal.....	20.0	Length of upper caudal lobe.....	39.5
Length of posterior margin of first dorsal.....	5.5	Length of subcaudal lobe.....	15.0
Base of first dorsal.....	19.5	Tip of caudal to notch.....	8.2

Dorsal very high, anterior margin nearly straight; distal margin sinuous, markedly concave basally, lower lobe short, acuminate, origin of fin over axil of pectoral; second dorsal small, its origin over anterior

third of anal, distal margin slightly concave, lower lobe acuminate, reaching nearly to base of caudal; pectorals small, distal margin nearly straight; ventrals broad, distal margin very slightly concave; anal larger than second dorsal, anterior lobe recurved, acute-angled, distal margin deeply concave, posterior lobe acuminate, not as long as that of second dorsal.

Color.—Dorsal surface deep olive-gray, sides light olive-gray, shading into white of belly; fins body color, with dusky margins.

Stomach contents.—Three menhaden 21, 22.2, and 22.8 cm. long respectively. One taken in 1913 had been feeding on small shrimp. A male 132 cm. long taken in Newport River, August 3, 1914, had in its stomach four menhaden, each 26 cm. long.

This species is not common in the harbor. None was taken by the laboratory force in 1912, only one in 1913, and two in 1914. The best places to seine for them are near the mouths of the rivers flowing into the harbor. According to Coles this is one of the most abundant sharks in the Cape Lookout region during the summer months. On one occasion he captured 65 specimens, averaging about 4 feet in length, at a single haul of the seine.

17. *Cestracion tiburo* (Linnæus). Bonnet-nosed shark; shovel-headed shark.

Reniceps tiburo, Yarrow, 1877, p. 217; Jordan and Gilbert, 1879, p. 387.

Sphyrna tiburo, Jordan, 1886, p. 26; Jenkins, 1887, p. 84; Wilson, 1900, p. 355; Smith, 1907, p. 35, fig. 5; Gudger, 1907, p. 1005; id., 1912, p. 143; Coles, 1914, p. 90.

Teeth.—Teeth in $\frac{29-32}{27-31}$ rows, with a like variation in form as described for *C. zygaena*, but possessing no diagnostic differences by which they may be distinguished from that species.

In a female 124 cm. long, there are no marked differences from the male of *C. zygaena*, 132 cm. in length; a female 94 cm. long has the same type of teeth but has only two rows of cusplless teeth at angles

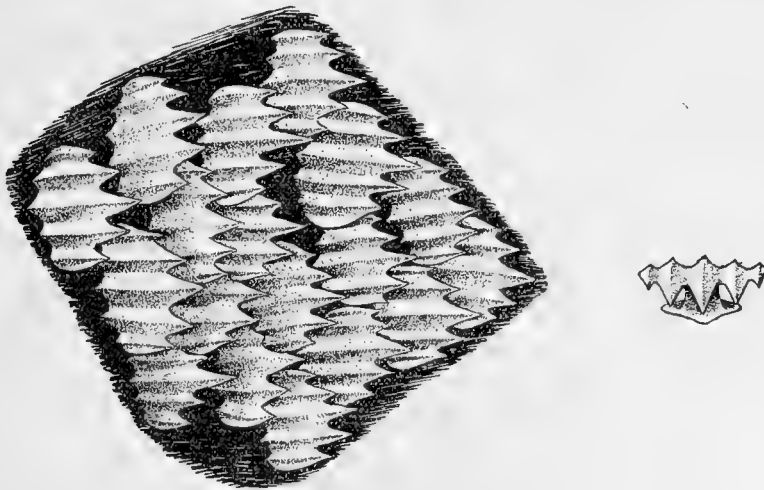

FIG. 18.—Denticles, *Cestracion tiburo*, 89.8 cm. long, from Beaufort, N. C.

in upper jaw and four in the lower. A female 147.5 cm. long has the long, pointed cusps, oblique in upper jaw, erect in the lower and compressed teeth, like those of the male of *zygaena*, 124.5 cm. long.

The average number of rows of teeth is lower in *tiburo* than in *zygaena*. The differences in the form of the teeth are not sexual. The jaws of those specimens in which the teeth are compressed, with oblique cusps in the upper jaw and erect or suberect in the lower are markedly smaller in proportion to the size of the fish than those with the pavement type in each species. As the specimens were not compared nor saved it is not known whether differences other than those of the teeth existed.

Denticles.—The dermal denticles are larger and not so closely imbricated, but quite similar in sculpturing to examples of *C. zygaena*, of the same size. In an example 89.8 cm. long they are about 0.27 mm. long by 0.3 mm. broad, imbricated, five-keeled, keels parallel; apical margin five-lobed, lobes acute-angled, pedicels slender, resting on a small rhomoidal basal plate.

MEASUREMENTS OF A FEMALE 147.5 CM. (58 INCHES) LONG FROM NEWPORT RIVER, AUG. 3, 1914.

	cm.		cm.
Breadth of head.....	20.8	Length of anterior margin of second dorsal.....	7.4
Tip of snout to—		Length of posterior margin of second dorsal.....	6.5
First gill slit.....	21.4	Base of second dorsal.....	4.8
Last gill slit.....	27.3	Distance from second dorsal to base of caudal.....	9.0
Base of pectoral.....	26.0	Length of outer pectoral margin.....	19.4
Front of mouth.....	7.8	Length of inner pectoral margin.....	6.8
Depth of body at origin of first dorsal.....	18.5	Breadth of pectoral.....	12.6
Horizontal diameter of orbit.....	1.7	Axil of pectorals to origin of ventrals.....	27.5
Length of nasal aperture.....	1.7	Length of outer margin of ventrals.....	9.5
Distance between angles of mouth.....	10.0	Length of inner margin of ventrals.....	3.8
Height of—		Breadth of ventrals.....	8.3
First gill slit.....	4.9	Distance from base of ventrals to origin of anal.....	9.2
Second gill slit.....	5.6	Length of anterior margin of anal.....	6.0
Third gill slit.....	6.0	Length of posterior margin of anal.....	4.2
Fourth gill slit.....	5.8	Base of anal.....	8.0
Fifth gill slit.....	4.8	Distance from anal to base of caudal.....	7.3
Length of anterior margin of first dorsal.....	16.9	Length of upper caudal lobe.....	29.2
Length of posterior margin of first dorsal.....	4.5	Length of subcaudal lobe.....	13.0
Base of first dorsal.....	10.4	Tip of caudal to notch.....	7.7
Distance between dorsals.....	27.3		

Dorsal fin high, anterior margin slightly convex, distal margin rather deeply concave, posterior lobe short, acute angled, origin of dorsal over tip of inner pectoral lobe; second dorsal small, slightly behind origin of anal; distal margin deeply concave, upper lobe rounded, lower lobe acuminate; pectorals short, their length not much greater than their breadth; distal margin slightly concave; anal low, broad, distal margin slightly incised; caudal short, about one-fifth total length; subcaudal lobe prominent.

This individual had nine embryos, six in the left uterus and three in the right one. Of these three were males, 12.2 to 14.1 cm. long, and four females 13.4 to 14 cm. long. Another specimen, 124 cm. long, taken on Bird Shoal August 6, 1914, had four embryos in each uterus, about 17.5 to 18.5 cm. long. The embryos lie with the head at the forward end of the uterus. The placenta, which was nearly as long as the embryo, was richly supplied with villi, some of which were 25 mm. long by 3 mm. in diameter. The yolk sac at the end of the placenta was attached to the wall of the uterus and was richly supplied with blood vessels.

SPECIMENS TAKEN DURING THE SUMMERS OF 1912 TO 1914.

Date.	Locality.	Length.	Weight.	Sex.	Stomach contents.
1912.		cm.	grams.		
June 27.....	Near laboratory.....	42.5	286	♂	1 shrimp (<i>P. brasiliensis</i>); remains of a small teleost; fragments of eel grass; bit of wood.
Do.....	do.....	49.4	474	♂	1 shrimp (<i>P. brasiliensis</i>).
Do.....	do.....	48.7	369	♂	1 small crab; 2 small yellow stones.
July 11.....	Near Morehead.....	95.0	3,290	♂	3 shrimps (<i>P. brasiliensis</i>).
Do.....	do.....	73.0	1,274	♂	Empty.
Do.....	do.....	70.0	1,161	♂	Material unidentifiable.
Do.....	do.....	70.0	1,161	♂	Do.
July 30.....	Newport River.....	47.0		♂	Empty.
Sept. 10.....	North River.....	58.7	780	♂	Do.
1913.					
July 1.....	do.....			♀	Small blue crabs.
July 22.....	Town Creek.....	89.8		♀	1 large blue crab and other unidentifiable material.
1914.					
July 22.....	North River.....	54.0		♂	Remains of a blue crab.
Aug. 3.....	Newport River.....	94.0		♂	Empty.
Do.....	do.....	174.5		♂	1 blue crab.
Aug. 6.....	Bird Shoal.....	97.0		♂	2 blue crabs; 1 pinfish; mass of algæ.
Do.....	do.....	124.0		♂	

This species is much more abundant in the harbor than the hammer-head, and appears to enter the harbor for the purpose of giving birth to its young.

Family GALEORHINIDÆ. The smooth dogfishes.

Genus GALEORHINUS Blainville.

18. *Galeorhinus lævis* Valmont. Whipper-tail; dogfish; smooth dogfish.

Mustelus canis, Smith, 1907, p. 32; Coles, 1914, p. 89.

Teeth.—Teeth small, numerous, pavementlike, anterior base of tooth slightly ridged; upper teeth with a short, blunt cusplike projection on posterior margin; lower teeth similar in form, cusp less prominent, absent from teeth near angles of mouth. No sexual differences were noted between the teeth of a male 75 cm. long and a female 91 cm. long from Cape Lookout.

Denticles.—The denticles are large (the larger ones in a specimen 90.8 cm. long being 0.4 mm. long by 0.3 mm. wide), unequal in size, overlapping, ovate in outline, with 2 to 4 short, low, nearly parallel keels on basal portion of denticle; the length and prominence of the keels vary; rarely do they extend to the apical margin; apex acute; pedicel small, relatively high; base small.

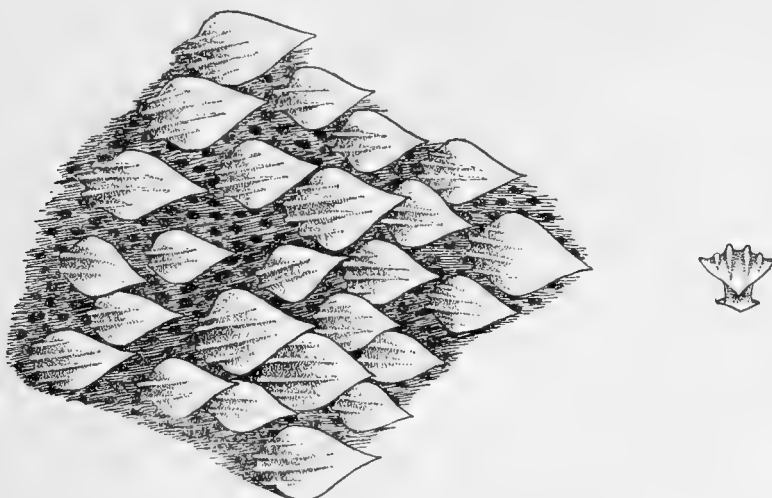

FIG. 19.—Denticles, *Galeorhinus lævis*, 91 cm. long, from Cape Lookout, N. C.

The laboratory has no record of the capture of examples of this species in Beaufort Harbor. It is abundant at Cape Lookout in the spring, but is rarely seen later than June. Individuals left by the fishermen, are common on the beaches at Cape Lookout in April. It is locally known as "whipper-tail."

Family SQUALIDÆ. The spiny dogfishes.

Genus SQUALUS Linnæus.

19. *Squalus acanthias* (Klein). Spiny dogfish.

Squalus acanthias, Gudger, 1912, p. 143; id., 1913b, p. 98; Coles, 1914, p. 92.

Teeth.—Teeth in $\frac{28}{23}$ rows, regular in arrangement, similar in form in each jaw; upper smaller than lower; cutting edges transverse, nearly horizontal, ending posteriorly in a small, sharp-pointed cusp, below this a deep notch and a prominent basal shoulder; on basal portion of tooth there is a narrow median lobe of enamel, outline of base more or less concave on each side of this projection. Cutting edges of upper teeth more oblique than the lower, the cusps being more erect; two rows of teeth functioning.

Denticles.—The denticles are large, being about 0.46 mm. long by 0.32 mm. broad in a shark 84.5 cm. long; a high median keel widest on basal portion of denticles and projecting beyond basal margin; a low keel along each margin normally present; apical margin tridentate, median lobe prominent; pedicel stout; base large, stellate.

At Cape Lookout, Coles states that this species is very abundant in April and the first week of May. Only a single example, taken May 23, 1907, has been recorded from Beaufort Harbor. This was a female,

from which three young ones, 14.5, 15, and 15.3 cm. in length were obtained. The description of teeth and denticles is based on this specimen.

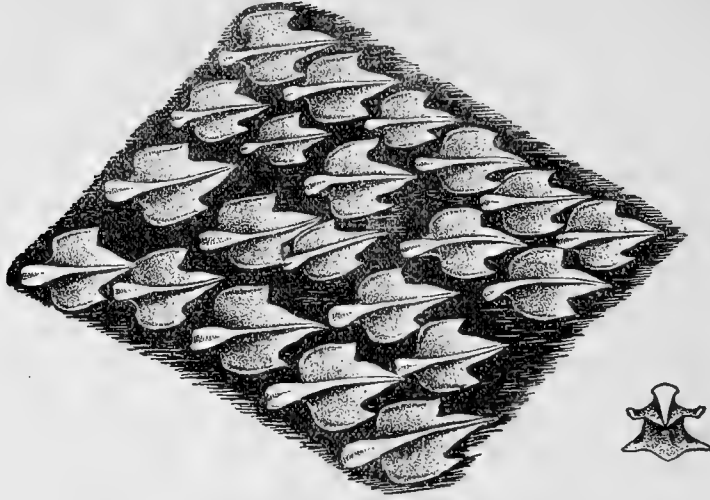

FIG. 20.—Denticles, *Squalus acanthias*, 84.5 cm. long, from Beaufort, N. C.

Family RHINIDÆ. The angel fishes.

Genus RHINA Klein.

20. *Rhina dumeril* (Le Sueur). Nursefish; Jakie.

Squatina squatina, Smith, 1907, p. 38; Gudger, 1913a, p. 10; Coles, 1914, p. 92.

Coles states that this species is a regular visitor at Cape Lookout, arriving the latter part of March and leaving about the 1st of May. As no examples of this species are at present available it is impossible to describe the teeth and armature of the skin.

Family PRISTIDÆ. The sawfishes.

Genus PRISTIS Klein in Schauplat. z.

21. *Pristis pectinatus* Latham. Sawfish.

Pristis antiquorum, Yarrow, 1877, p. 217.

Pristis pectinatus, Jenkins, 1885, p. 11; Jordan, 1886, p. 26; Jenkins, 1887, p. 84; Jordan and Evermann, 1898, pt. III, p. 2749, id., 1900, pl. VIII, fig. 27; Wilson, 1900, p. 355; Smith, 1907, p. 39, fig. 7; Gudger, 1912, p. 144; Coles, 1914, p. 92.

Teeth.—Teeth in about $\frac{94}{90}$ rows (88 to 178 rows above and 84 to 176 below),^a small, flattened, in pavement, arranged in quincunx; anterior margins rounded, posterior margins truncate; posterior basal portion of upper teeth with a short mesial projection and a slight indentation on either side of it; in the lower teeth the exposed projecting base is more pointed, margin on either side straighter.

Denticles.—Denticles on rostrum circular, buttonlike, close-set, sessile; on the head and trunk they vary from ovate to circular; those under first dorsal ovate; pedicel short. Description of teeth and denticles based on a specimen from Florida 71.7 cm. (28 $\frac{3}{4}$ inches) long in the United States National Museum.

FIG. 21.—Teeth, upper and lower jaws, *Pristis pectinatus*, 71.7 cm. long, from Florida. (Same specimen as fig. 22.)

"Scales on the very young with broad, rounded bases, short pedicels and leaf-shaped crowns, which latter are more or less sharp angled posteriorly on the greater portion of the body, but with age the crowns become modified, on the fin margins, about the snout and head, and appear convex and smooth, button-shaped, and sessile."^a

^a Garman, *The Plagiostomia*, p. 263.

This species is not rare in the Beaufort region. According to Coles it is usually found in the breakers on Lookout Shoals.

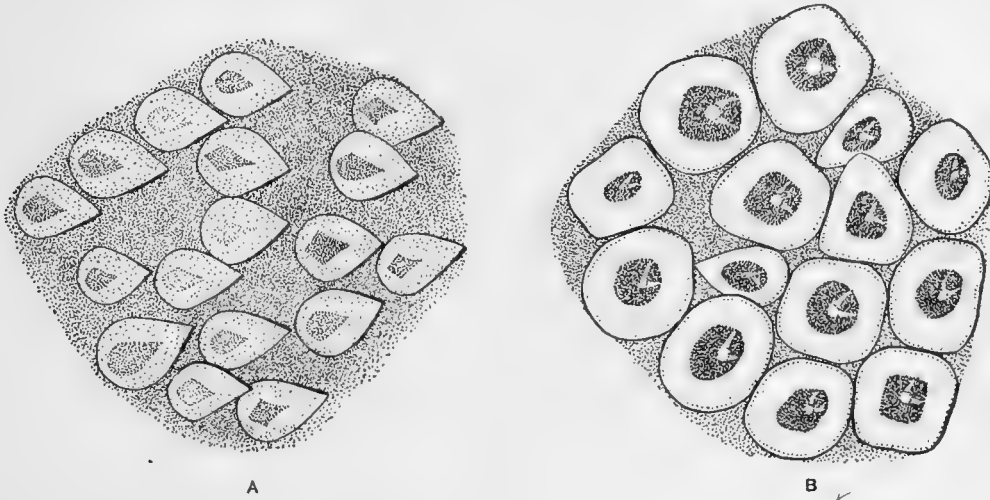

FIG. 22.—Denticles, *Pristis pectinatus*, 71.7 cm. long, from Florida. (U. S. National Museum no. 30678.) A, Denticles under first dorsal; B, denticles on upper surface of rostrum.

Family RHINOBATIDÆ. The sharklike rays.

Genus RHINOBATUS Klein in Schauplatz.

22. *Rhinobatus lentiginosus* Garman. Ray; clear-nose.

Rhinobatus lentiginosus, Smith, 1907, p. 40, fig. 8 (a and b); Coles, 1913, p. 33; id., 1914, p. 92.

Teeth.—Teeth in $\frac{63}{60}$ rows in a female 53.5 cm. long and in $\frac{56}{51}$ rows in a male 38.8 cm. long, in pavement, arranged in quincunx; similar in form in both sexes; anterior margin rounded, posterior margin of functioning surface truncate; posterior side of teeth narrowed basally to a cusplike projection at gum.

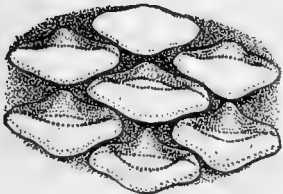
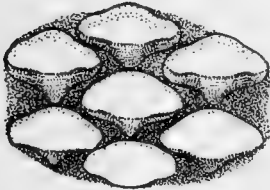

FIG. 23.—Teeth, upper and lower jaws, *Rhinobatus lentiginosus*, 53.5 cm. long. (Same specimen as fig. 24.)

Denticles.—The denticles are unequal in size and vary in form on different parts of the body; on clear space on either side of rostral cartilage they are small, spear-shaped, sharp-pointed, with concave margins; on back opposite angles to pectorals they are arrow-headed, very unequal in size; on sides under first dorsal they are ovate, sharp-pointed; on ventral surface they are in pavement, subquadrangular in outline.

There is a row of small compressed and depressed tubercles along the median line of the back; midway between the dorsals these are reduced to ridges covered by skin; a small tubercle on left shoulder and two on the right; a row in front of and above eye, ending at spiracle; five prominent tubercles on tip of snout, three small ones behind these. Description of a female 38.8 cm. long.

Examples from Beaufort agree in the main with descriptions of *lentiginosus*, but possess other characters which are said to distinguish *percellens* from this species.

Rostral cartilage narrow in the middle, broader toward tip of snout, ridges widening forward, the cartilage bearing a flange on the outer side of each near the end; groove between the rostral ridges

narrowing regularly toward tip of snout.

Nostrils a little wider than their distance apart, the latter one-half mouth; a long, narrow median flap on front margin of nostril and a narrow auxiliary flap extending for one-half distance to inner angle of nostril; posterior margin with an inner median flap, larger than one on anterior margin and two broad flaps on outer margin. Distance between angles of mouth slightly more than one-third distance from mouth to tip of snout; length of spiracles about equal to horizontal diameter of exposed portion of orbit, with two lobes, outer larger; supraocular lobe of orbit large; outer margin of pectorals broadly curved, strongly convex near axis; dorsals subequal, base of first one-third of its distance from base of ventrals, posterior margins truncate; caudal of moderate size, subcaudal convex.

Color in alcohol.—Dorsal surface light grayish-olive, thickly sprinkled with small spots of lighter coloration; clear space on either side of rostral cartilage olive-buff; pectorals and ventrals margined with lighter, with traces of a narrow intramarginal band of darker coloration. Ventral surface light naph-

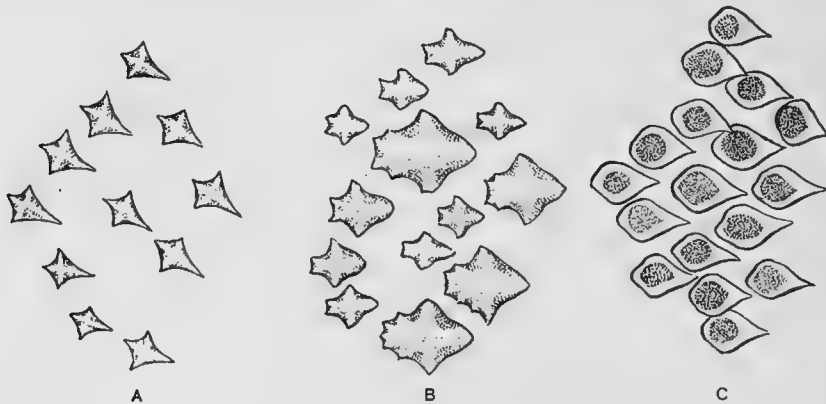

FIG. 24.—Denticles, *Rhinobalus lentiginosus*, 53.5 cm. long, from Cape Lookout, N. C. A, Denticles on clear space on either side of rostral cartilage; B, denticles on back opposite axil of pectorals; C, denticles on side of body below first dorsal fin.

thalene yellow, under surface of tip of snout dark gray; this area extends backward in a narrow, triangular patch, more than half way to front of mouth and along each side of snout to opposite nostrils. Fins slightly darker than ventral surface. The dark coloration on under side of snout is said to be characteristic of *percellens*.

Family NARCACIONTIDÆ. The electric rays.

Genus NARCINE Henle.

23. *Narcine brasiliensis corallina* Garman. Shockfish; small electric ray.

?*Torpedo occidentalis*, Jenkins, 1887, p. 84 (not of Yarrow).

Narcine brasiliensis, Coles, 1910, p. 337, p. 347; Bean and Weed, 1911, p. 232, pl. 10, 11; Gudger, 1913a, p. 2; Coles, 1913, p. 33; id., 1914, p. 93.

Narcine brasiliensis corallina, Garman, 1913, p. 298, pl. 26, fig. 3.

Teeth.—In a male 27.7 cm. long the teeth are $\frac{21}{21}$ rows, close-set, arranged in quincunx; dental plate narrow, folded outward; teeth small, base subcircular; posterior grinding surface ending in a narrow, pointed cusp, margin of cusp continuous with anterior margin of tooth.

In a female 34 cm. long the teeth are more flattened, grinding surface, including cusp, more nearly horizontal, cusp less prominent; teeth in $\frac{21}{21}$ rows, less crowded than in the male. Skin smooth.

Examples from Cape Lookout appear to agree more closely in color pattern with Garman's subspecies *corallina* than either of the other forms. According to Coles this species is a regular visitor at Cape Lookout, arriving in the bight of the cape on the night of July 4 of each year.

There is no authentic record of the occurrence of the *Torpedo*, *Narcacion nobilianus*, on this coast. The small electric ray (*corallina*) is known to the cape fishermen as "shockfish." It therefore seems probable that the form described by Jenkins was this species and not the *Torpedo*.

Yarrow lists the *Torpedo*, but the form described in his notes, as reported by fishermen, was not a ray, but the "electric toad" (*Astroscopus y-græcum*), a form he had not seen. Coues had taken a single specimen of the latter species; this accounts for its inclusion in Yarrow's report.

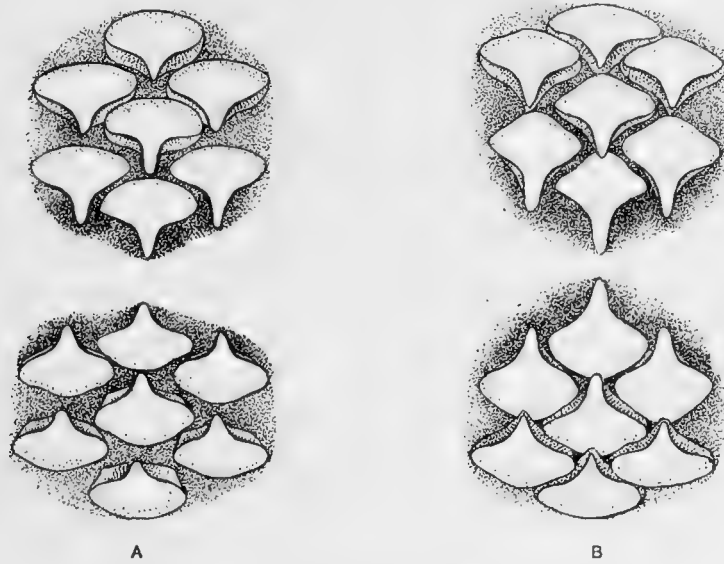

FIG. 25.—A, Teeth, upper and lower jaws, of a male, *Narcine brasiliensis*, 27.7 cm. long, Cape Lookout, N. C.; B, teeth, female, 34 cm. long, from same locality.

Family RAJIDÆ. The Skates.

Genus RAJA Linnæus.

KEY TO THE SPECIES.

- a. Snout very blunt, broadly rounded; disk rounded, slightly broader than long; teeth in about $\frac{44}{44}$ rows; upper surface of body with rosettes or groups of darker spots..... *ornata*.
- aa. Snout produced, angular, disk angular, much broader than long.
- b. Teeth in $\frac{46-49}{42-47}$ rows; disk and tail rough above; upper surface with numerous dark brown elongated spots..... *eglanteria*.
- bb. Teeth in $\frac{32-37}{32-35}$ rows; upper surface smoother than in most skates, marked with scattered, unequal, dark brown spots..... *stabuliformis*.

24. *Raja ornata* Garman.

Teeth.—Teeth in about $\frac{44}{44}$ rows, flat, in pavement; anterior margins rounded, posterior margins with a small median cusplike projection.

Armature of skin.—Entire upper surface roughened with small spines; lower surface smooth. A row of tubercles above median line of back and tail; a row on either side of these on back and two on the tail; a single spine on each shoulder in one specimen, absent in another; a series on each orbital ridge; a group on rostral ridge near tip of snout; spines along anterior margin of disk slightly larger than those on rest of disk. Descriptions of two young males 19.5 and 21 cm. long.

A female 25 cm. long differs in having three spines on each shoulder, one on forehead between eyes; a group on posterior pectoral lobe, and another near margin of disk opposite eyes.

Disk broadly rounded, with a slight concavity opposite spiracles, slightly broader than long, its length to hinder angle of pectorals 1.1 in its breadth, 2.1 to 2.3 in total length; tip of snout obtuse, not

produced; eyes prominent; interorbital narrow, about one-third snout; mouth small, waved, situated midway between tips of snout and fifth gill slit; ventrals long, narrow, outer margin rounded; tail with a thin narrow flap along lower outer margin.

Color.—Upper surface tulleul buff, marked with regular rosettes of small black or dark brown spots, six or more around a central one; six or seven rosettes arranged at regular intervals along upper surface of tail, one of these at origin of first dorsal, another at origin of second dorsal; ventral surface white.

On September 2, 1914, the *Fish Hawk* collected a female 25 cm. long, with 8-foot beam trawl, at station 8244 in 66 fathoms of water, and two young males 19.5 and 21 cm. long at station 8245 in 100 to 111 fathoms of water. These stations were about 36 to 40 miles east-southeast of Cape Lookout Light. This species has previously been taken only in deep water off the coast of Florida.

25. *Raja eglanteria* Bosc in Lacépède. Clear-nose ray; brier ray.

♀*Raja laevis*, Yarrow, 1877, p. 217; Jordan and Gilbert, 1879, p. 387 (after Yarrow); Jenkins, 1887, p. 84 (after Yarrow).
Raja eglanteria, Smith, 1907, p. 42, fig. 9; Gudger, 1910, p. 398; id., 1913a, p. 10; Coles, 1914, p. 92.

Teeth.—In a male 55 cm. ($22\frac{5}{8}$ inches) long, in $\frac{49}{47}$ rows, arranged in regular, parallel rows across the dental plate. Teeth small with a small conical cusp, resting on a broad circular base, anterior margin of each tooth overlapping the posterior basal margin of the tooth immediately in front of it; in front of mouth the cusps are erect, rather blunt at tip; in the back of the mouth they are much longer, recurved, sharp-pointed at tip; 8 to 10 teeth in each row functioning.

Teeth in a female 43.1 cm. (17 inches) long to posterior base of first dorsal (rest of tail lost), in $\frac{53}{47}$ rows; rows closer together, the flaring base of each tooth occupying part of the upper space between two adjacent teeth in each row, in quincunx; teeth in front of mouth with flaring edges, the margin being continuous with that of anterior basal portion of tooth, and forming a rhomboidal grinding surface; underneath, between the backward projecting cusp with its flaring basal expansion and the posterior base of the tooth there is a distinct groove into which the base of the following tooth fits; farther back on the jaws some of the teeth more closely resemble the male, except that the cusp has a slight basal expansion compressed to a sharp cutting edge which is continuous with the anterior margin of the tooth.

Armature of the skin.—In the male there is a patch of tentacula opposite the eyes near margin of disk, and a narrow, elongate intramarginal band at widest part of disk, tips of tentacula inclined toward median line of back; in front of and along inner margin of eye and spiracle there is a row of small tubercles; another of larger tubercles extends along the median line of the back to the second dorsal, two or three on each shoulder and a row along each side of dorsal surface of tail. Small, sharp-pointed spinules are scattered along rostral ridge; those at the tip of snout being enlarged, tuberclelike; others are present along outer pectoral margin, on shoulders, between rows of tubercles on tail and on under side of snout, backward to opposite mouth; rest of body smooth.

In a young male, 8 inches in length, the patches of enlarged tentacula opposite eyes and near outer margin of disk are absent. Tubercles over eyes, on shoulders, along median line of back and in three rows on tail prominent, sharp-pointed, recurved; dorsal surface everywhere studded with small spinules; on clear space on either side of rostral cartilage they are scatteringly present.

In the female the tentacula are absent; spinules scattered over dorsal surface; on the tail between the rows of tubercles they are enlarged, some of them nearly as large as the tubercles.

The *R. laevis* of Yarrow, reported as common, is believed to be this species. The species is common along the banks in the spring and is not rare at offshore stations at other seasons. There are no records of examples taken in the harbor.

26. *Raja stabuliformis* Garman. Smooth skate.

Raja laevis, Linton, 1905, p. 346; Smith, 1907, p. 41; Coles, 1914, p. 92.

Teeth.—Teeth in the female in $\frac{33}{33}$ rows, exposed surface of tooth rounded, posterior margin with a small but distinct cusplike projection; in the functioning teeth the exposed surface is subcircular, the cusplike projection being entirely worn away.

Teeth in the male, in $\frac{37}{35}$ rows, a long sharp-pointed thornlike cusp extends outward and backward from the subcircular base of each tooth; at the sides of the jaws the cusp is in the same plane as basal portion; exposed area of tooth ovate in outline.

Armature of the skin (male).—Tip of snout armed with small, forward projecting conical tubercles, a narrow band of these along anterior margin of disk ending in advance of outer angle of disk; a triangular intramarginal patch of large, depressed, sharp-pointed tentacula opposite the eyes; these point inward and backward; a large area of similar tentacula opposite angles, situated one-third of distance from angle to median line of back; small tubercles over eyes and behind spiracles; a more or less complete row of spinelike tubercles along median line of tail and between dorsals; a similar row along each side of tail, immediately above lateral fold; minute tubercles scatteringly present over upper surface of tail; outer ventral surface of snout armed with small recurved tubercles.

In the female the patches of tentacula are absent. The above description of teeth and denticles is based on a male 101.6 cm. (40 inches) long and a female 119.4 cm. (47 inches) long, from Woods Hole, Mass.

Color in alcohol.—Dorsal surface wood brown with scattered, unequal spots of clove brown, which vary in size from that of pupil to nearly that of orbit. Ventral surface cream color, pores black.

The *Fish Hawk* is reported to have collected small specimens off Cape Lookout on August 14, 1902, at station 7310 in 18 fathoms. Coles reports that the species is exceedingly rare and that he has taken specimens of a width of 4 feet on the rocks far offshore.

Family DASYBATIDÆ. The sting rays.

KEY TO THE GENERA.

- a. Tail long, whiplike, with one or more serrated spines; disk subquadrangular to subcircular. . *Dasybatus*.
- aa. Tail moderate to short, with a serrated spine (sometimes absent in young).
- b. Disk subcircular. *Urobatis*.
- bb. Disk much broader than long, rhomboidal. *Pteroplatea*.

Genus DASYBATUS Klein in Schauplatz.

KEY TO NORTH CAROLINA SPECIES OF DASYBATUS.

- a. PASTINACHUS: Tail with a keel or winglike expansion below only; disk quadrangular, its length 1.25 in its breadth; body of the young smooth; adult with broad stellate based, conical pointed, irregularly placed bucklers on the middle of the hinder part of the back and on top and sides of tail. *marinus*.
- aa. DASYBATUS: Tail with a low, black keel above and a broad, black winglike expansion below.
- b. Disk quadrangular, a little broader than long; young smooth; adult with a median row of tubercles along highest part of back and one or two on each shoulder; a small light gray or white spot on median line of snout immediately in front of eyes in adult; angle of disk, 54°. . *hastatus*.
- aaa. AMPHOTISTIUS: Tail with a winglike expansion above and a larger one below.
- c. Winglike expansions light-colored, yellowish to orange in life; disk subcircular; snout produced, pointed; in the adult the skin is more or less prickly, especially on interorbital area; a row of well-developed tubercles along median line of back and tail, one or two tubercles on each shoulder; very young smooth; angle of disk, 53°. *sabinus*.
- cc. Winglike expansions black; disk quadrangular (narrower and more rounded than in *hastatus*); snout blunt; skin nearly or quite smooth; a few tubercles along highest part of back and one or two on shoulders in adults; angle of disk, 59°. *say*.

27. *Dasybatus hastatus* (De Kay). Sting ray; stingaree.

Dasyatis hastata, Coles, 1910, p. 338; Gudger, 1913a, p. 4; Coles, 1914, p. 93.
Dasybatus hastatus, Garman, 1913, p. 391.

Teeth.—In a male (length of disk, 50.8 cm.) the teeth are in about $\frac{44}{47}$ rows, reddish-brown in color, exposed surface of upper teeth and of lower teeth except near angle of mouth leaflike, with a sharp-pointed, very slender acuminate tip; teeth near angles of lower jaw with their posterior edge rounded, ridged.

In a female 155.2 cm. long the teeth are in about $\frac{36}{44}$ rows, in pavement, irregularly rhomboidal in outline; yellow in color.

Armature of skin.—Skin in the young smooth; in larger examples small tubercles are present along median line of back and a row of three or more on each shoulder; later small spinules are scatteringly present on shoulders and interorbital space; in very old examples region adjacent to median line of back is thickly sprinkled with small spinules, these are also present on the tail immediately in front the spine and along the sides of the tail behind the spine.

MEASUREMENTS OF A MALE (NO. 1) 110.5 CM. (43.5 INCHES) LONG FROM NORTH RIVER, SEPT. 17, 1912, AND A FEMALE (NO. 2) 155.2 CM. (61.1 INCHES) LONG FROM FORT MACON, AUG. 1, 1913.

	No. 1.	No. 2.
	cm.	cm.
Tip of snout to posterior edge of pectoral.....	45.3	72.3
Tip of snout to posterior axil of pectoral.....	39.8	66.2
Tip of snout to base of spine.....	58.5	96.0
Breadth of disk.....	51.0	82.8
Length of anterior margin of disk.....	32.1	48.0
Length of posterior margin of disk.....	31.5	56.2
Tip of snout to anterior margin of orbit.....	10.8	17.9
Horizontal diameter of eye.....	2.4	2.1
Interocular space.....	8.1	13.2
Tip of snout to—		
Front of mouth.....	9.7	15.2
Inner angle of first gill slit.....	15.9	24.2
Inner angle of second gill slit.....	17.5	26.1
Inner angle of third gill slit.....	18.6	28.5
Inner angle of fourth gill slit.....	20.1	30.8
Inner angle of fifth gill slit.....	21.3	32.9
Interspace between anterior gill slits.....	9.9	15.1
Interspace between posterior gill slits.....	6.6	9.6
Tip of snout to vent.....	40.0	64.5
Length of ventrals.....	8.7	15.3
Length of claspers.....	10.7
Breadth of claspers.....	2.7
Breadth of mouth.....	5.5	15.3

Disk quadrangular; anterior margins nearly straight, meeting in an obtuse angle at tip of snout; posterior margins of disk slightly rounded, posterior angle rather sharp; ventrals projecting but little beyond the disk; tail with a low median keel on top behind the spine and a long cutaneous fold below.

When landed in the seine the female gave birth to three young, two females 40 and 51 cm. long and a male 48 cm. long. These were similar in form to the adult, upper surface devoid of tubercles.

The disk and ventrals are narrowly margined with white, with an intramarginal area of dark coloration, shading into body color; in adults there is a small gray or white spot on median line of snout immediately in front of eyes; sides of tail white or grayish; keel and fold of tail black. The ground color of these rays changes with change in color of background.

The females examined had been feeding on clams, shrimps, marine worms, and small teleosts. Males examined had eaten shrimps and blue crabs. An attempt was made to determine whether there was a selective difference between the sexes in the character of food which might throw some light on the differences in the form of the teeth, although several females, but none of the males examined, had been feeding on clams; sufficient material has not as yet been examined to be of value. No pieces of shell were present with the clam meat.

This species is common in the harbor, especially in North River. That their feeding habits attract them to regions where clams and oysters are to be found seems certain.

28. *Dasybatus sabinus* (Le Sueur). Sting ray.

Dasyatis sabina, Radcliffe, 1913, p. 396.

Teeth.—Teeth similar in form and coloration to *D. hastatus*; in a male 69.6 cm. long they are in about $\frac{44}{44}$ rows; in a female (length of disk 39 cm., tail mutilated) in about $\frac{36}{44}$ rows; upper teeth larger than the lower; upper jaw more strongly arched than in either of the other species of *Dasybatus*.

Armature of skin.—Skin in very small examples smooth, later a median row of sharp tubercles appears; in larger examples these extend as far back as spine and one or more tubercles appear on each shoulder; in adults the interorbital space is thickly sprinkled with small spinules; these are scatteringly present on the shoulder region in old individuals.

MEASUREMENTS OF A MALE 70 CM. ($27\frac{5}{8}$ INCHES) LONG.

	cm.		cm.
Length of disk.....	27.8	Interocular space.....	3.6
Breadth of disk.....	28.0	Diameter of eye.....	1.1
Length of tail.....	47.5	Width of mouth.....	3.5
Tip of snout to—		Distance between anterior gill slits.....	6.0
Outer angle of pectoral.....	18.9	Distance between posterior gill slits.....	3.8
Eye.....	5.6	Length of claspers.....	7.5
Front of mouth.....	3.5		
First gill slit.....	10.5		
Last gill slit.....	14.2		
Vent.....	25.0		

Disk subcircular; anterior margin sinuous, concave opposite mouth, tip of snout projecting, pointed; outer angles of disk broadly rounded; posterior angle evenly rounded; ventrals broad, truncate.

This small sting ray is very abundant in the Beaufort region, being taken in greater numbers than either *hastatus* or *sayi*. It is readily distinguished from these species by the subcircular disk, concave anteriorly, by the pointed snout, the more prominent tubercles, and by the light coloration of the keel and winglike expansion of the tail. In old examples these are somewhat darker in coloration.

29. *Dasybatus sayi* (Le Sueur). Sting ray; stingaree; whip-ray.

Trygon centrura, Yarrow, 1877, p. 216.

Dasybatis centrurus, Jordan and Gilbert, 1879, p. 386.

Dasybatis sayi, Jordan, 1886, p. 26.

Trygon sayi, Jenkins, 1887, p. 84; Wilson, 1900, p. 355.

Dasybatis sayi, Linton, 1906, p. 346; Smith, 1907, p. 44; Gudger, 1912, p. 144; Coles, 1914, p. 93.

Teeth.—Teeth similar in form and coloration to the other species described; in about $\frac{36}{36}$ rows in a male 90 cm. long and in about $\frac{37}{45}$ rows in a female 76 cm. long. Upper jaw more prominently arched than in *hastatus*, not as strongly arched as in *sabinus*.

Armature of skin.—Skin of the young, smooth; in large examples there is a short median row of small tubercles along highest part of back, and one or two on each shoulder; in old individuals stellate tubercles are scatteringly present on shoulder region and spinules on tail.

MEASUREMENTS OF A MALE 98 CM. (38.6 INCHES) IN LENGTH FROM NORTH RIVER.

	cm.		cm.
Length of disk.....	41.5	Tip of snout to—	
Breadth of disk.....	44.0	Inner angle of fourth gill slit.....	17.4
Length of anterior margin of disk.....	27.2	Inner angle of fifth gill slit.....	13.8
Length of posterior margin of disk.....	29.0	Distance between anterior gill slits.....	8.9
Tip of snout to—		Distance between posterior gill slits.....	6.2
Eye.....	9.1	Length of claspers.....	10.9
Front of mouth.....	7.8	Breadth of claspers.....	1.9
Inner angle of first gill slit.....	13.2	Interocular space.....	9.0
Inner angle of second gill slit.....	14.8	Breadth of mouth.....	4.8
Inner angle of third gill slit.....	16.1		

Disk subquadrangular, its length 1.15 in its width, anterior margins nearly straight, posterior margin convex; ventrals rounded, projecting well beyond posterior margin of disk.

This species is similar in form to *hastatus*, differing in having a black winglike expansion on upper side of tail behind spine; anterior margin of disk shorter in proportion to posterior margin and more evenly rounded; ventrals rounded, projecting for a greater distance beyond posterior margin of disk; upper surface smooth except in old examples; no light colored spot on middle of forehead in front of eyes; angle of snout slightly greater, about 59° as compared with 54° in *hastatus*.

A female 106 cm. long taken July 8, 1912, had the left uterus greatly enlarged, 14 by 10 cm.; the inner surface of the uterus was covered with the typical slender villi, about 2 cm. long, slightly enlarged at the free end; uterus partly filled with a yellow creamy substance which emitted a slight pungent odor. The embryos had undoubtedly been extruded during capture. Right uterus not enlarged.

This species is common throughout the harbor and at times the young are quite abundant in some localities.

Genus UROBATIS Garman.

30. *Urobatis sloani* (Blainville).

Urolophus jamaicensis, Gudger, 1913a, p. 4; Coles, 1914, p. 93.

Teeth.—"Teeth broader than long, lozenge-shaped on the crown, sharp in males, in $\frac{23}{21}$ rows in eight-inch specimen, $\frac{27}{25}$ in fourteen-inch." ^a

Armature of skin.—"Skin rough with small spines on head, dorsum and top of tail to upper edge of caudal; outer portions of disk, on pectorals and ventrals, and lower surfaces are smooth." ^a

There is a stout spine inserted at about the middle of the tail.

Coles captured a small example at Cape Lookout in June, 1911.

Genus PTEROPLATEA Müller and Henle.

KEY TO THE SPECIES.

- a. Caudal spine normally absent (reported to be present in very large examples); tail about one-fourth length of body; no tentacle behind spiracle..... *micrura*.
 aa. Caudal spine present at all ages; tail larger, nearly half length of body; a tentacle behind spiracle..... *altavela*.

31. *Pteroplatea micrura* (Schneider).

Pteroplatea macrura, Yarrow, 1877, p. 216; Jordan and Gilbert, 1879, p. 386; Jordan, 1886, p. 26; Jenkins, 1887, p. 84; Wilson, 1900, p. 355; Linton, 1905, p. 348; Smith, 1907, p. 45; Gudger, 1912, p. 142; Coles, 1914, p. 93.

Teeth.—In a male about 30 cm. long, the teeth are in $\frac{77}{66}$ rows, minute, arranged in quincunx, similar in form in both jaws; outline of teeth spear-shaped, cusps narrow, elongate, sharp-pointed, curved outward and backward; broad basal portion channeled, edges curved outward, so that the anterior margin of the

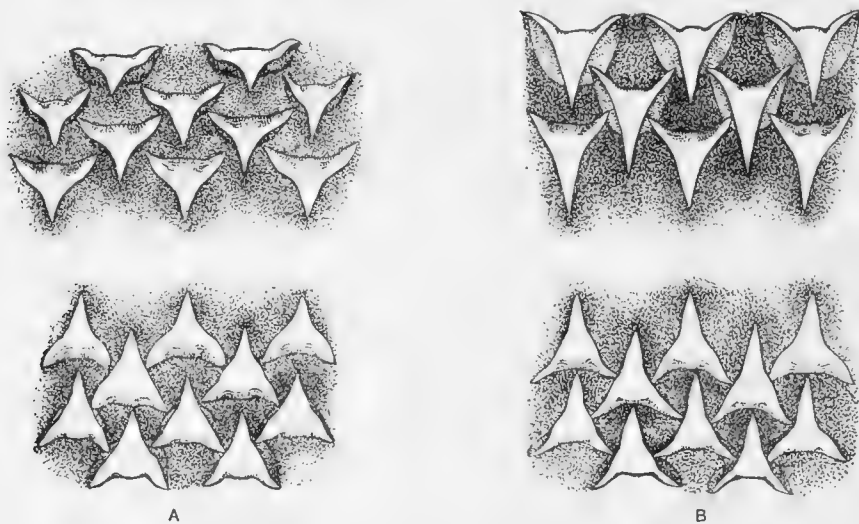

FIG. 26.—A, Teeth, upper and lower jaws, of a female, *Pteroplatea micrura*, 37 cm. long, from Beaufort, N. C.; B, teeth, upper and lower jaws, of a male, *Pteroplatea micrura*, about 30 cm. long, from Beaufort, N. C.

tooth before mucous is cleaned away appears as a concave edge with pointed outer angles, the basal portion being entirely concealed.

In a female 37 cm. long the teeth are in about $\frac{96}{77}$ rows, in one 50.4 cm. long in about $\frac{101}{83}$ rows. These resemble the teeth of the male except that the pointed cusp is shorter, not markedly longer than basal wings.

Skin smooth; very large examples are reported to have a caudal spine.

^a Garman, The Plagiostomia, p. 402.

On July 24, 1914, an adult female, 50.4 cm. long was taken in a seine at the laboratory. Length of disk 39 cm.; width 65.5 cm. Each uterus contained a single embryo, apparently almost fully developed. Each embryo was rolled up into a cylindrical body, one wing of the disk being coiled up inside the other, the latter folding over the whole; tip of snout infolded. (See illustration.) One of the embryos was 10.7 cm. long; disk 8.2 cm. long by 12.3 cm. wide, posterior margin of disk truncate, nearly straight. The uterus was lined with small villi, a mass of elongate ones extended downward through the distended opening of the spiracle of the embryo into its mouth, apparently affording a more direct source of supply of food. Its intestine was greatly distended, forming a great arch on the ventral surface, the circular valve being plainly visible on the surface. The intestine was filled with a greenish liquid, presumably excrement retained until birth. The ovary contained three yellow eggs about three-fourths cm. in diameter. The stomach of the parent was empty except for a few pieces of shell. Dissection of the dorsal surface of the tail revealed no trace of spine reported to be present in old individuals.

This species is very common in the Beaufort region and is taken on the sandy beaches in shallow water. Fishermen not infrequently report seeing large individuals several feet in breadth. Whether they are this species or *altavela* has not been determined.

32. *Pteroplatea altavela* (Linnæus).

Pteroplatea altavela, Nichols, 1914, p. 537; Coles, 1914, p. 93.

"Two grown embryos, one 17½ the other 15 inches in width, furnish probably the first definite North American record for this species.

"Mr. Coles writes that unfortunately the mother was not kept. However, the following data were secured.

"On May 22, 1914, a very large ♀ was captured. Width 6 feet 10 inches, length (snout to tip of ventrals) 3 feet 8 inches, tail 12 inches. It has two spines on the tail. This specimen contained four grown embryos, two on either side. Two of the embryos * * * have each a single well-developed spine on the tail." ^a

Family MYLIOBATIDÆ. The eagle rays.

Genus MYLIOBATIS Cuvier.

33. *Myliobatis freminvillii* Le Sueur. Eagle ray.

Myliobatis freminvillii, Jordan and Gilbert, 1879, p. 386.

Myliobatis freminvillii, Jordan, 1886, p. 26; Smith, 1907, p. 46; Coles, 1913, p. 29-30, 32, 33; id., 1914, p. 94.

Miliobatis freminvillii, Jenkins, 1887, p. 84.

Teeth.—Teeth in a male 69.2 cm. long, in seven rows in each jaw, in pavement, those in the three outer rows subequal, diamond-shaped, width fore and aft greater than breadth, width of median row about one-third breadth; 10 teeth in median row in lower jaw, 6 of which function, 8 in the upper jaw; 5 functioning; functioning teeth much pitted as result of crushing shells. Skin smooth, a serrated spine behind dorsal, present.

MEASUREMENTS OF A MALE (No. 1) 69.2 CM. (27¼ INCHES) LONG AND A FEMALE (No. 2) 45.5 CM. (18 INCHES) LONG.

	No. 1.	No. 2.
	cm.	cm.
Length of disk from tip of cephalic appendage.....	23.4	13.0
Breadth of disk.....	33.9	20.9
Length of anterior margin of disk.....	18.4	10.7
Length of posterior margin of disk.....	15.7	9.7
Tip of snout to eye.....	3.9	2.1
Horizontal diameter of eye.....	1.3	1.0
Interocular width.....	5.5	4.0
Tip of snout to—		
Mouth.....	3.9	2.1
Inner angle of first gill slit.....	7.4	4.2
Inner angle of fifth gill slit.....	9.4	5.9
Vent.....	18.8	11.6
Length of ventrals.....	4.5	2.5
Length of claspers.....	2.1
Length of caudal spine.....	6.0	2.5

^a Nichols, Bull. Am. Mus. Nat. Hist., vol. XXXIII, art. XXXII, p. 537.

This small ray is not infrequently taken in this region but is apparently never taken in large numbers. Coles has taken a few nearly every year at Cape Lookout.

Genus *AETOBATUS* Blainville.

34. *Aëtobatus narinari* (Euphrasen). Devilfish; spotted sting ray.

Aëtobatis narinari, Yarrow, 1877, p. 216; Jordan and Gilbert, 1879, p. 386.
Sloasodon narinari, Jordan, 1886, p. 26; Jenkins, 1887, p. 84.
Aëtobatus narinari, Smith, 1907, p. 46; Coles, 1910, p. 338-341; Gudger, 1912, p. 150; Coles, 1913, p. 29-32, fig. 1-2, pl. III (3 figures); Garman, 1913, p. 441, pl. 49, 54, 55, 57, 73; Gudger, 1914, p. 241, 323; Coles, 1914, p. 94.

Teeth.—Teeth in a single row in each jaw; dental plate of lower jaw about twice as long as the upper and about seven-ninths as wide; lower teeth strongly arched forward in the middle; upper teeth much straighter, slightly bent backward at the sides. In a male 220.3 cm. (7 feet, 2¾ inches) long, there are 14 teeth in the upper jaw, 7 functioning, and 20 in the lower jaw, 13 functioning; in a male 291 cm. (9 feet 6½ inches) long, there are 23 teeth in upper jaw, 11 functioning; 29 in the lower jaw, 19 functioning; functioning teeth more or less pitted.

Skin smooth, one or more strong serrated spines on tail behind dorsal.

Measurements and coloration of the male, 291 cm. long, taken with a dragnet by fishermen in North River, May 28, 1914, furnished by Mr. Hildebrand.

Tip of snout to posterior margin of ventrals, 134 cm.; width of disk, 185 cm.; interorbital, 23.5 cm.; eye, 3.8 cm.; snout, 22.8 cm.; width of mouth, 12 cm.; length of claspers, 40 cm.; length of dorsal base, 6.0 cm.; height of dorsal, 6.0 cm.

Color.—Upper surface very dark brown, almost black, with white spots or rings, or portions of rings, some of these C-shaped, others form perfect circles, still others are in pairs connected by a narrow isthmus of white; others are very close together, with only a slight stricture between them ∞. On the head and snout there are only round spots, no double spots or rings; the double spots are most numerous just back of the head; following these on posterior part of back and along posterior margin of disk are the rings; no transverse markings on body; tail plain black; ventral surface of body uniformly pale.

The stomach contents were the bodies of clams, without any of the shells.

In the specimen from Cape Lookout, 220.3 cm. long, whose length of disk to tip of ventrals was 74.3 cm., breadth of disk 106.8 cm., the jaws are barely half as large as in the specimen just described.

In small individuals the white spots on dorsal surface are all circular, smaller than eye.

This strikingly colored ray reaches a length of 12 feet or more. In the Beaufort region, where it is quite common, it feeds almost exclusively on clams which it digs from the natural beds. As to its method of getting the clams there still seems to be some difference of opinion. Owen (1840) advanced the supposition that the projecting lower jaw was used like a spade for digging the shellfish out of the sand. Coles (1910) and others state that the snout is used for this purpose. Gudger (1914) questions this use of the snout, but advances no opinion as to the probable method used.

The lower jaw projects beyond the upper, so that the front teeth of the upper jaw and the median ones of the lower are used in crushing shells, as indicated by their deeply pitted surfaces. The teeth on the projecting portion of the lower jaw are smoother than the crushing teeth. Gudger (1914) noted this difference, but offered no explanation for it. In the specimens at hand there are scratches or furrows on this smoother surface extending fore and aft as if some sharp object had scratched the surface in passing over it. The broken and irregular anterior margin of the jaw, the wearing down of the upper surface until the pits characteristic of the teeth farther back have disappeared, and the presence of the scratches convince the writer that Owen was correct and that the projecting lower jaw is used as a spade for digging up clams on which the species feed.

The stomach of the specimen 291 cm. long contained a considerable quantity of the meats of clams without any pieces of shells. Coles states that as much as a gallon of clams has been taken from the stomach of a single individual, and that the species is exceedingly destructive. The jaws of this species are highly specialized, being used to dig the clams, to crush the shells, following which the meat is separated from the shells. Coles has added some very interesting observations to our knowledge of this species, and more recently Gudger has written an extended review of the literature, together with additional data collected by himself at Beaufort and in Florida waters. This report is well illustrated.

Family RHINOPTERIDÆ. The cow-nosed rays.

Genus RHINOPTERA Kuhl.

35. *Rhinoptera quadriloba* (Le Sueur). Cow-nosed ray; devilfish.*Rhinoptera quadriloba*, Wilson, 1900, p. 355.*Rhinoptera bonasus*, Smith, 1907, p. 47; Gudger, 1912, p. 152; Coles, 1914, p. 94.

Teeth.—Teeth in a male 84.8 cm. long in 9 rows in the upper jaw and 8 in the lower, in pavement; median row in upper jaw widest, 2.6 in width of dental plate, second row on right side of wider teeth than the others, 2.5 in width of median row; with the exception of the marginal row on each side the other teeth are hexagonal; median row of lower teeth widest, four-fifths as wide as median row in upper jaw, each succeeding row smaller; 12 teeth in a row in upper jaw, 5 functioning; 13 in lower jaw, 6 functioning; functioning teeth deeply pitted. In this species the dental plates are more nearly subequal than in either of the preceding. Skin smooth, a narrow serrated spine immediately behind the dorsal fin.

MEASUREMENTS OF A FEMALE (No. 1) 60.1 CM. (23 $\frac{3}{8}$ INCHES) LONG AND A MALE (No. 2) 84.8 CM. (33 $\frac{3}{8}$ INCHES) LONG.

	No. 1.	No. 2.
	cm.	cm.
Length of disk.....	34.6	62.8
Breadth of disk.....	59.1	81.3
Length of anterior margin of disk.....	28.2	42.1
Length of posterior margin of disk.....	27.5	45.3
Snout.....	1.7	2.7
Horizontal diameter of eye.....	1.1	1.6
Interocular width.....	9.7	14.0
Preoral length of snout.....	6.4	9.3
Breadth of mouth.....	6.1	10.4
Tip of snout to vent.....	20.4	47.1
Tip of snout to inner angle of first gill slit.....	9.4	13.4
Tip of snout to inner angle of fifth gill slit.....	14.1	21.6
Interspace of anterior gill slits.....	9.9	15.1
Interspace of posterior gill slits.....	7.1	10.5
Length of ventrals.....	8.1	11.9
Length of spine.....	6.6	6.8

The stomach contained several small mollusks. This species is not uncommon in this region, apparently being a resident here. More examples of it are brought into the laboratory than any of the allied forms.

Family MOBULIDÆ. The sea devils.

KEY TO THE GENERA.

- a. Teeth on both jaws; mouth inferior.....*Mobula*.
 aa. Teeth on lower jaw only; mouth anterior.....*Manta*.

Genus MOBULA Rafinesque.

36. *Mobula hypostoma* (Bancroft). Small devilfish.*Mobula olfersi*, Coles, 1910, p. 341; Pellegrin, 1912, p. 414 (with photographs); Gudger, 1913a, p. 5; Coles, 1913, p. 33; id., 1914, p. 94.*Mobula hypostoma*, Garman, 1913, p. 453, pl. 38, 54, 57, 59, 75.

Teeth.—Teeth (male) in $\frac{57}{47}$ rows, minute; dental plate very long and narrow; teeth close-set, overlapping; posterior margin with one to five dentate prongs and with a minute cusp on the outer edge of each shoulder, a single row on upper jaw and several in the lower jaw about twice as wide as adjacent rows; teeth in lower jaw relatively wider and with shorter cusps than those in the upper.

Teeth in a female 142 cm. (56 inches) long in $\frac{53}{48}$ rows, in pavement, arranged in quincunx, not nearly so close-set as in the male, not overlapping, rows of wider teeth present as in the male; posterior margins of teeth smooth, or with slight ridges, apparently rudiments of the prongs characteristic of the teeth of the male. Skin smooth, no caudal spine.

MEASUREMENTS OF A FEMALE 142 CM. (56 INCHES) IN LENGTH.

	cm.		cm.
Tip of snout to origin of dorsal.....	55.0	Preoral length.....	15.3
Tip of cephalic appendage to tip of pectoral.....	72.5	Width of mouth.....	15.1
Breadth of disk.....	111.0	Height of dorsal.....	7.0
Tip of cephalic appendage to vent.....	69.3	Base of dorsal.....	7.2
Eye.....	2.5	Tip of tail to vent.....	77.0
Interorbital.....	21.0	Tip of ventral to vent.....	12.8

In this individual both uteri were equally developed, the embryos which were presumably quite young, had been extruded. The inner surface of the uterine wall was covered with the characteristic vascular villi. The uterine milk was greenish in color and more fluid than in an example of *D. say* examined.

The red corpuscles in this specimen were 18μ long by 11μ broad, the nucleus 6.6μ by 3.6μ or less.

The stomach was completely filled with countless numbers of a small Mysis-like crustacean, together with a quantity of mud. The remarkable development of the gill filaments is shown in the illustration. These are well adapted for straining out small organisms. This and the character of the teeth lead to the conclusion that its habit of feeding on small fishes, as described by Coles, is a very unusual one, and an examination of the stomach contents of individuals actually observed feeding on the fishes is desirable. The stomach contents of nine specimens taken at Cape Lookout July 10, 1913, were examined by Prof. W. P. Hay and in every case were found to contain only the Mysis-like crustacean.

Genus **MANTA** Bancroft.37. *Manta birostris* (Walbaum). Devilfish.

Ceratoptera vampirus, Yarrow, 1877, p. 216; Jordan and Gilbert, 1879, p. 386.

Manta birostris, Jordan, 1886, p. 26; Jenkins, 1887, p. 85; Wilson, 1900, p. 355; Smith, 1907, p. 47; Gudger, 1912, p. 152; Coles, 1914, p. 94.

Teeth.—"Teeth minute, rasplike, on the lower jaw only, occupying the entire width of the jaw, in about 100 rows separated by interspaces (on the young)."^a

Body and tail rough with small tubercles. There appears to be some uncertainty as to whether there is a barbed spine on the tail.

The numbers of examples of *Mobula hypostoma* taken by Coles at Cape Lookout and the rarity of observations of the present species, lead one to suspect that in the majority of cases the earlier records were of the former species. To date, there is no authentic record of the capture of one of these huge rays in this region. That it is found here is not questioned.

^a Garman, The Plagiostomia, p. 454.

BIBLIOGRAPHY.

- BEAN, BARTON A., and WEED, ALFRED C.
1911. An electric ray and its young from the west coast of Florida. *Proceedings, U. S. National Museum*, vol. 40, p. 231-232, pl. 10-11. Washington.
- BOULENGER, G. A.
1912. The small devilfish. *Country Life*, vol. xxxii, no. 821, p. 414-415 (2 photographs *Mobula ölfersi*). September 28, 1912. London.
- COLES, RUSSELL J.
1910. Observations on the habits and distribution of certain fishes taken on the coast of North Carolina. *Bulletin of the American Museum of Natural History*, vol. xxviii, p. 337-348. November 17, 1910. New York.
1913. Notes on the embryos of several species of rays, with remarks on the northward summer migration of certain tropical forms observed on the coast of North Carolina. *Bulletin of the American Museum of Natural History*, vol. xxxii, p. 29-35, pl. iii, 2 text fig. New York.
1914. Notes on the sharks and rays of Cape Lookout, N. C. *Proceedings of the Biological Society of Washington*, vol. xxviii, p. 89-94, April 13, 1915. Washington.
- EVERMANN, BARTON WARREN, and MARSH, MILLARD CALEB.
1902. The Fishes of Porto Rico. *Bulletin, U. S. Fish Commission*, vol. xx, pt. 1, 1900, p. 49-350, 49 pl., 112 fig. Washington.
- GARMAN, SAMUEL.
1913. The Plagiostomia (sharks, skates, and rays). *Memoirs of the Museum of Comparative Zoology at Harvard College*, vol. xxxvi, 528 p., 77 pl., 1913 (plates bound in separate volume). Cambridge.
- GOODE, GEORGE BROWN, and associates.
1884. Natural history of useful aquatic animals. *The Fisheries and Fishery Industries of the United States*, sec. I, vol. I, 895 p.; sec. I, vol. II, plates. Washington.
- GUDGER, EUGENE WILLIS.
1907. A note on the hammer-head shark, *Sphyrna zygaena*, and its food. *Science*, n. s., vol. xxv, p. 1005-1006. June 28, 1907. New York.
1910. Notes on some Beaufort, N. C., fishes. 1909. *The American Naturalist*, vol. XLIV, p. 395-404. July, 1910. New York.
1912. Natural history notes on some Beaufort, N. C., fishes, 1910-11, no. 1. Elasmobranchii—with special reference to utero-gestation. *Proceedings of the Biological Society of Washington*, vol. xxv, p. 141-156, December 4, 1912. Washington.
1913. Natural history notes on some Beaufort (N. C.) fishes, 1910-11. Reprint from *Journal of the Elisha Mitchell Scientific Society*, 16 p. Chapel Hill.
1913a. Natural history notes on some Beaufort (N. C.) fishes, 1912. *Proceedings of the Biological Society of Washington*, vol. xxvi, p. 97-110. May 3, 1913. Washington.
1914. History of the spotted eagle ray, *Aetobatus narinari*, together with a study of its external structure. Extract from *Publication no. 183 of the Carnegie Institution of Washington*, p. 241-324, 10 pl., 19 text fig. Washington.
- JENKINS, OLIVER P.
1885. Notes on the fishes of Beaufort Harbor, N. C. *Johns Hopkins University Circulars*, 11 p. October, 1885. Baltimore.
1887. A list of the fishes of Beaufort Harbor, N. C. *Studies from the Biological Laboratory, Johns Hopkins University*, vol. IV, p. 83-94. Baltimore.

JORDAN, DAVID STARR.

1886. Notes on fishes collected at Beaufort, N. C., with a revised list of the species known from the locality. Proceedings, U. S. National Museum, vol. ix, p. 25-30. Washington.

JORDAN, DAVID STARR, and GILBERT, CHARLES H.

1879. Notes on fishes of Beaufort Harbor, N. C. Proceedings, U. S. National Museum, vol. i, p. 365-388. Washington.

JORDAN, DAVID STARR, and EVERMANN, BARTON WARREN.

The fishes of north and middle America. Bulletin no. 47, U. S. National Museum, 4 vols., 3313 pages, 392 plates: 1896, text, pt. i; 1898, text, pts. ii-iii; 1900, text and plates, pt. iv. Washington.

LINTON, EDWIN.

1905. Parasites of fishes of Beaufort, N. C. Bulletin of the U. S. Bureau of Fisheries, vol. xxiv, 1904, p. 321-428, pl. i-xxxiv. Washington.

NICHOLS, JOHN TREADWELL.

1914. A new scorpæna and a rare ray from North Carolina. Bulletin of the American Museum of Natural History, vol. xxxiii, art. xxxii, p. 537-538, 1 text fig. New York.

PELLEGRIN, JACQUES.

1912. Sur la dentition des Diablos de Mer. Bulletin de la société, philomatique de Paris. Series 10, tome iv, p. 1-8. Paris.

RADCLIFFE, LEWIS.

1913. A summary of the work of the U. S. Fisheries marine biological station at Beaufort, N. C., during 1912. Science, n. s., vol. xxxviii, no. 977, p. 395-400. September 19, 1913. New York.

1914. The work of the U. S. Fisheries marine biological station at Beaufort, N. C., during 1913. Science, n. s., vol. xl, no. 1029, p. 413-417. September 18, 1914. New York.

SMITH, HUGH M.

1907. The fishes of North Carolina. Bulletin of the North Carolina Geological and Economic Survey, vol. ii, xii + 456 p., 21 pl., 188 fig. Raleigh.

WILSON, H. V.

1900. Marine biology at Beaufort. American Naturalist, vol. xxxiv, p. 339-360, 5 text fig. Boston.

YARROW, H. C.

1877. Notes on the natural history of Fort Macon, N. C., and vicinity. (No. 3.) Proceedings of the Academy of Natural Sciences of Philadelphia, vol. xxix, p. 203-218. Philadelphia.

EXPLANATIONS OF PLATES.

[The plates are all from photographs.]

PLATE XXXVIII.

FIG. 1.—*Carcharias taurus*, lateral view of teeth in upper jaw of a shark about 152 cm. long, from Cape Lookout, N. C.

FIG. 2.—*Carcharias taurus*, lateral view of lower jaw, same specimen as fig. 1.

FIG. 3.—*Vupecula marina*, lateral view of teeth from a specimen about 457 cm. long, from Cape Lookout, N. C.

FIG. 4.—*Cetorhinus maximus*, portion of jaw of specimen from Monterey, Cal. U. S. National Museum no. 27024.

PLATE XXXIX.

FIG. 1.—*Ginglymostoma cirratum*, teeth of lower jaw, from back. Jaws in U. S. National Museum originally from Pensacola, Fla.

FIG. 2.—*Scoliodon terræ-novæ*, lateral view of teeth from a female 102 cm. long, from Shackleford Banks, Beaufort, N. C.

FIG. 3.—*Aprionodon isodon*, lateral view of a female 50.8 cm. long, in the Beaufort laboratory collections.

FIG. 4.—*Carcharhinus milberti*, teeth of a female 147.3 cm. long from Woods Hole, Mass.

PLATE XL.

FIG. 1.—*Hypoprion brevirostris*, teeth of upper jaw of a male 248.9 cm. long, from Beaufort, N. C.

FIG. 2.—*Hypoprion brevirostris*, teeth of lower jaw of same specimen as fig. 1.

FIG. 3.—*Carcharhinus limbatus*, lateral view of a female 70 cm. long, from Beaufort, N. C.

FIG. 4.—*Carcharhinus limbatus*, lateral view of same specimen as fig. 3.

PLATE XLI.

FIG. 1.—*Carcharhinus acronotus*, teeth in upper jaw of a female 134 cm. long, from Shackleford Banks, Beaufort, N. C.

FIG. 2.—*Carcharhinus acronotus*, teeth in lower jaw of same specimen as fig. 1.

FIG. 3.—*Carcharhinus commersonii*, teeth in upper jaw of a specimen from Beaufort, N. C.

FIG. 4.—*Carcharhinus commersonii*, teeth in lower jaw of same specimen as fig. 3.

PLATE XLII.

FIG. 1.—*Galeocerdo arcticus*, teeth of upper jaw of a specimen from Loggerhead Key, Fla. U. S. National Museum. Collections.

FIG. 2.—*Galeocerdo arcticus*, teeth in lower jaw of same specimen as fig. 1.

FIG. 3.—*Galeorhinus lævis*, teeth of a male 75 cm. long, from Cape Lookout, N. C.

FIG. 4.—*Squalus acanthias*, teeth of a female 84.5 cm. long, from Beaufort, N. C.

PLATE XLIII.

FIG. 1.—*Cestracion zygena*, dorsal view of a male 124.5 cm. long, from Beaufort, N. C.

FIG. 2.—*Cestracion zygena*, teeth of a male 132 cm. long, from Beaufort, N. C.

FIG. 3.—*Cestracion zygena*, teeth of young example 52.3 cm. long, from Beaufort, N. C.

FIG. 4.—*Cestracion zygena*, teeth of upper jaw of a female 381 cm. long, from Beaufort, N. C.

FIG. 5.—*Cestracion zygena*, teeth of lower jaw of same specimen as fig. 4.

PLATE XLIV.

FIG. 1.—*Cestracion tiburo*, embryo 18 cm. long, showing placenta and villi. (Note remnant of yolk sac at end of placenta. The parent from which this specimen was taken was 124 cm. long, taken on Bird Shoal, Beaufort Harbor, August 6, 1914.)

FIG. 2.—*Cestracion tiburo*, teeth of a female 89.8 cm. long, from Beaufort, N. C.

FIG. 3.—*Cestracion tiburo*, teeth of a female 147.5 cm. long, from Beaufort, N. C.

PLATE XLV.

FIG. 1.—*Raja eglanteria*, teeth of a male 57.5 cm. long, from Cape Lookout, N. C.

FIG. 2.—*Raja stabuliformis*, teeth of a male 101.6 cm. long, from Woods Hole, Mass.

FIG. 3.—*Raja stabuliformis*, teeth of a female 119.4 cm. long, from Woods Hole, Mass. (Note that cusps of teeth along front of jaw are entirely worn away.)

FIG. 4.—*Raja stabuliformis*, teeth in back of jaw of preceding example, showing form before cusp is worn away.

PLATE XLVI.

FIG. 1.—*Dasybatus hastatus*, teeth of a male from Beaufort, N. C.

FIG. 2.—*Dasybatus hastatus*, teeth of a female 155.2 cm. long, from Beaufort (Fort Macon), N. C.

FIG. 3.—*Dasybatus hastatus*, a female 155.2 cm. long and young born at time of capture, from Beaufort (Fort Macon), N. C.

PLATE XLVII.

FIG. 1.—*Pteroplatea micrura*, dorsal view of an adult female 50.4 cm. long, from Beaufort, N. C.

FIG. 2.—*Pteroplatea micrura*, dorsal view of young embryos taken from specimen fig. 1. (Note manner in which young are coiled in ovary.)

FIG. 3.—*Aëtobatus narinari*, dorsal view of a specimen from Beaufort, N. C., showing characteristic coloration of young.

FIG. 4.—*Rhinoptera quadriloba*, teeth of a male 84.8 cm. long, from Beaufort, N. C.

PLATE XLVIII.

FIG. 1.—*Myliobatis freminwillii*, teeth of a male 69.2 cm. long, from Cape Lookout, N. C.

FIG. 2.—*Aëtobatus narinari*, teeth of a male 291 cm. long, from Beaufort, N. C.

FIG. 3.—*Mobula hypostoma*, teeth of a male from Cape Lookout, N. C.

FIG. 4.—*Mobula hypostoma*, teeth of a female 142 cm. long, from Cape Lookout, N. C.

PLATE XLIX.

FIG. 1.—*Mobula hypostoma*, gill arches, back view, of a female 142 cm. long, from Cape Lookout, N. C.

FIG. 2.—*Mobula hypostoma*, a catch of nine, taken by Mr. Russell J. Coles (second from the right) at Cape Lookout, N. C., July 10, 1913. (Photograph by Francis Harper.)

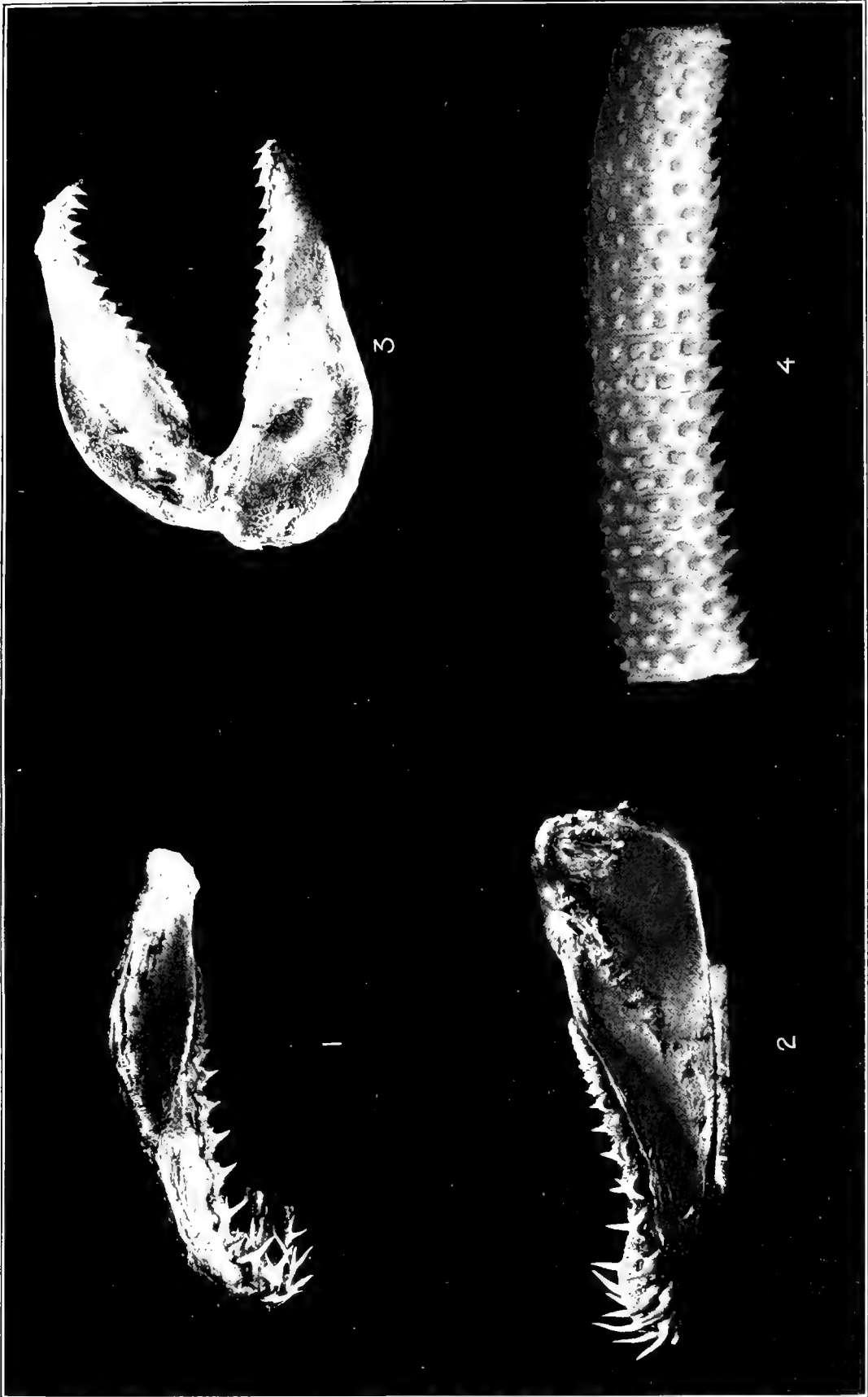

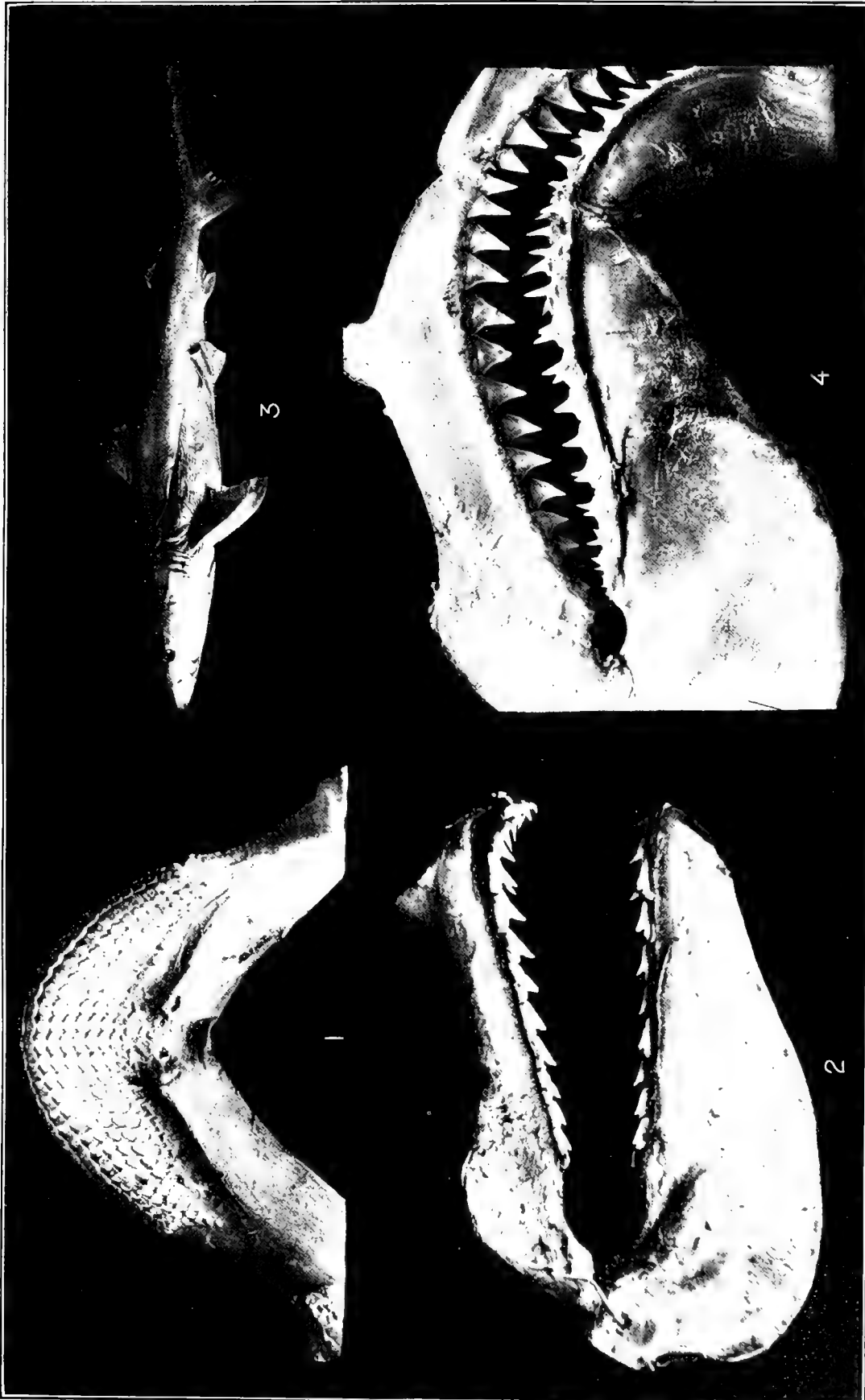

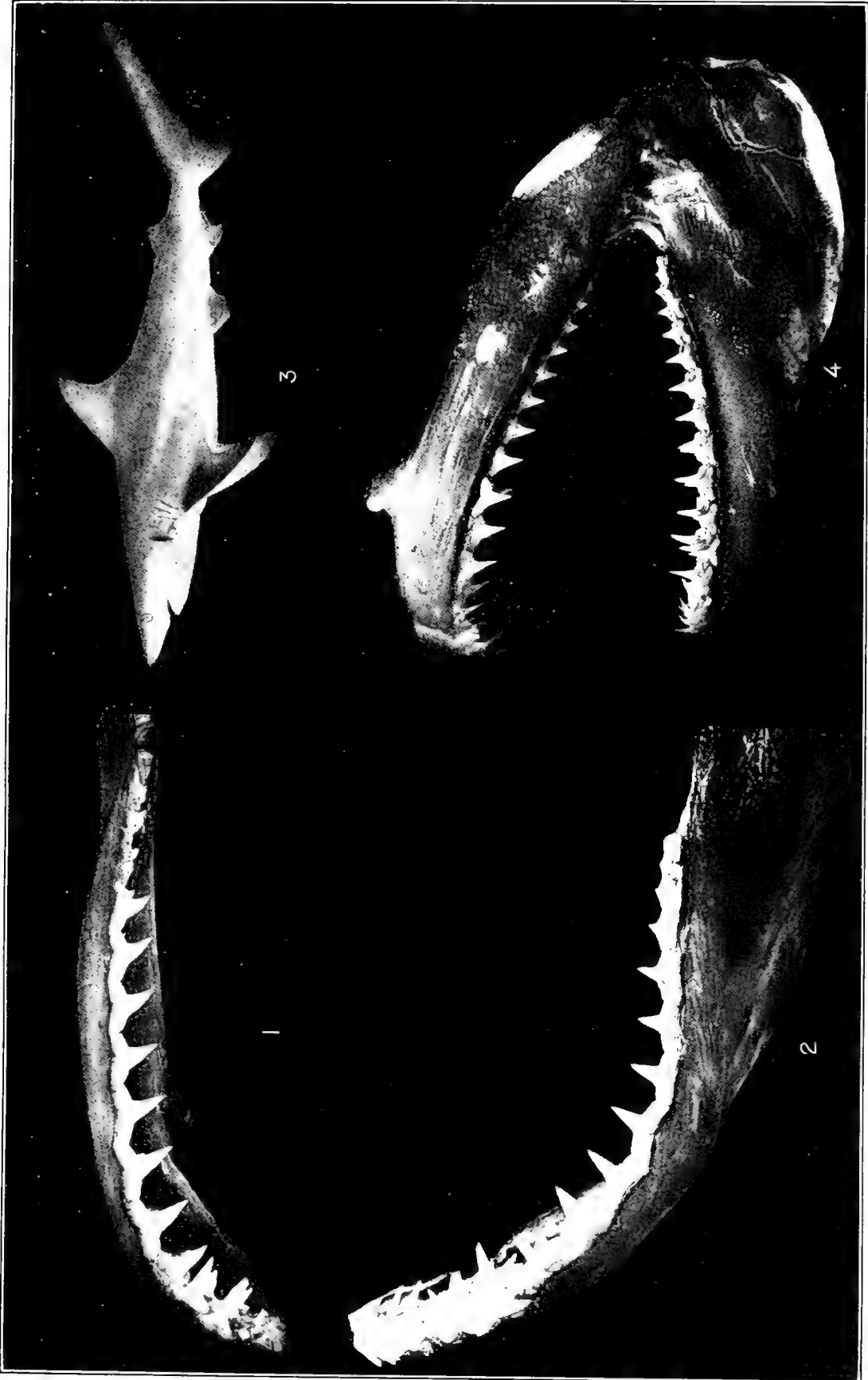

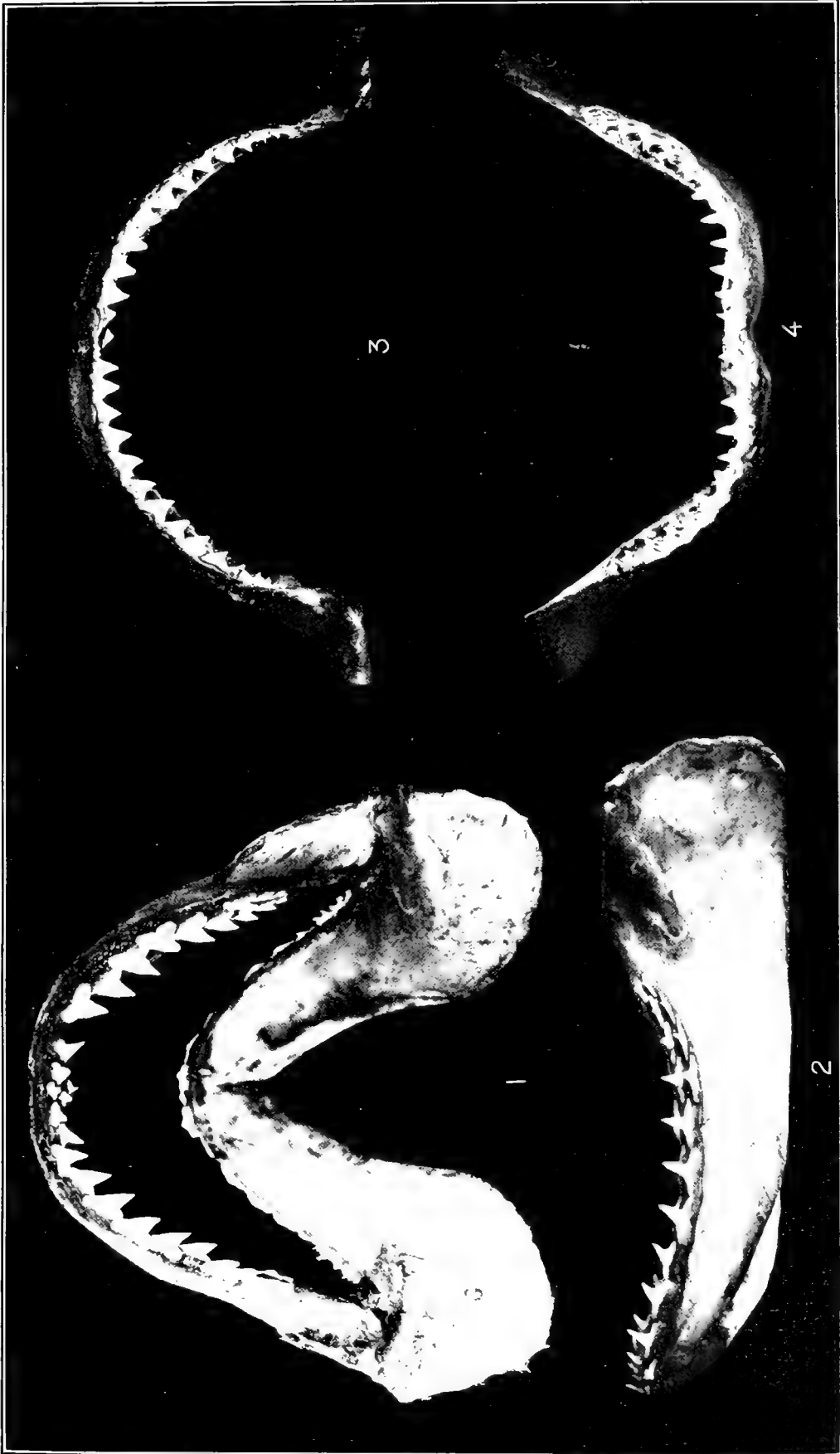

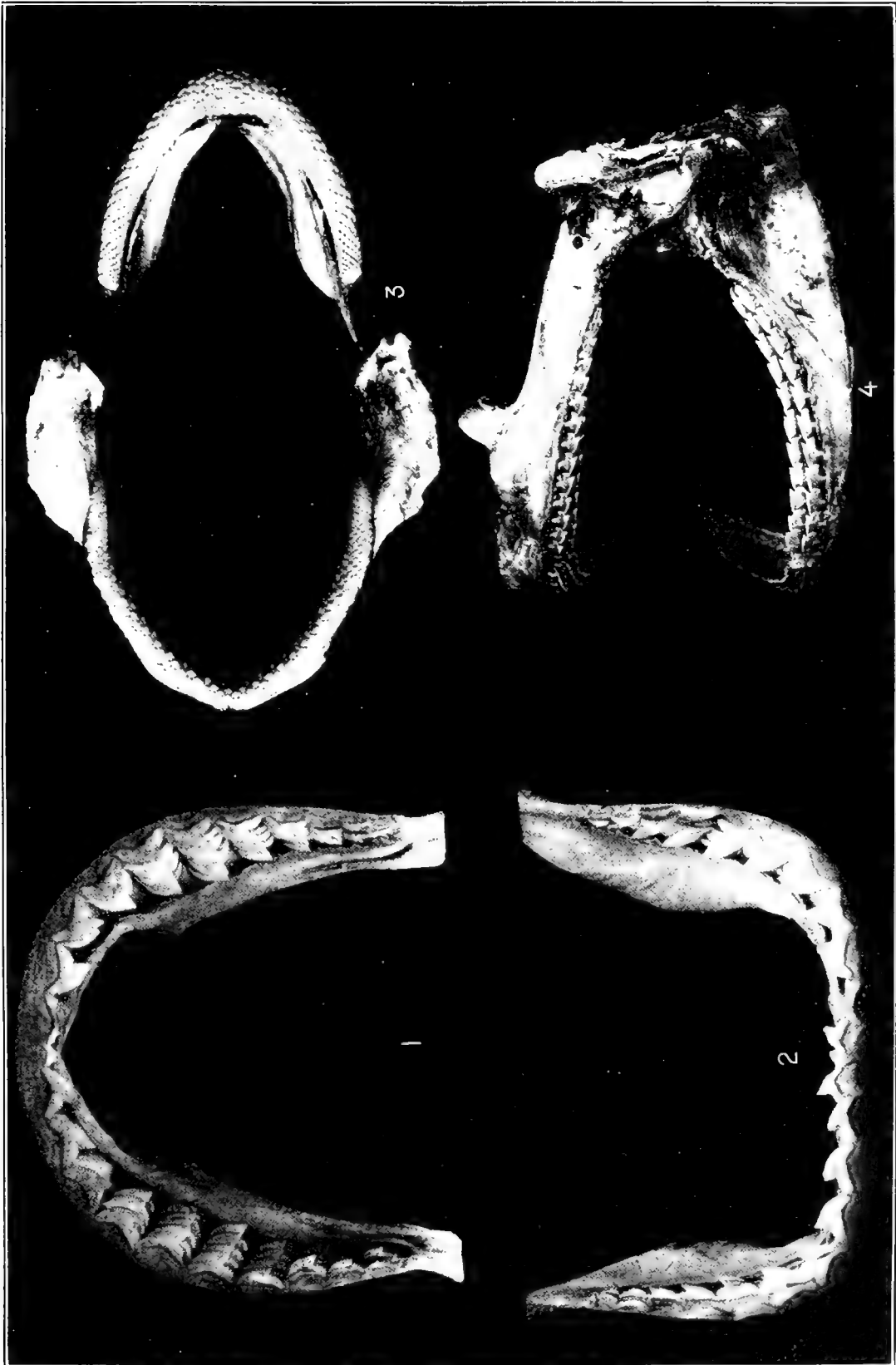





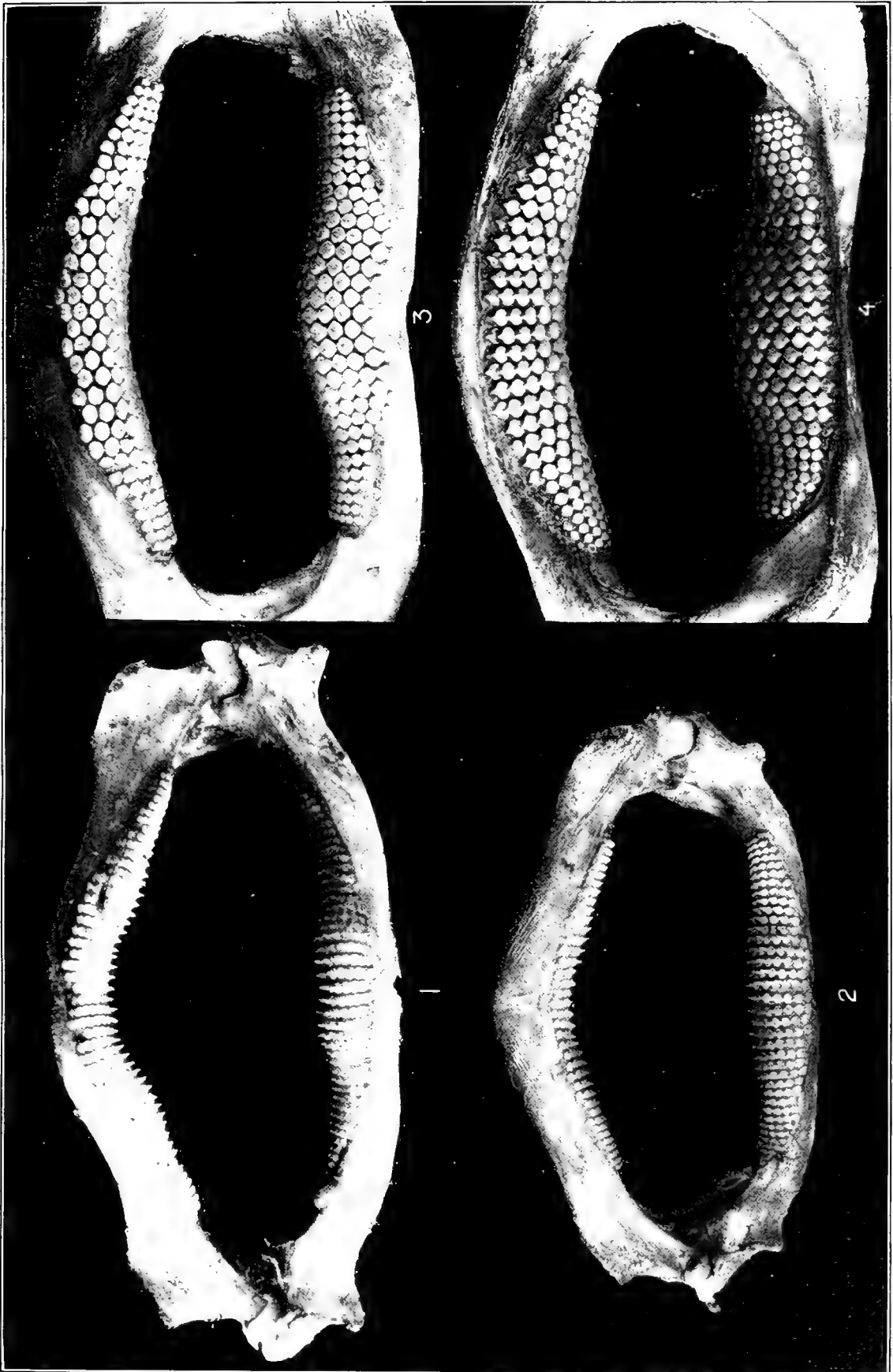

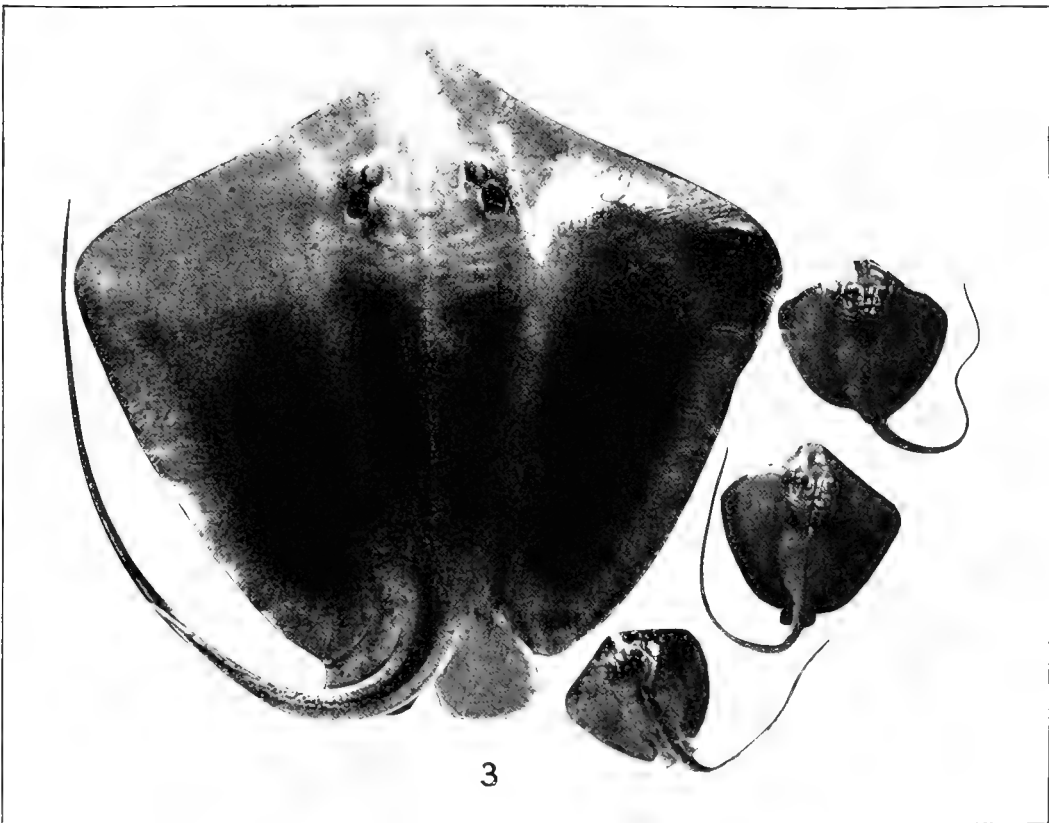
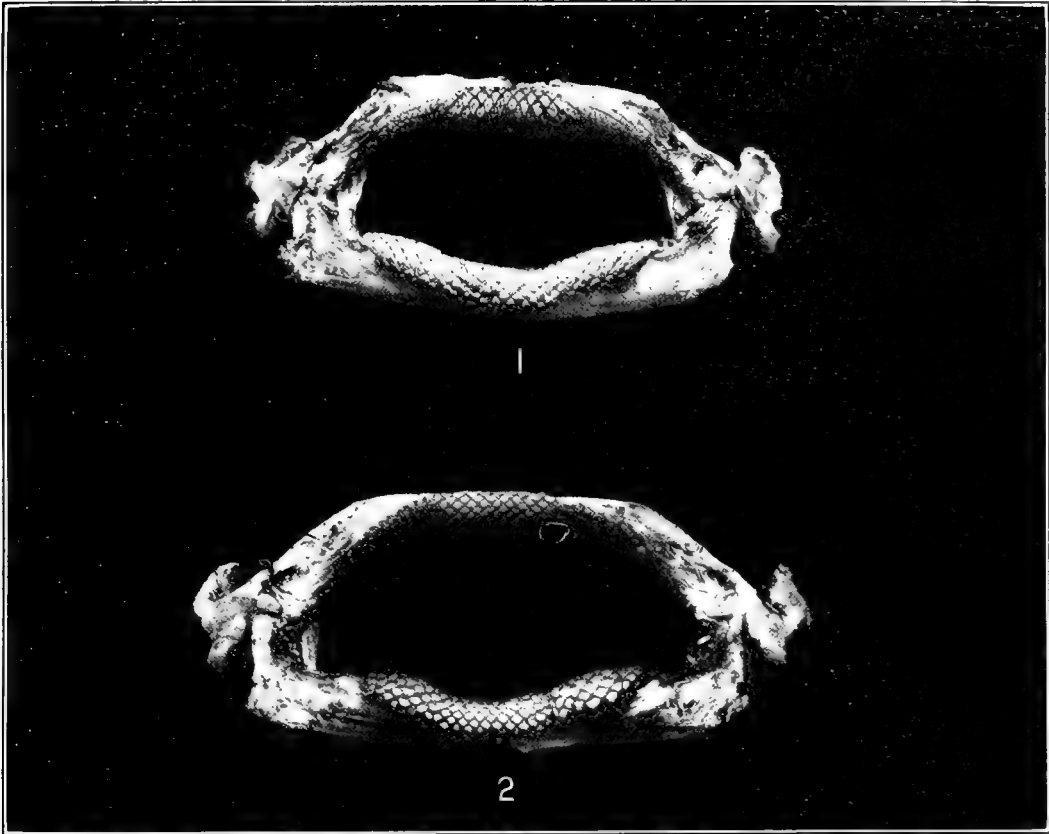

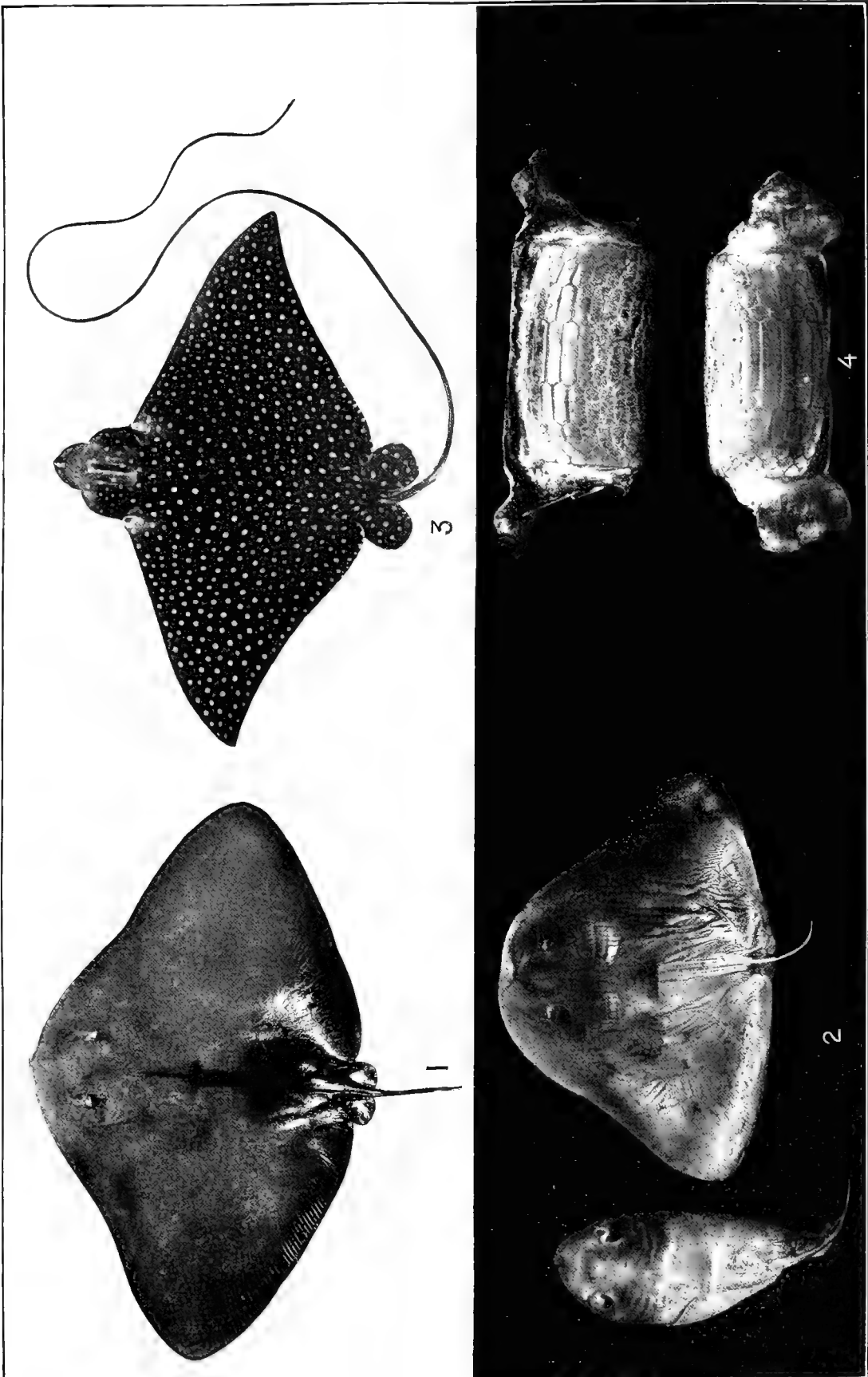

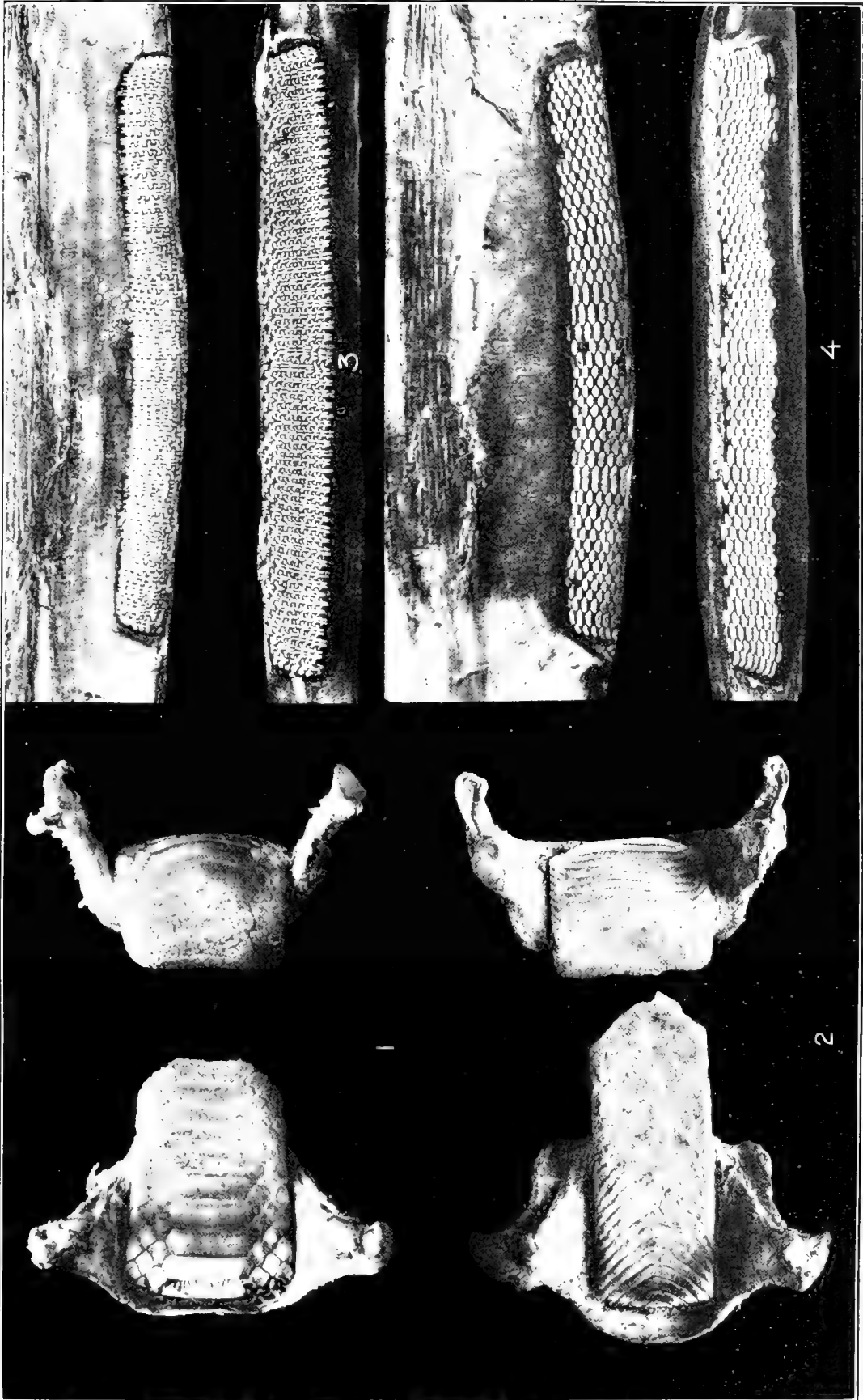

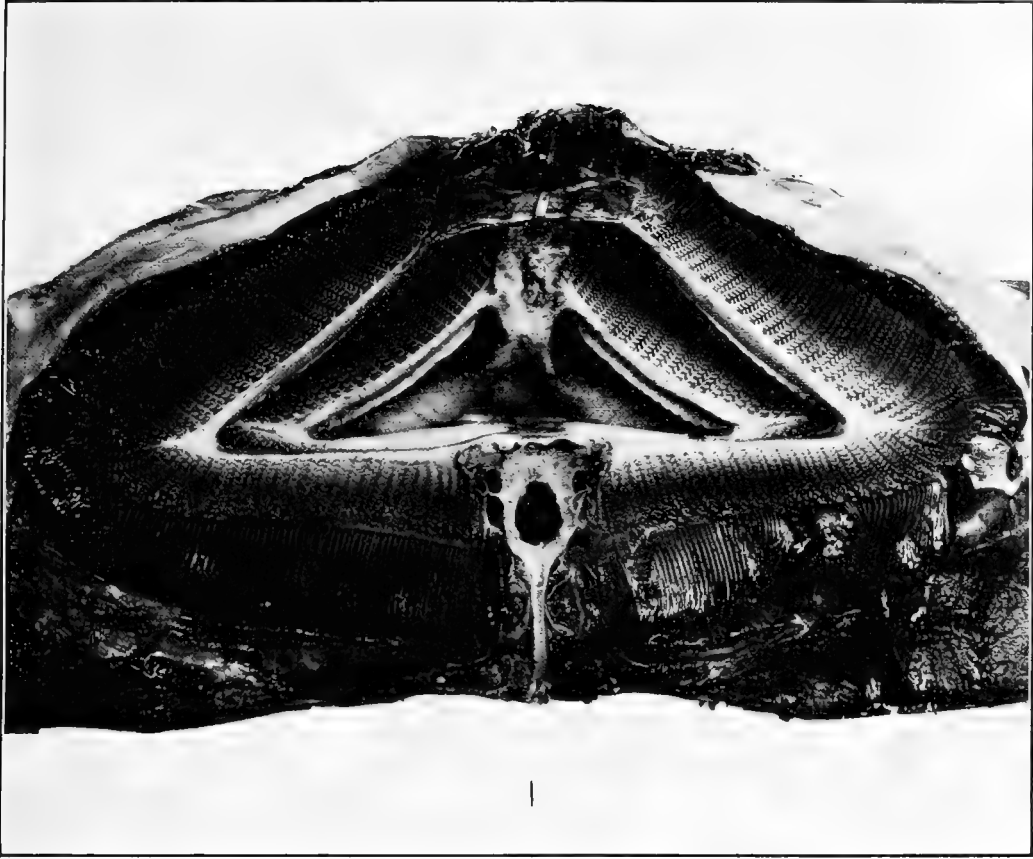

1



2

THE STRUCTURE AND GROWTH OF THE SCALES OF
THE SQUETEAGUE AND THE PIGFISH AS
INDICATIVE OF LIFE HISTORY



By Harden F. Taylor
Scientific Assistant, U. S. Bureau of Fisheries



Contribution from the United States Fisheries Biological Station, Beaufort, N. C.

CONTENTS.

	Page.
Introduction.....	289
Review of literature.....	290
Fastening to integument.....	290
Form and mode of orientation.....	291
Size.....	291
Circuli.....	292
Spines.....	294
Radii.....	295
Focus.....	295
Perforating canaliculi and internal lacunæ.....	296
Structure, formation, and growth.....	296
Classification.....	298
Age determination.....	299
Application of scale characters to age determination.....	304
Count of annuli.....	304
Polarized light.....	309
The selective action of picrocarmine stain.....	309
The origins of the radii.....	309
Year groups in length and weight.....	310
Interpretation of the radii.....	311
Life history of the squeteague (<i>Cynoscion regalis</i>) as indicated by the scales.....	314
Conclusions.....	316
Age determination.....	316
Radii.....	316
Circuli.....	316
Annuli.....	317
Classification.....	317
Life history.....	317
Supplemental observations on the pigfish, <i>Orthopristis chrysopterus</i>	319
Synonymy of terms.....	324
Bibliography.....	325

THE STRUCTURE AND GROWTH OF THE SCALES OF THE SQUETEAGUE AND THE PIGFISH AS INDICATIVE OF LIFE HISTORY.

By HARDEN F. TAYLOR,^a
Scientific Assistant, U. S. Bureau of Fisheries.

Contribution from the United States Fisheries Biological Station, Beaufort, N. C.

INTRODUCTION.

Since the invention of the microscope, fish scales have been the subject of numerous investigations and heated controversies^b relating almost wholly to structure, phylogenetic relations, and taxonomic value. It was not until 1898 that scales were thought to bear evidences of the age and life history of the fish, when Hoffbauer (1898, 1900) observed on the scales of carp concentric rings which he supposed to be growth rings. The discovery of these rings and their supposed relation to age and life history has actuated a renewal of investigations in England, Germany, Scotland, Norway, and other countries.

These concentric rings (or annuli, as they are called in this paper) are supposed to be produced by varying rapidities of growth. This theory has been applied minutely to investigations of Atlantic salmon and English brook trout and, to some extent, to cod, flounder, sole, eel, halibut, smelt, herring, mackerel, and other fishes, and by it an elaborate life history of the salmon has been worked out.

The theory has been objected to, especially by Tims (1906) and Brown (1903). The uncertainty existing as to regeneration and constancy of growth has given rise to grave doubts as to the reliability of these indications of age and life history. The fact stands out, as Masterman (1913a) shows, that these indications of age have never been satisfactorily tested; the relation of the annuli to growth has been a supposition, and investigations have been limited to a small number of species.

In America Cockerell, only, has worked on the taxonomy of scales, Nickerson, Ryder and Cockerell on their phylogenetic relations, and it is only recently that work on life history has been begun by Gilbert and McMurrich on the Pacific coast salmon, and Thompson on the halibut.

It is the purpose of this paper to embody the results of investigations directed toward explaining the various scale characters employed in the determination of life history, their origin, constancy, bearing on life history, the various methods of detecting them,

^a The writer acknowledges with thanks the assistance in writing this paper and valuable suggestions as to illustrations by Dr. J. J. Wolfe.

^b For an excellent review of the literature of fish scales, see Thomson (1906).

and a few other observations not closely allied to the main subject. These investigations have been carried on with *Cynoscion regalis* and *Orthopristis chrysopterus*, the scales of which have not been hitherto investigated, with the hope that the results might broaden the knowledge of scales, either by corroborating, modifying, or contradicting the extant theories.

There are also some observations of the radii with a discussion in which a conclusion is reached that is quite at variance with all previous theories of their origin. If this conclusion is sufficiently borne out by facts, it will either negative or seriously modify systems of classification employing the radii as characters.

A review of literature is necessary in order to bring out the investigations in the light of what has already been done.

REVIEW OF LITERATURE.

FASTENING TO INTEGUMENT.

Peters (1841) was the first to devote his attention to scales as a part of an integumental organization. He gives the following analysis of the skin: (1) Epidermis composed of squamous cells; (2) layer of pigmented cells; (3) skin proper, a layer composed of fibrous connective tissue and containing fatty globules; (4) an exceedingly thin membrane on the exterior surface of the scale, but distinct from the skin to which it is intimately fastened. In this are found the circuli and radii. He maintains that scales are not found on the epidermis, but in the skin itself.

Baudelot (1873) described scales as contained in sacs and more or less visible to the exterior, but in some cases (eels, etc.) covered entirely in the skin. The epidermis sometimes extends so far over the posterior field as to be pierced by the teeth in cases of ctenoid scales. The degree of firmness of anchorage to the scale pocket varies from species to species. In imbricated scales, the free portion has intimate connection with the skin. In saying that they are contained in dermal sacs, he implies an agreement with Peters as to their dermal origin.

Vogt (1842) advances an interesting theory as to the nature of the scale pocket. He regards it merely as a fold in the epidermal membrane. By this he implies that scales have their origin in the epidermis.

Leydig (1851) says: "The scales of most of our fresh-water fishes appear partly as ossifications of flattened skin continuations which are generally termed 'scale pockets.'" This is close to Vogt's theory, but he confuses "skin" with epidermal folds.

In considering the work of Klaatsch (1894), done on trout, *Esox*, and several cyprinoids for the younger stages, I can do no better than quote what he has to say about the fastening to the integument:

Under the epidermis, which contains a large number of mucous cells, the dermis is seen to be raised in a series of projections, each of which corresponds with the posterior free end of the scale. Each scale lies in an oblique direction from behind forward and becomes inclosed in a compartment of the dermis, the so-called "scale pocket." In this scale pocket one distinguishes an outer and an inner wall. The outer wall consists, in its posterior part, of loose connective tissue containing numerous chromatophores; in the anterior part, the outer wall is composed of tense connective tissue which is similar to the inner wall of the adjoining anterior scale pocket. The fibrous projections of this connective tissue of the outer

wall of the scale pocket unite themselves at the anterior border of the scale with the deepest layer of the dermis in which the fibers have a course parallel with the surface of the body. The inner wall of the scale pocket at its posterior part unites with the outer wall of the adjoining posterior pocket. Farther forward it is built up of the fibrous processes of the deep epidermal layer. Near the scale its condition changes, as immediately toward the inside the same number of cells is found in a ground substance only slightly developed and not fibrillated. The fibers of the deep dermis layer have a similar arrangement to that of the ganoids and selachians.^a

FORM AND MODE OF ORIENTATION.

Ryder (1893) worked on the arrangement of the scales on the body, seeking to account for their arrangement in rows and their imbrication. He shows that scales may lie in rows in three directions: (1) Downward and backward; (2) downward and forward; (3) along the long axis of the body.

He advances a most interesting opinion in explanation of this method of orientation, viz., that it is due to the segmentally arranged muscles of the body. In support of this he notices that in archaic types the number of scales corresponds with the number of somites in the body. He summarizes two important conclusions:

1. Scales of fishes bear a segmental relation to the remaining hard and soft parts of the body and are either repeated consecutively in oblique rows corresponding to the number of segments, or they may be repeated in rows corresponding to the number of somites, or segmental reduction may occur which may affect the arrangement of the scales so as to reduce the number of rows below the number of somites indicated by the other hard and soft parts.

2. The peculiar manner of interdigitation of the muscular somites as indicated by the sigmoid outline of the myocommata as seen from their outer faces and the oblique direction of the membrane separating the muscular cones has developed a mode of insertion of the myocommata upon the corium which has thrown the integument into rhombic areolæ during muscular contraction. These areolæ are in line in three directions and the folds separating them, particularly at their posterior borders, are inflected in such a manner by muscular tensions due to the arrangements of the muscular cones as to induce the condition of imbrication so characteristic of the squamation of many fishes.

Ryder seems to be the only scale investigator who takes into consideration the adaptation of the stiff scale to the movements of the fish's body—a subject which will be considered in connection with the function of the radii in another part of this paper.

Under the caption "Form and mode of orientation" in his paper, Baudelot (1873) takes notice only of the extreme variability, from genus to genus, from species to species, between individuals and even in the same individual. It is a well-known fact among modern taxonomists that the number of scales in longitudinal rows is constant enough within certain limits to be a valuable taxonomic character.

SIZE.

The basis of age determinations is the fact that the scales are constant throughout life, both in identity and number. Steenstrup (1861) noted that cycloid, ctenoid, and ganoid scales grow throughout life and increase in size proportionately to that of the fish, while placoid scales never exceed certain limits, but fall off, giving rise to others. The size and shape are agreed upon as constant within certain limits, and Cockerell and others use them as taxonomic characters. It is understood, however, that size is by no means constant.

^a Thomson's translation.

CIRCULI.

The concentricity of the circuli suggested their connection with growth as early as 1716, when Réaumur said of them: "They occupy the borders of each layer and they represent different degrees in the growth of scales."

It seems that the difficulty in cutting cross sections has been largely responsible for the confusion as to the nature of the circuli. They have been variously regarded as the ends of laminæ, grooves for blood vessels, "cellular lines," growth rings, crossings of transverse fibers in the superior layer, etc.

Peters (1841) admits a difficulty with the circuli. He contends that they are not the ends of laminæ, because they are not always parallel with the outer edge of the scale, but are sometimes perpendicular, a condition that could never occur in the case of lamina edges. His only attempt at explanation was that "the crossing of the fibers in the superior layer seems to explain the circuli."

Agassiz (1834) thought that the number of circuli agreed with the number of laminæ in the inferior layer, but Peters was never able to bring himself to this opinion. Blanchard (1866) rejected this theory because he found that in some species the number of circuli is the same in the young as in the old.

The "cellular lines" of Mandl (1840) are explained thus: "The laminæ are not superimposed layers, but have their origin in special cells in the superior layer and finally become lines"—a rather vague explanation.

Salbey (1868) attempted to show by vertical sections that they have no connection with the laminæ, but that they belong to the superior layer, and may disappear or be replaced, or new ones may be interposed between them.

Baudelot (1873) gives a thorough description of the circuli under the following scheme:

1. Presence: (a) May be present over the entire scale; (b) may be partially present (on the periphery); (c) may be absent.
2. Disposition: (a) Concentric; (b) regularly concentric at periphery, irregular at center.
3. On posterior field: (a) Sometimes appear; (b) sometimes very rare, losing their regularity and becoming enlarged at certain points or covered with tubercles.
4. Other modes of orientation: (a) Perpendicular with contour, but parallel with each other.
5. Number: (a) Greater in anterior than in lateral field; (b) greater in lateral than in posterior field.

He finds the form of the circuli to be a ridge with its edge turned toward the focus. Its edge is somewhat serrate, resembling the teeth of a saw. He notes zones where circuli appear to be closer together. He considers the circuli as having some relation to the moorings to the body, suggesting them as holdfasts. To show that they are not edges of laminæ he makes the following observations:

(1) The circuli very rarely effect a complete arrangement in the form of concentric lines; (2) the circuli may be perpendicular to the contour of the scale; (3) they may show the most irregular arrangement, become folded up against one another, entangled in all directions, or even form a sort of network of irregular meshes; (4) the circuli are appendages of the superficial layer of the scale; (5) they originate at the margin of the scale as points of isolated calcification; (6) they show a marked inclination to the focus.

To sum up his conclusions, he rejects Agassiz's idea that the circuli are the edges of laminæ. He considers them as related to the mooring of the scale to the integument,

and not as necessary organs of the scale. He finds the zones of apparently unequally distant circuli (annuli) which constitute the basis of the modern system of age determination. Variations in the number of ridges are not usually great on scales from similar positions on the bodies of fish of the same species. In fish of the same species but of different ages the number of ridges increases proportionately with age and consequently also with the diameter of the scale.

Klaatsch (1894) noticed that the concentric arrangement of the circuli is unusual for superficial reliefs. He says that in trout the cells arrange themselves so as to correspond exactly with the circuli. He further states:

One might expect that the superficial scleroblast layer would cover the deeper cell layer with its product so that the constituent part of the ridges would be taken up in the interior substance of the scale. This does not, however, occur. The cells arrange themselves as they pass through the changes described, so that they come to lie in the external surface of the ridges and contribute to their enlargement. They elaborate, as it were, the upper relief surface of the scale, for which the deeper cells had only supplied the foundation.

Ussow (1897) noticed the same thing, but at a later stage when the ridges had entirely formed. At the stage when the reliefs occurred for the first time no such aggregations existed. It is possible that these cells later take part in the formation of the reliefs, but he believes that the commencement of their formation arises at the expense of the peripheral elements of the papilla.

Tims (1906), in his work on cod scales, arrives at very different conclusions. He describes the circuli as a series of scalelets with their peripheral borders turned up by the pull of the stretched pocket. He notes the lateral fusion of two or more scalelets which, if carried out completely, would result in the typical clupeoid scale which is composed of eccentric imbricated rings.

In the recent work of Miss Esdaile (1912) are found detailed statistics relating to the circuli (which she calls annuli), their number and disposition, and, especially, enumerations of their occurrence on scales of different parts of the body. She finds that there is a uniform variation in their occurrence, an observation of much importance in age determination. Her conclusions are:

1. A great variation in the number of annuli and in the lengths of the scales taken from different parts of the body of the same fish is clearly indicated. This was found on each of three fish [*Salmo salar*], but the results obtained seem to be in no way correlated.

2. It is to be noticed that in the three fish examined the number of annuli in each peronidium increases from the head to the adipose fin, and then diminishes toward the tail. A similar increase and decrease is found on both the dorsal and ventral sides of the lateral line.

3. In a comparison of scales taken from positions at corresponding distances from the head on both dorsal and ventral sides of the lateral line it is seen that, as a general rule, the scales on the dorsal side have fewer annuli in each peronidium.^a

Masterman (1913a) regards the circuli as stiffening or supporting tissue of the scale. His discussion is, however, directed not so much toward the morphological significance of these structures as toward their bearing on age determination. Consequently his discussion of this subject is treated in this paper under the heading "Age determination."

^a Miss Esdaile has adopted the word "peronidium" as meaning that part of the scale which represents the growth of a summer and a winter together.

SPINES.

Kuntzmann (1824) described what he regarded as two distinct kinds of spines: (1) Spines which molt, and (2) permanent spines, which are integral parts of the superior layer of the scale. Mandl (1840) thought spines were comparable to true teeth. Leydig (1851) regarded them as extensions of osseous corpuscles, a view shared also by Peters. Salbey (1868) considered them as integral parts of the superior layer appearing successively at the posterior margin of the scale and which constantly wear away.

Baudelot (1873) gives a detailed description of all the variations of spines, which is too long to reproduce. He concludes, among other things, that their number increases with age and on different parts of the body, and in places where they are rudimentary they may drop off, leaving cycloid scales. He advances the theory that the spines have their origin in the serræ on the edges of the posterior circuli. In support of this hypothesis he uses the following arguments:

In many scales * * * the edges of the circuli present a series of very distinct microscopic indentations, and in some ctenoid scales the spines are so small as to appear only as indentations of the circuli of the posterior region which have become very prominent. In many cycloid scales the posterior region shows a series of tubercles arranged with as much regularity as the spines and presenting a striking analogy to these structures. These tubercles are, however, only partial thickenings of the concentric ridges (circuli). In the same fish the scales become altered and pass from the ctenoid to the cycloid condition, and in that case it frequently happens that the spines become replaced by simple ridges.^a

This substitution is to him sufficient proof of the homology of the spines and the circuli.

Klaatsch (1890) makes the cycloid scale typical of teleosts, because "(1) it represents simple conditions, and (2) it supplies a suitable object for placing the skin covering of the teleosts in line with the selachians and ganoids." He regards the ctenoid scale as the result of still further specialization in the teleosts.

Ussow (1897) thinks that there is no relation whatever between placoid teeth and the spines of ctenoid scales, but that the similarity is purely accidental. He thinks that spines are formed of the same substance as the superior layer of the scale—the hyalodentine of Hofer.

Tims (1906) finds in the minute projections on the scalelets of the cod the antecedent form from which the spines of ctenoid scales are derived. If these projections (which he finds more prominent on the posterior field) be more pronounced and slightly more perpendicular, we have the spines of ctenoid scales.

Cockerell and Moore (1910) advanced a somewhat different theory, as follows:

The teeth arise through the modification of the apical ends of the vertical circuli, i. e., circuli which in the apical region retain their vertical position. It is not evident that they have anything to do with the radii. In very highly specialized ctenoid scales * * * the teeth form a separate fringe which appears to have no intimate connection with the rest of the scale. It follows that a scale with completely transverse apical circuli can not be, and can not become, ctenoid. The reason why there are no ctenoid cyprinid scales seems to be that the group has advanced too far along the line of modification in regard to the circuli to be able to produce them.

^a Translation by Thomson.

RADII.

The first important hypothesis dealing with the nature of the radii was that of Agassiz (1840), who thought them "channels at the margin of the external surface which connect one layer with another and multiply during the growth of the scale." Mandl (1840) considered them as canals for transporting nutrition to the center of the scale. Peters, instead of giving them the function of connective canals, regarded them as sutures allowing growth in all directions. He also notes that they are sometimes concentric, as in *Ophidium*.

Williamson (1849) denied the existence of any such canals as Mandl described. He says that they are simply the absence of the superior tissue along their course. While they are not nutrient canals, neither do they pass through the entire calcareous portion of the scale and reach the soft portion, as Agassiz contended.

Salbey (1868) says that the radii are grooves in the superficial layer, but not through what he calls the conjunctive layer, and suggests that they are the channels for the continued calcification of the interior conjunctive substances which calcify slowly and are not in juxtaposition to any other nourishing parts. Tins considers the radii as adaptations to the increasing circumference.

Baudelot (1873) thoroughly describes radii, both as to structure and disposition. Aside from numerous variations, all of which he records minutely, mention might be made of the three main modes of disposition. These are (1) divergent from the focus; (2) parallel with each other; and (3) parallel with the contour of the scale. Their form may be that of simple lines of fissures in which the scale appears to be broken; a ravine whose sides are perpendicular with the sides of the scale; a wide and shallow trench; a groove of varying width; a series of depressions, or, in some cases, a series of small cavities in the same straight line. In regard to number, he says, "The number of radii of an individual is capable of varying with age, and if the number increases with age it may also be reduced." The same conclusions apply to the transverse or concentric grooves.

Baudelot pointed out that up to his time no satisfactory explanation of the radii had been offered, and in his attempt to explain them he attributes them to irregular calcification. He says:

Grooves are lines of noncalcification. The exterior layer has centers of calcification which later unite with one another as these centers extend. When the union takes place laterally the grooves will be radii; otherwise they will be transverse grooves, and when calcification takes place all over at the same time there will be no radii.

Cockerell (1911) finds radii on both the anterior and posterior fields, calling the former "basal" and the latter "apical" radii. He attaches enough importance to their number to make it a taxonomic character.

FOCUS.

The center of the scale would, to most observers, suggest a center of growth; nevertheless, it has been the subject of much conjecture. Vogt (1842) first noticed that the focus is larger in the adult than in the young, suggesting wear, unless the scale, in its entirety, increases in size—a supposition very difficult to substantiate. The comparatively large focus in some cases suggested to Agassiz (1834) that it might be the result of wearing down of the thickened center. Both Peters (1841) and Salbey (1868)

disagree with this, holding that since the scale is covered with a membrane constantly lubricated with mucus the wear on the hard scale would not be enough to make a noticeable difference. They account for it by a difference of growth.

Baudelot (1873) admits his inability to give an adequate explanation of the focus. He describes it with minute detail in all its variations and concludes that it and the annuli are due to the same cause but he can not tell what that cause is.

Hoffbauer (1898, 1900) calls it the center of growth representing the oldest part of the scale and also notes that in some cases it is abnormally large, but that at other parts of the same fish it is normal—observations in perfect accord with Dahl's explanation.

According to Tims (1906) "it consists of a flattened plate of calcified tissue, elliptical in shape with an irregular margin. From its appearance in section and from a surface view I believe it to be formed of a fusion of a number of basal plates, the spines of which have entirely disappeared."

Dahl (1911) gives an explanation of abnormally large foci which seems to be adequate. Those scales with such foci are simply regenerated scales, the focus being composed of secreted matter which filled the empty scale pocket following the loss of the old scale. He illustrates this with a cut, which shows his evidence to be quite conclusive.

PERFORATING CANALICULI AND INTERNAL LACUNÆ.

The observation by Blanchard (1866) of certain very small perforations through which water might freely flow seems to be the origin of the theory that scales have a respiratory function. He noticed that they are especially prominent in the Cyprinidæ.

They were first described by Baudelot, who was able to make out their structure clearly. He describes them as extremely small canals perforating the scale from top to bottom. They are found on the posterior side and pass through the scale obliquely—i. e., from the exterior surface they incline toward the periphery on the posterior side and from the longitudinal axis of the scale. They are developed from notches that appear in the posterior margin and, as the scale grows in size, the notches are surrounded by newly secreted substance becoming canals which extend through the entire thickness of the scale. As to function Baudelot thinks that nerves pass through them, thus relating them to the supposed sensory function of the lateral line.

In the interior of the scale the canaliculi may become more or less expanded, forming a cavity which, in extreme cases, pervades almost the entire scale between the inferior and superior layers. He called these lacunæ. In the case of *Dactylopterus volitans* the lacunæ are very large and are filled with a bony tissue which he regards as a connecting link between scales and bones. He confesses that he is unable to conjecture any function for them.

STRUCTURE, FORMATION, AND GROWTH.^a

Agassiz (1834) believed scales to be analogous to nails and hair and hence not living tissue. He explained growth as taking place by secretions from the floor of the scale pocket and by the increasing size of the scale pocket, which enlarges in proportion to the size of the body of the fish. The laminae were different leaves or folia. As to calcification, he regarded it as nonhomogeneous—i. e., occurring in corpuscles or calcareous bodies—which he believed to occur only on the superior and inferior surfaces.

^a For a review of the older literature on scales, see Thomson, 1904.

Mandl (1839), on the other hand, considered scales living tissue capable of growth by intussusception and consisting of two layers, the superior and the inferior. The inferior layer is laminate, while the superior layer is cartilaginous, the lower part being interspersed with calcareous corpuscles. The growth of the superior layer is peripheral, while that of the inferior layer takes place by the addition of secretions from the floor of the scale pocket. He described the corpuscles as separate elements or cells in the superior layer, in definite positions, and of a yellow color which disappears on acidulation.

Peters (1841) agreed with Mandl as to the laminate structure but with Agassiz as to the location of the corpuscles, with the exception that he was unable to find them on the surface of the superior layer.

Williamson (1849) followed, adopting the opinions of Agassiz, Mandl, and Peters, with modifications. He stated that there were three layers, the superior, the inferior, and the median. The superior layer differs both in structure and origin from the other two layers. In section it presents the appearance of an undulating outline with a very faintly laminate interior structure. It extends entirely to the periphery. In early stages it is a soft membrane which later calcifies. In substance it resembles the ganoin of *Lepidosteus* (*Lepisosteus*).

The median layer is built up of a mass of lenticular calcareous bodies which unite with one another as they increase in size, losing their shape in this coalescence. In thickness it decreases from the center to the periphery until it disappears, leaving the periphery flexible. After the fusion of the corpuscles the median layer splits up into horizontal laminæ which agree in direction with the membranous laminæ which exist previous to calcification.

The inferior layer consists of numerous membranous laminæ arranged in parallel horizontal lines more numerous at the center, only one appearing at the periphery. Each lamina is composed of fibers, all parallel with each other. They are the result of the calcification of the laminæ and have their origin as small centers of calcification which grow in size by the addition of layers to the outer surface, in section giving the appearance of concentric rings. Growth takes place by the successive increase in size of the laminæ of the inferior layer.

Salbey (1868) says that the inferior layer consists of thick lamellæ, separated by thinner ones. The thin lamellæ are conjunctive, while the thicker ones are calcareous. The thinner ones finally calcify and fuse with the thicker ones, giving the older scales the appearance of having fewer laminæ, while they really have more. According to him, the mode of growth is that the inferior lamina is fastened by a conjunctive substance which eventually calcifies, after which calcification another layer of the conjunctive substance is added, which in its turn calcifies, etc.

The work of Baudelot (1873) is in greater detail than that of any of the foregoing authors and probably of more value. He states that calcium phosphate and carbonate constitute the inorganic substance of the scale. He described the tissue of scales as being a striated substance separable into laminate folia. Corpuscles are more abundant in the exterior laminæ and comparatively rare in the inner ones. They increase in size with age and two or more may fuse. They represent products of a crystalline nature and exhibit a series of concentric lines from the center to the outer surface.

The origin of a scale is a calcified spot which slowly extends until it becomes a lamina. The scale always adheres by its inferior surface and periphery and always grows by the

addition of layers to the internal face. On the superior surface it is loosely connected. Subsequent calcification is from the exterior toward the interior and from the periphery toward the center.

Nickerson (1893) says:

Throughout the series of scale structures, beginning with the selachian type, there has been a constant tendency toward the reduction of the superficial parts (spines) and increase of the deeper parts which are independent of the epidermis. * * * In the higher teleosts the whole scale growth is within the dermis and the more superficial process is entirely lost.

Klaatsch (1894) divides the scale into the outer homogeneous layer and the inner fibrillar layer. The outer layer is bony tissue, entirely soluble in hydrochloric acid and having no special structure except a slight layering. It is formed from cells located chiefly in the lower surface of the overlying scale pocket. The scleroblasts (formative cells that give rise to scales) form the superficial reliefs. This exists for a long time before the inner layer appears.

The inner, less calcified layer consists of fibers in bundles, all the fibers in one bundle being parallel, and the bundles being parallel with each other but crossing those of the next higher and lower layers at acute angles. This is considered the connective tissue layer of the scale.

In the scleroblast layer there are polygonal elements between which there is a colorless network. The cells in this layer arrange themselves in groups whose nuclei come to lie closer together. Then those parts of the cells farthest from the nuclei separate and are added to the intercellular substance. This substance is added to the part of the cell already existing. The scale is thus an intercellular secretion which is eventually hardened by lime salts.

Ussow (1897) concludes his paper as follows:

The scale of teleosts is a plate consisting of two layers. The upper layer (including the relief) consists of a homogeneous tissue without any structure except a very slight striation parallel to the upper surface. This layer originates in the dermis at the expense of the so-called scleroblasts. * * * The tissue of this layer is a simple bony tissue. The lower layer also originates at the expense of the same elements. It is formed in part out of the indurated connective tissue.

Tims (1906) found that in the cod the calcareous material does not form an uninterrupted layer, but is in the form of minute isolated platelets the exterior surface of which bears a small spine resembling very small placoid scales.

CLASSIFICATION.

The first attempt at classification by means of scales was that of Heusinger (1823).^a He devised the following plan:

1. Fishes with scales entirely hidden in the skin: *Anguilla*, etc.
2. Those with scales proper: *Esox*, *Salmo*, etc.
3. Those with strongly toothed scales: *Chelodon*.
4. Those with osseous scales: *Lepidosteus*, etc.
5. Those with osseous plates: *Acipenser*, etc.
6. Selachians.

^a Thomson, 1904. This reference not verified by writer.

Kuntzmann's (1824) classification of scales, while artificial and crude, was far in advance of his time. It follows:

1. Membranous scales—those with concentric lines.
2. Semimembranous—membranous posterior field, but anterior field faintly marked, as in *Clupea*.
3. Simple scales—no radii or circuli; simple center.
4. Scales with a design.
5. Scales divided into regions.
6. Scales with prickles.
7. Spinous scales.

Agassiz (1834) gave great impetus to scale classification. He originated the four groups—ganoid, placoid, cycloid, and ctenoid. His system was abandoned on account of the great variability, but attempts are being made, it seems, to revive it. Cockerell and Miss Esdaile are working in this direction.

Mandl (1839) claimed to have found definite characteristics for each family and expressed his belief in their usefulness for distinguishing genera, and even species. Peters (1841) repudiated this statement when he found both cycloid and ctenoid scales in the same fish. Vogt (1842) was able to distinguish the different orders of ganoids by their scales.

Baudelot (1873) concludes that none of the characters can form a basis of classification, since the presence or absence of spines—the most important scale character—is too variable. Although the characters alone are of little value, yet taken together they ought not to be neglected in forming natural groups. Tims (1906) distinguishes the different groups of the Gadidæ but goes no further into classification.

The work of Cockerell (1910, 1911, 1913, 1915) and Cockerell and Callaway (1909) on classification is more elaborate than that of any other recent investigators. Cockerell says (1911):

It has been possible to test rather thoroughly the value of scale characters and the result has been to show that while they are not rarely deceptive through convergence, they are, on the whole, of great taxonomic importance.

As indexes of classification he uses size, shape, spines, radii, and circuli.

AGE DETERMINATION.

The more important means of age determination is based on Steenstrup's (1861) observation that all scales except placoid grow throughout life proportionately to the size of the fish. Agassiz, however, believed that scales are laminate and that one lamina was added each year. Baudelot also took this view, with slight modifications.

By polarized light Carlet (1878) was able to distinguish old scales from young ones, the former being birefringent, while the latter were monorefringent. Further, by means of picocarmine stain he was able to distinguish the newer lamina from the older ones, the uncalcified parts staining red, the calcified parts staining yellow.

Hoffbauer (1898, 1900) by observations on the hibernating habit of the carp, showed the supposition that the circuli were lamina edges was incorrect, since the number of laminae is not the same as that of the circuli and the number of laminae is greater than the number of years the fish has lived. He says that the number of circuli between annuli on

scales from the same region of the same fish is approximately constant. He noticed that the number of circuli increases where the scale becomes smaller and also that there is a considerable difference between different specimens for the same year. In short, his theory is that during favorable seasons when the food supply is plentiful, the fish grows more rapidly than in seasons of poorer food supply, and that this difference of growth is indicated by the circuli, they being closer together during seasons of slow growth than in seasons of rapid growth.

Johnston (1905, 1906, 1907, 1909), in Scotland, undertook to work out the difficult life history of the salmon from its scales. He found the annuli and correlated them with the known facts of the life of the fish in such a way as almost to establish the conclusion that they are winter marks. He discovered the "spawning mark," which is the worn or absorbed part of the scale that was the periphery at the time that the fish went into fresh water to spawn.

Thomson (1904) and Tims (1902, 1906) worked independently at about the same time. The work of the former was done on the Gadidæ and Pleuronectidæ. Besides a splendid review of the literature up to his time, of which liberal use has been made in this paper, he gives many minute measurements to support the points he makes. He is convinced that the annuli represent years and finds that the number of circuli in a band of a given width varies but little. His statistics show that if the annuli do not represent years there is a remarkable coincidence.

Tims is skeptical of age determinations by this means. He admits that he is able to follow Thomson through the first summer and winter bands, but that he can detect no further alternations. In his reasons for his disbelief he points out Klaatsch's observation that scales do not appear simultaneously all over the body and not until the fish is 3 to 4 cm. long, an objection which he admits, however, to be of little consequence. He finds variations in the number of annuli on scales on different parts of the same fish. Furthermore, the number of circuli varies indefinitely. And more important than all, scales are lost and are replaced, and for this reason age determination by means of scales is impossible.

Thomson, referring to Tims's objections, admitted that age determinations in old fishes are difficult, and in some fishes, even in the young, probably more difficult than in others, but asserted that in the cod the evidence is both plain and conclusive. He includes in his paper many observations of variation, tending to corroborate his conclusions.

Brown (1904) raises further objections to the theory supported by Thomson and others. They are:

1. Gadoid fishes shed their scales immediately after spawning.
2. After the age limit of spawning no further shedding takes place.
3. The concentric rings of scales of fish do not represent annual increments, but must have other causes.

He finds scales on a 3-year-old cod with 30, 60, and 90 circuli, respectively, depending on the location on the body; hence this method of determining age is of no value.

Among other conclusions, Dahl (1911) says that injuries or adverse conditions, even in summer, will produce annuli. Further, he applied the method devised by Johnston of calculating the length of the fish for each year by the proportionate width

of the several bands. By this means he shows that comparisons of fish of different localities can be made with much fewer fish. Suspecting that the scale-covered parts and the remaining parts of the body of the fish might not grow in the same proportion he made measurements to show that errors from such a source would be negligible.

Hutton (1909, 1910, 1914b, 1914c) wrote several papers popularizing and urging the economic importance of fish-scale examination. He also gave some notes on photographing scales.

Esdale (1912) did a valuable work in determining the degree of variation of scales on different parts of the salmon, *Salmo salar*. She shows that within certain limits the circuli in each year band ("peronidium") is proportionate to the width of the scale, but different in absolute number on different parts of the body of the fish. Criticism of this part of her work is offered below in connection with the writer's observations on age determinations (q. v.). In her second paper (1913) Miss Esdale gives the results of investigations of salmon scales devoted largely to points in the life history of that fish.

Gilbert (1913) worked on the salmon of the Pacific coast after essentially the same methods as those employed by Dahl, Hutton, Thomson, and others. His scale photography is brought to a high degree of perfection, and deserves special mention.

Milne (1913) in a work similar to Gilbert's, on salmon of the Pacific coast, offers a pertinent criticism of Dahl's (and Johnston's) method of calculating length. He was able to test this method by scales of two fishes captured, marked, measured, and recaptured by Johnston. On one, Milne points out, Johnston's calculation showed an error of only one-half inch for the kelt measurement of a 27-inch salmon; the other showed an error of 6 inches for a $26\frac{1}{4}$ -inch fish, from which he concludes "either that the scale is abnormal, or that Dahl's system of measurement is not applicable to a fish that has spawned."

McMurrich (1912), in addition to the methods of Gilbert and Milne, made use of evidences found on otoliths. In these structures, zones or lines may be observed which are believed by McMurrich and others to represent growth periods.

Masterman (1913a) perceived that much of the work of recent investigators was based on assumptions rather than on definitely settled facts. He therefore undertook a careful critique of the work done on salmon, making an effort to decide whether it had been proved that summer and winter growth rings are invariably and indubitably formed in their respective seasons; and whether the spawning mark invariably records the spawning period; and whether its absence can be taken as denoting maiden fish.

He states the usual assumptions of age determinations, but is doubtful of the reliability of this method beyond the fourth or fifth year of growth. Concerning the manner of growth of the circuli, he says: "They have an innate tendency to be produced roughly in lines equidistant from the center and at a certain distance from the preceding ridge * * *. The distance between neighboring ridges is determined by the rate of growth at the time." In addition to the accumulation of circuli in summer and winter bands, he notices other morphological arrangements of the circuli which may also help to indicate the seasons of active growth; but, to quote him on this point, "In the case of sea fish, at any rate, they may just as likely have reference to changes in food and temperature, with no direct reference to the calendar."

He divides the evidence necessary to prove the general theory of age determinations on scales into (a) morphological, (b) experimental, and (c) statistical. To summarize his conclusions:

(a) Morphological:

(1) The evidence necessary to prove that a broad band is formed in summer and a narrow one in winter has not yet been produced. On this point he cites the insufficiency of Dahl's and Johnston's evidence.

(2) "The scale can not be an accurate gauge of the lapse of time unless the zones, besides being produced in their respective seasons, are always produced in response to these seasons."

(3) "The formation of these two different series of growth—rings or zones—takes place in the winter half or summer half of the year, respectively" (quoting Dahl).

(b) Experimental: The evidence of fishes of known age and kept under artificial conditions is convincing as far as it goes (for the first two years), but can not be regarded as convincing through the entire term of life until more work is done.

(c) Statistical: "In studying the average sizes, average weights, and seasonal occurrence of the different age groups and numerous other statistical relations, the age data obtained from the scales give a rational and consistent result throughout."

Under the caption, "The morphology of salmonoid scales" he classifies the different circuli as complete circles, occurring in the earliest stages of the fish; crescentic or incomplete circles, occurring in normal summer growth, and incomplete seasonal crescentic ridges. These latter occur in the winter growth, and if his conclusions here are reliable, consideration of these short circuli should be a valuable addition to the methods already employed, but, of course, not necessarily applicable to any species other than the salmon studied by him.

In connection with his discussion of the "spawning mark," his conclusions may be summarized as follows:

1. It may be held as conclusive that the spawning mark is produced by changes incidental to the act of spawning.

2. The spawning mark is not caused by the mechanical vicissitudes of river life or the act of spawning, as assumed by Johnston, Dahl, and others. In support of this view he calls attention to the following points: (a) The spawning mark is produced prior to entering the river and in some cases, long prior to spawning; (b) the fact that the scale is imbedded deep in the dermal pocket would, alone, destroy the mechanical attrition theory; (c) since it is known that gonads are developed partly by the absorption of other tissues, it is not unreasonable to assume that the scales are among the tissues so absorbed.

3. It can not be taken as proved that the absence of the spawning mark is valid evidence that the fish has not spawned. In this connection he cites the case of salmon kept in aquaria at the Plymouth laboratory that were stripped for two successive seasons without the formation of a spawning mark. This, he admits, may possibly be due to the artificial conditions.

4. It seems impossible accurately to define the spawning mark. Consequently the personal element will enter into doubtful cases, and differences of opinion will result.

On the whole, Masterman's paper constitutes one of the most valuable contributions to scale literature. He suggests numerous researches on the subject that are needed and that might profitably be followed.

Calderwood (1914) takes up some of Masterman's criticisms of the spawning-mark doctrine. Referring to Masterman's theory that the mark is due to absorption incident to spawning he pointed out that the attrition is noted on the lateral, seldom on the anterior, margin. If Masterman's view is correct, the anterior margin ought to suffer most. It will be observed, however, that Masterman had taken this into consideration and suggested that this absorption of the lateral margin rather than the anterior margin might be in anticipation of the decreased girth after spawning. Calderwood also cites Milne's observation that the thickness of the scale is increased at the spawning mark which according to the latter observer is due to a continued secretion of the scale substance while the size of the body remains constant. Calderwood finds difficulty in seeing how absorption of scale substance and a deposition of more at one and the same time could take place; yet this must be true if Milne's contention is correct. Calderwood rather regards the attrition of the scale as necessary for the thickening and toughening of the skin, but fails to point out very clearly just how this is accomplished. He ends his paper by expressing the belief that the absence of the spawning mark is valid negative evidence.

In the application of the scale reading no more important work has been published than that of Hjort (1914). Since, however, no effort is made in this paper to review the general applications of the subject which are entirely too voluminous to permit it, further comment on his work may be omitted here. A great volume of work of this nature has been done not only by Hjort and his assistants, Lea and Dahl, but by McMurrich, Gilbert, Petersen, Johnston, Calderwood, Hutton, Esdaile, Masterman, Hoek, and a host of others.

The work of Winge (1915) on the cod supplies much of the evidence that Masterman found lacking in the salmon. He measured the "platelets" (Tims) or as he calls them "sclerites," each one individually from the focus to the periphery, constructed curves from these measurements, the maximal and minimal modes corresponding to the summer and winter growths, respectively. By comparing these scale measurements with the actual lengths of living fishes measured, marked and recaptured, he was able to show that these modes agree quite satisfactorily with the growth of the fish. These modes (the summer and winter growth bands) are, in the cod, formed in September and March, respectively.

Another division of his paper deals with the question whether the growth of the scale is exactly proportional to that of the fish. By measurements on four marked cod, he finds a surprisingly close agreement—altogether within the limits of experimental error. Furthermore, he was able to show that cod living under similar conditions will show similar curves when plotted in his manner. And, finally, he tests the otoliths as a means of determining age, using his data from scales as a check. Judging from his excellent technique, his results must be regarded as reliable. He concludes: "* * * in the cod examined a very high degree of uniformity exists between the growth of the scales and that of the otoliths. Both scales and otoliths exhibit growth rings by means of which the age of the cod can be determined."

Mention should be made here of the work of the investigators of the *Kommission zur Untersuchung der deutschen Meere*, Reibisch (1899), Jenkins (1902), Heincke (1905, 1908), Maier (1906), and Immermann (1908). These investigators worked chiefly on the sole, cod, and turbot, while Wallace (1907, 1909, 1911), in England, worked on the plaice, employing the otoliths and bones as means of age determination. The result of this work seems to show that not only are age indications to be found on scales, but on the otoliths, opercula, and bones. Since these structures reveal age only after they are prepared by special technique, it is evident that they can never be employed in the examination of large numbers of specimens, as can the scales. These structures have served the useful purpose of verifying, to a certain extent, the evidences found on scales.

In spite of all this work, there remain doubtful points. Heincke (1908) cites numerous instances of fishes that were very old, but undersized, along with examples of variation in size among fishes of this same age, but of different sex or from different localities. Yet he fails to show that these variations are in the number of age rings rather than in age. He concludes that the number of age rings is normal and correct and that growth in these cases is abnormal; but from his data he might as well have concluded that the size was normal but the number of rings abnormal.

APPLICATION OF SCALE CHARACTERS TO AGE DETERMINATION.

The idea that the age and life history of fishes may be determined by their scales has given rise to much investigation. Each method has been investigated and an attempt has been made to find other indications of age on scales.

The different means of determining age with more or less accuracy are:

(1) A count of the annuli aided by—

(a) Polarized light.

(b) The selective action of picrocarmine stains.

(c) The origins of the radii.

(2) Identification of year groups by measurements of length and weight.

These methods may be used in combination.

COUNT OF ANNULI.

It has been contended that, at least for some species, growth does not proceed uniformly, but that during the winter and in other seasons, because of lack of food or because of injuries or other causes, growth takes place more slowly than in summer or in seasons of more abundant food supply or when conditions are otherwise more favorable. Such changes of conditions as well as certain peculiar habits are said to leave their marks on scales. From the investigations of Johnston, Gilbert, and Dahl on salmon and trout, and Hoffbauer on carp, it would seem that circuli appear at fairly regular intervals of time while the growth of the scale in width depends on the growth of the fish. The appearance of the circuli at regular intervals of time while the scale increases more rapidly in size in summer than in winter would produce concentric areas in which the circuli were close together alternating with areas in which they were farther apart. The earlier investigators considered these areas in which the circuli are not widely separated "winter bands," assuming that the fish grew less rapidly in winter than in summer, thus producing rings analogous to the annual rings in tree trunks.

When viewed under low magnification, these alternate bands appear, in most cases, clearly; and if they really represent winters, it is a simple matter to determine age by counting them. Hoffbauer seems to have demonstrated that these zones do represent winters by observations on the scales of carp kept in aquaria and under known conditions.

One is, however, confronted with many obstacles in relying entirely on this means of age determination. In very old fishes, as Tims points out, the annuli, through wear and diminished growth, become so indistinct and close together that it is almost, if not quite, impossible to arrive at a satisfactory conclusion as to age.

Investigating the scales of *Cynoscion regalis* and *Orthopristis chrysopterus*, the writer has not been able to verify all these observations, for the reason, possibly, that these investigations were made on English brook trout, salmon, and carp, the scales of which he has not had the opportunity to examine.

Miss Esdaile (1912) in the following language accepts and states very clearly the fundamental assumption of all the workers on age determination:

Examination * * * shows that the annuli [circuli] are arranged in a definite manner, some far apart and others closer together. Those far apart are, according to Mr. Johnston, formed during the rapid growth of the fish in the summer, and those closer together during a time of slow increase in the winter.

This implies clearly that bands representing equal lengths of time ought to exhibit at least approximately equal numbers of circuli, and that scales of the same size ought to be sculptured with a similar number of circuli. But later in her paper she states that "there is no constant variation in the number of annuli in the different periods of the scales from the same position." In her table no. 2, scales from positions 4 and 5 have the third peronidia of the same width—0.48 mm.—yet one has 10 circuli, the other 7.8 circuli on the long axis. Again, scales from positions 6 and 7 have total lengths of 6.07 and 6.09 mm., respectively; yet one has a total of 107.8 circuli, the other of 118.2 circuli, a difference of 10.4 circuli, or 9.2 per cent variation from the mean. In no case where the widths of any two peronidia were the same, were the corresponding numbers of circuli identical.

A similar criticism can be made from the photographs in Gilbert's paper (1913); take, for example, plate VI, figure 10, of his paper: Judging from the width of the summer bands, the growth each year is less than that of the preceding, yet the separation of the circuli is greater each year than that of the preceding. There are more circuli per linear centimeter in the third band than in the fourth, yet the former is wider and is supposed to have grown more rapidly.

The following observations bear on the nature of the annuli:

1. The circuli on the scales of the *C. regalis* are almost equidistant. Figure 1 is a graph correlating the number of circuli and distance apart measured in tenths of a millimeter. Each ordinate unit represents one circulus and the units of the abscissa are tenths of a millimeter. If the annuli are uniformly one-tenth millimeter apart a 45° straight line would result. Barring very small fluctuations, this is true. Their separation does not vary in the vicinity of the annuli, nor does their separation vary with different distances from the periphery.

2. The direction of the annuli is not necessarily coincident with that of the circuli. This is more or less apparent on all the scales examined but is most strikingly demon-

strated on the scales of the Clupeidæ. On the scales of *Brevoortia tyrannus* and *Pomolobus mediocris* and others of the Clupeidæ the annuli cross the circuli at more or less acute angles—laterally at almost right angles—the annuli being coincident in direction with the scale contour while the circuli are arcs of concentric circles whose center is posterior to the scale, and are not coincident in direction with the contour. (Pl. LVII, fig. 22.) In these cases there seems to be no more than an accidental relation between the annuli and the circuli. It may be seen that this is also true for *C. regalis* in plate LVI, figure 19. Whether the annuli in these different genera are homologous characters is open to question, but their number, disposition, etc., suggest that they are.

3. On the scales of *Cynoscion regalis* the number of circuli between the last annulus and the periphery, is, in July and August^a much less than half the number of circuli between any two adjacent annuli. The number of circuli between any two annuli is from 30 to 100. Between the last annulus and the periphery the number of circuli varied from 4 to 8 in July and August.

4. Measurements calculated from the annuli considered as summer bands agree with the length groups actually measured. The following method was employed: Three hundred and eighty-two specimens were measured at random.^b Their lengths were found to fall in modes of 19.91, 26.31, etc., cm. (Tables 1, 2, 3.) Then the lengths of 28 specimens were divided into parts proportionate to the distances between the several annuli, and these lengths entered as the respective first, second, etc., years of the fish. (Table 1.) The averages of these lengths were then compared with the modal lengths of the 382 measured fish. (Table 2.) It will be seen that the averages agree remarkably.

5. Annuli are narrow areas parallel with the contour of the scale, in which the regularity of the circuli is interrupted, manifested as branches, breaks, or terminations.

6. The scale is separable into laminæ, the edges of which coincide with the annuli.

7. Annuli stain pink with picrocarmine.

8. Annuli have a refractive index different from that of the spaces between.^c So far as the writer has been able to determine, the refractive index of scales has never been actually measured.

The conclusion of previous investigators that annuli are approximations of circuli and are caused by retarded growth is rendered questionable by the foregoing observations. If the annuli were approximations of circuli, the expected curve would be the dotted lines in figure 1, showing retarded growth at the time the annuli were formed. In the second place, if retardation of growth brought the circuli closer together, then in the fifth or sixth year of the life of the fish, when growth is much slower than in the earlier years (indicated by the narrowness of the bands), the circuli would be closer together, giving the scale the appearance to the unaided eye, or under low magnification, of having at the center widely separated circuli while, approaching the periphery, the circuli would appear closer together. The scale would then have a light inner part, growing darker toward the periphery. The writer did not find this to be the case on the scales

^a This character is much less constant on the scale of the pigfish, *Orthopristis chrysopterus*, Linnæus, due, perhaps, to the more variable spawning time of the latter fish. Specimens 2 cm. long were taken as early as June 15 and as late as Sept. 1, 1913.

^b The detailed measurements in the table cover only 65 specimens. However, in addition to these the lengths of 382 fishes measured by Hecht and Crozier were used in constructing the modes.

^c Carlet (1878); Dahl (1910).

of *Cynoscion regalis*, nor, judging from the cuts in the papers of Hutton, Dahl, and others, does it appear to be true of other species. If each annulus represented a year and the circuli appeared at regular intervals of time, then the number of circuli could vary but little in each band. In the third place, that annuli and circuli have nothing in common is proved beyond doubt by the fact that the former may cross the latter. The suppositions referred to are negated by these observations, and it remains that

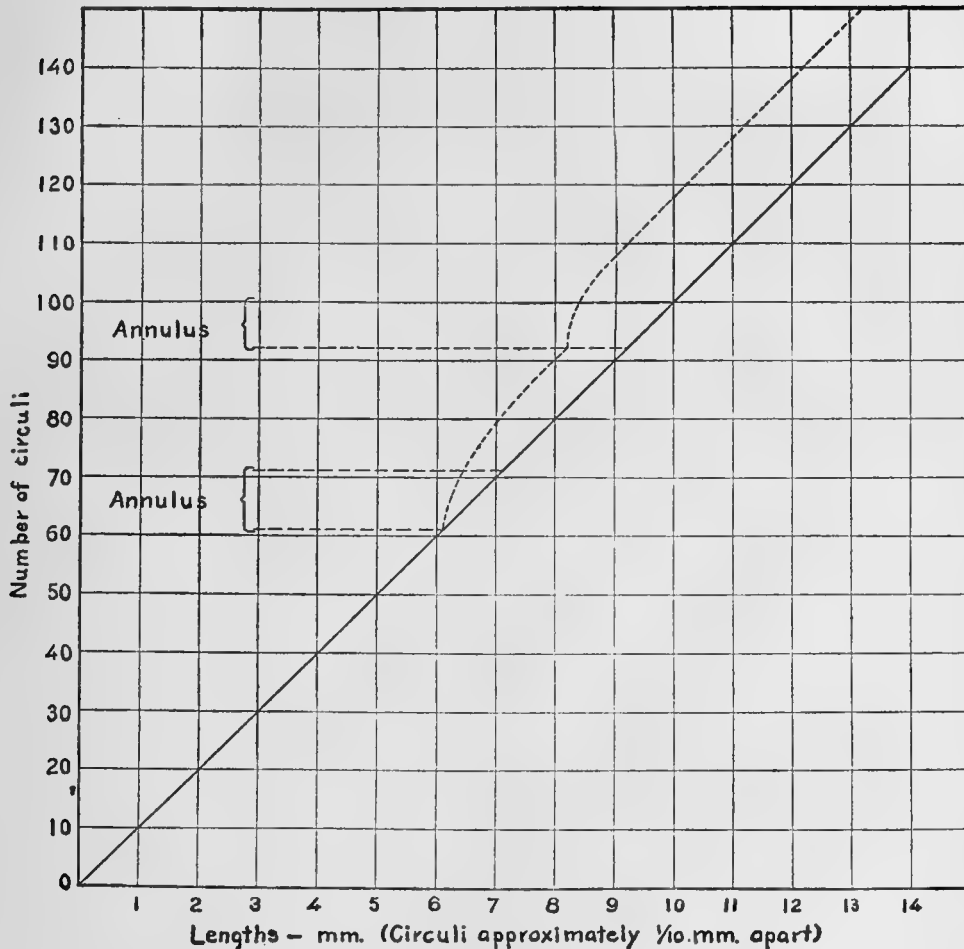

FIG. 1.—Showing number and distance apart of the circuli on a scale of the squeteague including two annuli. Dotted line represents the expected curve of such a correlation if the annuli were groups of approximated circuli.

one annulus may be produced each year, but that it is not produced by retarded growth, nor does it consist of approximated circuli.

That the annuli do not represent winters, as contended by the previously mentioned investigators, is verified by the observations on *Cynoscion regalis* as already noted. If the annuli represented winters, then in July and August the number between the periphery and the last annulus ought to be at least half the average number of circuli between any two adjacent annuli. But the small number of circuli found points to May or June as

the time of formation of the last annulus. In the case of the comparisons of measured and calculated lengths (table 2), if the annuli represented winters a discrepancy between the averages would be expected; for the fishes measured would be approximately an even number of years old (spawned in June and measured in July and August), while the winters represent points midway between birthdays. But the calculated and measured lengths agree remarkably (table 2; also fig. 2 and 7), suggesting the view that annuli are year-old marks, but not winter marks.

These observations seem to justify the opinion that the annuli are simply the margins of the laminae composing the scale. Plate LI, figure 3, a photomicrograph of a part of a scale under high magnification, including two annuli in the field, shows clearly that the annuli are not circuli closer together, but simply branching circuli. This branching possibly may be explained by the disproportionate growth of the anterior and posterior fields.

It is seen that while several circuli are being formed across the anterior field, only one is formed on the lateral field, hence the branching. A glance at plate LVI, figure 19, will show that all the circuli on the anterior field are traced back to a point on the posterior field where they join the following circulus, and that an annulus is being formed continually. Thus the last circulus on the periphery is, at its posterior extremity, part of an annulus that will not be complete till the next year. The beginning of a new annulus appears to be determined by a sufficient lateral growth to permit the formation of another circulus.

But this does not explain the annulus on the anterior field. Here, as elsewhere, it seems to be the edge of a lamina. Just why these laminae end at the ends of years is yet undetermined. It suggests that the fish passes through year cycles of growth, and that one lamina is formed each year. It has been suggested that the fish spawns every year from the first, and that the laminae represent differences of calcification during spawning time.

Dahl proposes a unique theory. The scale is secreted by the floor of the scale pocket and the increasing size of the pocket explains the increasing size of the scale. The thickness of the scale is only dependent on continued secretion. Thus if the scale pocket remains constant in size, so will the scale; if it increases in size, a new ring will be added to the periphery, etc. But a contraction of the pocket will produce an upward fold in the thin edge. It is conceivable to him that during the spawning period the body is more or less distended and while it is in this condition a new layer is added from the floor of the scale pocket. Now a contraction of the body follows the spawning period and with it a contraction of the scale pocket, pulling the thin periphery upward. Such a process would produce structures similar to what we know the annuli to be, if we leave the interior structure out of consideration.

The evidence, however, does not point to this conclusion. That spawning has nothing to do with the formation of annuli is evidenced by four different points:

(1) Annuli are often found running in a direction contrariwise to that of the circuli.

(2) Spawning leaves a mark on scales of a character quite different from that of the annuli. (Masterman 1913a, Milne 1913, Calderwood 1911.)

(3) Expansions and contractions of the body of the fish consequent upon the spawning of the fish could not possibly affect the scales on the caudal peduncle, head, etc., yet

annuli are found on scales taken from these parts which correspond exactly to those on scales taken from parts of the body subject to expansion.

(4) The process of expansion and contraction could not produce the separable laminae of which the annuli seem to be edges.

It seems to be explained by differences of calcification. The inferior layer, in which the laminae occur, is the secreted product of the floor of the scale pocket. As the fish grows, both the scale pocket and its secreting floor increase in size proportionately. We thus get a scale constantly increasing in size and thickness, the lower lamina of which is always the newest part. This secretion on the inferior side is constantly being added and calcifies much more slowly as it is pushed outward. If calcification should vary, we would find layers of more and less calcification. In this case, if the scale were torn forcibly, the less calcified part would yield while the more calcified parts would adhere, giving the idea of separable laminae. This was actually done; in one case six laminae were easily separated. The scale, according to this view, is a solid mass, and the apparent layers are strata of slightly differing degrees of calcification. That mineral metabolism, at least, in some marine animals is dependent on temperature is indicated by investigations^a in which it is shown that the magnesium content of crinoid skeletons is higher in tropical than in colder latitudes. It is quite possible that the same variation will be found in the calcium content of fish scales—not only in fishes from different regions, but in the different laminae of the same scale.

Polarized light.—The utility of polarized light in age determinations is twofold: (1) When the scale is young—i. e., less than 1 year old—it is monorefringent to polarized light; when more than 1 year old—i. e., consisting of more than one lamina—it is birefringent (the writer was unable to verify this observation);^b (2) when used with a selenite plate, the annuli stand out in colors different from those between. This is said to be due to the scarcity of mineral salts in the vicinity of the annuli. The chief value of polarized light is thus to bring out the annuli clearly in obscure cases. The refringency of light is of little value, since it only differentiates fishes less than 1 year old from those more than 1 year old, which usually in fishes so young is sufficiently indicated by the annuli alone.

The selective action of picrocarmine stain.—Picrocarmine is the most satisfactory selective stain for scales. Its value in age determinations depends, as shown by Carlet (1878), on the selection of the carmine by the uncalcified parts. By it the outer lamina—i. e., the youngest—which is deficient in mineral salts, is stained pink. The next inner lamina is an orange, while the older completely calcified laminae stain yellow with the picric acid. The edges of the several laminae up to three or four from the periphery also stain pink. The value of this stain in age determinations, then, is twofold: (1) It differentiates the last lamina, which is always the most difficult in old fishes; (2) it also stains the edges of the laminae between this one and the first or second. Thus in most cases the age of a fish 5 or 6 years old may be easily deciphered.

The origins of the radii.—Like polarized light and picrocarmine stain, the radii are only supplementary to the annuli as a means of age determinations.

^a Clarke, F. W., and Wheeler, W. C.: Composition of crinoid skeletons. Professional Paper 90-D, U. S. Geological Survey. June 16, 1914.

^b Carlet (1878).

As in the majority of teleosts, radii appear on the scale of *Cynoscion regalis* only on the anterior side. They begin, usually four to six in number (on the sides of the fish), at about the seventh circulus, counting from the focus. These usually continue to the periphery. As the scale increases in size, more radii are added on either side of those first appearing, beginning at various distances from the periphery. Proceeding laterally from the long axis, one finds that they extend diminishing distances from the periphery. They are usually symmetrically arranged—i. e., a radius beginning on one side of the axial radius will correspond with a similar radius beginning at the same distance from the periphery on the other side. The points at which radii begin in the main coincide with the annuli. It would, then, be a simple matter to count these points to determine age, but this rule is by no means infallible. Radii often begin between two annuli, and sometimes continue for a short distance only and then disappear. But radii beginnings, notwithstanding this variability, are sufficiently constant to afford a valuable means of verifying and supplementing the other methods.

In case we find an old fish on whose scales the annual rings are very obscure, the various aids in combination make it possible to determine accurately the age of the fish or, at least, to count the annuli. When the annuli near the periphery are so near and indistinct as to be indecipherable, the picrocarmine stain will clearly differentiate the last two laminae and probably stain the edges of two or three more. The radii origins indicate the intermediate ones. These can be verified by color differentiations of polarized light through a selenite plate. We then have the following scheme:

First annulus: Usually clearly distinguishable.

Second, third, and fourth annuli: Stain red with picrocarmine; color differentiations by polarized light.

Fifth and sixth annuli: The last stains red; the next inner stains orange.

YEAR GROUPS IN LENGTH AND WEIGHT.

This is a statistical method of verifying the other means of age determinations and must be employed before the age characters of any one species can be settled definitely. Upon measuring a great number of squeteagues the writer found that they fall into groups of different lengths around 20, 26, 31, 37, etc., cm. (Table 1 and text fig. 2.) These are what Johnston (1904, 1905, 1907, 1909) called "year groups"—those falling around 20 cm. being probably 1 year old, around 26 cm., 2 years old, etc. If the other means of determination agree with these results, they may be taken as correct.

Another suggested means of age determination—probably of little importance—is based on the observation of Williamson that the calcareous corpuscles are also built in layers, so that when viewed in section they appear as concentric rings. This, it seems, is due to a difference of calcification, and the rings would probably represent years, but investigations of the structure of these corpuscles have not been sufficient to warrant an opinion as to their value in this connection. At any rate, it would be an extremely difficult method to apply.

INTERPRETATION OF THE RADII.

Various conjectures as to the function and importance of the radii appear in the literature on scales. They were an important item in the Agassiz-Mandl controversy. In some systems of classifications by scales they have been considered constant enough to be used in distinguishing genera and species. Observations recorded below point to conclusions differing from any that have been advanced hitherto.

In examining a large tarpon scale focussing was accomplished by bending the scale on the stage. While this was being done the radii were noticed, their edges coming closer together as the scale was bent (viewed from the distal side), and they seemed to be lines of most flexibility.

The number of radii on different parts of the body of the fish seems to vary as the mobility of the parts. (Text fig. 2.) On the caudal peduncle more radii were found than on any other part of the body. This number decreases (subject to the influence of size, shape, thickness, etc.) as one proceeds anteriorly. On all the inflexible parts—i. e., above the head, on the opercula, nape, etc.—the scales were entirely without radii; but proceeding posteriorly, on the parts where there is slight movement, a wave was found in the anterior field. (Pl. LII, fig. 4.) Proceeding farther posteriorly, the number of radii increases and there is a tendency toward an increase ventrally from the median line of the back. In no case were radii found on scales taken from inflexible parts of the body, and the other factors being equal, notably shape, their number varied directly as the flexibility of the part from which the scales were removed.

These facts suggested that radii might be hinges to permit the scale to bend in adaptation to the movements of the body of the fish. The fact that all degrees in the formation of radii, from total absence, then wavy folds, then a few to finally numerous radii, are found and that these correspond with the mobility of the part, which varies from zero, then slight, and finally to the maximum on the peduncle, is alone sufficient evidence to support the hypothesis that radii are simply hinges.

There are numerous other evidences to support this hypothesis. As was shown under the head of age determination, the uncalcified parts stain red with picrocarmine; the radii stain heavily with it. Plate LIII, figure 14, shows a cross section of a scale that will illustrate how the radii facilitate bending.

An examination of a scale will make this clear. It will be noticed that the radii do not begin at the focus, but the young scale must increase to a size that will interfere with the movement of the fish, i. e., the scale must become stiffened by calcification so as not to bend readily with the body of the fish before the radii begin to appear.

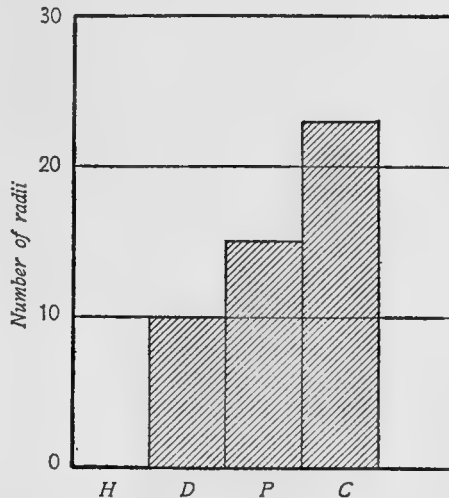

FIG. 2.—Polygon showing the occurrence of radii on scales taken from different parts of the body. H, scales from head; D, scales from a point below the anterior base of the spinous dorsal fin; P, scale from a point beneath pectoral fin; C, scales from caudal peduncle.

They then increase in number as the periphery is approached, the radii in most cases appearing late, beginning at the lamina edges. This is explained by the supporting effect of each lamina on the next following lamina. On the under side of the scale the radii do not appear, for the lower or uncalcified layer is flexible and does not break until it becomes calcified, when it leaves a fissure showing, in stained scales, the uncalcified, red-stained layer below.

All the other factors being constant, then, the radii might be expected to increase in a definite proportion as the periphery is approached. The number of radii varies with (1) the activity of the fish, (2) the size of the scale, (3) its shape, (4) its thickness, (5) its degree of calcification, (6) its curvature, and (7) the position of the fulcrum of the scale.

(1) Variations of activity may mean relative activity of the different parts of the body, or of the same parts of the body at different seasons of the life of the fish. By examining scales from all parts of the body of the same fish (pl. LII, LIII) it will be seen that there are no radii on the inflexible parts; on the very slightly movable parts very few are found; and on very movable parts the whole anterior field is sculptured with radii; but on certain scales, symmetrical in shape, and on flexible parts of the body, the number is found to increase to a certain extent as the periphery is approached, afterwards diminishing, until there are no more radii at the periphery than at the focus (pl. LIV, fig. 15). This is explained by the relative activity of the fish at different seasons. If this explanation is correct we have an index of the relative activity of the fish throughout life.

(2) As the scale increases in size the number of radii must increase proportionately if the extent of bodily movement remains constant; but if the radii are found to increase in number to a certain point, then remain the same in number where an increase would be expected, or decrease, and if we assume that the radii are caused by bodily movement, the probability is that the fish suffered a diminution in activity at this point. The number of radii at the several annuli on the scales of forty specimens were counted and tabulated (table 5), showing that the expected increase does not occur on *Cynoscion regalis*. Plate LIV, figure 15, shows a scale on which the radii thus decrease in number after the third year.

(3) Narrow scales have fewer radii than broad ones, the reasons for which are obvious. *Rachycentron canadus* has long narrow scales with very few radii; *Paralichthys albiguttus* has scales of a similar shape with one or two radii. The scales of *Istiophorus nigricans*, the extreme of this shape, have no radii at all. Scales around the vent of *Brevoortia tyrannus* or *Cynoscion regalis* are long and narrow, and have very few radii. On a scale taken from the top of the peduncle of *Cynoscion regalis*, one of the anterior angles was prolonged, and there were many more radii on the side of the prolonged angle than on the opposite side. Shape also determines the relative direction of the radii. When the anterior angles are both prolonged, the radii are seen to be parallel and not divergent, as usual. (Pl. LII, fig. 7.) The scales of *Fundulus majalis* normally possess this character, and here the radii are uniformly parallel.

(4) Thin scales have fewer radii than thicker ones. On the scale of *Urophycis earlii*^a no radii were found, and the scales were extremely thin, although large. Thickness, however, varies little in the scales of the same fish, and, so far as the writer has found, in the same species.

^a This is an interesting scale bearing evidence relating to Baudelot's theory of spines (see Review of Literature).

(5) Apparently the scales of some fish do not calcify so rapidly as those of others. *Synodus jactans* has very thick and broad scales; nevertheless they are not marked with so many radii as might be expected. They are calcified very little in comparison with those of *Archosargus probatocephalus*. In fact, judging from the flexibility of these scales, one would expect still fewer radii were it not for convexity.

(6) Most scales are more or less meniscus in shape, the convex side being exterior. This is believed to be responsible for the radiate rather than a transverse direction of the radii. If a scale were perfectly flat, fewer radii would appear, and they would run perpendicular to the long axis of the body of the fish. The more depressed the body of the fish, the more convex the scale, and consequently the more sculptured with radii.

Brevoortia tyrannus furnishes an example of a scale that is nearly flat. On this scale the radii are irregular in direction and are generally perpendicular to the long axis of the scale.

(7) The scale acts as a lever. When the posterior side is raised, the center rests against the upper edge of the scale pocket as a fulcrum, and the anterior edge is pressed inwardly. It is easily seen, then, that the more posterior the fulcrum—i. e., the more deeply inserted the scale—the more numerous the radii. As a further substantiation of this theory, it has been possible to tear the several laminae apart. The segments between two radii of the upper laminae were completely separable from the surrounding tissue, indicating that they were not held in place by the tissue of the laminae from which they were taken, but by the stratum below. In the upper laminae the scale being stiffened by calcification, broke into separable segments, while the uncalcified stratum below yielded when the scale was bent.

There are probably numerous other factors influencing the presence, number, and character of the radii. Among these might be mentioned the elasticity of the scale pocket. This is probably less in older fish than in young, with a concomitant increase in the number of radii. The shape of the body of the fish, its length, comparative activity, and habits may be more or less important influences.

With this large number of variants contributing to the production or nonproduction of radii, their value as taxonomic characters appears very doubtful. For instance, it is certain that the scale grows more anteriorly than posteriorly, being forced deeper and deeper into the pocket, throwing the fulcrum posteriorly, tending to produce more radii. It also increases in size, again necessitating more radii. At the same time, calcification is going on, making the scale less flexible, and its thickness is increasing by the constant addition of secretions from below, the shape remaining practically constant throughout life. All these conditions tend to a geometrical increase in the number of radii. But while the fish is growing older, its activity is possibly declining, tending to reduce the number of radii. Distention consequent upon spawning may be another factor, increasing or diminishing the number of radii. These variants may conflict and neutralize, or may work together to increase the number of radii. From all this we may conclude that by simply counting the radii without taking the contributing factors into consideration, fallacious conclusions may be reached.

Some of these factors are, however, taken into consideration in taxonomy. The shape of the fish is always noted. The size (number of scales in a line) and shape of scales are also noted. If now, instead of counting the radii, the other factors of elasticity and thickness were considered, we would have much more reliable additions to ordinary characters in classification.

LIFE HISTORY OF THE SQUETEAGUE (*CYNOSCION REGALIS*) AS INDICATED BY THE SCALES.

Unlike the salmon, which spends a life of widely varying conditions, and which, by its various markings, first attracted the attention of scale investigators to the possi-

bility of determining age by this means, the squeteague leaves only obscure evidences of its life history on its scales. Since it spends its entire life under fairly constant conditions, the sculpturings on its scales are rather uniform.

Effort has been made to determine: (1) The age of the fish of average size; (2) the rapidity of growth; (3) the age at first spawning; (4) the maximum age and length; (5) winter habits.

(1) The average length of all the fish measured^a is 32 cm.; of the 38 specimens the age of which were computed (see table 6 and text fig. 4), 94.7 per cent survive till the third year.

(2) The rapidity of growth during the first year of the life of the fish is remarkable. The average length of the squeteague at the completion of its first year is 20 cm. It is very rare for a fish to grow more during any subsequent year than in the first. (Text fig. 3.)^b However, there is here the possibility of a slight error. In fishes of 4 or 5 cm. in length the scales do not overlap, but

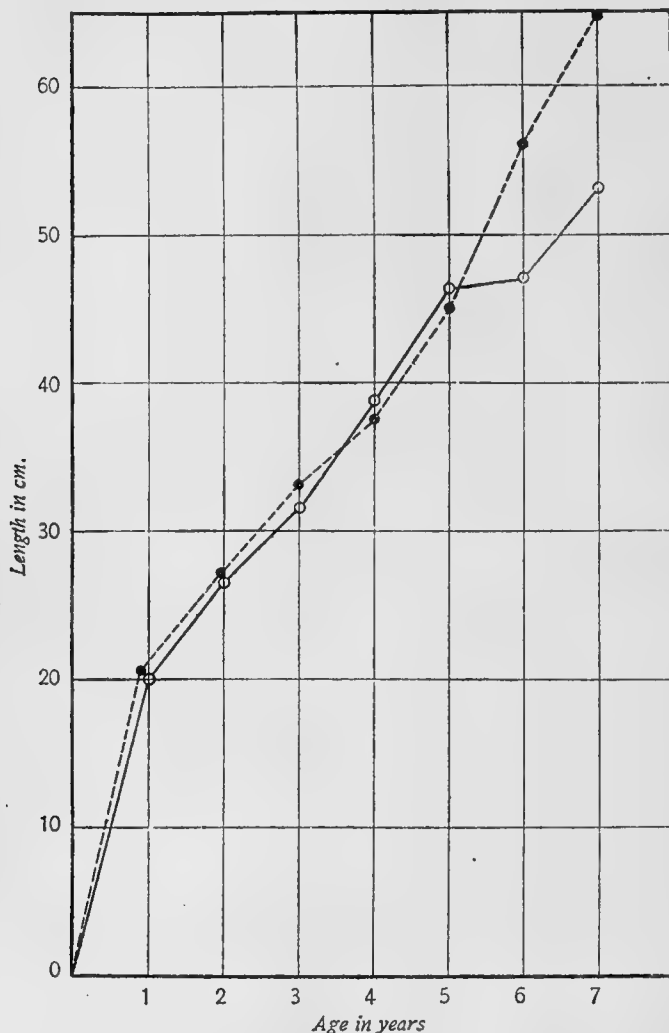

FIG. 3.—Comparison of calculated and measured lengths. Continuous line, lengths calculated from width bands on scales; broken line, length groups measured. *Cynoscion regalis*. (See table 3.)

must grow proportionately more rapidly than the body in order to do so. In addition to this, it is also noted that the proportion of the exposed part to the unexposed part

^a Including 382 fish measured by Hecht and Crozier and the 65 specimens represented in table 2, total of 447. It will be noticed that there are very few one-year fish in the table. This accounts for the high average of total length, 38 cm., which agrees well with the calculated length for the average age (4.1 yr.), which is in the fourth-year column, 38.48. (Table 1.)

^b Carl H. Eigenmann (Investigations into the history of the young squeteague; Bulletin, U. S. Fish Commission, vol. XXI, 1901, p. 47) concludes from measurements that a fish may reach the adult length of 400 mm. in 7 months. It will be noted that this is at wide variance with the conclusions in this paper based on evidences found on scales. It will also be noted that some of Eigenmann's measurements were made on young fish kept in an aquarium, while those of the larger fish were made on fish taken at a later time, with apparently no means of determining age.

is constantly diminishing, indicating a more rapid growth of scales than of the body. Hence, the proportionate distance apart of the several annuli does not represent the correct proportion of growth of the fish. This is probably compensated for by the late appearance of the scales (Vogt, 1845). The fish is from 3 to 4 cm. long before any scales appear. That any error here is negligible is testified to by the close agreement of the "calculated" and "measured" lengths. (Table 2.) After the fourth or fifth year, growth probably takes place very slowly, although the writer's data on very old fish are too meager to afford definite conclusions.

(3) Age at first spawning has been the subject of much conjecture. The opinion seems to have prevailed generally, probably on account of the rapid growth during

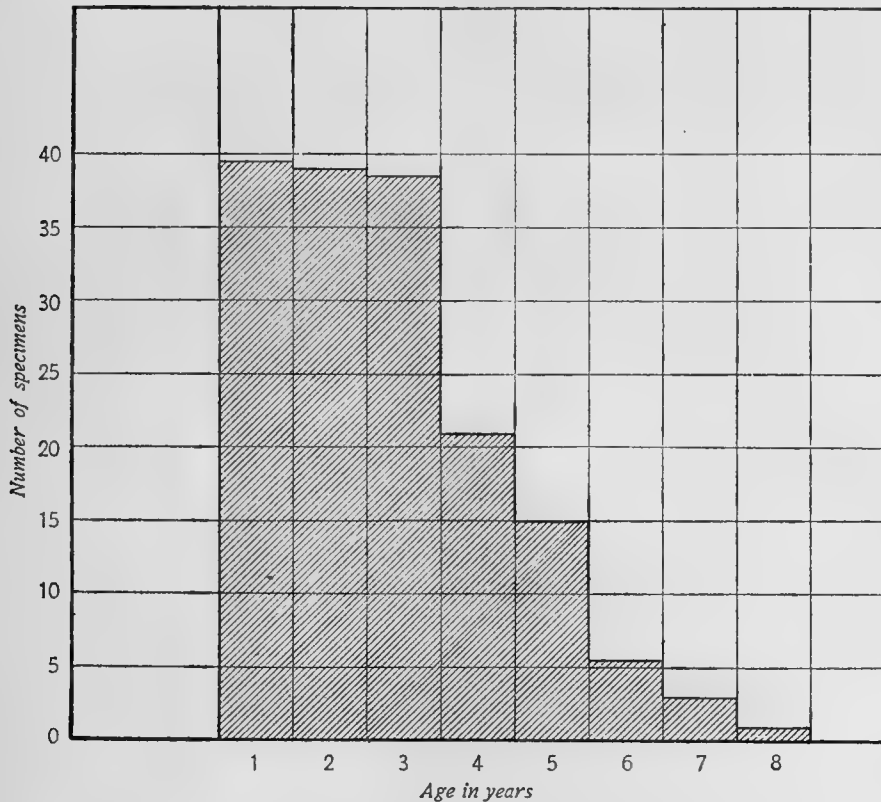

FIG. 4.—Polygon showing the occurrence of *Cynoscion regalis* at different ages.

the first year, that spawning takes place at the end of the first year. With the evidences afforded by scales, the writer is not prepared to accept this conclusion, unless the annuli represent spawnings and they occur every year of the life of the fish. There are two evidences which lead to the conclusion that spawning takes place for the first time in the third year: (a) The survival of 94.7 per cent of all fishes through three years. (See table 6.) As they increase in age and length after this point, their numbers decrease remarkably. (Text fig. 4.) (b) The relative activity, as indicated by the radii. (Table 5.)

If the ratio of the number of radii present to the number expected represents relative activity, a speculation may be ventured that activity decreases the third year. (See table 5.) It is at least possible that the activity, if variable at all, drops at first spawning, and decreases with age. This sudden decrease, followed by a continued decrease points to the third year as maturity, or the time of first spawning. If this is true, market fish ought to agree in size with fish of this age.

(4) The oldest fish caught was 8 years old, and at this age the annuli were so close together as to make their enumeration very difficult. It is likely that they seldom exceed this age, although fish of much greater size and probably greater age are reported from more northern waters.^a

(5) It may be inferred from observations of the scales that winter habits do not differ greatly from those of summer, the annuli alone not being sufficiently pronounced to warrant such a belief. At any rate, very little evidence has been gathered from scales bearing on this point.

CONCLUSIONS.

AGE DETERMINATION.

Age may be determined in two ways: (1) By counting the annuli, the count being facilitated by (a) polarized light, (b) picrocarmine stain, (c) beginnings of radii; (2) by year groups in length and weight.

RADII.

The following observations support the theory that radii are hinges permitting the scale to bend: (1) Scales on inflexible parts of the body have no radii, while their number when present is proportionate to the degree of flexibility. (2) In thick scales the radii are seen to close when the scale is flattened. (3) In broad scales the radii are more numerous than in narrow scales. (4) Very young (uncalcified) scales have no radii; in older scales they appear to begin at some distance from the focus. (5) In cross section they appear as ridges of calcified matter on the flexible uncalcified substratum; when these ridges approach each other the scale is so bent as to make it more nearly flat. (6) Scales whose anterior angles are prolonged and acute have parallel radii; those with rounded anterior peripheries have divergent radii. (7) Radii stain as uncalcified parts with picrocarmine, the stained uncalcified layer below being visible through the radii fissures. (8) Those radii which do not begin at a point near the focus usually have their beginning at an annulus which is explained by the tendency of a lamina to crease without the support of the next superior lamina. (9) The radii on the several laminae are in straight line one with another. This is explained by the support of the inflexible parts between the radii, i. e., the newly formed laminae will bend in lines coincident with those of the next superior lamina. (10) No previous theory explains them.

CIRCULI.

(1) The number, distance apart, and mode of growth of the circuli afford no evidence as to the cause or periodicity of the annuli; (2) they are of uniform distance apart, regardless of the rate of growth, hence they do not represent definite periods of time; (3) their function is probably that of anchoring the scale in the pocket.

^a Gill, Theodore: Natural history of the weakfish. Transactions of the American Fisheries Society, p. 269-276. Washington, 1910.

ANNULI.

(1) Annuli are edges of laminae, and are not composed of circuli occurring closer together; (2) they do not represent periods of retarded growth; (3) they probably represent differences in degree of calcification.

CLASSIFICATION.

(1) Spines, not being permanent, have little classificatory value; (2) radii have none; (3) shape, alone, has none; (4) size has none; (5) the foregoing characters, collectively, may be of some value in classification; (6) circuli, appearing as the most constant character, are probably of some classificatory value.

LIFE HISTORY.

(1) If the squeteague grows more in summer than in winter, it leaves no trace of such a difference on its scales; (2) this fish probably spawns in its third year; (3) the maximum age is not less than 8 years, the oldest fish caught being of this age; (4) an average adult fish of this species is 32 cm. long; (5) little has been learned of winter habits from scales.

TABLE I.—SHOWING GROWTH EACH YEAR OF CYNOSCION REGALIS, LENGTHS CALCULATED FROM GROWTH BANDS ON SCALES.^a

Number.	First year.	Second year.	Third year.	Fourth year.	Fifth year.	Sixth year.	Seventh year.	Eighth year.	Sex.	Age.	Weight.	Total length.
	cm.	cm.	cm.	cm.	cm.	cm.	cm.	cm.		Years.	gm.	cm.
1	24.44	31.77	38.09						0	3	489.0	38.3
2	22.10								0	1	75.9	22.1
3	19.80	30.80	38.50						0	3	524.5	38.5
4	13.44	23.52	28.00						0	3	198.0	28.0
5	16.01	18.08	20.45	25.20	29.35	31.72			0	6	273.0	31.4
6	19.44	23.50	26.74	31.61	34.86	42.97	48.65	56.00	0	8	1,370.0	56.0
7	19.85	30.30	36.57	42.84	45.98				0	5	822.0	46.0
8	13.97	20.61	24.63	27.31					0	4	191.0	27.4
9	16.33	22.87	30.40						0	3	248.0	30.5
10	32.37	40.81	47.85	55.59	56.99				0	5	1,788.0	57.0
11	19.43	23.33	29.17	31.11					0	4	270.0	31.0
12	22.16	28.69	31.30						0	3	299.0	31.3
13	17.68	24.00	30.31	32.84	40.41	42.94	45.45		0	7	795.0	45.5
14	18.70	27.12	33.66	50.50					0	4	1,176.0	50.5
15	26.71	34.95	40.09	47.35	56.61				0	5	1,602.0	56.5
16	26.77	34.88	39.34	46.63	57.99				0	5	1,900.0	58.0
17	26.86	33.97	41.08	48.10	55.12	60.65	65.50		0	7	2,635.0	65.5
18	15.75	18.38	21.00						0	3	85.0	21.1
19	18.34	24.45	27.50						0	3	184.0	27.5
20	22.30	28.50							0	2	184.0	28.5
21	23.05	27.32	31.59	36.71					0	4	510.0	38.0
22	13.77	18.37	26.02						0	3	163.0	26.0
23	21.96	26.23	29.47	31.13	36.79	38.02			0	6	445.0	38.0
24	14.49	21.43	25.18	29.47	33.50				0	5	340.0	33.5
25	21.39	27.93	31.59						0	3	298.0	31.5
26	19.87	25.39	26.50						0	3	170.0	26.5
27	11.67	17.51	23.35	28.53	30.50				0	5	270.0	30.5
28	21.71	28.95	38.26	43.48	50.60				0	5	1,135.0	50.5
29	24.94	30.77	37.50	45.19	50.00				0	5	1,361.0	50.0
30	17.47	26.31	32.64	38.08					0	4	426.0	38.0
31	22.06	26.47	29.80						0	4	227.0	30.0
32	13.60	21.76	26.29						0	3	161.0	26.3
33	22.03	26.37	30.71						0	3	799.0	30.5
34	17.07	22.59	25.38	27.50					0	4	184.0	27.5
35	20.41	25.78	29.00						0	3	227.0	29.0
36	18.57	22.28	26.00						0	3	143.0	26.0
37	15.86	25.55	35.24	46.69	55.50				0	5	1,580.0	55.5
38	24.82	32.36	37.32	42.28	59.15	65.50			0	6	2,260.0	65.5
Average	19.91	26.31	31.84	38.48	46.22	46.96	53.20	56.00		4.1		38.0

^a The measurements of length in this paper are from tip of snout to the end of the shortest rays, middle of the caudal fin.

TABLE 2.—LENGTHS AT DIFFERENT AGES OF 65 EXAMPLES OF CYNOSCION REGALIS AS CALCULATED FROM THE SCALES AND AS AVERAGES OF MEASURED YEAR CLASSES, WITH THE NUMBER OF FISH MEASURED IN EACH CASE.

Year.	Length.		Number of fish.		Year.	Length.		Number of fish.	
	Calculated.	Measured.	Calculated.	Measured. ^a		Calculated.	Measured.	Calculated.	Measured.
	<i>cm.</i>	<i>cm.</i>				<i>cm.</i>	<i>cm.</i>		
1.....	19.91	20.5	38	1(+10)	6.....	46.96	56.0	6	3
2.....	26.31	26.6	37	1(+13)	7.....	53.20	65.5	3	2
3.....	31.84	32.3	36	15(+1)	8.....		56.0		1
4.....	38.48	37.0	21	6(+3)					
5.....	46.22	45.2	15	9	Total. ^a			156	65

^a As the number 1, 2, 3, and 4 year-old fish used in table 1 was small the present table includes 27 additional specimens employed for length measurements, their distribution is indicated by the numbers in parentheses.

TABLE 3.—VARIATIONS IN LENGTH AT DIFFERENT AGES OF CYNOSCION REGALIS.

Year.	Maximum.	Minimum.	Difference.	Average. ^a	Year.	Maximum.	Minimum.	Difference.	Average. ^a
	<i>cm.</i>	<i>cm.</i>	<i>cm.</i>	<i>cm.</i>		<i>cm.</i>	<i>cm.</i>	<i>cm.</i>	<i>cm.</i>
First.....	32.37	11.67	20.70	19.91	Fourth.....	55.59	25.20	30.39	38.48
Second.....	40.81	17.51	23.30	26.31	Fifth.....	59.15	29.35	29.80	46.22
Third.....	47.85	21.00	26.85	31.84	Sixth.....	65.50	31.72	33.78	46.96

^a Average not of the maximum and minimum in class, but of entire class.

TABLE 4.—RELATIVE DISTANCE APART OF THE ANNULI (ARBITRARY STANDARD), AND THE NUMBER OF CIRCULI BETWEEN EACH TWO.

Band.	Width.	Number of circuli.	Ratio.
1	19	78	4.01
2	10	40	4.00
3	6	21	3.50
4	6	20	3.33
5	3	10	3.33

TABLE 5.—NUMBER OF RADII IN EACH YEAR OF THE LIFE OF 40 FISH, COUNTED ON THE ANNULI.^a

Number.	First year.	Second year.	Third year.	Fourth year.	Fifth year.	Sixth year.	Seventh year.	Number.	First year.	Second year.	Third year.	Fourth year.	Fifth year.	Sixth year.	Seventh year.
1.....	18	28						22.....	11	15	19				
2.....	9	13	16					23.....	11	20	18				
3.....	13	13	10	10	8	8		24.....	12	13	13	14	17		
4.....	38	46	49	52	75			25.....	14	18	20	22	22	20	18
5.....	17	18	19	27				26.....	18	20	21				
6.....	7	15	11	13	10			27.....	7	14	15				
7.....	16	26	33	29				28.....	18	32	35				
8.....	13	20	20					29.....	12	13	13	11	11		
9.....	12	15	17	16	18	18		30.....	12	22					
10.....	14	23	32	34	40	42		31.....	10	20	21	28			
11.....	9	12	13	17				32.....	10	20	21				
12.....	12	25	27	31				33.....	12	15	15				
13.....	15	20	18	24				34.....	16	21	21	23	28	31	
14.....	13	17	17	18				35.....	13	18	21	22	28		
15.....	13	19	15	15	12			36.....	12	21	24	23	28		
16.....	14	25	28					37.....	10	14	15	13	6	3	1
17.....	13	21	21	17				38.....	12	11	11	10			
18.....	11	16	17					39.....	22	32	42	53	62		
19.....	13	17	19					40.....	11	14	16	16	15		
20.....	13	17	17	8	5	1		Average.....	13.5	19.5	20.7	22.1	25.5	18.2	9.5
21.....	13	15	21	28	23	23									

^a Different series from table 1. The fortuity that the small number of scales more than three years old includes, No. 4, 10, and 39 which have an unusually large number of radii, serves in a measure to obscure the purpose of the table; with these abnormal figures omitted throughout, the averages corroborate the fact that it is otherwise obvious to one who examines the scales.

TABLE 6.—NUMBER OF FISH (*CYNOSCION REGALIS*) ATTAINING THE DIFFERENT AGES.^a

Year.	Sex.		Total.	Year.	Sex.		Total.
	Male.	Female.			Male.	Female.	
1.....	11	27	38	5.....	2	13	13
2.....	11	26	37	6.....	0	6	6
3.....	10	26	36	7.....	0	3	3
4.....	4	17	21	8.....	0	1	1

^a This table shows that 36 out of originally 38 specimens, or 94.7 per cent survived till the third year (see text, p. 314).

SUPPLEMENTARY OBSERVATIONS ON THE PIGFISH, *ORTHOPIRISTIS CHRYSOPTERUS*.

The foregoing investigations on the scales of the squeteague were done during the summer of 1912. The writer undertook a similar work on the scales of the pigfish in the summer of 1913. Besides bringing out some points in the life history of this fish, the investigation also throws additional light on the nature of the annuli.

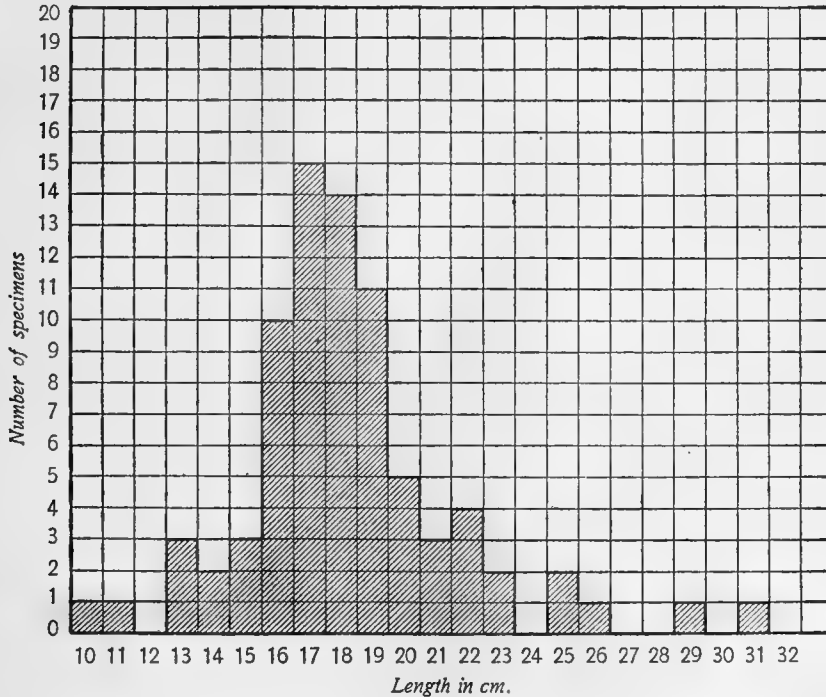

FIG. 5.—Occurrence of pigfish of different lengths, one year old and upward. The 10 cm. class consists of specimens 10 to 11 cm. in length, etc.

The scales of the pigfish are similar in type to those of the squeteague, i. e., they are ctenoid, radiate, and characterized by circuli, annuli, etc., and they have the same general shape as those of the squeteague.

The radii found on the scales of the pigfish are similar to those of the squeteague in structure, but are much more regular in arrangement. Branching is not common

inside the second annulus and as the annuli seldom exceed two in number, branching bears a much less important relation to age determination on the pigfish than on the squeteague. At the focus the radii are usually from six to nine in number, and more often than not continue to the periphery without branching.

The radii on the pigfish scales corroborate the evidence found on the squeteague and make even more convincing the probability that radii are adaptations to bodily

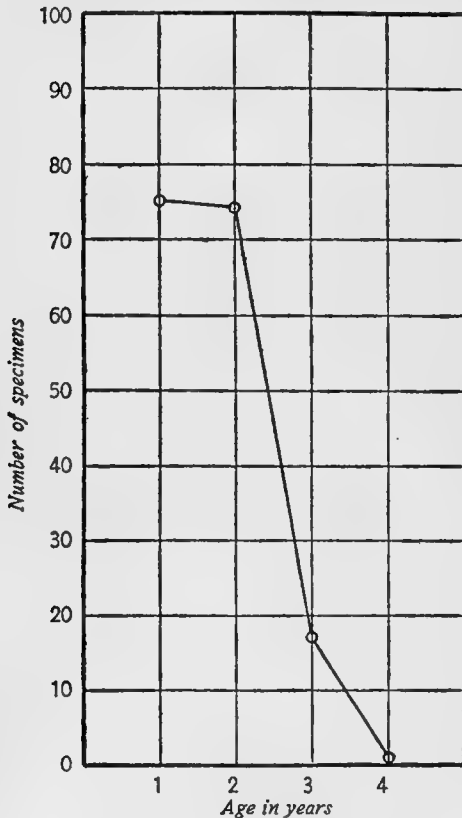

FIG. 6.—Occurrence of pigfish at different ages.

movement. A cross section of the pigfish scale shows a very characteristic structure strongly supporting the proposed explanation. Immediately under, and coincident with, the radii are corrugations, in the upper layer of whose summits are the radii. These corrugations stain rose pink in picrocarmine (Hoyer), while the superior layer stains hardly any.

Scales taken from the opercula of the pigfish offer still further corroboration of the conclusions drawn from observations on the scales of the squeteague. They present in cross section a sinuous outline suggesting the view that they are stages intermediate between those that bend and have the regular radii and those occupying inflexible parts and having no radii.

A series of experiments was carried on directed toward determining what influence food supply has on the formation of the annuli. Two aquaria were kept. (See feeding record, table 7.) In aquarium no. 1 four fish were placed, ranging from 14 to 18 cm. in length; in aquarium no. 2 seven fish of lengths ranging from 14 to 22 cm. were placed. All were started in aquaria on June 24. From June 27 the feeding record shows their treatment till they died or were taken out, August 22. In

the beginning the fish in aquarium no. 2 were fed sparingly, but as it was learned that they could live on very little, feeding was practically abandoned during the month of August. In all cases the fish in aquarium no. 1 were fed daily all they would eat, while those in no. 2, even when fed, were never satisfied. For some unaccountable reason all of the "well-fed" fish died on August 6, while one of the "starving" fish died August 5.

Careful watch was kept on the growth of the scales, but no difference whatever was noticeable in the formation of annuli. Any difference in growth was so small as not to be reckoned with. (Pl. LVIII, fig. 25, 26.)

These results appear to offer conclusive evidence that feeding habits have no influence upon the formation of annuli. Other possible factors yet untested are the influence of temperature and the presence of lime salts in the food and water.

The method of determining the probable length of life and spawning time of the pigfish was the same as that pursued for the squeteague. The survival of the great majority of pigfish through two years, followed by a sudden and great diminution in number, suggests the conclusion arrived at by Gilbert (1913) for the Pacific coast salmon, i. e., that this is the age of sexual maturity and that as a general rule they perish after this time. A glance at text figure 6 shows that out of 167 fish observed, only one reached the fourth year; 17 reached the third year, while 75 and 74 reached the ages of 1 and

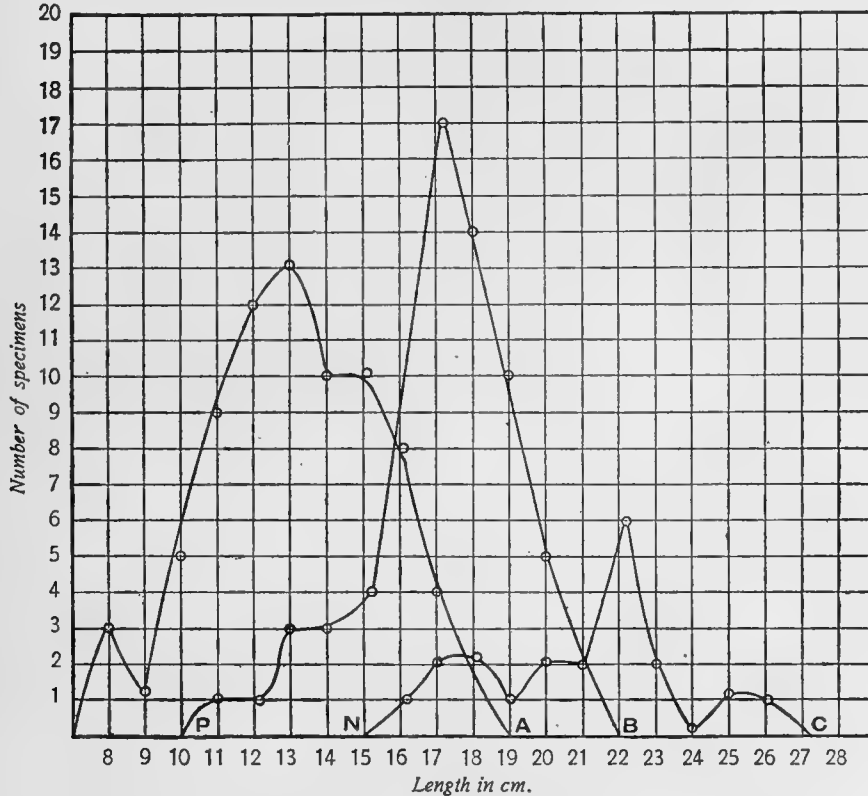

FIG. 7.—Occurrence of pigfish of one, two, and three years old. OA, fishes one year old; PB, two years; NC, three years. The 8 cm. class consists of specimens 8 to 9 cm. long, etc.

2 years, respectively. At all events, if the pigfish ever lives over four years it is extremely exceptional, since out of the total of 337 fish examined only one was found of that age, and none exceeded it. (Text figure 8.) Reasoning then from the small number of fish upon which perpetuation of the species would depend if spawning did not take place before the fourth or third year, we are forced to the assumption that the pigfish spawns in the second year if not in the first. There is no evidence on the scales to indicate whether or not spawning occurs in the first year, unless we regard the almost universal survival through the second year and the unripe condition of the ovaries and testes in July in 1-year-old fish as evidence that spawning does not occur the first year.

There seems to be greater latitude in the spawning time of the pigfish than in that of the squeteague. Not only was the length of individuals of the various age groups much more variable, but through the entire summer fry of all sizes from 1 cm. up were taken in great numbers in dragnets, while during the summer of 1912 the writer was led to believe that the squeteague had a very definite spawning time by the uniformity of length and the absence of small fry.

As to the winter habits of the pigfish the scales bear no evidence, since the experiments described above indicate that feeding habits have no influence upon the formation of the annuli.

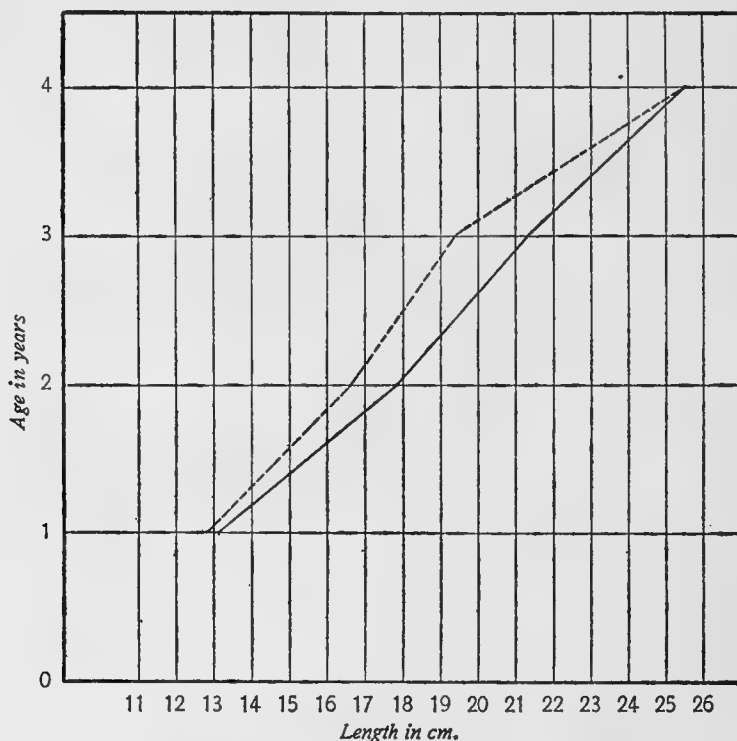

FIG. 8.—Comparison of calculated and measured lengths of the pigfish.

Numerous efforts were made to fix upon some method of marking individual scales for comparison of growth, and of paralyzing parts of the body to observe the formation of radii, but these efforts were uniformly without very encouraging results. To mark scales the writer tried AgNO_3 , india ink, slips of tinfoil inserted under the scales, various aniline dyes, etc., but in all cases the mark was sloughed off or had impressed itself only on the mucous secretion covering the body of the fish. In order to determine empirically the growth of scales, the writer removed with a pair of fine-pointed scissors a segment of a scale, leaving the remainder in the scale pocket for comparison. It appears that such a segment in the scale pocket is partly or completely absorbed and almost entirely regenerated.

TABLE 7.—FEEDING RECORD.^a

Date.	Aquarium no. 1.	Aquarium no. 2.	Date.	Aquarium no. 1.	Aquarium no. 2.
June 27.....	4 anchovies.....	4 anchovies.	July 9-13...	Fed well on cut fish...	No food.
June 28.....	2 shrimps.....	2 shrimps.	July 14.....	do.....	Anchovies sparingly.
June 29.....	do.....	No food.	July 15-27...	Anchovies daily.....	No food.
June 30.....	Fed well on anchovies.	2 anchovies.	July 28.....	Anchovies.....	Full meal anchovies.
July 1.....	Fed well on cut fish...	No food.	July 29-Aug.	Anchovies daily.....	No food. ^c
July 2.....	do.....	Do.	6, ^b		
July 3.....	do.....	Anchovies sparingly.	Aug. 7.....		Anchovies sparingly.
July 4.....	do.....	No food.	Aug. 8-10....		No food.
July 5.....	do.....	Well fed.	Aug. 11.....		Do.
July 6-7....	do.....	No food.	Aug. 12-22..		Do.
July 8.....	do.....	4 small anchovies.			

^a This feeding record embraces a period of 57 days. In aquarium no. 1 the fish were fed daily between June 27 and Aug. 6, when they died; while the fish in aquarium no. 2 were fed in the 57 days covered by the record only 9 times. This total for aquarium no. 2 includes 2 days well fed, July 5 and 28; the remaining feeding days they were fed very sparingly, the amount varying from 1 to 4 anchovies for 7 fishes.

^b All fish in aquarium no. 1 died; reason unknown.

^c One fish died.

TABLE 8.—TOTAL LENGTH AND TOTAL WEIGHT OF PIGFISH.

[Lengths for each year calculated from the annuli.]

No.	Total length.	Total weight.	Length first year. ^a	Length second year. ^a	Length third year. ^a	Length fourth year. ^a	No.	Total length.	Total weight.	Length first year. ^a	Length second year. ^a	Length third year. ^a	Length fourth year. ^a
	cm.	gm.	cm.	cm.	cm.	cm.		cm.	gm.	cm.	cm.	cm.	cm.
1.....	4.3	3.0					42.....	22.6	209.5	12.36	9.27	.97	
2.....	1.5	2.0					43.....	18.2	74.5	8.43	4.02	5.75	
3.....	1.8	1.0					44.....	19.6	94.1	14.70	4.90		
4.....	20.0	184.0	9.33	8.82	2.05		45.....	19.6	94.1	13.48	6.13		
5.....	20.0	184.0	14.48	4.21	2.10		46.....	16.1	52.3	12.21	3.89		
6.....	20.0	189.0	16.23	3.77			47.....	19.5	84.8	16.09	3.40		
7.....	13.0	47.0	11.37	1.62			48.....	17.2	63.4	12.61	4.58		
8.....	15.0	55.0	14.44	.56			49.....	17.1	55.3	15.50	1.60		
9.....	13.0	52.0	11.70	1.30			50.....	16.1	51.6	12.15	3.95		
10.....	14.0	50.0	13.12	.87			51.....	14.7	41.4	10.83	3.87		
11.....	11.5	32.0	8.75	2.73			52.....	22.0	145.7	12.97	4.51	4.51	
12.....	16.0	82.0	13.27	2.92			53.....	17.3	57.2	12.68	4.61		
13.....	13.2	4.8	10.80	2.40			54.....	19.4	90.5	17.00	2.40		
14.....	18.0	102.0	15.15	2.87			55.....	15.7	48.9	11.57	4.13		
15.....	5.5	2.0					56.....	17.8	74.1	13.35	4.45		
16.....	16.8	52.0	13.44	3.36			57.....	21.1	123.3	11.51	5.75	3.84	
17.....	26.2	207.2	13.42	8.63	4.15		58.....	20.6	99.7	18.30	2.29		
18.....	23.0	125.1	15.23	3.54	4.13		59.....	21.8	109.3	18.17	3.63		
19.....	25.5	200.8	14.16	4.25	4.25	2.83	60.....	18.1	78.0	16.16	1.94		
20.....	17.5	57.6	16.26	1.23			61.....	19.0	81.0	12.67	6.33		
21.....	20.2	82.8	15.08	5.12			62.....	17.9	64.9	16.89	.99		
22.....	17.2	62.6	13.18	2.87	1.16		63.....	17.3	67.1	14.57	2.85		
23.....	17.2	60.2	15.05	2.15			64.....	19.2	81.2	15.81	3.38		
24.....	18.3	75.3	14.42	3.91			65.....	17.7	65.2	14.90	2.79		
25.....	16.3	50.5	12.86	3.43			66.....	10.5	13.8	10.50			
26.....	19.2	80.7	15.51	3.69			67.....	19.5	97.0	14.73	1.73		
27.....	17.1	63.5	12.38	4.73			68.....	18.1	73.4	14.29	3.18		
28.....	19.8	88.2	16.53	3.15			69.....	18.2	83.1	13.23	4.96		
29.....	21.5	115.4	11.06	8.35	2.09		70.....	17.7	63.3	13.48	4.21		
30.....	19.1	77.4	15.28	3.82			71.....	17.6	70.2	15.84	1.76		
31.....	16.6	51.2	11.80	4.79			72.....	17.8	77.0	13.45	4.45		
32.....	23.6	150.6	16.48	5.24	1.87		73.....	16.3	54.8	11.15	5.15		
33.....	16.4	46.1	14.21	2.19			74.....	18.5	77.5	13.70	4.82		
34.....	16.8	60.3	10.50	3.97	2.33		75.....	18.0	67.8	12.24	4.32	1.44	
35.....	17.0	56.7	8.09	7.69	1.21		76.....	16.6	55.7	10.38	6.23		
36.....	13.6	74.5	13.66	4.94			77.....	18.4	71.6	11.50	6.90		
37.....	15.7	42.5	13.08	1.62			78.....	18.5	77.8	16.32	2.18		
38.....	18.5	72.1	17.13	2.35			79.....	25.8	205.5	10.32	10.32	5.16	
39.....	22.7	132.9	15.45	5.52	1.09		Average..			12.8	3.85	2.86	
40.....	18.4	76.2	11.67	6.73									
41.....	19.4	92.8	12.56	6.82									

^a Figures in these columns represent amount added for the respective years; the total length for any year may be found by adding the increment for one year to the preceding total.

TABLE 9.—PIGFISH.—COMPARING THE AVERAGE LENGTHS MEASURED FOR THE DIFFERENT YEAR GROUPS WITH THE LENGTHS CALCULATED, AND THE NUMBER OF SPECIMENS MEASURED AND CALCULATED IN EACH CASE.

Year.	Length.		Number of fish.	
	Measured.	Calculated.	Measured.	Calculated.
	<i>cm.</i>	<i>cm.</i>		
1.....	13.1	12.8	77	78
2.....	17.8	16.7	58	78
3.....	21.3	19.5	20	17
4.....	25.5	25.5	1	1
Total	156	174

SYNONYMY OF TERMS.

Owing to the great number of terms applied to the different structures of scales and the confusion resulting from it, this synonymy has been arranged to specify the terms employed in this paper.

The exterior surface of scales is marked with numerous, more or less distinct relieved lines, concentric, or nearly so, in most cases, with the periphery. They are variously known as *annuli* (Esdaile), *circuli* (Cockerell), *striæ*, *fibrillæ*, concentric rings, and growth-rings. Such lines are here denoted as *circuli*. (Pl. I, C.)

For their common center, usually somewhat posterior to the center of the scale, the term *focus* adopted by Cockerell is used in this paper. It has also been called the center, *centrum*, center of growth, and *nucleus*. (Pl. I, F.)

Concentric with the *circuli* are bands or zones, which are here denominated *annuli*. They are darker than the space between them and have been regarded as zones in which the *circuli* are closer together. They appear in some cases to be regions in which the regularity of the *circuli* is interrupted. They are variously known as *annuli*, *peronidia*, annual rings, winter bands, and growth-rings. (Pl. I, A.)

Radii, as they are called in this paper, are lines found usually on the anterior side of the scale, perpendicular to the *circuli*, directed from the focus to the periphery and usually increasing in number as the latter is approached. They have been known as grooves, radiating grooves, and *radii*. (Pl. I, R.)

The outer edge of the scale is called in this and other papers the *periphery*. It has been called the margin. (Pl. I, P.)

In some scales the posterior field is found to be covered with spines, barbs, or teeth. The author uses the term *spines* for these. They have been called denticles, spinules, and teeth. (Pl. I, Sp.)

A scale may be divided into four areas or fields. They are referred to in this paper as the *anterior field* or that portion covered in the scale pocket and directed toward the head of the fish; the *posterior field* or that part opposite the anterior field and in ctenoid scales covered with spines; and the *lateral fields* or those on either side of the scale. In connection with areas of the scale surface the words apical and basal have been used for posterior and anterior, respectively.

The *inferior* side is that nearest the body. The *exterior* or superior side is the sculptured side.

BIBLIOGRAPHY.

AGASSIZ, LOUIS.

1834. Recherches sur les poissons fossiles. 1833-1843. 2^e livraison, t. 1, p. 68-80. Neuchâtel.
1840a. Remarques sur la structure des écailles des poissons; extrait d'une lettre de M. Agassiz adressée à l'Académie des Sciences dans sa séance du 3 février, 1840. Annales des Sciences Naturelles, 2^e sér., t. XIII, p. 59-61. Paris.
1840b. Observations sur la structure et le mode d'accroissement des écailles des poissons, et réfutation des objections de M. Mandl. Annales des Sciences Naturelles, 2^e sér., t. XIV, p. 97-110. Paris.

ARWIDSSON, IVAR.

1910. Zur Kenntnis der Lebensgeschichte der jungen Lachse in den Flüssen vor der Hinabwanderung ins Meer. Conseil Permanent International pour l'Exploration de la Mer. Publications de Circonstance no. 54, 86 p., 4 taf. Copenhagen.

BAUDELLOT, E.

1873. Recherches sur la structure et le développement des écailles des poissons osseux. Archives de Zoologie Expérimentale et Générale, t. II, p. 37-244 et 427-480. Paris.

BLANCHARD, ÉMILE.

1866. Les poissons des eaux douces de la France. 656 p., illus. Paris.

BROWN, A. WALLACE.

1904. Some observations on the young scales of the cod, haddock, and whiting before shedding. Proceedings, Royal Society of Edinburgh, vol. XXIV for 1901-1903, p. 437-438. Edinburgh.

CALDERWOOD, W. L.

1911. Infrequency of spawning in the salmon as shown by the study of the scales of fish caught in fresh water. Fishery Board for Scotland. Salmon Fisheries, 1910, no. I, II, III; III pl. London.
1914. The spawning mark on salmon scales; a review (with plate). Fishery Board for Scotland. Salmon Fisheries, 1913, no. III, p. 21-26. Edinburgh.

CARLET, G.

1878. Mémoire sur les écailles des poissons téléostéens. Annales des Sciences Naturelles, VI^e, sér., t. VIII, no. 4, 19 p., 9 fig. Paris.

COCKERELL, T. D. A.

1910. On the scales of some Malacopterygian fishes. Proceedings, Biological Society of Washington, vol. XXIII, p. 111-114. Washington.
1911. The scales of fresh-water fishes. Biological Bulletin, Marine Biological Laboratory, Woods Hole, Mass., vol. XX, no. 6, p. 367-376. Woods Hole.
1913a. Observations on fish scales. Bulletin, U. S. Bureau of Fisheries, vol. XXXII, 1912, p. 117-174, pl. XXXII-XL. Washington.
1913b. The scales of some Queensland fishes. Memoirs of the Queensland Museum, vol. II, p. 51-59. Brisbane.
1915a. The scales of some Australian fishes. Memoirs of the Queensland Museum, vol. III, p. 35-56. Brisbane.
1915b. Scales of Panama fishes. Proceedings, Biological Society of Washington, vol. XXVIII, p. 151-160. Washington.

COCKERELL, T. D. A. and CALLAWAY, OTIS.

1909. Observations of the genus *Notropis*. Proceedings, Biological Society of Washington, vol. XXII, p. 189-196. Washington.

COCKERELL, T. D. A. and MOORE, EVELYN B.

1910. On the nature of the teeth in ctenoid scales. Proceedings, Biological Society of Washington, vol. XXIII, p. 91-94. Washington.

DAHL, KNUT.

1909. The assessment of age and growth in fish. *International Revue der Gesamten Hydrobiologie und Hydrographie*, bd. II, nr. 4 und 5, p. 758-769, 6 text fig. Leipzig.
1911. The age and growth of salmon and trout in Norway as shown by their scales. (Translated from Norwegian by Ian Baille.) *Salmon Trout and Association*, [1911] 141 p., x pl., 32 text fig. London.

DELSMAN, H. C.

1914. Über das Wachstum von Nordseehering und Zuiderseehering nach Untersuchungen an den Schuppen. *In* Rapporten en Verhandelingen Uitgegeven door het Rijksinstituut voor Visscherijonderzoek, deel I, afl. 2. 'S-Gravenhage.

ESDALE, PHILIPPA C.

1912. Intensive study of the scales of three specimens of *Salmo salar*. *Memoirs and proceedings, Manchester Literary and Philosophical Society*, 1911-1912, vol. 56, pt. I, memoir III, 22 p., 1 pl., 5 diagrams, 4 graphs. Manchester.
1913. The scientific results of the salmon scale research at Manchester University. *Memoirs and proceedings, Manchester Literary and Philosophical Society*, 1912-1913, vol. 57, pt. I, memoir III, 32 p., 10 graphs. London.

EVANS, ARTHUR T.

1915. A study of the scales of some of the fishes of the Douglas Lake region. *Transactions of the American Microscopical Society*, vol. xxxiv, p. 255-268. Decatur.

FRYD, CARLOS.

1901. Die Otolithen der Fische in Bezug auf ihre Bedeutung für Systematik und Altersbestimmung. *Inaugural-dissertation*. 54 p. Altona.

GARSTANG, WALTER.

1898. On the variations, races, and migrations of the mackerel (*Scomber scomber*). *Journal, Marine Biological Association of the United Kingdom (n. s.)*, vol. v, no. 3, 1897-99, p. 235-295. Plymouth.

GEMZOË, K. J.

1908. Age and rate of growth of the eel. *Report, Danish Biological Station*, vol. xiv, 1906, p. 10-39, 15 tables. Copenhagen.

GILBERT, C. H.

1913. Age at maturity of the Pacific coast salmon of the genus *Oncorhynchus*. *Bulletin, U. S. Bureau of Fisheries*, vol. xxxii, 1912, p. 1-22, xvii pl. Washington.
1914. Contributions to the life history of the sockeye salmon. (No. 1.) Province of British Columbia. *Report of Commissioner of Fisheries for 1913*, p. 53-78. Victoria.

GREEN, ERIK H. and TOWER, RALPH W.

1902. The organic constituents of the scales of fish. *Bulletin, U. S. Fish Commission*, vol. xxi for 1901, p. 97-102. Washington.

HAEMPEL, O.

1910. Über das Wachstum des Huchens (*Salmo hucho* L.) *International Revue der Gesamten Hydrobiologie und Hydrographie*, bd. III, nr. 1 und 2, p. 136-154, taf. II-IV. Leipzig.

HEINCKE, FR.

1905. The occurrence and distribution of the eggs, larvæ and various age groups of the food fishes in the North Sea. [Translated from the German by H. M. Kyle.] *Conseil Permanent International pour l'Exploration de la Mer. Rapports et Procès-Verbaux*, vol. III, Appendix E, 39 p. Copenhagen.
1908. Bericht über die Untersuchungen der Biologischen Anstalt auf Helgoland zur Naturgeschichte der Nutzfische (1 April, 1905 bis 1 Oktober, 1907). II. Die Altersbestimmung der Fische. p. 93-102. *In* Die Beteiligung Deutschlands an der Internationalen Meerforschung. IV/v Jahresbericht. Berlin.

HENNAH, T. H.

1873. On the scales of fish. *Brighton and Sussex Natural History Society. Twentieth annual report and abstract of proceedings*, p. 55-57. Brighton.

HERTWIG, O.

- 1876, 1879, 1882. Über das Hautskelet der Fische. Morphologisches Jahrbuch, bd. II, p. 328-395, taf. xxiii-xxviii, 1876; bd. V, p. 1-22, taf. I-III, 1879; bd. VII, p. 1-42, taf. I-IV. 1882. Leipzig.

HJORT, JOHAN.

1914. Fluctuations in the great fisheries of northern Europe viewed in the light of biological research. Conseil Permanent International pour l'Exploration de la Mer. Rapports et Procès-Verbaux, vol. XX, 288 p., illus., III pl. Copenhagen.

HJORT, JOHAN, and LEA, EINAR.

1911. Report on the International herring investigation during the year 1910. Conseil Permanent International pour l'Exploration de la Mer. Publications de Circonstance, no. 61, 57 p., illus. Copenhagen.

HOEK, P. P. C.

1909. On the age of salmon to be derived from the structure of the scales. Koninklijke Akademie van Wetenschappen te Amsterdam. Proceedings of the meeting (English edition), vol. XII, p. 485-502. Amsterdam.

HOFFBAUER, C.

- 1898, 1900. Die Altersbestimmung des Karpfen an seiner Schuppe. Allgemeine Fischerei-Zeitung, Jahrg. XXIII, 1898, p. 341-343; Jahrg. XXV, 1900, p. 135-139; p. 150-156; p. 297. München.

HOLT, E. W. L.

1899. North Sea investigations. [VII. On a dwarf variety of the plaice (*Pleuronectes platessa*, Linn.), with some remarks on the occasional ciliation of the scales in that species.] Journal, Marine Biological Association of the United Kingdom (n. s.), vol. III, p. 194-200. Plymouth.

HUTTON, J. ARTHUR.

1909. Salmon scales as indicative of the life history of the fish. 27 p., XIV pl. London.
 1910. Salmon scale examination and its practical utility, with notes on the Wye salmon fisheries and the photography of scales. 56 p., XXXII pl. London.
 1913. Wye salmon. Results of scale reading, 1908 to 1912. Salmon and Trout Magazine, no. 5, p. 14-39. London.
 1914a. Wye salmon. Results of scale reading, 1909 to 1913. Salmon and Trout Magazine, no. 7, 44 p., 4 pl. London.
 1914b. Recent investigations upon the life history of the salmon by the Board of Agriculture and Fisheries. Salmon and Trout Magazine, no. 7, 28 p. London.
 1914c. The spawning mark on Wye salmon. Salmon and Trout Magazine, no. 6, p. 13-21. London.
 1915. The mortality of male salmon. Knowledge, vol. XXXVIII, p. 283. London.

IMMERMANN, F.

1908. Beiträge zur Altersbestimmung der Fische: II. Die innere Struktur des Schollen-Otolithen. Wissenschaftliche Meeresuntersuchungen herausgegeben von der Kommission zur Untersuchung der deutschen Meere, n. f., bd. VIII, abt. Helgoland, p. 129-176, taf. 4-8, 10 abbild. Kiel.

IVOY, PAULZE D'.

1912. Étude scientifique des écailles de six saumons français. Bulletin de la Société Centrale d'Aquiculture et de Pêche, t. XXIV, no. 2, p. 17-20. Paris.

JENEINS, J. T.

1902. Altersbestimmung durch Otolithen bei den Clupeiden. Wissenschaftliche Meeresuntersuchungen herausgegeben von der Kommission zur Untersuchung der deutschen Meere, n. f., bd. VI, abt. Helgoland, p. 81-122. Kiel.

JENKINSON, J. W.

- 1911-1912. Growth, variability and correlation in young trout. Biometrika, vol. VIII, p. 444-455. Cambridge.

JOHNSTON, H. W.

1905. Scales of the Tay salmon as indicative of age, growth, and spawning habit. Fishery Board for Scotland, annual report 23, pt. II, p. 63-79. Glasgow.
 1906, 1907, 1909. The scales of salmon. Fishery Board for Scotland, annual reports, 25, pt. II, p. 54-66, v pl., 1906; 26, pt. II, p. 62-64, I pl., 1907; 28, pt. II, p. 21-24, pl. I, 1909. Glasgow.

KLAATSCH, H.

1890. Zur Morphologie der Fischschuppen und zur Geschichte der Hartschubstanzgewebe. Morphologisches Jahrbuch, bd. xvi, p. 209-258, pl. vi und vii. Leipzig.
1894. Über die Herkunft der Skleroblasten. Ein Beitrag zur Lehre von der Osteogenese. Morphologisches Jahrbuch, bd. xxi, p. 153-240, 5 abbild., ix taf. Leipzig.

KUNTZMANN.

1824. Bemerkungen über die Schuppen der Fische. Verhandlungen der Gesellschaft naturforschender Freunde in Berlin, bd. I, p. 269-284, taf. xi, xii, xiii. Berlin.

LEA, EINAR.

1910. On the methods used in the herring investigations. Conseil Permanent International pour l'Exploration de la Mer. Publications de Circonstance, no. 53, p. 7-174. Copenhagen.
1911. A study on the growth of herrings. Conseil Permanent International pour l'Exploration de la Mer. Publications de Circonstance, no. 61, p. 35-64. Copenhagen.
1913. Further studies concerning the methods of calculating the growth of herrings. Conseil Permanent International pour l'Exploration de la Mer. Publications de Circonstance, no. 66, 36 p. Copenhagen.

LEE, ROSA M.

1912. An investigation into the methods of growth determination in fishes. Conseil Permanent International pour l'Exploration de la Mer. Publications de Circonstance no. 63, 34 p. Copenhagen.

LEYDIG, FRANZ.

1851. Über die Haut einiger Süßwasserfische. Zeitschrift für Wissenschaftliche Zoologie, bd. iii, p. 1-12. Leipzig.

McMURRICH, J. PLAYFAIR.

1912. The life cycles of the Pacific coast salmon belonging to the genus *Oncorhynchus* as revealed by their otolith and scale markings. Proceedings and transactions, Royal Society of Canada, sr. 3, vol. vi, sec. iv, p. 9-28, x pl. Ottawa.
- 1913a. Some further observations on the life histories of the Pacific coast salmon as revealed by their scale markings. Proceedings and transactions, Royal Society of Canada, sr. 3, vol. vii, sec. iv, p. 23-32, iii pl. Ottawa.
- 1913b. Notes on the scale markings of the halibut and their bearing on questions connected with the conservation of the fishery. Proceedings and transactions, Royal Society of Canada, sr. 3, vol. vii, sec. iv, p. 33-41, iii pl. Ottawa.

MAIER, H. N.

1906. Beiträge zur Altersbestimmung der Fische. I. Allgemeines. Die Altersbestimmung nach den Otolithen bei Scholle und Kabeljau. Wissenschaftliche Meeresuntersuchungen herausgegeben von der Kommission zur Untersuchung der deutschen Meere, n. f., bd. viii, abt. Helgoland, p. 57-115, II taf., 31 abbild. Kiel.

MANDL, L.

1839. Recherches sur la structure intime des écailles des poissons. Annales des Sciences Naturelles, 2^e sér., t. xi. Zoologie, p. 337-371. Paris.
1840. Nouvelles observations sur la structure des écailles des poissons, extrait d'une lettre de M. Mandl à l'Académie des Sciences (séance du 24 février, 1840), à l'occasion des remarques de M. Agassiz. Annales des Sciences Naturelles, 2^e sér., t. xiii. Zoologie, p. 62-63. Paris.

MASTERMAN, A. T.

- 1913a. Report on investigations upon the salmon with special reference to age determination by study of scales. Board of Agriculture and Fisheries. Fishery investigations, sr. I. Salmon and fresh-water fisheries, vol. I, p. I-III, IV pl. London.
- 1913b. Report on investigations upon the smelt (*Osmerus eperlanus*) with special reference to age determination by study of scales and its bearing upon sexual maturity. Board of Agriculture and Fisheries. Fishery investigations, sr. I. Salmon and fresh-water fisheries, vol. I, p. 113-126, II pl. London.

MENZIES, W. J. M., JR.

1912. The infrequency of spawning in the salmon. Fishery Board for Scotland. Salmon Fisheries, 1911, no. 1, 7 p., II pl. London.

1913. Scales of salmon of the River Add. Fishery Board for Scotland. Salmon Fisheries, 1912, no. 1, 6 p., III pl. London.

MIESCHER-RUESCH, F.

1880. Statistische und biologische Beiträge zur Kenntniss vom Leben des Rheinlaches im Süswasser. Internationale Fischerei-Ausstellung zu Berlin 1880. Schweiz. II. Ichthyologische Mittheilungen aus der Schweiz. p. 154-231. Leipzig.

MILNE, JOHN ADAM.

1913. Pacific salmon: An attempt to evolve something of their history from an examination of their scales. Proceedings, Zoological Society of London, 1913, p. 572-610, 24 text fig. London.

MÖRNER, C. TH.

1898. Die organische Grundsubstanz der Fischschuppen vom Chemischen Gesichtspunkte als betrachtet. Zeitschrift für Physiologische Chemie, bd. XXIV, p. 125. Strassburg.

NICKERSON, W. S.

1893. The development of the scales of *Lepidosteus*. Bulletin, Museum of Comparative Zoology at Harvard College, vol. XXIV, no. 5, p. 115-139, IV pl. Cambridge.

NUSBAUM, JÓZEF.

1907. Materialien zur vergleichenden Histologie der Hautdecke der Wirbeltiere. III. Zur Histogenese der Lederhaut und der Cycloid-Schuppen der Knochenfische. Anatomischer Anzeiger, bd. XXX, p. 297-310, 10 abbild. Jena.

PETERS, W.

1841. Bericht über den microscopischen Bau der Fischschuppen. Muller's Archiv für Anatomie, Physiologie und Wissenschaftliche Medecin, Jahrg. 1841, p. cccix. Berlin.

REIBISCH, J.

1899. Über die Eizahl bei *Pleuronectes platessa* und die Altersbestimmung dieser Form aus den Otolithen. Wissenschaftliche Meeresuntersuchungen herausgegeben von der Kommission zur Untersuchung der deutschen Meere, n. f., bd. IV, abt. Kiel, p. 233-248, taf. Kiel.

1908. Ein Dicken-Koeffizient als Mass für Alter und Ernährungszustand der Fische. In Die Beteiligung Deutschlands an der Internationalen Meeresforschung, IV/v Jahresbericht, p. 59-65. Berlin.

RYDER, JOHN A.

1893. On the mechanical genesis of the scales of fishes. Proceedings, Academy of Natural Sciences of Philadelphia, sr. 3, 1892, p. 219-244, 3 text fig. Philadelphia.

SALBEY, R.

1868. Über die Structur und das Wachstum der Fischschuppen. Archiv für Anatomie, Physiologie und Wissenschaftliche Medicin, Jahrg. 1868, p. 729-749, pl. XVII. Leipzig.

SALOMON, K.

1908. Zur Altersbestimmung des Huchens. Österreichische Fischerei-Zeitung, jahrg. v, nr. 16, p. 265-266. Wien.

SCHNEIDER, GUIDO.

1909. Über des Wachstum der Aale (*Anguilla vulgaris* Flem.) in den Gewässern Schwedens. Conseil Permanent International pour l'Exploration de la Mer. Publications de Circonsance, no. 46, 18 p., 1 text fig. Copenhagen.

SCOTT, WILL.

1912. The regenerated scales of *Fundulus heteroclitus* Linné, with a preliminary note on their formation. Proceedings, Indiana Academy of Science, 1911, p. 439-444. Indianapolis.

SHANN, EDWARD.

1910. Some notes on the life history and rate of growth in *Gobius minutus*. Annals and Magazine of Natural History, sr. 8, vol. v, no. 27, p. 217, pl. IX, X. London.

SMITH, H. HAMMOND.

1913. The value of the spawning mark. Salmon and Trout Magazine, no. 5, p. 59-62, illus. London.

STEENSTRUP, J.

1861. Sur la différence entre les poissons osseux et les poissons cartilagineux au point de vue de la formation des écailles. *Annales des Sciences Naturelles*, 4^e sér., t. xv, Zoologie, p. 368. Paris.

TIMS, H. W. MARETT.

1902. On the structure of the scales in the cod. Report, British Association for the Advancement of Science ... Belfast ... 1902, p. 660-661. London.
1906. The development, structure, and morphology of the scales in some teleostean fish. *Quarterly Journal of Microscopical Science*, vol. XLIX, p. 39-68, pl. vi. London.

THOMPSON, WILLIAM F.

1915. A preliminary report on the life-history of the halibut. Province of British Columbia. Report, Commissioner of Fisheries for year ending December 31, 1914. p. 76-120. Victoria.

THOMSON, J. STUART.

1902. The periodic growth of scales in *Gadidæ* and *Pleuronectidæ* as an index of age. *Journal, Marine Biological Association of the United Kingdom* (n. s.), vol. vi, p. 373-375, 1 pl. Plymouth.
1904. The periodic growth of scales in *Gadidæ* as an index of age. *Journal, Marine Biological Association of the United Kingdom* (n. s.), vol. vii, p. 1-109. Plymouth.

TUCKER, HENRY.

1911. Scale variation in *Stilosoma extenuatum*. *Proceedings, Academy of Natural Sciences of Philadelphia*, sr. 2, vol. 63, p. 549-550, 2 fig. Philadelphia.

USSOW, S. A.

1897. Die Entwicklung der Cycloid-Schuppe der Teleostier. *Bulletin de la Société Impériale des Naturalistes de Moscou*, 1897, p. 339-354, taf. vi u. vii. Moscou.

VOGT, C.

- 1842, 1845. *Histoire naturelle des poissons d'eau douce de l'Europe centrale*; par L. Agassiz ... Neuchâtel, 1839-1845, t. i. Embryologie des *Salmones* par C. Vogt. 1842. 2. livr. [pt. 2] L'anatomie des *Salmones*, par L. Agassiz & C. Vogt. (*Mémoires de la Société des Sciences Naturelles de Neuchâtel*, t. iii.) p. 147-148. Neuchâtel.

WALLACE, WILLIAM.

1907. Report on the age and growth rate of the plaice in the southern North Sea as determined by the investigation of otoliths. *Marine Biological Association, International fishery investigations, report II* (southern area), 1904-1905, pt. I, p. 1-47, v pl. London.
1909. Report on the size and age of the plaice at maturity in the North Sea and English Channel. *Marine Biological Association, International fishery investigations, report II* (southern area), 1904-1905, pt. II, p. 51-88, 1 chart. London.
1911. Further report on the age and growth rate of the plaice in the North Sea and English Channel as determined by the investigations of otoliths. *North Sea Investigation Committee, report III* (southern area), 1906-1908, p. 109-175, 10 text fig., 1 chart, 14 tables. London.

WALTER, E.

1901. Altersbestimmung der Karpfen nach der Schuppe. *In: Knauthe, Die Karpfenzucht*, p. 88-122. Neudamm.

WEISKE, H.

1883. Über die Zusammensetzung von Fischschuppen und Fischknochen. *Zeitschrift für Physiologische Chemie*, bd. vii, 1882-83, p. 466-473. Strassburg.

WILLIAMSON, W. C.

1849. On the microscopic structure of the scales and dermal teeth of some ganoid and placoid fish. *Philosophical transactions, Royal Society of London*, vol. CXXXIX, pt. II, p. 435-476 London.

WINGE, O.

1915. On the value of the rings in the scales of the cod as a means of age determination. Illustrated by marking experiments. *Meddelelser fra Kommission for Havundersøgelser, serie Fiskeri*, bd. iv, 21 p., 1 pl. København.

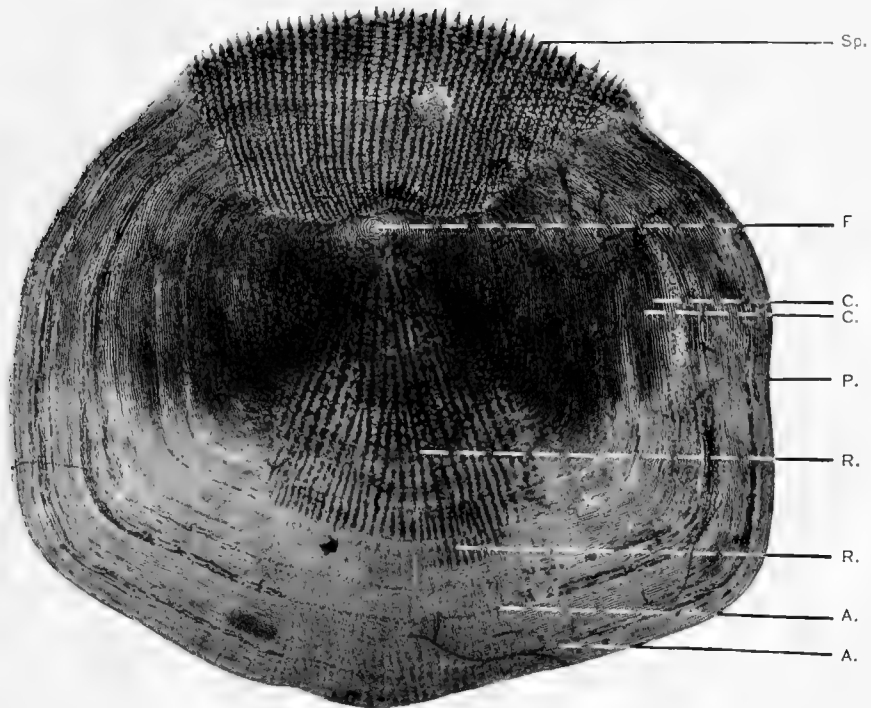

FIG. 1.—*Cynoscion regalis*. Typical scale showing all the terms used in this paper: F, focus; C, circuli; P, periphery; R, radii; A, annuli; Sp., spines. $\times 10$.





FIG. 2.—*Cynoscion regalis*. Regenerated scale showing unusually large focus marked with fine sculpturing. $\times 12$.

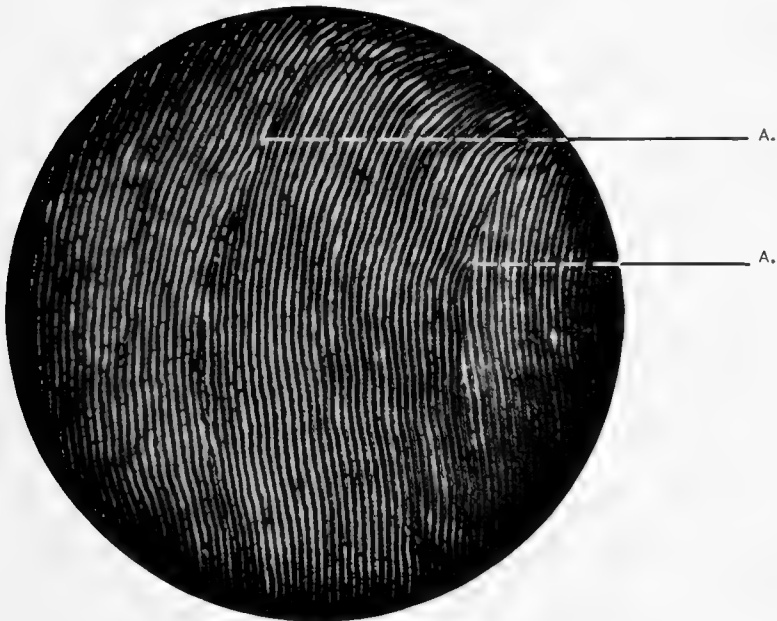

FIG. 3.—*Cynoscion regalis*. Photomicrograph of two annuli, A, showing that the annuli are not in reality bands in which the circuli are closer together. $\times 40$.



FIG. 4.—Scale taken from the head of the fish directly above the eye and slightly off the median line. $\times 12$.



FIG. 5.—Scale taken from above the eye and on the median line. $\times 14$.



FIG. 6.—Scale taken from check. $\times 14$.

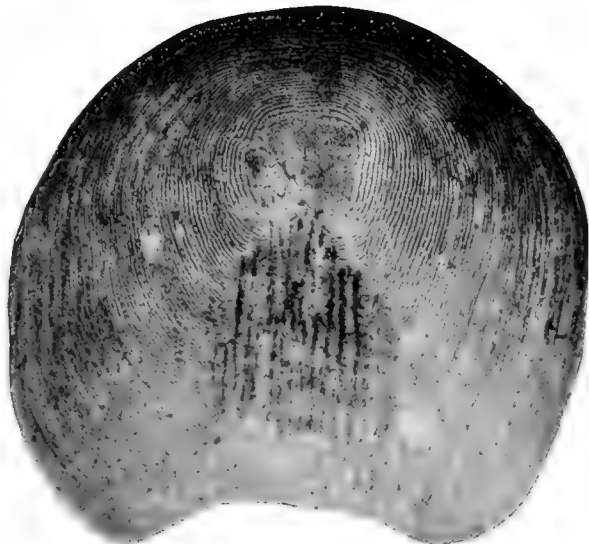

FIG. 7.—Scale taken from posterior base of the dorsal fin. $\times 14$.

Cynoscion regalis.—Scales taken from different parts of the body showing the influence of movement and shape on the presence and number of radii.



FIG. 8.—Scale taken from side of vent. X 12.



FIG. 9.—Scale taken from point near the vent. X 12.



FIG. 10.—Scale taken from side of vent. X 12.



FIG. 11.—Scale taken from point near the vent. X 10.

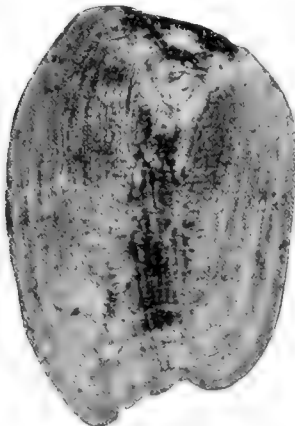

FIG. 12.—Scale taken from slightly below the anterior base of the dorsal fin. X 10.



FIG. 13.—Scale taken from base of first dorsal fin on median line. X 10.



FIG. 14.—Cross section of scale bent to show opening of radii. X 40.

Cynoscion regalis.—Scales taken from different parts of the body showing the influence of movement of the fish and shape of the scale on the presence and number of radii.



FIG. 15.—Scale showing the diminution of the number of radii after the third year. $\times 12$.



FIG. 16.—Scale taken from anterior base of caudal fin. $\times 14$.

Cynoscion regalis.—Scales taken from different parts of the body showing the influence of movement of the fish and shape of the scale on the presence and number of radii.



FIG. 17.—*Cynoscion regalis*. Scale from a fish beginning its second year. $\times 15$.

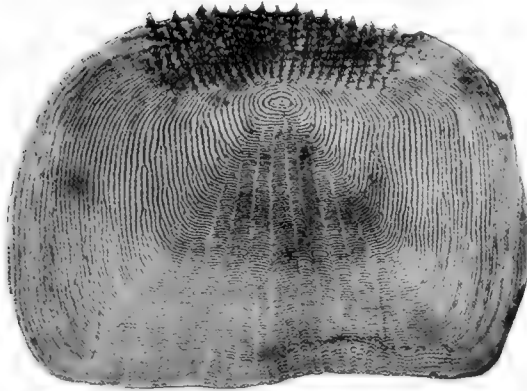

FIG. 18.—*Cynoscion regalis*. Scale from a fish beginning its third year. $\times 14$.



FIG. 19.—*Cynoscion regalis*. Scale from a fish beginning its fourth year. $\times 12$.

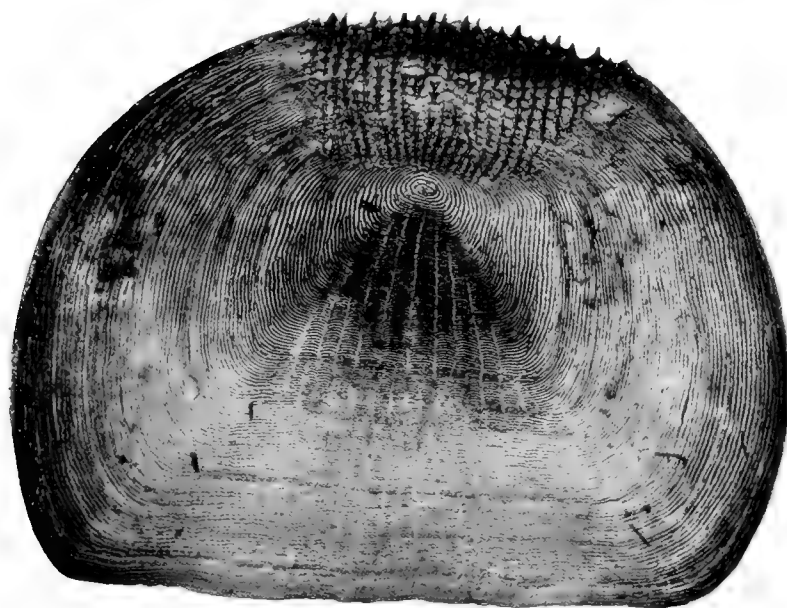

FIG. 20.—*Cynoscion regalis*. Scale from a fish beginning its fifth year. $\times 12$.



FIG. 21.—*Cynoscion regalis*. Scale from a fish beginning its sixth year. $\times 10$.

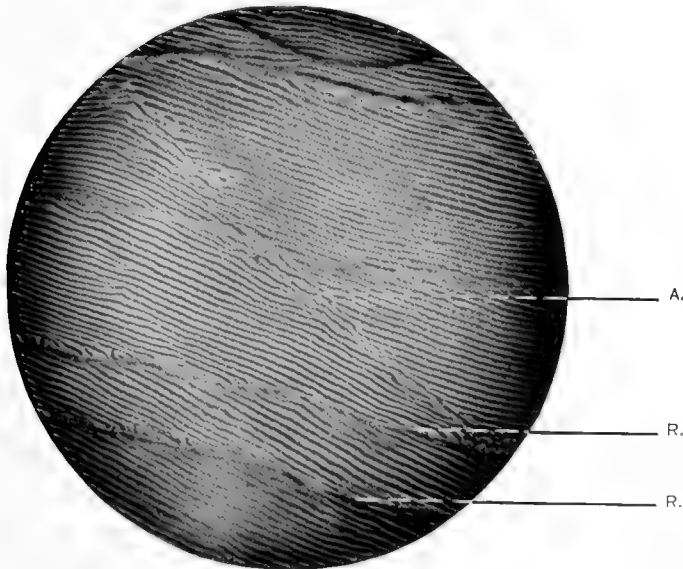

FIG. 22.—*Pomolobus mediocris*. Showing annulus crossing circuli. A, annulus; R, radii. $\times 40$.

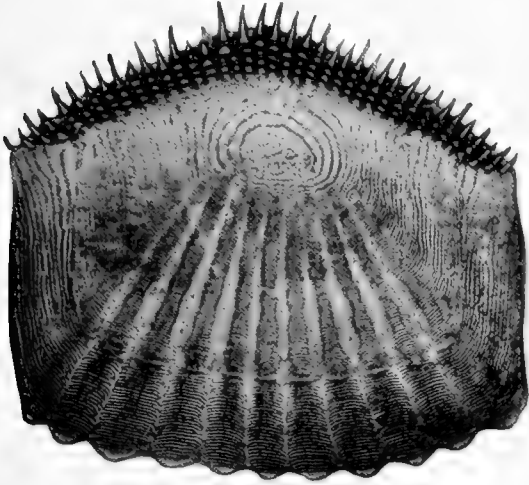

FIG. 23.—*Orthopristis chryopterus*. Scale from a fish 1 year old. $\times 35$.

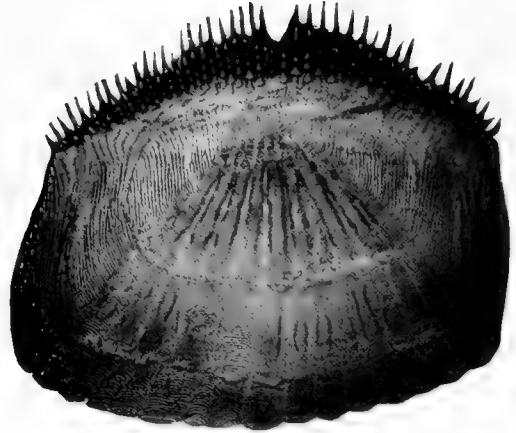

FIG. 24.—*Orthopristis chryopterus*. Scale from a fish 2 years old. $\times 12$.

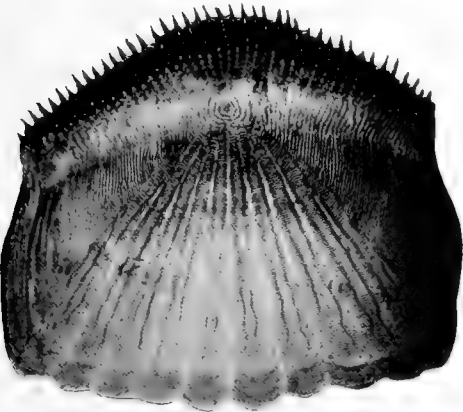

FIG. 25.—*Orthopristis chryopterus*. Scale from a well-fed fish in aquarium no. 1. $\times 12$. (See table 7.)

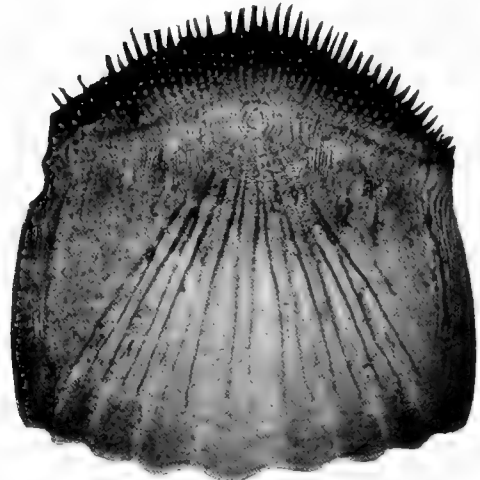

FIG. 26.—*Orthopristis chryopterus*. Scale from a sparingly fed fish in aquarium no. 2. $\times 12$.

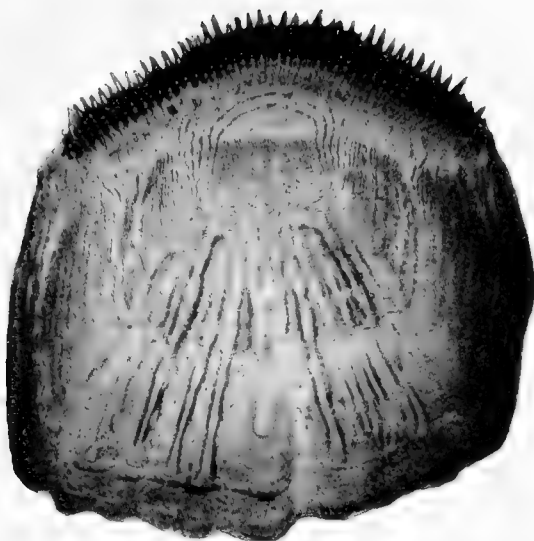

FIG. 27.—*Orthopristis chrysopterus*. Scale from a fish 4 years old. $\times 12$.

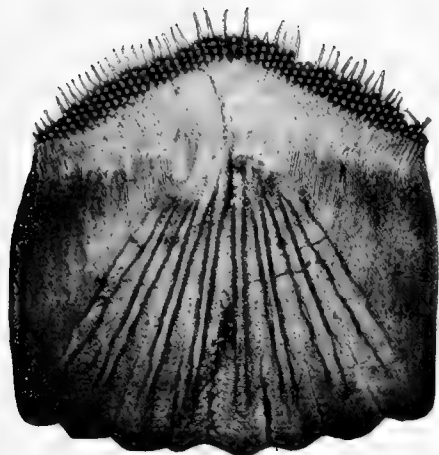

FIG. 28.—*Orthopristis chrysopterus*. Scale from a fish 14 cm. long but with no annuli. $\times 12$.

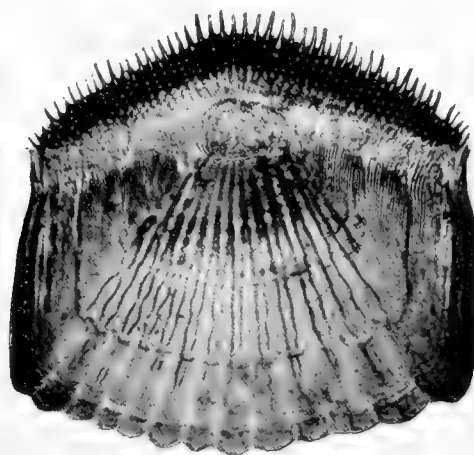

FIG. 29.—*Orthopristis chrysopterus*. Scale from a fish 3 years old. $\times 12$.

COPEPOD PARASITES OF FRESH-WATER FISHES AND THEIR
ECONOMIC RELATIONS TO MUSSEL GLOCHIDIA



By Charles Branch Wilson, Ph. D.
State Normal School, Westfield, Massachusetts



Contribution from the United States Fisheries Biological Station, Fairport, Iowa

COPEPOD PARASITES OF FRESH-WATER FISHES AND THEIR ECONOMIC RELATIONS TO MUSSEL GLOCHIDIA.

By CHARLES BRANCH WILSON, Ph. D.
State Normal School, Westfield, Massachusetts.

Contribution from the United States Fisheries Biological Station, Fairport, Iowa.

INTRODUCTION.

Under an appointment by the Commissioner of Fisheries, during the summer of 1914, at the United States Fisheries biological station at Fairport, Iowa, an extended examination was made of the parasitic copepods which infest our fresh-water fishes in the Mississippi River and its tributaries and of the mussel glochidia which are also parasitic upon fish during their term of metamorphosis. Several of the early American naturalists became interested in the copepods found upon fresh-water fish, and many new species were described. This was especially true of Le Sueur and Dana, and singularly enough the Danish investigator, Krøyer, also obtained a number of American species from fish sent to the Copenhagen Museum. But in every instance the species described were isolated, they were sometimes founded upon single specimens, and many of them have never been seen since their original discovery.

Prof. S. I. Smith published in the Report of the United States Commissioner of Fish and Fisheries for 1872-73 a list of the crustacean parasites of the fresh-water fishes of the United States (p. 661-665). This list included two argulids, one caligid, one ergasilid, six lernæopods, three of which were new to science, and two lernæans, 12 species in all. With true scientific foresight, Prof. Smith stated that the few species he enumerated were "doubtless only a small fraction of those which really prey upon our common fishes," and that his principal object was to "call attention to the subject and furnish a basis for future investigation" (p. 661). But his suggestion did not meet with the response it deserved and beyond the investigations of Smith himself, Packard, Kellcott, Wright, Fasten, and a few others, all widely scattered, no attempt has been made to increase the list up to the time of the present investigation.

About 1895 Mr. R. R. Gurley, at that time in the employ of the United States Bureau of Fisheries, gathered together all the available data with reference to the copepods parasitic upon fresh-water fishes, translating the descriptions given by Krøyer and other foreign investigators and identifying both hosts and parasites amongst the material in possession of the Bureau. He made no attempt to establish new species, but only to bring together all that had been previously described, and he accumulated

a manuscript of about 150 pages, which was subsequently turned over to the present author. This has proved of great value on other occasions as well as the present, and Gurley's original identifications and additions to the work of previous authors are acknowledged in the following pages.

The specimens and other material were derived from several sources. First, the work of the biological station involves the handling of large numbers of fish, and several of the regular staff, notably Mr. H. W. Clark, Mr. T. Surber, and Dr. A. D. Howard, have saved such parasitic copepods as they found while examining the gills for glochidia. These were generously turned over to the present author, who had also accumulated a large number of specimens during the surveys of the mussel fauna of various regions of the United States under the auspices of the Bureau of Fisheries.

These collections were augmented during the present investigations by a careful examination of all the preserved gills of fish in the possession of the biological station, of the gills of live fish caught by the regular seining crew or brought to the station for glochidial infection, and of a large number of dead fish caught by local fishermen.

In these different ways, and including chiefly the waters of the Mississippi Valley, the original list has been increased to 46 species, 10 of which are new to science; 1 of Krøyer's and 1 of Le Sueur's species have been rediscovered, and there have been added the larvæ of 4 other species in various stages of development.

During the investigation it early became apparent that certain economic relations existed between the copepod parasites and the mussel glochidia, which are also parasitic on fish. Although the broad fact that parasitized fish do not take or hold glochidia as well as the nonparasitized ones was observed early in the work at the station, nevertheless the existence of particular mutual relations between copepods and glochidia had never been suspected. Of all the authors above mentioned Fasten is the only one who has ever treated the copepods from an economic standpoint, and his excellent papers deal chiefly with the artificial propagation of a single species. It is at once evident, however, that the interrelations between the fish and the two kinds of parasites must exert considerable influence upon the artificial propagation of mussels, as well as upon an intelligent study of the parasitism of the copepods. Accordingly these economical discussions are placed first in the present paper, and the description of the species is left until the last.

RELATIONS BETWEEN THE COPEPODS AND THEIR HOSTS.

As has elsewhere been stated, both by the present author (Proceedings of United States National Museum, vol. 25, p. 654) and by other investigators, it is not probable that the copepod parasites of fresh-water fishes become under natural conditions a serious menace to the life of their host. But it must be remembered that their presence upon the fish is always injurious to the latter and can never be beneficial nor even indifferent.

1. There is a notion prevalent in certain quarters that a limited amount of dirt and vermin is wholesome rather than harmful. It is needless to say that this is erroneous, and that there is no truth also in the idea that a few of these creatures do their host no real harm, but that a considerable number must be present in order to become really injurious. Even a single parasite withdraws from its host enough blood for its own

sustenance. That amount may be small, but it is nevertheless a loss, and it weakens the fish's vitality by just so much. The simple fact that a sufficient number of parasites can weaken or even kill a fish is enough to prove that each one does his share toward that end and is therefore harmful. And here in the Mississippi Valley there are other considerations which tend to greatly increase this influence of parasitism.

2. The parasites, especially the ergasilids, are more numerous upon young fish; one can scarcely examine a young crappie or calico bass 3 to 5 inches in length without finding it infested with *Ergasilus cæruleus*, its particular parasite, and the same may be said of the hosts of the other ergasilids. It is not quite as noticeable in the case of the argulids and lernæopods, although even here the smaller fish are the ones most frequently infested. These young fish are like the young of all animals, including even man. They are growing rapidly; they need all the vital energy they can produce to carry on this growth successfully, and hence they are more susceptible to the injurious effects of parasitism than the matured adult. We thus find a maximum of numbers of parasites at that very stage of development when there is a minimum of resistance on the part of the host, and this greatly increases the influence of the former upon the latter.

3. Again, the parasites are more numerous in the slews and cut-offs (so-called lakes) than in the main river. This is due partly to the absence of a current, thereby enabling the parasite larva to swim about freely, and partly to the crowding together of the parasites and fish, which materially aids the former in their search for the latter; but in these shut-off bodies of water the conditions are not as favorable to the fish as in the open river, especially late in the season. There is not as much food, the water is not as well aerated, and there is a keener struggle for existence. Furthermore, in these slews the young fish far outnumber the older ones; these are the very places to which they resort to escape their enemies. Scarcely a fish can be found in these "lakes" and slews which is free from parasites, and towing reveals the presence of large numbers of parasite larvæ swimming about in search of a host. Thus the parasites attack their hosts not only at the stage of development when they are most susceptible, but also in the places and under the conditions when they are least able to withstand the attack, again greatly augmenting the influence of parasitism.

4. With the time, the place, and the conditions thus favorable to the parasites, the latter respond quickly and show an abnormal increase in development. A far greater number reach maturity than under less favorable conditions; these in turn breed, and the number of larvæ is increased a hundredfold; a considerable percentage find hosts, thus crowding the gills of the young and already weakened fish. In this way parasites that are comparatively harmless under ordinary conditions may, and often do, become a serious menace to the life of the fish.

These considerations are enough to show that the presence of even a few parasites is not a matter of indifference. Fortunately, under ordinary conditions the parasite has an even harder struggle for existence than its host. In this struggle the different kinds of parasites are affected differently, while the ultimate issue is the same for them all.

The ergasilids swim about freely until they reach maturity. The male never becomes a parasite, but completes its life as a free swimmer, while the female seeks a particular host. During this comparatively long free-swimming period both sexes have to

contend with many enemies. They are then a part of the plankton and as such have to contribute their share toward the support of all the varied life which feeds upon the plankton. There are many animals which eat copepods and none of them are at all particular as to the species. These free-swimming ergasilids are fully as toothsome as other kinds and are as often eaten. The male never escapes this danger, but the female does when she has once fastened to the gills of a fish. It sometimes happens, however, that when the female is ready to fasten to a fish all the fishes suitable for hosts have left the vicinity. Under such conditions the female parasite must die unless she can swim far enough to find a host.

The argulids swim about freely, even after reaching maturity, especially the males. During this swimming they also become part of the plankton and share in its dangers and vicissitudes. Being external parasites, they are not compelled to find a particular host, for they can remain temporarily upon almost any fish until their true host is found. They are thus much less susceptible to the dangers of the plankton than the ergasilids, and when they have once reached maturity they are thenceforth free from such dangers. Their much larger size also operates in their favor, for they are too bulky to be caught by most of the creatures which eat ordinary copepods.

The lernæopods have but a very short free-swimming period, a few hours at the most, and during that time they, too, are subject to the dangers of the plankton. They must not only survive these dangers but they must also find a particular host within this brief period or they perish; and the same disaster often overtakes them that happens to the ergasilids, namely, when they are ready to attach themselves there are no suitable hosts available.

The lernæids also become a part of the free-swimming plankton at two separate periods in their development. First during the nauplius and metanauplius stages, when they are indistinguishable from all other copepods in the same stages, so far as the dangers of the plankton are concerned. Then they spend the copepodid stages as parasites upon the gills of some fish, apparently any that happens to be available. On leaving this intermediate host they again enter the plankton and swim about freely while a union of the sexes takes place. The male develops no farther, but the female must seek a permanent host, and this time it must be a particular species of fish. During this latter period, therefore, they are in the same condition as the lernæopods and often experience the same trouble, namely, when they are fully developed there are no suitable hosts available.

It follows that the parasites are ordinarily held in check by these means, and if they are to become anything of a menace to the fish there must be peculiar conditions favorable to them and unfavorable to their hosts. The custom practiced by the biological station of seining the fish out of the "lakes" and slews that are likely to go dry and putting them back into the main river is the best thing that could be done to get rid of the parasites. We have just seen that the latter breed rapidly under the conditions obtaining in the slew and that everything works together in their favor. By removing the fish such breeding is at once stopped; all the parasite larvæ and adults left in the slew die, and the new conditions in the main river are such as to keep subsequent breeding within due bounds.

RELATIONS BETWEEN THE COPEPODS AND THE GLOCHIDIA.

We have just discussed the relations between the fish and the copepods, but both copepods and glochidia infest our common fresh-water fishes. Consequently, in view of the efforts which are being put forth by the United States Bureau of Fisheries for the success of artificial mussel propagation it becomes imperative to know whether the habits of these two kinds of parasites are harmonious or antagonistic. Does the presence of copepods upon our common fishes influence in any way their susceptibility to infection by mussel glochidia? This problem can be most intelligently discussed in the form of a series of questions and answers.

I. *Are the fish that serve as hosts for the copepods those which are naturally susceptible to infection by glochidia?*

This question can be best answered by arranging in tabular form a list of the fishes with their glochidia and copepod parasites in parallel columns.

FISH HOSTS WITH THEIR GLOCHIDIA AND COPEPOD PARASITES.

Fish host.	Mussel parasites.		Copepod parasites.		Suggestions.
	On the fins.	On the gills.	On the gills.	On fins and outer body.	
<i>Acipenser rubicundus</i> (rock sturgeon)				<i>Argulus canadensis</i>	
<i>Ambloplites rupestris</i> (red-eye)		<i>Arcidens confragosus</i>	<i>Achtheres ambloplitis</i> <i>Ergasilus centrarchidarum</i>	<i>Argulus maculosus</i> <i>Lernaeocera crudata</i>	
<i>Ameiurus lacustris</i> (fork-tailed cat)			<i>Ergasilus elegans</i> <i>Lernaeocera</i> sp.....	<i>Lernaeocera tortua</i>	<i>Lampsilis anodontoides</i> on gills.
<i>Ameiurus natalis</i> (yellow cat)	<i>Anodonta corpulenta</i>		<i>Ergasilus versicolor</i>	<i>Argulus maculosus</i>	<i>Quadrula glochidia</i> on gills.
<i>Ameiurus nebulosus</i> (bullhead)			<i>Ergasilus versicolor</i> <i>Lernaeocera variabilis</i> <i>Achtheres pimelodi</i>	<i>Argulus maculosus</i> <i>Lernaeocera tortua</i>	<i>Quadrula glochidia</i> on gills.
<i>Amia calva</i> (dogfish)				<i>Argulus americanus</i> <i>Argulus flavescens</i>	<i>Ergasilus</i> species on gills. ^a
<i>Anguilla chrysope</i> (eel)		<i>Quadrula heros</i> <i>Arcidens confragosus</i>			
<i>Aplodinotus grunniens</i> (sheepshead)	<i>Anodonta corpulenta</i> <i>Arcidens confragosus</i> <i>Quadrula heros</i>	<i>Lampsilis alata</i> <i>Lampsilis gracilis</i> <i>Lampsilis lugensii</i> <i>Lampsilis lavissima</i> <i>Lampsilis purpurata</i> <i>Plagiola donaciformis</i> <i>Plagiola elegans</i> <i>Plagiola securis</i>		<i>Argulus appendiculatus</i> <i>Lernaeocera tenuis</i>	
<i>Apomotis cyanellus</i> (green sunfish)	<i>Anodonta corpulenta</i>	<i>Plagiola securis</i> <i>Quadrula metanevra</i> <i>Lampsilis</i> sp..... <i>Lampsilis ligamentina</i>	<i>Ergasilus ceruleus</i> <i>Ergasilus centrarchidarum</i>		<i>Argulus appendiculatus</i> on outside of body.
<i>Argyrosomus artemi</i> (lake herring)			<i>Achtheres coregoni</i> <i>Achtheres corpulentus</i> <i>Salmincola imermis</i>		<i>Glochidia</i> on gills.
<i>Argyrosomus hoyi</i> (cisco)			<i>Achtheres coregoni</i> <i>Achtheres corpulentus</i>		<i>Glochidia</i> on gills.
<i>Catostomus catostomus</i> (red sucker)				<i>Argulus catostomi</i>	
<i>Chanobryttus gulosus</i> (warmouth bass)		<i>Lampsilis parva</i> <i>Lampsilis fallaciosa</i>	<i>Ergasilus centrarchidarum</i> <i>Ergasilus ceruleus</i>		
<i>Coregonus clupeiformis</i> (whitefish)			<i>Achtheres coregoni</i> <i>Achtheres corpulentus</i>	<i>Argulus canadensis</i>	
<i>Cristivomer namaycush</i> (siscowet (siscowet))			<i>Salmincola siscowet</i>		

Dorosoma cepedianum (gizzard shad).....	Arcidens confragosus. Anodonta corpulenta. Unio gibbosus.	Ergasilus lanceolatus.....	Argulus appendiculatus.....
Erimyzon succetta (chub sucker).....	Quadrula plicata.....	Argulus catostomi.....	Argulus catostomi. Ergasilus species on gills. ^b
Esox lucius (pickereel).....	Quadrula plicata.....	Ergasilus cœruleus. E. centrarchidarum.	Lernaeocera cruciata..... Lernaeocera cruciata on gills.
Eupomotis gibbosus (sunfish).....	Quadrula pustulata.....	Ergasilus versicolor. Achtheres pimelodi.	Argulus trilineatus..... Ergasilus megaros. (in the nasal Fossa.) Anodonta glochidia on fins.
Goldfish.....		Ergasilus cœruleus. Ergasilus elegans.	Argulus appendiculatus..... Argulus appendiculatus.....
Ictalurus anguilla (Fulton cat).....	Lampsilis anodontoides.....	Ergasilus elegans. Lernaeocera variabilis.	Argulus lepidostei..... Argulus lepidostei. Argulus mississippiensis.
Ictalurus punctatus (channel cat).....	Lampsilis anodontoides.....	Ergasilus cœruleus.	Argulus ingens. Argulus nobilis (?). Ergasilus elegans on gills.
Ictiobus bubalis (smallmouth buffalo).....	Lampsilis anodontoides.....	Ergasilus cœruleus. Ergasilus centrarchidarum.	Lernaeocera variabilis. Lernaeocera pomotiids. Argulus sp. on outside of body.
Ictiobus cyprinella (redmouth buffalo).....	Lampsilis ligamentina.....	Achtheres pimelodi. Ergasilus versicolor.	Argulus flavescens..... Lernaeocera cruciata. Argulus appendiculatus.
Lepisosteus osseus (long nosed gar).....	Quadrula pustulosa.....	Achtheres micropteri. Ergasilus centrarchidarum.	Lernaeocera cruciata. Argulus appendiculatus.
Lepisosteus platostomus (short-nosed gar).....		Achtheres micropteri. Ergasilus nigritus. Ergasilus centrarchidarum.	Lernaeocera catostomi. Lernaeocera cruciata.
Lepisosteus tristechus (alligator gar).....		Achtheres ambloplitis. Salmincola talculata. Salmincola californiensis. Salmincola beani.	Glochidia on gills.
Lepomis pallidus (bluegill) ^c	Anodonta corpulenta.....		
Leptops olivaris (mud cat).....			
Micropterus dolomieu (smallmouth black bass).....			
Micropterus salmoides (largemouth black bass).....			
Moxostoma macrolepidotum duquesnei (redhorse).....			
Oncorhynchus nerka (redfish).....			
Oncorhynchus tshawytscha (quinnat salmon).....			

^a Ergasilus gibbus is recorded by several observers from the European Anguilla anguilla.

^b Ergasilus sieboldi has been found on the gills of this fish in Europe.

^c Lepomis auritus (Linn.), common in streams east of the Alleghanies, carries E. centrarchidarum on its gills, but so far as known has never been examined for glochidia.

A careful reading of this table shows us:

1. The fish which carry the copepods are also those which serve as hosts for the glochidia.

There are a few exceptions on either side—some fish, like the eel and the shovel-nosed sturgeon, which carry only glochidia, and others, like the dogfish and the bull-head, which carry only copepods. But these are simply the exceptions that prove the rule, and we must also remember that not all the fishes in the list have been thoroughly examined for both copepods and glochidia. Future investigations are very likely to reduce these exceptions and possibly to eliminate them entirely. This is exactly what would be expected, for the temporary parasite, the glochidium, is not so very different in some respects from the permanent parasite, the copepod. The conditions which are favorable to the one would favor the other also, and the conditions which are adverse to the one would be adverse to the other. Hence we may go a step further and affirm:

2. The species of fish which are ordinarily free from copepod parasites do not furnish conditions favorable to infection by glochidia.

The numerous species of buffalofish, carp, suckers, lampreys, minnows, shiners, dace, chubs, and darters are excellent examples. The above table includes all the fresh-water fish at present known to serve as hosts for either copepods or glochidia, and practically none of these fish appear in either list. Nor are they likely to appear in any numbers, for these fish have been as thoroughly examined as any others, but nothing has been found upon them. Lefevre and Curtis mention some of the mechanical factors which tend to render a fish immune to infection by glochidia, such as the smallness of the gill openings, the rapidity of the fin movements, and the texture of the gills. They mention as the most striking instances of immunity the German carp, certain minnows, and the darters, three of the above-named fish. By means of artificial infection they exposed these fish to glochidia, a few of which fastened upon their gills and fins; but these were quickly sloughed off, and none could be carried through the parasitic period. "The disappearance of the hookless glochidia of *Lampsilis* from both gills and fins of the carp * * * suggests rather that there may be some reaction of the host's tissues comparable to the processes which confer immunity against parasitic bacteria in higher vertebrates." (Lefevre and Curtis, Bulletin Bureau of Fisheries, vol. xxx, p. 163.)

We can readily understand how an immunity of this character could operate against the parasitic copepods as well as against the glochidia. Extensive examination in the future may, and probably will, reveal straggling copepods and glochidia, but in such small numbers that they must be regarded as accidental infections.^a

3. The fish which make the best copepod hosts are also those which are naturally infected with the greatest number and variety of glochidia.

A fish's efficiency as a host may be measured either by the number of any single parasite it harbors, or by the variety of species. In the copepod parasites these two criteria are usually separated and must be considered independently. In the mussel glochidia they are nearly always united, and may therefore be treated conjointly.

Keeping these facts in view, we notice first that the crappie, *Pomoxis annularis*, stands at the head of both lists. It serves as the host of at least 13 species of mussel glochidia, and yields often as many as 500 or 800 specimens of some particular species

^a *Argulus foliaceus* and *Ergasilus sieboldii* have been found once or twice on the carp (*Cyprinus carpio*) in Europe, while *Lernæocera pectoralis* was reported by Kellicott from the red-fin shiner (*Notropis cornutus*) in the Shiawassee River, Mich.

like *L. ligamentina* or *L. ventricosa*. When artificially infected, each crappie will take from 1,000 to 2,000 glochidia and sometimes even more.

Turning now to the copepods, we find that while it carries on its gills only two species, it is, nevertheless, the worst infected fish in the Mississippi River so far as numbers are concerned. Hardly a crappie examined during the summer season failed to yield specimens of one or both copepods, and frequently the number from a single fish reached into the hundreds and sometimes came close to a thousand. The difference in size between the glochidia and copepods make these numbers closely correspond, and the limit in both instances is apparently determined only by the actual living space on the gills.

The second fish on the list is the sheepshead, *Aplodinotus grunniens*, which serves as a host for 11 species of mussels, and upon the gills of which the number of individual glochidia is usually well up in the hundreds and frequently reaches into the thousands.^a This is an apparent exception to the rule, for while there is an external *Argulus* parasite to correspond with the few fin glochidia, a careful examination of all the sheepshead gills that were available (about 500) failed to reveal a single copepod; but there are certain facts which profoundly influence our judgment in the present instance.

First, and of the greatest importance, this fish habitually feeds upon thin-shelled mussels, crushing the shells with its powerful pharyngeal jaws. Whenever the shell of a gravid mussel is crushed in this way the gills of the fish necessarily become infected with the glochidia which are set free. *L. lævissima* and *P. donaciformis* are the ones whose glochidia are found in greatest numbers, and these as well as most of the others have papery shells. This method of infection is quite different from that in the crappie and other fish and comes close to being artificial. Furthermore, such infection is practically constant, in fact as constant as the feeding of the fish, and thus the gills are kept loaded with glochidia all the time. The presence of these glochidia prohibits that of the copepods, as will be shown later. The glochidia of the thick-shelled mussels like *Q. heros* are obtained in the usual way and are much fewer in number.

Again we find upon the sheepshead's gills, in addition to the mussel glochidia a trematode ectoparasite, which exists in as great abundance as the copepods upon the gills of the crappie. The presence of these worms may still further explain the absence of copepods.

After the sheepshead comes the sauger with six species of glochidia, the green sunfish with five, the bluegill and white bass with four each, and the gizzard shad, the largemouth black bass, the skipjack, and the calico bass with three each. Of these the bluegill, the white bass, and the calico bass are each infested with the same two species of *Ergasilus* as the crappie, in smaller numbers but still to a considerable degree. The largemouth black bass carries a still smaller number of individual copepods but compensates for it by being the host of five different species. The green sunfish, the gizzard shad, and the skipjack have but a single copepod parasite on their gills, but they are also really the host of but a single kind of glochidium, the others being found in such small numbers that they can be regarded only as accidental infections. Having thus determined that the same fish serve as hosts for both copepods and glochidia, a second question naturally arises:

^a On the gills of one fish of this species 5,200 glochidia of *P. donaciformis* were found, and upon another fish 10,400 of the same glochidia.

II. *Is there any fellowship between the different species of the two kinds of parasites? Do we find certain species of glochidia associated with the same copepod in a majority of instances?*

This question can also be answered by reference to the table (p. 338), from which we deduce the following:

1. Of the external-fin glochidia *Anodonta corpulenta* is by far the most widely distributed and is always accompanied by an external *Argulus* parasite, usually *A. appendiculosus*. The green sunfish, the calico bass, and the skipjack are apparent exceptions; *Anodonta* glochidia have been found upon them but no *Argulus* copepod. It must be remembered, however, that the glochidia are fastened in the fins and remain there no matter how long the fish may have been kept or how much it may have been handled. On the other hand, the copepod merely clings to the outside surface of the fish and is easily brushed off when alive and practically always falls off when dead. Only a few of these fish have been examined under conditions favorable for finding the copepods, while the conditions are always favorable for finding glochidia.

Such being the case, it seems reasonable to expect that an *Argulus* parasite will be found upon the three fish just mentioned as the result of future examination; but the argument ought to work equally well in the opposite direction, and hence we may look for the future discovery of the glochidia of *A. corpulenta* upon the channel cat, its copepod fellow having been already found.

2. The glochidia found upon the gills of fish may be divided into the two great groups of *Lampsilis* species and *Quadrula* species. Accompanying the former we find *Ergasilus cæruleus* in every instance, except upon the largemouth black bass, where it is replaced by *Ergasilus nigrinus*, one of the new species. Accompanying the *Quadrulas* we find *Ergasilus versicolor* upon the catfishes and the skipjack and *Ergasilus centrarchidarum* upon the Centrarchidæ. In this instance the copepods and glochidia are equally well protected, and the only hindrance to their discovery is the lack of fish specimens. Some species of fish are always scarce, while others that may be ordinarily plentiful may be scarce at just the time when they are likely to become infested with the copepods or the glochidia. Hence, while one of the parasites might be well known upon the fish, the other might have escaped notice.

Apparently something of this sort has happened to a few of the catfishes and Centrarchidæ; copepods have been found upon them repeatedly, but thus far no mussel glochidia have been discovered. It would seem reasonable, however, to expect them, and some species of *Quadrula* will probably be found in the future upon the yellow cat, the bullhead, and the Fulton cat, while some species of *Lampsilis* will be found upon the common sunfish, *Eupomotis gibbosus*, the warmouth bass, and the smallmouth black bass.^a

In connection with the association between *E. centrarchidarum* and *Quadrula* glochidia the following may be suggested:

(a) *E. centrarchidarum* is found on the gills of the largemouth black bass, but it is accompanied by *E. nigrinus*, one of the new species which evidently takes the place on this host of *E. cæruleus*, the regular associate of *Lampsilis* species. The presence of *centrarchidarum*, therefore, is not to be interpreted as indicating that it is here excep-

^a Since the writing of this paper two species of *Lampsilis* glochidia have been discovered upon the gills of the warmouth bass and have been inserted in the table on page 338.

tionally associated with *Lampsilis* species but, rather, that *Quadrula* glochidia will be found in the future upon this fish as they have been upon so many of the sunfishes and basses other than the largemouth.

(b) Upon the sunfishes it is worth noticing that the two copepods *caeruleus* and *centrarchidarum* occur together, and we should expect such fish to become the natural hosts of both *Lampsilis* and *Quadrula* glochidia. Two of them, the bluegill and the green sunfish, have already yielded both kinds of glochidia, and it would seem probable that future investigation will find both kinds upon the other sunfish where now there is but a single kind.

(c) *E. centrarchidarum* is found upon the gills of the wall-eye, which have thus far yielded only *Lampsilis* glochidia; but upon the sauger, another fish of the same genus as the wall-eye, both kinds of copepods and both kinds of glochidia appear. Furthermore, both fishes yield the same species of *Argulus*, so that it does not seem presumptive to suppose that the second species of *Ergasilus* and *Quadrula* glochidia will eventually be found upon the wall-eye, as they have already been upon the sauger.

3. There is a single well-marked instance of individual association between a glochidium and a copepod. *Lampsilis anodontoides*, whose glochidia are practically confined to the gars, is found to be accompanied by a peculiar copepod, *Ergasilus elegans*, another new species, which differs markedly from the others of its genus in the fact that the female remains free swimming for a much longer period. Indeed, it seems probable that they leave the fish's gills after having fastened to them and swim about freely. There are two other new species, *Ergasilus lanceolatus* from the gizzard shad and *E. elongatus* from the spoonhill cat, which are fully as peculiar as *E. elegans* and which may well be the copepod half of other individual associations whose glochidial half has not yet appeared. Furthermore, we may look for *E. elegans* upon the alligator gar, whose gills have already yielded specimens of *Lampsilis anodontoides*.

4. It has long been known that certain species of copepods are confined to particular hosts and are not found upon any others. The table furnishes us several well-marked examples of this: *Argulus mississippiensis* and *A. ingens* are each found upon a single host, and although the two hosts are gars and very closely related to each other the copepods are distinct species. Again, the two species of *Ergasilus* just mentioned, namely, *lanccolatus* and *elongatus*, are each restricted to a single kind of fish and are not likely to be found elsewhere. The same is true of *Ergasilus megaceros* and of *Salmincola oquassa* and *S. edwardsii*; in fact, a good proportion of copepod parasites of both fresh-water and salt-water fish show such restrictions.

When we look at the glochidia we find that there are fully as many of them confined to a single host. *Lampsilis alata*, *gracilis*, and *purpurata*, and *Quadrula solida*, *ebenus*, and *trigona* are good examples. Probably further investigations will modify many of these as well as of the copepods, but it is equally probable that some of them will prove to be always solitary. In the case of the glochidia we are not compelled to wait for natural infections, for we can subject a fish to the glochidia of many mussels and determine experimentally whether or not it will make a suitable host for them. In fact, this has been done by Dr. A. D. Howard, who, in the Bureau of Fisheries document no. 801, calls attention on page 36 to what he calls "Restricted infection," which he has demonstrated by actual experiment in the case of *Quadrula pustulosa* upon the channel cat.

Nothing of this sort can be tried with the copepods, since we can not supply larvæ in the right stages of development as we can glochidia. But although our knowledge of both kinds of parasites is rather limited as yet, enough data have been accumulated to show that the two kinds of parasites behave very similarly in regard to their hosts. There is thus a decided similarity between them when each is found by itself upon some suitable host.

III. *Does the actual presence of copepods on a fish's gills exert any influence upon its susceptibility to infection by glochidia?*

In other words, granting that the same fish do serve as hosts for both glochidia and copepods, are the conditions favorable for both at the same time? This is manifestly something which can not be watched under natural conditions, and the only way to answer the question is by artificial infection experiments. Accordingly a hundred crappies, *Pomoxis annularis*, of nearly uniform size (5 to 6 inches long), which had been caught and brought to the station for artificial infection, were carefully examined and 25 were found to be infested with *Ergasilus cæruleus*, while the other 75 were free from them. The entire hundred were then infected in the usual manner and under exactly the same conditions with the glochidia of the black sand-shell, *Lampsilis recta*. After infection the 25 parasitized fish were killed, their gills were removed, and the number of copepods and glochidia on each was counted with the following results:

Fish.	Glochidia.	Copepods.	Fish.	Glochidia.	Copepods.
1	0	350	14	102	87
2	46	150	15	7	393
3	176	121	16	190	36
4	126	140	17	63	310
5	104	78	18	495	8
6	337	7	19	40	196
7	47	253	20	80	112
8	38	218	21	16	372
9	169	142	22	395	10
10	257	44	23	9	403
11	301	63	24	11	396
12	372	30	25	143	134
13	280	31			

The average number of glochidia upon each of the nonparasitized fish was between 1,000 and 1,200. By comparing this with the numbers given in the table we deduce the following:

1. The presence of even a small number of copepods upon the gills of a fish reduces its susceptibility to infection by glochidia to one-third or one-fourth of what it would be if no copepods were present.

Even the gills that contained 10 copepods or less showed the presence of only a few hundred glochidia instead of the thousand or more upon a nonparasitized fish. Such a marked reduction can not be explained by the mere presence of the copepods; they do not occupy enough of the gills to exert any crowding influence, neither are they ever found attached to the tips of the filaments where the glochidia mostly congregate. Manifestly there is room enough for both kinds of parasites without serious crowding; gills that will accommodate 1,200 glochidia with no apparent injury to the fish can certainly find room for more than 400 when only 10 copepods are present.

Lefevre and Curtis say that the stimulus which causes the glochidium to close and thus to fasten itself to the fish is purely a mechanical one (Bulletin Bureau of Fisheries,

vol. XXVIII, pt. 1, p. 622). Here again the mere presence of a few copepods upon the gills of a fish could have no effect upon such a stimulus. The respiratory movements of the fish may have considerable to do with it; the crappie's respiration is not very vigorous even at its best, and this is especially true of small fish (Lefevre and Curtis, *Journal Experimental Zoology*, vol. 9, p. 103).

The irritation due to the presence of parasitic copepods may still further reduce these movements and thus prevent infection by glochidia; but if this were the only cause 10 copepods could hardly produce so large an effect. It would seem as if there must be something further, either chemical or physiological in its action, in order to accomplish the known results. It will not be very easy to prove what this is, but meanwhile the facts remain unaltered that in some way the presence of a very few copepods greatly reduces the fish's susceptibility to infection by glochidia.

2. As the number of copepods upon a fish's gills increases its susceptibility to infection by glochidia diminishes. Naturally a limit is soon reached beyond which the susceptibility has diminished so much that practically there can be no infection at all; this limit for small crappies is about 200 copepods. If more than this number is present, the glochidia are very scattering and are usually below 50 in number. The copepods often increase to 500, and in such instances there are no glochidia, or, if any, their number is expressed by a single digit.

Certain conclusions naturally follow from these facts. The first is that it is obviously disadvantageous to attempt to infect with glochidia fish that are already carrying copepods. A few glochidia will always stick to their gills, but not in sufficient numbers to repay the labor expended. Since the large fish are relatively freer from copepods than the smaller ones, it follows that they make the better hosts. Not only are their gills larger and thus capable of carrying more glochidia, but the latter will fasten to them more readily because of the comparative absence of copepods.

Again, the fish from the main river, whatever their size, make better hosts than those from the slews and "lakes," because they, too, are freer from copepods. This is especially true at those times when the water is very low; during a long-continued drought it would be of little use to try infecting fish caught in such places because they would be so infested with other parasites that very few of the glochidia would fasten to them. The best thing to do with such fish would be to replace them in the main river and trust to taking them again after they had gotten rid of their copepods.

3. It is obviously a poor rule that does not work both ways, and we find that the presence of glochidia is as prohibitive to the copepods as are the latter to the former. This also is something that can not be watched under natural conditions; neither can it be proved by experiment, for we can not supply parasitic copepods as freely as we can glochidia; but it is abundantly sustained by a study of natural infections on the gills of fish taken in the river. There are in the possession of the biological station about 1,000 vials of gills showing natural infection by various glochidia. These were all carefully examined for parasitic copepods under a dissecting microscope, and in not a single instance where the number of glochidia exceeded 300 was there even a single copepod present.

This mutual antagonism between the copepods and glochidia enables us to understand clearly why the sheephead's gills are never infested with copepods. From the nature of the fish's food, as already explained, its gills are kept crowded with glochidia

all the time, and thus the copepods are shut out. This leads to the conclusion that when a fish's gills are artificially infected with glochidia the fish is thereby rendered immune to the copepods. Artificial infection therefore, as regularly practiced at the biological station, not only does the fish no harm but is even positively beneficial.

And this suggests a possible safeguard or remedy for some fish hatcheries. It occasionally happens that parasitic copepods get to breeding in a hatchery in such numbers that they kill the fish. Judging from the cases thus far reported, this seems more likely to occur among trout than among other game fish. The European trout (*Salmo fario* Linnæus) is the natural host of *Margaritana margaritifera*, but our American trout have been examined very little for glochidia. However, if there is any virtue in the conclusions here drawn, the very fact that they are more susceptible than other fish to the copepod parasites indicates that they would make excellent hosts for glochidia. If this be so, an infection with glochidia would be harmless to the fish, but at the same time would render them immune to the copepods. At all events, the experiment is worth trying.

4. The breeding season of the copepods thus acquires especial economic importance with reference to mussel propagation. It is manifest that at the close of a breeding season, when the larval brood of copepods have sought and found their hosts, their numbers will be at a maximum. Consequently this would be the time least favorable to infection with glochidia. On the other hand, the early spring, before the copepods begin to breed, and the intervals between successive breeding periods, would be the most favorable to glochidial infection.

We are not yet sufficiently acquainted with either kind of parasite to be able to make a complete schedule of their times of breeding, but many interesting facts have been ascertained.

Lefevre and Curtis in the Bulletin of the Bureau of Fisheries, volume xxx, page 141, divide mussels into two groups according to the length of the period of gravidity. Those having a long period of gravidity, among which *Lampsilis* species predominate, produce ripe glochidia during the fall and winter and spring months. Those having a short period of gravidity, among which *Quadrula* species predominate, produce ripe glochidia during the summer months. Turning now to the copepods, we find that the ergasilids and argulids have three breeding seasons in the year, the first at the end of May or the beginning of June, the second at the middle or latter part of July, and the third in the latter part of September. We do not yet know all the breeding seasons of the lernæids and lernæopods, but from the material here presented and that obtained from many other investigations it is certain that they also have a breeding season during the middle or latter part of July, and it is probable that there are two other seasons corresponding to those just given.

Comparing the breeding of the copepods with that of the mussels, it will be seen that the winter or early spring is the best time for infection with *Lampsilis* glochidia, since the only copepods then on the fish's gills are such adults as have lasted through the winter. None of the *Quadrula* group produce glochidia early enough to be used for spring infection, and the best months for them would be July and September, just before the second and third copepod breeding seasons; and from what has already been said of the cumulative effects of unfavorable conditions during low water the month of July would ordinarily be preferable to September.

In the paper already referred to Lefevre and Curtis call attention to the desirability of reducing the length of the parasitic period of the glochidium (p. 191), which is inversely proportional to the temperature of the water. Whether the shortening of the parasitic period during the warm summer weather will compensate for the increase in the number of parasitic copepods is a question that can be decided only after careful experimentation. We now know, however, that the presence of these copepods and their periods of breeding are factors that must be given due consideration before the question can be solved.

SYSTEMATIC.

A complete description, fully illustrated with appropriate figures, is given of all the species which are new to science. Of those which have been previously described only such notes are included as are of interest or furnish additional information. The larvæ of a few species were hatched out in the laboratory of the station, and they also are fully described and illustrated, since they add considerably to our previous knowledge of the species. Several parasites were obtained by H. Krøyer, a Danish zoologist, from fish taken near New Orleans and sent to the Royal Museum in Copenhagen. Most of these fish were such as come up the Mississippi River from the Gulf of Mexico, and hence their parasites can not be included amongst the strictly fresh-water species; but they are included in the present list because they are likely to be found in that part of the river.

The parasites of fish in the Great Lakes, the Lake of the Woods in Canada, and of several isolated lakes are also enumerated, since they are all fresh-water forms and really belong with the great fresh-water fauna of the interior of our continent. A few species have been included from west of the Rocky Mountains and east of the Appalachians.

THE ARGULIDÆ.

Argulus canadensis, new species. (Pl. LX.)

Host and record of specimens.—Three fine females were obtained by T. Surber at Le Claire, Minn., from fish caught in the Lake of the Woods. Two were from a species of whitefish, *Coregonus*, while the third was from a rock sturgeon, *Acipenser rubicundus*. The better of the first two is made the type of the new species and has been given catalogue no. 43521, U. S. National Museum. The other has been given catalogue no. 43525, U. S. National Museum, while the specimen from the sturgeon received catalogue no. 43526, U. S. National Museum.

Specific characters of the female.—Carapace elliptical, a little longer than wide, the posterior lobes broad, evenly rounded, and reaching to about the center of the third thorax segment, leaving the two posterior pairs of legs fully visible in dorsal view. Instead of projecting anteriorly the cephalic area is slightly reentrant, ovate, and relatively very small; posterior sinus one-third the length of the carapace, its width posteriorly equal to its length, but narrowed and squarely truncated anteriorly. The supporting rods in the lateral areas of the carapace are peculiarly arranged, meeting at a point far forward and giving the creature a sort of hunch-backed appearance. The respiratory areas are also peculiar, the outer one club-shaped, the large end anterior, while the handle of the club extends backward along the outer margin of the inner area, an arrangement wholly different from anything heretofore described. Abdomen a little more than one-fourth the entire length, its width to its length as 5 to 8; anal sinus cut beyond the center, its sides parallel, lobes narrow-elongate and rather bluntly rounded, papillæ basal. Eyes large and so far forward as to almost touch the anterior margin, but widely separated; sucking disks also far forward and well separated, one-eighth the width of the carapace.

Antennæ small and weakly armed, the terminal joints of the first pair not reaching beyond the lateral claw, the anterior claw minute and nearly straight; second antennæ slender, basal joint enlarged with a small spine on its posterior margin. A pair of large accessory spines behind the antennæ and close to the median line; another pair between the bases of the maxillipeds or slightly posterior to them.

The supporting rods of the membranous border of the sucking disks are made up of an oblong basal joint and a series of 10 or 11 plate-like disks, overlapping one another like shingles and diminishing in size distally, similar to those in *Argulus megalops*. The basal joint of the maxillipeds is much swollen, the basal plate does not quite reach the posterior margin, and is armed with three slender acuminate teeth; this plate has a rounded lobe outside of the teeth, which carries a short spine at its center. The ventral protuberance is large in area, oval in outline, and is put on diagonally, the small end filling out the rounded external lobe just mentioned; there are also spiny areas at the distal end of the basal and third joints, and over the whole surface of the second joint; there are two terminal claws and a fingerlike process outside of them.

Color (preserved material), carapace, abdomen, and the entire ventral surface a clear creamy white; dorsal surface of the thorax covered with rounded spots of a deep reddish purple, with a white streak through the center above the intestine; these spots extend forward beneath the carapace as far as the mouth; eyes and semen receptacles a lighter purple.

Total length, 12 mm.; carapace, 7.2 mm. long, 7 mm. wide; abdomen, 3.4 mm. long, 2.2 mm. wide. (*canadensis*, Canadian.)

Remarks.—This is a large and powerful parasite and is evidently our American representative of the European species *coregoni*. It would be interesting to ascertain whether they produce any such effect on the fish in the Lake of the Woods as is recorded for the fish of the lakes in Jemtland by Dr. Nystrom. (Proceedings U. S. National Museum, vol. 25, p. 725.)

That our species is distinct from *coregoni* is shown by the following differences. There are no flagella on any of the legs, while in *coregoni* they are full sized. The cephalic area is recentrant anteriorly instead of protuberant. The eyes almost touch the anterior margin and are rather small. There is no ovate papilla on either side of the opening of the oviduct, which Thorell makes one of the prominent characters of *coregoni*. The respiratory areas are very different, not only from *coregoni* but from every other known species of *Argulus*. This is evidently a northern species, since it has not been found upon any of the numerous species of *Coregonus* in the Great Lakes. The male is as yet unknown.

***Argulus flavescens*, new species.** (Pl. LXI, fig. 7-12.)

Host and record of specimens.—Two females were obtained from the outside of the dogfish, *Amia calva*, caught in "Sunfish Lake," near Fairport, Iowa, August 8, 1914. The better of the two is made the type of the new species and has received catalogue no. 47759, U. S. National Museum; the other becomes a cotype with catalogue no. 47760, U. S. National Museum. A third mutilated specimen was obtained from the gills of the mud cat, *Leptops olivaris*.

Specific characters of female.—Carapace elliptical, a little longer than wide, and evenly rounded; lateral sinuses scarcely perceptible; posterior sinus more than twice as long as wide, and two-fifths the length of the carapace, with nearly parallel sides; posterior lobes not reaching the abdomen, broad and plump; abdomen broadly ovate, as wide as long, and narrowed to a short neck where it joins the thorax; anal sinus about one-third the length of the abdomen, considerably enlarged at the base; anal papillæ spherical and basal.

Entire under surface of the body, including the abdomen, covered with small spines, pointing backwards; eyes small, placed well forward and some distance apart, facets minute; lateral ramifications of the stomach large and particularly prominent by reason of their color and lobed edges; respiratory areas made up of a small anterior, nearly circular portion, and a long posterior portion, which reaches nearly to the tip of the posterior lobes; sucking disks of medium size, placed well forward and close together. First antennæ slender, the anterior claw rudimentary, the lateral claw curved into three-quarters of a circle, the two terminal joints slender and reaching well beyond the tip of the claw. Second antennæ with swollen basal joint and three long terminal joints, abruptly reduced to one-third the width of the basal joint and sparsely armed with setæ; a small flattened spine on the basal joint of each antenna and an accessory pair of larger and sharper spines posterior to the second antennæ and close to the midline.

Basal plate of the maxillipeds small and narrow, with short, flattened, and bluntly rounded teeth; raised area a long and narrow oval; the four terminal joints each with a roughened area along the anterior and distal margins; last joint tipped with two minute claws and a fingerlike process. Swimming legs of the usual pattern, the posterior pair with a small lobe, which is not boot-shaped, but flares at both ends,

and which does not reach the margin of the abdomen. The supporting rods of the border of the sucking disks are made up of a basal rectangular section and from four to six barrel-shaped terminal sections, the distal one incomplete and shaped like the letter J, with the stem convoluted.

Color, a pale yellowish white; the entire digestive canal, including the ramifications of the stomach, a rich creamy yellow, in strong contrast to the white background; eyes dark cinnamon brown; upper surface of the body covered with irregular spots of jet black, thickly sprinkled along the center and over the lateral ramifications of the stomach, but entirely lacking around the eyes and the anterolateral sinuses; semen receptacles yellow, surrounded by a black line.

Total length, 6 mm.; carapace, 4.35 mm. long, 4.20 mm. wide; abdomen 1 mm. long and wide.

(*flavescens*, yellowish, alluding to the digestive system).

Remarks.—This is a small and highly colored species and is apparently rather rare, since only the three specimens were found during the entire summer. It may be recognized at once by the prominent yellow lateral lobes of the stomach, the jet-black pigment spots on the dorsal surface, and the comparatively minute abdomen, with its tiny anal papillæ in the enlarged base of the anal sinus. It seems probable that the mud cat is the real host of this species and that the two specimens on the outside of the dogfish were only seeking temporary lodgment.

***Argulus mississippiensis*, new species.** (Pl. LXI, fig. 13-15; pl. LXII, fig. 21; pl. LXIII.)

Host and record of specimens.—Six males and six females were taken by the author from the short-nosed gar, *Lepisosteus platostomus*, at Fairport, Iowa, July 17, 1912. They have been given catalogue no. 43571, U. S. National Museum. One of the largest females has been selected as the type of the species and has received catalogue no. 43528, U. S. National Museum. This species is found upon the back of the gar's neck just above the dorsal aorta, and there is usually only one parasite on each fish.

Specific characters of female.—Carapace about three-fifths of an ellipse, its long diameter transverse; anterior sinuses narrow and deep; posterior sinuses one-quarter the length of the carapace, longer than wide, its sides approximately parallel; lateral lobes very broad, obliquely truncated posteriorly, not quite reaching the abdomen. Eyes comparatively minute and widely separated; respiratory areas placed obliquely at the extreme posterior end of each lobe, the outer area semilunar, its ends considerably enlarged and well rounded, the inner area about the same size as one of the sucking disks, inserted on the inner side of the outer area near its anterior end, but separated from it by a considerable interval. Abdomen elliptical, one-fourth longer than wide, and half as long as the carapace; posterior sinus narrow-triangular, not cut to the center; papillæ lateral, near the tips of the lobes; semen receptacles elliptical and close to the midline, their long diameters parallel with the axis of the abdomen.

Antennæ small and stout; first pair with a medium-sized anterior claw and a long and stout lateral one, the terminal joints linear and not projecting beyond the tip of the lateral claw; second pair with a ventral protuberance on the basal joint just above the basal spine. Sucking disks small, only one-fourteenth the width of the carapace and widely separated; supporting rods slender and made up of a variable number of linear joints; no fringe on the margin. Maxillipeds also small but stout; basal plate projecting far behind the margin of the basal joint and carrying a large lobe distal to the spines; the latter large and acuminate; ventral protuberance small and circular; a roughened plate on the third joint; terminal claws and papillæ minute. A pair of small accessory spines between the bases of these maxillipeds and another larger pair some distance behind the antennæ.

Each of the three posterior pairs of swimming legs carries a ventral lobe fringed with setæ on the basal joint; the lobes on the second and third legs are small, that on the fourth legs is much larger and projects beyond the lateral margin of the abdomen; the second joint of the endopod of the fourth legs also carries a small posterior lobe. There is a small anal papilla on either side of the opening of the oviduct.

Total length of figured specimen, 15 mm.; carapace, 10 mm. long, 12 mm. wide; abdomen, 4.80 mm. long, 3.75 mm. wide.

Specific characters of male.—The general make-up of the male is similar to that of the female, the carapace lobes slightly overlapping the base of the abdomen; the testes are elliptical and not much larger than the semen receptacles in the female; the basal portion of the anal sinus, proximal to the papillæ, is a mere slit, whose sides are in contact or even overlap slightly. The secondary sexual apparatus is very complicated and closely resembles that of *A. lepidostei*. There is a roughened plate, armed

with short spines, on the ventral surface of the basal joint of the second legs, at each end of which is a stiff fingerlike projection; the basal joint of the third legs carries a boot-shaped posterior lobe fringed with setæ; on the anterior margin, parallel with the axis of the joint, is a fingerlike process, covered with short spines, whose tip is turned forward just beyond the distal end of the joint; inside of this tip is the base of another long process, flattened anteroposteriorly and covered with short spines, which extends outward parallel with the second joint and overlaps the bases of the rami; on the posterior margin of this second joint, distal to the opening of the semen receptacle, is a small laminate process, fringed with long setæ; the musculature of these two basal joints is peculiar, as may be seen in fig. 27. The peg on the fourth leg is double and stouter than in most species.

Total length of figured specimen, 11 mm.; carapace, 7.50 mm. long, 9 mm. wide; abdomen, 3.50 mm. long, 2.50 mm. wide.

Color of both sexes: Carapace, abdomen, and the ventral surface a light yellow, thickly sprinkled on the dorsal surface with small circular dots of light cinnamon brown. There are no spots on the thorax but the dorsal surface of the oviducts beneath the muscles is dark cinnamon brown, and it shows through very plainly; semen receptacles and testes dark orange yellow; eyes deep cinnamon brown.

(*mississippiensis*, of or belonging to the Mississippi River.)

Remarks.—With the exception of *Argulus ingens*, this is the largest species of the genus in America, and the measurements sometimes exceed those given above. For example, one female was found which measured 20 mm. in length, while one of the males was 15 mm. long. In addition to its large size it presents many peculiarities of structure, the most noticeable being the double lobes on the fourth legs, the peculiar papillæ on the sides of the anal sinus, and the complicated respiratory areas. One of these parasites is as large as an ordinary copper penny and must drain the blood of its host quite severely. Fortunately for the fish, it is rare to find more than one parasite on a single fish; otherwise they would soon drain its blood. The present species completes the list and is the third found upon the gars, so that each gar now has its peculiar parasite, *Argulus lepidostei* upon the long-nosed gar, *A. mississippiensis* upon the short-nosed gar, and *A. ingens* upon the alligator gar.

***Argulus lepidostei* Kellicott.** (Pl. LXII, fig. 16-19; pl. LXIV; pl. LXV.)

Argulus lepidostei, Kellicott, Bull. Buffalo Soc. Nat. Sci., vol. 3, p. 214, 1877; Wilson, Proc. U. S. Nat. Mus., vol. 25, p. 712, pl. 16.

Host and record of specimens.—Twenty males and twenty-one females were obtained from the short-nosed gar, *Lepisosteus platostomus*, at Fairport, June 23, 1914, by Dr. A. D. Howard; they have been given catalogue no. 43543, U. S. National Museum. One male and a female were taken from the long-nosed gar, *L. osseus*, at Defiance, Ohio, by H. W. Clark; these have received catalogue no. 43522, U. S. National Museum. Most of these were found near the pectoral fins of their host, as was recorded of the original specimens by Prof. Kellicott.

Specific characters of female.—In addition to the descriptions given in the above references we may note the following: The respiratory areas are situated close to the posterior end of the lateral lobes; the outer and larger area is curved parallel with the margin of the carapace, its anterior end is narrowed, while the posterior end is thickened; the smaller and inner area is elliptical in outline and is inserted in the inner margin of the outer area near its anterior end (see fig. 29).

The ventral surface of the carapace is covered with orange-colored spines pointing backward. The color of the living female is a pale lemon yellow in young specimens, with only a few spots of cinnamon brown. These spots increase in size and number with advancing age and in full-grown adults become continuous along the dorsal surface of the free thorax. The eyes are deep violet brown, the semen receptacles a much paler yellowish brown.

Specific characters of male.—The accessory sexual apparatus of the male is complicated; the posterior flap on the second legs is roughened and armed with short spines; the peg on the fourth legs has an accessory peg distal to itself, which is solid and is not connected with the receptacle inside the first peg; the boot-shaped flap on this leg has no heel.

On the third legs a long slender and flattened process extends outward from the anterior margin of the ventral surface of the basal joint, parallel with the axis of the leg. Its tip is curved upward around the end of the second basal joint and often extends back toward the body on the dorsal surface. Above this process, on the anterior margin of the dorsal surface of the second joint, are two peculiar structures.

The proximal one is a curved papilla, solid and thickly covered with short spines; the distal one is a hollow conical papilla, split along its dorsal surface, its free edge and much of its dorsal surface covered with short spines. In the posterior portion of this second basal joint is the usual semen receptacle within easy reach of the peg on the fourth legs (see fig. 17).

The color of the male is similar to that of the female but paler; the brown on the dorsal surface of the free thorax forms in adults a continuous line over the intestine; testes at first brownish yellow, then light reddish brown, and finally cinnamon brown. The ventral surface of both sexes is pale yellowish white without any pigment.

The newly hatched larva.—Two females of this species full of ripe eggs were captured July 3, 1914; one of them laid a string of 30 eggs the following night and these all hatched on July 14, an interval of 10 days, the water being kept at the same temperature as that in the river (72° F.). This is the shortest incubation period yet observed for any species of *Argulus*, and since the eggs were kept at the same temperature as the river water it must be close to the normal period.

The eggs are similar to those of *A. maculosus* (Proceedings U. S. National Museum, vol. 32, pl. 31, fig. 15), the chief differences being that they are not inclined to one another but are all in the same straight line, and while there are two large jelly masses at the junction of every two eggs there is no row of them standing out like the spokes of a wheel. The eggs were transparent and cream colored when first laid but became opaque within 36 hours, and the eyes appeared on the fifth day.

The newly hatched larvæ are much more active than those of *maculosus* and swim about rapidly with a steady gliding motion similar to that of the adult. At first they swim largely at the surface but later sink to the bottom. They are much more heavily pigmented than any larvæ thus far observed, especially through the center of the carapace and along the midline of the thorax, the pigment being the same color as that of the adult.

Carapace broadly elliptical, the width to the length in the proportion of 13 to 14; anterior margin evenly rounded and with a scattering fringe of very short hairs, amongst which are one or two longer ones on either side; posterior sinus broad and very shallow; free thorax and abdomen forming a wide triangle, whose base, the second thorax segment, is a little less than half the width and whose altitude is a little more than half the length of the carapace. Abdomen half the width of the last thorax segment and a little longer than wide; anal laminae small and rectangular, each armed with two short spines of about the same length.

In the first antennæ the hook of the basal joint is long and slender and reaches to the base of the terminal joint; the latter is spherical and armed with seven large setæ, whose tips reach beyond the margin of the carapace, while all the rest of the appendage is covered.

In the second antennæ the entire endopod projects beyond the carapace, the distal joint of the basipod is twice the length of the proximal joint, the temporary exopod is curved backward, is distinctly three-jointed, and is tipped with a single short spine.

The temporary mandibular palps are exactly like those of the *maculosus* larva, even to the spine connected with their base. The second maxillæ ("anterior maxillipeds") are also similar and terminate in two sickle-shaped claws, of which the dorsal one is armed with three barbs.

The maxillipeds ("posterior maxillipeds") are five-jointed, the second and third joints armed on their ventral surface with spines and bristles. The first swimming legs have a two-jointed basipod, the distal joint armed along its anterior border with a row of short spines; the exopod is three-jointed and ends in two short spines; the endopod is one-jointed and terminates in two long nonplumose setæ. All the other swimming legs are uniramous, immovable stumps, each ending in a short and blunt spine. There are no traces of skin glands.

The eyes are large and close to the lateral margins; the ocelli are also exceptionally large and there are only 10 or 12 in each eye. The pattern of the median eye is also peculiar and very different from that of any other species. The sting connected with the mouth is long and projects far in front of the carapace.

Total length, 0.66 mm.; carapace, 0.40 mm. long, 0.35 mm. wide.

Remarks.—This species is fairly common on the gars in the river, and as it was recorded by Kellicott from the Niagara River at Buffalo it is probably as widely distributed as its host. Young specimens of both sexes, fully developed but only 1.50 mm. in length, were obtained in the tow in considerable numbers during the middle and latter part of August in several of the slews and in "Sunfish Lake," near Fairport.

These tiny specimens were very active and moved about much more constantly and with more speed than the free-swimming forms. They were so thin as to be almost perfectly transparent and made excellent microscope mounts. Their abnormal abundance was doubtless due to the congested conditions in the places where they were found, as already noted (p. 335).

***Argulus stizostethii* Kellicott. (Pl. LXII, fig. 20.)**

Argulus stizostethii, Kellicott, Amer. Jour. Micros., vol. 5, p. 53; Wilson, Proc. U. S. Nat. Mus., vol. 25, p. 713, pl. 17.

Host and record of specimens.—This species was originally obtained by Kellicott from the wall-eye, *Stizostedion vitreum*, in the Niagara River near Buffalo. Adult specimens have been obtained by the author from wall-eyes and saugers, *S. canadense*, in the Mississippi River and from wall-eyes in Lake Maxinkuckee. Young specimens of both sexes less than 1.50 mm. in length were taken in considerable numbers in the tow at "Sunfish Lake," near Fairport, August 2, 1914. These were associated with *A. lepidostei*, the numbers of the two species being about even, but the males of both species much more numerous than the females.

Specific characters of female.—These small *Arguli* being transparent, it was possible to make out the nervous system with ease. Comparing it with that of other species, we may notice first the exceptionally large size of the eyes, each of which is as large as the entire supraesophageal ganglion. The optic nerves are also very large and swollen into a barrel shape.

The first of the ventral chain of ganglia is enlarged laterally to nearly twice the diameter of the four following ones, which are all the same width, but the second and fifth ones are three times the length of the third and fourth. The nerves are given off exactly like those in *A. americanus* (Proceedings U. S. National Museum, vol. 25, p. 633).

The supporting rods in the membranous border of the sucking disks are made up of 10 or 12 parts; the basal one is a narrow oblong with concave sides, the second, third, fourth, and fifth are much wider but about the same length, convex posteriorly and concave anteriorly; the remaining parts are more or less completely fused into a narrow threadlike rod.

The bordering fringe is narrow and made up of short and stiff hairs. The male was fully described in the references above given, and there is nothing to add here.

Remarks.—This species is not as common as the preceding; it was originally obtained from the wall-eye, but Kellicott records that specimens placed in an aquarium with the long-nosed gar and some minnows fastened on them and eventually killed the minnows. This suggests that under natural conditions they may often fasten on other fish than their usual host, especially under the conditions prevailing in the slews and "lakes."

Its presence in such numbers in the tow is indicative that the species must be fairly common in the vicinity.

***Argulus appendiculosus* Wilson.**

Argulus appendiculosus Wilson, Proc. U. S. Nat. Mus., vol. 32, p. 419, pl. 32.

Host and record of specimens.—The types of this species were obtained from a sucker (species not given) at Montpelier, Vt., and were sent to the United States Bureau of Fisheries at Woods Hole, Mass., in August, 1898.

Since the original description it has been found in several places in the Mississippi Valley, as follows: A single female from the outside of the channel cat, *Ictalurus punctatus*, at Cumberland Falls, Ky., July 7, 1911, catalogue no. 39588, U. S. National Museum; a male and female from the outside of the sheephead, *A. grunniens*, at Lock 21 on the Cumberland River in Kentucky, catalogue no. 43523, U. S. National Museum; several specimens of both sexes from the largemouth black bass, *M. salmoides*, at Fairport, Iowa, July 20, 1912, catalogue no. 43527, U. S. National Museum; two males and two females from the outside of the redmouth buffalo, *Ictiobus cyprinella*, at Fairport, May 27, 1910, catalogue no. 43542, U. S. National Museum; a male and female from the smallmouth buffalo, *I. bubalus*, at Fairport, June 28, 1914, catalogue no. 47761, U. S. National Museum. Isolated specimens were also obtained from the gizzard shad, *Dorosoma cepedianum*, the crappie, *Pomoxis annularis*, and the white bass, *Roccus chrysops*, which goes to prove that these fish at least serve as occasional hosts.

Remarks.—This species was established in 1907 upon 20 specimens taken from a sucker at Montpelier, Vt., and both sexes were fully described and figured in the reference above given. All that can be added here is a few data with reference to the color. Both sexes when alive are a transparent creamy white, covered on the dorsal surface of the carapace and abdomen with opaque white dots, circular in

outline, very minute and thickly scattered, especially near the margin of the carapace. On the carapace there are also blotches of pale reddish brown, much larger than the white spots and more widely scattered. Each blotch has a small spot near the center where there is no pigment; immediately around this spot the pigment is deeper in color and pales gradually toward the edges. The dorsal surface of the thorax over the eggs is a rich golden yellow, thickly streaked with longitudinal rows of purplish brown blotches, smaller than those on the carapace, deeper in color, more uniform in size, and more regular in shape. Most of these blotches also have small circular spots free from pigment, sometimes two to four in the same blotch and of different sizes. The eyes are deep golden yellow, each separate facet with a dark purple center. The sperm receptacles are golden yellow.

Although the species was originally found outside of the Mississippi Valley, there seems to be no doubt that it belongs here. Its wide distribution and the variety of hosts show that its range is universal throughout the eastern and central United States.

Argulus ingens Wilson.

Argulus ingens Wilson, Proc. U. S. Nat. Mus., vol. 42, p. 233, pl. 30.

Host and record of specimens.—Both sexes of this species were obtained from the alligator gar, *Lepisosteus trisioechus*, at Moon Lake, Miss.

No alligator gars were captured during the present summer, but they are fairly common in the Mississippi River, and when carefully examined will probably yield specimens of this parasite.

Argulus nobilis Thiele.

Argulus nobilis Thiele, 1904, Mitteil. aus dem Zool. Mus. Berlin, II Band, 4 heft, p. 28, pl. 7, 8, fig. 64-76.

Host and record of specimens.—Thiele found six females and one male of this species among the specimens of the Berlin Zoological Museum; the name of the host upon the museum label was given as "*Lepidosteus aculeatus*." No such association of names is known in ichthyological literature, nor is there any hint as to whether the mistake was made in the generic or the specific name, so that we are left in a quandary as to its identification. Thiele suggested that it may have been "*L. viridis*," which is the name given by Günther to the alligator gar, but this was only a guess and was unaccompanied by any proof.

Remarks.—The present species differs from *ingens* in the relative size of the abdomen and carapace, in most of the details of the first and second antennæ, in the general structure and armature of the maxillipeds, and especially in the accessory sexual apparatus of the second and third swimming legs of the male. The two species resemble each other in their exceptionally large size, in the general form of the abdomen, and in the approximation of the two outer spines on the basal plate of the maxillipeds. Nothing is stated with reference to the respiratory areas of *nobilis*, but those of *ingens* are very peculiar.

If Thiele's conjecture that the alligator gar is the host of this species should prove true, it would greatly increase the probability that *ingens* and *nobilis* are synonymous, and Thiele's name would take precedence.

At present, however, there are so many specific differences, and the identity of the host is so uncertain, that we can only leave the species as described and await future developments.

Argulus maculosus Wilson.

Argulus maculosus, Wilson, Proc. U. S. Nat. Mus., vol. 25, p. 715, pl. 19.

Host and record of specimens.—The original types of this species were 11 females and 3 males, found unlabeled in the National Museum collection, and a single female from the muscalonge, *Esox nobilior*, at Clayton, N. Y. Since then two females were obtained from the red-eye, *Ambloplites rupestris*, at Lake Maxinkuckee, Ind., August 8, 1906, and a single female from the yellow catfish, *Ameiurus natalis*, August 22, from the same locality. Numerous specimens were subsequently obtained from the two catfish, *Ameiurus nebulosus* and *A. natalis*, at Lake Maxinkuckee, and these are evidently their true hosts. (Proceedings U. S. National Museum, vol. 32, p. 416).

Some egg strings were obtained from these last ripe females and have received catalogue no. 32826, U. S. National Museum; the newly hatched larvæ (catalogue no. 32822, U. S. National Museum) were fully described in the last reference above given.

Remarks.—There is nothing to add to the full descriptions already given. Only one mutilated specimen has yet been found from the Mississippi River, but as the two catfish are plentifully distributed throughout the valley no doubt more will be discovered in the future.

Argulus versicolor Wilson.

Argulus versicolor Wilson, Proc. U. S. Nat. Mus., vol. 25, p. 716, pl. 20; vol. 27, p. 643, fig. 22-33, text.

Host and record of specimens.—This species was originally obtained from the common pickerel, *Esox lucius*, at Warren, Mass. It was also found at other localities in the same State. A male and female were taken from the same host at Lake Maxinkuckee, Ind., August 15, 1906.

Remarks.—The single pair above mentioned are the only specimens of this species thus far found in the Mississippi Valley, but the host is one of the most widely distributed fish in America and other specimens should be discovered in the future. They are usually found inside the mouth or in the gill cavity and not on the outside surface.

Argulus catostomi Dana and Herrick.

Argulus catostomi Dana and Herrick, Amer. Jour. Sci., vol. 31, p. 297, unnumbered plate; Wilson, Proc. U. S. Nat. Mus., vol. 25, p. 709, pl. 13; vol. 32, p. 411, pl. 29.

Host and record of specimens.—This species was originally found upon a sucker near New Haven, Conn. It was taken by the present author from *Catostomus bostonensis* in Massachusetts, and from *C. catostomus* at Lake Maxinkuckee, Ind., and from *C. nigricans* and *C. catostomus* in the Missequoi River at Swanton, Vt. The Maxinkuckee specimens have been given catalogue no. 32820, U. S. National Museum.

Remarks.—Only one or two suckers were taken during the summer of 1914 and no specimens were found upon them, but the species is in the valley and is probably as widely distributed as its host.

Argulus americanus Wilson.

Argulus americanus Wilson, Proc. U. S. Nat. Mus., vol. 25, p. 718, pl. 21; vol. 27, p. 627, fig. 1-21, text.

Host and record of specimens.—Originally obtained by Prof. Reighard from *Amia calva* in the laboratory aquaria at Ann Arbor, Mich., this species was afterward found on the same host at Lake Maxinkuckee, Ind. (catalogue no. 32825, U. S. National Museum), and at Fairport, Iowa, August 26, 1912 (catalogue no. 43601, U. S. National Museum), and on *Umbra limi* in one of the aquaria at Fairport, Iowa, February 7, 1911 (catalogue no. 43529, U. S. National Museum).

Remarks.—This species is a great aquarium pest and thus is more likely to attract notice than some of the others. It is widely distributed throughout the valley but fortunately sticks closely to the dogfish for a host. Its presence on the mud minnow as above recorded was probably only temporary, and apparently it does not infest other fish.

Both sexes of the adults and the larvæ are fully described and figured in the references given above.

Argulus trilineatus Wilson.

Argulus trilineatus Wilson, Proc. U. S. Nat. Mus., vol. 27, p. 651, fig. 34-38, text.

Host and record of specimens.—The type was a female taken from goldfish in an aquarium at Macon, Ga. Another female was obtained by L. V. Lewis in a bowl of goldfish at Henderson, Ky., October 30, 1914, and sent to the National Museum for identification. It was afterward returned to Mr. Lewis.

Remarks.—In the reference given above the specific name ended in the letter "a" through an oversight of the author; it should end in "us" so as to agree with the genus name, and that change is here made.

It was gratifying to obtain a second specimen from Kentucky and thus to know that the species was a valid one and quite widely distributed. This latter location comes within the range of the present paper and so the species is here included.

Argulus funduli Krøyer.

Argulus funduli Krøyer, Naturhistorisk Tidsskrift, 3 Raekke, 2 bd., p. 92.

Host and record of specimens.—Krøyer found this species on the gills of a species of *Fundulus* near New Orleans. While this brings it into the Mississippi River, its host is a marine or brackish-water fish, and hence the parasite does not rightly belong among the fresh-water forms. The present author has found it repeatedly at Beaufort, N. C., and at Woods Hole, Mass., but always in salt water.

ERGASILIDÆ.

Ergasilus lanceolatus, new species. (Pl. LXVI, fig. 40-46.)

Host and record of specimens.—Twenty females with egg strings were obtained from the gills of the gizzard or hickory shad, *Dorosoma cepedianum*, at Lock 21 on the Cumberland River in Kentucky, July 16, 1911. This lot has been given catalogue no. 43555, U. S. National Museum, and from it has been selected a single female (catalogue no. 43556, U. S. National Museum) to serve as the type of the new species.

Specific characters of female.—General body form long and narrow, lanceolate; cephalothorax elliptical, one-half longer than wide, almost squarely truncated posteriorly, projecting a little anteriorly, with a small knob at the center of the anterior margin. First three free segments narrowed regularly backwards, the first of them (second segment) a little more than half the width of the carapace and about twice the width of the fourth segment; fifth segment very short and narrow; genital segment one-half wider than the fifth segment, with strongly convex sides. Abdomen the same width as the fifth segment, three-jointed, the basal joint longer than the others; anal laminae small, rectangular in outline, each armed with two setae, the inner of which is 7 or 8 times the length of the outer one.

First antennae six-jointed, the basal joint much longer than any of the others and armed with a very long, jointed seta, the other joints carrying shorter and simple setae. Second antennae not very large but powerful, basal joint short but much swollen and projecting strongly on the outer margin; second joint with a small stout spine near the center of the inner margin; terminal claw long, stout, and strongly curved.

The mouth parts project much more strongly than in any species thus far examined, both the upper and the under lips standing out prominently to form a long and sharp cone, from whose summit project on either side the long first maxillae. Mandibles exceptionally large and thickset, the terminal portion turned forward at right angles to the basal. The latter carries on its anterior margin, just outside the narrow neck, a bluntly rounded process projecting forward; the cutting blade is triangular in outline and armed with setae along its inner margin only.

The palp is exceptionally long; starting from the posterior corner of the basal joint and reaching nearly to the center of the cutting blade with a row of corrugations along its outer margin.

First maxillae small but projecting strongly, each armed with two plumose setae; second maxillae much smaller than the mandibles, but otherwise of the usual size and pattern. Endopods of the first, third, and fourth legs longer than the exopods; exopods of second legs longer than the endopods; all three joints of the endopods of the first legs and the two basal joints of the endopods of the second legs armed with minute teeth along their outer margins; exopod of fourth legs two-jointed, the basal joint twice the length of the terminal one. The arrangement of spines and setae is as follows: First exopod, 1-0, 0-0, II-5; endopod, 0-1, 0-1, II-4; second exopod, III-0, I-1, I-6; endopod, 0-1, 0-2, I-4; third exopod, I-0, 0-1, 0-6; endopod, 0-1, 0-2, I-4; fourth exopod, 0-0, I-4; endopod, 0-1, 0-1, I-2.

The egg strings when first extruded are conical, largest at the base and tapering to a single egg at the tip; when fully developed they are cylindrical and considerably shorter than the body; eggs in 5 or 6 rows, about 10 eggs in a row.

Color (preserved material), a uniform light brown without pigment markings.

Total length, 1 mm.; cephalothorax, 0.60 mm. long, 0.40 mm. wide. Length of egg strings, 0.60 to 0.80 mm.

(*lanceolatus*, lanceolate, alluding to the general body shape.)

Remarks.—This species is not associated as yet with any glochidium, but may well take the place of *caeruleus* or *centrarchidarum* or *versicolor*.

Its presence on the shad indicates that this fish would make a good host for some of the gill glochidia as well as for those already found upon its fins. Like other parasites found upon the herrings and their close relatives, this species does not infest any fish except its immediate host, and hence it is not likely to be found except on the gizzard shad.

Ergasilus nigrilus, new species. (Pl. LXVII.)

Host and record of specimens.—Ten females, most of them with egg strings, were obtained from the gills of the largemouth bass *Micropterus salmoides*, in the Mississippi River at Fairport, Iowa, July 20, 1914. They have received catalogue no. 43562, U. S. National Museum, and become cotypes of the

new species, while a single female (catalogue no. 43561, U. S. National Museum) has been selected to serve as the type.

Specific characters of female.—General body form short and squat; cephalothorax three-quarters of the entire length, one-fifth longer than wide, and strongly flattened dorsoventrally; dorsal surface moderately convex, ventral surface flat, with the mouth projecting but little, if any.

Antennal area rectangular in outline with rounded corners and projecting strongly anteriorly, so that the bases of both pairs of antennæ are carried in front of the body of the carapace. This latter is about as long as wide, is slightly narrowed posteriorly, and shows a distinct dorsal groove and marginal sinus separating the head from the first thorax segment, which is only one-fifth the length of the head. Second (first free) segment abruptly narrowed to half the width of the first and very short; remaining thorax segments also short and narrowed regularly backward; fifth segment concealed dorsally between the fourth and genital segments; the latter considerably wider and three times the length of the fourth segment, with strongly convex sides. Abdomen three-jointed, joints about the same length but narrowing posteriorly and indistinctly differentiated; anal laminæ small and rectangular, each bearing two setæ, of which the inner one is twice the length of the outer, and about the same length as the free thorax and abdomen.

Egg strings ovate and strongly divergent, only one-fourth longer than wide, and so much inflated that they meet dorsally at the midline; eggs large, arranged in eight or nine longitudinal rows, about seven eggs in the longest rows. First antennæ six-jointed, the penultimate and basal joints longer than the others and all the joints heavily armed with setæ; second antennæ long and stout, the basal joint much inflated and quite convex externally, the terminal claw stout and strongly curved.

Mouth parts rather small and effectively concealed beneath the upper lip, not projecting as in other species but flattened with the rest of the ventral surface. Mandibles with a narrow cutting blade, armed with setæ along the inner margin only; palp about as long as the cutting blade, armed with setæ or toothed along the posterior margin.

First maxillæ with a large base and two stout setæ; second maxillæ with a straight cutting blade, fringed with setæ along both margins, basal joint large and rectangular. Endopods of first and fourth legs much longer than exopods, the two rami of the second and third legs equal; exopod of fourth legs two-jointed. The arrangement of the spines and setæ is as follows: First exopod, I-0, 0-1, II-5; endopod, 0-1, 0-2, I-4; second exopod, I-0, 0-1, 0-6; endopod, 0-1, I-2, 0-5; third exopod, 0-0, 0-1, 0-5; endopod, 0-1, 0-2, 0-5; fourth exopod, 0-0, 0-4; endopod, 0-1, 0-2, 0-5.

Color (preserved material), young females a uniform creamy white without pigment; in later development black pigment appears in scattered spots on the dorsal surface of the carapace and gradually covers the entire copepod, including even the swimming legs and anal laminæ and setæ but not the second antennæ.

Total length, 0.70 mm.; carapace, 0.50 mm. long, 0.40 mm. wide. Egg strings, 0.35 mm. long, 0.23 mm. wide.

(*nigritus*, blackened.)

Remarks.—This tiny species may be recognized at once by the jet-black color of the mature adults and by the very short and thickset egg strings.

It can not be very common, since only the single lot has been obtained from many hundreds of largemouth black bass which have been examined for copepod parasites. It seems to take the place on this bass of *cæruleus* upon the other Centrarchidæ, being associated with *Lampsilis* glochidia.

***Ergasilus megaceros*, new species.** (Pl. LXVI, fig. 49; pl. LXVIII, fig. 57-61.)

Host and record of specimens.—Four females, two of which had egg strings, were taken from the lamellar plates in the nasal fossæ of a Fulton cat, *Ictalurus anguilla*, captured at Fairport, Iowa, May 16, 1914. Three of these specimens have been given catalogue no. 43548, U. S. National Museum, and become cotypes of the new species, the fourth and best one (catalogue no. 43544, U. S. National Museum) becoming the type.

Specific characters of female.—General body form long and slender; cephalothorax ovate, one-half longer than wide, narrowed and pointed anteriorly, squarely rounded posteriorly; first thorax segment as wide and half as long as the head and separated from the latter by marginal sinuses and a distinct dorsal groove; eye far forward just behind the bases of the first antennæ; thorax segments diminishing regularly in size backward, the fifth one very short; genital segment the same width as the fourth seg-

ment, with strongly convex sides. Abdomen three-jointed, the joints all about the same width and length; anal laminae nearly as long as the entire abdomen, narrow and enlarged at the tip into a rounded knob on the outer margin, each tipped with two long plumose setae, the inner of which is one-half longer than the outer. Egg strings elongate ellipsoids, a little shorter than the cephalothorax; eggs large, arranged in 6 or 7 longitudinal rows, about 8 eggs in the longest rows.

First antennae exceptionally large, six-jointed, the jointing indistinct, the fourth segment carrying on the inner distal corner a huge jointed seta, which reaches back to the center of the second thorax segment; the terminal joint is tipped with another huge seta, unjointed but nearly as long as the jointed one. Second antennae also long but slender, the terminal claw bluntly rounded. Mouth tube protruding strongly; mandibles with a short neck and cutting blade, turned forward diagonally; palp long and narrow and armed along its inner margin with short bristles.

First maxillae of the usual pattern; second maxillae meeting on the midline, the cutting blade short and small and armed with a few sharp spines. Endopods of the first and fourth legs longer than the exopods; rami of the other legs equal; arrangement of the spines and setae as follows: First exopod, 1-0, 1-1, 1-6; endopod, 0-1, 0-1, 0-6; second exopod, 1-0, 1-1, 1-5; endopod, 0-1, 0-2, 1-4; third exopod, 1-0, 1-1, 1-5; endopod, 0-1, 0-2, 1-4; fourth exopod, 1-0, 1-4; endopod, 0-1, 0-2, 1-3.

Color, a transparent yellowish white, oviducts white, egg tubes yellow, the ventral surface of the carapace and thorax covered with irregular patches of a light sky-blue pigment.

Total length, 1 mm.; carapace, 0.50 mm. long, 0.40 mm. wide; first antennae, including setae, 0.60 mm. long. Egg strings, 0.40 mm. long.

(*megaceros*, μέγας, large, and κέρα, horn, alluding to the large first and second antennae.)

Remarks.—So far as known, this is the first parasitic copepod to be found in the nasal fossae of any fresh-water fish. They are common in both the nasal fossae and spiracles of salt-water fish, sharks, and rays, and probably the reason why they have never been found in fresh-water fish is simply because they have never been looked for. The nostrils of this catfish were only quarter of an inch in diameter, and hence the ergasilid larva must do some strenuous hunting to find its chosen place on the host. It is more than likely that the examination of similar fossae on other large fresh-water fish will yield specimens of this or similar species. Being found thus in the nose, the species can not be associated in any way with mussel glochidia, but its presence emphasizes the testimony of those species found on the gills, that the Fulton cat would make a good host for glochidia. If the ergasilid larva can find its way into the nose of these fish, it is possible that the mussel glochidium can perform the same feat. At all events it will be worth while to examine the nose of large fishes for both copepods and glochidia.

***Ergasilus elongatus*, new species.** (Pl. LXVI, fig. 47, 48; pl. LXVIII, fig. 62-66.)

Host and record of specimens.—Twenty-five females with egg strings were obtained from the gill rakers of the spoonbill cat, *Polyodon spathula*, from the Mississippi River at New Boston, Ill., July, 1914, catalogue no. 47764, U. S. National Museum. Thirty females from the same host at Keokuk, Iowa, August 28, 1914, catalogue no. 47763, U. S. National Museum. A single female (catalogue no. 47765, U. S. National Museum) has been selected from this last lot to serve as the type of the new species. Sections of two gills of the same fish, with specimens of the species in situ, have received catalogue no. 47762, U. S. National Museum.

Specific characters of female.—General body form an elongate ovoid, the larger end anterior; cephalothorax one-half longer than the rest of the body, widest at its center, strongly tapered anteriorly, almost squarely truncated posteriorly. Antennal area reaching the entire width of the anterior end and distinctly separated from the rest of the head.

Free thorax segments diminishing regularly in width and length from in front backwards; fifth segment plainly visible and half the width of the fourth; genital segment barrel shaped, its sides moderately projecting. Abdomen segments the same length but diminishing regularly in width; anal laminae half as long again as the last abdomen segment, narrow with square corners, each tipped with two short setae, the inner of which is one-half longer than the outer. Egg strings to the entire length of the body as 8 to 11, rather narrow; eggs arranged in 6 or 7 longitudinal rows, about 25 in the longest rows.

First antennae rather slender and short, six-jointed, and sparsely armed with setae; second antennae also short but stout, not long enough to reach more than halfway around the gill raker, but clasping it so tightly as to make a groove in it. Mouth tube exceptionally far forward and not projecting as strongly as in most species; upper lip rather square, and entirely covering the mouth parts. Mandibles as large

as the second maxillæ, cutting blade turned forward at right angles to the base, very wide and armed with setæ along both margins; palp short and narrow, with a row of comblike teeth along its inner margin. First maxillæ small and inconspicuous, not visible in side view owing to the fact that they are covered by the upper lip; second maxillæ small, the cutting blade narrow and armed with setæ along both margins. This species resembles *elegans* in having the endopod of the first legs as well as the exopods of the fourth pair two-jointed.

The arrangement of the spines and setæ is as follows: First exopod, I-0, I-2, III-5; endopod, 0-1, II-6; second exopod, I-0, I-1, I-7; endopod, 0-1, 0-2, I-5; third exopod, I-0, II-0, I-5; endopod, 0-1, 0-2, II-5; fourth exopod, 0-0, I-5; endopod, 0-1, 0-2, I-4. The oviducts are so arranged that when filled with ripening eggs they do not distort the shape of the cephalothorax as in other species.

Color, a transparent grayish white, oviducts and egg strings dark yellow, ventral surface covered with an interlaced network of lines and patches of indigo blue.

Total length, 1.40 mm.; cephalothorax, 0.85 mm. long, 0.30 mm. wide. Egg strings, 1 mm. long. (*elongatus*, elongate, alluding to the general body form.)

Remarks.—This species is unique in its general body form as well as in its habitat and may be recognized by either peculiarity. It will be remembered that in the paddle fishes, to which the spoonbill cat belongs, the gill rakers are very long and slender and in a double series on each gill arch, the series separated by a broad membrane. These copepods were fastened to the rakers, sometimes on the outside, sometimes on the inside between the raker and the membrane, with their head indifferently in either direction, toward the arch or away from it, and the short but stout second antennæ grasped the raker firmly enough to make around it a groove from which the copepod could not be separated except by cutting the raker close to the antennæ.

So far as known this is the only instance of any of the Ergasilidæ fastening itself to the bony gill rakers instead of the soft filaments, and this makes the strength of the attachment the more worthy of notice.

Apparently this species is not connected with any glochidium, but this may be changed later when the spoonbill cat has been further and more extensively examined. The body is fully as thick as it is wide and the carapace fits snugly on the general contour, giving the copepod a peculiarly clean and graceful appearance.

Ergasilus elegans, new species. (Pl. LXIX, fig. 67-73.)

Host and record of specimens.—This species was captured several times in the tow at Patterson Lake and "Sunfish Lake" before it was found on any fish host; these free-swimming specimens have been given catalogue no. 47767, U. S. National Museum, and are all without egg strings. A second lot with egg strings was obtained from the gills of the bullhead, *Ameiurus melas*, caught in "Sunfish Lake," August 24, 1914; they have been numbered catalogue no. 47768, U. S. National Museum. A single female has been selected from this lot to serve as the type of the new species, with catalogue no. 47769, U. S. National Museum. A few were also obtained from the gills of the long-nosed gar, *Lepisosteus osseus*, in the Mississippi near Fairport, Iowa, catalogue no. 47766, U. S. National Museum. Others were found on the gills of the short-nosed gar, *L. platostomus*, from Patterson Lake, August 6, 1914.

Specific characters of female.—General body form elongate; cephalothorax one-half longer than wide, the first thorax segment distinctly separated from the head and somewhat narrower; carapace well rounded and scarcely projecting anteriorly; antennal area poorly differentiated.

Second, third, and fourth thorax segments about the same length and diminishing regularly in width, fifth segment scarcely visible; genital segment barrel-shaped, with moderately projecting sides. Abdomen three-jointed, joints about the same length but diminishing slightly in width; anal setæ as long as the last two segments, twice as long as wide, with square corners, each tipped with two setæ, a longer, jointed one at the inner corner, and a shorter oblique one at the outer corner.

Egg strings less than half the length of the body and rather wide; eggs exceptionally large and arranged in two rows, 15 or 18 eggs in each string. First antennæ six-jointed and heavily armed with setæ; second antennæ very long and slender, basal joint short and not swollen; second joint and terminal claw the same length, the former with a small spine on its ventral surface, the latter bent into a half circle. Mandibles with a rectangular base abruptly narrowed into the neck, which is half as long as the base and is tipped with a triangular cutting blade, heavily fringed with setæ around its entire margin; palp as long as the cutting blade, narrow and armed along the inner margin with a row of heavy, comblike

teeth. First maxillæ small but protruding well and armed with long setæ; second maxillæ with a broadly triangular blade, fringed only along its posterior margin; muscles and rudiments of the maxillipeds present behind the second maxillæ; lower lip a small narrow, semicircular plate behind the tips of the second maxillæ. Endopod of the first swimming legs and exopod of the fourth legs two-jointed; all the other rami three-jointed; arrangement of the spines and setæ as follows: First exopod, 1-0, 0-1, 11-5; endopod, 0-1, 11-5; second exopod, 1-0, 0-1, 1-6; endopod, 0-1, 0-2, 1-4; third exopod, 1-0, 0-1, 1-5; endopod, 0-1, 0-2, 1-4; fourth exopod, 1-0, 1-5; endopod, 0-1, 0-2, 1-3.

Ground color that of transparent cartilage, covered over the entire ventral surface with large irregular patches of deep purplish blue; these coalesce into a line along either side of the digestive tract, which latter is a rich golden yellow; on the bases of the antennæ and mouth parts, around the eyes, and outside the blue line in the genital segment are patches of pale brick red; the compound eye is dark purple.

Total length, 1.25 mm.; cephalothorax, 0.60 mm. long, 0.40 mm. wide. Egg strings, 0.50 mm. long. (*elegans*, elegant, neat in appearance.)

Remarks.—This species closely resembles *versicolor*, but can be readily distinguished by the two-jointed endopod of the first legs. From all the other species it is at once distinguished by its varied coloration, as well as by its free-swimming habits. It is associated with *Lampsilis anodontoides*, the yellow sand-shell, and apparently with no other glochidia. Accordingly it is likely to be found upon the alligator gar at the right season.

In swimming the large second antennæ are folded like arms across the thorax, and neither they nor the first antennæ are used for locomotion.

Movement is accomplished entirely by means of the swimming legs and consists of a series of rapid dashes, without any particular direction.

These movements are swifter and they carry the copepod many times farther than those of the regular free-swimmers, so that if the tow be placed in a large shallow glass these free-swimming parasites can be at once detected by their movements. Apparently this species swims about freely in the slews until its eggs are ripe, since the females obtained from the tow are fully as large as those from the fish.

Like the young *Arguli* they frequent the surface in the daytime and sink to lower depths at night, and they must fasten upon the fish when fully matured rather than in a larval stage.

Ergasilus cæruleus Wilson. (Pl. LXIX, fig. 74.)

Ergasilus cæruleus Wilson, Proc. U. S. Nat. Mus., vol. 39, p. 334, pl. 43.

Host and record of specimens.—When this species was established it was found only upon bluegills in Tippecanoe Lake and Twin Lakes, Ind. Here in the Mississippi River, however, it is extremely abundant; its chief hosts are the two crappies, *Pomoxis annularis* and *P. sparoides*.

From the former lots have been obtained which have received catalogue no. 43531, 43535, 43530, 43532, U. S. National Museum; from the latter the lots are catalogue no. 43545, 43514, U. S. National Museum. Catalogue no. 43541, U. S. National Museum, contains a set of gills just as they were taken from *P. annularis*, with the parasites preserved in situ, and nearly 500 of them upon the single fish.

A single female (catalogue no. 43538, U. S. National Museum) was obtained from the blue-spotted sunfish, *Apomotis cyanellus*; several (catalogue no. 47774, U. S. National Museum) were taken from the bluegill, *Eupomotis gibbosus*, captured near Fairport, Iowa; two were found on the sauger, *Stizostedion canadense* (catalogue no. 47776, U. S. National Museum); three on the gills of the white bass, *Roccus chrysops* (catalogue no. 47777, U. S. National Museum); and one on the gills of the long-nosed gar, *L. osseus*. These fish were all captured in the Mississippi River at or near Fairport during the present season.

Newly hatched nauplius larva.—Some of the females obtained on August 14 were carrying eggs whose blue color showed that they were ready to hatch. These were accordingly placed in a suitable aquarium and all hatched out on the following day. The issuing nauplius proved to be quite similar to that of *Ergasilus centrarchidarum*, but with these differences:

General body form ovate, considerably narrowed and pointed posteriorly, and nearly twice as long as wide; the knob at the posterior end, the future abdomen, is much larger than in *centrarchidarum* and projects farther. The three pairs of appendages are similar in all their general features to those of the other Ergasilidæ and differ only in little details. The basal joint of the first pair is somewhat swollen; the masticatory process on the second pair is proportionally large and carries a very long spine which is not much curved; the lamina shaped like the blade of a case knife, found upon the endopod of the third appendages, is sometimes jointed and is relatively large.

The upper lip is diamond shaped, considerably longer than wide, the anterior end well rounded, the posterior end pointed, and reaching some distance behind the masticatory processes of the second antennæ.

The balancers at the posterior end of the body are straight instead of curved and stand at an angle of about 45 degrees with the body axis.

Remarks.—The large numbers (500 or more) of specimens found upon a single fish are worthy of notice; in some instances it does not seem as if any more could be crowded upon the gills, three or four copepods being found, one above another, upon the same filament. Like the original specimens from the bluegills, they are always found on the inner side of the gill filament, between the rows of filaments on the same arch.

Here in the Mississippi Valley the two crappies are evidently the chief hosts of the species and it is worthy of note that they are vegetable feeders like the bluegill. This species of *Ergasilus* therefore may be fairly regarded as a parasite of the vegetarian Centrarchidæ.

It is also worth recording that of the many hundreds of *cæruleus* examined every one was scrupulously clean; there were no protozoa or algæ upon any of the specimens. This is in marked contrast to the following species from the catfishes, nearly every specimen of which is covered with these parasites. The present species is associated with the *Lampsilis* group of glochidia and has been found upon every species of fish that serve as hosts for these glochidia except the sheepshead and the largemouth black bass, on which latter fish it is replaced by *E. nigrilus*, a new species.

Ergasilus versicolor Wilson.

Ergasilus versicolor Wilson, Proc. U. S. Nat. Mus., vol. 39, p. 341, pl. 45.

Host and record of specimens.—Originally found upon two species of catfish at Lake Maxinkuckee, Ind., this ergasilid proves to be even more abundant upon the catfishes of the Mississippi, and the following lots were obtained during the summer: Catalogue no. 43558, U. S. National Museum, from the gills of the skipjack, *Pomolobus chrysochlorus*, taken in Lake Pepin and sent to Fairport July 23; catalogue no. 47770, U. S. National Museum, from the gills of the channel cat, *Ictalurus punctatus*, taken at Fairport July 25; catalogue no. 43533, U. S. National Museum, from gills of channel cat taken at Fairport September 2, 1910; catalogue no. 43560, U. S. National Museum, from gills of the bullhead, *Ameiurus nebulosus*, taken in Patterson Lake July 3; catalogue no. 43509, U. S. National Museum, from gills of the Fulton cat, *Ictalurus anguilla*, taken at Fairport May 14, 1914.

Remarks.—All these specimens except those included in no. 47770 were heavily infested with parasitic protozoa and fresh-water algæ, and some were so thoroughly covered as to be effectively concealed. This is probably due in part to the feeding habits of their hosts, all of whom stick close to the mud at the bottom of the river.

The species is associated with the *Quadrula* group of glochidia and in all probability will be found upon *Leptops olivaris*, the mud cat.

Ergasilus centrarchidarum Wright.

Ergasilus centrarchidarum Wright, Proc. Canadian Institute, n. s., vol. 1, p. 243, pl. 1; Wilson, Proc. U. S. Nat. Mus., vol. 39, p. 331, pl. 42.

Host and record of specimens.—In addition to those found upon various hosts at Lake Maxinkuckee, Ind., and recorded in the last reference given above, the following lots were obtained during the past summer: Catalogue no. 43507, U. S. National Museum, from the gills of *Pomoxis annularis*, taken in the Mississippi at Fairport, May 25, 1910; catalogue no. 43537, U. S. National Museum, from the gills of the largemouth black bass, *M. salmoides*, taken in Crooked S Slew, Fairport, May 26, 1910; catalogue no. 47778, U. S. National Museum, from the gills of the white bass, *Roccus chrysoops*, taken at Fairport, August 6; catalogue no. 47775, U. S. National Museum, from the gills of the sauger, *S. canadense*, taken at Fairport, August 14; catalogue no. 47779, U. S. National Museum, from the gills of the largemouth black bass, taken in Patterson Lake, August 6; catalogue no. 47780, U. S. National Museum, from the gills of the warmouth, *Chænobryttus gulosus*, taken in Patterson Lake, August 6. A single female was also obtained from the gills of the green sunfish, *Apomotis cyanellus*, taken at Fairport, August 10.

Remarks.—This species is frequently associated with *cæruleus* upon the same host, but the two can always be separated by their position on the gill filaments; *centrarchidarum* is always on the outside, while *cæruleus* is as constantly on the inside between the two rows of filaments, and no exception has yet been found to this rule.

This species is associated with glochidia of the *Quadrula* group, and its presence in considerable numbers upon any fish indicates that its host would make a good carrier of *Quadrula* glochidia. It is worthy of note that these two species, *centrarchidarum* and *cæruleus*, which accompany the two groups of glochidia, are associated upon those fish which serve as hosts for the glochidia and are often found together, while *centrarchidarum* and *versicolor* are never found upon the same fish although they accompany the same group of glochidia.

***Ergasilus chautauquaensis* Fellows.**

Ergasilus chautauquaensis Fellows, Proc. Amer. Soc. Microscopists, vol. 9, p. 246, 1 plate, unnumbered; Wilson, Proc. U. S. Nat. Mus., vol. 39, p. 343, pl. 46.

Host and record of specimens.—This species was originally discovered in the tow of Lake Champlain and both sexes were afterwards found by the present author in some samples of tow from Lake Mendota at Madison, Wis.; these specimens received catalogue no. 38617, U. S. National Museum. It has not thus far been found upon any fish, but in all probability its habits are like those of the new species *elegans*. The males are free-swimmers throughout life and the females swim freely until their eggs are ready to pass out into the external sacks. The present species will probably be found at another time of year upon the gills of some fish in Lake Champlain or Lake Mendota.

***Ergasilus funduli* Krøyer.**

Ergasilus funduli Krøyer, Naturhistorisk Tidsskrift, (3), vol. 2, p. 228, pl. 11, fig. 1, a-f; Wilson, Proc. U. S. Nat. Mus., vol. 39, p. 328.

Host and record of specimens.—Krøyer found a few specimens of this species on the gills of *Fundulus ocellaris* (*F. limbatus* Krøyer) taken near New Orleans in the Mississippi River. This is another of the marine or brackish water fish that comes up the river a little ways, but its parasites can not be regarded as true fresh-water species.

***Ergasilus lizæ* Krøyer.**

Ergasilus lizæ Krøyer, Naturhistorisk Tidsskrift, (3), vol. 2, p. 232; Wilson, Proc. U. S. Nat. Mus., vol. 39, p. 340.

Host and record of specimens.—This is another species captured by Krøyer near New Orleans on the gills of *Mugil curema* (*M. liza* Krøyer). Like the preceding, it can not be regarded as a true fresh-water species, neither have any further specimens ever been found.

LERNEOPODIDÆ.

***Salmincola californiensis* (Dana). (Pl. LXX.)**

Lernæopoda californiensis Dana, U. S. Exploring Expedition during the years 1838 to 1842, vol. 12, p. 1379, pl. 96, fig. 1a, 1b. *Salmincola californiensis* Wilson, Proc. U. S. Nat. Mus., vol. 47, p. 605.

Host and record of specimens.—Eight females were obtained from the gills of *Oncorhynchus nerka* at Big Payette Lake, Idaho, June, 1914, and were sent to the author from the United States Bureau of Fisheries. They have received catalogue no. 43563, U. S. National Museum, and since Dana's original specimens have been lost they will serve as surrogate types of the species.

Specific characters of female.—Dana's original description and figures were excellent as far as they went, but he included only the general body characters and no appendages were mentioned except the second maxillæ.

These new specimens show a wider and shorter body, strongly flattened on the ventral surface, and in the larger females showing distinct ventral grooves of segmentation. The cephalothorax is inclined nearly at right angles to the trunk; the contour of its dorsal surface is clearly shown in figure 77 and is very different from that of any other species of the genus, approaching most closely that of *salmonea*.

The first antennæ are very short, apparently three-jointed, and tipped with a minute spine; the second antennæ are long and stout, the basal portion two-jointed, the rami one-jointed and about the same size, the exopod tipped with a fairly large chela, the endopod with two or three small spines; on the ventral surface of the exopod near the base of the chela is a peculiar compound spine. The mandibles are long and slender, with strongly hooked teeth; the first maxillæ are short, somewhat swollen at the center, and end in three small spines of about the same size; the second maxillæ in younger specimens are smooth and longer than the trunk, in older females much wrinkled and shorter than the trunk. The maxillipeds are large and stout, the basal joint considerably swollen and armed on its inner margin

near the distal end with a small papilla like those in other species; the terminal joint is slender and is tipped with a larger and a smaller claw, somewhat like a chela.

Total length (larger specimens), 4.40 mm.; cephalothorax, 1.60 mm. long, 2.40 mm. wide; trunk, 2.75 mm. long, 3.30 mm. wide. Egg strings, 5.40 mm. long, 1.25 mm. wide. Bulla 1.65 mm. in diameter.

Remarks.—It is gratifying to obtain new specimens of Dana's species, probably from the same host. They confirm his description in all its essential features and enable us to supply the details of the appendages which were lacking. They also establish the species beyond any doubt, as is shown by the dorsal contour of the cephalothorax, the general body form and proportions, and the details of the mandibles, second antennæ, and first maxillæ.

Salmincola siscowet (Smith).

Lernæopoda siscowet Smith, Report U. S. Commissioner Fish and Fisheries for 1872-73, pt. 2, p. 664, pl. 3, fig. 15, 16; Wilson, Proc. U. S. Nat. Mus., vol. 47, p. 608, pl. 30, fig. 23-29.

Host and record of specimens.—Seven females were taken from the gills of *Cristivomer namaycush siscowet* at Outer Island, Lake Superior, by J. W. Milner; they are numbered 39597, U. S. National Museum.

Salmincola edwardsii (Olsson).

Lernæopoda edwardsii Fasten, Report Wisconsin Commissioners of Fisheries for 1911-12, p. 11, 4 unnumbered plates; Biol. Bull., vol. 27, p. 116, pl. 1-3.

Salmincola edwardsii Wilson, Proc. U. S. Nat. Mus., vol. 47, p. 609, pl. 30, fig. 30-35.

Host and record of specimens.—Twenty-five females (catalogue no. 43574, U. S. National Museum) from gills of brook trout, *Salvelinus fontinalis*, at Wild Rose, Wis. Others have been obtained from the same host at Caledonia, N. Y.; Houghton, Mich.; Northville, Mich.; St. Paul, Minn.

Remarks.—This species often causes serious trouble in fish hatcheries, loading the gills of the trout until they are suffocated and large numbers of them perish. Each of the lots mentioned above have come from hatcheries thus afflicted, and Fasten's first paper gives an excellent account of the disease produced in brook trout by this parasite.

Salmincola oquassa Wilson.

Salmincola oquassa Wilson, Proc. U. S. Nat. Mus., vol. 47, p. 611, pl. 31, fig. 36-40.

Host and record of specimens.—Five females were obtained from the blueback trout, *Salvelinus oquassa*, at Rangely Lakes, Me., November 27, 1884; they have received catalogue no. 39604, U. S. National Museum.

Salmincola bicauliculata (Wilson).

Lernæopoda bicauliculata Wilson, Proc. U. S. Nat. Mus., vol. 35, p. 472, pl. 82.

Salmincola bicauliculata Wilson, idem, vol. 47, p. 612, pl. 31, fig. 41, 42.

Host and record of specimens.—A single female was taken from a "trout" at Mapleton, Oreg., by Dr. S. E. Meek in 1896 and has received catalogue no. 38575, U. S. National Museum.

Salmincola falculata (Wilson).

Lernæopoda falculata Wilson, Proc. U. S. Nat. Mus., vol. 35, p. 473, pl. 83.

Salmincola falculata Wilson, idem, vol. 47, p. 613, pl. 31, fig. 43, 44.

Host and record of specimens.—Four females from the gills of *Oncorhynchus nerka* at Baker Lake, Wash., in 1902, catalogue no. 38586, U. S. National Museum. Three other lots were obtained by the Bureau of Fisheries from trout in California, catalogue no. 38588, 38589, 38590, U. S. National Museum.

Salmincola inermis (Wilson).

Lernæopoda inermis Wilson, Proc. U. S. Nat. Mus., vol. 39, p. 632, pl. 68.

Salmincola inermis Wilson, idem, vol. 47, p. 614, pl. 32, fig. 47-51.

Host and record of specimens.—This species has been found abundantly upon the lake herring, *Argyrosomus artedi*, in Lakes Huron and Superior and in rivers running into them.

Salmincola beani (Wilson).

Lernæopoda beani Wilson, Proc. U. S. Nat. Mus., vol. 35, p. 470, pl. 81.

Salmincola beani Wilson, idem, vol. 47, p. 615, pl. 32, fig. 52, 53.

Host and record of specimens.—Found in considerable numbers on the gills of the quinnat salmon, *Oncorhynchus tshawytscha*, in McCloud River, Cal., and at Battle Creek, Colo.

Salmincola carpenteri (Packard).

Achtheres carpenteri Packard, Annual Report U. S. Geol. and Geog. Survey of the Territories for 1873, p. 617, 1 text figure.
Salmincola carpenteri Wilson, Proc. U. S. Nat. Mus., vol. 47, p. 616, pl. 33, fig. 54-60.

Host and record of specimens.—From the gills of "trout" in a tributary of the East River, Colo., and from "salmon" at Battle Creek, Colo.; the former host has been identified by R. R. Gurley as *Salmo mykiss*.

Remarks.—Neither this nor any of the other species of the genus have ever been found associated with any glochidium, but not because the two are uncongenial. Very few, if any, of the species of trout and salmon have been examined for glochidia, because usually the streams and lakes in which they live are inhabited by only a few mussels, none of which are of any value commercially. Furthermore, neither of the two kinds of fish are found in those localities where artificial infection has been tried, and thus there has been no chance to ascertain whether they will take the glochidia or not. But the susceptibility of these fish to copepod parasites would lead us to suppose that they would make good hosts for glochidia. In all probability future examination will discover glochidia upon some of them, and if artificial propagation is tried in lakes as well as rivers there would seem to be no reason why these fish could not be used as carriers for the glochidia.

Achtheres pimelodi Krøyer. (Pl. LXXI.)

Achtheres pimelodi Krøyer, Naturhistorisk Tidsskrift, 3 Raekke, 2 bd., p. 272, pl. 17, fig. 5a, 5b; Wilson, Proc. U. S. Nat. Mus., vol. 47, p. 628, pl. 38.

Host and record of specimens.—Both sexes have been obtained from the gill arches of various catfish; from *Ictalurus punctatus* at Cincinnati, Ohio; from *Ameiurus nebulosus* at Put-in Bay, Ohio; from *Ictalurus anguilla* and *Leptops olivaris* at Fairport, Iowa. From the former of the last two a female was obtained and numbered 47726, U. S. National Museum; from the latter a female with ripe eggs, which has been given catalogue no. 47771, U. S. National Museum.

First copepodid larva.—The egg strings of the ripe female just mentioned were detached and the larvæ hatched out in an aquarium, August 22, 1914. These larvæ differed in several important particulars from those of *ambloplitis* already described (Proceedings U. S. National Museum, vol. 39, p. 208), as may be seen by the following:

Cephalothorax elliptical, the breadth to the length as 11 to 17, not enlarged anteriorly over the base of the second antennæ; head separated from the first thorax segment by lateral notches, but without a well-defined groove; posterior lobes large and evenly rounded. Attachment end of the filament exceptionally large, somewhat quadrate in dorsal view, and close to the frontal margin; coiled portion of the filament also unusually long and situated far back in the cephalothorax. Dorsal color patch about the same size as the attachment end of the filament, shield-shaped, and placed nearly at the center of the cephalothorax. Posterior portion of the body made up of four segments, all the same width, but diminishing in length backwards, the fourth one about one-third the length of the first, which latter carries on its sides, the rudiments of a third pair of swimming legs. Anal laminæ twice the length and more than half the width of the last segment, so that they overlap on the midline, each armed with two large sword-shaped, jointed setæ on the inner side and three shorter ordinary ones on the outer margin.

First antennæ four-jointed and heavily armed with setæ; second antennæ similar to those in *ambloplitis*; mandibles short and thickset, made up of a single spherical joint tipped with a stout spine and carrying a triangular palp on the outer margin. First maxillæ two-jointed, the basal joint spherical, the terminal one long and pointed; second maxillæ with a strongly swollen, almost spherical basal joint and a stout terminal claw, bent at right angles near its center; maxillipeds comparatively slender, with two unarmed joints and a stout curved claw. Swimming legs similar in all respects to those of *ambloplitis*, biramose, each ramus one-jointed, the exopods tipped with four plumose setæ, the endopods with six.

Total length, 0.45 mm.; width of cephalothorax, 0.20 mm.

Remarks.—The most noticeable differences between the present larva and that of *ambloplitis* are the lack of separation of the first thorax segment, the comparatively enormous attachment filament, the swordlike setæ on the anal laminæ, and the bulky, swollen form of the mandibles, first and second maxillæ. In the present larva also the mandibles have a rudimentary palp while the first maxillæ have none, the reverse being the case in *ambloplitis*. There are four patches of pigment, but the dorsal patch and the posterior ventral one are relatively much larger than the others, which are reduced to minute spots.

Achtheres corpulentus Kellicott.

Achtheres corpulentus Kellicott, Proc. American Soc. Microscopists, vol. 1, p. 54, pl. 1, fig. 1-3; Wilson, Proc. U. S. Nat. Mus., vol. 47, p. 619.

Host and record of specimens.—This species has been obtained from *Argyrosomus artedi* in Buffalo Harbor and Niagara River; from *A. prognathus* in Lake Ontario and Lake Michigan; from *A. hoyi* in Lake Michigan; and from *Coregonus clupeiformis* in Lake Erie.

Achtheres micropteri Wright.

Achtheres micropteri Wright, Proc. Canadian Institute, n. s., vol. 1, p. 249, pl. 2, fig. 1-11; Wilson, Proc. U. S. Nat. Mus., vol. 47, p. 620, pl. 34.

Host and record of specimens.—Found by Wright on the smallmouth black bass near Toronto, Canada, and by the present author on the same host in the Kankakee River, Ind.; also found upon the largemouth black bass in the Kankakee River and at Lake Maxinkuckee, Ind., and at Constantia, N. Y.

Remarks.—On the gills of the largemouth bass this species, together with *Ergasilus centrarchidarum*, is often associated with glochidia of the *Lampsilis* group. Thus far none of these glochidia have been found on the gills of the smallmouth bass, but since both of the copepod parasites are found there it is reasonable to believe that future search will reveal some of the glochidia. At all events, the presence of the copepods shows that both bass are good subjects for artificial infection.

Achtheres lacæ Krøyer.

Achtheres lacæ Krøyer, Naturhistorisk Tidsskrift, 3 Raekke, 2 bd., p. 348, pl. 17, fig. 6; Wilson, Proc. U. S. Nat. Mus., vol. 47, p. 622, pl. 35.

Host and record of specimens.—Found originally by Krøyer in the mouth of a North American perch, which he called "*Perca lacæ*," probably *P. flavescens*. Eight females were obtained from the gills of the striped bass, *Roccus lineatus*, in the Potomac River near Washington, D. C.

Remarks.—If Krøyer's specimens really came from *P. flavescens*, they were strictly fresh-water species; the striped bass, on the other hand, goes back and forth from fresh to salt water. This fact of course would make it of no use as a carrier of glochidia; none have ever been found upon its gills nor are they likely to be in the future.

Achtheres coregoni (S. I. Smith).

Lernæopoda coregoni Smith, Report U. S. Commissioner Fish and Fisheries for 1872-73, pt. 2, p. 664, pl. 3, fig. 17.
Achtheres coregoni Wilson, Proc. U. S. Nat. Mus., vol. 47, p. 623, pl. 36.

Host and record of specimens.—This species has been found upon the whitefish, *Coregonus clupeiformis*, in Lake Michigan, upon *Argyrosomus artedi* in the Niagara River, and upon *A. hoyi* in Lake Michigan. It has not yet been associated with any glochidium.

Achtheres ambloplitis Kellicott.

Achtheres ambloplitis Kellicott, Proc. American Soc. Microscopists, vol. 1, p. 56, pl. 3, fig. 6, 7; Wilson, Proc. U. S. Nat. Mus., vol. 47, p. 626.

Host and record of specimens.—Found on the red-eye, *Ambloplites rupestris*, at Lake Maxinkuckee, Ind., and in the Shiawasse River, Mich., and upon "redfish" at Big Payette Lake, Idaho.

Remarks.—This species is associated with *Lampsilis* glochidia on the gills of the red-eye, and its presence indicates that these fish are good hosts for artificial infection, as has been proved by actual experiments.

LERNÆIDÆ.

Lernæocera variabilis, new species. (Pl. LXXII.)

Host and record of specimens.—Ten females were obtained from the scales and flesh of *Lepomis pallidus* in Whisky Slew, Fairport, Iowa, July 10, 1912, and have received catalogue no. 47727, U. S. National Museum; fifteen females were obtained from the same host in the Mississippi River at Fairport, July 25, 1912, and have received catalogue no. 47738, U. S. National Museum; six females from the same host in McPhersons Slew, Fairport, August 8, 1912, catalogue no. 47739, U. S. National Museum; eight copepodid larvæ from the gill filaments of the short-nosed gar, *Lepisosteus platostomus*, in "Sunfish Lake," Fairport, July 24, 1914, catalogue no. 47740, U. S. National Museum; five copepodid larvæ from gill filaments of the sauger, *Stizostedion canadense*, in Whisky Slew, Fairport, August 12, 1914, catalogue no. 47741, U. S. National Museum; four copepodid larvæ from gill filaments of sauger in Dark

Slew, Fairport, August 14, 1914, catalogue no. 47742, U. S. National Museum; three copepodid larvæ from gill filaments of sauger in Lake Pepin, Mississippi River, August 28, 1914, catalogue no. 47743, U. S. National Museum. One or two copepodid larvæ were also obtained from the gills of the bullhead, *Ameiurus melas*, in "Sunfish Lake," August 20, 1914; these were preserved and used for sectioning.

Specific characters of female.—Body club-shaped, enlarged two or three diameters posteriorly; horns varying in number, size, and arrangement; usually they are four in number, short and very wide and strongly flattened dorso-ventrally, so that they become thin laminæ; the four are arranged in pairs, attached to the sides of the thorax, behind the head, the first pair just in front of the first swimming legs, the posterior pair just in front of the second legs; they are all about the same size, nearly as wide as long, and each is attached separately to the thorax and extends out nearly at right angles to the long axis of the body. Sometimes the two anterior horns are much larger than the posterior ones (fig. 90) and are turned forward like a large horseshoe, whose sides are parallel to the body axis; sometimes the two posterior horns are more or less fused into a single one, much smaller than the lateral anterior ones. Instead of being buried in the flesh these horns are often applied to the surface of the scales (fig. 92), with whose substance they apparently fuse quite solidly, so as to furnish a secure attachment.

The body is segmented and the diameter posteriorly is three times that anteriorly; at the posterior end there is a small lateral tubercle on either side, ventral to the egg string, and a much larger median dorsal tubercle, the abdomen, which reaches far behind the lateral ones; the anal papillæ are comparatively large and jointed, and each carries three or four small setæ around the base in addition to the large terminal one.

The egg strings are narrow and elongate, less than a third the length and width of the body.

Head elliptical, a little longer than wide, without an anterior rostrum; first antennæ three-jointed, the two basal joints considerably longer and wider than the terminal one, and all of them heavily armed with setæ; second antennæ two-jointed, the terminal joint half as long again as the basal and ending in a single large claw and a tuft of setæ, the basal joint unarmed. Mandible a single slender curved claw mounted on a stout hemispherical base inside the lips; first maxilla a very much stouter claw, curved abruptly near the base and bluntly rounded at the tip; second maxilla armed with the usual two stout claws, also abruptly curved, but nearer the tip, which is much sharper than in the first maxilla.

Maxilliped comparatively large and stout, tipped with five strong curved claws, with a large blunt knob at their base and a medium-sized papilla on the inner margin, tipped with a single seta.

Color a dark creamy white.

Body length (excluding horns and egg strings), 6 mm.; greatest diameter, 1 mm. Length of egg strings; 3 mm.; diameter of same, 0.36 mm.

(*variabilis*, variable, alluding to the size, number, and position of the cephalic horns.)

Remarks.—This species is chiefly characterized by the four flattened horns, which are entirely separated to their base and which are often attached to the surface of a scale instead of being buried in the flesh. The antennæ are also quite different from those of other species.

The discovery of the copepodid larvæ upon the gills of the sauger, the catfish, and the short-nosed gar serves to associate this species, and presumably the others also, with gill glochidia. These larvæ are very similar to an adult ergasilid but are smaller and of course without egg strings. They are very lively and loosen their hold (which is made by means of the curved claws on the second antennæ) on the gill filament at the slightest provocation and dart around over the gills rapidly, taking a new hold somewhere else. For this reason they would probably offer more hindrance to the attachment of the mussel glochidia than the sluggish ergasilids. At the same time the hindrance would be only temporary, since these are larvæ whose transformation only requires a brief period for its accomplishment, after which they leave the gills and fasten themselves elsewhere upon the body of a new host.

***Lernæocera tenuis*, new species. (Pl. LXXIII, fig. 102-107.)**

Host and record of specimens.—A single female was taken from the side of the body of a sheephead, *Aplodinotus grunniens*, at Fairport, July 16, 1914; it becomes the type of the new species and has been given catalogue no. 47737, U. S. National Museum.

Specific characters of female.—Body long and slender with very little posterior enlargement; a single horn on either side of the head attached farther back than in other species, extending out at right angles to the body axis, and divided into two branches, the dorsal of which is much larger and nearly four times as long as the ventral; both branches are somewhat enlarged and bluntly rounded at the tip.

Behind the head the body narrows for a short distance, then widens gradually, and there is no abrupt posterior enlargement. At the posterior end on either side above the base of the egg string is a small tubercle which is single and does not project much from the body; the dorsal median tubercle, the abdomen, is considerably larger than the lateral ones and terminates in the usual anal papillæ. Each egg string is half the length of the body and four-fifths the width and tapers posteriorly to a narrow rounded point; the eggs are minute and there are about 150 in a string.

The head is circular in outline and a little wider than long; first antennæ three-jointed, joints diminishing a little in length and diameter from the base outward and heavily armed with setæ; second antennæ two-jointed, joints the same length, the basal one unarmed, the terminal one with the usual armature of stout curved claw and setæ. Second maxillæ as large as the maxillipeds, with stout terminal claws; maxillipeds short and thickest, each with four terminal claws, a small knob at their base and a minute process on the inner margin.

Color (preserved material), a grayish white.

Body length (excluding the horns and egg strings), 9.60 mm.; greatest diameter, 0.60 mm.; transverse length of both horns and head, 5.66 mm. Length of egg strings, 4.25 mm.

(*tenuis*, slender, alluding to the body as a whole.)

Remarks.—This species may be recognized by the fact that its horns stand out at right angles to the body axis and are cylindrical instead of flattened; its body is not enlarged posteriorly, and the egg strings are very long and slender. It does not appear to be common, since only a single specimen has thus far been found, and it is not known to be associated with any glochidium.

***Lernæocera cruciata* Le Sueur.** (Pl. LXXIII, fig. 108, 109; Pl. LXXIV, fig. 110.)

Lernæocera cruciata Le Sueur, 1824, Jour. Acad. Nat. Sci. Philadelphia, vol. 3, p. 286, pl. 2; Kellicott, 1880, Proc. Amer. Soc. Microscopists, vol. 1, p. 64, pl. 1, fig. 1.

Host and record of specimens.—This species was originally reported by Le Sueur from the "rock bass, *Cichla ænea*" (*Ambloplites rupestris*) of Lake Erie. Kellicott's specimens were taken from "rock bass in the Shiawassee River, the Upper Saginaw, at Corunna, Mich., about 25 per cent of the fish being parasitized. * * * They are taken occasionally from the Niagara at Buffalo." (p. 68.) Gurley in his manuscript identified this species from the following hosts and localities: On rock bass from Lake Erie at Erie, Pa., June 21, 1894; from the Sandusky River at Fremont, Ohio; and from Fox Creek (tributary of the Detroit River) at Detroit, Mich., the latter on August 22, 1894 (collector, Cloudsley Rutter). On the sunfish, *Eupomotis gibbosus*, from Cattaraugus Creek (tributary of Lake Erie) at Gowanda, N. Y., August 17, 1893; from Elk Creek, Girard County, Pa., August 3, 1893; and from the Maumee River at Perrysburg, Ohio. On the redhorse, *Moxostoma macrolepidotum duquesnei*, from Maple River in Cass County, N. Dak. Gurley adds: "It should further be noted that the specimen in question is clearly *L. cruciata* and not Krøyer's *L. catostomi*, which also infests the redhorse."

Three lots of specimens were taken from the flesh along the sides of the body of the largemouth black bass, *Micropterus salmoides*; 10 females from Black Creek, N. C., catalogue no. 42306, U. S. National Museum; 7 females from Crooked S Slew, Fairport, Iowa, catalogue no. 47728, U. S. National Museum; 5 females from Scott, Lonoke County, Ark., catalogue no. 47729, U. S. National Museum.

Specific characters of female.—Body club-shaped, rather slender toward the head, gradually increasing in diameter posteriorly and terminating in a sudden enlargement at the posterior end. From either side of the cephalothorax extends a stout horn, chitinous in texture, which immediately divides into two conical branches, one of which is turned forward and the other backward at varying angles. The basal portion of each horn is short and very broad, while the base of the posterior branch is often twice the diameter of the anterior. Body obscurely segmented, with a large double tubercle on either side at the posterior end, the median dorsal tubercle, the abdomen, being still larger though single and terminating in two small anal papillæ, each armed with two or three setæ. Egg strings conical, the base attached to the body, the pointed end free, one-third as wide as long; eggs small, not arranged in rows, about 100 in each string.

Head one-quarter wider than long, with a narrow rostrum projecting from the center of the anterior margin; first antennæ four-jointed, the basal joint the shortest, the next joint the longest, all the joints heavily armed with setæ; second antennæ two-jointed, joints about the same length, the basal one unarmed, the terminal one ending in two curved claws, two long setæ and a shorter one, with four minute spines along the inner margin.

First maxilla ending in a single claw; second maxilla with two claws of the same size; maxillipeds two-jointed, the basal joint unarmed, the terminal joint ending in five curved claws, at the base of which is a large rounded knob, and back of the knob on the inner margin a tiny process terminated by a single spine. The bases of the maxillipeds are so far behind the mouth tube that their tips do not quite reach the bases of the second maxillæ.

Color of young specimens a uniform creamy white, turning more or less dark reddish brown with age, the tips and sometimes the entire branches of the cephalic horns dark brown, almost black.

Body length (excluding horns and egg strings), 8 mm.; greatest diameter, 0.70 mm.; diameter of posterior enlargement, 1.40 mm. Length of egg strings, 2.10 mm.; greatest diameter of same, 0.70 mm. (*cruciata*, torturing or tormenting.)

Remarks.—The parasite is usually attached nearer the head than the tail of the fish; the head, horns, and one-third of the body are buried in the flesh, usually beneath a scale or in the angle between two scales, and in such a way that the posterior two-thirds of the body points diagonally backward, and when the fish is in motion hangs close to the body of the latter. This species is associated with the glochidia of *Anodonta corpulenta* upon the largemouth black bass, and suggests that these external glochidia will subsequently be found also upon the other fish which serve as hosts for this Lernæoceran.

Lernæocera tortua Kellicott. (Pl. LXXIV, fig. 111-113.)

Lernæocera tortua Kellicott, 1881, Proc. Amer. Soc. Microscopists, vol. 2, p. 41, 1 unnumbered plate.

Host and record of specimens.—Originally obtained by Kellicott from Grindstone Creek, a tributary of Lake Ontario, in July, 1880. Each Lernæocera was deeply buried in a tumor caused by its presence just behind, or in the axilla of, a pectoral fin of "*Ameiurus catus* Gill." According to Dr. B. W. Evermann *A. catus* does not occur in Lake Ontario, the forms found there and usually referred to it being either *melas* or *nebulosus*, in this instance more probably the latter. Seven females were taken from *A. nebulosus* at Thomaston, Ga., by B. B. White and have been given catalogue no. 12030, U. S. National Museum. A single female was taken from *Ictalurus furcatus* at Fairport, Iowa, June 2, 1910, and has received catalogue no. 47772, U. S. National Museum.

Specific characters of the female.—Body straight and somewhat enlarged posteriorly; a lateral horn on either side of the cephalothorax, dichotomously branched, tuberculated, and standing out from the head at right angles to the body axis, so that the two horns are in the same straight line; a single dorsal horn, forked at the apex; all three horns strongly flattened anteroposteriorly and half as wide as long. In the Iowa specimen the horns are flattened, but the branches are much smaller and more slender than those of the Georgia specimens. Body sometimes obscurely segmented, with no lateral tubercles at the posterior end; the median dorsal tubercle or abdomen comparatively long and three-quarters of the diameter of the body; anal papillæ large and well armed with plumose setæ; egg strings moderately long (one-third the length of the body) and subcylindrical, tapering posteriorly.

Head ovate, considerably longer than wide; first antennæ four-jointed, the three distal joints about the same length, the proximal joint shorter; second antennæ three-jointed, the two distal joints about the same length, the proximal one much shorter; the terminal joint is enlarged and tipped with a long curved claw and several curved setæ; second maxillæ comparatively stout, each terminating in two large curved claws; maxillipeds rather short and stout, the terminal joint much narrower than the basal and ending in four or five slender claws, with a large knob at their base, but no papilla on the inner margin.

The two lateral cephalic horns are united across the front of the head and the ridge thus formed projects a long ways ventrally, owing to the anteroposterior flattening of the horns. On the ventral edge of the ridge, or a little removed from it on the posterior surface, is the first pair of swimming legs.

Color (preserved material), a rich reddish brown.

Body length (excluding horns and egg strings), 11.25 mm.; greatest diameter, 0.75 mm.; combined length of lateral horns, 3.90 mm. Length of egg strings, 4 mm.

Remarks.—The foregoing description and the accompanying figures agree fully with those given by Kellicott, except in the position of the fourth swimming legs (see p. 111). In all the specimens obtained at Thomaston, Ga., the fourth legs are relatively much nearer the posterior end of the body than is represented by Kellicott, and there is no indication of another groove posterior to them or between them and the third pair. This species does not seem very widely distributed nor very abundant in any locality. While its hosts are common in the Mississippi River, only a single specimen of the parasite has thus far been found.

Lernæocera catostomi Krøyer.

Lernæocera catostomi Krøyer, 1863, Naturhistorisk Tidsskrift, vol. 2, p. 321, pl. 18, fig. 4, a-e.

Host and record of specimens.—Two females were found by Krøyer upon a *Moxostoma macrolepidotum duquesnii* from the Mississippi River near St. Louis, Mo. None have been found since and the original specimens are probably lost, so that we are compelled to rely wholly upon Krøyer's description and figures, which may be summed up as follows:

Specific characters of female.—Body long and club-shaped, enlarged two or three diameters posteriorly; a short horn on either side of the cephalothorax, flattened anteroposteriorly and cleft at the tip; a similar median dorsal horn. Body segments indistinct; lateral tubercles at the posterior end poorly defined, median dorsal tubercle, the abdomen, but little longer and comparatively wide; egg strings narrow and elongate.

Head circular in outline, with a small broadly obtuse rostrum on the anterior border; first antennæ three-jointed and heavily armed with setæ; second antennæ two-jointed, the basal joint long and linear, the terminal joint small, oval, and armed with small setæ and spines; maxillipeds with a swollen basal joint and an oval terminal joint, tipped with four large and strong claws, gradually increasing in size, the outermost one as long as the segment; knob at the base of these claws small, papilla on the inner margin also small and tipped with a single spine.

Color, a uniform whitish yellow.

Body length (excluding horns and egg strings), 8 mm.; greatest diameter, 1.35 mm.

Remarks.—Neither of Krøyer's specimens had complete egg strings, so that their length can not be given, but the remnant left on one of the females indicated that they were long and narrow and the eggs were small. The species is readily distinguished from *cruciata*, which is found on the same host by the fact that it has three horns instead of two. From *tortua* it may be distinguished by the smaller size of the horns and the larger size of the abdomen and by the details of the antennæ and maxillipeds.

Lernæocera pomotidis Krøyer. (Pl. LXXIV, fig. 114-118.)

Lernæocera pomotidis Krøyer, 1863, Naturhistorisk Tidsskrift, vol. 2, p. 323, pl. 15, fig. 5, a-h.

Host and record of specimens.—Six or seven females were originally obtained by Krøyer from the gills of a "*Pomotis*" species near New Orleans. These are the types of the species and if extant are in the Royal Museum at Copenhagen. A single female was taken from the gill cavity of the bluegill, *Lepomis pallidus*, at Fairport, August 29, 1914. It has received catalogue no. 47773, U. S. National Museum, and will serve as a surrogate type of the species if the original specimens are no longer in existence.

Specific characters of the species.—Body long and slender, only slightly enlarged posteriorly; a horn on either side of the cephalothorax, divided into two branches which are longer than those in *cruciata*, more slender, and more nearly parallel with the long axis of the body; each horn is two-fifths the entire length of the body and about the same diameter as the anterior portion of the thorax. Body obscurely segmented, the lateral tubercles at the posterior end large, distinct, and with a slight emargination at the center; the median dorsal tubercle, the abdomen, heart-shaped and but a trifle longer than the lateral ones; egg strings narrow and elongate.

Head circular in outline, about the same length and width and without any anterior rostrum; first antennæ four-jointed, the three terminal joints the same length and well armed with setæ, the basal one shorter and unarmed; the terminal joint carries at its tip two curved claws, similar to those on the second antennæ; the latter are two-jointed, the terminal joint considerably longer than the basal and more slender; second maxillæ small with slender terminal claws; maxillipeds also small and slender, two-jointed, and terminating in three claws, with no knob at their base but with a large process on the inner margin, tipped with a tiny spine; these maxillipeds do not quite reach the posterior border of the maxillæ.

Color a uniform creamy white.

Total length (excluding horns and egg strings), 10.45 mm.; greatest diameter, 0.50 mm.; length of horns, 4.20 mm.

Remarks.—This is undoubtedly the same as Krøyer's specimens and shows that the species is not confined to the lower part of the river nor to one host, but is likely to be found elsewhere. The present host is one of the sunfishes and is closely related to Krøyer's "*Pomotis* sp.," and may even possibly be identical with it. The species may be distinguished by the long, sharp, and slender horns and by the fact that the body has almost no posterior enlargement. It is also worth special notice that it is found on the gills or in the gill cavity and not on the outside of the body. It is not well enough known as yet for it to be associated with any glochidium.

Lernæocera pectoralis Kellicott.

Lernæocera pectoralis Kellicott, 1882, Proc. Amer. Soc. Microscopists, vol. 4, p. 77.

Host and record of specimens.—A dozen females were obtained from the red-finned shiner, *Notropis cornutus*, in the Shiawassee River at Corunna, Mich., in July and August, 1881. They were fastened to reddish lumps in the axils of the pectoral fins. None of these original specimens have been preserved and no others have been obtained, so that Kellicott's description gives us all the knowledge we possess of the species; he published no figures.

Specific characters of female.—Body strongly bent and club-shaped; three horns on the cephalothorax, the two lateral ones three or four pronged, the dorsal one stout and forked at the apex. Body indistinctly segmented; the lateral tubercles at the posterior end small, the median dorsal tubercle, the abdomen, much longer and wider, and extending far over the bases of the ovisacs; the latter are short and club-shaped.

Total length, 7.50 mm.; width of horns, 1.70 mm.

Remarks.—This species resembles *L. tortua* but is little more than half as long, the dorsal horn is forked, the egg strings are shorter and club-shaped, and the terminal setæ on the anal papillæ are not plumose.

None of these species of *Lernæocera* are as yet well enough known to enable us to establish their relations with the mussel glochidia. Whatever may be the relations of the adult fastened in the flesh of its host to the mussel glochidia on the fins, it is reasonably certain that the copepodid larvæ of the various species of *Lernæocera* are much more closely related to the glochidia on the gills. Before we can understand this relation thoroughly, there must be considerable more research and observation on the genus.

To facilitate the distinctions between the different species, the following table may be presented; in it the entire length of the parasite is taken as 100 units, and the distance of the four pairs of swimming legs from the anterior border of the head (excluding the horns) is given in percentages of 100.

Species.	1 leg.	2 legs.	3 legs.	4 legs.
Variabilis.....	4	8.3	30	70
Tenuis.....	7.4	11	35	70
Tortua.....	5.4	7	30	70
Pomotidis.....	12	38	52	88
Cruciata.....	10	15	42	75
Catostomi.....	4	8	48	80

It is almost certain that the absolute distances vary in the same species with the development of the individual; the older the parasite becomes the farther removed are the legs from the head; but the relative distance of the pairs one from another ought not to vary much, and it is these relative distances that are expressed in the above table.

The male does not develop beyond the fourth copepodid stage and never attaches itself to the flesh of a fish nor to the body of the female, but after the mating of the sexes the male dies. This makes it necessary to secure the male from the tow or from the gills of some fish prior to the mating, by no means an easy task; but these males and the copepodid stages of the females furnish the data which will eventually decide the validity of the various species, as well as their economic relations.

GENERAL REMARKS.

In a recent paper by Dr. W. A. Cunnington, which is a report on the parasitic Eucopepoda and forms part of the "Zoological Results of the Third Tanganyika Expedition,"^a he says: "It is clear that whatever may be the case for marine fishes, the fishes

^a Proceedings Zool. Soc. London, 1914, p. 819-829, pl. 1.

of fresh water are relatively seldom the prey of parasitic Eucopepoda under natural conditions" (p. 828). And he adds: "A study of the literature of the subject confirms our conclusion."

His judgment is based upon the results of this African expedition, during which he says very large numbers of fish were examined, but only two of them were found infested with eucopepods.

While such a conclusion seems inevitable from the data he has given, it must be understood as applying to Africa, and perhaps to that portion covered by these Tanganyika expeditions and not to the world at large. There has been very little work done on the parasites of fresh-water fishes, as has been already shown (p. 333), and no one can say what the future holds in store. It is possible that other portions of Africa are richer in these parasites, and it is certain that the results of the present investigation are not essentially inferior to those obtained from salt-water fishes. It has already been stated (p. 341) that a fish's efficiency as a host may be measured either by the number of any single parasite it harbors or by the variety of species. If we are comparing fresh-water fish with salt-water fish, or the fish from one region in the world with those from another region, we should take into account both the number and the variety. In variety of forms the salt-water fish considerably surpass those from fresh water, but in number of specimens the latter sometimes surpass the former. The present author never has obtained any salt-water fish that could compare with the two crappies in numbers of parasites. Furthermore, in the variety of species found upon any single kind of fish the fresh-water fish present an average fairly comparable with those from salt water. Three and four from the same fish are the general rule rather than the exception. (See table, p. 338.)

And if we were to include the mussel glochidia and all other kinds of gill parasites with the copepods, the salt-water fish would be hard pushed for a victory. Not many salt-water fish can compare with the crappie (*P. annularis*), which harbors 13 species of glochidia, 3 species of copepods, and 3 species of trematode ectoparasites, 19 in all; or with the sheepshead, which acts as the host of 11 species of glochidia, 2 species of trematodes, and two of copepods, 15 in all; or with the sauger, upon which have been found 6 species of glochidia, 2 species of trematodes, and 4 species of copepods, 12 in all. And it must be remembered that these are all natural infestations, which have occurred under perfectly normal conditions. When we come to the abnormal conditions which are favorable to the copepod parasites, then their numbers increase to such a degree that they cause serious epidemics in the breeding ponds and often kill off large numbers of the fish; and since it is fresh-water fish only that are bred in this way it follows that this sort of damage is confined to them and does not occur amongst salt-water fish.

The facts presented in the present paper open up a very fascinating chapter in the book of copepod parasitology, and one that bids fair to become far-reaching in its practical relations; but it must be remembered that we have as yet scarcely made a beginning, and that a vast amount of work is still to be done before we can reach a final solution of the problems. From the facts here presented, however, it would seem as if fresh water presented fully as rich a field to the parasitologist as can be found in the ocean.

EXPLANATION OF PLATES.

PLATE LX.

Female of *Argulus canadensis*.

- | | |
|---|-------------------------------------|
| FIG. 1. Dorsal view. | FIG. 5. Maxilliped. |
| FIG. 2. Respiratory areas. | FIG. 6. Basal joints of fourth leg. |
| FIG. 3. First and second antennæ. | |
| FIG. 4. Chitin ribs supporting the margin of the sucking disks. | |

PLATE LXI.

Females of *Argulus flavescens* and *A. mississippiensis*.

- | | |
|---|--|
| FIG. 7. Dorsal view of <i>A. flavescens</i> . | FIG. 12. Basal joints of fourth swimming leg. |
| FIG. 8. Respiratory areas. | FIG. 13. Chitin ribs of sucking disk of <i>A. mississippiensis</i> . |
| FIG. 9. First and second antennæ. | FIG. 14. Maxilliped. |
| FIG. 10. Chitin ribs supporting the margin of the sucking disk. | FIG. 15. Second, third, and fourth swimming legs of male. |
| FIG. 11. Maxilliped. | |

PLATE LXII.

Male and female of *A. lepidostei* and male of *A. mississippiensis*.

- | | |
|---|--|
| FIG. 16. Dorsal view of male of <i>A. lepidostei</i> . | FIG. 19. Maxilliped of female. |
| FIG. 17. Third leg of male, showing accessory sexual apparatus. | FIG. 20. Chitin ribs supporting sucking disk of <i>A. stizostethii</i> . |
| FIG. 18. Chitin ribs supporting margin of sucking disk. | FIG. 21. Dorsal view of male of <i>A. mississippiensis</i> . |

PLATE LXIII.

Male and female of *Argulus mississippiensis*.

- | | |
|------------------------------------|---|
| FIG. 22. Dorsal view of female. | FIG. 25-27. Second, third, and fourth legs of male, showing accessory sexual apparatus. |
| FIG. 23. Respiratory areas. | |
| FIG. 24. First and second antennæ. | |

PLATE LXIV.

Male and female of *Argulus lepidostei*.

- | | |
|------------------------------------|--|
| FIG. 28. Dorsal view of female. | FIG. 31, 32. Second and fourth legs of male, showing accessory sexual apparatus. |
| FIG. 29. Respiratory areas. | |
| FIG. 30. First and second antenna. | |

PLATE LXV.

Newly hatched larva of *Argulus lepidostei*.

- | | |
|--|------------------------------|
| FIG. 33. Dorsal view. | FIG. 37. Second maxilla. |
| FIG. 34. First antenna. | FIG. 38. Maxilliped. |
| FIG. 35. Second antenna. | FIG. 39. First swimming leg. |
| FIG. 36. Mouth tube and first maxilla. | |

PLATE LXVI.

Females of *Ergasilus lanceolatus*, *elongatus*, and *megaceros*.

- | | |
|---|---|
| FIG. 40. Dorsal view of <i>E. lanceolatus</i> . | FIG. 47. Side view of <i>E. elongatus</i> . |
| FIG. 41. Mouth parts. | FIG. 48. Mouth parts. |
| FIG. 42. Second antenna. | FIG. 49. Mouth parts of <i>E. megaceros</i> . |
| FIG. 43-46. First, second, third, and fourth swimming legs. | |

PLATE LXVII.

Female of *Ergasilus nigrinus*.

- | | |
|--------------------------|---|
| FIG. 50. Dorsal view. | FIG. 53-56. First, second, third, and fourth swimming legs. |
| FIG. 51. Second antenna. | |
| FIG. 52. Mouth parts. | |

PLATE LXVIII.

Females of *Ergasilus megaceros* and *E. elongatus*.

- | | |
|---|---|
| FIG. 57. Dorsal view of <i>E. megaceros</i> . | FIG. 62. Dorsal view of <i>E. elongatus</i> . |
| FIG. 58-61. First, second, third, and fourth swimming legs. | FIG. 63-66. First, second, third, and fourth swimming legs. |

PLATE LXIX.

Female of *Ergasilus elegans*.

- | | |
|--------------------------|--|
| FIG. 67. Dorsal view. | FIGS. 70-73. First, second, third, and fourth swimming legs. |
| FIG. 68. Second antenna. | FIG. 74. Nauplius larva of <i>E. caruleus</i> . |
| FIG. 69. Mouth parts. | |

PLATE LXX.

Female of *Salmincola californiensis*.

- | | |
|-------------------------------------|--------------------------------|
| FIG. 75. Dorsal view. | FIG. 79. Ventral view of same. |
| FIG. 76. Side view. | FIG. 80. Mandible. |
| FIG. 77. Top of head. | FIG. 81. First maxilla. |
| FIG. 78. Second antenna, side view. | FIG. 82. Maxilliped. |

PLATE LXXI.

Male and first copepodid larva of *Achtheres pimelodi*.

- | | |
|------------------------------------|---|
| FIG. 83. Side view of male. | FIG. 87. Mouth parts: <i>md</i> , mandible; <i>mx</i> ¹ , first maxilla. |
| FIG. 84. First and second antennæ. | FIG. 88. Second maxilla. |
| FIG. 85. First maxilla. | FIG. 89. Maxilliped. |
| FIG. 86. Dorsal view of larva. | |

PLATE LXXII.

Female of *Lernæocera variabilis*.

- | | |
|--|--|
| FIG. 90. Ventral view. | FIG. 95. Mouth parts: <i>md</i> , mandible; <i>mx</i> ¹ , first maxilla; <i>mx</i> ² , second maxilla; <i>lb</i> , labium. |
| FIG. 91. Head and anterior thorax, much enlarged. | FIG. 96. Maxilliped. |
| FIG. 92. Scale of fish host, showing mode of attachment. | FIG. 97-100. First, second, third, and fourth swimming legs. |
| FIG. 93. First antenna. | FIG. 101. Anal lamina. |
| FIG. 94. Second antenna. | |

PLATE LXXIII.

Females of *Lernæocera tenuis* and *L. cruciata*.FIG. 102. Ventral view of *L. tenuis*.

FIG. 103. First and second antennæ.

FIG. 104. Mouth parts: mx^2 , second maxillæ; mxp , maxillipeds.

FIGS. 105-107. First, second, and third swimming legs.

FIG. 108. Ventral view of *L. cruciata*.

FIG. 109. Dorsal view of same.

PLATE LXXIV.

Females of *Lernæocera tortua*, *cruciata*, and *pomotidis*.FIG. 110. Mouth parts and antennæ of *L. cruciata*: an^1 , first antenna; an^2 , second antenna; mx^1 , first maxilla; mx^2 , second maxilla; mxp , maxilliped.FIG. 111. Ventral view of *L. tortua*.

FIG. 112. Dorsal view of horns.

FIG. 113. Antennæ and mouth parts, lettering as in figure 110.

FIG. 114. Ventral view of *L. pomotidis*.

FIG. 115. Dorsal view of posterior end of body.

FIG. 116. First antenna.

FIG. 117. Second antenna.

FIG. 118. Maxilliped.

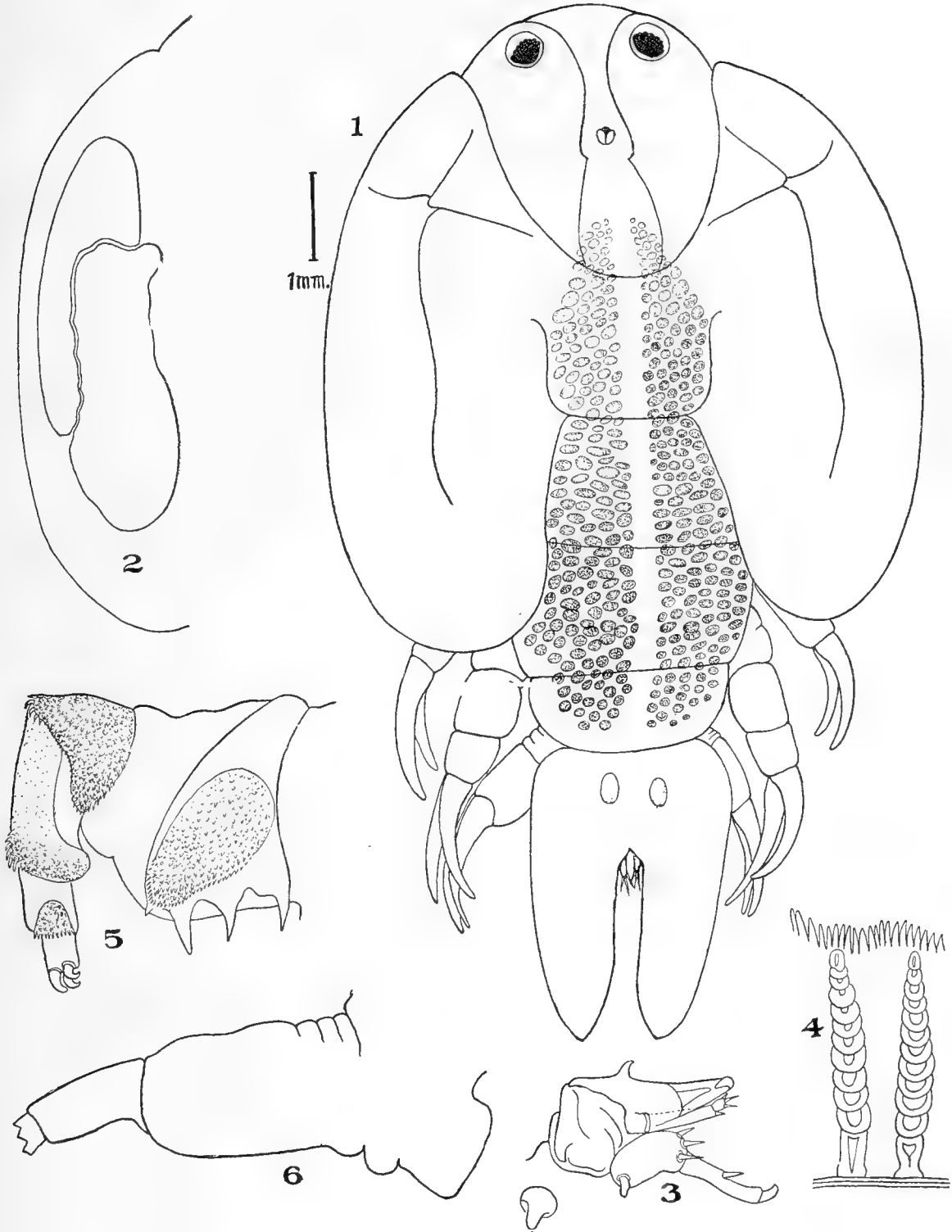

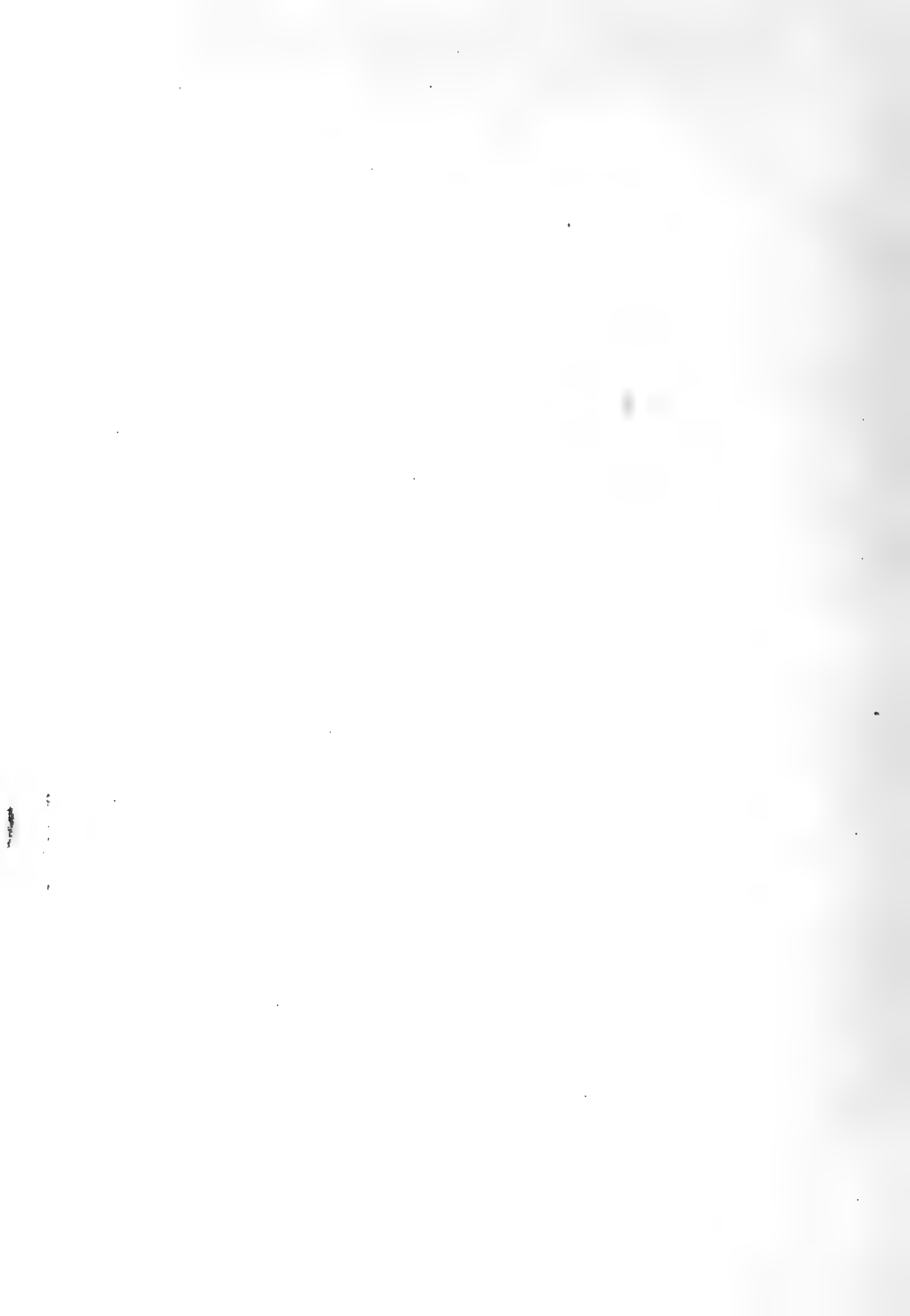

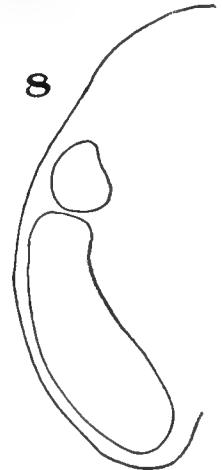
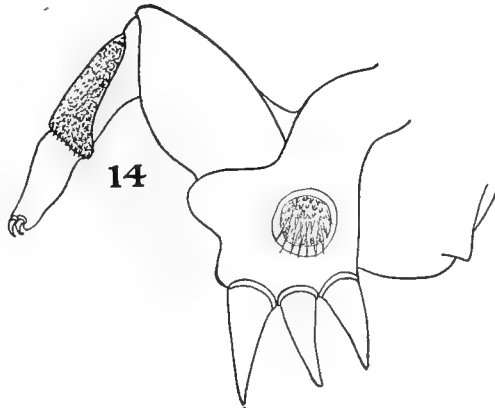
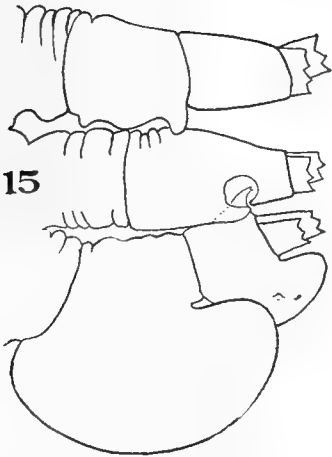
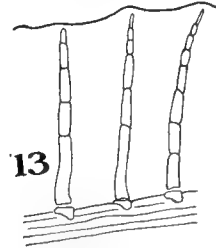
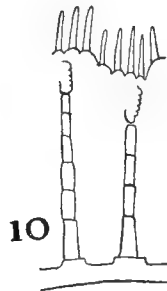
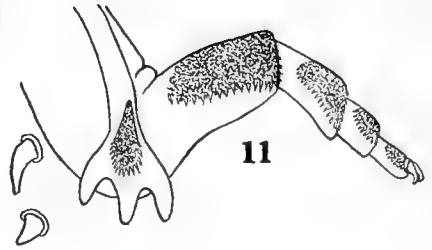
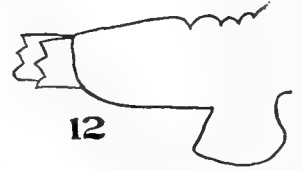
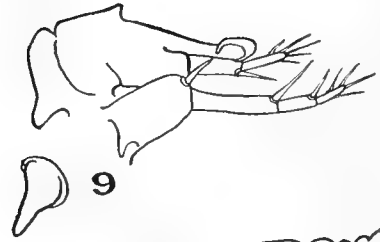
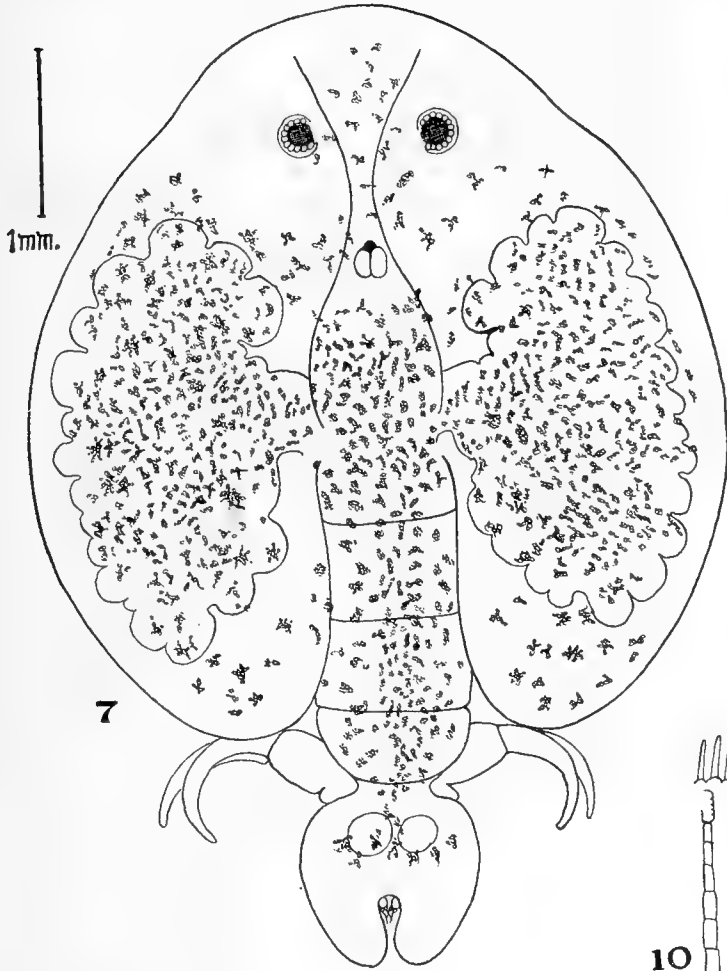

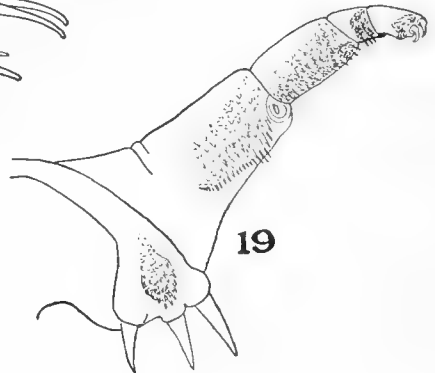
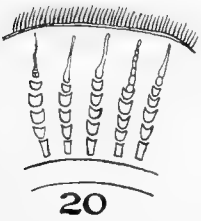
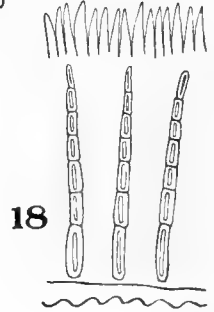
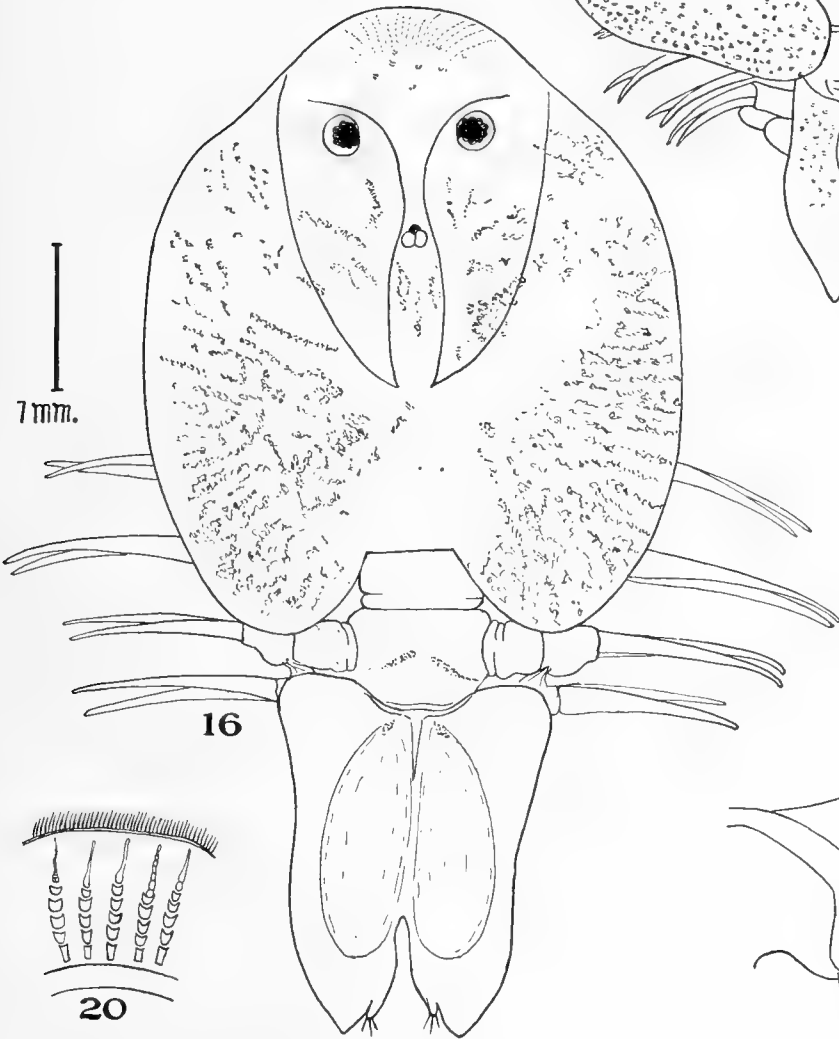
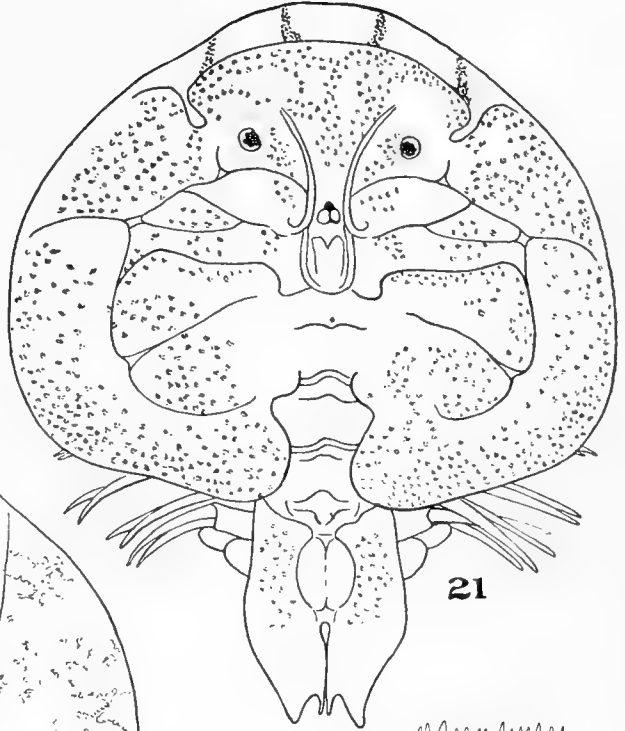
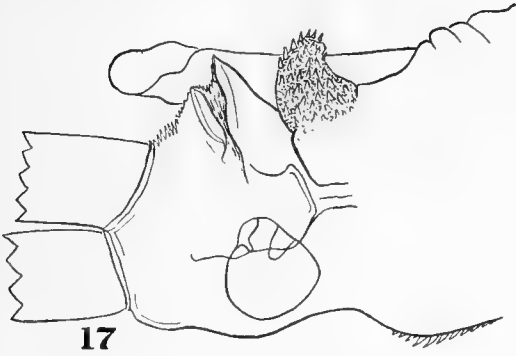

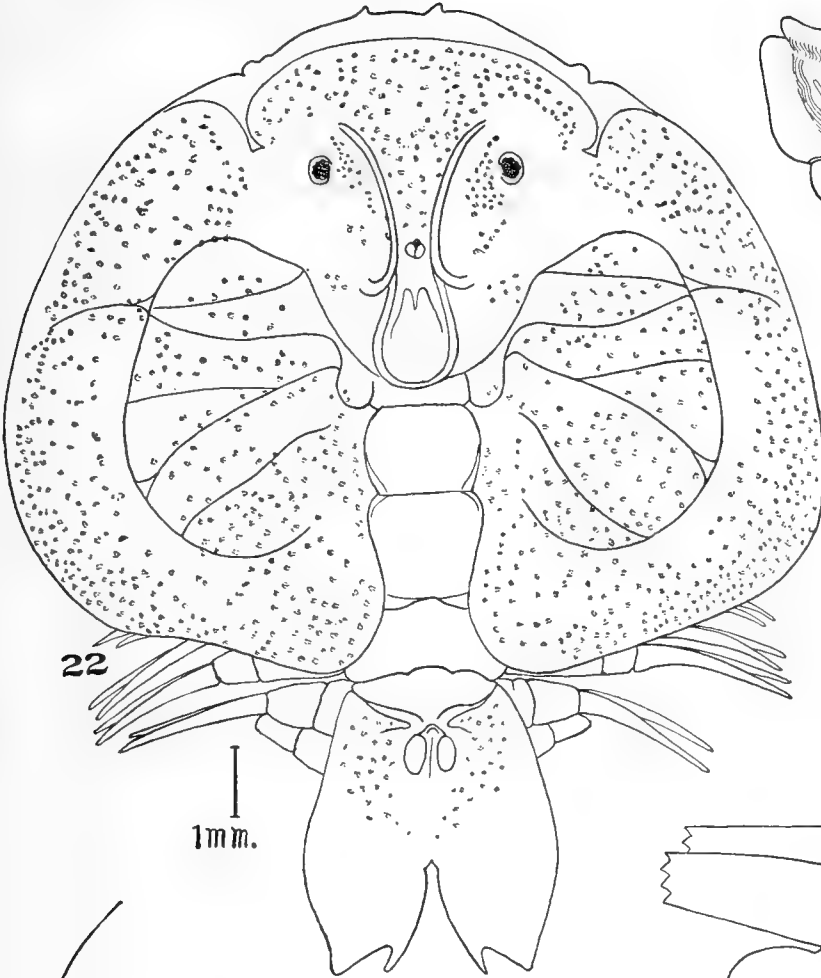

22

1mm.

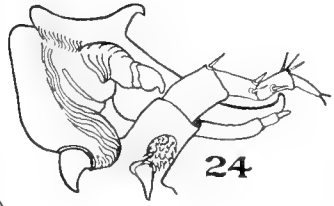

24

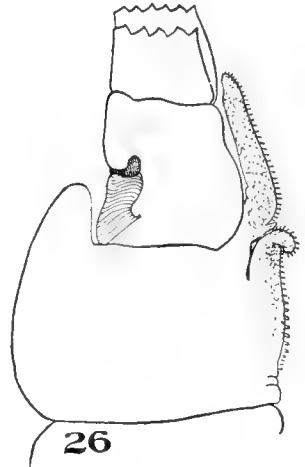

26

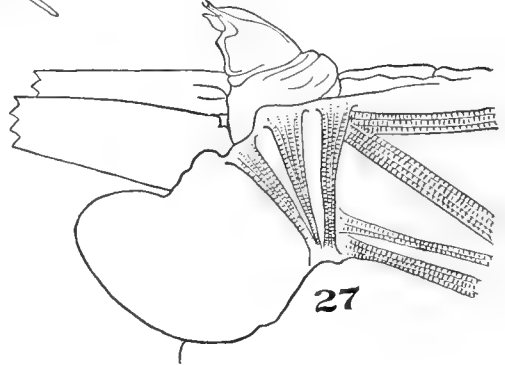

27

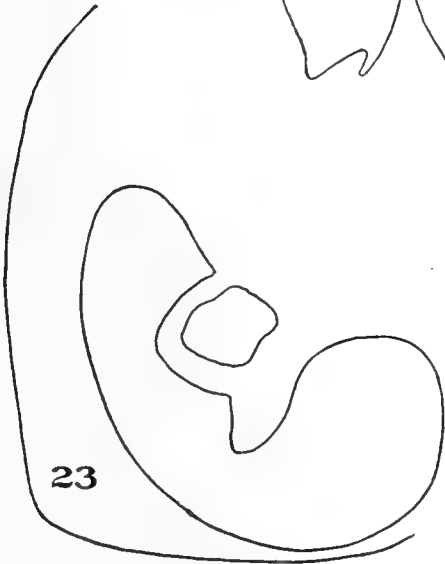

23

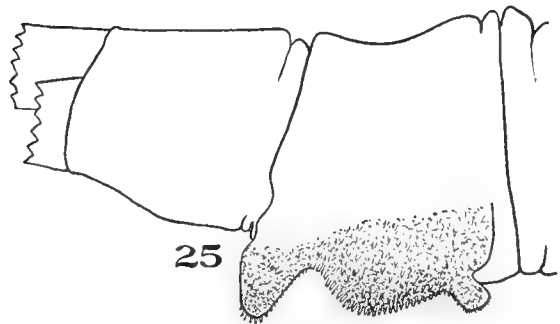

25

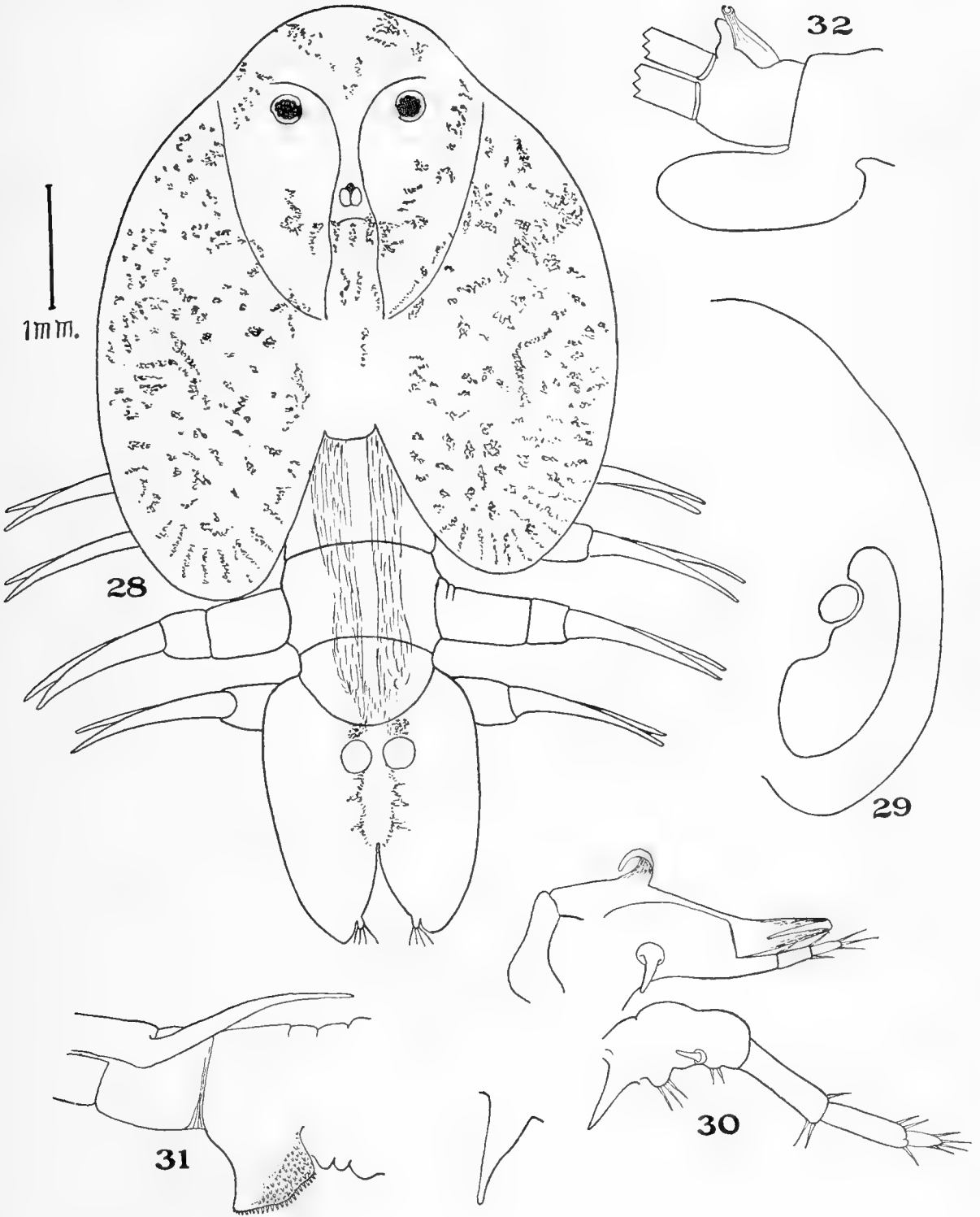

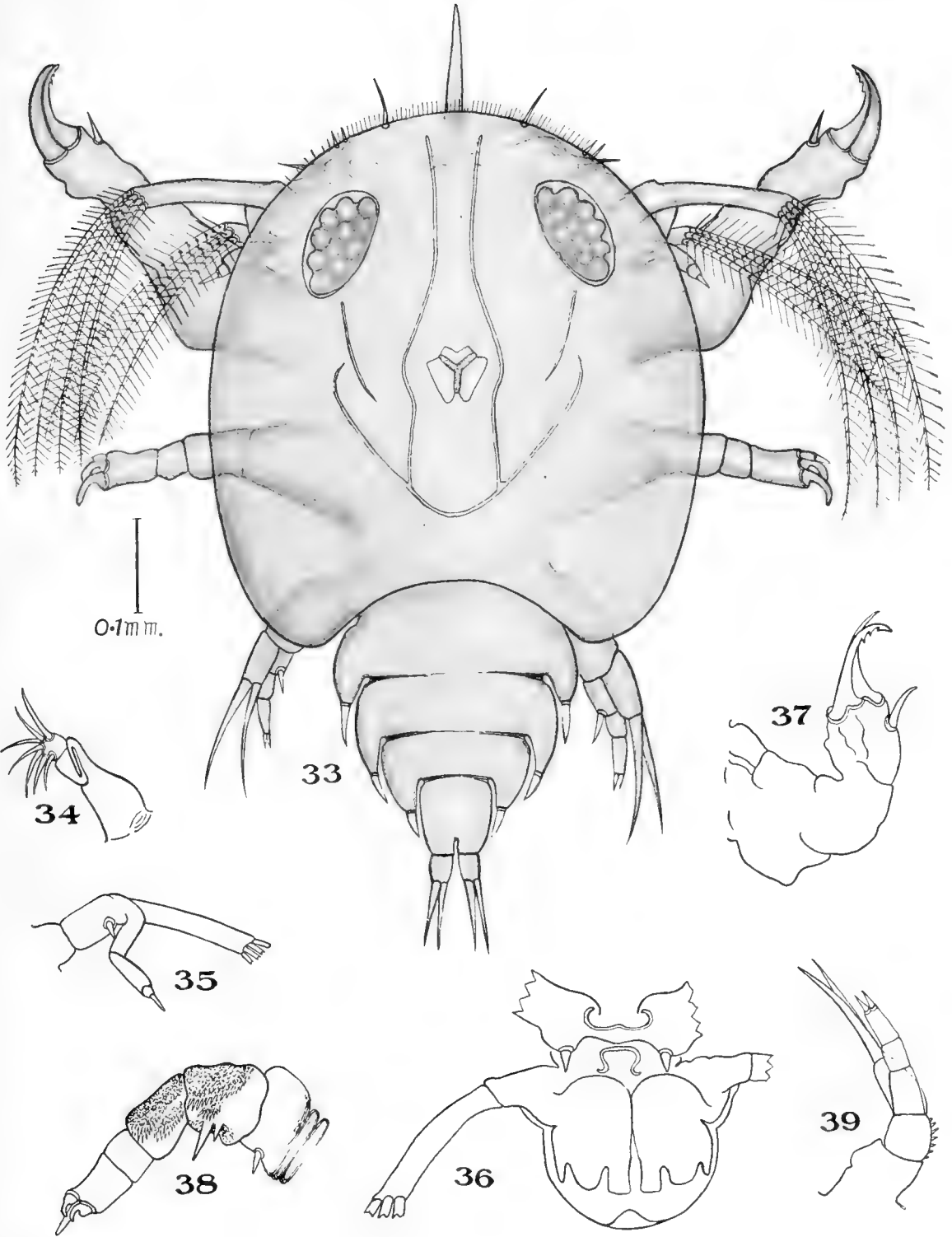

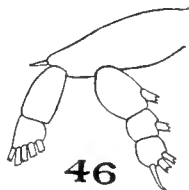
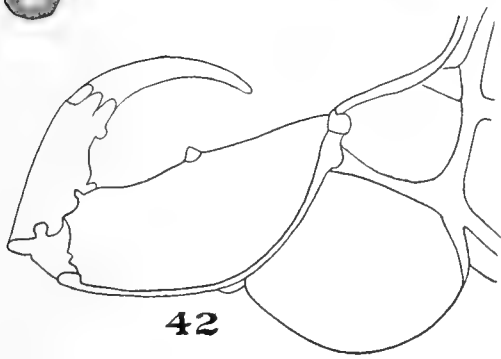
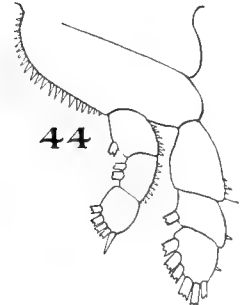
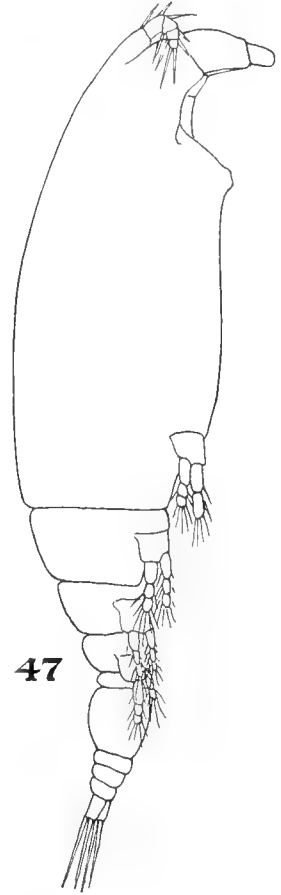
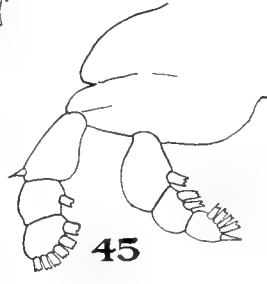
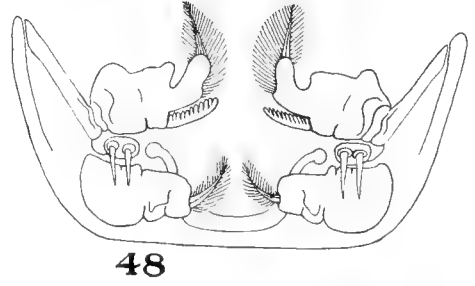
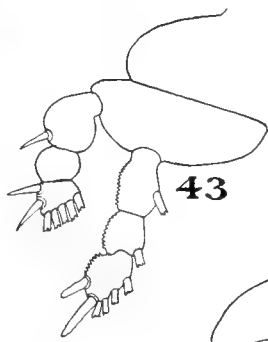
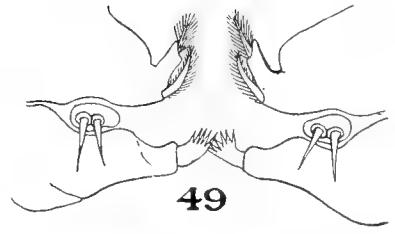
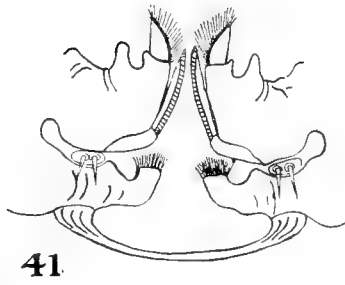
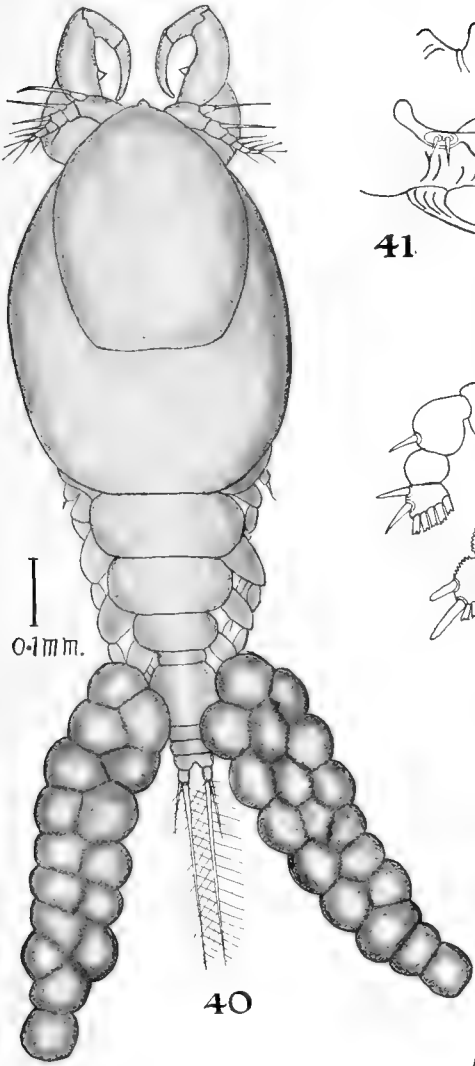

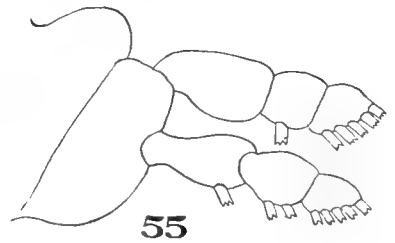
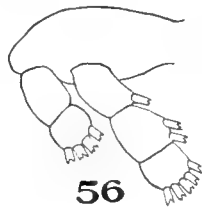
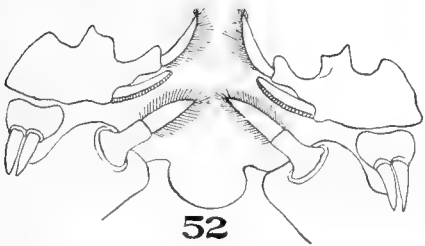
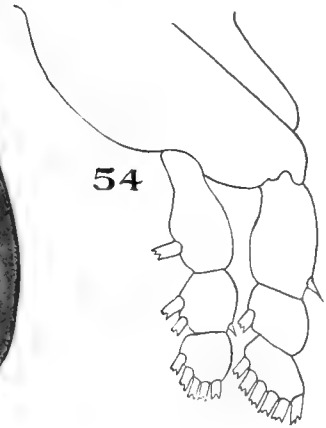
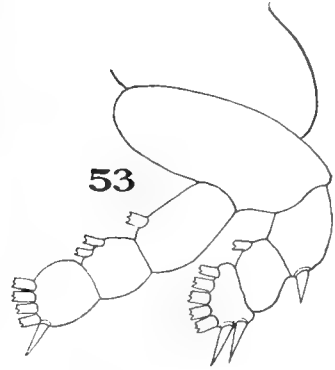
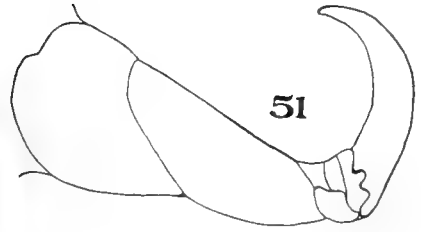
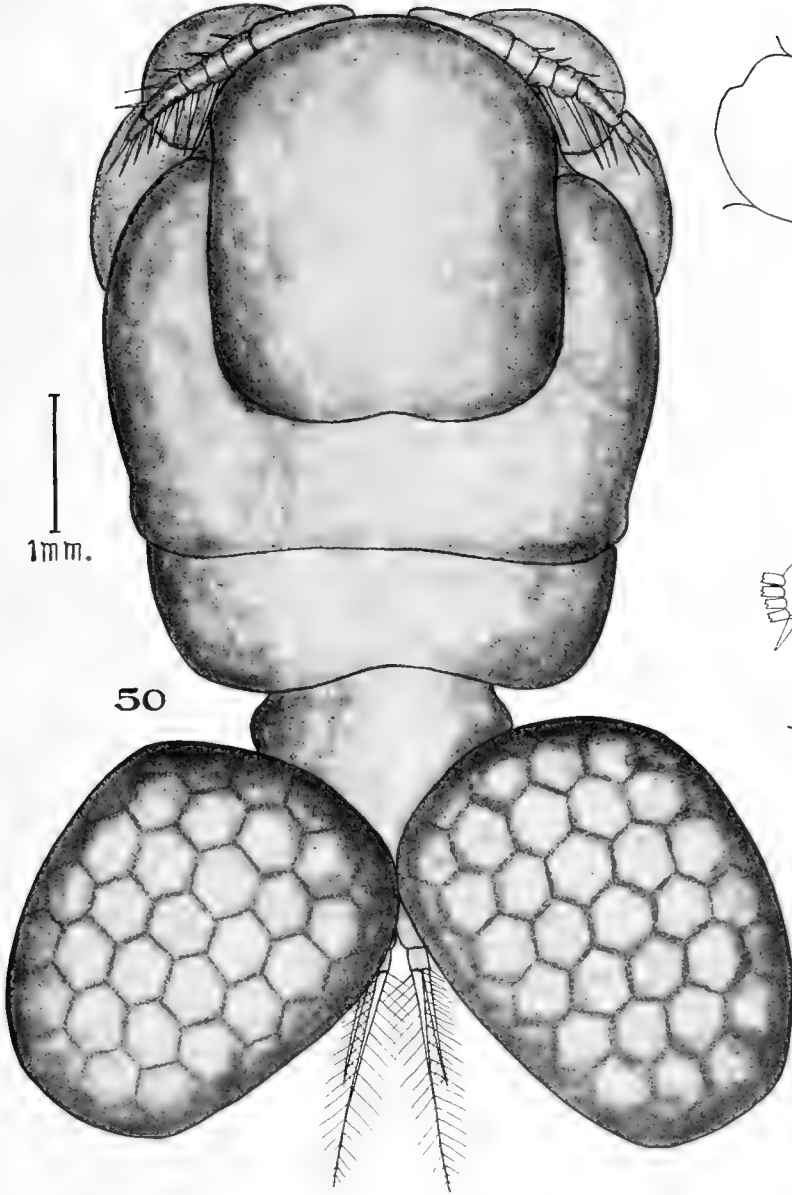

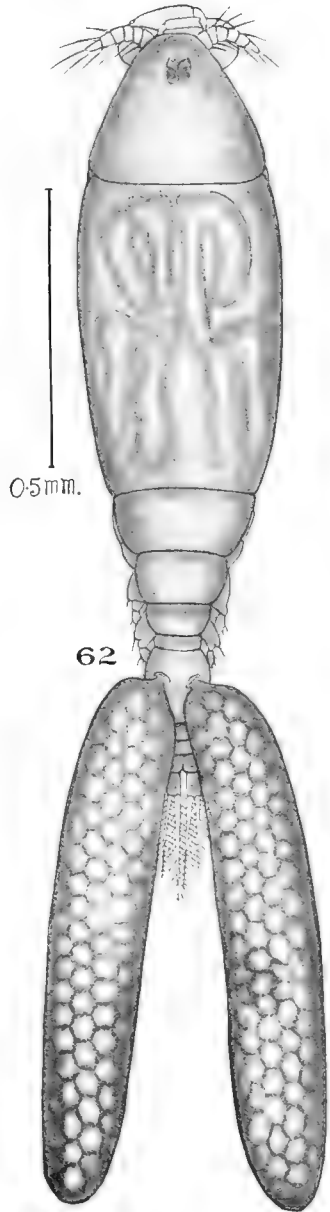
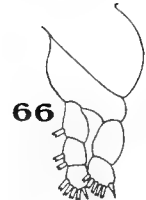
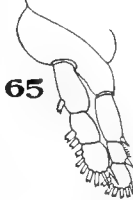
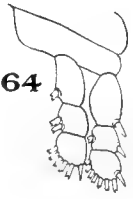
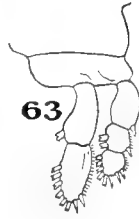
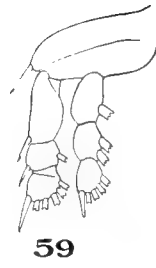
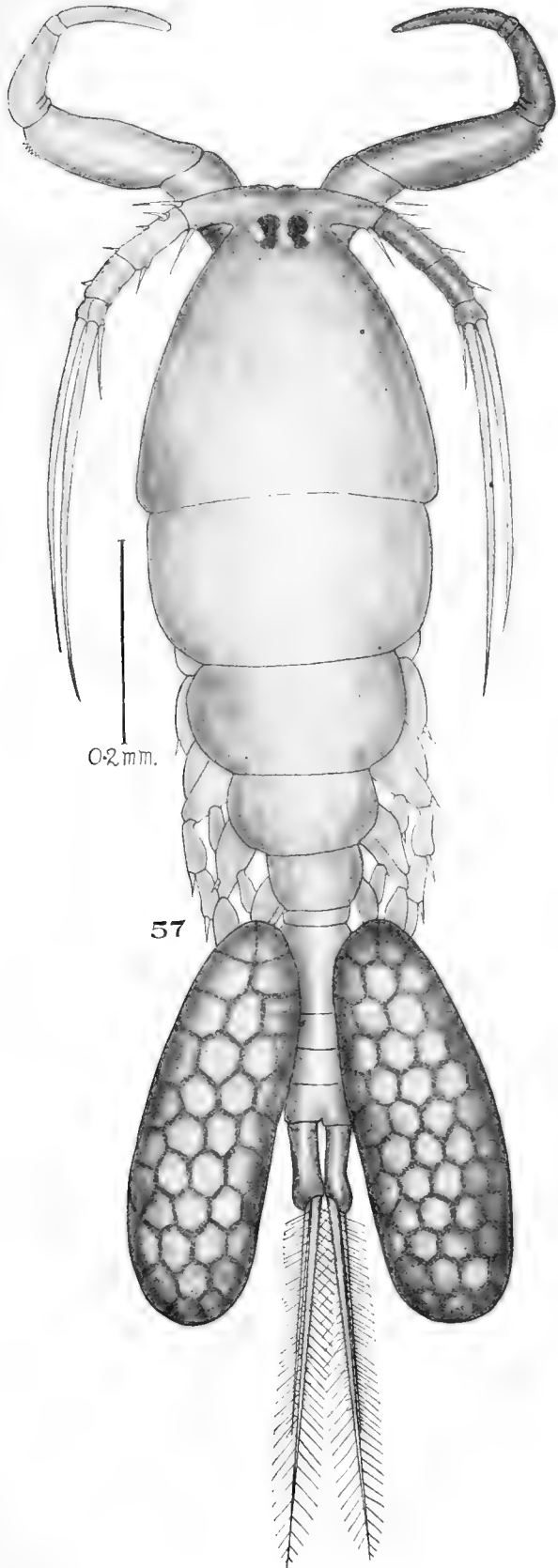

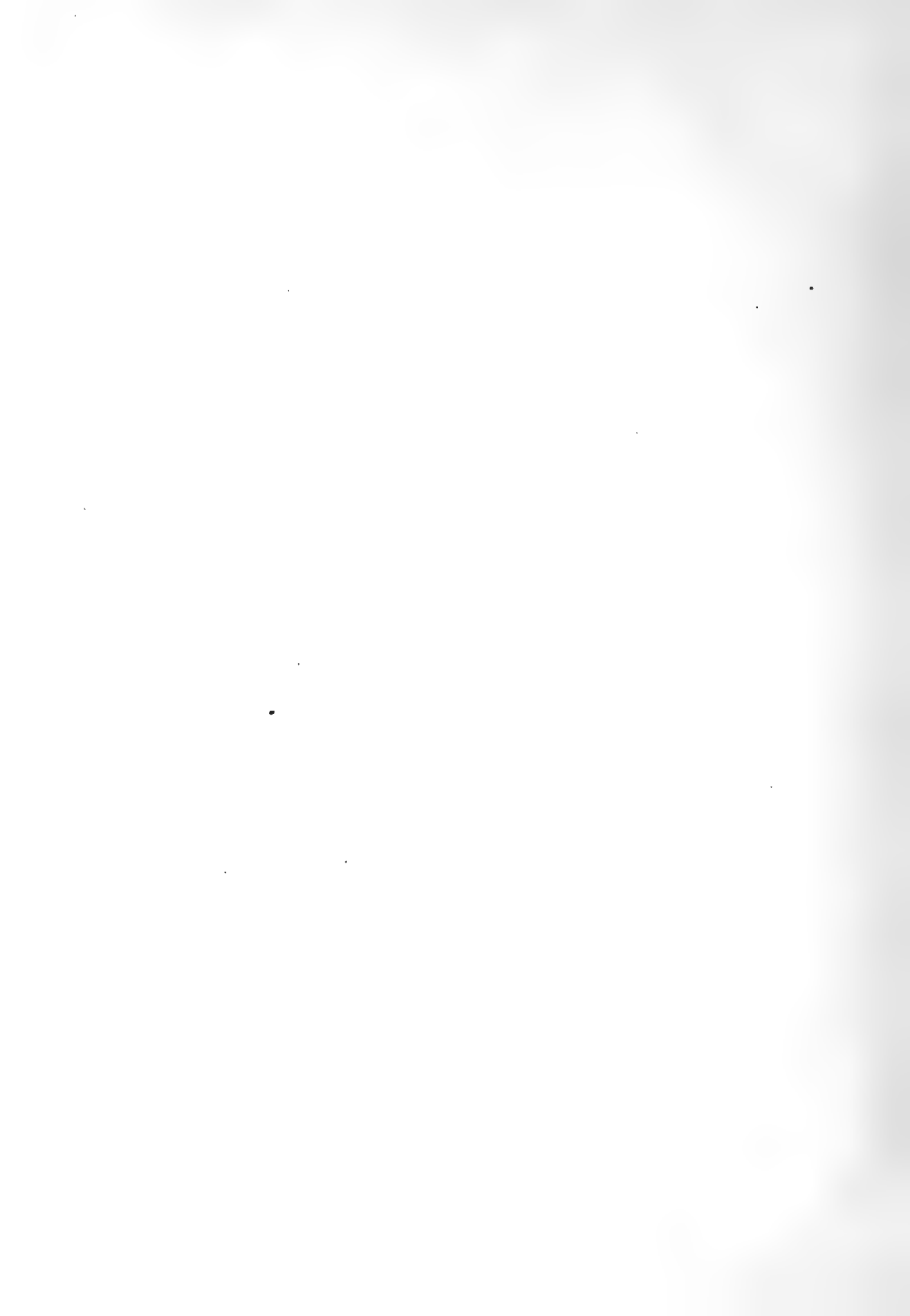

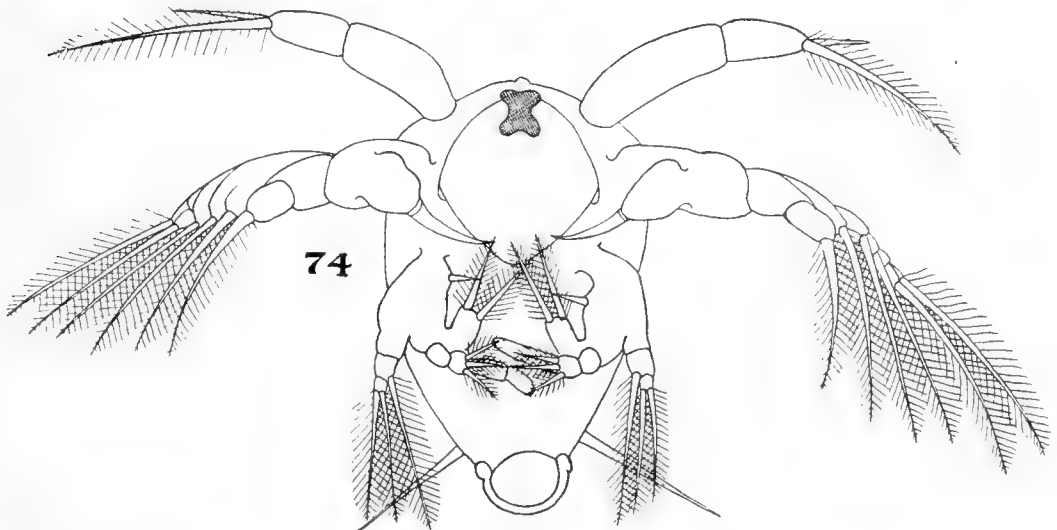
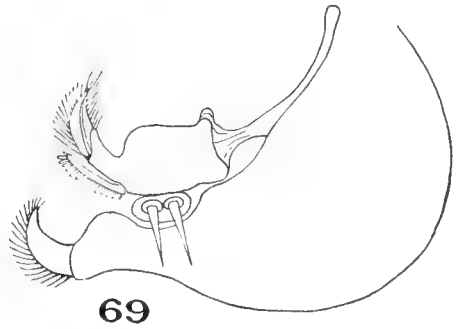
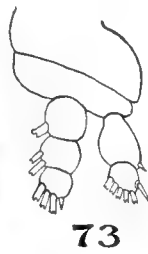
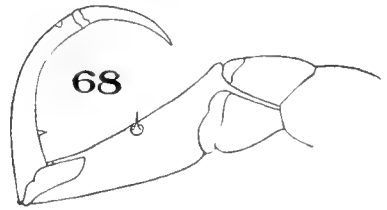
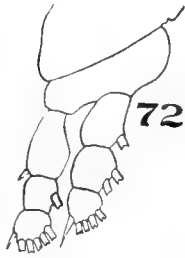
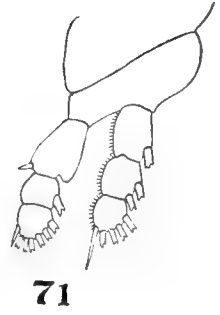
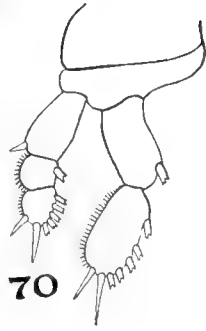
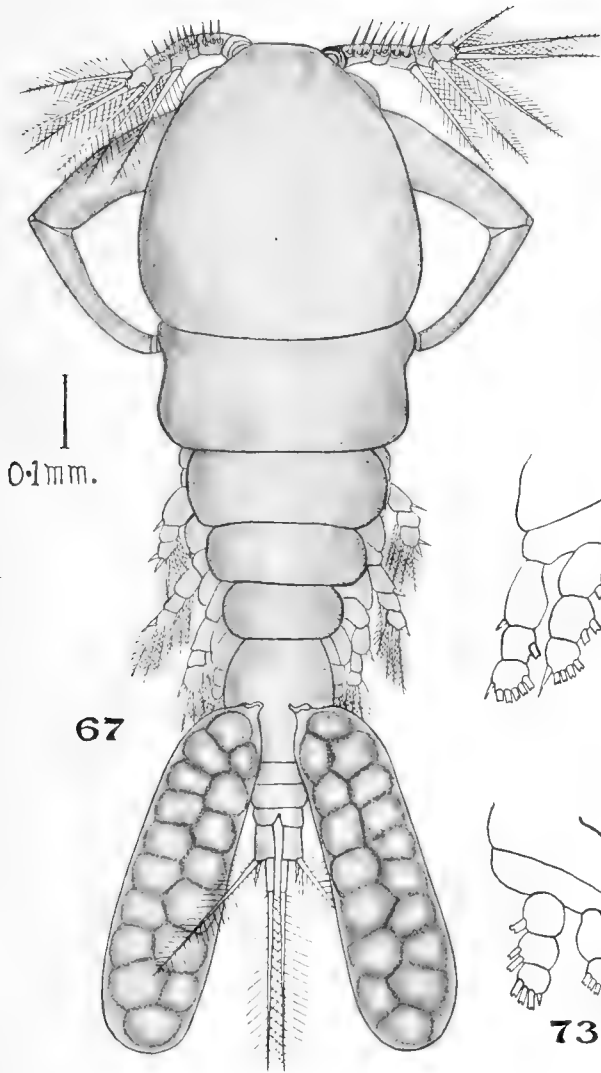

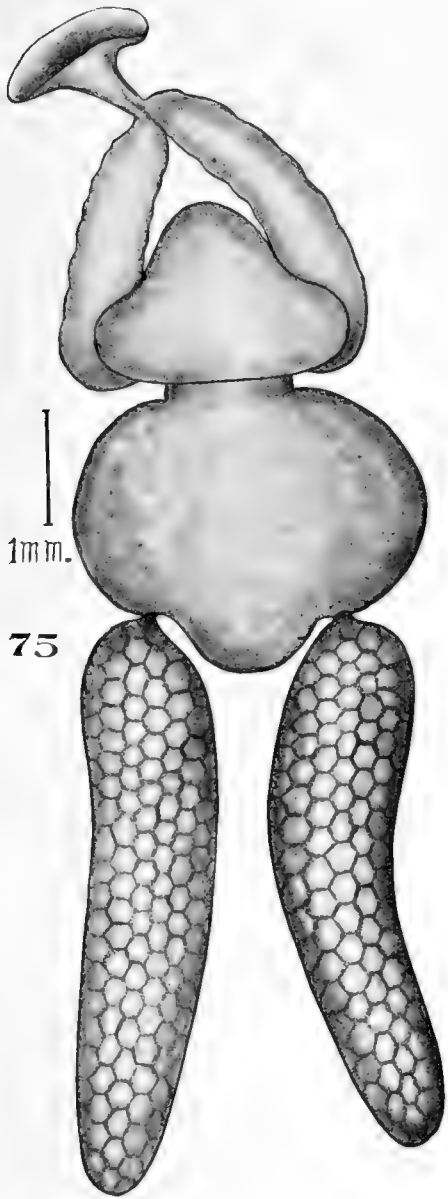

76

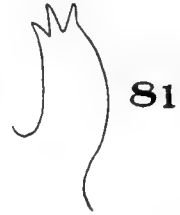

81

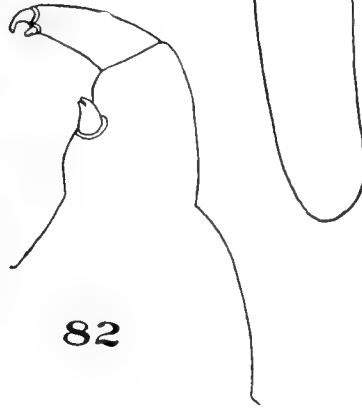

82



78

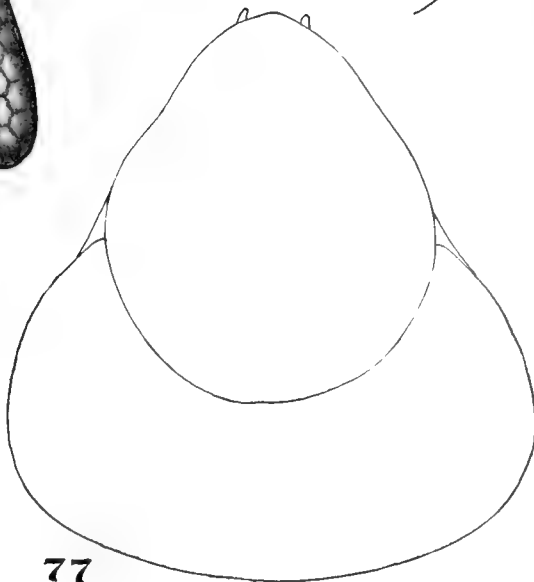

77



80



79

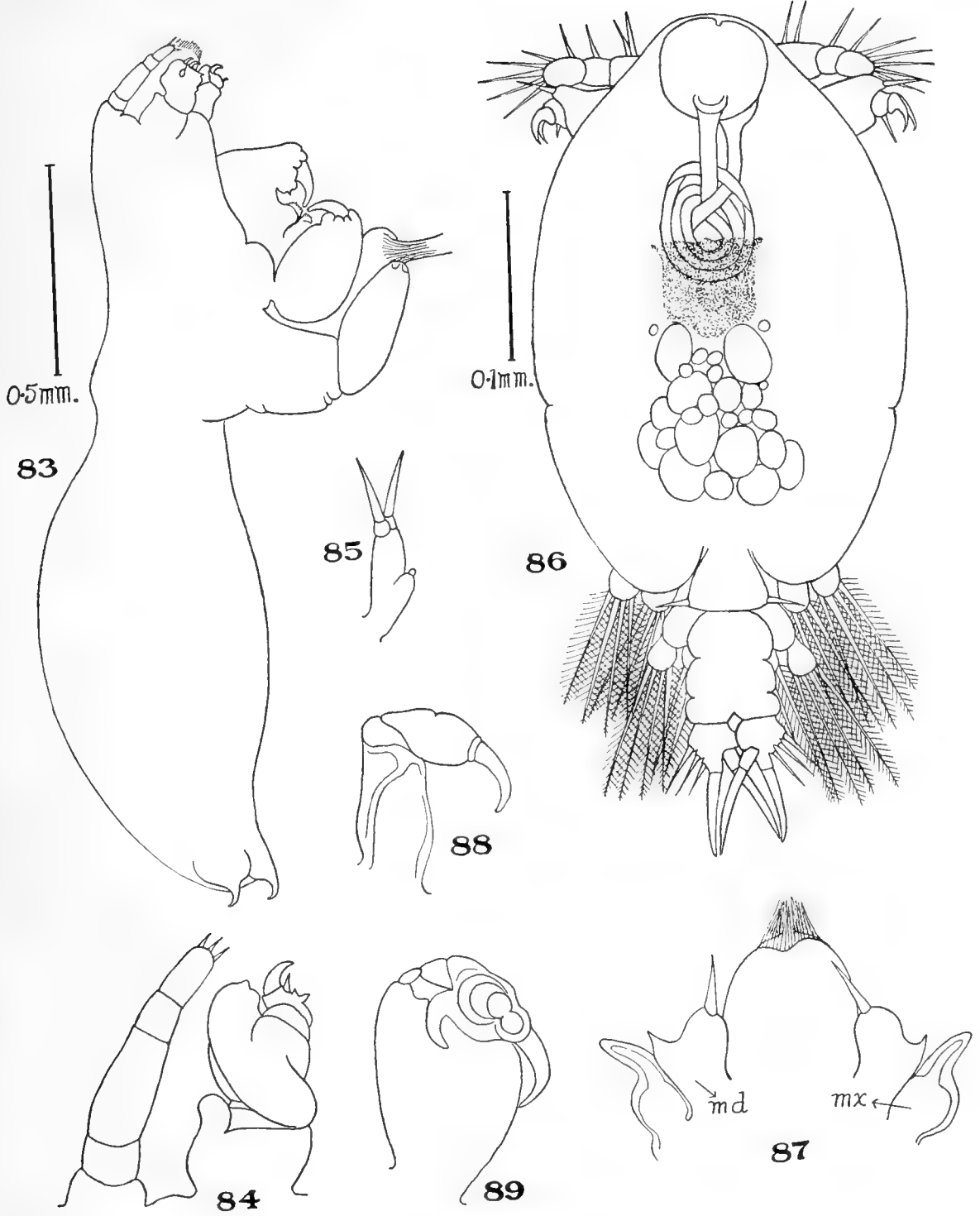

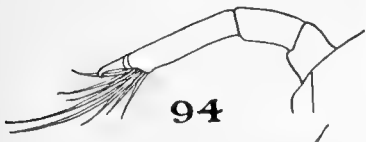

94

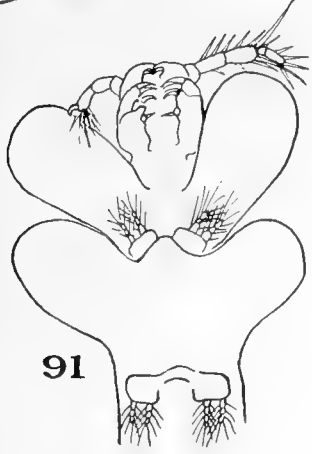

91



92

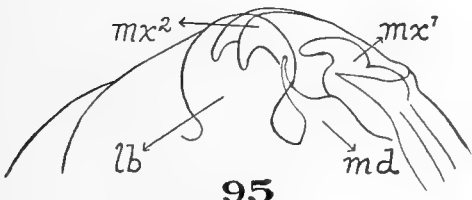

95



1mm.

90

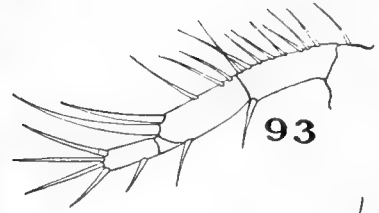

93



97

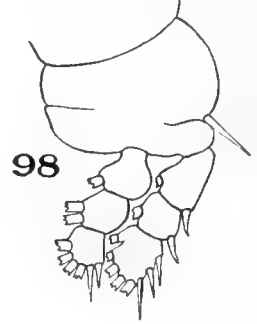

98

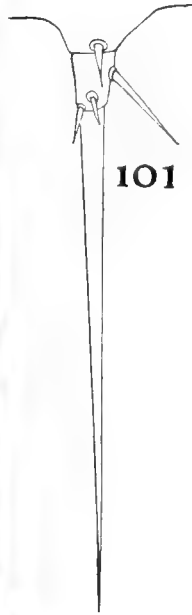

101

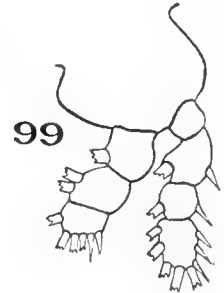

99

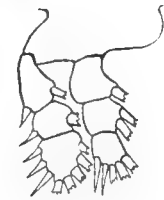

100

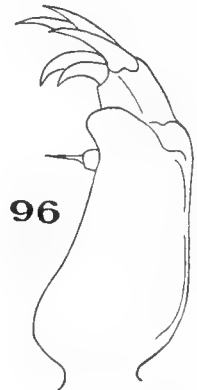

96

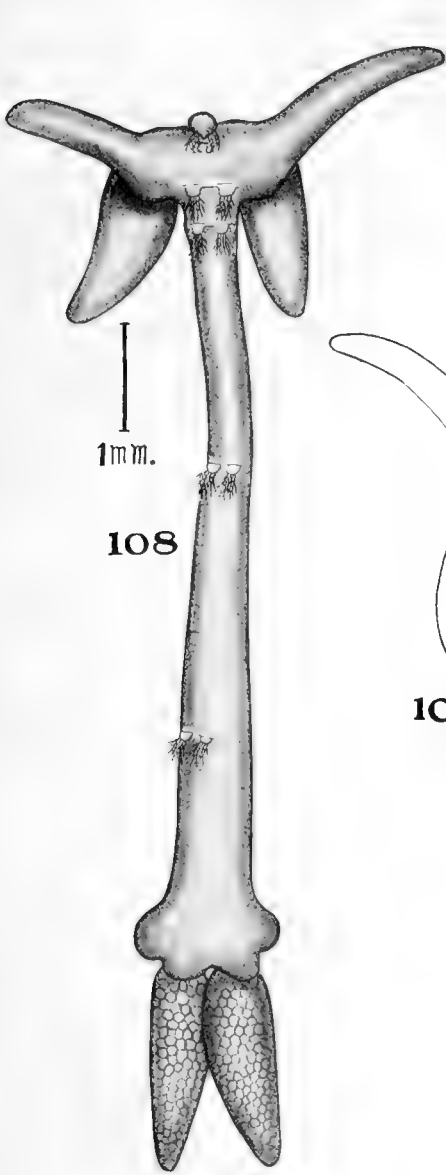

108

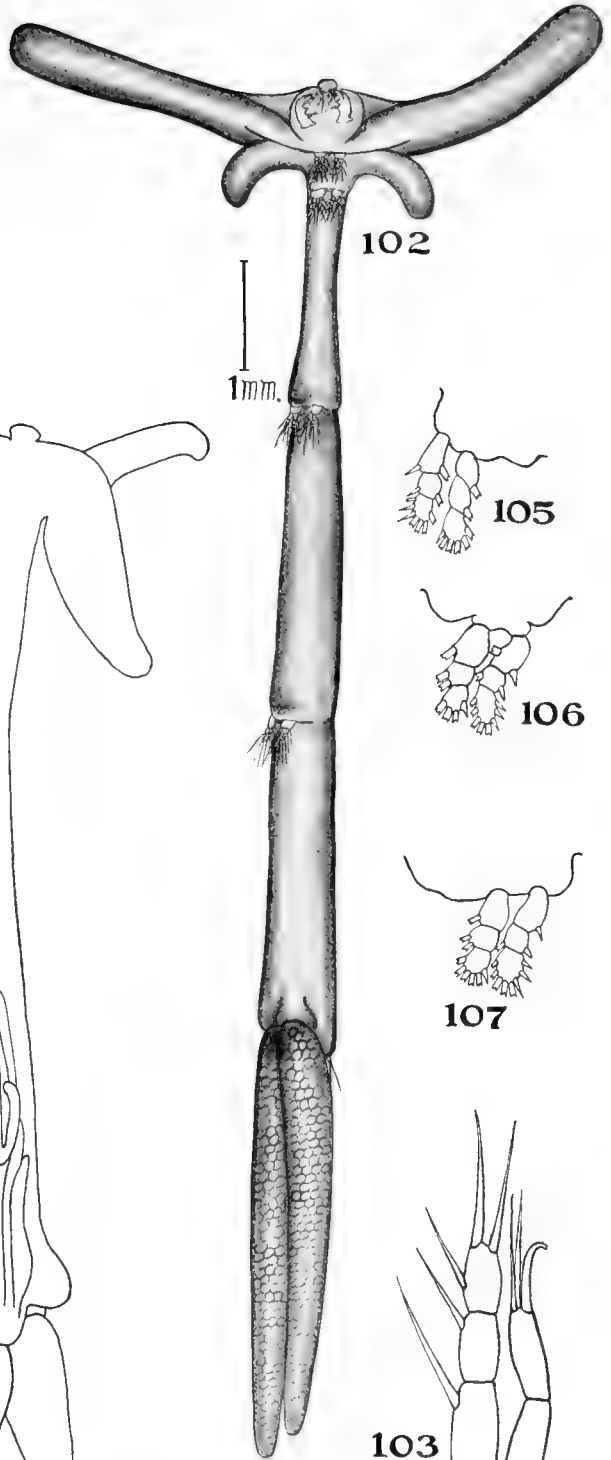

102

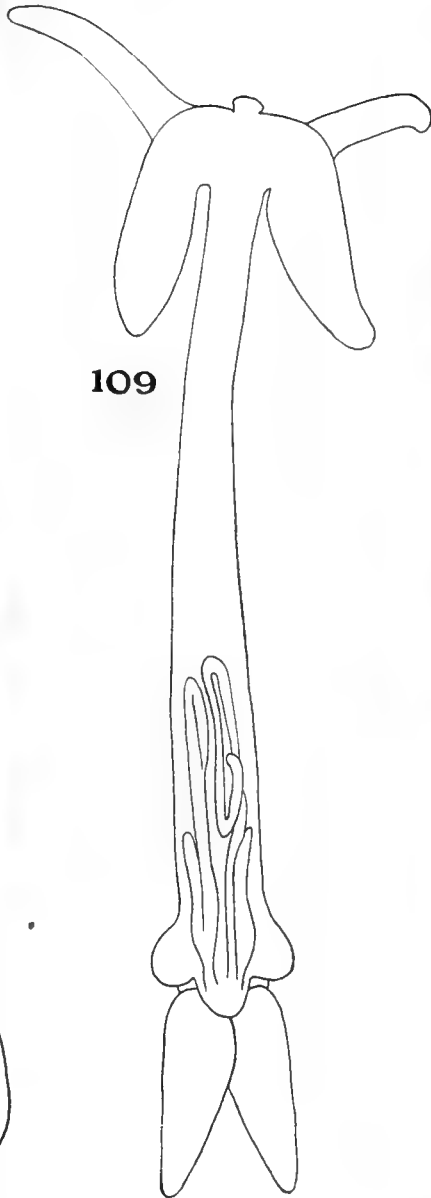

109



105

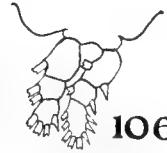

106

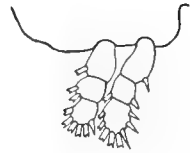

107

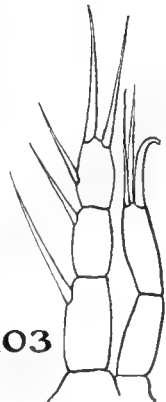

103

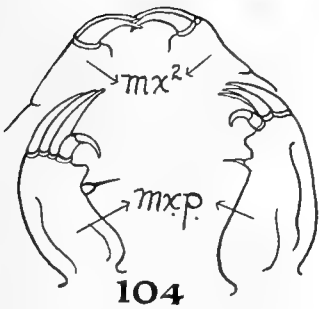

104

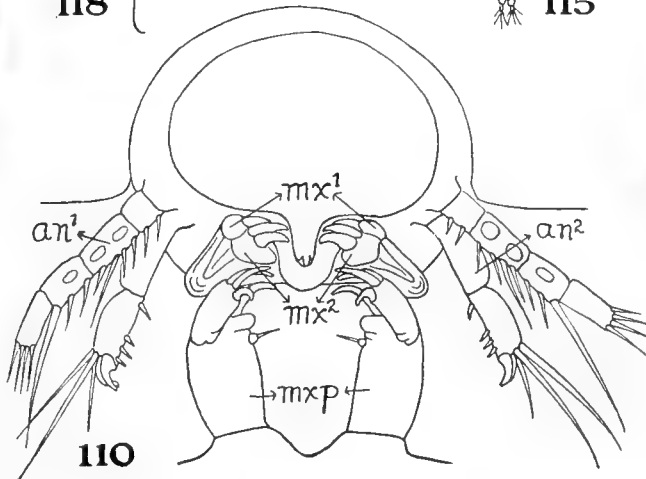
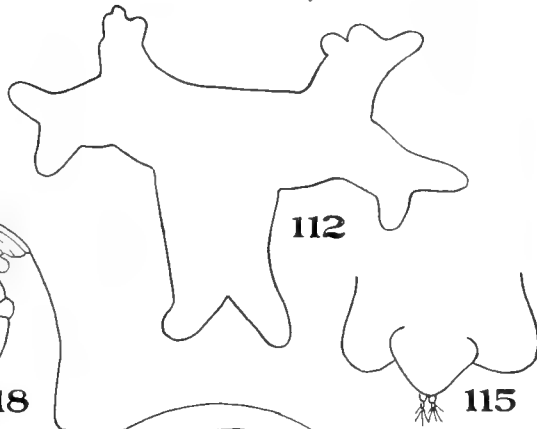
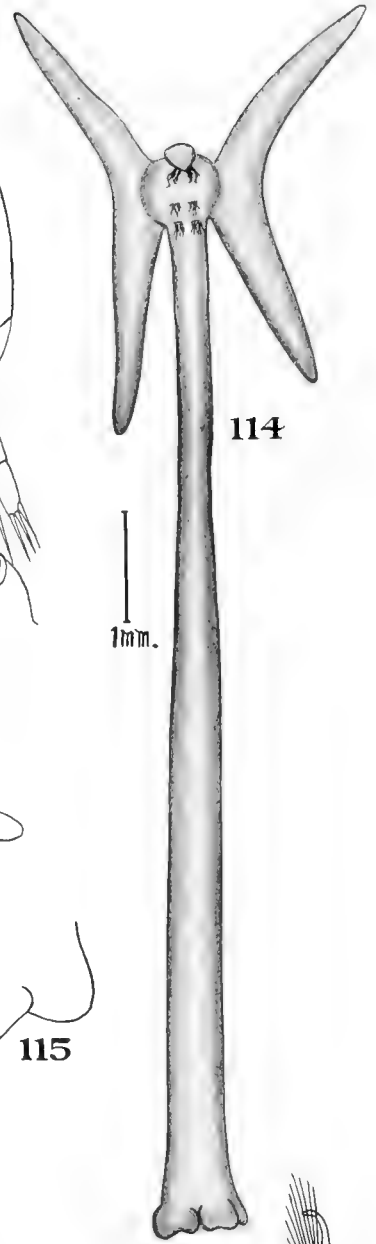
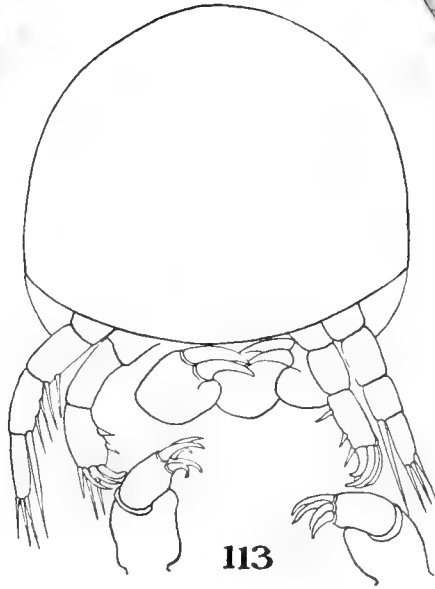
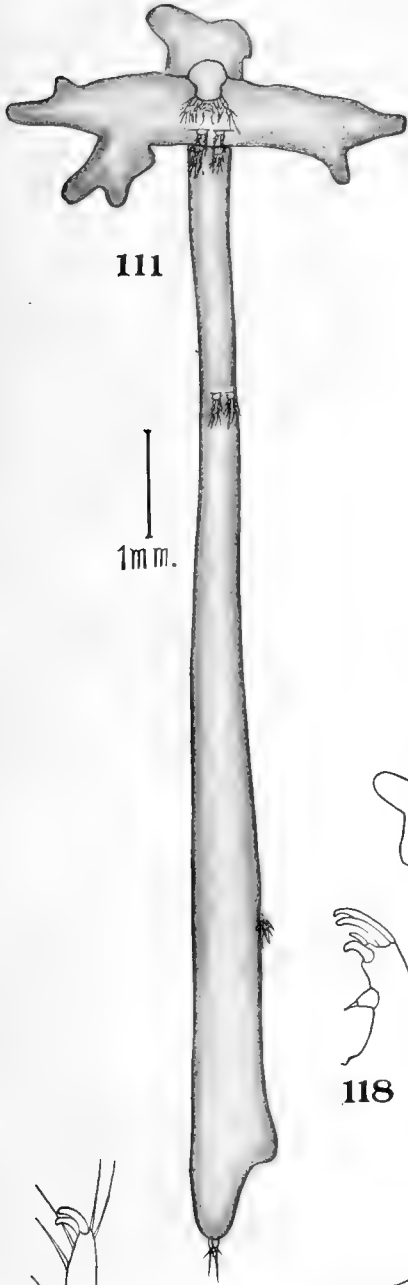

THE FISHES OF THE STREAMS TRIBUTARY TO
TOMALES BAY, CALIFORNIA



By John Otterbein Snyder
Stanford University, California



THE FISHES OF THE STREAMS TRIBUTARY TO TOMALES BAY, CALIFORNIA.

By JOHN OTTERBEIN SNYDER,
Stanford University, California.

INTRODUCTION.

The larger coastal streams of California which enter the ocean at points between the Klamath and Carmel Rivers are in most cases inhabited by one or more species of fluvial fishes which are either identical with forms found in the Sacramento-San Joaquin system or are very closely related to them. Beginning at the north and enumerating these streams, it is found that Redwood Creek has no fresh-water fishes. Bear, Eel, and Mad Rivers are inhabited by a single species, *Catostomus humboldtianus*, a representative of the common Sacramento sucker. Mattole, Noyo, and Big Rivers and the smaller streams which drain the region between Bear and Navarro Rivers have no fluvial species. Navarro and Gualala Rivers each has a single species of *Hesperoleucus* (*Rutilus symmetricus* of authors generally), a minnow measurably differentiated from *H. venustus* of the Russian and Sacramento Rivers, while Garcia River, about as large as either of these and draining a basin between them, has no minnows. Russian River has several species of minnows and one sucker, all of which are Sacramento forms. The streams entering San Pablo and San Francisco Bays have fishes identical with those of the Sacramento; in fact, they form a part of the great Sacramento-San Joaquin system, the waters of the bay not constituting a barrier sufficient at all times to prevent the passage of fresh-water fishes. The small creeks between the Golden Gate and Monterey Bay are not known to have fluvial fishes. In the streams tributary to Monterey Bay are found Sacramento species and others closely allied to them.

Faunal reports have appeared from time to time dealing with the various basins of this entire region except that including the streams which enter Tomales Bay, and it is the purpose of this paper to present an account of the fishes which inhabit them.^a

Only two streams flow into Tomales Bay which are large enough to support fishes, Papermill Creek, with Olima and Bear Valley Creeks as tributaries, which enters the southern end of the bay, and Walker Creek, which flows into the northern part. A recent examination of these streams shows that the fishes living there are specifically identical with those of near-by basins. Besides forms able to withstand salt water, as the trout, cottoids, and sticklebacks (no salmon were seen), there are found here a sucker, *Catostomus occidentalis*, and a minnow, *Hesperoleucus venustus*,^b the latter occurring in all the streams, while the sucker is apparently absent from Walker Creek.

^a Under the direction of the Bureau of Fisheries the writer and Lee R. Dice visited the creeks tributary to Tomales Bay in the latter part of October, 1910, and while searching for young salmon made a collection of fishes on which this account is based.

^b Through some oversight Evermann and Latimer (Barton Warren Evermann and Homer Barker Latimer: On a collection of fishes from the Olympic Peninsula, together with notes on other west coast species; Proceedings of the Biological Society of Washington, vol. XXIII, p. 133) record *Rutilus bicolor* as having been taken in Walker Creek. This species is indigenous to the Klamath system.

No important differences have been detected between the fishes of the streams entering Tomales Bay and those of Russian River or the Sacramento. There is then no zoological evidence to offer concerning the origin of the Tomales Bay fauna further than that it was probably derived from either the Russian River Basin or from some stream tributary to San Pablo Bay, for it will be observed from the map that the catchment basin of Tomales Bay is bounded on the north and east by the territory drained by Russian River and the

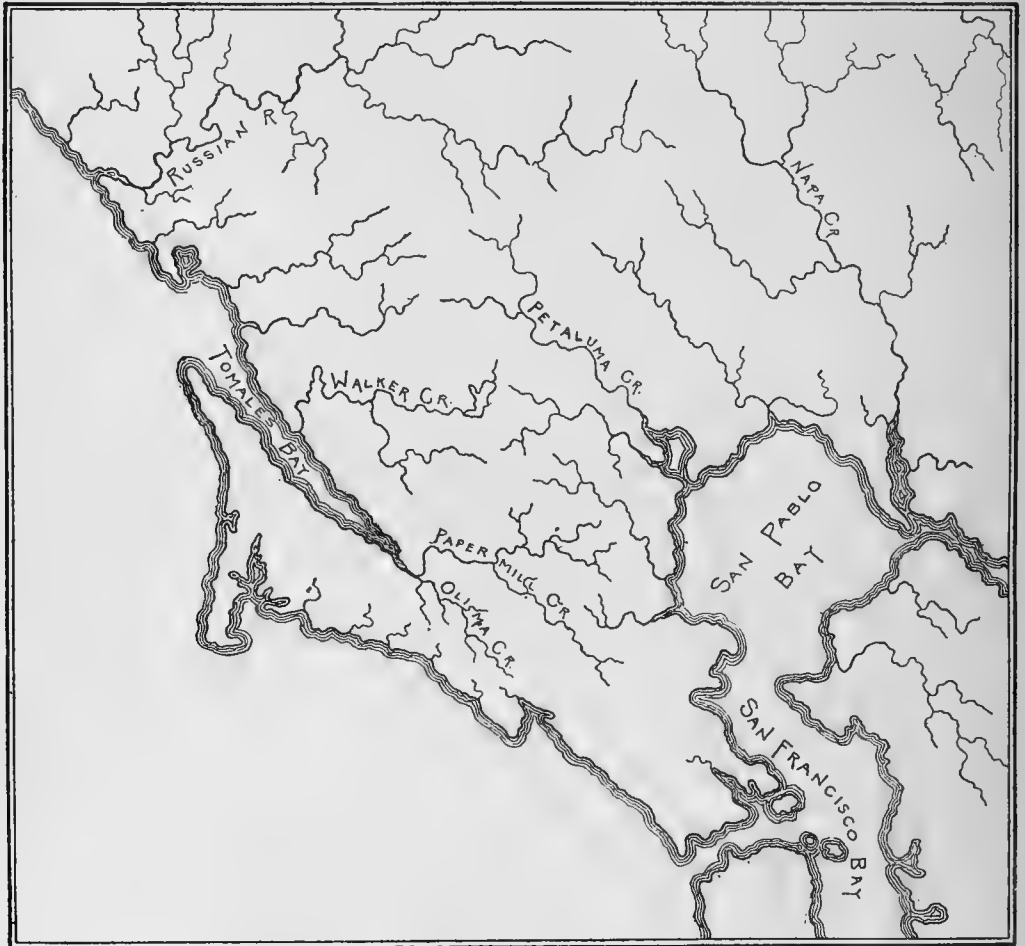

Map of Tomales Bay, showing tributary streams large enough to support fishes.

small creeks which flow into San Pablo Bay.^a Furthermore, it is separated from rivers farther up the coast by a barrier of sea water which can not be traversed by fluvial species.

SYSTEMATIC DISCUSSION.

Catostomus occidentalis Ayres. Sacramento sucker.

This species was observed in Olima and Papermill Creeks but not in Walker Creek. Specimens have been collected in Olima Creek at its mouth. On the 20th of October and on the following day,

^a Of interest in this connection is a paper by Prof. Ruliff S. Holway; The Russian River, a characteristic stream of the California coast ranges. University of California publication, in Geography, vol. 1, no. 1, Apr. 8, 1913.

when the water was low and clear, the stream was carefully examined for a distance of 3 or 4 miles above its mouth, and although minnows and trout were plentiful, no suckers were seen. Neither is the species well represented in Papermill Creek, which has a considerably larger volume of water. Much time was spent in carefully observing the stream above Tocaloma before any individuals were seen. Specimens were later obtained only with great difficulty, as they were uncommonly shy, seeking shelter under driftwood and overhanging banks, usually disappearing long before the trout or minnows were disturbed.

When compared with examples of the species from Russian River and the Sacramento Basin, a slight degree of differentiation appears in the Papermill Creek specimens. The dorsal fin is a little higher, the caudal seems to be somewhat longer, and the scales a little larger. In numerous specimens from the Russian and Sacramento Rivers, between which no differences have been detected, the dorsal measures 0.15 to 0.21 of the length, while the Papermill Creek specimens have a dorsal measuring 0.19 to 0.23. The caudal of Sacramento examples measures 0.21 to 0.27, that of Papermill Creek specimens 0.24 to 0.29. Sacramento individuals have 13 to 17 scales above the lateral line, while those from Papermill Creek have 11 to 13. These measurements have been based on only 15 specimens from Papermill Creek and are not sufficient in number to be of real value. It is of interest, however, that the apparent differentiation of these specimens is in the direction of that exhibited by *C. humboldtianus* of Bear, Eel, and Mad Rivers.

Measurements of 10 specimens follow:

MEASUREMENTS OF TEN SPECIMENS OF CATOSTOMUS OCCIDENTALIS, PAPERMILL CREEK.

Length of body.....mm..	210	210	198	180	112	138	140	121	111	110
Length head.....	0.225	0.235	0.23	0.24	0.24	0.23	0.23	0.225	0.24	0.25
Depth body.....	.22	.22	.21	.22	.23	.24	.25	.24	.25	.24
Depth caudal peduncle.....	.09	.085	.09	.09	.08	.09	.08	.09	.08	.09
Length caudal peduncle.....	.165	.175	.15	.165	.17	.15	.16	.15	.16	.16
Length snout.....	.11	.11	.10	.11	.11	.11	.11	.10	.11	.11
Diameter eye.....	.04	.04	.04	.04	.05	.04	.035	.04	.045	.05
Interorbital width.....	.10	.095	.10	.10	.10	.09	.09	.095	.09	.095
Depth head.....	.16	.165	.165	.17	.165	.16	.17	.17	.17	.17
Snout to occiput.....	.20	.20	.20	.20	.21	.22	.21	.20	.22	.21
Snout to dorsal.....	.49	.495	.50	.51	.52	.49	.50	.49	.50	.50
Snout to ventral.....	.55	.565	.565	.57	.60	.575	.57	.58	.58	.59
Length base of dorsal.....	.17	.175	.19	.16	.19	.19	.185	.18	.17	.18
Length base of anal.....	.08	.09	.08	.075	.09	.08	.075	.07	.08	.07
Height dorsal.....	.19	.20	.22	.20	.23	.21	.20	.20	.21	.21
Height anal.....	.24	.27	.21	.20	.20	.19	.18	.18	.19	.18
Length pectoral.....	.21	.23	.23	.21	.23	.21	.20	.21	.20	.20
Length ventral.....	.175	.18	.17	.155	.18	.175	.17	.17	.17	.18
Length caudal.....	.26	.26	.28	.25	.29	.26	.24	.27	.26	.24
Dorsal rays.....	13	13	14	13	13	12	13	12	12	12
Anal rays.....	7	8	8	7	8	8	8	7	8	7
Scales lateral line.....	69	68	64	62	66	63	59	62	63	60
Scales above lateral line.....	12	12	12	13	13	12	11	12	12	11
Scales below lateral line.....	10	9	10	10	10	9	8	8	9	9
Scales before dorsal.....	32	30	31	30	29					

Hesperoleucus venustus Snyder. San Francisco roach.

Examples of this species resemble those of the Russian River in the trim, slender body, rather pointed snout, slender caudal peduncle, and long fins. They have usually 9 dorsal and 8 anal rays, the number counted in 167 specimens being as follows:

	Dorsal rays.			Anal rays.	
	8	9	10	7	8
Papermill Creek.....		78	2	1	79
Bear Valley Creek.....		37			37
Walker Creek.....	5	45		3	47
	5	160	2	4	163

Where 8 rays are recorded the last is cleft to the base, the distinction in this case being somewhat arbitrary. The scales in the lateral series number from 49 to 59, the most usual number being 50 to 56.

Scales lateral line.....	49	50	51	52	53	54	55	56	57	58	59
Papermill Creek.....	1	5	5	8	14	11	13	10	5	6	1
Bear Valley Creek.....	2	3	2	6	7	7	4	4	2	1	1
Walker Creek.....	2	5	6	8	7	6	7	6	2	1
	5	13	13	22	28	24	24	20	9	8	2

In shape the scales are more or less quadrangular, although elongate and spatulate specimens often occur. The basolateral angles are strong and well marked. The apicolateral angles are usually weak. Lateral radii are not common, and not over two have been observed on one side of a scale. The apical radii number from 11 to 25.

This form differs from those of the Navarro and Gualala Rivers in being more slender in outline, in having somewhat longer and more pointed fins, and a different number of fin rays, *H. navarroensis* having generally 8 dorsal and 8 anal rays, and *H. parvipinnis* 8 dorsal and 7 anal rays.

Minnnows were seen in large numbers in the pools of Olima, Bear Valley, Papermill, and Walker Creeks. They were especially abundant in Walker Creek, where they were considerably smaller than those of Papermill Creek. In the latter stream specimens were collected October 21 which measured 130 millimeters, something more than 5 inches in length. An attempt was made to determine the age of some of these from an examination of the scales, and it appeared that fishes measuring from 100 to 130 millimeters in length were in their third year; those measuring from 70 to 110 millimeters were in their second year; individuals hatched in the previous spring were from 70 to 110 millimeters long. None was seen which appeared to be older than the third year.

Measurements of 10 specimens from Papermill Creek are here given.

MEASUREMENTS OF TEN SPECIMENS OF MINNOWS, 'PAPERMILL CREEK.

Length of body.....mm..	87	85	85	80	81	78	80	81	76	70
Length head.....	0.25	0.25	0.26	0.27	0.26	0.255	0.25	0.25	0.26	0.24
Depth body.....	.277	.27	.26	.28	.26	.26	.27	.26	.29	.25
Depth caudal peduncle.....	.10	.11	.11	.105	.105	.10	.11	.105	.10	.11
Length snout.....	.09	.09	.10	.10	.085	.085	.08	.09	.09	.085
Diameter eye.....	.055	.06	.055	.06	.06	.06	.06	.06	.06	.065
Interorbital width.....	.10	.09	.09	.10	.09	.09	.09	.10	.10	.09
Depth head.....	.19	.20	.19	.185	.20	.18	.19	.20	.19	.19
Snout to occiput.....	.21	.21	.21	.22	.21	.21	.21	.22	.21	.22
Snout to dorsal.....	.58	.59	.58	.58	.58	.58	.58	.58	.59	.57
Snout to ventral.....	.51	.52	.53	.54	.52	.53	.53	.53	.53	.52
Length base of dorsal.....	.14	.135	.14	.135	.13	.125	.13	.13	.125	.13
Length base of anal.....	.10	.10	.11	.10	.10	.095	.09	.10	.09	.10
Height dorsal.....	.18	.19	.18	.19	.19	.18	.20	.18	.18	.20
Height anal.....	.165	.18	.16	.18	.17	.16	.18	.17	.17	.18
Length pectoral.....	.18	.18	.18	.21	.20	.19	.19	.19	.185	.23
Length ventral.....	.15	.16	.14	.16	.16	.14	.15	.16	.145	.17
Length caudal.....	.25	.27	.27	.29	.28	.265	.27	.28	.275	.275
Dorsal rays.....	9	9	9	9	9	9	9	9	9	9
Anal rays.....	8	8	8	8	8	8	8	8	8	8
Scales lateral line.....	56	54	58	54	53	57	55	56	53	52
Scales above lateral line.....	14	13	13	13	13	13	14	13	13	13
Scales below lateral line.....	8	7	7	8	7	7	8	8	8	8
Scales before dorsal.....	31	32	32	30	32	33	33	32	32	33

Salmo irideus Gibbons. Rainbow trout.

Small trout were plentiful in Papermill and Olima Creeks. A few were seen in Walker Creek. Large steelheads come in from the bay immediately following the first heavy rains of winter.

Gasterosteus cataphractus (Pallas). Alaska stickleback.

This species enters all the streams which flow into Tomales Bay.

Cottus asper Richardson. Prickly bullhead.

Found in the deeper and more quiet pools in the lower courses of the streams, and especially common near their mouths.

Cottus gulosus (Girard). Rifflefish.

Two small specimens were collected on the rocky bottom of Papermill Creek several miles above Tocaloma.

This is the rifflefish of the miners, known to them because it frequently lodged above the riffles or cross slats of their sluices, and by its vigorous flopping sometimes caused fine particles of gold to pass over.

C. aleuticus was not seen.

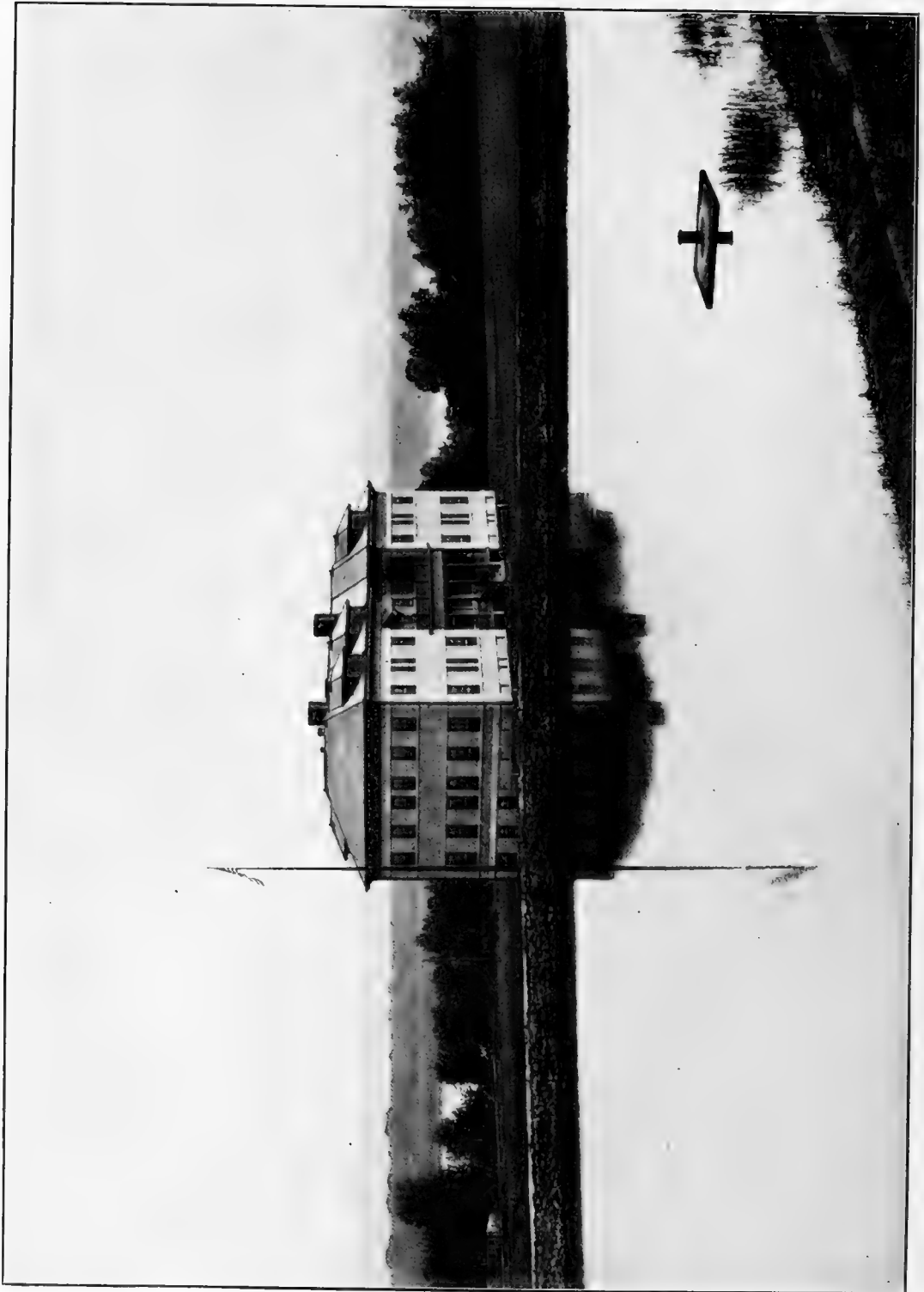

FIG. 1.—Main laboratory, with storage reservoir in foreground. Fisheries biological station, Fairport, Iowa.

THE FAIRPORT FISHERIES BIOLOGICAL STATION: ITS
EQUIPMENT, ORGANIZATION, AND FUNCTIONS



By Robert E. Coker, Ph. D.

Assistant in Charge of Scientific Inquiry, Bureau of Fisheries

(Formerly Director of the Station)

CONTENTS.



	Page.
Functions of the station	387
Establishment of the station	387
Equipment of the station	388
Buildings and ponds	388
The water systems	388
Other equipment	392
Personnel	397
Grounds of the station	397
Biological environment	398
Mussel propagation, by experiment and practice	399
Organization and general plan	399
Methods of propagation	400
Investigations relating to propagation	401
Propagation and reclamation of fish with experimental and practical ends	402
Investigations	403
Studies of mussels	403
Investigation of fishes, with reference to habits, propagation, and environmental conditions	404
Associate or temporary investigations	404

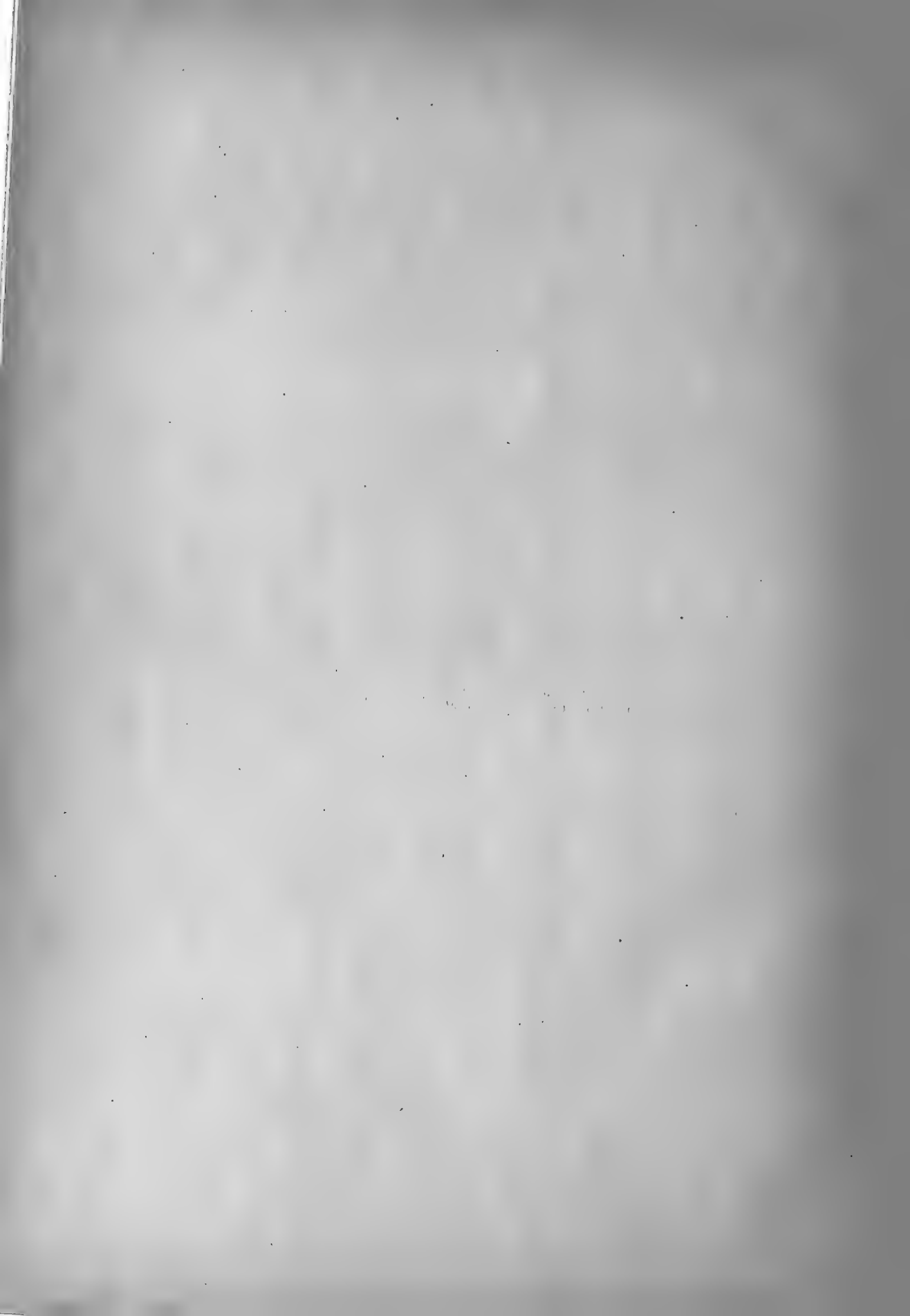

THE FAIRPORT FISHERIES BIOLOGICAL STATION: ITS EQUIPMENT, ORGANIZATION, AND FUNCTIONS.



By ROBERT E. COKER, Ph. D.,

Assistant in Charge of Scientific Inquiry, Bureau of Fisheries.

(Formerly Director of the Station.)



FUNCTIONS OF THE STATION.

By means of the Fairport fisheries biological station, with personnel of investigators and fish culturists, equipment of laboratories and ponds, and apparatus for scientific and practical work, the Bureau is enabled to inaugurate a more positive effort for the promotion of all fishery interests of the Mississippi Basin. This institution is located upon the Mississippi River, approximately midway between St. Paul and the mouth of the Ohio, 8 miles above Muscatine, Iowa, and 20 miles below Davenport, Iowa, and Rock Island, Ill.

The station, with permanent and temporary employees and associates, engages in the propagation of the pearly mussels; in the cultivation of fishes with experimental and practical ends; in the investigation of problems relating to mussels, to fishes and to fishery conditions; and in biological research. With such scope, this biological station affords a nucleus for many phases of the Bureau's activities for the promotion of fishery interests in interior waters. Its operations are not restricted to the station or to its vicinity, but extend into the distant parts of the basin, as evidenced by the propagation of mussels in Minnesota, Wisconsin, Indiana, and Arkansas, and by the investigation of fishery resources and biological conditions in South Dakota and Tennessee, in Minnesota and Louisiana, and elsewhere.

In brief, the institution is a "fish-cultural experiment station," as well as a center for mussel propagation and for investigations in laboratory and field. The broad field and the varied responsibility do indeed require care against the dissipation of energies, but all activities so far have been coordinated in such a way as to make them mutually helpful and contributory to a common end. It is the function of the station in the first years to lay a secure foundation upon which, as means and agents become available, the service may be continually extended.

ESTABLISHMENT OF THE STATION.

The station was established by act of Congress in 1908; the construction was begun in the late fall of 1909; with temporary equipment, the station began operations in the investigation of mussel problems in June, 1910; the propagation of mussels on a practical scale was entered upon in 1912; the main laboratory building was constructed in 1912

and 1913, and opened for general investigations June 15, 1914. In response to the urgent request of local organizations, there was held on August 4, 1914, a formal celebration of the opening of the laboratory, with exercises of dedication. The attendance of some 5,000 persons, the sympathetic addresses by men of prominence in public life and by scientific men of established repute, and the presentation of a memorial tablet,^a were regarded as manifestations of an unusual public interest and a gratifying indorsement of the purposes of the Bureau as expressed by this new endeavor.

The equipment and the several phases of activity of the station are briefly described under several heads, but it is not found practical to separate in description the practical and the experimental aspects either of the propagation of mussels or of the fish-cultural operations.

EQUIPMENT OF THE STATION.

BUILDINGS AND PONDS.

The main laboratory building is about 100 by 50 feet, with two complete stories, besides a finished half story and a basement (pl. LXXV). The building includes offices for administration, six laboratory rooms, a museum, a preparation room, a photographic room, a library, storerooms, packing room, eleven dormitory rooms, dining room, kitchen, and bathrooms. The laboratory is provided with steam heat, with filtered water service throughout, and with running river water in the basement. A fume chamber with proper vent is built in the chemical laboratory and there are many sinks, tanks, and aquaria where required. The several floor plans are shown in text figures 1 to 4.

There is also a tank house which is a one-story building, 25 by 50 feet, located near the laboratory (pl. LXXVI). Nearly all of the tanks in the laboratory and tank house are of concrete of light but substantial construction, and painted concrete floors generally are found where water is used.

An important building is the boiler and pump house on the river bank about 700 feet from the laboratory. Other necessary buildings are the boat and net house, the temporary laboratory, the storehouse and carpenter shop, the shell-testing plant, the barn, and five cottages affording living quarters for members of the regular staff (pl. LXXVII, fig. 3 and 5).^b

Up to the present time there have been constructed 17 earth ponds, the largest of which is a little over an acre in extent. They are intended primarily for rearing fish which constitute a reserve stock for use in mussel propagation and for experiments in the propagation of fish and mussels. The larger units generally have a depth of 6 feet in deepest portion. The total acreage of earth ponds is about 7 acres. There are also 14 small concrete-lined ponds with a combined area of about 4,800 square feet. The concrete-lined ponds are designed for retaining fish or for experimental work relating to the growth of mussels or to other problems as they may arise. (See map following p. 405.)

THE WATER SYSTEMS.

Two systems of water are used. The crude river water of the Mississippi at this place contains the necessary elements for the life of fish and mussels, and after standing in the earth ponds, under the active influence of sunlight and vegetation, it develops a

^a In memory of J. F. Boepple, founder of the fresh-water pearl button industry and late shell expert of this station, presented by those who have built an important industry upon the foundation so well laid by Mr. Boepple.

^b Other ponds are in construction (May, 1916.)



FIG. 2.—Fisheries Biological Station. Southwest portion of grounds, with principal buildings, Mississippi River in background. From left to right, temporary laboratory, boat-house, concrete ponds of series C, storage reservoir in foreground, tank house, and main laboratory.

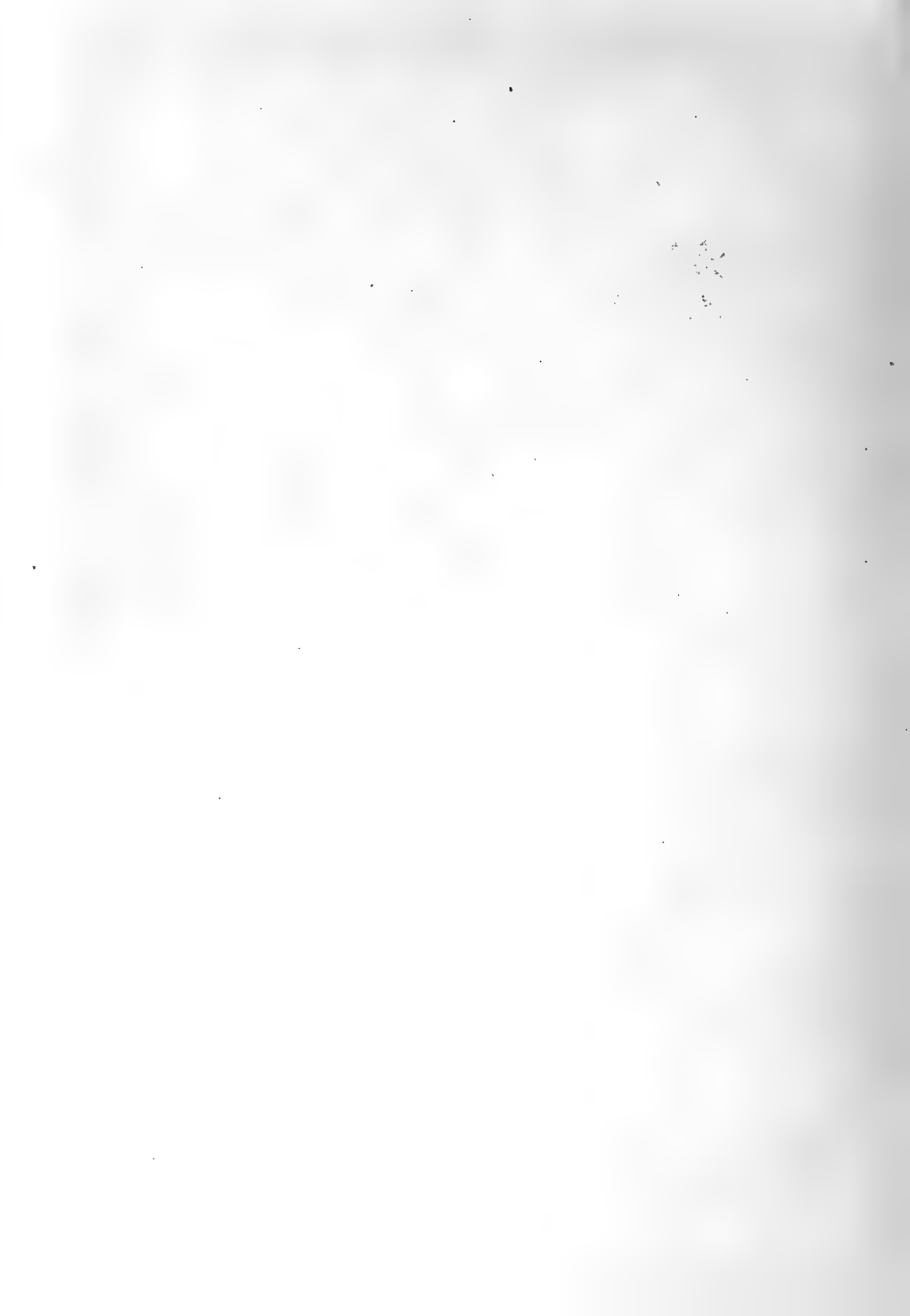

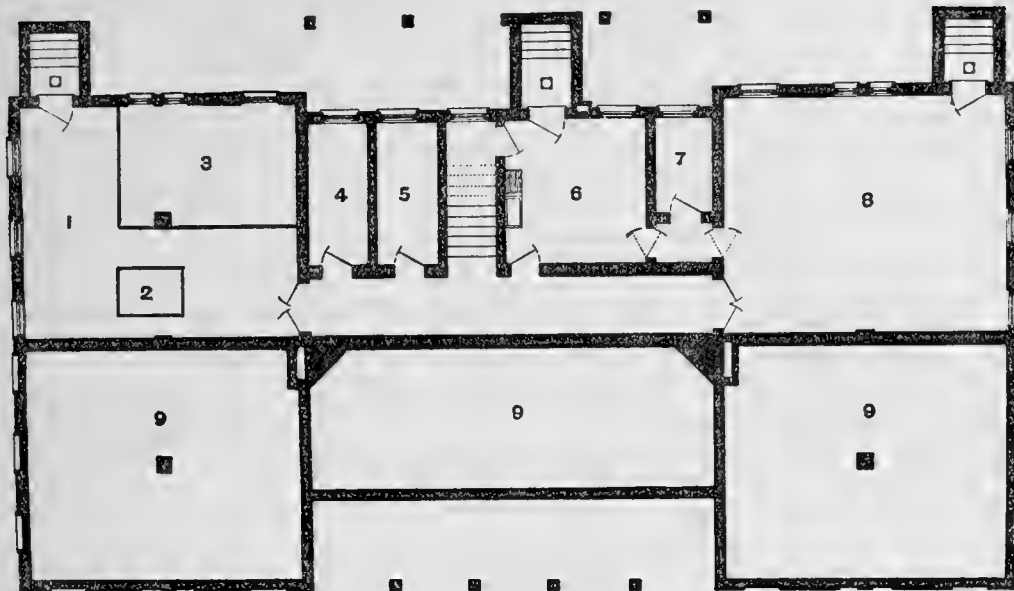

FIG. 1.—Plan of basement of laboratory. 1, Furnace room; 2, steam boiler; 3, coal bin; 4, store room; 5, toilet; 6, kitchen; 7, pantry; 8, dining room; 9, not excavated.

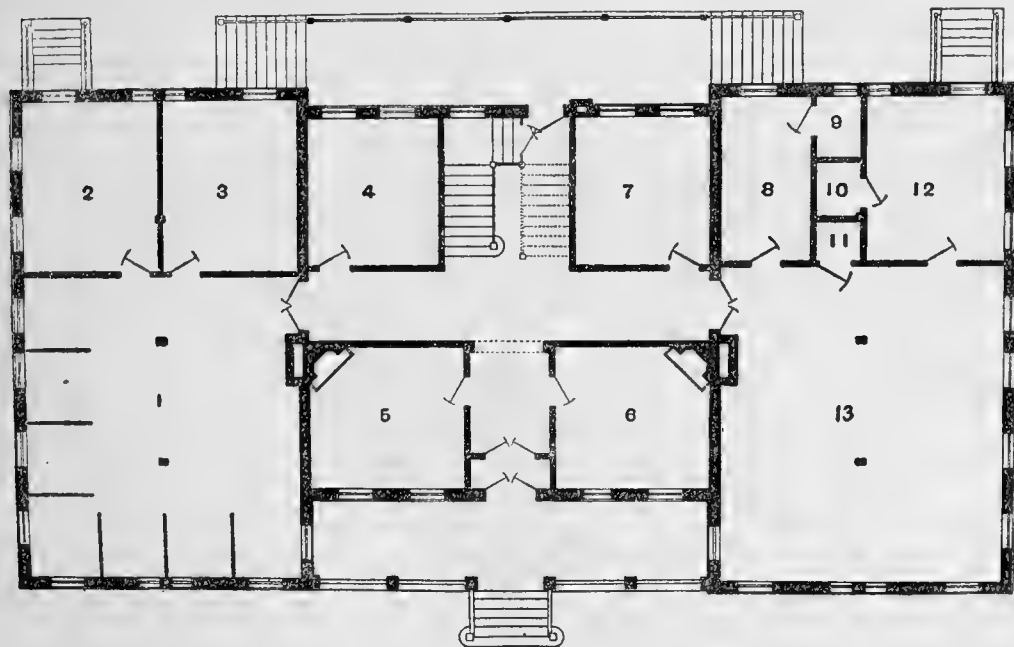

FIG. 2.—Plan of main floor of laboratory building. 1, General laboratory; 2, library; 3, chemical laboratory; 4, sterilizing and embedding room; 5, general office; 6, director's office; 7, stock room; 8, packing room; 9, closet for office storage; 10, alcohol closet; 11, janitor's closet; 12, preparation room; 13, museum.

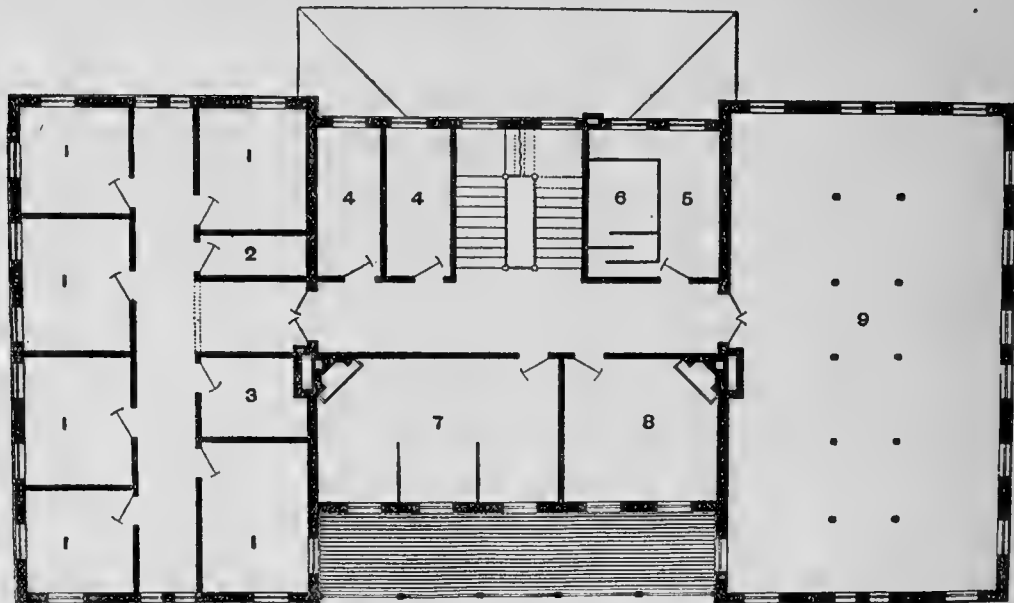

FIG. 3.—Plan of second floor of laboratory building. 1, Six bed chambers; 2, linen closet; 3, janitor's closet; 4, two bathrooms; 5, photographic room; 6, dark room; 7, north laboratory; 8, director's laboratory; 9, west wing.

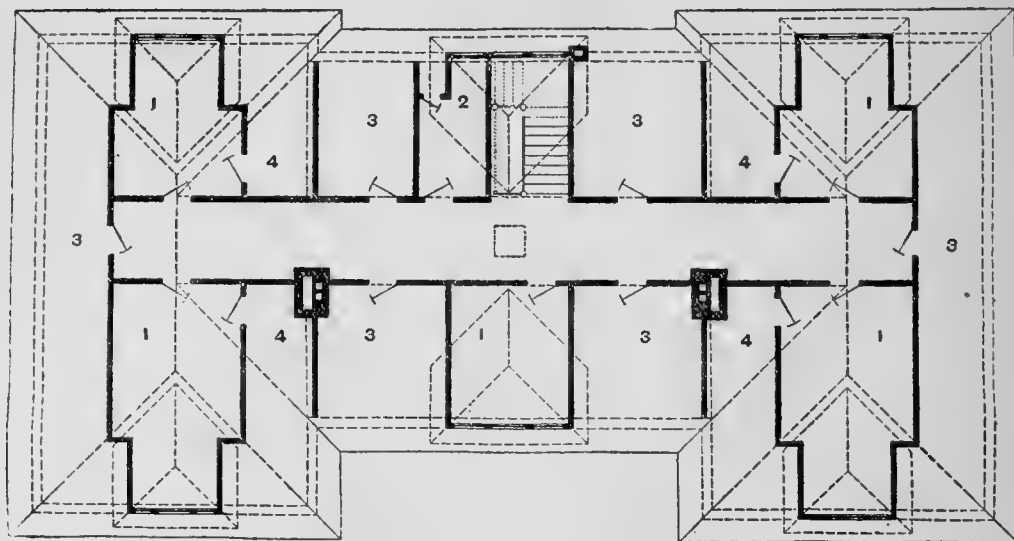

FIG. 4.—Plan of third floor of laboratory building. 1, Five bed chambers; 2, bathroom; 3, six dark storage chambers; 4, four large closets.

rich stock of food to form a peculiarly favorable condition for fish life. For domestic and scientific purposes it is also necessary to have a small supply of clear water, which is obtained by passing river water, after preliminary sedimentation, through a covered gravity sand filter.

The pumping equipment consists of two 60-horsepower return tubular boilers and three steam turbine-driven centrifugal pumps. The two larger pumping units are of 40 and 20 horsepower and have capacities of 1,400 and 800 gallons per minute, respectively; the crude river water is delivered through a main of 14 and 10 inch pipe to the storage reservoir, from which there is a gravity flow to the ponds, to the tank house, to the basement of the laboratory, and to the temporary laboratory, which has been converted into a hatchery (text fig. 5, p. 393).

The storage reservoir for river water has, in approximate terms, an area of nine-tenths of an acre, a depth of $14\frac{1}{2}$ feet at the outlet, and a capacity of 2,000,000 gallons. The reservoir allows opportunity for sedimentation of the coarser particles in the river water and for the development of the elements of fish food. While pumping operations are usually carried on for five to eight hours each week day, the capacity of the reservoir makes it possible to discontinue operations in case of emergency for two or three days.

The smallest pumping unit is a 15-horsepower steam turbine-driven centrifugal pump which delivers filtered water to low and high pressure cisterns, respectively, which are constructed of concrete in the ground and covered (text fig. 6). The low-pressure cistern is of 60,000 gallons capacity and at sufficient elevation to supply all floors of the laboratory building; it is connected also to the tank house and the barn. The high-pressure cistern is of about 4,000 gallons capacity and located about 75 feet higher, so as to supply the cottages and hydrants upon the hillside (text fig. 7). The use of the two cisterns permits substantial economy in pumping operations, since it is not necessary to lift any considerable amount of water higher than is requisite for the intended service. The clear water is obtained by passing a small portion of the water from the storage reservoir through a gravity sand filter of about 20,000 gallons maximum daily capacity, located near the boiler house. The filtered water is not absolutely pure, but has been used with satisfaction.

There must, of course, be complete systems of pipe lines for water, sewers, and drains, and these comprise in all about 3 miles of underground piping (text fig. 4, 5, 6 and 7). The water-pipe lines are principally of cast-iron, well asphalted within and without, with bevel joints and the sections drawn together by bolts. Some threaded pipe is used, but the asphalted cast-iron has been most satisfactory. To prevent freezing, the water lines are laid with a minimum of 4 or 5 feet of cover, according to location. The size of water pipes varies from 2 to 14 inches; that of sewers and drains from 4 to 15 inches. A feature of the pipe lines is the provision of emergency connections. It is possible to cut out the reservoir and to pump directly into all units ordinarily supplied from the reservoir (text fig. 5). Similarly, it is possible to pump directly into all buildings and hydrants supplied from the clear-water cisterns (text fig. 6). The former connection is accomplished by the insertion of proper valves at a junction point just south of the railway, and the latter by a short emergency line on the hillside. An explanation of the emergency connection on the reservoir line will be of interest.

It will be noted from the plan of the river water system, as shown in text figure 5, that the 10-inch "reservoir supply line" (through which water passes from the pumps to

the reservoir) and the 8-inch "pond supply" (through which water returns from the reservoir to the ponds below the railroad) pass through the same culvert beneath the railway tracks, and are therefore parallel and closely approximated for a short distance. A little south of the railroad, a crossover connects the two lines, as may be seen in the foreground of figure 7, plate LXXVIII. There is a valve in the crossover which is ordinarily closed, so that the two lines function quite distinctly. It is possible, however, to open this valve and at the same time to close a valve in the reservoir supply line just above the crossover. If the pumps are then set in operation, the water passes through the 14-inch portion of the reservoir line as far as the crossover, where it turns into the pond supply and its various branches, and will even flow into the lower end of the reservoir unless the valve controlling the normal outlet from the reservoir be closed. Again, if for any reason it becomes necessary to operate both pumps at the same time and thus to force an unusually large volume of water through the reservoir supply line, the friction head may be substantially lowered, by leaving open all valves in connection with the crossover. The discharge through the 14-inch pipe then divides into several streams, passing through (a) the 10-inch continuation of the reservoir line, (b) the 8-inch pond supply, and (c) the 4-inch "A-B branch." In this case the water may be permitted to enter the reservoir at both ends, that is, through the normal outlet as well as through the inlet.

The plans of drains and sewers are shown in text figures 7 and 8. All sewers from buildings north of the railroad and the drains from the reservoirs, cisterns, and upper tiers of ponds, converge into a main 12-inch line, which discharges into a storm channel in the eastern part of the grounds. Through this storm channel the waste water passes into the river some distance below the intake for the pumps.

OTHER EQUIPMENT.

At the present time the station owns two launches, one of which is kept on Lake Pepin, Minn., at a considerable distance from the station (pl. LXXIX, fig. 11), the other being regularly used at Fairport. There are also three small power flatboats employed in investigations and in fishing operations and a number of small rowboats both at the station and in the field.

The original temporary laboratory has been equipped with a battery of hatching jars which may be used for experimental purposes or for practical hatching operations, as opportunities and necessities arise.

It is unnecessary in this place to mention in detail the scientific apparatus such as is ordinarily found in a biological laboratory, or to refer to the various field and mechanical tools that are necessary for the maintenance of an institution of this size located at a distance from an important town.

Mention should be made, however, of the fact that the station has a complete outfit of simple button-making machinery of the old type, by means of which commercial tests of shells can be made by cutting and finishing buttons or novelties. The machinery is that which was formerly used by the late J. F. Boepple, who founded the freshwater pearl button industry. The shell-testing shop is the small building seen at the extreme left of figure 3 (pl. LXXVII), being designated on the map as the temporary pump house.

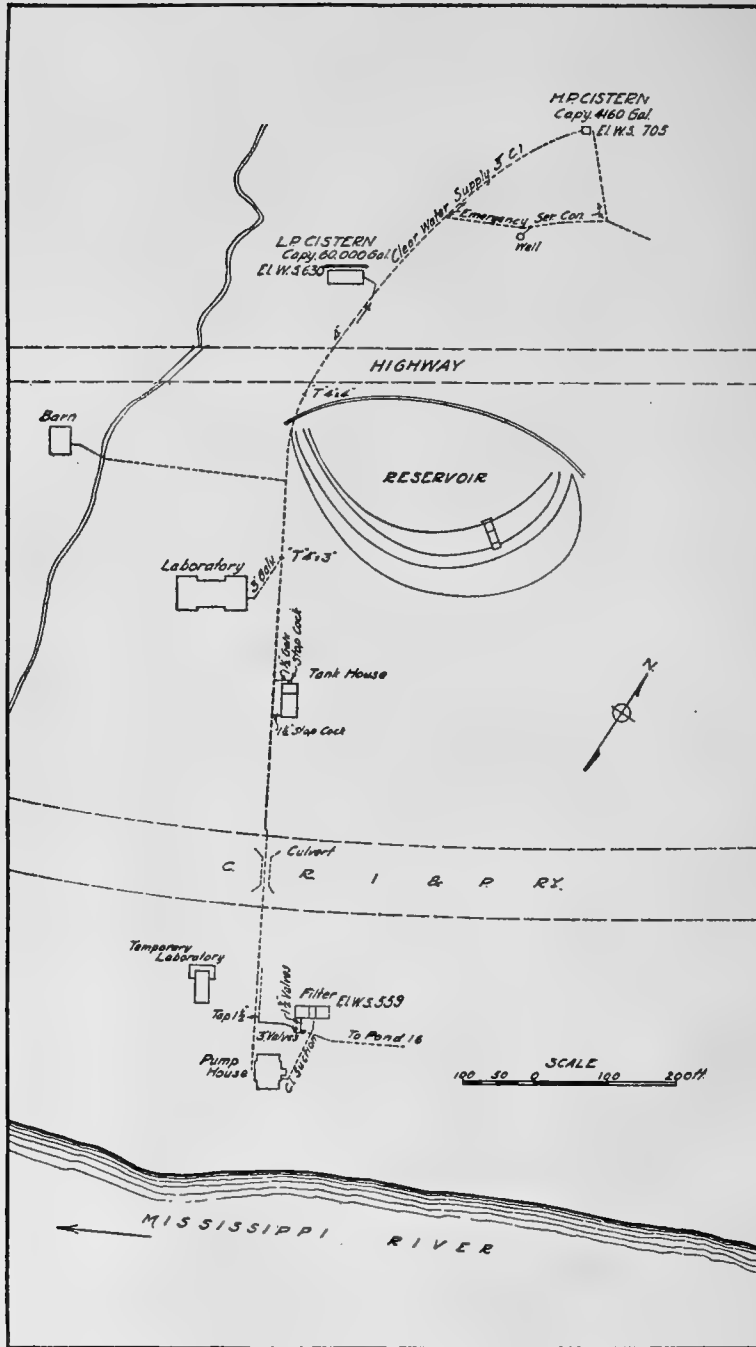

FIG. 6.—Plan of clear-water supply, Fairport station. (See also fig. 7.)

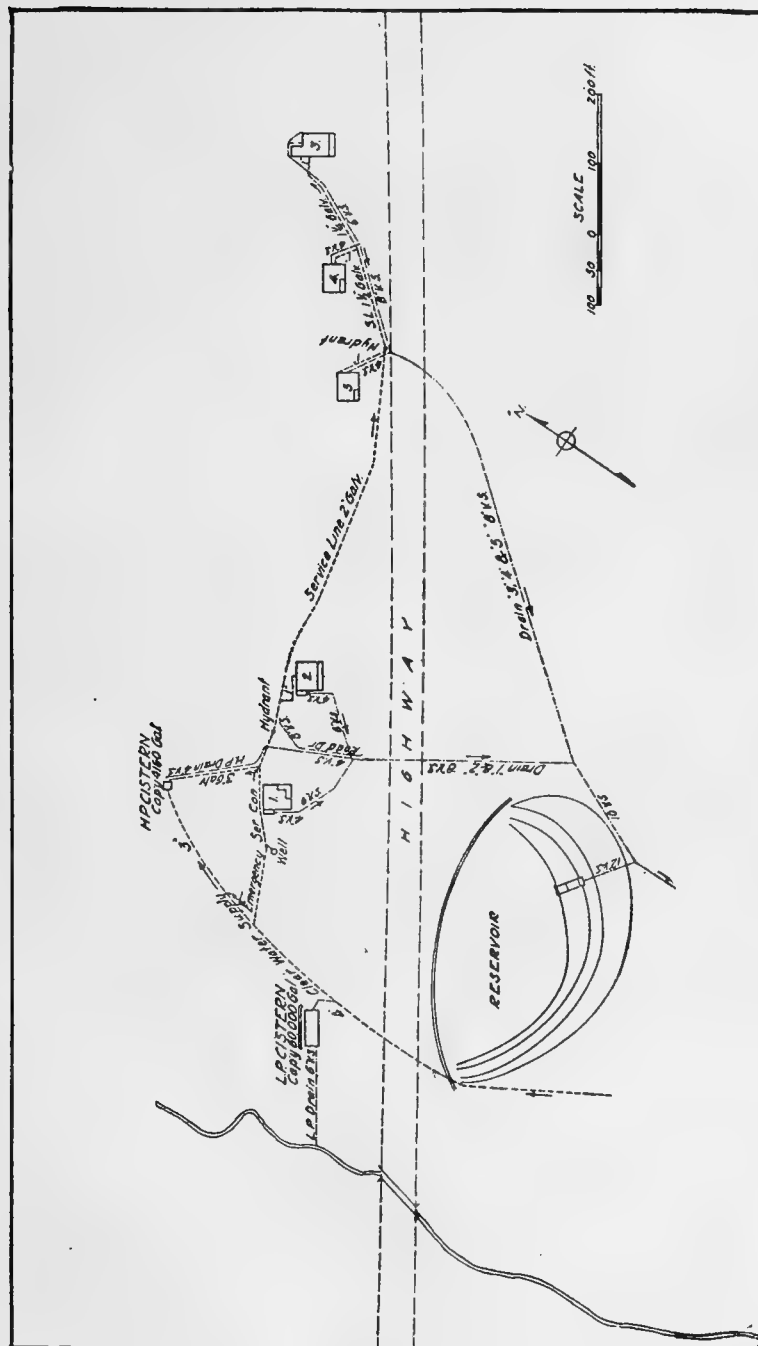

FIG. 7.—Plan of clear-water service and upper portion of sewage system, Fairport station. (See also fig. 6 and 8.)

PERSONNEL.

The personnel consists of the director, superintendent of fish culture, four scientific assistants, including two associated with the Homer station, a shell expert, a foreman, two laborers, an engineer, and two firemen. The work of the station is not carried out by these men alone; in the propagation of mussels, which is distributed over a wide territory, it is necessary to engage temporary foremen who, as the heads of local parties, assume no light measure of responsibility. In a later place reference is more appropriately made to the associated investigators who must contribute so largely to the ultimate usefulness of the institution.

GROUNDS OF THE STATION.

The grounds of the station comprise 60 acres and will afford opportunity for subsequent expansion with the construction of additional ponds. Being intersected by the Rock Island double-track railway, and by the county highway, the grounds are divided into three portions which happen to be somewhat distinct in character. (See map following p. 405.)

The lower or southern grounds between the railway and the river afford convenient locations for pumping station, boathouse, shops, and ponds, series A (concrete) and B (earth). (Pl. LXXVII, fig. 3.) The lowest parts of the lower grounds are only slightly flooded by the highest stages of the river, but the pond embankments and the floors of all buildings are above the highest recorded flood stage—that of 1892. Technically, this level is 560 feet, referred to the Memphis datum, while "low" water is 541.689 feet. The highest stage attained since the establishment of the station is 555.4, in 1912, the lowest being about $1\frac{1}{2}$ feet below "low."

The main grounds north of the railway and south of the highway comprise over 30 acres of original meadow and bottoms, mostly suited for ponds. There is a generally moderate slope rising more abruptly to the highway. This region affords excellent sites for the chief buildings, laboratory and tank house, for the storage reservoir (water surface 592.5 feet), and the principal ponds (pl. LXXVI, fig. 2; pl. LXXVII, fig. 4). A small portion, known as the western grounds, is cut off by a natural drain channel, or storm gully, and is occupied by the barn lot and a field that is not at present utilized, except as pasturage for the station horses.

Above the highway is a beautiful hillside, somewhat terraced naturally and covered by an original grove of walnut and oak (pl. LXXVII, fig. 5). While the cottages are conveniently and attractively located upon the principal terraces, yet practically nothing has been done to mar the naturally beautiful features of the grove. Since the hill ascends rather quickly to an elevation nearly 200 feet above the river, it has been easy to find favorable spots where the high and low pressure cisterns could be constructed at a moderate cost and under ground, while still at sufficient heights to give the desired pressures. The water surface elevations of these cisterns are 630 and 705 feet, respectively, or at heights of 69.5 and 144.5 feet above the floor of the pumping station.

It will be manifest that the grounds as a whole possess most favorable features in the way of natural drainage, ample space for the construction of ponds, and natural and easy grades for the construction of reservoirs, cisterns, and pipe lines for gravity flow

to the buildings and fish-cultural ponds. It has previously been shown how, in the location of reservoir and low and high pressure cisterns, advantage has been taken of the grades to obviate the pumping of any water higher than is necessary for the desired head and thus to provide for minimizing the perpetual cost of operation.

A word should be said as to the unusual natural beauty of the location. The particularly graceful outline of the hillside gives an effective background for the main building as viewed from the river or the railway, while its heights offer vantage points for the survey of the entire station. In the architectural and engineering features of the station proper, consideration has been given to simplification and to harmonizing of design with reference to the natural endowment. Much of the attractiveness of the station and much of the congeniality of the laboratory for persevering and enthusiastic labors is fairly attributed to the inspiring influence of the appropriate natural surroundings.

BIOLOGICAL ENVIRONMENT.

In fisheries or in biology, studies in a laboratory can only be supplemental to those based upon outdoor nature. A true biological station must be larger out of doors than indoors. While, therefore, a full report could properly be written upon the subject of the environment, it is beside our intention in this place to offer more than the mention of some general features of the surroundings which will suggest the nature of the habitats available for study.

It is manifest that the assembly of fish-cultural ponds, supplied originally with water from the Mississippi but permitted to develop essentially pond conditions, stocked with abundant aquatic vegetation and rich in entomostraca, insect adults and larvæ, together with the customary variety of smaller animal forms that thrive on the bottom, amidst the vegetation or in free-swimming condition, offer favorable opportunities for biological and physical studies bearing upon problems of fish food, as well as for investigations of more particular scientific interest.

The river with its willow-lined shores, its variety of sandy bars, gravel and mud bottoms, deeper channels, and quiet eddies below the wing dams, presents many favorable conditions for investigations where collecting may be done by hand, by dredge, by nets, or by seines. Fishes of many species, turtles, mussels, *Necturus*, etc., are not only near at hand, but are taken daily in course of the routine collecting of the station.

Just across the river are the islands and lowlands of Illinois, where distinctive conditions are found amid the intricate slues and in the ordinarily isolated overflow ponds that form the favored breeding grounds of some species of important fishes.

Botanists find a rare interest in certain striking habitats within a couple of miles of the laboratory, such as Wyoming Hill, Wild Cats' Den, and, on the Illinois side, "Turtle Slide" and "The Grottoes." Especially The Grottoes and Wild Cats' Den are of a character unique for the geographic region, displaying striking plant associations and presenting opportunities for examination of trees and plants of great rarity for the territory, some of which are growing in luxuriant natural abundance.

At some distance from the station, and yet reached by a day's journey by steamboat, by launch, or by rail, is the newly formed Lake Cooper above the dam at Keokuk and Hamilton. Here, as pointed out in a previous report,^a are unexampled opportunities

^a Coker, Robert E.; Water-power development in relation to fish and mussels of the Mississippi. U. S. Bureau of Fisheries, document 805. 1913.



FIG. 3.—From left to right, concrete ponds of series A, shell-testing shop, storehouse and carpenter shop, concrete filter bed, flagstaff (old position), boiler house, temporary laboratory, boathouse.



FIG. 4.—Ponds, series D, concrete ponds, series C, and southeast portion of grounds. The largest pond is a little more than an acre in extent. (See also fig. 13.)



FIG. 5.—On hillside, director's cottage, and in the distance cottage of foreman, scientific assistant, and superintendent. In foreground, reservoir and ponds, series D.

for the study of the development of lake conditions and of the effect of such conditions upon the abundance of commercial fishes. As far as its means permit, the Bureau has already availed itself of these advantages for studies of the movement of fishes and of the effect of the new conditions upon the supply of fish food and the development of fishery resources. A good deal of valuable data has already been secured.

The favorable features of location and environment which have been described under the heads of "Grounds" and "Biological environment" are some of those which dictated the establishment of the station at Fairport.

MUSSEL PROPAGATION, BY EXPERIMENT AND PRACTICE.

ORGANIZATION AND GENERAL PLAN.

In the practical propagation of mussels the Fairport station serves as headquarters for field operations conducted throughout the Mississippi Basin, including the Mississippi River and its various tributaries. There may be in the field at one time from two to six field parties operating near the station or at distances of several hundred miles, and all parties are organized under the superintendent of fish culture.

While the available personnel and means do not permit of covering the extensive field, the present endeavor is to restrict the operations to certain localities favorable for the work and needing of replenishment, and to distribute these localities as widely as practicable through the territory. Hence operations are now conducted in Lake Pepin of Minnesota and Wisconsin, on the Mississippi at Fairport, Iowa, on the Wabash in Indiana, and on the White and Black Rivers of Arkansas.

Each field party is under the direction of a competent head, who may be a permanent or temporary employee, sent out from the Fairport station or from the central office in Washington to work under the direction of the Fairport station. The crews employed in the seining of fishes, inoculating them with glochidia, and liberating them again in the river are made up of local laborers or fishermen temporarily employed.

There is no definite outlay of apparatus required. The chief of the party is provided with a compound microscope or a dissecting microscope, an ordinary Coddington magnifier, the usual dissecting instruments, and a field equipment which may consist of seines, fyke nets, tubs, tanks, buckets, etc. A Government-owned launch and rowboats may be used or launch and rowboats may be employed in the region where the operations are conducted. It is generally convenient to use flat-bottom rowboats of small size, 16 to 24 feet in length, but a launch is also practically necessary in order that more rapid movements can be made from place to place, thus extending the sphere of operations possible for a day's work. In some cases the field parties can find accommodation in towns conveniently situated, but in other cases a house-boat must be rented in order that the fishing party may have a place in which to sleep and board.

The methods of propagation are based upon a peculiar feature of the normal course of development of fresh-water mussels. The very young fresh-water mussels, with rare exception, when first liberated from the incubation pouches of the parent, must become parasitic upon fish in order to pass through the next stage of their existence. To this end, if the chance offers after liberation, the young mussels, or glochidia, as they are called in this stage, attach themselves to the gills, fins, or scales of a fish. The mussels of economic importance attach themselves almost exclusively to the gills. In attaching or biting on the fish a very slight wound seems to be caused, which begins at once to

heal over; but in the process of mending the glochidium is overgrown and thus inclosed within the tissues of the fish. The mussel is now actually an internal parasite, in which condition it remains for a period of two weeks, more or less. It is thus conveyed wherever the fish goes, until, when the proper stage of development is reached, it frees itself from the host and falls to the bottom; if through favorable fortune it finds suitable lodgment, it continues its growth to form an adult mussel.^a

The glochidia are so small that the infection, if not excessive, has no apparent injurious effect upon the fish that serves as host. Investigations by the station have shown that mussels do not attach to fish indiscriminately, but that for each species of mussel there is a limited number of species of fish which may serve as host. Particular instances are mentioned on a later page.

The task of propagation is to bring together suitable fish and the glochidia of mussels. Careful studies of natural and artificial infections show that a moderate sized fish may successfully carry in parasitism from 1,000 to 2,000 of the microscopic glochidia, but that under the chance operation of nature few of the glochidia find a lodgment upon the proper fish or upon any fish.

During the last fiscal year, in round numbers, 344,000,000 glochidia were liberated in parasitic condition, 208,000 fish being employed in the operations. A considerable proportion of these glochidia undoubtedly fall upon unfavorable ground or from other causes fail of reaching maturity. However, it is the large number which can be infected and liberated at small expense that justifies a confidence in the accomplishment of commensurate benefits. The average cost per 1,000 glochidia artificially infected in the fiscal year 1915 was 2.7 cents, inclusive of overhead expenses.

METHODS OF PROPAGATION.

The operation of infecting the fish with glochidia is a very simple one, though the methods may vary considerably with each party. Essentially the method is as follows:

(1) The first step is to secure a number of gravid mussels in order to obtain a supply of glochidia. Generally this can be accomplished by visiting the beds where mussel fishermen are engaged in work, looking over the catch, and picking out the desired number of gravid females, for which a small sum may be paid.

(2) These mussels are then opened, the marsupial passages are cut out, placed in a pan of water, where they may be opened with scissors or scalpel and the glochidia squeezed out into the water. The glochidia are taken up with a suitable pipette and placed in a small container, such as a glass or can. Usually this operation is delayed until the fish have been obtained.

(3) It is now necessary to secure as many fish as possible by means of seine or nets, and the species of fish must be appropriate for the species of mussel to be propagated. (See pl. LXXIX fig. 8-10.) After the fish are transferred from the seine to tubs or tanks, and when a suitable number of fish are in the tanks, overcrowding being avoided, a lot of glochidia are thrown into the water. (See pl. LXXIX, fig. 11.) There is no definite rule as to the number of glochidia to be used with any number of fish, but the person in charge is guided by his experience with due regard to the temper-

^a There are one or two species of mussels which need not attach to fish, but these are of no commercial value. There are a few species which during the period of parasitism increase in size manifold, being true parasites; but the greater number of species are between these two extremes, using the fish for conveyance and protection, but certainly deriving no considerable amount of nourishment.



FIG. 6.—Interior of general laboratory, showing alcove arrangement and concrete tank tables.



FIG. 7.—Three principal cast-iron pipe lines entering culvert beneath railway tracks. From left to right, the 4-inch clear-water supply, the 14-inch (reducing to 10-inch) reservoir supply, and the return 8-inch pond supply. In the foreground a valve box is seen; the valve controls an emergency "crossover" connection between reservoir supply and pond supply. (See text, p. 392.)

ature of water, the number and size of fish, and the activity of the glochidia. The fish may remain exposed to the glochidia for a period of 5 to 20 minutes. From time to time a specimen of fish is taken by hand, or with a small hand net, and the gills examined to ascertain if a sufficient degree of infection has obtained. When, in the judgment of the operator, the fish show the optimum degree of infection they are ready for liberation.

(4) Using buckets or small nets, the fish are transferred from the tank back into the river or the entire tub may be turned over into the river. This concludes the operation of infection as ordinarily carried on in a practical way.

INVESTIGATIONS RELATING TO PROPAGATION.

A good deal of experimental work is being carried on at the station to determine what species of fish are best suited for certain species of mussels, to ascertain the period of parasitism and the life history of the young mussels after parasitism, and to lead to such improvement of methods as will make the work most productive of practical results.

In addition to the study of special problems of importance, three general lines of investigation have been carried on practically continuously. These are (1) the daily collection of fish from the river for study of the condition of natural infection, (2) experiments in artificial propagation, employing various species of mussels and fish and keeping careful observation of the methods and results, and (3) the study of the habits and distribution of juvenile mussels. The results have been so favorable as to justify the continuance of these studies for a considerable time.

The fishes of the sunfish family, game fishes, such as the bass, crappie, sunfish, etc., are usually used for the mucket (*Lampsilis ligamentina*) and the fat mucket (*Lampsilis luteola*). For a very important mussel, the pimple-back (*Quadrula pustulosa*), the Siluridae, or catfishes, are found to be best suited. One of the best species of mussel, the "niggerhead" (*Quadrula ebeus*), is known to become parasitic only upon one species of fish, the river herring, *Pomolobus chrysochloris*. This fish is so delicate that it has been impossible to handle it in a practical way, and, therefore, no operations in the propagation of this mussel are yet pursued. Some experiments have been conducted which are promising of success. Examples of the herring found during the breeding season of the "niggerhead" are usually so heavily infected that it may not be necessary to use artificial methods with this mussel, although the abundance of the fish should be promoted. The matter is now under investigation. A very valuable species of mussel, the yellow sand-shell (*Lampsilis anodontooides*), is parasitic upon the several species of gar.

Other investigations are now being conducted with reference to the possibility of rearing young mussels after parasitism in ponds or in floating crates, and the preliminary results are as encouraging as could be expected. It is interesting to note that from glochidia of commercial species of mussels artificially infected upon fish at this station, young mussels have been reared within a period of two years to such a size that it was possible to cut and finish buttons from the shells (pl. LXXX). Some of these were reared in floating crates and some in one of the larger earth ponds. They are not only the first mussels to be reared to such a size from artificial infection, but they are the first commercial forms known to have grown in ponds. The experiments have not yet

advanced to a stage where any definite statements can be made as to the practicability of rearing fresh-water mussels in waters other than the natural mussel streams.

Two years ago an interesting discovery was reported by Lefevre and Curtis, when it was found that some glochidia of the squaw-foot mussel (*Strophitus edentulus*) developed into young mussels without becoming parasitic. Howard, in our laboratory, has since extended these observations by showing that the glochidia of that species will also develop by the customary mode of parasitism and by the discovery that another species, a small "floater" (*Anodonta imbecillis*), will develop without parasitism. Neither of these species, the only ones that have ever been made to develop without the use of a fish as host, is of any commercial importance, but it suggests itself as an important investigation that methods should be sought for causing other and useful species to develop without the fish. Whether the problem should prove simple or difficult, it is worthy of the endeavor.

The interesting and very practical discoveries which have been made, as a result of the close association of practical and investigational work, and the direct bearing of the information gained upon the promotion of the natural resources are held to demonstrate the essential wisdom of Congress in providing at the beginning that the propagation of mussels and the investigation of mussels should go "hand in hand."

The most clearly outstanding feature of our work is the absolute dependence of mussel conservation upon fish conservation in the broadest sense. There can not be abundant mussels if there are not abundant fishes. There can not be varied mussel resources if there are not varied resources in fin fishes. Probably no step for the promotion of the mussel fishery would yield greater benefits to that fishery than effective efforts for the conservation of fin fishes.

The interlocking interests of shell fishers and fin fishers is properly a matter of particular interest and worthy of emphasis, although, of course, the conservation of fishes rests upon a far broader basis than any consideration of value derived from the dependence of shell fisheries.

PROPAGATION AND RECLAMATION OF FISH WITH EXPERIMENTAL AND PRACTICAL ENDS.

The pond-cultural operations are planned to be carried out with particular experimental objects. It is hoped by careful observational and experimental methods to contribute to the improvement of methods of cultivation of pond fishes, especially as relates to the rearing of fish to a size suitable for the table. It is held as a most important responsibility of the station to stimulate and to guide the development of fish farming as a more widespread industry. This function as a fish-cultural experiment station should rightly be regarded as second to none, but its full accomplishment will depend upon the future provision of means proportionate to the labors involved and the far-reaching benefits to be gained.

Meantime the propagation of mussels and of fishes is well carried on hand in hand. While it is not feasible now to rear the quantity of fish requisite for the propagation of mussels, it is attempted by means of the experimental operations of pond culture at the station to obtain a reserve stock of young fish of several species which in the fall are infected with mussels and liberated in the river. A threefold purpose is served in the increase both of the fish and of the mussels in the public waters and in the acquisition of experimental data.



FIG. 8.—Seining fish from overflow water for infection with glochidia of mussels. (See text, p. 403.)



FIG. 10.—Seining fish in Lake Pepin for mussel propagation.



FIG. 11.—Transferring the fish to the infection tank. The foreman standing in the boat is pouring the glochidia from a can into the tank. (See text, p. 400.)



FIG. 9.—Sorting the fish for infection with glochidia.

From the account of the operations of mussel propagation it is seen that the supply of fish for use in mussel propagation is obtained chiefly by seining in the public waters. In the spring after the heavy floods there are many overflow ponds near the course of the rivers which are filled with water and fish during the flood and which are left isolated as the water recedes. Under natural conditions these ponds will dry up and the fish will die. In connection with the work of mussel propagation some of the overflow ponds are seined out and such fish as are suitable for infection with mussels are used in that work. These and other fish that are taken are then liberated in the main course of the river; thus a double object is accomplished in the reclamation of fish, which would otherwise be lost, and in the infection with glochidia of mussels. During the past fiscal year 66,645 adult fish were reclaimed in this way. While this reclamation work, as carried on at the Fairport station, is incidental to propagation work, the benefits are of great importance and would in large part justify the entire expense of the field work in propagation. The Bureau also carries on an extensive work in the reclamation of fish which is not connected with this station.

INVESTIGATIONS.^a

STUDIES OF MUSSELS.

The investigations relating to the natural and artificial propagation of mussels have already been referred to in connection with the work of propagation. Such experiments and observations are those which have received the principal attention of the permanent staff continuously and which have been most productive of results. The systematic study of conditions of natural infection, the careful experimental observation of artificial infections of mussels on various species of fish, the systematic study of glochidia, the investigation of the early or juvenile life history and distribution of juveniles, the rate of growth of mussels, the structure of shell and conditions affecting its abnormalities, the formation of pearls, the chemical and physical properties of mussel shell, the utilization of mussel meats—these are some of the problems which have been engaged upon, and several of which have been reported by the different investigators. As illustrations of the nature of results gained, there may be mentioned the accumulation of observations making easier the identification of mussels in the glochidium stage, the discovery of the particular relations existing between mussels and fishes, there being a restricted group of hosts for each species of mussel, the discovery of an additional case of development without parasitism, the discovery of important enemies of the juvenile mussels, the observation that rate of growth in some important species is more rapid than had ever been supposed, the observation that interruptions of the growth of mussels may cause effective flaws or faults in the structure of the shell, and the demonstration that mussels may directly absorb nutritive substances from solution in the water.

Mention must be made of the investigation of streams and lakes productive of mussels. In some cases the studies have been in the nature primarily of economic reconnoissances, in others more particular attention has been given to the facts and problems of distribution and ecological relations. The Kankakee, the Maumee, the

^a In so brief a summary of the investigation it will not be necessary or practicable to associate each topic with the name of an investigator. It is, however, desired to mention the names of those whose studies have contributed to the success of the station. Profs. George Lefevre, W. C. Curtis, and Charles B. Wilson, H. Walton Clark, Dr. A. D. Howard, Thaddeus Surber, A. F. Shira, Prof. F. D. Barker, J. F. Boepple, J. B. Southall, Ernest Danglade, E. P. Churchill, F. B. Isely, W. I. Utterback, and the present writer have appeared as authors of published reports emanating from this laboratory. Among others who are now conducting experiments and investigations are Emerson Stringham, H. L. Canfield, Dr. A. S. Pearse, R. H. Linkins (with Prof. H. B. Ward), and Miss Susanne Parsons (with Prof. F. D. Barker).

Cumberland, the Illinois, and the Fox Rivers have been reported upon as well as various streams in Oklahoma, Missouri, Minnesota, and South Dakota, and Caddo Lake in Texas.

Yet other studies have related to the methods and condition of the mussel fishery, and the essential measures of protection and conservation of the resources both in mussels and in fish.

INVESTIGATION OF FISHES, WITH REFERENCE TO HABITS, PROPAGATION, AND ENVIRONMENTAL CONDITIONS.

The operations of fish propagation with experimental ends in view has been alluded to on a previous page. Two fundamental objects are the encouragement of fish farming and the laying of a surer foundation for the intelligent conservation of the public fish resources. Problems which are now receiving especial attention are: The possibilities of promoting the abundance of fish food in artificial ponds; the proper association of species of fish for best results in pond culture; the study of the migrations, habits, and food of fresh-water fishes; the effect of artificial improvements or developments in the course of streams upon the abundance or distribution of fishes; and the propagation and rearing of buffalofish, an important commercial fish that is diminishing in abundance. It is thought that the station is now in a position to direct some effective attention to these significant problems, although its activities under present conditions can not be nearly so broad as the importance and the complexity of the problems would justify.

During the past year buffalofish, from eggs artificially fertilized and hatched in the laboratory, were reared in the ponds of the station under varying conditions. The results at the close of the season were most encouraging as regards the percentage of survival under the least favorable conditions of food supply and crowding and the rate of growth under better conditions. From 180,000 fry planted first in a small new pond and subsequently removed to a new pond of 1 acre extent, barren of vegetation and with only the scant natural food supply in a pond of this kind, about 50,000 fingerling buffalofish were obtained in the fall, having a length from 1 to 6½ inches. Where a small number were placed in a small pond with good growth of vegetation, an average length of more than 6 inches resulted. About 19,000 of the buffalofish were retained for further growth under experimental conditions.

Other experiments are being conducted with such food fishes as the bass, bream, crappie, and catfish. While the progress of these investigations is satisfactory, it is yet too early to announce definite results.

ASSOCIATE OR TEMPORARY INVESTIGATIONS.

From the description of the equipment of the station, it is manifest that the laboratory and the ponds, as well as the natural environment, afford unusual facilities for the investigation of problems of biology. It is the policy of the Bureau to encourage the use of its facilities by competent investigators for the promotion of biological studies. Every step of the endeavors of the Bureau for the promotion of fishery interests shows the essential need of more knowledge than is now possessed. We do not know enough either of the habits and development of economic forms or of the

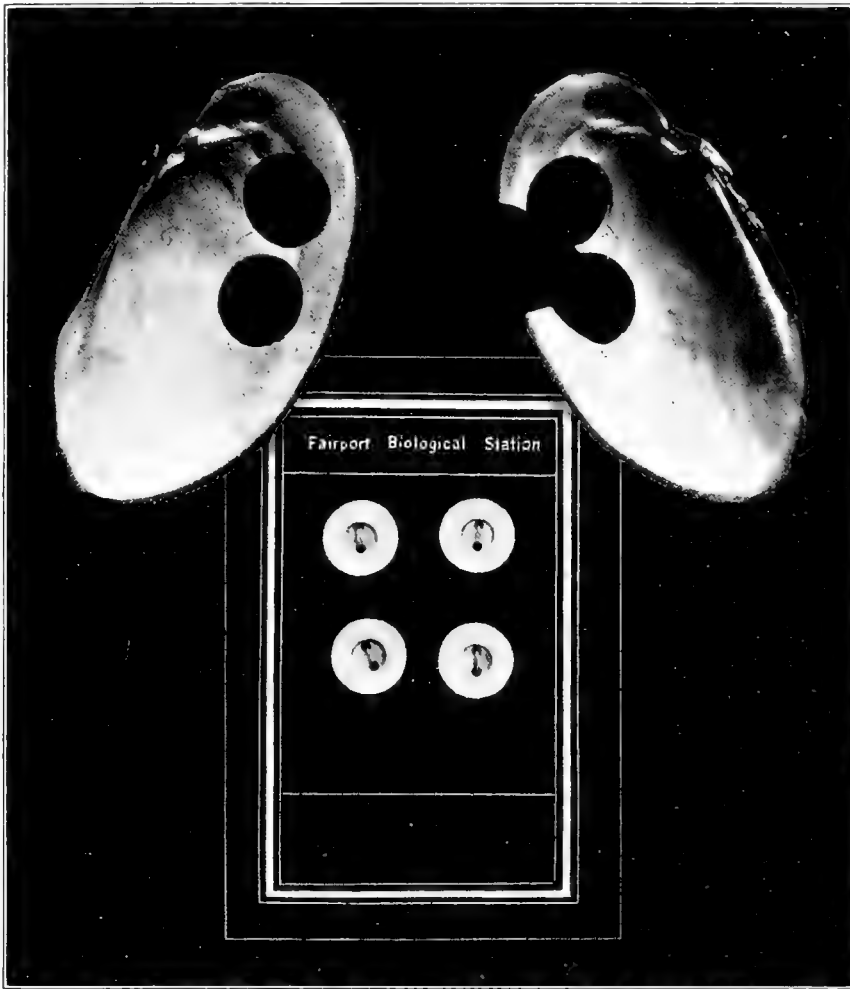
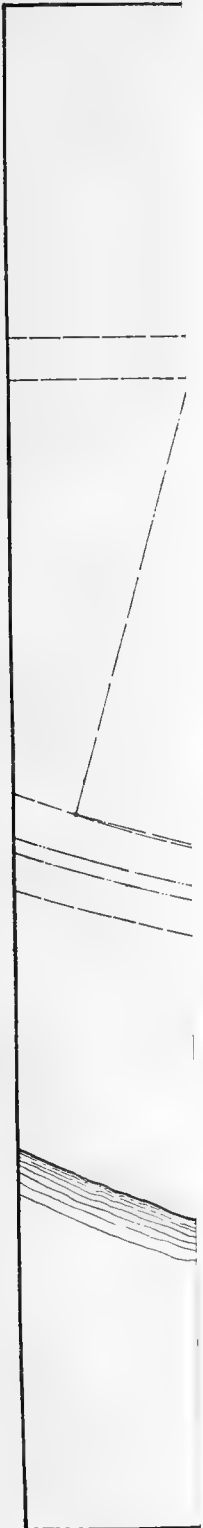

FIG. 12.—Shells of mussels reared in a pond from glochidia artificially infected upon fish. The buttons were cut from the shells within two years from the date of infection. The quality is good, but the shells are yet too thin for commercial uses. (See text, p. 401.)



FIG. 13.—Ponds used for experiments in cultivation of fish and mussels. The mussels of figure 12 were reared in the pond in right foreground. Buffalo fish are being reared in pond in left background.



Map showing

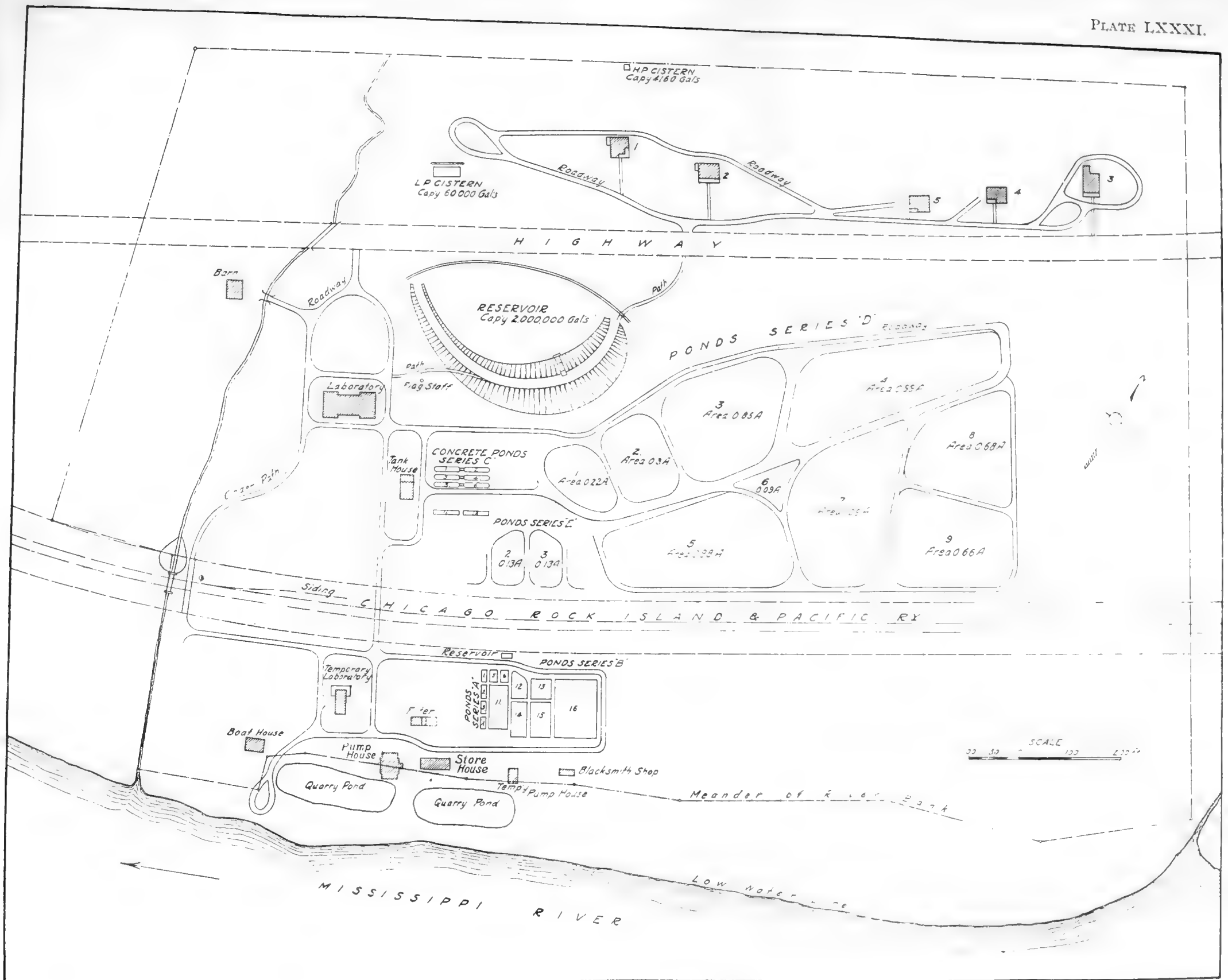

Map showing general plan of Fisheries Biological Station, Fairport, Iowa, 1916. The grounds comprise 60 acres, rising from the bank of the river at low water to an elevation of about 170 feet near the high-pressure cistern.

conditions of their existence; and such conditions involve an unlimited variety of elements. Before we can form a proper judgment of the possibilities of fishery development or take any intelligent step for increasing the abundance of fish life we have to know something of the favorable and the unfavorable features of the environment of the fish, something of the enemies, the parasites, the competitors, the food elements, and the minute forms upon which the prey of fish subsist; finally, we are compelled to study the chemical and the physical conditions of the streams or lakes or ponds. It is a fair statement that the possibilities of effective service for the promotion of fisheries are directly proportionate to the growth of knowledge of fresh-water biology, including the environmental conditions.

It is impossible for the Bureau alone to cope with a task thus outlined. Therefore, in pursuance of the custom established since the beginning of the Fish Commission, the Bureau not only manifests its sympathy with the excellent investigations pursued by other institutions but invites to its laboratories for temporary periods the men of technical skill and ability whose services it is not always practicable to employ. Particularly during the summer season, therefore, there are found in the laboratory a number of temporary investigators, whose relation to the Bureau is upon one or another basis. Appointments with stated compensation can be extended to a limited number of skilled scientists who will engage upon problems selected or approved by the Bureau as of immediate importance. The Bureau may direct the course of these studies and the time and manner of reporting. There are other investigators who find in the laboratory the facilities necessary for the prosecution of their studies and who make application for the occupancy of tables. To these, upon the approval of the application, the Bureau is glad to extend its facilities freely, and the applicant enters upon his studies without compensation or reimbursement of expenses, other than the free use of the ordinary facilities. It is perhaps unnecessary to state that the Bureau gives due consideration both to the equipment of the applicant and to the proposed subject of investigation. The relation in such cases is one of mutual benefit; the table occupant receives privileges for which a substantial compensation might be necessary in some institutions, and the Bureau finds its future practical efforts facilitated by the increase of knowledge resulting from studies regarding the local forms or local conditions. The advantages of association and coordination in scientific work are too well known to require emphasis.

Some important phases of the work of the Bureau, including the operations of mussel propagation, owe their origin to studies which were pursued primarily for scientific ends but which were given practical effect through the volunteer or temporary association of university men with the Bureau, involving relatively small demands upon the appropriated funds. The general policy of offering judicious encouragement to biological research was at the beginning the expression of a well-founded faith; at the present time it is based upon the sure demonstration of experience.

NOTES ON THE EMBRYOLOGY AND LARVAL DEVELOPMENT
OF FIVE SPECIES OF TELEOSTEAN FISHES



By Albert Kuntz, Ph. D.
St. Louis University, School of Medicine



Contribution from the United States Fisheries Biological Station, Beaufort, N. C.

NOTES ON THE EMBRYOLOGY AND LARVAL DEVELOPMENT OF FIVE SPECIES OF TELEOSTEAN FISHES.



By ALBERT KUNTZ, Ph. D.,
St. Louis University, School of Medicine.



Contribution from the United States Fisheries Biological Station, Beaufort, N. C.



INTRODUCTION.

The work of which the results are embodied in the present paper comprises observations on the eggs and larvæ of five species of teleosts, viz, *Cyprinodon variegatus*, *Lucania parva*, *Kirtlandia vagrans*, *Gobiosoma boscii*, and *Ctenogobius stigmaticus*. This work was carried on at the Beaufort, N. C., station of the United States Bureau of Fisheries during the summer of 1914. It was undertaken in pursuance of a general plan of the Bureau to secure a record as complete as possible of the time of spawning and of the embryological and larval development of fishes common in these waters.

It is not the purpose of this paper to discuss at length the embryological development of each species, but rather by means of illustrations and descriptions to afford a ready means of identifying eggs or larval fishes at any time during embryological and larval life. The eggs of the three species first named above are very typical. The study of their development adds nothing essentially new to our knowledge of the embryology of teleosts. The eggs of *Gobiosoma boscii* are characterized by a small yolk sphere and a relatively large amount of protoplasm. This condition is emphasized still further in the eggs of *Ctenogobius stigmaticus* in which the yolk sphere is exceedingly minute and the quantity of protoplasm relatively enormous. The disparity of yolk in proportion to the quantity of protoplasm present in these eggs leads to some interesting deviations, during the process of gastrulation and the differentiation of the embryo, from the course followed by the more typical teleostean eggs.

Observations were made exclusively on living material. The eggs of each species were fertilized and hatched in the laboratory. Males ripe for stripping were rarely taken. In nearly all cases fertilization followed the maceration of the testes of the male in the water into which the eggs were stripped.

CYPRINODON VARIEGATUS. SHEEPSHEAD MINNOW.

Spawning.—The spawning season of this species, which is very abundant in the brackish waters of North Carolina, continues throughout the summer. According to records kept by Mr. S. F. Hildebrand, director of the station, gravid females were taken in Mullet Pond as early as April 17. The ovaries of these females contained, in addition to the mature ova, immature ova of at least two different stages of development, thus suggesting the probability that more than one brood is produced during the season.

On May 4 young ranging from 6 to 12 mm. in length were present in considerable numbers. During the month of August, when the following observations on the eggs and young of this species were made, young ranging from 6 to 30 mm. and over in length were present in great abundance. It is obvious therefore that the spawning season continues from April until late summer.

Females ripe for stripping taken in August spawn relatively few ova, while immature ova in various stages of development are still present in the ovaries. Many females which could not be stripped when taken yielded a relatively small number of mature ova after being kept in an aquarium for several days. The presence in the ovaries of ova in various stages of development and the relatively small number ripe for spawning at the same time during late summer seem to indicate that these fish spawn repeatedly during the season.

Eggs.—The mature unfertilized ova (fig. 1) are spherical in form and 1.2 to 1.4 mm. in diameter. Their specific gravity is slightly greater than that of sea water and

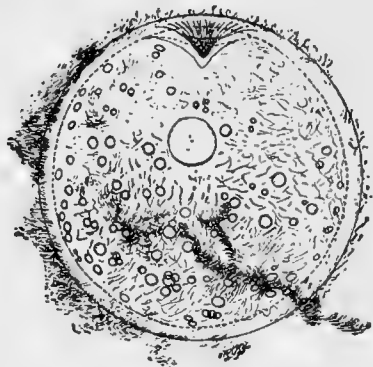

FIG. 1.—Mature unfertilized egg. $\times 33$.

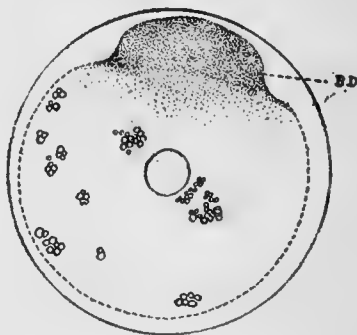

FIG. 2.—Egg with fully developed blastodisc (BD).

CYPRINODON VARIEGATUS.

they adhere in clumps, being held together by a tangle of very minute adhesive threads. They are yellowish in color and highly translucent. The egg membrane is thick and horny. Between it and the delicate vitelline membrane there is a perceptible perivitelline space. The large micropyle appears as a conspicuous cone-shaped depression in the egg membrane which also causes a slight indentation in the surface of the yolk. Scattered over the surface of the yolk are small groups of minute oil globules. The single large oil globule contained in the yolk sphere normally rests at the upper pole.

Blastodisc.—The quantity of protoplasm contained in these eggs is relatively large. Before fertilization the protoplasm is disposed in a layer of uniform thickness investing the yolk. After fertilization has taken place this layer of protoplasm becomes concentrated at one pole of the yolk sphere to form the blastodisc. The protoplasm being coarsely granular in appearance, the "streaming" movements toward the pole of the blastodisc which occur during the process of concentration may be readily observed. These "streaming" movements have been well described by Ryder^a in the eggs of the cod and more recently by other investigators in the eggs of other species of teleosts.

^a Ryder, J. A.: Embryography of osseous fishes. Report, United States Fish Commission, 1882, p. 455-605.

The fully developed blastodisc (fig. 2, BD) forms a thick protoplasmic cap, circular in outline, covering one pole of the yolk sphere. It is apparently of nearly uniform thickness throughout the central area and thins out very abruptly near the periphery. At the periphery it fades away almost imperceptibly into the very thin layer of protoplasm which remains at the surface of the yolk.

After fertilization has taken place the egg membrane becomes slightly expanded and the perivitelline space becomes more apparent. As the blastodisc becomes differentiated the egg also becomes somewhat more transparent.

Segmentation.—Segmentation takes place in a manner quite typical for the eggs of teleosts. The first act of cleavage occurs about one and one-half hours after fertilization. The second occurs less than 30 minutes after the first. The first and second cleavage planes cut the blastodisc meridionally and at right angles to each other. The first four blastomeres are usually approximately equal in size and quite symmetrical. The cleavage furrows cut deeply into the blastodisc and the blastomeres show a decided

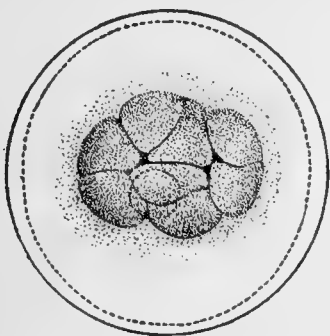

FIG. 3.—Egg with blastodisc of 8 cells.

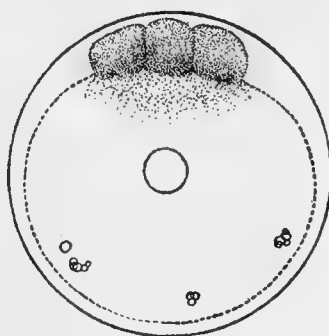

FIG. 4.—Egg with blastodisc of 8 cells, optical section.

tendency to assume a spherical form. During the 2-cell stage the axis of the blastodisc at right angles to the first plane of cleavage is noticeably elongated. During the 4-cell stage the two axes are again approximately equal.

As the third act of cleavage occurs one axis of the blastoderm again becomes distinctly longer than the other. The eight blastomeres thus formed are at first quite symmetrical, but before the fourth act of cleavage occurs much of the symmetry of the blastoderm is lost and the arrangement of the cells becomes quite irregular (fig. 3). Viewing the blastoderm of eight cells from the surface, the cells appear distinctly outlined peripherally. Viewed in optical section from the side, however, the marginal cells appear somewhat constricted at the base but are not entirely cut off peripherally (fig. 4). They remain continuous with the thin layer of protoplasm which invests the yolk.

As segmentation continues beyond the 8-cell stage the arrangement of the cells becomes increasingly less symmetrical. A typical blastoderm of 16 cells is illustrated in figure 5. A less symmetrical blastoderm of the same stage in an egg of *Lucania parva* is illustrated in figure 21. The blastoderm is now approaching a circular outline and becomes more nearly circular as segmentation advances.

Formation of the periblast.—As segmentation advances the blastoderm becomes distinctly dome-shaped and the segmentation cavity becomes apparent beneath its central area. The thin layer of protoplasm at the surface of the yolk becomes concentrated at the periphery of the blastoderm to form a somewhat flattened ridge. This ridge of protoplasm gives rise to the periblast (fig. 6, PB). While the periblast is becoming differentiated nuclei become apparent in it. As observed by Agassiz and Whitman,^a these nuclei are doubtless derived from the marginal cells of the blastoderm. The periblast is relatively broad and deep. The periblast nuclei are relatively numerous and easily observable in the living material.

During the earlier stages in the differentiation of the periblast the cells at the periphery of the blastoderm remain continuous with it. As segmentation advances farther the peripheral cells of the blastoderm become completely cut off from the periblast. A thin sheet of protoplasm now advances centripetally beneath the segmentation cavity.

Formation of the germ ring and differentiation of the embryo.—The germ ring arises during the later stages in the differentiation of the periblast as an apparent thickening

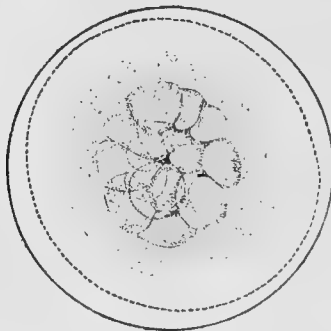

FIG. 5.—Egg with blastoderm of 16 cells.

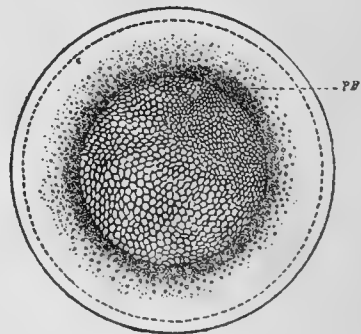

FIG. 6.—Egg with blastoderm in late cleavage stage; PB, periblast.

CYPRINODON VARIEGATUS.

of the peripheral area of the blastoderm. (A late stage in the differentiation of the germ ring in an egg of *Lucania parva* is illustrated in figure 22.) This apparent thickening is due primarily, as observed by Götte,^b to the thinning of the central area of the blastoderm and secondarily to the ingrowth (invagination) of the marginal cells. The part played by invagination can not be satisfactorily studied in living material. For a detailed discussion of the rôle of invagination in the formation of the germ ring and the embryonic shield the reader is referred to Wilson's valuable paper on the embryology of the sea bass.^c

As the central area of the blastoderm becomes thinner its under surface becomes distinctly concave. The subgerminal cavity between the blastoderm and the central periblast is now closed in on all sides by the germ ring.

Before the germ ring is completely differentiated it becomes apparent that invagination begins earlier and advances more rapidly at one pole than round the rest of the

^a Agassiz and Whitman: On the development of some pelagic fish eggs. Proceedings, American Academy of Arts and Sciences, vol. 20, 1834.

^b Götte, A.: Der Keim des Forelleneies. Archiv. f. Mikr. Anat., 1873.

^c Wilson, H. V.: The embryology of the sea bass (*Serranus atrarius*). Bulletin, United States Fish Commission, vol. ix 1889, p. 209-277.

periphery of the blastoderm. From this pole, which is the posterior or embryonic pole of the blastoderm, a broad tongue of cells several layers in depth grows forward into the subgerminal cavity. While the germ ring is becoming differentiated the blastoderm gradually increases in size by centrifugal growth. After the germ ring is completely differentiated the growth of the blastoderm round the yolk continues more rapidly than in the earlier stages. The broad tongue of cells growing forward from the germ ring at the posterior pole of the blastoderm becomes longer and gradually assumes a roughly triangular form. In this manner the embryonic shield becomes distinctly outlined. As the embryonic shield increases in size a thickening representing the axis of the future embryo occurs along its anteroposterior axis. As soon as this linear thickening occurs an embryonic and an extra-embryonic area may be distinguished within the embryonic shield. Figures 7 and 8 illustrate two successive stages in the differentiation of the embryonic shield and the embryonic axis. The linear thickening advances anteriorly from the posterior pole of the blastoderm but the differentiation of the embryonic axis begins in the head region and advances posteriorly. The embryonic area soon

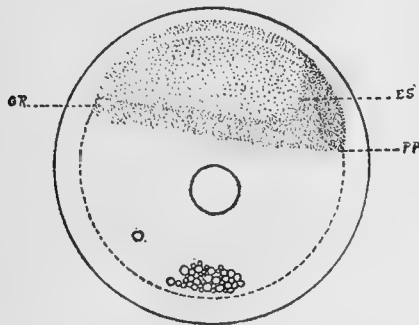

FIG. 7.—Egg with blastoderm showing germ ring, GR, fully differentiated and an early stage in differentiation of embryonic shield, ES; PP, posterior pole of blastoderm.

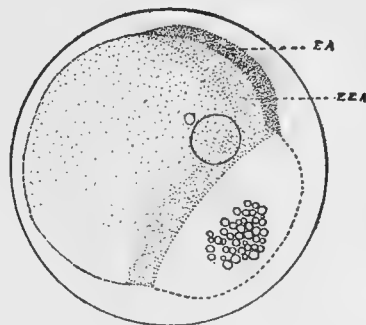

FIG. 8.—Egg showing later stage in differentiation of embryonic shield; EA, embryonic area; EEA, extra-embryonic area.

CYPRINODON VARIEGATUS.

becomes broader in the anterior or head region than in the posterior region. In surface view the embryonic area now presents a more or less regular spatulate form. During the formation of the embryonic shield and the differentiation of the embryonic axis the growth of the blastoderm round the yolk advances very rapidly. Before the embryo is well differentiated (fig. 8) the blastoderm covers more than three-fourths the surface of the yolk. Before segmentation of the embryo becomes apparent the blastoderm has grown completely round the yolk and the blastopore is closed (fig. 9).

The closure of the blastopore occurs less than 24 hours after fertilization. At this time the embryo extends less than halfway round the circumference of the yolk. It is relatively short and thick and somewhat irregular in outline. There is as yet no evidence of pigmentation and the embryo is almost transparent.

Soon after the closure of the blastopore relatively large melanophores appear sparsely scattered on the surface of the embryo and throughout the extra-embryonic blastoderm. Yellow chromatophores appear somewhat later. The latter never become numerous in the extra-embryonic blastoderm but soon become more numerous on the

embryo than the melanophores. Figure 10 is an attempt to illustrate the distribution of chromatophores on the embryo and in the extra-embryonic blastoderm about 48 hours after fertilization. No attempt is here made to distinguish between black and yellow chromatophores. The embryo is now segmented throughout and circulation is established. The chromatophores in the extra-embryonic blastoderm show a marked tendency to become aggregated along the larger blood vessels.

As development advances the yolk mass becomes materially reduced. At 72 hours after fertilization (fig. 11) the embryo appears relatively large and plump. The posterior portion of the body is free from the yolk and moves freely within the egg membrane.

As the time of hatching approaches the yolk mass may be reduced to half its original volume. The embryo is well developed and exhibits a characteristic distribution of

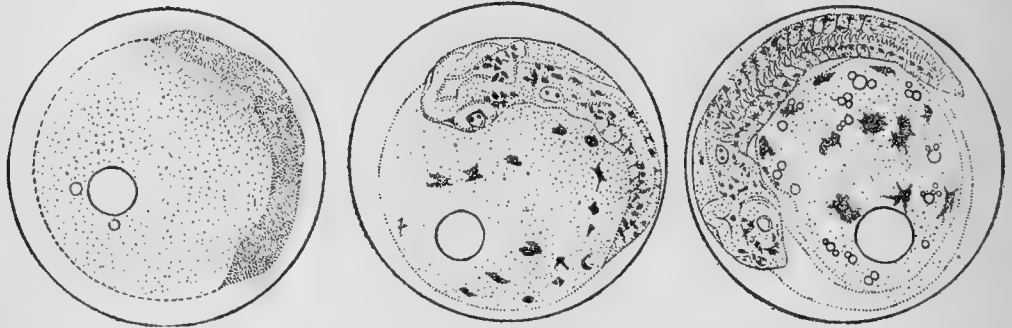

CYPRINODON VARIEGATUS.

FIG. 9.—Egg showing an early stage in differentiation of embryo. FIG. 10.—Egg 48 hours after fertilization. FIG. 11.—Egg 72 hours after fertilization.

chromatophores. It remains relatively short and plump. Its length usually does not exceed the circumference of the egg.

Larval development.—Incubation at laboratory temperature occupies five to six days. The newly hatched larvæ (fig. 12) are approximately 4 mm. in length and relatively plump. The yolk sac remains relatively large but the head is not deflected. The dorsal fin fold has its origin relatively far posteriorly. Both dorsal and ventral fin folds are continuous. The depth of each fold is less than half the depth of the body posterior to the vent. The vent is located at the posterior margin of the yolk sac. The larva is slightly yellowish in color and the posterior half of the body is marked by lighter and darker vertical bands.

At five days after hatching (fig. 13) the yolk is almost completely absorbed. The larvæ are now 5 mm. or over in length. The head has become bluntly pointed and the depth of the body has somewhat increased. The general color remains slightly yellowish and the vertical bands are somewhat more conspicuous than in the preceding stage.

Figure 14 illustrates a young fish 9 mm. in length. At this stage many of the characters of the adult are already apparent. The body is relatively slender, however, and the back is not yet elevated. The vertical bands characteristic of the species are present but not fully developed.

Young fish 12 mm. in length (fig. 15) exhibit practically all of the diagnostic characters of the species. The back is becoming strongly elevated and the depth of the body is proportionally greater than in the preceding stage. The caudal fin still

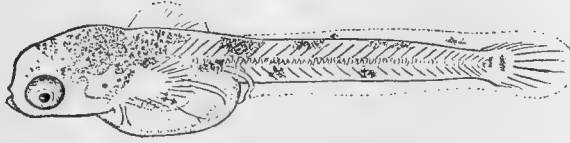

FIG. 12.—Newly hatched fish, actual length 4 mm

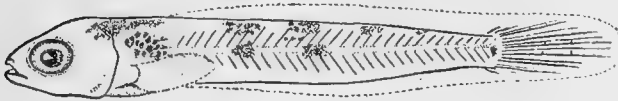

FIG. 13.—Larval fish 5 days after hatching, actual length 5 mm.



FIG. 14.—Young fish 9 mm. in length.



FIG. 15.—Young fish 12 mm. in length.

CYPRINODON VARIEGATUS.

remains more rounded than in the adult. The coloration is quite characteristic, although the general color is lighter and the light vertical bands are more conspicuous than in the adult.

LUCANIA PARVA. RAINWATER-FISH.

Spawning.—The spawning season of this species, like that of *Cyprinodon variegatus*, continues throughout the summer. According to the records kept by Mr. Hildebrand, females ripe for spawning were taken in Mullet Pond on April 17. He also observed at this time that in addition to mature ova the ovaries contained immature ova in various stages of development and suggested the probability that more than one brood is produced during the season. Young ranging from 15 to 19 mm. in length were taken on May 25. During the latter half of July, when the present study was begun, this species was still spawning freely, although a few of the females taken were entirely spent. The ovaries of many of the females gravid with mature ova still contained immature ova in more than one stage of development. Females ripe for spawning were taken in consid-

erable numbers as late as August 15. During the latter half of August very few females with mature ova were taken. Young ranging from 10 to 30 mm. and over in length were present in abundance throughout July and August.

Eggs.—The mature unfertilized ova (fig. 16) are spherical in form and 1.1 to 1.3 mm. in diameter. Their specific gravity is slightly greater than that of sea water and they

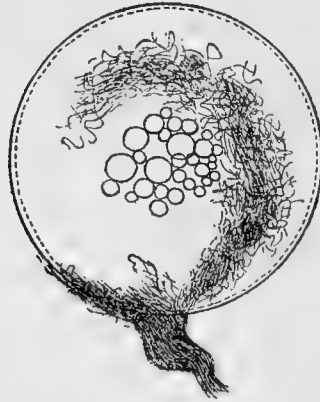

FIG. 16.—Mature unfertilized egg. $\times 35$.

LUCANIA PARVA.

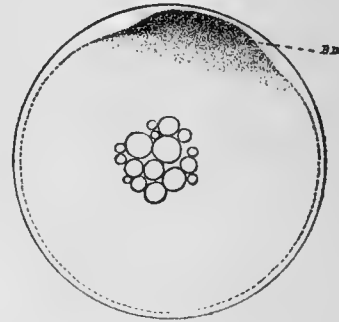

FIG. 17.—Egg showing early stage in formation of blastodisc (BD).

are held together in loose clumps by a tangle of coarse adhesive threads. They are very slightly yellowish in color and almost transparent. The egg membrane is relatively thick and horny. A small perivitelline space is apparent but not conspicuous. The micropyle is relatively small. The yolk sphere contains a group of oil globules of unequal size, varying from 12 to 20 in number, which normally rests at the upper pole.

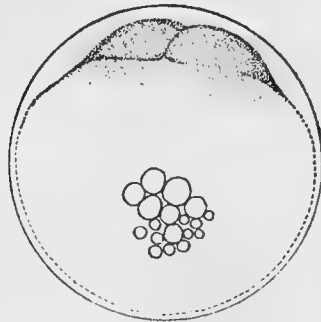

FIG. 18.—Egg with blastoderm of 2 cells.

LUCANIA PARVA.

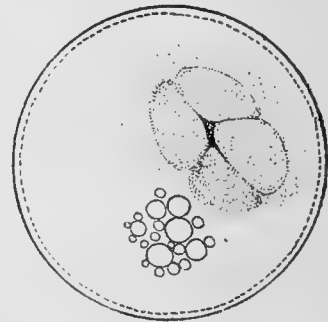

FIG. 19.—Egg with blastoderm of 4 cells.

Embryology.—The eggs of this species develop in a manner quite typical for teleosts. The course of their development conforms essentially to the course of development as outlined above for the eggs of *Cyprinodon variegatus*. The embryology of this species will, therefore, be discussed but briefly and with reference to the above discussion of the embryology of the former species.

The quantity of protoplasm contained in these eggs is relatively less than that contained in the eggs of the former species and early development advances somewhat more rapidly. The blastodisc is well developed one hour after fertilization. An early stage in the development of the blastodisc is illustrated in figure 17. It is now lenticular in form, but before cleavage occurs it becomes of nearly uniform thickness throughout

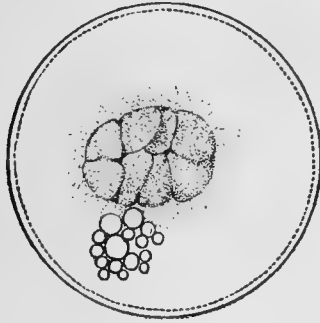

FIG. 20.—Egg with blastoderm of 8 cells.

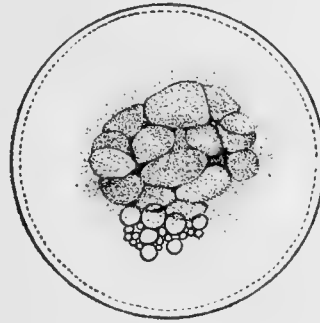

FIG. 21.—Egg with blastoderm of 16 cells.

LUCANIA PARVA.

the central area and thins out abruptly near the periphery. The first act of cleavage usually occurs within one and one-fourth hours after fertilization. A typical 2-cell stage is illustrated in figure 18. Successive stages of cleavage are illustrated in figures 19 to 21.

Later cleavage advances relatively rapidly and at 13 hours after fertilization the germ ring is completely differentiated (fig. 22, GR). Figure 23 illustrates a late stage in

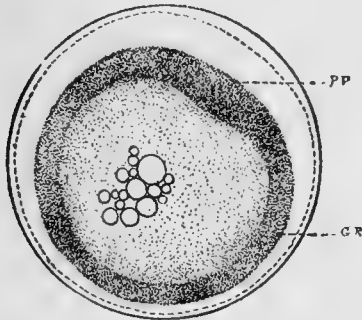

FIG. 22.—Egg with blastoderm showing germ ring (GR) fully differentiated; PP, posterior pole of blastoderm.

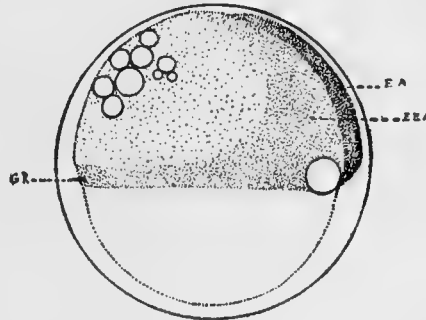

FIG. 23.—Egg with blastoderm showing advanced stage in differentiation of embryonic shield; EA, embryonic area; EAA, extra-embryonic area. GR, germ ring.

LUCANIA PARVA.

the formation of the embryonic shield in which the embryonic axis is already differentiated. The blastoderm now covers more than half the surface of the yolk.

At 24 hours after fertilization (fig. 24) the embryo is well differentiated and the blastopore is closed. At this stage the length of the embryo is less than half the circumference of the yolk sphere and is relatively more slender than the embryo of *Cyprinodon variegatus* at a corresponding stage.

The later development of the embryo advances relatively slowly. Incubation at laboratory temperature occupies seven to eight days. Before the close of the second

day of incubation the embryo becomes segmented throughout and circulation is established. An attempt is made in figures 26 and 27 to illustrate the course of the larger blood vessels in the extra-embryonic blastoderm 68 hours after fertilization.

A late stage in the development of the embryo is illustrated in figure 29. It is now relatively large, its length exceeding the circumference of the egg. The yolk mass is materially reduced and the embryo is free to move within the egg membrane.

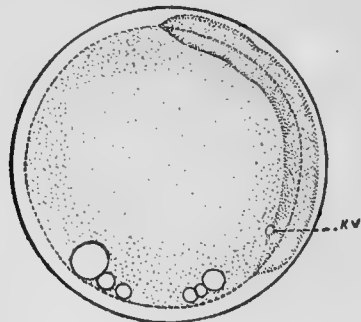

FIG. 24.—Egg 24 hours after fertilization; KV, Kupfer's vesicle.



FIG. 25.—Egg 48 hours after fertilization.

LUCANIA PARVA.

Pigmentation.—The eggs of *Lucania parva* afford very favorable material for the study of the development of chromatophores. While the embryonic shield is becoming differentiated, cells which may be recognized in the living material by their refractile properties proliferate from its inner margin and from the inner margin of the germ ring and become sparsely scattered over the blastoderm. These cells are irregular in outline and usually send out a relatively small number of slender protoplasmic processes. They



FIG. 26.—Egg 68 hours after fertilization, viewed from the dorsal aspect of the head of the embryo.



FIG. 27. Egg 68 hours after fertilization, viewed from the anterior aspect of the head of the embryo.

LUCANIA PARVA.

undergo slow ameboid movements which involve form changes of the cell body rather than marked extension and retraction of protoplasmic processes. These cells at first appear isolated. Before the embryonic axis is well differentiated many of them are apparently connected by their protoplasmic processes and form a syncytial network which involves the entire extra-embryonic area of the blastoderm. Some of the ameboid cells still remain isolated.

Soon after the closure of the blastopore, i. e., about 24 hours after fertilization, melanin granules arise in some of these ameboid cells. These granules first appear in the central region of the cell, i. e., in proximity with the nucleus, and gradually push out toward the periphery or into the protoplasmic processes. Under high magnification the movements of these granules may be readily observed. They are apparently determined by the movements in the cytoplasm.

In the course of a few hours after the appearance of the first melanin granules, yellow pigment granules arise in some of the ameboid cells. Like the melanin granules, the yellow pigment granules arise in the central region of the cell and later push out toward the periphery. The movements of these granules are apparently identical with those of the melanin granules.

The phenomena involved in the development of chromatophores could not be as satisfactorily observed on the embryo as in the extra-embryonic blastoderm. Pigment arises in the chromatophores on the embryo simultaneously with the appearance of pigment in the chromatophores in the extra-embryonic blastoderm. Furthermore the



FIG. 28.—Egg 90 hours after fertilization.



FIG. 29.—Egg just before hatching.

LUCANIA PARVA.

chromatophores on the embryo, during the early stages of development, are cells of essentially the same character as those in the extra-embryonic blastoderm. It is quite probable that they arise in the same manner. Figure 25 is an attempt to illustrate the distribution of chromatophores on the embryo and the extra-embryonic blastoderm about 44 hours after fertilization.

After circulation becomes well established the majority of the chromatophores in the extra-embryonic blastoderm become aggregated along the larger blood vessels. The distribution of chromatophores along the blood vessels in the extra-embryonic blastoderm 68 hours after fertilization is illustrated in figures 26 and 27.

As indicated above, the pigment granules arise in the central region of the cell and gradually push out toward the periphery. Until pigment is present in all parts of the cell the parts free from pigment remain clear. Even after pigment has been present in all parts of the cell it may become concentrated in the central region leaving the peripheral region clear. In many instances as the pigment becomes concentrated isolated granules or groups of granules remain far out in the protoplasmic processes. The concentration and redistribution of pigment granules is obviously not due to ameboid movements of the cells but to movements of the pigment granules in the

cytoplasm. This conclusion is in full accord with the findings of Franz (1908) in larvæ of *Pleuronectes platessa*.^a

As development advances ameboid movements of the chromatophores become less apparent. No conclusive evidence of ameboid movement of chromatophores was secured during the later stages of embryonic development or in newly hatched fishes.

Larval development.—The newly hatched larvæ are 4.5 to 5 mm. in length. The yolk sac remains large but the head is not deflected. The dorsal fin fold has its origin relatively far posteriorly. Both dorsal and ventral fin folds are continuous. The depth of each fold does not exceed half the depth of the body posterior to the vent. The vent is located at the posterior margin of the yolk sac. The color is light yellow and quite uniform.

At seven days after hatching (fig. 31) the larvæ have grown to a length of approximately 6 mm. The yolk is completely absorbed. The head is slightly depressed and

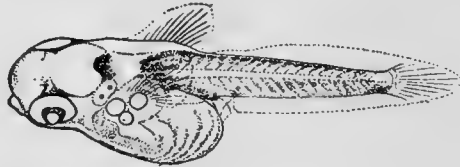

FIG. 30.—Newly hatched fish, actual length 4.5 mm.



FIG. 31.—Larval fish 7 days after hatching, actual length 6 mm.

LUCANIA PARVA.

the depth of the body is somewhat greater than in the preceding stage. The color remains light yellow.

The young of this species assume the general appearance of the adults relatively early. Young 15 to 20 mm. in length show many of the diagnostic characters of the species. The larger young taken in July and August were almost identical in appearance with the adults.

KIRTLANDIA VAGRANS. ROUGH SILVERSIDE.

Spawning.—During the latter half of July and the first week in August a few females of this species ripe for spawning were brought into the laboratory. The great majority of the females taken during this period were already spent. The height of the spawning season obviously occurs earlier in the summer.

Eggs.—The mature unfertilized ova are spherical in form and 0.8 to 1 mm. in diameter. They are slightly heavier than sea water and are held together in clumps by a tangle of adhesive threads, a small tuft of which arises from the membrane of each egg. They are slightly yellowish in color and almost transparent. A small perivitelline

^a Franz, V.: Die Struktur der Pigmentzelle. Biologisches Zentralblatt, vol. 28, p. 536-543.

space is apparent between the egg membrane and the vitelline membrane. The micropyle is relatively small. The yolk sphere contains a group of oil globules of unequal size, varying from about 8 to 15 in number, which normally rests at the upper pole.

Embryology.—The embryological development of these eggs conforms in all essential respects to the course of development as above outlined for the eggs of *Cyprinodon*

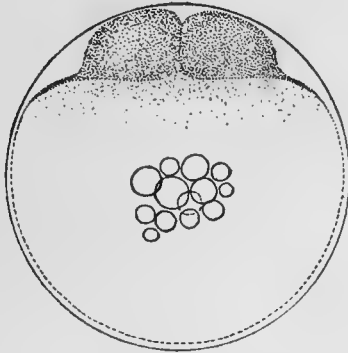

FIG. 32.—Egg with blastoderm of 2 cells. X 50.

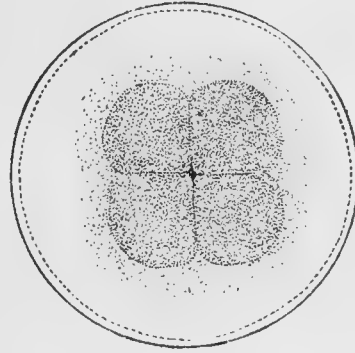

FIG. 33.—Egg with blastoderm of 4 cells.

KIRTLANDIA VAGRANS.

variegatus. A detailed discussion of the embryology of this species would therefore be superfluous. Successive stages in the process of cleavage and the differentiation of the embryo are illustrated in figures 32 to 37. Early development advances somewhat more rapidly than in the eggs of *Cyprinodon*. The embryo is well differentiated less

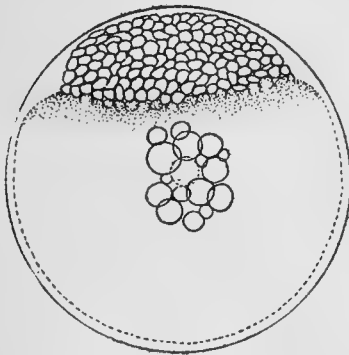

FIG. 34.—Egg with blastoderm in advanced cleavage stage.

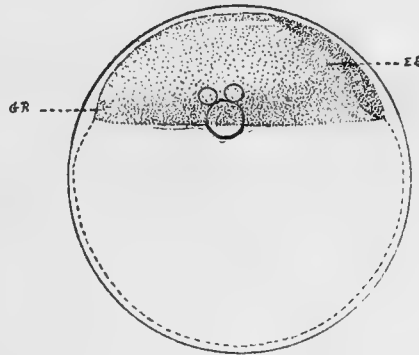

FIG. 35.—Egg with blastoderm showing germ ring (GR) fully differentiated and an early stage in differentiation of embryonic shield (ES).

KIRTLANDIA VAGRANS.

than 20 hours after fertilization. At 40 hours after fertilization (fig. 38) the embryo is relatively large. It is segmented throughout and circulation is well established. A few chromatophores are now apparent on the anterior region of the body. A few hours later a relatively small number of melanophores arises also in the extra-embryonic blastoderm.

Figure 39 illustrates an egg shortly before hatching. The length of the embryo now exceeds the circumference of the egg. The yolk mass is materially reduced and the embryo moves freely within the egg membrane. Pigmentation has not increased materially and the embryo remains relatively transparent.

Larval development.—The incubation period, at laboratory temperature, occupies six to seven days. The newly hatched larvæ (fig. 40) are approximately 5 mm. in length.

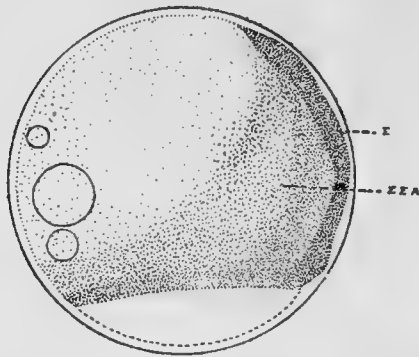

FIG. 36.—Egg showing an early stage in differentiation of embryo (E); EEA, extra-embryonic area of embryonic shield.

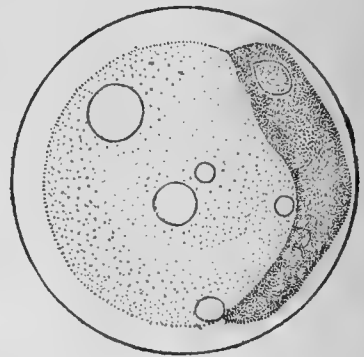

FIG. 37.—Egg showing later stage in differentiation of embryo.

KIRTLANDIA VAGRANS.

The yolk sac is relatively small. The dorsal fin fold has its origin just posterior to the head. Both dorsal and ventral fin folds are continuous. The depth of each fold does not exceed half the depth of the body at the vent. The vent is located near the posterior margin of the yolk sac. The newly hatched larvæ are highly transparent. A few pig-

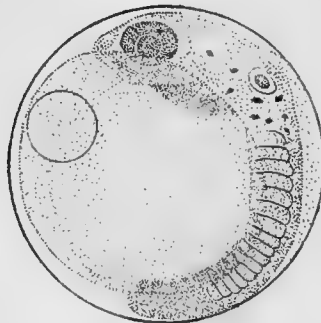

FIG. 38.—Egg 40 hours after fertilization.



FIG. 39.—Egg just before hatching.

KIRTLANDIA VAGRANS.

ment spots occur on the dorsal aspect of the head and in a line at the base of the ventral fin fold.

Figure 41 illustrates a young fish 9 mm. in length. The body is relatively slender. The soft dorsal and anal fins are becoming differentiated. A few pigment spots remain scattered on the dorsal aspect of the head and a dark longitudinal line extends along the side of the body. The silvery character of the side is not yet apparent.

Figure 42 illustrates a young fish 11 mm. in length. At this stage the young exhibit some of the characters of the adult. The characteristic number of rays are present in the soft dorsal and anal fins. The spinous dorsal is not yet fully differentiated. The

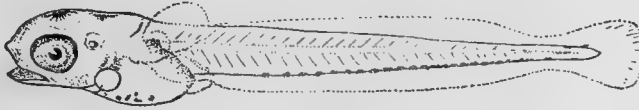

FIG. 40.—Newly hatched fish, actual length 5 mm.



FIG. 41.—Young fish 9 mm. in length.

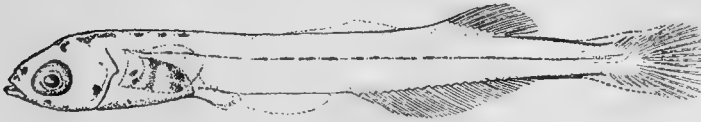

FIG. 42.—Young fish 11 mm. in length.

KIRTLANDIA VAGRANS.

color remains lighter than that of the adult. The sides are becoming distinctly silvery, but the pale green on the back, characteristic of the species, is not yet apparent.

GOBIOSOMA BOSCI. NAKED GOBY.

Spawning.—This relatively obscure species was found spawning in Mullet Pond throughout August. The majority of the females taken during this period were already spent. Only occasionally was one found ripe for stripping. Obviously the height of the spawning season was past.

Eggs.—The mature unfertilized ova (fig. 43) are approximately spherical in form and about 0.5 mm. in diameter. They are yellow in color and opaque. Their specific gravity is greater than that of sea water. In the ovary they are attached to a central rachis by a thick peduncle composed of bundles of minute hairlike threads and inserted in the egg membrane. When stripped from the female they remain aggregated in a compact clump. The egg membrane is comparatively thin and closely applied to the vitelline membrane.

As soon as fertilization has taken place the egg membrane begins to expand and gradually assumes an elliptical form. When fully expanded the major axis is 1.2 to 1.4 mm. in length, the minor axis 0.5 to 0.7 mm. The point at which the peduncle is inserted remains at one pole of the major axis. The egg remains located near one pole of the major axis where it lies in a cavity the volume of which is somewhat greater than its own. The wall of this cavity is indicated by a dotted line in figure 44. It is indicated also at a later stage in figure 48.

Embryology.—The volume of protoplasm is considerably greater in proportion to the volume of yolk in these eggs than in the more typical teleostean eggs described above. In the unfertilized egg the protoplasm is disposed in a layer of uniform thickness investing

the yolk sphere. After fertilization has taken place this layer of protoplasm becomes concentrated in a typical manner to form the blastodisc (fig. 44, BD). The protoplasmic movements involved in the process of concentration can not be satisfactorily observed by reason of the opacity of the yolk. The fully differentiated blastodisc is relatively thick and covers a relatively larger area of the surface of the yolk than is the case in the more typical eggs described above. It thins out gradually toward the periphery and



FIG. 43.—Mature unfertilized egg. $\times 50$.

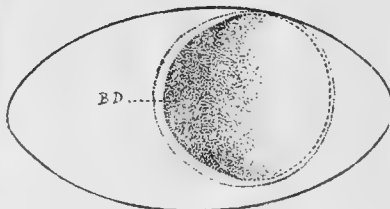

FIG. 44.—Egg with fully developed blastodisc (BD).

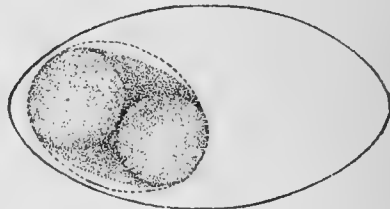

FIG. 45.—Egg with blastoderm of 2 cells.

GOBIOSOMA BOSCI.

fades away almost imperceptibly into the thin layer of protoplasm which remains at the surface of the yolk.

Cleavage occurs essentially as in the eggs above described. The volume of protoplasm being relatively greater, however, the cleavage furrows become deeper and the early blastomeres become more widely separated and show a more marked tendency to become spherical in form. After the first act of cleavage is completed the first two



FIG. 46.—Egg with blastoderm of 4 cells.



FIG. 47.—Egg with blastoderm of many cells.

GOBIOSOMA BOSCI.

blastomeres, in surface view, appear circular in outline. The same tendency is apparent also in the 4-cell stage. After the second act of cleavage is completed the first four blastomeres stand out in perspective (fig. 46) as more or less isolated rounded elevations. As cleavage advances the blastoderms exhibit a greater degree of irregularity than is observed in the more typical teleostean eggs. Figure 47 illustrates an egg four hours after fertilization. The blastoderm is now circular in outline but remains relatively thick.

As cleavage advances the blastoderm becomes distinctly dome-shaped and a small cleavage cavity becomes apparent. The periblast appears relatively thick, but can not be satisfactorily observed in the living material by reason of the opacity of the yolk. The phenomena involved in the formation of the germ ring and the early differentiation

of the embryo also are somewhat obscured in the living material. As far as may be observed, however, these stages conform in all essential respects to the corresponding stages above described in the egg of the *Cyprinodon variegatus*.

The later development of the embryo advances rapidly. At 48 hours after fertilization (fig. 48) the embryo is well formed and already shows six to eight somites. At 60



FIG. 48.—Egg 48 hours after fertilization.

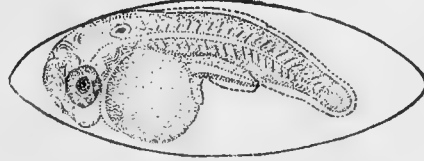

FIG. 49.—Egg 60 hours after fertilization.

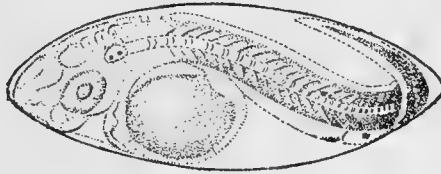

FIG. 50.—Egg 96 hours after fertilization.

GOBIOSOMA BOSCI.

hours after fertilization (fig. 49) the embryo has increased materially in size. Its length exceeds three-fourths the length of the major axis of the egg membrane. The yolk mass remains opaque, but the embryo is highly transparent. No pigment is as yet apparent.



FIG. 51.—Newly hatched fish, actual length 2 mm.



FIG. 52.—Larval fish 3 mm. in length.

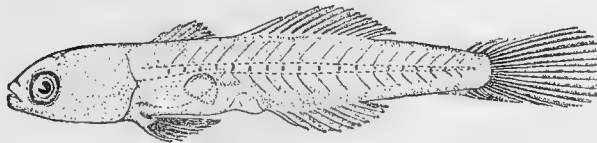

FIG. 53.—Young fish 10 mm. in length.

GOBIOSOMA BOSCI.

As the time of hatching approaches (fig. 50) the length of the embryo exceeds the length of the major axis of the egg membrane and the tail becomes bent upon itself. The embryo remains highly transparent, only a few small pigment spots appearing in proximity with the vent.

Larval development.—The incubation period at laboratory temperature occupies approximately five days. The newly hatched larvæ (fig. 51) are approximately 2 mm. in length and almost transparent. The remaining yolk mass is opaque. The air bladder is already apparent at the posteriodorsal aspect of the yolk mass. The dorsal fin fold has its origin relatively far posteriorly. Both dorsal and ventral fin folds are continuous. The depth of each fold does not exceed half the depth of the body at the level of the vent. The vent is located less than half the length of the body from the posterior end. A few small pigment spots occur just above the vent and at the base of the ventral fin fold posterior to the vent.

Figure 52 illustrates a larval fish 3 mm. in length. The yolk is completely absorbed. The body remains almost transparent. The line of pigment spots at the base of the ventral fin fold is somewhat more conspicuous than in the newly hatched larvæ.

Young fish 10 mm. in length (fig. 53) show many of the diagnostic characters of the species but remain almost free from pigment. The air bladder is still apparent microscopically. The head is gradually assuming the shape characteristic of the species. The fins are well differentiated and the sucking disc formed by the ventrals is well developed.

CTENOGOBIOUS STIGMATICUS. SCALLOPFISH.

Spawning.—Like the related species, *Gobiosoma bosci*, this species was spawning in Mullet Pond throughout August. As in the case of the former species, also the majority

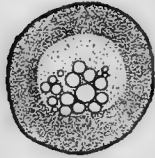

FIG. 54.—Mature unfertilized egg. $\times 60$.

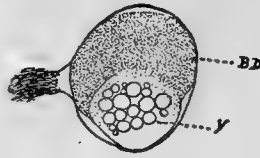

FIG. 55.—Egg with fully developed blastodisc (BD); Y, yolk.



FIG. 56.—Egg with blastoderm of 2 cells.



FIG. 57.—Egg with blastoderm of 4 cells.

CTENOGOBIOUS STIGMATICUS.

of the females taken were already spent. Obviously, the height of the spawning season occurs earlier in the summer.

Eggs.—The mature unfertilized ova (fig. 54) are very small, having an average diameter of approximately 0.3 mm., and somewhat irregular in form. They are yellow in color and highly translucent. Each ovum is attached in the ovary by a slender peduncle composed of very minute threads inserted in the egg membrane. When the female is stripped the eggs do not remain aggregated. They are only slightly adhesive. Their specific gravity is very little greater than that of sea water. The egg membrane is thin and delicate and is usually drawn out into a blunt apex at the insertion of the peduncle. Except on this side the egg membrane appears closely applied to the vitelline membrane. These eggs are characterized by a relatively enormous amount of protoplasm and very little yolk. The transparent yolk mass usually rests in the center of the mass of protoplasm, but in some eggs it occupies a somewhat eccentric position.

Blastodisc.—As soon as fertilization has taken place the protoplasm becomes concentrated to form the blastodisc (fig. 55, BD). The process of concentration can hardly be described as a “streaming” of the protoplasm toward one pole of the yolk sphere, but rather as a thinning of the layer of protoplasm on one side of the yolk and a corresponding thickening on the opposite side which pushes the yolk out into an extremely eccentric position. The fully differentiated blastodisc covers approximately half the area of the surface of the yolk. The other half remains invested by a very thin layer of protoplasm, which is continuous with the blastodisc.

Segmentation.—Early cleavage takes place essentially as in the more typical teleostean eggs, but advances more rapidly. The first act of cleavage occurs approximately 30 minutes after fertilization and the successive acts follow each other in rapid succession. Because of the disparity of yolk the figures presented by the early cleavage stages differ widely from those presented by the corresponding stages of the more typical eggs. The first cleavage plane cuts deeply into the blastodisc and divides it into two blastomeres of approximately equal volume (fig. 56). They are usually quite symmetrical but may show considerable variation. The second cleavage plane cuts the first at right angles. Figure 57 illustrates a typical blastoderm of four cells viewed through the transparent yolk. The blastomeres are quite symmetrically

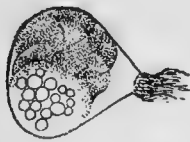

FIG. 58.—Egg with blastoderm of 8 cells.



CTENOGOBIOUS STIGMATICUS.

FIG. 59.—Egg with blastoderm of 16 cells.



FIG. 60.—Egg with blastoderm of many cells.

arranged and are seen to extend beyond the periphery of the yolk. They remain continuous with the thin layer of protoplasm by which the latter is invested.

The early blastoderm usually spreads widely over the surface of the yolk, the blastomeres being arranged in a single series. Figure 58 illustrates an egg with a blastoderm of 8 cells which deviates somewhat from this condition, the blastomeres appearing heaped up at one side of the yolk. Figure 59 illustrates an egg with a very typical blastoderm of 16 cells. The cells remain in a single series and the yolk sinks deeply into the concavity of its inner surface.

As cleavage advances beyond the 16-cell stage the cells no longer remain in a single series but become heaped up on one side of the yolk. Eggs in advanced stages of cleavage are illustrated in figures 60 and 61.

During the later stages of cleavage the granular protoplasm on the surface of the yolk at the margin of the blastoderm becomes somewhat more conspicuous (fig. 61). This slightly thickened zone in the layer of protoplasm investing the yolk doubtless represents the periblast. It does not become differentiated into a well-marked ridge, however, and nuclei were not apparent in it.

As cleavage advances further the blastoderm becomes more distinctly dome-shaped, its central area becomes appreciably thinner, and the periphery advances round the

yolk. The blastoderm is now distinctly thickest at the periphery. A well-marked germ ring, however, is not apparent. The yolk mass becomes constricted at the level of the periphery of the blastoderm and is apparently squeezed up into the dome-shaped space beneath its central area, almost entirely obliterating the cleavage cavity (fig. 62). As the peripheral growth of the blastoderm advances still further the yolk is entirely engulfed and the blastopore is closed.

Differentiation of the embryo.—The closure of the blastopore occurs within six hours after fertilization. Soon after this stage is reached a distinct linear thickening of the

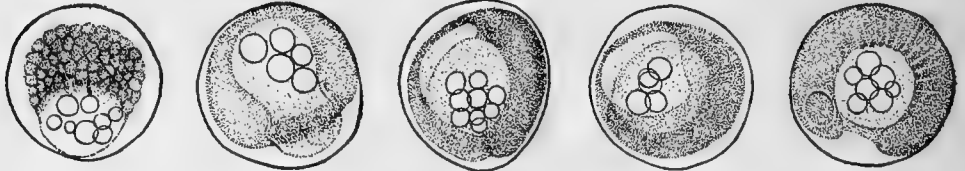

CTENOGOBIOUS STIGMATICUS.

FIG. 61.—Egg with blastoderm in late cleavage stage.

FIG. 62.—Egg with blastoderm growing round yolk, shortly before closure of blastopore, 5 hours after fertilization.

FIG. 63.—Egg showing early stage in differentiation of embryo, 6 hours after fertilization.

FIG. 64.—Egg showing later stage in differentiation of embryo.

FIG. 65.—Egg showing embryo well differentiated.

blastoderm, representing the axis of the future embryo, grows anteriorly from the blastopore (fig. 63). Whether invagination of cells from the periphery of the blastoderm plays a part in the differentiation of the linear thickening could not be determined in the living material. A distinct embryonic shield was at no time apparent. As this linear thickening of the blastoderm advances anteriorly, the subgerminal cavity becomes apparent at its anterior extremity. As the differentiation of the embryonic axis advances the anterior region of the differentiated area of the blastoderm becomes dis-



CTENOGOBIOUS STIGMATICUS.

FIG. 66.—Egg 11 hours after fertilization.

FIG. 67.—Egg just before hatching.

FIG. 68.—Newly hatched fish, actual length 1.2 mm.

tinctly broader than the posterior region (fig. 64). Obviously, the differentiation of the embryo begins in the anterior or head region and advances posteriorly.

The further differentiation of the embryo advances rapidly. Within 11 hours after fertilization (fig. 65) the embryo is well formed and already shows 10 to 12 somites. At 12 hours after fertilization (fig. 66) the embryo makes almost a complete turn within the egg membrane. The posterior region of the body is already free from the yolk. Pigment is not yet present and the embryo is highly transparent. Figure 67 illustrates an egg just before hatching. The yolk mass is materially reduced. The embryo remains highly transparent but is marked by small areas of delicate pigment. It now makes more than a complete turn within the egg membrane.

Larval development.—The period of incubation at laboratory temperature occupies not over 18 hours. The newly hatched larvæ are approximately 1.2 mm. in length and exceedingly delicate. They remain highly transparent but are marked by small areas of delicate yellow pigment on the dorsal aspect of the head, just over the vent, and in a vertical band approximately halfway from the vent to the tip of the tail. Both dorsal and ventral fin folds are continuous. The depth of each fold is equal to or greater than the depth of the body posterior to the vent. The vent is located a little less than half the length of the body from the anterior end.

These larvæ being extremely delicate, it was not found possible to keep them alive in the laboratory longer than a few hours. As no recently hatched young were taken, the advanced larval stages can not be described. Young ranging from 25 to 30 mm. in length have already assumed the general appearance of the adults and present many of the diagnostic characters of the species.



NOTES ON THE FISHES OF EAST TENNESSEE



By Barton Warren Evermann and Samuel F. Hildebrand

NOTES ON THE FISHES OF EAST TENNESSEE.

By BARTON WARREN EVERMANN and SAMUEL F. HILDEBRAND.

INTRODUCTION.

In September and October, 1893, the senior writer of this paper made an examination of a number of the springs and streams of east Tennessee for the purpose of selecting a site for a Federal fish-cultural station in that State.

The field investigations were begun September 24 and continued until October 19, during which time Dr. Evermann was assisted by Dr. Revere R. Gurley, then of the United States Fish Commission, and Dr. Josiah T. Scovell, of Terre Haute, Ind.

In addition to an examination of numerous springs with special reference to their suitability for fish-cultural purposes, many of the streams of east Tennessee were investigated with regard to the volume and character of their waters, the physical characteristics of the country through which they flow, and the abundance and distribution of the different species of fishes and other aquatic life which they contain.

A full and detailed report on the fish-cultural phases of the investigations was made to the Commissioner of Fisheries immediately upon the completion of the field work.

Although the study of the fishes collected was begun at that time, a multiplicity of other and more pressing duties intervened, and not until recently was an opportunity presented for completing the report.

GENERAL PHYSICAL FEATURES OF EAST TENNESSEE AND DESCRIPTIONS OF THE REGIONS AND WATERS EXAMINED.

The investigations were confined almost wholly to east Tennessee, and entirely to the Tennessee River Basin. The valley of east Tennessee, as a continuation of the great valley of Pennsylvania and Virginia, aids in forming one of the principal features of the Appalachian Mountain system. It trends from northeast to southwest with other members of the system and is between 50 and 60 miles wide. It is bounded on the southeast by the Bald, Great Smoky, and Unaka Mountains which rise to an elevation of 4,000 to 5,000 feet. On the northwest it is bounded by the Cumberland Plateau, which has an elevation of about 2,000 feet. The valley has an elevation of about 700 feet in the southwest, rising to about 1,400 feet in the northeast.

The mountains on the southeast are of Lower Silurian, Cambrian, or older rocks, while the plateau on the northwest is of Devonian and Carboniferous strata. The rocks of the valley itself are mainly of the Upper Silurian. The numberless mountain ridges which subdivide the great valley into many minor ones are mainly composed of compact limestones and sandstones, while the valleys are of shales and fragile schists.

The most extensive exposure of rocks seen in the valley was in the neighborhood of Chattanooga.

In the valley of Chickamauga Creek the lowest stratum is a massive limestone called the Chickamauga limestone, while Missionary Ridge, forming the western boundary of this valley, is composed mainly of Knox dolomite. In the valley of Chattanooga Creek west of the ridge, Chickamauga limestone occurs again, while Lookout Mountain on the west rises from this limestone through Knox dolomite and Devonian strata to a heavy bedded carboniferous sandstone, known as the Walden sandstone, at an elevation of 2,000 feet, which is about the elevation of the western boundary of the great valley. Lookout Creek on the west has cut down to the Chickamauga limestone, while the hills on the west rise to the Walden sandstone again.

The soil covering these rocks is frequently clay, often very red and filled with masses of flint or chert. In some places the soil is sandy, and in many places seemed to be of poor quality. The forests are mainly of oak and pine, with hickory, maple, sweet gum, sycamore, sassafras, blue beech, laurel, and cedar, with willows, alders, etc., along the streams, and some chestnuts on the higher ridges.

KNOXVILLE AND VICINITY, SEPTEMBER 27 AND 28.

Several springs in the vicinity of Knoxville were examined, among them the following being the most important:

Fountain Head Springs at Fountain City.—These are four or five in number, the largest, known as Fountain Head Spring, emerges from near the base of a clay bank about 10 feet high, and flows off through a relatively level tract of land, after forming a small marsh near the spring. The temperature of the water at 10.30 a. m. was 58° F. Measured immediately below the spring the stream averaged 2½ feet wide, 5 inches deep, and flowed three-fifths of a foot per second. This gives a flow of about 280 gallons per minute. The water is pure and clear and the pond below is filled with water cress.

A few rods distant are two other springs, each of which, however, is smaller than the one just described. The temperature is about the same in all of these springs.

The total amount of water that could be obtained here by bringing the various springs together is probably about 400 gallons per minute.

Callahan Springs.—These springs are located about 5 miles northwest of Knoxville. The principal one comes out from limestone rock, flows about one-quarter of a mile, when it disappears and follows an underground passage for about 200 feet; then it appears as a stream about 2½ feet wide, 2½ inches deep, and flowing 10 feet in seven seconds. This indicates a volume of about 300 gallons per minute. The temperature of the water at 4.20 p. m. at the place where it finally leaves the rock was 58.5° F.

Tennessee River.—The Tennessee River was fished at the mouth of Lyon Creek.

Lyon Creek.—This creek was examined near the insane asylum, about 5 miles west of Knoxville. It was fished for the last half mile of its course. Width 13 to 15 feet; depth less than a foot; current about 1½ feet per second; temperature at noon 60° F.; of air in shade at 10 a. m., 62° F.

The bed and banks of this stream are of red clay, the bottom quite muddy in most places; some limestone rock; banks usually 2 to 5 feet high, covered with a good

growth of willows, sycamores, oaks, walnuts, papaws, etc. In the stream there are many logs and much rubbish.

From Knoxville southwesterly for some 70 miles to Athens, only limestones were seen. The Knoxville dolomite, which is abundant at Chattanooga and intervening localities, is very prominent at Knoxville. Some of the beds are fine-grained, hard, and blue; some contain numerous chert nodules which fill the soil resulting from the decay of such rocks. These beds of clay and chert are often compact enough to stand firmly in vertical sections. The rocks generally are much tilted, often standing at a high angle. These rocks abound with fissures and small caves, and springs are common everywhere, but no springs of large size occur in the immediate vicinity of Knoxville.

CHATTANOOGA AND VICINITY, SEPTEMBER 29 TO OCTOBER 2.

Newman Spring, Ga.—This spring is about 6 miles southeast of Chattanooga, on the east side of Missionary Ridge near Rossville Gap, and a few rods from the Tennessee line. There are several small springs here which, by damming (about 6 feet high one-fourth mile below the spring), have been converted into a large pond known sometimes as Green's pond. This pond is about 20 by 80 rods and covers 8 to 10 acres. We had no facilities for measuring the depth, but it is probably 10 feet or more in the deepest places. Most of the springs are now beneath the surface of the pond. One spring at the west end flows about 30 gallons. Its temperature was 59° F. at 4 p. m., when the air was 72° F. At the lower (east) end of the pond the temperature at a depth of 2 feet was 63° F., while at the surface near the west end it was 67° F. The pond is well filled with *Myriophyllum*, *Potamogeton*, *Chara*, *Lemna*, various species of algæ, and other species of water-loving plants. Desmids and diatoms and the smaller crustaceans seemed to be abundant. The water is hard and, of course, comes from limestone. The water is led from the pond through a race to a gristmill a short distance below, and finally finds its way into South Chickamauga Creek, where it enters the State of Tennessee. The total amount of water supplied by this pond was estimated by us at 1,500 gallons per minute. The land surrounding the pond is mostly of yellow clay and sand and is extensively cultivated.

Crawfish Springs, Ga., September 30.—These springs, situated about 12 miles south of Chattanooga near the West Chickamauga Creek, are of enormous size. The upper one, near the Park Hotel, had been dammed, thus forming a large pool 15 to 25 feet deep. The water is exceedingly clear, small objects upon the bottom being distinctly seen in a depth of 12 feet. The temperature at 8½ feet depth at noon was 59° F. The dam, measured on the lower side, is about 15 feet high, or nearly that height above the surface of the water in the stream immediately below.

The waste water flowing over the lip of the dam measures 11 feet wide, 2 inches deep, and flows 3 feet per second. This is about 2,500 gallons a minute. The amount wasting through the power house is probably as many gallons more, so that the entire flow of this one spring may be put at 5,000 gallons per minute, or 7,200,000 gallons per day.

Below this spring the large stream which flows from it runs for several rods through a rather deep gorge which it has worn through the limestone rock, then the banks become lower, particularly the left one. At a distance of less than a mile from the spring its outlet unites with West Chickamauga Creek. At various places in this course there are springs which come out in the bed of the stream; one just below the railroad bridge

probably furnishes even more water than the Crawfish Spring proper. These various springs augment the stream greatly, so that, measured near its mouth, it was found to average 120 feet wide and 5 feet deep, but possesses a rather slow current.

The upper spring and much of the outlet are abundantly supplied with *Myriophyllum*, among which small crustaceans and mollusks abound.

Many years ago the United States Fish Commission placed a few rainbow trout in this spring. It was stated that the plant proved very successful, and much sport was afforded to local anglers and guests.

Chickamauga Creek.—This stream was examined at Lee and Gordon's mill, on the Lafayette road, 3 miles from Crawfish Springs. The stream, which has a rocky bed in most places where examined, is here 62 feet wide, 1 foot deep, current $1\frac{3}{7}$ feet per second, temperature 63° F. Fishes were quite abundant.

South Chickamauga, Chattanooga, and Lookout Creeks have rocky beds, and when the water in the Tennessee is low the currents of these creeks are rapid, but when the water is high in the Tennessee it backs up these creek channels for miles, depositing great quantities of sediment. Across the river north of Chattanooga, rocks, soil, and timber are much the same as on the south side of the river.

Read's Spring, October 1.—This spring, about 7 miles north of Chattanooga, is really a series of small springs, altogether forming a creek of considerable size. The largest one issues from the limestone bluff at the head of the creek and is a very nice spring. The temperature is 58° F. and the flow, when increased by the addition of a number of much smaller springs a few yards below, is about 300 gallons per minute.

The springs and streams are well filled with various species of algæ, insect larvæ, and small mollusks.

Nickajack Cave and Stream, October 2.—This cave, at Shellmound, about 20 miles southwest of Chattanooga, has been eroded from limestone rock by a little stream which flows into the Tennessee within a mile of the cave. When high, the river backs up into the cave for a long distance. The cave seemed to have increased downward by erosion and upward through the fall of strata from above. The mouth of the cave is about 150 feet wide and 75 feet high. The stream was followed into the cave for more than half a mile. It was found to be a continuous stream, 1 to 2 feet deep and 8 to 10 feet wide in most places, but at irregular intervals there were pools 2 to 4 feet deep. Curiously enough, this stream seems to be subject to considerable fluctuation in volume. No fishes are known from this cave except from near the entrance, but a species of blind crawfish occurs in limited numbers.

CLEVELAND, TENN., OCTOBER 3 AND 4.

Cleveland, about 30 miles a little northeast of Chattanooga, is situated in an undulating region in which we saw nothing but limestone rocks, from which springs issued in abundance. There are a great many springs, large and small, in the vicinity of Cleveland, of which the most important are:

Craigmile's Springs.—These are situated 1 mile north of Cleveland. By damming and embanking, a pond of an acre or more has been formed. The principal spring issues from the limestone at the upper edge of the pond. The total flow is about 400 gallons per minute. The water is of good quality. The temperature of the water as it issues from the rock is 59° F.; in a small spring below the dam it is 60° F.; while in

the boat house it was 68° F. at 10 a. m. when the air was 74° F. There is considerable algæ and Chara growing in the pond.

Payne's Spring.—This spring is located about 2 miles north of Cleveland. It emerges at the foot of a low hill, which is of red clay resting on sandstone. It is a very fine spring, flowing about 1,000 gallons per minute. The temperature of the water is 58° F. The stream flowing from it is filled with water cress. The outlet is in South Mouse Creek, a short distance to the north.

Stith's Springs.—About 1 mile south of Cleveland are two good springs, about one-fourth mile apart. The combined flow is about 275 to 300 gallons and the temperature of the water is 59° F.

Julian's Spring.—This is a large spring about 8 miles southeast of Cleveland. It has a flow of over 400 gallons per minute, and the temperature was 59.5° F. when the air was 74° F. The soil in this region is thin and mostly red clay. The vegetation in the streams was especially abundant, the algæ, water cress, etc., greatly obstructing the flow of the water. The forests are mainly of oak with some pines and other trees. We noticed three oaks, three elms, pine, chestnut, black walnut, maple, tulip, sweet gum, dogwood, ash, cedar, hickory, ironwood, persimmon, sassafras, blue beech, sumach, wild cherry, redbud, sycamore, wild plum, willow, alder, elder, etc., making up quite a varied forest vegetation, indicating considerable variety of soil and possibly of rocks, but to a casual observer the outcropping rocks seemed much the same everywhere in the region about Cleveland.

ATHENS, TENN., OCTOBER 4 TO 7.

About Athens, 30 miles east of north from Cleveland, the country is more broken and uneven. The rocks were generally limestone, but near Arnwine Spring, about 5 miles north of Athens, other rocks were seen. This region is also well supplied with springs and streams. Within a few miles are several of the most important rivers of east Tennessee. To the southward 12 to 15 miles is the Hiawassee, to the northeast about 20 miles is the Little Tennessee, while the Tennessee River is only 15 miles distant on the west or 25 miles on the northeast. These and a great number of smaller streams near-by are all excellent fish streams. Among the more important springs which we examined in the vicinity of Athens are the following:

Arnwine Spring, or Mallock Spring.—This spring is about 5 miles north of Athens. It is a very large and excellent spring, issuing from a fissure in the limestone at the base of a gentle hillside, and at once forming a large stream which flows southeast over granitoid, schistose, and other metamorphic rocks through a narrow valley which becomes wider as the distance from the spring increases. This spring is tributary to a branch of North Mouse Creek, which flows for a short distance over metamorphic rocks, but most of its course is over a limestone bed. The temperature of the water in the spring was 57.5° F. at 3.30 p. m. when the air was 72° F. The volume of water furnished by this spring is over 2,000 gallons per minute.

The spring, mill race, and upper end of the pond are well filled with water vegetation, consisting chiefly of mosses on the rocks, Lemna, Chara, and filamentous algæ. We were surprised to find no water cress, Myriophyllum, or Potamogeton in this spring and pond.

In the mill race and stream are a great many small gasteropods and small blobs, and crawfish, young dace, and frogs are quite numerous.

The stream below the mill is well suited to such small fishes as darters and minnows, and we found 10 or 12 species of these two families. Smallmouth black bass and rock bass are abundant farther down the stream.

Norvel Spring.—This spring is situated about 7 miles east of Athens, or 2 miles north of Tellico Junction. This, like all other springs of east Tennessee, comes out of limestone rock. The stream, measured 2 rods below the spring, was found to be 52 inches wide, 4 inches deep, and to flow $1\frac{3}{5}$ feet per second, which would give a volume of more than 1,000 gallons per minute. The temperature of the water was 59° F. at 9 a. m. when the air was 67° F.

The opening through which the spring issues from the rock is unusually large, and the sound of running water from some distance back of the opening can be distinctly heard. It was stated that on at least one occasion, during a heavy rain, cornstalks and other surface rubbish came up in the spring; these, presumably, had been carried underground through some "sink" connected with the stream somewhere. At such times the water must necessarily become more or less muddy.

Easttaunaula Creck.—This is a small stream flowing southwest through the town of Athens and joining the Hiawassee near Calhoun. The water is relatively warm and the species of fishes found were chiefly minnows and darters.

TELLICO PLAINS, TENN., OCTOBER 7 TO 9.

On Tellico River, about 20 miles east of Athens, the rocks are metamorphic; no limestone seen; only slates, schists, granites, and other forms of metamorphic rocks; soil scanty. Timber varied; fewer oak, more pine, chestnut, black walnut, maple, beech, dogwood, ash, hickory, whitewood, sweet gum, and others were seen. Water plants were not abundant and those found were different from any observed before. Between Athens and Tellico mainly limestone with much red soil.

The Tellico River at Tellico Plains breaks through the last important foothills of the Great Smoky Mountains, turns abruptly northward, and joins the Little Tennessee about 30 miles northeast of Athens. The Tellico is one of the most beautiful and interesting of the many fine streams which have their sources in the Great Smokies. At Tellico Plains it is a cold clear stream about 60 feet wide. Its banks, however, are 80 to 90 feet apart, so that in high water the stream is considerably wider. The granite axis of the fold flanked by shale is shown here. Just above the "Mansion" house the stream flowing over the upturned edges of this shale, whose dip is upstream, causes a very pretty series of rapids when the water is not too low, otherwise a series of isolated streams and pools 1 to 4 feet deep. The river here averaged perhaps 2 feet deep and had a very swift current. Lower down in the more level country the current is less rapid and the depth is correspondingly greater. In the more rapid portions of the river the rocks are covered with a species of moss which adheres very closely to them and among which small mollusks and insect larvæ were abundant. The principal fishes in this part of the stream were darters, which were found to be quite plentiful. In the deeper and more quiet water the smallmouth black bass, pike (*Lucius*), wall-eyed pike, and goggle-eye are abundant, affording much sport to local fishermen.

The upper portion of this river would apparently prove very suitable for trout, unless the rapacious species already mentioned be too numerous.

MARYVILLE, TENN., OCTOBER 9 TO 10.

There are many springs in the vicinity of Maryville, only a few of which were examined.

Pistol Creek.—This is a small stream flowing through the town. It is about 15 feet wide and 1 foot deep, and is fed chiefly by springs, some of which are of large size.

There is one spring a short distance west of the Jackson House which furnishes about 350 gallons per minute. Another in the town east of the hotel runs about 450 gallons per minute; its temperature was 59° F. at 6 a. m. when the air was 55° F.

About 2 miles northeast of the town is a series of small springs, the total flow of which is probably 400 gallons per minute. The temperature is 59° F.

GREENVILLE, TENN., OCTOBER 10 TO 11.

At Greenville, something over 75 miles northeast of Knoxville, only limestone rocks were seen, and they were the only rocks noticed between the two places. This is also a region of springs, and several very good ones are found in and about the town. There is one large spring in the town near the Grand Central Hotel.

Davis Spring, about 1½ miles northwest of Greenville, is quite a good spring, flowing about 500 gallons per minute. Temperature 59° F., air 84° F.

Big Spring.—This spring is about 8 miles southwest of Greenville and flows only about 500 gallons per minute. Temperature of water 59° F., air 68° F.

Nolichucky River.—This is a stream of considerable size, flowing westward from the Unaka Mountains through Greene County to the French Broad River southwest of Morristown. It was visited at Love's ferry south of Greenville. At that place it is about 250 feet wide, 10 to 15 feet deep, and has a strong current. The Nolichucky is one of the best fish streams in east Tennessee. Algæ, Chara, water cress, Lemna, and other aquatic vegetation are abundant in the springs and little streams flowing from them and in protected places in the river.

Roaring Fork.—We visited Roaring Fork about 5 miles northeasterly from Greenville. In all directions rock, soil, and timber were much the same; soil red and thin on the hills, lighter colored and thicker in the valleys; on the hills forests of oak and chestnut with occasional pines and hickories. In the valleys sycamore, maple, elm, and willow were common; beech, mulberry, black walnut, whitewood, redbud, and others were seen.

TAZEWELL, TENN., OCTOBER 12 TO 14.

Tazewell, Claiborne County, is about 40 miles north and a little east of Knoxville. The rock of this region is chiefly limestone which is readily soluble, as evidenced by the numerous caves of considerable size. Tazewell is 100 to 150 feet below the summits along the divide between Powell and Clinch Rivers, both of which flow southwesterly, each about 6 miles from Tazewell, the former to the north and the latter to the south. The town is 400 to 450 feet above the level of the rivers. The country is rocky and broken, abounding in steep slopes, narrow valleys, and rapid streams. The rocks are mainly limestones, but we saw one thin bed of shale; soil scanty; agriculture practicable only in the narrow valleys; forests of oak, pine, chestnut, sassafras, persimmon, etc., on the higher slopes, with maple, hickory, box elder, ash, willow, etc., along the stream. Near the railway station there is an opening into a large cave and other caves are found in the immediate vicinity.

Clinch River.—We examined this river at Walker's ford about 8 miles in a direct line southwest from Tazewell. At that place the river is about 400 feet wide, shallow, and easily waded in most places. The current is swift, and there are many small islands in the river. The rocks are chiefly limestone, but one bed of shale was noticed. The soil is thin, and agriculture is practically confined to the narrow valleys.

This stream is well supplied with fishes, the species of minnows, darters, and suckers being especially numerous. The Clinch River is also remarkable for its rich molluscan fauna, the species of gasteropods being especially abundant and interesting.

Three small creeks enter the Clinch River at or near Walker's ford. Bear Creek joins it from the northeast and Flint Creek from the south, their mouths being almost directly opposite each other. Just above the ford the river has cut its way through Lone Mountain, and just below the ford it has cut in a similar way through Wallen's ridge, below which Straight Creek enters the Clinch from the northeast.

Ousley Spring.—This spring, about 8 miles from Tazewell, flows approximately 500 gallons per minute. It is surrounded by trees. The stream formed by the spring is nearly $3\frac{1}{2}$ feet wide, 2 to 4 inches deep, and has a 2-foot current. The temperature was 55.5° F., the coldest we found in Tennessee. The stream comes out near the base of a limestone ledge on the left side of the road going to Walker's ford, and flows across the road and into a meadow.

CUMBERLAND GAP, OCTOBER 14 TO 19.

Cumberland Gap, about 12 miles in a direct line northwest of Tazewell, is an interesting locality from a geological point of view. The upper strata on either side of the Gap are of red sandstone, the lower strata east of the Gap of limestone, all in nearly horizontal strata. But in the Gap there is a mass of shale or slate through which a railway tunnel has been driven. We did not work out the relations of these strata, but the slate in the Gap and not east of it at the same level suggests an old anticlinal which has been covered by nearly horizontal strata of limestones and sandstones. In the cave just east of the Gap the strata seem to dip a little toward the west, at least the stream in the cave crowds the west wall which overhangs the stream. The cave exhibits well several kinds of cave action. By mechanical action and by solution the stream is enlarging the cave downward and sidewise. Rocks falling from above furnish material for rock fragments which aid in erosion, while they are dissolved by the water and broken upon each other. In other places the fallen rocks are cemented together by stalagmitic matter from dripping water, and in some cases chambers are being obliterated by the growth of stalactites which serve as pillars to prevent the rocks from falling, and then the room is at length filled by the slowly forming stalagmite. Soil thin. Forests of chestnut and oak, some pine, maple, sassafras, etc.

King Solomons Cave.—This cave was examined October 14. One enters the cave through a house built over its mouth. The descent of 15 to 20 feet into the cave is made by a winding stairway. After going some little distance a small creek about 10 feet wide and 18 inches deep is reached. Several hauls were made with a small seine, but no fish were found. It is doubtful if any are there. The only animal life noted were two salamanders, crickets, flies (probably two species), one spider, a beetle, and a worm. A species of mould was abundant. At the mouth of the cave we caught two specimens of *Rhinichthys atronasmus* which had been put there by the owner of the house.

Ball Creek.—This is a small stream rising just west of Tazewell and, flowing south, joins Big Sycamore Creek a mile above the latter's union with the Clinch. A small collection of fishes was made in this creek.

Big Sycamore Creek.—This creek, tributary to Clinch River, was examined by Dr. Gurley and some fishes obtained.

Indian Creek.—Dr. Gurley examined this tributary of Powell River near Cumberland Gap October 17. He also made small collections in Nigger Cave on the same date.

Following is a list of the streams and springs examined and the localities at or near which they were visited. Collections were obtained at most of the places mentioned.

For convenience of reference the names of the streams and springs are arranged in alphabetic order. For detailed descriptions of the various places see pages 434-441.

Arnwine, or Matlock, Spring and Creek, 5 miles north of Athens or 2 miles north of Mount Verd, October 4, 5.

Ball Creek, near Tazewell, October 15.

Bear Creek, near Walker's ford, 12 miles southwest of Tazewell, October 12.

Big Spring, 8 miles southwest of Greenville, October 11.

Big Sycamore Creek, near Tazewell, October 18.

Callahan Springs, 5 miles northwest of Knoxville, September 27.

Chickamauga Creek, at Lee and Gordon's mill, September 30.

Clinch River, at Walker's ford, 12 miles southwest of Tazewell, October 12.

Craigmile's spring, 1 mile north of Cleveland, October 3.

Crawfish Springs, near Chickamauga, September 30.

Davis Spring, 1½ miles from Greenville, October 11.

Eastannaula Creek, at Athens, October 7.

Flint Creek, near Walker's ford, 12 miles southwest of Tazewell, October 12.

Fountain Head Springs, at Old Camp Ground, Fountain City, 5 miles north of Knoxville, September 27.

Green's pond, or Newman Spring, 6 miles southeast of Chattanooga near Rossville Gap, September 29.

Greenville Spring, in the town of Greenville near the Grand Central Hotel, October 10.

Indian Creek, near Cumberland Gap, October 17.

Julians Spring, 8 miles southeast of Cleveland, October 4.

King Solomons Cave, at Cumberland Gap, October 14.

Lyon Creek, 5 miles west of Knoxville, near the insane asylum, September 28.

Matlock, or Arnwine, Spring and Creek, 5 miles north of Athens or 2 miles north of Mount Verd, October 4, 5.

Newman Spring, or Green's pond, 6 miles southeast of Chattanooga, September 29.

Nickajack Cave and Stream, at Shellmound, 22 miles west of Chattanooga, October 2.

Nigger Cave, at New Tazewell, October 12.

Nolichucky River, at Love's ferry south of Greenville, October 11.

Norvel Spring and branch, 7 miles east of Athens, or 2 miles north of Tellico Junction, October 7.

Ousley Spring, 8 miles from Tazewell, October 12.

Payne's spring, 2 miles north of Cleveland, October 3.

Pistol Creek and Springs, at Maryville, October 10.

Read's spring, 7 miles north of Chattanooga, October 1.

Roaring Fork, 5 miles north of Greenville, October 11.

Springfield Springs, 2 miles northeast of Maryville, October 10.

Stith's springs, 1 mile south of Cleveland, October 4.

Tellico River, at Tellico Plains, October 8.

Tennessee River, near mouth of Lyon Creek, 5 miles west of Knoxville, September 28.

Wildwood Spring, at Wildwood, 9 miles from Chattanooga, October 2.

Wine House Cave, at Shellmound, about 22 miles west of Chattanooga, examined October 19, 1901, by Prof. W. P. Hay.

ANNOTATED LIST OF SPECIES.

Following is an annotated list of the species of fishes obtained or observed during these investigations. Unless otherwise stated, the specimens from each stream or spring were obtained at the place mentioned in the alphabetically arranged list of streams, springs, and localities on page 441.

1. *Ictalurus punctatus* (Rafinesque). Channel cat.

Four specimens, 2.25 to 3.25 inches long, from Ball Creek; four, 3 to 3.5 inches long, from Clinch River; and one, 2.5 inches long, from Chickamauga Creek.

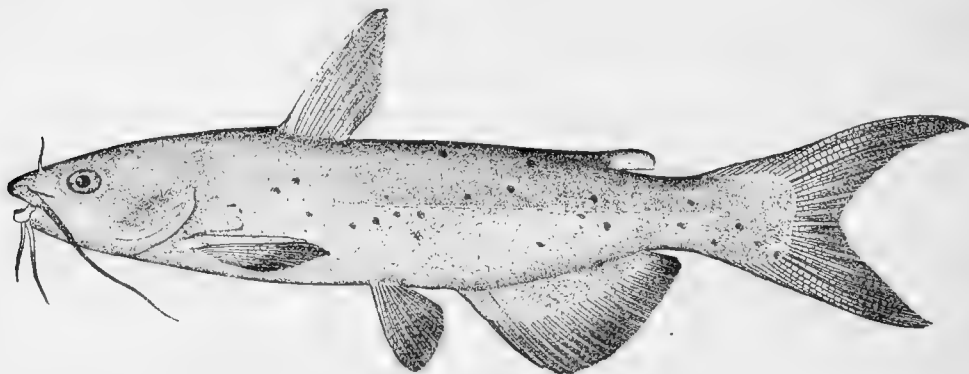

FIG. 1.—*Ictalurus punctatus*. Channel cat.

2. *Leptops olivaris* (Rafinesque). Mud cat; yellow cat.

Three young, 4 to 5.5 inches long, from Clinch River.

3. *Schilbeodes eleutherus* (Jordan). Mad tom.

Abundant in Clinch River; seven specimens saved, 1.5 to 2.25 inches long.

4. *Schilbeodes miurus* (Jordan). Mad tom.

Common in Clinch River, Tennessee River, and Chickamauga Creek. Nine specimens, 1.5 to 2.5 inches long, from Clinch River; one, 2.25 inches long, from Tennessee River; and three, 2 to 2.75 inches long, from Chickamauga Creek.

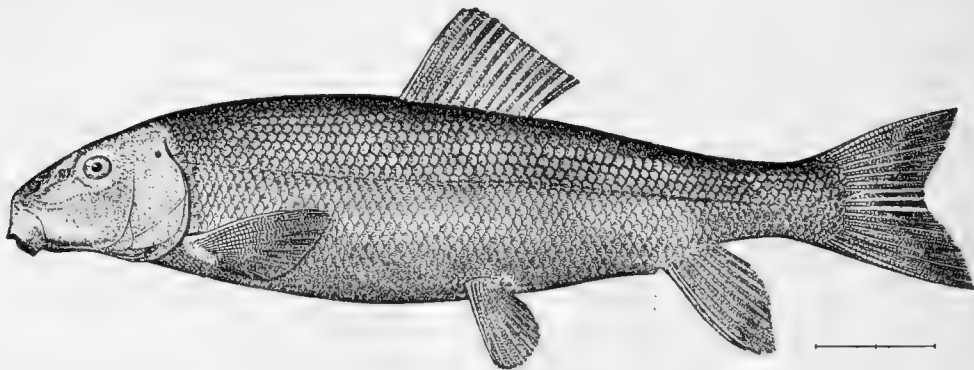

FIG. 2.—*Catostomus commersonii*. Common white sucker.

5. *Catostomus commersonii* (Lacépède). Common white sucker.

One specimen, 3 inches long, from Ball Creek; five, 4.5 to 6.5 inches long, from Arnwine Spring Creek; eight, 5 to 10 inches long, from Eastaunaula Creek; and several from Roaring Fork.

6. *Catostomus nigricans* Le Sueur. Hog sucker; stone roller.

Common in most streams examined. Three specimens, 3 to 3.75 inches long, from Ball Creek; two, 2 and 4 inches long, from Tennessee River; four, 4.5 to 9.5 inches long, from Eastaunaula Creek; one of 5 inches long, from Arnwine Spring; four, 3 to 3.5 inches long, from Tellico River; and one 3 inches long, from Chickamauga Creek. Specimens also from Indian Creek, Roaring Fork, and Clinch River.

7. *Moxostoma aureolum* (Le Sueur). Common redhorse.

Abundant nearly everywhere. Twenty-eight specimens, 2.5 to 3.75 inches long, from Indian Creek; twelve, 2.25 to 3 inches long, from Ball Creek; twelve, 2.75 to 3 inches long, from Clinch River; one 2.75 inches long, from Nolichucky River; five, 3.75 to 8.5 inches long, from Roaring Fork; six, 2.5 to 6.25 inches long, from Tennessee River; one 9 inches long, from Arnwine Spring Creek; and six, 4 to 9 inches long, from Chickamauga Creek.

The free edge of the dorsal fin is slightly concave in all our specimens.

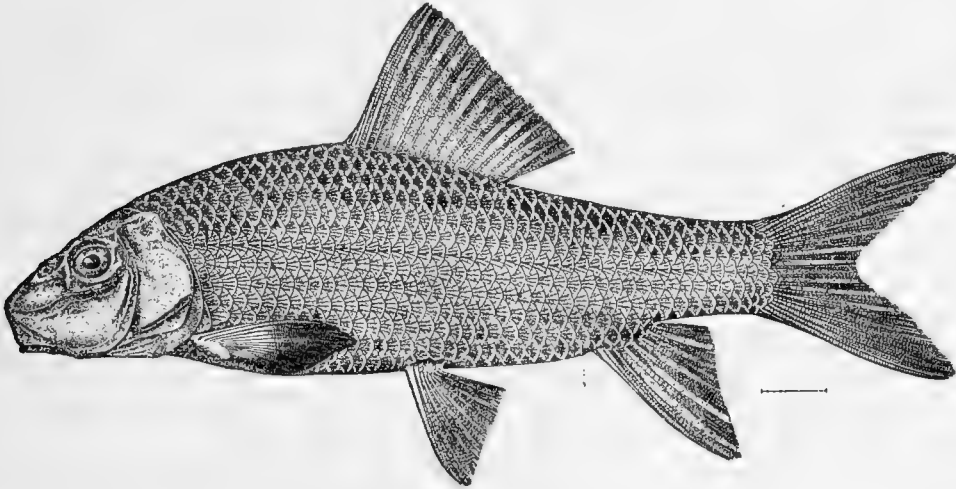

FIG. 3.—*Moxostoma aureolum*. Common redhorse.

8. *Placopharynx duquesnii* (Le Sueur). Big-toothed sucker.

A fine specimen of this species was examined by the senior writer on July 4, 1878, at Alexander's on the French Broad River, from which the fish was caught.

9. *Campostoma anomalum* (Rafinesque). Stone roller; rot-gut minnow.

Abundant in most places. Forty-seven specimens, 2 to 6 inches long, from Indian Creek; seventeen, 1.75 to 4.75 inches long, from Ball Creek; three, each 2.75 inches long, from Clinch River; thirty-six, 2.25 to 5.5 inches long, from Roaring Fork; fifty-four, 1.5 to 5.75 inches long, from Eastaunaula Creek; and one 4.75 inches long, from Chickamauga Creek. It was also found in the Tellico River.

10. *Chrosomus erythrogaster* (Rafinesque). Red-bellied dace.

Observed only in Roaring Fork.

11. *Pimephales notatus* Rafinesque. Blunt-nosed minnow.

Found by us only in Chickamauga Creek, from which we have two specimens each 2 inches long.

12. *Semotilus atromaculatus* (Mitchill). Horned dace; creek chub.

Two specimens, 3.5 and 5.5 inches long, from Ball Creek; four, 4.25 to 5.25 inches long, from Eastaunaula Creek; and one 2.25 inches long, from Norvel Spring.

13. *Cliola vigilax* (Baird & Girard).

One specimen, 2.5 inches long, from Ball Creek; fourteen, 1.5 to 2.25 inches long, from Clinch River; three, 2 to 2.25 inches long, from Tennessee River; and three, 1.75 to 2.5 inches long, from Chickamauga Creek.

14. *Notropis blennioides* (Girard). Straw-colored minnow.

Thirteen specimens, 1.5 to 1.75 inches long, from Indian Creek; twelve, 1.5 to 2 inches long, from Ball Creek; nine, 1.5 to 1.75 inches long, from Clinch River; and seven, 1.75 to 2.25 inches long, from Roaring Fork.

15. *Notropis shumardi* (Girard).

Two specimens, each 2.5 inches long, from Indian Creek.

16. *Notropis galacturus* (Cope).

Very common throughout the region examined. Eighty-eight examples, 1.75 to 4.25 inches long, from Indian Creek; thirty-six, 1.75 to 4.75 inches long, from Clinch River; twelve, 1.75 to 2.25 inches long, from Tennessee River; one 3 inches long, from Roaring Fork; forty-seven, 2 to 4 inches long, from Eastaunaula Creek; twenty-five, 2.5 to 4 inches long, from Tellico River; and twelve, 2 to 3 inches long, from Chickamauga Creek. Specimens also from Ball Creek.

The young among these specimens have the mouth almost terminal and the gape oblique. When the fish reaches a length of about 2.5 inches the mouth becomes subinferior, the gape nearly horizontal, and the upper jaw projecting.

17. *Notropis cornutus* (Mitchill). Shiner.

Very common throughout the entire region. Ten specimens, 3.25 to 5 inches long, from Indian Creek; eight, 2.75 to 6 inches long, from Ball Creek; two, each 2 inches long, from Walker's ford; thirty, 1.75 to 4.5 inches long, from Roaring Fork; three, 3.25 to 6 inches long, from Eastaunaula Creek; two, each 5 inches long, from Arnwine Spring Creek; and one 3 inches long, from Tellico River. Specimens were obtained also from Nolichucky River and Chickamauga Creek.

18. *Notropis coccogenis* (Cope).

A fairly abundant species. Four specimens, 3.25 to 4 inches long, from Indian Creek; one 1.5 inches long, from Ball Creek; twenty-nine, 2.75 to 4.25 inches long, from Arnwine Spring; twenty-nine, 2 to 3.75 inches long, from Tellico River; and ten, 2.5 to 3 inches long, from Chickamauga Creek.

19. *Notropis zonatus* (Agassiz).

Five specimens, 2 to 2.75 inches long, from Nolichucky River.

Head 4.2; depth 4.5; D. 8; A. 10; scales 6-40-4, 15 before the dorsal; pectoral not reaching ventrals; dorsal inserted slightly behind ventrals. No distinct lateral band; no caudal spot; fins plain.

This species has previously been recorded only from the mountain streams in the Ozark region of Missouri and Arkansas.

20. *Notropis rubricroceus* (Cope). Red fallfish.

Four specimens, 2 to 2.25 inches long, from Cleveland, Tenn., probably from South Mouse Creek, where they were collected May 18, 1894, by Mr. J. D. Patton, who kindly sent them to us. The species was not obtained by us in 1893.

21. *Notropis leuciodus* (Cope).

This species was found only in Indian Creek and Tellico River, in each of which it is fairly abundant. We have nineteen specimens, 1.5 to 2.5 inches long, from Indian Creek, and nine specimens of same size from Tellico River.

22. *Notropis telescopus* (Cope).

Abundant in Indian Creek and Tellico River, but not seen elsewhere. We have sixty-five specimens, 1.5 to 2.75 inches long, from Indian Creek and seventy-five, 2 to 3.25 inches long, from Tellico River.

23. *Notropis stilbius* Jordan.

One specimen, 1.75 inches long, from Ball Creek; forty-one, 1.75 to 2 inches long, from Clinch River; one 2 inches long, from Tellico River; four, each 2 inches long, from Nolichucky River; and four, 2 to 2.75 inches long, from Chickamauga Creek.

This minnow has been previously recorded only from the Alabama basin, where it is said to be abundant. It is apparently very close to *N. telescopus*, but the larger eye and more backward insertion of the dorsal of the present species separate the two. Eye 3 in head, longer than snout; distance from origin of dorsal to base of caudal equal to distance from middle of eye to origin of dorsal.

24. *Notropis micropteryx* (Cope).

We have forty-four specimens, 1.75 to 2.25 inches long, from Clinch River, and three, 2.5 to 2.75 inches long, from Tennessee River.

25. *Phenacobius uranops* Cope.

Three examples, 3 to 4 inches long, from Indian Creek; two, 3 and 3.25 inches long, from Ball Creek; one 3.25 inches long, from Clinch River; and six, 2.5 to 3.25 inches long, from Chickamauga Creek.

Scales in lateral series, 53 to 64; before dorsal, 22 or 23.

26. *Rhinichthys atronasus* (Mitchill). Black-nosed dace.

A species widely distributed throughout this region. We have twenty-two specimens, 1.5 to 3 inches long, from Indian Creek; two from King Solomons Cave; thirty-one, 1.25 to 3 inches long, from Ball Creek; eight, 2 to 3.5 inches long, from Nigger Cave; one 1.75 inches long, from Roaring Fork; thirteen, 2.5 to 3.25 inches long, from Eastaunaula Creek; and five, 1.5 to 2.5 inches long, from Norvel Spring.

This species as represented in this collection is very variable. Depth in length of body, from 5 to 6; length of snout very variable; examples from Ball Creek have snout almost as long as examples of the related species, *R. cataractæ*; eye 1.25 to 2 in length of snout; scales 60 to 70; size of barbel quite variable. Our alcoholic specimens show no distinct variation in color.

Smaller scales and a more distinct barbel are characters given to distinguish the variety *croceus* from the typical species, but specimens from Nigger Cave, 2 to 3.5 inches long, have 70 scales in a lateral series, with the barbel scarcely visible; other examples, from Indian Creek, 1.75 to 2.25 inches long, have 60 scales in a lateral series, and a very evident barbel.

27. *Hybopsis hyostoma* (Gilbert).

Only two specimens obtained, one 2.25 inches long, from Clinch River and one 1.5 inches long, from Tennessee River.

28. *Hybopsis monaca* (Cope).

Two specimens, each 2.75 inches long, from Indian Creek; six, each 2.75 inches long, from Clinch River; also obtained from Ball Creek.

29. *Hybopsis dissimilis* (Kirtland). Spotted shiner.

This species, though widely distributed, was not abundant anywhere. We have eight specimens, 2.25 to 3.5 inches long, from Indian Creek; two, 2 and 3 inches long, from Tennessee River; and one, 3 inches long, from Tellico River. We also have specimens from Ball Creek and Chickamauga Creek.

30. *Hybopsis amblops* (Rafinesque). Silver chub.

This species was not found to be abundant, but it is distributed throughout the entire region examined. We have 32 specimens, 1.5 to 2.75 inches long, from Indian Creek; two, 1.5 and 1.75 inches long, from Ball Creek; seven, 2 to 3.5 inches long, from Clinch River; three, each 1.75 inches long, from Tennessee River; one 2 inches long, from Roaring Fork; one 2.75 inches long, from Eastaunaula Creek; and five, 2.5 to 3 inches long, from Chickamauga Creek. We also found it in Tellico River.

31. *Hybopsis kentuckiensis* (Rafinesque). Hornyhead; river chub.

One of the most abundant and widely distributed fishes of the region. We have 59 specimens, 1.75 to 5 inches long, from Indian Creek; ten, 1.5 to 6.5 inches long, from Ball Creek; seven, 2.5 to 3 inches long, from Clinch River; two, 2.5 and 5.5 inches long, from Tennessee River; two, 4.25 and 4.75 inches long, from Eastaunaula Creek; five, 2 to 4.5 inches long, from Tellico River; one 5.25 inches long, from Arnwine Spring Creek; and twenty-nine, 2 to 5.5 inches long, from Chickamauga Creek.

32. *Fundulus catenatus* (Storer).

Our collections contain 141 specimens, 1.5 to 3.75 inches long, from Indian Creek; five, 2.5 to 3.25 inches long, from Ball Creek; ten, 1.75 to 2.75 inches long, from Clinch River; and one 1.75 inches long, from Tellico River.

33. *Fundulus notatus* (Rafinesque). Top minnow.

Five specimens, 1.25 to 2.25 inches long, from Norvel Spring, the only place where it was seen.

34. *Typhlichthys subterraneus* Girard. Small blindfish.

On October 19, 1901, Prof. W. P. Hay, while studying the crawfish fauna of Tennessee, visited Nickajack Cave and other caves in the vicinity of Shellmound. In Wine House Cave, which is probably

a part of Nickajack Cave, he saw a small blindfish which was almost certainly this species. He was unable to capture it.

Wine House Cave is reached by going through the cellar of a house, then down a passage about 80 feet.

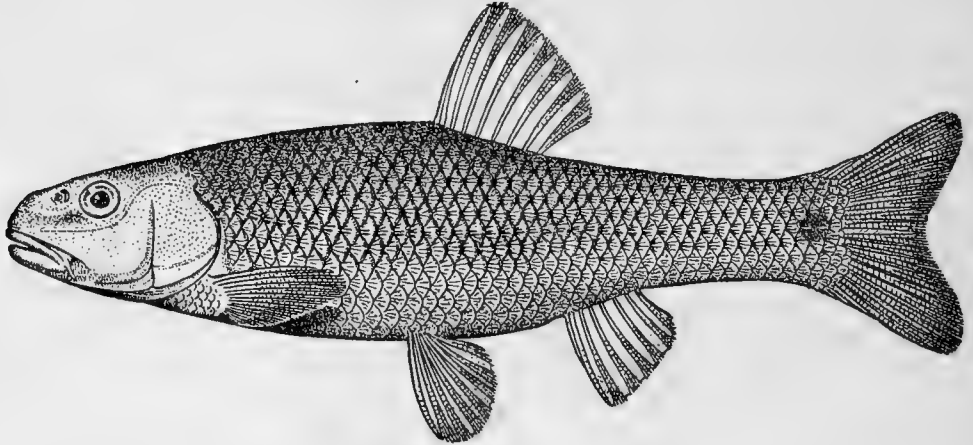

FIG. 4.—*Hybopsis kentuckiensis*. Hornyhead.

35. *Ambloplites rupestris* (Rafinesque). Rock bass; red-eye; goggle-eye.

Only a few small specimens of this fish were obtained. We have six examples, 1 to 4 inches long, from Clinch River; one 3 inches long, from Roaring Fork; and eight, 1 to 4 inches long, from Eastaunaula Creek. It is also known to occur in the Tellico River.

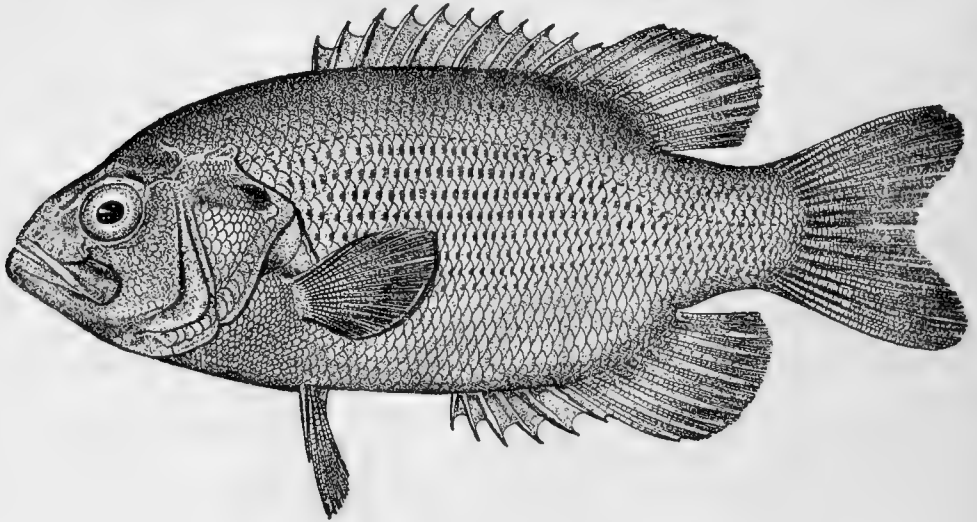

FIG. 5.—*Ambloplites rupestris*. Rock bass.

36. *Lepomis megalotis* (Rafinesque). Long-eared sunfish.

Common throughout the region but only small examples obtained. Six specimens, 1.75 to 2 inches long, from Ball Creek; five, 1.75 to 2.75 inches long, from Clinch River; one 1.75 inches long, from Tellico River; two, each 3 inches long, from Arnwine Spring; and one 1.5 inches long, from Chickamauga Creek.

37. *Lepomis pallidus* (Mitchill). Bluegill.

Found by us only in Arnwine Spring, whence we have three specimens 4.75 to 6.5 inches long.

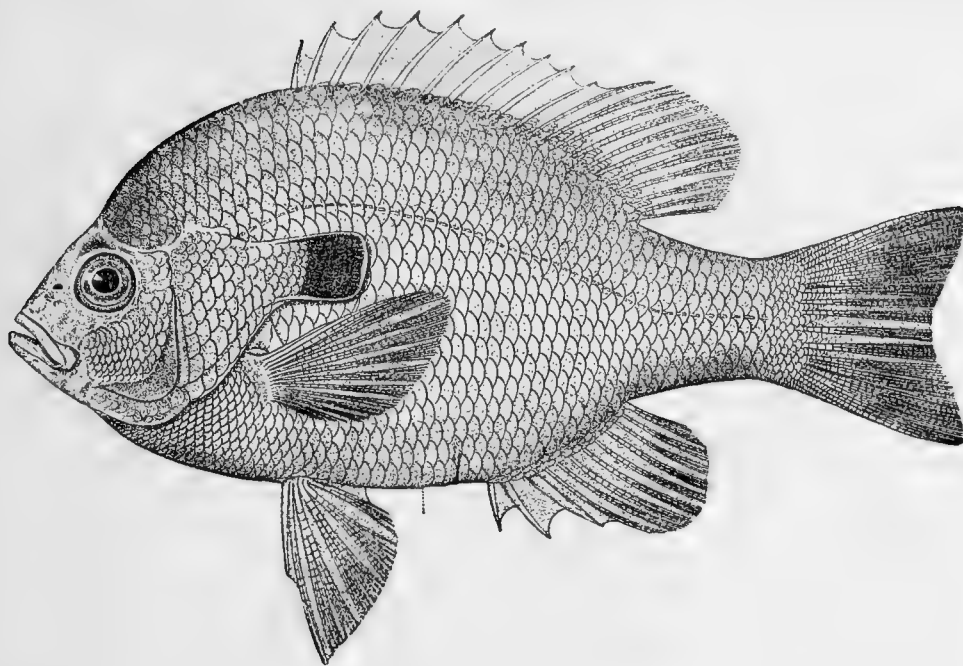

FIG. 6.—*Lepomis megalotis*. Long-ear sunfish.

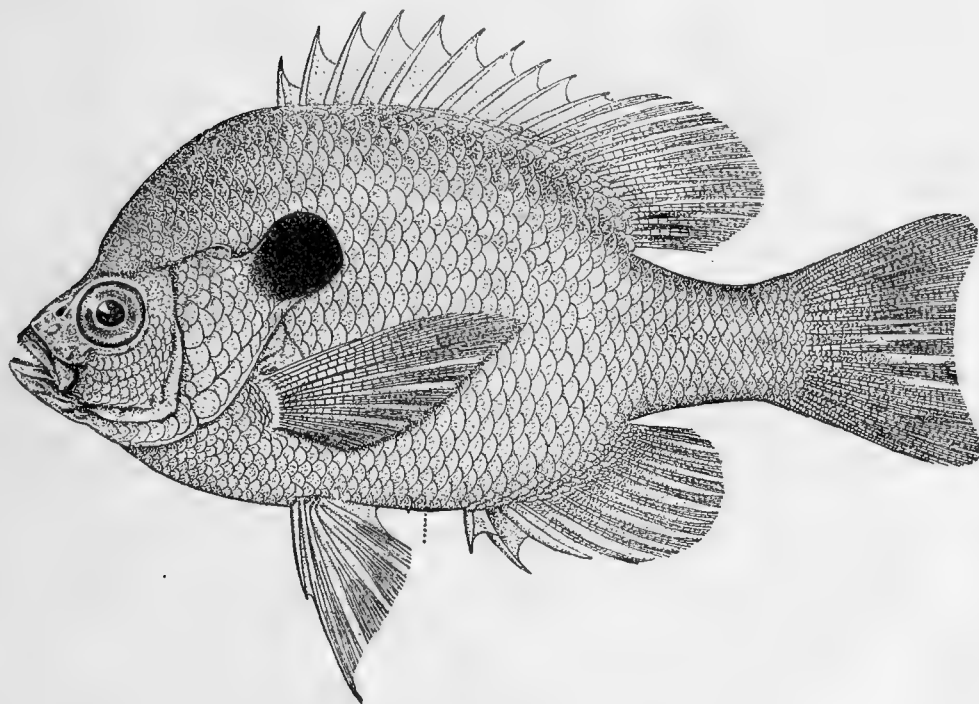

FIG. 7.—*Lepomis pallidus*. Bluegill.

38. *Micropterus dolomieu* (Lacépède). Smallmouth black bass.

Only small specimens obtained. Seventeen, 2.25 to 3.75 inches long, from Indian Creek; three, 2.25 to 2.5 inches long, from Ball Creek; three, 3.5 to 4.5 inches long, from Clinch River; and two, each 3 inches long, from Tellico River. It was also obtained in Chickamauga Creek.

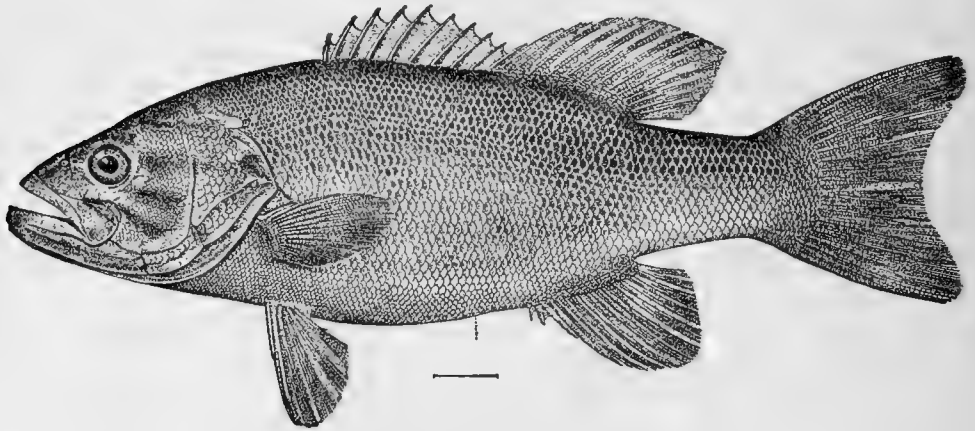

FIG. 8.—*Micropterus dolomieu*. Smallmouth black bass.

39. *Micropterus salmoides* (Lacépède). Largemouth black bass; "green trout."
Found by us only in Clinch River and Chickamauga Creek.

40. *Stizostedion vitreum* (Mitchill). Wall-eyed pike.

Reported as common in the Tellico River, but no specimens were obtained.

In a letter dated March 2, 1904, Dr. E. G. Anderson, of Newport, Tenn., reports the capture, in the French Broad River near that place, of three fine examples of wall-eyed pike. They measured 28, 29, and 31½ inches in length, and weighed 8½, 9, and 12 pounds, respectively. They were caught by Mr. J. C. King, of Rankin, Tenn.

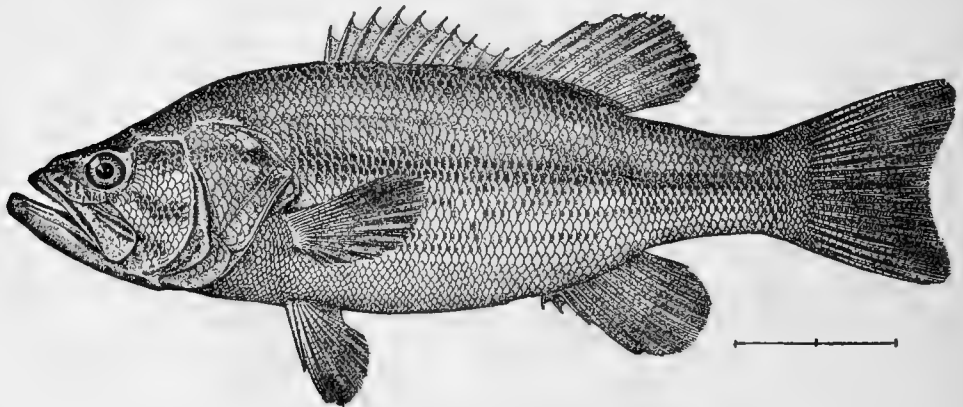

FIG. 9.—*Micropterus salmoides*. Largemouth black bass.

41. *Stizostedion canadense* (Smith). Sauger; sand pike.

One specimen, 14 inches long, from Big Sycamore Creek.

42. *Percina caprodes* (Rafinesque). Log perch.

Not common. Found by us only in Indian and Ball Creeks and Tennessee River.

43. *Hadropterus macrocephalus* (Cope).

Found by us only in Indian Creek, whence we have one specimen 2.75 inches long. Scales in lateral line 80 to 83, 80 pores.

44. *Hadropterus aspro* (Cope & Jordan). Black-sided darter.

Found by us only in Ball Creek, from which we have three specimens, each 2.15 inches long.

Head 4 in body; D. XII or XIII, 13; A. II, 9 or 10; scales 5 to 7-57 to 60-9 to 11. Fewer scales in transverse series than given in current descriptions.

45. *Hadropterus evides* (Jordan & Copeland).

Widely distributed but not many specimens obtained. Five examples, 1.25 to 2.5 inches, from Clinch River. It was also found in the Tellico River.

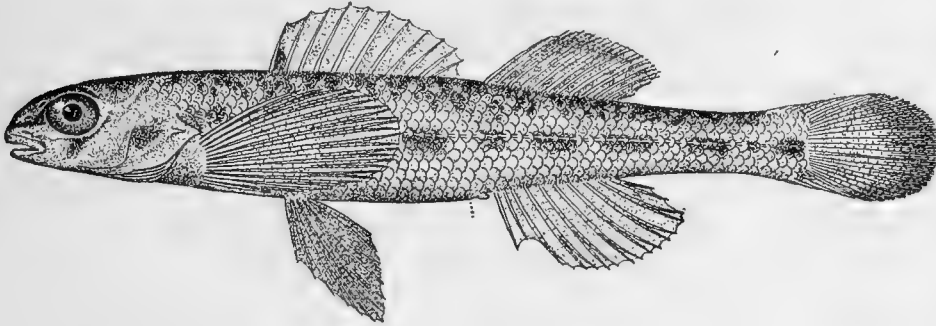

FIG. 10.—*Cottogaster copelandi*.

46. *Hadropterus scierus* Swain.

Seven specimens, 2.25 to 3 inches long, from Clinch River.

47. *Hypohomus aurantiacus* (Cope).

This beautiful darter was found only in Clinch River at Walker's ford, where two fine specimens, 2.5 and 3 inches long, respectively, were secured. They showed the following life colors: Belly and lower two-thirds of side white, with slight greenish shade; middle of side with a series of almost continuous large rectangular black blotches, extending forward across the opercle and preopercle, under eye, and around snout, but scarcely on upper jaw; anterior end of this series mostly below lateral line, posterior half with lateral line running through its middle; side above this band very light straw yellow with a series of about 21 to 23 small dark spots running from occiput to under soft dorsal; a dark median line and some dark clouding on back; fins all plain, except tip of spinous dorsal, which is light orange.

48. *Cottogaster copelandi* (Jordan).

Seven specimens, each 1.25 inches long, from the Tennessee River.

Only the anterior portion of the belly naked; ordinary scales for a short distance in front of anal.

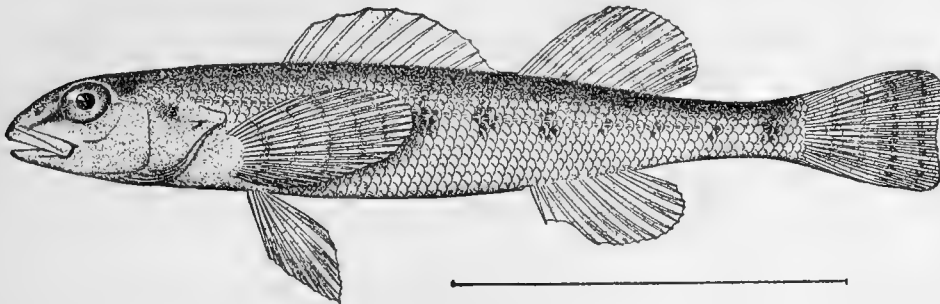

FIG. 11.—*Ulocentra stigmæa*.

49. *Ulocentra stigmæa* (Jordan).

Eleven specimens, 1.5 to 2.75 inches long, from Ball Creek, and two, each 2.5 inches long, from Arnwine Spring Creek.

We have compared these with specimens from Wolf and Obeyes Rivers collected by Dr. Kirsch. Two forms are represented.

Examples from Wolf and Obeyes Rivers in general agree with the cotypes, which were secured from the United States National Museum for comparison, but they differ in having the cheeks naked,

fewer scales (five) in a transverse series below the lateral line, and the lateral line extending as far back as the last ray of the soft dorsal, wanting on 13 to 15 scales. Other examples from Ball Creek and Arnwine Spring Creek have a more slender body; ventral outline nearly straight; longer snout, which is less convex in profile than in the typical form; mouth horizontal, lower jaw included, premaxillary with a narrow frenum. Scales 6-50 to 54-7. Lateral line incomplete, pores wanting on 7 to 10 scales. Breast naked, opercles with large scales, cheeks with a small patch of scales back of the lower posterior border of the orbit. These specimens are closely related to the form *saxatilis*, described as a distinct species by O. P. Hay,^a but which was later found to be identical with *stigmaea* by Dr. Gilbert.^b

50. *Ulocentra gilberti* Evermann & Thoburn.

Three specimens, 1.5 to 2 inches long, from Clinch River.

This species was described by Evermann and Thoburn.^c The above specimens represent the type and cotypes. United States National Museum type no. 47511.

51. *Ulocentra meadiæ* Jordan & Evermann.

Three specimens, each 2 inches long, from Indian Creek.

This species was described by Jordan and Evermann.^d The above specimens represent the type and cotypes. United States National Museum type no. 48903.

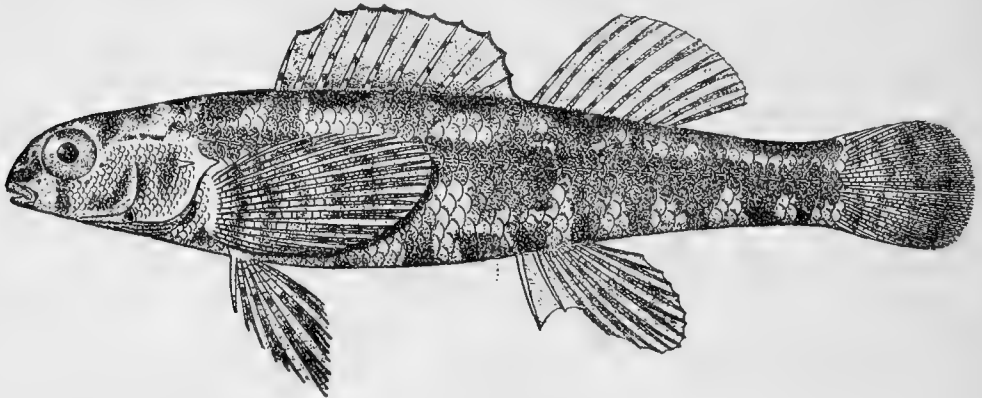

FIG. 12.—*Etheostoma zonale*.

52. *Ulocentra simotera* (Cope).

One hundred seventy-eight specimens, 1.25 to 2.25 inches long, from Indian Creek; twenty-eight, 1.75 to 2 inches long, from Ball Creek; fifty-six, 1.25 to 2.25 inches long, from Roaring Fork; six, 1.5 to 2.5 inches long, from Eastaunaula Creek; three, 1.5 to 2 inches long, from Tellico River; and fifty-two, 1.5 to 2.25 inches long, from Arnwine Spring Creek.

A variable species. Opercles scaly; cheeks often closely scaled; sometimes almost naked; premaxillary occasionally joined to the forehead by a narrow frenum. Color variable; some examples with faint blotches on back and sides; other examples with quite evident blotches on back and sides; these sometimes connecting at sides, forming bars posteriorly; a few specimens with a dark lateral band.

53. *Diplesion blennioides* (Rafinesque). Green-sided darter.

This species was found to be fairly abundant throughout this region. Forty-seven specimens, 1.75 to 3.25 inches long, from Indian Creek; one, 3.75 inches long, from Ball Creek; eight, 2.5 to 3.75 inches long, from Clinch River; one, 4 inches long, from Tennessee River; six, 2.5 to 3.5 inches long, from Chickamauga Creek.

54. *Etheostoma variatum* Kirtland.

One specimen from Indian Creek.

55. *Etheostoma zonale* (Cope).

Eighty specimens, 1.5 to 2 inches long, from Indian Creek; one, 1.5 inches long, from Ball Creek; one, 2.25 inches long, from Eastaunaula Creek; and nine, 1.75 to 2 inches long, from Chickamauga Creek. This species was obtained also from the Tellico River.

^a Proceedings U. S. National Museum, vol. 3, 1880, p. 495.

^b Bulletin U. S. Fish Commission, vol. IX, 1889, p. 150.

^c Bulletin U. S. National Museum, no. 47, p. 1049.

^d Bulletin U. S. National Museum, no. 47, p. 2852.

56. *Etheostoma camurum* (Cope). Blue-breasted darter.

Thirty-five specimens, 1.25 to 2.25 inches long, from Clinch River. Specimens were also obtained from Indian Creek, Ball Creek, Tennessee River, and Tellico River.

57. *Etheostoma maculatum* Kirtland.

Found in Indian and Ball Creeks and Clinch, Tennessee, and Tellico Rivers.

58. *Etheostoma rufilineatum* (Cope).

Twenty-nine specimens, 1.25 to 2.5 inches long, from Indian Creek; two, 1.5 to 2.5 inches long, from Ball Creek; nine, 1 to 2 inches long, from Clinch River; two, 1.75 and 2 inches long, from Tennessee River.

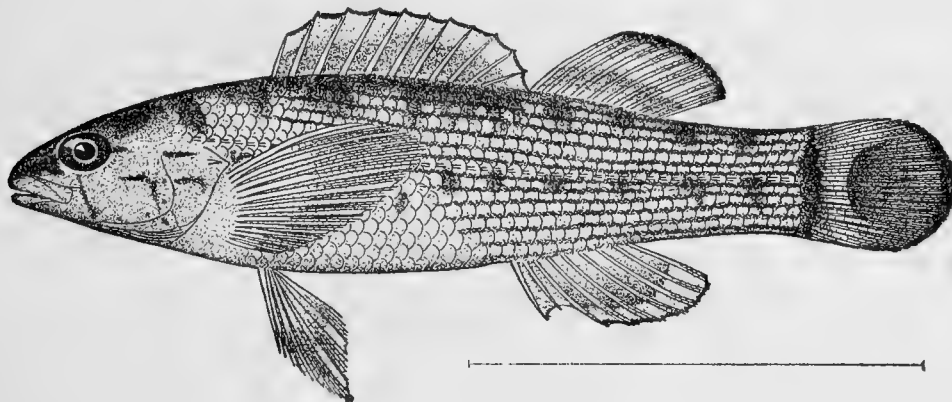

FIG. 13.—*Etheostoma rufilineatum*.

59. *Etheostoma flabellare* Rafinesque. Fan-tailed darter.

This species was found in but two places. One specimen, 1 inch long, from Indian Creek; four, 1.25 to 1.5 inches long, from Ball Creek.

60. *Cottus ictalops* (Rafinesque). Miller's thumb.

This species common throughout this region. Sixty specimens, 1.25 to 2.25 inches long, from Indian Creek; twenty-seven, 1.25 to 3.75 inches long, from Ball Creek; three, each 1.5 inches long, from Tennessee River; one, 3.5 inches long, from Nolichucky River; forty-eight, 1.5 to 4 inches long, from Arnwine Spring; twenty-five, 1.5 to 4 inches long, from Eastaunaula Creek; three, 1.5 to 3.75 inches long, from Norvel Spring; twenty-three, 1.25 to 3.25 inches long, from Chickamauga Creek; and two from Nickajack Cave.

GENERAL INDEX

	Page.		Page.
acanthias, <i>Squalus</i>	267	beani, <i>Salmincola</i>	363
Achtheres ambloplitis.....	365	Beaufort, N. C., sharks and rays.....	241-284
coregoni.....	365	bicauliculata, <i>Salmincola</i>	363
corpulentus.....	365	Big-toothed sucker.....	443
lace.....	365	Birds, Pribilof Islands, Alaska.....	121
micropteri.....	365	birostris, <i>Manta</i>	280
pimelodi.....	364	Black-sided darter.....	449
acronotus, <i>Carcharhinus</i>	259	blennioides, <i>Diplesion</i>	450
Aëtobatus narinari.....	278	biennius, <i>Notropis</i>	444
Alaska, Pribilof Islands, 1914.....	113-172	Blindfish.....	445
birds.....	121	Blue-breasted darter.....	451
fishing.....	125	Bluegill.....	446
foxes.....	105	Blunt-nosed minnow.....	443
fur-bearing animals.....	113-121	bosci, <i>Gobiosoma</i> , embryology and larval development.....	423
reindeer.....	117	brasiliensis corallina, <i>Narcine</i>	270
sea lions.....	119	brevirostris, <i>Hypoprius</i>	253
seals.....	113-105	Bullhead, prickly.....	381
stickleback.....	380	cæruleus, <i>Ergasilus</i>	360
altavela, <i>Pteroplatea</i>	277	California, fishes Tomales Bay tributaries.....	377-381
Ambloplites rupestris.....	446	californiensis, <i>Salmincola</i>	362
ambloplitis, <i>Achtheres</i>	365	Campostoma anomalum.....	443
amblops, <i>Hybopsis</i>	445	camurum, <i>Etheostoma</i>	451
americanus, <i>Argulus</i>	355	canadense, <i>Stizostedion</i>	448
Ancyclosetta, color changes and adaptation.....	177-238	canadensis, <i>Argulus</i>	348
Angel fishes.....	268	caprodes, <i>Percina</i>	448
anomalum, <i>Campostoma</i>	443	Carcharhinidæ, requiem sharks.....	250
appendiculosus, <i>Argulus</i>	353	<i>Carcharhinus acronotus</i>	259
Aprionodon isodon.....	252	commersonii.....	260
Argulidæ.....	348	milberti.....	257
<i>Argulus americanus</i>	355	carcharias, <i>Carcharodon</i>	247
appendiculosus.....	353	<i>Carcharias taurus</i>	244
canadensis.....	348	Carchariidæ, sand sharks.....	244
catostomi.....	355	<i>Carcharodon carcharias</i>	247
flavescens.....	349	carpenteri, <i>Salmincola</i>	364
funduli.....	355	Cat sharks.....	249
ingens.....	354	cataphractus, <i>Gasterosteus</i>	380
lepidostei.....	351	catenatus, <i>Fundulus</i>	445
maculosus.....	354	Catfishes.....	442
mississippiensis.....	350	catostomi, <i>Argulus</i>	355
nobilis.....	354	Lernæocera.....	369
stizostethii.....	353	<i>Catostomus commersonii</i>	442
trilineatus.....	355	nigricans.....	443
versicolor.....	355	occidentalis.....	378
articus, <i>Galeocercdo</i>	261	Catulidæ, cat sharks.....	249
asper, <i>Cottus</i>	381	<i>Catulus retifer</i>	249
aspro, <i>Hadropterus</i>	449	centrarchidarum, <i>Ergasilus</i>	361
atromaculatus, <i>Semotilus</i>	443	Cestracion tiburo.....	265
atronasus, <i>Rhinichthys</i>	445	zygæna.....	263
aurantiacus, <i>Hypohomus</i>	449	Cestraciontidæ, hammer-head sharks.....	263
aureolum, <i>Moxostoma</i>	443	<i>Cetorhinus maximus</i>	248
Basking sharks.....	248	Channel cat.....	442
Bass, largemouth black.....	448	chautauquaensis, <i>Ergasilus</i>	362
smallmouth black.....	448	Chromosus erythrogaster.....	443
rock.....	446	chrysopterus, <i>Orthopristis</i> , scales indicative of life history.....	289-330

	Page.		Page.
Chub.....	443, 445	Ergasilus <i>lizee</i>	362
<i>cirratum</i> , <i>Ginglymostoma</i>	248	<i>megaceros</i>	357
<i>Cliola vigilax</i>	443	<i>nigrilus</i>	356
<i>coccogenis</i> , <i>Notropis</i>	260	<i>versicolor</i>	361
<i>commersonii</i> , <i>Carcharhinus</i>	260	erythrogaster, <i>Chrosomus</i>	443
<i>Catostomus</i>	442	Etheostoma <i>camurum</i>	452
Common redhorse.....	443	<i>flabellare</i>	451
<i>copelandi</i> , <i>Cottogaster</i>	449	<i>maculatum</i>	452
Copepod parasites, fresh-water fishes.....	333-374	<i>rufilineatum</i>	451
<i>coregoni</i> , <i>Achtheres</i>	365	<i>variatum</i>	450
<i>cornutus</i> , <i>Notropis</i>	444	<i>zonale</i>	450
<i>corpulentus</i> , <i>Achtheres</i>	365	evides, <i>Hadropterus</i>	449
<i>Cottogaster copelandi</i>	449	Fairport fisheries biological station.....	387-405
<i>Cottus ictalops</i>	451	biological environment.....	398
<i>asper</i>	381	buildings and ponds.....	388
<i>gulosus</i>	381	equipment.....	388
Cow-nosed rays.....	279	fishes, reclamation.....	402
Creek chub.....	443	function.....	387
<i>cruciata</i> , <i>Lernæocera</i>	367	propagation, mussels, fishes.....	399-404
Ctenogobius <i>stigmaticus</i> , embryology and larval develop- ment.....	426	water systems.....	388
Cynoscion <i>regalis</i> , scales.....	289-330	<i>fulcata</i> , <i>Salmincola</i>	363
Cyprinodon <i>variegatus</i> , embryology and larval develop- ment.....	409	Fallfish, red.....	444
Dace, black-nosed.....	445	Fan-tailed darter.....	451
horned.....	443	Fisheries biological station, Fairport, Iowa.....	387-405
red-bellied.....	443	Fishes:	
Darter, blue-breasted.....	451	color changes and adaptation.....	177-238
black-sided.....	449	copepods and mussel glochidia, parasites.....	333-374
fan-tailed.....	451	embryology and larval development, teleostean.....	409-429
green-sided.....	450	habits, propagation, environmental conditions.....	404
Dasybatidae, sting rays.....	273	hosts, copepod parasites.....	334
Dasybatus <i>hastatus</i>	273	parasites, fresh-water.....	333-374
<i>sabinus</i>	274	propagation and reclamation.....	402
<i>say</i>	275	reclamation and propagation.....	402
Devilfish.....	279	scales, squeteague and pigfish, indicative of life his- tory.....	289-330
Diplesion <i>blennioides</i>	450	teleostean, embryology and larval development.....	409-429
<i>dissimilis</i> , <i>Hybopsis</i>	445	Tennessee, east.....	433-451
Dogfishes.....	267	Tomales Bay tributaries.....	377-381
<i>dolomieu</i> , <i>Micropterus</i>	448	Fishing, Pribilof Islands, Alaska.....	125
<i>dumeril</i> , <i>Rhina</i>	268	<i>flabellare</i> , <i>Etheostoma</i>	451
<i>duquesnii</i> , <i>Placopharynx</i>	443	<i>flavescens</i> , <i>Argulus</i>	349
Eagle rays.....	277	Flounders:	
<i>edwardsii</i> , <i>Salmincola</i>	363	<i>Ancylosetta</i> , color changes and adaptation.....	177-238
<i>eglanteria</i> , <i>Raja</i>	272	<i>Paralichthys</i> , color and adaptation.....	177-238
Electric rays.....	270	<i>freminvillii</i> , <i>Myliobatis</i>	277
<i>elegans</i> , <i>Ergasilus</i>	359	<i>funduli</i> , <i>Argulus</i>	355
<i>eleutherus</i> , <i>Schilbeodes</i>	442	<i>Ergasilus</i>	362
<i>elongatus</i> , <i>Ergasilus</i>	358	<i>Fundulus catenatus</i>	445
Embryology and larval development, teleostean fishes.....	409-429	<i>notatus</i>	445
Ctenogobius <i>stigmaticus</i>	426	Foxes, Pribilof Islands, Alaska.....	105
Cyprinodon <i>variegatus</i>	409	Fur seal and other life, Pribilof Islands, 1914.....	13-172
<i>Gobiosoma bosci</i>	423	birds.....	121
<i>Kirtlandia vagrans</i>	420	foxes.....	105
<i>Lucania parva</i>	415	reindeer.....	117
naked goby.....	423	sea lions.....	119
rainwater-fish.....	415	seals.....	13
rough silverside.....	426	<i>galacturus</i> , <i>Notropis</i>	444
scallopfish.....	426	<i>Galeocercus arcticus</i>	261
sheepshead minnow.....	426	<i>Galeorhinidae</i> , smooth dogfish.....	267
<i>Ergasilidae</i>	356	<i>Galeorhinus laevis</i>	267
<i>Ergasilus caeruleus</i>	360	<i>Gasterosteus cataphractus</i>	380
<i>centrarchidarum</i>	361	<i>gilberti</i> , <i>Ullocentra</i>	450
<i>chautauquaensis</i>	362	<i>Ginglymostoma cirratum</i>	248
<i>funduli</i>	362	Glochidia, mussel, economic relations to copepod para- sites.....	333-374
<i>elegans</i>	359	<i>Gobiosoma bosci</i> , embryology and larval development.....	423
<i>elongatus</i>	358	Goggle-eye.....	446
<i>lanceolatus</i>	356	Green-sided darter.....	450

	Page.		Page.
Green trout.....	448	micrura, Pteroplates.....	276
gulosus, Cottus.....	381	milberti, Carcharhinus.....	257
Hadropterus aspro.....	449	Miller's thumb.....	451
evides.....	449	Minnows.....	409, 443, 444, 445
macrocephalus.....	448	mississippiensis, Argulus.....	350
scierus.....	449	miurus, Schilbeodes.....	442
Hammer-head sharks.....	263	Mobula hypostoma.....	279
hastatus, Dasybatus.....	273	Mobulidæ, sea devils.....	279
Hesperoleucus venustus.....	379	monaca, Hybopsis.....	445
Hog sucker.....	443	Moxostoma aureolum.....	443
Hornyhead.....	446	Mussel glochidia, economic relations to copepod parasites.....	333-374
Hybopsis amblops.....	445	Mussel propagation.....	399
dissimilis.....	445	Myliobatidæ, eagle rays.....	277
hypostoma.....	445	Myliobatis freminwillii.....	277
kentuckiensis.....	445	Naked goby, embryology and larval development.....	423
monaca.....	445	Narcacionidæ, electric rays.....	270
hypostoma, Hybopsis.....	445	Narcine brasiliensis corallina.....	270
Hypohomus aurantiacus.....	449	narinari, Aëtobatus.....	278
Hypopriion brevirostris.....	253	nigricans, Catostomus.....	443
hypostoma, Mobula.....	279	nigritus, Ergasilus.....	356
ictalops, Cottus.....	451	nobilis, Argulus.....	354
Ictalurus punctatus.....	442	notatus, Fundulus.....	445
inermis, Salmincola.....	363	Pimephales.....	443
ingens, Argulus.....	354	Notropis blennioides.....	444
Iowa, Fairport fisheries biological station.....	387-405	coccogenis.....	444
irideus, Salmo.....	380	cornutus.....	444
isodon, Aprionodon.....	252	galacturus.....	444
Isuridæ, mackerel sharks.....	247	leuciodus.....	444
Isurus tigris.....	247	micropteryx.....	445
kentuckiensis, Hybopsis.....	445	rubricroceus.....	444
Kirtlandia vagrans, embryology and larval development.....	420	shumardi.....	444
laceæ, Achtheres.....	365	stilbius.....	444
lævis, Galeorhinus.....	267	telescopus.....	444
lanceolatus, Ergasilus.....	356	zonatus.....	444
lentiginosus, Rhinobatus.....	269	Nurse sharks.....	248
lepidostei, Argulus.....	351	occidentalis, Catostomus.....	378
Lepomis megalotis.....	446	olivaris, Leptops.....	442
pallidus.....	446	oquassa, Salmincola.....	363
Leptops olivaris.....	442	Orectolobidæ, nurse sharks.....	248
Lerneidæ.....	365	ornata, Raja.....	271
Lernæocera catostomi.....	369	Orthopristsis chrysopterus, scales indicative of life history.....	289-330
cruciata.....	367	pallidus, Lepomis.....	446
pectoralis.....	370	Paralichthys, color changes and adaptation.....	177
pomotidis.....	369	Parasites, fresh-water fishes.....	333
tenuis.....	366	copepods.....	333
tortua.....	368	mussel glochidia.....	337
variabilis.....	365	parva, Lucania, embryology and larval development.....	415
Lernæopodidæ.....	362	Perch, log.....	448
leuciodus, Notropis.....	444	Percina caprodes.....	448
lizeæ, Ergasilus.....	362	pectinatus, Pristis.....	268
Log perch.....	448	pectoralis, Lernæocera.....	370
Long-eared sunfish.....	446	Phenacobius uranops.....	445
Lucania parva, embryology and larval development.....	415	Pigfish, scales, indicative of life history.....	289
Mackerel sharks.....	247	Pike.....	448
macrocephalus, Hadropterus.....	448	pimelodi, Achtheres.....	364
maculosus, Argulus.....	354	Pimephales notatus.....	443
Mad tom.....	444	Placopharynx duquesnii.....	443
Manta birostris.....	280	pomotidis, Lernæocera.....	369
marina, Vulpecula.....	246	Pribilof Islands, Alaska, 1914.....	13
maximus, Cetorhinus.....	248	birds.....	121
meadiæ, Ulocentra.....	450	fishing.....	125
megaceros, Ergasilus.....	357	foxes.....	105
megalotis, Lepomis.....	446	fur seals.....	18
micropteri, Achtheres.....	365	general description.....	17
Micropterus dolomieu.....	448	natives.....	132
salmoides.....	448	reindeer.....	117
micropteryx, Notropis.....	445	sea lions.....	119

	Page.		Page.
Prickly bullhead	381	Seals, fur, 1914	13-104
Pristidæ, sawfishes	268	breeding, harem bull	45
Pristis pectinatus	268	bulls, idle and young	50
Pteroplatea altavela	277	census of herd, 1914	25
micrura	276	character and habits	18
punctatus, Ictalurus	442	classes of seals, distinctions	58
quadriloba, Rhinoptera	279	driving, killing, and curing skins, methods	85
Radii, interpretation	311	existing laws, effect of	96
Rainbow trout	380	herd, management of	77
Rainwater-fish, embryology and larval development	415	improvements, practical	92
Raja eglanteria	272	land sealing, effect of	76
ornata	271	mortality of	70
stabuliforis	272	pelagic sealing	74
Rajidæ, skates	271	sealing, history	21
Rays and sharks, Beaufort, N. C.	247	Semotilus atromaculatus	443
utilization	242	Sharks and rays, Beaufort, N. C.	241-284
Red fallfish	444	utilization	242
Red-bellied dace	443	Sharklike fishes	269
Redhorse, common	443	Sheepshead minnow, embryology and larval development	409
regalis, Cynoscion, scales, indicative of life history	289-330	Shilbeodes eleutherus	442
Reindeer, Pribilof Islands, Alaska	117	miurus	442
Requiem sharks	250	Shiner	444, 445
retifer, Catulus	249	Shockfish	270
Rhina dumeril	268	shumardi, Notropis	444
Rhinichthys atromasus	445	Silver chub	445
Rhinidæ, angel fishes	268	Silverside, rough, embryology and larval development	420
Rhinobatidæ, sharklike rays	269	simotera, Ulocentra	450
Rhinobatus lentiginosus	269	siscowet, Salmincola	363
Rhinoptera quadriloba	279	Skates	271
Rhinopteridæ, cow-nosed rays	279	Skates, sharks, rays	243
Rifflefish	381	sloani, Urobatis	276
River chub	445	Smooth dogfishes	267
Roach, San Francisco	379	Squalidæ, spiny dogfishes	267
Rock bass	446	Squalus acanthias	267
Rot-gut minnow	443	Squeteague, scales, indicative of life history	289-330
Rough silverside, embryology and larval development	420	stabuliforis, Raja	272
rubricroceus, Notropis	444	Stickleback, Alaska	380
rufilineatum, Etheostoma	451	stigmaea, Ulocentra	449
rupestris, Ambloplites	446	stigmaticus, Ctenogobius, embryology and larval development	426
sabinus, Dasybatus	274	stilbius, Notropis	444
Sacramento sucker	378	Sting rays	269, 273, 274-275
Salmincola carpenteri	364	Stingaree	275
beani	363	Stizostedion canadense	448
bicauliculata	363	vitreum	448
californiensis	362	stizostethii, Argulus	353
edwardsii	363	Stone roller	443
falculata	363	Straw-colored minnow	444
inermis	363	subterranean, Typhlichthys	445
oquassa	363	Sucker	378, 442, 443
siscowet	363	Sunfish, long-eared	446
Salmo irideus	380	taurus, Carcharias	244
salmoides, Micropterus	448	telescopus, Notropis	444
San Francisco roach	379	Tennessee, east, fishes	433
Sand pike	448	region and waters, examined	433
Sand sharks	244	species, list	442
Sauger	448	tenuis, Lernæocera	366
Sawfishes	268	terræ-novæ, Scoliodon	250
say, Dasybatus	275	Thresher sharks	246
Scales, structure and growth, squeteague and pigfish	289-330	tiburo, Cestracion	265
radii, interpretation	311	Tiger sharks	261
squeteague and pigfish	289-330	tigris, Isurus	247
Scallopfish, embryology and larval development	426	Tocaloma	381
Schilbeodes eleutherus	442	Tomales Bay tributaries fishes	377-381
scierus, Hadropterus	449	Top minnow	445
Scoliodon terræ-novæ	250	tortua, Lernæocera	368
Sea devils	279		
Sea lions, Pribilof Islands, Alaska	119		

	Page.		Page.
<i>trilineatus</i> , <i>Argulus</i>	355	<i>venustus</i> , <i>Hesperoleucus</i>	379
Trout, rainbow.....	380	<i>versicolor</i> , <i>Argulus</i>	355
<i>Typhlichthys subterraneus</i>	445	<i>Ergasilus</i>	361
<i>Ulocentra gilberti</i>	450	<i>vigilax</i> , <i>Cliola</i>	443
<i>meadia</i>	450	vision, color, in fishes.....	215
<i>simotera</i>	450	<i>vitreum</i> , <i>Stizostedion</i>	448
<i>stigmæa</i>	449	<i>Vulpecula marina</i>	246
<i>uranops</i> , <i>Phenacobius</i>	445	<i>Vulpeculidæ</i> , thresher sharks.....	246
<i>Urobatis sloani</i>	276	Walled-eyed pike.....	448
vagrans, <i>Kirtlandia</i> , embryology and larval development.....	420	Whipper-tail.....	267
<i>variabilis</i> , <i>Lernæocera</i>	365	Whip-ray.....	275
<i>variatum</i> , <i>Etheostoma</i>	450	<i>zonale</i> , <i>Etheostoma</i>	450
<i>variegatus</i> , <i>Cyprinodon</i> , embryology and larval development.....	409	<i>zonatus</i> , <i>Notropis</i>	444
		<i>zygæna</i> , <i>Cestracion</i>	263



SMITHSONIAN INSTITUTION LIBRARIES



3 9088 01017 7186