

HARVARD UNIVERSITY.



LIBRARY

OF THE

MUSEUM OF COMPARATIVE ZOOLOGY.

7716
Exchange

Oct. 1, 1897 - March 24, 1903

BULLETIN

OF THE

Illinois State Laboratory

OF

NATURAL HISTORY,

URBANA, ILLINOIS.

VOLUME V.

*CONTRIBUTIONS TO A KNOWLEDGE OF THE NATURAL
HISTORY OF ILLINOIS.*

1897-1901.

Illinois State Laboratory of Natural History,
Urbana, Ill.
1902.

CONTENTS.

	PAGE.
Article I.—Plankton Studies. I. Methods and Apparatus in Use in Plankton Investigations at the Biological Experiment Station of the University of Illinois. By C. A. KOFOID (7 Plates.) March, 1897.....	1
Article II.—A Contribution to a Knowledge of North American Fresh-water <i>Cyclopidae</i> . By ERNEST B. FORBES. (13 Plates.) September, 1897.....	27
Article III.—The North American Species of <i>Diaptomus</i> . By FREDERICK WILLIAM SCHACHT. (15 Plates.) December, 1897.....	97
Article IV.—The North American <i>Centropagida</i> belonging to the Genera <i>Osphranticum</i> , <i>Limnocalanus</i> , and <i>Epischura</i> . By FREDERICK WILLIAM SCHACHT. September, 1898.....	225
Article V.—Plankton Studies. II. On <i>Pleodorina illinoisensis</i> , a New Species from the Plankton of the Illinois River. By C. A. KOFOID. (12 Plates.) September, 1898.....	273
Article VI.—A List of the <i>Protozoa</i> and <i>Rotifera</i> found in the Illinois River and Adjacent Lakes at Havana, Illinois. By ADOLPH HEMPEL. (5 Figures.) January, 1899.....	301
Article VII.—First Supplement to the Check-List of the <i>Coccida</i> . By T. D. A. COCKERELL. February, 1899.	389
Article VIII.—A Statistical Study of the Parasites of the <i>Unionida</i> . By H. M. KELLY. May, 1899.....	399
Article IX.—Plankton Studies. III. On <i>Platydorina</i> , a New Genus of the Family <i>Volvocida</i> , from the Plankton of the Illinois River. By C. A. KOFOID. (1 Plate.) December, 1899.....	419
Article X.—Notes on Species of North American <i>Oligochaeta</i> . III. List of Species found in Illinois, and Descriptions of Illinois <i>Tubificida</i> . By FRANK SMITH. (2 Plates.) March, 1900.....	441
Article XI.—Notes on Species of North American <i>Oligochaeta</i> . IV. On a New Lumbriculid Genus from Florida, with additional Notes on the Nephridial and Circulatory Systems of <i>Misoprorodrilus asymmetricus</i> Smith. By FRANK SMITH. (1 Plate.) June, 1900.....	459
Article XII.—The <i>Hirudinea</i> of Illinois. By J. PERCY MOORE. (8 Plates.) February, 1901.....	479



OCT 1 1897 BULLETIN

7710

OF THE

ILLINOIS STATE LABORATORY

NATURAL HISTORY,

URBANA, ILLINOIS

VOLUME V.

*ARTICLE I.—PLANKTON STUDIES. I. METHODS AND
APPARATUS IN USE IN PLANKTON INVESTIGA-
TIONS AT THE BIOLOGICAL EXPERIMENT STA-
TION OF THE UNIVERSITY OF ILLINOIS*

By C. A. KOFOID, PH. D.

Illinois State Laboratory of Natural History,

URBANA, ILLINOIS.

1897.

STATE LABORATORY OF NATURAL HISTORY

LABORATORY STAFF

PROFESSOR STEPHEN ALFRED FORBES, PH. D.,
Director of State Laboratory and State Entomologist

CHARLES ARTHUR HART,
Systematic Entomologist and Curator of Collections

FRANK SMITH, A. M.,
Assistant Zoologist

CHARLES ATWOOD KOFROID, PH. D.,
Superintendent of Biological Station

CHARLES CHRISTOPHER ADAMS, B. S.
Entomological Assistant.

MARY JANE SNYDER,
Secretary.

HENRY CLINTON FORBES,
Librarian and Business Agent.

LYDIA MOORE HART,
Artist.

ARTICLE I.—*Plankton Studies. I. Methods and Apparatus in Use in Plankton Investigations at the Biological Experiment Station of the University of Illinois.* By C. A. KOFOID.

Less than ten years ago a new field of biological science was opened by the German investigator Hensen, namely, the quantitative examination of the "Plankton." This term was applied to all plants and animals floating free in the water and incapable by their own efforts of materially changing their position. Thus adult fish which brave the waves and stem the current would not be included in the plankton, while the passive eggs or the helpless fry would fall within the limits of the definition. Practically, the content of the term plankton as applied to fresh water is the sum total of its minute life, both plant and animal.

The scope of our plankton work upon the Illinois River and its adjacent waters includes a continuous, systematic, and exhaustive examination of the plant and animal life suspended in the waters of a river system, with a view to determining its amount and seasonal changes, its local and vertical distribution, its movement and relation to the current, the effect upon it of floods and of drouth, of light and of temperature, the organisms which compose it, their seasonal and cyclic changes, and their mutual interrelations. Added interest arises from the fact that this is the first application of this method of biological investigation to a river system and its related waters.

It is the purpose of the present paper to describe the methods and apparatus employed in the plankton work at the Biological Station at Havana, Illinois, during the years 1894-1896. Both are, as a rule, the result of mutual conference of the various members of its staff. During the first fifteen months of the existence of the Station the plankton work was in the hands of Professor Frank Smith, and when, on July 1, 1895, the writer assumed charge of this work at the Station he found the oblique haul, described on a subse-

quent page, already inaugurated and in successful operation. It now devolves upon him to prepare for publication a description of this method, but the credit for devising it and putting it in operation belongs to those from whose hands he received it. The apparatus was used without modification until August 23, 1895, when the detachable bucket was added to the net, and in October of the same year the separable carriage was introduced. In May, 1896, the pumping method was substituted for the oblique haul in making plankton collections.

Upon the opening of the Station in April, 1894, the examination of the water by the plankton method was decided upon, and in the early part of June the first regular collections were made. The method of plankton collection ordinarily employed,—as, for example, by Hensen ('87 and '95) in the Baltic and North Seas and in the Atlantic Ocean, by Apstein ('92 and '96) and Zacharias ('93-'96) in the lakes of northern Germany, by Reighard ('94) in Lake St. Clair, and by Ward ('96a) in Lake Michigan,—has been without exception the vertical haul, in which the net is lowered to the bottom of the body of water and then raised in a vertical line to the surface, thus filtering a vertical column of water. Difficulties beset the application of this method to the waters at Havana. In the first place all the bodies of water examined at the Station are quite shallow, the majority of the plankton collections being made in less than three meters of water. The river itself is the deepest water in the locality, but at its lowest stage there are only three meters of water in the main channel, where collections are made. This depth is increased at times of flood, the maximum reached in the past three years being 6.1 meters. The shallowness of the water thus practically precludes examination by means of the vertical haul.

A second difficulty exists in the unstable nature of the bottom generally found throughout the locality to which the operations of the Station are confined. This consists of a soft black mud, composed largely of the detritus of decaying vegetation and alluvial soil deposited from the silt-charged waters at times of flood. It is extremely unstable and upon the least

disturbance mingles with the water, rendering it impossible to take a clean plankton collection. The soiling of the net and the fouling of the water consequent upon dropping a large plankton net upon the bottom further preclude the vertical haul in the plankton work at Havana.

I. THE OBLIQUE-HAUL METHOD. (PLATES I.-III.)

The oblique haul was at first adopted as the method best suited to the situation. This is accomplished by suspending the net to a carriage which runs upon a rope stretched obliquely from the bottom to the surface of the water. By this means the column of water traversed by the net is increased to an adequate length. It also permits the employment of a net small enough to be easily operated from a row-boat. A short description of this method of plankton collection has been given by Professor Forbes ('94). The parts of the apparatus used in making the oblique haul will now be described.

1. *The Quantitative Net* (Plates I. and II.).—The net used by us is the modification of the Hensen net suggested by Apstein ('91 and '92) for fresh-water work, and more fully described by him ('96) as the smaller model quantitative net. It consists of three parts: (*a*) the filtering net proper, (*b*) the detachable bucket, and (*c*) the head-piece of the net.

a. The *filtering net* has the form of an inverted truncated cone, whose base has a diameter of 25 cm. and whose side is 40 cm. The truncated apex, to which the bucket is attached, is 4 cm. in outside diameter. This net is made of No. 20 silk bolting cloth, which can be obtained from wholesale dealers in supplies for flouring mills. That used by us bears the brand, "Especially for milling purposes. Dufour & Company." This is the same brand of cloth as that which was used by Reighard ('94) and Ward ('96a) in their plankton work upon the Great Lakes. It is stated by the manufacturers to contain 29,929 meshes to the English square inch. Examination under the microscope shows that this cloth contains 32477 ($\approx 172.75 \times 188$) meshes to the square inch after sponging and pressing with a hot iron four times.

The average area of the openings is reported by Reighard ('94, p. 57) to be:

.00003596 sq. cm. in the new cloth,

.00002808 sq. cm. in cloth that had been wetted and then dried,

.00002336 sq. cm. in cloth that had been used for 40 hauls of a net.

As the new silk shrinks considerably after its first wetting, we have followed the practice of thoroughly and repeatedly sponging it and pressing it with a hot iron before cutting out the net. Otherwise in a single-seam net there is sufficient shrinkage to cause the filtering cone to take a position oblique to the true axis of the net (See Apstein, '96, p. 34, Fig. 3).

The following directions for making a pattern for the net are here inserted, as they may be of use to those to whom the original descriptions given by Apstein ('91, '92, and '96) are inaccessible.

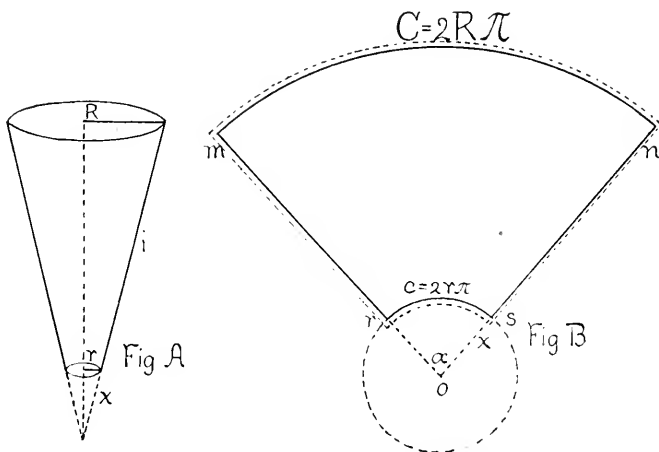

Fig. A.—Completed cone. Fig. B.—Completed pattern for the silk net.
(Both after Apstein.)

The net has the form of a truncated cone (Fig. A), whose side ($i = 40$ cm.) and radii of the ends ($R = 12.5$ cm., and $r = 2$ cm.) are known. The silk exposed in the net has the area and dimensions of the surface of this truncated cone.

If, now, we complete the truncated cone and denote the side of the small cone, added for completion, by x , it follows that

$$x : x+i :: r : R;$$

$$x = \frac{ri}{R-r} = 7.619 \text{ cm.}$$

If, now, we imagine the surface of the completed cone unrolled and spread in one plane (Fig. B), the circumferences $C (= 2R\pi)$ and $c (= 2r\pi)$ will form arcs subtending an unknown angle α , and it follows that the circle described by the radius $x (= 2r\pi)$ is to $2r\pi$ as 360° is to α , or

$$\frac{2x\pi}{2r\pi} = \frac{360}{\alpha};$$

$$\alpha = \frac{360r}{x};$$

$$\alpha = 94.5^\circ.$$

This angle α being known, it is a simple matter to lay off the pattern for the net. The pattern for the linen head-piece is constructed in a similar manner. Allowance must be made along the edges mr and ns (Fig. B) for the longitudinal seam. It has been our custom to allow 4 mm. upon one margin and 8 mm. upon the other (Fig. 2, Plate I.). The two edges are brought together and backstitched at a (Fig. 2), and the wider margin is then turned under the other and felled at b upon the outside of the net. Thus only a single seam 4 mm. in width traverses the length of the net. A very fine needle is used in the sewing, and the line of stitches can be effectually closed with a light coat of rubber cement. Allowance must also be made along the edge mn for attachment of the silk between the linen cone (Plate I., Fig. 1, $c, b, l.$) and the cover-strip ($c, s.$) at the seam sm , and for the fastening of the silk, along the margin rs , between the net clamp ($n, c.$) and the head-piece ($h, p.$) of the bucket. In order to get the net into the clamp it is necessary to slit the silk at several points to within a short distance of the line rs (Fig. B).

b. The *detachable bucket* (Plate II., Fig. 3-5) used by us differs in several particulars from that described by Apstein ('91, '92, and '96) and also from the one devised by Reighard ('94, p. 26, Plate II.). It copies the Reighard bucket in sub-

stituting a removable plug for the turncock in the Apstein bucket, and differs from both in the base and in the manner of attachment of the silk in the windows.

In form it is a cylinder 7 cm. in height and 4 cm. in outside diameter. (Owing to the material available for construction our bucket measures 4.4 cm. in outside diameter.) It consists of three pieces: the head-piece, the bucket proper, and the band clamp.

The *head-piece of the bucket* (Plate II., Fig. 3, *h. p.*) is a cylinder 2 cm. in height, whose upper edge is rounded upon the inner face. The lower edge is threaded at *m* (Fig. 3) so as to screw into the top of the bucket proper, which is correspondingly threaded at *n* (Fig. 4). The screw is so constructed that the inner surface is uninterrupted when the bucket proper is fully screwed on. The head-piece also bears three equidistant eyes (Fig. 3, *e.*), in which are tied the three stay-lines (*s. l.*) which pass up to the large, and then to the small, rings of the net, and finally unite with the draw-line (Plate III., Fig. 6, *d. l.*). The position and manner of attachment of these stay-lines can be seen in Plate II., Fig. 3, and in Plate III., Fig. 6. The net is clamped on the head-piece by the circular net clamp (Plate II., Fig. 3, *n. c.*), which is a band of brass 1 cm. in width. To the ends of the band are attached wings (*w. n. c.*), which are approximated by means of a thumb-screw (*t. s.*). By this operation the silk beyond the line *rs* (Fig. B.) is firmly clamped between the brass band of the net clamp and the head-piece of the bucket.

The *bucket proper* (Plate II., Fig. 4 and 5) is a brass cylinder 5 cm. in height, and of the same diameter inside and out as the head-piece. In the side of the bucket at a height of 2 cm. are cut three windows 2.5 × 3.5 cm. These windows are closed by a band of No. 20 silk held in place by a band clamp, in which are windows similar to those in the wall of the bucket. The bucket was constructed from a heavy piece of brass tubing, the bottom (Fig. 4, *b.*) being inserted in the following manner. The tube is turned out to the shoulder (Fig. 3, *sh.*) and heated in a jet of steam, and while still hot the piece of brass from which the bottom (*b.*) is finished, is

inserted upon the shoulder. The shrinking of the tube as it cools holds the bottom firmly in place, and it can then be completed as shown in Fig. 3. At the center of the bottom is the outlet of the bucket, which is reamed to hold the tapering plug (*p.*). Both the plug and the bottom are finished obliquely to a drip-point (*d. p.*) at one side. This facilitates the removal of the last few drops of the catch from the bucket. The bucket below the bottom of the windows holds about 7 cu. cm. The base (*ba.*) retains the original thickness (.5 cm.) and its weight adds to the stability of the bucket. Since the drip-point does not project below the base the bucket can be set down, and, owing to the fact that its center of gravity is low, it is not easily overturned. This is a distinct advantage where the work must be done in a small row-boat at the mercy of the waves.

The *band clamp* (Plate II., Fig. 4 and 5, *b. c.*) is a sheet of brass 4.5×15.3 cm., and about .1 cm. in thickness. At a distance of .75 cm. from the ends the sheet is bent out at right angles, and a brass bar $4.5 \times .75 \times .25$ cm. is soldered in the angle thus formed (Plate II., Fig. 4 and 5, *pl.* and *pl.*). The band is now bent around the bucket and the ends brought together by means of two screws (*sc.*) which pass through the one bar and screw into the other (Plate II., Fig. 5, *pl.* and *pl.*). The windows (Fig. 4, *w.*) can now be cut through both the band and the walls of the bucket. The pillar (Fig. 5, *pi.*) between the windows adjacent to the ends of the clamp is .5 cm. wider than the other pillars, whose width is about 1 cm. The inner edges of the windows are carefully rounded so as to afford no lodgment for the plankton. It is also a convenience to attach the band of silk (Fig. 4, *s.*) which closes the windows to the side of the bucket by means of a thin coat of King's waterproof cement. The band clamp can then be slipped over the bucket and the silk bound firmly in place by tightening the two screws (Fig. 4 and 5, *sc.*). The base also bears an eye (*e.*) for the line which fastens the bucket to the carriage at *s* (Plate III., Fig. 6).

The above-described detachable bucket, devised by the writer, has certain obvious advantages over the Apstein and

Reighard buckets after which it is very largely modeled. Its advantages are its stability, the drip-point, and the band clamp, the latter permitting readily the renewal of the silk in the bucket.

Previous to the adoption of the bucket just described, the net in which the collections at Havana were made was closed by a circular piece of silk clamped on the end of a brass cylinder screwing into the head-piece (Plate I., Fig. 1, *h. p.*). The clamp used for this purpose is similar to that employed to fasten the net to the head-piece. (See Plate I., Fig. 1, and Plate II., Fig. 3, *u. c.*) When a collection had been made the silk circle was removed and, with the plankton condensed upon it, transferred to the killing fluid. This form of plankton bucket was used by Apstein ('92) on his qualitative plankton net, and was afterwards described by Borgert ('96) for a net to be towed behind steam-vessels.

c. The *head of the net* (Plate I., Fig. 1) is a truncated cone, at whose upper and lower ends are rings 10 and 25 cm. in diameter respectively (*u. r.* and *l. r.*). These rings are made of No. 5 (American Standard Gauge) brass wire. The side of the cone (*c. b. l.*) is made of heavy linen, known in the trade as "butchers' linen." Its lower edge is joined to the silk net at the seam (Plate I., Fig. 1, *sm.*), where it also meets the cover-strip (*c. s.*)—a narrow band, made of the same cloth—which extends over the lower ring (*l. r.*). In the upper edge of the cone is bound a heavy cord (*cd.*) which, in turn, is fastened to the upper ring (*u. r.*) by a series of loops of strong thread (*th.*). The upper ring and the cone are supported by three equidistant wire stays (*ws.*). These are made of No. 8 brass wire and are provided with an eye at each end. The lower eye (*l. e.*) embraces the lower ring and is held in place by small hips soldered upon each side. The upper eye (*u. e.*) is attached to the cord (*cd.*) by a small cloth strap (*st.*) and also serves as a point of attachment for a stay-line (*s. l.*) which runs from the bucket to the lower end of the wire stay (*ws.*) to which it is fastened, passing from this to the upper eye (*u. e.*) and then to the draw-line (Plate III., Fig. 6, *d. l.*).

2. *The Carriage* (Plate III., Fig. 6 and 7).—The carriage for the plankton net is a wooden bar, $100 \times 5 \times 2$ cm. It bears upon one edge two ceiling pulleys (Fig. 6, *p.* and *p'.*), through which passes the carriage rope (*c. r.*). In order that there may be no tendency on the part of the carriage to float, two bars of lead (*L.*) are inserted in its lower edge, so that it naturally assumes a position upon the lower side of the rope. The carriage is so constructed that it may be separated along the line *a b c*, thus freeing the net from the fixed carriage rope. Its two parts are held together by two flat brass hooks (*h.*) which enter the staples (*s.*). The net and the lines pertaining thereto are attached to the removable part of the carriage at four points (*w, x, y, z*) at which screw-eyes are inserted, the attachment being made by means of small metal snaps (*sn.*). At the anterior end of the carriage a stay-line (*s. l. z*), coming from the end of the draw line (*d. l.*), is fastened to the screw-eye *w*. Upon this line comes the main stress when the carriage is drawn along the rope. The uppermost of the three stay-lines of the net (*s. l. l*) bears a snap which is fastened to the screw-eye *x* at the lower anterior corner of the carriage. This makes it certain that the plane of the mouth of the net will be kept perpendicular to the line of progress of the carriage. A snap at *y* binds the net to the carriage and another at *z* supports the bucket.

3. *Accessory Apparatus* (Plate III.).—The stay- and draw-lines are of braided linen. The latter is about thirty-five meters in length and is carried on a hand-reel. It is knotted at intervals of one meter to a point thirty meters from the opening of the plankton net. The carriage rope is a five-sixteenths inch braided rope known in the trade as "sash cord." It does not kink in handling, and if once thoroughly seasoned is subject to little change when wet and cannot easily be stretched. This rope is about forty meters in length and is marked by colored threads at a point exactly thirty meters (Plate III., Fig. 7, *m.*) from the opening of the net. The location of the end knot (Fig. 6, *k.*) is marked in a similar manner.

Three sharpened stakes (Fig. 7, *b. s.*, *m. s.*, and *e. s.*), the

brace-, main-, and end-stakes, respectively three, four and one half, and five meters in length, complete the apparatus necessary for making an oblique haul.

4. *Operation of the Oblique Haul* (Plate III).—In this operation two persons are required, an oarsman to handle the skiff and an operator for the apparatus. The method of procedure is as follows. The brace rope (Fig. 7, *b. r.*) is fastened near the lower end of the brace stake (*b. s.*) and the latter is then set as firmly as desired. The main stake (*m. s.*) is then put in place and the brace rope is tied to it. Next, the carriage rope (*c. r.*) is fastened to the main stake (*m. s.*) at a point 5 to 8 meters distant from the thirty-meter knot (*m*). The boat is then rowed away in line with the two stakes and the carriage rope is unreeled until the end is reached, when it is run through the pulleys (Fig. 6, *p.* and *p.*') of the upper part of the carriage. The end knot (*k.*) is then tied and fastened to the rear pulley (*p.*') by the release thread (*th.*). The carriage rope is next tied to the lower part of the end stake (Fig. 7, *c. s.*), and at a point just in front of the anterior pulley (*p.*) it is bound to the end stake by the release line (*r. l.*). The lower part of the carriage with the suspended plankton net can now be attached to the upper part, and the end stake is ready to be placed. When the end stake is set, the carriage line (Fig. 7, *c. r.*) runs obliquely from the release line to the surface of the water at the main stake. The net occupies the position *n.* (Fig. 7), and having been lowered vertically does not strain any water in its descent. After placing the end stake the skiff is rowed to the main stake as the draw-line (Fig. 7, *d. l.*) of the carriage is unreeled. A quick jerk upon the carriage rope snaps the release line (*r. l.*) on the end stake, and the slack in the carriage rope can be taken up at the main stake. The carriage rope and net now take the position *c. r.*' and *n.*' (Fig. 7), and the thirty-meter knot *m* is at the surface of the water. Everything is now in readiness for making the catch. At the signal the release thread (*th.*) which binds the rear pulley to the end knot is broken by a quick pull upon the draw-line. The carriage bearing the plankton net is drawn up the oblique rope the distance of thirty meters in one minute

by the operator, who regulates the speed by the meter knots on the draw-line and the counting of the oarsman, one count being given every other second by the watch. By this method a *uniform* velocity for the plankton net at all parts of its ascent and in different hauls is assured, and a very important source of error in the vertical haul, as it is usually made, is avoided. The oblique haul is not so complicated as it may perhaps seem to the reader. With a little practice the whole operation may be completed in less than twenty minutes.

Whenever a current is present in the body of water examined, it has been our custom to make the oblique haul across the current, thus eliminating, so far as may be, its effect upon the coefficient or straining capacity of the net. In water in which there is little or no current it is of advantage, in working in a skiff, to set the apparatus "with the wind." In waters abounding in vegetation, channels of the length and width requisite for making the oblique haul were opened from time to time by cutting out and removing the rank growth of aquatic plants.

5. *Difficulties encountered.*—Certain difficulties attended the operation of the oblique haul. Owing to the turbidity of the water, in many situations it was practically impossible to place the apparatus so as to avoid vegetation. Whenever the plankton net or the ropes strike a submerged plant, a cloud of flocculent debris is set free in the water and the collection is fouled. It was only with the greatest labor that channels could be kept open in the vegetation, for its rapid growth and its shifting by the wind soon closed any opening that had been made. Again, the manipulation of the apparatus in rough weather is somewhat difficult, the waves at times tearing loose the stakes before the completion of the collection. At periods of high water the strong current and the increased depth made it impossible to set the apparatus or keep it in place. This necessitated the substitution of a series of vertical hauls from a floating boat for the customary oblique method of collection.

The plankton at Havana is subject to extreme local and seasonal variations, not only in volume but also in composi-

tion. For example, at one time *Cladocera* predominate and at another diatoms are present in vast numbers, and at still another rotifers constitute practically the whole of the plankton. Observations upon the operation of the net in the midst of these fluctuations awakened the suspicion that the amount of water *actually strained* was subject to considerable variation, dependent, among other causes, upon the amount and, more especially, the composition of the plankton. If the plankton were constant in quantity, kind, and distribution, the error arising from the progressive clogging of the net as it traverses the thirty meters would be distributed alike in all of the catches, and they would still be comparable; but the existence of the fluctuations in the plankton just noted and the consequent variation in the amount of water strained, constitute an important source of error in any deductions based upon comparisons of catches made under these variable conditions. This source of error is present in the vertical as well as in the oblique haul. Furthermore, change in the *silk itself* consequent upon use adds to the errors due to the fact that the collection is made by *drawing the net through the water*. A series of field experiments (to be described in a later paper) upon the progressive clogging of the net and the coefficient of various plankton nets, in a wide range of season and situation, have abundantly justified our abandonment of the system of collection in which the *net is drawn through the water* for one in which a known quantity of *water is put through the net*.

II. THE PUMPING METHOD.

For many years the biological examination of potable water has been conducted by straining or filtering water delivered through service pipes at the faucet by pressure due to the use of a pump.

Giesbrecht ('96) describes the collection of *Copepoda* in the Red Sea by Krämer, who strained the water delivered by the ship's pump to the bath-tub of an ocean steamer.

Cleve ('96), at the suggestion of Dr. John Murray, collected plankton on board a steamer in the North Sea by attaching a silk net to the pump when the deck was washed.

Previous to this, Hensen ('87) used the steam pump for putting known amounts of surface water through the filtering net. Hensen's quantitative work was, however, based upon collections made by vertical hauls of the plankton net. Peck ('96), in his work upon the marine plankton of Buzzard's Bay, obtained water for examination by the Sedgwick-Rafter method (see Rafter, '92, and Twenty-third Annual Report of the State Board of Health of Massachusetts for 1891, pp. 395-421) by means of a steam-pump connected with a two-inch hose which was lowered to the desired depth. Beyond these instances no other applications of the pump to the collection of plankton have come to my notice, and there appears to be no record of its use in quantitative work by the Hensen method.

The impossibility of using the vertical haul in shallow waters, the difficulties in the operation of the oblique haul, and especially the error involved in the variable coefficient of the net, have led to the adoption of the pumping method in the plankton work at Havana.

1. *The Pump* (Plates V. and VI.).—The pump we use is a double acting force-pump, known in the trade as a "Thresher Tank Pump." It is worked by an upright handle, and has two cylinders, each 6×9 inches, and throws an almost continuous stream. Its capacity is one cubic meter of water per six hundred strokes, provided that the water is delivered to the net without elevation. The stroke is of definite length and its action is regular, the rate employed being one stroke per second. The pump is provided with 20 feet of 2-inch spiral-wound suction hose, terminating in a funnel 20 cm. in diameter. The mouth of the funnel is covered with a linen net of $\frac{1}{2}$ -inch mesh to prevent the entrance of stray bits of vegetation, and the end of the hose is weighted to insure its sinking readily. It was found necessary to paint all exposed iron in the water chambers of the pump with a thin coat of asphaltum to prevent the formation of rust scales.

Before the pump was put in use for regular plankton collections, tests were made of the straining capacity of the silk under the impact of the current from the discharge hose. It

was found that when the water was delivered from a 1-inch hose into the plankton net and the filtrate refiltered in a second net of the same silk (No. 20), a considerable quantity of the more minute forms, *Rotifera* and *Protozoa*, were forced through the meshes of the first net. This led to the adoption of the 1½-inch discharge hose, and of a net devised by the writer to reduce the force of the discharge, to protect the silk from direct contact with the current, and to equalize the pressure upon the filtering surface.

2. *The Net* (Plate IV., Fig. 8-10).—The net consists of the cover with its accessories and the net proper, the two being so constructed as to be readily separable. From the under side of the conical copper top to which the hose is attached hangs the silk net. When in use the net is supported in a wooden frame, which also serves as a float. The rim fits into the circular central opening and rests upon a projecting ledge of the frame (Fig. 8, *fl.*) in such a manner that the silk does not come in contact with the wood. The frame is so proportioned that the net projects about 8 cm. above the level of the water. Experience has demonstrated that even when the water is full of silt or the plankton is very abundant this elevation is sufficient to provide for filtration without forcing the water into the net by the pump. In ordinary circumstances the water does not rise more than 2-4 cm. above the level of the water in which the net is submerged. Thus practically the whole straining surface is under water. Two turn buttons (*t. b.*) hold the net firmly in place so that it cannot be dislodged by the action of the waves when the water is rough.

The cover (Plate IV., Fig. 8, *cov.*) is an obtuse cone of sheet copper, 33 cm. in diameter and 20 cm. on the side. The apex bears a curved connector (*con.*) upon which the 1½-inch hose can be slipped. The cover is beaded for rigidity, and carries two handles (*h.*) for lifting the net from the frame. After the water enters the net two devices are employed to check the force of the discharge. The first is an inner copper cone (*i. c.*), with diameter of 13 cm. and side of 10, placed in the axis of the net immediately below the orifice of

the connector. The cone is suspended from the top by means of three stays (*st.*), and sheds the water centrifugally against an inner net (*i. n.*) of No. 12 silk. This net is hung from a ring (*r. l.*) fixed to the under surface of the cover by three supports, one of which (*t. s.*) swings upon the pivot (*p.*) and permits the removal of the net. The inner net conforms to the proportions of the outer net but is only 27 cm. in diameter at the top. At its apex is an opening 8 cm. in diameter, through which plankton caught on the sides can be washed into the lower part of the outer net.

To secure rigidity the margin of the cover is provided with a projecting horizontal wing (*zc.*), to which is attached the foot (Plate IV., Fig. 8-10, *f.*). This in cross-section is L-shaped, extending obliquely downward and outward, the oblique and horizontal arms being respectively 2.5 and .75 cm. in length. The foot fits into a circular trough (*tr.*) 1-1.25 cm. in width and 2.75 in height. The inner wall (Fig. 9, 10, *i. w.*) of the trough is parallel to the oblique face of the foot, against which it rests when the cover is in place. The cover is held in the trough by means of four turn clamps (Fig. 9, *c.*), which are fastened by straps (*str.*) upon the outer wall (*o. w.*) of the trough. When the clamps are released and swing to the position *c'*, the cover can be removed, and the upper margin of the outer net (Fig. 9, *o. n.*) can be folded over the inner wall of the trough. When, now, the cover is replaced, the net is firmly clamped between the oblique face of the foot and the inner wall of the trough. (Cf. Fig. 9 and 10.) This method of attachment permits the ready removal of the net for the purpose of drying the silk, and at the same time insures a tight joint.

The net is made of the customary No. 20 silk and measures 92 cm. on the side. The upper border is faced upon the outer surface for 6 cm. and upon the inner for 2 cm. with butchers' linen, so that the wear in the fastening of the net falls upon the linen, while the silk only is exposed to the water to be filtered (Fig. 10). To insure the uniform placing of the margin of the net in the fastening, a heavy cord (*cd.*) is sewed in the border, against which the angle of the foot

rests when placed in position. The plankton bucket, with its method of attachment to the net, is similar to that described for the vertical net.

3. *The Method of Operating the Pump.*—The pump is carried in a suitable row-boat, and the suction hose is operated from the stern by one person while a second attends to the pump and the net (Plate VI.). In the choice of a location and in the position of the boat, due regard must be had to the direction of the wind and the current, if any, so that no filtered water may reënter the pump. In our work in the lakes it has been our custom to tie the boat to poles set for this purpose; but in the river the boat has been allowed to drift with the current in order to make the collection, so far as may be, from the same body of water. After the depth is ascertained the suction hose is lowered to within a foot of the bottom, the pump is thoroughly rinsed, and while still filled with bottom water the discharge hose is connected with the net. As the pumping progresses the funnel is raised at regular intervals; for example, every tenth stroke, the interval and the distance raised varying, however, with the total depth of the water to be traversed. Since the pump is filled with bottom water when pumping begins, it is necessary to shorten the first interval by the number of strokes required to fill the pump and to correspondingly lengthen the last one. In this manner a vertical column of water of the desired volume may be pumped through the net. In addition to the vertical catch we have followed the custom of making one from bottom water and another from surface water. After the requisite number of strokes of the pump have been made the hose is disconnected and the net removed from the frame and thoroughly rinsed down. The catch is concentrated in the bucket and transferred to the bottle of alcohol or formalin.

The pumping method has been successfully employed in freezing weather by attaching a foot-warmer to the side of the pump and encasing the whole in a wrapping of felt paper. The foot-warmer burns a cake of specially prepared coal, and will keep the pump warm during a day's work of ten hours. A special drain-cock (not shown in Plate V.) provides for the

removal of all water from the cylinders when the pump is not in use.

4. *Advantages of the Pumping Method.*—As compared with methods dependent upon hauling the plankton net through the water, several points of advantage are to be found in the pumping method. It is more accurate, since the actual volume of water strained can be determined, and the changes in the coefficient of the net due to seasonal and local variations in the quantity and composition of the plankton and to alterations in the silk of the net with use are to a very large degree eliminated. The method is also widely applicable: as water may be drawn from any desired level, it may be applied to the problem of vertical distribution; and it may be used in very shallow water, in the midst of vegetation, in creeks, in strong currents, under the ice—in fact, in a wide variety of situations from which the vertical or oblique hauls are wholly excluded or to which they are with difficulty applied. Again, no matter how poor the water may be in plankton, it is always possible to strain an amount sufficient to furnish enough plankton for measurement. The method is also a comparatively rapid one, requiring for a plankton collection only about one third of the time consumed in making the oblique haul.

The pumping method is thus admirably adapted to the situation with which we deal at Havana, *i. e.*, shallow water and an abundance of vegetation. It is not, however, limited in its applicability to such situations, but with the help of a steam-vessel and a steam-pump it is capable of application to larger and deeper bodies of water.

III. PRESERVATION AND EXAMINATION OF THE PLANKTON.

1. *Preservation.*—The living plankton is transferred directly from the bucket of the net to a wide-mouth two-ounce bottle, and the sides of the bucket are rinsed down thoroughly with a spray of 1% formalin to insure the complete removal of all of the catch. Enough strong alcohol is then added to the bottle to make a grade of about 75%. Surface and bottom collections are usually preserved in 1% formalin, or in 75% alcohol after killing in micro-sulphuric acid. The bottles are all labeled with a gummed slip bearing the accessions'

catalogue number, designation of the catch (whether surface, bottom, vertical, or qualitative), station, killing agent, and date. For convenience in handling they are then arranged chronologically in racks, each holding six bottles. Data blanks bearing the catalogue number are filled out for each station examination. The locality, date, time of day, the condition of the sky, the direction and force of the wind, the stage of the river and the amount and direction of its change in the twenty-four hours preceding, the depth of the water, its turbidity (measured by means of a porcelain disk), the disturbance of the surface, the temperature of the air and that of the water at surface and bottom, the current, the kind of vegetation and distance from it, the manner of collection and means of preservation of the catches made,—all are matters of regular record, together with any other data peculiar to the collection which could possibly interest the student of the plankton.

2. *Quantitative Examination.*—The quantitative examination of all of the plankton collections made at Havana has been undertaken by the writer. Determination of the quantity of the plankton by both the volumetric and enumerative methods is necessary, owing to the presence, especially in flood waters, of a large amount of silt. The gravimetric or weighing method suggested by Zacharias ('95) is, as Ward ('96) has suggested, objectionable on account of the unknown and presumably variable amount of water or alcohol present in the still moist plankton. Many of the planktons at Havana taken in silt-laden waters contain a considerable amount of mineral and earthy matter. This constitutes a further objection to the application of the gravimetric method to our collections. A combination of the gravimetric and volumetric method has been suggested by Ward ('96), in which plankton of known volume is dried to a constant weight, burned, the ash weighed and afterwards digested in concentrated HCl, and the residue then washed, dried, and weighed. The amounts of organic matter, of soluble salts (calcareous), and of silicious matter can then be determined, and thus corrections for sand-laden planktons can be approximately computed. It is evident that this method cannot be applied to

planktons rich in diatoms nor to the silt-laden planktons from Havana, for a large part of the silt is debris of organic origin, and the method above described does not differentiate the organic material of the plankton from that of the silt. For the quantitative investigation of these silt-laden planktons we are thus practically limited to the enumerative method with such incidental help as may be derived from volumetric determination.

The *volumetric determination* has taken two forms, the settling and the centrifugal methods. The former as used by us is the same as that employed by Reigliard ('94) and Ward ('96a). The plankton is transferred to graduated tubes and is allowed to stand twenty-four hours, when the amount of the plankton settled at the bottom of the fluid, is read by the graduations upon the tube. The tubes used are the carbon tubes employed by chemists in the Eggert color test for the estimation of carbon in steel. Our tubes in most frequent use contain 25 and 50 cubic centimeters respectively, are about twelve millimeters in inside diameter, and are graduated to tenths of a cubic centimeter. For very small planktons another tube, containing only ten cubic centimeters and measuring six millimeters in inside diameter, was used. After a series of measurements in the tubes above described it became evident that a considerable error was involved in the method. Repeated measurements of the same plankton in the same tube, after standing twenty-four hours, revealed a considerable variation in the volume, as high as 30% in some instances. Furthermore, planktons do not settle to an equal density. Those composed of *Kotifera* or small *Cladocera* (as *Chydorus*) pack closely, while others containing filamentous forms, as *Oscillaria* or *Fragillaria*, and those in which the larger *Eutomostraca* are predominant, settle very loosely. Thus the determination of the volume of the plankton by the settling method does not give a uniform test of the amount of plankton present. Furthermore, the process is a tedious one, especially when large numbers of catches are to be handled.

The centrifugal machine (Plate VII.) was finally hit upon as affording the best solution of the difficulties presented in

the settling method. In our machine we have utilized the double arms, aluminum shields, and percentage tubes of the Purdy Electric Centrifuge. The tubes contain 15 cubic cm., are graduated to tenths of a cubic cm., and the conical tips permit the measurement of small planktons with accuracy. The arms are borne upon an upright shaft which is driven by a system of gears turned by means of a crank handle, one turn of the crank giving 24 revolutions of the vertical shaft. The direction and the speed are thus easily controlled by the operator. The machine is clamped firmly to a table when in operation. All parts of the machine, except those from the Purdy Centrifuge, were devised by Professor W. H. VanDervoort, of the College of Engineering, and were constructed in the University shops. Planktons are subjected to 2,000 revolutions in two minutes, the motion at first being slow and frequently reversed. The practical limit of compression by this machine is thus reached, and successive measurements of the same planktons show that its action is quite uniform. The average amount of compression in a wide range of planktons is about 50%, the volume by the centrifuge method ranging from 30% to 70% of that obtained by the settling method. No discussion is needed to prove that the more perfect the compression the more accurate are the volumetric determinations of the plankton. In this lies the main argument for the use of the centrifuge in quantitative plankton work. It also permits rapid work and is easily manipulated. Our machine was completed in January, 1896, and this is, I believe, the first application of the centrifugal machine to quantitative plankton work. Cori ('96) has devised a simple centrifugal machine for precipitation purposes in zoological work, but it does not seem to be fitted for quantitative determination of plankton.

The machine employed by us was also in use for the precipitation of living plankton from the water when Dolley's paper ('96) was received describing a large and powerful centrifuge, "the planktonokrit," devised for the same work. It is only by means of some such machine as this that a complete examination of the contents of the water is possible.

The *enumerative or counting method* involves a recognition of all of the different organisms composing the plankton and the enumeration of the individuals of each species present in a part or the whole of the catch. The number present under a square meter of surface or in a cubic meter of water can then be computed. This work is the basis of the discussion of the seasonal range, local distribution, and interrelations of the components of the plankton. The method of counting at present employed by us is that described by Rafter ('92) as a part of the Sedgwick-Rafter method of microscopical examination of potable waters. This method was employed by Professor J. I. Peck ('96), and I am indebted to him for many kind suggestions on its use. The apparatus consists of a brass cell, 20×50 mm. and 1 mm. in depth, cemented upon a glass slide, a 1-cubic-cm. pipette, a mechanical stage, and an area-stop for the eyepiece. After the plankton to be examined is diluted to the desired degree and thoroughly stirred, one cubic centimeter is transferred with the pipette to the cell, in which one cubic millimeter underlies each square millimeter of the cover-glass. By means of the mechanical stage any desired cubic millimeter of the cell can be placed in the center of the field. The area-stop is a circle of black paper to be placed in the eyepiece, which cuts off all the field except that visible through a square opening at its center. This opening should be of such a size that with the objective employed for the counting work exactly one square millimeter of the cell is subject to inspection.

Ordinarily the counting of from ten to twenty squares suffices for a fair test of the occurrence of organisms in plankton; but in the work upon the richly diversified plankton at Havana we have found it necessary to increase the number to fifty or even one hundred for the commoner and smaller species, while for the larger and the rarer forms a great part or even the whole of the catch must be examined.

URBANA, ILLINOIS, November 23, 1896.

BIBLIOGRAPHY.

Apstein, C.

'91. Ueber die quantitative Bestimmung des Plankton im Süßwasser. In Zacharias's "Die Tier- und Pflanzenwelt des Süßwassers." Bd. II., pp. 255-294. Leipzig.

'92. Das Plankton des Süßwassers und seine quantitative Bestimmung. Schrift d. Naturw. Ver. f. Schlesw.-Holstein, Bd. IX., Heft 2, pp. 267-273.

'96. Das Süßwasserplankton, Methode und Resultate der quantitativen Untersuchung. Mit 113 Abbildungen. 200 pp., 5 Tab. Kiel und Leipzig.

Borgert, A.

'96. Ein einfaches Netz zum Fischen von Plankton bei schneller Fahrt. Zeitschr. f. wiss. Mikr., Bd. XII., pp. 307-312.

Cleve, P. T.

'96. Microscopic Marine Organisms in the service of Hydrography. Nature, Vol. 55, pp. 89, 90.

Cori, C. J.

'96. Ueber die Verwendung der Centrifuge in der zoologischen Technik und Beschreibung einer einfachen Hand-centrifuge. Zeitschr. f. wiss. Mikr., Bd. XII., pp. 303-306.

Dolley, C. S.

'96. The Planktonokrit, a Centrifugal Apparatus for the Volumetric Estimation of the Food-Supply of Oysters and other Aquatic Animals. Proc. Acad. Nat. Sci. Phila., 1896. pp. 276-289.

Forbes, S. A.

'94. Illinois State Laboratory of Natural History, Champaign, Ill. Biennial Report of the Director, 1893-1894. 36 pp., 17 Pls. Chicago.

Giesbrecht, W.

'96. Ueber pelagische Copepoden des Rothen Meeres, gesammelt von Marinestabarzt Dr. Augustin Kramer. Zool. Jahrb., Abth. f. Syst., Bd. IX., pp. 315-328, Taf. 5, 6.

Hensen, V.

'87. Ueber die Bestimmung des Planktons, oder des im Meere treibenden Materials an Pflanzen und Thieren. V. Bericht d. Kommission zu wiss. Untersuchung d. deutschen Meere zu Kiel, 1887. XII.-XIV. Jahrg., pp. 1-107, 6 Taf. Nebst Anhang, pp. 1.-XIX.

'95. Methodik der Untersuchungen bei der Plankton-Expedition. Mit 114 Figg. im Text, 260 pp., 11 Taf. und 1 Karte. Kiel und Leipzig. (Ergebnisse der Plankton-Expedition der Humboldt-Stiftung, Bd. I. B.)

Peck, J. I.

'96. The Sources of Marine Food. Bull. U. S. Fish Comm., Vol. XV., pp. 351-368, Pls. 64-71.

Rafter, G. W.

'92. The Microscopical Examination of Potable Water. No. 103, Van Nostrand's Science Series. 160 pp., 5 Pls., New York.

Reighard, J. E.

'94. A Biological Examination of Lake St. Clair. Bull. Mich. Fish Comm. No. 4. 60 pp., 2 Pls., and map.

Ward, H. B.

'96. A New Method for the Quantitative Determination of Plankton Hauls. Proc. Am. Micr. Soc., Vol. XVII., pp. 255-260.

'96a. A Biological Examination of Lake Michigan in the Traverse Bay Region. Bull. Mich. Fish Comm., No. 6. 100 pp., 5 Pls.

Zacharias, O.

'93-'96. Forschungsberichte aus der Biologischen Station zu Plön, Theil I-IV. Berlin.

'95. Ueber die Wechselnde Quantität des Planktons im Grossen Plöner See. Forschungsberichte a. d. Biol. Station zu Plön, Theil III., pp. 97-117.

*EXPLANATION OF PLATES.

PLATE I.

FIG. 1. Longitudinal section of plankton net. $\times 1_1$.

<i>c, b, l.</i>	Cone of butchers' linen.	<i>s, l.</i>	Stay-line.
<i>cd.</i>	Cord.	<i>sm.</i>	Seam.
<i>cs.</i>	Cover-strip.	<i>s, n.</i>	Silk net.
<i>e.</i>	Eye.	<i>st.</i>	Strip fastening cone to stay
<i>h, p.</i>	Head-piece of bucket.	<i>th.</i>	Thread.
<i>l, e.</i>	Lower eye of wire stay.	<i>u, e.</i>	Upper eye of wire stay.
<i>l, r.</i>	Lower wire ring.	<i>u, r.</i>	Upper ring.
<i>n, c.</i>	Net clamp.	<i>w, s.</i>	Wire stay.

FIG. 2. Seam in silk net. $\times 2$.

<i>a.</i>	Backstitch.	<i>b.</i>	Fell.
-----------	-------------	-----------	-------

PLATE II.

FIG. 3.—Longitudinal section of head-piece of plankton bucket. $\times 1$.

<i>e.</i>	Eye.	<i>s.</i>	Silk.
<i>h, p.</i>	Head-piece.	<i>s, l.</i>	Stay-line.
<i>n, c.</i>	Net clamp.	<i>t, s.</i>	Thumb-screw.
<i>m.</i>	Thread, screwing into <i>n</i> of Fig. 4.	<i>w, n, c.</i>	Wing of net clamp.

*Plates I., II., III., and IV. were drawn by C. A. Kofoid and inked by Miss L. M. Hart.

FIG. 4.—Longitudinal section of plankton bucket. $\times 1$.

<i>b.</i> Bottom.	<i>pl.</i> Plate of clamp.
<i>ba.</i> Base.	<i>pi.</i> Pillar.
<i>b. c.</i> Band clamp.	<i>s.</i> Silk.
<i>d. p.</i> Drip-point.	<i>sc.</i> Screw.
<i>e.</i> Eye.	<i>sh.</i> Shoulder.
<i>n.</i> Thread, screwing on <i>m</i> ,	<i>w.</i> Window.
Fig. 3.	<i>x-y.</i> Line of section shown
<i>p.</i> Plug.	in Fig. 5.

FIG. 5.—Cross-section of plankton bucket at *x-y*, Fig. 4. $\times 1$. Lettering as in Fig. 4.

PLATE III.

FIG. 6.—Carriage, with suspended plankton net. $\times \frac{1}{8}$.

<i>a b c.</i> Line of separation of carriage.	<i>s.</i> Staple.
	<i>s. l. 1, s. l. 2, s. l. 3.</i> Stay-lines from the draw line to net and bucket.
<i>bu.</i> Bucket.	
<i>c. r.</i> Carriage rope.	<i>s. l. 4.</i> Stay-line to carriage.
<i>d. l.</i> Draw-line.	<i>sn.</i> Snap.
<i>h.</i> Hook.	<i>th.</i> Thread.
<i>k.</i> End knot.	<i>w. s.</i> Wire stay.
<i>l.</i> Lead.	<i>w. x y z.</i> Screw-eyes for attachment of net.
<i>p.</i> Front pulley.	
<i>p.'</i> Rear pulley.	

FIG. 7.—Operation of the oblique haul. $\times \frac{1}{20}$.

<i>b. r.</i> Brace rope.	<i>e. s.</i> End stake.
<i>b. s.</i> Brace stake.	<i>m.</i> 30-meter knot.
<i>bt.</i> Boat.	<i>m. s.</i> Main stake.
<i>c. r.</i> Carriage rope before release.	<i>n.</i> Net before release.
	<i>n.'</i> Net after release.
<i>c. r.'</i> Carriage rope after release.	<i>r. l.</i> Release line.
	<i>sur.</i> Surface of water.
<i>d. l.</i> Draw-line.	

PLATE IV.

FIG. 8. Plankton net used with the pump, shown in longitudinal section. $\times \frac{1}{4}$.

<i>b. l.</i> Butchers' linen.	<i>o. n.</i> Outer net.
<i>con.</i> Connector.	<i>p.</i> Pivot for support of ring.
<i>cov.</i> Cover.	<i>ri.</i> Ring for inner net.
<i>f.</i> Foot.	<i>st.</i> Stay for inner cone.
<i>fl.</i> Float.	<i>t. b.</i> Turn button.
<i>h.</i> Handle.	<i>t. s.</i> Turn support.
<i>i. c.</i> Inner cone or spreader.	<i>tr.</i> Trough.
<i>i. n.</i> Inner net.	<i>w.</i> Wing.

FIG. 9.—Rim of cover of net, showing clamp for holding cover in place. $\times 1$.

- | | |
|-------------------------------|------------------------------------|
| <i>c.</i> Clamp, in position. | <i>i. w.</i> Inner wall of trough. |
| <i>c'</i> . Clamp, released. | <i>o. w.</i> Outer wall of trough. |
| <i>cov.</i> Cover. | <i>str.</i> Strap of clamp. |
| <i>f.</i> Foot of cover. | <i>w.</i> Wing of cover. |

FIG. 10. Same, showing method of fastening outer silk net: cover partially removed. $\times 1$.

- | | |
|-------------------------------|-------------------------|
| <i>b. l.</i> Butchers' linen. | <i>o. n.</i> Outer net. |
| <i>cd.</i> Cord. | |

Other lettering as in Figure 9.

PLATE V.

The plankton pump. $\times \frac{1}{16}$.

PLATE VI.

The plankton pump in operation.

PLATE VII.

The centrifugal machine. $\times \frac{1}{4}$.

PLATE I.

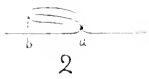
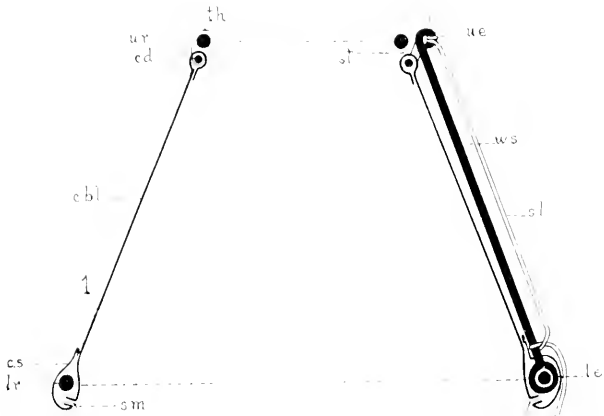

nc [hp] e

PLATE II.

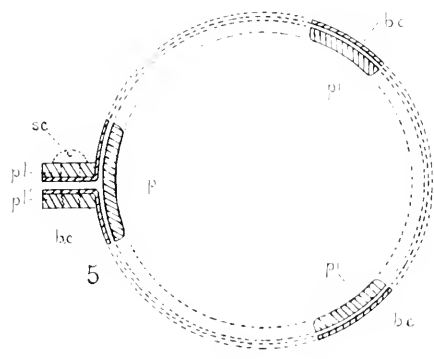
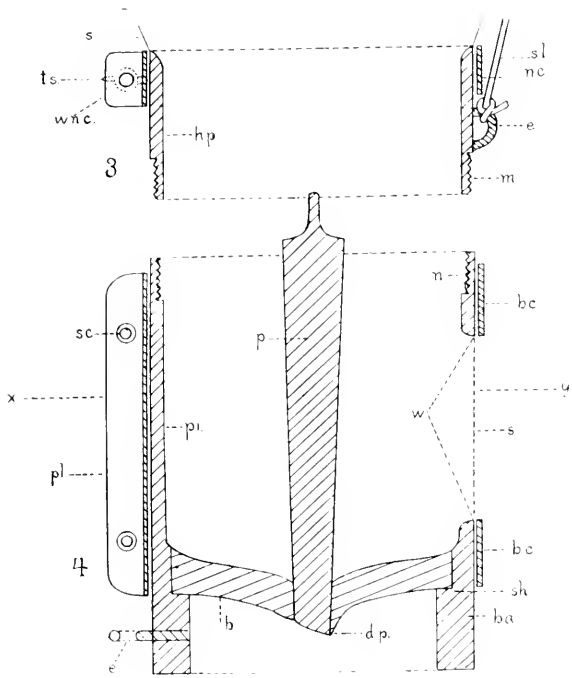

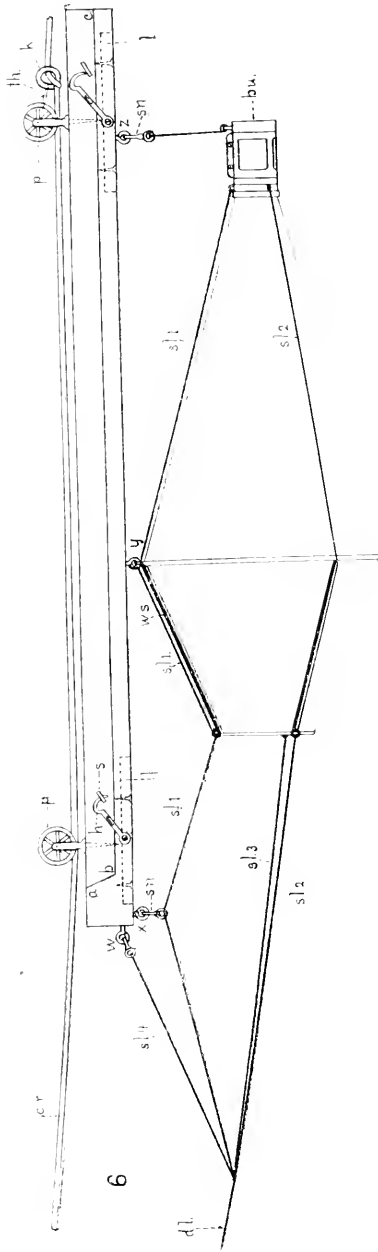

PLATE IV.

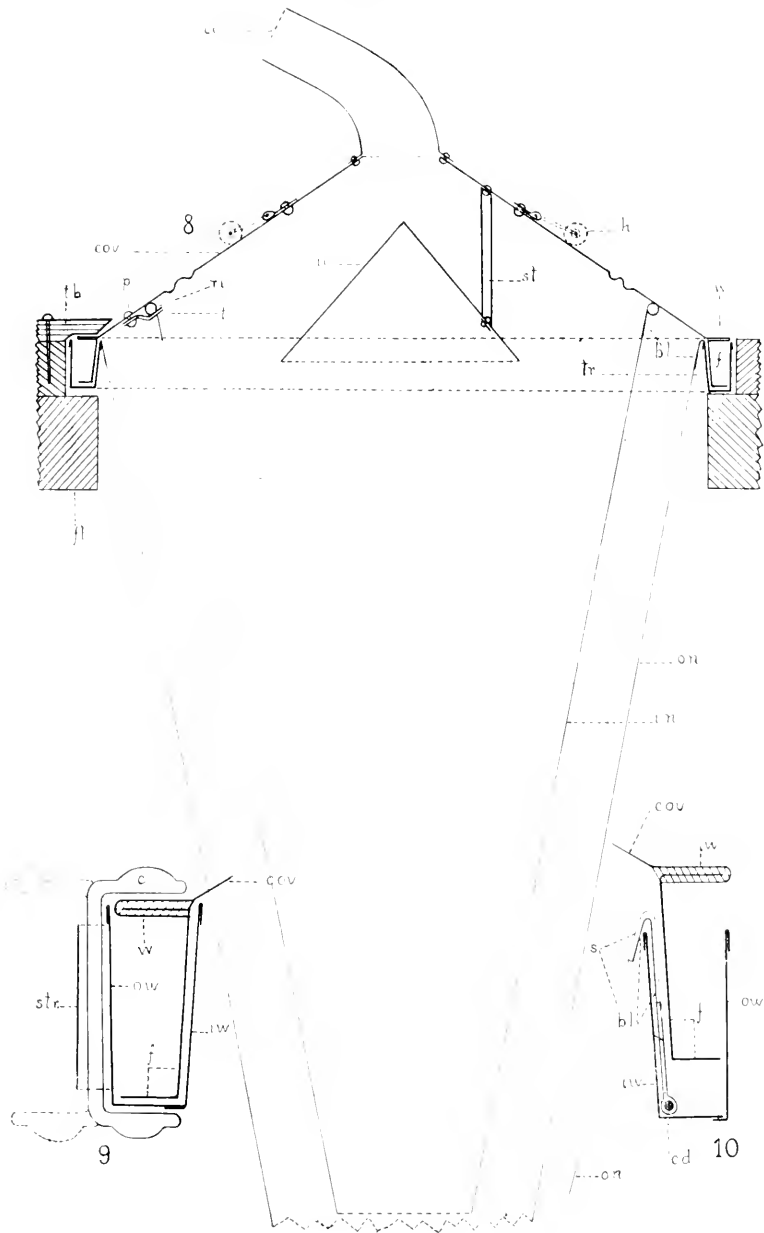

PLATE V.

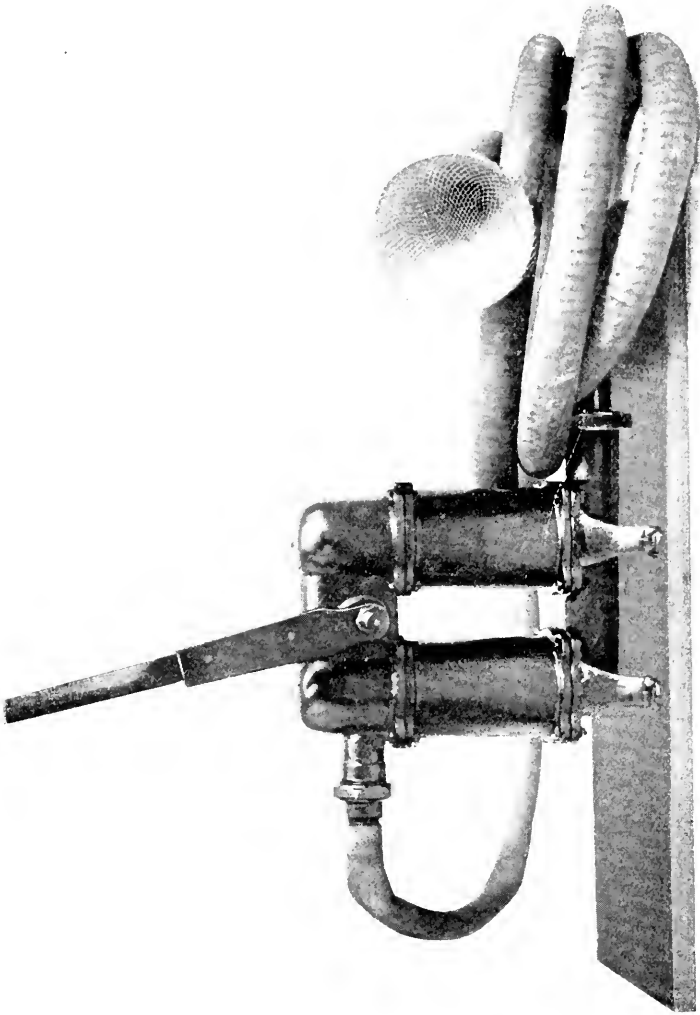

PLATE VI.

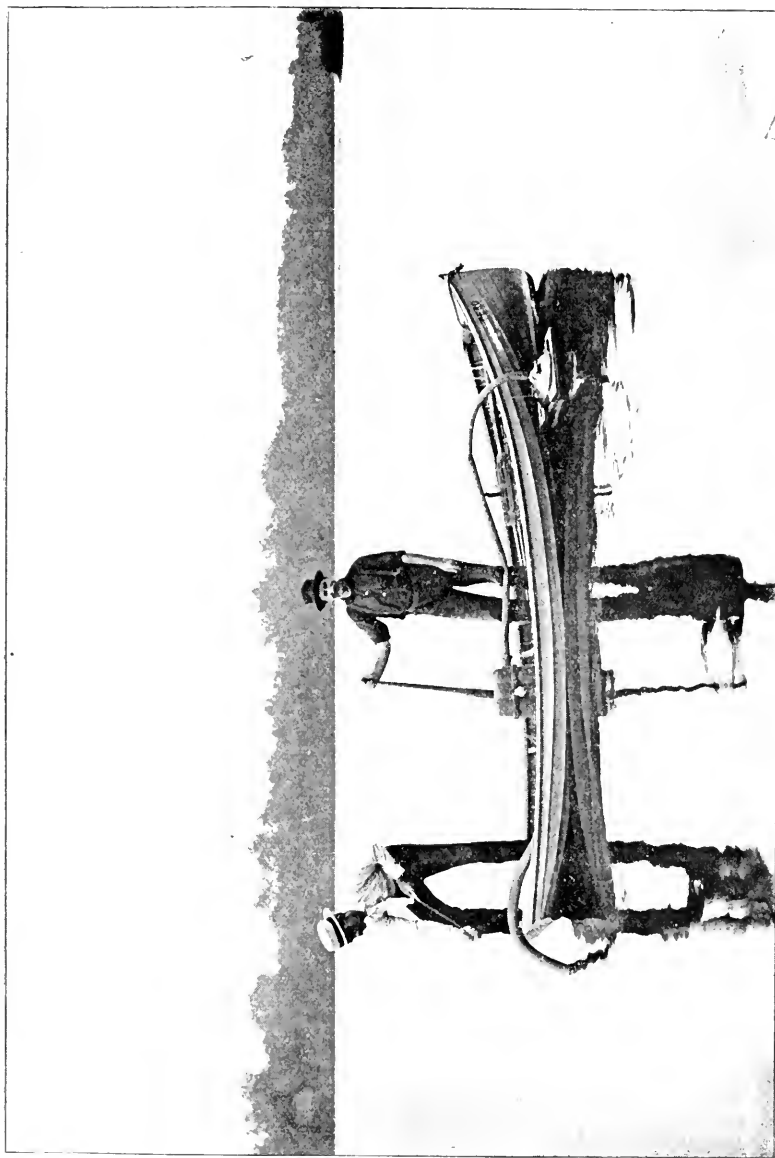
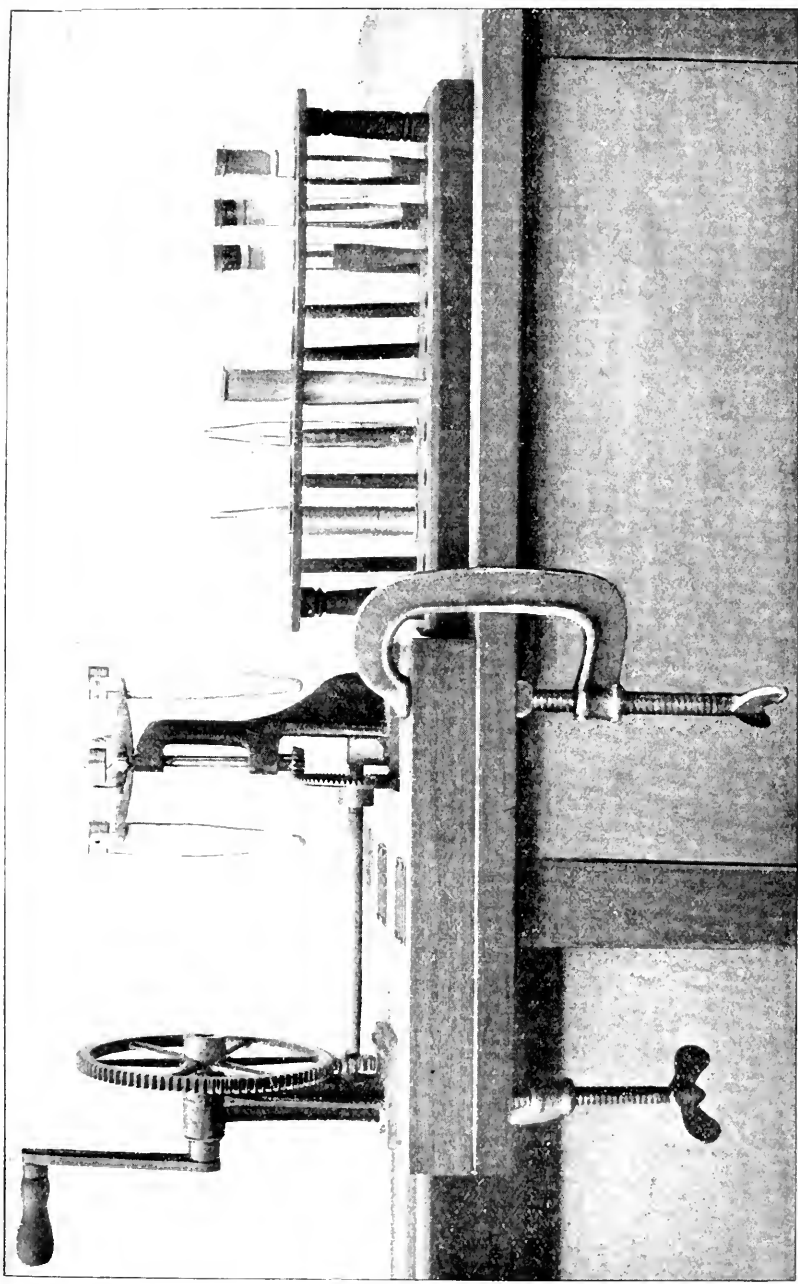

PLATE VII.



BULLETIN

OCT 1 1897

OF THE

⁷⁷¹⁰
ILLINOIS STATE LABORATORY

OF

NATURAL HISTORY,

URBANA, ILLINOIS.

VOLUME V.

*ARTICLE II.—A CONTRIBUTION TO A KNOWLEDGE OF
NORTH AMERICAN FRESHWATER CYCLOPIDÆ.*

BY ERNEST B. FORBES, B. S.

Illinois State Laboratory of Natural History,

URBANA, ILLINOIS.

1897.

STATE LABORATORY OF NATURAL HISTORY.

LABORATORY STAFF.

Professor STEPHEN ALFRED FORBES, PH. D.,
Director of State Laboratory and State Entomologist

CHARLES ARTHUR HART,
Systematic Entomologist and Curator of Collections.

FRANK SMITH, A. M.,
Assistant Zoölogist.

CHARLES ATWOOD KOFOLD, PH. D.,
Zoologist, and Superintendent of Biological Station.

CHARLES CHRISTOPHER ADAMS, B. S.,
Entomological Assistant.

RALPH WALDO BRAUCHER, B. S.,
Entomological Assistant.

MARY JANE SNYDER,
Secretary.

HENRY CLINTON FORBES,
Business Agent and Librarian.

LYDIA MOORE HART,
Artist.

ARTICLE II.—*A Contribution to a Knowledge of North American Fresh-water Cyclopidae.* BY ERNEST B. FORBES.

INTRODUCTION.

During the past twenty years the fresh-water *Copepoda* of North America have received considerable attention from a small number of pioneer investigators, but as yet no one has made a careful comparative study of authentic representatives of the species described by them. It is my purpose in this paper to make a first contribution to a revision of the nomenclature of this genus, such as is usually found necessary when, for the first time, the work of unaffiliated investigators is brought into careful comparison. I have embodied in this paper, not a complete revision of the American species of *Cyclops*, but only such results of my study on that group as have now been brought to a satisfactory conclusion.

The excellent work of Claus and Schmeil in Germany has greatly modified our ideas of the comparative value of certain specific characters; and the revision of the European species of this genus in Schmeil's monograph¹ has made it possible for me to begin a revision of the American species along the same general lines.

The *receptaculum seminis*, which has recently come to be considered as the most important structure for purposes of specific distinction, has received almost no attention from American investigators; but after studying this organ in series of specimens of closely related forms from a great variety of widely separated situations, I have been forced to include under the same species name forms which have heretofore been considered valid species, and to discard as local or at the most varietal differences, distinctions which have

¹This paper was prepared in the course of undergraduate study at the University of Illinois, and was accepted by the Faculty of the University June 7, 1897, as a thesis for the degree of Bachelor of Science in Zoölogy.

²Deutschlands freilebende Süsswasser-Copepoden. I. Teil: Cyclopidae.

been used for the separation of species by our most eminent workers.

I have made a vigorous effort to obtain authentic examples of all the species considered; and while I have been in general successful, I have been forced in the case of Herrick's species to depend wholly upon the collections to which I have had access myself, and the identifications of other men who have collected in Herrick's localities.

The collections which I have had an opportunity to study in the preparation of this paper are those of the Illinois State Laboratory of Natural History, extending over a period of more than twenty years; several made under the auspices of the U. S. Fish Commission in Wisconsin and in the far West; collections made in Florida by Mr. Adolph Hempel and in Manitoba by Prof. L. S. Ross, of Drake University, Iowa, and kindly loaned me by these gentlemen; and all of the collections made at the Illinois Biological Station at Havana, Illinois. This material is from the following states: Massachusetts, Florida, Ohio, Indiana, Michigan, Wisconsin, Illinois, Kentucky, Iowa, Missouri, Minnesota, Idaho, Wyoming, Washington, and Oregon, and from Manitoba, in the Dominion of Canada.

The localities represented by these collections are widely distributed and of great variety. They extend from the New England states in the northeast to Florida in the southeast, to Manitoba on the north and to Washington and Oregon in the northwest, and from the sea-level in Massachusetts and Florida to some of the highest lakes in the Rocky and Sierra Nevada Mountains. In these collections are *Cyclops* from small temporary ponds of a few weeks' duration, from the greatest lakes and rivers in the world, and from a great number and variety of situations intermediate in character. They have been made in every season of the year; and although the southwestern part of the United States is not represented, they probably contain nearly all of the American species of the genus.

The results published in this paper do not, however, represent an exhaustive study of the distribution of the species

treated, and a more careful inspection of the collections examined would doubtless make evident many interesting facts with regard to the details of distribution.

I have had, for comparison with our American forms, named European specimens from S. A. Poppe, Prof. G. O. Sars, and Dr. Otto Schmeil. Those from Poppe were received in 1883 by Dr. S. A. Forbes and represent the following species: *Cyclops agilis*, *helicolaudicus*, *pulchellus*, *signatus*, and *strenuus*. During the present year Dr. Schmeil has sent specimens of *Cyclops fuscus*, *varicans*, *leuckarti*, *albidus*, *strenuus*, *serrulatus*, *viridis*, and *phaleratus*, while Prof. Sars has sent to Dr. Forbes examples of the species of the following list: *Cyclops viridis*, *nannus*, *robustus*, *hyalinus*, *oithonoides*, *albidus*, *fuscus*, *vernalis*, *macrurus*, *gigas*, *leuckarti*, *insignis*, *bisctosus*, *fimbriatus*, *bicuspidatus*, *affinis*, *crassicaudis*, *phaleratus*, *bicolor*, *scutifer*, *serrulatus*, *varicans*, *dybowskii*, *lacustris*, and *strenuus*. These authoritatively named European specimens have given me the opportunity for comparative studies of American and European Cyclopidae—the first, so far as I am aware, which have been made in America.

The mere study of American specimens of species first described from European material has not given me, in many cases, the data necessary for a critical judgment of the synonymy of such forms, and I have consequently accepted, as a rule, the determinations of Claus and Schmeil, whose long experience and critical and exhaustive work give to their conclusions the highest authority.

The genera and subgenera of Claus ('93a, '93c, '93d) seem to me very convenient subdivisions of this varied genus, and the species of this paper have, so far as possible, been arranged under Claus's groups. I find it necessary, however, to create two new subgenera, *Orthocyclops* and *Homocyclops*, for the two American species *C. modestus* and *C. ater*. The descriptions are incomplete, however, because of the lack of knowledge concerning the males of these two species.

Certain characters used by some of our American investigators for specific distinction have proven unreliable, and a

brief discussion of their comparative values may be of service to beginners in the study of this genus.

The number of antennal segments may be depended upon as fairly constant. It never varies in adult specimens by more than a single segment, and then only in the case of a very few species. The length of the antennæ, while constant in some species, is remarkably variable in others, notably in *C. serrulatus*. The proportionate length of antennal segments does not always remain the same in species in which the antenna is variable as to length. Sensory structures and the hyaline plates of the distal antennal segments are reliable characters.

In certain species, *C. phaleratus* for instance, the proportions of the stylets are quite constant, but in *C. viridis*, *serrulatus*, and *bicuspidatus*, the range of variation is very great; consequently such measurements are not of the highest specific value. The apical bristles of the stylets are not very variable as to comparative lengths, but the minute details of their structure are not constant. This fact is illustrated by the variation in the shape of the outer apical spine of *C. viridis* var. *brerispinosus* (Pl. XI., Fig. 1).

The armature of the swimming feet is of considerable value in certain cases, and is constant as a rule. Sometimes, however, the presence or absence of a spine or seta is not accompanied by other perceptible differences. The general character of the armature with regard to strength, etc., may usually be relied upon; but I have often seen in a single specimen all of the gradations between spines and setæ, and it would be impossible from this character to say which of the two names should be applied.

Of the easily observable structures, the fifth foot is the most valuable for specific distinction. Slight variations sometimes occur in the shape of the segments and in the comparative lengths of spines and setæ, but, as a rule, characters drawn from this appendage are quite constant.

Of all the specific characters, the most valuable are those derivable from the *receptaculum seminis*. Unfortunately, it is often very difficult to see this organ distinctly, especially if

the specimens have been killed in alcohol; but this difficulty is readily avoided by the use of formalin as a preservative. A 1% solution is amply strong, and the osmosis of fluids is not rapid enough to rupture the receptaculum, as is the case when strong alcohol is used. Some slight differences in the appearance of the receptaculum are due to stage of sexual activity of the animal. In the case of *C. viridis* var. *insectus* such a difference is noticeable. In Fig. 3, Pl. XI., the solid line represents the outline of the empty receptaculum; the dotted line, the shape when fully distended.

Through the generosity of Prof. G. O. Sars and Dr. Otto Schmeil, I have received much valuable material from Europe, by means of which I have been able to compare American and European forms. I wish also to acknowledge the assistance received from my co-laborers, Messrs. R. W. Sharpe and F. W. Schacht, and also to thank Prof. L. S. Ross, of Drake University, and Mr. Adolph Hempel, now of the Museu Paulista, Brazil, for the courtesies shown me in the loan and collection of material. A very great part of the credit for such portions of this paper as may be of value is due to my instructor, Dr. S. A. Forbes, whose kind supervision and encouragement have constantly guided and aided me in this work.

Genus **CYCLOPS** O. F. MÜLLER.

Subgenus **Cyclops** s. str. CLAUS.

Cyclops leuckarti CLAUS. (Pl. VIII., Fig. 1-3.)

Cyclops leuckarti, Claus, '57, p. 35, Pl. I., Fig. 4; Pl. II., Fig. 13, 14.

Cyclops leuckarti, Schmeil, '92, pp. 57-64, Pl. III., Fig. 1-8.

Cyclops leuckarti, Herrick and Turner, '95, pp. 96-98, Pl. XVI.; XVIII., Fig. 1, A-J; XXIV., Fig. 2-6.

This species is of medium size, but is rather more slender than usual (Pl. VIII., Fig. 1). The cephalothorax is broadest at the first segment and tapers conspicuously toward the posterior end. The length as compared to the breadth is about as eleven to six.

The abdomen is long and slender, but the stylets are short, being one third or one fourth as broad as long. They are

not markedly divergent, and there is no conspicuously broad space between their points of attachment. The outer apical seta is delicate and as long as the stylet. Of the remaining three, all of which are well developed, the middle one is the longest and the innermost the shortest.

The first antennae are long and slender, terminating at the middle or end of the third cephalothoracic segment. The last two segments are both long, but the sixteenth (penultimate) is the longer of the two. These two segments bear broad hyaline plates (Pl. VIII., Fig. 2). The margin of the one borne by the sixteenth segment is entire, but the one on the following segment besides being finely serrate its whole length is deeply notched near its distal end. This notch is very characteristic of the species. On the twelfth segment is the usual sense-club.

The posterior border of the second segment of the outer maxillipeds usually bears a series of rounded transverse ridges, which extend in a series from the proximal end of the segment nearly to the other end. The presence of this structure seems characteristic of the European form, but may rarely be entirely absent in American specimens.

The setae and spines of the swimming feet are conspicuously long and strong. The margin of the connecting lamella of the fourth pair of feet bears a pair of sharp teeth. The feet are armed as follows:—First pair: outer ramus, two spines, four setae; inner ramus, one seta, one spine, four setae. Second and third pairs: outer ramus, three spines, three setae; inner ramus, one seta, one spine, four setae. Fourth pair: outer ramus, three spines, four setae; inner ramus, one seta, two spines, two setae.

The rudimentary foot (Pl. VIII., Fig. 3) is two-segmented. The basal segment is short and roughly quadrate, with a long plumose seta borne on its outer angle. The distal segment is long and slender. On the middle of the inner side is borne a long pectinate spine, and at the tip a seta of about equal length.

The *receptaculum seminis* is large and elliptical, and the anterior part, from which proceed the canals, is laterally expanded.

The egg-sacs are carried at a broad angle from the abdomen.

In length the female varies, in American specimens, from .95 to 1.5 mm.

The color is always inconspicuous and may be light blue or gray.

This is in general a very rare species in America. I have never, until recently, found it in collections in any great numbers, but in twos or threes at long intervals. I lately found it, however, in immense numbers in a collection made in August, 1896, from Fox River, Illinois. It is found in just such situations as is *C. edax*, but usually in very much smaller numbers. I have seen this species in collections from Lake Harriet, Minnesota; Delavan Lake, Wisconsin; and from Quiver, Flag, and Dogfish lakes, and the Sangamon and Fox rivers—all in Illinois. It is widely distributed in the lakes and rivers of America, but has not been reported from temporary pools.

Cyclops edax FORBES. (Pl. IX., Fig. 1-3.)

Cyclops edax, Forbes, '90a, p. 709, Pl. III., Fig. 15; IV., Fig. 16-19.

Cyclops annulatus, Wierzejski, '92, pp. 237, 238, Pl. VI., Fig. 14-18.

Cyclops leuckarti, Marsh, '93, pp. 209-211, Pl. IV., Fig. 17; V., Fig. 2-6.

SYNONYMY AND COMPARISON.

This form has been confounded with *C. leuckarti* Claus, from which, however, it is very easily separated by a careful comparison of specimens.

The original description of this species was incomplete in that no mention was made of the sense-club on the twelfth antennal segment, or of the hyaline plates of the sixteenth and seventeenth segments. As in *C. leuckarti* (Pl. VIII., Fig. 2), the plate of the sixteenth segment has an entire edge, though the plate itself is much narrower. The plate of the seventeenth segment (Pl. IX., Fig. 2) differs markedly from the corresponding structure in *C. leuckarti*. In *C. edax* the edge of the plate is cut by a series of deep oblique notches, forming teeth which point strongly backward. These notches

are deepest near the distal end and thence diminish in both directions. The segment itself is deeply excavated within and the plate merely completes its usual outline, while in *C. leuckarti* the segment is but slightly excavated and the broad plate projects far beyond the outline of the segment.

In *C. edax* the last two segments are equal, while in *C. leuckarti* the sixteenth segment is a fourth longer than the last.

The two pointed teeth of the connecting lamella of the fourth feet, which are characteristic of *C. leuckarti*, may sometimes be present in *C. edax*, though they are in this species not so sharp as in the other and are placed farther apart.

The transverse ridges of the outer maxillipeds, which Schmeil describes as characteristic of *C. leuckarti*, are usually absent in *C. edax* and when present are quite inconspicuous. They begin, as in *C. leuckarti*, at the proximal end of the segment, but soon fade away.

The abdominal stylets in *C. edax* are more divergent than in *C. leuckarti*, and are inserted farther apart.

The fifth feet (Pl. IX., Fig. 3) are markedly different. In *C. edax* the two setae of the distal segment are parallel and the surfaces to which they are attached are at right angles to the long axis of the segment. In *C. leuckarti* the surface of attachment of the lower seta is at an angle of about forty-five degrees to the long axis of the segment. Furthermore, the whole distal segment is broader in *C. edax*.

There are differences in general proportions and appearances which make it very easy for one well acquainted with these species to distinguish them at a glance, but these differences can only be demonstrated by a long series of measurements. The structure of the *receptaculum seminis* is identical in the two species, so far as I can tell; but though the species are undeniably closely related, I think that on account of the above-mentioned differences they should be kept distinct.

Cyclops edax may possibly be the same as *C. leeuwenhoekii* Hoek, which Schmeil has made synonymous with *C. leuckarti*.

If the figures as published by Hoek are correct, *C. edax* differs from *C. leeuwenhoekii* in the following particulars: In *edax* the labrum has eleven teeth; in *leeuwenhoekii* it has but ten. In *edax* the seventeenth antennal segment is longer than the sixteenth; in *leeuwenhoekii* the sixteenth is longer than the seventeenth. In *edax* the first foot, outer ramus, bears on the distal segment two spines and four setae; in *leeuwenhoekii* the corresponding segment bears three spines and two setae. In *edax* the inner margin of the distal segment of the fifth foot is not incurved as in *leeuwenhoekii*. In *edax* there are never less than five prominent teeth in the lamella of the seventeenth antennal segment; in *leeuwenhoekii* but three are figured. The transverse ridges on the maxilliped of *leeuwenhoekii* are more prominent, smaller, and more numerous than in *edax*.

DISTRIBUTION.

This form is very abundant and widely distributed in America. I have found it, among many other places, in collections from the Mississippi and Illinois rivers; from various lakes and ponds of Illinois; from Sister Lake and Lake Butler in Florida; from Spirit Lake and Lake Okoboji in Iowa; and also from lakes Michigan, Superior, Winnepago, and Michigamme, and Yellowstone, Delavan, and Cedar lakes. It was described in 1892 by Wierzejski from the Argentine Republic under the name of *C. annulatus*.

SPECIFIC DESCRIPTION.

The cephalothorax is oval, compact, and broadest before the middle. The first segment is as long as the remainder. The last thoracic segment is scarcely broader than the first abdominal.

The first abdominal segment is very long, equaling the following three. The last segment is the shortest and is bordered by the usual row of spinules. The preceding segments are bordered posteriorly by coarse serrations, more pronounced and regular on the ventral than on the dorsal side. The stylets are one third as wide as long, and in a long series of measurements of individuals from the most widely separated

localities this proportion only varied by one thirtieth. The inner margins of the stylets are ciliate. The lateral spine is a trifle behind the middle; the outer seta about as long as the ramus; the inner five sixths the length of the third from within; the latter two thirds as long as the second.

The antennæ terminate between the end of the second and the end of the third segments. There is a sense-club and seta on the twelfth segment. The sixteenth segment is never longer than the seventeenth. The sixteenth and seventeenth segments bear hyaline plates (Pl. IX., Fig. 2), that of the sixteenth segment being very narrow, with its edge entire, and that of the seventeenth broader, with its edge deeply notched. The notches are most pronounced near the distal end and fade away in each direction. The intervening teeth point strongly toward the base of the antenna. The segment is excavate on the inner side, and the hyaline lamella completes the normal outline of the segment by filling up the depression.

The swimming feet are armed as follows: First pair: outer ramus, two spines, four setæ; inner ramus, one seta, one spine, four setæ. Second and third pairs: outer ramus, three spines, three setæ; inner ramus, one seta, one spine, four setæ. Fourth pair: outer ramus, three spines, four setæ; inner ramus, one seta, two spines, two setæ.

The feet of the fifth pair (Pl. IX., Fig. 3) are two-segmented. The distal segment bears two parallel setæ, the outer one of which is set at about the middle of the segment. This seta is most strongly spinulose on the outer side, while the distal one is plumose on both sides.

The *receptaculum seminis* is large and elliptical, the long axis corresponding to the long axis of the segment. The lateral canals are connected with the expanded upper portion. The receptaculum is almost exactly as in *C. leuckarti*.

The egg-sacs are elliptical and stand out from the abdomen.

The usual length of the female is 1.2-1.4 mm.

Cyclops viridis JURINE. (Pl. X., Fig. 1-3.)

Monoculus quadricornis var. *viridis*, Jurine, '20, p. 46, Pl. III., Fig. 1.

Cyclops viridis, Schmeil, '92, pp. 97-101, Pl. VIII., Fig. 12-14.

SYNONYMICAL DISCUSSION.

Though the subdivision of the *viridis* group here proposed is not entirely satisfactory and may not be final, still after long study of more extensive collections than have heretofore been brought into comparison in America, I have arrived at some conclusions with regard to the subdivision of the group which may be of service to any one following me in the study of the American *Cyclopidae*.

C. viridis occurs in America, so far as I now know, only in the larger forms of that species. *C. ingens* (Herrick, '82a) seems to me the only described form corresponding very nearly to the European *viridis*, and I therefore regard it as the American representative of that species. It is considered by Marsh as equivalent to *C. americanus* (= *C. insectus*), and Herrick himself says that it is distinguished from this form only by its greater size. From Fig. 3, Pl. XXV., in Herrick and Turner '95, I judge that *C. ingens* is synonymous with *C. viridis*, thus representing in America the maximum development of the species, as does *C. gigas* in Europe.

Dr. Forbes has for years recognized such a form as *C. ingens*, and it is to be found in the temporary ponds of central Illinois. The species was in 1870 given the manuscript and label name of *C. lewis*, but the description was never published. This *C. ingens* or *lewis* differs from specimens of *viridis* received from Sars and Schmeil only in its greater size, and from specimens of *C. gigas* received from Sars only in some of the more minute details in the outline of the two segments of the fifth foot. The two forms *gigas* and *ingens* are undoubtedly typical *C. viridis*. It is of interest to note that in both of these large forms the small spine of the fifth foot is not separate from the segment, but is a process of the segment itself. Schmeil states that in *C. viridis* it may or may not be separated from the segment by a suture. *C. ingens* is the only form in America having the stylets ciliate

internally. In the smaller forms most closely related to *viridis*, in which the small spine of the fifth foot is always separate from the segment, the inner border of the stylet is never ciliate, though in rare cases the whole inner aspect of the stylet seems to be set with the shortest of hairs, only visible on account of their points of attachment.

The first species closely related to *viridis* described in America was *C. insectus*, described in 1882 by Dr. Forbes. Later in the same year C. L. Herrick described a very closely related form under the name of *C. parvus*. This species has been most profusely figured by Herrick, but his drawings of the fifth foot are so very different as to make it impossible to say where it belongs in this most perplexing group. I have failed in my attempts to obtain authentic examples of *C. parvus*, but have found a few specimens answering to Herrick's description in a temporary pond in Urbana, Illinois. I cannot, however, vouch for their identity. In the same collection I found other specimens differing from those above mentioned only in the presence of the additional spine of the first and fourth feet—the feature separating this form from *C. insectus*.

So variable is *C. insectus*, found, as it is, in an endless variety of situations and localities, that the lack of a single spine on the distal segment of the outer ramus of the first and fourth feet is not sufficient ground for the distinction of even a variety, for I find, as does Dr. Schmeil, that the armature of the swimming feet is not in all species absolutely constant.

In Herrick and Turner '95 (Pl. XXXIV., Fig. 5), is a drawing of the fifth foot of *C. parvus*. This drawing was evidently made with somewhat greater care than were those on Plates XX. and XXI., and represents approximately the same appendage in *C. insectus*.

Cyclops americanus, described by C. D. Marsh in 1892, proves on examination of authentic examples to be synonymous with *C. insectus*. Undoubtedly *C. americanus* of Herrick and Turner is identical with Marsh's form and is consequently also a synonym of *insectus*.

Cragin in 1883 figured a form as *C. viridis* and stated that it was found at Cambridge, Mass. This form is *C. insectus*. *Cyclops uniaugulatus*, described as new in the same article, is also *C. insectus*, the only apparent difference being a very slight one in the armature of the swimming feet.

Cyclops brevispinosus, described in 1884 by Herriek, differs from *C. insectus* principally in the shape of the outermost terminal spine of the stylet. In the type of *brevispinosus* this spine is very broad, heavy, and knife-like in character. I have seen considerable variations in the shape of this spine and have observed all of the gradations between it and the usual slender spine of *C. insectus*. I think, however, that *C. brevispinosus* should be considered as a good variety. The following description of *C. viridis* is a translation of the description by Schmeil (92).

SPECIFIC DESCRIPTION.

“The two axes of the cephalothorax compare about as two to one; the ratio of the length of the cephalothorax and the abdomen is almost the same. The cephalothorax tapers about equally in both directions; each segment projects laterally far beyond the following. Seen from the side, the posterior angles of all the plates of the cephalothoracic segments are rounded, those of the first and fifth segments being at first straight, then convexly produced at their ends; and the second, third, and fourth segments, in which such prominences are lacking, are slightly lengthened posteriorly.

“The first abdominal segment is but little broadened in its anterior part. The posterior borders of all the segments are coarsely serrate, with the exception of the last, which bears a fringe of spinules.

“The stylets are often two, three, or even four times as long as the last abdominal segment. The inner border is always ciliate. The lateral spine is set beyond the middle of the outer edge. The outermost of the apical bristles (all of which are narrowly plumose) is not, as is the case with most species, changed into a spine, and is exceeded in length by the innermost. Both middle bristles are well developed, but their

proportional lengths are not entirely constant. Usually the smaller of the two is as long as the abdomen, and the larger exceeds it in length. They are often of exactly the same size, and often the difference is considerable.

"The first antennae are seventeen-segmented, usually reaching back only to the posterior border of the first cephalothoracic segment. The last three segments are but little longer than those immediately preceding. The twelfth segment bears a projecting sense-club.

"The remaining pairs of appendages, with the exception of the rudimentary feet, present no notable characters and hence are systematically valueless. Spinous armature of swimming feet, 2. 3. 3. 3.

"The rudimentary foot (Pl. X., Fig. 2) is two-segmented. The extraordinarily broad basal segment bears on the lower outer angle a long plumose hair. On the lower border, immediately at the inner angle of this segment, is attached the relatively small distal segment, which bears at its distal end a plumose hair and at the inner margin a very minute spine."

"The *receptaculum seminis* (Pl. X., Fig. 3), the two small lower divisions of which terminate in the lateral canals, are usually covered by the larger, more or less heart-shaped upper division. Exact knowledge of the structure of this organ is usually first possible after the application of delicate pressure.

"The large elliptical egg-masses stand off from the abdomen at a very sharp angle.

"The color is usually a dirty green, seldom a light brown. In a pool in Diemitz I met with quite fire-red examples.

"The size is very variable. With individuals 1.5-2 mm. one finds others 2.5, 3, 4, or even 5 mm. in length.

"The clearest and simplest recognition characters are the rudimentary feet and the structure of the *receptaculum seminis*."

*In a foot-note Schmeil states that Claus, Hoek, Richard, and Landé, consider this spine as a process of the segment, that Lilljanin figures it as separated from the segment by a suture, and that he, Schmeil, had observed it both ways.

Var. **brevispinosus** HERRICK.

(Pl. XI., Fig. 1 and 2.)

Cyclops brevispinosus, Herrick, '84, p. 148, Pl. S, Fig. 7-11.*Cyclops brevispinosus*, Marsh, '93, pp. 205-206, Pl. IV., Fig. 11, 12.*Cyclops brevispinosus*, Herrick and Turner, '95, p. 95, Pl. XXIII., Fig. 1-4; XXIV., Fig. 7-12.

This species of Herrick's, which I reduce to a variety, is distinguished from typical *C. viridis*, as follows: 1. By the form of the outer terminal spine of the stylet, which is short, broad, and knife-like. This form of spine is connected in series (Pl. XI., Fig. 1) with the slender spine of the variety *insectus*. 2. By the fifth foot (Pl. XI., Fig. 2). In this appendage the small spine is never a part of the segment as it may be in the European *viridis* and always is in the American form. This spine is also longer than in *viridis* and is lanceolate in shape. 3. By the armature of the swimming feet. The spines of these appendages are extravagantly long and heavy. While at first sight these differences might seem sufficient for the complete separation of the two forms, the distinguishing characters are in most species of *Cyclops* so variable that it seems to me best to consider *brevispinosus* as merely a variety.

The *receptaculum seminis* is as in *insectus*.

I find this variety in collections from Lakes Michigan, Manitoba, Okoboji, (Iowa); and from Lake Winnebago, Green Lake, and Lake Geneva in Wisconsin; from Swan Lake in Montana, and Lake Pend d'Oreille in Idaho; from the Detroit, Cahumet, and Illinois Rivers; and from Sand, Fox, Quiver, Dogfish, Phelps, and Thompson's lakes—all in Illinois. It is never especially abundant but seems to be quite generally distributed.

Var. **insectus** FORBES.

(Pl. XI., Fig. 3-6.)

Cyclops insectus, Forbes, '82a, p. 649, Pl. IX., Fig. 6.*Cyclops parens*, Herrick, '82a, p. 229, Pl. VI., Fig. 12-15.*Cyclops insectus*, Herrick, '84, pp. 151, 152, Pl. U., Fig. 9.*Cyclops viridis*, Cragin, '83, p. 68, Pl. IV., Fig. 8-16.*Cyclops unimaculatus*, Cragin, '83, p. 71, Pl. IV., Fig. 17.*Cyclops insectus*, Schmeil, '92, p. 95.

Cyclops parvus, Marsh, '93, pp. 208, 209, Pl. IV., Fig. 16; V., Fig. 1.

Cyclops americanus, Herrick and Turner, '95, pp. 91, 92, Pl. XIV., Fig. 1-9.

Cyclops parvus, Herrick and Turner, '95, pp. 93, 94, Pl. XX., Fig. 12-15; XXI., Fig. 22; XXIII., Fig. 8; XXX., Fig. 1-8.

This variety represents in America the smaller members of the *viridis* relationship. It is distinguished from *viridis* in Europe by the lack of cilia on the inner side of the stylets, by some slight differences in the shape of the *receptaculum seminis* (Pl. XI., Fig. 3), and by the different shape of the fifth foot. The *receptaculum seminis* differs in that the upper part is larger in proportion to the segment in *insectus* and is somewhat different in outline. In the fifth foot (Pl. XI., Fig. 4 and 5), the outer distal angle of the basal segment is much less produced and the spine of the distal segment, which is always separated from the segment by a suture, varies in length from a minute barbule to a long heavy spine, longer than the segment itself. The armature of the swimming feet (Pl. XI., Fig. 6) is not constant and is not in *C. viridis* useful even as a varietal distinction.

This brief diagnosis includes under the varietal name *insectus*, forms which differ superficially to a marked degree, but after continuous work for more than a year with very large collections from all parts of the United States I have been forced to throw them all together for the simple reason that there is no one set or combination of characters sufficiently invariable to subdivide the group.

The antennae of this variety usually terminate at or before the end of the first cephalothoracic segment, but in examples from Alturus Lake, they reach the middle of the second segment.

The stylets of this variety vary considerably in proportions. The following series of measurements of nine specimens shows the extent to which this character varies. On the left is a list of the localities from which the specimens were obtained and on the right are figures representing the proportion between the length and breadth of the stylet.

Pond, Normal, Ill.	63:9
Creek, Wyoming.	52:11
Lake Winnebago.	52:8
Lake Superior,	44:9
Illinois River.	40:9
Mississippi River.	37:8
Pond, Urbana, Ill.	34:7
Pond, Yellowstone Park,	33:9
Slough, Manitoba,	33:9

There is a very peculiar semicircular indentation of the outer side of the basal segment of the inner ramus of the fourth foot often present in this variety, but it may be entirely absent or only present in a slight degree of development. Whatever the function of this peculiar indentation, it does not seem to be essential to the animal.

The fifth foot varies but little in the basal segment but the distal segment is peculiarly variable. In one extreme, which reaches its highest development in the Illinois River, this segment is very short, its length compared to its breadth being as 3.5 to 3, and its sides strongly outcurved. The small spine is situated some distance from the end of the segment and is very small indeed. Examples of the other extreme are common in the ponds of central Illinois. In these the last segment is much longer, its length being to its breadth as 9 to 5. In this form the spine is parallel to and often longer than the segment.

The shape of this distal segment seems to vary independently of the other specific characters, and all gradations between the two forms may be found in a single pond. These variations are not demonstrably connected with the environment.

The *receptaculum seminis* (Pl. XI., Fig. 3) is, when fully distended, of the shape represented by the dotted line, but otherwise may have the shape outlined by the solid line. As will be seen by comparing this figure with that of the *receptaculum seminis* of *C. viridis* (Pl. X., Fig. 2), the anterior portion of the receptaculum is comparatively larger in *insectus* and its outline as a whole is somewhat different.

I find that the coloring of this species is so variable that no

dependence can be placed upon it for purposes of distinction. This variety may be wholly red or blue or greenish or it may even be colorless.

It is found everywhere in the United States and Canada where *Cyclops* have been collected, and no situation seems to be free from them. In Illinois by far the greater portion of the *Cyclops* of the small ponds and temporary pools and puddles belong to this species.

Cyclops bicuspidatus CLAUS. (Pl. XII., Fig. 1-4.)

Cyclops bicuspidatus, Claus. '57, p. 209.

Cyclops pulchellus, Sars. '63, pp. 246, 247, Pl. XI., Fig. 6 and 7.

Cyclops naxus, Herrick. '82a, p. 229, Pl. V., Fig. 6-13, 15-17.

Cyclops thomasi, Forbes. '82a, p. 649.

Cyclops bicuspidatus, Schmeil, '92, pp. 75-87, Pl. II., Fig. 1-3.

Cyclops minutus, Forbes, '93, p. 247.

Cyclops serratus, Forbes, '93, pp. 247, 248.

Cyclops forbesi, Herrick and Turner, '95, p. 104.

SYNONYMICAL DISCUSSION.

This immensely variable and widely distributed species is represented in the United States by a number of forms which have been described by our most reliable zoölogists as species new to science. As more complete series of collections from the United States have been studied, it has become evident that these forms are so closely connected in series, that distinctions which a few years ago were considered as specific must be cast aside and the whole group united under the name of the European form.

With regard to *Cyclops thomasi* Forbes, I must agree with Dr. Schmeil that there is no need of considering this form as even a variety. A close study of the type specimens of *Cyclops thomasi* reveals a number of small differences between it and *Cyclops bicuspidatus* as described by Dr. Schmeil, but they agree almost exactly with other descriptions, by European investigators, of forms included in Dr. Schmeil's synonymy of *C. bicuspidatus* Claus. Only a single specimen of the form as described by Dr. Schmeil has been found by me in collections from this country. This single individual came from a

pond at Wood's Holl, Mass. The most conspicuous difference between this form and *C. thomasi* is a slight one in the shape of the fifth foot.

In the Illinois River are specimens which bridge over completely the gap between *C. bienspidatus* and Herrick's *C. narius*, and I see no reason for considering *narius* as a good variety.

Cyclops minnilus Forbes is distinguished from *C. thomasi* by different proportions alone. It is one of the western representatives of this species and has been collected in the lakes and rivers of Wyoming.

Cyclops serratus Forbes is found in the same situations as *C. minnilus*, from which it is distinguished by a slight difference in the armature of the feet and by the fact that the vertical comb of spines of the furcal stylets is but poorly developed. The name *serratus* being already in use, Herrick renamed the species *forbesi*. This is the most elongate of the American representatives of the species.

SPECIFIC DESCRIPTION.

This is a long and slender species (Pl. XII., Fig. 1) with seventeen-segmented antennae, oval cephalothorax, slender abdomen, very long and slender caudal stylets, and but two developed setae to each stylet. The longer of these setae is about twice as long as the shorter. The cephalothorax is widest at about the middle. In specimens from the eastern United States the posterior angles of the cephalothorax are not usually prominent except in the case of the last segment, where they are laterally produced. In the far western specimens the posterior angles of all the segments are prominent. The peculiar appearance of the cuticle caused by circular pits or depressions which Dr. Schmeil mentions, is rarely present in the American form. I have found it in greatly varying degrees of definiteness in specimens from Lake Superior and from Wyoming.

The first segment of the abdomen of the female (Pl. XII., Fig. 1) is emarginate behind the prominent lateral angle. This segment is about as long as all the others together. The

posterior margins of all but the last segment are irregularly and often very obscurely serrate. The last segment is bordered posteriorly by the usual row of spinules. The stylets are often slightly outcurved. In relative length to breadth they vary from four to one to nine to one, but the usual proportion is as seven to one. The inner of the two longer setae is as long as the entire abdomen, and the outer of the two but half that length. The extreme outermost of the terminal setae is two thirds as long as the inner. On the outer side of each stylet, a little behind the middle, is placed a spine surrounded at its base by a ring of spinules, and at one fourth of the distance from the proximal end is a vertical comb of small spines (Pl. XII., Fig. 2). This character seems to be invariably present.

The antennae of the female are moderately robust and terminate in the American forms between the posterior end of the first segment and the middle of the third segment. A sense-club is borne on the distal end of the twelfth segment. No hyaline plate is present on the terminal segments. The last three segments gradually increase in length toward the distal end of the antennae, the antepenult being two fifths the length of the last. The two segments preceding the former, taken together, are shorter than the last segment, and about equal to the penultimate.

The armature of the thoracic legs is as follows:—First pair: outer ramus, two spines, four setae; inner ramus, one seta, one spine, four setae. Second pair: outer ramus, three spines, four setae; inner ramus, one seta, one spine, four setae. Third pair, exactly like second. Fourth pair: outer ramus, three spines, four setae; inner ramus, one seta, two spines, two setae.

The fifth pair (Pl. XII., Fig. 3) are two-segmented, the basal segment about as long as broad, with a plumose seta at the outer angle, the terminal segment roughly cylindrical, at least twice as long as broad, with two terminal setae, the outer of which is as long as the seta of the preceding segment and the inner a little more than half that length. This inner seta is sometimes spine-like.

The *receptaculum seminis* (Pl. XII., Fig. 4) is regular in outline, the anterior border being a low arch extending completely across the segment. The posterior portion is much deeper and about half as wide. The broad spermal canals arise from the anterior angles. The porus is exactly between the two anterior angles.

The egg-sacs are usually small and round in the specimens from large lakes; otherwise they are elliptical and very large.

The usual length of the female is 1-1.4 mm.

This species is very widely distributed in America. It has been found in Massachusetts and Wyoming and in all the intervening territory. It is the common pelagic species of the Great Lakes, but also occurs in large numbers in our ponds and rivers. Inhabiting, as it does, such a great amount of territory and such a variety of situations, it is not strange that it proves to be a very variable form. The Massachusetts form is exactly as described by Dr. Schmeil. In Wyoming this species is very much more slender in all its details, though not differing markedly in any other way from the type. Between these two extremes in location are a great number of intermediates in form. The fifth foot is rather variable, but I note no variation in the shape of the *receptaculum seminis*. The vertical combs of spines on the stylets are always present, but are not always conspicuous in the Western specimens. Although the most attenuate specimens examined were usually from large lakes and the most robust from ponds, I find that no other generalizations are possible with regard to the character of the specimens in connection with the nature of the situation—probably on account of the frequent transfers of individuals from one of these situations to another.

Subgenus *Macrocyclops* CLAFS.

Cyclops albidus JURINE. (Pl. XIII.)

Monoculus quadricornis var. *albidus*, Jurine, '20, p. 44, Pl. II.; Fig. 10, 11.

Cyclops quincornis, Forbes, '90a, pp. 707-709, Pl. II., Fig. 9; III., Fig. 14.

Cyclops signatus var. *unicornis*, Herrick and Turner, '95, pp. 106, 107, Pl. XV., Fig. 5-7; XX., Fig. 1-7; XXXIII., Fig. 1, 2.

Cyclops albidus, Schmeil, '92, pp. 128-132, Pl. I., Fig. 8-14b; Pl. IV., Fig. 15.

SYNONYMY.

Since the description of *C. gyrrinus* by Dr. Forbes in 1890, more careful descriptions of *C. albidus* in Europe and further studies in America have established the identity of the two forms. The original description of *C. gyrrinus* was incomplete in that the presence of the sense-club and hyaline plates was not observed.

SPECIFIC DESCRIPTION.

This is a stout, heavy species, with a strongly arched cephalothorax, which, as a whole, is usually quite elliptical, with the lateral angles of the segments almost invisible; but in specimens from Manitoba I find the cephalothorax shaped much as in *C. viridis*. The first segment in these is subspherical, narrowing posteriorly, and the posterior end of the second segment is much broader than the anterior end. All of the lateral angles are prominent. The breadth of the first segment compared with its length is as ten or eleven to twelve.

The dorsum of the fifth segment in this species is ornamented by three or four transverse rows of spinules, the posterior one of which borders the segment.

The abdomen is thick and heavy. The first segment in the female is but slightly enlarged and tapers very little. The remaining segments are cylindrical. The stylets are short and slightly divergent. The proportion of the length to the breadth of the stylet varies but slightly. The usual ratio is two and one half to one. The apical bristles are all well developed, the third from without being the longest, and the innermost three times as long as the outermost.

The first antennae of the female are seventeen-segmented, and reach to the first abdominal segment. The distal three segments bear hyaline plates, entire, except for minute serrations on the distal half of the plate of the seventeenth segment. The twelfth segment bears an unusually large sense-club.

The swimming feet are armed as follows:—First pair: outer ramus, four spines, four setae; inner ramus, one seta,

one spine, four setae. Second and third pairs: outer ramus, four spines, five setae; inner ramus, one seta, one spine, four setae. Fourth pair: outer ramus, three spines, five setae; inner ramus, one seta, two spines (inner naked and movable), two setae (distal one minute).

The fifth foot is two-segmented. The basal segment is two thirds as wide as long, its outer margin straight, its inner, convex and minutely hairy. The distal end is truncate, with a very long seta at the outer distal angle. The second segment is about as long as the preceding is wide, lobed in the middle and trisetose, the outer seta shorter than the inner, and the latter about half as long as the median.

The anterior portion of the *receptaculum seminis* is kidney-shaped and the posterior is two-lobed. The lateral canals are attached to the lower portion.

The usual length of the female in America is from 1.26-1.4 mm., but it seems to be much greater (2.5 mm.) in the European representatives of the species.

The color, which is blue or green, is distributed in dark bands with nearly colorless intervals on the thorax, the last abdominal segment and stylets, and on the second, third, ninth, and tenth antennal segments.

This species is very generally distributed, having been found in all the localities in America from which collections have been examined. It is not common in temporary ponds, but I have several times noted its occurrence in wells.

Subgenus **Homocyclops** n. subgen.

Cephalothorax very robust. Antennae seventeen-segmented. Rami of swimming feet three-segmented. Fifth feet one-segmented, bearing one spine and two setae.

Cyclops ater HERRICK. (Pl. XIV., and Pl. XV., Fig. 1-3.)

Cyclops ater, Herrick, '82a, p. 228, Pl. III., Fig. 9-12.

Cyclops ater, Marsh, '95, pp. 13, 14, Pl. VI., Fig. 1-4, 6, 12.

Cyclops ater, Herrick and Turner, '95, pp. 89, 90, Pl. VII., Fig. 11, 12; XII., Fig. 9-12; XXI., Fig. 13-15, 17, 18.

The cephalothorax is peculiarly short and broad. Its first

segment is very large and is twice as long as the remaining segments together. The posterior edges of all the segments are smooth.

The abdomen is relatively small, but is broad in proportion to its length. It tapers but little and the first segment is scarcely at all enlarged. The segments, except the last, are finely and irregularly notched posteriorly. The caudal stylets are short, the length to the breadth being about as three to one. They are not ciliate within. In the small number of specimens which I have had an opportunity to examine there is no outer lateral spine, but at the usual place for this spine, a little behind the middle, is a shallow scar where a spine might at some time have been attached. I do not think, however, that this is probable. The terminal setae are all well developed, but the median pair is much longer than the lateral ones. The innermost seta is slightly longer than the outermost. Of the four, the second from the inside is the longest.

The first antennae of the female are seventeen-segmented and reach to the middle or end of the second cephalothoracic segment. The twelfth segment bears the usual seta and sense-club, though the latter organ is unusually small. The fourteenth segment bears an especially long, strong seta. The last two segments (Pl. XV., Fig. 1) bear a narrow hyaline lamella which projects some distance beyond the end of the seventeenth segment. The edge of this plate is entire. Of the last three segments, the middle one (sixteenth) is the longest.

The setae of the swimming feet are short and stout. The armature is as follows:—First pair: outer ramus, three spines, five setae; inner ramus, one seta, one spine, four setae. Second and third pairs: outer ramus, four spines, five setae; inner ramus, one seta, one spine, four setae. Fourth pair: outer ramus, three spines, five setae; inner ramus, one seta, two spines, two setae.

The fifth feet (Pl. XV., Fig. 2) are one-segmented and bear one strong spine and two setae each. The spine is about one third the length of the setae. The inner seta, that is the one next the spine, is borne on a conical projection from the

body of the segment. Neither the setae nor the spine seem to be provided with hairs or spinules.

The *receptaculum seminis* (Pl. XV., Fig. 3) is of an unusual and very characteristic shape. The anterior part is small, and its outline is marked by two anterior and two lateral rounded prominences. The posterior part consists of a median lobe, partially divided posteriorly, and two curved lateral lobes from which lead the lateral canals. The porus is in the median part connecting the upper and lower divisions.

The egg-sacs are of the usual size and shape.

In length the female varies from 1.77 to 2.88 mm.

The color is unusually variable. It is commonly dark blue or green but may be gray or red. The deep color and large size make this a conspicuous species.

Herrick says that it is widely but sparingly distributed over the Mississippi Valley. Marsh reports it from Rush, Round, St. Clair, Intermediate, Twenty-sixth, and Susan lakes in Wisconsin. I have noted its occurrence in collections from Thompson's, Quiver, Flag, Phelps, and Dogfish lakes near Havana, Illinois.

Subgenus *Orthocyclops* n. subgen.

Antennae sixteen-segmented. Rami of swimming feet, three-segmented. Fifth feet three-segmented, distal segment bearing two apical setae.

Cyclops modestus HERRICK. (Pl. XV., Fig. 4, and Pl. XVI., Fig. 1-3.)

Cyclops modestus, Herrick, '83a, p. 500.

Cyclops modestus, Herrick and Turner, '95, pp. 108, 109. Pl. XXI., Fig. 1-5.

Cyclops modestus, Marsh, '93, pp. 213, 214. Pl. V., Fig. 10-13.

Cyclops capilliferus, Forbes, '93, pp. 248, 249. Pl. XII., Fig. 14-17; XLI., Fig. 18.

SYNONYMY AND DISTRIBUTION.

By a study of the type specimens of *Cyclops capilliferus* I find that they agree almost completely with Herrick's description of *C. modestus*. The descriptions differ with respect to

the position of certain spines of the feet, but this is really a difference in description rather than in characters. I find also that specimens collected in Wyoming agree exactly with the Illinois representatives of the species.

I have noted its occurrence in collections from Quiver, Dogfish, and Thompson's lakes, and from the Illinois River, near Havana, Ill.; from the Sangamon River, in Champaign county, Illinois; and from Grebe Lake in Yellowstone Park. Marsh reports it from Rush Lake, Wisconsin, and Herriek finds it in Cullman county, Alabama, and in Minnesota lakes. I have never found it in temporary ponds nor in any of the Great Lakes. From the situations in which it occurs I judge that this species seeks shallow, weedy water rather than pelagic situations. It is not an especially rare species, but I have never found more than a very few individuals in a single collection.

SPECIFIC DESCRIPTION.

The cephalothoracic segments are closely articulated and the sides regularly convex. The first segment is longer than usual and the fourth is semicircularly excavate behind. The posterior edges of the first three segments are irregularly notched and the fourth is smooth. The length of the cephalothorax is to its breadth as two to one.

The abdomen is long, slender, and cylindrical, and is peculiar in lacking the usual fringe of spines on the posterior edge of the last segment. The posterior edges of the other segments are likewise smooth. The anterior end of the first segment is but little enlarged. The segments diminish regularly in length from first to last. The caudal stylets are about twice the length of the last segment and four times as long as broad. The lateral seta is placed a trifle beyond the middle of the ramus. Behind the lateral spine the stylet is peculiarly excavate. The outer terminal bristle, which is set farther forward than in most species, is a short, sparsely plumose seta, but the other three setae are well developed. Of these three the middle one is considerably the longest and the inner one slightly shorter than the outer.

The antennæ are regularly sixteen-segmented, though Herrick mentions having notes on a similar form in which the antennæ are seventeen-segmented. They reach to the middle of the second cephalothoracic segment. On the third, tenth, and thirteenth segments are remarkably long, heavy setæ. The antenna (Pl. XVI., Fig. 1) is given a characteristic appearance by the conspicuous seta on the third segment and a sharp change in direction between the third and fourth segments. The last segment is much shorter than the one preceding.

The setæ of the three-segmented legs are long and slender. The distal segments of the third and fourth pairs of legs turn inward in a way peculiar to this species. The legs are armed as follows:—First pair: outer ramus, four spines, four setæ; inner ramus, six setæ. Second pair: outer ramus, four spines, five setæ; inner ramus, six setæ. Third pair: outer ramus, three spines, five setæ; inner ramus, six setæ. Fourth pair: outer ramus, three spines, five setæ; inner ramus, one seta, two spines, two setæ.

The fifth foot (Pl. XVI., Fig. 2) has three freely movable segments, though the basal one is small. The second segment bears one seta without, and the third segment bears two setæ—both at the tip. The outer seta is apt to be bent inward across the inner one. These feet are usually large and placed very close together.

The *receptaculum seminis* (Pl. XVI., Fig. 3) is very much as in *Cyclops bicuspidatus* Claus. It is nearly elliptical in outline, and only a small part of the anterior end extends farther forward than the suture in which the porus is situated. The lateral canals lead from the anterior part.

The egg-sacs are long and narrow and lie close to the abdomen.

In length this species does not vary to any marked degree from an average of 1.2 mm.

The coloring is most beautiful, varying from violet to purple. It is evenly distributed, and is quite persistent in specimens preserved in formalin.

Subgenus **Eucyclops** CLAUSS.

Cyclops serrulatus FISCHER. (Pl. XVII., and Pl. XVIII.,
Fig. 1-3.)

Cyclops serrulatus and *C. serrulatus* var. *montanus*, Brady, '78, Vol.
I., pp. 109-111, Pl. XXII., Fig. 1-14.

Cyclops serrulatus and *C. serrulatus* var. *elegans*, Herrick, '84, Pl. Q.
Fig. 17-19; Pl. Q.; Fig. 10.

Cyclops serrulatus, Schmeil, '92, pp. 141-146, Pl. V., Fig. 6-14.

SYNONYMY, VARIATION, AND DISTRIBUTION.

This is one of the most common and widely distributed of American *Cyclops*. It occurs almost everywhere between Maine and California and from Florida to Manitoba.

Herrick's variety *elegans* is based on such variable characters that no one acquainted with the species throughout its range could for an instant consider this form as worthy of a varietal name, especially since the measurements and descriptions of the type and the variety are contradictory as published in his "Synopsis of the Entomostraca of Minnesota." Herrick says that the variety is distinguished from the type by its greater size and by the elongation of the antennae and caudal stylets; but gives 1.5 mm. as the length of the type, and 1.34 as that of the *larger* variety. In Europe the largest specimen on record measured 2.2 mm. in length, much more than Herrick's large variety. As to the length of the antennae, I find that this varies immensely and quite independently of other variations in proportion. Below is a series of measurements of seven egg-bearing females of this species, from widely separated situations and exhibiting its variability. Further study of a much larger number of specimens has convinced me that there are no varietal distinctions possible among the American representatives of this species, unless for convenience we arbitrarily separate off the extreme forms. With the exception of the specimen from Thompson's Lake, each individual is fairly representative of the species as found in its own locality.

Locality	Length to breadth of caudal stylet	Antenna terminates	Length	Breadth.
Portage La Prairie, Manitoba078 : .018 = 4.3 : 1	Before end of first segment.	.7	.252
Urbana, Ill.027 : .015 = 1.8 : 1	End of first segment.	.54	.198
Spoon River, Ill.072 : .0225 = 3.2 : 1	End of first segment.	.792	.324
Thompson's Lake, Ill.075 : .018 = 4.2 : 1	End of third segment.	.72	.216
Pelican Creek, Wyo.	.087 : .03 = 2.9 : 1	Middle of second segment.	.882	.324
Wood's Holl, Mass..	.111 : .027 = 4.1 : 1	Middle of third segment.	.882	.36
Lake Geneva, Wis..	.24 : .027 = 8.9 : 1	End of third segment.	1.426	.45

It is also my opinion that Brady's variety *montanus* should be considered as merely a variation of the typical form.

SPECIES DESCRIPTION.

The cephalothorax (Pl. XVII.) is quite regular in shape, being almost exactly elliptical in outline. Its segments are closely joined and its lateral outlines smooth. The fourth segment is deeply excavated behind and is usually bordered by fine sharp teeth or by long hairs.

The abdomen (Pl. XVII., and Pl. XVIII., Fig. 1) is broad in front, but narrows so rapidly posteriorly that the greater part of the first segment is as narrow as the slender segments following. Behind the enlargement of the first segment the abdomen tapers very little. The last segment is bordered posteriorly by the usual row of spinules, and the preceding segments by fine sharp serrations. The stylets are commonly about straight, but are occasionally strongly outcurved and divergent. Their length to breadth varies from 1:1.8 to 1:9 but 1:4 is the commonest proportion. A row of spinules, spines, or curved hooks marks the outer border of each stylet and extends from its base to the point of insertion of the outer apical spine, near the posterior end. These projections in-

crease rapidly in length at the posterior end and fade away in front. The male does not have this character, and adult females are very rarely found without it. Of the four apical bristles the middle two are well developed. The inner one of this pair is much longer than the outer. The innermost of the four is a very slender seta. The outermost varies in character from a long seta bordered externally by barbules and internally by long slender cilia, to a long strong spine serrate on both sides. It may be anywhere from one half to four fifths as long as the stylet.

The first antennæ are twelve-segmented. Dr. Schmeil notes the presence of a minute sensory bristle on the ninth segment in the place occupied by the sense-club on the twelfth segment of seventeen-segmented antennæ. It is very inconspicuous indeed. The last three segments are usually very long and are armed on the inner side by hyaline plates.

The usual armature of the swimming feet is as follows:—First pair: outer ramus, three spines, five setæ; inner ramus, one seta, one spine, four setæ. Second and third pairs: outer ramus, four spines, five setæ; inner ramus, two spines, four setæ. Fourth pair: outer ramus, three spines, five setæ; inner ramus, one seta, two spines, two setæ.

The fifth foot (Pl. XVIII., Fig. 2) is one-segmented and plate-like. On the inner side is a very strong serrate spine. At the tip, borne on a cone-shaped projection, is a very long slender seta, parallel to the spine. On the outer side is a delicate little seta projecting outward at a considerable angle.

The *receptaculum seminis* (Pl. XVIII., Fig. 3) is almost completely divided into an anterior and a posterior part, by a median constriction. The porus is situated in the middle of this narrow connecting part. The lower half extends down into the narrow part of the first abdominal segment. The spermal canals are attached to the receptaculum at the outer angles of the lower part.

The egg-sacs are usually long, with many eggs, but sometimes contain only a few, arranged in a spherical mass.

Ordinarily the egg-sac tapers to a sharp point at the lower end, and stands out from the abdomen at a wide angle.

The size is remarkably variable. In Europe, the length varies from .883 to 2.2 mm. In America I have measured specimens varying in length from .54 to 1.47 mm. A common length is .9 mm.

Cyclops prasinus FISCHER. (Pl. XIX., Fig. 1 and 2, and Pl. XX., Fig. 1 and 2.)

Cyclops prasinus, Fischer, '60, pp. 652-654, Pl. XX., Fig. 19-26a.

Cyclops fluvialtilis, Herrick, '82 a, p. 231, Pl. VII., Fig. 1-9.

Cyclops magnocarpus, Cragin, '83, pp. 70, 71, Pl. III., Fig. 14-23.

Cyclops prasinus, Schmeil, '92, pp. 150-156, Pl. V., Fig. 1-5.

Cyclops fluvialtilis, Herrick and Turner, '95, pp. 114, 115, Pl. XXVI., Fig. 1-8; XXX., Fig. 1.

SYNONYMY AND DISTRIBUTION.

On account of the great difficulty in determining the structure of the *receptaculum seminis* of *C. prasinus*, this organ has escaped study in the American representatives of this species, and although Marsh had noted a general resemblance of Herrick's *C. fluvialtilis* to Vosseler's *C. pentagonus* (*C. prasinus* Fischer), he did not consider these as identical. By a careful study of a large number of specimens of *C. fluvialtilis* from Illinois, Florida, and Wisconsin, I find a complete agreement in the characters of the *receptaculum seminis* of *C. prasinus* and *C. fluvialtilis* and in all other specific characters as well.

I have noted the occurrence of *C. prasinus* in collections from Sister Lake, Florida; Long Lake, Adams county, Ill.; ponds and temporary pools at Urbana, Ill.; Illinois River at Havana, Ill.; Phelps, Flag, and Thompson's lakes in Fulton county, Ill.; Dogfish and Quiver lakes in Mason county, Ill.; and from Lake Geneva, Wisconsin. Herrick reports it from Lake Minnetonka, Minn., and from an estuary of the Mississippi. Marsh finds the species in Lakes Erie, Michigan, and St. Clair, and in fifteen smaller lakes of Michigan and Wisconsin. Cragin found it in ditches at Cambridge, Mass.

It is thus, in all probability, quite generally distributed over the eastern and central United States, but I have not found it in collections from the far West. It occurs in all situations from great lakes and rivers to temporary roadside puddles of but a few weeks' duration.

SPECIFIC DESCRIPTION.

This minute species has a slender cephalothorax which is very nearly elliptical in outline. The first segment is regularly convex anteriorly and is unusually long. The posterior borders of the segments are entire. The lateral edges of the last segment are fringed by a row of the finest hairs.

The abdomen is long and slender and tapers but little. The enlargement of the anterior segment is slight. The posterior borders of all the abdominal segments are very finely serrate. The stylets are short and divergent but are not themselves outcurved. The lateral spine is inserted just beyond the middle of the stylet. The inner and outer apical bristles are very short and delicate, the inner one, the longer of the two. Only the middle pair of setæ are well developed, and the outer of these is three fourths the length of the inner.

The first pair of antennæ (Pl. XIX., Fig. 2) of the female are twelve-segmented and often reach quite to the first abdominal segment. The seventh, eighth, and ninth segments are very long. The last three segments are curved and the last four are freely movable. Schmeil states that the ninth segment bears a sense-club. I do not find it present in the American representatives of the species, although there is a minute sensory bristle on the end of the tenth segment. The last three segments bear a hyaline plate whose edge is entire.

The spines and setæ of the three-segmented swimming feet are very long and slender. The armature is as follows:—First pair: outer ramus, three spines, five setæ; inner ramus, six setæ. Second pair: outer ramus, four spines, five setæ; inner ramus, six setæ. Third pair armed like second. Fourth pair: outer ramus, three spines, five setæ; inner ramus, one seta, one spine, three setæ.

The fifth foot (Pl. XX., Fig. 1) is one-segmented and bears

three bristles. The inner one is a ciliate spine while the other two are plumose setæ. The middle one of the three is borne at the tip of a cone-shaped process. The inner edge of the foot is bordered by a row of minute hairs.

The *receptaculum seminis* (Pl. XX., Fig. 2) is most peculiar and characteristic. It consists of two parts, anterior and posterior, separated by the suture marking the original division of the first abdominal segment. The upper part consists of two S-shaped canals, one on each side of the median line, extending across the abdomen. The inner ends which point downward, fuse in a thicker portion connecting the anterior division with the posterior. The part of the receptaculum behind the suture consists of two lateral sacs, which connect with each other and with the upper part of the receptaculum at the same point. In the middle of this common part is the porus. The outer ends of the tubular portion are slightly enlarged; otherwise the diameter is uniform. The structure of this organ has never before been observed in the American representatives of *Cyclops prasinus*.

The egg-sacs contain few ova and are closely adherent to the abdomen.

The length of the female varies from .48 to .7 mm.

The color is unusually variable. The prevailing color of European specimens seems to be green. I have seen both blue and pink individuals. Herrick says that the color varies from deep indigo to greenish brown.

Subgenus **Paracyclops** CLAUS.

Cyclops phaleratus KOCH. (Pl. XX., Fig. 3.)

Cyclops phaleratus, Koch. '35-'41, Heft 21, pp. 8, 9, Pl. IX.

Cyclops perarmatus, Cragin, '83, pp. 72, 73, Pl. I, Fig. 9-18.

Cyclops phaleratus, Schmeil, '92, pp. 170-178, Pl. VIII., Fig. 1-11.

Cyclops phaleratus, Herrick and Turner, '95, pp. 120, 121, Pl. XVII.,

Fig. 1-7; XVIII., Fig. 2-2d; XIX., Fig. 1; XXI., Fig. 6-10.

Cyclops phaleratus, Marsh, '95, pp. 19, 20.

DISTRIBUTION.

In America this species is rare, though evidently widely distributed. I have noted its occurrence in collections from the Illinois River at Havana, Ill.; a pond at Urbana, Ill.:

Delavan Lake, Wisconsin; Quiver Lake, Ill.; Green Lake, Wisconsin; Cedar Lake, Ill.; and a slough at Portage La Prairie, Manitoba. Marsh reports it from Lake St. Clair; and from Twenty-sixth Lake, Pigeon River, and Intermediate Lake, Michigan. Cragin describes this species as *Cyclops perarmatus* from Glacialis Pond, Cambridge, Mass. It is a littoral rather than a pelagic form and where occurring in large bodies of water it is found only in the marginal vegetation.

SPECIFIC DESCRIPTION.

The cephalothorax is broad and elliptical. The first segment is longer than the remainder. The chitinous covering of the fifth segment, which in all other species of this genus is composed like the four preceding cephalothoracic segments of a dorsal and ventral plate, is in *C. phaleratus* like the chitinous covering of the abdominal segments in that it consists of but one piece. The ventral portion of the posterior border of this segment is set with a row of fine teeth, evanescent in the middle. About the rudimentary feet are several rows of fine spinules.

The abdomen is large and cylindrical, and very little smaller than the last cephalothoracic segment. The first segment tapers very little. The posterior borders of the first, second, and third abdominal segments of the female are finely serrate. The last segment is very short and the spines on its posterior border are especially long and strong. The profusely spinose stylets are short and broad and taper very rapidly. On the ventral side of each ramus is a row of long spinules, extending from the middle line of the anterior border to the point of insertion of the lateral spine. From this point on, the rami taper much more rapidly. The inner border of the stylets is ciliate and the whole inner aspect may be spinose. The outermost apical bristle, which is placed high up on the side of the stylet, is short, and plumose on both sides. The inner bristle is very slender and is about as long as the outer. It is plumose on the outside only.* The two median bristles

*Incorrect in figure.

alone are well developed. The inner one of this pair is from two to three times as long as the outer. Except for the outer side of the outer one of the pair, the anterior third of each is naked. The remainder is usually sparsely plumose.

The antennæ of the female may be either ten- or eleven-segmented and reach only a little beyond the middle of the first cephalothoracic segment. In the ten-segmented antenna the seventh segment bears a delicate sensory hair at its distal end. This hair is borne on the eighth segment of the eleven-segmented antenna.

The second antennæ are short and proportionately broad. On the outer side of the second segment is a double row of spinules. On the upper border of this segment is a spine and a fringe of spinules. This spine and the shortest one at the end of the third segment are very peculiar. Both are strongly curved near the tip, and the inner side of this curve is fringed by a comb-like row of teeth.

The three-segmented swimming-feet are strongly armed and their outer borders bear rows of long spinules. The armature of the distal segments is as follows:—First pair: outer ramus, three spines, five setæ; inner ramus, one spine, four setæ. Second pair: outer ramus, four spines, four setæ; inner ramus, one spine, four setæ. Third pair: outer ramus, four spines, five setæ; inner ramus, one spine, four setæ. Fourth pair: outer ramus, three spines, five setæ; inner ramus, one seta, two spines, two setæ.

The rudimentary feet are lateral rather than ventral and consist of mere flange-like processes. They are connected by a row of strong serrations extending across the ventral side of the segment. Each foot is armed by three subequal spines, one naked and the other two plumose.

The *receptaculum seminis* consists of two sections, which extend as two narrow bands across the segment. The porus is situated on the median line where the two divisions unite.

The egg-sacs contain many eggs and are closely appressed to the abdomen. Schmiedl calls attention to the fact that the oviducts, which in all other species are contained wholly within the cephalothorax, in *C. phaleratus* extend as blind

saes as far back in the abdomen as the anterior border of the third segment.

The female varies in length from .9 mm. to 1.26 mm., and the male is usually about .2 mm. shorter. The largest specimens measured came from Portage La Prairie, Manitoba.

This is a beautifully colored species. The ground color is reddish brown. The second cephalothoracic segment, the last abdominal segment with the stylets, the swimming feet, and the last segment of the first antennæ are sky-blue. A yellow spot surrounds the eye.

The egg-sacs are dark blue or black.

The best character for the ready recognition of this species is its strong superficial resemblance to the genus *Canthocamptus*.

GENERAL DISTRIBUTION OF CYCLOPS IN NORTH AMERICA.

Of the eighteen species and three varieties of Cyclops which have been reported as occurring in North America, but three species and two varieties, namely, *ater*, *modestus*, and *edar*, and varieties *insectus* and *brevispinosus* of *viridis* are characteristic of America, while the remaining fifteen species and one variety are common to both Europe and America.

Probably *bicuspidatus*, *serrulatus*, *viridis*, *albidus*, and *edar* might be found in any state in the Union, so general is their distribution.

In the Great Lakes by far the most abundant species are *bicuspidatus* and *edar*. Often either one or the other of these two species will constitute nearly the whole of the crustacean plankton.

Collections from the high lakes and ponds of the Northwest usually contain Cyclops, often in considerable numbers, but they are never present in such great quantities as is the genus *Diaptomus* and the Cladocera. The commonest of these mountain forms are as follows: *bicuspidatus*, *viridis* var. *insectus*, *serrulatus*, and *albidus*, though *viridis* var. *brevispinosus*, *bicolor*, *dybourskii*, *modestus*, and *edar* have been found in such situations. In collections from Crater Lake, Oregon, I found a very few specimens of *albidus* and *ser-*

ralatus. This lake is in the Cascade Mountains and is the highest lake of its size in the world.

As very few observations have been made on the Cyclopidae of rivers, I examined a continuous series of collections made in the Illinois River at the Illinois Biological Station, extending from May to September, 1896. In the first of these collections *bicuspidatus* was the predominating form, but it soon disappeared entirely, its place being taken by *viridis* var. *insectus*. From this time throughout the summer *insectus* was by far the most abundant form. *Edax*, *viridis* var. *brevispinosus*, *leuckarti*, *prasinus*, *scerrulatus*, and *varicans* were common in the collections, while *jimbriatus* var. *popei*, *viridis*, *modestus*, *bicolor*, *albidus*, and *phaleratus* were of rare occurrence.

LIST OF NORTH AMERICAN SPECIES.

Below is a list of the fresh-water Cyclopidae reported from America. I have myself seen all of the species of this list except those herein credited to Herrick.

Genus *CYCLOPS*.

I. Subgenus *Cyclops* s. str. Claus.

1. *Cyclops leuckarti* Claus.

This is a rare species throughout the north central States.

2. *Cyclops insignis* Claus, *vide* Herrick.

Herrick has found at Long Island a form which he identifies as this species.

3. *Cyclops edax* Forbes.

This is a very common species in the Great Lakes and in the waters of the north central States, Florida, and Wyoming. It occurs in Argentina, South America.

4. *Cyclops oithonoides* Sars, *vide* Herrick.

I regard the occurrence of this species in America as very doubtful.

5. *Cyclops dybowskii* Lande.

A rare species found only in the small mountain lakes of Wyoming and in a temporary pond at Urbana, Illinois.

6. *Cyclops viridis* Jurine.

Either the typical form or its varieties occur everywhere in the fresh waters of the United States. It is the commonest form of the temporary ponds.

a. var. *brerispinosus* Herrick.

b. var. *insectus* Forbes.

7. *Cyclops bicuspidatus* Claus.

This species is of the widest range and greatest abundance. It is the commonest Cyclops in the Great Lakes.

8. *Cyclops vernalis* Fischer.

Occurs in small numbers in Lake Geneva, Wisconsin.

II. Subgenus *Macrocyclus* Claus.

9. *Cyclops fuscus* Jurine.

Occurs sparingly in the ponds and lakes of Wisconsin, Michigan, Illinois, and Massachusetts.

10. *Cyclops albidus* Jurine.

Rather a common species throughout the whole range of the genus.

III. Subgenus *Homocyclus* n. subgen.

11. *Cyclops ater* Herrick.

Very rare throughout the Mississippi Valley. Also in Lake St. Clair (Kofoid).

IV. Subgenus *Orthocyclus* n. subgen.

12. *Cyclops modestus* Herrick.

An uncommon species in the lakes and streams of Wyoming, Alabama, and the north central States.

V. Subgenus *Microcyclus* Claus.

13. *Cyclops bicolor* Sars.

Rare in Wyoming, Illinois, Wisconsin, Michigan, and Minnesota.

14. *Cyclops caricans* Sars.

A fairly common species throughout the range of *Cyclops* in North America.

VI. Subgenus *Eucyclops* Claus.

15. *Cyclops serrulatus* Fischer.

Very common everywhere.

16. *Cyclops prasinus* Fischer.

Abundant in all sorts of waters in the Mississippi Valley, Massachusetts, and Florida.

VII. Subgenus *Paracyclops* Claus.

17. *Cyclops phaleratus* Koch.

A rare species in Manitoba, Massachusetts, Alabama, and the north central States.

18. *Cyclops fimbriatus* var. *poppei* Rehberg.

A rare species in Manitoba, Alabama, and the north central States.

19. *Cyclops affinis* Sars, *vide* Herrick.

If this form occurs in America it is very rare, and limited in its distribution.

BIBLIOGRAPHICAL LIST OF ARTICLES
CONSULTED.

Apstein, C.

- '92. Quantitative Plankton-Studien im Süßwasser. Biol. Centrabl., Bd. XII., No. 16 u. 17, pp. 484-512.
'92a. Über das Plankton des Süßwassers. Sitzungsber. d. naturw. Ver. f. Schleswig-Holstein, Bd. IX., Heft 11., 3 pp.
'94. Vergleich der Planktonproduktion in verschiedenen holsteinischen Seen. Ber. d. naturf.-Gesellsch. zu Freiburg i. B., Bd. VIII., pp. 70-78.

Asper, G.

- '80. Beiträge zur Kenntnis der Tiefseefauna der Schweizerseen. Zool. Anz., III. Jahrg., Nos. 51 and 54, pp. 130-134, 260-267.

Baird, W.

- '50. The Natural History of the British Entomostraca. 364 pp., 36 Pls.

Barrois, Th.

- '95. Fauna der Gewässer Syriens. Biol. Centrabl., Bd. XV., Nr. 24, pp. 869-873.

Birge, E. A.

- '94. Plankton Studies on Lake Mendota. I. The Vertical Distribution of the Pelagic Crustacea during July, 1894. Trans. Wis. Acad. Sci., Arts, and Letters, Vol. X., pp. 421-484, Pls. VII.-X.

Blanchard, R., et Richard, J.

- '90. Sur les Crustacés des Sebchas et des Chootts d'Algérie. Bull. de la Soc. zool. de France, T. XV., pp. 136-138.
'91. Faune des Lacs Salés d'Algérie. Mém. de la Soc. zool. de France, T. IV., pp. 512-535, Pl. VI.

Boeck, A.

- '65. Oversigt over de ved Norges Kyster iagttagne Copepoder hørende til Calanidernes, Cyclopidernes og Harpacticidernes Familier. Vidensk.-Selsk. Förh. Christiania, 1864, pp. 226-281.

Brady, G. S.

- '68. Notes on the Crustacean Fauna of the English Lakes. Intell. Obs., No. LXXII., pp. 416-424, Pl. I.
'69. On the Crustacean Fauna of the Salt Marshes of Northumberland and Durham. Nat. Hist. Trans. North. and Durh., Vol. III., pp. 120-136, Pls. IV., V.
'78-'80. A Monograph of the Free and Semi-Parasitic Copepoda of the British Islands, Vol. I., pp. 1-148, Pls. 1-33; Vol. II., pp. 1-182, Pls. 34-82; Vol. III., pp. 1-84, Pls. 83-93.

- '91. A Revision of the British Species of Fresh-water Cyclopida and Calanida. Nat. Hist. Trans. Northumb., Durh. and Newcastle-upon-Tyne, Vol. XI. Part I., pp. 68-120, Pls. I.-XIV.

Camera, C.

- '92. Ricerche sui Copepodi liberi del Piemonte. Boll. dei Mus. di Zool. ed Anat. comp. della R. Univ. di Torino, Vol. VII., No. 120, pp. 1-13.

Canu, E.

- '92. Les Copépodes du Boulonnais. Morphologie, Embryologie, Taxonomie. Trav. du Lab. de Zool. Marit. de Wimereux-Ambleteuse, T. VI. 294 pp., 30 Pls.

Cederström, G. C. U.

- '93. Om Vara Cyclops-former. Ent. Tidskrift, Arg. 11. Häft 1-3, pp. 145-152.

- '93a. Tillägg till Afhandlingen om Cyclopiderna. Ent. Tidskrift, Arg. 11. Häft 4, pp. 243-247, Fig. 1-24.

Claus, C.

- '57. Das Genus Cyclops und seine einheimischen Arten. 40 pp., 3 Pls. Marburg.

- '58. Zur Anatomie und Entwicklungsgeschichte der Copepoden. Arch. f. Naturgesch., XXIV. Jahrg., Bd. I., pp. 1-76, Taf. I.-III.

- '63. Die freilebenden Copepoden mit besonderer Berücksichtigung der Fauna Deutschlands, der Nordsee und des Mittelmeeres. 230 pp., 37 Pls. Leipzig.

- '76. Untersuchungen zur Erforschung der genealogischen Grundlage des Crustaceen-Systems. Ein Beitrag zur Descendenzlehre. 114 pp., 19 Pls. Wien.

- '91. Über das Verhalten des nervösen Endapparates an den Sinneshaaren der Crustaceen. Zool. Anz., XIV. Jahrg., No. 375, pp. 363-368.

- '93. Über die Bildung der Greifantenne der Cyclopiden und ihre Zurückführung auf die weiblichen Antennen und auf die der Calaniden. Zool. Anz., XVI. Jahrg., Nos. 423 u. 424, pp. 261-269, 277-285.

- '93a. Über die Antennen der Cyclopiden und die Auflösung der Gattung Cyclops in Gattungen und Untergattungen. Anz. der K. Akad. d. Wissensch. Wien., Nr. IX., pp. 79-83.

- '93b. Über die sogenannten Bauchwirbel am integumentalen Skelet der Copepoden und die medianen Zwischenplatten der Ruderfußpaare. Arb. Zool. Inst. Univ. Wien., T. X., 3 Heft, pp. 217-232, Taf. XXIII.-XXV.

- '93c. Neue Beobachtungen über die Organisation und Entwicklung von Cyclops. Ein Beitrag zur Systematik der Cyclopiden. Arb. Zool. Inst. Univ. Wien., T. X., 3 Heft, pp. 283-356, Taf. XXXI.-XXXVII.

'93d. Weitere Mittheilungen über die Antennen-gliederung und über die Gattungen der Cyclopiden. Anz. der K. Akad. d. Wissensch. Wien., Nr. XIII., pp. 116-120.

'95. Über die Wiederbelebung im Schlamme eingetrockneter Copepoden und Copepoden-Eier. Arb. Zool. Inst. Univ. Wien, T. XI., 1 Heft, pp. 1-11, Taf. I., II.

'95a. Über die Maxillarfüsse der Copepoden. Arb. Zool. Inst. Univ. Wien, T. XI., 1 Heft, pp. 49-63, Taf. VIII.

Cragin, F. W.

'83. A Contribution to the History of the Fresh-water Copepoda. Trans. Kansas Acad. Sci., Vol. VIII., pp. 66-80. Pls. I.-IV.

Daday, E. v.

'84. Catalogus Crustaceorum faunae Transylvaniae. Orv.-Természettud. Értesítő, Vol. IX., pp. 161-187.

'85. Neue Thierarten aus der Süßwasserfauna von Budapest. Term. fiz., Bd. IX., No. 2, pp. 208-215, Taf. IX.

'85a. Monographia Eucopodorum liberorum in Hungaria hucusque repertorum. Math. és Természettud. Közlem., Vol. XIX., pp. 117-311. Pls. I.-IV.

'91. Adatok Magyarország édesvizi mikroszkopos faunájának ismeretéhez. Term. fiz., Vol. XIV., pp. 16-31. Pl. I.

'91a. Beiträge zur mikroskopischen Süßwasserfauna Ungarns. Term. fiz., Bd. XIV., pp. 107-123. Pl. I.

Dana, J. D.

'48. Conspectus Crustaceorum quae in Orbis terrarum circumnavigatione, Caroli Wilkes e Classe Reipublicae Federatae duce, collectorum. Proc. Am. Acad. Arts and Sci., Vol. I., pp. 149-155.

Eusebio, J. B.

'88. Recherches sur la faune des eaux du Plateau Central. Le Faune Pélagique des Lacs d'Auvergne. Trav. Labor. Zoöl. Girod, T. I., pp. 1-29, Pl. I.

Fischer, S.

'60. Beiträge zur Kenntniss der Entomostraceen. Abhandl. d. kgl. bayerisch. Acad. d. Wissensch., Bd. VIII., Abth. III., pp. 615-682. Taf. XX.-XXII.

Forbes, S. A.

'76. List of Illinois Crustacea, with Descriptions of New Species. Bull. Ill. State Lab. Nat. Hist., Vol. I., No. 1, pp. 3-25.

'82. On the Food of Young Whitefish (*Coregonus*). Bull. U. S. Fish Comm., Vol. I., pp. 269, 270.

'82a. On some Entomostraca of Lake Michigan and Adjacent Waters. Am. Nat., Vol. XVI., pp. 537-543, 640-650, Pls. VIII., IX.

- '87. The Lake as a Microcosm. Bull. Peoria Sci. Ass'n, 1887. 15 pp.
- '90. Preliminary Report upon the Invertebrate Animals inhabiting Lakes Geneva and Mendota, Wisconsin, with an Account of the Fish Epidemic in Lake Mendota in 1884. Bull. U. S. Fish Comm., Vol. VIII., pp. 473-487.
- '90a. On some Lake Superior Entomostraca. Ann. Rep. U. S. Comm. Fish and Fisheries, 1887, pp. 701-717, Pls. I-IV.
- '93. A Preliminary Report on the Aquatic Invertebrate Fauna of the Yellowstone National Park, Wyoming, and of the Flathead Region of Montana. Bull. U. S. Fish Comm., 1891, pp. 207-258, Pls. XXXVII.-XLII.
- Fric^v (Fritsch), A.**
- '72. Die Krustenthiere Böhmens. Archiv der naturw. Landesdurchf. Böhmen, Band II., Abth. IV., pp. 203-269.
- '95. Über Schmuckfarben einiger Süßwasser-Crustaceen. Bull. Internat'l Acad. des Sci. de l'Empereur François Joseph I., Classe des Sci. Math. et Nat. II. 7 pp., 2 colored plates.
- Fritsch (Fric^v, A., u. Vávra, V.**
- '92. Vorläufiger Bericht über die Fauna des Unter-Pocernitzer- und Gatterschläger Teiches. Zool. Anz., XV. Jahrg., No. 382, pp. 26-30.
- '94. Untersuchungen über die Fauna der Gewässer Böhmens. IV. Die Tierwelt des Unterpočernitzer und Gatterschläger Teiches als Resultat der Arbeiten an der übertragbaren zoologischen Station. Arch. d. naturw. Landesdurchf. v. Böhmen, Bd. IX., Nr. II. 123 pp.
- Fric^v, J. A.**
- '82. Note préliminaire sur l'ontogénie de nos Copépodes d'eau douce. Zool. Anz., V. Jahrg., No. 121, pp. 498-503.
- Garbini, A.**
- '94. Primi materiali per una Monografia limnologica del Lago di Garda. Bull. della Soc. Entom. It., Anno XXVI., pp. 1-50.
- '95. Appunti di Carcinologia Veronese. Estratto dal Vol. LXXI., Série III., Fasc. I., dell'Accademia di Verona. 91 pp.
- Giesbrecht, W.**
- '81. Die freilebenden Copepoden der Kieler Förhrde. Ber. d. Kom. z. w. Unters. d. deutsch. Meere in Kiel, pp. 87-168, Taf. I.-XII.
- Gruber, A.**
- '78. Die Bildung der Eiersäckchen bei den Copepoden. Zool. Anz. I. Jahrg., p. 247.
- Guerne, J. de**
- '87. Notes sur la faune des Açores. Diagnoses d'un Mollusque, d'un Rotifère, et de trois Crustacés nouveaux. Le Naturaliste, 1887. 7 pp.

'87a. La faune des eaux douces des Açores et le transport des animaux à grande distance par l'intermédiaire des oiseaux. *Compt. rend. de la Soc. Biol.*, Séance du 22 oct., 1887. 4 pp.

'88. Excursions zoologiques dans les îles de Fayal et de San Miguel (Açores). Campagnes scientifiques du Yacht monégasque l'Hironnelle. *Troisième Ann.* (1887). pp. 7-110.

Guerne, J. de, et Richard, J.

'89. Sur la faune des eaux douces du Groenland. *Compt. rend. de l'Acad. des Sci.*, 25 mars, 1889.

'89a. Note sur les Entomostracés d'eau douce recueillis par M. Charles Rabot dans la Province de Nordland, Norvège septentrionale. *Bull. de la Soc. zool. de France*, T. XIV., pp. 27-31.

'91. Entomostracés, Rotifères, et Protozoaires provenant des récoltes de M. E. Belloc dans les étangs de Cazau et de Hourtins (Gironde). *Bull. de la Soc. zool. de France*, T. XVI., pp. 112-115.

'91a. Sur quelques Entomostracés d'eau douce de Madagascar. *Bull. de la Soc. zool. de France*, T. XVI., pp. 223. 224.

'91b. Entomostracés recueillis par M. Charles Rabot en Russie et en Sibérie. *Bull. de la Soc. zool. de France*, T. XVI., pp. 232-236.

'92. Cladoécères et Copépodes d'eau douce des environs de Rufisque. *Mém. de la Soc. zool. de France*, T. V., pp. 526-538.

'92a. Voyage de M. Charles Rabot en Islande. Sur la faune des eaux douces. *Bull. de la Soc. zool. de France*, T. XVII., pp., 75-80.

'92b. Sur la faune pélagique de quelques lacs des Hautes-Pyrénées. *Assoc. franç. pour l'avanc. des Sci.*, Congrès de Pau, séance du 19 sept. 3 pp.

'93. Sur la faune pélagique des lacs du Jura français. *Compt. rend. de l'Acad. des Sci.* 3 pp.

Häcker, V.

'95. Über die Selbständigkeit der väterlichen und mütterlichen Kernbestandtheile während der Embryonalentwicklung von Cyclops. *Arch. f. mikr. Anat.*, Bd. 46, pp. 579-618, Taf. XXVIII.-XXX.

Hartog, M. M.

'88. The Morphology of Cyclops and the Relations of the Copepoda. *Trans. Linn. Soc. London*, Vol. V., Part I., pp. 1-46, Pls., I-IV.

Hartwig, W.

'93. Verzeichniss der lebenden Kriebsthiere der Provinz Brandenburg. *Statt handschriftl. Mittheilungen herausgeg. v. Märkischen Prov.-Mus. der Stadtgemeinde Berlin.* Pp. 1-44.

- '94. Die lebenden Krebstiere der Provinz Brandenburg. Nachtrag zu meinem "Verzeichniss" von 1893. "Brandenburgia." Monatsblatt der Gesellsch. f. Heimatkunde der Prov. Brandenburg zu Berlin, Nr. 7, Okt., 1894, pp. 165-169.

Hay, W. P.

- '92. The Crustacea of Indiana. Proc. Ind. Acad. Sci., 1891, pp. 147-151.

Heller, C.

- '71. Untersuchungen über die Crustaceen Tirols. Ber. des med.-naturw. Vereins in Innsbruck, 1 Jahrg., pp. 67-96. Taf. I, II.

Herriek, C. L.

- '79. Microscopic Entomostraca. Seventh Ann. Rep. Geol. and Nat. Hist. Surv. Minn., pp. 81-123, Pls. I.-XXI.
- '82. Habits of Fresh-water Crustacea. Am. Nat., Vol. XVI., pp. 813-816.
- '82a. Papers on the Crustacea of the Fresh Waters of Minnesota. Tenth Ann. Rep. Geol. and Nat. Hist. Surv. Minn., pp. 221-255, Pls. I.-XI.
- '83. Heterogenesis in the Copepod Crustacea. Am. Nat., Vol. XVII., pp. 208-212.
- '83a. Heterogenetic Development in Diaptomus. Am. Nat., Vol. XVII., pp. 381-389, 499-505, Pls. V.-VII.
- '83b. Types of Animal Life selected for Laboratory Use in Inland Districts. 33 pp., 1 Pl. Minneapolis.
- '84. A Final Report on the Crustacea of Minnesota included in the Orders Cladocera and Copepoda. Twelfth Ann. Rep. Geol. and Nat. Hist. Surv. Minn., pp. 1-191., Pls. A-V.
- '87. Contribution to the Fauna of the Gulf of Mexico and the South. List of Fresh-water and Marine Crustacea of Alabama, with Descriptions of the New Species and Synoptical Keys for Identification. Mem. Denison Sci. Ass'n. Vol. I., No. 1., pp. 1-56, Pls. I.-VII.

Herriek, C. L., and Turner, C. H.

- '95. Synopsis of the Entomostraca of Minnesota. Geol. and Nat. Hist. Surv. Minn., Zool. Series, II. 525 pp., 81 Pls.

Hoek, P. P. C.

- '76. Zur Kenntniss der freilebenden Süßwasser-Copepoden der Niederländischen Fauna. Nied. Arch. f. Zool., Bd. III., Heft II., pp. 127-140. Taf. VII.-IX.
- '78. De vrijlevende Zoetwater-Copepoden der Nederlandsche Fauna. Tijdschr. der Nederlandsche Dierkundige Vereeniging, Deel III., pp. 1-36, Taf. I-V.

Imhof, O. E.

- '83. Die pelagische Fauna und die Tiefseefauna der zwei Savoyersseen: Lac du Bourget und Lac d'Annecy. Zool. Anz., VI. Jahrg., No. 155, pp. 655-657.
- '84. Weitere Mittheilungen über die pelagische Fauna der Süßwasserbecken. Zool. Anz., VII. Jahrg., No. 169, pp. 321-327.
- '85. Pelagische Thiere aus Süßwasserbecken in Elsass-Lothringen. Zool. Anz., VIII. Jahrg., No. 211, pp. 720-723.
- '85a. Weitere Mittheilung über die pelagische und Tiefseefauna der Süßwasserbecken. Zool. Anz., VIII. Jahrg., No. 190, pp. 160-163.
- '86. Neue Resultate über die pelagische und Tiefseefauna einiger im Flussgebiet des Po gelegener Süßwasserbecken. Zool. Anz., IX. Jahrg. No. 214, pp. 41-47.
- '86a. Vorläufige Notizen über die horizontale und verticale geographische Verbreitung der pelagischen Fauna der Süßwasserbecken. Zool. Anz., IX. Jahrg., No. 224, pp. 335-342.
- '86b. Über mikroskopische pelagische Thiere aus der Ostsee. Zool. Anz., IX. Jahrg., No. 235, pp. 612-615.
- '87. Über die microscopische Thierwelt hochalpiner Seen. Zool. Anz., X. Jahrg., Nos. 211 u. 242, pp. 13-17, 53-42.
- '87a. Notizen über die pelagische Fauna der Süßwasserbecken. Zool. Anz., X. Jahrg., Nos. 264 u. 265, pp. 577-582, 604-606.
- '87b. Studien über die Fauna hochalpiner Seen insbesondere des Kantons Graubünden. Jahresber. d. naturf. Gesellsch. Graubündens, N. F., XXX. Jahrg., pp. 45-161.
- '88. Die Vertheilung der pelagischen Fauna in den Süßwasserbecken. Zool. Anz., XI. Jahrg., No. 280, pp. 284-291.
- '88a. Beitrag zur Kenntniss der Süßwasserfauna der Vogesen. Zool. Anz., XI. Jahrg., No. 290, pp. 565, 566.
- '90. Notizen über die pelagische Thierwelt der Seen in Kärnten und in der Krain. Zool. Anz., XIII. Jahrg., Nos. 335, 338, 339, pp. 261-263, 347-349, 372-377.
- '90a. Notiz über pelagische Thiere aus einem Teiche in Galizien. Zool. Anz., XIII. Jahrg., No. 336, pp. 284-285.
- '95. Tierwelt der hochalpinen Seen. Biol. Centrabl., Bd. XV., Nr. 13, pp. 507-517.

Joseph, G.

- '82. Systematisches Verzeichniss der in den Tropfstein-Grotten von Krain einheimischen Arthropoden nebst Diagnosen der vom Verfasser entdeckten und bisher noch nicht beschriebenen Arten. II. Theil. Erfahrungen im wissenschaftlichen Sammeln und Beobachten der den Krainer Tropfstein-Grotten eigenen Arthropoden. Berl. Entomol. Zeitschr., Bd. XXVI., Heft 1, pp. 1-50.

Jurine, L.

'20. Histoire des Monocles qui se trouvent aux environs de Genève.
pp. I-XVI. + 1-258. Pls. I-XXII. Genève et Paris.

Kafka, Josef.

'92. Untersuchungen über die Fauna der Gewässer Böhmens. II.
Die Fauna der Böhmisches Teiche. Archiv d. Naturwissensch.
Landesdurchf. von Böhmen, VIII. Bd., No. II.

Kerville, H. G. de.

'88. Les Crustacés de la Normandie: Espèces fluviatiles, stagnales et
terrestres. Bull. de la Soc. des Amis des Sci. nat. de Rouen, 1888,
1^{re} Sem., pp. 133-158.

Kingsley, J. S.

'84. Entomostraca. Stand. Nat. Hist., Vol. II., pp. 22-41.

Koch, C. L.

'35-'41. Deutschlands Crustaceen, Myriapoden, und Arachniden.
Heft. XXI., XXV. Regensburg.

Kochs, W.

'92. Versuche über die künstliche Vermehrung kleiner Crustaceen.
Biol. Centralbl., Bd. 12, Nr. 18 u. 19, pp. 599-606; Translation in
Bull. U. S. Fish Comm., Vol. XIV., pp. 306-308.

Ladenburger, R.

'84. Zur Fauna des Mansfelder Sees. Zool. Anz., VII. Jahrg., No.
168, pp. 299-302.

Landé, A.

'92. Quelques Remarques sur les Cyclopides. Mém. de la Soc. zool.
de France. T. V., pp. 156-173.

Lauterborn, R.

'94. Über die Winterfauna einiger Gewässer der Oberrheinebene.
Mit Beschreibungen neuer Protozoen. Biol. Centralbl., Bd. XIV.,
Nr. 11., pp. 390-398.

Lilljeborg, W.

'53. De Crustaceis ex ordinibus tribus: Cladocera, Ostracoda, et Cope-
poda, in Scania occurrentibus. Pp. I-XV. + 1-122. Pls. I-XXVI.

Lovén, S.

'61. Om några i Vetteru och Venern funna Crustaceer. Öfv. Kongl.
Vet.-Akad. Förhandl., Arg. XVIII., No. 7, pp. 285-314.

Lubbock, J.

'63. Notes on some New or Little-known Species of Fresh-water
Entomostraca. Trans. Linn. Soc., London, Vol. XXIV., pp. 197-210
Pl. XXXI.

Marsh, C. D.

- '91. Preliminary List of Deep-water Crustacea in Green Lake, Wis., U. S. A. Zool. Anz., XIV. Jahrg., No. 370, pp. 275, 276.
- '92. On the Deep-Water Crustacea of Green Lake. Trans. Wis. Acad. Sci., Arts. and Letters, Vol. VIII., pp. 211-213.
- '93. On the Cyclopidae and Calanidae of Central Wisconsin. Trans. Wis. Acad. Sci., Arts. and Letters, Vol. IX., pp. 189-224. Pls. III.-VI.
- '93a. Notes on the Copepoda of Wisconsin. Science, Vol. XXII., No. 544, pp. 3, 4.
- '95. On the Cyclopidae and Calanidae of Lake St. Clair, Lake Michigan, and certain of the Inland Lakes of Michigan. Bull. Mich. Fish Comm., No. 5. 24 pp., 9 Pls.

Milne-Edwards, H.

- '34-'40. Histoire naturelle des Crustacés, comprenant l'anatomie, la physiologie, et la classification de ces animaux. Tome I., II., III. 42 Pls. Paris.

Moniez, R.

- '87. Liste des Copépodes, Ostracodes, Cladocères, et de quelques autres Crustacés recueillis à Lille en 1886. Bull. de la Soc. zool. de France. T. XII., pp. 568-578.
- '89. Note sur la faune des eaux douces de la Sicilie. Feuille des jeunes Naturalistes, Année 20, No. 230. pp. 17-19.
- '89a. Faune des eaux souterraines du département du Nord, et en particulier de la ville de Lille. Rev. Biol. du nord de la France, 1^{re} Ann., pp. 175-179.
- '89b. Sur quelques Cladocères et sur un Ostracode nouveaux du Lac Faticaca. Rev. Biol. du nord de la France, 1^{re} Ann., p. 421.

Mrázek, A.

- '91. O hermafroditismu u Copepodů. Vestník Král. České Spol. Nák., pp. 389-393, Pl. XII.
- '93. Příspěvky k poznání sladkovodních Copepodů. Věstník Král. České Spol. Nák. Třída math.-přír., 1893. 74 pp., Pls. VI.-VIII.
- '93a. Über abnorme Vermehrung der Sinneskolben an dem Vorderfühler des Weibchens bei Cyclopiden und die morphologische Bedeutung derselben. Zool. Anz., XVI. Jahrg., No. 417, pp. 133-138.
- '93b. Über die Systematik der Cyclopiden und die Segmentation der Antennen. Zool. Anz., XVI. Jahrg., No. 424, pp. 285-289; No. 425, pp. 293-299.
- '93c. Zur Morphologie der Antenna der Cyclopiden. Zool. Anz., XVI. Jahrg., No. 430, pp. 376-385.

- '95. Copepoden. Deutsch-Ost-Africa Wiss. Forschungsergebnisse, etc., Band IV., Die Thierwelt Ost-Afrikas. 11 pp., 3 Pls.

Müller, O. F.

1792. Entomostraca seu Insecta testacea quae in aquis Daniae et Norvegiae reperit, descripsit et iconibus illustravit. 134 pp., 21 Pls. Havniae.

Nordqvist, O.

- '86. Bidrag till Kännedomen om Crustaceafannan i några af mellersta Finlands sjöar. Acta Soc. pro Fauna et Flora Fenn., T. III., No. 2. pp. 1-26.
- '87. Die pelagische und Tiefsee-Fauna der grösseren finnischen Seen. Zool. Anz., X. Jahrg., Nos. 254, 255. pp. 339-345, 358-362.
- '90. Bidrag till Kännedomen om Bottniska vikens och norra Östersjöns evertebratfauna. Meddel. af Soc. pro Fauna et Flora Fenn., 17 Häft., pp. 83-128.

Nusbaum, J.

- '92. Zur Kenntnis der Würmerfauna und Crustaceenfauna Polens. Biol. Centralbl., Bd. XII., Nr. 2. pp. 54-58.

Pavesi, P.

- '79. Nuova serie di ricerche della fauna pelagica nei laghi italiani. Rend. del R. Inst. Lombardo. Ser. II., Vol. XII., fasc. XI., XII. 10 pp.
- '79a. Ulteriori studj sulla fauna pelagica dei laghi italiani. Rend. del R. Inst. Lombardo. Ser. II., Vol. XII., fasc. XVI. 21 pp.
- '82. Excursione Zoologica al Lago di Toblino. Atti della Soc. Ital. di Sci. Nat., Vol. XXV. 5 pp.
- '83. Altra serie di ricerche e studi sulla fauna pelagica dei laghi italiani. Atti della Soc. Ven.-Tren. di Sci. Nat., Vol. VIII., pp. 340-403, Pls. VIII.-XIV.

Poggenpohl, M. J.

- '74. Verzeichniss der Copepoden, Cladoceren, und Ostracoden der Umgebung von Moskau. Schriften der Gesellsch. v. Freunden d. Naturwissensch., etc., zu Moskau, Bd. X., Abt. II., pp. 69-77, Taf. XV.-XVII. (German title of Russian article.)

Poppe, S. A.

- '84. Bemerkungen zu R. Ladenburger's: Zur "Fauna des Mansfelder Sees" in No. 168 des Zoologischen Anzeigers. Zool. Anz., VII. Jahrg., No. 175. pp. 499, 500.
- '89. Notizen zur Fauna der Süßwasser-Becken des nordwestlichen Deutschland mit besonderer Berücksichtigung der Crustaceen. Abh. d. Naturw. Ver. zu Bremen, Bd. X., pp. 517-550, Taf. VIII.

- '89a. Berichtigung zu Dr. O. E. Imhof's Aufsatz: "Fauna der Süßwasserbecken" in No. 275 des Zool. Anz. 1888, p. 166. Zool. Anz., XII. Jahrg., No. 300, pp. 99, 100.
- '91. Beiträge zur Fauna der Insel Spiekerooge. Abh. d. Naturw. Ver. zu Bremen, Bd. XII. 6 pp.
- Poppe, S. A., u. Mrázek, A.**
- '95. Entomostraken des Naturhistorischen Museums in Hamburg. Jahrb. der Hamburgischen Wiss. Anstalten, XII. Beiheft. 20 pp., 4 Pls.
- Poppe, S. A., et Richard, J.**
- '90. Note sur divers Entomostracés du Japon et de la Chine. Bull. de la Soc. zool. de France, T. XV., pp. 73-78.
- Rath, O. v.**
- '91. Zur Kenntniss der Hautsinnesorgane der Crustaceen. Zool. Anz., XIV. Jahrg., Nos. 365, 366, pp. 195-200, 205-214.
- Rehberg, H.**
- '80. Zwei neue Crustaceen aus einem Brunnen auf Helgoland. Zool. Anz., III. Jahrg., No. 58, pp. 301-303.
- '80a. Beitrag zur Kenntniss der freilebenden Süßwasser-Copepoden. Abh. d. Naturw. Ver. zu Bremen, Bd. VI., pp. 533-554. Taf. VI.
- '80b. Weitere Bemerkung über die freilebenden Süßwasser-Copepoden. Abh. d. Naturw. Ver. zu Bremen, Bd. VII., pp. 61-67, Taf. IV.
- Richard, J.**
- '87. Liste des Cladocères et des Copépodes d'eau douce observés en France. Bull. de la Soc. zool. de France, T. XII., pp. 156-163.
- '88. Cladocères et Copépodes non marins de la Faune française. Rev. Sci. du Bourbonnais, mars-avril, 1888, pp. 1-28
- '90. Sur les Entomostracés et quelques autres animaux inférieurs des lacs de l'Auvergne. Rev. des Sci. Nat. Appliquées, No. 10, 20 mai, 1890.
- '90a. Sur la glande du test des Copépodes d'eau douce. Note préliminaire. Bull. de la Soc. zool. de France, T. XV., pp. 113-118.
- '90b. Description du *Bradya Edwardsi*, Copépode, aveugle nouveau, vivant au Bois de Boulogne avec divers Entomostracés dans les eaux alimentées par le puits artésien de Passy. Mém. de la Soc. zool. de France, T. III., pp. 214-222.
- '90c. Entomostracés d'eau douce recueillis à Belle Ile (Morbihan). Bull. de la Soc. zool. de France, T. XV., pp. 33, 34.
- '91. Sur les Entomostracés du Lac Balaton. Bull. de la Soc. zool. de France, T. XVI., pp. 135-137.
- '91a. Entomostracés d'eau douce de Sumatra et de Célèbes. Zool. Ergeb. einer Reise in Niederland, Ost-Ind., Bd. II., pp. 118-134, Pl. X.

- '91b. Recherches sur le Système glandulaire et sur le Système nerveux des Copépodes libres d'eau douce. Ann. Sci. Nat., Zool., T. XVI., pp. 113-270. Pls. V.-VIII.
- '92. Sur quelques Entomostracés de l'île d'Elbe et de l'île de Monte-Cristo. Bull. de la Soc. zool. de France, T. XVII., pp. 226-229.
- '93. Copépodes recueillis par M. le Dr. Théod. Barrois en Égypte, en Syrie, et en Palestine. Rev. Biol. du nord de la France, 5^e ann., No. 10, juillet, 1893. 36 pp., 51 Fig.
- '94. Sur quelques animaux inférieurs des eaux douces du Tonkin (Protozoaires, Rotifères, Entomostracés). Mém. de la Soc. zool. de France, T. VII., pp. 237-243.
- '94a. Entomostracés recueillis par M. E. Modigliani dans le Lac Toba (Sumatra). Ann. del Mus. Civ. di Storia Naturale di Genova, Serie 2. a, XIV. (XXXIV.), pp. 565-578.
- '95. Sur quelques Entomostracés d'eau douce d'Haiti. Mém. de la Soc. zool. de France, T. VIII. 11 pp. 11 figs.
- '95a. Cladoécères et Copépodes recueillis par M. Kavraisky près de Tiflis et dans le Lac Goktsha. Bull. de la Soc. zool. de France, T. XX., pp. 91. 92.
- '95b. Contribution a la Faune des Entomostracés de la France. Feuille des jeunes Naturalistes, III. Série, 25^e Ann., Nos. 295 et 296. 9 pp.

Rückert, J.

- '95. Zur Befruchtung von *Cyclops strenuus* (Fisch.). Anat. Anz., X. Bd., No. 22, pp. 708-725; Abstract, Zool. Centralbl., II. Jahrg., pp. 555, 556.
- '95a. Über das Selbstandigbleiben der väterlichen und mütterlichen Kernsubstanz während der ersten Entwicklung des befruchteten Cyclops-Eies. Arch. f. Mikr. Anat., Vol. 45, pp. 339-369, Taf. XXI., XXII.; Abstract, Zool. Centralbl., II. Jahrg., pp. 554, 555.

Sars, G. O.

- '62. Oversigt af de indenlandske Ferskvandscopepoder. Forhandl. Vidensk.-Selsk. i Christiania, 1862, pp. 212-262.
- '63. Beretning om en i Sommeren 1862 foretagen zoologisk Reise i Christianias og Trondhjems Stifter. Nyt Mag. f. Naturvidensk., Bd. XII., pp. 193-252.
- '64. Beretning om en i Sommeren 1863 foretagen zoologisk Reise i Christianias Stifter. Nyt Mag. f. Naturvidensk., Bd. XIII. 36 pp.
- '89. On a small Collection of Fresh-water Entomostraca from Sydney. Christiania Vidensk.-Selsk. Forhandl., 1889, No. 9, pp. 1-9.
- '96. On Fresh-Water Entomostraca from the Neighborhood of Sydney partly raised from dried Mud. 81 pp., 8 Pls. Kristiania.

Say, T.

- '18. An Account of the Crustacea of the United States. Journ. Acad. Nat. Sci. Phil., Vol. I., pp. 421-458.

Schmankewitsch, W.

- '77. Zur Kenntniss des Einflusses der äusseren Lebensbedingungen auf die Organisation der Thiere. Zeitschr. f. wiss. Zool., Bd. XXIX., pp. 429-501.

Schmeil, O.

- '91. Beiträge zur Kenntniss der Süsswasser-Copepoden Deutschlands mit besonderer Berücksichtigung der Cyclopiden. Zeitschr. f. Naturwiss. Halle, Bd. 64, pp. 1-10.
 '92. Deutschlands freilebende Süsswasser-Copepoden. I. Teil. Bibliotheca Zoologica, Heft II. 191 pp., 8 Pls.
 '94. Zur Höhlenfauna des Karstes. Zeitschr. f. Naturwiss. Halle, Bd. 66, pp. 339-353.

Scott, T.

- '94. On the food of *Utricularia vulgaris*, an Insectivorous Plant. Ann. Scot. Nat. Hist., No. 10, pp. 105-112.

Scourfield, D. J.

- '93. The Entomostraca of Wanstead Park. Journ. Quekett Micr. Club, Ser. II., Vol. V., No. 32, pp. 161-178.
 '94. Entomostraca and the Surface-film of Water. Journ. Linn. Soc., Vol. XXV., pp. 1-19, Pls. I, II.
 '95. A Preliminary Account of the Entomostraca of North Wales. Journ. Quekett Micr. Club, Vol. VI., Ser. II., No. 37, pp. 127-143.

Seligo, A.

- '90. Hydrobiologische Untersuchungen. I. Zur Kenntniss der Lebensverhältnisse in einigen westpreussischen Seen. Schrift. d. naturf. Gesellsch. zu Danzig, Bd. VII., N. F., Heft 3, pp. 43-89.

Sowinsky, W.

- '91. Matériaux pour servir à l'étude des Crustacés d'eaux douces dans la partie occidentale de la Russie. Mém. de la Soc. des natural. de Kiew, T. XI., Part I., pp. 107-161. (French title of Russian article.)

Timm, R.

- '94. Beiträge zur Meeresfauna von Helgoland. III. Die Copepoden und Cladoceren Helgolands. Wiss. Meeresuntersuch. herausg. v. d. Komm. z. Untersuchung der deutschen Meere in Kiel und der Biol. Anstalt a. Helgoland, N. F., I. Bd., pp. 155-159.
 '94a. Beiträge zur Fauna der südöstlichen und östlichen Nordsee. IV. Copepoden und Cladoceren. Wiss. Meeresuntersuch. herausg. v. d. Komm. z. Untersuchung der deutschen Meere in Kiel und der Biol. Anstalt a. Helgoland, N. F., I. Bd., pp. 363-402, Pls. V., VI.

Turner, C. H.

- '92. Notes upon the Cladocera, Copepoda, Ostracoda, and Rotifera of Cincinnati, with Descriptions of New Species. Bull. Sci. Lab. Denison Univ., Vol. VI., Part II., pp. 57-74. Pls. 1, 2.

Ulianin, W. N.

- '75. Crustaceen von Turkestan. Reise A. P. Fedtschenkos in Turkestan. Schrift. d. Gesellsch. v. Freunden der Naturwiss., etc., zu Moskau. Bd. XI., Abth. VI., pp. 1-61. Taf. I-XIII. (German title of Russian article.)

Underwood, L. M.

- '86. List of the Described Species of Fresh-Water Crustacea from America, North of Mexico. Bull. Ill. St. Lab. Nat. Hist., Vol. II., pp. 323-384.

Urbanowicz, F.

- '84. Zur Entwicklungsgeschichte der Cyclopiden. Zool. Anz., VII. Jahrg., No. 181, pp. 615-619.

Vernet, H.

- '71. Observations anatomiques et physiologiques sur le genre Cyclops. 47 pp., 1 Pl. Genève.

Villipoix, R. M. de

- '88. Contribution a l'étude de la faune des eaux douces de la vallée de la Somme. (Copépodes et Cladocères.) Bull. Soc. limn. du nord de la France. Nr. 193-195. 23 pp.

Voeltzkow, A.

- '91. Vorläufiger Bericht über die Ergebnisse einer Untersuchung der Süßwasserfauna Madagascars. Zool. Anz., XIV. Jahrg., No. 367, pp. 221-230.

Vosseler, J.

- '86. Die freilebenden Copepoden Württembergs und angrenzender Gegenden. Jahresh. des Ver. für vaterl. Naturkunde in Württ., 1886, pp. 167-202, Taf. IV.-VI.

- '89. Die Copepodenfanna der Eifelmaare. [including (p. 123-), "Über einen Cyclops mit verkrüppelter Furka." Archiv für Naturgesch., LV. Jahrg., Bd. 1, pp. 117-124, Taf. VI.

- '91. Die Krebsfauna unserer Gewässer. In Zacharias's "Die Tier- u. Pflanzenwelt des Süßwassers," Bd. I., pp. 325-380. Leipzig.

Walter, A.

- '88. Trauskaspische Binnenerustaceen. Zool. Jahrbücher. Abth. f. Syst., Bd. III., pp. 987-1014, Taf. XXXV.

Wierzejski, A.

- '82. Materiały do fauny jezior tatrzańskich. Copepoda. Sprawozd. Kom. fiz. Akad. umiej. T. XVI. 25 pp., 2 Pls.

- '92. Skorupiaki i Wrotki (Rotatoria) słodkowodne zebrane w Argentynie. Rozpr. Wydz. mat.-przyr. Akad. Umiej. w Krakowie, T. XXIV., pp. 229-246, Pls. V.-VII.
- '95. Przegląd fauny skorupiaków galicyjskich. Sprawozd. Kom. fiz. Akad. Umiej. w Krakowie, T. XXXI., pp. 160-215, Taf. II.; Extract (German translation), Übersicht der Crustaceen-Fauna Galiziens, Anz. d. Akad. d. Wiss. Krakau, Juni, 1895, pp. 170-178.

Zacharias, O.

- '85. Ergebnisse einer zoologischen Exkursion in das Glatzer-, Iser-, und Riesen-gebirge. Zeitschr. f. wiss. Zool., Bd. 43, pp. 252-270.
- '87. Zur Kenntnis der pelagischen und littoralen Fauna norddeutscher Seen. Zeitschr. f. wiss. Zool., Bd. XLV., pp. 255-281, Taf. I.
- '87a. Zur Kenntnis der Entomostrakenfauna holsteinischer und mecklenburgischer Seen. Zool. Anz., X. Jahrg., No. 248, pp. 189-193.
- '87b. Faunistische Studien in westpreussischen Seen. Schrift. der naturf. Gesellsch. zu Danzig, N. F., Bd. 6, Heft 4, pp. 43-71, Taf. I.
- '88. Zur Kenntnis der Fauna des Süßen und Salzigen Sees bei Ifalle a. S. Zeitschr. f. wiss. Zool., Bd. XLVI., pp. 217-232.
- '88a. Zur Fauna einiger norddeutscher Seen. Biol. Centralbl., Bd. VIII., No. 17, pp. 540, 541.
- '89. Bericht über eine Zoologische Exkursion an die Kraterseen der Eifel. Biol. Centralbl., Bd. IX., Nos. 2, 3, 4, pp. 56-64, 76-80, 107-113.
- '93. Fauna des grossen Plöner Sees. Biol. Centralbl., Bd. XIII., Nr. 11 u. 12 pp. 377-484.
- '94. Über die Verteilung der Planktonorganismen innerhalb eines Sees. Biol. Centralbl., Bd. XIV., Nr. 3, pp. 122-128.
- '95. Über die vertikale Verteilung limnetischer Crustaceen, insbesondere über diejenige von *Cyclops oithonoides*. Biol. Centralbl., Bd. XV., Nr. 18, pp. 686-688.

Zaddach, E. G.

- '44. Synopsis Crustaceorum Prussicorum Prodrömus. pp. I.-VIII. + 1-33. Regiomonti (Königsberg).

Zenker, W.

- '54. Über die Cyclopiden des süßen Wassers. Archiv für Naturgesch., XX. Jahrg., Bd. 1, pp. 88-103, Taf. VI., Fig. 8-14.

Zschokke, F.

- '90. Faunistische Studien an Gebirgsseen. Verh. d. Naturf. Gesellsch. in Basel, Bd. IX., 62 pp.
- '90a. Beitrag zur Kenntnis der Fauna der Gebirgsseen. Zool. Anz., XIII. Jahrg., No. 326, pp. 37-40.

- '91. Weiterer Beitrag zur Kenntnis der Fauna von Gebirgsseen. Zool. Anz., XIV. Jahrg., Nos. 360 u. 361, pp. 119-123 u. 126-129.
- '94. Die Tierwelt der Juraseen. Rev. Suisse de Zool., T. II., pp. 349-376, Pl. XIV.
- '95. Die Fauna hoehgelegener Gebirgsseen. Verhandlung der Naturf. Gesellsch. in Basel, Bd. XI., Heft I., pp. 36-133, Taf. 1.

EXPLANATION OF PLATES.

PLATE VIII.

- FIG. 1. *Cyclops bouckarti* Claus.
- FIG. 2. Last two segments of antenna of same.
- FIG. 3. Fifth foot of same.

PLATE IX.

- FIG. 1. *Cyclops edax* Forbes.
- FIG. 2. Last two segments of antenna of same.
- FIG. 3. Fifth foot of same.

PLATE X.

- FIG. 1. *Cyclops viridis* Jurine.
- FIG. 2. Fifth foot of same.
- FIG. 3. Receptaculum seminis of same.

PLATE XI.

- FIG. 1. Variations in outer terminal spine of stylet of *Cyclops viridis* var. *brevispinosus* Herrick.
- FIG. 2. Fifth foot of same.
- FIG. 3. Receptaculum seminis of *Cyclops viridis* var. *insectus* Forbes.
- FIG. 4 and 5. Fifth foot of same.
- FIG. 6. Swimming foot of same.

PLATE XII.

- FIG. 1. *Cyclops bicuspitatus* Claus.
- FIG. 2. Stylet of same.
- FIG. 3. Fifth foot of same.
- FIG. 4. Receptaculum seminis of same.

PLATE XIII.

Cyclops albidus Jurine.

PLATE XIV.

Cyclops ater Herrick.

PLATE XV.

- FIG. 1. Last two segments of antenna of *Cyclops ater* Herrick.
- FIG. 2. Fifth foot of same.
- FIG. 3. Receptaculum seminis of same.
- FIG. 4. *Cyclops modestus* Herrick.

PLATE XVI.

- FIG. 1. Antenna of *Cyclops modestus* Herrick.
- FIG. 2. Fifth foot of same.
- FIG. 3. Receptaculum seminis of same.

PLATE XVII.

Cyclops serrulatus Fischer.

PLATE XVIII.

- FIG. 1. *Cyclops serrulatus* Fischer.
- FIG. 2. Fifth foot of same.
- FIG. 3. Receptaculum seminis of same.

PLATE XIX.

- FIG. 1. *Cyclops prasinus* Fischer.
- FIG. 2. Antenna of same.

PLATE XX.

- FIG. 1. Fifth foot of *Cyclops prasinus* Fischer.
- FIG. 2. Receptaculum seminis of same.
- FIG. 3. *Cyclops phaleratus* Koch.

ERRATA.

- Page 31, line 8, for *solid* read *dotted*; line 10, for *dotted* read *solid*.
 Page 34, line 6, for *equal* read *subequal*.
 Page 44, line 8, for *species* read *variety*.
 Page 63, line 16, before America insert North.
 Page 66, under Birge, E. A., for '94 read '95.
 Page 73, under Koch, C. L., for XXV. read XXXV.
 Page 77, line 2, before Zoology insert 7^e Sér.; line 3, for XVI. read XII.
 Page 78, line 13, for Heft II. read Heft 11.
 Page 79, for *Villipoir*, R. M. de, read *Villepoix*, R. M. de.
 Page 80, under Zacharias, O., for '85 read '86; and in entry for '87, for Taf. I. read Taf. XV.
 Page 81, line 5, for '95 read '94.

- | | |
|---|---|
| <p><i>gigas</i>, 29, 37.
 <i>gyrinus</i>, 47, 48.
 <i>helgolandicus</i>, 29.
 <i>hyalinus</i>, 29.
 <i>ingens</i>, 37.
 <i>insectus</i>, 37, 38, 39, 41.
 <i>insignis</i>, 29, 63.
 <i>lacustris</i>, 29.
 <i>leenwenhoekii</i>, 34, 35.
 <i>leuckarti</i>, 29, 31, 34, 36, 63.
 <i>leuckarti</i>, 33.
 <i>levis</i>, 37.
 <i>macrurus</i>, 29.</p> | <p>var. <i>brevispinosus</i>, 30, 39,
 41, 62, 63, 64.
 var. <i>insectus</i>, 31, 41, 62,
 63, 64.
 Diaptomus, 62.
 Eucyclops, 54, 65.
 Homocyclops, 29, 49, 64.
 Macrocylops, 47, 64.
 Microcyclops, 64.
 <i>Monoculus quadricornis</i> var. <i>albidus</i>,
 47.
 var. <i>viridis</i>, 37.
 Orthocyclops, 29, 51, 64.
 Paracyclops, 59, 65.</p> |
|---|---|

INDEX.

Synonyms in Italics.

- Canthocamptus, 62.
 Clacocera, 62.
 Copepoda, 27.
 Cyclopida: European, 29.
 list of North American species,
 63.
 Cyclops, 31, 63.
 affinis, 29, 65.
 agilis, 29.
 albidus, 29, 47, 62, 63, 64.
 americanus, 37, 38, 42.
 annulatus, 33, 35.
 ater, 29, 49, 62, 64.
 bicolor, 29, 62, 63, 64.
 bicuspidatus, 29, 30, 44, 53, 62,
 63, 64.
 bisetosus, 29.
 brevispinosus, 39, 41.
 capilliferus, 51.
 crassicaudis, 29.
 dybowskii, 29, 62, 63.
 edax, 33, 62, 63.
 fimbriatus, 29.
 var. *poppei*, 63, 65.
 fluvialilis, 57.
 forbesi, 44, 45.
 fuscus, 29, 64.
 general distribution of, in
 North America, 62.
 gigas, 29, 37.
 gyrinus, 47, 48.
 helgolandicus, 29.
 hyalinus, 29.
 ingens, 37.
 insectus, 37, 38, 39, 41.
 insignis, 29, 63.
 lacustris, 29.
 leenwenhoekii, 34, 35.
 leuckarti, 29, 31, 34, 36, 63.
 leuckarti, 33.
 leris, 37.
 maerurus, 29.
- Cyclops—*continued*.
 magnoctenus, 57.
 minutus, 44, 45.
 modestus, 29, 62, 63, 64.
 nanus, 29.
 narus, 44, 45.
 oithonoides, 29, 63.
 parvus, 38, 41, 42.
 pentagonus, 57.
 peranotus, 59, 60.
 phaleratus, 29, 30, 59, 63, 65.
 prasimus, 57, 63, 65.
 pulchellus, 29, 44.
 robustus, 29.
 sentifer, 29.
 serratus, 44, 45.
 serrulatus, 29, 30, 54, 62, 63, 65.
 var. *elegantis*, 54.
 var. *montanus*, 54, 55.
 signatus, 29.
 var. *tennicornis*, 47.
 stremus, 29.
 thomasi, 44, 45.
 uniongulatus, 39, 41.
 varicans, 29, 63, 64.
 vernalis, 29, 64.
 viridis, 29, 30, 37, 41, 42, 43,
 48, 62, 63, 64.
 var. *brevispinosus*, 30, 39,
 41, 62, 63, 64.
 var. *insectus*, 31, 41, 62,
 63, 64.
- Diaptomus, 62.
 Eucyclops, 54, 65.
 Homocyclops, 29, 49, 64.
 Macrocyclops, 47, 64.
 Microcyclops, 64.
Monoculus quadricornis var. *albus*,
 47.
 var. *viridis*, 37.
 Orthocyclops, 29, 51, 64.
 Paracyclops, 59, 65.

PLATE VIII.

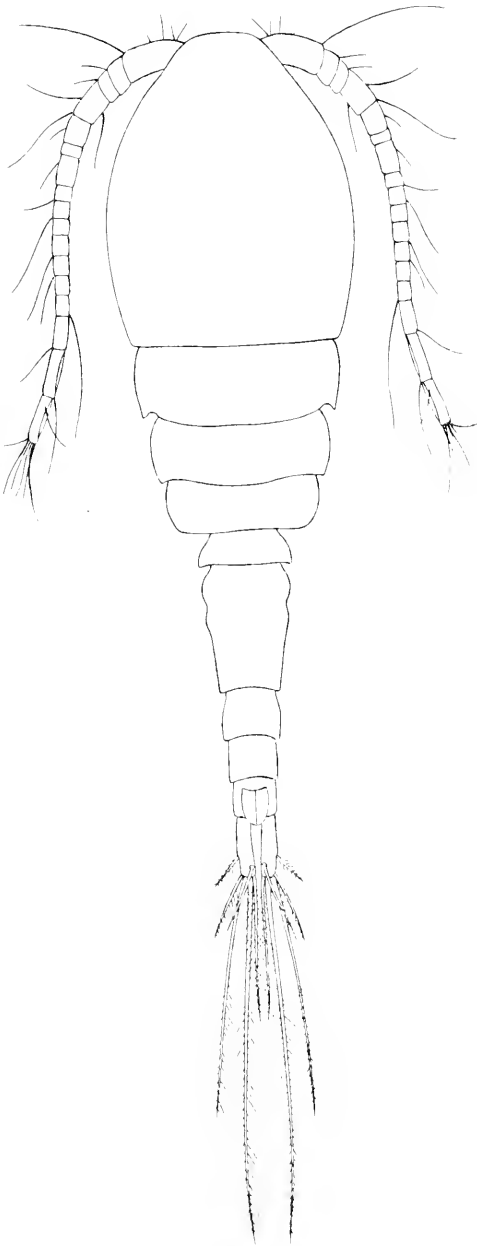

1

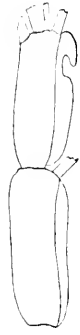

2



3

PLATE IX.

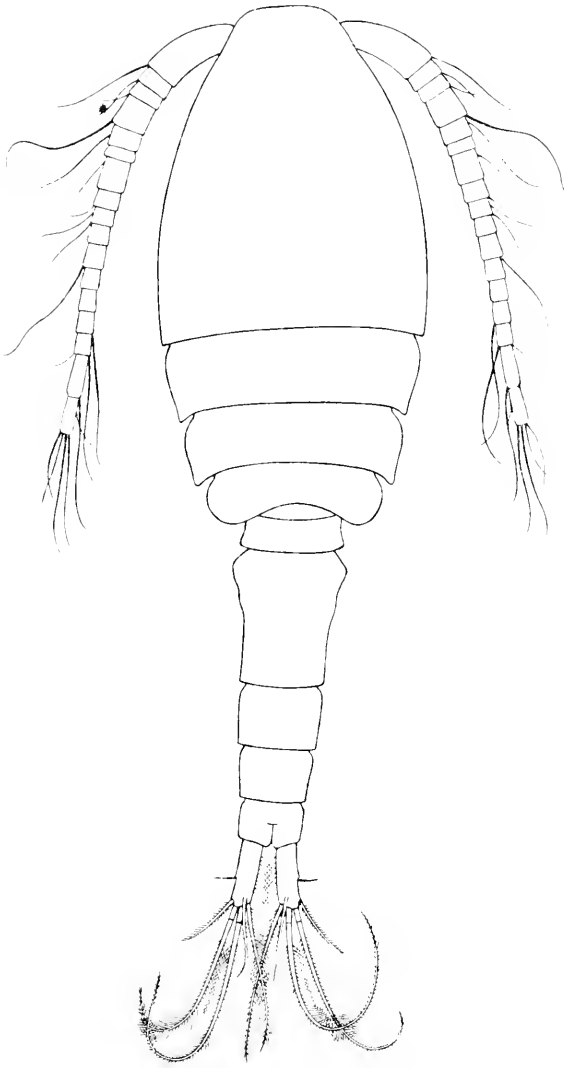

1



2

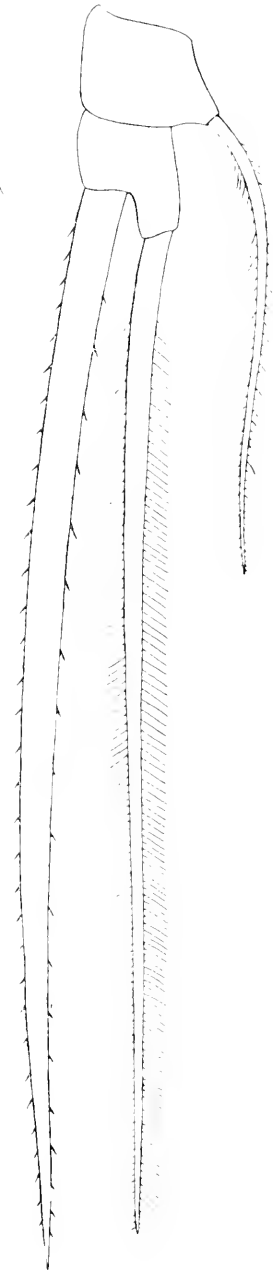

3

PLATE X.

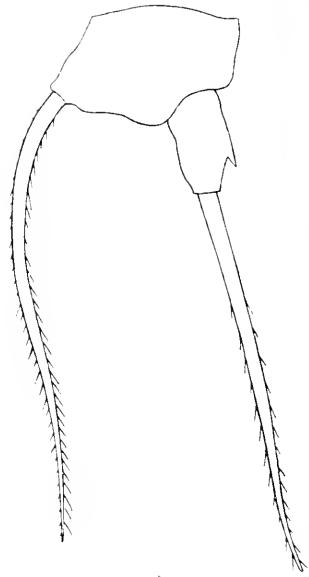
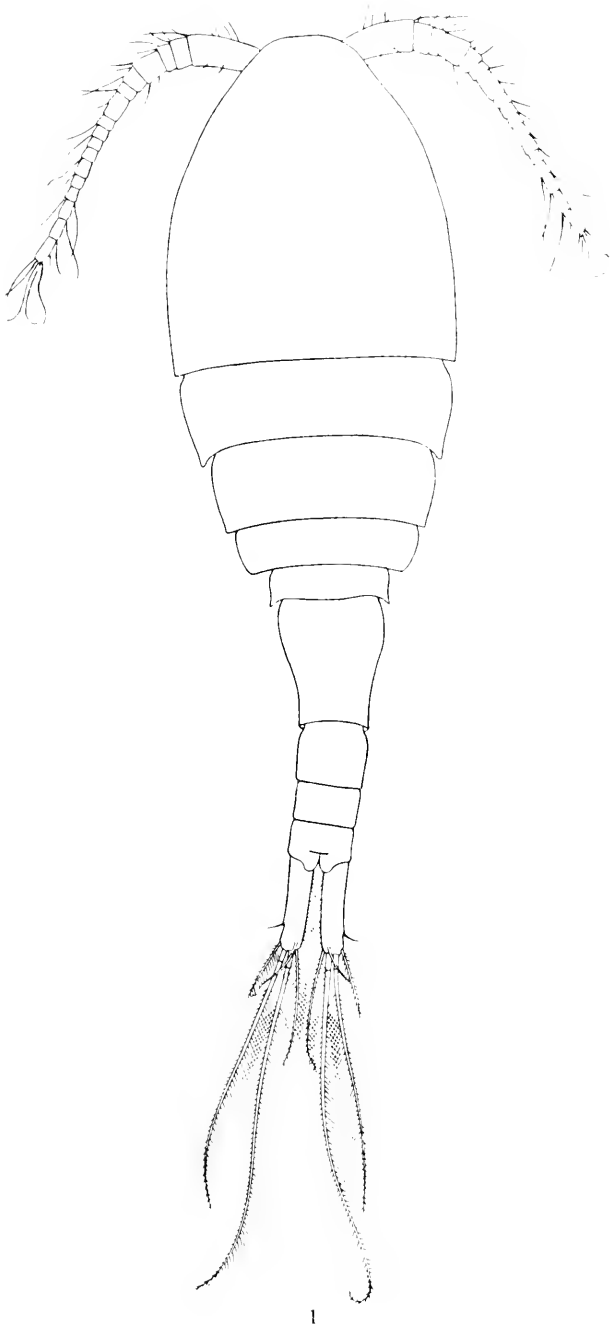

2

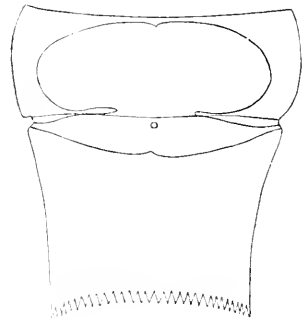

3

1

PLATE XI.

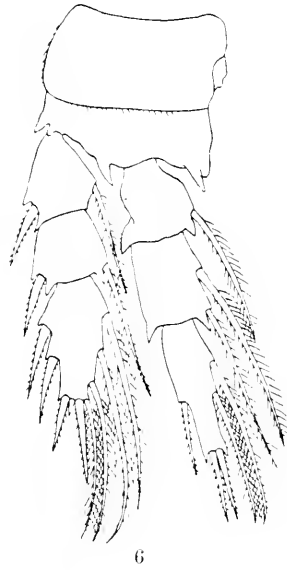
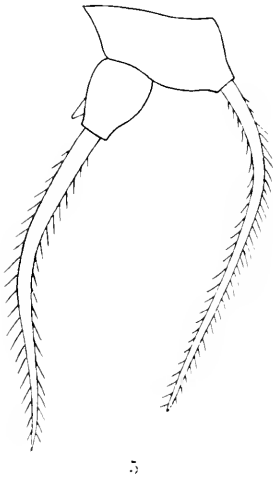
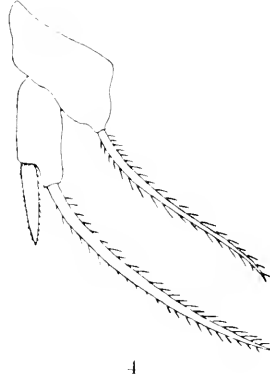
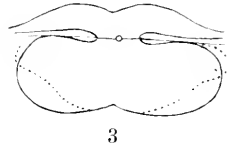
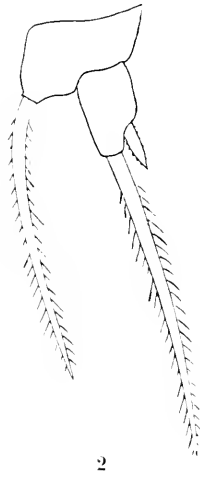
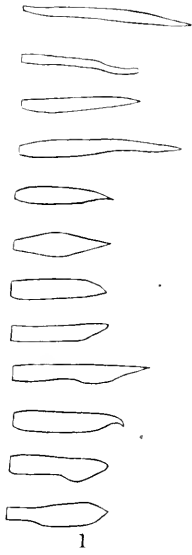
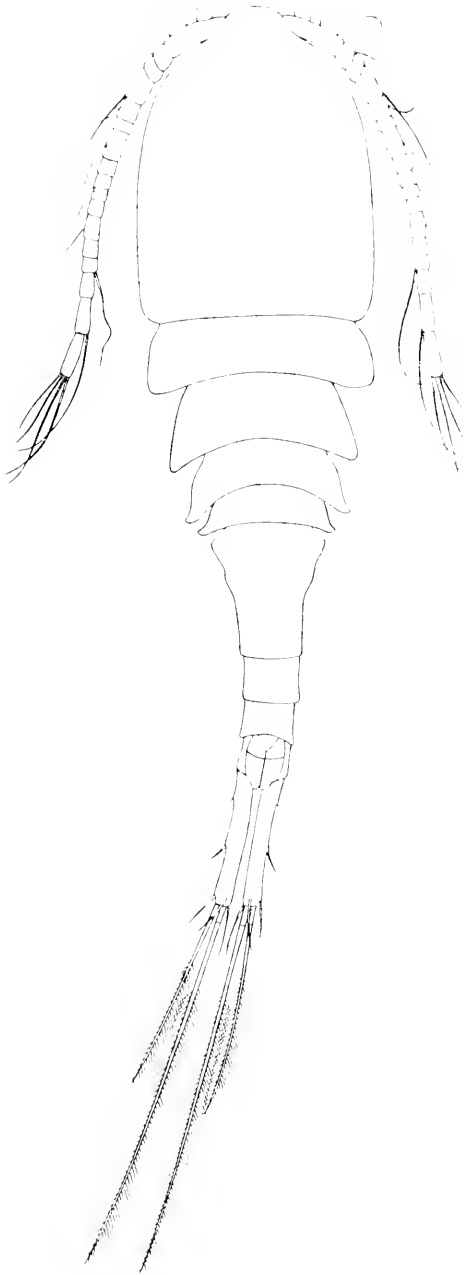
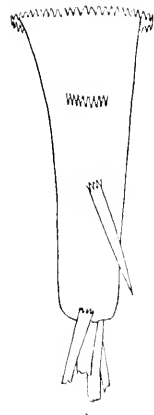

PLATE XII.



1



2

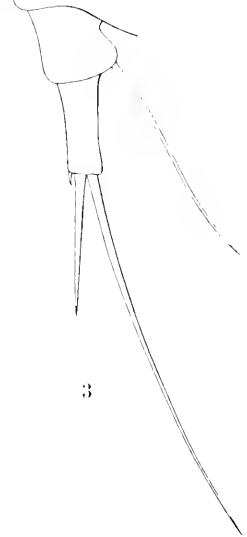

3



4

PLATE XIII.

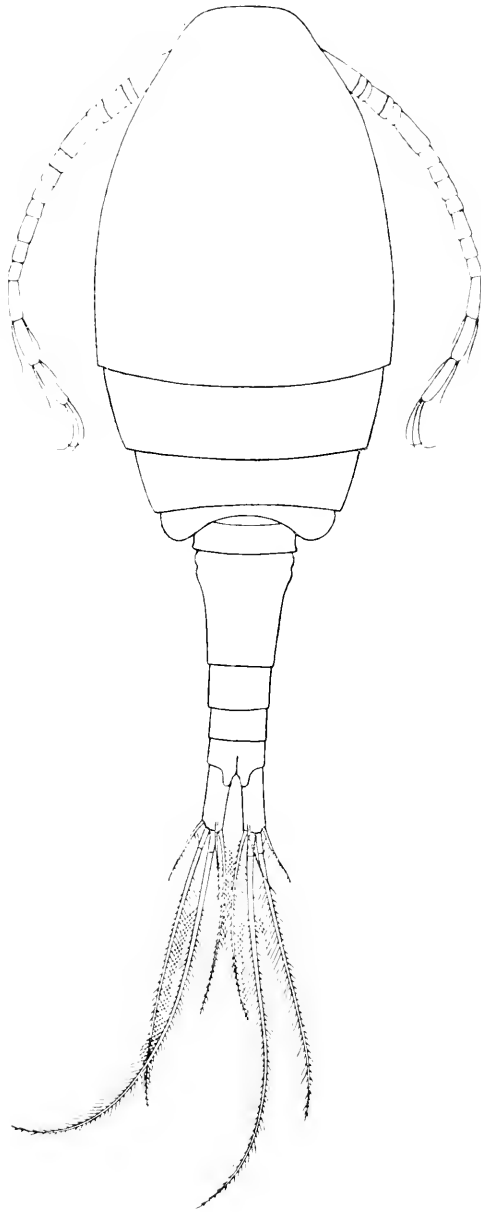

PLATE XIV.

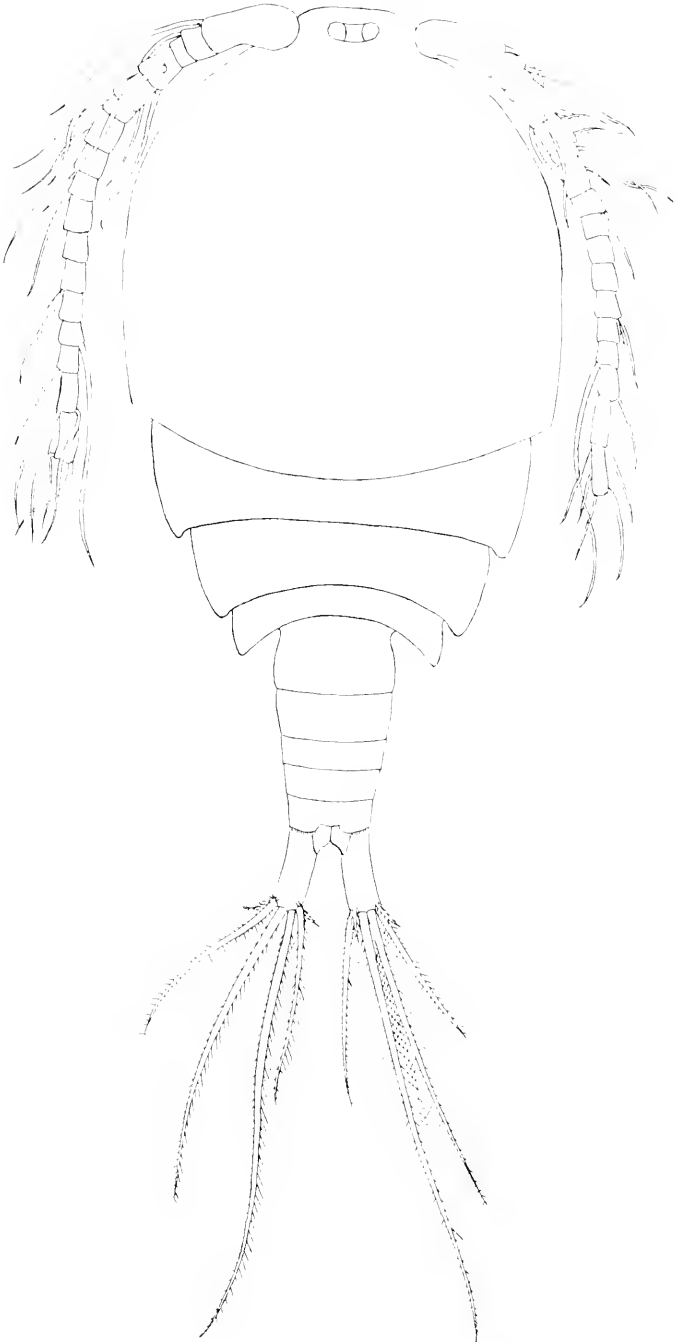

PLATE XV.

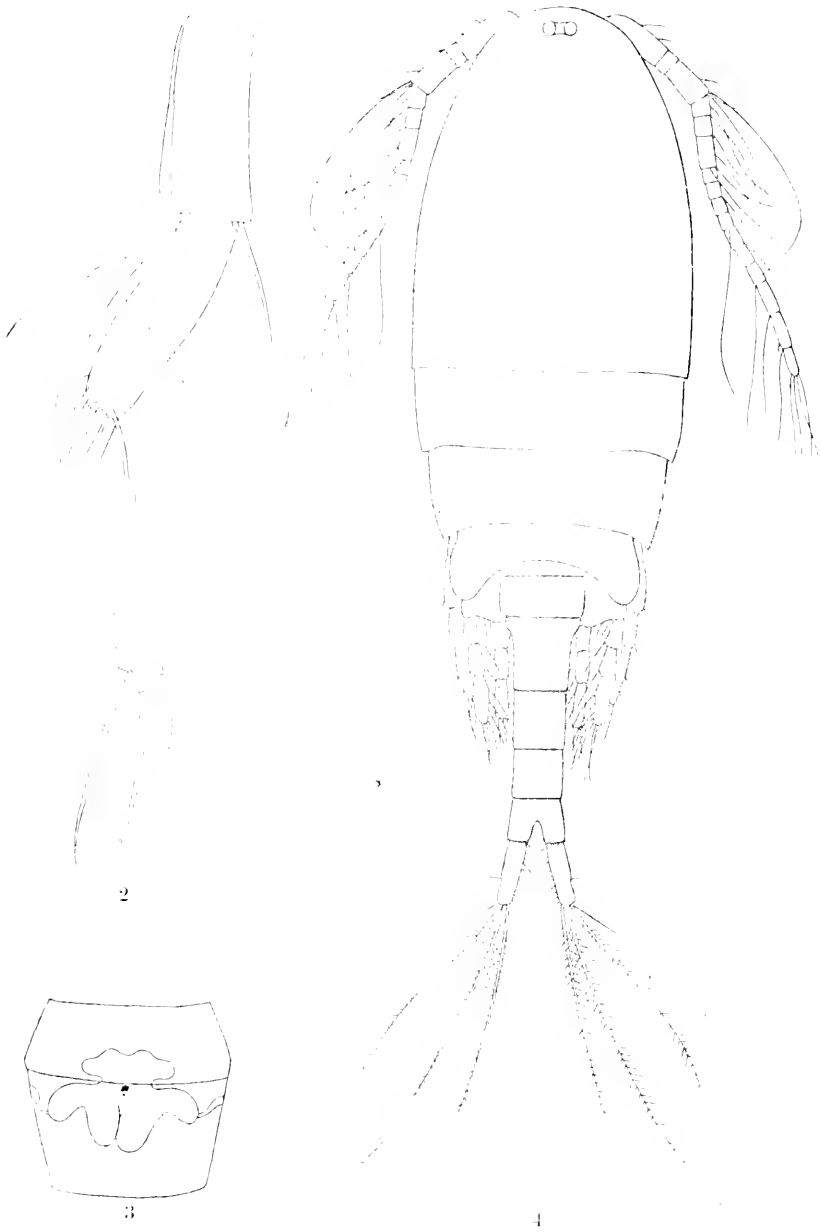

PLATE XVI.

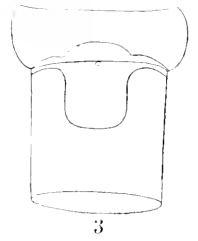
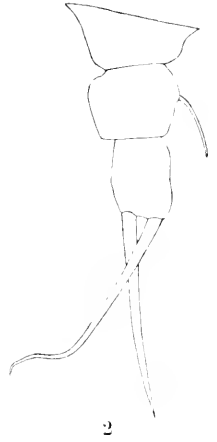
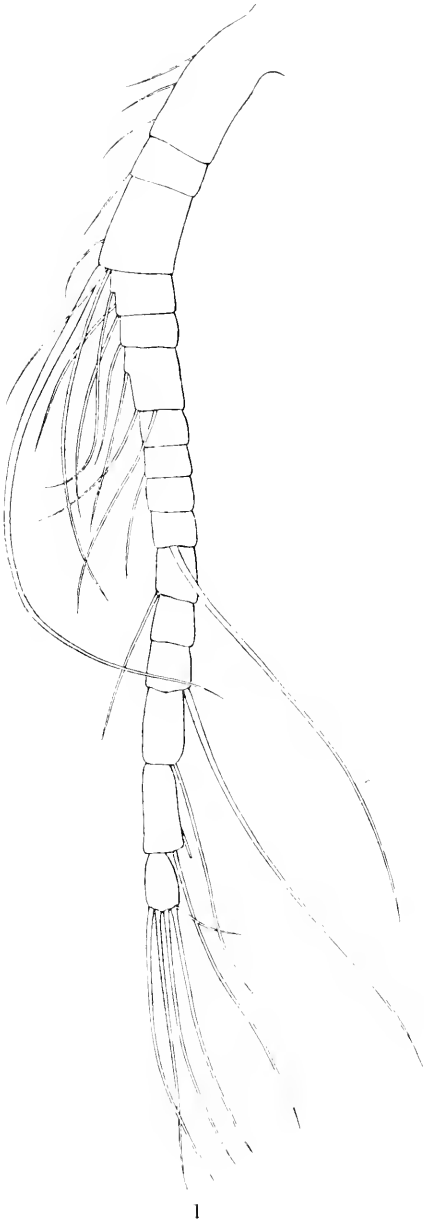

PLATE XVII.

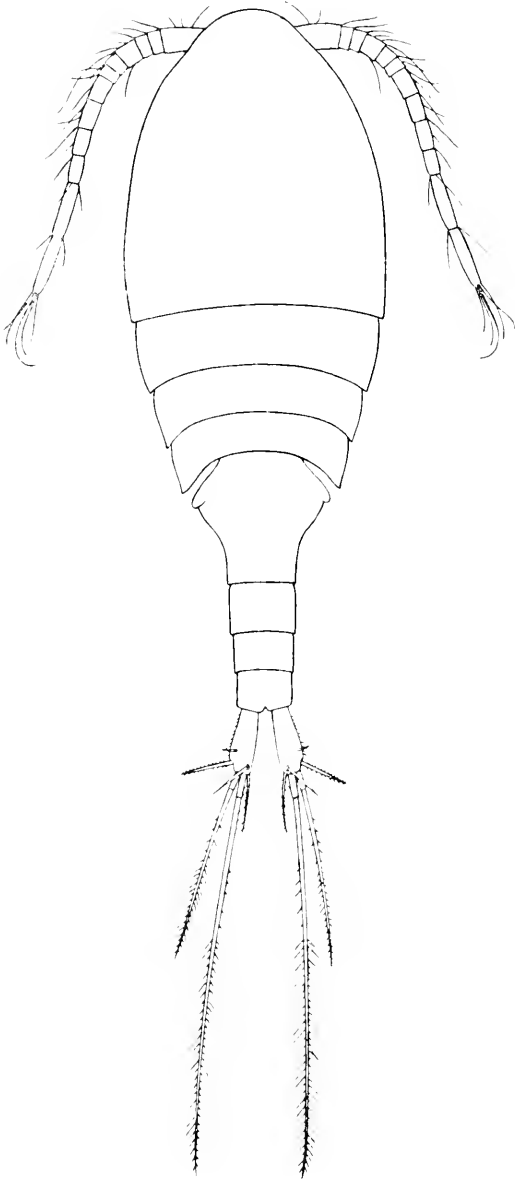

PLATE XVIII.

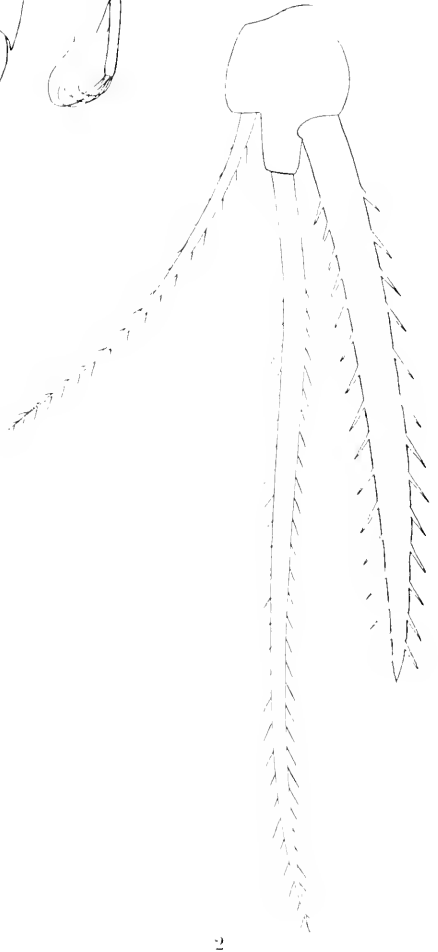
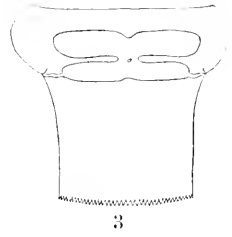
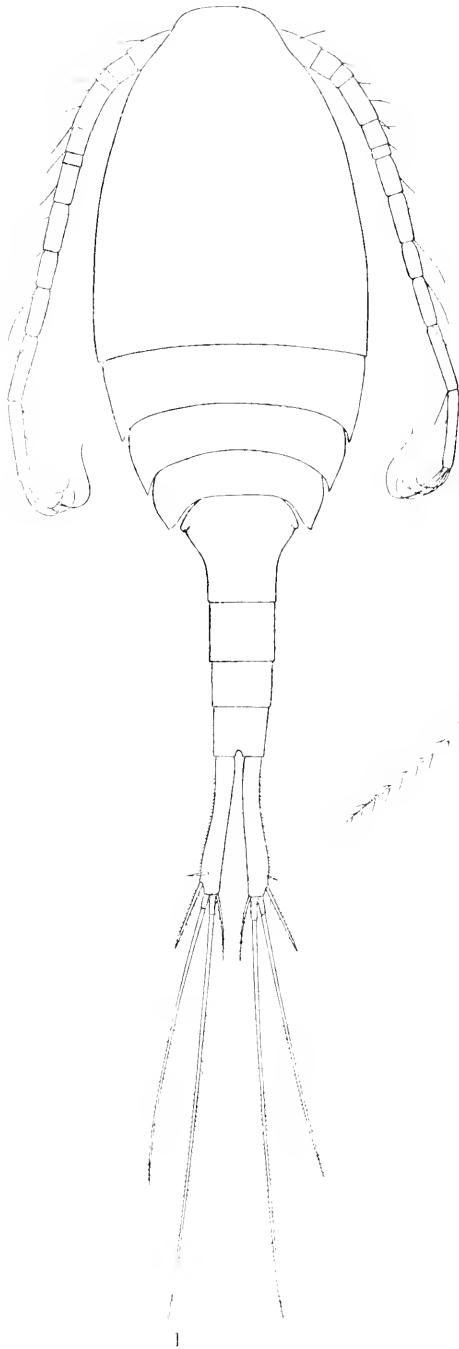

PLATE XIX.

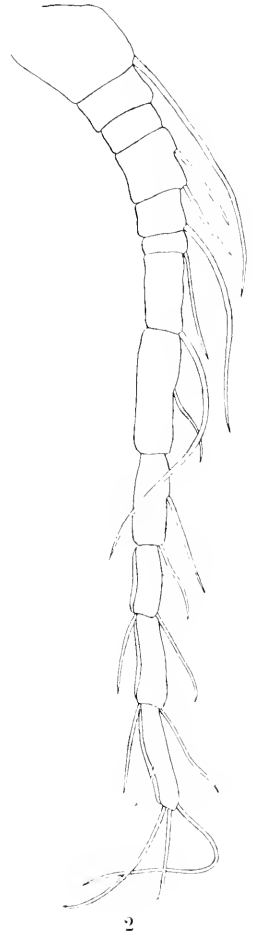
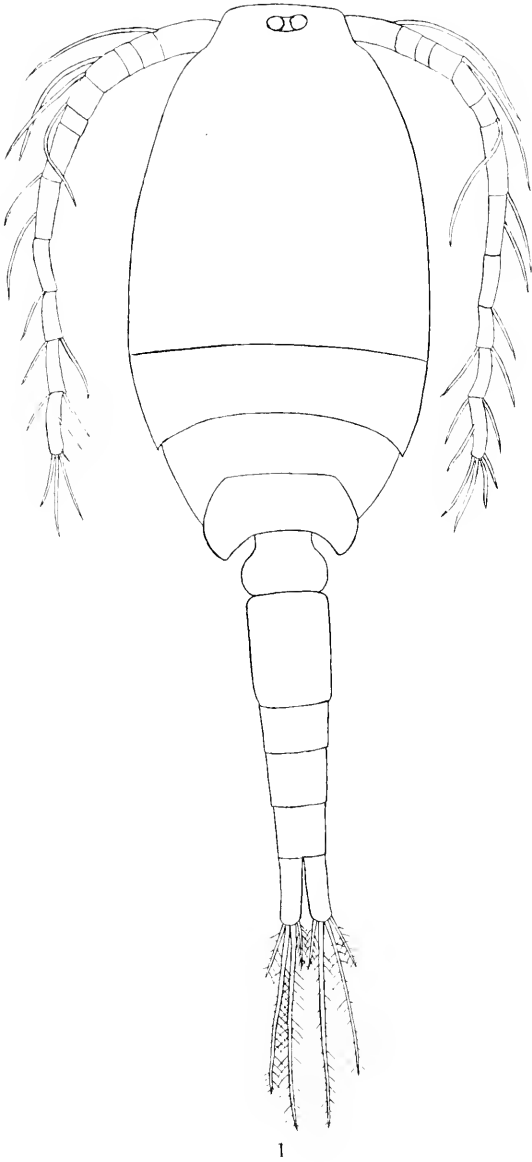
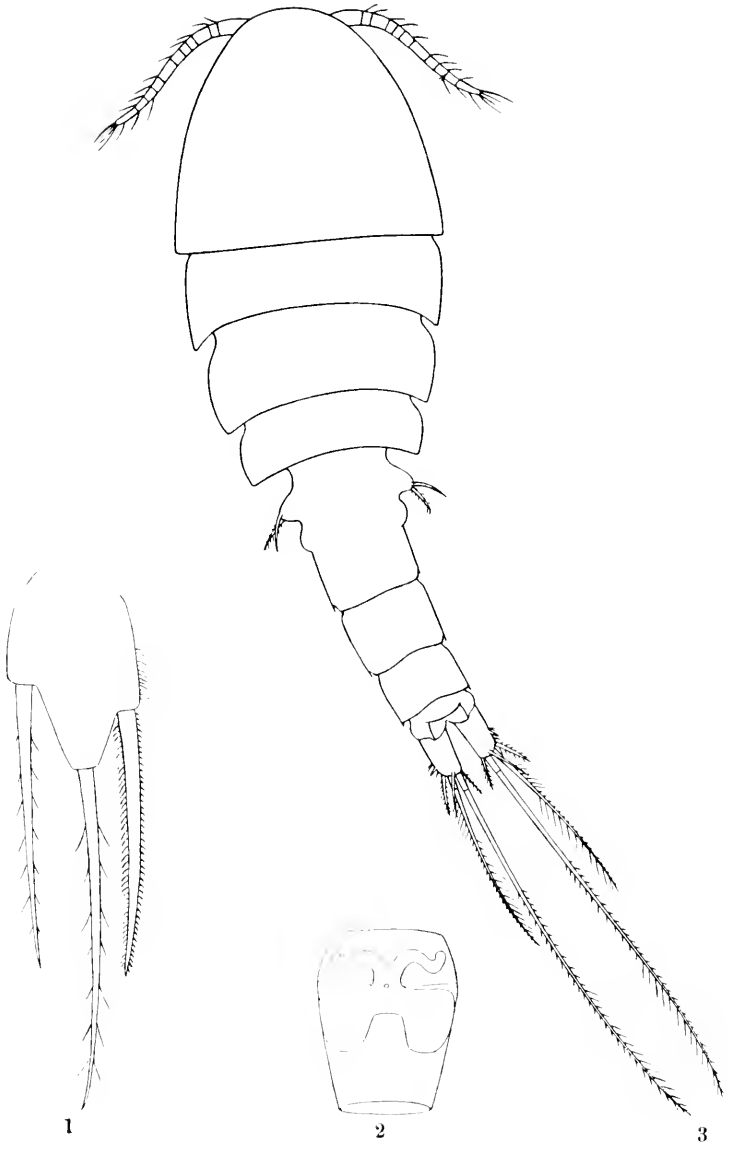

PLATE XX.





BULLETIN

DEC 23 1897

OF THE

7710
ILLINOIS STATE LABORATORY

OF

NATURAL HISTORY,

URBANA, ILLINOIS

VOLUME V.

*ARTICLE III.—THE NORTH AMERICAN SPECIES OF
DIPTOMUS.*

BY FREDERICK WILLIAM SCHACHT, B. S.

Illinois State Laboratory of Natural History,
URBANA, ILLINOIS,
1897.

STATE LABORATORY OF NATURAL HISTORY.

LABORATORY STAFF.

PROFESSOR STEPHEN ALFRED FORBES, PH. D.,
Director of State Laboratory and State Entomologist.

CHARLES ARTHUR HART,
Systematic Entomologist and Curator of Collections.

FRANK SMITH, A. M.,
Assistant Zoölogist.

CHARLES ATWOOD KOFOID, PH. D.,
Zoölogist, and Superintendent of Biological Station.

CHARLES CHRISTOPHER ADAMS, B. S.,
Entomological Assistant.

RALPH WALDO BRAUCHER, B. S.,
Entomological Assistant.

MARY JANE SNYDER,
Secretary.

HENRY CLINTON FORBES,
Business Agent and Librarian.

LYDIA MOORE HART,
Artist.

ARTICLE III.—*The North American Species of Diaptomus.*
 BY FREDERICK WILLIAM SCHACHT.

INTRODUCTION.

The first published reference to that group of genera of *Entomostraca* now known under the family name of *Centropagidae* is contained in O. F. Müller's "Entomostraca seu Insecta testacea quae in aquis Daniae et Norvegiae reperit," etc., published at Frankfort-on-the-Main in 1785, in which paper certain copepod species now included under the genus *Diaptomus* were treated under the general name of *Cyclans*.

The following paper was prepared in the course of undergraduate study in the Zoölogical Department of the University of Illinois, and was accepted by the Faculty of the University June 7, 1897, as a thesis for the degree of Bachelor of Science in Zoölogy.

described that its recognition is apparently impossible. Since the publication of Underwood's "List of the described Species of Fresh-water Crustacea from America North of Mexico" ('86) the number of recognized North American species of *Diaptomus* has increased from five to twenty-three.

The literature of the genus previous to 1889 was widely scattered and the synonymy greatly complicated, but the comprehensive and careful "Revision" published in that year by de Guerne and Richard ('89b) has had the effect greatly to facilitate its study. The most important recent European contributions to a knowledge of the *Centropagidae*

STATE LABORATORY OF NATURAL HISTORY.

LABORATORY STAFF.

Professor STEPHEN ALFRED FORBES, PH. D.,
Director of State Laboratory and State Entomologist.

CHARLES ARTHUR HART,
Systematic Entomologist and Curator of Collections.

MARY JANE SNYDER,
Secretary.

HENRY CLINTON FORBES,
Business Agent and Librarian.

LYDIA MOORE HART,
Artist.

ARTICLE III.—*The North American Species of Diaptomus.*
BY FREDERICK WILLIAM SCHACHT.

INTRODUCTION.

The first published reference to that group of genera of *Entomostraca* now known under the family name of *Centropagidae* is contained in O. F. Muller's "Entomostraca seu Insecta testacea quae in aquis Daniae et Norvegiae reperit," etc., published at Frankfort-on-the-Main in 1785, in which paper certain copepod species now included under the genus *Diaptomus* were treated under the general name of *Cyclops*. Species of *Diaptomus* were later described by Jurine ('20) under *Monoculus*, but the genus *Diaptomus* was first established by Westwood ('36). Various names have since been applied more or less closely to the generic group: *Cyclopsina*, Milne-Edwards ('38); *Glanca*, Koch ('38); and *Cyclops*, Nicolet ('48).

The first American species of *Diaptomus* recognizably described was *D. sanguineus* Forbes ('76). Later Dr. Forbes ('82a) described three additional species of this genus (*sivilis*, *leptopus*, and *stagnalis*), and two new genera of *Centropagidae* (*Epischura* and *Osphranticum*), with a single species of each. Prof. C. L. Herrick's publications on the group began in 1877 and those of Marsh in 1891. A single species (*D. kentuckyensis*) named by Chambers in 1881 is so imperfectly described that its recognition is apparently impossible. Since the publication of Underwood's "List of the described Species of Fresh-water Crustacea from America North of Mexico" ('86) the number of recognized North American species of *Diaptomus* has increased from five to twenty-three.

The literature of the genus previous to 1889 was widely scattered and the synonymy greatly complicated, but the comprehensive and careful "Revision" published in that year by de Guerne and Richard ('89b) has had the effect greatly to facilitate its study. The most important recent European contributions to a knowledge of the *Centropagidae*

have been made by Claus, Schmeil, Poppe, Imhof, Zacharias, and others, in Germany; by Brady, in England; by Nordqvist, in Finland; by Sars, in Norway; and by Lilljeborg in Sweden, the latter especially having described a number of American species. Perhaps the finest work yet published on *Copepoda* in general is Giesbrecht's monograph on the "Pelagischen Copepoden des Golfs von Neapel" ('92), the general classification of which is followed in the present article.

It has been my purpose in preparing this paper to do for the students of American *Centropagidae* a service similar to that which de Guerne and Richard have rendered to students of this group as distributed throughout the world. I am under especial obligation to my instructor, Prof. S. A. Forbes, to whose encouragement and aid any value this paper may have is to be largely attributed. I am indebted also for specimens or other favors to Dr. Wilhelm Lilljeborg, of Upsala, Sweden; to Dr. Otto Schmeil, of Magdeburg, Germany; to Herr S. A. Poppe, of Vegesack, Germany; to Prof. C. Dwight Marsh, of Ripon College, Wisconsin; to Prof. L. S. Ross, of Drake University, Des Moines, Iowa; to Mr. Adolph Hempel, now of the Museu Paulista, São Paulo, Brazil; to Prof. Frank Smith, of the University of Illinois; to Mr. C. E. Phillips, of Millington, Ill.; and to my friend and fellow student, Mr. E. B. Forbes. I have also to call attention to the fact that most of the figures accompanying this paper were drawn by the Artist of the State Laboratory, Miss Lydia M. Hart.

From Dr. Lilljeborg I received specimens of *Diaptomus signicauda*, *D. minutus*, *D. trybomi*, *D. eiseni*, *D. franciscanus*, *Epischura nevadensis*, and *E. nordenskiöldi*. Prof. Ross and Mr. Hempel kindly loaned me their personal collections, the former thus furnishing me *D. siciloides*, *D. piscinae*, and *D. claripes* sp. nov., and the latter, *D. mississippiensis* and *D. albuquerqueensis*. Prof. Marsh has sent me slides or entire specimens of *D. ashlandi*, *D. mississippiensis*, and *D. reighardi*. To Dr. Schmeil I owe thanks for several kind letters, for the European species *D. gracilis*, *D. graciloides*, *D. castor*, *D.*

salinus, *D. caralensis*, and *D. zachvatkini*, and for specimens of *Heterocope* and *Temorella*,—all of which, however, arrived too late to be of service to me in connection with this paper. From Herr Poppe I received the following species: *D. tyrrelli*, *D. gibber*, *D. incongruus*, *D. deitersi*, *D. drieschi*, *D. zachvatkini*, and *Limnocalanus sinensis*.

The material at my command was nearly complete, including all but two of the known North American forms (*D. noramericanus* and *D. birgei*), and the collection of the literature of the group to which I have had access is probably as ample as that to be found in any library in this country. In compiling the bibliographical list appended to this paper, Schmeil's monograph on the *Centropagidae* ('96) was taken as a basis and was especially helpful, while a great deal was also gained from the works of de Guerne and Richard.

By far the greater part of the collections examined are the property of the Illinois State Laboratory of Natural History. They represent localities distributed over the entire continent, from Massachusetts in the East to Oregon in the West, as far south as Florida and as far north as Canada, and including the following states: Massachusetts, Florida, Mississippi, Ohio, Indiana, Illinois, Iowa, Minnesota, Michigan, Wisconsin, Oregon, Washington, Montana, Wyoming, California, Idaho, and Nevada. In addition to the above I have examined specimens from Manitoba, Newfoundland, and Greenland.

The localities represented by these collections vary widely in character, ranging from temporary pools on the Illinois prairies to Lakes Michigan and Superior; from the warm lakes of the Florida swamps to the cold mountain lakes of the Rockies; and from the small head-water streams of the Kaskaskia to the sluggish Illinois and the mighty Mississippi. The collections were made at all seasons of the year and at nearly all times of the day and night.

Although no very complete data for any single locality are at hand, it is found that in ordinary years the spring and early summer are the most favorable seasons for collecting in our latitudes. Individuals are found, however, at all times; and in some cases the normal habitat is a lake whose waters are

but little above the freezing point, or even, as in the case of *D. minutus*, water flowing from the foot of a glacier. Although this would seem to indicate that these crustaceans are quite hardy, I have repeatedly found that in jars containing living specimens of *Cyclops*, *Diaptomus*, and *Osphranticum*, those of *Diaptomus* were the first to succumb to unfavorable conditions.

The genus *Diaptomus* is the most cosmopolitan of its family, species having been reported from North and South America, Europe, Asia, Africa, and Australia. No species, however, is known to be common to the mainlands of Europe and of America. This fact is the more remarkable since almost the direct opposite is true of the companion genus, *Cyclops*, only one or two species of which are, so far as known, peculiar to this continent. Even *D. minutus*, which is found in Oregon, Illinois, Wisconsin, Minnesota, Michigan, Newfoundland, Greenland, and Iceland, has not as yet been found in northern Europe or even in Great Britain, although the expanse of salt water between Iceland and Scotland or between Iceland and Scandinavia is but little greater than that between Greenland and the mainland of North America. But few species of this genus have been described from tropical regions, most of them having thus far been found in the north temperate zone; a fact to be attributed doubtless in large measure to the greater attention paid to zoological studies in these northern latitudes.

In this paper the plan followed by de Guerne and Richard in their "Revision" has been adopted, separate keys being made for males and for females. When females are so nearly alike as in *D. sicilis*, *siciloides*, *pallidus*, and *ashlandi*, it is somewhat difficult to find distinguishing characters, and differences not usually taken into account must be seized upon. The males are much more easily separated, since they offer a larger number of peculiarities. Giesbrecht and Schmeil have paid considerable attention to the armature of the entire male prehensile antenna instead of regarding only that of the last three segments, and in one or two cases I have done the same. In this connection a fact became

evident which if found to be generally true will necessitate a slight modification of the description of the family *Centropagidae*. I refer to the presence of a sense-club on the first segment of the right male antenna. In his monograph Giesbrecht in his description ('92, p. 85), says, "Vordere antennen ähnlich wie bei den Calaniden gebaut." On another page (42) we find this statement: "The normal number of processes seems to be three for each segment, a proximal seta, a distal seta, and a sensory structure [æsthetaski], but this triad is never complete on all segments, the sense-club on the first segment being always wanting and the sense-club and proximal seta nearly always absent on the twentieth to the twenty-fourth." In *Diaptomus stagnalis* and *D. clavipes* a sense-club is present on the first segment. The statement that the inner rami of the fifth pair of feet are "rudimentary, one-segmented, or lacking" will not hold in many species. Taking only those forms among non-American species which were described in de Guerne and Richard ('89b), we find the following with two-segmented inner rami: *D. mirus*, *D. lobatus*, *D. theeli*, and *D. glacialis*, Lilljeborg; *D. coruleus* Fischer, *D. gibber* Poppe, and *D. wierzejskii* Richard; and at least three American species have the inner ramus two-segmented—*D. stagnalis* Forbes distinctly, and *D. ciseni* Lillj. and *D. albuquerqueensis* Herrick indistinctly so.

It is expected that the keys here printed will be used in connection with the descriptions and figures, since the species vary within certain limits, and no hard and fast description can be given which will cover the peculiarities of every individual of a species. Local varietal differences or slight variations in proportion may make a key useless, and in all cases the totality of characters should be considered. A glance at the figures will indeed often be found more helpful than any verbal description.

Following the usual plan of specific descriptions, the first paragraph, referring to the general appearance of the body, thorax, abdomen, and furca and their relative proportions, applies always to the female unless especially stated otherwise.

SYNOPSIS OF THE RELATIONSHIPS OF THE GENERA *Osphranticum*,
Limnocalanus, *Diaptomus*, AND *Epischura*,
 OF THE FAMILY *Centropagidae*.

(Adapted and compiled from Giesbrecht (92), and from manuscript
 of Prof. S. A. Forbes.)

- 1 (19). Division of body into cephalothorax and abdomen between the thoracic segment bearing the fifth pair of feet and the segment bearing the genital apertures. In the male the fifth pair of feet assists in copulation. Abdomen with five segments; without appendages. Genital organs of the male unsymmetrical. Pulsating dorsal vessel generally present. Female deposits eggs singly or carries them with her in single sac until emergence of the nauplii. Suborder I. GYMNOPLEA.
- 2 (3). Anterior antennæ of male symmetrical or nearly so, and more richly provided with sense-clubs [*æsthetascs*] than those of the female. Fifth pair of feet of female either normal, or degenerate to complete disappearance. Secondary sexual distinctions of male not confined to peculiarities in the structure of the body, the antennæ, the fifth pair of feet, and the segmentation of the abdomen, but usually present in the cephalic appendages and sometimes also in the swimming feet. Marine. Tribe I. AMPHASKANDRIA.
- 3 (2). Anterior antennæ of male unsymmetrical. Fifth pair of feet in the female either normal or degenerated, but never absent. Secondary sexual characters of male generally confined to peculiarities in the structure of the body, the antennæ, and the fifth pair of feet. Marine and fresh-water. Tribe II. HETERARTHANDRIA.
- 4 (18). Rostrum present. Fourth and fifth thoracic segments confluent.
- 5 (6). Abdomen of female 1-3-segmented. Antennæ 16-24-jointed; last two segments always confluent. In the male the fifth pair of feet rarely with a rudimentary inner ramus. Antennæ with segments 19-21 and sometimes 22-25 confluent. Marine.

Family PONTELLIDÆ.

6 (5). Abdomen of female 3- or 4-segmented; sometimes unsymmetrical. Antennæ never with less than 24 segments. In the male, segments 19-21 and generally 22 and 23 are confluent. Abdomen 5-jointed; either right or left antenna prehensile. The fifth pair of feet are grasping organs and both always present, but with inner ramus normal, or degenerate to complete disappearance. Family CENTROPAGIDÆ.

7 (8). Thorax 6-jointed. All the feet of female with 3-segmented rami. Abdomen 3-jointed. Antennæ 25-jointed, segments 24 and 25 confluent. Right male antenna prehensile. Outer ramus of left fifth foot 2-jointed; of right, subchelate.

Subfamily CENTROPAGINA.

8 (7). Thorax 5-jointed. Fourth and fifth thoracic segments confluent.

9 (16,17.) Abdomen of female 3-jointed, sometimes unsymmetrical. Antennæ 23- or 24-jointed. Four anterior pairs of feet generally with 3-segmented rami. Fifth pair of feet degenerate, with inner ramus wanting or small and 1-jointed, outer ramus 1-3 jointed. Prehensile antenna generally the right; segments 19-21 and 22 and 23 confluent. Subfamily TEMORINA.

10 (11). Furca with but three large terminal setæ to each ramus. Abdomen of male unsymmetrical, provided with lateral prehensile apparatus. Fifth pair of legs of female uniramous, 3-jointed, not terminating with a long spine. Genus *Epischura*.

11 (10). Furca with four large terminal setæ to each ramus.

12 (13). Inner ramus of first pair of legs 2-jointed; of the following three pairs 3-jointed. Fifth pair of legs in both male and female biramous, inner ramus rudimentary. Genus *Diaptomus*.

13 (12). Both inner and outer rami of the first four pairs of legs 3-jointed. Fifth pair of legs in both sexes biramous, those of the female differing from the other legs only by the presence of a strong inner hook on the second

joint of the outer ramus; those of the male with the inner ramus 3-jointed and provided with plumose hairs, as in the other legs.

- 14 (15). Fifth pair of legs of female with the inner hairs of the last joint of the outer ramus transformed into short thick spines. In the male, outer ramus of left leg of fifth pair with two joints; outer ramus of right leg with three.
Genus *Osphranticum*.

- 15 (14). Fifth pair of legs of female with the inner hairs of the last joint of the outer ramus long and plumose. Fifth pair of legs of male with both outer rami 2-jointed.
Genus *Limnocalanus*.

- 16 (9, 17). Abdomen of female 4-jointed, symmetrical. Antennæ 25-jointed, articles 24 and 25 not confluent. Four anterior pairs of feet generally with 3-segmented rami, the fifth with 3-segmented outer and 2- or 3-segmented inner ramus. Male antennæ with segments 19-21 and 21-23 confluent. Fifth pair of feet subchelate; the right with 2-, the left with 3-segmented rami.
Subfamily LEUCKARTINA.

- 17 (9, 16). Abdomen 3- or 4-jointed, not always symmetrical. Four anterior pairs of feet with 3-jointed rami. Generally the left antenna of the male geniculate. Articles 19-21, 22 and 23 (or 22-25), and 1 and 2 confluent. Fifth pair of legs with 3-segmented outer and 1-3-segmented inner rami. Chelæ undeveloped or wanting.
Subfamily HETEROCILETINA.

- 18 (4). Rostrum wanting. Fourth and fifth thoracic segments of female not confluent. Abdomen 3-segmented. Male genital opening on the left; right antenna prehensile, segments 17 and 18, and 19 and 20 confluent. Inner rami of fifth pair of feet wanting; outer ramus of left foot 4-segmented, of right foot 3-segmented. Marine.
Family CANDACIDE.

- 19 (1). Division of body into anterior and posterior parts in front of the last (fifth) thoracic segment. This bears, almost without exception, a more or less rudimentary

pair of feet, which in the male never assist in copulation; on the contrary, the male attaches the spermatophores directly to the vulva of the female without the help of appendages. Genital organs of the male generally paired, the openings always symmetrical. Pulsating dorsal vessel almost always absent. The female carries the eggs with her, generally cemented into one or two egg sacs, until emergence of the young.

Suborder II. PODOPLEA.

DIAPTOMUS WESTWOOD.

Cyclops, O. F. Müller, 1785.

Monoculus, Jurine, '20.

Diaptomus, Westwood, '36.

Cyclopsina, Milne-Edwards, '38.

Glaucæa, Koch, '35-'41

Cyclops, Nicolet, '48-'49.

“Cephalothorax always with seven segments, of which the anterior two, indistinctly confluent, form the head. The last thoracic segment in the female rather large, posteriorly deeply emarginate in the middle, and often produced laterally on both sides into a biangulate lamina. Abdomen short, narrower than the thorax; in female of four segments (caudal rami included), of which the first is dilated anteriorly and very often armed with a lateral spine on each side; in male composed of six obvious segments of about equal width. Caudal rami with five uniaarticulate plumose setæ and with another much smaller, more slender seta within. The front provided with two minute tentaculiform appendages. The first pair of antennæ composed of 25 segments, increasing slightly in length toward the tip. The geniculate articulation between the 18th and 19th segments of the right male antenna; the six preceding segments swollen, the five following sometimes confluent into two articles. The outer ramus of the second pair of antennæ 7-jointed, longer than the inner ramus, the last article longest of all and armed with very long apical setæ; setæ of preceding articles short and

subequal. Second pair of maxillæ short and thick; third pair elongate, directed forward, 7-segmented, and provided with short setæ. The eight anterior swimming feet biramose, the inner ramus of the first pair 2-, of the following pairs 3-segmented. The last pair of feet different from the rest, 5-segmented, the second segment armed within with a small appendage or rudiment of an inner ramus; in the female short, equal, the last segment very short and rudimentary, the penultimate always produced into a strong hook curved inward; in the male the right foot subchelate, the last article formed into a very long movable hook. Eye single.”*

The following remarks on the genus are from de Guerne and Richard’s “Revision”:

“The genus *Diaptomus*, known at a very early date, was for a long time confounded with *Cyclops*. Clearly distinguished much later, it contained for a very long time only a few recognized species, and even these were insufficiently defined. Since their study has been taken up with more attention other forms have been distinguished, and the number of species now exceeds forty, and further explorations will undoubtedly bring others to light.†

“If we attempt to arrange characters in the order of their importance from a systematic point of view, we must say in the beginning that they are furnished almost wholly by the males. Except in certain cases the isolated females are difficult to determine. They are, however, rarely met with alone, and collections commonly contain, whatever the season, both sexes together.

“Among the characters furnished by the male, the greatest importance must be assigned to those of the fifth pair of feet. The length of the inner rami, composed of one or two segments, varies considerably (*minutus* to *castor*). As for the outer rami, the last article of the left foot should be examined first. It sometimes has the form of a kind of forceps and sometimes terminates in a sort of cushion bearing two short obtuse spines, which perhaps represent the branches of the

*Translated from the Latin diagnosis of de Guerne and Richard’s “Révision des Calanoides d’Eau Douce,” pp. 9 and 10.

†Sixty-five now, many having been added since the publication of the “Revision.”

foreeps. All the transitions between these two forms may be found in a series of species. Certain articles of the right ramus may also bear divers characteristic appendages. Finally, the terminal claw and the lateral spine of the last article often present by their form and their position enough peculiarities to greatly facilitate the determination.

"The right antenna of the male also furnishes some good characters, among which figure in the first rank the appendages of the antepenultimate article, much varied as to form and size (*D. bacillifer*, *wierzejskii*, *caruleus*).

"Generally speaking, the fifth pair of feet of the females furnish the most important specific characters, although they do not have the same technical value as in the male. At the same time various peculiarities drawn from the conformation of the last cephalothoracic and of the first abdominal segments and from the length of the antennæ, aid greatly in the determination."

KEY TO THE NORTH AMERICAN SPECIES OF *Diaptomus*, BASED ON
THE CHARACTERISTICS OF THE MALE.

- 1 (15). Antepenultimate article of right antenna without hook-like process at tip.
- 2 (3). Antepenultimate article of right antenna with narrow hyaline lamina. Second basal segment of right fifth foot armed at the inner margin with two hook-like processes, and on the anterior surface at the apical margin, with a hook-like process extending beyond the middle of the first segment of the outer ramus. Inner ramus extending barely beyond the middle of the first segment of the outer ramus; heavily spined at apex. Marginal spine below the middle of the segment, near the apical angle; short, stout, much less than half as long as the segment. Terminal hook very stout, longer than preceding segment. Left leg extending about to end of first segment of outer ramus of right leg; second basal segment tuberculate on inner margin. Inner ramus very long, extending about to middle of last segment of outer ramus; incurved,

tuberculate, and armed at apex with short, blunt spines. Last segment of outer ramus armed with a short blunt spine and a very long spinulose one.

claripes.

3 (2). Antepenultimate article of right antenna without hyaline lamina.

4 (5,10). Inner ramus of right fifth foot not reaching end of first segment of outer ramus; sharply pointed. First segment of outer ramus with hyaline lamina. Marginal spine below middle of segment; less than half as long as segment. Terminal hook longer than the two preceding segments. Left leg extending slightly beyond end of first segment of outer ramus of right leg; inner ramus reaching slightly beyond end of first segment of outer ramus, indistinctly 2-segmented, apex bluntly rounded.

tyrrelli.

5 (4,10). Inner ramus of right fifth foot reaching end of first segment of outer ramus.

6 (7). Inner ramus of left fifth foot extending to base of second segment of outer ramus, or slightly beyond. Marginal spine below middle, near apical angle; less than half as long as segment. Terminal hook at least as long as the two preceding segments. Left leg reaching about to middle of second segment of outer ramus of right leg. Last segment of outer ramus armed with forcipate structure; inner digitiform process armed with cushion on inner margin.

pallidus.

7 (6). Inner ramus of left fifth foot reaching to middle of second segment of outer ramus.

8 (9). Marginal spine of right leg above middle of segment, very stout, as long as or longer than segment. Terminal hook almost as long as the two preceding segments and second basal segment taken together. Inner ramus as long as first segment of outer ramus. First segment of outer ramus with broad hyaline lamina on inner margin. Left leg not quite reaching middle of second segment of outer ramus of right leg.

birgei.

- 9 (8). Marginal spine of right leg below middle of segment; slender, less than half as long as segment. Terminal hook longer than the two preceding segments, a sharp angle dividing it approximately into halves. Inner ramus reaching end of first segment of outer ramus; apex bluntly rounded. Left leg reaching beyond middle of last segment of outer ramus of right leg. Last segment of outer ramus ending in a forcipate structure; outer digitiform process stout, armed on inner margin near tip with cushion-like hairy process. *reighardi*.
- 10 (4, 5). Inner ramus of right fifth foot reaching well beyond end of first segment of outer ramus.
- 11 (12). Inner ramus of left fifth foot long, extending beyond middle of second segment of outer ramus; leg itself (disregarding terminal spines) not reaching end of first segment of outer ramus. Marginal spine of right leg inserted below middle of segment, near apical angle; much less than half as long as segment. Terminal hook shorter than the preceding segment. *piscine*.
- 12 (11). Inner ramus of left fifth foot short, not extending beyond middle of second segment of outer ramus.
- 13 (14). Inner ramus of left fifth foot not reaching to middle of second segment of outer ramus; leg itself reaching end of second segment of outer ramus of right leg. Marginal spine below middle of segment near apical angle; almost as long as segment. Terminal hook longer than the preceding segment. Inner ramus of right foot extending beyond end of first segment of outer ramus. *oregonensis*.
- 14 (13). Inner ramus of left fifth foot reaching middle of second segment of outer ramus; leg itself reaching about to middle of second segment of outer ramus of right leg. Marginal spine below middle of segment, about half as long as segment. Terminal hook longer than the two preceding segments. Inner ramus of right foot extending to middle of second segment of outer ramus. *mississippiensis*.

- 15 (1). Antepenultimate article of right antenna with hook-like process at tip.
- 16 (27). Process on antepenultimate article as long as or longer than penultimate article.
- 17 (20). Process curved.
- 18 (19). Inner ramus of right leg alone 2-segmented, extending almost to middle of second segment of outer ramus. Marginal spine below middle, near distal angle, smooth, about half as long as segment. Terminal hook fully as long as the two preceding segments and the second basal segment taken together. Second basal segment not dilated. Left leg reaching about to middle of first segment of outer ramus of right leg; inner ramus barely reaching middle of last segment of outer ramus. *franciscanus.*
- 19 (18). Inner ramus of both legs 2-segmented. Marginal spine below middle, near apical angle; hairy, almost as long as segment. Terminal hook longer than the two preceding segments, but not as long as those and the second basal segment taken together. Second basal segment dilated into rugose lamella. Inner ramus of right leg extending about to middle of second segment of outer ramus. Left leg extending about to middle of second segment of outer ramus of right leg; inner ramus extending beyond middle of last segment of outer ramus. *cisni.*
- 20 (17). Process straight.
- 21 (22). Process sharply pointed. Marginal spine below middle, about half as long as segment. Terminal hook longer than the two preceding segments. Inner ramus of right leg extending a little beyond end of first segment of outer ramus. Left leg reaching slightly beyond end of first segment of outer ramus of right leg; last segment of outer ramus with hairy cushion on inner margin; inner ramus extending almost to middle of last segment of outer ramus. *shoshone.*
- 22 (21). Process blunt or swollen at tip.

- 23 (24). Inner ramus of right leg rudimentary, barely surpassing end of segment from which it arises. Marginal spine about at middle of segment, very small. Terminal hook shorter than the very long preceding segment. Left leg extending slightly beyond end of first segment of outer ramus of right leg; inner ramus very narrow, extending about to middle of second segment of outer ramus. *minutus*.
- 24 (23). Inner ramus of right leg not rudimentary, longer than first segment of outer ramus.
- 25 (26). Marginal spine well above middle of segment, about half as long as segment. Terminal hook longer than the two preceding segments. Inner ramus of right leg very narrow. Left leg reaching slightly beyond end of first segment of outer ramus of right leg; inner ramus extending to middle of last segment of outer ramus. *ashlandi*.
- 26 (25). Marginal spine below middle of segment, less than half as long as segment. Terminal hook very slender, longer than the two preceding segments. First segment of outer ramus with hyaline lamina at inner distal angle. Left leg extending about to middle of second segment of outer ramus of right leg; inner ramus extending barely to middle of second segment of outer ramus. *sicilis*.
- 27 (16). Process shorter than penultimate article.
- 28 (33). Process the continuation of a hyaline lamina.
- 29 (30). Process extending at least to middle of penultimate article. Hyaline lamina extending but little more than the distal half of the segment. Marginal spine below middle of segment; shorter than segment. Terminal hook longer than the two preceding segments but not as long as those and the second basal segment together. Inner ramus of right leg extending slightly beyond end of first segment of outer ramus. Left leg extending slightly beyond end of first segment of outer ramus of right leg; inner ramus extending about to middle of last segment of outer ramus. *noramericanus*.

- 30 (29). Process extending very slightly beyond end of article of which it is a part. Hyaline lamina extending entire length of segment.
- 31 (32). Inner ramus of right leg reaching well beyond middle of the very long first segment of the outer ramus. Marginal spine below middle, near apical angle; less than half as long as segment. Terminal hook shorter than the preceding segment. Left leg (excluding terminal spines) reaching about to middle of first segment of outer ramus of right leg. Last segment of outer ramus terminated by two spines; inner ramus reaching well beyond end of first segment of outer ramus, but not to middle of last segment. *leptopus.*
- 32 (31). Inner ramus of right leg rudimentary (the suture being rarely visible), barely reaching the end of the very short first segment of the outer ramus. Marginal spine below middle of segment, less than half as long as segment. Terminal hook stout, longer than the preceding segment. Second basal segment very broad, armed at outer distal angle with a process about as large as the inner "ramus." Left leg very short, barely reaching end of second basal segment of right leg; inner ramus very short, extending barely beyond end of first segment of outer ramus. *sanguineus.*
- 33 (28). Process not the continuation of a hyaline lamina.
- 34 (41). Process straight.
- 35 (36). Process serrate on outer margin, extending beyond middle of penultimate article. Inner ramus of right leg very broad and short, extending but slightly beyond middle of first segment of outer ramus. Marginal spine above middle of segment, less than half as long as segment. Terminal hook longer than the very long preceding segment. Left leg very short, extending barely beyond end of first segment of outer ramus of right leg. First basal segment of both legs with long slender spine on posterior surface. *trybomi.*
- 36 (35). Process not serrate.

- 37 (38). Inner ramus of right leg rudimentary, extending but slightly beyond the end of the segment to which it is attached. Marginal spine below middle of segment, slender, fully half as long as the very long segment. Terminal hook shorter than the preceding segment. Left leg (disregarding terminal spines) not reaching end of first segment of outer ramus of right leg. Last segment with two spines: one long, slender, outcurved; the other short, stout. Inner ramus extending almost to end of last segment of outer ramus. *lintoni*.
- 38 (37). Inner ramus of right leg not rudimentary, extending to middle of first segment of outer ramus or beyond.
- 39 (40). Inner ramus of right leg extending about to middle of first segment of outer ramus. Marginal spine below middle, about half as long as segment. Terminal hook longer than the preceding segment. Second basal segment with hyaline lamina on inner margin. Left leg (disregarding terminal spines) reaching about to middle of first segment of outer ramus of right leg; inner ramus reaching end of first segment of outer ramus, corrugate on inner margin. *stagnalis*.
- 40 (39). Inner ramus of right leg extending beyond the end of the very short first segment of outer ramus. Marginal spine below middle of segment, stout, longer than segment. Terminal hook very long, stout, longer than remainder of leg. Left leg extending beyond end of first segment of outer ramus of right leg; second segment with ciliate lamina on inner margin; inner ramus reaching end of first segment of outer ramus. *albuquerqueensis*.
- 41 (34). Process curved.
- 42 (43). Process small, not reaching middle of penultimate article. Marginal spine below middle; rather stout, less than a third the length of segment. Terminal hook noticeably longer than the two preceding segments. First segment of outer ramus with hyaline lamina on inner margin, the inner apical angle of which is not

produced. Inner ramus of right leg not reaching end of first segment of outer ramus; apex bluntly rounded. Left leg reaching about to end of first segment of outer ramus of right leg; inner ramus reaching middle of last segment of outer ramus, margins sinuously curved.

siciloides.

- 43 (42). Process stout, reaching to middle of penultimate article or beyond. Marginal spine below middle of segment, less than half as long as segment. Terminal hook not much if any longer than the two preceding segments. First segment of outer ramus with hyaline lamina on inner margin, which is much produced at the outer apical angle. Inner ramus of right leg conical, not reaching end of first segment of outer ramus. Left leg reaching to tip of first segment of outer ramus of right leg. Inner ramus extending beyond middle of last segment of outer ramus; margins parallel; armed on outer margin near base with small hemispherical process.

signicauda.

KEY TO THE NORTH AMERICAN SPECIES OF *Diaptomus*, BASED ON THE CHARACTERISTICS OF THE FEMALE.

- 1 (18). Inner ramus of fifth pair of legs noticeably shorter than first segment of outer ramus.
- 2 (10). Outer ramus distinctly or indistinctly 3-segmented.
- 3 (4,7). Inner ramus distinctly 2-segmented, the first segment very short and subquadrate; barely reaching end of first segment of outer ramus; armed with two straight hairy spines, almost as long as the ramus. Second segment of outer ramus with small spine near base of third segment; spinose on both margins. Third segment armed with two stout spines, the inner hairy, about twice as long as the outer, which is about as long as the spine on the preceding segment. Last thoracic segment strongly produced. First abdominal segment longer than remainder of abdomen, greatly dilated, armed on each side with large spine; second segment shorter than third. Furcal rami about as

long as wide, hairy within. Antennæ extending barely to base of abdomen. *stagnalis*.

4 (3,7). Inner ramus indistinctly 2-segmented.

5 (6). Terminal spines of inner ramus about half as long as ramus. Second segment of outer ramus armed with a single spine. Two spines on the third segment; suture between this and preceding segment indistinct. Inner ramus extending beyond middle of first segment of outer ramus; armed at apex with two long spines. Third segment of outer ramus armed with two very large stout spines, the inner hairy, less than twice as long as the outer. First abdominal segment longer than remainder of abdomen; armed anteriorly with large lateral process. Antennæ reaching process on first abdominal segment. *eiseni*.

6 (5). Terminal spines of inner ramus not nearly half as long as ramus. Second segment of outer ramus with a spine. Inner ramus extending slightly beyond middle of first segment of outer ramus. Third segment of outer ramus hairy and about twice as long as the inner, which is smooth. First abdominal segment longer than remainder of abdomen, armed laterally with strong spines. Antennæ extending beyond tips of furcal setæ.

albuquerqueensis.

7 (3,4). Inner ramus 1-segmented.

8 (9). Terminal spines of inner ramus smooth, more than half as long as ramus, which is rounded at apex and hairy. Second segment of outer ramus straight, as long as or longer than preceding segment; armed at base of third segment with short spine, shorter than either of the two on third segment. Inner spine of third segment hairy, about twice as long as the outer, which is smooth. Both spines considerably longer than the segment itself. Last thoracic segment armed on each side with two small spines. First abdominal segment shorter than remainder of abdomen, dilated, armed with large spines; second segment very short.

Third segment and furcal rami about equal. Antennae reaching base of abdomen. *shoshone.*

9 (8). Terminal spines of inner ramus smooth, not nearly half as long as ramus, which is hairy at apex and on inner margin. Second segment of outer ramus curved, barely as long as preceding segment; armed at base of third segment with an inconspicuous spine. Third segment armed with two short spines but slightly longer than the segment. Last thoracic segment armed with small spines. First abdominal segment with a sharp spine; longer than remainder of abdomen. Antennae reaching furcal rami. *noraméricanus.*

10 (2). Outer ramus 2-segmented.

11 (12). Inner ramus almost rudimentary, not nearly reaching the middle of first segment of outer ramus. Second segment of outer ramus considerably shorter than first; third segment represented by two spines, the inner about twice as long as the outer. Last thoracic segment armed on each side with small spine. First abdominal segment as long as remainder of abdomen; second segment very short; third, longer than furcal rami. Antennae reaching slightly beyond furca.

minutus.

12 (11). Inner ramus not rudimentary, reaching beyond the middle of first segment of outer ramus.

13 (14). Second segment of outer ramus armed with a short spine; denticulate within and without. Third segment represented by two subequal spines. Inner ramus not nearly reaching end of first segment of outer ramus; hairy on inner margin; terminal spines fully half as long as segment. First abdominal segment dilated, about equal in length to remainder of abdomen; second segment and furcal rami each longer than third segment. *piscina.*

14 (13). Second segment of outer ramus not armed with a spine.

- 14 (15). Inner ramus armed with very short subequal spines and hairy at apex. Second segment of outer ramus curved, denticulate on inner margin; third segment represented by two spines, the inner the longer and about half as long as the second segment. Last thoracic segment produced, armed with two large spines on each side; penultimate thoracic segment produced into dorsal hump. First abdominal segment as long as remainder of abdomen, armed with large spine on each side; second segment shorter than the third, which is about equal to the furcal rami. Antennae extending about to base of abdomen. *sanguineus*.
- 15 (14). Inner ramus armed with long conspicuous spines.
- 16 (17). Second segment of outer ramus straight, about as long as the first, armed with a spine at base of third segment. Inner spine of third segment slightly the longer. Inner ramus hairy at apex; terminal spines straight, hairy, about a third as long as the ramus. Last thoracic segment armed on each side with a spine. First abdominal segment short, unarmed. Antennae extending to end of thorax. *leptopus*.
- 17 (16). Second segment of outer ramus straight, slightly shorter than first; third segment represented by two subequal spines. Inner ramus barely as long as first segment of outer ramus, hairy at apex, armed with two rather long spines. Antennae extending to end of furca. *birgei*.
- 18 (1). Inner ramus clearly reaching end of first segment of outer ramus or beyond.
- 19 (22). Outer ramus 3-segmented.
- 20 (21). Third segment of outer ramus small but distinct; inner of the two spines slightly the longer. Second segment curved, shorter than first; denticulate on inner margin; armed with small spine at base of third segment. Terminal spines of inner ramus very long, almost as long as the ramus. Last thoracic segment armed with two minute spines. First abdominal

segment as long as remainder of abdomen, dilated, armed with small spines; second segment very short; third segment longer than furcal rami. Antennæ extending to furca. *franciscanus.*

- 21 (20). Third segment of outer ramus very indistinct or aborted; armed with two short subequal spines. Second segment of outer ramus about as long as the first, hairy within and without. Inner ramus reaching about to end of first segment of outer ramus, hairy, armed with two long hairy subequal spines. First abdominal segment shorter than remainder of abdomen, dilated but unarmed; second segment shorter than the third, which is longer than the furca. Antennæ not reaching end of furca. *piscine.*

22 (19). Outer ramus 2-segmented.

- 23 (26). Second segment of outer ramus armed with a spine in addition to the two spines representing the third segment.

24 (25). Terminal spines of inner ramus hairy, nearly half as long as ramus, which reaches to the end of the first segment of the outer ramus. Second segment of outer ramus shorter than the first, slightly curved, denticulate within; third segment represented by two spines, the inner hairy, about half as long as the outer, which is smooth. First abdominal segment longer than remainder of abdomen; second segment shorter than third; the third longer than furca. Antennæ reaching tip of furcal rami. *lintoni.*

- 25 (24). Terminal spines of inner ramus hairy, not nearly half as long as ramus, which is hairy at the apex. Third segment of outer ramus represented by two spines, the inner about twice as long as the outer. Second segment armed with a small spine. Last thoracic segment greatly produced laterodorsally; armed on each side with two small spines. First abdominal segment about as long as remainder of abdomen and armed with two large spinose processes; second segment

shorter than third and about equal to furcal rami. Antennæ extending beyond base of furca but not beyond the tip. *tyrrelli*.

26 (23). Second segment of outer ramus not armed with an additional spine.

27 (32). Second segment of outer ramus longer than preceding segment.

28 (29). Outer of the two spines representing the third segment of outer ramus very small and inconspicuous; second segment shorter than the first, denticulate. Inner ramus reaching slightly beyond end of first segment of outer ramus; hairy on outer margin and at apex; armed with two rather long subequal spines. Last thoracic segment produced laterodorsally, armed with two spines on each side. First abdominal segment slightly shorter than remainder of abdomen, dilated, armed on each side with a large spine; second segment shorter than third; third segment and furca about equal. Antennæ reaching beyond tip of furca. *claripes*.

29 (28). Outer spine rather conspicuous.

30 (31). Terminal spines of inner ramus smooth. Inner ramus reaching end of first segment of outer ramus; apex hairy; spines small. Second segment of outer ramus about as long as the first, denticulate, point acute; third segment represented by two spines. First abdominal segment as long as remainder of abdomen, dilated, armed with small spines; second segment shorter than third; third about equal to the furca. Antennæ extending to tips of furcal setæ.

oregonensis.

31 (30). Terminal spines of inner ramus hairy, subequal. Second segment of outer ramus about equal to the first; third segment represented by two subequal spines. Last thoracic segment armed on each side with two small spines; the penultimate thoracic segment with a small hump. First abdominal segment slightly

shorter than remainder of abdomen; second segment shorter than third; third segment and furca about equal. Antennæ extending beyond end of furca but not to tips of furcal setæ. *signicauda.*

- 32 (27). Second segment of outer ramus shorter than preceding segment.
- 33 (34). Last thoracic segment with a large dorsal process, armed with two spines, one minute. First abdominal segment longer than remainder of abdomen, with short mucronate process anteriorly, and posteriorly with large triangular process. Second segment of outer ramus straight, hairy; third segment represented by two spines, the inner about twice as long as the outer. Inner ramus noticeably shorter than first segment of outer ramus, with two long subequal spines at the apex. Antennæ barely reaching furca. *tryblomi.*
- 34 (33). Last thoracic segment without dorsal process.
- 35 (36). First abdominal segment longer than remainder of abdomen, dilated, armed with small spine on each side; second segment very short; third segment shorter than furcal rami. Second segment of outer ramus shorter than the first; third segment represented by two spines of which the inner is the longer. Inner ramus extending beyond end of first segment of outer ramus, hairy, armed with two smooth subequal spines. Antennæ extending just beyond furca. *ashlandi.*
- 36 (35). First abdominal segment about equal to remainder of abdomen.
- 37 (38). Second abdominal segment very much shorter than the third. Last two thoracic segments confluent; the last one armed on each side with two small spines. First abdominal segment with large spine on each side; third segment longer than the second or the furca. Second segment of outer ramus shorter than the first; third segment represented by two small spines, the inner about twice as long as the outer. Inner ramus

hairy, armed with two small spines. Antennæ reaching slightly beyond end of furcal rami. *siciloides*.

38 (37). Second abdominal segment slightly shorter or at least not longer than the third.

39 (42). Furca longer than third abdominal segment.

40 (41). First abdominal segment nearly as long as remainder of abdomen; dilated laterally, armed with one small spine on each side. Second segment of outer ramus shorter than the first; third segment represented by two spines, the inner the longer and pointed obliquely outward. Inner ramus reaching end of first segment of outer ramus; apex hairy and armed with two spines. Antennæ reaching end of furcal setæ.

reighardi.

41 (40). First abdominal segment as long as remainder of abdomen; dilated laterally but unarmed. Last thoracic segment produced, armed with one small spine on each side. Head partially divided by a suture. Third segment of outer ramus represented by two spines, the inner smooth, about twice as long as the outer, which is delicately hairy. Inner ramus hairy, armed with two long subequal spines. Antennæ reaching beyond end of furca.

gullivus.

42 (39). Furca about equal to third abdominal segment.

43 (44). First abdominal segment about as long as remainder of abdomen and armed with small spines, equal on the two sides. First thoracic segment armed with small spine on each side. Second segment of outer ramus shorter than the first; third segment represented by two spines, the inner about twice as long as the outer. Inner ramus longer than first segment of outer ramus; hairy, armed with two spines, the inner twice as long as the outer; margin sinuously curved. Antennæ reaching beyond tip of furca.

sicilis.

44 (43). First segment of abdomen as long as remainder of abdomen; armed with two large lateral spines, the

right somewhat the longer. First two thoracic segments equal, together about half as long as entire thorax; last segment armed with two small spines. Second segment of outer ramus very broad, especially at the base. Inner ramus hairy on outer margin and at tip, which is armed with two rather long slender spines. Antennæ reaching beyond furca.

mississippiensis.

Diaptomus sicilis FORBES. (Pl. XXI., Fig. 1-3.)

Diaptomus sicilis. Forbes, '82a, p. 645, Pl. VIII., Fig. 9, 20.

Diaptomus pallidus var. *sicilis*, Herrick, '84, p. 142, Pl. Q. Fig. 18.

Diaptomus sicilis, de Guerne et Richard, '89b, p. 23, Fig. 13, 14; Pl. II., Fig. 13.

Diaptomus sicilis. Forbes, '90, p. 702, Pl. I., Fig. 6.

Diaptomus sicilis. Marsh, '93, p. 197, Pl. III., Fig. 8, 10.

Body slender, widest in front of the middle; suture between head and thorax distinct. Last two thoracic segments confluent; the last one produced laterodorsally and armed on each side with one or two small spines; (in the male unarmed.) Abdomen long and narrow, especially in the male, in which the first segment is the longest and slightly the broadest. In the female (Pl. XXI., Fig. 3) this segment is fully as long as the remainder of the abdomen, dilated, and armed on each side with a spine; last three segments subequal. Furcal rami fully twice as long as broad and hairy within.

Antennæ 25-segmented, reaching well beyond the tips of the furcal rami. Male geniculate antenna moderately swollen beyond the twelfth segment; first two segments without special armature; antepenultimate segment armed with narrow spine-like process with swollen apex, reaching to the middle of the penultimate segment; segments 19, 20, and 21 confluent, as are also 22 and 23.

Fifth pair of legs in the male (Pl. XXI., Fig. 1) rather long and slender. First basal segment of the right foot with a large tubercle on the posterior surface near the outer margin, bearing a minute blunt spine. Second basal segment subquadrate, about one and a half times as long as broad. At the beginning of the distal third of its outer margin, is a

small cuticular projection bearing a delicate hair. First segment of the outer ramus subquadrate, slightly longer than broad, the inner distal angle provided with a small semi-elliptical hyaline lamina arising from the anterior surface of the leg; second segment slightly arcuate, the two margins parallel, fully twice as long as wide. Marginal spine long and slender, slightly curved, about half as long as the segment, and inserted at the beginning of the distal third. Terminal hook long, slender, and regularly curved; very minutely denticulate on the inner margin.

Inner ramus of the right leg either one- or two-segmented, extending beyond the end of the first segment of the outer ramus; minutely hairy at the tip.

There is nothing distinctive about the basal segments of the left leg. The first segment of the outer ramus is about one and a half times as long as broad; the inner distal angle gradually rounded and minutely hairy. The second segment is narrow, twice as long as broad; armed at the tip with two digitiform processes and sometimes with a much smaller third process between the two. This segment appears very broad and fleshy because of a cushion-like process with rugose surface which extends beyond the inner margin of the segment for half its length. The other, upper, half is occupied by a minutely hairy semicircular cushion.

Inner ramus of the left foot either one- or two-segmented, extending to the middle of the last segment of the outer ramus; hairy at the tip.

Basal segments of the fifth pair of feet in the female (Pl. XXI., Fig. 2) not characteristic. The usual delicate hair is found on the outer margin of the second basal segment. First segment of outer ramus long and narrow, more than twice as long as broad. Second segment almost as long as the first, narrow, tapering to a fine point, delicately spinose at the inner margin. Third segment wanting; represented by two spines, both sharp and slender, the inner about twice as long as the outer.

Inner ramus of fifth leg of female one-segmented, projecting slightly beyond the end of the first segment of the outer

ramus, the proximal four fifths of uniform width. At the beginning of the distal fifth of the inner margin is a rather sharp angle, from which projects a long, slender, slightly curved spine, about one fifth the length of the ramus. Beyond this the ramus tapers to a blunt point, hairy at the apex. Besides the spine already mentioned there is a smaller one, only about half as long, having its point of insertion very near and slightly above the first.

Length of female 1.23-1.28 mm; of male 1.00-1.18 mm.

D. sicilis closely resembles both *D. ashlandi* and *D. pallidus*, differing from the latter, however, in the presence of a hook on the right male antenna, and from both in the details of structure of the fifth pair of feet of the male.

A very interesting variation was noticed in the inner rami of the fifth pair of feet of the male. In specimens taken from Lake Superior, at Marquette, Mich., the rami were sometimes both one-segmented, sometimes both were two-segmented, and at other times one ramus was two-segmented while the other was one-segmented. Herrick (Herrick and Turner, '95) states that all his specimens had one-segmented rami; also that the process on the right male antenna was shorter than described by Dr. Forbes.

Although *D. sicilis* is not at all uncommon, it has occurred less frequently in the collections I have examined than have *D. siciloides* Lillj., *D. ashlandi* Marsh, or *D. oregonensis* Lillj. Marsh ('93) records *D. sicilis* from the Great Lakes and from Green Lake, Wis., it being the common pelagic species in 1890 and 1891, while in 1892 not a single specimen was found there although the collections were made at the same time of year. The type was described (Forbes '82a) from Lake Michigan and had not then been found anywhere else. In 1890 Dr. Forbes found it in Lake Michigan, in northern Michigan, as well as in Lake Michigan. His variety *imperfectus* is *D. ashlandi* Marsh. In the Yellowstone Park collections *sicilis* was found in considerable quantities, but as both *D. sicilis* and *D. ashlandi* were present, it would require a re-examination of the material to determine the distribution of the two species in that locality.

Diaptomus piscinæ FORBES. (Pl. XXII., Fig. 1-4.)

Diaptomus piscinæ, Forbes, '93, p. 253, Pl. XLI., Fig. 22.

Diaptomus piscinæ, Herrick and Turner, '95, p. 74, Pl. V., Fig. 13.

“A species of medium size and symmetrical proportions, antennæ reaching to the tip of the abdomen, cephalothorax broadest about the middle, with four distinct sutures, the posterior lateral angles not produced but armed with two distal spines.

“The right antenna of the male is without appendage to the antepenultimate joint, and the fifth pair of legs in the same sex has the inner ramus well developed on both the right and left sides. The usual length is 1.75 millimeters, the transverse diameter 0.45 millimeters; the abdomen with furca is a little more than one third the length of the cephalothorax.

“The fifth pair of legs of the female [Pl. XXII., Fig. 2, 4] is without especially marked characters, except that the inner ramus, which reaches to the tip of the principal segment of the outer, is provided with two long, stout, equal setæ more than half as long as the ramus itself. The third joint of the outer ramus is aborted and bears two short, stout spines, and the joint preceding bears a slender spine outside the base of the last. The terminal claw of this joint is simple and nearly straight, viewed in the usual position.

“In the male the fifth pair of legs [Pl. XXII., Fig. 1] has a considerable resemblance to the corresponding appendages of *D. leptopus*, from which, however, this species differs by its more slender form and by the absence of the antennal hook. The peduncle of the left leg is quadrate and equal in length to the basal segment of the outer ramus, but is nearly twice as wide. The sides of this latter segment are parallel, the inner terminal angle is broadly rounded and minutely ciliate, and to the outer terminal angle is attached the second segment of the ramus. This segment is a trifle shorter than the preceding and less than half as wide, and bears at its tip a stout, blunt, conical spine, whose length is equal to that of the diameter of the ramus, and within this a long flexible

hair as long as the ramus itself. The inner ramus of this leg is very long, reaching beyond the middle of the terminal joint of the outer ramus. It is slightly concave towards this ramus and terminates with a broadly rounded or subtruncate, thickly ciliate end, forming an acute outer angle and an obtuse inner one. Seen at right angles to this view, the tip is simply obtusely pointed.

“The right leg of the male is without remarkable distinguishing characters. Basal joint of the outer ramus about two thirds as long as the peduncle and nearly as wide; second joint slightly longer than the peduncle, equal to the first in width; and the terminal claw sinuate or irregularly curved. The stout seta on the outer margin of the second segment of this ramus is borne at about a quarter the length of the segment from the distal end, and is approximately half as long as the segment to which it is attached. The inner ramus is a little longer than the basal joint of the outer. It is not dilated or otherwise modified, but terminates bluntly, bearing at the tip a covering of long cilia.

“The right antenna of the male is without notable distinctive characters. The antepenultimate segment is as long as the two following taken together; the fourth from the tip bears two long sword-like spines at its margin, both attached to its basal fourth; the expanded segments are well armed with conical spines, straight and curved, but without hooks.

“Small lakelet near Gardiner, Montana.”

This is the only one of the four species described by Dr. Forbes ('93) which I have found in any other collections than the original ones. In collections loaned me by Prof. L. S. Ross, of Drake University, Iowa, made by him at Portage Slough, Manitoba, Canada, in June, 1895, I found quite a number of specimens of this species, which, however, exhibit a number of peculiarities. The fifth pair of legs in the female are stouter and the inner ramus is relatively shorter than in the Montana specimens, the latter not reaching to the end of the first segment of the outer ramus as it does in the type. The spines on the inner ramus also have a more

‡Description quoted from Forbes, '93

distinct and broader basal portion than the individuals from Yellowstone Park. Both the inner and outer margins of the second segment of the outer ramus are hairy in Dr. Forbes's specimens, but much more pronouncedly so in the specimens from Portage Slough.

The fifth pair of feet of the male are very similar to the corresponding appendages of *D. claripes* sp. nov. and *D. leptopus* Forbes. Dr. Forbes notes the differences between his species (*piscine* and *leptopus*), and from *claripes* both may be distinguished at a glance by the inner rami and the other peculiarities mentioned in the description of that species. A characteristic of *D. piscine*, and one which was neither figured nor described, is a fin-shaped process on the middle of the anterior surface of the second basal segment of the right fifth foot of the male. This is armed on the inner margin with a row of bead-like tubercles and is more distinct in the Portage Slough specimens. This process corresponds to a similar one in *D. claripes*. The lower two thirds of the inner margin of this segment are hairy, and at the end of the proximal third is a small triangular projection.

The terminal hook and the marginal spine of the outer ramus of the right male foot are both denticulate on the lower half of the inner margin.

In the "Preliminary Report on the Aquatic Invertebrate Fauna of the Yellowstone National Park, Wyoming, and of the Flathead Region of Montana" the inner ramus of the right fifth leg of the male (Fig. 22) by mistake was not figured. The description was correct but the figure did not correspond.

The first and second segments of the outer ramus of the left fifth foot of the male are hairy on the inner margin.

The length of the Portage Slough specimens is as follows: female, 2.11 mm; male, 2.06 mm.

Diaptomus lintoni FORBES. (Pl. XXVII., Fig. 1.)

Diaptomus lintoni, Forbes, '93, p. 252, Pl. XLII., Fig. 26-28.

Diaptomus lintoni, Herrick and Turner, '95, p. 68, Pl. V., Fig. 12.

"A large red species occurring commonly with *D. shoshone*, but distinguishable from it at a glance by its different shape,

its longer antennæ, its smaller size, and by characters derived from the right antenna and the fifth foot of the male. The thorax is symmetrically elliptical in shape, broadest at the middle. The posterior angles are not produced or bifid, but are each armed with a minute spine. The first segment of the abdomen of the female is not especially produced, but bears at its broadest part a minute spine on each side. The abdomen itself is very short, its length contained about three and one third times in that of the cephalothorax. The antenna of the female is long and slender, 25-jointed, reaching a little beyond the tip of the abdomen.

“The fifth pair of legs in this sex is similar to those of *D. shoshone*, but much smaller. The inner ramus is not jointed. It is longer than the basal joint of the outer ramus, bears two stout plumose setæ at its tip, somewhat shorter than the ramus itself, and has likewise at its inner tip a patch of small spines or fine hairs. The second segment of the outer ramus with its terminal claw is two thirds as long again as the preceding segment, the breadth of the latter two thirds its length. The third joint is indicated by a single long stout seta and one or two smaller ones.

“In the male the geniculate antenna is relatively rather slender, its last two joints without special appendages, its penultimate with a slender transparent apical process, reaching about to the middle of the succeeding segment, acute at tip, but neither serrate nor emarginate. Fifth pair of legs in the male [Pl. XXVII., Fig. 1] usually without internal ramus to the right leg, but this ramus sometimes represented by a small rudiment. The limb is usually slender and its terminal claw short. The basal segment of the outer ramus is nearly as long as the adjacent segment of the pedicel, and the slender second segment of this ramus is fully as long. Long lateral spine borne near the tip of this segment. The terminal claw is about two thirds as long as the segment, is somewhat abruptly angulated near its base and slightly recurved at the tip. The inner ramus of the left leg is very stout and long, reaching almost to the tip of the outer ramus, is slightly curved outwards and has the apex

minutely hairy. The basal segment of the outer ramus is thick, two thirds as broad as long, somewhat inflated within, where it extends downward and beyond the articulation with the second segment as a rounded expansion covered with extremely fine hairs. Second segment of this ramus longer than first, but only half as wide, bearing at its tip, within, a rather small, obliquely projecting cushion covered with cilia, and with two stout terminal spines, one short, blunt, straight, and smooth, the other curved and plumose, its length about half that of the segment to which it is attached.

“The total length of this species is about 2.5 millimeters, excluding caudal setæ; depth, 0.42 millimeters.

“This species is closely related to *D. stagnalis*, Forbes, from which it differs conspicuously by its smaller size, more symmetrical cephalothorax, without prominent or bifid angles, and longer and more slender antennæ, with longer and more slender appendage to the antepenultimate segment.

“In the fifth legs of the female this species differs from *stagnalis* especially with respect to the inner ramus, which is larger and longer than in the other, lacks the characteristic segmentation of *stagnalis*, and bears at its tip shorter and broader setæ. In the male the terminal claw of the outer ramus of the right fifth leg is much more slender than in *stagnalis*, and the inner ramus is much less developed. The left leg of this pair is different in a number of details, especially in the length and strength of the inner ramus and the length and dissimilarity of the setæ at the end of the outer.

“Common in lakes and pools of Yellowstone Park.”*

This species is one of the three American forms in which the inner ramus is rudimentary or wanting, the other two being *D. sanguineus* Forbes and *D. minutus* Lilljeborg. It has not been recorded from any localities outside of those in which it was originally found.

* Description quoted from Forbes, '83.

Diaptomus leptopus FORBES.

Cyclops longicornis (?), Herrick, '77, p. 238, Fig. 1.

Diaptomus kentuckyensis (?), Chambers, '81, p. 48, Pl. A, Fig. 12-18;
Pl. B, Fig. 19-23.

Diaptomus leptopus, Forbes, '82a, p. 646, Pl. VIII., Fig. 17-19.

Diaptomus castor (?), Herrick, '82, p. 221, Pl. I., Fig. 1-7; Pl. II., Fig. 12, 16.

Diaptomus longicornis var. *leptopus*, Herrick, '84, p. 140.

Diaptomus leptopus, de Guerne et Richard, '89b, p. 21, Pl. II., Fig. 19;
Pl. III., Fig. 9.

Diaptomus leptopus, Marsh, '93, p. 195, Pl. III., Fig. 4, 5.

Diaptomus leptopus, Herrick and Turner, '95, p. 64, Pl. II.; Pl. IX.,
Fig. 9.

Body long and slender, widest a little before the middle. Head rather noticeably narrower than thorax, suture between them distinct. Fifth and sixth thoracic segments confluent, the last produced dorsally on each side into a triangular process with a bluntly rounded apex armed with a single blunt spine. The last thoracic segment of the male and the first abdominal segment of both sexes unarmed. First abdominal segment short, a little more than half as long as the succeeding segment. Furcal rami about one and a half times as long as wide, hairy within.

Antennæ 25-jointed, extending to the tip of the furcal rami. The male prehensile antenna rather thickly swollen, the first segment without armature, the other segments armed as follows: 2, with a short seta and a sense-club; 3, short seta and sense-club; 4 and 6, long spine; 5 and 7, long seta and sense-club; 8, long spine and very short spine; 9, long seta, long spine, and sense-club; 10 and 11, process and long spine; 12, long spine, very short spine, and sense-club; 13, process, long spine, and sense-club; 14, long seta, long spine, and sense-club; 15, process, short seta, long spine, and sense-club; 16, process, long spine, long seta, and sense-club; 17, process and short thick spine; 18, process; 19, 20, and 21 (completely ankylosed), a process, a long seta, and a very short spine; 22 and 23 (completely ankylosed), a narrow hyaline lamina produced into a hook which extends but little beyond the end of the segment, and two long setæ; 24, two

long setae; and 25, four long setae and a sense-hair. Some of the setae on the last segments are sparsely hairy.

Second basal segment of the right fifth leg of the male subquadrate, about twice as long as wide; a delicate hair at the outer margin a short distance above the distal angle. First segment of the outer ramus somewhat narrower than the second basal segment, about twice as long as wide; second segment very long and narrow, about three times as long as wide. Marginal spine slender, about one third the length of the segment, inserted about half its length above the outer distal angle of the segment. Terminal hook slender, regularly curved, about as long as the preceding segment; distal half of inner margin denticulate.

Inner ramus of right fifth foot one-segmented, reaching almost to the end of the first segment of the outer ramus; apex broadly triangular and minutely hairy.

Second basal segment of the left leg of the male subquadrate, slightly broader than long; provided with a delicate hair a short distance above the outer apical angle. First segment of the outer ramus irregular in form, about one and a half times as long as broad, with two rounded protuberances, the one forming the inner apical angle delicately hairy. Second segment long and narrow, almost as long as the preceding segment and a fourth as wide as long; delicately hairy at the inner margin; armed at the apex with a short, thick, blunt digitiform process, and a long curved spine as long as the segment itself and hairy at the inner margin.

Inner ramus of left fifth leg long and narrow, extending beyond the middle of the second segment of the outer ramus; margins sinuous; apex triangular, hairy.

Second basal segment of the fifth pair of feet in the female with the usual marginal hair. First segment of the outer ramus subquadrate, about twice as long as wide; second segment narrow, about as long as the first, tapering to a rather blunt point, finely dentate on the inner margin and with a single tooth on the outer, opposite the last tooth on the inner margin; third segment small but distinct, armed with two short sharp spines, the inner slightly longer than the outer.

Just without these, on the second segment, is a third spine, shorter than either of the other two.

Inner ramus of fifth leg of female one-segmented, extending beyond the end of the first segment of the outer ramus; apex hairy; armed with two long subequal spines hairy on both margins and about a third the length of the ramus.

Length of female 1.89 mm.; of male 1.83 mm.

Breadth of female 0.70 mm.; of male 0.60 mm.

The numerous published figures and descriptions of this species have probably made it well known to all students of North American *Centropagidae*. The synonymy, however, is interesting. In the Geological and Natural History Survey of Minnesota, Herrick ('77, p. 238) describes and figures "A New Cyclops." It is evident at a glance that this is a *Diaptomus*, but of what species cannot be determined. In "Microscopic Entomostraca" (Herrick, '79, p. 90) he refers to this "Cyclops" and says, "In the Report of the Geological and Natural History Survey of Minnesota for 1878 it [*Diaptomus longicornis*] was mentioned and a figure given, but erroneously called *Cyclops*." In a "Final Report on the Crustacea of Minnesota" (Herrick, '84, p. 140) he makes *D. leptopus* Forbes a variety of *D. longicornis* Herrick, establishing a second variety, *similis* (Plate Q, Fig. 5-7). In his "Synopsis of the Entomostraca of Minnesota" (Herrick and Turner, '95) he recognizes *D. leptopus* Forbes as a distinct species, making *D. longicornis* var. *leptopus* a synonym; although in this same work *D. longicornis* var. *similis* Herrick is not set up as a species, neither is the name regarded as a synonym. The figures (Herrick '84, Pl. Q, Fig. 5-7) are not well drawn, but it is not likely that this form is *leptopus*. *D. similis* is referred to once (Herrick and Turner '95, p. 58) in connection with *D. franciscanus* Lilljeborg. *Diaptomus kentuckyensis* Chambers ('81) is also quite possibly *D. leptopus*, although the description is very vague and the figures are inaccurate.

Diaptomus sanguineus FORBES. (Pls. XXIII., XXIV., and XXV.)*Diaptomus sanguineus*, Forbes, '76, pp. 15, 16, 23, Fig. 24, 28-30.*Diaptomus sanguineus*, Forbes, '82a, p. 647, Pl. VIII., Fig. 1-7, 13.*Diaptomus armatus*(?), Herrick, '82, p. 223, Fig. 1, *a, b*.*Diaptomus armatus*(?), Herrick, '84, p. 139.*Diaptomus sanguineus*, Herrick, '84, p. 138, Pl. Q, Fig. 12.*Diaptomus mianctonka*, Herrick, '84, p. 138, Pl. Q, Fig. 8-10.*Diaptomus sanguineus*, de Guerne et Richard, '89b, p. 20, Fig. 9-11;
Pl. IV., Fig. 24.*Diaptomus sanguineus*, Marsh, '93, p. 195, Pl. III., Fig. 1-3.

A rather large species, one fourth to one third as wide as long. The cephalothorax widens gradually to the third segment (being broadest at the suture between that segment and the fourth), then narrows less gradually to the abdomen. In the male the thorax is less uniform in breadth than in the female. The last cephalothoracic segment is greatly produced on each side laterodorsally and bears a large spine, slightly swollen at the base, varying in length from that of the segment to one fourth its length. On the same segment and midway between the outer spine and the abdomen is another broader and shorter spine. Both of these spines are slightly curved. In the female (Pl. XXIV., Fig. 3) they are generally quite noticeably larger than in the male. On the first abdominal segment is still another spine, slightly outcurved and pointing outward, about as large as the second of the spines mentioned above. In the female the penultimate cephalothoracic segment bears a dorsal hump at its anterior margin (Pl. XXIV., Fig. 5, 6). This is wanting in the male. The abdomen is produced dorsally and ventrally at the anterior part, making it look like a keel (Pl. XXIV., Fig. 1, 2), the keel being most pronounced on the ventral side. The egg-mass is large and elliptical, with the major axis transverse to the body.

Antennæ 25-segmented, the seventeenth or eighteenth segment reaching about to the base of the abdomen. The right male antenna is thickly swollen beyond the geniculate joint. The last two segments have no special armature, but the antepenultimate one (Pl. XXIII., Fig. 6-8) is armed at the

inner distal angle with a short thick recurved hook with smooth edges, extending but little beyond the joint. This is merely the continuation of the hyaline lamina at the side of the segment.

Second basal segment of the right fifth leg of the male (Pl. XXIII., Fig. 1-5), seen from behind, irregularly trapezoidal in form, very broad distally, and about twice as long as its narrowest part is wide. On the outer distal angle of this segment is another projection, equal to or greater in length than the inner ramus. This also shows great variation, and is either rounded or acute or even acuminate at the apex. First and second segments of outer ramus subquadrate, the second about as wide as the first and about two and a half times as long. About a third the length of the second segment from its base is a considerable contraction, the width here being about half the width of the broadest part. Slightly below the middle, on the outer margin, is a spine, minutely serrate at the inner edge. This is generally long and straight, about half the length of the segment, but varies, and is sometimes shorter, thicker, curved, and less than one third the length of the segment (Pl. XXIV., Fig. 4; Pl. XXV., Fig. 3-5). Terminal hook rather long and slender, slightly and sometimes sinuously curved, about one and a fourth times the length of the preceding segment. The inner margin is serrate, beginning about the middle of the hook and continuing to the tip.

Inner ramus of the right fifth foot wanting, a peculiarity rarely found among the American species of *Diaptomus*, but approached most closely by *D. lintoni* Forbes and *D. minutus* Lilljeborg, in which the ramus is very small, almost rudimentary. The ramus is represented by an immovable spine, minutely spinose at the tip. This is greatly diverse in shape and sometimes gives indications of a joint (Pl. XXIII., Fig. 2), as if a case of ankylosis.

Left fifth foot of the male biramose; second basal segment quadrate, with a short thick spine just above the outer distal angle. Second segment of outer ramus irregularly subquadrate, about two thirds as wide as long, provided at the inner

margin with a cushion-like protuberance densely covered with minute hairs. This segment is produced into two spines, forming a forcipate structure. The inner spine is slightly shorter than the main part of the segment, thick, incurved, and movable, and armed on its outer margin and on the distal third of the inner one with minute hairs. The outer spine is immovable, ending in a blunt point, and its curve is rather more pronounced than that of the inner one.

Imer ramus of left fifth foot one-segmented, straight, and armed with minute hairs at the apex. It is about three times as long as broad and reaches beyond the middle of the second segment of the outer ramus.

First basal segment of the fifth foot of the female (Pl. XXV., Fig. 1, 2) subquadrate, slightly longer than broad, bearing a short thick spine near the outer distal angle. The distal segment is also subquadrate and bears the usual delicate hair. Outer ramus two-jointed, the first segment oblong, about twice as long as wide; second segment in the form of a thick incurved hook, with a broad, quadrate basal portion. The hook is about three times as long as its greatest breadth, the distal fourth of the inner edge armed with a variable number of teeth (8-15). Third segment wanting, represented by two spines; the outer short, thick, about one third the length of the segment; the inner rather longer and more slender, sinuously curved, and about half as long as the second segment.

Inner ramus of fifth foot of female straight, one-segmented, about four times as long as broad; armed at the tip with two smooth spines of almost equal length and but slightly curved. The tip of the ramus is delicately hairy.

Length of female 1.4-2.12 mm; of male 1.-2. mm.

Breadth of female .4-.43 mm; of male .3-.33 mm.

The synonymy of this species is almost as complicated as that of *D. leptopus*. First described by Dr. Forbes ('76), it was next described under two different names (*D. sanguineus* and *D. minnetonka*) by Herrick ('84). I am also led to believe very strongly that Herrick's *D. armatus* is nothing but a variant of *D. sanguineus*. The descriptions and figures (Herrick, '82, p. 223, Fig. 1, *a* and *b*) seem to me to be

without specific value. The following, taken from Herrick and Turner '95a, p. 72, is his most complete description. "It appears to be allied to *sanguineus*. The antennæ are said to be shorter than the body, the caudal stylets narrow, the right male antenna has a hook upon its antepenultimate joint and is strongly geniculate. But the one feature which may determine the species is the existence of a tooth or spur near the base of the claw of the right fifth foot of the male."

In collections from Phelps Lake, Havana, Ill., made May 18, 1894, occurred a single male specimen of a variant of *D. sanguineus* which might easily be described as a new species if the spine at the base of the terminal hook were taken as the one specific characteristic to which all others must be subordinated. This spine is straight and minutely dentate on both margins. In all other respects, except a slight difference in the length of the terminal hook, the specimen is a normal *D. sanguineus*. The fifth pair of legs is shown in Pl. XXV., Fig. 5. The occurrence of this specimen, taken in connection with the loose descriptions of *armatus*, has led me to believe in the identity of Herrick's species and this variant.

In regard to *D. minnetonka*, Marsh ('93) points out that it is probably but a variety of *D. sanguineus*. In his "Synopsis of the Entomostraca of Minnesota" Herrick says: "We are inclined to agree with Marsh that this form is but one of the many variations of *D. sanguineus*"; but he nevertheless retains *minnetonka* as a species name instead of making it a synonym of *sanguineus*.

Diaptomus sanguineus occurs in early spring in standing water in connection with *D. stagnalis* Forbes, from which it may be distinguished at a glance by the difference in size, *D. stagnalis* being about twice as large as *D. sanguineus*. The latter is generally a deep red, but *D. stagnalis* is often blue, with abdomen and antennæ a brilliant red.

The theory of Herrick (Herrick and Turner, '95) in regard to the transition of forms, "beginning with *D. stagnalis* and passing through several varieties to *D. sanguineus* later in the season," will not hold owing to the fact that sexually mature specimens of both species have been found in the same pools at the same time.

The collection from which the variant mentioned above was taken, made in May, 1894, consisted almost entirely of *D. sanguineus*. Collections from the same waters made in July, 1896, did not contain a single individual of this species, but *D. siciloides* Lilljeborg and *D. pallidus* Herrick, were present in immense numbers.

VARIATION IN *D. SANGUINEUS* FORBES.

Plates XXIII., XXIV., and XXV. were prepared before the thesis work proper was undertaken and exhibit the results of a study in variation. From these figures it will at once be evident that *D. sanguineus* is an unusually variable species, and without the intermediate forms the extremes might almost be regarded as distinct. The specimens examined were all from the collections of the Biological Station at Havana, so that the variations are probably not so great as they would be if widely separated localities were represented. Especial attention was given to variations of specific characters, and most particularly to the relative proportions.

The second basal segment of the right leg of the male, which is usually very broad, in fact one of the most characteristic features of the male, is shown in Pl. XXIII., Fig. 2, to be sometimes of very ordinary width, the other extreme being shown in Pl. XXIV., Fig. 4. The relative position and length of the projection on the outer distal angle of this segment also vary a great deal, the extremes noted being shown in Pl. XXIII., Fig. 1 and 2.

The marginal spine of the outer ramus of the right fifth leg, the position, relative length, and characters of which are of specific value in most species, lacks such value almost entirely in *D. sanguineus*. The extreme variation is shown in Pl. XXIV., Fig. 4, and Pl. XXV., Fig. 3.

The inner ramus of the right fifth leg, though always very short, varies in length from that shown in Pl. XXIV., Fig. 4, to that in Pl. XXIII., Fig. 2, on the latter of which is also shown a rather clearly marked suture which is usually wanting.

The variation in the size of the males is indicated by the drawings of the fifth pair of legs. (See Pl. XXV., Fig. 3-5, and Pl. XXIV., Fig. 4.)

The antepenultimate article of the prehensile antenna (Pl. XXIII., Fig. 6-8) is not so variable, but still quite a difference may be noted in the width of the hyaline plate and in the relative lengths of the segments.

In the female the variation in size is even greater than in the male, the fifth legs being shown in Pl. XXV., Fig. 1, 2. The variation in the "hump" of the female is slight (Pl. XXIV., Fig. 5, 6), as is also that of the first abdominal segment (Pl. XXIV., Fig. 1, 2).

While I have found no variation whatever in the color of *D. sanguineus*, all of the specimens I have seen alive being a bright uniform red, as were also those examined by Dr. Forbes ('76), and by Gissler ('81), Gissler later ('81a) found individuals colored as follows: body and legs bluish, antennæ and furca red, and abdomen yellow. Herrick says in the description of *D. minnetonka* (Herrick and Turner, '95), which is a synonym of *D. sanguineus*, "color dark." In the same work, in his description of *D. sanguineus*, he says "brilliantly colored." According to my observation color is of no certain specific value in *Diaptomus*, but it may be that there are definite seasonal variations—a subject which I have not investigated.

Diaptomus stagnalis FORBES. (Pl. XXVIII., Fig. 2.)

Diaptomus stagnalis, Forbes, '82a, p. 646, Pl. VIII., Fig. 8, 10-12, 14.

Diaptomus giganteus, Herrick, '82, p. 222, Pl. II., Fig. 3, 11, 15.

Diaptomus stagnalis, Herrick, '84, p. 139, Pl. Q, Fig. 11, 13.

Diaptomus stagnalis, de Guerne et Richard, '89b, p. 23, Pl. IV., Fig. 14.

Head distinct from thorax; fifth and sixth thoracic segments confluent. Lateral angles of last thoracic segment strongly produced backward, each angle bilobed, the outer lobe about twice as large as the inner; (in the male this segment is salient.) Abdomen peculiar in that there is a sudden narrowing at the beginning of the third segment. First abdominal segment armed with a large spine on each side (in the male unarmed); second and third segments of the abdomen subequal, about twice as wide as long. Furcal rami subquadrate, hairy within. Furcal setæ rather short,

densely plumose. There is but little difference in the length of the abdominal segments of the male.

Antennæ 25-segmented, reaching to the middle of the abdomen. Prehensile antenna of the male (Pl. XXVIII., Fig. 2) thickly swollen anterior to the twelfth article, with armature as follows: segments 1 and 5, long spine and sense-club; 2, three long spines and sense-club; 3, short seta; 4 and 6, long spine; 7, short seta and sense-club; 8 and 12, long spine and short spine; 9, long spine, short seta, and sense-club; 10, 11, 13, and 17, process and long spine; 14 and 16, long spine, short seta, and sense-club; 15, process, two long spines, and sense-club; 18, process; 19, 20, and 21 (ankylosed, with the sutures indistinctly indicated), two processes, a stunted spine, and a long seta; 22 and 23 (ankylosed), a broad hook-like process not reaching the end of the penultimate segment, and four setæ; 24, two setæ; and 25, four setæ, a sense-hair, and a sense-club.

Second basal segment of the right fifth foot of the male subquadrate, about twice as long as wide; on the posterior surface a large smooth hyaline lamina occupying about a third of the inner margin near the middle, and near the outer distal angle a minute cuticular process bearing a delicate hair. First segment of the outer ramus almost three times as long as broad; second segment about as long as the first and for about the proximal third nearly as wide, but beyond this considerably broader. Marginal spine near the outer distal angle; straight, very strong and thick, little less than half as long as the segment. Terminal hook rather short and very stout, irregularly curved, heavily and closely denticulate at the distal half of the inner margin.

Inner ramus of the right fifth leg spatulate, not nearly reaching the middle of the first segment of the outer ramus; apex rounded, armed with a few strong spines.

Second basal segment of the left fifth foot armed at the outer margin, a short distance above the distal angle, with a short, thick, pointed spine. First segment of the outer ramus about three times as long as wide, armed at the distal third of the inner margin with a few strong hairs. Second segment

about half as long as the first, having on the inner margin two cushion-like processes (the upper, smaller one hairy, and the lower densely tuberculate), and being armed at the tip with two processes forming a forcipate structure, the outer broad, plowshare-shaped, the inner a long and narrow spine, hairy within.

Inner ramus of left fifth foot one-segmented, of the same width throughout, with a broadly rounded tip; inner margin rugose.

Second basal segment of the fifth foot of the female with the usual delicate hair at the outer margin. First segment of outer ramus short and broad. Second segment large, about one and a half times as long as the first, armed on the middle third of the inner margin with seven or eight very large, strong, pointed spines, and on the outer margin and opposite the upper spines of the inner margin with three or four spines. Third segment distinct, armed with two spines, the outer one short, thick, sharp, smooth, the inner one about twice as long and armed with a few rather strong spinules. Just without these spines, on the second segment, is a shorter, smooth spine.

Inner ramus of the fifth foot of the female distinctly two-segmented, the first segment subquadrate, the second as wide as the first and nearly twice as long, and armed at the tip with two thick heavy spines reaching to the end of the second segment of the outer ramus. These spines are armed with heavy spinules. Disregarding the spines, the ramus reaches just to the end of the first segment of the outer ramus.

Length of female 4.0-4.5 mm.; of male 3.5-4 mm.

This *Diaptomus* is the largest of the American species and a very beautiful one. Dr. Forbes states in his original description ('82a) that "all were red throughout." Specimens taken in April, 1897, from ponds south of Urbana, Ill., when they were in the height of sexual activity, were colored as follows: thorax and anterior appendages (all but the first pair of antennæ) blue; first pair of antennæ, fifth pair of legs (in the male), and abdomen red. In the female all the legs were blue.

The pool from which they were taken was particularly rich in decaying vegetable material and received the drainage of a pasture in which cattle and horses were allowed to graze. The water literally swarmed with *Volvox*; and *Diaptomus*, *Cyclops*, and insect larvæ were very abundant. The food supply was practically inexhaustible and the specimens taken were unusually large.

***Diaptomus shoshone* FORBES.** (Pl. XXVI., Fig. 1-3.)

Diaptomus shoshone. Forbes, '93, p. 251. Pl. XLII., Fig. 23-25.

Diaptomus shoshone. Herriek and Turner, '95, p. 61. Pl. V., Fig. 11.

"A very large and robust species. Thorax broadest in front, across the maxillæ, tapering gradually, with little convexity, to the posterior third. In the female the angle of the last segment is bifid, both projecting points being minutely spinose at tip. The first segment of the abdomen (Pl. XXVI., Fig. 1) is laterally expanded, the expansion of the left side with a minute spine at the apex, behind, that on the right produced at the same point into a small, prominent, rounded tubercle, 0.03 millimeter in length, about as broad as long, making this first segment somewhat unsymmetrical. This is not merely a modified cuticular appendage, but is penetrated by the hypodermis. Egg-mass very large, obovate (narrowest forward).

"Right antenna of male robust, the last two joints without special appendages, antepenultimate with a very long inarticulate process at its outer apex, extending beyond the tip of the penultimate and to the middle of the last segment. The margins of this process are smooth, but it is broad and emarginate at the tip.

"The fifth pair of legs in the male resemble the corresponding appendages of *Diaptomus stagualis*, but differ notably in detail. The left ramus of the right leg is borne at the inner terminal angle of the second joint; is longer than the joint following; is armed at the apex with a few small acute spines; and bears upon its outer margin, near the tip, a broad fascicle of delicate hairs. The basal joint of the outer ramus is two thirds the length of the second joint of the peduncle,

and without hairs or spines of any description. The second joint of this ramus is about equal in length to the second joint of the peduncle, and bears on its outer margin, close to the tip, the usual stout seta, which is two thirds as long as the joint to which it is attached. The terminal claw is not regularly curved, but is nearly straight for the basal three fourths. The left leg is biramose, the inner ramus straight, slender, extending about to the middle of the second joint of the outer, and armed at its tip. The second joint of this ramus is as long as the first, if measured from the tip of the apical spine. This spine, seen from behind, is stout, conical, rather blunt, and has opposed to it within, projecting from the inner angle of the segment, a stout, curved seta, slightly plumose on its distal half. Between these, but more closely applied to the outer spine, is a hemispherical cushion-like elevation, set with small, short spinules. On the basal half of the inner margin of this terminal segment is also a much larger hemispherical cushion, but with longer and more slender hairs, while the terminal half of the inner margin of the segment preceding is also moderately inflated and covered with delicate hairs.

“The antennæ of the female are 25-jointed, as usual, and reach to the base of the abdomen. The legs of the fifth pair (Pl. XXVI., Fig. 2) closely resemble those of *stagnalis*, but have the terminal setæ of the inner rami much less developed. This ramus is a little shorter than the basal joint of the outer ramus, and of about half its diameter. It bears at its tip two stout setæ equaling the ramus itself in length, plumose under a high power, and has, in addition, at its inner tip and on the inner margin adjacent, a patch of delicate hairs and spines. The second joint of the outer ramus is as long as the first, if measured to the tip of its terminal claw. The latter is nearly straight, very slightly recurved. This joint bears a single spine at its outer distal angle, just within which is the rudiment of the third segment of the ramus, which bears two spines similar to the above, the inner of which is the longer, the outer itself being longer than the adjacent spine of the second joint. Adults of both sexes are blood-red throughout except the egg-sac of the female, which is purple.

“Dimensions of female: Length to tip of caudal setæ, 3.1 millimeters; abdomen, with setæ, 1.16 millimeters, without, 0.67 millimeters; thorax, 1.95 millimeters in length; depth, 0.725 millimeter; width, 1 millimeter.

“Male averaging scarcely smaller, but somewhat differently proportioned: Thorax, 1.85 millimeters in length; depth, 0.58 millimeter; width, 0.08 [1.08]* millimeter; abdomen, without setæ, 0.745 millimeter; with setæ, 1.35 millimeters in length.

“Especially abundant in Shoshone Lake, but occurring in other lakes and even in pools of some size in Yellowstone Park.”[†]

The drawings here given are in some cases the same as those in the original description with unimportant corrections or additions, but two new figures (Pl. XXVI., Fig. 1, 3) have been added. I have not found this species in any collections except those from Yellowstone Park and the Flat-head region, in which it is rather abundant.

A few points may be added to the original description. In the female the first basal segment of the fifth pair of legs bears a short sharp spine on the outer margin a short distance above the distal angle. Both spines of the rudimentary third segment of the outer ramus are distinctly spinose on the inner margin. The first abdominal segment is almost as long as the remainder of the abdomen; the second segment very short, about half as long as the succeeding segment or the furca. Furcal rami about one and a half times as long as wide and hairy within. My observations differ from those of Prof. Forbes in that, as a rule, the abdomen of the female is not asymmetrical, the first segment bearing on each side a small tubercle armed with a minute spine. In the male the first abdominal segment is very slightly dilated laterally but unarmed, and about half as long as any one of the five succeeding segments, which differ very little in length. The furcal rami are fully twice as long as wide and hairy within.

*The 0.08 in the original description is probably a typographical error, since the specimens measured by myself were about 1.08 millimeters in length.

[†]Description quoted from Forbes, '93.

Diaptomus pallidus HERRICK. (Pl. XXVII., Fig. 3.)

Diaptomus pallidus, Herrick, '79, p. 91, Pl. II.

Diaptomus pallidus, Herrick, '83a, p. 383, Pl. VII., Fig. 1-6.

Diaptomus pallidus, Herrick, '84, p. 142, Pl. Q, Fig. 17.

Diaptomus pallidus, de Guerne et Richard, '89b, p. 62, Fig. 34.

Diaptomus pallidus, Marsh, '93, p. 196, Pl. III., Fig. 6, 7, 9.

Diaptomus pallidus, Herrick and Turner, '95, p. 73, Pl. IV, Fig. 1-6;
Pl. V., Fig. 10; Pl. XIII., Fig. 17.

Of medium size, slender; cephalothorax widest near the middle; head partially divided by a suture; suture between head and thorax distinct. Fifth and sixth thoracic segments confluent; last thoracic segment produced laterodorsally, bearing a small spine on each side. First abdominal segment unarmed but dilated laterally (not dilated in the male), about as long as the remainder of the abdomen; second segment the shortest. Furcal rami hairy within.

Antennæ 25-segmented, reaching about to the tips of the furca or slightly beyond. Male prehensile antenna moderately swollen; no special armature on the last three segments; segments 19 and 20 ankylosed, armed with a process and a long seta; 21, 22, and 23 ankylosed, armed with two long setæ; 24, with two long setæ; and 25 with four long setæ and a sense-club. Some of the antennal setæ are very minutely and sparsely hairy.

First basal segment of right fifth foot of male (Pl. XXVII., Fig. 3) with large tubercle bearing a small spine on the posterior aspect; second basal segment as usual, about equal in length to the first. First segment of the outer ramus subquadrate, about as long as wide; second segment about as wide as the preceding and about one and a half times as long, bearing on the inner margin, at the end of the proximal third, a small sharp-pointed cuticular projection. The outer margin of this segment is almost straight to the beginning of the distal third, where a sharp angle is made from which springs the marginal spine. This spine is sharp, slender, slightly curved, a little more than one third the length of the segment. Terminal hook slender, about one and a half times as long as the second segment; not regularly

curved, but with a sharp angle at the beginning of the distal third; minutely denticulate within.

Inner ramus of right fifth foot one-segmented, slender, narrowing gradually from base to tip, extending but slightly beyond the proximal third of the second segment of the outer ramus; hairy at the apex and very delicately denticulate on the outer margin.

Basal segments of left fifth foot subquadrate, the second slightly longer than the first and both slightly longer than broad; second segment delicately tuberculate on the inner margin. First segment of outer ramus about half as wide and three fourths as long as the basal segment. Second segment about as long as the first, and very similar to the corresponding segment of *D. sicilis* Forbes, from which it differs, however, in its armature. This consists of a movable claw, blunt or slightly thickened at the tip, forming a forcipate structure with an inner cushion-like process. The claw usually lies close against this and is difficult to make out. It is hairy on both margins.

Inner ramus of the left fifth foot one-segmented, hairy at the apex and delicately denticulate on the outer margin, extending to the end of the first segment of the outer ramus or slightly beyond it.

Second basal segment of the fifth foot of the female with the usual hair at the outer distal angle. First segment of the outer ramus subquadrate, about twice as long as broad. Second segment about as long as the first, tapering to a blunt point; inner margin denticulate. Third segment wanting, represented by two spines, the inner about twice as long as the outer and smooth, while the outer is delicately hairy.

Inner ramus of fifth foot of female one-segmented, reaching the end of the first segment of the outer ramus; hairy at the apex and within, and armed at the tip with two long subequal delicately hairy spines.

I have found specimens from the Illinois River at Havana with the inner ramus of the right fifth foot reaching barely beyond the end of the first segment of the outer ramus. The first basal segment of the left foot of the male is provided with

a hyaline lamina ending in a pointed spine-like projection; and the second basal segment is tuberculate at the inner margin, as is also the outer margin of its inner ramus. All of these differences are quite constant but not of sufficient importance to constitute even a variety.

D. pallidus was found in immense numbers in connection with *D. siciloides* Lilljeborg during the entire time of my stay at the Biological Station at Havana—that is July and part of August, 1896. So far as I was able to ascertain, *siciloides* was slightly the more abundant, but the difference was not very evident.

Herrick's original description of *D. pallidus* ('79) was very indefinite, and the establishment of the species really dates from 1893, when Marsh figured and described it in a manner to make it recognizable by later students. De Guerne and Richard ('89b) place it among their "species insufficiently described."

Diaptomus albuquerquensis HERRICK. (Pl. XXVII., Fig. 2, 4.)

Diaptomus albuquerquensis, Herrick, '95, p. 45, Fig. 16-26.

Diaptomus albuquerquensis, Herrick and Turner, '95, p. 67, Pl. VI., Fig. 1-3; Pl. VII., Fig. 1-11.

A medium-sized species. Cephalothorax widest about the middle. Suture between head and thorax distinct. Last two thoracic segments, seen from above, indistinctly confluent, the last one produced laterodorsally and armed on each side with two rather long spines; in the male produced but but very slightly and armed with only one spine on each side. First abdominal segment in the female longer than the remainder of the abdomen, dilated laterally, and armed on each side with a single spine; second and third segments subequal; each shorter than the furcal rami, which are barely twice as long as wide and hairy within. First abdominal segment in the male short, a little more than half as long as any one of the succeeding three segments; dilated very slightly, and armed on each side with a spine; fifth segment about as long as the first. Furcal rami barely twice as long as wide and hairy within.

Antennæ of the female 25-segmented, extending well beyond the tips of the furcal setæ; somewhat shorter in the male, reaching about to the tips of the furcal setæ. Right male antenna moderately swollen beyond the thirteenth segment. Beyond the twelfth segment the antenna is armed as follows: 13, with large process; 14, process, short seta, and very long seta; 15, very short stunted spine, short seta, and long seta; 16, a short and a long seta; 17, process, short seta, and long seta; 18, large process; 19 and 20 (completely ankylosed), short stunted spine and long seta; 20, 21, and 22 (also completely ankylosed), two setæ, and a hooked process extending beyond the middle of the penultimate article; 24, two setæ; and 25, four setæ.

Left fifth leg of the male (Pl. XXVII., Fig. 4) short, not reaching to the end of the second segment of the outer ramus of the right leg. First and second basal segments subequal, the first armed at the middle of the outer margin with a rather long sharp spine; the second slightly broader than the first, and provided a short distance above the outer distal angle with the usual delicate hair, and at the middle of the inner margin with a small hyaline plate. First segment of the outer ramus about twice as long as wide; outer margin arcuate, inner margin convex and delicately hairy. Second segment racket-shaped, the broad basal half being almost circular; hairy on the inner margin. The digitiform terminal half is blunt and delicately denticulate on the margin. From the anterior aspect projects a delicately hairy spine about as long as the digitiform process, but more acute and pointing inward.

Inner ramus of left fifth leg short, one-segmented, barely reaching to the end of the first segment of the outer ramus; margins slightly sinuous; apex bluntly rounded, very delicately hairy, the hairs at the apical angles being somewhat stouter and spine-like.

First basal segment of right fifth leg of male subquadrate, slightly longer than broad; armed at the outer distal angle with a stout, sharp spine pointing straight outward. Second basal segment subquadrate, about equal to the first, and

armed on the outer margin, a short distance above the apical angle, with a spine-like hair. First segment of outer ramus subquadrate, slightly narrower than the second basal segment, and about as wide as long; second segment about as wide as the first and twice as long; provided at the end of the proximal third with a small bead-like tubercle. Marginal spine very large and strong, longer than the segment itself, somewhat sinuously curved, and inserted near the distal angle. Terminal hook very long, as long as the remainder of the right leg including the basal segments, but not twice as long as the marginal spine; very slightly recurved at the tip and denticulate at the inner margin.

Inner ramus of the right fifth leg one-segmented, very short, barely reaching the end of the first segment of the outer ramus; apex bluntly rounded and delicately hairy.

First segment of outer ramus of fifth foot of female (Pl. XXVII., Fig. 2) subquadrate, about twice as long as wide. Second segment, or unguiform process, about as long as the first, subconical or but slightly curved, delicately denticulate on the inner margin. Third segment small but distinct, armed with two spines, the inner of which is more than twice as long as the outer, reaching about to the middle of the second segment.

Inner ramus of fifth foot of female indistinctly two-segmented, short, reaching just beyond the end of the first segment of the outer ramus; apex bluntly triangular, armed with a few short hairs, the innermost of which is longer than the rest and spine-like.

Length of female 1.2 mm.; of male 1.05 mm.

The material in which the specimens described were found was loaned me by Mr. Adolph Hempel, of Gotha, Florida, and was collected by him in a series of Florida lakes from January to March, 1896.

D. albuquerqueensis is one of the few American species of Diaptomus in which the inner ramus of the fifth leg of the female is two-segmented. In some cases this ramus, instead of being bluntly triangular, is acute, and reaches only to the end of the first segment of the outer ramus. The first basal

segment is sometimes armed at the outer distal angle with a short, sharp spine.

Herrick (Herrick and Turner, '95) states that he found the second segment of the left fifth leg of the male to be granular on the inner margin, and the marginal spine of the right leg denticulate on the inner margin and at the base. In both these respects my specimens differ from his, the second segment of the left foot being hairy instead of granular, and the marginal spine of the right foot perfectly smooth. Herrick's statement that "the first pair of antennæ reach to the extremity of the furca or surpass them" leads me to think that they are longer in the Florida specimens than in his, since they clearly reach beyond the tips of the furcal setæ in every individual which I have examined.

In New Mexico Herrick found this species, in connection with *D. novamexicanus*, in the water supply of the city of Albuquerque; but in the Florida lakes it was found with *D. mississippiensis* Marsh, the two forms being about equally abundant. They are very much alike in general appearance, but the males may be distinguished without dissection by the antepenultimate article of the right antenna, which is armed in *D. albuquerqueusis* while it is unarmed in *D. mississippiensis*. Herrick gives the length of the female as 1.4-1.6 mm., but the largest female from Florida was 1.2 mm., while the male was only 1.05 mm. in length, the average being considerably smaller.

Diaptomus novamexicanus Herrick.

Diaptomus novamexicanus, Herrick, '95, p. 46, Fig. 27-29.

Diaptomus novamexicanus, Herrick and Turner, '95, p. 70, Pl. VI., Fig. 7-10.

Among the smaller species of the genus, moderately robust. Cephalothorax widest somewhat in front of the middle. Last two thoracic segments distinct, the last armed on each side with a small, short spine. First abdominal segment very long, much exceeding the remainder of the abdomen, provided on each side with a short, sharp spine; second segment the shortest. Furcal rami equal in length to the

preceding segment and about twice as long as wide; provided with short apical setæ.

Antennæ of the female 25-segmented, reaching to the base or the end of the furca. Antepenultimate article of the right male antenna armed with a lamina produced anteriorly into an unguiform process which is shorter than the penultimate article.

Outer ramus of the fifth pair of feet in the female obviously three-segmented. Unguiform process of the second segment arcuate, finely denticulate within and at the end, armed on the outer margin near the base of the last segment with a small spine. Last segment small but distinct and armed with two short subequal spines.

Inner ramus of fifth foot of female one-segmented, as long as the basal segment of the outer ramus; apex ciliate and armed with two subequal spines.

Left fifth leg of male reaching slightly beyond the end of the first segment of the outer ramus of the right foot. First basal segment armed on the outer margin with a short, sharp spine. Second segment of the outer ramus oblong-ovate, armed with two large spines; inner margin delicately aculeate toward the apex, and bearing a ciliate lamina.

Inner ramus of left fifth leg one-segmented, quite long, reaching beyond the middle of the second segment of the outer ramus; hairy at the apex.

First basal segment of right fifth leg of male armed on the outer margin with a rather long, sharp spine. First segment of the outer ramus subquadrate, slightly longer than broad; second segment very long and narrow, more than twice as long as the preceding segment. Marginal spine slender, more than half as long as the segment itself, and inserted at about the beginning of the distal third. Terminal hook long and slightly curved.

Inner ramus of right fifth leg one-segmented, rather long, reaching beyond the end of the first segment of the outer ramus; apex acute, minutely ciliate.

Length of female 1.1–1.2 mm.

The above description is compiled from Herrick's first paper on this species ('95) and from the figures and the English and Latin descriptions in his later paper (Herrick and Turner, '95). Both of these articles are published as original descriptions, although there was nine months' difference in the time of their appearance.

***Diaptomus oregonensis* LILLJEBORG.** (Pl. XXIX., Fig. 1, 2.)

Diaptomus oregonensis, de Guerne et Richard, '89b, p. 53, Pl. II., Fig. 5; Pl. III., Fig. 8.

Diaptomus oregonensis, Marsh, '93, p. 200, Pl. IV., Fig. 4, 5.

Diaptomus oregonensis, Marsh, '95, p. 8, Pl. VII., Fig. 5.

Diaptomus oregonensis, Herrick and Turner, '95, p. 72, Pl. IV., Fig. 7-12; Pl. IX., Fig. 3.

A species of medium size. Cephalothorax widest about the middle. The last two thoracic segments confluent above, the last one, seen from above, slightly produced laterally, bluntly rounded but unarmed; in the male armed with two very minute spines on each side. First abdominal segment as long as the rest of the abdomen.* Third segment and furcal rami subequal, the latter about one and a half times as long as broad and delicately hairy within. In the male the first abdominal segment is short and unarmed; second and third segments and furcal rami about equal; fourth segment the longest, about equal in length to the first two segments taken together. Furcal rami about as in the female.

Antennæ of the female 25-segmented, extending beyond the tips of the furcal setæ. Prehensile antenna of the male but slightly swollen, the antepenultimate article entirely unarmed.

First basal segment of fifth leg of female (Pl. XXIX., Fig. 2) with the usual delicate hair on the outer margin. First segment of outer ramus about twice as long as wide, slightly arcuate, margins parallel; second segment about as long as the first, moderately curved, terminating in an acute point,

*This segment had a very peculiar appearance. Owing to the thicker anterior part, the segment seemed to have a suture at about the middle, and this was so misleading that I doubted if the specimens on the slides were really females until I could see the antennæ, and not until I could get a side view was I at all certain that there was only one segment.

very minutely hairy on the inner margin; third segment wanting, represented by two short spines, the inner twice as long as the outer.

Inner ramus of fifth leg of female one-segmented, extending very slightly beyond the first segment of the outer ramus; apex obtuse, hairy, armed on the inner margin and at the tip with two rather long subequal spines.

First basal segment of right fifth leg of male (Pl. XXIX., Fig. 1) with a small tubercle on the outer margin; second segment subquadrate, about one and a half times as long as the first. First segment of the outer ramus subquadrate, about as long as the first basal segment with overhanging outer apical angle; second segment slightly narrower than the first, about twice as long as wide, with a small projection at the middle of the inner margin. Marginal spine near the apical angle, slender, with a slight angle about one fourth its length from the base; length about equal to the distance between its base and the base of the segment. Terminal hook long and slender, longer than the two preceding segments but not as long as those and the second basal segment; very minutely denticulate on the inner margin.

Inner ramus of right fifth leg one-segmented, extending to a point about midway between the base of the second segment of the outer ramus and the projection on the inner margin of this segment; outer margin hairy; apex bluntly triangular and hairy.

Second basal segment of left fifth leg of male subquadrate, about one and a half times as long as broad, slightly produced on the inner margin a short distance above the apical angle. First segment of outer ramus slightly narrower than the second basal segment and about twice as long as wide; outer margin moderately arcuate, the inner margin hairy. Second segment produced into three digitiform processes: the outermost blunt and by far the longest; the middle one blunt, barely one fourth the length of the outer; and the last very short, hardly more than a tubercle, with an acute apex pointing straight inward. The segment is armed on the inner margin with a hairy, cushion-like process.

Inner ramus of left fifth leg somewhat spatulate, extending slightly beyond the end of the first segment of the outer ramus; inner margin hairy; apex bluntly rounded and hairy.

Length of female 1.25 mm.; of male 1.15 mm.

The above description is based on specimens found in collections made in Lake Calhoun, Minn., in July, 1891, and differs considerably from Lilljeborg's original description in de Guerne and Richard's "Revision."

He gives the length of the female as about 1.5 mm.; that of the male, 1.4 mm.

I did not find in a single instance that the female had the last thoracic segment armed with two minute spines on each side, although they were present in the male. Lilljeborg does not specify to which sex this part of his description applied, but I assume that he followed the usual custom of referring to the female unless especially stated otherwise.

The spines on the inner ramus of the female I found to be on the inner instead of the outer margin, and they are so figured by Marsh ('93).

In most cases I found but one spine representing the third segment of the outer ramus of the fifth foot of the female, while one specimen was found having one outer ramus as in the type, the other with only one spine. I have thought it best to make the description correspond to the type in this particular, regarding the variation as local since Marsh ('93) figures the two spines.

The inner ramus of the right fifth foot of the male in the Minnesota specimens was longer than represented in the original figures, and hairy on the inner margin and at the apex. This hairiness is not mentioned in the original description and this ramus is figured smooth, while the inner ramus of the left fifth foot, which is no more hairy than the right, is hairy in the drawings.

In the left fifth foot of the male the first segment of the outer ramus, although hairy, has not the definite cushion-like process figured by Lilljeborg, and the outer two digitiform processes of the second segment instead of being serrate within are perfectly smooth. From Herrick's statement

(Herrick and Turner, '95, p. 73) that "according to Richard's drawing the spines are dentate," I judge that he also found them smooth, since his own figures show them to be so.

This species was first found in 1888 at Portland, Oregon, by Trybom, and described in 1889 by Lilljeborg in de Guerne and Richard's "Revision." Marsh says ('93) that it is the most common form in central Wisconsin, being found quite generally in the shallower lakes, and that it occurs in the Great Lakes, but not abundantly ('95). Herrick (Herrick and Turner, '95) says that within the limits of Minnesota it had been found only in Lake Minnetonka. I can now add Lake Calhoun, Minn., and Sand Lake in northern Illinois.

Diaptomus siciloides LILLJEBORG.

Diaptomus siciloides, de Guerne et Richard, '89b, p. 54, Pl. I., Fig. 7, 8, 28, 34.

Diaptomus siciloides, Herrick and Turner, '95, p. 69, Pl. VIII., Fig. 10.

"Among the smaller of this genus. The general form of the body agrees almost exactly with that of *D. gracilis* Sars. Cephalothorax slender, widest at the middle. The last two thoracic segments confluent above. Lateral lobes of the last one, seen from above, short and rounded, with rather large mucros. First abdominal segment long, fully as long as the remaining part of the abdomen (without the setæ); with distinct lateral processes at the anterior part, acuminate and bending forward slightly. Furcal rami short, but fully one and a half times as long as broad.

"First pair of antennæ of the female, reflexed, surpass the furca but do not reach the tips of the furcal setæ; composed of 25 articles. Antepenultimate article of the prehensile antenna of the male provided with a rather long hook-like process reaching about to the middle of the penultimate article.

"Fifth pair of feet in the female small but rather thick; outer ramus biarticulate, hook-like process of second segment slightly curved, and almost equal to the first segment; the inner margin partly ciliate. Inner ramus simple, slightly longer than the first segment of the outer ramus; with a small seta, slightly hairy at the apex.

“The inner margin of the first segment of the outer ramus of the right fifth foot of the male dilated into a rather large hyaline lamella. The second segment of this ramus moderately curved, the outer margin obtusely biangulate, the spine placed below the middle. Claw simply curved. Inner ramus small and slightly surpassing the middle of the first segment of the outer ramus.

“The second segment of the outer ramus of the left fifth foot almost triangular, with a beak-like spine and delicately hairy within (*intus tenui ore et subtiliter hispido*); the apical process obtuse, with a spine at the inner margin. Inner ramus simple, sinuous, and reaching to or beyond the middle of the second segment of the outer ramus.

“Length of female about 1.3 mm.; that of male slightly less.

“Found in the month of May in Lake Tulare near the city of Fresno, Cal., by G. Eisen.

“In the general form of the body this *Diaptomus* closely resembles *D. gracilis* Sars as well as *D. sicilis* Forbes. It is on account of this last resemblance that it was called *siciloides*. It differs, however, from both: from *D. gracilis* in the shape of the last thoracic segment and of the abdominal segments, of the first pair of antennæ, and of the fifth pair of feet; from *D. sicilis* in the shape of the fifth pair of feet, although this difference is not very great. It resembles *D. sicilis* more closely than *D. gracilis*.

“It seems to live in great numbers in Lake Tulare near Fresno, Cal. The female bears only four eggs.”*

The statement concerning the number of eggs borne by the female is erroneous, the number being variable, and apparently dependent to a great degree on the temperature of the water and on the food supply. In the high mountain lakes from which the species was first described the statement above quoted may hold true, but in the warm sluggish waters of the Illinois River, where food is abundant, the egg-sac is very large, as many as eighteen eggs having been counted on a single female. This is true also of specimens taken

* Lilljeborg's description from de Guerne et Richard, 89b.

from other localities, and no tendency toward constancy in number of eggs for the same locality was made out.

The furcal rami in both sexes are hairy within, a point not mentioned in the original description, although the rami are so figured. All the specimens which I examined from the various localities had this characteristic, although individuals varied slightly in this particular.

As mentioned under the description of *D. pallidus*, *D. siciloides* was the most abundant form found at Havana. It also formed the greater part of the material from Spirit Lake, Iowa, which was kindly loaned me by Prof. L. S. Ross, of Drake University, Iowa.

The individuals taken from the Illinois River at Havana, Illinois, in July and August, 1896, were all of an indefinite color about like opalescent glass. The egg-sac in these was blue, and there was a small pink spot near the eyes and just behind them. These were the only specimens of *siciloides* which I had opportunity to examine alive.

Diaptomus minutus LILLJEBORG. (Pl. XXX., Fig. 5-8.)

Diaptomus minutus, de Guerne et Richard, '89b, p. 50, Pl. I., Fig. 5, 6, 14; Pl. III., Fig. 25.

Diaptomus minutus, Marsh, '93, p. 199, Pl. IV., Fig. 1-3.

Diaptomus minutus, Marsh, '95, p. 8, Pl. VII., Fig. 3.

“Among the smallest of the genus. Body slender, widest in front of the middle of the cephalothorax and at the posterior part of the head. Fourth and fifth segments commonly confluent above, sometimes in the adult specimen separated by a suture; the lateral lobes, seen from above, short and rounded, and provided with minute mucros. First abdominal segment of the female (Pl. XXX., Fig. 8) about as long as the remainder of the abdomen; rather dilated at its anterior part and rounded laterally; furnished with very minute spines. Second segment very short, third segment much longer, and these segments indistinctly joined. Furcal rami about twice as long as broad. Furcal setae unusually long.

“First pair of antennae of female somewhat surpass the furca; composed of 25 segments. Antepenultimate article of

the prehensile antenna of the male (Pl. XXX., Fig. 7) with a slender process, long and straight, having a slight appearance of an apical curve, and extending beyond the penultimate article and sometimes almost reaching the end of the last article.

“Setæ of swimming feet unusually long. Outer ramus of the fifth pair of feet in the female (Pl. XXX., Fig. 5) bi-articulate; unguiform process of second article slightly curved and minutely ciliate without. Inner ramus small and almost rudimentary, with acuminate apex.

“Right foot of the fifth pair of the male (Pl. XXX., Fig. 6) large but slender; the second article of the outer ramus with marginal spine minute and placed above the middle. Terminal claw thick toward the base, rather short, and partly minutely ciliate within. Inner ramus very small and quite rudimentary.

“The left foot of the same pair very similar to that of *D. siciloides* and *D. signicauda*; the second article of the outer ramus almost elliptical, the inner margin slightly emarginate and partly ciliate at the lower part; with a large and obtuse apical spine and a smaller inner spine. Inner ramus simple, attenuate toward the apex, and extending about to the middle of the second article of the outer ramus.

“Length of female 1–1.1 mm; of male hardly 1 mm.

“Found in Greenland, 61° 30'–69° N. Lat., by Dr. C. Nyström and N. O. Holst, and at St. John's, Newfoundland, by the former.

“This species is distinguished from others by its minute size and by the fifth pair of feet. The female bears only two eggs. *D. minutus* has been found in the Isle of Disko, northern Greenland, but it seems to be more common in the southern part. It is without doubt spread over the northern part of North America, since it has also been found at St. John's, Newfoundland.”

“We are able to confirm in every respect the description given above by Professor Lilljeborg. We have, in fact, recognized some rare specimens of *D. minutus* in a collection

* Lilljeborg's description from de Guerne et Richard, 89b.

which M. Riballier des Isles, French consul at Newfoundland, was kind enough to make according to our directions at Kinney's Pond near St. John's. This *Calanid* [centropagid] was found in great numbers by M. Ch. Rabot in 1888 in the following localities in Greenland: Lake Egedesminde (Bay of Disko); Godhavn; near the glacier of Jakobshavn, and in the Tasersuak of Julianehaab.*

"Marsh finds this form in Green Lake [Wisconsin], and in the Great Lakes; it may, therefore, be expected in Lake Superior in Minnesota."†

Marsh ('95) places *sicilis* var. *imperfectus* as a synonym under *minutus*, but does it, as he says, "with considerable hesitation." In looking over the drawings in the possession of the State Laboratory I found some which had been reproduced but not published, and from these it was evident at a glance that the var. *imperfectus* was not *minutus* but *ashlandi*, although this was not evident from the description. A single specimen of *minutus* was found among the collections from Yellowstone Park, but it was so badly mutilated that no drawings could be made from it.

Specimens from Greenland, kindly sent me by Professor Lilljeborg, conform to his description but are somewhat smaller than those figured by Marsh.

Diaptomus trybomi LILLJEBORG. (Pl. XXXI., Fig. 1-5.)

Diaptomus trybomi, de Guerne et Richard, '89b, p. 58, Pl. I., Fig. 35; Pl. II., Fig. 6; Pl. III., Fig. 14; Pl. IV., Fig. 28.

Diaptomus trybomi, Herrick and Turner, '95, p. 57, Pl. VIII., Fig. 17; Pl. IX., Fig. 4; Pl. X., Fig. 13.

"Of medium size. Cephalothorax widest about the middle. Last two segments distinctly separated, and the last, seen from above (Pl. XXXI., Fig. 3), slightly produced laterally, provided with two spines (one of them minute) on each side. Besides this the right part of this segment (Pl. XXXI., Fig. 2) bears a large dorsal appendage, triangular in form, with mucronate apex, and extending toward the right. The

* de Guerne et Richard, '89b.

† Herrick. From Herrick and Turner, '95.

first caudal segment of the female is very characteristic of the species (in the male it is of the ordinary form) and, unlike that of *D. signicauda*, surpasses in length the rest of the abdomen. This segment is provided at the anterior part on both sides with a short and mucronate lateral process, and at the posterior part with a large triangular process extending almost directly toward the right, with apex slightly acuminate. Furcal rami rather short, not twice as long as broad.

“First pair of female antennæ 25-segmented, almost reaching the base of the furca. The antepenultimate article of the prehensile male antenna (Pl. XXXI., Fig. 1) armed with an almost straight and rather slender process reaching almost to the middle of the penultimate article, and provided without with small teeth.

“Outer ramus of the fifth pair of feet in the female (Pl. XXXI., Fig. 5) two-segmented; the unguiform process of the second segment slightly curved, robust, moderately ciliate within and at the middle part, last cilium broad, spine-like. Third segment wanting, produced into two short spines, the outer half as long as the inner.

“Inner ramus one-segmented, almost equal to the first segment of the outer ramus; apex obliquely acuminate, provided with two rather long subequal spines.

“Second segment of the outer ramus of the right fifth foot of the male (Pl. XXXI., Fig. 4) very long, longer than the first segment and the basal segment taken together. Marginal spine of this segment inserted above the middle. Terminal hook slightly curved, inner margin ciliate.

“Inner ramus curved, ovate, broad, pointing inward, with mucronate apex, barely reaching to the end of the first segment of the outer ramus.

“First and second segments of the outer ramus of the left foot ciliate within, the second one obovate, hirsute toward the apex, and bearing two short spines one of which points inward.

“Inner ramus one-segmented, slender, equal to the first segment of the outer ramus.”

“Length of female about 1.5 mm.; of male 1.4 mm.

"This species, so remarkable from the peculiarities presented by the last thoracic and the first abdominal segments, was found by the Swedish naturalist, Trybom, at Multrooma Falls, Oregon."

The above is the description as given by Dr. Lilljeborg (de Guerne et Richard, '89b). It agrees with the specimens sent me by himself, but I note a few additional details.

The abdomen of the female, seen from above, is asymmetrical, as is also the last thoracic segment. The first abdominal segment is dilated anteriorly, and posteriorly is produced on the right to form a blunt, almost semicircular, process. Seen from the side this is fin-shaped, and both this process and the one on the last thoracic segment are penetrated by muscles. The furcal rami are hairy within.

In the male the peculiar form of the right inner ramus, the extreme shortness of the left leg, and the very irregular shape of its last segment are especially characteristic. The spines on the first basal segment of each leg and the teeth on the terminal segment of the right leg are also conspicuous because of their great size.

The peculiarity of a dorsal process is found, to my knowledge, in but two other species: *D. sanguineus* Forbes, and *D. signicauda* Lilljeborg. In the small size of the inner ramus of the right fifth foot of the male, *D. trybomi* approaches the male of *D. sanguineus* Forbes, *D. minutus* Lillj., and *D. lintoni* Forbes.

De Guerne and Richard give Multrooma Falls as the locality, which was probably intended for Multnomah Falls, Oregon, although Prof. Lilljeborg in a personal letter also gives the former spelling.

Diaptomus franciscanus LILLJEBORG. (Pl. XXX., Fig. 1-4.)

Diaptomus franciscanus, de Guerne et Richard, '89b, p. 45, Pl. I., Fig. 12, 13, 34; Pl. III., Fig. 23.

Diaptomus franciscanus, Herrick and Turner, '95, p. 58, Pl. VIII., Fig. 12, 16.

"Larger and more robust than *Diaptomus tyrrelli*. Cephalothorax widest in the middle, and the last two segments confluent above. Lateral lobes of the last thoracic segment

seen from above, short and obtuse posteriorly; armed with small spines. First abdominal segment (Pl. XXX., Fig. 1) about equal to the rest of the abdomen, moderately dilated anteriorly, rounded at the sides, and armed here with small spines or mucros; always destitute of all lateral processes. An imperfect suture remains long after maturity in the posterior part of this segment. Second segment of the abdomen much shorter than the third, and also more slender and easily pushed within the preceding joint.* Furcal rami short, fully one and a half times longer than broad; sparsely ciliate within.

“First pair of antennæ of female, reflexed, extend about to the furca; composed of 25 articles. Antepenultimate article of the male prehensile antenna (Pl. XXX., Fig. 2) provided with an unguiform process, slightly surpassing the end of the penultimate article.

“Outer ramus of the fifth pair of feet in the female (Pl. XXX., Fig. 4) three-segmented, the third segment very small but distinct, and bearing two spines. The unguiform process of the second segment of this ramus rather arcuate and finely ciliate within at the lower part, the last spine thicker than the rest. Inner ramus simple and equal to the first segment of the outer ramus, bearing two long equal spines at the apex, of which the outer is ciliate within at the base.

“The right fifth foot of the male (Pl. XXX., Fig. 3) rather robust. The second segment of the outer ramus almost rectangular and comparatively short; the outer marginal spine placed near the apex, and the inner margin armed with a minute spine. Terminal hook long, distinctly sigmoid or S-shaped and tapering toward the apex. Inner ramus small and barely reaching the middle of the second article of the outer ramus; either imperfectly two-segmented or one-segmented and armed with an apical spine.

“The second segment of the outer ramus of the left fifth foot of the male lamelliform, almost triangular, and thinner within. This segment on the thicker, outer, side bears a short

*The meaning of the original at this point is rather obscure. It reads: “Segmentum 2-dum caudæ 3-tio multo brevius ejusque testa tenuior et facile adstruenda.”

spine in the middle, and ends in a short obtuse process, the inner apical angle of which exhibits three small oblique incisions. The inner margin is minutely ciliate. The inner ramus is simple and slender, attenuate toward the apex, and reaching about to the middle of the second segment of the outer ramus.

"Length of female, 2.3 mm. ; of male, 2.0 mm.

"Found near San Francisco by G. Eisen.

"This *Diaptomus* approaches *D. longicornis* var. *similis* Herrick in the shape of the body and of the lateral lobes of the last thoracic segment, but it differs greatly in respect to the fifth pair of feet, especially in the male. It seems to be common in the vicinity of San Francisco, hence the name, *franciscanus*."*

The female is conspicuous chiefly for the extremely long spines with which the inner rami of the fifth pair of feet are armed. These are about as long as the ramus itself and hairy at the base. The thorax and abdomen are of ordinary form. The furca are hairy within, and also, but more sparsely, on the outer margin. In the male the outer margin is not hairy.

The outer ramus of the left fifth foot of the male is terminated by a peculiarly flattened segment (Pl. XXX., Fig. 3). In a male of this species sent me by Professor Lilljeborg, both inner rami of the fifth pair of legs are two-segmented.

Diaptomus eiseni LILLJEBORG.

Diaptomus eiseni, de Guerne et Richard, '89b. p. 44, Pl. I., Fig. 19, 29, 33.†

Diaptomus eiseni, Herrick and Turner, '95, p. 58, Pl. X., Fig. 11.

"Among the largest of the genus. Cephalothorax widest at the posterior part of the head. The last two thoracic segments usually confluent above or indistinctly segmented, and the lateral lobes of the last segment, seen from above, short

* Lilljeborg's description and remarks from de Guerne et Richard, '89b.

† Confusion may be caused by a slight mistake which crept into de Guerne et Richard's "Revision." In the index and under the species names, Fig. 20, Pl. I. is given as the fifth foot of *D. serricornis* and also of *D. eiseni*. The "explanation of plates" however, gives Fig. 29, Pl. I., as that of *D. eiseni*, which by comparison with the description is found to be correct.

in the female; upper posterior angle rather acute, lateral angle very obtuse, the spines of both angles thick and short. First abdominal segment slightly longer than the remainder of the abdomen (setæ excepted), produced anteriorly into a rather large lateral process with spines pointing obliquely backward. Second abdominal segment very short. Furcal rami short; sparsely hairy; about one and a half times as long as broad.

“First pair of antennæ reach to the lateral processes of the first abdominal segment; composed of 25 segments. Antepenultimate article of the prehensile antenna of the male with a long curved and acuminate process almost surpassing the end of the antenna.

“Outer ramus of the first pair of feet, especially in the female, pectinately setose.

“Outer ramus of the fifth pair of feet in the female two-segmented, the second segment with large unguiform process within and heavily spined without. The inner ramus of this foot rather long, clearly not reaching the end of the first segment of the outer ramus; suture sharply indicated; provided at the apex with two spine-like setæ and within with minute spines.

“Right fifth foot of the male rather robust. Second basal segment dilated within into a rugose lamella; second segment of the outer ramus with marginal spine placed near the apex. Inner margin of terminal claw slightly sigmoid; from the middle toward the apex first delicately pectinately spined, and thence tuberculate. Inner ramus small and indistinctly two-segmented, extending slightly beyond the middle of the second segment of the outer ramus; armed at the apex with a spine, and at the same place and within with thick cilia.

“Left foot of the fifth pair of the male much smaller than the right. Second or last segment of the outer ramus of this foot with the apex narrowed but obtuse, and within this an acuminate spine; an emarginate narrow and hairy lamina on the inner margin. Inner ramus slender, rather long, and notably surpassing the middle of the second segment of the outer ramus; indistinctly two-segmented, the apex similar to that of the right inner ramus.

"Length of female, 4 mm.; of male, 3.5 mm.

"Found, near Fresno, Cal., by G. Eisen, the Swedish zoölogist, member of the San Francisco Scientific Academy."

"This *Diaptomus* is dedicated to Mr. G. Eisen, who found it in California with a great number of other Entomostraca. It was given by him to the Zoölogical Museum of the University of Upsala. *D. eiseni* is very distinct from all the American species described by Profs. Forbes and Herrick."*

The last thoracic segment of the female is strongly produced posteriorly and the first abdominal segment is moderately dilated and armed on each side with a large spine. This form may also be recognized on account of its great size, being but little smaller than *D. stagnalis* or *D. shoshone* Forbes. The fifth pair of legs are remarkable for the extreme size of the inner of the two spines representing the third segment of the outer ramus, which is made still more striking by a row of strong teeth on each margin. The second segment of the outer ramus is also armed with strong teeth on the inner margin.

The fifth pair of legs of the male may be easily recognized from the fact that at least an indication of a suture is found on each inner ramus, making it indistinctly two-segmented. The rugose lamella on the second basal segment of the right fifth leg is also very characteristic.

***Diaptomus signicauda* LILLJEBORG.** (Pl. XXIX., Fig. 3-6.)

Diaptomus signicauda, de Guerne et Richard, '89b, p. 55, Pl. I., Fig. 15, 16, 31; Pl. III., Fig. 22.

Diaptomus signicaudatus, Herrick and Turner, '95, p. 63, Pl. VIII., Fig. 13; Pl. IX., Fig. 10.

"This species is among the smaller species of this genus. Form of the body very slender. Cephalothorax widest in front of the middle, at the second segment. Last two segments of the thorax (Pl. XXIX., Fig. 6) confluent above, the last, seen from above, with rather large and projecting lateral lobes, posterior angles acute, with small spines. Fourth thoracic segment, seen from the side, provided above with a small

* Lilljeborg's description and remarks from de Guerne et Richard, '89b.

hump. First abdominal segment of the female very characteristic of the species, giving to it its name. This segment is provided at the anterior part with short, mucronate lateral processes, and at the posterior part on the right side with a large process bent obliquely backward and moderately acuminate. Besides this an indication of a suture is also often present. The length of this segment, posterior process excepted, is slightly less than the remainder of the abdomen. Furcal rami hardly more than half as long as broad.

“First pair of antennæ of the female always 25-segmented; reflexed, slightly surpass the furcal rami, but do not reach the end of the furcal setæ. The antepenultimate article of the prehensile antenna of the male (Pl. XXIX., Fig. 4) armed with a medium-sized hook-like process.

“Fifth pair of feet of female (Pl. XXIX., Fig. 5) very similar to the corresponding pair of *D. siciloides*. Outer ramus two-segmented; unguiform process of the second segment slightly curved, almost parallel with the first article; very delicately ciliate within, the last cilia thicker and spine-like.

“Inner ramus one-segmented, longer than the first segment of the outer ramus; apex obliquely acuminate and ciliate, and bearing two equal ciliate spines.

“The right fifth foot of the male (Pl. XXIX., Fig. 3) rather slender. First segment of the outer ramus dilated within into a small hyaline lamina. The second segment as long as the first article and the second basal segment together. The marginal spine of the second segment is situated a little below the middle. Terminal hook simply curved.

“Inner ramus rather broad, acuminate, and short, not reaching to the end of the first segment of the outer ramus.

“The second segment of the outer ramus of the left foot elliptical or oblong-ovate; within and toward the apex very delicately aculeate, and bearing two large spines, one of which inclines inward.

“Inner ramus simple and slender, but long, and extending beyond the middle of the second segment of the outer ramus.

“Length of female about 1.5 mm.; of male, 1.3 mm.

“Found in the Sierra Nevada Mountains, California, at a height of from 8,000–10,000 feet above sea-level by G. Eisen. Appears to be very common in small pools in this locality.

“This *Diaptomus* is very distinct from all known species on account of the peculiar form of the first abdominal segment. In this respect it approaches *D. roubaui* Richard, and the genus *Epischura* Forbes. In the case of these Copepoda, however, it is the male which is distinguished by the irregularity of the abdomen. The name which I have given it refers particularly to the shape of the female abdomen.”*

There is nothing to add to the above description of this species except that the furca are delicately hairy within, a fact neither shown in the drawings nor mentioned in the original description. The last thoracic segment of the female is strongly produced, and the first abdominal segment greatly dilated at its anterior part. The process on the first abdominal segment is even larger in some cases than represented in the original drawings.

In the male also the last thoracic segment is produced, but not so much as in the other sex. The fifth pair of legs are very similar to those of *D. siciloides*, from which they may be distinguished by the shape of the right inner ramus and of the hyaline lamina on the first segment of the outer ramus of the right fifth leg. Both inner rami are delicately hairy, but I fail to find the smooth, cushion-like process on the outer margin and at the base of the left inner ramus which is figured in the original drawings but of which no mention is made in the text.

The females of *D. signicauda* and *D. trybomi* both have a “dorsal process,” and in this respect approach *D. sanguineus* Forbes.

Individuals of this species were kindly sent me by Dr. Lilljeborg, but were unavoidably delayed until after this description was completed. There was no time to rewrite it, hence these remarks are in the form of addenda. The same is true of *trybomi*, *ciscui*, and *franciscanus*.

*Lilljeborg's description and remarks from de Guerne et Richard, '89b.

Diaptomus ashlandi MARSH. (Pl. XXXII., Fig. 1-4.)

Diaptomus sicilis var. *imperfectus*, Forbes '90, p. 703.

Diaptomus ashlandi, Marsh, '93, p. 198, Pl. III., Fig. 11-13.

Diaptomus ashlandi, Herrick and Turner, '95, p. 60, Pl. VI., Fig. 4-6.

Diaptomus ashlandi, Marsh, '95, p. 7, Pl. VII., Fig. 2.

A small, slender species, about the same width throughout. Suture between head and thorax distinct. Last two thoracic segments distinct, the last one strongly bifid and armed on each side with a small blunt spine. Abdomen long and narrow; inclusive of the furca, about half as long as the cephalothorax. First abdominal segment as long as the remainder of the abdomen exclusive of the furcal rami; dilated laterally; with a small spine on each side (unarmed in the male). Second and third segments subequal. Furcal rami barely twice as long as wide; hairy within.

Antennae 25-segmented, reaching to the base of the furcal rami or slightly beyond. Prehensile antenna (Pl. XXXII., Fig. 4) moderately swollen; segments 19, 20, and 21, and 22 and 23, ankylosed; process on the antepenultimate segment extending almost to the middle of the last segment, the end knobbed and roughened or tuberculate at the inner margin.

Fifth pair of legs of the male (Pl. XXXII., Fig. 3) rather slender; left leg reaching about to the end of the first segment of the outer ramus of the right leg. On the anterior surface of the first basal segment of the right leg is a large tubercle bearing at the tip a small acute spine. Second basal segment without special characteristics. First segment of the outer ramus subquadrate, slightly broader than long; inner apical angle somewhat produced, the process ending in an acute point. Second segment about three times as long as the first, with a sharp angle at end of proximal third, from the point of which springs the lateral spine. This is about half as long as the segment, with an angle near its base. Terminal hook long and slender, rather more robust than that of *D. sicilis* Forbes, but shaped very much like it; minutely denticulate on the inner margin.

Inner ramus of right fifth leg one-segmented, very narrow, extending about half its length beyond the end of the first segment of the outer ramus; apex with an acute triangle, hairy at the tip; sides parallel.

First basal segment of the left fifth leg produced on the anterior aspect, near the outer margin, into a long tubercle ending in a minute, sharp spine; second basal segment with delicate hair near the outer distal angle. First segment of the outer ramus subquadrate, shorter than the preceding, slightly longer than broad; second segment about as long as the first and about twice as long as wide; very similar to the corresponding segment of *D. sicilis* Forbes.

Inner ramus of left fifth leg long and narrow, margins sinuously curved; extending about to the middle of the last segment of the outer ramus; delicately hairy at the tip.

Second basal segment of fifth leg of female (Pl. XXXII., Fig. 1, 2) with the usual delicate hair at the outer margin. First segment of the outer ramus about twice as long as wide; second segment somewhat longer than the first, tapering to a rather sharp point and curving outward slightly, delicately denticulate on the inner margin; third segment wanting, represented by two spines, the outer about twice as long as the inner.

Inner ramus one-segmented, extending slightly beyond first segment of the outer ramus, hairy, ending in acute triangular tip; armed at the apex with two rather long subequal spines which are sometimes hairy.

Length of female .97 mm.; of male .9 mm.

A reference to the "Distribution of American Species" (see page 183), will show the wide range of this form. In the collections of the U. S. Fish Commission from Lake Sammamish, Lake Union, and Lake Washington, Wash.; Tsiltecos Lake, Talikenitch Lake, and Klamath Lake, Oregon; and Lake Pend d' Oreille and Gamble's Lake, Idaho, *D. ashlandi* was found in immense numbers, being either the only centropagid or occurring in connection with *Epischura nevadensis* Lilljeborg.

Diaptomus ashlandi is very similar to *D. sicilis* Forbes and hardly to be distinguished from it but for a slight difference in the last segment of the left fifth foot of the male and the position of the marginal spine of the right fifth foot. In the Laboratory collections from Yellowstone Park and the Flat-head region of Montana forms occur which seem to be intermediate between the two, and it was exceedingly difficult to decide to which, if either, of the two species they belonged. *D. ashlandi* seems to me, however, to be a good species, since the form, as described by Marsh ('93 and '95) and as found by myself in other collections, exhibits constant, though somewhat minute, differences from *sicilis* hard to describe, but at once evident from the figures.

A very peculiar modification of the inner ramus of the fifth foot of the female was noted in a specimen taken from an alkaline pond in Yellowstone Park. In this individual one of the feet (Pl. XXXII., Fig. 1) was normal in every respect, while the inner ramus of the other was armed on its outer margin, at the end of the proximal third, with a sharp, smooth spine about half as long as the ramus itself.

D. sicilis var. *imperfectus* Forbes ('90) is here made a synonym of *D. ashlandi*, because unpublished Laboratory drawings of that variety clearly show it to be such. Marsh's description must stand, since the description of *imperfectus* was not complete enough to identify the form. This species was also noticed by Dr. Forbes in the collections reported on in '93, but was erroneously regarded by him as an immature form of *D. sicilis*.

Diaptomus reighardi MARSH. (Pl. XXVIII., Fig. 1.)

Diaptomus reighardi, Marsh. '95, p. 9, Pl. I., Fig. 1-4.

A medium-sized species; body about the same width throughout. Sutures between the first and second, and between the last two, thoracic segments distinct; last thoracic segment not produced, armed on each side with a very minute spine. First abdominal segment almost as long as the rest of the abdomen, dilated laterally, armed on each side with a

minute spine; second and third segments subequal; furcal rami slightly longer than the third segment, about twice as long as wide; and delicately hairy within. In the male the second abdominal segment and the furcal rami are subequal, and each is longer than any of the other segments. The furcal rami are considerably longer than the preceding segment, fully twice as long as wide, and hairy within.

Antennæ 25-segmented, reaching well beyond the tips of the furcal setæ. Right male antenna not much swollen anterior to the geniculate joint: antepenultimate segment unarmed.

Left fifth leg of male (Pl. XXVIII., Fig. 1) short, extending beyond the middle, but not reaching the end of the second segment, of the outer ramus of the right leg. First basal segment armed at the outer distal angle with a short, sharp spine. Second basal segment about equal to the first, almost as wide as long. First segment of the outer ramus irregularly trapezoidal in form, about half as wide as the second basal segment, and delicately hairy on the inner margin. Second segment somewhat as in *D. oregonensis* Lilljeborg. It is produced into two digitiform processes, the outer of which is more than twice as long as the inner and armed on the inner margin at the tip, with a small cushion-like, delicately hairy process. There is a distinct suture between the main part of the second segment and the inner of the two processes, and the process itself is minutely denticulate on the outer margin.

Inner ramus of left fifth leg one-segmented, reaching to the base of the inner digitiform process; outer margin hairy, almost straight; inner margin somewhat sinuously curved.

First basal segment of the right fifth foot of the male subquadrate, slightly longer than wide, armed at the outer distal angle with a short, sharp spine. Second segment about as wide as the first and one and a half times as long; provided with the usual hair on the outer margin. First segment of the outer ramus a little more than half as long as the second basal segment and slightly longer than wide; second segment less than half as wide as long and more than twice as long as the preceding segment. Marginal spine rather short, about

as long as the segment is wide; inserted near the beginning of the distal third; slightly curved and distinctly denticulate on the inner margin. Terminal hook rather slender, a little more than twice as long as the preceding segment; not regularly curved, but divided approximately into thirds by abrupt angles, the upper one very sharp, below which on the inner margin, the hook is delicately but distinctly denticulate.

Inner ramus of right fifth foot short, one-segmented, reaching just to, or extending very slightly beyond, the end of the first segment of the outer ramus; apex bluntly triangular and delicately hairy.

First segment of the outer ramus of the fifth leg of the female subquadrate, about twice as long as wide; second segment slightly shorter than the first, moderately curved, the inner margin distinctly denticulate; third segment wanting, being represented by two spines; the outer short and thick and only about half as long as the inner.

Inner ramus of fifth leg of female, one-segmented, extending slightly beyond the end of the first segment of the outer ramus; delicately hairy at the apex and on the distal fourth, and armed in addition to this with two slender spines about as long as the shorter of the two representing the third segment of the outer ramus.

Length of female, 1.1395 mm.; of male, 1.0248 mm.

The above measurements are those of Professor Marsh. The largest female I examined was 1.13 mm. in length, the smallest, 1 mm.; while the largest male I measured was 1 mm. in length, the smallest, .96 mm.

Prof. Marsh originally described this species, and I am greatly indebted to him for the specimens from which the above description was made. He found *D. reighardi* in only three localities, all in Michigan; North Lake, on Beaver Island, Intermediate Lake, and Crooked Lake. I do not know of its having been recorded from any other place.

At first sight *D. reighardi*, in respect to the fifth pair of legs of the male, is very like *D. oregonensis* Lilljeborg, but the details of structure are very different in the two, and there can be no doubt as to the validity of the species.

Diaptomus birgei MARSH.

Diaptomus birgei, Marsh, '94, p. 16, Pl. I., Fig. 4-6.

Diaptomus birgei, Herrick and Turner, '95, p. 79, Pl. XLVII., Fig. 4-6.

“Of moderate size. The first segment of the cephalothorax is nearly equal in length to the three following. The first segment of the abdomen of the female is as long as the remainder of the abdomen and the furca. It is much dilated in front. The second segment is nearly twice as long as the third, and about equal in length to the furca. The second and third joints are very closely united.

“The antennæ extend to the end of the furca. The right antenna of the male is much swollen anterior to the geniculating joint; the antepenultimate joint is produced on its distal end into a short, blunt process, which makes very nearly a right angle with the longitudinal axis of the joint.

“The outer ramus of the fifth foot of the female is two-jointed, the third joint being represented by two spines. The inner ramus is one-jointed, hardly as long as the first joint of the outer ramus, and armed at the tip with minute setæ and two rather long spines.

“The basal joint of the right fifth foot of the male is elongated, trapezoidal in form, its greatest breadth being at its distal extremity. The first joint of the outer ramus is broader than long, armed on its inner margin with a broad, thin expansion of the integument. The second joint is elongate, broader at base; the lateral spine is situated at about the middle of its length, is long and stout, and armed on its inner margin with fine serrulations. The terminal hook is slightly angular, and armed with fine serrulations on its inner margin. The inner ramus is one-jointed, equaling in length the first joint of the outer ramus.

“The left fifth foot of the male reaches slightly beyond the first joint of the outer ramus of the right. The basal joint is quadrangular, considerably shorter than the right basal joint. The first joint of the outer ramus is about twice as long as broad. The second joint is slightly longer than the first joint; it is expanded at base, where it is armed with fine hairs, and

terminates in a finger-like process bearing a falciform spine. The inner ramus extends to about one half the length of the second joint.

“Length of female, 1.5 mm.; of male, 1.3 mm.”*

Marsh states, in connection with the original description, that the material in which this species was found—collected by Professor Birge at New Lisbon, Wisconsin—contained only a few individuals, and that his own search for it in other Wisconsin localities had been unsuccessful. He says also that the species resembles the European species *D. gracilis* more closely than any other American form.

The description quoted above is the only literature on the subject, and while a request for slides or specimens of the species by Professor Marsh was kindly complied with in the case of most of his species, to his own as well as my regret he was unable to let me have either slides or specimens of *D. birgei*.

Unfortunately, as Marsh says, but few specimens were found, and further study of the species must consequently be deferred until later collections shall afford an opportunity.

***Diaptomus mississippiensis* MARSH.** (Pl. XXXIII., Fig. 1-4.)

Diaptomus mississippiensis, Marsh, '94, p. 15, Pl. I., Fig. 1-3.

Diaptomus mississippiensis, Herrick and Turner, '95, p. 78, Pl. XLVII., Fig. 1-3.

A medium-sized species. Body slender, widest about the middle of the posterior third, the male a little more slender than the female, and the widest part slightly farther forward. Last two cephalothoracic segments indistinctly confluent; suture between the first two distinct. Last cephalothoracic segment, seen from above, not produced, but bearing a minute obtuse spine pointing backward; seen from the side it is broadly rounded, with the spine in the middle, giving it the form of a brace (—). First abdominal segment about as long as the remainder of the abdomen (Pl. XXXIII., Fig. 4), with a short obtuse spine opposite the anterior margin of

*Description quoted from Marsh, '94.

the *receptaculum seminis*; the second segment the shortest; third segment slightly longer than the second. In the male (Pl. XXXIII., Fig. 1) there is little difference in the length of the abdominal segments. Furcal rami broad, but little longer than the third abdominal segment; distinctly hairy within. Furcal setæ thick at the base, tapering gradually toward the tip; distinctly setose. The inner furcal seta is smooth in both sexes.

Antennæ 25-segmented, reaching to or slightly beyond the tips of the furcal setæ. The right male antenna with the six segments preceding the geniculation greatly swollen; antepenultimate article unarmed; segments 19, 20, and 21, also 22 and 23 ankylosed.

Fifth pair of feet of the female (Pl. XXXIII., Fig. 2) of moderate size. First basal segment trapezoidal, the longer base forming the inner margin. Second segment of the outer ramus long, narrow, acuminate, shorter than the preceding segment, perfectly smooth within. Third segment wanting; represented by two straight and pointed spines, an inner short one and an outer one more than twice as long.

Inner ramus of fifth foot of female one-segmented, reaching almost to the middle of the second segment of the outer ramus; distinctly hairy on inner margin near the apex, where it is armed with two spines, the inner one being fully one third as long as the ramus itself.

First segment of outer ramus of right fifth foot of male (Pl. XXXIII., Fig. 3) subquadrate, slightly longer than broad, the second segment nearly twice as long as the first, its upper half about as wide as the first. A little below the middle of this segment the inner margin is produced into a short spine-like process, concave toward the apex of the segment. Between this and the apex the segment is produced into a narrow, triangular hyaline lamina, tapering from the broad upper part to the inner apical angle. Marginal spine long and curved, concave toward the apex of the segment and inserted very near the outer apical angle. Terminal hook long and very slender, with two sharp angles dividing it approximately into thirds; upper third rather thick as

compared with the remainder; lower two thirds very minutely spinose; tip sometimes slightly recurved.

Inner ramus of right fifth foot one-segmented, narrowing but slightly toward the tip. It reaches almost to the middle of the last segment of the outer ramus, but not to the hook-like process. Apex rounded; unarmed or very delicately hairy.

Outer ramus of the left fifth foot two-segmented. First segment irregularly trapezoidal; small and inconspicuous, with a delicately hairy cushion-like process on the inner margin. Last segment consisting of two digitiform processes, forming a forcipate structure. Seen from behind, the upper process is smooth, the base slightly swollen. It is a little longer than the other and about one and a half times as long as the preceding segment, tapering gradually from the thickened part to an obtuse point. The lower process (seen from behind) is about equally broad at the base and at the beginning of the last third, whence it narrows quite suddenly to form an obtuse point. It is provided within and at the apex with four or five small teeth.

Inner ramus of left fifth foot paddle-shaped, considerably broadest at the apex; reaching almost to the tip of the outer ramus; either smooth or very delicately hairy.

Length of female, 1.2 mm.; of male, 1.1 mm.

Most of the specimens examined were taken from Lake Maitland, Florida, from material kindly loaned me by Mr. Adolph Hempel.

The above was prepared as a description of a new species, but when I saw Professor Marsh's slides there was no longer any doubt as to the identity of *mississippiensis* and this Florida form. Prof. Marsh ('94) figures the furca of the female as perfectly smooth within, while in all of the specimens from Florida, as well as in those which he kindly loaned me, they are distinctly, though not heavily, setose within. The inner rami of the fifth pair of feet in the male, however, differ considerably—probably a varietal difference, since in a few of my specimens they approached the form shown in his figures. In the Florida specimens I fail to find the asymmetry in the

abdominal spine mentioned by Marsh, but since the specimens from the two localities differ in other respects it is not unlikely that this difference also may exist.

Found by Professor Marsh in collections from small lakes and ponds in Mississippi, and by the writer in material collected from a number of Florida lakes in March, 1896, by Mr. Adolph Hempel. Professor Marsh states that in collections made in Mississippi in January and February, 1893, *D. mississippiensis* was the only *Diaptomus* found; but in the Florida collections this species occurred in connection with *D. albuquerquensis* Herrick, the two being about equal in numbers. In general appearance these two species are very similar, but they are widely different in the details of their structure.

***Diaptomus tyrrelli* POPPE.**

Diaptomus tyrrelli, Poppe, '88, p. 159.

Diaptomus tyrrelli, de Guerne et Richard, '89b, p. 39, Pl. I., Fig. 17, 18; Pl. IV., Fig. 26.

Diaptomus fresnanus, Lilljeborg, *in litt.**

Diaptomus tyrrelli, Herrick and Turner, '95, p. 76, Pl. X., Fig. 9.

“Of medium size. Cephalothorax widest at the middle and at the lateral lobes of the last segment. Last two thoracic segments confluent above, and the last, seen from above, produced obliquely into large lateral processes, almost ovate, acuminate posteriorly, with a rather large mucro. First abdominal segment almost as long as the rest of the abdomen, somewhat dilated anteriorly, and provided with long mucronate lateral processes. Second and third abdominal segments rather short, with a vestige of a transverse suture anteriorly. Furcal rami short, sparsely hairy, and almost one and a half times as long as broad.

“First pair of antennæ in the female, reflexed, reach almost to, sometimes to the end of, the furca; composed of twenty-five segments. Antepenultimate article of the prehensile antenna of the male wholly unarmed, or minutely and scarcely perceptibly armed.

* The description given herewith is that of *D. fresnanus* Lilljeborg, sent by him to de Guerne and Richard, and published by them under the name of *D. tyrrelli*.

“Outer ramus of the fifth pair of feet in the female biarticulate; unguiform process of the second segment almost parallel to the first segment, slightly curved within and minutely ciliate on the inner margin, the last cilia spine-like. Inner ramus simple and slender, about equal to the first segment of the outer ramus; armed at the outer margin and near the apex with two medium-sized spines; apex obtuse and finely hairy.

“Right fifth foot in the male slender and of medium size. First segment of the outer ramus with a small hyaline lamella near the inner apical angle. Second segment comparatively small and strongly curved; the outer marginal spine at about the middle. Terminal hook slightly sigmoid; inner margin smooth. Inner ramus minute and simple, not reaching the end of the first segment of the outer ramus.

“Second segment of the outer ramus of the left foot of the same pair almost triangular; inner margin slightly sinuate and ciliate and armed with two obtuse processes (one apical, the other lateral). Inner ramus indistinctly two-segmented extending about to the middle of the second segment of the outer ramus; minutely hairy within and at the apex.

“Length of female 1.9 mm.; of male 1.8 mm.”*

“This *Diaptomus* is distinguished from all its related forms by the large lateral lobes of the last thoracic segment. These lobes, seen from above, are acuminate, but seen from the side, the posterior extremity is obtuse and armed with two spines.

“The first abdominal segment is remarkable on account of its long, strong, pointed processes.

“The female of this species slightly resembles *D. ambiguus* Lillj., from Behring Isle, but the lateral projections of the first abdominal segment are wanting in the latter. *D. tyrrelli* differs from most other American species in the absence of a prolongation on the antepenultimate article of the male prehensile antenna.

“The first specimens of this copepod were collected in Summit Lake, in the Rocky Mountains, at a height of 5,300 feet, and sent to Herr S. A. Poppe by Mr. J. B. Tyrrell, of Ottawa, Canada.

*Lilljeborg's description from de Guerne et Richard, '89b.

“The description given was sent to us by Prof. Lilljeborg as that of a new species described by him under the name of *D. fresnauus*. It was established from specimens found by G. Eisen at Centreville, near Fresno, Cal. *D. tyrrelli* here reaches a size somewhat greater than that which it has at Summit Lake, where it is only 1.5 mm. long.”*

Owing to the kindness of Herr Poppe I was enabled to examine specimens of *D. tyrrelli*, but found nothing to add to the above description. I failed to obtain specimens from Dr. Lilljeborg, and so am unable to say whether or not there are minor differences to be found in individuals from the two localities in which they have hitherto been found.

Diaptomus clavipes n. sp. (Pl. XXXIV., Fig. 1-3; Pl. XXXV., Fig. 1, 2.)

Body of about the same width throughout, except at the head and at the last thoracic segment, where it narrows slightly. Last two thoracic segments confluent, the last one with slightly rounded posterior angles, armed on each side with a short blunt spine. In the male the body is less strongly bifid than in the female, and the spines are smaller. There is but slight difference in the length of the abdominal segments (Pl. XXXV., Fig. 2), the second segment being longest and about equal to the furcal rami. The first segment is asymmetrical and armed on each side with a thick blunt spine, the one on the right side being the more conspicuous; in the male the segment is unarmed. Furcal rami hairy within; furcal setae long, slender, and covered with delicate hairs.

Antennae 25-segmented, extending beyond the furcal setae. Geniculate antenna of the male (Pl. XXXIV., Fig. 2) greatly swollen from the twelfth to the eighteenth segments inclusive. The armature of the segments is as follows: 1 and 7 have a sense-club and a long spine; 2, two long spines, a sense-club, and a sense-hair; 3, a sense-club and a long seta; 4 and 6, a long spine; 5, a sense-club and a short seta; 8, a short and a long spine; 9, a short spine, a long seta, and a

*De Guerne et Richard, 1896.

sense-club; 10 and 11, two long spines, one much thicker than the other, and a process; 12, a long spine, a short spine, and a sense-club; 13, a long spine and a process; 14, a long spine, a long seta, and a sense-club; 15, a process, a long spine, a short seta, and a sense-club; 16, a process, a long spine, a long seta, and a sense-club; 17, a plate-like process, a long and a short spine; 18, a plate and a short spine; 19, 20, and 21 (usually completely ankylosed but sometimes with sutures indistinctly visible), a very long spine, a long seta, and a short cuticular process; 22 and 23 (completely ankylosed), a narrow hyaline lamina (bisected by a sense hair) and two setae; 24, two setae; and 25, two long setae and two short ones, a sense hair, and a sense-club.

Fifth pair of feet in the male (Pl. XXXV., Fig. 1) characteristic. First basal segment of the right leg produced at the inner apical angle into a process (generally blunt but sometimes spine-like) having on the posterior surface a tubercle bearing a short blunt spine. Second basal segment (Pl. XXXIV., Fig. 1) armed at the inner margin with two processes, the proximal one broad, prominent, concave toward the apex of the segment; the other, slightly above the middle of the segment, a mere sharp triangular point. At the outer apical angle is a slight indentation from which springs a delicate hair, and from the inner apical angle arises the inner ramus. First segment of the outer ramus irregular, about one and a half times as long as broad, with a small sharp triangular point on the inner margin at about the beginning of the distal fifth. On this segment is a structure which is not, to my knowledge, found in any other *Diaptomus*. This is a hook arising from the middle of the posterior aspect, and reaching to the end of the segment. It is sickle-shaped, perfectly smooth, and although supplied with muscles does not seem to be movable. Second segment subquadrate, about twice as long as wide. The marginal spine is short, almost straight, about a third the length of the segment, delicately serrate within. Terminal hook very stout, as long as the two preceding segments, tapering gradually, and slightly recurved at the tip; armed for the distal two thirds of the inner margin with strong teeth.

Inner ramus of the right fifth foot short, about the same breadth throughout, almost reaching the middle of the first segment of the outer ramus; armed at the tip with a number of strong blunt spines.

Second basal segment of the left fifth leg subquadrate, the inner margin distinctly tuberculate, the outer apical angle with a delicate hair. First segment of the outer ramus subquadrate, about a fourth longer than broad; provided at the inner margin with a narrow hyaline lamina, produced at the inner apical angle into a delicately hairy cushion-like process. The second segment is narrow, about half as broad as the preceding; delicately hairy within, and produced at the inner distal angle into a cushion-like process densely covered with minute hairs. On the posterior side of this segment are two processes: one a long straight spine, more than half as long as the segment itself and armed at the inner margin with very strong hairs or spinules, largest at the base and decreasing in size toward the tip; the other a short, thick, blunt process, perfectly smooth, about a third the length of the spine.

Inner ramus of left fifth leg very long and narrow, arcuate (the concavity toward the outer ramus), about one eighth as broad as long, reaching beyond the end of the first and almost to the middle of the second segment of the outer ramus. It is broadest at the base and at the apex, armed at the tip with a number of strong blunt spinules, and tuberculate its entire length.

Second basal segment of the fifth pair of feet in the female (Pl. XXXIV., Fig. 3) trapezoidal, with the longest base forming the inner margin. From the outer margin springs the usual delicate hair. The first segment of the outer ramus is subquadrate, not quite twice as long as broad. Second segment subconical, almost straight, a little shorter than the preceding segment; the third segment wanting, represented by two sharp slender spines, the outer more than twice as long as the inner.

Inner ramus of fifth foot of female, one-segmented, longer than the first segment of the outer ramus and of uniform

width; delicately hairy both within and without; apex bluntly rounded and armed with two spines, the inner long, sharp, sinuously curved, the outer also sharply pointed but only about half as long as the inner.

Length of female, 1.37 mm.; of male, 1.28–1.68 mm.

Found (not very abundantly) in material from West Okoboji Lake, Iowa, very kindly loaned me by Prof. L. S. Ross, of Drake University, Des Moines, Iowa.

This species is very similar to Dr. Forbes's *D. piscinæ* and *D. leptopus*, but the details of structure will serve at once to distinguish it from them. The hook on the first segment of the right fifth foot of the male is very characteristic, as are also the processes on the inner margin of the second basal segment of the same leg. *D. clavipes* offers such a mass of peculiar details that it is distinguished with ease from all other species heretofore described.

The name *clavipes* was chosen because of the club-like inner rami of the fifth pair of legs of the male, the inner ramus of the left leg especially resembling an Indian war-club.

A very curious fact in regard to the distribution of this species was noted. East and West Okoboji lakes are united by a very deep, somewhat narrowed channel, but are so nearly one lake that no account of the division is taken by Rand & McNally in their atlas. Although there is nothing whatever to hinder free migration from one part of the lake to the other, not an individual was found in material from E. Okoboji, taken the same day and under the same circumstances as that from W. Okoboji in which the specimens were found.

SPECIES INSUFFICIENTLY DESCRIBED.

***Diaptomus caroli* HERRICK.**

Diaptomus caroli, Herrick and Turner, '95, p. 69.

This species name occurs once in the description of *D. siciloides* (Herrick and Turner '95), but although I have searched diligently in Herrick's writings for an original description or even a previous reference to this species, I have been unable

to find a word in addition to the following. Speaking of *D. siciloides*, he says: "This species approaches *D. sicilis* Forbes and *D. caroli* Herrick very closely, and is said also to resemble *D. gracilis* Sars. From *caroli* it may be at once distinguished by reason of the fact that the third joint of the outer ramus of the fifth foot of the female is obsolescent." The "*D. caroli* Herrick" would lead one to suppose that it had been described before; but, although this work contains the names and short descriptions of all the other species, *D. caroli* is not among them. I doubt, therefore, whether I am justified in putting it even under the head of "insufficiently described" species.

Diaptomus longicornis var. **similis** HERRICK.

Diaptomus longicornis var. *similis*, Herrick, 1884, p. 141, Pl. Q, Fig. 5-7.

Diaptomus similis, Herrick and Turner, '95, p. 58.

Something has already been said in regard to this doubtful species under the head of *D. leptopus*. First mentioned in Herrick's "Final Report," as one of two varieties,—the other being the true *leptopus* as acknowledged by him ('95a),—it is not mentioned again except in the description of *D. jeansianus*, where he says "The form of the fifth feet chiefly separates this species from *Diaptomus similis* Herrick." This species cannot stand until a more complete description is written.

DISTRIBUTION OF THE AMERICAN SPECIES OF DIAPTOMUS.

D. sicilis Forbes is one of the most common species in the Great Lakes, and has been found in Wisconsin, Michigan, Minnesota, and Yellowstone Park. In Illinois it is recorded from Cedar Lake and Fox Lake.

D. piscine Forbes has been recorded only from Yellowstone Park, and I now add Portage Slough, Manitoba, Can.

D. lintoni Forbes has been found only in Yellowstone Park.

D. leptopus Forbes is found in Massachusetts, Wisconsin, Minnesota, and Illinois.

D. sanguineus Forbes is very common throughout central and southern Illinois, and has been recorded from New York, Wisconsin, Minnesota, and Alabama.

D. staqualis Forbes is also a common species, and is recorded from Minnesota, Illinois, Ohio, Kentucky, and Alabama.

D. shoshone Forbes has never been found outside of Yellowstone Park.

D. pallidus Herrick is an exceedingly common species in central Illinois and has been recorded from Ohio, Wisconsin, and Minnesota.

D. albuquerqueensis Herrick was first described from Albuquerque, N. M., and is also found in Florida.

D. noramericanus Herrick has only been recorded from Albuquerque, N. M.

D. oregonensis Lilljeborg is a very common species in Illinois, occurring generally with *D. siciloides* Lillj. and *D. pallidus* Herrick. It is also common in Wisconsin and is found in Michigan, Minnesota, and Oregon.

D. siciloides Lilljeborg is found in immense numbers at Havana, Ill. I have found it also in Iowa and Indiana collections, and it was originally described from L. Tulare, Fresno, Cal.

D. minutus Lilljeborg is probably the common species in the northern tier of states. It has been found in Yellowstone Park, in the Great Lakes, and in Wisconsin, Michigan, Newfoundland, Greenland, and Iceland.

D. franciscanus Lilljeborg has been found only by G. Eisen, near San Francisco, Cal.

D. eiseni Lilljeborg is also a California species.

D. signicauda Lillj., one of the most peculiar of American species, is recorded only from the Sierra Nevadas.

D. trybomi Lilljeborg is recorded only from Multnomah Falls, Oregon.

D. ashlandi Marsh seems to be the most widely distributed of American forms, having been found in the Great Lakes, in Indiana, Michigan, Wisconsin, Oregon, Idaho, Washington, and in Yellowstone Park.

D. reighardi Marsh has been recorded only from New Lisbon, Wisconsin.

D. mississippiensis Marsh is common in Mississippi, and has been found in Florida in connection with *D. albuquerquensis* Herrick.

D. tyrrelli Poppe was described by the author of the species from Summit Lake, and by Lilljeborg, under the name *D. fresnans*, from Fresno, near Centreville, Cal.

D. clavipes n. sp. is described in this paper from West Okoboji Lake, Iowa.

GENERAL BIBLIOGRAPHY* OF THE GENERA DIAP-
TOMUS, EPISCHIURA, LIMNOCALANUS,
AND OSPHRANTICUM.

This bibliographical list has been prepared principally in furtherance of Dr. Schmeil's purpose to compile a complete bibliography of the Copepoda of the world. To this end the list published by him in his Monograph (Schmeil, '96) has been critically reviewed and in some instances corrected, and a number of additions have been made. New species described since the publication of de Guerne and Richard's Revision ('89b) are noted in connection with the articles containing the original descriptions.

All articles except those marked with an asterisk are in the library of the Illinois State Laboratory of Natural History or in that of the University of Illinois.

Apstein, C.

'92. (See Article II.)

'96. Das Süßwasserplankton. Methode und Resultate der quantitativen Untersuchung. 201 pp., 113 Abbild., 5 Tab. Kiel u. Leipzig. Review, Zool. Centralbl., III. Jahrg., No. 22, pp. 764-769.

Aurivillius, C. W. S., u. Cleve, P. T.

'96. Das Plankton des Baltischen Meeres. Bihang till K. Svenska Vet.-Akad. Handl., Bd. XXI., Afd. IV., No. 8, pp. 1-83, Taf. I., II.; Abstract, Zool. Centralbl., IV. Jahrg., 1897, No. 16, pp. 546-550.

Baird, W.

'50. (See Article II.)

Barrois, Th.

'91. Sur trois Diatomus nouveaux des environs du Caire. Rév. Biol. du Nord de la France, T. III., Nos. 6, 7, 8.

*'95. Contribution à l'étude de quelques lacs de Syrie. Rev. Biol. du Nord de la France, T. VI., No. 6, pp. 224-240; Abstract, Biol. Centralbl., XV. Bd., Nr. 24, pp. 869-873.

*'96. Recherches sur la faune des eaux douces des Agores. Mém. Soc. sci., agr., arts, Lille. Sér. V., Fasc. VI. 172 pp., 3 cartes; Abstract, Zool. Centralbl., III. Jahrg., No. 18, pp. 609-611.

Birge, E. A.

'95. On the Vertical Distribution of the Pelagic Crustacea of Lake Mendota, Wis., during July, 1894. Biol. Centralbl., XV. Bd., Nr. 9, pp. 353-355.

*As the bibliographical list published in connection with the preceding paper, Article II. of this series, contains a large number of titles identical with those of this bibliography, these duplicate titles are not reprinted here, but reference is made, under the author's name and the year of publication, to the bibliographical list of the preceding article.—S. A. FORRES.

'95a. Plankton Studies on Lake Mendota. I. The Vertical Distribution of the Pelagic Crustacea during July, 1894. *Trans. Wis. Acad. Sci., Arts, and Letters, Vol. X., pp. 421-484, Pls. VII.-X.*

'95b. Turkey Lake as a Unit of Environment, and the Variation of its Inhabitants: Cladocera.† *Proc. Ind. Acad. Sci., 1895, No. 5, p. 245.*

'97. The Vertical Distribution of the Limnetic Crustacea of Lake Mendota. *Biol. Centralbl., XVII. Bd., Nr. 10, pp. 371-375.*

Blanchard, R.

'90. Sur une matière colorante des *Diaptomus*, analogue à la carotine des végétaux. *Compt. Rend. de l'Acad. des Sci., Paris, T. CX., pp. 292-294.*

'90a. Sur une carotine d'origine animale, constituant le pigment rouge des *Diaptomus*. *Mém. de la Soc. zool. de France, T. III., p. 113.*

Blanchard, R., et Richard, J.

'90. (See Article II.)

'91. (See Article II.)

'97. Sur la faune des lacs élevés des Hautes-Alpes. *Mém. de la Soc. zool. de France, T. X., pp. 43-61.*

Brady, G. S.

'68. (See Article II.)

'78-'80. (See Article II.)

'86. Notes on Fresh-water Entomostraca from South Australia. *Proc. Zoöl. Soc. London, 1886, pp. 82-84. 3 Pls.*

'86a. Notes on Entomostraca collected by Mr. A. Haley in Ceylon. *Journ. Linn Soc. London, Zoöl., Vol. XIX., pp. 293-317, Pl. XXXVII., Fig. 21-26.*

'91. (See Article II.)

Buehholz, R.

*'74. Crustaceen. Die zweite deutsche Nordpolfahrt in den Jahren 1869 u. 1870, Bd. II., pp. 262-398. *15 Pls.

Bundy, F. W.

'82. A List of the Crustacea of Wisconsin. With Notes on some New or Little-known Species. *Trans. Wis. Acad. Sci., Arts, and Letters, 1877-81, Vol. V., pp. 176-184.*

Cajander, A. H.

'69. Bidrag till kännedom om sydvestra Finlands Krustaceer. *Not. Sällsk. pro Fauna et Flora Fennica Förh., Heft X., pp. 373-376.*

†Reference to *Diaptomus* and to *Epischura lacustris*.

Chambers, V. T.

- '81. Two New Species of Entomostraca. Journ. Cincinnati Soc. Nat. Hist., Vol. IV., pp. 47, 48. 2 Pls.

Chyzer, C.

- '58. Über die Crustaceenfauna Ungarns. Verh. d. K.-K. zool.-bot. Gesellsch. Wien, Bd. VIII., p. 505.

Claus, C.

- '58. (See Article II.)

- '63. (See Article II.)

- '76. (See Article II.)

- *'77. Die Schalendrüse der Copepoden. Sitzungsber. Akad. Wien, Math. Nat. Cl., LXXIV, Bd., I. Abth., pp. 717-721. 1 Pl.

- '88. Über den Organismus der Nebaliden und die systematische Stellung der Leptostraken.† Arb. zool. Inst. Univ. Wien, VIII, Bd., pp. 1-148. Taf. I-XV.

- '93. (See Article II.)

- '93a. (See Article II., '93b.)

- '93b. (See Article II., '93c.)

- '95. Über die Wiederbelebung im Schlamme eingetrockneter Copepoden und Copepoden-Eier. Zugleich ein Beitrag zur Kenntniss von *Microcyclops diaphanus* (Fisch.) = *minutus* (Cls.). Arb. Zool. Inst. Univ. Wien, T. XI., 1 Heft, pp. 1-11, Taf. I., II.

- '95a. Über die Maxillarfüsse der Copepoden und die morphologische Deutung der Cirripedien-Gliedmassen. Arb. Zool. Inst. Univ. Wien, T. XI., 1 Heft, pp. 49-63, Taf. VIII.

Cragin, F. W.

- '83. (See Article II.)

Daday, E. v.

- '84. Catalogus Crustaceorum fauna Transylvaniae. (e collectione Musei transylvanici, collegit et determinavit). [Latin title of Hungarian article.] Orv. Természettud. Értesítő, Vol. IX., pp. 161-187

- '85. (See Article II., 85a.)

- '85a. Ujjállatfajok Budapest édesvízi faunájából. Term. fiz., Vol. IX., p. 127, Pl. XI.

- '85b. (See Article II., '85.)

- *'90. Conspectus Diaptomorum fauna hungaricae. Math. naturw. Berichte a. Ungarn, Bd. XIII., pp. 114-143, Pls. IV.-VI.

- '90a. Übersicht der Diaptomus-Arten Ungarns. Math. naturw. Berichte a. Ungarn, Bd. XIV., pp. 177-180.

†Fütterung mit Farbstoffen an Diaptomus, pp. 99, 101.

*91. Adatok Magyarország édesvízi mikroszkopos faunájának ismertetéhez. Term. füz., Vol. XIV., pp. 16-31, Pl. I. Also in German: Beiträge zur Mikropischen Süßwasserfauna Ungarns, *Ibid.*, pp. 107-123.

*91a. Az eddig pontosan ismert Diaptomus-fajok meghatározó táblázata. Tabella synoptica specierum generis Diaptomus hucusque recte cognitarum. [Article in Hungarian and Latin.] Term. füz., Vol. XIV., pp. 32-51.

*97. Beiträge zur Kenntniß der Microfauna der Tátra-Seen. Term. füz., Vol. XX., pp. 149-196.

Dahl, Fr.

*94. Die Copepodenfauna des unteren Amazonas. Ber. d. naturf. Gesellsch. zu Freiburg, i. B., Bd. VIII., pp. 10-23, Taf. 1., Fig. 1-4.
Diaptomus kenseii n. sp.

*95. Neues über Morphologie und Ethologie der Copepoden. Zool. Centrabl., II. Jahrg., No. 22 u. 23, pp. 673-678.

De Kay, J. E.

*44. Crustacea. Nat. Hist. New York, Zoölogy, Part VI., pp. 1-65. Pls. I.-XIII.

Eusébio, J. B.

*88. Recherches sur la faune des eaux du Plateau Central. La Faune pélagique des lacs d'Auvergne. Rev. d'Auvergne (Clermont-Ferrand) [*Fide* Schmeil]. Separate, pp. 1-29, Pl. I., Fig. 10.

Fellows, C. S.

*87. A description of *Ergasilus chautauquaensis*, a New Species of Copepoda, and a List of other Entomostraca found at Lake Chautauqua in August, 1886. Proc. Am. Soc. Microscopists, 1887. 4 pp., 1 Pl.

Férussac, D. de

*06. Mémoire sur deux nouvelles espèces d'Entomostracés et d'Hydrachnes (*Cyclops mülleri* [= *Diaptomus coruleus*] and *Cypris reniformis*). Ann. Mus. hist. nat., T. VII., p. 213.

Fischer, S.

*51. Beiträge zur Kenntniß der in der Umgegend von St. Petersburg sich findenden Cyclopiden. Bull. Soc. Imp. des Naturalistes de Moscou, T. XXIV., Pt. II., pp. 409-438, Pls. IX., X.

*53. Beiträge zur Kenntniß der in der Umgegend von St. Petersburg sich findenden Cyclopiden. Fortsetzung. Bull. Soc. Imp. des Naturalistes de Moscou, T. XXVI., Pt. II., No. 1, pp. 74-100, Pls. II., III.

Forbes, S. A.

*76. (See Article II.)

- '78. The Food of Illinois Fishes. Bull. Ill. State Lab. Nat. Hist., Vol. 1., No. 1, pp. 71-89.
- '78a. On the Crustacea eaten by Fishes. Bull. Ill. State Lab. Nat. Hist., Vol. 1., No. 2, p. 87.
- '80. The Food of Fishes. Bull. Ill. State Lab. Nat. Hist., Vol. 1., No. 3, pp. 18-65; Rep. Ill. State Fish Comm., 1884, pp. 90-127.
- '80a. On the Food of Young Fishes. Bull. Ill. State Lab. Nat. Hist., Vol. 1., No. 3, pp. 66-79.
- '82. On the First Food of the Young White Fish. American Field, Mar. 11, 1882.
- '82a. (See Article II.)
- '82b. (See Article II., '82.)
- '83. The Food of the Smaller Fresh-water Fishes. Bull. Ill. State Lab. Nat. Hist., Vol. 1., No. 6, pp. 65-95; Rep. Bd. Ill. State Fish. Comm., 1886, pp. 114-138.
- '83a. The First Food of the Common White-Fish (*Coregonus clupeiformis* Mitch.). Bull. Ill. State Lab. Nat. Hist., Vol. 1., No. 6, pp. 95-109; Rep. Bd. Ill. State Fish Comm., 1886, pp. 139-149.
- '87. (See Article II.)
- '90. (See Article II. '90a.)
- '90a. (See Article II. '90.)
- '93. (See Article II.)

Forel, A. F.

- '78. Faunistische Studien in den Süßwasserseen der Schweiz. Zeitschr. f. wiss. Zool., Bd. XXX., Suppl., pp. 383-391.
- '82. Die pelagische Fauna der Süßwasserseen. Biol. Centralbl., II. Bd., Nr. 10, pp. 299-305; Translation, Ann. Mag. Nat. Hist., Vol. X., p. 320.

Francé, R. H.

- '94. Zur Biologie des Planktons. Vorläufige Mitteilung. Biol. Centralbl., XIV. Bd., Nr. 2, pp. 33-38.

Friè (Fritsch), A.

- '72. (See Article II.)
- '95. Über Parasiten bei Crustaceen und Räderthieren der süßen Gewässer. Bull. Internat'n'l d'Acad. des Sci. de l'Empéreur François Joseph I, Classe des Sci. Math. et Nat., pp. 1-7.
- '95a. (See Article II. '95.)

Fritsch (Friè), A., u. Vávra, V.

- '92. (See Article II.)
- '94. (See Article II.)

Fric, J. A.

'82. (See Article II.)

Gadeau de Kerville, H.

'88. Les Crustacés de la Normandie: espèces fluviales, stagnales et terrestres; première liste. Bull. de la Soc. des Amis des Sci. nat. de Rouen, 1888, 1^{re} Sem., pp. 133-158.

Garbini, A.

'93. Primi Materiali per una Monografia Limnologica del Lago di Garda. III. Limnofauna. Estr. dal Vol. LXIX., Ser. III., dell'Accad. Agric., Arti. e Comm. di Verona, pp. 28, 37, 49.

'94. (See Article II.)

'95. Fauna Limnetica e Profonda del Benaco. Boll. Mus. di Zool. ed Anat. comp. della Univ. di Torino, Vol. X., No. 198, pp. 2, 4, 5.

'95a. Appunti di Carcinologia Veronese. I. Elenco dei Crostacei veronesi. Estr. dal Vol. LXXI., Ser. III., Fasc. I., dell'Accad. di Verona, p. 3.

'95b. Appunti di Carcinologia Veronese. II. Considerazione ecologiche e corologiche. Estr. dal Vol. LXXI., Ser. III., Fasc. I., dell'Accad. di Verona, pp. 9, 14.

'95c. Distribuzione e Intensità della Fauna atesina. Estr. dal Vol. LXXI., Ser. III., Fasc. II., dell'Accad. di Verona, p. 10.

Gerstäcker, A.

'54. Bericht über die Leistungen in der Naturgeschichte der Crustaceen, Arachniden, und Myriapoden während des Jahres 1852 und 1853. Arch. f. Naturgesch., XX. Jahrg., Bd. 2, pp. 72-108.

'63. Copepoda. Handbuch der Zoologie, pp. 402-403. Leipzig.

'66-'79. Copepoda. Bronn's Klassen und Ordnungen des Thierreichs, V. Bd., 1. Abtheil., pp. 590-806.

Giesbrecht, W.

'81. Vorläufige Mitteilung aus einer Arbeit über die freilebenden Copepoden des Kieler Hafens. Zool. Anz., XIV. Jahrg., No. 83, pp. 254-258.

'82. Die freilebenden Copepoden der Kieler Förhde. IV. Ber. d. Komm. z. w. Unters. d. deutsch. Meere in Kiel, pp. 87-168, Taf. I-XII.

'92. Systematik und Faunistik der pelagischen Copepoden des Golfs von Neapel und der angrenzenden Meeresabschnitte. XIX. Monograph. der Fauna und Flora des Golfs von Neapel, 831 pp., 54 Pls. Berlin.

'93. Mitteilungen über Copepoden. 6. Zur Morphologie der Maxillipeden. Mitteilungen a. d. zool. Stat. zu Neapel, Bd. XI., Heft I., pp. 83-102.

'95. Mitteilungen über Copepoden. 7. Zur Morphologie des weiblichen Abdomens. Mitteilungen a. d. zool. Stat. zu Neapel, Bd. XI., Heft IV., pp. 631-648.

Gissler, C. F.

'81. Variations in a Copepod Crustacean. Am. Nat., Vol. XV., pp. 689-698.

'81a. Note regarding Change of Color in *Diaptomus sanguineus*. Am. Nat., Vol. XV., p. 742.

Grobben, C.

'80. Die Antennendrüse der Crustaceen. Arb. Zool. Inst. Univ. Wien, Bd. III., pp. 93-110, Taf. IX.

'92. Zur Kenntniss des Stammbaumes und des Systems der Crustaceen. Sitzungsber. der K. Akad. der Wissensch. in Wien. Math.-naturw. Classe, Bd. CL, Abt. I., Jan., 1892, pp. 1-38.

Gruber, Aug.

'78. Über Bildung und Wirkung der Spermatophoren bei *Diaptomus gracilis* und *Heterocope robusta*. Dissertation. Promotionschrift zur Erlangung der Doktorwürde, der philosoph. Facult. der Univ. Leipzig vorgelegt. 34 pp., 2 Pls. Leipzig.

'78a. Die Bildung der Eiersäckchen bei den Copepoden. Zool. Anz., 1. Jahrg., No. 11, p. 247.

Guerne, J. de

'86. Description du *Centropages grimaldii*, Copépode nouveau du golfe de Finlande. Bull. de la Soc. zool. de France, T. XI., pp. 276-285.

'87. Sur les genres *Ectinosoma* Boeck et *Podon* Lilljeborg, à propos de deux Entomostracés (*Ectinosoma atlanticum* G. S. Brady et Robertson, et *Podon minutus* G. O. Sars) trouvés à la Corogne dans l'estomac des sardines.* Bull. de la Soc. zool. de France, T. XII., p. 29.

Guerne, Jul. de, et Richard, J.

'88. Sur la distribution géographique du genre *Diaptomus*. Compt. rend. de l'Acad. des Sci., 2 juillet, 1888. 3 pp.

'88a. Diagnoses de deux *Diaptomus* nouveaux d'Algérie (*D. blanchardi* et *D. lilljeborgi*). Bull. de la Soc. zool. de France, T. XIII., pp. 160-162.

'89. (See Article II., '89a.)

'89a. (See Article II., '89.)

'89b. Révision des Calanides d'eau douce. Mém. de la Soc. zool. de France, T. II., pp. 53-181, Pls. I-IV, and 60 fig. in text.

*Reference to *Limnocalanus grimaldii*.

- '90. La distribution géographique des Calanides d'eau douce. Association française pour l'avancement des sciences fusionnée avec l'Assoc. scient. de France, Congrès de Paris, Séance du 14 août, 1889. 5 pp., 1 Pl.
- '90a. Diagnose d'un *Diaptomus* nouveau du Congo (*D. loveni*). Bull. de la Soc. zool. de France, T. XV., pp. 177-178.
- '90b. Description du *Diaptomus alluaudi* n. sp., recueilli par M. Alluaud dans un réservoir d'eau douce à Lanzarote (Canaries). Bull. de la Soc. zool. de France, T. XV., pp. 198-200.
- '90c. On the Fresh-Water Fauna of Iceland. Ann. and Mag. Nat. Hist., Series VI., Vol. X., pp. 340-342.
- '91. (See Article II.)
- '91a. Synonymie et distribution géographique de *Diaptomus alluaudi*. Bull. de la Soc. zool. de France, T. XVI., pp. 213-217.
- '91b. (See Article II., '91a.)
- '91c. Entomostracés recueillis par M. Charles Rabot en Russie et en Sibérie (Gouvernements de Kasan, de Perm, de Vologda, et de Tobolsk). Bull. de la Soc. zool. de France, T. XVI., pp. 232-236.
- '92. Sur la faune des eaux douces de l'Islande. Compt. rend. de l'Acad. des Sci., T. CXIV., pp. 310-313.
- '92a. (See Article II.)
- '92b. Documents nouveaux sur la distribution géographique des Calanides d'eau douce. Assoc. franç. pour l'avanc. des Sci., Congrès de Marseille, 1891, T. XX., Plate V. 5 pp. Paris.
- '92c. (See Article II., '92b.)
- '93. (See Article II.)
- *'94. *Diaptomus checreuri*, Copépode nouveau d'Algérie. Bull. de la Soc. zool. de France, T. XIX., p. 176.
- '96. Première liste des Copépodes et Cladocères d'eau douce du Portugal. Bull. de la Soc. zool. de France, T. XXI., pp. 157-159.
- '96a. *D. blanci*, Copépode nouveau recueilli par M. Edouard Blanc à Boukhara (Turkestan). Bull. de la Soc. zool. de France, T. XXI., pp. 53-56. 5 Fig.

Häcker, F.

- *'95. Die Vorstadien der Eireifung. Zusammenfassende Untersuchungen über die Bildung der Vierergruppen und das Verhalten der kernbläschen-nucleolen. Arch. f. mikr. Anat., Bd. 45, pp. 200-273; Abstract. Zool. Centralbl., 11. Jahrg., Nr. 18, pp. 551-553.

Hansen, H. J.

- '93. Zur Morphologie der Gliedmassen und Mundteile bei Crustaceen und Insekten. Zool. Anz., XVI. Jahrg., Nos. 420 u. 421, pp. 193-198, 201-212.

Hartog, M. M.

- '80. On the Anal Respiration of the Copepoda. Quart. Journ. Microsc. Sci. London, Vol. XX., pp. 241-245; Proc. Manchester Lit. and Philos. Soc., Vol. XIX., pp. 61, 62.
- '82. De l'œil impair des Crustacés. Compt. rend. Acad. Paris, T. XCIV., pp. 1430-1432; Ann. Mag. Nat. Hist., Vol. X., pp. 71, 72; Archiv Zool. Experim., Vol. X., pp. 7, 8.
- '88. (See Article II.)

Hartwig, W.

- '93. (See Article II.)
- '94. (See Article II.)
- '97. Zur Verbreitung der niederen Crustaceen der Provinz Brandenburg. Forschungsber. a. d. Biol. Stat. zu Plön, Theil V., pp. 115-149. Stuttgart.

Heller, C.

- '71. (See Article II.)

Herrick, C. L.

- '77. A New Cyclops.† Geol. and Nat. Hist. Surv. of Minn., 5th Ann. Rep., pp. 238-239. 2 Figs.
- '79. (See Article II.)
- '79a. Fresh-water Entomostraca. Am. Nat., Vol. XIII., pp. 620-629. 4 Pls.
- '82. (See Article II., '82a.)
- '83. (See Article II.)
- '83a. (See Article II.)
- '84. (See Article II.)
- '87. (See Article II.)
- '95. Micro-Crustacea from New Mexico. Zool. Anz., XVIII. Jahrg., Nr. 467, pp. 40-47. 2 Taf.
[*D. albuquerqueensis* and *D. novamericanus*.]

Herrick, C. L., and Turner, C. H.

- '95. (See Article II.)

Hoek, P. P. C.

- '76. (See Article II.)
- *'77-'78. Zur Entwicklungsgeschichte der Entomostraken. II. Zur Embryologie der freilebenden Copepoden. Nederl. Arch. f. Zool. Bd. IV., pp. 55-74, Taf. V.-VI.
- '78. (See Article II.)

Imhof, O. E.

- '83. (See Article II.)

†*Diaptomus* sp. ?

- '84. Resultate meiner Studien über die pelagische Fauna kleiner und grösserer Süßwasserbecken in der Schweiz. *Zeitschr. f. wiss. Zool.*, Band XL., pp. 154-178.
- '84a. (See Article II., '84.)
- '85. (See Article II., '85a.)
- '85a. Über die blassen Kolben an den vorderen Antennen der Süßwasser-Calaniden. *Zool. Anz.*, VIII. Jahrg., Nr. 197, p. 353.
- '85b. (See Article II., '85.)
- '86. (See Article II.)
- '86a. (See Article II., '86b.)
- '87. Über die microscopische Thierwelt hochalpiner Seen (600-2780 m. ü. M.). *Zool. Anz.*, X. Jahrg., Nos. 241 u. 242, pp. 13-17, 33-42; Abstract, *Am. Nat.*, Vol. XXI., p. 671.
- '87a. (See Article II.)
- '87b. (See Article II.)
- '88. Fauna der Süßwasserbecken. *Zool. Anz.*, XI. Jahrg., Nos. 275 u. 276, pp. 166-172, 185-190.
- '88a. (See Article II., '88.)
- '90. (See Article II., '90a.)
- '90a. (See Article II., '90.)
- '90b. Notizen über die Süßwasser-Calaniden. *Zool. Anz.*, XIII. Jahrg., Nos. 349 u. 350, pp. 629-633, 651-658.
- '91. Über die pelagische Fauna einiger Seen des Schwarzwaldes. *Zool. Anz.*, XIV. Jahrg., No. 355, pp. 33-38.
- '92. Zusammensetzung der pelagischen Fauna der Süßwasserbecken. *Biol. Centralbl.*, XII. Band., Nr. 6, 7 u. 8, pp. 171-182, 200-205.
- *'93. Les organismes inférieurs des lacs à la région du Rhône. *Arch. des Sci. phys. et nat.*, octobre-décembre, 1893.
- '94. Fauna hochgelegener Seen. Seen der Rocky-Mountains, Nord-Amerika. Von S. A. Forbes. *Biol. Centralbl.*, XIV. Bd., Nr. 8, pp. 287-293.
- '95. (See Article II.)
- '96. Die Binnengewässer-Fauna der Azoren; Referat nach de Guerne und Barrois. *Biol. Centralbl.*, XVI. Bd., Nr. 18, pp. 683-688.

Jurine, L.

- '20. (See Article II.)

Kafka, Josef.

- '92. (See Article II.)

Kerville, H. (See Gadeau de Kerville, H.)

King, R. L.

- *'55. On Australian Entomostracans. Papers and Proc. Roy. Soc. Van Diemen's Land, Vol. III., Pt. I.

Koch, C. L.

- '35-'41. Deutschlands Crustaceen, Myriapoden, und Arachniden, Heft. XXI., XXXV. Regensburg.

Koelbel, C.

- '85. Carcinologisches. Sitzungsber. d. K. Akad. d. Wiss. Wien, Math.-naturw. Klasse., Bd. XC., I Abteil., pp. 312-323. Pl. I. Fig. 1-5.

Kortchaguine, A. N.

- *'87. Fauna der Umgebung Moskaus. I. Crustaceen [German title of Russian article]. (Arb. aus. d. Laborat. d. Zool. Mus. der Univ. Moskau.) Schriften der Gesellsch. v. Freunden d. Naturwissensch. zu Moskau, Bd. LII.

Ladenburger, R.

- '84. Zur Fauna des Mansfelder Sees. Zool. Anz., VII. Jahrg., Nr. 168, pp. 299-302.

Lauterborn, R.

- '94. Über die Winterfauna einiger Gewässer der Oberrheinebene. Mit Beschreibungen neuer Protozoen. Biol. Centrabl., XIV. Bd., Nr. 11, pp. 391-398.
- '94a. Beiträge zur Süßwasserfauna der Insel Helgoland. Wissenschaftliche Meeresuntersuchungen, "Neue Folge," Bd. I., Heft 1, pp. 216-221.

Leydig, Fr.

- '59. Bemerkungen über den Bau der Cyclopiden. Arch. f. Naturg. XXV. Jahrg., I. Bd., pp. 194-207, Taf. IV.

Lilljeborg, W.

- '53. (See Article II.)

'63. Beskrifning öfver två arter Crustaceer af ordinarie Ostracoda och Copepoda. Öfv. af K. Vet.-Akad. Förhandl. Arg. XIX., p. 391.

'87. On the Entomostraca collected by Mr. Leonhard Stejneger, on Bering Island, 1882-83. Contributions to the Natural History of the Commander Islands. Proc. U. S. Nat'l Mus., 1887, pp. 154-156.

'88. Descriptions de deux espèces nouvelles de *Diaptomus* du nord de l'Europe. Bull. de la Soc. zool. de France, T. XIII., pp. 156-158.

Lubbock, J.

- *'53. On two New Species of Calanida, with Observations on the Spermatie Tubes of *Pontella*, *Diaptomus*, etc. Ann. Mag. Nat. Hist., Vol. XII., pp. 115-124, 159-165, Pls. V., VI.

- *54. On the Fresh-water Entomostraca of South America. Trans. Entom. Soc. N. S., T. III.
- *56. On some Entomostraca collected by Dr. Sutherland in the Atlantic Ocean. Trans. Entom. Soc. London, Vol. IV., Part II., pp. 8-39, Pls. II.-XII.
- *57. Description of eight New Species of Entomostraca found at Weymouth. Ann. Mag. Nat. Hist., Vol. XX., pp. 401-410, Pls. X., XI.
- *60. On Some Oceanic Entomostraca collected by Capt. Toynebee. Trans. Linn. Soc. London, Vol. XXIII., pp. 295, 296; Ann. Mag. Nat. Hist., Vol. XI., pp. 488, 489.
- '63. (See Article II.)

Maitland, R. T.

- *74. Naamlijst van Nederlandsche Schaaldieren. Tijdschr. Nederl. Dierk. Vereen., I Deel, pp. 228-269.

Marezzeller, E. v

- '73. Über *Diaptomus amblyodon* n. sp. Verh. d. K.-K. zool.-bot. Gesellsch. Wien, Bd. XXIII., p. 593, Taf. VI.

Marsh, C. D.

- '91. (See Article II.)
- '92. (See Article II.)
- '93. (See Article II.)
- '93a. (See Article II.)
- '94. On two New Species of Diaptomus. Trans. Wis. Acad. Sci., Arts, and Letters, Vol. X., pp. 15-17, Pl. I.
[*D. mississippiensis* and *D. birgeti*, n. sp.]
- '95. (See Article II.)
- '97. On the Limnetic Crustacea of Green Lake. Trans. Wis. Acad. Sci., Arts, and Letters, Vol. XI., pp. 179-224, Pls. V.-XIV.

Milne-Edwards, H.

- '34-'40. (See Article II.)
- '38. Extrait d'un Mémoire sur la distribution géographique des Crustacés. Compt. rend. des Séances de l'Acad. des Sci. 9 pp.

Moniez, R.

- '87. (See Article II.)
- '89. (See Article II., '89a.)

Mrázek, A.

- '91. (See Article II.)
- '93. Příspěvky k poznání sladkovodních Copepodů [Contributions to the Knowledge of Fresh-water Copepoda]. Věstník Král. České Spol. Nák. Třída math.-přír., 1893. 74 pp., 8 Pls.; Abstract. Zool. Centralbl., I. Jahrg., pp. 593, 594.

'93. (See Article II., '93c.)

'95. (See Article II.)

*'96. Zur Entwicklungsgeschichte einiger Taenien.† Sitzungsber. d.k. böhm. Gesellsch. Wiss. Math.-nat. Classe. 16 pp., 1 Pl.: Abstract, Zool. Centrabl., IV. Jahrg., No. 15, pp. 522, 523.

Müller, O. F.

1792. (See Article II.)

Nicolet.

*'48-'49. Crustaceos. In Gay, C., Historia física y política de Chile etc., Zoologia, Vol. III., pp. 288-292.

Nordqvist, O.

'86. (See Article II.)

'87. (See Article II.)

'88. Die Calaniden Finlands. Bidrag till Kännedom af Finlands Natur och Folk. Utgifva af Finska Vetensk.-Soc., Heft 47. pp. 192-275. 10. Pls.

'89. Über einen Fall von androgyner Missbildung bei *Diatomus gracilis* G. O. Sars. Arch. f. Naturgesch. LV. Jahrg., pp. 241-243, Taf. XII.

'90. (See Article II.)

Norman, A. M.

'86. Museum Normanianum; or a Catalog of the Invertebrata of Europe and the Arctic and North Atlantic Oceans, pp. 22, 23.

Ouchakoff, N.

*'55. *Pontie* de Wacarino. Bull. de la Soc. imp. des natural. de Moscou, T. XXVIII.

Pavesi, P.

'79. (See Article II.)

'79a. (See Article II.)

'83. (See Article II.)

Pickering, C.

'44. Generic Description of *Scopiphora vagans*. Nat. Hist. N. Y., Zoöl., Part VI., Crustacea, p. 62.

Pitard, E.

*'97. Sur le Plankton du lac de Joux. Arch. Sci. phys. et nat., 4^{me} pér., T. III. 3 pp.

*'97a. Sur le Plankton du lac Brenet. Arch. Sci. phys. et nat., 4^{me} pér., T. III. 2 pp.

Poggenpol, M. J.

'74. (See Article II.)

†Contains reference to *Diatomus*.

Poppe, S. A.

- '84. Bemerkungen zu R. Ladenburger's: Zur "Fauna des Mansfelder Sees" in No. 168 des Zoologischen Anzeigers. Zool. Anz., VII. Jahrg., No. 176, pp. 499, 500.
- '86. Ein neuer *Diaptomus* aus dem Hirschberger Thal. Zeitschr. f. wiss. Zool., Bd. 43, pp. 285-289, Taf. X., Fig. 1-12.
- '88. Diagnoses de deux espèces du genre *Diaptomus* Westwood. Bull. de la Soc. zool. de France, T. XIII., pp. 159, 160.
- '89. (See Article II.)
- '89a. (See Article II.)
- '91. Ein neuer *Diaptomus* aus Brasilien. Zool. Anz., XIV. Jahrg., No. 368, pp. 248-250. 3 Fig.
[*D. detersi* n. sp.]

Poppe, S. A., u. Mrázek, A.

- '95. Entomostraken des Naturhistorischen Museums in Hamburg. 1. Die von Herrn Dr. F. Stuhlmann auf Zanzibar und dem gegenüberliegenden Festlande gesammelten Süßwasser-Copepoden. 2. Taf. 2. Entomostraken von Süd-Georgien. 1 Taf. 3. Die von Herrn Dr. H. Driesch auf Ceylon gesammelten Süßwasser-Entomostraken. 1 Taf. Beiheft zum Jahrb. der Hamburgischen wissenschaftl. Anstalten. XII. 20 pp.

Poppe, S. A., et Richard, J.

- '90. (See Article II.)
- '92. Description du *Diaptomus schmackeri* n. sp., recueilli par M. Schmaeker dans le lac Tahoo (Chine). Bull. de la Soc. zool. de France, T. XVII., pp. 149-151. 6 Fig.

Rath, O. v.

- '91. (See Article II.)

Rehberg, H.

- '80. (See Article II., '80a.)
- '80a. (See Article II., '80b.)

Richard, J.

- '87. (See Article II.)
- '87a. Sur la faune pélagique de quelques lacs d'Auvergne. Compt. rend. d'Acad. des Sci., 14 novembre et 12 décembre, T. CV., pp. 951-953.
- '88. Entomostracés nouveaux ou peu connus. Bull. de la Soc. zool. de France, T. XIII., p. 156.
- '88a. (See Article II., '88.)
- *'89. Anomalie de l'antenne droite chez *Diaptomus caeruleus* Fisch., mâle. Bull. de la Soc. zool. de France, T. XIV., pp. 38, 39.

- '89a. Note sur les pêches effectuées par M. Ch. Rabot dans les lacs Enara, Imandra, et dans le Kolozero. Bull. de la Soc. zool. de France. T. XIV., pp. 100-109.
- '89b. Description du *Mesochra blanchardi*, Copépode nouveau des Sebkhias algériennes. Bull. de la Soc. zool. de France. T. XIV., pp. 317-321.
- '90. (See Article II., '90c.)
- '90a. Sur les Entomostracés et quelques autres animaux inférieurs des lacs de l'Auvergne. Rev. des Sci. Nat. Appliquées, 37^e Ann., 1^{re} Sem., No. 10, pp. 472-481. 10 Fig.
- '90b. (See Article II., '90a.)
- '90c. (See Article II., '90b.)
- '90d. Note préliminaire sur le système nerveux de quelques espèces de *Diaptomus*. Bull. de la Soc. zool. de France. T. XV., pp. 212-219.
- '91. (See Article II.)
- '91a. (See Article II.)
- '91b. Recherches sur le système glandulaire et sur le système nerveux des Copépodes libres d'eau douce, suivies d'une révision des espèces de ce groupe qui vivent en France. Ann. Sci. nat. zool., T. XII., pp. 113-270, Pl. V.-VIII.
- '92. Free Fresh-water Copepoda. Ann. Sci. Nat., Vol. XII., pp. 113-270; Abstract, Journ. Roy. Micr. Soc., 1892, p. 478.
- '93. Copépodes recueillis par M. le Dr. Théod. Barrois en Égypte, en Syrie et en Palestine (Mars—Juin, 1890). Rev. Biol. du Nord de la France, 5^e ann., No. 10, juillet, 1893. 36 pp., 51 Fig.
- '94. Entomostracés recueillis par M. E. Modigliani dans le Lac Toba (Sumatra). Ann. del Mus. Civ. di Storia Nat. di Genova, Ser. II.^a, Vol. XIV. (XX XIV.), Oct., 1894, pp. 565-578, Fig. 9-14.
[*Diaptomus darwini* n. sp.]
- '95. (See Article II., '95a.)
- '95a. (See Article II., '95b.)
- '97. Sur quelques Entomostracés d'Eau douce des environs de Buenos Aires. Anales del Mus. Nac. de Buenos Aires. T. V., pp. 321-332, Fig. 1-6.
[*Diaptomus bergi* n. sp.]
- '97a. Entomostracés recueillis par M. le Directeur Steindachner dans les lacs de Janina et de Scutari. Ann. d. K. K. Naturhist. Hofmus., Bd. XII., Heft 1, pp. 63-66, Fig. 1-4.
[*Diaptomus steindachneri* n. sp.]
- '97b. Entomostracés de l'Amérique du Sud recueillis par MM. U. Deiters, J. von Ihering, G. W. Müller et G. O. Poppe. Mém. de la Soc. zool. de France, T. X., pp. 263-301, Fig. 1-45.

- '97c. Sur deux Entomostracés d'Eau douce recueillis par M. Chafanjon en Mongolie. Bull. du. Mus. d'hist. nat., 1897, No. 4, pp. 131-135, Fig. 1-5.

[*Diaptomus chafanjonii* n. sp.]

Rückert, J.

- *'94. Zur Eireifung bei Copepoden. Merkel-Bonnet's Anat. Hefte, I. Abt., XI. Heft, pp. 261-351, Taf. XX.-XXV.; Abstract, Zool. Centralbl., II. Jahrg., No. 10, pp. 291-295.

Russki.

- *'89. Le faune pélagique du lac de Kabane. [French title of Russian work.] Trav. Soc. imp. des nat. de l'Univ. de Kasan, T. XIX.

Sars, G. O.

- '62. (See Article II.)

- '63. (See Article II.)

- '64. (See Article II.)

- '86. Crustacea. II. Den norske Nordhavs-Expedition 1876-78, pp. 76-79. Christiania.

- '89. On some Fresh-water Ostracoda and Copepoda raised from dry Australian mud. Forh. i Vidensk.-Selskab. i Christiania, pp. 1-77, Pl. I.-VIII. (Pls. I. and II. colored.)

- '95. On some South African Entomostraca raised from dried mud. Vidensk.-Selskab. Skrifter, I. Math.-naturw. Klasse. 1895, Nr. 8, pp. 1-55. 8 Pls.

[*Paradiaptomus lamellatus*, n. gen. and n. sp.]

- '96. On a new Fresh-water Ostracod, *Stenocypris chevreuxi*, G. O. Sars, with notes on some other Entomostraca raised from dried mud from Algeria. Arch. f. Math. og Naturvid. Kristiania. 27 pp., 3 Pls.

- '97. Pelagic Entomostraca of the Caspian Sea. Extrait de l'Annuaire du Musée Zoologique de l'Académie Impériales des Sci. de St.-Petersbourg. 1897. 73 pp., 8 Pls.

Schmeil, O.

- '89. Über den Diaptomus des salzigen Sees (*Diaptomus richardi* n. sp.). Zool. Anz., XI. Jahrg., No. 323, pp. 646-649.

- '91. (See Article II.)

- '92. Deutschlands freilebende Süßwasser-Copepoden. I. Teil: Cyclopida. Bibliotheca Zoologica, Heft II. 191 pp., 8 Pls.

- '94. (See Article II.)

- '94a. Einige neue Harpacticidenformen des Süßwassers. Zeitschr. f. Naturwissensch., Bd. LXVII., pp. 341-350.

- '95. Neue Spaltfusskrebse der Fauna der Provinz Sachsen. Zeitschr. f. Naturwissensch., Bd. LXVIII., pp. 126-130.

'96. Deutschlands freilebende Süßwasser-Copepoden. III. Teil: Centropagidae. Abt. I. u. II. Bibl. Zool. Heft 21, Lfg. I. u. II., Taf. I.-XII., 3 Fig. in Text; Abstract, Biol. Centrabl., XVI. Bd., Nr. 23, pp. 845-847.

'97. Deutschlands freilebende Süßwasser-Copepoden. Nachtrag. Bibl. Zool. Heft 21, Nachtrag, pp. 145-188, Taf. XIII., XIV.

Scott, T.

*'94. *Diaptomus serricornis* Lilljeborg, in Lochs in Barra and North Uist. Ann. Scot. Nat. Hist., Oct., pp. 258, 259.

Scourfield, D. J.

'93. (See Article II.)

'94. Entomostraca and the Surface-film of Water. Journ. Linn. Soc., Vol. XXV., Zoölogy, No. 158, pp. 1-19, Pls. I., II.

'95. A Preliminary Account of the Entomostraca of North Wales. Journ. Quekett Micr. Club, Vol. VI., Ser. II., No. 37, pp. 127-143, Pl. VIII.

'97. Verzeichniß der Entomostraken von Plön. Forschungsber. a. d. Biol. Stat. zu Plön, Theil V., pp. 180-183. Stuttgart.

Seligo, A.

'90. (See Article II.)

Siebold, C. Th.

*'39. Beiträge zur Naturgeschichte der wirbellosen Thiere. II. Über das Begattungsgeschäft des *Cyclops castor*. Neueste Schrift. Nat. Ges. Danzig, Bd. III., Heft 2, pp. 36-50, Taf. 2, Fig. 41-44. (Übersetzt in: Ann. Sci. Nat. Paris, T. XIV., pp. 26-38, Taf. V. Nach Giesbrecht.) [*Fide* Schmeil.]

Sowinsky, W.

'91. (See Article II.)

*'91a. Sur la nouvelle espèce du genre *Diaptomus*, trouvée dans le lac Ribnoye-Ozero près de la ville Stawropol. [French title of Russian article.] Mém. de la Soc. des natural. de Kiew, T. XI., Part I. 4 pp., 1 Fig. in text.

Steck, Th.

'93. Beiträge zur Biologie des grossen Moosseedorfsees. Mitt. d. naturf. Gesellsch. in Bern, Jahrg. 1893, pp. 20-73.

Stuhlmann, F.

'91. Beiträge zur Fauna central-afrikanischer Seen. Zool. Jahrb., Abteil. f. System., Bd. V., pp. 924-926.

Székely, B.

*'82. Tanulmányok a *Diaptomus* petefejlődésének első phasisairól a blastoderma fellépéséig. Kolozsvárt.

Thallwitz, J.

- *91. Die Süßwasser-Calaniden Deutschlands. Nat. Rundschau, Bd. VI., pp. 131, 132. Berlin.

Turner, C. H.

- '92. (See Article II.)

Ulianin, W. N.

- *74. Cladoceren und Copepoden einiger Seen des centralen Russlands. Schriften d. Gesellsch. v. Freunden der Naturwissensch., etc., zu Moskau, Bd. X., Abt. II., pp. 78-81.

- '75. Crustaceen von Turkestan. Reise A. P. Fedtschenko's in Turkestan. [German title of Russian article.] Schrift. de Gesellsch. v. Freunden der Naturwissensch., etc., zu Moskau, Bd. XI., Abt. VI., Copepoden, pp. 22-41, Taf. VI.-XII.

Underwood, L. M.

- '86. (See Article II.)

Vejdovský, F.

- '82. Thierische Organismen der Brunnengewässer von Prag. 66 pp., 8 Pls. Prag.

Villepoix, R. M. de

- '88. (See Article II.)

Vosseler, J.

- '86. (See Article II.)

- '89. (See Article II.)

- '91. Die Krebsfauna unserer Gewässer. In Zacharias's "Die Thier- und Pflanzenwelt des Süßwassers," Bd. I., pp. 323-380. 6 Fig. Leipzig.

Weber, Max.

- '92. On the Fresh-water Crustacea of the Indian Archipelago with Observations on the Fauna of Fresh-water in General. Ann. Nat. Hist., Ser. 6. Vol. XIV., pp. 237-253.

- '92a. Die Süßwasser-Crustaceen des Indischen Archipels, nebst Bemerkungen über die Süßwasser-Fauna im Allgemeinen. Zool. Ergeb. einer Reise in Niederländ. Ost-Ind., pp., 528-571, Taf. XXX. Leiden.

Westwood, J. O.

- *36. Cyclops. Partington's Cyclopedia. Nat. Hist.

Wierzejski, A.

- '82. Materyjaly do fauny jezior tatrzańskich. [Materials for the Fauna of the Carpathian Lakes.] Copepoden. Sprawozd. Kom. fiz. Akad. Umiej., T. XVI., pp. 233, 234, Taf. III.

- *83. Zarys fauny stawów tatrzańskich. Pamiętn. Tow. tatr., T. VIII. Krakau.
- '87. O Krajowych skorupiakach z rodziny Calanida. [On the native Copepoda of the Family Calanida.] Rozpr. i Sprawozd. Wydz. mat.-przyr. Akad. Umiej. Krakow, T. XVI. 13 pp., 1 Pl.
- '95. Przegląd fauny skorupiaków galicyjskich. [Review of the Crustacean Fauna of Galicia.] (See Article II. for citation.)

Wille, N.

- '96. Mittheilungen aus der biologischen Gesellschaft in Christiania. Biol. Centralbl., XVI. Bd., Nr. 3, pp. 124-126.

Zacharias, O.

- *85. Studien über die Fauna des Grossen und Kleinen Teichs im Riesengebirge. Zeitschr. f. wiss. Zool., Bd. XLII., pp. 483-516, Taf. XXVI.
- '87. (See Article II.)
- '87a. Zur Entomostrakenfauna der Umgebung von Berlin. Biol. Centralbl., Bd. VII., Nr. 5, pp. 137-139.
- '87b. (See Article II.)
- '88. (See Article II., '88a.)
- '88a. Die Tierwelt der Eifelmaare. Biol. Centralbl., VIII. Bd., Nr. 18, p. 574.
- '88b. Über die geographische Verbreitung des Genus *Diaptomus*. Biol. Centralbl., VIII. Bd., Nr. 18, p. 575.
- '89. Bericht über eine Zoologische Exkursion an die Kraterseen der Eifel. Biol. Centralbl., IX. Bd., Nos. 2, 3, pp. 56-64, 76-80.
- '90-'91. Über ein interessantes Kapitel der Seenkunde. Biol. Centralbl., X. Bd., Nr. 18, pp. 123-128.
- '93. Fauna des grossen Plöner Sees. Forschungsber. aus der Biol. Station zu Plön, Theil I., pp. 3-13; Extract, Biol. Centralbl., XIII. Bd., Nr. 11 u. 12, pp. 377-382.
- '94. Faunistische Mittheilungen. Fauna des grossen Plöner Sees. Forschungsber. aus der Biol. Stat. zu Plön, Teil. II., pp. 57-66.
- '95. Über die horizontale und vertikale Verbreitung limnetischer Organismen. Forschungsber. aus der Biol. Stat. zu Plön. Theil III., pp. 118-128. Extract, Biol. Centralbl., XIII. Bd., Nr. 11 u. 12, pp. 377-382.
- '95a. Statistische Mittheilungen aus der Biologischen Station am grossen Plöner See. Zool. Anz., XVIII. Jahrg., pp. 28, 70, 87, 125, 140, 190, 256, 305, 367, 414, 448.
- '96. Quantitative Untersuchungen über das Limnoplankton. 64 pp. Berlin.

- '97. Biologische Beobachtungen an den Versuchsteichen des Schles. Fischerei-vereins zu Trachenberg. Forschungsber. a. d. Biol. Stat. zu Plön, Theil V., pp. 10-28. Stuttgart.

Zaddach, E. G.

- '44. Synopses Crustaceorum Prussicorum Prodrömus. Dissertatio Zoologica. 47 pp. Regiomonti (Königsberg).

Zenker, W.

- '54. (See Article II.)

- '54a. System der Crustaceen. Arch. f. Naturgesch., XX. Jahrg., Bd. I., pp. 108-118.

- '54b. Kritik der Eriehson'schen Gliedmassentheorie. Arch. f. Naturgesch., XX. Jahrg., Bd. I., pp. 118-138.

Zograf, N.

- *'96. Essai d'explication de l'origine de la faune des lacs de la Russie d'Europe. Compt. rend. des séances du troisième congrès internat. de Zool., Leyde, 16-21 sept., 1895, pp. 183-195. Leyde. Abstract, Zool. Centralbl., III. Jahrg., No. 14, pp. 481-483.

Zopf, W.

- '95. Cohn's Hämatochrom ein Sammelbegriff. Biol. Centralbl., XV. Bd., Nr. 11, pp. 417-427.

Zschokke, F.

- '90. (See Article II.)

- '90a. (See Article II.)

- '91. (See Article II.)

- *'91a. Die zweite zoologische Excursion an die Seen des Rhätikon. Verhandl. Naturf. Gesellsch. Basel, Bd. IX., 2. Teil, pp. 425-508; Abstract, Journ. Roy. Micr. Soc., 1892, p. 194.

- '94. Die Tierwelt der Juraseen. Rev. Suisse de Zool. et Ann. du Mus. d'hist. nat. de Genève, T. II., Liv. II., pp. 349-376, Pl. XIV.

- '94a. Die Fauna hoch gelegener Gebirgsseen. Ein Beitrag zur Kenntniss der Vertikalen Verbreitung niederer Tiere. Verb. d. Naturf. Gesellsch. in Basel, Bd. XI., Heft 1, pp. 36-133, Taf. I.

- '95. Die biologische Station zu Plön nach den Forschungsberichten. Teil II. u. III. Biol. Centralbl., XV. Bd., Nr. 10, pp. 408-415.

EXPLANATION OF PLATES.

PLATE XXI.

- FIG. 1. *Diaptomus sicilis*, fifth feet of male. $\times 280$.
FIG. 2. Fifth feet of female of same (minus one outer ramus). $\times 280$.
FIG. 3. Last thoracic segment and abdomen of female of same. $\times 140$.

PLATE XXII.

- FIG. 1. *Diaptomus piscinar*, fifth feet of male.
FIG. 2. Fifth foot of female of same (Portage Slough specimen). $\times 280$.
FIG. 3. Last thoracic segment and abdomen of female of same. $\times 140$.
FIG. 4. Fifth foot of female (Yellowstone Park specimen). $\times 280$.

PLATE XXIII.

- FIG. 1-5. *Diaptomus sanguineus*, second basal segment of right fifth foot of male. $\times 210$.
FIG. 6-8. Terminal segments of right male antenna of same. $\times 210$.

PLATE XXIV.

- FIG. 1, 2. *Diaptomus sanguineus*, first abdominal segment of female, seen from the side. $\times 110$.
FIG. 3. Last thoracic and first abdominal segments of female of same. $\times 110$.
FIG. 4. Fifth feet of male of same. $\times 210$.
FIG. 5, 6. Dorsal outline of female of same, showing hump. $\times 110$.

PLATE XXV.

- FIG. 1, 2. *Diaptomus sanguineus*, fifth foot of female. $\times 240$.
FIG. 3, 4. Right fifth foot of male of same. $\times 210$.
FIG. 5. Fifth feet of male of same (variant). $\times 210$.

PLATE XXVI.

- FIG. 1. *Diaptomus shoshone*, last thoracic segment and abdomen of female. $\times 80$.
FIG. 2. Fifth foot of female of same. $\times 280$.
FIG. 3. Abdomen of male of same. $\times 128$.

PLATE XXVII.

- FIG. 1. *Diaptomus lintoni*, fifth feet of male. $\times 280$.
FIG. 2. *Diaptomus pallidus*, fifth foot of female. $\times 280$.
FIG. 3. Fifth feet of male of same. $\times 280$.
FIG. 4. *Diaptomus allouquerqueensis*, fifth feet of male. $\times 400$.

PLATE XXVIII.

- FIG. 1. *Diaptomus reighardi*, fifth feet of male. $\times 460$.
 FIG. 2. *Diaptomus stagalis*, right antenna of male. $\times 80$.

PLATE XXIX.*

- FIG. 1. *Diaptomus gregonensis*, fifth feet of male. $\times 240$.
 FIG. 2. Fifth foot of female of same. $\times 300$.
 FIG. 3. *Diaptomus signicauda*, fifth feet of male. $\times 200$.
 FIG. 4. Terminal segments of right antenna of male of same. $\times 200$.
 FIG. 5. Fifth foot of female of same. $\times 200$.
 FIG. 6. Last thoracic segment and abdomen of female of same. $\times 100$.

PLATE XXX.[~]

- FIG. 1. *Diaptomus franciscanus*, last thoracic segment and abdomen of female. $\times 40$.
 FIG. 2. Terminal segments of right antenna of male of same. $\times 200$.
 FIG. 3. Fifth pair of feet of male of same. $\times 200$.
 FIG. 4. Fifth foot of female of same. $\times 200$.
 FIG. 5. *Diaptomus minutus*, fifth foot of female. $\times 300$.
 FIG. 6. Fifth foot of male of same. $\times 300$.
 FIG. 7. Terminal segments of right antenna of male of same. $\times 300$.
 FIG. 8. Last thoracic segment and abdomen of female of same. $\times 250$.

PLATE XXXI.

- FIG. 1.* *Diaptomus trybomi*, terminal segments of right male antenna. $\times 160$.
 FIG. 2.* Last thoracic segment and abdomen of female of same, seen from right side. $\times 96$.
 FIG. 3. The same, seen from above. $\times 140$.
 FIG. 4.* Fifth pair of feet of male of same. $\times 210$.
 FIG. 5.* Fifth foot of female of same. $\times 240$.

PLATE XXXII.

- FIG. 1. *Diaptomus ashlandi*, fifth pair of feet of female (a variant). $\times 240$.
 FIG. 2. Fifth foot of female of same. $\times 240$.
 FIG. 3. Fifth pair of feet of male of same. $\times 240$.
 FIG. 4. Anterior fifteen segments of right antenna of male of same. $\times 240$.

PLATE XXXIII.

- FIG. 1. *Diaptomus mississippiensis*, last thoracic segment and abdomen of male. $\times 256$.
FIG. 2. Fifth foot of female of same. $\times 256$.
FIG. 3. Fifth pair of feet of male of same. $\times 256$.
FIG. 4. Abdomen of female of same seen from below (Prof. Marsh's specimen). $\times 256$.

PLATE XXXIV.

- FIG. 1. *Diaptomus clavipes*, right fifth foot of male (inner ramus wanting). $\times 280$.
FIG. 2. Right antenna of male of same. $\times 140$.
FIG. 3. Fifth foot of female of same. $\times 400$.

PLATE XXXV.

- FIG. 1. *Diaptomus clavipes*, fifth feet of male. $\times 280$.
FIG. 2. Last thoracic segment and abdomen of female of same. $\times 140$.

INDEX.

(Synonyms in Italics.)

- Amphaskandria, 102.
 Candacidae, 104.
 Centropagidae, 97, 101, 102, 103.
 Centropagina, 103.
 Cyclops, 100, 106, 141.
Cyclops, 97, 106, 132.
 longicornis, 130.
Cyclopsina, 97, 105.
 Diaptomus, 102, 103, **105**.
 albuquerqueensis, 98, 113, 115,
 146, 176, 183.
 ambiguus, 177.
 armatus, 133, 135, 136.
 ashlandi, 98, 100, 111, 120, 124,
 158, **167**, 183.
 baeillifer, 107.
 birgei, 99, 108, 117, **172**.
 caroli, **181**.
 castor, 98, 106.
 castor, 130.
 clavipes, 98, 108, 119, 127, **178**, 184
 caeruleus, 107.
 deitersi, 99.
 drieschi, 99.
 eiseni, 98, 110, 115, **162**, 166, 183.
 franciscanus, 98, 110, 118, 132,
 160, 166, 182, 183.
 fresnauus, 176, 178.
 gibber, 99.
 giganteus, 138.
 gracilis, 98, 173, 182.
 graciloides, 98.
 incongruens, 99.
 kentuckyensis, 97, 130, 132.
 leptopus, 97, 112, 117, 125, 127,
 130, 135, 181, 182.
 hintoni, 113, 118, **127**, 134, 160, 182
 longicornis, 132.
 var. *leptopus*, 130, 132.
 var. *similis*, 132, 162, **182**.
 minuetonka, 133, 135, 136, 138.
 minutus, 98, 106, 111, 116, 129,
 134, **156**, 183.
 mississippiensis, 98, 109, 122,
 149, **173**, 184.
 novamexicanus, 99, 111, 116,
 149, 183.
 oregonensis, 109, 119, 124, **151**,
 169, 171, 183.
 Diaptomus—*continued*.
 pallidus, 100, 108, 121, 124, 137,
 144, 156, 183.
 var. *sicilis*, 122.
 piscinae, 98, 109, 116, 118, **125**,
 127, 181, 182.
 reighardi, 98, 109, 121, **169**, 184.
 roubani, 166.
 salinus, 99.
 sanguineus, 97, 112, 117, 129,
 133, 160, 166, 183.
 serricornis, 162.
 shoshone, 110, 116, **141**, 164, 183.
 sicilis, 97, 100, 111, 121, **122**,
 145, 155, 169, 182.
 var. *imperfectus*, 124, 158, 167,
 169.
 siciloides, 98, 100, 114, 121, 124,
 137, 146, **154**, 157, 165,
 166, 181, 182, 183.
 signicauda, 98, 114, 120, 157,
 159, 160, **164**, 183.
 signicaudatus, 164.
 similis, 132, 182.
 stagnalis, 97, 113, 115, 129, 136,
 138, 141, 142, 164, 183.
 trybomi, 98, 112, 120, **158**, 166, 183
 tyrrelli, 99, 108, 119, 160, **176**.
 184.
 wierzejskii, 107.
 zachariasi, 99.
 Epischura, 97, 102, 103, 166.
 nevadensis, 98, 168.
 nordenskiöldi, 98.
Glaucæa, 97, 105.
 Gymnoplea, 102.
 Heterarthrandria, 102.
 Heterochatina, 104.
 Heterocope, 99.
 Leuckartiina, 104.
 Limnocalanus, 102, 104.
 sinensis, 99.
Monoculus, 97, 105.
 Osphranticum, 97, 102, 104.
 Podoplea, 105.
 Pontellida, 102.
 Temorella, 99.
 Temorina, 103.
 Volvox, 141.

PLATE XXI.

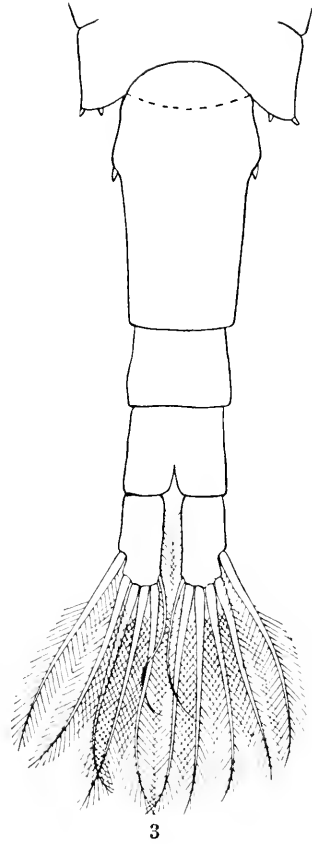
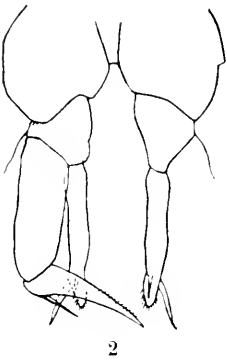
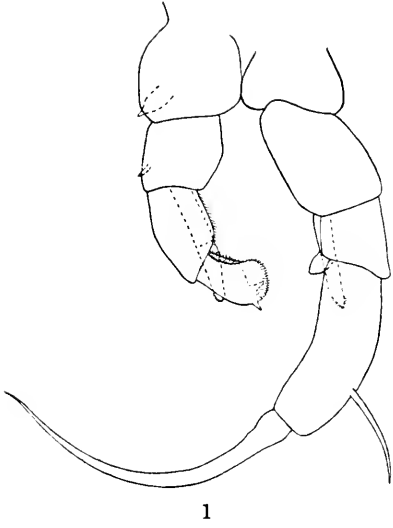
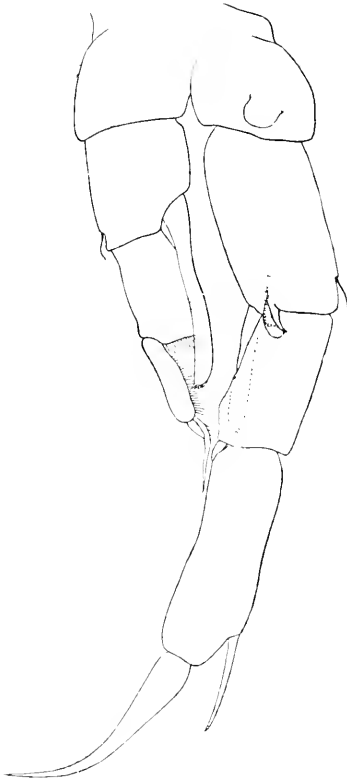
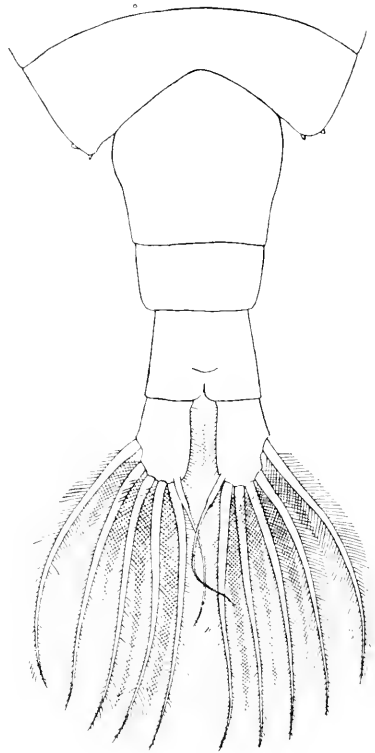

PLATE XXII.



1



3

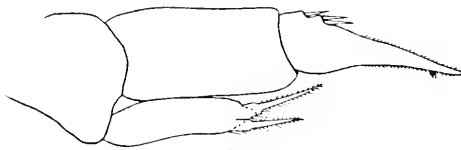

2

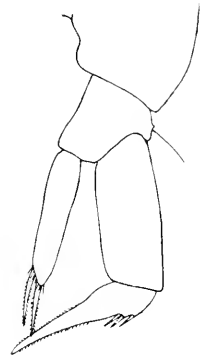

4

PLATE XXIII.

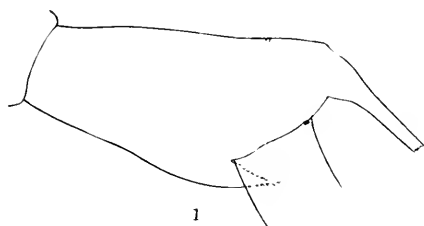

1

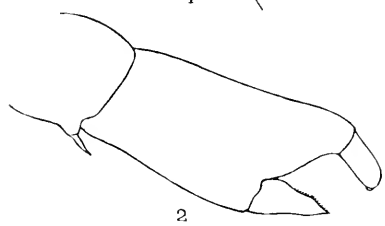

2

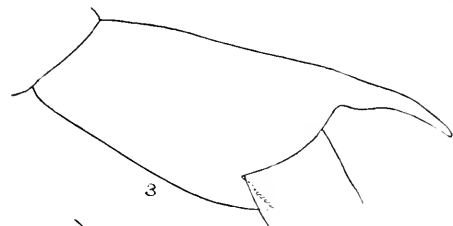

3

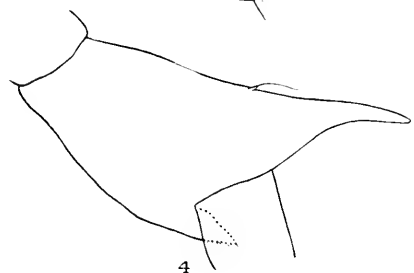

4

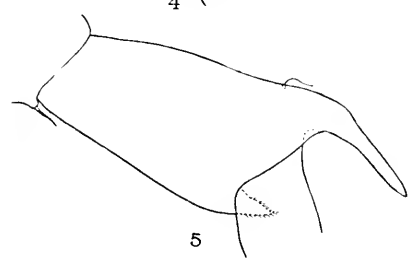

5

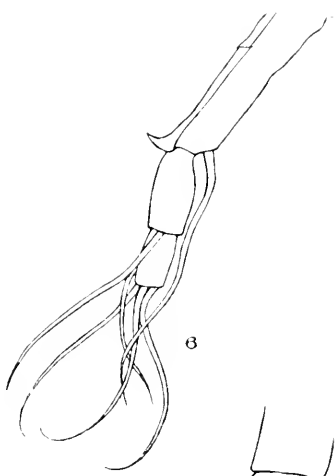

6

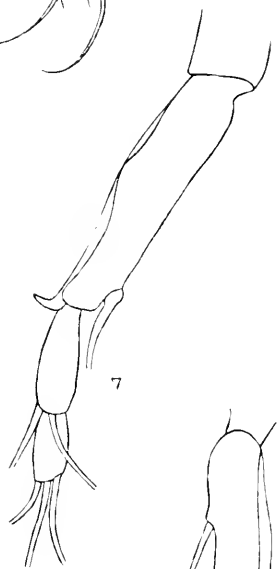

7

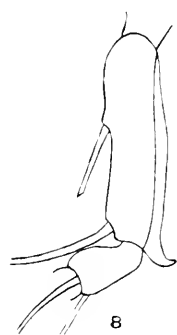

8

PLATE XXIV.

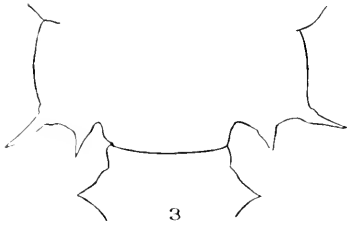
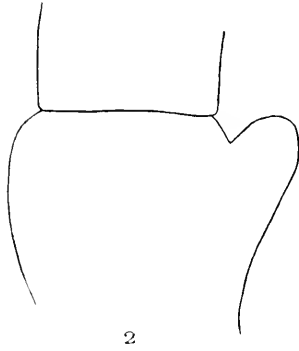
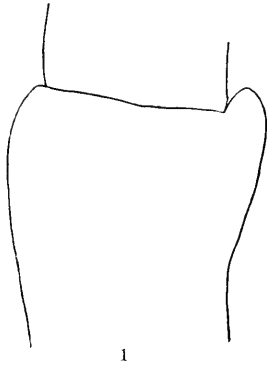
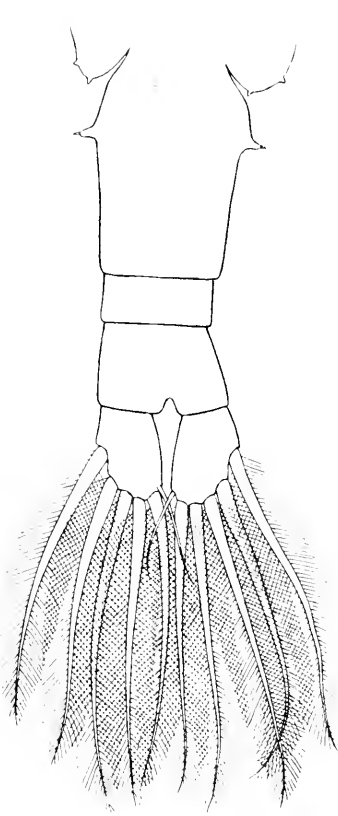

PLATE XXV.



PLATE XXVI.



1

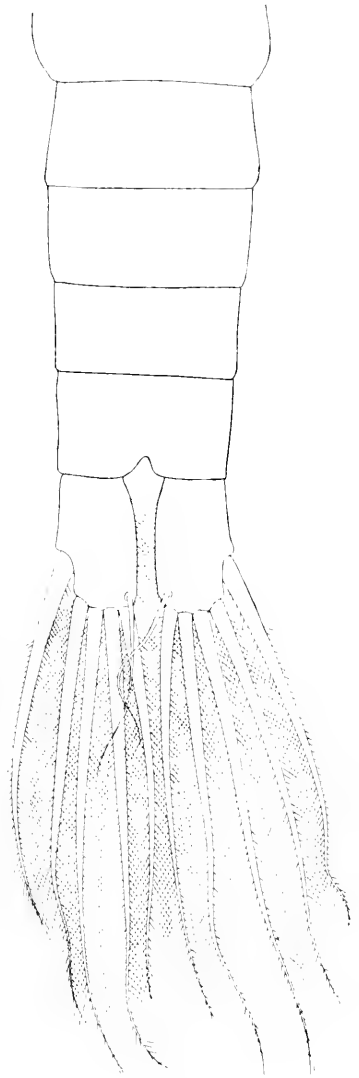

3

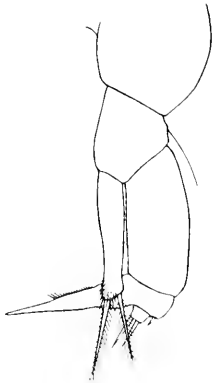

2

PLATE XXVII.

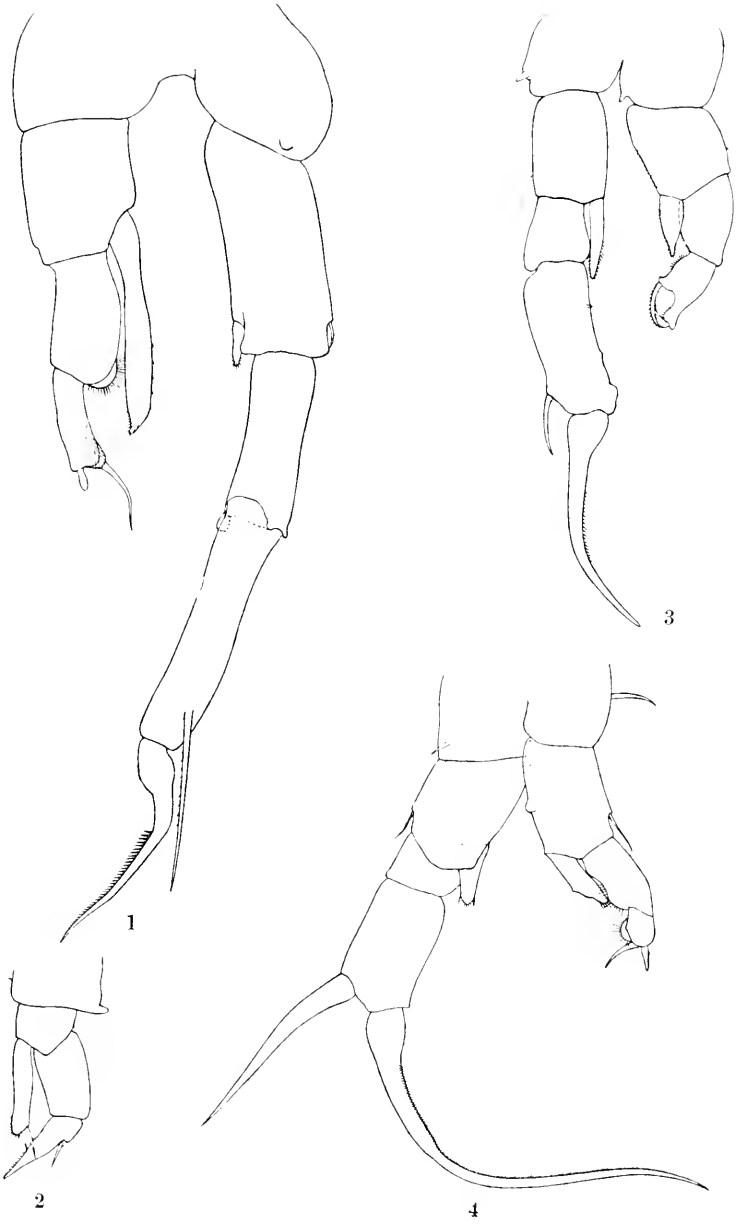
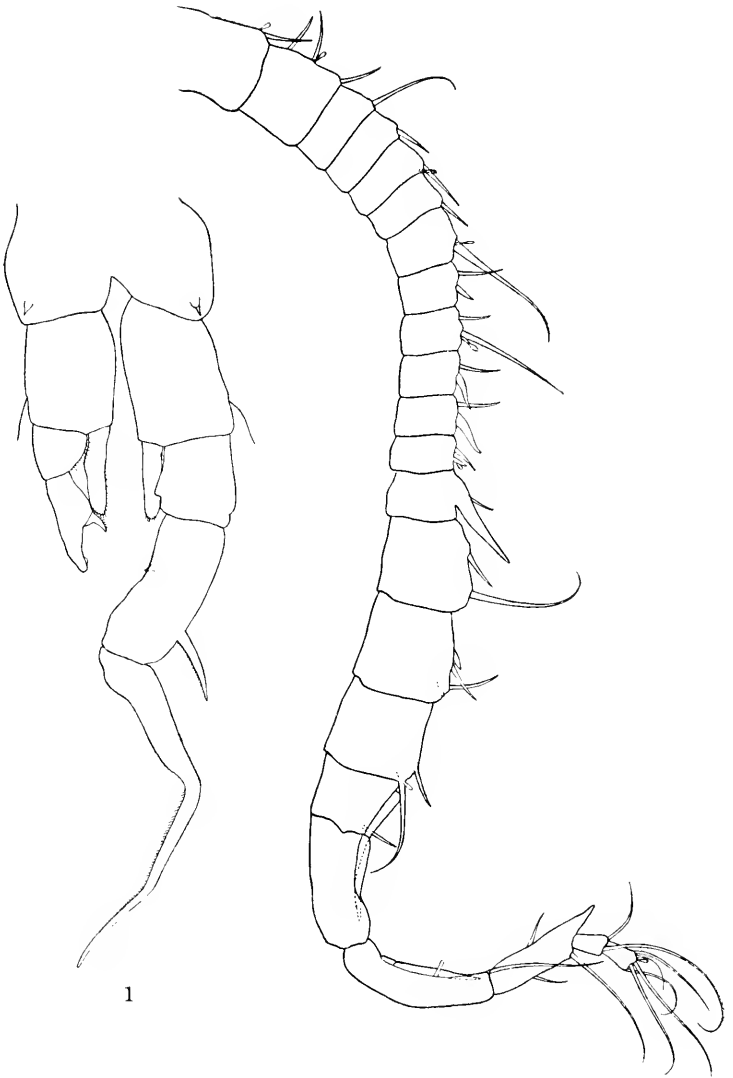

PLATE XXVIII.



1

2

PLATE XXIX.

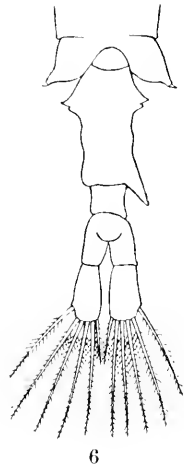
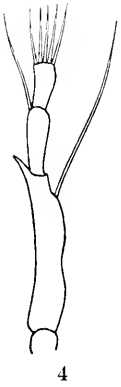
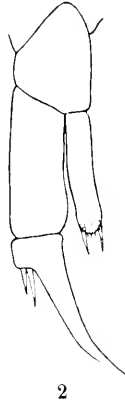
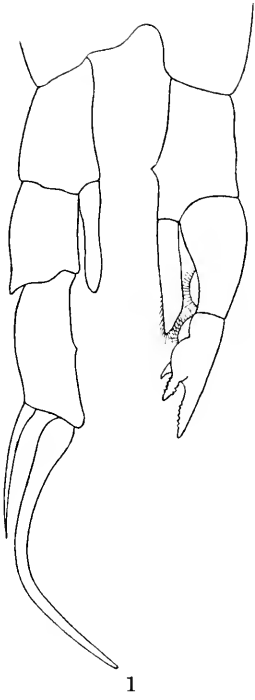

PLATE XXX.

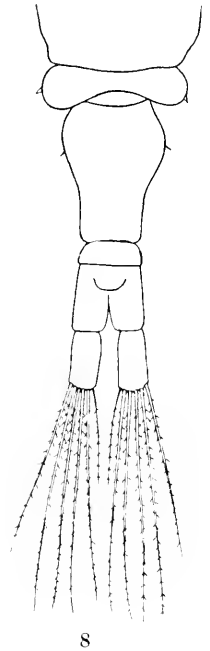
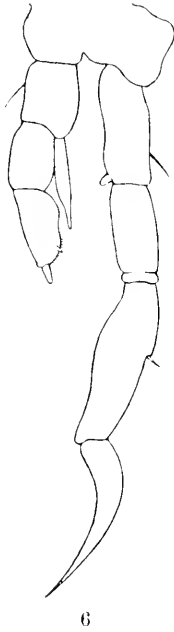
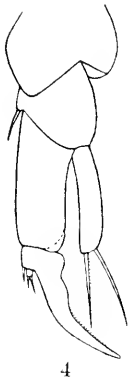
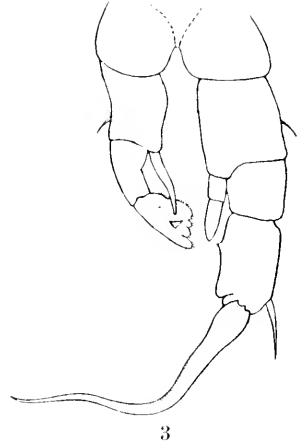
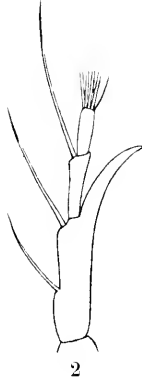
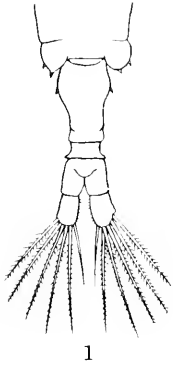

PLATE XXXI.

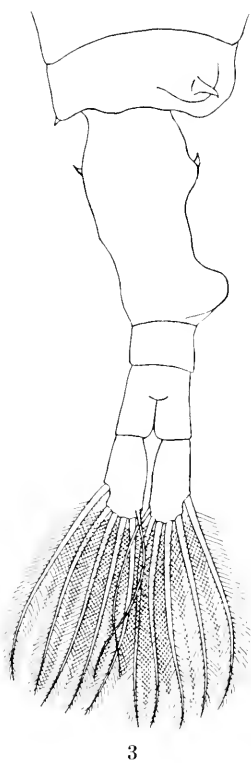
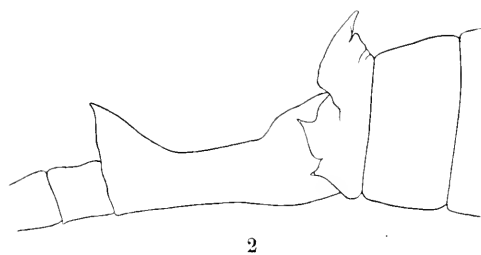
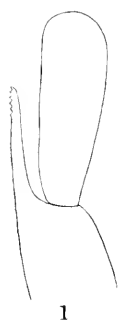
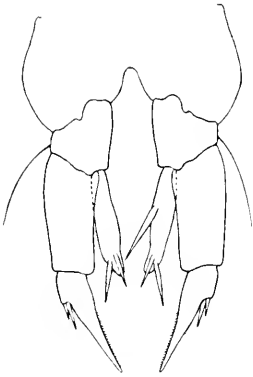
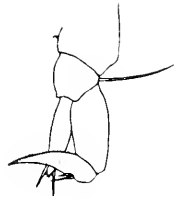

PLATE XXXII.



1



2



3

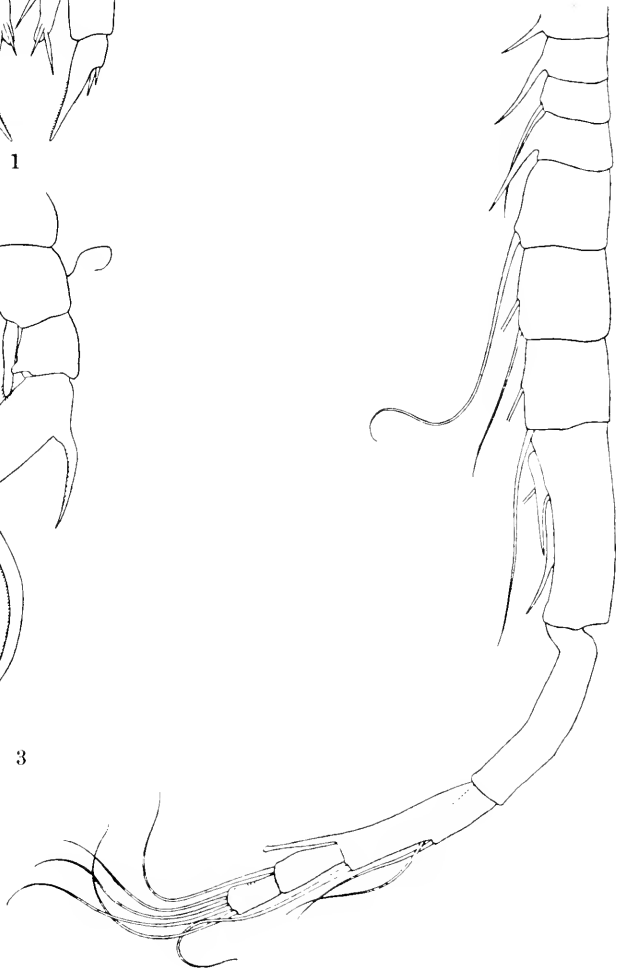

4

PLATE XXXIII.

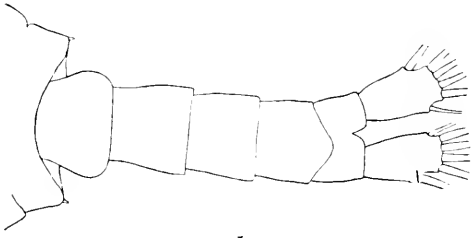

1



2

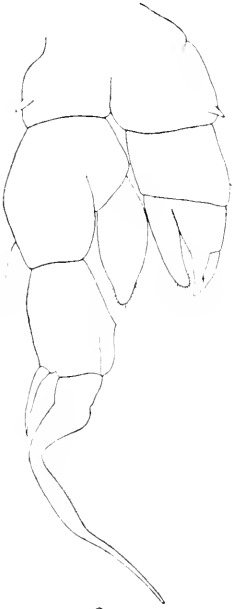

3



4

PLATE XXXIV.

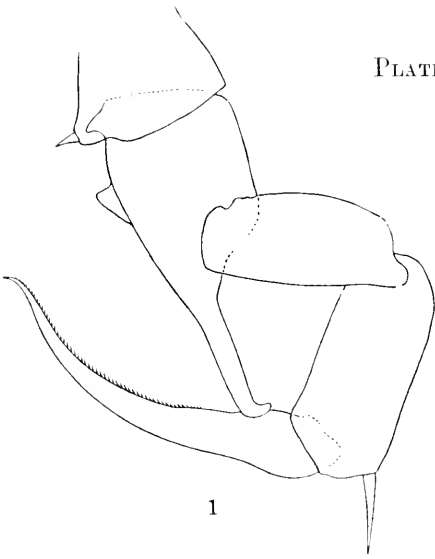

1

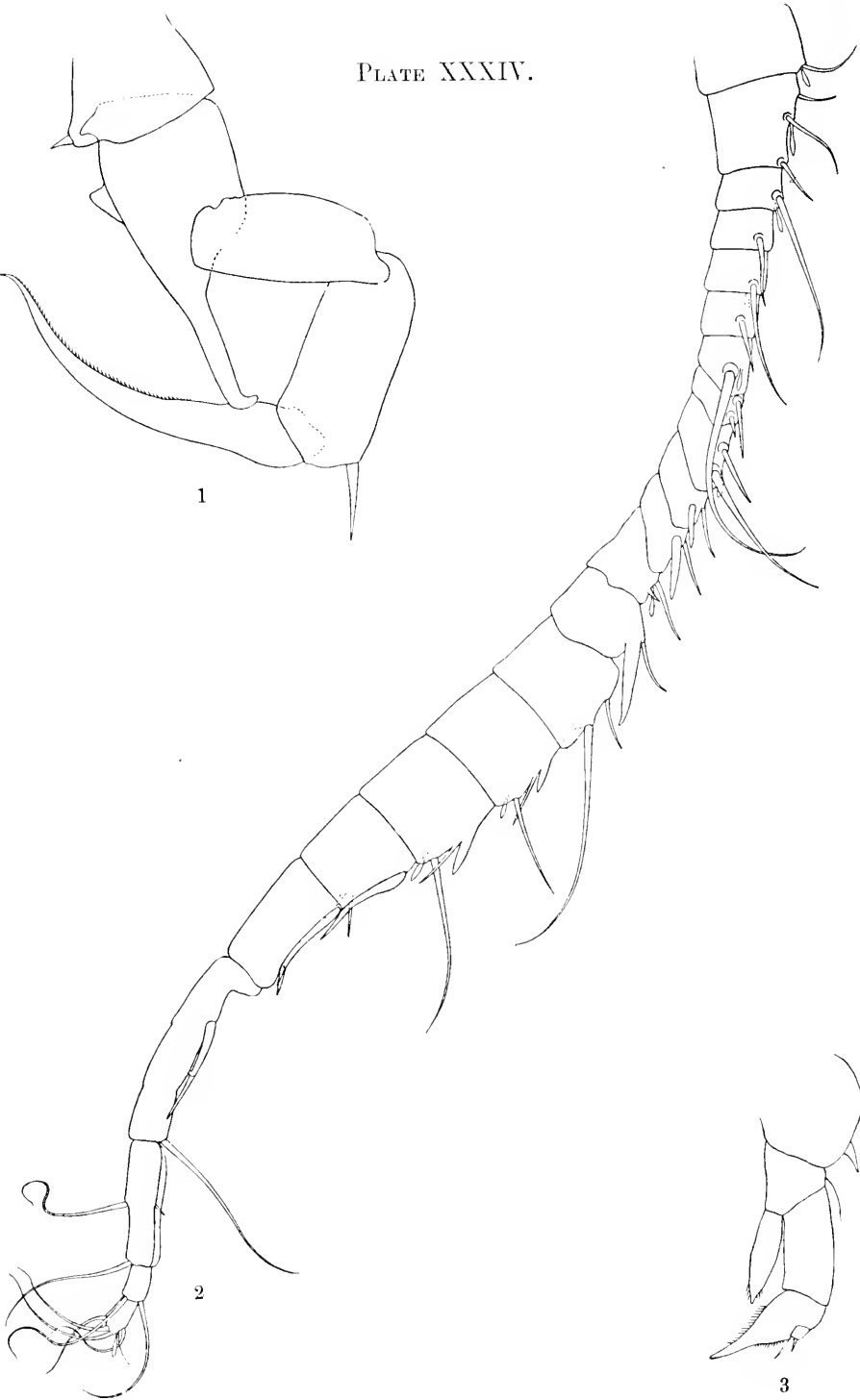

2

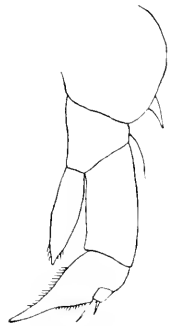

3

PLATE XXXV.

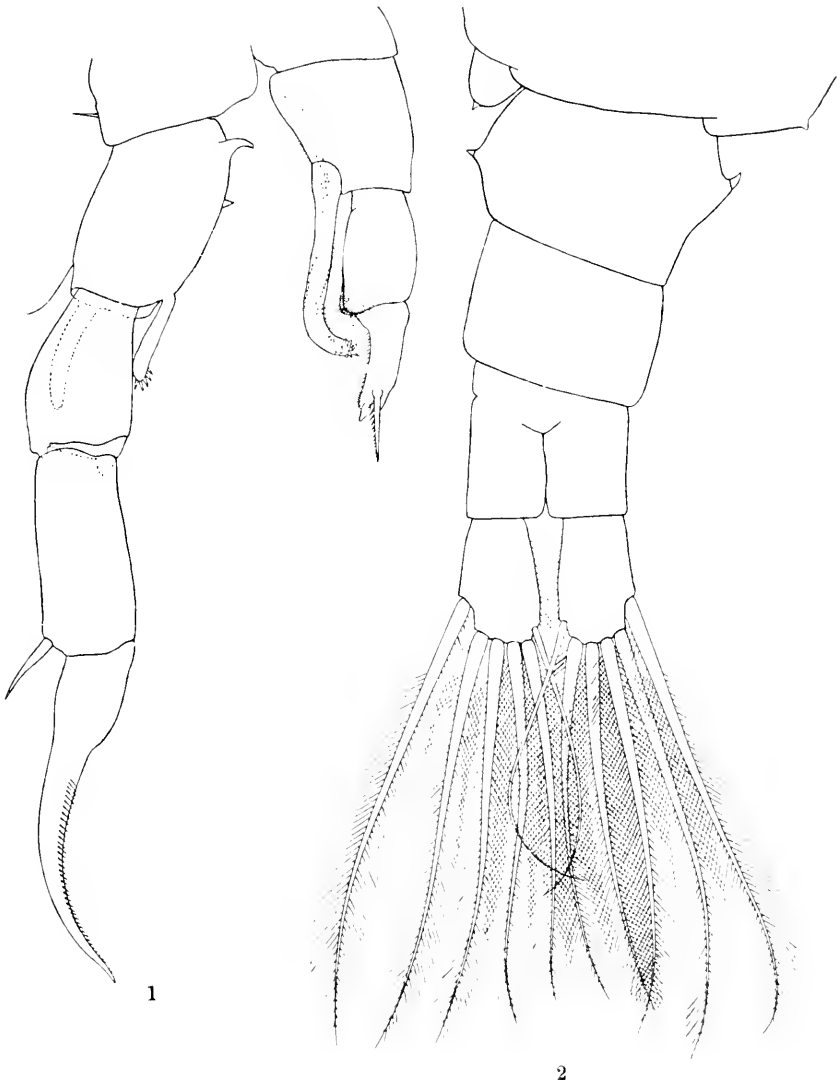

SEP 20 1898

BULLETIN

7710

OF THE

ILLINOIS STATE LABORATORY

OF

NATURAL HISTORY,

URBANA, ILLINOIS.

VOLUME V.

*ARTICLE IV.—THE NORTH AMERICAN CENTROPAGIDÆ
BELONGING TO THE GENERA OSPHRANTICUM, LIM-
NOCALANUS, AND EPISCHURA.*

BY FREDERICK WILLIAM SCHACHT, B. S.

Illinois State Laboratory of Natural History,
URBANA, ILLINOIS.

1898.

STATE LABORATORY OF NATURAL HISTORY.

LABORATORY STAFF.

PROFESSOR STEPHEN ALFRED FORBES, PH. D.,
Director of State Laboratory and State Entomologist.

CHARLES ARTHUR HART,
Systematic Entomologist and Curator of Collections.

FRANK SMITH, A. M.,
Assistant Zoölogist.

CHARLES ATWOOD KOFOID, PH. D.,
Zoölogist, and Superintendent of Biological Station.

ERNEST BROWNING FORBES, B. S.,
Entomological Assistant.

WALLACE CRAIG, B. S.,
Zoölogical Assistant.

MARY JANE SNYDER,
Secretary.

HENRY CLINTON FORBES,
Business Agent and Librarian.

LYDIA MOORE HART,
Artist.

ARTICLE IV. — *The North American Centropagidae belonging to the Genera Osphranticum, Limnocalanus, and Epischura.* By FREDERICK WILLIAM SCHACHT, B. S.

INTRODUCTION.

In Article III. of this Bulletin the writer discussed the North American species of *Diaptomus*, and in the present paper, in furtherance of the same purpose, the genera *Osphranticum*, *Limnocalanus*, and *Epischura* are treated. In the introduction to the former article was given a short account of the work of writers on the *Entomostraca* now included in the family *Centropagidae*, especially those genera found in North America. No reference is made there to the genera *Heterocope* and *Eurytemora*, since at that time I regarded the presence of these two genera in North America as rather doubtful.

The only statement that *Heterocope* was ever found on this side of the Atlantic is made by Cragin ('83). After an enumeration of the genera of fresh-water *Copepoda* he says: "Of these eleven genera, four — *Diaptomus*, *Limnocalanus*, *Cyclops*, and *Canthocamptus* — have been recorded as common to the Old World and the New. I add *Heterocope* on the authority of my friend, Mr. William Patten, who informs me that a species is common in Watertown, Massachusetts." This evidence is not sufficient to justify the treatment of the genus in this paper.

In regard to *Eurytemora* (= *Temora* *Temorella*) I was perhaps overhasty in my conclusions, but it being now too late to remedy the omission, the following statements must suffice. In his "Final Report" Herrick ('84) notes the occurrence of *Temora affinis* Poppe in the rivers flowing into the Gulf of Mexico as well as in the brackish waters into which these rivers flow. In the "Crustacea of Alabama" ('87) he notes, under the name of *Temorella affinis*, a species which according to his statement is the same. The figures of

This paper was accepted by the Faculty of the University of Illinois June 1, 1898, as a thesis for the degree of Master of Science in Zoölogy.

*The parenthetical figures in the text of this paper refer usually to the bibliography of Article III., which is, however, supplemented by an additional list appended to this discussion.

the species in question differ, however, so considerably in these two articles that, as Schmeil ('98) says, nothing certain can be said of this species until Herrick declares himself as to which of the two sets of drawings are correct. Schmeil regards Herrick's form as possibly a new species. The recent discovery of a new species of this genus, *Eurytemora herdmani* L. C. Thompson and A. Scott, in the St. Lawrence River and Gulf removes all doubt as to the presence of the genus in American waters.

Of the three genera treated in this paper, *Osphranticum*, containing a single species, and *Epischura*, containing three¹, are, so far as now known, confined strictly to North America and are strictly fresh-water in their habitat. *Osphranticum* is ordinarily found in shallow or stagnant lakes and ponds (Forbes) or in running water (Herrick), while *Epischura* occurs, as a rule, in deep clear lakes. The genus *Limnocalanus* is peculiar in its habitat. One of the two species, *L. sinensis* Poppe, from China, is, so far as known, a strictly fresh-water form, while the other, *L. macrurus* Sars, although found as yet in America in fresh water only, occurs in Europe and Asia in both fresh- and salt-water lakes and in the ocean. Since there are only these two species known, it was thought best to treat both in this paper. *L. grimaldii* de Guerne is regarded by the writer as a synonym of *L. macrurus* Sars², for reasons given in the discussion of the latter species.

A brief discussion of the structural similarities and differences indicative of the relationships of the genera *Osphranticum*, *Limnocalanus*, *Diaptomus*, and *Epischura* may properly precede this paper, special attention being given to characters which are regarded as of generic or specific value.

Giesbreeht, in his "Monograph" ('92), gives special rank to the structure of the first pair of antennae as a distinguish-

¹See "On the Plankton collected continuously during two Traverses of the North Atlantic in the Summer of 1897; with Descriptions of New Copepoda; and an Appendix on Dredging in Puget Sound." By W. A. Herdman, L. C. Thompson, and Andrew Scott. Trans. Liverpool Biol. Soc., Vol. XII, (1897), p. 79.

²*E. fluvialis* Herrick is not considered one of these.

³The *Zoologisches Centralblatt* (Jahrg., III., pp. 181-183) contains a review of an article by N. Zograf entitled "Essai d'Explication de l'origine de la Faune des lacs de la Russie d'Europe" in which a reference occurs to *L. macronyx* G. O. S. This is probably an error, since it is the only reference to a species of that name which I have been able to find.

ing character in the *Copepoda*. If this be taken as a basis of classification here, *Osphranticum*, with its 23-segmented antennae, would form a group by itself, while *Limnocalanus*, *Diaptomus*, and *Epischura*, with their 25-segmented antennae would constitute another group.

Osphranticum seems to be the most primitive of the American *Centropagidae*, the fifth legs especially being less differentiated than in any of the other genera. This is particularly true of the female, in which all of the legs are biramous, each ramus consisting of three segments. In the male the left fifth leg is similar to the preceding legs, but the right one has a two-segmented outer ramus, the second segment being apparently formed by the coalescence of the second and third segments. In both sexes the inner rami of all the pairs of legs are alike.

Limnocalanus apparently approaches most closely to *Osphranticum*, the fifth pair of legs of the female being very similar in general structure to those of *Osphranticum*, as is perhaps most strikingly illustrated in the case of *L. macrurus* Sars and *O. labronectum* Forbes. In *Limnocalanus* both rami of the four anterior pairs of legs in both sexes are three-segmented and but slightly modified, as are also those of the fifth pair of legs of the female; but in the latter the second segment of the outer ramus is produced on the inner margin into a hook-like process, as in *Osphranticum*. The inner rami of the fifth pair of legs of the male are still three-segmented and similar to those of the preceding legs, but the outer rami are modified and are two-, or indistinctly three-, segmented.

Diaptomus is perhaps next in respect to modification. In this genus all the legs are biramous, but the first pair consists of a three-segmented outer, and a two-segmented inner, ramus. The following three pairs have both rami three-segmented. In the female the fifth pair of legs has a two- or, more rarely, three-segmented outer ramus, and a one- or, occasionally, two-segmented inner ramus. In the male the inner ramus is one- or, rarely, two-segmented, while the outer ramus of the right leg is three-segmented and that of the left leg two-segmented.

In *Epischura*, as in the other three genera, the cephalothorax is six-segmented. All of the swimming legs have a three-segmented outer, but a one-segmented inner, ramus. In the female the inner ramus has entirely disappeared in the fifth pair of legs, and the outer ramus is two-segmented. In the male also the fifth pair of legs are without inner rami, and the outer ramus of the right leg is two- or three-segmented, that of the left leg three-segmented. A peculiarity of this genus is the modification of the abdomen of the male into a clasping organ. The abdomen of the female is also modified in at least one species (*lacustris*).

So much for the relationships indicated by the structures considered. According to the above, *Osphranticum* must be regarded as the most primitive form, *Epischura* as the most modified, and *Limnocalanus* and *Diaptomus* as occupying an intermediate position. I think that the mass of characters will support this statement, although there are other characters which would lead one to doubt somewhat its correctness. For example, in *Osphranticum* and *Diaptomus* the females carry the eggs in an egg-sac, while in *Limnocalanus* and *Epischura* they do not. In *Osphranticum*, *Diaptomus*, and *Epischura* the spermatophore persists for some time; but I have not seen a single female *Limnocalanus* with a spermatophore, although according to Giesbrecht the fertilization by means of a spermatophore is about the only characteristic which all *Copepoda* have in common.

The material at my command for the preparation of this paper has been complete; that is to say, I have had specimens of all the known species of the genera treated, and access to the most recent literature. The collections examined belong in great part to the Illinois State Laboratory of Natural History, in part to Prof. Frank Smith, of the University of Illinois, and in part to myself. The following localities are represented: Norway, the Caspian Sea, Lake Sitai and the Whangpoo River in China, Newfoundland, and the States

"The sexually mature individuals are to some extent so transformed by parasitism that unless the fertilization by means of spermatophores be excepted they seem to have no characteristic common to all which would at the same time distinguish the order *Copepoda* from the other orders of *Eutomostraca*." (Giesbrecht, '92, p. 49.)

of Illinois, Indiana, Ohio, Michigan, Washington, Oregon, Montana, Wyoming, Idaho, and Nevada.

Through the kindness of Professor Smith I was able to examine collections from Lake George and Lake James in Steuben County, Ind., in which I found specimens of *Epischura lacustris* and *Diaptomus oregonensis*. Mr. Chancey Juday, Curator of Collections, University of Indiana, kindly sent me collections from Tippecanoe Lake, Eagle Lake, and Turkey Lake, in Indiana, in which occurred *Epischura lacustris*, *Diaptomus sicilis*, *D. oregonensis*, and *D. siciloides*. I also acknowledge my indebtedness to Prof. G. O. Sars, who kindly furnished me with specimens of *Limnocalanus grimaldii*, thus enabling me to compare them with *L. macrurus*—also furnished by him to the Illinois State Laboratory of Natural History; to Herr S. A. Poppe, for specimens of *Limnocalanus sinensis*; to Professor Lillejeborg for *Epischura ucradensis*; and to Dr. C. A. Kofoid, Superintendent of the Illinois Biological Station at Havana, to whom I owe thanks for his many kindnesses during my stay at the Station in July, 1896, and while at the University.

No illustrations accompany this paper, since the species treated may be identified by figures already published.

OSPHRANTICUM FORBES.

Osphranticum, Forbes, '82a, p. 645.

*Potamoichetor**, Herrick, '82, p. 23.

Osphranticum, Herrick, '84, p. 134.

Osphranticum, Herrick, '87, p. 12.

Osphranticum, de Guerne et Richard, '89b, p. 149.

Osphranticum, Herrick and Turner, '95, p. 85.

Cephalothorax compact, six-segmented, the first two segments confluent above, the last segment produced into a bluntly-rounded lobe on each side. Abdomen (furca included) composed of five segments in the female, of six in the male. Furcal rami hairy on the inner margins; armed with five plumose setae, the second from within the longest, and with a delicate smooth seta on the inner margin of the

*Spelled *Potamoichetor* in Herrick's subsequent references.

dorsal surface. First pair of antennæ 23-segmented; right male antenna geniculate between the 18th and 19th segments, and the 19th and 20th segments ankylosed. Second pair of antennæ, mandibles, and first, second, and third pairs of maxillæ as in *Diaptomus*, but stouter. All the swimming legs biramose, with three-segmented inner and outer rami; armed with stout setæ. In the female the legs of the fifth pair are alike, biramose, the rami three-segmented, the inner ramus the shorter. Fifth pair of legs of male biramose, dissimilar. Both rami of left leg three-segmented, the inner ramus the shorter. Outer ramus of right leg two-segmented, the inner three-segmented and like the inner ramus of the left leg. Egg-sac obovate.

Osphranticum labronectum FORBES.

Osphranticum labronectum, Forbes, '82, p. 645, Pl. VIII., Fig. 24, 28, 29; Pl. IX., Fig. 1, 2, 4, 5, 7, 9.

Potamoichetor fucosus*, Herrick, '82, p. 224, Pl. II., Fig. 12-14; Pl. III., Fig. 1-8, 13, 14.

Osphranticum labronectum, Herrick, '84, p. 134, Pl. Q2, Fig. 1-8, 13, 14.

Osphranticum labronectum, Herrick, '87, p. 12.

Osphranticum labronectum, de Guerne et Richard, 89b, p. 149, Fig. 1, 2.

Osphranticum labronectum, Herrick and Turner, '95, p. 86, Pl. XII., Fig. 1-8, 13, 14; Pl. LIX., Fig. 7, 8.

Of medium size, body compact, widest before the middle. Cephalothorax composed of six segments decreasing gradually in length from before backward; first two segments confluent above, the last segment slightly produced at the angles into bluntly-rounded points, but unarmed. Abdomen (furca included) composed of five segments, decreasing in length from before backward. Furcal rami, however, slightly longer than the preceding segment and about twice as long as wide; hairy on the inner margin and armed with five long plumose setæ of which the second from within is the broadest and longest, the middle one being next in length, and the other three subequal; dorsal surface of each ramus armed near the inner apical angle with a delicate smooth seta. Abdomen of male composed of six segments: the first shorter

Spelled *Potamoichetor* in Herrick's subsequent references.

than any of the others except the fifth, which is the shortest: the second, third, and fourth segments decreasing in length in regular order; the second slightly shorter than the furcal rami, which are armed as in the female.

Antennae 23-segmented, extending about to the end of the cephalothorax, or barely surpassing it. Right male antenna geniculate between the 18th and 19th segments: 19th and 20th segments ankylosed; six segments preceding the geniculation rather thickly swollen; penultimate segment produced at the inner apical angle into a broad bluntly-rounded process extending slightly beyond the end of the segment.

Fifth pair of legs of male biramose. Second basal segment of right leg armed above the middle of the outer margin with a delicate hair slanting upward. First segment of outer ramus slightly longer than the width at the base, irregularly trapezoidal, the outer margin forming the longest side: armed at the outer apical angle with a stout spine about as long as the segment itself and provided on each margin with a narrow hyaline lamella; just within this, another very minute spine. Second segment irregular in form, the proximal third subquadrate, about as wide as the preceding segment, produced at the inner apical angle in the form of a rather large cushion-like pad sparsely covered with delicate hairs: distal two thirds subquadrate, about half as wide as the proximal third, provided on the inner margin with delicate hairs, and armed a short distance above the middle of the outer margin with two spines, one large and one small, similar to those on the preceding segment: apex of segment armed with three spines fully as long as the segment itself, the outer two straight, the inner curved inward slightly, and each of them provided with a hyaline lamella, the edges of which seem to be plumose. Just posterior to the inner apical seta is a short slender spine.

First segment of inner ramus of right leg irregular in form, about as long as wide, provided on the inner margin with a few fine hairs. Second segment slightly wider than the preceding, barrel-shaped, and slightly longer than wide: provided on the inner margin with a few fine hairs, and at the

outer apical angle with a long delicate plumose seta. Third segment slightly narrower than the second; margins sulcate, armed with six subequal plumose setae similar to the seta on the preceding segment, of which three are apical, two are on the outer margin, and one is on the inner. The setae are so placed as to form two groups of three each.

Basal segments of left fifth leg like those of right leg. First segment of outer ramus similar to the corresponding segment of the outer ramus of the right leg and similarly armed, but not quite so broad. Second segment subquadrate, about one and a half times as long as wide; outer apical angle armed as in the preceding segment; inner margin provided with a few delicate hairs. Third segment considerably narrower than the second and slightly shorter; armed at the apex with two lamellate setae and a short sharp spine. Inner ramus like that of right leg.

Fifth pair of legs of female biramous. Second basal segment provided on the outer margin, a short distance above the middle, with a delicate hair slanting upward. First segment of outer ramus subquadrate, slightly broader than long; armed at the outer distal angle with a long lamellate spine, and on each side of this with a very minute smooth spine. Second segment somewhat shorter and narrower than the preceding; armed at the outer distal angle like the first segment, except that the inner of the small spines is wanting; inner apical angle produced into a long, moderately stout lamellate hook, shaped about like the blade of a pruning knife; both margins provided with a few fine hairs. Third segment slightly longer than the second, about twice as long as wide; armed at the outer apical angle with a plumosely lamellate spine almost as long as the segment itself, and at the apex with two similar subequal spines (about twice the length of the lamellate spine) and a short smooth spine; outer margin provided with a few long fine hairs; inner margin sulcate and armed with four slender subequal plumose setae about as long as the segment.

Inner ramus of fifth leg of female three-segmented, the first segment irregular in shape, with a somewhat projecting

inner apical angle. Second segment subquadrate, about one and a half times as long as wide; armed at the outer apical angle with a plumose spine almost twice as long as the segment, and on the inner margin with a few fine hairs. Third segment slightly longer and narrower than the preceding; irregularly triangular, with sulcate margins and truncate apex; armed on the outer margin with two long, slender, plumose setae, at the apex with two similar setae and a short smooth spine, and on the inner margin with one seta similar to those already mentioned and one shorter lamellate seta, and provided on the upper half with a few fine hairs.

Length of female, 1.703 mm.; that of male, 1.362 mm.

The above description was prepared from specimens collected in the summer of 1896 at the Illinois Biological Station, at Havana, Ill.; from type specimens; and from other State Laboratory material collected at various times and places, mostly in Illinois.

The single species of this exclusively North American genus was first described by Herrick in a paper read before the Minnesota Academy of Sciences in 1879, but which, owing to a fire, was not published until 1882. The description then appeared, under the name *Potamoichetor fucosus*, in the Tenth Annual Report of the Geological and Natural History Survey of Minnesota (Herrick '82). This Report was not distributed, however, until after the August number of the "American Naturalist" appeared, which contained the description of *Osphranticum labronectum* by Forbes ('82).

De Guerne and Richard, in their "Revision" ('89b), publish the best figures of this species. Although not strictly correct in every particular, the omissions are of minor importance, as may be seen by the following enumeration of them. In the fifth legs of the female the hair on the second basal segment, the small spines at the outer apical angles of the segments of the outer ramus, the hairs on the outer margins of these segments, and the lamella of the hook at the inner apical angle of the second segment of this ramus are not figured. The third segment of the inner ramus is not quite correct. Here the hairs on the inner margin, the

lamella on the upper spine of this margin, and the small spine on the apex of the segment are all omitted. In the figures of the fifth pair of legs of the male, the small spines at the outer apical angles of the segments of both outer rami, the spine at the inner apical angle of the last segment of the right outer ramus, and the hairs on the inner margin of the first segment of both inner rami are wanting.

Although this species is widely distributed,—having been found in Alabama, Illinois, Minnesota, Oregon, and Wyoming,—no differences sufficient to establish even a new variety have been found in specimens from these localities so widely separated and so varied in character. Herrick, in his papers, states that all the specimens examined by him, from Alabama to Minnesota, had 24-segmented antennæ. Forbes found the antennæ 23-segmented, de Guerne and Richard, who examined specimens sent to Poppe by Forbes, agreed with him, and the writer also found the antennæ of all the specimens he examined to be 23-segmented. The specimens collected by Dr. Forbes in April, 1877, and described in 1882, were uniform pale brown; those collected by the writer at Havana, Ill., in July, 1896, were hyaline or opalescent white; while a single male found in June, 1897, at Urbana, Ill., in a temporary pool, was bright scarlet throughout, and hardly to be distinguished from the specimens of *D. sanguineus* among which it was found. Herrick has found *Osphranticum* in “estuaries of running water,” and says that according to his observations it prefers such localities. The writer’s observations tend to confirm Forbes’s statement that it prefers swamps and pools, or at least quiet or stagnant water. At the Biological Station at Havana, during the summer of 1896, a single specimen was captured in the Illinois River, in midstream, while in Quiver Lake, in a mat formed of *Ceratophyllum* and *Lemna* in a stagnant portion near shore (substation C), they were comparatively numerous, though not occurring in any such numbers as either *Diatomus* or *Cyclops*. In fact, in none of the collections examined were they at all common.

Prof. Forbes, in connection with the original description,

makes a remark in regard to the "steady movement in the water," and this is all, to my knowledge, that has been said about the habits of *Osphrauticum*. The following statements, gathered from observation of a number of specimens kept for some time in a large flat dish may therefore be of interest. Their movements in the water are very different from the short jerky springs of *Cyclops*, and they differ also from those of *Diaptomus* in that they are more regular. The motions of these three genera might perhaps be expressed by telegraphic symbols as follows: *Cyclops*, - - - - -; *Diaptomus*, - - - - -; and *Osphrauticum*, - - - - - . *Osphrauticum* swims equally well on the dorsal or ventral surface, seeming, however, to prefer the former position. As in *Diaptomus*, the anterior end is elevated in swimming, and the antennae are actively employed. Sometimes it will turn backward somersaults, going over and over in the water, but I have seen this done only when individuals were swimming on the back. When startled they would dart to the bottom, hide for an instant under a bit of debris, and then make another dash, repeating the performance until they deemed themselves out of danger.

Since *O. labronectum* is the only species known, no key will be required.

LIMNOCALANUS G. O. SARS.

Limnocalanus, Sars, '62, p. 226.

Centropages, de Guerne, '86, pp. 276-285.

Body long and narrow, the front armed with two hook-like processes. Cephalothorax widest at the middle, composed of six well-defined segments; last thoracic segment not produced laterally but slightly projecting posteriorly and armed on each side with a minute blunt spine. Abdomen slender; in the female composed (furca included) of four (*macrurus*) or five (*sinensis*) segments. Furcal rami very long, hairy on the inner margin; armed with five stout plumose setae (the second from within the longest), and one slender seta (plumose in *sinensis*), shorter than the rest, on the dorsal surface.

near the inner margin and opposite the outermost of the other setae.

First pair of antennae shorter than the body, 25-segmented, the last segment very small. Right male antenna geniculate between the 18th and 19th segments, each of which is armed with a hyaline lamina. Outer ramus of second pair of antennae seven-segmented⁺ and armed with very long setae. Mandibles produced at the inferior extremity into nine teeth, of which the outer two are longer than the rest, the inner two slender and setiform; palpus long and narrow, three-segmented, the last two segments very short, outer ramus small, armed with long setae. First pair of maxillae about as in *Diaptomus*. Second pair of maxillae robust, eight-segmented, the last segment produced into long stout claws; margins otherwise sparsely hairy; the falcate apex bare or armed with very small dense spines. Maxillipeds seven-segmented, much elongated and narrow, directed forward, and armed with numerous long setae.

All the swimming legs biramose. Both rami of the four anterior pairs of legs three-segmented, the inner shorter than the outer.

Outer ramus of fifth pair of legs of female three-segmented; armed within, on the second segment, with a very strong, curved, hook-like process. Inner ramus as in the other legs.

Outer ramus of right fifth leg of male two- (*sinensis*) or indistinctly three- (*macrurus*) segmented, the second segment produced into a stout hook-like process. Outer ramus of left fifth leg two-segmented, the second segment armed with a slender digitiform process. Inner rami three-segmented, alike, and similar to those of the preceding pair (*macrurus*), or differing from one another (*sinensis*). Eye single, near the lower margin of the head.

This genus was established by Dr. Sars in 1862 to receive

*The parts of the generic description referring to the structure of the second pair of antennae, the mandibles, maxillae, maxillipeds, and the swimming legs are compiled from Sars ('62 and '97), Nordqvist ('88), and de Guerne and Richard ('89b). In regard to the second pair of antennae of *macrurus* the writers mentioned state that the outer ramus is seven-segmented, and Nordqvist says further that the suture between the second and third segments is indistinct, and figures the antenna with six segments. Sars ('97) says of *grimaldii* that the outer ramus is six-segmented and so figures it. After careful examination, I find no difference in the second pair of antennae of *macrurus* and *grimaldii*, the segmentation being equally distinct, each of the four spines between the second and last segments marking a segment.

a fresh-water centropagid closely resembling the marine genus *Calanus*, and until 1889 *L. macrurus* was the only representative known. In that year Poppe described (de Guerne et Richard, '89b) a new species, *L. sinensis*, from China. The latter, so far as now known, is a purely fresh-water form, and *L. macrurus* was at first so regarded, but in Asiatic and European countries it has been found to occur in both fresh and salt water,—in America it has as yet been found only in fresh water,—and further search may show that *L. sinensis*, too, is common to both. *L. macrurus* is the only American representative of the genus, but it was deemed best to include *sinensis* in this paper, thus making the revision of the genera treated complete.

As already stated, the genus is represented by only two species, *macrurus* and *sinensis*. The former is common to America, Europe, and Asia, having been found in the river Jana (in East Siberia), in the Caspian Sea, in the Arctic Ocean, in the lakes of northern Norway, Sweden, and Finland, and in the deeper northern lakes of North America; the latter, *sinensis*, has been found only in eastern China.

Marsh, in his "Limnetic Crustacea of Green Lake" ('97), records some observations on the habits of *Limnocalanus*, and states that it is repelled by bright light and high temperatures, and hence performs diurnal migrations which are more pronounced in cold weather. It seems to have two periods of maximum occurrence, May and November, but is found at all times, although never very abundantly. In March and April most of the individuals are immature.

To my knowledge *Limnocalanus* has never been found with an egg-sac, differing in this respect from *Osphranticum* and *Diaptomus* but agreeing with *Epischura*. The spermatophore, a slender tubular structure, adheres to the female for a considerable time after attachment.

From a practical and economic standpoint *Limnocalanus* is of importance as contributing to the first food of *Coregonus clupeiformis* (Forbes '83a), of *Labidesthes sicculus*, and probably of other lake fishes.

See Forbes "On the Food Relations of Fresh-water Fishes: a Summary and Discussion," Bull. Ill. State Lab. Nat. Hist., Vol. II., Art. V (11), p. 522, 1885.

Since there are only two species of *Limnocalanus* known, the key is naturally very simple, and only the most striking differences are used.

KEY TO THE SPECIES OF LIMNOCALANUS.

Based on the Characters of the Female.

- 1 (2). Hook-like process at inner apical angle of second segment of outer ramus of fifth leg armed for the entire length of both margins with fine symmetrical teeth. Outer apical angle of same segment armed with a stout serrate spine. Second basal segment without plumose seta at outer apical angle. *macrurus*.
- 2 (1). Hook-like process at inner apical angle of second segment of outer ramus of fifth leg armed on the entire inner margin with large teeth and on the outer margin with a few fine ones*. Outer apical angle of same segment without spine. Second basal segment without plumose seta at outer apical angle. *sincensis*.

Based on the Characters of the Male.

- 1 (2). Right outer ramus of fifth legs 3-segmented (third segment indistinct). Hook-like process of second segment of this ramus simply and but slightly curved; provided with hyaline plate. Inner rami alike. *macrurus*.
- 2 (1). Right outer ramus of fifth legs clearly 2-segmented. Hook-like process of second segment of this ramus somewhat sinuously curved. Inner rami unlike. *sincensis*.

Limnocalanus macrurus Sars.

Limnocalanus macrurus, Sars, '62, p. 226.

Limnocalanus macrurus, Forbes, '82a, p. 649.

Centropages grimaldii, de Guerne, '86, p. 276.

Limnocalanus macrurus, Nordqvist, '88, p. 31. Pl. I., Fig. 9-11; Pl. II., Fig. 1-5; Pl. III., Fig. 1-4.

*In de Guerne and Richard's "Revision," Fig. 5a in the description of Plate IV. should be Fig. 15a.

Limnocalanus macrurus, de Guerne et Richard, '89b, p. 77, Pl. IV.,
Fig. 5, 11, 12.

Limnocalanus macrurus auctus, Forbes, '90, p. 648.

Limnocalanus macrurus, Marsh, '93, p. 201, Pl. IV., Fig. 7.

Limnocalanus macrurus, Marsh, '95, p. 11, Pl. IV., Fig. 1, 2; Pl. V.,
Fig. 1-5.

Limnocalanus macrurus, Herrick and Turner, '95, p. 49, Pl. I., Fig. 1-1.

Limnocalanus geluablii, Sars, '97, p. 39, Pl. IV., Fig. 1-18.

Body slender. Thorax rather more than one fourth as broad as long, and composed of six well-defined segments, of which the first (constricted at about the middle and armed at the front with two hook-like processes pointing forward and downward) is the longest—about equal to the three succeeding segments taken together; third and fourth segments subequal, together slightly longer than the second, which is armed on the dorsal and lateral surfaces, near the distal end, with a row of rather stout spines; fifth segment somewhat longer than the last, which is not produced laterally, but armed on each side with a very small spine. Abdomen of female composed of four segments, the first about a third longer than either of the two succeeding segments, which are subequal. Furcal rami about a fifth longer than the first segment, and slightly shorter than the second and third segments taken together; sparsely provided on the dorsal surface with short sharp spines, and on the inner margin with spines and hairs; one plumose seta on the outer margin at the beginning of the distal fifth; and four plumose apical setae and a delicate smooth seta on the dorsal surface near the inner apical angle. In the male the first and fourth abdominal segments are subequal, each about a fourth longer than the fifth, which is the shortest; second and third segments subequal, each about twice as long as the fifth; second, third, and fourth segments armed like the second abdominal segment of the female. Furcal rami proportioned about as in the female and similarly armed.

Antenna 25-segmented; right male antenna geniculate between the 18th and 19th segments. The armature of the segments is as follows: 1 and 10 have a short seta and two sense-hairs; 2, a short seta and three sense-hairs; 3, a short

seta and a sense-hair; 4, a short seta and a short spine; 5 and 7, a long seta, a short one, and a sense-hair; 6, a short stunted spine; 8, a short broad seta, a short curved spine, and a sense-hair; 9, a long broad seta and a sense-hair; 11, a short broad seta and a sense-hair; 12, a sense-club, a short curved spine, and a short broad seta; 13, a short broad seta and a sense-club; 14, a long seta and a short broad seta; 15, a sense-club and two short broad setae; 16, a long seta, a sense-club, and a short broad seta; 17, a sense-club, and a broad, pointed, knife-like process; 18, a long sense-club, and a hyaline lamella armed with teeth and extending almost the entire length of the segment; 19, 20, and 21 (ankylosed, the suture between 19 and 20 obscurely indicated), a blunt digitiform process at the inner apical angle, a seta, a blunt stunted spine slightly below the middle, and a stunted spine and a knife-like process still lower down; 22 and 23, (ankylosed, suture indistinct), two setae and a sense-hair; 24 two setae; and 25 (very short), four setae and a sense-club.

First basal segment of right fifth leg of male subquadrate. Second basal segment about as wide as the first and about twice as long, provided at the outer apical angle with an inconspicuous hyaline process. First segment of outer ramus considerably narrower than the second basal segment, less than twice as long as wide; armed at the outer apical angle with a stout spine, serrate on the inner margin, and on the inner margin below the middle with a hyaline process. Second segment slightly narrower than the first; produced at the inner apical angle into a hook-like process, which is armed on the outer margin, near the base, with two sharp slender spines, and provided on both margins with a hyaline lamina having an appearance of transverse striation. The hook is fully three times as long as the segment itself.

Inner ramus of right fifth leg three-segmented, the first segment irregular in form, about twice as long as wide; armed on almost the entire outer margin with a few fine hairs, and at the beginning of the distal third with a slender plumose seta. Second segment somewhat wider than the

first, and rather more than twice as long as wide; armed on the outer margin with a few hairs and a moderately stout plumose seta. Third segment about as wide as the second, with margins sulcate; outer margin armed with two stout plumose setae, the proximal third with a few fine hairs; inner margin and apex each armed with two stout plumose seta.

First basal segment of left fifth leg subquadrate, having near the inner apical angle a large tubercle bearing a few rather long hairs. Second basal segment somewhat narrower than the preceding and not twice as long as wide; armed at the outer apical angle with a prominent hyaline process. First segment of outer ramus subquadrate, rather more than twice as long as wide; armed on the inner margin, at the beginning of the distal third, with a small process provided with hairs, and at the outer apical angle with a short blunt spine and a long stout movable spine serrate on the inner margin. Second and third segments ankylosed, forming one very long narrow segment, slightly narrower than the first and more than twice as long; provided for the greater part of the inner margin with hairs, and armed on the outer margin with three spines, the upper two similar to the larger one of the preceding segment, the third sometimes serrate on both margins; provided at the inner apical angle with a narrow digitiform process about half as long as the segment itself and serrate on the outer margin.

Inner ramus of the left fifth leg very similar in every respect to that of the right leg.

First basal segment of fifth leg of female of the ordinary form. Second basal segment about as wide as the first and barely twice as long as wide; outer half of the distal margin produced in the form of an irregularly triangular flap extending over the margin of the first segment of the outer ramus. First segment of outer ramus quadrate, about twice as long as wide; armed at the outer apical angle with a stout spine serrate on the inner margin. Second segment somewhat narrower than the first and not quite twice as long as wide; armed with hairs on both margins and at the outer apical angle with one short spine and a longer, stouter one serrate

on the inner margins; inner apical angle produced in the form of a moderately curved hook armed on both margins with spines or teeth. Third segment narrower than the second and fully three times as long as wide; hairy on the upper part of both margins, and armed on the outer margin, at the beginning of the distal third, with two spines, one stout and serrate and the other short and smooth; outer apical angle armed with three spines, two short and smooth, the other long and serrate on the inner margin; inner margin sulcate, and armed with two stout plumose setae; apex armed with two setae, the inner seta plumose on both margins, the outer plumose on the inner margin and provided on the outer with a hyaline lamina.

Inner ramus of fifth leg of female three-segmented. First segment hairy on the outer margin; outer apical angle armed with a moderately stout plumose seta. Second segment subquadrate, more than twice as long as wide; hairy on both margins; armed at the outer apical angle with a plumose seta. Third segment somewhat longer and broader than the second; margins sulcate, both hairy at the upper part; armed with six stout plumose setae, two apical and two on each margin.

Length of female 2.2—2.6 mm.; that of male 2.05—2.4 mm.

The above description was prepared from specimens of *L. macrurus* sent by Professor Sars to the Illinois State Laboratory of Natural History, and from specimens of *L. grimaldii* kindly sent by him to me. Nothing further need be said about *L. macrurus*, the type of the genus, except in regard to synonymy and distribution.

The original description of the species appeared in the "Forhandlinger i Videnskabs-Selskabet i Christiania" (Sars '62). De Guerne ('86) described it under the name of *Centropages grimaldii*; Nordqvist, in "Die Calaniden Finlands" ('88), made this a synonym of *L. macrurus*; and de Guerne and Richard, in their "Revision" ('89b), acknowledged the correctness of Nordqvist's view. Recently, however, Professor Sars, in his "Pelagic Entomostraca of the Caspian Sea" ('97), re-established de Guerne's form as a new species of

Limnocalanus, L. grimaldi de Guerne. Except for a difference in size and in the proportions of the segments of the fifth legs of both sexes, which segments are somewhat less robust in the fresh-water form than in the one from the Caspian Sea, and but for a slight though noticeable difference in the lateral aspect of the head, the two forms exactly correspond. It does not seem to me that such slight differences warrant the establishment of a new variety, much less of a new species. With the exceptions just noted, the details of structure mentioned in the foregoing description are equally prominent in both forms, as are those noted in the following discussion of the published figures of the species.

The best illustrations of *L. macrurus* are given in "Die Calaniden Finlands" (Nordqvist, '88) and in the "Revision des Calanides d'eau douce" (de Guerne et Richard, '89b), although in neither publication are they strictly correct. De Guerne and Richard's figures of the fifth pair of legs of the female do not show the projection of the second basal segment over the first segment of the outer ramus, nor the hairs on the inner margin of the second segment of this ramus and on the third segment of the inner ramus, nor the serrations on the spine at the outer apical angle of the last segment of the outer ramus. Nordqvist says that the outer ramus has three segments but figures it with two. The inner ramus he represents as smooth on the outer margin of all its segments, and gives the ordinary form to the outer of the two setae on the apex of the last segment of the outer ramus, while de Guerne and Richard picture it with a hyaline lamina on both margins and a few fine spinules on the inner margin. Neither is correct with regard to this seta, since it is plumose on the inner margin and has a hyaline lamina on the outer one.

Both de Guerne and Richard's and Nordqvist's figures of the fifth pair of legs of the male fail to show the hairs on the inner margins of the inner rami, the hyaline processes on the outer margin of the second basal segment of the left leg and on the first segment of the right outer ramus, and the serrations on the hook of the last segment of the left outer ramus. Further, Nordqvist fails to figure the hyaline process on the

second basal segment of the right leg, the two spines on the outer margin near the base of the hook of the second segment of the right outer ramus, the serrations of the apical spine of the second segment of the left outer ramus, and the process on the inner margin of the first segment of the same ramus. De Guerne and Richard omit the tubercle on the inner apical angle of the first basal segment of the left leg, the hairs on the inner margin of the second segment of the left outer ramus, and the hyaline lamina on the process of the second segment of the right outer ramus, which is figured by Nordqvist as being on the outer margin only, while it is really on both. Nordqvist also fails to show the spines at the base of the outer margin of this hook.

I have had no opportunity to examine specimens of the marine genus *Centropages*, but the drawings of the fifth pair of legs of the female of *L. macrurus* and of *C. hamatus* are so similar that it is hardly to be wondered at that de Guerne regarded the two forms as belonging to the same genus. The fifth pair of the legs of the males also show the same general structure in the two genera, although they differ materially in detail.

L. macrurus is the only species of the family *Centropagidae* which is common to Europe and America. This is probably due to the fact that it occurs in both fresh and salt water, and thus the Atlantic offers no barrier to its distribution. It has been recorded from Sweden, Norway, and Finland, from the Kara and Baltic Seas and the Gulf of Finland, and from the ocean off Spitzbergen; and it is probably widely distributed in the countries of northern Europe and Asia. In America it was first recorded from Lake Michigan (Forbes, '82), and later, under the name of *L. macrurus auctus*, from Lake Superior (Forbes, '90). Marsh ('93 and '95) found it in Green Lake, Wisconsin, in Lake St. Clair, Michigan, and in Lake Huron.

Limnocalanus sinensis POPPE.

Limnocalanus sinensis, de Guerne et Richard, 89b, p. 79. Pl. IV.,

Fig. 4, 15, 15a, 16.

Limnocalanus sinensis, Herrick and Turner, '95, p. 49.

Body six-segmented, slender, more attenuate at the anterior than at the posterior part; suture between head and thorax distinct. Second thoracic segment about as long as the other five, which differ but little in length. Last two thoracic segments distinct, the last segment somewhat produced posteriorly and armed on each side with a short blunt spine. First abdominal segment barely three times as long as the second, which is but slightly longer than the fourth; third segment about one and three fourths times as long as the second. Furcal rami more than twice as long as the third segment and barely four times as long as broad; somewhat sparsely hairy within. All of the furcal setae in both sexes distinctly plumose, the innermost seta much more slender than the others and placed on the dorsal surface of the ramus, almost directly opposite the base of the outer one. In the male the first and fifth segments are subequal, each slightly longer than the second and third, which are also about equal. Fourth segment the shortest, about three fourths as long as the second. Furcal rami fully three times as long as the fourth segment, about four and a half times as long as broad, and armed as in the female.

Antenna 25-segmented, hardly extending to the base of the furca. Right antenna of the male moderately swollen from the 12th to the 18th segments inclusive. The armature of the segments anterior to the 10th segment is as follows: 11 has a sense-club and a short seta; 12, a sense-club, a short seta, and a short curved spine; 13, a sense-hair and a sense-club; 14, a sense-hair, a sense-club, and a long plumose seta; 15, a sense-hair, a sense-club, and a long spine; 16, a sense-hair, a sense-club, and a long plumose seta; 17 a broad knife-like process and a sense-club; 18, a short stunted spine, another spine somewhat longer, and a hyaline lamina armed with teeth about half as long as the lamina is broad; 19, 20, and 21 (completely ankylosed), a short

stunted spine, a long plumose seta, two processes, and a hyaline lamina armed with teeth about as long as the lamina is wide and occupying about a third of the margin slightly below the middle; 22 and 23 (completely ankylosed), a short seta, a short stunted spine, and a long plumose seta; 24, two long plumose setae; and 25 (very short), three long plumose setae and a sense-club.

First basal segment of right fifth leg of male not characteristic. Second basal segment irregular in form, about two and a half times as long as wide, armed on the anterior aspect, below the inner proximal angle, with a stout sharp spine, and at the middle of the inner margin with a number of exceedingly short hairs or spines. First segment of outer ramus narrower than second basal segment, about one and three fourths times as long as wide; armed at the outer distal angle with a straight sharp spine serrate on the inner margin. Second segment produced in the form of a long stout sub-sigmoid hook, widest some distance below the base and tapering gradually to a rather blunt point; inner margin of broadest part roughened by a number of irregularly disposed ridges, otherwise both margins perfectly smooth.

Inner ramus of right fifth leg three-segmented, the first segment subelliptical, more than twice as long as wide, and hairy at the middle of the inner margin. Second segment considerably broader than the first, bulging out at the middle and armed here with a few rather long hairs; inner apical angle armed with a rather short plumose seta. Third segment subelliptical, more than twice as long as wide; armed with six stout plumose setae, two apical and two on each of the lateral margins.

First basal segment of left fifth leg not characteristic. Second basal segment about one and three fourths times as long as wide; armed at the outer distal angle with a plumose seta, and at the middle of the inner margin with a few very short hairs or spines; produced at the inner apical and proximal angles into smooth hemispherical processes, the lower of which is the larger. First segment of outer ramus subquadrate, about twice as long as wide, produced at the

middle of the inner margin into a smooth rounded process, and armed at the outer apical angle with a stout straight spine serrate on the inner margin. Third segment about twice as long as its greatest width, dilated at the middle of the inner margin and armed here with a few rather long hairs; outer margin armed with three spines similar to the one on the preceding segment, and at the apex with a long, narrow, slightly curved process, perfectly smooth, and somewhat longer than the segment from which it springs.

Inner ramus of left fifth leg three-segmented. First segment subquadrate, slightly more than twice as long as wide; provided at the middle of the inner margin with a hemispherical process armed with a few scattered hairs. Second segment somewhat broader than the first and about as long; armed at the inner proximal angle with a small sharp spine, and at the middle of the inner margin with two irregularly roughened processes provided with hairs; a long plumose seta on the inner margin just below the lower of the two processes. Third segment slightly narrower and shorter than the second, both margins sulcate, armed with six stout plumose setae arranged about as in the corresponding segment of the inner ramus of the right leg.

First basal segment of fifth leg of female subquadrate. Second basal segment about as wide as the first and approximately one and three fourths times as long as broad; hairy at the middle of the inner margin and armed on the outer apical angle with a plumose seta. First segment of outer ramus subquadrate, about one and three fourths times as long as broad; armed on the inner margin, near the proximal angle, with a smooth hemispherical process, and on the outer apical angle with a stout spine, serrate on the inner margin. Second segment slightly narrower at the base than the first, but widening distally and produced at the inner apical angle into a stout hook-like process armed on the inner margin with six or seven strong teeth, largest near the middle of the hook, and near the proximal end with five or six smaller teeth. On the outer margin of the hook and opposite the smaller teeth of the inner margin are a number of rather minute

teeth. Third segment about half as wide as the second and approximately three times as long as its greater width; inner margin sulcate and armed with five stout parallel plumose setae; outer margin armed with two strong straight spines, the upper at about the beginning of the distal third, the lower at the apical angle, and both serrate on the inner margin. Just within the apical spine are a short blunt process and a long, narrow, awl-like process almost twice as long as the segment.

Inner ramus of fifth leg of female three-segmented, the first segment subelliptical, somewhat less than twice as long as wide, and hairy at the middle of the inner margin. Second segment a little wider than the first, about twice as long as wide, hairy at the middle of the inner margin; outer apical angle armed with a stout plumose seta. Third segment about as wide as the first, margins sulcate; armed with six stout plumose setae, two apical and two on each side.

Length of female about 1.65 mm.; that of the male 1.60 mm.

The above description is based on specimens kindly sent me by Herr S. A. Poppe. On examination I found a few minor differences between the specimens sent me and the original figures. These differences I note below. The second thoracic segment instead of being only as long as the two succeeding ones is about as long as the remainder of the thorax. The innermost furcal seta is plumose instead of smooth—as figured in the original drawings. In the fifth pair of legs of the male the spines on the outer ramus of the left leg were found to be serrate on the inner margin instead of smooth. The spine or seta on the outer apical angle of the second basal segment of this leg is plumose. The inner margin of this segment is hairy or minutely spinose. Neither the short hook-like spine at the inner proximal angle of the second segment of the left inner ramus, nor the stout straight spine (serrate on the inner margin) at the outer apical angle of the right outer ramus is figured or described in de Guerne and Richard's "Revision." I was unable to find the hairs

§ Measurements as given in de Guerne and Richard's "Revision" (896).

which Poppe figures on the inner margin of the second segment, and on the outer margin of the third segment, of the outer ramus of the fifth leg of the female.

This species differs so much from *L. macrurus*, that it might almost be regarded as the type of a new genus, but Poppe has not considered the differences as of generic value, nor have de Guerne and Richard. Unlike *L. macrurus*, the inner rami of the fifth pair of legs of the male although both three-segmented differ from one another, and the right outer ramus is composed of two segments instead of three. In the female the differences are not so striking, for while the outer rami are noticeably unlike, the inner rami are very similar.

This species was found in Lake Sitai, China, and in the Whangpoo River, which flows from it, the waters of both of which are perfectly fresh. To my knowledge it has not yet been recorded from any other locality.

EPISCHURA FORBES.

Scopiphora (?), Pickering, '44, p. 62.

Epischura, Forbes, '82a, p. 617.

Epischura, Herrick, '83a, p. 384.

Epischura, Herrick, '87, p. 13.

Epischura, Herrick and Turner, '85, p. 81.

Epischura, de Guerne et Richard, '89b, p. 141.

Cephalothorax more or less distinctly six-segmented. Abdomen (furca included) composed of five segments in the female and of six in the male; in the female, of the ordinary form (*nevalensis*, *nordenskioldi*) or flexed to the right and provided with a process on the right side of the second segment (*lacustris*); in the male, straight or very slightly flexed (*nordenskioldi*) or strongly flexed to the right (*lacustris*, *nevalensis*); in the males of all species, second, third, and fifth segments provided on the right side with processes. Furcal rami hairy on the inner margin, provided in both sexes with three plumose terminal setae, one slender simple seta at the inner apical angle, and a stout spine at the outer apical angle.

First pair of antennae 25-segmented. Right male antenna geniculate between the 18th and 19th segments; segments

19—21, and 22 and 23 ankylosed; antepenultimate segment unarmed; segments preceding geniculation very slightly swollen. Second pair of antennæ about as in *Diaptomus*.

All the swimming legs biramose, the outer ramus three-segmented, the inner, one-segmented. Fifth pair of legs of the female alike, uniramous, three-segmented, the first segment of the ramus being, however, really the second basal segment; armed at the outer apical angle with a hair or delicate spine. Third segment armed with a varying number of spines (5—7).

Fifth pair of legs of the male unlike, uniramous, modified into a grasping organ. Right leg two- (*lacustris*, *nevadensis*) or three-segmented (*nordenskiöldi*); last segment almost always flexed. Left leg three-segmented, the first segment produced on the inner margin to form a strong hook-like process; last segment variously armed on the outer margin with a number of spines, and provided on the inner margin with fine long hairs.

Female generally bears spermatophore, and does not carry eggs in egg-sac.

Inhabits deep fresh water lakes.

As will be seen from the above, the doubtful *E. glaucatilis* Herrick has not been considered in this description, but only the three recognized species, *lacustris*, *nevadensis*, and *nordenskiöldi*.

The species of this genus seem not to be fully differentiated from each other. This is illustrated by the variable armature of the fifth pair of legs of the females, *nevadensis* having sometimes one and sometimes two spines at the outer apical angle of the second segment and either six or seven spines on the last segment, and *nordenskiöldi* also varying in the latter respect, having sometimes five and sometimes six spines. All female specimens of *lacustris* observed, were constant in the armature of the fifth legs, but in the left fifth leg of the male the second segment, although generally unarmed, was sometimes provided at the outer apical angle with a small spine.

This genus, confined so far as known to North America,

and represented in different sections by different species, is found from Newfoundland on the north and east to Washington on the west, and as far south as central Illinois and Indiana.

KEY TO THE SPECIES OF EPISCHURA.

Based on the Characters of the Female.

- 1 (2). Abdomen flexed to the right; second segment armed on the right side with a process. Furcal setae and spines very broad. Fifth leg with last segment twice as long as the first; last segment armed with seven spines. *lacustris.*
- 2 (1). Abdomen straight; second segment unarmed. Furcal setae and spines of ordinary width.
- 3 (4). Fifth legs very robust, first segment almost as wide as long; second segment sometimes armed with two spines; third segment armed with six (occasionally seven) spines. *nevadensis.*
- 4 (3). Fifth legs slender, first segment considerably longer than wide; second segment armed with a single small spine; third segment armed with five (sometimes six) spines. *nordenskiöldi.*

Based on the Characters of the Male.

- 1 (2). Abdomen straight, abdominal processes small and inconspicuous. Right leg three-segmented, the first segment armed on the inner margin with a hook; second and third segments armed at the outer apical angle with a small spine. Process on first segment of left leg but slightly curved. *nordenskiöldi.*
- 2 (1). Abdomen flexed to the right; abdominal processes large. Right leg two-segmented.
- 3 (4). First segment of right leg with subtriangular toothed plate on the inner margin, and a hair at the outer apical angle. First segment of left leg very stout and strongly curved; second segment unarmed. *nevadensis.*

- 4 (3). First segment of right leg entirely unarmed. First segment of left leg with comparatively slender process; second segment armed at the outer apical angle with a small spine. *lacustris.*

***Epischura nordenskiöldi* LILLEBERG.**

Epischura nordenskiöldi. de Guerne et Richard, '96, p. 94, Pl. I, Fig. 36; Pl. II., Fig. 15, 23.

Epischura nordenskiöldi. Herrick and Turner, '95, p. 85, Pl. XI., Fig. 2, 5, 9.

Epischura nordenskiöldi. Schmeil, '98, p. 183.

About medium size, body rather robust, widest in front of middle. Cephalothorax six-segmented, the first two segments confluent and together somewhat longer than the remainder; third segment slightly longer than either of the last three, which are subequal; last two segments distinct, the last segment produced on each side at the posterior angle into a bluntly-rounded lobe armed at the tip with a minute spine. Abdomen (including furca) five-segmented, slender, a little less than half as long as the cephalothorax; first two segments indistinctly confluent below; third segment slightly longer than the fourth. Furcal rami about twice as long as broad and ciliate on the inner margin; armed at the apex with three slender plumose setae fully three times as long as the ramus itself, at the outer apical angle with a short stout spine, and on the dorsal surface, near the inner margin, with a delicate smooth seta. Abdomen of male (furca included) six-segmented, the second, third, and fifth segments armed on the right side with prehensile processes; flexed to the right but slightly or not at all. First segment somewhat broader than long, slightly produced along the left margin into a process ending at the posterior angle in a lobe-like expansion. Second segment slightly narrower and longer than the first; produced on the right side in the form of a subtriangular plate, somewhat longer than wide and pointing obliquely backward. The process is armed at the tip with a small sharp spine, on the inner margin, near the apex, with two or three rather large teeth, and within these with a number of smaller

ones. Third segment slightly shorter than the preceding; process very simple, small and inconspicuous, bluntly pointed, extending almost straight backward; armed on outer margin, near the tip, with a slight, blunt protuberance. Fourth segment unarmed, about half the length of the first. Fifth segment about as long as the fourth; armed with a narrow triangular plate, broadest anteriorly and bluntly rounded at the apex. Dextral margins of the fourth and fifth segments tuberculate. Furcal rami about as in the female.

Antennae 25-segmented, extending almost to the base of the furca. Right antenna of the male geniculate between the 18th and 19th segments; segments preceding the geniculation slightly or not at all swollen.

Right fifth leg of the male three-segmented. First segment irregular in form, about twice as long as wide, armed on the outer margin, near the distal angle, with the usual delicate hair; inner margin provided with a curious, smooth, bluntly-pointed hook-like process extending downward almost parallel to the margin. Second segment irregular, about twice as long as wide; outer margin smoothly convex, armed near the distal angle with a small spine; outline of inner margin sinuous. Third segment long and narrow, with a broad basal portion about half as wide as the segment is long; curved inward slightly at the tip and armed here, on the outer margin, with a minute spine.

First segment of left fifth leg with a subquadrate main portion produced on the inner margin into a long, smooth broad hook but slightly curved; armed at the outer distal angle with the usual hair. Second segment somewhat narrower than the first, subquadrate, about twice as long as wide; outer distal angle armed with a small sharp spine; inner margin sometimes with indications of minute teeth or serrations at about the middle. Third segment curved inward slightly, about as broad as the second and fully four times as long as broad; armed on the outer margin with four rather small sharp spines, the first at about the middle, the second midway between this and the apex of the segment, the other two near the apex and nearer together than the upper ones; armed on

the distal part of the inner margin with long delicate hairs. This segment is much simpler than the corresponding segment of *lacustris* and *nevadensis*.

Fifth pair of legs of the female miramose, three-segmented. First segment subquadrate, somewhat longer than wide, armed near the outer distal angle with a hair or delicate spine. Second segment somewhat narrower than the first and slightly longer; armed at the outer apical angle with a small sharp spine. Third segment slightly narrower than the second and barely one and a half times as long; armed with five or six spines*, two (one) outer, one inner, and three apical. Of the outer spines, the upper one is at about the middle of the segment and the lower one is directly opposite the inner spine. Of the apical spines, the middle one is spinulose on both margins and the outer one on the inner margin.†

Length of female 1.9 mm.; ‡ that of male 1.1 mm.

The above description was prepared from specimens kindly sent me by Dr. Lillejeborg, the measurements, however, with the modification explained in the foot-note, being those given in the original description. The material was a part of that collected by Dr. C. Nyström, a member of the Nordenskiöld expedition to Greenland in 1871, and was not in the best state of preservation, owing no doubt to the length of time since its collection.

Figures of this species may be found in de Guerne and Richard's "Revision" ('89b), and imperfect copies of these in Herrick's "Synopsis" (Herrick and Turner '95). The fifth pair of legs of the male are correctly represented in the "Revision" except that the spine at the outer apical angle of the right leg is not shown; indeed it is not mentioned in the description. The spine figured on the outer margin of the

* The armature of this segment differs somewhat in different specimens. See on a subsequent page the discussion in regard to the fifth leg of the female.

† Having only a few specimens to study, I could not satisfactorily determine whether the other spines were also spinulose or not, but I am quite positive with regard to the two mentioned. I think it likely that they are armed as in *lacustris*.

‡ It is quite evident that a mistake was made in regard to the measurements given in the original description: "Length of female, caudal setae excepted, about 2.9 mm., and of male 1.1 mm." In the specimens I examined there was no such difference in length in favor of the female; in fact the single entire female I had the opportunity to measure was 1.333 mm. in length, while the average length of five males was considerably above this—1.698 mm. I have hesitated to substitute these measurements because of the limited number examined, and have altered Lillejeborg's figures to what I think they were intended to be.

second segment of the right leg, which Schmeil ('98) says he could not find, was present in all the specimens examined by the writer. In one of the two specimens of females examined the last segment of the fifth leg was armed with five spines, as shown in the original figures, while the other had six. I think that six may perhaps be found to be the rule, in which case the species approaches *ucradensis* and *lacustris* more closely, the former having six and sometimes seven spines, and the latter constantly seven. The fact that none of the other writers, Lilljeborg, de Guerne and Richard, and Schmeil, have mentioned the existence of a sixth spine would, however, militate against this assumption.

The male of *nordenskiöldi* is very easily distinguished from the males of the other two species. The fifth pair of legs, while of the same general type as in the rest of the genus, are less modified and yet very characteristic. But for the fact that it is, as a rule, difficult to make out, the hook-like process on the first segment of the right leg would alone serve to distinguish *nordenskiöldi*. Further, the right leg is three-segmented instead of two; the last segment is armed on the outer margin, at the apex, with a small spine; and the hook on the first segment of the left leg is comparatively simple. The abdomen is also less modified than that of *ucradensis* and *lacustris*. Instead of being quite strongly flexed to the right it is almost or entirely straight, while the processes are small and inconspicuous, there being some difficulty in discerning the one on the fifth segment.

The fifth pair of legs of the female also serve, though not so readily, to distinguish this species. They differ from those of *lacustris* in that the last segment is armed with only five or six spines, instead of seven, and in the relative length of the segments. From the fifth legs of *ucradensis* they may be distinguished by the difference in proportions, those of *ucradensis* being much more robust than those of *nordenskiöldi*, which are intermediate between the other two. The different arrangement of the spines on the last segment, the occasional absence of the sixth spine on this segment, and the presence, at least occasionally, of a second spine at the outer apical

angle of the second segment of the leg of *nevadensis*, will all assist in determining the species.

De Guerne and Richard (89b) make the statement that the females always have the spermatophore—which they describe as curved in a semicircle around the abdomen—attached. On none of the females examined by the writer was this structure present. It may of course have been torn off, although even then the statement that it is always present seems to me too strong, since in *E. lacustris* and *E. nevadensis* the female, even when mature, is very often found without a spermatophore.

Epischura nevadensis LILLJEBORG.

Epischura nevadensis, de Guerne et Richard, '89b, p. 93. Pl. II., Fig. 17, 24; Pl. III., Fig. 21.

Epischura nevadensis columbia, Forbes, '93, p. 254. Pl. XLI., Fig. 19-21.

Epischura nevadensis, Herrick and Turner, '95, p. 84. Pl. XI., Fig. 1, 6, 8.

Epischura nevadensis columbia, Herrick and Turner, '95, p. 84. Pl. XI., Fig. 4, 10.

Epischura nevadensis, Schmeil, '97, p. 183.

Of medium size and somewhat oval in form, broadest before the middle. Front armed on each side with a hook-like process pointing downward. Cephalothorax six-segmented, the second segment the longest, about twice as long as the first or last, which are subequal, the remaining three segments subequal, each about a fourth the length of the second. First two segments somewhat confluent, as are the last two; last segment, seen from above, not produced and entirely unarmed. Abdomen (furca included) composed of five segments, the first two confluent and together almost as long as the two following, which are subequal and slightly longer than the furca. Furcal rami subquadrate, very short and broad, and provided on the posterior part of the inner margin with a few fine hairs; armed at the outer apical angle with a stout pointed spine, and at the inner apical angle with a slender smooth seta, posterior margin armed with three long delicately plumose setae, of which the inner is the longest, the other two being about equal. In the male the abdo-

men is asymmetrical, flexed to the right, and consists of six segments (furca included). The segments vary but little in length, the furca being, however, the shortest, the fifth, second, and first increasing in length in the order of their mention, the third and fourth subequal, each slightly longer than the first. Seen from above, the first segment is produced slightly to the left at its posterior margin. Second, third, and fifth segments armed with processes on the right side. The process on the second segment is a broad thin lamina about as long as the segment is broad, smooth on the convex anterior margin and for about the distal fourth of its posterior margin (which is almost straight), but for the remaining three fourths of this margin provided with minute irregular teeth having a tendency to point toward the abdomen; apex acute and slightly recurved. The process on the third segment springs from the posterior part as a broadly rounded smooth hyaline lamina slightly longer than broad. Fourth segment unarmed. Fifth segment provided with two processes, the anterior one (pointing forward and upward) consisting of a narrow irregularly triangular plate with an acute apex and smooth margins, the posterior one having the form of a truncated triangle, armed at the apical margin with three or four large equal teeth and one or two much smaller ones. Posterior to this process the right margin of the segment is armed with a row of bead-like tubercles which, near the suture between the furca and this segment, lengthen to form two or three blunt spines. Furcal rami slightly longer proportionally than in the female, but similar in other respects.

Antennae 25-segmented, long and slender, extending slightly beyond the posterior end of the third abdominal segment in the female and beyond the fourth segment in the male. Right male antenna geniculate between the 18th and 19th segments; segments 19, 20 and 21, and 22 and 23 ankylosed; antepenultimate article unarmed.

Right fifth leg of male two-segmented. First segment irregularly pentagonal, the longest base forming the outer margin, which is armed near the distal angle with a delicate seta; basal half of inner margin armed with a broad irregu-

lar hyaline plate which near its middle is somewhat produced and provided with a number of delicate serrations. Second segment consists of a broader basal portion and a narrow terminal part, the latter constituting about three fourths the entire length, and extending upward to the middle of the inner margin of the preceding segment; apex produced at the inner margin, forming a kind of hook.

Left fifth leg uniramous, three-segmented. First segment armed near the outer apical angle with a delicate seta and produced on the inner margin into a large plate-like hook almost as broad as the segment and strongly curved inward. Second segment irregular in shape, slightly longer than broad, and unarmed.* Third segment or terminal hook contorted, about twice as long as the second segment; basal portion broad, with a projecting inner angle; inner margin sinuous, the lower curve densely provided with fine long hairs; outer margin armed with three short, sharp unequal spines increasing in size from above downwards; the attenuate apex provided with a spine considerably larger than the others.

Fifth leg of female uniramous, three-segmented. First segment subquadrate, with flaring sides; armed near the outer apical angle with a rather delicate smooth seta. Second segment subquadrate, about one and a half times as long as the first and about two and a half times as long as broad; armed at the outer distal angle with a short sharp spine (occasionally with two subequal spines). Third segment (terminal spines excluded) about as long and wide as the second; outer margin armed with a short sharp spine at about the beginning of the distal half (another spine occasionally present a short distance above this); apex provided with three spines, the two outer ones subequal and the middle one considerably larger; inner margin armed with two spines near the apex of the segment, the upper about half the size of the lower, and the margins of both denticulate.

Length of female 2-2.5 mm.; that of male 1.7-2.1 mm.

The above description is based on type specimens of *E.*

*On one or two specimens I noticed quite a large tubercle, with a roughened tip, projecting from the anterior aspect of this segment near the outer proximal angle, but did not find it at all constant.

nevadensis columbica Forbes; on other specimens collected in the same localities—Swan Lake and Flathead Lake, Montana; and on specimens from Gamble's Lake and Lake Pend d'Oreille, Idaho, from Lake Tahkemitich and Tsilteos Lake, Oregon, and from Lake Union and Lake Washington, Washington, sent to the State Laboratory by Messrs. Evermann and Meek of the U. S. Fish Commission. I had also a large number of the Nevada form kindly sent me by Prof. Lilljeborg, but, unfortunately, there was not a single mature individual in this lot, and for this reason I cannot say on my own responsibility that *E. nevadensis* Lilljeborg and *E. nevadensis columbica* Forbes are identical. A careful examination of the material at hand, however, inclined me to that belief, and, moreover, Professor Schmeil, both in a personal letter and later in the "Bibliotheca Zoologica" (Schmeil, '97) says that they are, after having examined authentic specimens from both localities. He states also that Professor Forbes was perfectly justified in establishing his *columbica* as a new variety, since Lilljeborg's descriptions and figures are inaccurate in several respects. In the following paragraph are given the points in which my observations differ from those of Forbes and of Lilljeborg.

In all the specimens examined the segments of the fifth leg of the female are proportionately longer and narrower than figured by Lilljeborg. This fact may be due to his having made his drawings from an individual not perfectly matured. This difference was noted by Forbes in his description of *columbica* ('93). The appendage near the outer distal angle of the first segment of this leg is correctly drawn as a seta by Lilljeborg, while Forbes's figure represents it as spine-like. The fact that a second spine is occasionally found at the outer distal angle of the second segment must have been observed by Lilljeborg, since his drawings show it, although no mention of it is made in the original description of *nevadensis* (de Guerne et Richard, '89b). Forbes refers to it in his description of *columbica* but does not figure it. A seventh spine on the outer margin of the last segment was correctly said by Forbes to be occasionally present. Lilljeborg does not seem

to have found this spine, but Schmeil confirms Forbes's statement. The inner two spines on the last segment are serrate on both margins, but this fact is shown in none of the figures, nor is it mentioned in the literature referred to. The first segments of the fifth pair of legs in the male are each provided with a rather delicate seta near the outer distal angle. This is shown in the published figures, but Lilljeborg mentioned only the one on the left leg. The ordinary appearance of the lamina of the second segment of the right leg is best shown in Forbes's figures.

This species is quite common in the western United States, having been found to occur in considerable quantities in collections from Nevada, Idaho, Oregon, Washington, and Montana, and further collections will no doubt show a still more general distribution. It occurred in collections with *Diaptomus ashlandi* Marsh and with *D. minutus* Lilljeborg.

Epischura lacustris FORBES.

Scopiphora vagans (?), Pickering, '44, p. 62.

Epischura lacustris, Forbes, '82a, p. 648, Pl. VIII., Fig. 15, 16, 21-23, 25-27; Pl. IX., Fig. 8.

Epischura lacustris, Herrick, '84, p. 131, Pl. Q, Fig. 15.

Epischura lacustris, de Guerne et Richard, '89b, p. 90, Pl. IV., Fig. 3, 9, 10.

Epischura lacustris, Forbes, '90, p. 704, Pl. L, Fig. 1-5; Pl. II., Fig. 7.

Epischura lacustris, Forbes, '93, p. 255.

Epischura lacustris, Marsh, '93, p. 200, Pl. IV., Fig. 6.

Epischura lacustris, Marsh, '95, p. 10, Pl. II., Fig. 1-6; Pl. III., Fig. 1-6.

Epischura lacustris, Herrick and Turner, '95, p. 82, Pl. XIII., Fig. 15.

Of medium size. Body elliptical, widest before the middle. Cephalothorax composed of six segments, the first two subequal and together somewhat longer than the remaining four. Third, fourth, and fifth segments subequal and together about equal to the first. Sixth segment slightly longer than any of the three preceding; not produced laterally. Abdomen flexed to the right, the first segment very short. Second segment the longest and about equal to the remainder of the abdomen

(furca included); produced on the right side into a slight semicircular process. Third segment and furcal rami subequal, each slightly longer than the fourth segment. Furcal rami very broad and delicately hairy within; armed at the outer apical angle with a short, sharp broad spine (the one on the right ramus the larger), and within this with three delicately plumose apical setae, the outer of which, at the base and for a considerable part of its length, is even broader than the spine but gradually tapers and ends in a delicate flagellum, while the other two setae are much narrower than the outer seta but about as long. At the inner apical angle is a much smaller delicate smooth seta. Abdomen of male much more strongly flexed to the right than that of female, composed of six segments (furca included), the second, third, and fifth produced on the right side. First segment short, about twice as broad as long. Second segment somewhat longer than the first, the process about as long as the segment is wide, with a smooth anterior margin and an irregularly serrate inner margin with a hooked tip. Third segment about as long as the first; process about as long as the segment, of nearly the same width throughout, the tip bluntly rounded and armed anteriorly with a hemispherical tuberculate cushion or pad, and on the posterior margin, almost opposite, with another similar process. Fourth segment slightly longer than the third, and unarmed. Fifth segment slightly shorter than the fourth and armed with two processes, the anterior of which is perfectly smooth, pointing forward and to the right, the posterior one pointing almost straight to the right, armed on the anterior margin with a number of large teeth (8—10), its posterior margin smooth at the tip but minutely denticulate for the basal three fourths. Furcal rami armed about as in the female but with no such difference in the width of the apical setae and with narrower spines.

Antennae 25-segmented, extending to the posterior margin of the fourth abdominal segment. Right male antenna slender, geniculate between the 18th and 19th segments; segments 19—21, and 22 and 23 ankylosed; antepenultimate segment without special armature.

Left fifth leg of male uniramous, three-segmented. First segment subquadrate, produced on the inner margin into a long, broad, strongly curved hook-like process about twice as long as the main part of the segment and armed at the tip with a broad blunt spine; provided at the outer apical angle with a rather stout hair or spine. Second segment about as long as the first but much narrower; margins parallel, the inner margin concave; usually unarmed but sometimes provided at the outer apical angle with a minute sharp spine. Third segment irregularly triangular in form and about one and a half times as long as the second, somewhat produced at the inner proximal angle; armed at the tip with a short broad spine, on the outer margin with three spines, dividing it approximately into thirds, and on the inner margin with a close row of long delicate hairs.

Right fifth leg uniramous, two-segmented. First segment irregular in form, the outer margin almost straight, the inner produced on the lower half into a large lamella or flat process*; usual seta at the outer apical angle wanting. The second segment consists of a broader basal and a narrower terminal part which is always flexed inward and upward; inner margin slightly produced at the tip.

Fifth leg of female uniramous, three-segmented. First segment barrel-shaped, armed at the outer apical angle with a delicate spine. Second segment about half as wide as the first and about three times as long as wide; armed at the outer distal angle with a minute spine. Third segment slightly narrower than the second and about one and a half times as long; armed on the outer margin with three spines (the upper two smooth, the lower one spinulose); on the apical margin with three spines (the outer two spinulose on their opposed margins and the inner one on both), and on the inner margin with one spine, spinulose on the inner margin.

Length of female 1.784 mm.; that of male 1.376 mm.

The above description was prepared from type specimens, from Dr. Forbes's slides, from specimens taken in the same

*In one or two specimens I thought I saw indications of several teeth, similar to those in *E. nevadensis*, but could not fully satisfy myself of their presence.

locality as the type,—Normal, Ill.,—and from other specimens collected at various times and places in Illinois, Indiana, and Michigan.

This species, the type of the genus, was first described in the "American Naturalist" (Forbes, '82a), and de Guerne and Richard, Forbes, Herrick, and Marsh have since published descriptions and figures. *Scopiphora vagans* Pickering is, as de Guerne and Richard, Herrick, and Marsh have said, probably identical with *Epischura lacustris*, but this can never be definitely determined since the following quotation is all that has been published concerning *S. vagans*.

"Genus *Scopiphora*, Pickering. Body small. Eye single, in the anterior margin of the shield. Antennæ large, and as long as in the preceding genus *Cyclops*, and has the same motions in the water. Abdomen terminating in two styles each with three setæ; a brush under the last or last three joints. Ovaries none. Legs spiny.

"*S. vagans* (Pickering) MSS."*

This is, of course, too meager a description upon which to establish a genus, and the writers mentioned above, as well as Dr. Schmeil ('98), have considered it insufficient and allowed Forbes's name to stand. Herrick explains the "brush" as some parasitic growth. May it not rather have been the fifth, and perhaps the fourth, pair of legs projecting straight backward under the abdomen which caused this appearance?

In the following three paragraphs are noted the points in which my observations differ from those of previous writers as shown by their descriptions and figures.

The abdomen of the male is very complicated in its segmentation, and in the original description (Forbes, '82a) was described as having processes on the second, third, fourth, and fifth segments. All figures published previous to the appearance of "A Preliminary Report on the Aquatic Invertebrate Fauna of the Yellowstone National Park, etc." (Forbes, '93), including those of de Guerne and Richard's "Revision," were incorrect. In Forbes's paper attention was called to the fact that the fourth segment was without a

* See Pickering, '44

process but that the fifth had two as in all the other species, and in the same year Marsh in his "Cyclopidae and Calanidae of Central Wisconsin" ('93), published the first correct figure of the abdomen, but seems to have been unaware of it, since in his "Cyclopidae and Calanidae of Lake St. Clair" ('95) he says, "Forbes has recently called attention to the fact that the fourth abdominal segment of the male is without a process and that the fifth bears two processes." His figure in this paper also ('95) is correct.

The armature of the fifth leg of the female is nowhere represented with exact correctness. The first segment is correctly figured by Forbes ('90) and by de Guerne and Richard in their "Revision," with a spine at the outer apical angle, but this is wanting in Marsh's figure ('95). The second segment is correctly shown in all the illustrations. The third segment, which has three outer spines, three apical ones, and one inner spine, is represented in all the figures without the upper spine on the outer margin. The armature of the spines themselves is nowhere correctly shown, the differences being evident by comparing the specific description with the drawings.

The left fifth leg of the male is usually represented with the outer apical angle of the first segment unarmed; de Guerne and Richard, however, figure this correctly. The second segment is often armed with a spine at the outer apical angle, but this is wanting in all of the figures; nor are the three spines on the outer margin of the third segment shown, there being in most cases only one but sometimes two. The right leg is correct in all the figures.

The spermatophore is very persistent, and a female is rarely found without one or several. In this species it is a long tube-like sac extending upward and to the left under the abdomen, differing considerably from the same appendage in *E. uccadensis*, in which it extends downward and backward, and when in position has somewhat the appearance of a keel. It is also much longer in *E. lacustris* than in *E. uccadensis*.

E. lacustris is quite common in the North Central States, being found in the deeper, clearer lakes in connection with *Limnocalanus macrurus* Sars, *Diaptomus sicilis* Forbes, *D.*

ashlandi Marsh, *D. pallidus* Herrick, or *D. siciloides*, *D. oregonensis*, and *D. minutus*, Lilljeborg, and sometimes with two or more of these species. It has been found in Illinois, Indiana, Ohio, Minnesota, Michigan, Wisconsin, and also at East Portland, Oregon.

DOUBTFUL SPECIES.

***Epischura fluviatilis* HERRICK.**

Epischura fluviatilis, Herrick, '83a, p. 381, Pl. V., Fig. 10-20.

Epischura fluviatilis, Herrick, '84, p. 133, Pl. Q, Fig. 14-16.

Epischura fluviatilis, Herrick, '87, p. 13, Pl. II., Fig. 21-24.

Epischura fluviatilis, de Guerne et Richard, '89b, p. 92, Pl. IV., Fig. 13, 20.

Epischura fluviatilis, Forbes, '93, p. 254 (foot-note).

Epischura fluviatilis, Herrick and Turner, '95, p. 83, Pl. XIII., Fig. 14-16.

Lamellipodia [*Epischura*] *fluviatilis*, Schmeil, '98, p. 183.

Of small size, body rather slender; color greenish blue. Cephalothorax imperfectly six-segmented. Abdomen three-segmented, differing in no way from that of *Diaptomus* except in the number of furcal setae. In the male the second abdominal segment bears on its left side a peculiar process consisting of two parts forming a clasping organ, the inner part of which is about as long as the third segment and armed at the apex with two small spines, the outer part being slender, curved, and about twice as long as the inner.

Antennae 25-segmented, extending somewhat beyond the end of the thorax. Right male antenna geniculate between the 18 and 19th segments; last six segments not ankylosed, enlarged portion not greatly swollen.

Swimming legs biramous, the outer ramus consisting of three segments, the inner ramus of one segment. Basal segments of the two legs fused beyond the last.

Fifth pair of legs of male uniramous, the two basal segments entirely fused. Right fifth leg three-segmented, the first two segments subquadrate and subequal, about three times as long as wide and entirely unarmed. Third segment slightly longer and broader than the second, tapering to a

blunt point and armed on the outer margin with three spines.

Left fifth leg very peculiar, consisting of a single lamelliform subcircular segment, armed on the flat surface with two opposable claws forming a forcipate structure.

Fifth pair of legs of female uniramose, three-segmented (two basal segments). First segment about twice as long as broad. Second segment narrower than the preceding and about twice as long; armed at about the middle of the outer margin with a spine. Third segment curved inward, somewhat longer and narrower than the second, ending in a sharp point, and armed on the outer margin with two spines dividing it approximately into thirds.

Mulberry Creek, Cullman county, Alabama.

Length, about 1.103 mm.

The above description was compiled from drawings and descriptions found in Herrick's writings (Herrick, '83a, '84, and '87, and Herrick and Turner, '95), since all attempts to obtain material from Cullman county, Ala., or from any other part of that State, were unsuccessful.

A brief discussion of the published figures and descriptions will not be superfluous in connection with a doubtful species. In the *American Naturalist*, Vol. 17 (Herrick, '83a), is published the original description of *E. gluviatilis*, and a figure representing apparently a ventral view of the last thoracic segment and abdomen, and the fifth pair of legs of the male. In this drawing the process on the third segment is on the right side, making it sinistral in the animal as Herrick says it is; but in his "List of Fresh-water and Marine Crustacea of Alabama" ('87) he gives another figure, which is just as apparently a ventral view of the same thing. In this latter figure, however, the process is sinistral, making it dextral in the animal, and also making the left leg three-segmented and the right leg one-segmented. Two other figures (Herrick, '84 and Herrick and Turner, '95) also show the process on the right side, but there is nothing to indicate whether they are dorsal or ventral views.

Now, in regard to the synonymy. If the process is on the left side, as is maintained in all of Herrick's descriptions, this

species cannot belong to the genus *Epischura*, as has already been pointed out by Forbes ('93, p. 254) and Schmeil ('98), since the process cannot be homologized with the similar process in *Epischura* proper. If, however, the process is dextral, as shown in three out of the four figures published, it might be more easily homologized with the process in the other species of the genus. It would also be more likely that the left leg was three-segmented and the right one especially modified into a clasping organ if *E. glacialilis* belonged to this genus, although even then the fact that the second segment of the left (right?) leg is not at all produced inwardly and the structure of the right (left?) leg is radically different would present difficulties. The fifth legs of the female are very similar to those of *Epischura*, but partake slightly of the characters of *Heterocope*. Schmeil says ('98) that, judging from analogy with other genera, there is one basal segment too many in the fifth pair of legs of both sexes. Herrick, in the "American Naturalist" (Herrick, '83), gives a drawing of a swimming leg of *E. glacialilis*, with its one-segmented inner ramus, which, if the upper, incomplete part shown is to be regarded as another segment, certainly gives it, as Schmeil says, one too many segments. If, however, it is an adhering part of the thoracic segment, it will differ from a swimming leg of *E. lacustris* only in that in *lacustris* the first basal segments instead of being fused their entire length, as in *glacialilis*, are fused for about the basal two fifths only. The fifth legs of both sexes are similar in arrangement to the above, although on account of the absence of an inner ramus it is less evident. I believe that the appendage figured at the outer apical angle of the furca is intended for a spine, rather than a seta as Schmeil supposes it to be. From this it will be seen that the drawings and descriptions conflict, and Dr. Schmeil was perhaps justified in proposing to establish a new genus, *Lamellipodia*, to receive this species. It seems to me, however, that it would be better to wait until material collected in the same locality and described and figured by a more careful observer has determined whether or not this species is a good one, and I have hesitated, therefore, to adopt a new name for a form the description of which, to use Marsh's words in regard to *Scopiphora vagans* Pickering, "is manifestly inaccurate in some particulars, and may be in all."

ADDITIONS TO THE BIBLIOGRAPHICAL LIST
PUBLISHED IN ARTICLE III.*

Birge, E. A.

'97. The Vertical Distribution of the Limnetic Crustacea of Lake Mendota. *Biol. Centralbl.*, XVII. Bd., pp. 371-374; Abstract, *Zool. Centralbl.*, IV. Jahrg., No. 18 u. 19, pp. 606, 607.

Erlanger, R. v.

'97. Über die Chromatinreduktion in der Entwicklung der männlichen Geschlechtszellen. *Zool. Centralbl.*, IV. Jahrg., No. 8, pp. 265-278.

Forbes, S. A.

'85. On the Food Relations of Fresh-Water Fishes: a Summary and Discussion. *Bull. Ill. State Lab. Nat. Hist.*, Vol. II., Art. VIII., pp. 475-538.

Frič, A., und Vávra, V.

'97. Untersuchungen über die Fauna der Gewässer Böhmens. III. Untersuchung zweier Böhmerwaldseen, des Schwarzen Sees und des Teufelsees. *Arch. d. naturw. Landesdurchf. v. Böhmen*, Bd. X. 74 pp., 33 Fig.; Abstract, *Zool. Centralbl.*, V. Jahrg., No. 5, pp. 158, 159.

Fuhrmann, O.

*'97. Recherches sur la faune des lacs alpins du Tessin. *Rev. suisse de Zool.*, T. XV., pp. 489-543.

Loude, Ad.

*'92. Notatki Karcynologiczka. *Kosmos* (Lemberg) T. 17, pp. 113-148, 561-565. (*Filed* Steuer, '97a.)

Richard, J.

'96. Sur la faune de quelques lacs élevés du Caucase d'après les récoltes de M. Kavraisky. *Bull. de la Soc. zool. de France*, T. XXI., pp. 183-185.

Schacht, F. W.

'97. The North American Species of Diaptomus. *Bull. Ill. State Lab. Nat. Hist.*, Vol. V., Art. III., pp. 97-207, Pls. XXI-XXXV.

Scott, Th.

*'98. *Diaptomus hircus* G. S. Brady, in Loch Lochy, Mouness. *Ann. Scott. Nat. Hist.*, Jan., 1898, p. 55.

Scott, Th., and Duthie, R.

*'97. An Account of the Examination of some of the Lochs of Shetland. Fifteenth Ann. Rep. Fisheries Board. for Scotland, pp. 327-333.

*All articles except those marked with an asterisk are in the Library of the State Laboratory of Natural History or in that of the University.

Scott, Th., and Scott, A.

- '97. Notes on *Smarestes pygmaei* Hesse, and some other rare Crustacea. Ann. Nat. Hist., Vol. 20, pp. 489-494. 2 Pls.

Steuer, A.

- '97. Copepoden und Cladoceren des süßsen Wassers aus der Umgebung von Triest. Verhandl. d. k.-k. zool.-bot. Gesellsch. Wien. Jahrg. 1897. 16 pp., 1 Pl.
- '97a. Ein Beitrag zur Kenntniss der Cladoceren-und Copepodenfauna Kärntens. Verhandl. d. k.-k. zool.-bot. Gesellsch. Wien. Jahrg. 1897. 49 pp., 6 Fig.
- '97b. Liste aller bisher in Kärnten gefundenen Cladoceren und Copepoden. "Carinthia" II., Nr. 4. Klagenfurt.

Székely, B.

- *'82. Tanulmányok a *Diaptomus* petefejlődésének első phásisairól a blastoderma fellépéséig. Kolozsvár, 1882. (Fide Steuer, '97a.)

INDEX.

(Synonyms in italics)

- Calanus, 237.
 Canthocamptus, 225.
 Centropages, 244.
 hamatus, 244.
Centropages, 235.
 grimaldii, 238, 242.
 Centropagidae, 225, 227, 244.
 Copepoda, 225, 227, 228.
 Cyclops, 225, 234, 235, 263.
 Diaptomus, 225, 226, 227, 228, 230,
 234, 235, 236, 237, 250, 265.
 ashlandi, 260, 265.
 minutus, 260, 265.
 oregonensis, 229, 265.
 pallidus, 265.
 sanguineus, 234.
 sicilis, 229, 264.
 siciloides, 229, 265.
 Entomostraca, 225, 228.
 Epischura, 225, 226, 227, 228, 237,
 249, 267.
 fluviatilis, 226, 250, 265.
 lacustris, 228, 229, 249, 250, 251,
 252, 254, 255, 256, 260, 267.
 nevadensis, 229, 249, 250, 251,
 254, 255, 256, 262, 264.
 nevadensis-calumbia, 256, 258,
 259.
 Epischura—*Continued*.
 nordenskiöldi, 249, 250, 251,
 252.
 Eurytemora, 225.
 herdmani, 226.
 Heterocope, 225, 267.
Lamellipodia, 267.
 fluviatilis, 265.
 Limnocalanus, 225, 226, 227, 228,
 235.
 grimaldii, 226, 229, 236, 239, 243.
 macronyx (?), 226.
 macrurus, 226, 227, 229, 235, 236,
 237, 238, 264.
 macrurus-auctus, 239, 244.
 sinensis, 226, 229, 235, 236, 237,
 238, 245.
 Osphranticum, 225, 226, 227, 228,
 229, 234, 235, 237.
 labronectum, 227, 230.
Potamoichator, 229, 230.
Potamoichator, 229.
 fucosus, 230, 233.
Temora, 225.
 affinis, 225.
Temorella, 225.
 affinis, 225.
Scopiphora, 249, 263.
 vagus, 260, 263, 267.



SEP 20 1898

BULLETIN

7710

OF THE

ILLINOIS STATE LABORATORY

OF

NATURAL HISTORY,

URBANA, ILLINOIS.

VOLUME V.

*ARTICLE V.—PLANKTON STUDIES. II. ON PLEODORINA
ILLINOISENSIS, A NEW SPECIES FROM THE PLANK-
TON OF THE ILLINOIS RIVER.*

BY C. A. KOFOID, PH. D.

Illinois State Laboratory of Natural History,
URBANA, ILLINOIS,
September, 1898.

STATE LABORATORY OF NATURAL HISTORY.

LABORATORY STAFF.

Professor STEPHEN ALFRED FORBES, PH. D.,
Director of State Laboratory and State Entomologist.

CHARLES ARTHUR HART,
Systematic Entomologist and Curator of Collections.

FRANK SMITH, A. M.,
Assistant Zoölogist.

CHARLES ATWOOD KOFROID, PH. D.,
Zoölogist, and Superintendent of Biological Station.

ERNEST BROWNING FORBES, B. S.,
Entomological Assistant.

WALLACE CRAIG, B. S.,
Zoölogical Assistant.

MARY JANE SNYDER,
Secretary.

HENRY CLINTON FORBES,
Business Agent and Librarian.

LYDIA MOORE HART,
Artist.

ARTICLE V.—*Plankton Studies. II. On Pleodorina illinoisensis, a New Species from the Plankton of the Illinois River.* By C. A. KOFOLD.

The genus *Pleodorina* was discovered in 1893 by Shaw ('94) at Palo Alto, California, and in May of the following year the species *Pleodorina californica*, upon which the genus was founded, was detected by Mottier ('94) in water from a shallow stagnant pool near Bloomington, Indiana. During the same summer the form also occurred in the Illinois River and its adjacent waters (Clinton, '94), and it has been found in the plankton of these situations in succeeding years from June to September. The distribution of the species in this continent is thus quite extended, and it is not at all improbable that continued investigation of fresh-water plankton will demonstrate that this genus has a cosmopolitan distribution similar to that of some other genera of the family *Volvocineæ* to which it belongs.

On June 16, 1898, a form which may be referred to the genus *Pleodorina* was found in the Illinois River in water entering the stream in large part from Cook's Slough and Quiver Lake. Owing to high water (ten feet above low-water mark) prevailing at the time, a considerable portion of the habitat of the form in question consisted of submerged territory, with shallow warm water abounding in growing aquatic and semi-aquatic vegetation.

This *Pleodorina* could not be found in Quiver Lake collections made on the 7th of June, but on the 16th it was present in the river in small numbers, increasing until the 20th, when a maximum was reached. From this time the numbers decreased until the 27th, when, following a rise in the river, the species seemingly disappeared entirely from the plankton. It was also found sparingly in Thompson's Lake during this period, a large area of slightly submerged territory being at this time tributary to the lake.

Associated with this species in great abundance was *Eudorina elegans*, in all stages of asexual reproduction, and *Pseudorina morum* was also present in smaller numbers and in like

condition. *Volvox*, *Englena*, *Phacus*, *Lepocinclis*, *Trachelomonas*, *Dinobryon*, *Synura*, *Mallomonas*, *Uroglena*, *Melosira*, and *Fragillaria* occurred in varying frequency, but only a single specimen of *Pleodorina californica* was found in collections containing the species described in this paper. The animal plankton was represented in the main by rotifers, *Polyarthra* being most abundant, while *Synchaeta*, *Euchlanis*, *Pterodina*, *Brachionus*, and *Anuraea* were also present. *Difflugia*, *Codonella*, *Bosmina*, *Cyclops* and nauplii complete the list of the more common associates of this *Pleodorina* in the plankton.

Pleodorina illinoisensis n. sp.

The species here described consists of an ellipsoidal conobium or colony of 32, rarely 16 and still more rarely 64, biflagellate cells. The shape is quite constant, occurring in the youngest colony and continuing throughout the asexual cycle until the daughter colonies abandon the gelatinous matrix of the maternal organism. Among the large number examined only a few specimens were seen which approached a spherical form. Measurements of twelve seemingly full-grown colonies from material freshly killed in 2% formalin showed a range of 101 to 137 μ in long diameter, and an average of 113 μ . The transverse diameter ranged from 84 to 102 μ , and averaged 94 μ . Individuals in which the gonidia have begun to divide show a considerable swelling of the hyaline gelatinous envelope. One specimen containing 2- and 4-cell stages measured 178 \times 155 μ , and when the young colonies are ready to escape, the parent may measure as much as 200 \times 175 μ . At the time of escape the young colonies measure 46 \times 38 μ . The measurements of the colonies approach very closely those given by Bütschli ('80-'89, p. 840) for *Eudorina*; viz., 100-150 μ ; and the colonies of this genus found in association with the form here described exhibit dimensions almost, if not quite, identical with those above recorded for the *Pleodorina*.

The colony (Pl. XXXVI., Fig. 1) contains, as a rule, 32 cells arranged, as Henfrey ('56) first noted for *Eudorina*, in

five circles, two of which are polar and contain four cells each, while eight cells are found in each of the remaining three circles, one of which is equatorial and the other two lie between the latter and the polar circles. The cells resemble those of *Eudorina* in that they are situated in the periphery of the hyaline gelatinous matrix and are not closely crowded together, the degree of separation depending upon the age of the colony and varying considerably in different cases. Their inner ends do not approach the center of the colony as is the case in *Pandorina*. No trace of any protoplasmic connection between the cells of a colony could be detected in the living organisms, nor in material killed in formalin or in chromo-acetic acid and afterwards stained in fuchsin, hematoxylin, or Bismark brown. Specimens treated by Zograf's method (1% osmic acid followed by 4% crude pyroligneous acid) or by 1% osmic acid followed by picrocarmine, showed no connection between the cells.

The colony is surrounded by a common gelatinous sheath (*sh.*) increasing in thickness (3.5 to 12 μ) with the age of the organism. This membrane or sheath is of equal thickness in all regions and consists of two parts: an outer, thin, denser, more highly refractive layer (*o.l.*); and an inner homogeneous one (*i.l.*), which shows no traces of the concentric structure found in *Pandorina*. It is within this latter layer that the increase in thickness takes place in the older colonies. It is limited centrally by a thinner and less highly refractive layer (*m.m.*) which encloses the common matrix (*m.*) in which the cells of the colony lie. Frequently among the older organisms there occur upon the posterior end of the colonies blunt, pseudopodia-like protuberances (Pl. XXXVI., Fig. 4) of the sheath, of irregular form and of no constant number. Their position and the fact that they are often, though not always, found in old colonies from which some of the daughter colonies have already apparently escaped, suggest that they may mark the place of exit of the young individuals from the parent. Similar protuberances were observed upon *Eudorina* and *Pandorina*, under similar conditions, in the collections in which the *Pleodorina* under

discussion was found. Wills ('80) found that the daughter colonies of *Volvox globator* escaped through a rift in the posterior hemisphere of the parent, and Klein ('89) observed the same phenomenon in *Volvox aureus*. The escape of the daughter colonies in *Pleodorina* has not been observed by me.

The sheath stains deeply in an aqueous solution of methylen blue, more deeply, in fact, than the enclosed matrix, the outer layer taking the deeper stain. It also shrinks to about one fourth its former thickness. This shrinkage, together with that of the central matrix, causes the sheath to wrinkle along lines which bound hexagonal areas from whose centers the cells now project, thus giving the appearance of a division of the surface of the colony into regular polygons. The sheath shows no trace of the layer of radial rod-like structures found by Klebs ('86) in *Pandorina*, but iodine or methylen blue demonstrates a finely granular condition like that described for *Eudorina*. The sheath is traversed by the pairs of flagella which arise from the outer ends of each of the cells.

The matrix (*m.*) is a gelatinous substance of some consistency, filling the colony inside of the inner membrane. In the living colonies, in those which were killed in the various reagents mentioned above and afterwards stained, and in disintegrating material, no traces of any divisions can be detected in this substance that are not due to wrinkling caused by shrinkage. Methylen blue or iodine causes the matrix to show a faintly reticulated or vacuolated appearance due to different densities of staining. That the substance of the matrix has considerable consistency even in the swollen condition found in the maternal colonies, is shown by the fact that the flagella of the young forms, before rotation begins, can be seen to penetrate the matrix of the parent very slowly. Their ends are often blunted or even knob-like and their lateral motion is very limited. The movement of the young colonies through the matrix is a very slow and gradual one, showing the gelatinous consistency of the substance in which they are imprisoned.

The striking feature in the structure of this species, as in the case of *P. californica* (Shaw, '94), is the presence of two

distinct types of cells in the colony (Pl. XXXVI., Fig. 1), the vegetative (*v. c.*) and the gonidial (*g. c.*) cells. The presence of these two types of cells at once places this new species in the genus *Pleodorina* rather than in *Eudorina*—which it otherwise closely resembles.

The vegetative cells (*v. c.*) are four in number and constitute the anterior polar circle, being always directed forward in locomotion, as in the other species of the genus. Their number remains the same in the smaller colonies of sixteen cells and in the larger ones of sixty-four. The diameter of these cells ranges from 9.5 to 16.8 μ , twelve cells averaging 12.25 μ . The size of these cells varies even in the matured colonies, measurements at this stage ranging from 9.6 to 15.6 μ . At birth the cells of the young colonies vary in diameter from 3.5 to 5 μ in different parents. In the daughter colonies while still in the maternal matrix, no distinction in size between the vegetative and gonidial cells can be detected, nor can this distinction be made in the younger free-swimming colonies, it being thus impossible at this stage to distinguish the young *P. illinoisensis* from the similar stages of *Eudorina elegans* with which they were associated. When the young colonies have attained dimensions of $46 \times 38 \mu$, the vegetative cells measure 4 μ and the gonidia 4.8 μ . A like similarity between the two kinds of cells in the young colonies exists, according to Shaw ('94), in *P. californica*.

In structure the vegetative cells (Pl. XXXVI., Fig. 2) are in most particulars similar to the gonidia, described below. They sometimes appear to be a trifle lighter green in color—a difference which may be due to their smaller size. The principal differences lie in the smaller number of pyrenoids and the larger size, both absolute and relative, of the stigma or eye-spot.

As to the fate of the vegetative cells, the evidence at hand is insufficient and conflicting. In three colonies in which the daughters were moving about in the maternal matrix, some having already escaped, the vegetative cells showed very evident signs of degeneration, the contents being

shrunken and irregular. In the larger number of instances of this stage under observation the cells appeared normal, showing no trace of degeneration or division. In one instance only have I found a specimen in which the vegetative cells had divided beyond question. This was a colony in which the gonidia had completed their division but had not escaped. Three of the vegetative cells were in the two-cell stage and one was undivided. In two instances matured colonies have been found in which four smaller daughter colonies (of eight and sixteen cells respectively) were present at one pole.

The gonidial cells (Pl. XXXVI., Fig. 3) constitute the remainder of the colony. They usually number 28, rarely 12 or 60, and occupy the parts behind the anterior polar circle of vegetative cells. These cells in most instances can be easily distinguished by their larger size. In form they are spherical, though some specimens in preserved material are slightly flattened on their inner ends. In diameter they range in seemingly full-grown colonies from 15 to 25 μ , averaging in twelve specimens 19.2 μ . Their dimensions just before their division, that is in colonies in which division has begun, also show the extreme range quoted above, the smaller diameter having been found in a sixteen-cell colony. As a rule the gonidia are all of the same size, but occasionally specimens have been found in which one or more dwarf cells occur among them. These are irregular in their distribution and can be distinguished at once from the vegetative cells by their position. Similar dwarf cells were found in both *Paudorina* and *Eudorina*. In matured colonies gonidial cells are frequently found which fail to divide. The gonidia are of a light green color, a trifle darker than the vegetative cells. Their color in general is similar to that in *Eudorina*, and is somewhat lighter than that in *Volvox* and *Paudorina*, with which they are associated.

A distinct cell membrane (*c. m.*) is found about each of the cells. In the living condition and in the material preserved in formalin it forms a highly refractive hyaline layer, about 1 μ in thickness, outside of the green contents of the cell. It stains very faintly in hematoxylin and assumes a deep brown

faint with long-continued action of iodine and sulphuric acid. In the case of diseased colonies hereafter mentioned the cell membranes persist, often retaining their original form and shape, after the entire disappearance of the contents.

The greater part of the cell contents consists of what seems to be one large chromatophore (Pl. XXXVI., Fig. 2, *chr.*), which occupies all of the cell except the centrally placed nucleus with its enveloping protoplasm, and a slender column (*p. c.*) passing from this region to the anterior end of the cell. In many cells a faintly marked notch or furrow (*fu.*, Fig. 1) is to be detected on one side of the chromatophore at the anterior end of the cell. This seems to mark the line of contact of the sides of the chromatophore which has surrounded the nucleus. In the 2- and 4-cell stages of the gonidial cells the nucleus and the protoplasmic mass are plainly seen to occupy one side of the cell (Pl. XXXVII., Fig. 7, 8), but in the cells of the young colony it again occupies a central position. The chromatophore is uniformly of a bright chlorophyll-green, and shows a finely granular structure under high magnification. In the youngest colonies each cell contains but a single spherical pyrenoid (*pr.*), which occupies a lateral position in the chromatophore, in the inner hemisphere of the cell. In the older colonies the number of pyrenoids increases, as many as twelve having been found. They are scattered irregularly through the chromatophore, and may occur in any part of it. A similar increase of pyrenoids is reported by Shaw ('94) for *P. californica*. In the vegetative cells the number of pyrenoids is often but 2-4, and is, as a rule, less than that of the gonidial cells. In a very few instances as many as eight have been found, and in one old colony the vegetative cells seemed to be packed full of pyrenoids. In the young colonies the pyrenoids have a diameter of about 1 μ , and in the older colonies of 2.5 μ .

The nucleus (*n.*) lies in about the center of the cell in the midst of a mass of protoplasm enclosed by the chromatophore. In mature gonidial cells before division it has a diameter of 7-8 μ , and contains a sub-central nucleolus (*ncl.*) whose diameter is 3 μ . The nucleolus stains deeply with picro-

carmine, and is by this means easily distinguished from the pyrenoids, which it resembles in appearance and size. The nuclear membrane is detected with difficulty. It encloses a faintly stained nuclear reticulum (*r.*). In the younger cells the nucleus is much smaller (4-5 μ), the nucleolus is relatively larger, and the reticulum is not evident. In the living cell the nucleolus alone can be seen in the midst of the grayish protoplasmic mass at the center of the cell. The protoplasm is continued from this central region peripherally, in the axis of the cell as a slender column (*p. c.*), to the anterior end, where it includes the stigma and bases of the two flagella. A protoplasmic mantle enclosing the chromatophore was not demonstrated.

The stigma or eye-spot (*s.*) lies at the anterior end of the cell, near its axis, and is often so placed that an equilateral triangle may be drawn with it and the bases of the two flagella as apices. It is of a bright reddish brown color, though in some of the posterior cells the color is often very faint, giving the stigma the appearance of a slightly tinged oil-globule. It is of an elongated hemispherical shape when seen from the side, and has a circular outline when seen from above. Its upper end often projects slightly so as to elevate the cell membrane. The application of killing agents and alcohol soon removes its color, and even in formalin this fades out in the course of a few days, leaving merely a colorless, highly refractive structure. The larger stigmata have a diameter of 2.5 μ and a depth of 2.8 μ , and are to be found in the cells in the anterior part of the colony, especially in the four vegetative cells of the anterior polar circle. Posteriorly the stigmata are less prominent, and are often not to be found at all as brightly colored spots but merely as pale globules whose position alone affords a clue to their real character.

This specialization of the stigmata in the anterior end of the colony occurs also in *Eudorina*, *Pandorina*, and *Volvox*, and Shaw ('94) states that in *P. californica* the stigmata, which are present in the posterior part of the young colonies (in gonidial cells), become less conspicuous and disappear as the colony enlarges and the differentiation of the cells pro-

ceeds. This prominence of the stigmata in the anterior end, together with the facts that this end is always directed foremost in locomotion and that the species showing this differentiation are positively phototactic in the vegetative condition when the differentiation is prominent, all point toward the participation of the stigmata in the function of light perception. An interesting phenomenon occurs at the time of the division of the gonidia, for the stigma of the mother cell persists and is passed on through the five successive cell divisions to the outer end of one of the cells of the daughter colony, situated in the margin of the cup which arises from the plate of cells and closes to form the ellipsoidal daughter colony. Inasmuch as this cup always closes from the inside out, that is with the opening directed outward, it is evident that the stigma must traverse the distance between the outer end of the mother cell and its inner end, which corresponds to the outer ends of the cells of the daughter colony. New stigmata arise in the cells of the daughter colony, but being at first very small are thus quickly distinguishable from the persisting stigma. The ultimate fate of this persisting stigma has not been traced.

No contractile vacuole was observed in the living cells, and careful search with a Zeiss $\frac{1}{2}$ -inch oil-immersion lens for this structure in preserved and stained material has led to no positive identification of a vacuole. The bleached stigma and what seem to be the enlarged bases of the flagella are the only areas discernible in the anterior end of the cell which at all resemble a contractile vacuole. Shaw ('94) finds in picro-nigrosin material a single vacuole in the anterior end of the young cells of *P. californica*.

The flagella (*f.*) are two in number for each cell, and unite with the cell at the anterior end adjacent to the stigma. The two flagella have the same proportions, and in adult colonies they measure 40 μ in length. In the young colonies they are relatively longer. They are visible on the young colonies shortly after the cup closes, and persist upon the maternal colony during the early divisions of the gonidia.

The locomotion of the colonies of *Pleodorina illinoisensis*

is of the type prevailing among other spherical or ellipsoidal genera of the *Volvocineæ*; viz., rotation about the principal or long axis of the colony, either from right over to left or the reverse, frequently with one direction predominating, progression being usually along the line of the axis, the same end of the colony always leading. In *P. illinoisensis* the vegetative pole always leads in locomotion in horizontal, oblique, and vertical movements, and is therefore the anterior pole of the colony. Under normal conditions, when under observation, this species is rarely quiet during the period of growth. While still within the matrix of the mother colony the ceaseless rotation with its frequent reversals begins. Colonies in the life cell, while favorable conditions prevail, can be seen in active movement, jostling one another and their neighbors in their seemingly aimless wanderings. When an object is met which does not yield to their persistent rotation, their movements may slacken for a time to be resumed shortly in some line of less resistance. The rotation of this species is prevailingly from right over to left as the following tables show, which indicate the number and direction of the reversals of rotation in ten individuals in one minute.

Direction	1	2	3	4	5	6	7	8	9	10	Total
Right over to left . .	2	1	1	2	1	2	1	5	4	3	22
Left over to right . .	2	0	0	1	1	2	1	4	3	2	16

A few days later a second set of observations was made with the following result:

Direction	1	2	3	4	5	6	7	8	9	10	Total
Right over to left . .	3+	5±	3±	3±	4+	3+	5+	3+	2+	4+	35
Left over to right . .	2-	5±	2±	3±	3-	3-	5-	2-	2-	3-	30

In the majority of instances where the direction of rotation was observed it was from right over to left, the ratios being 22 to 16, and 35 to 30. These tables give some idea of the frequency of change in direction and its variation in different individuals, but do not show the duration of the directions of

rotations. This is indicated in a general way in the second table by the plus and minus signs, which show the direction in which the rotation was of longer and shorter duration. In conclusion it may be said that both directions of rotation occur, though that from right over to left is more frequently met with, or, in other words, is of longer duration.

With regard to locomotion in *P. californica*, Shaw ('94) says that "the movement of the plant in the water was followed in the case of a few individuals bearing well-developed gonidia. In swimming through the water the vegetative pole is directed forward and the plant revolves to the right (in observed cases) on the axis connecting the vegetative and reproductive poles. The path is parallel to this axis in upward vertical as well as in horizontal movement." The polarity of this genus thus expressed physiologically in the movements of the colony is accompanied by a corresponding structural differentiation of the cells composing the organism.

In *Gonium*, according to Fresenius ('56), the motion of the colony resembles that of a wheel, progression taking place in the line of the axis of rotation. According to Bütschli ('83-'87, p. 858), locomotion is accomplished by the rotation of the plate-like colony around its shorter axis, the direction of rotation being to the right in some individuals and to the left in others. Pfeffer ('84), on the other hand, describes the rotation during the forward movement as alternately from the right and the left. Migula ('90) calls attention to the wavering, often backward, and irregular movements of this genus, and also notes its rotation about an axis through the middle of the colony. This rotation is either to the right or to the left, no predominance being mentioned. Polarity is thus marked in the activity of the *Gonium* colony, though not expressly marked in its structure except as it appertains to the individual cells.

In *Stephanosphaera* the polarity in structure is but slightly marked in the colony, being indicated in some colonies by the asymmetrical position of the cells, but there is a physiological differentiation in that one pole of the colony leads in locomotion. In this genus also, according to Colm ('52), the

rotation is in either of the two directions and is subject to frequent change. No predominant direction was noted by him.

In *Pandorina* the only structural expression of polarity is found in the greater development of the stigmata in the cells in the anterior end of the colony. In other particulars the poles are not differentiated. Braun ('51) maintains that in this genus the rotation is constantly around the long axis of the colony in the direction of the hands of a clock, when the motion is toward the observer. Nägeli (*vide* Bütschli, '83-'87, p. 858), on the other hand, observed rotation in both directions. My own observations upon *Pandorina morum* show beyond question that the direction of rotation is not constant, as the following table demonstrates.

Direction	1	2	3	4	5	6	7	8	9	10	Total
Right over to left.	6+	12+	5±	1-	2±	3±	7±	1+	1+	3±	41
Left over to right.	6-	12-	4±	2+	2±	4±	6±	2-	1-	3±	42

The table gives the direction and number of changes in direction in rotation of ten colonies, each observed for one minute. The plus and minus signs indicate the estimated predominance in duration. According to the table the instances of direction observed are approximately equal for the two directions, though that from right over to left showed the greater duration. The younger and smaller colonies showed much the greatest activity and exhibited more frequent changes in direction than the older colonies. In all observed cases the same end continues to lead in locomotion, physiological polarity being thus fully developed in this genus.

In the case of *Eudorina* the structural polarity of the vegetative colonies is no more marked than it is in *Pandorina*, though according to Carter ('58) there is in the monœcious sexual colony a differentiation, in that the four cells at one pole divide to form spermatozoa, while the remaining twenty-eight become egg-cells. It should be noted in this connection that no such colonies were observed by Goroschankin ('75) in the sexual generation. The literature at hand presents no

precise statement as to locomotion in this genus. As observed by me, it closely resembles that described above for *Pleodorina illinoensis*; viz., rotation around the long axis of the colony, the same pole constantly leading in progression. The direction of rotation is frequently reversed, though it was predominantly from right over to left in the cases observed. A functional polarity thus exists in this genus.

In *Volvox*, according to Klein ('90), there is a polar differentiation as regards the stigmata that is even more marked than it is in the genera previously mentioned. He finds that the cells of the pole directed forward in locomotion each possess a stigma which is especially large and intensely colored; that the color fades out and the stigmata become smaller and paler as the equator is approached; and that beyond this they are usually represented merely by a colorless oil-drop, which in some cases may even disappear. The posterior hemisphere is also marked by the development there of the gonidia, as was first shown by Colm ('56), and occasionally ellipsoidal colonies are found whose long axis connects the anterior and posterior poles. Locomotion in *Volvox* is accomplished, as elsewhere in the family, by the rotation of the colony about its principal axis. Wills ('80) observed the predominance of the rotation to the right and its occasional brief reversal. Klein ('89) states that this preference is found in *V. globator*, but that it is not shown by *V. aureus*. In this latter species the changes are frequent and are often separated by a brief pause. Backward motion is rarely seen and lasts but a short time. In the case of *Volvox* the axis of rotation is slightly oblique, the center of the colony remaining in the line of progress, but the axis of rotation being inclined from above the line at the anterior pole to below it at the posterior one.

We thus find that *Pleodorina illinoensis*, which exhibits both a structural and physiological polarity, shares with most, if not all, of the genera of the family to which it belongs, the physiological differentiation which is expressed in locomotion, and also, in observed cases, exemplifies the extreme form of a predominance of rotation in one direction.

We also find that the structural differentiation shown in the decadence of its posterior stigmata obtains in varying degrees in the other spherical and ellipsoidal genera of the family—least in *Pandorina*, most in *Volvox*. The genus *Pleodorina* agrees with *Volvox* in having a structural polarity based upon the division of the colony into vegetative and gonidial regions, but the differentiation is simpler. Of the two species of *Pleodorina*, the one here described exhibits the simplest possible differentiation of the colony consistent with the symmetry of the organism; viz., the differentiation of the anterior polar circle of four cells as vegetative members of the colony. Of the two species of the genus it thus stands nearer *Eudorina*, while its sister species *P. californica* approaches more closely to *Volvox* both in the number of cells and in the extent of the differentiation.

The discovery of this additional species of the genus *Pleodorina* thus supports the opinion expressed by Shaw ('94), who founded the genus, that it was intermediate between *Eudorina* and *Volvox* but nearer the former. Judging merely from the asexual stage, *P. illinoisensis* affords additional evidence of the close relationship of *Pleodorina* and *Eudorina*.

Throughout the preparation of this paper the writer has had constantly in mind the possibility that the form here described is merely a stage in the life cycle of *Eudorina*. A number of facts lend support to this hypothesis: (1) the occurrence of *Pleodorina illinoisensis* with *Eudorina elegans*; (2) their marked similarity, aside from the four vegetative cells, in structure and measurements; (3) the impossibility of separating the youngest free-swimming colonies of the two forms; (4) a considerable variation in the size of the vegetative cells in *Pleodorina*, grading toward the condition in *Eudorina*; (5) some evidence that in certain cases at least the vegetative cells may divide, one case of a 2-cell stage having been seen in the hundreds, if not thousands, of specimens examined, and one instance noted in which a maternal colony containing thirty-two daughter colonies had at one pole four colonies which were slightly smaller than the remaining twenty-eight; and (6) the occur-

rence of pleomorphism in the family *Volvocineae*, Klein ('89 and '90) citing no less than twenty-four "combinations" in the case of *Volvox aureus*. It may then be that the form here described as *Pleodorina illinoensis* is only a "Pleodorina stage" of *Eudorina*.

The abrupt disappearance of this supposed new species from the plankton prevented the carrying out of breeding experiments designed to test its validity, and it seems that the matter must remain undecided for the present. In the absence of satisfactory proof that the form here described is but a phase of the life cycle of *Eudorina* it has seemed best to the writer to make the above suggestion and to take the only course open in publication, namely, the description of the form as a new species, inviting the criticism of subsequent investigation. The dilemma here presented is by no means an isolated one in plankton work, nor is it new to the family *Volvocineae*: witness the long confusion which existed over the two species of *Volvox*, *aureus* and *globator*, which has been at last cleared up by the excellent work of Klein ('89, '89a, '90) and Overton ('89). Another instance is often presented when *Pandorina* and *Eudorina* both occur in the same collections and the plankton statistician must decide to which genus each specimen observed must be referred. Typical specimens of each can be found, but all individuals do not conform to the type, or they may present conditions in which the conformation is obscured by some phase of the life cycle.

The asexual reproduction of *Pleodorina illinoensis* (Pl. XXXVII.) resembles that of other species of the genus in that it is accomplished by the repeated division of the gonidial cells, resulting in the formation of daughter colonies in the maternal matrix. These escape later from the parent organism, and by growth attain the adult condition with the differentiation of the four vegetative cells. Five successive cell divisions, pervading all the cells of the parent organism except the vegetative cells, are necessary for the completion of the process, and result in the 2-, 4-, 8-, 16-, and 32-cell stages of the forming colonies. The first two of these divisions result in the formation of a quadrangular plate of cells—a form which is retained

through the two succeeding divisions, which produce the 8- and 16-cell stages. The cupping of this plate, which results in the formation of an ellipsoidal colony, is apparent as early as the 4-cell stage (Pl. XXXVII., Fig. 9) and continues through the later stages (Fig. 11, 13), so that by the time the 16-cell plate is formed it has almost the curvature of a saucer. With the formation of thirty-two cells the closure of the cup proceeds and is soon completed. The orifice of the cup is directed outward in all cases, and thus the ends of the cells of the daughter colony which are formed from the *outer* end of the maternal gonidial cell come to lie in the inner side of the cup, and are the *inner* ends of the cells of the daughter colony. In the matured colonies the young usually lie with their long axes parallel to the surface of the parent. I have not, however, been able to identify the point of closure of this cup with this region or positively with any other.

The sequence and position of cleavage planes which produce the quadrangular plate of the 16-cell stage is, in the main, similar to that described by Goroschankin ('75) and Braum ('75) for *Eudorina* and *Volvox*. Beyond this stage there is some doubt as to the agreement. A full discussion of the subject is beyond the scope of the present paper, for which the following brief description must suffice. The first cleavage plane (I) divides the gonidial cell into two hemispheres along the axis of the cell, and the daughter nuclei, with the surrounding protoplasm, are placed close together in the center of the opposing faces of the new cells (Pl. XXXVII., Fig. 7). The second plane (II) is at right angles (Fig. 8-9) to the first and also passes through the regions representing the axis of the ancestral cell. In this instance also the nuclei are gathered near the center of the young colony, which exhibits to an appreciable extent the curving indicative of the later formation of the cup. The 8-cell stage results from the divisions of each of the quadrants of the 4-cell stage by a plane (III) which is parallel to one of the previous planes and perpendicular to the other, meeting the latter at a point about midway between the center and the circumference. By

a subsequent adjustment of the cells the four more centrally placed ones come to form a sort of a Greek cross whose angles are filled by the other four (Pl. XXXVII., Fig. 10, 11). The 16-cell stage is formed by four additional planes, each of which divides one of the cross-cells and its corner neighbor. The location of these planes may be described in the same terms as the last excepting that they meet the radial planes, I and II, at about one fourth the distance from the circumference toward the center. The capping of the plate soon advances to such an extent that it consists of a square of four centrally placed cells, upon each of the four sides of which there overhangs a row of three cells, of three grades of elevation (Pl. XXXVII., Fig. 12, 13). The succeeding division and the completion of the cap (Pl. XXXVII., Fig. 14) result in the young colony's assuming the ancestral form. Throughout these divisions the number of pyrenoids in the daughter cells grows steadily less. But one can be found in each cell in the 32-cell stage, while in the 16-cell stage two are readily recognizable in each cell. In the earlier stages and before division the number often varies, and the pyrenoids are frequently so crowded that enumeration is difficult if not impossible. It seems not improbable that these structures also must undergo some division during the process of cell multiplication. During the processes of division the nuclei continue to occupy a position near the inner ends of the cells (in the new colony), and it is only after the divisions have been completed that they come to occupy their usual positions at the center of the cells—perhaps as a result of the growth of the chromatophore.

No stage of sexual reproduction has been positively identified for this species.

A peculiar condition of the colonies of this species, also occurring in *Pandorina* and *Eudorina*, deserves passing notice. It occurred with considerable frequency in all three genera and resulted in each case in the destruction of the entire colony affected. The early stages of the disease, if it be such, are indicated by the homogeneous condition of the cells and the fading out of the color, together with a flattening of the cell contents into a disk- or lozenge-shaped mass (Pl.

XXXVI., Fig. 4). In the subsequent stages this mass assumes a yellow and then a brownish color, takes on an irregular shape (Pl. XXXVI., Fig. 5), and disintegrates, leaving the empty cell walls occupying the matrix. In spite of the suggestion in the above description there was never any trace of the formation of spermatozoa in the colonies presenting these phenomena, neither was there any indication of encystment. There was no indication of either a fungous or an algal parasite, and it seems not improbable that the occurrence of these diseased forms may have been due to some unfavorable local condition in the water tributary to the habitat of the genera affected.

The following brief synopsis of the prominent characters of this genus and its two species will serve as a convenient diagnosis for their determination.

Pleodorina Shaw.—Colony consists of a spherical or elliptical cœnobium of greenish biflagellate cells of two types, vegetative and gonidial, in the anterior and posterior parts of the colony respectively, which lie in the periphery of a hyaline gelatinous matrix and are surrounded by a common hyaline envelope. Cells each with one reddish stigma, which is more prominent in the anterior part of the colony. No connecting filaments between the cells. Non-sexual reproduction by gonidia, which are formed by increase in size of a part of the cells of the colony. Daughters escape from parent as small colonies of biflagellate cells which at this stage are all similar. Sexual reproduction not known.

P. californica Shaw.—Number of cells in colony 64 or 128. Maximum diameter of colony 175–340 μ . Vegetative cells constituting approximately one half the colony. Gonidial cells 2–3 times diameter of vegetative cells. Known habitat: ponds, ditches, and streams in California, Indiana, and Illinois.

P. illinoisensis n. sp.—Number of cells in colony usually 32, rarely 16 or 64. Dimensions of colony range from $46 \times 38 \mu$ to $200 \times 175 \mu$. Vegetative cells always four in number. Gonidial cells approximately 1.1–2 times diameter of vegetative cells. Known habitat: submerged lands along the Illinois River. Types deposited in collections of Illinois State Laboratory of Natural History and United States National Museum.

BIBLIOGRAPHY.

Braun, A.

- '51. Betrachtungen über die Erscheinung der Verjüngung in der Natur, insbesondere in der Lebens- und Bildungsgeschichte der Pflanze. XVI+364 pp., 3 Taf. Leipzig.
'75. Über einige Volvocineen. Ber. d. Gesellsch. naturforsch. Freunde zu Berlin, 1875, pp. 9-18.

Butschli, O.

- '80-'89. Protozoa. Bronn's Klassen und Ordnungen des Thierreichs. Bd. I., Th. I.-III., 2035 pp., 79 Taf. Leipzig und Heidelberg.

Carter, H. J.

- '58. On Fecundation in *Eudorina elegans* and *Cryptoglena*. Ann. Mag. Nat. Hist., Ser. 3, Vol. II., pp. 237-253, Pl. VIII.

Clinton, G. P.

- '94. *Pleodorina* in Illinois. Botan. Gazette, Vol. XIX., p. 383.

Cohn, F.

- '52. Über eine neue Gattung aus der Familie der Volvocineen. Zeitschr. f. wiss. Zool., Bd. IV., pp. 77-116, Taf. VI.
'56. Observations sur les Volvocinées. Ann. d. Sci. Nat., Bot., IV., Ser., T. V., pp. 323-332; also, with some changes, in 34 Jahresber. d. Schles. Gesellsch. f. vaterl. Cultur f. 1856, pp. 39, 40, 77-83.

Fresenius, G.

- '56. Über die Algengattungen *Pandorina*, *Gonium* und *Raphidium*. Abhandl. der Senckenberg. naturforsch. Gesellsch., Bd. II., pp. 187-200, Taf. VIII.

Goroschankin, J.

- '75. Genesis im Typus der palmellenartigen Aigen. Versuch einer vergleichenden Morphologie der Familie der Volvocinea (German title of Russian article). Mittheil. der kais. Gesellsch. naturforsch. Freunde in Moskau, Bd. XVI., 40 pp., 2 Taf.

Henfrey, A.

- '56. Notes on some Fresh-water Confervoid Algae New to Britain. Trans. Micr. Soc. London, N. S., Vol. IV., pp. 49-54, Pl. IV.

Klebs, G.

- '86. Über die Organisation der Gallerte bei einigen Algen und Flagellaten. Untersuch. a. d. botan. Inst. zu Tübingen. Bd. II., pp. 333-418, Taf. III., IV.

Klein, L.

- '89. Morphologische und biologische Studien über die Gattung *Volvox*. Pringsheim's Jahrb. f. wiss. Botan., Bd. XX., pp. 133-211, Taf. X.-XII.

'89a. Neue Beiträge zur Kenntniss der Gattung Volvox. Ber. d. deutsch. botan. Gesellsch., Jahrg. 1889, Bd. VII., pp. 42-53. Taf. III.

'90. Vergleichende Untersuchungen über Morphologie und Biologie der Fortpflanzung bei der Gattung Volvox. Ber. d. naturf. Gesellsch. zu Freiburg i. B., Bd. V., pp. 29-120, Taf. II.-VI.

Migula, W.

'90. Beiträge zur Kenntniss des Gonium pectorale. Botan. Centralbl., Bd. XLIV., pp. 72-76, 103-107, 143-146, Taf. II.

Mottier, D. M.

'94. Pleodorina in Indiana. Botan. Gazette, Vol. XIX., p. 383.

Overton, E.

'89. Beitrag zur Kenntniss der Gattung Volvox. Botan. Centralbl., Bd. XXXIX., pp. 65-72, 113-118, 145-150, 177-182, 209-214, 241-246, 273-279, Taf. I.-III.

Pfeffer, W.

'84. Locomotorische Richtungsbewegungen durch chemische Reize. Untersuch. a. d. botan. Inst. zu Tübingen, Bd. I., pp. 363-482.

Shaw, W. R.

'94. Pleodorina, a new genus of the Volvocineae. Botan. Gazette, Vol. XIX., pp. 279-283. Pl. XXVII.

Wills, A. W.

'80. On the Structure and Life History of Volvox globator. Midland Naturalist, Vol. III., pp. 209-214, 233-237, Pl. VII., VIII.

EXPLANATION OF PLATES.

ABBREVIATIONS.

<i>A.</i> , anterior pole.	<i>nel.</i> , nucleolus.
<i>chr.</i> , chromatophore.	<i>o. l.</i> , outer layer of sheath.
<i>c. m.</i> , cell membrane.	<i>P.</i> , posterior pole.
<i>f.</i> , flagellum.	<i>p. c.</i> , protoplasmic column.
<i>fu.</i> , furrow.	<i>pr.</i> , pyrenoid.
<i>g. c.</i> , gonidial cell.	<i>r.</i> , reticulum.
<i>i. l.</i> , inner layer of sheath.	<i>s.</i> , stigma.
<i>m.</i> , matrix.	<i>sb.</i> , sheath.
<i>m. m.</i> , matrix membrane.	<i>v. c.</i> , vegetative cell.
<i>n.</i> , nucleus.	1, 11, 111, cleavage planes.

PLATE XXXVI.

- FIG. 1. *Pleodorina illinoisensis*, lateral view of colony. $\times 500$.
 FIG. 2. Lateral view of vegetative cell. $\times 1500$.
 FIG. 3. Lateral view of gonidial cell. $\times 1500$.
 FIG. 4. Lateral view of matured colony, showing posterior lobes.
 $\times 185$.
 FIG. 5. Diseased cell, early stage. $\times 1250$.
 FIG. 6. Diseased cell, later stage. $\times 1250$.

PLATE XXXVII. †

- FIG. 7. *Pleodorina illinoisensis*, top view of 2-cell stage.
 FIG. 8. Top view of 4-cell stage.
 FIG. 9. Lateral view of 4-cell stage.
 FIG. 10. Top view of 8-cell stage.
 FIG. 11. Lateral view of 8-cell stage.
 FIG. 12. Top view of 16-cell stage.
 FIG. 13. Lateral view of 16-cell stage.
 FIG. 14. Top view of 32-cell stage.

† Figures drawn by C. A. Kofoid and inked by Miss L. M. Hart.

+ Figs. 7-14 magnified 1000 diameters.

PLATE XXXVI.

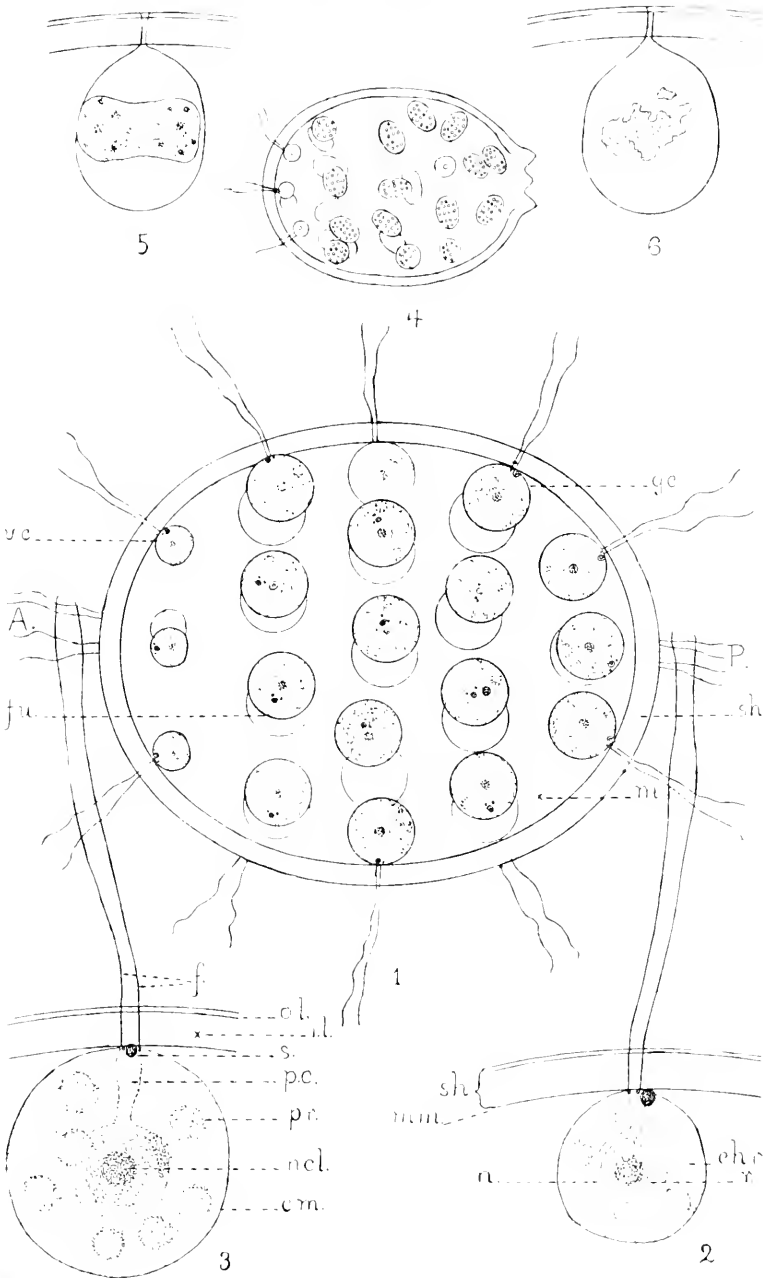
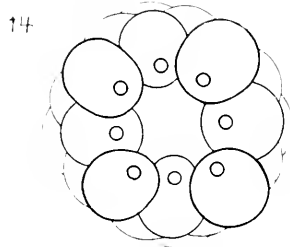
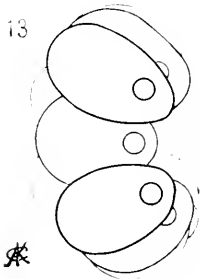
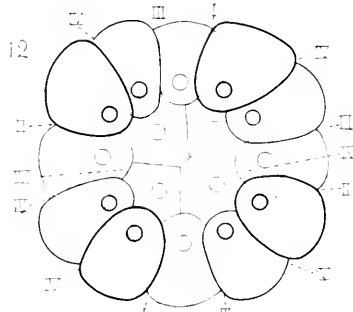
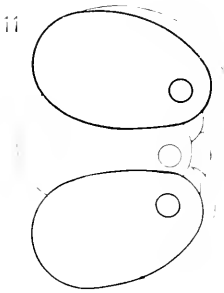
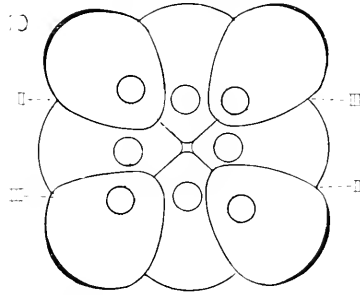
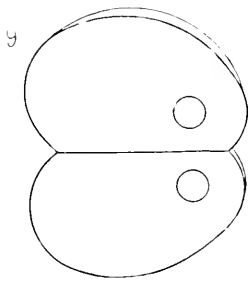
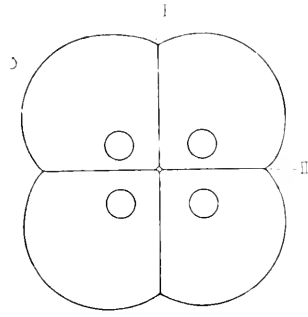
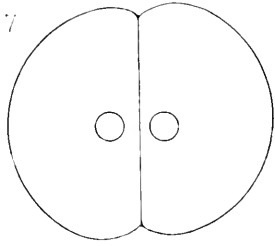

PLATE XXXVII.



案

JAN 27 1898

7710

BULLETIN

OF THE

ILLINOIS STATE LABORATORY

OF

NATURAL HISTORY,

URBANA, ILLINOIS.

VOLUME V.

*ARTICLE VI.—A LIST OF THE PROTOZOA AND ROTIFERA
FOUND IN THE ILLINOIS RIVER AND ADJACENT
LAKES AT HAVANA, ILL.*

BY ADOLPH HEMPEL, M. S.

Illinois State Laboratory of Natural History,
URBANA, ILLINOIS.
December, 1898.

STATE LABORATORY OF NATURAL HISTORY.

LABORATORY STAFF.

Professor STEPHEN ALFRED FORBES, PH. D.,
Director of State Laboratory and State Entomologist.

CHARLES ARTHUR HART,
Systematic Entomologist and Curator of Collections.

FRANK SMITH, A. M.,
Assistant Zoölogist.

CHARLES ATWOOD KOFOID, PH. D.,
Zoölogist, and Superintendent of Biological Station.

ERNEST BROWNING FORBES, B. S.,
Entomological Assistant.

WALLACE CRAIG, B. S.,
Zoölogical Assistant.

MARY JANE SNYDER,
Secretary.

HENRY CLINTON FORBES,
Business Agent and Librarian.

LYDIA MOORE HART,
Artist.

ARTICLE VI.—*A List of the Protozoa and Rotifera found in the Illinois River and Adjacent Lakes at Havana, Ill.**
 BY ADOLPH HEMPEL.

INTRODUCTORY.

The material studied in the preparation of this paper was collected at the Biological Experiment Station established on the Illinois River, at Havana, April 1, 1894, by the University of Illinois and the Illinois State Laboratory of Natural History. The work of collecting the material began April 7, 1894, and was carried on almost entirely at nine substations, designated as A, B, C, D, E, F, G, K, and L. The first three are in Quiver Lake, which is an arm of the river on its east side, about two miles above Havana. A is at the head of the lake; B, at a wet, springy place on the eastern shore, about half a mile from the head; and C, about a mile and a half from the head, including both the east and west shores at this point as well as the middle of the lake, where the towing-net was hauled, the depth here at low water being about four feet. D is about half a mile above Havana, on the east bank of the river, and E about two and a half miles north of the town, in the main river, opposite C, collections being taken especially from the west shore and the middle of the river, where the depth at low water was about nine feet. About

*Before Mr. Hempel had completed that part of his manuscript relating to the *Protozoa*, he left to accept a position in the *Museu Paulista*, in São Paulo, Brazil, and the entire manuscript was placed in my hands by Dr. Forbes to be prepared for publication. At first I was reluctant to undertake the work, but realizing the value of the paper as planned by Mr. Hempel to students and teachers of Illinois natural history, I have spared no effort to put it in the most useful form for this class of workers.

On account of the limited time and area represented in this list, it can only be regarded as a preliminary one, not sufficient for permanent generalizations on seasonal or local distribution, but rather as a history of these groups at the Station during the two years covered by Mr. Hempel's work. It seemed undesirable, for the same reason, to attempt to give keys to the species listed. I have, however, for the *Protozoa*, carefully compiled from Bütschli a synopsis of the distinctive characters of the larger subdivisions represented in the list, and have drawn up from Bütschli, Leidy, and Kent condensed generic descriptions, following, as did Mr. Hempel, the order given by Bütschli. The chlorophyll-bearing forms, such as *Fabrea* and *Euglena*, are retained among the *Protozoa* since they are included by Bütschli, but it is proper to state that they are now regarded as plants by a large number of authors. For the *Rotifera*, I have compiled a synopsis of the families from Hudson and Gosse, and Mr. Hempel's generic diagnoses are mostly from the same source.

Under each species in the list is a brief account of the important points in its history for the two years. These accounts were drawn up from Mr. Hempel's records, and may prove of especial value to students at the Station. Aside from these summaries and the additions previously mentioned, the manuscript remains substantially as Mr. Hempel left it, and will be found to contain much interesting and useful information for the student of microscopic life.

CHAS. A. HART.

half a mile below Havana, west of the river, is situated Phelps Lake, which is merely a shallow depression something over half a mile long and less than a quarter of a mile wide, surrounded by woodland, and usually filled with water to a depth of one or two feet; near its upper end F is located. G is in the southern part of Thompson's Lake, a large permanent body of water, about five miles long and over half a mile wide, with a depth at low water of about four feet, lying to the west of the river above Havana. K is located near the middle of Flag Lake, which is a large but very shallow body of water, about three miles long and half a mile wide, lying between Thompson's Lake and the Illinois River, and full of coarse "flags"—*Scirpus*, *Sagittaria*, etc.,—*Nymphaea*, *Nelumbo*, and *Ceratophyllum*. L is situated in Dogfish Lake, which opens into the west side of Quiver Lake, and is about a mile long and a quarter of a mile wide, and somewhat shallower than Quiver Lake at C. Collections were also made in the "Pumpkin Patch," a small marshy bay communicating with Quiver Lake at its head, and in Matanzas Lake, just east of the river, about three and a half miles south of Havana.

Studies of the *Protozoa* and *Rotifera* at the Biological Station were begun respectively in the latter part of April and of May, 1894. This work was carried on at the Station throughout the season until September 10, and all subsequent catches from that date to April 1, 1896, were examined and a record was kept of the *Protozoa* and *Rotifera* found in them. The period of time thus covered was about two years, the interval between the collections varying from a week to two months. The results of this work form the basis of the present article. Several species which were first noticed later than April, 1896, are incorporated in their proper place. The list is intended primarily as a record of the *Protozoa* and *Rotifera* found in the general collections made at the various substations, and in but few instances were data obtained from other sources. Doubtless the number of species recorded would be considerably greater if the time had been spent in endeavoring to list as many forms as could be found, regardless of substations. As it was, there were two difficulties

which materially interfered with the making of full and satisfactory substation lists. The first obstacle was the imperfect preservation of many forms in the material put up for examination, the identification of this material being thus largely restricted to those forms which possessed structures sufficiently hard to preserve without distortion. The second was due to changes in the list of substations under examination: A and B had to be abandoned, because of extreme low water, in August, 1894; Phelps Lake, in which was substation F, became entirely dry by the 18th of that month, and work there was suspended until January, 1895, when a rise in the river refilled the lake bed; and in the spring of 1895 D was abandoned and two new substations, K and L, situated in Flag and Dogfish Lakes respectively, were added to the list.

My thanks are due to my instructor, Dr. S. A. Forbes, for his interest in my work and for counsel and guidance while the work was in course of preparation; to Prof. Frank Smith and to Dr. C. A. Kofoid for suggestions and help in technique and research; to Mr. C. A. Hart, who has kindly undertaken to revise the manuscript and prepare it for the printer; and to Miss Lydia M. Hart, who has contributed the figures.

METHODS OF COLLECTION AND PRESERVATION.

During the first season, in making collections in the river and in other places comparatively free from vegetation, a tow-net of No. 12 silk was used, both surface and oblique hauls being taken at intervals of from seven to ten days. The collections along shore and among plants were secured by means of a Birge net, or cone-dredge, at different intervals varying from fourteen to twenty-five days. Many kinds were obtained by squeezing out the water from vegetation; while large forms, such as *Megalotrocha* and *Conochilus*, were picked out with forceps and pipette. In 1896 Dr. C. A. Kofoid, Superintendent of the Station, introduced the use of a pump in making collections. This method has many advantages over the earlier ones, as by means of it collections can easily be made from any desired depth, or from among weeds where a tow-net could not be hauled.

Several methods were followed in the preservation of the tows. Some of the material was killed in 50% alcohol and then transferred to 70% alcohol; another part was killed in 95% alcohol; and piero-nitric acid, followed by 70% alcohol, was extensively used. Flemming's fluid as employed by Rousselet ('93), and a solution of potassium permanganate recommended by Zacharias ('94, p. 88) were also used. A second paper by Rousselet ('95), in which he describes the method of killing with $\frac{1}{4}$ % osmic acid and then preserving in a 2.5% solution of formalin, was received in time to be used in connection with the work in 1895. In 1896 nearly all the qualitative catches were killed and preserved in 2% formalin. Good results were obtained in almost all cases. If one is limited in time and can have but one killing agent, formalin comes nearest being the ideal all-around killing fluid. By far the best results, however, are obtained with osmic acid, according to the process worked out by Rousselet; but the use of this agent requires much time and patience.

PROTOZOA.

The *Protozoa* present a very attractive field for study, including a large number and great variety of species. We find here a more marked difference in structure and form than among the *Rotifera*; yet all the *Protozoa* are either simple one-celled animals or colonies of single-celled individuals.

They exhibit a great variety of structural detail, and range in length from 6 mm. to .005 mm. Many of the forms are marine, but a great number occur in fresh or stagnant water. Notwithstanding their diversity of structure, the *Protozoa* have, as a rule, the protoplasm or body substance differentiated into an inner part, called the endoplasm, and an outer envelope, called the ectoplasm. This differentiation may be temporary, as in the *Rhizopoda*, or permanent, as in the *Flagellata* and *Infusoria*. A single nucleus is usually present, though some species have more than one. The *Infusoria* are characterized by the presence of a paramecus, or micronucleus, in addition to the larger nucleus, or mega-

nucleus. One or more contractile vacuoles are usually present except in the *Sporozoa* and *Cystoflagellata*, in which none have as yet been discovered.

As a pool dries up, the *Protozoa* it contains assume a spherical shape and secrete about themselves a chitinous shell, when they are said to be encysted, the spheres being called cysts. In this condition they can readily withstand drought, and when rain comes and fills up the pool they revive, break through the chitinous envelope, and assume their former shape. Encystment may also take place just before spore formation.

Protozoa occur abundantly in every pond or wayside pool as well as in the larger bodies of water, and one might naturally think that they would be favorites with the zoölogists and be thoroughly well studied; but in the United States there are only a few persons who have given much attention to them. Among these may be mentioned Prof. Joseph Leidy, Prof. D. S. Kellicott, and Dr. A. C. Stokes, each of whom has done much to awaken interest in these small forms and to bring them into notice.

In order to get a good idea of the structure of the *Protozoa* we may now consider some typical forms of the various groups.

The lowest of the *Protozoa*, belonging to the class *Sarcodina*, are the subclass *Rhizopoda*, or root-footed animals, so called because they send out a number of root-like processes of protoplasm, known as pseudopodia, by means of which they move from place to place. Among the forms included under this head are *Amoeba*, *Difflugia*, *Arcella*, and *Euglypha*. *Amoeba* consists of a small portion of protoplasm differentiated into a granular endoplasm and a clear transparent contractile ectoplasm, and having a nucleus and contractile vacuole. As already indicated, the animal moves along by thrusting out processes of protoplasm in the direction of locomotion. As these pseudopodia are thrust out at one part of the body they are drawn in at another part. Because of this peculiar movement the *Amoeba* has no constant form, its shape changing continually. Aside from locomotion the

pseudopodia also serve in obtaining food, for when they come in contact with a diatom, for example, they flow around it and entirely enclose it. Then the soft parts are digested, and as the *Amoeba* moves along the undigested hard parts are extruded. The structure of *Difflugia* is essentially the same as that of *Amoeba*, with the exception that the *Difflugia* builds for itself a small shell or lorica, using sand, diatoms, and particles of other foreign matter. *Arcella* secretes a homogeneous chitinous shell, which is usually free from all foreign substance. *Englypha* secretes chitinous plates and then unites them to form its shell.

The subclass *Holozoa* includes a number of the *Sarcodina* characterized by having numerous thread-like pseudopodia. These are not continuously thrust out and retracted, but have a permanent form. The *Radiolaria* constitute another subclass of the *Sarcodina*, but as it includes only marine forms it is unnecessary to consider it here. The prevailing mode of reproduction among the *Sarcodina* is division, although budding and spore formation also occur.

The class *Sporozoa* is composed of a number of *Protozoa* which reproduce by means of spore formation. The occurrence of fission or budding among any members of the group has not as yet been demonstrated. All of them are parasitic, living in the intestines or in other organs or tissues of higher animals, and therefore show a marked degeneration of structure. *Gregarina* may be taken as a type. It is more or less oval in outline, with the protoplasm differentiated into a well-marked endoplasm and ectoplasm. The body is constricted at about one third of its length from the anterior end. A nucleus is present, but pseudopodia and the contractile vacuole are wanting.

In the class *Mastigophora* the members of the order *Flagellata* are characterized by the possession of one or more flagella which serve as organs of locomotion, and also aid the animal in securing food, since by means of them a constant current of water is directed towards the mouth. The well-known *Euglena* may be considered as a type. The body is elongate and more or less cylindrical, and is highly flexible and very

variable in shape. The endoplasm and ectoplasm are well differentiated. From the anterior end of the body projects a long slender flagellum, just below which is the mouth opening. Near the base of the flagellum is the red stigma, sometimes called the eye-spot. A little behind this pigment spot is the contractile vacuole. This empties into a sort of vestibule. The posterior extremity of the body is, in some species, prolonged into a short spine-like process. A large nucleus is present. The endoplasm usually contains a number of starch bodies.

The order *Dinoflagellata* includes *Peridinium* and *Ceratium*, which have a hard covering or shell of modified cellulose. Contractile vacuole and nucleus are present. There are two flagella; one extending out in front of the animal, while the other encircles the body and lies in an equatorial groove.

The members of the class *Infusoria* have more or less of the surface of the body covered with fine cilia. These are permanently present in the subclass *Ciliata*, but in the subclass *Suctorina* are found only in the young. In the holotrichous *Ciliata* they are comparatively uniform, and usually invest the entire body surface. By some authors these forms are all grouped under the name *Holotricha*. A large part of them, however, constitute a group sufficiently distinct from all other *Ciliata* to be ranked as a separate order, the *Gymnostomata*. The mouth is naked, and closed except when in use, the food being swallowed. In the remaining *Ciliata*, constituting the order *Trichostomata*, the mouth usually remains open, and the food is swept into it by the action of cilia or undulating membrane.

The holotrichous *Trichostomata* form the suborder *Aspirotricha*, which is well represented by *Paramecium aurelia*, the slipper animalcule. Its body is elongate, pointed posteriorly, and rounded and slightly narrower anteriorly. The entire surface is covered with fine cilia. On the ventral surface is an anterior oblique groove, at the posterior end of which the oral opening is situated. The nucleus is large. Two contractile vacuoles are present, which usually assume a stellate appearance upon contracting. The ectoplasm or cuticula is

provided with a number of rods called trichocysts. These are used for defense, and are comparable with the nematocysts in *Hydra*.

The suborder *Spirotricha*, which includes the remaining ciliates, is characterized by the presence of a spiral or nearly circular wreath of cilia—the adoral wreath—leading to the mouth opening, and partly or entirely enclosing a usually well-marked area known as the peristome-field. This suborder comprises four quite well-marked divisions, *Heterotricha*, *Oligotricha*, *Hypotricha*, and *Peritricha*, distinguished largely by the ciliary structure and distribution.

The *Heterotricha* have the body clothed with short, fine cilia and an adoral circle or spiral of longer cirrose cilia at the anterior end, around the peristome-field. *Stentor polymorphus* may be taken as typical of this group. The body is variable in form, but may be described as trumpet shaped, expanded anteriorly and attenuated posteriorly. It is sometimes found in large attached colonies, and at other times is free-swimming. The body is covered with longitudinal rows of very fine cilia, while those around the peristome are modified into strong flattened structures. The left margin of the peristome is involuted, forming a little pocket, at the bottom of which is the oral opening. The endoplasm usually contains a number of granules. The ectoplasm is supplied with a layer of fine longitudinal contractile fibrils, called the myophan. The contractile vacuole is large and the nucleus large and moniliform.

The *Oligotricha* are a rather small group of short, rounded to obconic forms, with the peristome-field occupying the the anterior end, as in *Stentor*, and surrounded by a nearly or quite completely circular adoral wreath. The ciliation of the body varies in amount. A lorica is sometimes present.

The *Hypotricha* differ from the other groups in that they are usually flattened and have the locomotor cilia upon the ventral surface. These cilia are frequently modified into strong styles or uncini. The dorsal surface is smooth or furnished with a few rows of stiff cilia. The oral and anal openings are distinct. Usually the peristome-field is on the

anterior part of the ventral surface, triangular, and partly surrounded by the adoral wreath. *Stylonichia* may be regarded as typical of this group. Its body is elongate, rounded at the ends, and persistent in shape. The cilia form a continuous border around the ventral margin. The peristome-field is placed anteriorly on the left side of the ventral surface. It is well supplied with cilia and with a band-like undulating membrane. A number of the frontal cilia are modified into styles. There are several claw-like caudal setae, and some anal spines. The contractile vacuole is single; the nuclei two in number, usually oval.

In the *Peritricha* the cilia are usually limited to an adoral wreath at the expanded end. Sometimes a circle is present at the opposite end. The well-known *Vorticella*, or bell animalcule, is a good example of this group. The body is spheroidal or more or less bell-shaped, and the ectoplasm is prolonged posteriorly into a stalk, by means of which the animal is attached. The myophan fibrils of the body unite and form a large contractile muscular fiber extending throughout the length of the stalk. The cuticular surface is sometimes transversely striated and otherwise ornamented. The right limb of the adoral ciliary wreath descends into the pocket or vestibulum, at the bottom of which the oral opening is situated. Contractile vacuoles one or several; nucleus band-like, large.

The subclass *Suctorio* is the most highly differentiated of the *Infusoria*. This is especially seen in the matter of reproduction, for many of them reproduce by internal budding. *Tokophrya* may be considered as a type of this group. The body is usually persistent in shape, more or less oval, and fastened by the attenuate posterior end to a rigid stalk. Instead of cilia, the adult forms have a number of fine hair-like tentacles, either scattered irregularly over the anterior surface or arranged in several fascicles. These tentacles are slightly movable and may be extended or retracted, serving to capture prey and to convey food substance into the body; for, notwithstanding their slender form, particles of food from the mass being fed upon may be seen passing within these

tentacles to the body of the *Tokophrya*. The nucleus is large and usually oval in shape; the contractile vacuoles are one to several in number. All the members of this genus reproduce by internal budding. The young *Tokophrya* is provided with an equatorial circle of cilia, by means of which it swims rapidly through the water, later fastening itself to some object, when the cilia disappear and the form of the adult begins to be assumed.

METHODS OF CAPTURE AND STUDY.

All of the methods of capture suggested on a later page for the *Rotifera* will answer equally well for the *Protozoa*. Of course, infusions of hay or grass will furnish certain kinds. The method of keeping water from ponds and ditches in watch-glasses as described for the *Rotifera*, if duly attended to, will not fail to give satisfactory results. Considerable attention should be given to the examination of small *Crustacea*, aquatic insect larvæ, pond snails, small turtles, and crayfishes, as many *Protozoa* are likely to be found upon them. *Vorticella* may be found on the roots of *Lemna*, or on fixed aquatic plants.

Whenever possible, *Protozoa* should be studied alive. Good results were obtained in the preservation of *Tokophrya quadripartita* by the following process. A small colony was transferred to a drop of water upon a slide and a cover-glass placed over it, the cover-glass being raised by little supports of wax so that it did not touch the zooids. A drop of an aqueous solution of corrosive sublimate was then added and allowed to remain about half a minute, when it was washed out and 30% alcohol substituted, this being gradually changed to 70%. Next, the zooids were stained for about twenty minutes in Kleinenberg's hamatoxylin and then decolorized with acidulated alcohol, consisting of .5% hydrochloric acid in 70% alcohol, which in turn was well washed out with pure 70% alcohol. Then the alcohol was gradually changed to 95%, after which clove oil was substituted and allowed to remain until the zooids were clear. Finally they were mounted in balsam. All the changes from water to

balsam were made on the slide by the irrigation process, that is, by placing a drop of the liquid on the slide at the edge of the cover-glass, and then drawing it under the cover-glass by means of blotting-paper. The *Tokophrya* was attached to *Opercularia*, and many of the latter genus were killed well expanded, thus suggesting the idea that this method could probably be used with good results for other *Vorticellidae*.

GEOGRAPHICAL DISTRIBUTION.

There is probably no place on earth, unless it be a sandy desert or a subterranean stream, where *Protozoa* may not be found. No stream is too clear or pond too muddy for them to thrive in. They are found in the warm waters of the tropics and in the icy waters of the northern countries. The United States stands next to Europe in the number of recorded species. A considerable number are also found in Australia. There are many cosmopolitan species, which is not so remarkable when we consider that the light cysts may very readily be carried long distances by air currents.

FOOD RELATIONS.

But little attention has been paid to the food of the *Protozoa*, and it is very desirable that students should make and record careful observations along this line.

In general it is known that *Amoeba*, *Arcella*, *Difflugia*, *Vorticella*, *Opercularia*, and the like, feed largely on diatoms and desmids, diatoms especially seeming to be a favorite food of such forms as *Vorticella* and *Opercularia*. *Euglena* has been found within the body of *Opercularia*, and *Tokophrya* and *Acineta* are predaceous, living upon other *Protozoa*.

Individuals of the latter genus have been seen to kill and devour *Vorticella*. Schewiakoff ('93) says that rotifers, daphnids, and *Chaetonotus* also serve as food for *Protozoa*. No doubt many of the species that possess chlorophyll derive some nourishment from gases, as plants do; while other forms absorb organic matter in solution in the water. It is probably true that plants constitute a larger proportion of their food than animals, but the data on this point are so meager that no general statement can be made.

On the other hand, the *Protozoa* play an important part in the food of other organisms. Many rotifers feed freely upon them, and even young fishes have been found with *Difflugia* in their stomachs. *Euglena*, *Volvox*, *Pandorina*, *Difflugia*, and *Codonella* are among the forms observed in the stomachs of rotifers; but so few observations on this subject have been recorded, that very little information can be gathered at present.

LOCAL DISTRIBUTION.

In the waters from which our Station collections were made the *Protozoa* were not so abundant nor so widely distributed as the rotifers. In all, ninety-three species are recorded, one of which (*Difflugia fragosa*) is here described for the first time. Species which could not be identified with certainty are not included in the list.

The most widely distributed form was *Difflugia globulosa*, which appeared at every substation and was present in nearly every month of the year. Other species of *Difflugia* and species of *Arcella* were found during a considerable part of the year, including the summer months. *Dinobryon sertularia* was very abundant, occurring from December to June; *Euglena viridis* was observed throughout the summer months; *Volvox globator* was found in every month except February; *Coleps hirtus* was present from May to October; and *Codonella cratera* was frequently seen from April to September. All through the summer months many species of *Vorticella*, *Epistylis*, and *Opercularia* were taken in the towings or upon the backs of turtles and the larger *Crustacea*, but few of them could be definitely determined.

A number of the species here recorded were found in aquaria started with dried mud from the bed of Phelps Lake.

I have found it very difficult to make a sharp distinction between the littoral or shore forms, and the so-called pelagic or limnetic forms found in the open waters. These waters were so shallow—the average depth at the various substations ranging from two to twelve feet—and so full of vegetation, that the only species that seemed entitled to be considered as

pelagic were those that evidently preferred clear open water, free from vegetation.

Thirty-five of the species here treated were found in open water, either in surface, bottom, or oblique towings. They are as follows:

<i>Arcella vulgaris</i> Ehrbg.	<i>Euglena acus</i> Ehrbg.
<i>Arcella vulgaris discoides</i> Leidy.	<i>Euglena oxymiris</i> Schmarda.
<i>Arcella vulgaris angulosa</i> Leidy.	<i>Euglena torta</i> Stokes.
<i>Arcella dentata</i> Ehrbg.	<i>Trachelomonas acuminata</i> Schmarda.
<i>Diffugia globulosa</i> Duj.	<i>Phacus longicauda</i> Ehrbg.
<i>Diffugia pyriformis</i> Perty.	<i>Phacus pyrum</i> Ehrbg.
<i>Diffugia acuminata</i> Ehrbg.	<i>Volvox globator</i> Ehrbg.
<i>Diffugia lobostoma</i> Leidy.	<i>Pleodorina californica</i> Shaw.
<i>Diffugia corona</i> Wallieh.	<i>Cryptomonas ovata</i> Ehrbg.
<i>Diffugia aculeata</i> Ehrbg.	<i>Peridinium tabulatum</i> Ehrbg.
<i>Diffugia tuberculosa</i> Hempel.	<i>Ceratium brevicorne</i> Hempel.
<i>Diffugia fragosa</i> n. sp.	<i>Paramecium aurelia</i> O. F. Müll.
<i>Actinophrys sol</i> Ehrbg.	<i>Stentor polymorphus</i> O. F. Müll.
<i>Actinosphaerium eichhornii</i> Ehrbg.	<i>Stentor caeruleus</i> Ehrbg.
<i>Raphidiophrys pallida</i> Schulze.	<i>Stentor barretti</i> Barrett.
<i>Dinobryon sertularia</i> Ehrbg.	<i>Halteria grandinella</i> O. F. Müll.
<i>Euglena viridis</i> Ehrbg.	<i>Codonella cratera</i> Leidy.
<i>Euglena spirogyra</i> Ehrbg.	<i>Tintinnopsis illinoisensis</i> Hempel.

To these might be added *Didinium nasutum* O. F. Müll., mentioned by Zacharias ('94a), and *Trachelomonas caudata* Ehrbg, both of which were found in aquaria started with mud from the bottom of Phelps Lake.

One peculiar fact noted was the occurrence of a number of *Rhizopoda* in the surface towings. Prof. Frank Smith ('94) lists three species as occurring in surface collections in Lake St. Clair; Dr. C. A. Kofoid lists eight species from the waters

of Lake Michigan; while at Havana nine forms were found. These are as follows:

Arcella vulgaris Ehrbg.	Difflugia globulosa Duj.
Arcella vulgaris discoides Leidy.	Difflugia pyriformis Perty.
Arcella vulgaris angulosa Leidy.	Difflugia lobostoma Leidy.
Arcella dentata Ehrbg.	Difflugia corona Wallich.
	Difflugia aculeata Ehrbg.

These forms appeared in the surface collections frequently, being at times quite a constant factor in the catches.

CLASSIFICATION.

Many different classifications of the *Protozoa* have been proposed, but the arrangement given by Bütschli ('80-'89) has been followed throughout in the construction of this list. Kent's "Manual of the Infusoria" ('80-'82) was mainly used in the determination of the species of that class. For the species described since the publication of Kent's Manual and Leidy's *Rhizopods* ('79) citations are given, by date, to the works containing the original descriptions, and these titles may be found in the list of literature appended to this paper.

SYNOPSIS OF THE HIGHER GROUPS OF PROTOZOA.⁺

- I. Class *Sarcodina*. Forms that move about by a simple protoplasmic movement, by a flowing motion, or by the formation of protoplasmic processes (pseudopodia).
 1. Subclass *Rhizopoda*. Form usually protean; pseudopodia lobose or slender, more or less temporary structures without axial support, often restricted by a shell to a part of the body surface.
 - Order *Rhizopoda*. (Includes all the recent forms of this subclass.)
 1. Suborder *Amoebæa*. Naked; pseudopodia lobose or filiform. Two families; one mostly marine.
 - Amoebidae*. Pseudopodia usually lobose, never forming a network.

⁺Compiled from Bütschli ('80-'89).

2. Suborder *Testacea*. Shelled forms; pseudopodia lobose or filiform. Four fresh-water families.

Arcellidae. Shell homogeneous or incrustated with sand grains or other foreign material; pseudopodia lobose.

Euglyphidae. Shell built of round or hexagonal plates; pseudopodia filiform at tip.

- 2 Subclass *Heliozoa*. Body usually globose; pseudopodia thread-like, constant, radiating in all directions.

1. Order *Aphrothoraca*. Naked, or with gelatinous envelope.

2. Order *Chalarathoraca*. Coated with silicious bodies of a definite form, spicular, discoid, etc.

3. Order *Desmorthoraca*. Skeleton shell nearly or quite spherical, latticed, with numerous openings.

3. Subclass *Radiolaria*. Body globose, with a silicious shell; pseudopodia filiform, radiating in all directions. Marine.

II. Class *Sporozoa*. Parasitic forms, multiplying exclusively by spore formation.

III. Class *Mastigophora*. Provided with one or more vibratile anterior or lateral flagella; body not ciliated.

1. Order *Flagellata*. One or more anterior, rarely lateral, flagella, not encircled by a membranous collar; body naked or loricated.

2. Order *Choanoflagellata*. One anterior flagellum, encircled by one or two thin membranous raised collars.

3. Order *Dinoflagellata*. Two flagella, anterior or lateral (if we consider the advancing pole in locomotion as the anterior end), one directed longitudinally, the other transversely, and usually encircling the body more or less; body with a shell or armor; no definite mouth.

4. Order *Cystoflagellata*. Large, phosphorescent marine forms.

IV. Class *Infusoria*. Clothed with cilia, entirely or in part; cilia variously differentiated and modified.

1. Subclass *Ciliata*. Cilia persistent through life; food taken through a mouth, except in some parasitic forms.
 1. Order *Gymnostomata*. Mouth usually closed when not in use, without undulating membrane or well-developed ciliary structures; food taken by swallowing; throat, if present, without ciliary structures, usually surrounded by a wall of more or less indurated parallel longitudinal rods. Three families.
 2. Order *Trichostomata*. Mouth or throat rarely closed, provided with well-developed undulating membrane or ciliary structures, food usually drawn in or engulfed.
 1. Suborder *Aspirotricha*. Body invested with fine and comparatively uniform cilia, no anterior spiral adoral wreath.
 2. Suborder *Spirotricha*. A spiral to nearly circular adoral ciliary fringe bordering a differentiated peristome-field and ending at the mouth; cilia of fringe often broad or lamellate.
 1. Section *Heterotricha*. Entire surface usually rather uniformly ciliated, the adoral series larger than the rest, and more or less spirally arranged. Four families.
 2. Section *Oligotricha*. Body more or less globular or obconic; peristome-field wholly on the anterior end, adoral wreath nearly or entirely a closed circle; ciliation well developed to wanting; in some instances loricated. Four families.
 3. Section *Hypotricha*. Body usually flattened; ventral cilia modified into setæ or styles, back usually with rows of stiff bristles; peristome-field about in the plane of the ventral surface, adoral wreath bordering its left and anterior sides, and sometimes a part of its right side. Four families.
 4. Section *Peritricha*. Solitary or united in social colonies; cilia confined to the adoral wreath encircling the expanded terminal peristome-field; a

second circlet of cilia sometimes present at the opposite end of the body. Three families.

2. Subclass *Suctoría*. Cilia present only in the free-swimming young; food absorbed by tubular tentacles; reproduction by budding, rarely by division. Eight families.

Class *SARCODINA*.

Subclass RHIZOPODA.

Order RHIZOPODA.

Family *AMOEBIDÆ*.

AMOEBA BORY.

Body naked, with pseudopodia; contractile vacuole and nucleus present; reproduction by bipartition in the active condition.

1. *A. proteus* RÖSEL.

This species appeared only in towings from the river channel at E in September.

2. *A. radiosum* ENRBB.

A few examples of this interesting form were taken in the tow-net in Phelps Lake in July.

PELOMYXA GREEFF.

Amœba-like, naked, usually quite large (up to 2 mm. in diameter), moving by means of short, broad pseudopodia, and commonly more or less slug-like when in motion. Nuclei very numerous.

3. *P. villosa* LEIDY.

This was found sparingly in June, July, and August: in July with the preceding species in towings from Phelps Lake; and on the other occasions at C in bottom towings and in collections from the vegetation along the east shore.

Family **ARCELLIDÆ.****ARCELLA** EHRRG.

Shell chitinous, usually round, convex above, concave beneath with a large round opening at middle; color yellow or brown, its surface smooth or thickly pitted; usually several nuclei and contractile vacuoles.

4. **A. vulgaris** EHRRG.

This species occurred in small numbers in the towings throughout the year, except during the winter months, and in summer was occasionally found in collections from the vegetation along shore. It seems remarkable that none were found in towings from Thompson's Lake except a few which appeared in March, 1895.

5. **A. vulgaris discoides** LEIDY.

This variety was usually found in company with the typical form, in about the same numbers and similarly distributed. A single finding in midwinter at C is recorded, also its occurrence in Matanzas Lake.

6. **A. vulgaris angulosa** LEIDY.

Not so common as the preceding forms, but similarly distributed.

7. **A. dentata** EHRRG.

This form was very rare, and was seen but twice; once during August, and again in September, in towings from substation C.

DIFFLUGIA LECLERC.

Shell variously shaped, sometimes chitinous, but usually composed principally of small grains of sand and other foreign substances. Pseudopodia narrow, long, sometimes branching, rounded at the ends. Nucleus usually single.

8. **D. globulosa** DUJ.

This was widely distributed, occurring at all the substations, usually in the towings, and much less frequently in the Birge-net collections. It was never very common, but con-

tinued to appear throughout the year, becoming very scarce during cold weather.

9. **D. pyriformis** PERTY.

Although this was even less common than the preceding species, its occurrences were quite uniformly distributed through the entire year, and it was recorded from all the principal substations. It was also found in Matanzas Lake. It appeared usually in the towsings, rarely in shore collections. In February a few were taken in a towing at C, underneath a foot of ice.

10. **D. pyriformis** *vas* LEIDY.

Not common; taken only in July and August in towsings from substations K and L (Flag and Dogfish lakes).

11. **D. pyriformis compressa** CARTER.

In July and August a few appeared in towsings from Thompson's and Dogfish lakes.

12. **D. urceolata** CARTER.

No individuals of this species were found in any of the collections, but in November a quantity of dried mud was collected from the bed of Phelps Lake, which was entirely dry at this time, and several small aquaria were started by placing some of this mud in jars of filtered water. Several examples of *D. urceolata* appeared in these aquaria, as well as other forms which will be mentioned in their proper place.

13. **D. acuminata** EHREG.

Like *D. pyriformis*, this was scarce, but generally distributed through the year and at the various substations. It also occurred under the ice at C in February, and in Matanzas Lake. With one exception it was found only in the towsings.

14. **D. lobostomata** LEIDY.

This species was very generally distributed. It was found almost entirely in the towsings, associated with *D. globulosa*. In the fall it became common and even abundant, but was noticeably sparser in winter. This species was among those collected from under the ice at C in February. It is also recorded from Matanzas Lake.

D. lobostomata may be easily mistaken at first for *D. globulosa*. It is smaller than *globulosa*, however, and long in proportion to its width. I have found both species in the stomachs of rotifers.

15. **D. corona** WALLICH.

This beautiful and attractive species was moderately common throughout the year, less common in winter, appearing in collections from nearly all of the substations, usually in tows, but often also in shore collections.

Schewiakoff ('93) identifies this species with *D. lobostoma*, but in my judgment the two species are distinct. *D. corona* is larger and more spherical than *lobostoma*, and the fundus always bears one or more spines. In *corona*, the border of the mouth has quite a number of lobes or crenulations, while in *lobostoma* there are usually but three or four lobes present. Among all the specimens of *D. lobostoma* that I have examined there was but one which had more than three lobes; and, on the other hand, I have never seen a *corona* with so small a number of lobes.

16. **D. aculeata** EHREB.

Centropyxis aculeata Ehrbg.

The record of this species shows it to be much scarcer than the two preceding, although occurring pretty uniformly through the year. It was found both in tows and shore collections, and seems to prefer weedy waters.

17. **D. tuberculosa** HEMPEL ('96).

Found in three out of six tows taken on one occasion in Matanzas Lake in August. But few individuals were found. In the following season a few examples were taken in the river channel at E in September and October. It is easily recognized and remembered by its irregular outline and by the presence of tubercles.

18. **D. fragosa**, n. sp. (Fig. 1, 2.)

This form was found several times, and seems to be new.

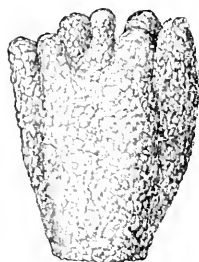

Fig. 1. *Diffugia fragosa*, n. sp. Lateral view.

Shell composed of fine sand grains, irregular in form, about one and a half times as long as wide, widest at fundus, thence tapering to the mouth where it is slightly constricted; mouth irregular, slightly notched. The peculiarity of this species is the presence upon the fundus of from one to eight ascending processes or spines, rounded at tip. These originate at about the middle of the shell, giving an irregular outline to the shell when seen from above. Pseudopodia simple, fine, and few in number.

Length .23 mm., width .15 mm.

It appeared occasionally from August to November of the second year in tows, mostly from the river at E, with a few from lake substations (G and C).

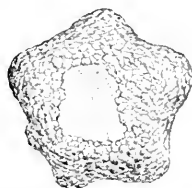

Fig. 2. *Diffugia fragosa* n. sp. View showing mouth opening.

Family EUGLYPHIDÆ.

EUGLYPHA Duj.

Shell uniaxial, formed of round or hexagonal silicious plates in overlapping rows; mouth opening usually toothed. Pseudopodia not anastomosing.

19. *E. alveolata* Duj.

Rare, occurring only in a towing from C in May.

Subclass HELIOZOA.

(Sun Animalcules).

Order APHROTHORACA.

ACTINOPHRYS EHREG.

Body soft, spherical, with numerous radiating fine filamentous pseudopodia; endosarc finely granular; ectosarc vacuolated; division between the two not well marked. Nucleus single, central; usually a large contractile vacuole in the periphery.

20. **A. sol** EHREB.

This occurred only during the warmer half of the year, from June to October, largely in collections from among vegetation, where it was on one occasion quite common. A few were found in lake towings.

ACTINOSPHERIUM STEIN.

Body spherical, with numerous long tapering radiating pseudopodia; protoplasm vacuolated, vacuoles of the ectosarc larger than those of the endosarc, the division between endosarc and ectosarc distinctly marked. Nuclei numerous; contractile vacuoles located at the periphery.

21. **A. eichhornii** EHREB.

This interesting and fine species was seen only a few times, appearing in towings from the river and Dogfish Lake from July to September.

Order CHALARATHORACA.

RAPHIDIOPHRYS ARCHER.

Isolated, or united into colonies. Body spherical, with numerous fine, long, straight, radiating pseudopodia; division between endosarc and ectosarc not distinct. One or more nuclei. Surface layer densely filled with fine, straight or curved spicules, tangentially arranged.

22. **R. pallida** EHREB.

Found in small numbers in towings from substation C, in Quiver Lake, during July and August.

23. **R. elegans** HERTW. LESS.

Rare, occurring only in September, in towings from C.

Class **MASTIGOPHORA**.

Order FLAGELLATA.

Suborder MONADINA.

Family **HETEROMONADIDÆ**.

Subfamily **DENDROMONADINÆ**.

ANTHOPHYSA BORY.

Zoöids minute, obliquely pyriform, united into round clusters of fifty to sixty, which are borne upon the extremities

of a dichotomously branching pedicel; anterior extremity prolonged into a spine-shaped process on one side. Flagella two, one much shorter than the other. Nucleus and contractile vacuole usually conspicuous.

24. **A. vegetans** O. F. MÜLLER.

A number of colonies were found in an aquarium started with mud from the dry bed of Phelps Lake.

Subfamily **DINOBRYONINÆ**.

DINOBRYON EHREBG.

Animals in transparent loricae, which are united into branching colonies. Free-swimming; zooids with a long and a short flagellum, an anterior pigment spot, and two lateral chromatophores.

25. **D. sertularia** EHREBG.

Very common and often extremely abundant in the towsings, especially from waters containing vegetation, during the period from December to June.

26. **D. sertularia divergens** IMHOFF.

Observed in May, in towsings from substation C.

27. **D. sertularia angulatum** SELIGO.

Abundant in the towsings from Dogfish Lake in April.

28. **D. sertularia undulatum** SELIGO.

Common in the river towsings from E during April.

Suborder **EUGLENOIDINA**.

Family **EUGLENIDÆ**.

EUGLENA EHREBG.

Animals free-swimming, generally oval to elongate, usually obtuse anteriorly, and more or less prolonged and attenuate posteriorly. A well-developed mouth and flagellum at the anterior end, and near this end a red pigment spot. Color usually green.

In the latter part of summer *Euglena* is universally abundant, even in the smallest pools and ditches. At certain

times of day, except in case of a storm, these and related species appear in vast numbers at the surface of the water, forming the "water-bloom." In the vicinity of the Station, this frequently formed green, brown, or red patches along the shores, or drifted down the main channels in long streaks or broad areas, not dense enough to be evident when close at hand but very noticeable if viewed obliquely from a short distance. On small pools the water-bloom often becomes a dense green, paint-like, scum. It frequently consists in great part of some single species. *Euglena* is readily eaten by rotifers and by some *Protozoa*. The rotifer *Eosphora aurita* was found in the water-bloom.

29. **E. viridis** EHREB.

During the warmer season, from May to September, this was frequent to abundant in the towings from most of the substations, and very abundant in the water-bloom that was examined. This species is highly changeable in shape.

30. **E. spirogyra** EHREB.

A few were found in a towing from Phelps Lake in July. This pretty species preserves its form better than the preceding, is slightly thicker in proportion to its length, and its surface is marked with oblique rows of small bead-like elevations.

31. **E. acus** EHREB.

Occurred from July to September, in small numbers, in towings from the river and several lakes. It is very slender, ending posteriorly in a sharp point, and is persistent in shape.

32. **E. oxyuris** SCHMARDT.

Frequent and often common during about the same period as that recorded for *viridis*; occurring from June to October. It is elongate, obliquely striate, often spirally contorted. A fine species, persistent in shape, and easily recognized.

33. **E. torta** STOKES ('85).

This small species was observed but once, namely, in a towing taken from Phelps Lake in July. It agreed in all particulars with Dr. Stokes's description, and the species appears

to be well defined and valid. It is elongate, with three longitudinal spiral furrows or elevations.

AMBLYOPHIS EHREBG.

Very similar to *Euglena* in structure and colors, but with the posterior end rounded, not at all acuminate.

34. **A. viridis** EHREBG.

Found infrequently in the river channel at E in August and September.

TRACHELOMONAS EHREBG.

Differs but little from *Euglena*, except that it is enclosed in a lorica or shell, varying in shape from elongate-oval to spherical, and with a minute anterior opening, through which the flagellum issues.

35. **T. caudata** EHREBG.

This appeared in large numbers in aquaria started with dried mud from the empty bed of Phelps Lake. Within two days after starting the aquaria the *Trachelomonas* began to develop. At first they had no loricae, and were scarcely distinguishable from *Euglena viridis*. After a short time the lorica began to appear, first around the central and anterior parts of the body. At this stage, before the posterior part of the lorica had become fully formed and hardened, the animals while swimming about would occasionally contract the body, drawing the posterior part into the lorica.

In the second year's work a few were found in August and September in towings from the river at E.

36. **T. acuminata** SCHMARDT.

Phelps Lake, with its shallow water and lack of vegetation, seemed to be well fitted for the development of the *Euglenidae* during the first season of our work, since more species were found here than at any other of the substations. *T. acuminata* was scarce, appearing in the lake in July and August. It is also recorded from Matanzas Lake.

37. **T. armata** EHREBG.

A single occurrence is recorded, namely, at C in July.

38. **T. urceolata** STOKES.

Rare; found during September in towings from the river at E.

39. **T. torta** STOKES ('88).

Observed only in September, in towings from the river and Dogfish Lake. Not common.

40. **T. hispida** STEIN.

Found in towings from Dogfish Lake in September.

Family **CHLOROPELTIDIDÆ.**

PHACUS NITZSCH.

Persistent in shape, ellipsoidal to pyriform, mostly compressed and leaf-like, with a posterior, pointed, tail-like prolongation; cuticle indurated, longitudinally or spirally striated; mouth and throat asymmetric, opening dorsally; body green, with anterior pigment spot.

41. **P. triqueter** EHREBG.

Scarce; found in September in towings from the river channel.

42. **P. pyrum** EHREBG.

Found but once, namely, in a towing from the river channel in October.

43. **P. longicauda** EHREBG.

This fine and attractive species was present in small numbers from June to September, and was generally distributed. A single occurrence in October is also on record.

Suborder ISOMASTIGODA.

Family **CHRYSOMONADIDÆ.**

SYNURA EHREBG.

Individuals oval to elongate, each contained in a membranous lorica, commonly united into free-swimming subglobose colonies; flagella two, subequal; one or more colored eyespots.

44. **S. uvella** EHREG.

This species was seen only occasionally at first, a few being observed in April and a single one in July. In October and November it became common in the river towings, and from December to March was more or less abundant at all the substations under examination, reaching its maximum in January.

Family **VOLVOCIDÆ.**

PANDORINA BORY.

Colonies free-swimming, spherical to oval, consisting usually of 16, rarely 32, individuals closely joined at a common center.

45. **P. morum** BORY.

Observed only during the second year's work, from April to September, and again from January to March. It was quite common, but was not found in Phelps Lake. This species forms an important element in the food of large rotifers.

VOLVOX LINN.

Colonies spherical, large, consisting of many thousand similar zooids forming an enclosing wall about a large central gelatinous mass.

46. **V. globator** LINN.

Abundant and well distributed in the field studied, except in Phelps Lake, where it was only seen once. In midwinter it became rare. It was abundant near the field laboratory in Quiver Lake during July, and though many were taken here in the bottom towings, none appeared in the surface towings made during the day.

PLEODORINA SHAW.

Colonies more or less oval, consisting of about 128 individuals of two kinds, the large ones about one pole and the small ones about the other, enclosing a central gelatinous mass.

47. **P. californica** SHAW ('94).

Occurred from July to October in both years, often in great abundance, in towings and among vegetation in the river and deeper lakes.

Family **CRYPTOMONADIDÆ.**

CRYPTOMONAS EHRLG.

Free-swimming, ovate or elongate, anterior end oblique, with a peristome-like excavation, in which is the oral opening, leading to a distinct pharynx; two flagella issuing from beneath a lip-like anterior marginal prolongation; two lateral brown to green chromatophores.

48. **C. ovata** EHRLG.

This was found in both years, but only in September and October. Except a record from substation L it was taken only in the river at E, where it was found excessively abundant in both months.

Order CHOANOFLLAGELLATA. (Collared Monads.)

Family **CRASPEDOMONADIDÆ.**

Subfamily **CODONOSIGINÆ.**

DIPLOSIGA FRENZEL.

Individuals attached singly, without pedicel; two concentric anterior membranous collars, the inner one small.

49. **D. frequentissima** ZACH. ('94).

Taken abundantly in April, 1896, and in smaller numbers during the following month in towings from the river channel at E. These minute individuals were attached to the rays of *Asterionella*, a colonial diatom.

ASTROSIGA KENT.

Individuals united into stellate colonies by the attachment of their pedicels at a common center.

50. A. radiata ZACH. ('94).

One example observed by Dr. Kofoid in plankton from the river at E, in May.

Subfamily **SALPINGÆCINÆ**.**SALPINGÆCA** JAMES-CLARK.

Loricated, solitary, attached directly or by pedicel.

51. S. minuta KENT.

This extremely small form was found attached to the loricae of *Dinobryon sertularia* from the river, in May.

Order **DINOFLAGELLATA**.Suborder **DINIFERA**.Family **PERIDINIDÆ**.**PERIDINIUM** EHRLG.

Free-swimming, covered with an ornamented shell encircled by an equatorial groove, dividing the shell into two similar halves, the anterior formed of thirteen or fourteen plates, the posterior of seven, two of which, nearest the posterior extremity, are each often drawn out distally into a horn-like prolongation. A moderately wide longitudinal groove extends back from the equatorial groove at the middle of the ventral surface. Two flagella, one of which lies in the equatorial groove.

52. P. tabulatum EHRLG.

Found in July and August, but only in Thompson's and Matanzas lakes, abundantly in the former situation though not in any of the intervening waters.

CERATIUM SCHIRANK.

Differing from *Peridinium* especially in the form and structure of the shell. This is somewhat flattened dorso-ventrally, with a broad uncovered area on the ventral surface;

the two ends and two lateral plates just back of the equatorial groove drawn out into horn-like processes, often much longer than the width of the shell, usually the left process not developed, so that there are but three in all; the two halves similar in size and texture, the anterior with six plates, the posterior with four.

53. **C. hirundinella** O. F. MÜLL.

A few individuals were noted in towings from the river and Thompson's Lake in August and September of the second year only.

54. **C. brevicorne** HEMPEL ('96).

A few were taken in the river channel at E in August and September, also in each of six successive towings in Matanzas Lake in August.

Class *LVFUSORIA*.

Subclass *CILIATA*.

Order *GYMNOSTOMATA*.

Family **ENCHELIDÆ**.

Subfamily **HOLOPHRYINÆ**.

LACRYMARIA EHREG.

A distinct circle of large cilia around the mouth; body narrowed anteriorly and more or less bottle-shaped, moderately elastic.

55. **L. truncata** STOKES ('85a).

Taken only once, in a Birge-net collection amongst vegetation at the mouth of Dogfish Lake, in August.

Subfamily **COLEPINÆ**.

COLEPS NITZSCH.

More or less barrel-shaped, axis slightly curved; persistent in shape; covered with quadrangular plates in checker-board arrangement, with intervening spaces in which arise rows of

long cilia. A circle of cilia surrounds the large terminal mouth opening.

56. **C. hirtus** EHREG.

This lively and interesting little species was taken mostly from June to September in both years, with scattering occurrences in May, October, and December. It was not very common, although widely distributed.

Subfamily **CYCLODININÆ**.

DIDINIUM STEIN.

Obovate or obconic, anterior end feebly convex to distinctly concave, the mouth borne on a prominent conical elevation; ciliation reduced to an anterior and a median circle, the latter sometimes wanting.

57. **D. nasutum** O. F. MULL.

One or two examples of this very peculiar protozoan were found in the aquaria started with dried mud from Phelps Lake. It is a fine species of striking form and very quick movements.

Family **TRACHELIIDÆ**.

Subfamily **AMPHILEPTINÆ**.

AMPHILEPTUS EHREG. (Swan Animalcules.)

Elastic, ovate, anterior part more or less flattened and produced like an elephant's trunk, along the lower edge of which (oblique in side view) extends the slit-shaped mouth; surface entirely and finely ciliate; contractile vacuoles single or multiple.

58. **A. anser** EHREG.

Found in August in a Birge-net collection from among plants at the mouth of Dogfish Lake.

DILEPTUS DUL.

Elongate, with a very long, slender flexible snout, along the ventral edge of which is a band of trichocysts, ending at the

round mouth-opening at the base of the snout. A row of cilia extends along each side of the band of trichocysts and around the mouth; ciliation of body fine and uniform.

59. **D. anser** O. F. MÜLL.

Taken once, in August, with the Birge net, in vegetation on the west side of the river at E.

Family **CHLAMYDODONTIDÆ.**

Subfamily **NASSULINÆ.**

NASSULA EHRRG.

Oval or somewhat elongate, ends equally rounded; mouth circular, situated on the ventral surface back of the anterior extremity, left side more or less constricted beside the mouth; a row of stronger cilia extending from the mouth along the constriction; body finely and evenly ciliated, usually highly colored, with a pigment spot at the constriction.

60. **N. ornata** EHRRG.

Found once, in an aquarium started with dried mud from Phelps Lake.

Order TRICHOSTOMATA.

Suborder ASPIROTRICHA.

Family **PARAMÆCIIDÆ.**

PARAMÆCIUM O. F. MÜLL. (Slipper Animalcule.)

Ovate to elongate, flexible; densely, finely, and evenly ciliated; peristomal groove feebly or moderately excavated, narrowing posteriorly, and ending in the oval mouth, which is in the middle part of the ventral surface; one or two stellate contractile vacuoles.

61. **P. aurelia** O. F. MÜLL.

Very few individuals of this common species were found, possibly because of the lack of stagnant water at any of the substations. A few were taken among vegetation and in towings in August, and examples appeared in towings in October and January, all in the main river.

Suborder SPIROTRICHA.

Section HETEROTRICHA.

Family PLAGIOTOMIDÆ.

CONCHOPHTHIRIUS STEIN.

Colorless, not elastic, strongly compressed, in lateral view oval; mouth usually near the middle of the ventral edge, which is here sinuated because of the more or less excavated trough-like peristome-field; ciliation uniform, cilia rather long, usually a few larger ones along the anterior edge of the peristome-field and at the posterior extremity.

62. *C. anodontæ* EHREG.

Among the gills of *Unio anodontoides* from the river in July. Found also in other Unionidæ.

SPIROSTOMUM EHREG.

Colorless or green, elongate, often very much so, very elastic and flexible, rarely compressed; peristome-field narrow and long, extending from near the anterior end nearly straight to the mouth, with a zone of adoral cilia upon its left margin, turning obliquely into the mouth; ciliary striation very distinct, and slightly oblique; dorsally a long, canal-like extension from the large contractile vacuole at the posterior end.

63. *S. teres* C. & L.

Found only once, in August, in a towing from Quiver Lake.

Family STENTORIDÆ.

STENTOR OKEN.

Fixed or free-swimming at will; trumpet-shaped when expanded, tapering to the attached posterior end, the anterior end broad and flattened, occupied entirely by the peristome-field, which is encircled by the adoral zone of cilia; this takes a slightly spiral course on the ventral edge of the peristome-field, descending into the pharynx; ciliation of body very

fine, in longitudinal rows, often with intervening bristles; body more or less contracted when free-swimming; when attached, often protected by a tubular gelatinous sheath.

64. **S. polymorphus** O. F. MÜLL.

Not very common at any time, occurring now and then from April to July in towings and vegetation collections taken in lakes. In an aquarium in the zoölogical laboratory of the University this species was very abundant, large colonies more than half an inch in diameter being formed, consisting of a gelatinous substance in which the animals were fixed.

65. **S. roeselii** EHREBG.

Not common; found in towings and among vegetation in the river and in Quiver Lake.

66. **S. barretti** BARRETT.

A few examples seen in March from the river at E. This is closely allied to *S. roeselii*, but to me the two appear distinct.

67. **S. cœruleus** EHREBG.

Found in some catches from along the shores of Quiver Lake in May, in one of which it was common. This form also occurred in aquaria at the University laboratory. Small glass jars were filled with water containing some of them, and after these had stood for several weeks the inner surface of the jars was fairly lined with the *Stentor*. They reproduce very rapidly, and with a little care a constant supply for laboratory use can be kept on hand.

68. **S. igneus** ? EHREBG.

A *Stentor* was found several times in the towings, which I have doubtfully referred to this species. It was found once in Dogfish Lake in August, and afterwards in towings from the river at E from November to January, being abundant in December.

69. **Stentor** sp.

A small green species was found in a weedy bay—the “Pumpkin Patch”—at the head of Quiver Lake; but was not definitely determined.

Section OLIGOTRICHIA.

Family HALTERIIDÆ.

STROMBIDIUM C. & L.

Free-swimming, colorless, yellowish, or green, usually persistent in shape, globose, pyriform, or urceolate, usually narrowed or pointed behind; anterior end convex, encircled by the adoral zone, the oral end of which follows a ventral excavation back to the mouth-opening towards the middle of the body; without cilia except a few on the ventral surface, either irregularly scattered or in a short oblique row.

70. **S. claparedi** KENT.

Rare; taken in September and December in the river and Thompson's Lake.

HALTERIA DUG.

Free-swimming, colorless, persistent in shape, more or less globose, anterior end feebly convex, adoral zone about as in *Strombidium*, to which the genus is closely allied. Surface with a number of long stiff bristles or springing hairs, irregularly scattered or gathered into an equatorial zone. By means of these bristles the animal progresses with a succession of quick springing or leaping movements, as indicated by the name of the genus.

71. **H. grandinella** O. F. MÜLL.

This peculiar species was of frequent occurrence from June to September, and a few were seen in January and February. It was very generally distributed.

Family TINTINNIDÆ.

TINTINNOPSIS STEIN.

Lorica chitinous, usually campanulate, structureless; numerous foreign particles imbedded in its outer surface, mostly grains of sand.

72. **T. illinoisensis** HEMPEL ('96).*

Found in April and May, in company with *Coltonella cratera*, in towings from the Illinois River, Thompson's Lake,

*Subsequent studies by Dr. Kofoid indicate that this form is not specifically distinct from *Tintinnidium flaviatile* Stein.

and Quiver Lake. In the following year it was again noted in small numbers, during August and September, in towsings from the river at E.

CODONELLA HAECKEL.

Lorica indurated, short-urceolate in form, composed of hexagonal or circular areolets, each with a darker central dot; structure usually more or less obscured by a covering of foreign particles, a slight constriction at the base of the neck of the lorica; peristomal cilia often altered into leaf-like lamelle.

73. *C. cratera* LEIDY.

Difflugia cratera Leidy.

Few species among the *Infusoria* attract so much attention as this. It was frequent to abundant in towsings from the deeper and more permanent bodies of water under examination, continuing apparently throughout the year. At Thompson's Lake it was abundant in December, and again in February was found in a towing from under eighteen inches of ice. On one occasion in the latter part of August six towsings were taken in different parts of Matanzas Lake and examples of *C. cratera* were found in all but one of these towsings. This lake is fed almost entirely by springs, and consequently the water is in places comparatively cool during the summer, thus affording a congenial habitat for species that thrive best in cold waters. One towing was taken near the point where the water from a large spring enters the lake, and contained an abundance of this form. The species serves as food for such rotifers as *Asplanchna* and *Asplanchnopus*.

Section HYPOTRACHA.

Family OXYTRICHIDÆ.

Subfamily PLEUOTRICHINÆ.

STYLONYCHIA EHRBG.

Free-swimming, persistent, obovate or elliptic, peristome not greatly narrowed; anterior styles usually eight, occupy-

ing a more or less circular area; five claw-like ventral styles and five straight anal styles; three long caudal setae at the posterior extremity.

74. **S. mytilus** EURBG.

This species seems to avoid the open water, as it did not occur in the towings, although it was not uncommon in occasional shore collections among vegetation in June and again in December.

Section PERITRICHIA.

Family VORTICELLIDÆ.

Subfamily URCEOLARINÆ.

TRICHODINA EURBG.

Free-swimming, more or less short-cylindrical, elastic and flexible, especially the peristome end, which bears a well-developed adoral zone; posterior end forming an adhesive disc, bearing a complicated attachment-ring of radiating structure which is encircled by a posterior ciliary wreath, used in creeping and swimming, margin of disc forming a thin transparent edge. Parasitic on the surface of *Hydra* and other invertebrates.

75. **T. pediculis** EURBG.

Frequent on *Hydra viridis*, in towings from Dogfish Lake (substation L) in April.

Subfamily VORTICELLINÆ.

SCYPHIDIA DUL.

Not forming colonies; individuals elongate-cylindrical, attached by a posterior disc which does not bear a ring of cilia; peristome moderately well developed. Parasitic upon mollusks.

76. **Scyphidia** sp.

A species of this genus was observed on the siphonal papillae of *Unio parvus*, but was not determined.

VORTICELLA LINN. (Bell Animalcule.)

Inverted bell-shape, attached singly by a slender pedicel containing a highly contractile central thread; peristome end usually very wide; nucleus usually band-like. Many species of this genus were found, but few of them could be determined with any certainty.

77. **V. campanula** EHREBG.

Found in July among *Lemnaceæ* and other vegetation in Quiver Lake and the river, and once again in December in a river towing.

78. **V. microstoma** EHREBG.

A few were noted in July, taken from among *Lemnaceæ* upon the river at E.

79. **V. similis** STOKES ('87).

Common in July on roots of *Lemnaceæ* in the very weedy bay of Quiver Lake known as the "Pumpkin Patch."

CARCHESIUM EHREBG.

Animals like *Vorticella*, but forming tree-like colonies, the individuals borne upon the tips of a single branching stalk, with a contractile central thread. At the forkings of the stems the contractile thread of one branch is continuous with that of the stem below, while that of the other is not connected, thus permitting the independent extension and contraction of the separate zooids.

80. **C. polypinum** LINN.

This was also found on the roots of *Lemnaceæ* in the "Pumpkin Patch" in July. The colonies found were rather small. It was not common.

81. **C. lachmanni** KENT.

This species was abundant about the field laboratory in Quiver Lake in May. It was first noticed in some breeding-cages used in rearing aquatic larvæ. It multiplies very rapidly in foul or stagnant water. Some were placed in glass jars in the laboratory, and in a few days the entire inner surface of the jars was coated with a dense grayish layer.

82. **C. granulatum** KELL.

Many large colonies of this species were found in May upon an *Asellus* taken from the west side of the river at E.

ZOOTHAMNIUM BORY.

Similar to *Vorticella* and forming branching contractile colonies; but in this genus the contractile central thread is continuous throughout, dividing with each branching of the stem, whereby the act of contraction involves the entire colony.

83. **Z. arbuscula** EHREB.

This interesting and beautiful form was met with twice in the towings; in June from Quiver Lake, and in August from the river at E. A number were found on the latter occasion. The colonies are usually large and symmetrical, and when once seen will be remembered.

EPISTYLIS EHREB.

Animals forming colonies, borne on a rigid, noncontractile tree-like pedicel; individuals bell-shaped, more or less elongate to cylindrical; adoral zone encircling a slightly raised disc within the peristome margin, its oral end descending at one side, through an excavated vestibule, to the mouth opening; anterior end not so flexible as in *Vorticella*.

Several species were found, but only two could be definitely determined.

84. **E. plicatilis** EHREB.

Found at various times, especially in May, at a number of different places, twice in river towings, but usually attached to various insect larvæ, and on the shells of water-snails, such as *Physa* and *Vicipara*. *Tokophrya quadripartita* was sometimes found associated with it.

85. **E. flavicans** EHREB.

This species was noted as abundant on plants on two occasions in summer, and was found to be quite generally distributed, though not very abundant, in towings taken in the winter time.

RHABDOSTYLA KENT.

Similar to *Epistylis*, but not forming colonies.

Several undetermined species of this genus were found on various *Eutomostraca*, on a rotifer (*Polyarthra platyptera*), and on small aquatic worms.

OPERCULARIA GOLDF.

Forming colonies as in *Epistylis*, individuals more or less narrowed at the anterior end, peristome not laterally expanded; adoral disc very strongly elevated, while the surrounding peristomal ring is deeply excavated and the vestibule conspicuously wide and very deep; the adoral disc is therefore borne upon a column, on which it is usually obliquely placed, looking like a ciliated lid to the anterior end.

86. *O. nutans* EHREG.

Found in May on a *Planorbis* from Quiver Lake at C.

87. *O. rugosa* KELL. ('84).

Common among vegetation; a few found in bottom towing in Quiver Lake. Observed in May and July in the river and in Quiver and Thompson's Lakes. This is a fine species, and can be easily recognized by its thick pedicel and sessile zooids. Schewiakoff ('93) marks the species with an interrogation point, but I see no reason for it.

88. *O. irritabilis* HEMPEL ('96).

This fine large species was found at a variety of places from May to July, during which time it was common and often abundant, always occurring attached to the surface of some animal, especially young musk-turtles (*Aromochelys odoratus*). It was also found upon the backs of snapping turtles (*Chelydra serpentina*), and on two kinds of crayfishes, *Cambarus diogenes* and *C. blandingii acutus*. Its food consists partly of diatoms and *Euglena*.

The species is similar to *Opercularia articulata* Ehrbg., but differs from it in the shape of the body, the character of the peristome border and pharynx, and the elevation of the ciliary disc.

Tokophrya quadripartita was found common in company with this species, as was also a small *Opercularia*, which may prove to be only a variety of *irritabilis*. The zoöids of this small form measured .08 mm. in length and .042 mm. in width, but otherwise seem to agree with those of *irritabilis*.

COTHURNIA ENRIG.

Animal similar to *Epistylis*, but more elongate; contained in a lorica which is subcylindrical, of variously modified shapes, often expanded at middle and narrowed near the opening, attached posteriorly, either directly or by a short pedicel; sometimes closed when the animal is retracted within it. Nucleus elongate, band-like.

89. *C. curva* STEIN.

Found upon *Urnatella gracilis* in July, in bottom towings from the river at E.

VAGINICOLA LAM.

Animal similar to that of *Cothurnia*; lorica sac-like, narrowed at the opening, attached lengthwise by the ventral surface and flattened, the opening turned upwards.

90. *V. gigantea* D'UDEK.

A few individuals were found in September among vegetation in Thompson's Lake.

Subclass SUCTORIA.

Family ACINETIDÆ.

TOKOPHRYA BUTSCHLI.

Solitary, not loricated, globose to elongate, attached posteriorly by a rigid pedicel; reproducing by the formation of ciliated embryos within the body of the parent.

91. *T. cyclopum* C. & L.

In May and July a few were found on *Cyclops* in towings from Quiver Lake and the river.

92. *T. quadripartita* C. & L.

This was the commonest of the *Suctorina* in our collections.

It occurred principally in May and June, in collections from a number of substations, and was usually found associated with *Epistylis plicatilis* and *Opercularia irritabilis*, attached to small animals taken among vegetation. It is recorded from *Cambarus diogenes*, *C. blandingii acutus*, *Chelydra serpentina*, *Aromochelys odoratus*, and larvæ of *Hexagenia*.

ACINETA EHREB.

Solitary, ovate or elongated, basally or entirely within a cup-like lorica with a rigid pedicel; reproduction as in *Tokophrya*.

93. *A. mystacina* EHREB.

In the aquaria started with dried mud from Phelps Lake this species was quite common. It is very voracious, living upon *Ciliata*. Several specimens were observed while thus eating, and the passage of food particles through the tentacles was easily seen.

ROTIFERA.

The researches and investigations of morphologists during recent years have led to a clearer and fuller acquaintance with the details of animal structure, thus stimulating study along related lines. The field of the systematist has thus been broadened and extended. With a thorough knowledge of the anatomy of the animal body rather than a mere acquaintance with its external appearance, he is now better able to trace the relationships of the various subdivisions of the animal kingdom, and to place each form in the group to which it properly belongs. At the same time has come the study of œcology—the relation of organisms to each other and to their environment. Nothing can be more fascinating, or of more value in solving the general problems of life than this study of interrelations and dependences; but it cannot be carried on rightly unless our knowledge of the morphology, habits, etc., of the forms under observation is as complete as science can make it. Nor should this study be confined solely to animals of large size and easy of access; it must be

extended until it includes the minutest creature; for it is through these simple, minute organisms that we may arrive at the relations which exist between the inorganic and the organic.

The *Rotifera* constitute one of these groups of minute animals. It is a somewhat small group, consisting of about six hundred known species, one hundred and seventy of which have been found in the United States. They range in length from .05 to 2.5 mm. The body is usually elongate, sac-like or more or less oval, and is commonly provided with two circles of cilia on the corona or frontal border of the head, which, as the name indicates, have the appearance of two small wheels. These cilia are used in locomotion, and also assist the animal in obtaining food, since by their rapid vibration a stream of water is directed towards the mouth or buccal orifice, carrying with it particles of food material. The word *rotifer* is, however, misleading, since in many cases the circles of cilia or ciliary discs are so modified that they have lost all resemblance to a wheel. Sometimes but a single disc is present; again, there may be merely a row of cilia around the anterior border of the animal; and in rare cases the cilia are even entirely wanting. Some of the *Rotifera* have the body covered with a very thin chitinous external cuticula, while a great many have a hard, inflexible carapace or lorica. A number of species inhabit tubes, which they either secrete or build up from surrounding debris and pellets of excreta.

Members of this group are readily recognized by the presence of the mastax, a more or less irregularly three-lobed muscular organ, containing the teeth, jaws, or trophi, as they are variously called. These are composed of chitin, are hard and durable, and are true masticatory organs. Although some of the rotifers have no cilia, all of them agree in having a mastax and trophi, and as these structures are peculiar to the *Rotifera* they afford a ready means of identification.

The mastax is usually situated in the anterior part of the body, just behind the buccal orifice or lips, and a short œsophagus connects it with a large stomach lying in the posterior dorsal part of the animal. Many rotifers have the

power of protruding the trophi through the buccal orifice, and they may often be found nibbling at algae and other aquatic plants. Although the trophi are used by many rotifers to crush their food, there are some large forms, like *Asplanchna*, that swallow their food entire, as is shown by the uninjured rotifers, protozoans, and algae found in their stomachs.

The chitinous jaws or trophi (Fig. 3) consist typically of two hammer-like lateral parts, the mallei, bearing one to seven comb-like apical teeth, and working upon the two halves of a divided central part, the incus. The mallei are usually separable into an apical part bearing the teeth, the uncus, and a basal part, the manubrium. The two divisions of the incus are the rami and its basal projection is the fulcrum. These inner and outer pairs vary greatly in relative development, the mallei in some groups disappearing entirely. Hudson and Gosse recognize seven types of trophi, as shown in the figure below. Dr. Hudson's summary of the distinguishing features of these types is given on the next page.

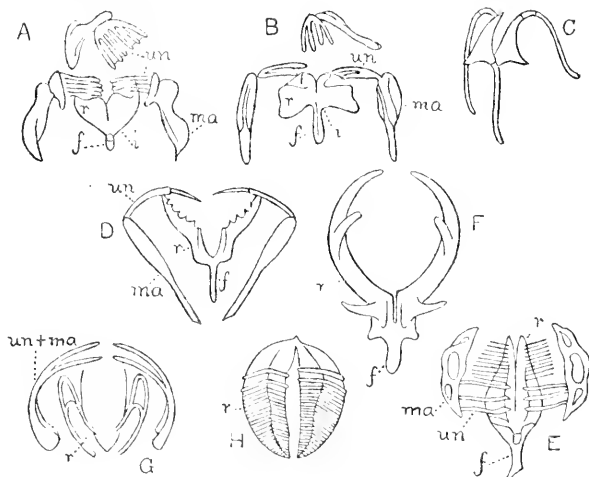

Fig. 3. Diagram of trophi: A, malleate; B, sub-malleate; C, virgate; D, forcipate; E, malleo-ramate; F, incudate; G, uncinuate; H, ramate. *f.* fulcrum; *i.* incus; *ma.* manubrium; *r.* ramus; *un.* uncus. (After Hudson, from the Cambridge Natural History.)

Malleate (A). Mallei stout; manubria and unci of nearly equal length; unci 5- to 7-toothed; fulcrum short; as in *Brachionus urceolaris*.

Sub-malleate (B). Mallei slender; manubria about twice as long as the unci; unci 3- to 5-toothed; as in *Euchlanis depleta*.

Virgate (C). Rami as well as mallei rod-like; as in *Furcularia*.

Forcipate (D). Mallei rod-like; manubria and fulcrum long; unci pointed or evanescent; rami much developed and used as a forceps; as in *Diglena forcipata*.

Malleo-ramate (E). Mallei fastened by the unci to rami; manubria 3 loops soldered to the unci; unci 3-toothed; rami large, with many striae parallel to the teeth; fulcrum slender; as in *Melicerta ringens*.

Incudate (F). Mallei evanescent; rami highly developed into a curved forceps; fulcrum stout; as in *Asplanchna ebbesbornii*.

Uncinate (G). Unci 2-toothed; manubria evanescent; incus slender; as in *Stephanoceros cichhorui*.

Ramate (H). Rami sub-quadrantia, each crossed by two or three teeth; manubria evanescent; fulcrum rudimentary; as in *Philodina roseola*.

The œsophagus, connecting the mastax and stomach, is lined with cilia, which by their vibratory motion cause a constant stream of water to flow towards the stomach, carrying particles of food with it.

The stomach is a large sac with thin walls, and usually contains a number of oil or fat globules. This may be demonstrated by killing rotifers with osmic acid, when the oil globules will be turned black by the acid. It is astonishing to see how much may be crammed into the stomach of a rotifer. I have frequently found specimens of *Asplanchnopus* with six or seven other rotifers in its stomach, and I once found a rotifer that had just made a meal of half a dozen small crustaceans (*Chydorus*).

There are at least three sets of glands within the body of a rotifer. One pair, the supposed salivary glands, are

globular in shape and situated at the sides of the mastax. Another pair, the so-called liver or gastric glands, more or less kidney-shaped, are situated behind the mastax and on the anterior part of the stomach, and, as their name implies, are supposed to secrete a digestive fluid for the stomach. The third pair are located in the foot, and are called the foot glands. They are usually tubular, more or less elongate in form, and secrete a sticky substance by means of which the rotifer anchors itself to weeds, sticks, or other objects.

No true circulatory or respiratory organs are present, although there is an excretory system. This consists of a pair of tubes or canals, one on each side of the body, running almost its entire length, and connected posteriorly with a contractile vesicle which, in turn, opens into the cloaca. Upon each lateral canal are a number of small cup-like structures, the vibratile tags, each one probably provided with cilia or flagella by means of which the fluid of the body is caused to flow into these vibratile tags and thence into the lateral canals, thence passing to the exterior by way of the contractile vesicle and cloaca. While it is probable that all rotifers are provided with a contractile vesicle, this has not been demonstrated for every species.

All rotifers, especially the more highly organized kinds, are well provided with muscles for the extrusion and retraction of head and foot, and for the working of the skipping appendages where such exist. These muscles are transversely striated, and the striae can be distinctly seen in such forms as *Triarthra*, *Polyarthra*, and *Pedalion*.

A nervous system and various sense organs are also present in rotifers. The sense organs consist of various styles or setae on the head and, usually, a brush of fine setae on each side at the lumbar region. The brain is rather large and is usually situated in front of and above the mastax. From this brain nerve fibers extend to the various sense organs. There are also from one to three so-called eyes, which are usually ruby-colored or black, and are situated either on the posterior part of the brain or on the frontal border of the head. They probably serve more for the

perception of light than for the formation of images. While the eyes are absent in the adults of some species, they may always be found in the embryonic or young forms.

Rotifers are dicecious and dimorphic; that is, the sexes are represented by separate individuals, and the males differ greatly from the females in size and organization. Descriptions of rotifers apply only to the females, as the males are but little known and may be found for only a few days once or twice a year. The male is usually inferior in size to the female, and consists of a transparent sac with a circle of cilia around the anterior border. It has no internal structures except a sperm sac and copulatory organ, eats nothing, and disappears in a few days.

Rotifers are usually oviparous, although there are forms, like *Rotifer* and *Asplanchna*, that are viviparous. There are three kinds of eggs. One of these is the ordinary egg, from which the female hatches, and which is sometimes encased in a spiny or roughened shell. Another form, from which the males are hatched, is smaller and smooth-shelled. These two are the so-called summer eggs. The third is the "lasting" or "ephippial" egg, which is larger than either of the other forms and has a hard, thick shell, well able to withstand drought and frost. The eggs are usually carried about attached to the posterior part of the lorica just above the foot.

Experiments were long ago made which show that the adult rotifer can be revived after it has been subjected to a severe drying process. Interesting results were obtained by us by starting aquaria with earth from the bottoms of dried-up ponds and lakes. Within two days after filtered water had been placed on the dried mud, full-grown specimens of *Brachionus* with eggs were found, which goes to prove that the rotifers had been dried with the mud and had revived when the water was added. Further experiments along this line might be profitably carried on to ascertain just how long rotifers can remain in this condition without having their vitality impaired, and to find out whether they will survive after being subjected to the hard frosts of a severe winter.

METHODS OF CAPTURE AND STUDY.

Rotifers should be widely studied, not only because they are interesting but because they are so easily accessible to nearly every one. Representatives of the group are found in every pool, pond, river, or other body of water. They seem to be little dependent upon the coarser aquatic vegetation, since they are equally abundant in waters with or without vegetation. No pond or mud hole is too insignificant to be populated by some of these forms. If one wishes to study them at times other than their usual season, or desires to have material for class use, all that is necessary is to collect some of the bottom of a dried-up pond and keep it until ready for the material. Then a small quantity may be put into a glass jar with some filtered water, and in twenty-four hours the forms will begin to appear. Such an aquarium may be kept up almost indefinitely by placing it in a moderately cool room in the sunlight; and renewing the water from time to time as it evaporates.

This work of starting aquaria from the bottom of dried-up bodies of water should be extensively practiced, as the observer will in this way meet many forms which he would not otherwise find; not only rotifers but numbers of *Protozoa* and microscopic plants as well.

Another method of obtaining material is to collect water from various sources and start a number of cultures by placing small quantities of the water in watch-glasses, or other small dishes, keeping a sharp lookout that the water does not dry out. If these dishes are examined from time to time they will be found to have developed certain forms of *Protozoa*, one species or another predominating in each of the dishes. After a time, if the student has been faithful, the chances are that he will be rewarded by finding in several of the dishes an almost pure culture of some particular species. This method was tried by Prof. Frank Smith in the zoölogical laboratory of the University of Illinois during the winter of 1894 with good results, pure cultures of *Distyla ohioensis*, *Hydatina senta*, *Stentor caruleus*, *Stylonychia mytilus*, and other species being obtained.

If there are marshes, weedy lakes, or river banks in the neighborhood, many rotifers may be obtained by gathering quantities of the weeds and allowing them to remain for a day or two in a glass jar with water. An examination of the water will then usually reveal the presence of the rotifers. Sometimes it is merely necessary to gather handfuls of the weeds and press out the water, which may be immediately examined. Other forms may be found by searching carefully the roots of *Lemnaea*, and the fronds of *Utricularia* or *Ceratophyllum*. Many fixed forms may be obtained by carefully examining the under sides of the leaves of water lilies and pondweed (*Potamogeton*). If catches are to be made in large bodies of water free from vegetation, a tow-net made of fine bolting-cloth (No. 12) will be indispensable.

The requisites for the examination of material and the study of rotifers are a compound microscope, several large and small pipettes, watch-glasses, slides and cover-glasses, and several killing and fixing agents. Of course the best results are obtained by studying the rotifers while alive; but if for any reason this cannot be done the material may be preserved and studied later. If the living subjects under examination are too lively and energetic they may be quieted down by adding to the water, very gradually, a 2% solution of cocaine or chloral hydrate.

If material is to be preserved, good results may be obtained by killing either in 50% alcohol or picronitric acid*, either of which, after one or two hours should be replaced by 70% alcohol, and this, again, by 80% or 90%, in which the material may be indefinitely preserved. Permanent mounts may be made from material preserved in this way by gradually substituting glycerine for the alcohol, and then mounting the objects in glycerine in a cell on a slide. By far the best method of preservation thus far devised is that given by Mr. C. F. Rousselet ('95). He first narcotizes the rotifers

*The formula for picronitric acid is as follows:

Water.....	100	volumes
Nitric acid (25% N_2O_5)	5	"
Picric acid	as much as will dissolve in mixture.	

Filter before using.

with a "cocaine-spirit mixture," made according to the following formula:

2% solution of cocaine.....	30 parts.
Methylated spirit	10 parts.
Water	60 parts.

Just before the cilia stop vibrating the rotifers are killed with a $\frac{1}{4}$ % solution of osmic acid, in which they are kept for about half a minute, after which they are thoroughly washed in water from a few minutes to half an hour and are then permanently preserved in a $2\frac{1}{2}$ % solution of formalin. This is an aqueous solution of formaldehyde and as prepared for sale has a strength of 40%. The species which have gelatinous tubes are more satisfactorily preserved in a mixture of equal parts of a 1% solution of corrosive sublimate and a $\frac{1}{2}$ % solution of common salt, since formalin extends the tubes to two or three times their natural length. In place of cement cells for permanent mounting, Mr. Rousset uses slides with concave centers and fastens the cover-glass by means of Miller's caoutchouc cement.

GEOGRAPHICAL DISTRIBUTION.

The *Rotifera* are cosmopolitan in their range, being found in all parts of the world. They inhabit mostly fresh water, but a number of species are found in the sea. Some of the species, such as *Rotifer vulgaris* and *Hyalina senta*, apparently occur in all parts of the world. There seems to be something about the organization of the rotifer that enables it to thrive under a great variety of conditions. The same forms are found in both rivers and muddy ponds in the United States, in clear streams of Europe or even in Alpine lakes, in the rivers of Egypt, and in the reservoirs of India. Climate and temperature seem to have little effect upon the distribution of rotifers.

FOOD RELATIONS.

The rotifers play an important part in the economy of nature, since they evidently take a prominent position among

* I find that Brown's transparent rubber cement answers this purpose very well.

the forms which, in the matter of food relations, bridge the gap between plants and animals. Many of the smaller forms like *Metopidia*, *Colurus*, *Mouostyla*, and also *Dinocharis* and *Euchlanis* are frequently found chewing the ends of fine filamentous alga. At one time a *Mastigocerca* was observed feeding on a piece of alga. It would puncture the outside, and appropriate the immediate contents of a cell; then it would creep along, make another puncture, and continue its meal. Diatoms also serve as food, and a *Notholea* was found that had its stomach crammed full of the rays of *Asterionella*. *Asplanchna priodonta* and also *A. brightwellii* seem to be omnivorous. I have frequently found *Pediastrum*, *Volvox*, *Colouella cratera*, *Dijflugia globulosa*, *Anurea tecta* and *A. cochlearis* in their stomachs. One *Asplanchna herrickii* was observed that had just made a meal of two *Brachionus militaris*; while an *Asplanchnopus myrmeco* was found with its stomach gorged with *Chydorus*.

On the other hand, the larger species of *Rotifera* doubtless form a considerable portion of the food of mollusks, minnows, buffalo fish, carp, suckers, and the like. Specimens of *Anurea cochlearis* were found in the stomach of a young "croppie" and in that of a young catfish. It is possible that the smaller *Crustacea* also live upon rotifers. This was especially indicated in Phelps Lake (substation F). There were times when the water of this lake was swarming with *Entomostraca* and the rotifers were very scarce, yet in a few weeks there would be very few *Entomostraca* and a great abundance of rotifers. Possibly the periodical disappearance of the rotifers was due to lack of food, but the disappearance of the *Crustacea* seems explainable only on the supposition that they depended on the rotifers for food. At one time a towing was taken at this substation in which there was such an abundance of *Pediastrum*—an element in the food of rotifers—that the water was colored green, and in this same towing there was an abundance of rotifers and very few *Entomostraca*.

* SEASONAL DISTRIBUTION.

While our seasonal histories of the *Protozoa* show but little tendency to a concentration in any particular part of

the year, the species of *Rotifera*, on the other hand, often have a well-marked period of abundance, with scattering occurrences at other times. The season of abundance varies greatly even in species of the same genus. Some are summer and some winter species; some have shorter and some longer periods. In general the group is well represented throughout the entire year. No towing was taken by us at any time that did not contain some rotifers. In 1894 they were most abundant from June to September, while comparatively few species were listed in October. The December records show an increase in such forms as *Brachionus*, *Anurea*, and *Notholca*. On February 23, 1895, tows were taken at substation G, under eighteen inches of ice, which were remarkable for the abundance of life they contained. Eight species of rotifers were found in this catch, three of which included individuals with eggs attached.

The forms which were common enough to show definite indications of their seasonal distribution are given in the following list, which can be greatly improved—perhaps in some cases disproved—by more extensive and systematic observations. The period of greatest abundance is given in italics.

- Floesularia ornata*: Sept.
Megalotrocha semibullata: July, *Aug.*
Conochilus: Jan., *Feb.-July*, Aug., Sept.
Rotifer: *July-Sept.*, Oct.-June.
Philodina: *June-Sept.*, Oct.
Asplanchnidæ: Jan., Feb., *Apr.-Sept.*, Nov., Dec.
Synecheta pectinata: *Sept.-May*, June, Aug.
S. stylata: July-Sept., *Oct.*
Polyarthra platyptera: *Dec.-Mar.*, Apr.-Nov.
Triarthra longiseta: Feb., *Apr.-Sept.*, Dec.
Plesoma lynceus: May, June, *July-Oct.*, Nov., Dec.
Notorhamatidæ: June, *July-Sept.*, Oct.
Mastigocerca bieristata: May, *June-Sept.*, Oct.
Celopus: June-Aug.
Dinocharis pocillum: *Mar.-July*, Oct.-Jan.
Salpina eustala: June, July-Sept., Oct.
Euchlanis: Apr.-June, *July-Sept.*, Oct.-Dec.

- Cathypnida: Mar.-May, *June-Oct.*, Nov.-Dec.
 Colurus: Mar., Apr., *June-Sept.*, Oct.
 Metopidia: Mar., June, *July-Sept.*, Oct., Dec.
 Pterodina patina: *June-Oct.*, Nov.-May.
 Brachionus pala: May-July, *Aug.-Apr.*
 B. dorcas: Oct., Nov., *Dec.-Apr.*, May.
 B. punctatus: *June-Sept.*
 B. ureolaris: Jan., Feb., Mar., Apr.
 B. bakeri, angularis, and militaris: Feb.-May, *June-Sept.*,
 Oct., Dec.
 Schizocerca: June-Sept.
 Notus quadricornis: May, June, *July-Sept.*, Oct., Nov.
 Anuraea tecta and cochlearis: Jan., Feb., *Mar.-Aug.*, Sept.-
 Dec.
 A. aculeata: *Jan.-June*, Nov., Dec.
 Notholea acuminata: Oct., Nov., *Dec.-Apr.*, May.
 Pedalion mirum: May, *July-Sept.*, Oct.

LOCAL DISTRIBUTION.

The Rotifera were widely distributed, being well represented at all of the substations. One hundred and eight forms were observed and identified. The five lakes under examination reflect their peculiarities in the species records. Thompson's, Quiver, and Dogfish lakes have well-defined shores, never become dry, and are more or less permanently supplied with aquatic vegetation. Their rotifer fauna was much the same. Phelps and Flag lakes, on the other hand, were very shallow, margined by mud flats which grew in size as the water dried up under the summer sun, the latter lake being substantially a reedy swamp. Species found in the other three lakes were often not present in these two, while a few forms were conspicuously more abundant in one of these than in the other three.

It is difficult to distinguish littoral and pelagic forms in this list. At most of the substations the water was comparatively shallow, its average depth where the tow-net was used ranging from about one and a half feet in Phelps Lake to nine feet in the river at E. Because of this shallowness

the forms preferring life amongst vegetation and near the shores or bottom doubtless often mingled with those inhabiting the clear open water, the same forms being usually found in both surface and bottom towings. The amount of aquatic vegetation present was an important item in the question. In Phelps and Thompson's lakes and in the river at E there was comparatively little visible plant life, while at D—in the river—and in Quiver and Dogfish lakes aquatic plants of all kinds flourished; indeed, Quiver Lake was almost entirely choked up during the first summer and autumn with *Ceratophyllum*, *Elodea*, *Spirogyra*, and the like. There was, however, a slight current in Quiver Lake, which kept a narrow channel free from weeds, so that it was possible to take towings at C during the entire season. On the whole it seems most satisfactory to consider those forms found near the shore or among vegetation as littoral, and those taken in open water free from vegetation as pelagic. Of the species studied the following twenty-four are in this sense pelagic:

- Conochilus dossuarius* Hudson.
- C. unicornis* Rousselet.
- Asplanchna ebbesbornii* Hudson.
- A. brightwellii* Gosse.
- A. priodonta* Gosse.
- A. herriekii* de Guerne.
- Synchaeta pectinata* Ehrbg.
- S. stylata* Wierz.
- Polyarthra platyptera* Ehrbg.
- Triarthra terminalis* Plate.
- Plesoma lynceus* Ehrbg.
- Brachionus mollis* Hempel.
- B. pala* Ehrbg.
- B. dorcas* Gosse.
- B. dorcas spinosus* Wierz.
- B. punctatus* Hempel.
- B. variabilis* Hempel.
- B. angularis* Gosse.
- B. angularis bidens* Plate.
- Anurea tecta* Gosse.

- A. aculeata Ehrbg.
- A. cochlearis Gosse.
- Notholea acuminata Ehrbg.
- Pedalion mirum Hudson.

Among these pelagic forms the most abundant were *Asplanchna brightwelli*, *Synchaeta pectinata*, *Polyarthra platyptera*, *Triarthra terminalis*, *Brachionus pala*, and *Anuraea cochlearis*. *Brachionus militaris* was probably the most abundant form of the littoral species.

Of all the substations under examination, C yielded the greatest number of species. There were two reasons for this. In the first place, a variety of conditions prevailed here. There was dense floating vegetation on each side of the lake, and at the same time a tolerably clear channel through the middle. Again, a greater number of collections were made here than at any other substation on account of the location of the field headquarters at this point. A and B were not satisfactory locations since they had to be abandoned early in the season. F was a constant source of surprise, and the catches made there were very interesting in regard to both numbers and variety. This was a very fruitful substation until August, when it completely dried up. D yielded nothing unusual, and the catches there were essentially the same as those among vegetation at the other substations. E was a typical river situation, and was satisfactory in every way. Next to C it yielded the largest number of species and, as might have been expected, all of the pelagic forms were found here. G was in a lake typical of the larger and more permanent lakes of the river bottoms, and contained a remarkable variety and number of organisms. Unfortunately its usefulness to us was reduced by the fact that it was difficult of access, and was consequently visited only at long intervals—usually a month, but sometimes longer.

AFFINITIES AND CLASSIFICATION.

There has been much discussion about the affinities of the *Rotifera*. Dr. C. F. Hudson ('75) thinks that such forms as *Pedalion* link them with the *Crustacea*, while, on the other

hand, forms like *Trochosphaera* seem to indicate that they are derived from the *Annelida*. The nervous and excretory systems are very similar to those of the turbellarian worms, which fact seems further to strengthen the theory that the rotifers are related to the *Vermes*. In the present state of our knowledge it seems best to class them as a separate group under the head of *Vermes*.

The entire group has been divided into four well-marked orders, mainly with reference to locomotion. These are the *Rhizota*, fixed when adult; the *Bdelloida*, "that swim with their ciliary wreath and creep like a leech;" the *Ploima*, "that swim with their ciliary wreath and (in some cases) creep with their toes;" and the *Scirtopoda*, "that swim with their ciliary wreath, and skip with arthropodous limbs."

In the preparation of the following list I have depended largely upon the superb monograph of Hudson and Gosse ('86), from which most of the descriptive matter is taken, and have in the main followed their classification, except in a few cases where it has been shown that they are in error. It seems unnecessary to give the synonymy of any forms described in the monograph, except perhaps in a few special cases regarding which there are differences of opinion; but for all forms in this list that have been described since the publication of Hudson and Gosse's Supplement ('89), a citation is given to the work containing the original description.

Other rotifers were found, as yet either unidentified or undescribed. Owing to limited time and opportunity they were not worked up, and are not included in this list.

SYNOPSIS OF THE FAMILIES OF ROTIFERA.

I. Order *Rhizota*. Fixed when adult, usually inhabiting a gelatinous tube; foot transversely wrinkled, not retractile within the body, ending in an adhesive disc or cup.

Flosculariidae. Coronal cup usually produced into setigerous or ciliate lobes; buccal orifice central; ciliary wreath a single half circle above the buccal orifice; trophi unciniate. (Fig. 3, G.)

Meliceritidae. Corona not produced into setigerous lobes; buccal orifice lateral; ciliary wreath a marginal continuous curve, bent on itself at the dorsal surface, so as to encircle the corona twice, with the buccal orifice between its upper and lower curves, and having also a dorsal gap between its points of flexure; trophi malleo-ramate (Fig. 3, E); usually inhabiting tubes made of pellets.

- II. Order *Bdelloida*. Swimming with their ciliary wreath and creeping like a leech; foot wholly retractile within the body, telescopic, ending almost invariably in three toes.

Philodinidae. Corona a pair of circular lobes transversely placed; ciliary wreath a marginal continuous curve, bent on itself at the dorsal surface so as to encircle the corona twice, with the buccal orifice between its upper and lower curves, and having also two gaps, the one dorsal, between its points of flexure, the other ventral, in the upper curve, opposite the buccal orifice; trophi ramate. (Fig. 3, H.)

Adinetidae. Corona a flat surface, facing ventrally; ciliary wreath the furred ventral surface of the corona; trophi ramate (Fig. 3, H); frontal column soldered to dorsal surface, and ending in two hooks.

- III. Order *Ploima*. Swimming with their ciliary wreath and (in some cases) creeping with their toes.

1. Suborder *Illoricata*. Integument flexible, not stiffened to an inclosing shell, except in *Plesonma*; foot, when present, almost invariably furcate, but not transversely wrinkled; rarely more than feebly telescopic, and partially retractile.

Microcodonidae. Corona obliquely transverse, flat, circular; buccal orifice central; ciliary wreath a marginal continuous curve encircling the corona, and two curves of larger cilia, one on each side of the buccal orifice; trophi forcipate (Fig. 3, D); foot stylate.

Asplachnidae. Corona subconical, with one or two

apices; ciliary wreath single, edging the corona; intestine and cloaca absent.

Synchaetidae. Corona a transverse spheroidal segment, sometimes much flattened, with styliigerous prominences; ciliary wreath a single interrupted or continuous marginal curve, encircling the corona; mastax very large, pear-shaped; trophi forcipate (Fig. 3, D); foot minute, furcate.

Triarthridae. Body furnished with skipping appendages; corona transverse; ciliary wreath single, marginal; foot absent.

Hydatinidae. Corona truncate, with styliigerous prominences; ciliary wreath two parallel curves, the one marginal, fringing the corona and buccal orifice; and the other lying within the first, the styliigerous prominences being between the two; trophi malleate (Fig. 3, A); foot furcate.

Notommatidae. Corona obliquely transverse; ciliary wreath of interrupted curves and clusters, usually with a marginal wreath surrounding the buccal orifice; trophi forcipate (Fig. 3, B); foot furcate.

2. Suborder *Loricata*. Integument stiffened to a wholly or partially inclosing shell; foot various. Corona and ciliary wreath various in shape, trophi of different types, but, except in the *Pterodinidae*, these structures are never as in *Rhizota* or *Bdelloida*.

Division I. Foot jointed, stylate or furcate; not transversely wrinkled nor wholly retractile.

Rattulidae. Body cylindrical or fusiform, smooth, without plicae or angles; contained in a lorica closed all around, but open at each end, often ridged; trophi long, asymmetrical; eye single, cervical. Variously asymmetrical.

Dinocharidae. Lorica entire, vase-shaped, or depressed; sometimes faceted, often spinous; head distinct, with a chitinous covering; foot and toes often greatly developed; trophi symmetrical.

Salpinidae. Body more or less completely enclosed in

a firm lorica, which is open at each end, and divided down the back by a fissure whose sides are united by membrane; two furcate toes always exposed.

Euchlanidae. Lorica of two dissimilar plates, one dorsal, one ventral, united so as to form two confluent cavities, of which the upper is much the larger; foot jointed, furcate.

Cathypniidae. Body enclosed in a lorica which is open at each end, and consists of two plates; the dorsal more or less elevated; the ventral nearly flat, the two divided by a deep lateral longitudinal sulcus, covered with flexible membrane; toes two or one, always exposed.

Coluridae. Body enclosed in a lorica, usually of firm consistence, variously compressed or depressed, open at both ends, closed dorsally, usually open or wanting ventrally; head surmounted by a chitinous arched plate or hood; toes two, rarely one, always exposed.

Division II. Foot transversely wrinkled, wholly retractile, furcate or ending in a ciliated cup; sometimes absent.

Pterodiniidae. Lorica entire, various; corona and ciliary wreath as in the *Philodiniidae*; trophi malleo-ramate (Fig. 3, E); foot jointless, toeless, ending in a ciliated cup or absent.

Brachionidae. Lorica box-like, open at each end, generally armed with anterior and posterior spines; foot long, excessively flexible, ending in two toes.

Anuraeidae. Lorica box-like, broadly open in front, behind open only by a narrow slit; usually armed with spines or elastic setae; foot wholly wanting.

IV. Order *Scirtopoda.* Swimming with their ciliary wreath, and skipping with arthropodous limbs; foot absent.

Pedalionidae. Arthropodous limbs six; head truncate; corona of two concave lobes; ciliary wreath as in *Philodiniidae*; trophi malleo-ramate (Fig. 3, E).

Order I. RHIZOTA.

Family **FLOSCULARIDÆ.**

FLOSCULARIA OKEN.

Frontal lobes short, expanded, or wanting; setæ very long and radiating, or short and cilia-like; foot terminated by a non-retractile peduncle, ending in an adhesive disc.

1. **F. ornata** EHREB.

Infrequent. Found during September on *Ceratophyllum* at substation L in Dogfish Lake.

Family **MELICERTIDÆ.**

LIMNIAS SCHRANK.

Provided with a tube, which is usually dark colored, but not made of pellets. Corona distinctly two-lobed; dorsal gap wide; dorsal antenna minute.

2. **L. ceratophylli** SCHRANK.

This fine form was first found in an aquarium started with dried mud from the bed of Phelps Lake, and in September was discovered on *Ceratophyllum* and *Potamogeton* from Thompson's Lake. While the rotifer was expanded a constant stream of fine particles kept moving away from it, the movement being quite uniform and the direction definite, as if the stream were shot out of the nozzle of a hose.

CEPHALOSIPHON EHREB.

Corona nearly circular; dorsal gap distinct; dorsal antenna obvious; ventral antennæ absent, two dorsal hooks enclosing the dorsal antenna.

3. **C. limnias** EHREB.

Infrequent, occurring in September on vegetation from Thompson's Lake.

ÆCISTES EHREB.

Corona a wide oval, indistinctly two-lobed; dorsal gap minute; dorsal antenna absent; ventral antennæ obvious.

4. **O. intermedius** DAVIS.

Infrequent, occurring during August on *Ceratophyllum* from Thompson's Lake.

5. **O. mucicola** KELL.

A few examples of this species were found in Dogfish Lake during September, 1895, on *Rivularia*.

MEGALOTROCHA EHREBG.

Forming spherical colonies of many individuals; corona kidney-shaped or four-sided, with a deep ventral sinus; trunk with two or four opaque warts on breast.

6. **M. alboflavicans** EHREBG.

Colonies of this rotifer were found in Quiver Lake during June and August, 1894, the clusters being attached to *Ceratophyllum*. In September of the same year young free-swimming clusters were taken in the tow-net from the Illinois River. The young have a small corona and well-developed eyes, and might easily be mistaken for *Conochilus* were it not for the presence of the opaque warts. In November a quantity of vegetable matter was taken from the shores of Quiver Lake and put into an aquarium, and in a few days several of the colonies were found attached to the plants. During September of the following year it was found in Dogfish Lake.

7. **M. semibullata** HUDSON.

This interesting form was not discovered until July of the second year, when it was occasionally found in the weedy waters of Flag Lake. It increased rapidly until the following month, when it was very abundant. The colonies seemed to hang by slender threads to stems of rushes and other aquatic plants, and when disturbed would swim through the water with a revolving motion. I was one day watching some of these colonies, when one of them, coming very near the surface of the water, was pounced upon and quickly devoured by a water beetle, *Diucetes*.

TROCHOSPHERA SEMPER.

Solitary, free-swimming; body a perfect sphere; buccal orifice on the spherical surface; principal wreath dividing the

sphere into two hemispheres, and passing above the buccal orifice; dorsal gap in the wreath at the pole opposite to buccal orifice; secondary wreath a fragment on the under side of the buccal orifice; ventral antennæ extremely minute; no tube.

8. **T. solstitialis** THORPE.

The occurrence of this rare and remarkable form in this country was reported for the first time by Dr. C. A. Kofoid ('96a). It was found by him in the Illinois River and Flag Lake in June, July, and August, 1896.

CONOCHILUS EHREBG.

Clusters of several or many individuals, free-swimming; corona horse-shoe shaped; gap in the ciliary wreath ventral.

9. **C. dossuarius** HUDSON.

This species was found in all the bodies of water under observation. It was present during the greater part of the year from January to September, reaching its maximum in March. Many clusters were taken with a tow-net in Thompson's Lake, in February, 1895, under eighteen inches of ice. These specimens appeared larger and more vigorous than those seen during the summer. It is readily recognized by the small number of individuals composing the cluster; by the presence of the two antennæ, which stand out on the arched ventral surface like tall chimneys on a building; and by the fact that eggs are almost invariably found in connection with the colonies.

10. **C. unicornis** ROUSSELET ('92).

C. leptopus Forbes, '93.

This rotifer was found only in May and June. During this time only a few were taken in the tow-net at C, although it was common in the river at D and E, and was taken in both surface and oblique tows at the latter substation.

Order BDELLOIDA.

Family PHILODINIDÆ.

ROTIFER SCHRANK.

Eyes two, situated within the frontal column. (Trophs, Fig. 3, 4.)

11. **R. macrurus** SCHRANK.

In June one specimen was found in a surface towing from C, in Quiver Lake.

12. **R. vulgaris** SCHRANK.

A few were found during July in the surface towings from the river at E. In March it was also found in the oblique towings from the same place.

13. **R. tardus** EHRLG.

This species was comparatively rare. In June it was found among the vegetation on the west shore of Quiver Lake at C, and in June, September, and October it occurred in the towings from the river at E.

14. **R. neptunius** EHRLG.

Actinurus neptunius Ehrbg.

This peculiar and interesting form was found in the river at E from May to October, in Matanzas Lake in August, and in Thompson's Lake in September. Although it was not common at any time, still it was persistent during the months mentioned, and was found in both surface and oblique towings. It is rather remarkable that it was not found among the vegetation.

PHILODINA EHRLG.

Eyes two, placed above the brain.

15. **P. macrostyla** EHRLG.

Philodina tuberculata Gosse.

One specimen of this rotifer was taken in August among the vegetation on the west shore of Quiver Lake, at the mouth of Dogfish Lake.

16. **P. megalotrocha** EHRLG.

This form was well distributed, being found in Quiver and Phelps lakes and in the river (substations C, F, D, and E). It was taken in surface and oblique towings and among vegetation. There was hardly a collection made at these substations from June to September in which it did not occur, and it was also found once in October at E.

CALLIDINA EHRLG.

Eyes wanting.

17. **C. elegans** EHRLG.

This species was found once, in September, in towings from Dogfish Lake.

Order III. PLOIMA.

Family **ASPLANCHNIDÆ.****ASPLANCHNA** GOSSE.

Body sac-like, foot wanting; corona with two apices; trophi (Fig. 3, F), two plates working together like the jaws of an insect, not inclosed within a mastax. Viviparous.

18. **A. ebbesbornii** HUDSON.

This large species was found once during June, in a surface towing from the river at E, in company with *A. priodonta*. So far as I know, it has not been previously recorded from the United States. It is a fine, attractive form, and not easily confused with other species of this genus.

19. **A. brightwellii** GOSSE.

This form was the most abundant representative of its genus in the field studied by us. It was widely distributed among the various substations, and present during nearly the entire year, reaching its maximum in July and August. It appropriates almost everything in the way of food: *Asterionella*, *Colouella cratera*, *Dijuglia globulosa*, *Anuraea cochlearis* and *A. tecta* have all been found in stomachs of individuals of this species.

20. **A. priodonta** GOSSE.

This species was found from April to September in both years. In 1894 it was most abundant in May and June, and in 1895 the maximum was reached in August. It occurred mostly in towings from the Illinois River and from Thompson's Lake, but was also found in Quiver and Dogfish lakes. This form, like most of the members of this genus, is distinctively pelagic. None were found among vegetation. Like

the preceding species it is omnivorous. *Asterionella*, *Pediasstrum*, *Volvox globator*, *Codonella cratera*, *Anuraea tecta*, and *A. cochlearis* were common in its food.

21. **A. herrickii** DE GUERNE.

The record of this species presents a similar history for each of the two years. It appeared in April and May, reaching its maximum in May; was not seen at all in June, and but once in July; and in August and September it occurred extensively, but was not common. Like *A. priodonta*, it was found in the river and more permanent lakes,—Quiver, Dogfish, and Thompson's,—but not in the two shallower lakes, Phelps and Flag—liable to dry up more or less in late summer.

Professor Forbes, in studying this species, found several small parasites within the body. They were apparently one-celled, very changeable in shape, and seemed to have three flagella-like pseudopodia.

Two specimens of *Brachionus militaris* were found in the stomach of one example of this *Asplanchna*, and *Anuraea cochlearis*, *Volvox globator*, and *Bosmina* also serve as food for it.

22. **A. girodi** DE GUERNE.

Taken only in towings from Flag Lake, during April, 1896.

ASPLANCHNOPUS DE GUERNE.

Like *Asplanchna*, but with a ventral retractile foot, ending in two toes.

23. **A. myrmeleo** EHREB.

Notommata myrmeleo Ehrbg.

This fine large rotifer was present in small numbers from May to September. It occurred in collections from Quiver Lake, Dogfish Lake, and the Illinois River, and was found both in the open water and among vegetation. Individuals can be easily recognized in the water without a lens by their large size and sluggish movements. They are great eaters, and their stomachs are almost invariably filled with other rotifers and crustaceans, sometimes so gorged with food that

the body walls are greatly distended. *Monostyla* and *Chydorus* seem to be their favorite food.

This form has not been previously listed from the United States.

SACCOLUS GOSSE.

Corona with one apex; trophi inclosed in a mastax, virgate, with unequal mallei; alimentary canal very large, having eight caeca; eggs attached after deposition.

24. *S. viridis* GOSSE.

This species was scarce, appearing only in surface towings taken at the mouth of Quiver Lake during May, 1896.

Family SYNCHÆTIDÆ.

SYNCHÆTA EHREB.

Form usually that of a long cone whose apex is the foot; front furnished with two ciliated auricles; ciliary wreath of interrupted curves; foot small, furcate.

25. *S. pectinata* EHREB.

This was abundant and widely distributed, being found at all of the substations. It was not found in July, and was noticeably scarcer in June and August. At all other times of the year it was common and often abundant, especially in May and November. The records for each of the two years were substantially alike. This is a very pretty gem in the water, very quick in its movements, darting hither and thither, and consequently difficult to study, but after its characters are once made out it will long be remembered.

26. *S. stylata* WIERZ. ('92).

Found only in the Illinois River and Quiver Lake, from July to October, and again in March; most abundant in October in the river.

This was also found by Jennings ('94) in Lake St. Clair.

Family TRIARTHRIDÆ.

POLYARTHRA EHREB.

Body small, sac-like; skipping appendages, when present, in clusters on the shoulders; eye single, occipital; mastax large and pear-shaped; trophi forcipate.

27. *P. platyptera* EHRBG.

This is one of the four species that were present during every month of the year. It seems to thrive best in cold water, for it was most abundant during December, January, and March, and reached its minimum in June. It was found in all the bodies of water under observation. Many individuals were larger than the dimensions given by Hudson and Gosse, some of them measuring .2 mm. in length. *Rhabdostyla* was found parasitic on many that were taken in Phelps Lake.

28. *P. platyptera euryptera* WIERZ. ('91).

Rare; found in September, in towings from the Illinois River.

29. *P. aptera* HOOD ('93).

In November, 1894, a quantity of dried mud from the bottom of Phelps Lake was taken to the University, and, as has been previously stated, aquaria were started by putting filtered water upon this mud. This species was found at two different times in these aquaria, but was not observed at any of the substations.

TRIARTHRA EHRBG.

Body sac-like; spines single, two lateral, one ventral; eyes two, frontal; mastax of moderate size; trophi malleo-ramate.

30. *T. longiseta* EHRBG.

Not especially common but generally present in both years in the river and lakes studied except Flag Lake, during the period from April to September. A very few were also seen in both years in December and February.

Plate ('85) describes a new rotifer, calling it *T. terminalis*. He says: "The attachment of the posterior spine is not ventral but terminal, just in front of the anal opening, and the spine cannot be flexed anteriorly. The spines are smooth, although I found one individual in which they bore very small spinules, as in *T. longiseta*."

Many of the individuals taken here had smooth spines, while others had them notched. The posterior spine was

inserted on the posterior part of the body. It is my belief that *terminalis* and *longisetæ* are identical.

As far as known, this is the first time the species has been recorded for the United States.

PEDETES GOSSE.

Body ovate, tailed; toes absent; eyes two, frontal; two leaping styles articulated to the breast.

31. **P. saltator** GOSSE.

One specimen was found in an aquarium started with dried mud from the bottom of Phelps Lake. The species was probably not abundant, since several aquaria had been started before this specimen was discovered.

Family **HYDATINIDÆ.**

HYDATINA EHREBG.

Not loricate; body conical, tapering towards the foot; foot short and confluent with the trunk; eye absent.

32. **H. senta** EHREBG.

This large, fine form was rare. It was seen only in March and July, 1895, in the main river at E.

PLESOMA HERRICK ('85).

With a lorica composed of two ovate valves united above and partially united below; foot springing from middle of ventral margin.

33. **P. lynceus** EHREBG.

Euchlanis lynceus Ehrbg.

Plesoma lentilare Herrick.

Gomphogaster arcuatus Vorce.

Gastropus chreubergii Imhof.

Gastroschiza lynceus Bergendal.

Gastroschiza foveolata Jägerskiöld.

Bipalpus lynceus Wierzejski and Zacharias.

Plesoma lynceus Jennings ('94a.)

Not common. Found in all the more permanent waters from May to December, but most frequently from July to

October. It seems to be most at home creeping among the vegetation, such as was so abundant at substation C in Quiver Lake.

A very fine rotifer, arresting the attention by its unusual activity and attractive lorica.

Family **NOTOMMATIDÆ.**

TAPHROCAMPA GOSSE.

Body fusiform or cylindrical, annulose, furnished with two furcate toes; trophi forcipate; cilia very limited or wanting.

34. **T. annulosa** GOSSE.

Infrequent, being found only at substation C in Quiver Lake, among vegetation and in open water, from July to September of the first year.

NOTOMMATA GOSSE.

Body cylindrical, not annulose, furnished behind with a projecting tail; evertile and protrusile ciliated auricles on the head; brain large, usually containing opaque chalk masses; trophi virgate. Numerous species, in some of which one or more of these characters may be lacking.

35. **N. aurita** EHREG.

Infrequent; taken among vegetation in the Illinois River in July.

36. **N. cyrtopus** GOSSE.

Infrequent, occurring during February in towings from the Illinois River.

37. **N. tripus** EHREG.

Occurred only during June and July, in both surface and bottom towings from Quiver Lake.

38. **N. lacinulata** EHREG.

This form was found once, in July, when a few were taken among the vegetation at the mouth of the "Pumpkin Patch;" a bay full of wild rice and other vegetation, communicating with the west side of Quiver Lake, near the head of the lake.

FURCULARIA EHREG.

Body generally larviform, cylindrical, with a tendency to enlargement in the lumbar region: front conical, broad, and deep; eye single, frontal, sometimes wanting; incus forcipate, much developed, protrusile; toes two, furcate, usually conspicuous.

39. **F. forcicula** EHREG.

This species was scarce, being taken only in May, 1896, in surface towings at the mouth of Quiver Lake.

40. **F. longiseta** EHREG.

This rather peculiar form was found only in Quiver Lake. In July and August, and once in March, a few were taken. It occurred both among vegetation and in the towings.

EOSPHORA EHREG.

Body oblong, head dilated and furnished with protrusile auricles; foot very distinct, with telescopic joints and furcate toes; eyes three, one large, cervical, two minute, frontal.

41. **E. aurita** EHREG.

One morning in July, 1894, we saw a large quantity of red scum on the river. Upon examining it several specimens of this rotifer were found. In September of the same year it was again found, on the west shore of Quiver Lake, among vegetation.

DIGLENA EHREG.

Body subcylindric but very versatile in outline, often swelling behind and tapering to the head; eyes two, minute, situated near the edge of the front; foot furcate, trophi forcipate, generally very protrusile.

42. **D. grandis** EHREG.

This large form was found only in Quiver Lake in 1894, once in August, and again in October.

43. **D. catellina** EHREG.

This species was found in small numbers during August in the red scum at the mouth of Quiver Lake.

44. **D. biraphis** GOSSE.

This species was rare, being found only in bottom towings from Quiver Lake in July.

Family **RATTULIDÆ.****MASTIGOCERCA** EHREG.

Body fusiform or irregularly thick, not lunate; toe a single long style, with accessory stylets at its base; lorica often furnished with one or more thin dorsal ridges.

45. **M. carinata** EHREG.

This form was not very common. It was mostly found, in both years, at substation C in Quiver Lake, from June to September, the maximum being in July, when it was also seen in the river. A single occurrence in this lake in December is also noted. At one time I watched a *Mastigocerca* feeding on some *Spirogyra*. It would puncture the side of a filament with its sharp trophi and eat the green contents of the cell; then it would creep along, open another cell and appropriate its contents; and so on, until satisfied.

46. **M. elongata** GOSSE.

Found but once, in a towing taken below the surface of Quiver Lake in June.

47. **M. bicornis** EHREG.

I found this species several times in the towings during June and July, and again in November, mostly in Quiver Lake, but in June also in oblique towings from the river at E.

48. **M. stylata** GOSSE.

This form was scarce, being found only in towings from the Illinois River in August, 1895.

49. **M. bicristata** GOSSE.

This species and *M. carinata* were the commonest representatives of the genus at the Station. *M. bicristata* was found but once in the river, in September, but appeared in moderate numbers in Quiver Lake from May to August, and in Thompson's Lake from August to October.

The specific characters as given by Gosse are, "Two equal subparallel carinae, running nearly the whole length of the

dorsum." The two carinae of the specimens taken at Havana extend a trifle more than two thirds the length of the dorsum. The carinae are high, thick at base, and very conspicuous. The length of the specimens averages greater than that given by Mr. Gosse. I found them as long as .58 mm., including the toe, which is nearly half the entire length. The toe is slightly curved and ends in a spine, with two smaller accessory spines.

50. **M. lata** JENNINGS ('94).

This species was met with in June and several times during October, in surface towings, and also in towings taken below the surface, from Quiver Lake. It is easily recognized by the indentation on the right side of the body next to the foot joint, and by the flattened truncate column of the corona.

CÆLOPUS GOSSE.

Body cylindrical, curved; foot bulbous, inclosed; toes, one broad plate with another laid upon it in a different plane.

51. **C. porcellus** GOSSE.

This curious and interesting form was found in towings and among vegetation from Quiver Lake from June to August, and in surface towings from the river in June.

52. **C. tenuior** GOSSE.

This form was taken in Quiver Lake in the same months as the preceding, and was generally found in company with it, although in smaller numbers.

Family **DINOCHARIDÆ.**

DINOCHARIS EHREBG.

Lorica vase-shaped, faceted, with projecting plates, or armed dorsally with spines; head retractile within a chitinous cap; eye single; foot and toes very long, the former bearing spines.

53. **D. pocillum** EHREBG.

The records of this species for both years show a seasonal distribution quite the reverse of that characterizing its relatives, which are generally commonest in the warmer months,

from June to October. This was most frequently seen, though never very numerous, from December to June, with occasional appearances in October and November and in July. Found in the towings, mostly in Quiver Lake, and not at all in Phelps, Flag, or Thompson's lakes.

SCARIDIUM EHRRG.

Lorica vase-shaped or pear-shaped; very thin, transparent, smooth, without spines or projecting plates; head with a chitinous cuticle, except in front; eye single; foot without spurs; toes very long.

54. **S. longicaudum** EHRRG.

But few specimens of this rotifer were taken. It is recorded from the deeper lakes, from July to October.

Family **SALPINIDÆ**.

SALPINA EHRRG.

Lorica an oblong box, furnished with spines, but widely open at each end, split down the back; head and foot protrusile; toes furcate, long, straight; trophi submalleate; eye single, cervical.

55. **S. eustaia** GOSSE.

In both years this species was present from June to September, with a single occurrence in October. It was found in the Illinois River and the deeper lakes, but was not abundant.

Our specimens agree with the description given by Mr. Gosse, but average smaller, the largest individual measuring .23 mm. in length.

Family **EUCHLANIDÆ**.

EUCHLANIS EHRRG.

Dorsal plate with the median portion arched; ventral plate nearly flat, usually with a flange on each side; eye single.

Members of this genus were frequently seen eating diatoms

and fine filamentous algæ. They would grasp the threads of algæ with the rami and chew them preparatory to swallowing.

56. ***E. dilatata*** EHRLG.

This species was present from July to September in the river and deeper lakes, being found at the same substations as the foregoing species and reaching its greatest abundance in July. It was the only member of its genus found in Dogfish Lake, where it continued to occur until December, long after it had disappeared at the other substations. It was also found once in April in this lake.

57. ***E. triquetra*** EHRLG.

Not so abundant as the preceding species; found only in the Illinois River and Quiver Lake, from June to October. This is the most conspicuous and beautiful representative of this genus. It may very readily be distinguished by the curious "three-winged" shape of the lorica.

58. ***E. deflexa*** GOSSE.

This was found only in towsings from Quiver Lake during the period from May to September.

59. ***E. pyriformis*** GOSSE.

Of infrequent occurrence, during November, in towsings from Flag Lake.

Family **CATHYPNIDÆ.**

CATHYPNA GOSSE.

Lorica subcircular horizontally, usually much arched vertically; lateral inangulation wide and deep; toes two, furcate.

60. ***C. luna*** EHRLG.

This species was present from April to December, and at all of the substations except B. Its maximum of abundance was reached in July and August. The records for the first and second year are very similar.

61. ***C. leontina*** TURNER ('92).

Seasonal distribution about the same as that of *C. luna*. It was found in the Illinois River and deeper lakes, and was present both in towsings and among vegetation. It was commonest about July.

DISTYLA ECKSTEIN.

Lorica of the form of a long ellipse, open and membranous before, closed behind, depressed, higher before than behind; lateral inangulation feeble; toes two; selvage-like thickenings of the lorica around the foot.

62. **D. gissensis** ECKSTEIN.

Found but once, in a towing from Phelps Lake in July.

63. **D. ohioensis** HERRICK ('85).

Excepting a rare occurrence in April, this species was present only from July to November. It was found in Quiver and Dogfish lakes.

64. **D. stokesii** PELL ('90).

Cathypna stokesii Pell *

This little species was found four times in tows from Quiver Lake; once in July, again in September and in October, and again in March. The entire surface of the lorica is finely stippled.

65. **D. hornemanni** EHRBG.

Occurred only in tows from Thompson's Lake, during September.

MONOSTYLA EHRBG.

Like *Cathypna*, but with only a single toe.

66. **M. lunaris** EHRBG.

This form was found in January and April, but principally from June to November. It occurred upon vegetation and in tows from the Illinois River, and from all the lakes studied except Phelps Lake.

67. **M. cornuta** EHRBG.

Taken in limited number among plants and in tows in the Illinois River and in Quiver Lake, from July to October.

Individuals have been observed nibbling and eating bits of algae, like the species of *Euchlanis*.

68. **M. bulba** GOSSE.

This species was as abundant among the vegetation as in the open water, and was found in all the bodies of water

*Jennings ('94) has pointed out that this species belongs to *Distyla* rather than to *Cathypna*.

except the two shallower lakes, Phelps and Flag. It was present from April to November, and was most common during the period from July to September.

69. **M. quadridentata** EHREBG.

This was found at all of the substations except that in Phelps Lake. It occurred from May to December and was uniformly present, though never very abundant, throughout the warmer months, from June to October.

70. **M. closterocerca** SCHMARDA.

Scattered occurrences at various times and places characterize the record of this rather rare species. A maximum in September is feebly indicated. It was found in all the deeper lakes.

71. **M. mollis** GOSSE.

Rare, being taken only in tows from the Illinois River in August.

Family **COLURIDÆ.**

COLURUS EHREBG.

Body subglobose, more or less compressed; lorica composed of two lateral plates, open in front, united dorsally, gaping behind, and generally open ventrally; frontal hood in the form of a hook, not retractile; foot permanently extended; of distinct joints, terminated by two furcate toes.

72. **C. deflexus** EHREBG.

Occurred only in oblique tows from Quiver Lake, during March.

73. **C. bicuspidatus** EHREBG.

This species was not common at any time, and was found only in the Illinois River and deeper lakes. It was present from July to October, also once in April, frequenting both vegetation and open water.

74. **C. obtusus** GOSSE.

This attractive minute species was found in Quiver Lake and once in the Illinois River. It was taken among vegetation and in tows from June to September.

METOPIDIA EHREBG.

Lorica usually depressed, entire, with an opening at each end for the protrusion of the head and foot; frontal hood in the form of a hook; foot and toes as in *Colurus*; eyes usually two.

75. **M. solidus** GOSSE.

Of rare occurrence. Found in towings from Quiver Lake in September.

76. **M. acuminata** EHREBG.

No member of this genus was common at any time. The present species was taken only in March, July, and December, in towings from the deeper lakes—Dogfish and Thompson's.

77. **M. oxysternum** GOSSE.

Rare. Found in towings from Quiver Lake and the Illinois River from September to December.

78. **M. rhomboides** GOSSE.

This species was more numerous than any other member of the genus. It was found in towings from the Illinois River and deeper lakes during August and September, and also once in December.

79. **M. triptera** EHREBG.

This species was found in Quiver Lake during July and August, and in Thompson's Lake in July.

80. **M. bractea** EHREBG.

Found sparingly among vegetation and in towings from Quiver Lake in July of both years.

81. **M. oblonga** EHREBG.

Metopidia elliptica Turner ('92).

Found sparingly among vegetation in Quiver Lake and in the river in June and July of the first year. Length of lorica .105 mm.

Family **PTERODINIDÆ**.

PTERODINA EHREBG.

Lorica entire, greatly depressed, of two oval, but nearly circular, plates united at their edges; foot wholly retractile,

transversely wrinkled, jointless, toeless, ending in a ciliated cup.

82. **P. patina** EHREG.

This species was present throughout the entire year, and was found in the river and in all the deeper lakes. As to the shallower lakes, it was rare in Flag and not found at all in Phelps. It occurred both in towsings and among vegetation. Its period of abundance is evidently from June to October.

83. **P. valvata** HUDSON.

Very rare, being found only once—among vegetation in Quiver Lake, in June, 1894.

Family **BRACHIONIDÆ.**

BRACHIONUS EHREG.

Lorica without elevated ridges, gibbous both dorsally and ventrally; foot very flexible, uniformly wrinkled, without articulation; toes very small.

84. **B. mollis** HEMPEL ('96).

This active species was found, during July and August, in towsings from the Illinois River, Phelps Lake, and Flag Lake, but was not common except in Phelps Lake, where it was abundant.

85. **B. pala** EHREG.

This species was present all the year round, and was found at nearly all of the substations. It was very abundant at times, especially in April, August, September, November, and December.

There seem to be several varieties of this species. Some individuals have no posterior spines; others have the two prominences which guard the foot developed into spines, and also have two other posterior spines. There are still others in which these posterior spines are remarkably developed, so that they are twice the length of the occipital spines.

This is undoubtedly a pelagic species, since it was found in surface and bottom towsings, and but once among vegetation near the shore.

86. **B. dorcas** GOSSE.

This is a winter species, as the records of both years show. It was found in towings from the Illinois River and from all the various lakes in which collections were made, from December to April, with a few scattering occurrences just before and after this period, becoming very abundant in April.

Like the preceding species, this one was found only in towings, and is recognized as a pelagic form.

87. **B. dorcas spinosus** WIERZ. ('91).

But few specimens of this variety were found. It occurred in towings from the Illinois River and Quiver Lake during May, 1894, and in towings from the river and Thompson's Lake taken in January, March, and May, 1895. This indicates a seasonal history like that of the typical form.

88. **B. punctatus** HEMPEL ('96).

This was moderately common, and appeared from June to September. It occurred only in the open water, and was taken in most of the waters studied.

I have had the opportunity to study living examples of this rotifer since the publication of my description ('96), which was drawn up from dead specimens somewhat inflated by the preserving fluid, and is consequently not as accurate as it might be. I find that in the live specimens the dorso-ventral diameter is less than was at first supposed, the rotifer being flatter than the illustration represents it.

89. **B. urceolaris** ENDBG.

This also seems to be a winter species, occurring from January to April. It was found only the second year, in towings from the river and from all the lakes studied except Phelps Lake, and though usually not very common, it was very abundant in Thompson's Lake in March.

90. **B. rubens** ENDBG.

This species occurred from December to March in small numbers in towings from the river and from all the lakes but

Phelps Lake. It also appeared in the river at E in August and September, 1894, becoming very abundant in August.

This is a very difficult species to work with, since it varies greatly. Specimens were found ranging from .17 to .25 mm. in length. The pectoral edge is slightly more notched in our specimens than in the typical form.

91. **B. variabilis** HEMPEL ('96).

This is a very restless active species, most common from April to July, but present also in most of the other months of the year. It was found only in the open water, but at nearly all of the substations, and was very abundant in Phelps Lake at the time when the Station work first began.

92. **B. bakeri** EHREBG.

This is preëminently a summer species, making its first appearance in our collections in May, becoming common from June to August, and disappearing again in October. It occurred in all the waters studied except Flag Lake, and was found among vegetation as well as in the open water.

This is also a variable species.

93. **B. bakeri brevispinus** EHREBG.

Infrequent. Found in tows from the Illinois River during April, 1896.

94. **B. angularis** GOSSE.

This species was common and often abundant in summer. It occurred from April to September, with occasional appearances in October, December, February, and March, its time of greatest abundance being in July and August. It was found in all of the waters of the Station except Flag Lake.

Comparatively few specimens were found that had the characteristic bluntly angled lorica. The majority of them were more or less smooth; and in many instances there were minute dots or tessellations on the surface of the lorica. In connection with this species was found the following variety with two posterior spines.

95. **B. angularis bidens** PLATE ('85). (Fig. 4, 5.)*B. caudatus* Barrois et Daday ('94.)

This form was present from April to September, most abundantly in July and August. It was found at the same substations as the preceding species.

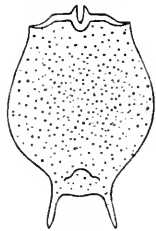

Fig. 4. *Brachionus caudatus* Barrois & Daday.

Dr. Plate, in describing this form, gives it specific rank. Barrois and Daday have recently described a form under the name *B. caudatus*. A careful comparison of the figures of

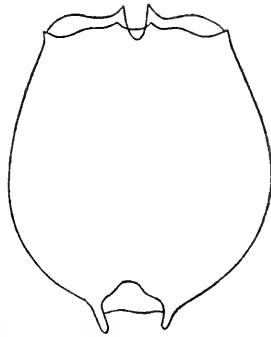

Fig. 5. *Brachionus bidens* Plate.

the two forms shows that they are identical. As Plate says: "The animal is closely related to *B. angularis* Gosse, with which it corresponds in size and shape of the lorica; and differs from it alone in that the surface of the lorica is not roughened by angular ridges but is entirely smooth, or, at most, very finely punctate." The opening for the protrusion of the foot is characteristic in both forms. I found individuals grading from *angularis* to forms that had the two posterior spines even more developed than in *caudatus*. I see no reason why this form should not be recognized as a variety with the name proposed by Plate.

96. **B. militaris** EHREG.

This is also a summer species, occurring in both years from June to October, and found but once outside this period—in December. It was most abundant from July to September, and was found in all the bodies of water studied, although it was rarer in the two shallower lakes. It was equally abundant among vegetation and in open water. Notwithstanding the short period of its occurrence this was the most abundant species of the genus. Collections made among vegetation during the summer months were almost a "pure culture" of it. It became abundant very suddenly and disappeared with equal abruptness.

SCHIZOCERCA DADAY.

Foot long, ending in a fork of two unequal branches, each terminated by a pair of unequal toes.

97. **S. diversicornis** DADAY.

This species did not make its appearance in our collections until 1895, and then it was quite rare. It was well distributed, however, being taken in towings from the Illinois River and from the three more permanent lakes. It occurred from July to September.

98. **S. diversicornis homoceros** WIERZ. ('91).

Not so abundant as the preceding, being found but twice; once in Phelps Lake in June, 1894, and again in Thompson's Lake in August, 1895; on both occasions in the towings.

NOTEUS EHREBG.

Lorica faceted, and covered with raised points; gibbous dorsally, flat ventrally; foot obscurely jointed; toes moderately long; eyes wanting.

99. **N. quadricornis** EHREBG.

This beautiful creature was found many times in the towings or among vegetation, but it was never abundant. It is evidently a summer species as it was present only from May to November. Found in the Illinois River and in the three deeper lakes.

Family **ANURÆIDÆ**.

ANURÆA GOSSE.

Lorica an oblong box, open widely in front, narrowly in rear; dorsal surface usually tessellated; spines present; the egg, after extrusion, carried attached to the lorica.

100. **A. hypelasma** GOSSE.

This species was found only in towings from Thompson's Lake and among vegetation in Quiver Lake, in July, 1895.

101. **A. tecta** GOSSE.

This species was present very uniformly throughout the year, but was not at any time common. It was found in the river and in all of the lakes except Flag Lake.

102. **A. aculeata** EHREG.

This is a winter species. It was present in towings from all the substations from November to June, reaching its greatest abundance in May.

103. **A. aculeata valga** EHREG.

Found in towings from the Illinois River and Thompson's Lake during April, 1895.

104. **A. cochlearis** GOSSE.

This was the commonest representative of its genus, and was present every month in the year, most abundantly from April to September. It was found in towings from all of the substations.

105. **A. serrulata** EHREG.

Found once—in a towing from the Illinois River in December, 1895.

NOTHOLCA GOSSE.

Lorica ovate, truncate and six-spined in front, sometimes produced behind: dorsal surface marked longitudinally with alternate ridges and furrows; extruded eggs not usually carried.

106. **N. acuminata** EHREG.

This is clearly a winter species, being present during both years in towings at nearly all of the substations from October to May. It reached its greatest abundance during March and April. It was found both among vegetation and in open water.

107. **N. longispina** KELL.

Found only in towings from the Illinois River in January, 1895.

Order IV. SCIRTOPODA.

Family **PEDALIONIDÆ**.

PEDALION HUDSON.

Limbs arranged around the body in pairs, and parallel to its longitudinal axis; two stylate ciliated appendages on the posterior dorsal surface.

108. **P. mirum** HUDSON.

This curious and interesting species was taken several times in the tows during the summer. It was first seen in the river at E in May, and was rather common there from July to October. During this period it was also taken in Phelps and Thompson's lakes.

LITERATURE CONSULTED.

Anderson, H. H.

'89. Notes on Indian Rotifers. Journ. Asiatic Soc. Bengal. Vol. LVIII., Pt. II., pp. 345-358, Pl. XIX.-XXI.

Barrois, Th., et Daday, E. v.

'94. Contribution à l'Étude des Rotifères de Syrie et descriptions de quelques espèces nouvelles. Rev. Biol. du Nord. de la France. T. VI., pp. 391-400, 401-409. 410, Pl. V. 15 fig. in text.

Bergh, R. S.

'82. Der Organismus der Ciliodlagellaten. Morph. Jahrb., Bd. VII., pp. 177-288. Taf. XII.-XVI.

Biedermann, Richard.

'93. Über die Structur der Tintinnen-Gehäuse. Inaugural Dissertation zur Erlangung der Doctorwürde an der Christian-Albrecht Universität zu Kiel. 42 pp., 3 Taf.

Butschli, O.

'80-'89. Protozoa. Bronn's Klassen und Ordnungen des Thier-Reichs, Bd. I., Th. I.-III. 2035 pp., 79 Pl.

Calman, W. T.

'92. On certain New or Rare Rotifers from Forfarshire. Ann. Scottish Nat. Hist., 1892, pp. 240-245, Pl. VIII.

Daday, E. v.

'87. Monographie der Familie der Tintinnodeen. Mitth. zool. Stat. Neapel, Bd. VII., pp. 473-588, Taf. XVIII.-XXI.

Entz, Géza.

'85. Zur näheren Kenntniss der Tintinnoden. Mitth. zool. Stat. Neapel Bd. VI., pp. 185-214, Taf. XIII., XIV.

Fol, Hermann.

'81. Contribution a la Connaissance de la Famille des Tintinnodea. Arch. des Sci. phys. et nat., III. Per., T. V., pp. 5-24, Pl. I.

Forbes, S. A.

'93. A Preliminary Report on the Aquatic Invertebrate Fauna of the Yellowstone National Park, Wyoming, and of the Flathead Region of Montana. Bull. U. S. Fish Comm., 1891, pp. 207-258. Pl. XXXVII.-XLII.

Guerne, Jules de

'88. Excursions zoologiques dans les îles de Fayal et de San Miguel (Azores). Campagnes scientifiques du yacht monégasque l'Hirondelle, III. Ann. (1887). 110 pp., 1 Pl. and 9 fig. in text.

Hempel, Adolph.

- '96. Descriptions of New Species of Rotifera and Protozoa from the Illinois River and Adjacent Waters. Bull. Ill. State Lab. Nat. Hist., Vol. IV., Art. X., pp. 310-317. Pl. XXII.-XXVI.

Herrick, C. L.

- '85. Notes on American Rotifers. Bull. Sci. Lab. Denison Univ., Vol. I., pp. 43-62. Pl. II.-IV., X.+1.

Hood, John.

- '93. Three New Rotifers. Journ. Quekett Micr. Club, Ser. II., Vol. V., pp. 281-283, Pl. XII.

Hudson, C. T.

- '75. [Classification and Affinities of the Rotifera.] Nature, Vol. XII., p. 413.

Hudson, C. T., and Gosse, P. H.

- '86. The Rotifera or Wheel-Animalcules, Vol. I., vi+129 pp., Pl. I.-XV.; Vol. II., 144 pp., Pl. XVI.-XXX. London.

- '89. *Ibid.* Supplement. vi+64 pp., Pl. XXXI.-XXXIV. London.

Janson, Otto.

- '93. Versuch einer Übersicht über die Rotatorien-Familie der Philodinaeen. Beilage zum Abhandl. d. Naturw. Vereins zu Bremen. Bd. XII. 82 pp., 5 Pl.

Jennings, H. S.

- '94. A List of the Rotatoria of the Great Lakes and of some of the Inland Lakes of Michigan. Bull. Mich. Fish Comm., No. 3. 34 pp., 2 Pl.

- '94a. Rotifers related to *Euchlanis lynceus* Ehrbg. Zool. Anz., XVII. Jahrg., pp. 55, 56.

Johnson, Herbert P.

- '93. A Contribution to the Morphology and Biology of the Stentors. Journ. Morph., Vol. VIII., pp. 467-562, Pl. XXIII.-XXVI.

Kellicott, D. S.

- '84. Observations on Infusoria, with Descriptions of New Species. Proc. Am. Soc. Micr., 1884, pp. 110-125, Pl. III.

- '87. Notice of some Fresh-water Infusoria, with Remarks on Collecting and Preserving these Delicate Animals. The Microscope, Vol. VII., pp. 225-233. 4 fig.

- '88. Partial List of Rotifera of Shiawassee River at Corunna, Mich. Proc. Am. Soc. Micr., Vol. X., pp. 84-96. 3 fig. in text.

Kent, W. Saville.

- '80-'82. A Manual of the Infusoria. Vol. I., pp. x+472; Vol. II., pp. 473-913; Vol. III., 79 Pl. London.

Kofoid, Charles A.

'96. A Report upon the Protozoa observed in Lake Michigan and the Inland Lakes in the Neighborhood of Charlevoix during the Summer of 1894. Bull. Mich. Fish. Comm., No. 6, App. II., pp. 76-84.

'96a. On the Occurrence of *Trochosphaera solstitialis* in the Illinois River. Science, Vol. IV., N. S., pp. 935, 936.

Leidy, Joseph.

'79. Fresh-water Rhizopods of North America. Rep. U. S. Geol. Surv. Terr., Vol. XII., xi+324 pp., 48 Pl.

McMurrich, J. Playfair.

'94. Text-book of Invertebrate Morphology. viii+661 pp., 291 fig. New York.

Pell, A.

'90. Three New Rotifers. The Microscope, Vol. X., pp. 143-145. 3 fig.

Plate, Ludwig.

'85. Beiträge zur Naturgeschichte der Rotatorien. Jenaische Zeitschr., Bd. XIX., pp. 1-120, Taf. 1-111.

Rousselet, C. F.

'92. On *Conochilus unicornis* and *Euchlanis parva*—two New Rotifers. Journ. Quekett Micr. Club, Ser. II., Vol. IV., pp. 367-370. Pl. XXIV.

'93. On a Method of Preserving Rotatoria. Ibid., Ser. II., Vol. V., pp. 205-209.

'95. Second Note on a Method of Preserving Rotatoria. Ibid., Ser. II., Vol. V., pp. 5-13.

Schewiakoff, Wl.

'93. Über die Geographische Verbreitung der Süßwasser-Protozoen. Mém. l'Acad. Impér. des Sci. de St.-Petersbourg, Ser. VII., T. XLII., No. 8. 201 pp., 4 Taf.

Shaw, W. R.

'94. *Pleodorina*, a New Genus of Volvocineæ. Bot. Gazette, Vol. XIX., pp. 279-283. Pl. XXVII.

Smith, Frank.

'94. List of the Protozoa and Mollusca observed in Lake St. Clair in the Summer of 1893. Bull. Mich. Fish Comm., No. 4, pp. 42-44.

Stokes, A. C.

'85. Some apparently undescribed Infusoria from Fresh Water. Am. Nat., Vol. XIX., pp. 18-27. 8 fig.

'85a. Some New Infusoria from American Fresh Waters. Ann. and Mag. Nat. Hist., Ser. V., Vol. XV., pp. 437-449, Pl. XV.

- '87. Notices of New Fresh-water Infusoria. VI. Am. Monthly
Mier. Journ., Vol. VIII., pp. 141-147, Pl. VIII.
- '87a. Microscopy for Beginners. xiii + 308 pp., 178 fig. New York.
- '88. A Preliminary Contribution toward a History of the Fresh-
water Infusoria of the United States. Journ. Trenton Nat. Hist.
Soc., Vol. I., pp. 71-319, Pl. I.-XIII.

Turner, C. H.

- '92. Notes upon the Cladocera, Copepoda, Ostracoda, and Rotifera
of Cincinnati, with Descriptions of New Species. Bull. Sci. Lab.
Denison Univ., Vol. VI., Pt. II., pp. 57-74, Pl. I., II.

Wierzejski, A.

- '91. Liste des Rotifères observés en Galicie. Bull. Soc. Zool. France.
T. XVI., pp. 49-52. 4 fig.
- '92. Rotatoria (Wrotki) Galicyi. Rozpr. Wydz. mat.-przyr. Akad.
Umiej. w Krakowie, T. XXVI., pp. 160-265, Tab. IV.-VI.

Zacharias, Otto.

- '93. Faunistische und biologische Beobachtungen am Gr. Plöner See.
Forschungsber. aus der Biol. Station zu Plön, Th. I., pp. 3-44, Pl. I.
- '94. Faunistische Mittheilungen. Ibid., Th. II., pp. 57-90. Taf. 1.,
II. 2 fig. in text.
- '94a. Beobachtungen am Plankton des Gr. Plöner See's. Ibid., Th.
II., pp. 91-137.
- '95. Faunistische Mittheilungen. Ibid., Th. III., pp. 73-96. Taf.
I., II.
- '95a. Fortsetzung der Beobachtung über die Periodicität der Plank-
ton wesen. Ibid., Th. III., pp. 129-144.
- '95b. Quantitative Untersuchungen über das Limnoplankton. Ibid.,
Th. III., pp. 1-64.

7710

BULLETIN

OF THE

ILLINOIS STATE LABORATORY

OF

NATURAL HISTORY,

URBANA, ILLINOIS.

VOLUME V.

*ARTICLE VII.—FIRST SUPPLEMENT TO THE CHECK-LIST
OF THE COCCID.E.*

BY T. D. A. COCKERELL.

Illinois State Laboratory of Natural History.
URBANA, ILLINOIS,
January, 1899.

STATE LABORATORY OF NATURAL HISTORY.

LABORATORY STAFF.

Professor STEPHEN ALFRED FORBES, PH. D.,
Director of State Laboratory and State Entomologist.

CHARLES ARTHUR HART,
Systematic Entomologist and Curator of Collections.

FRANK SMITH, A. M.,
Assistant Zoölogist.

CHARLES ATWOOD KOFORD, PH. D.,
Zoölogist, and Superintendent of Biological Station.

ERNEST BROWNING FORBES, B. S.,
Entomological Assistant.

WALLACE CRAIG, B. S.,
Zoölogical Assistant.

MARY JANE SNYDER,
Secretary.

HENRY CLINTON FORBES,
Business Agent and Librarian.

LYDIA MOORE HART,
Artist.

ARTICLE VII.—*First Supplement to the Check-List of the Coccidae.* BY T. D. A. COCKERELL, *New Mexico Agricultural Experiment Station.*

Since the publication of the Check-List* in 1896 no less than three hundred and twenty-two species have been added. A few of these are old species which had been accidentally omitted or improperly reduced to synonyms, but the number of actually new species is very great, and bears witness to the activity of coccidologists. Forty species, given as valid in the Check-List, are here reduced to varieties or synonyms.

As before, I have included a number of names of species (mostly by Green) which I know to be either in press or awaiting very early publication.

The group *Idiococcinae* has been abandoned and merged into *Coccinae*. The *Coccinae* could very well be divided into two subfamilies and perhaps four tribes, as follows:

- (A.) *Coccinae*. Newly hatched larva with rows of dorsal spines, and the last antennal joint usually short.
- (1.) *Coccini*. Anal ring hairless. (*Coccus*, etc.)
 - (2.) *Eriococcini*. Anal ring hairy, hairs normally 8. (*Eriococcus*, etc.)
- (B.) *Dactylopiinae*. Newly hatched larva without dorsal spines, last antennal joint usually long.
- (1.) *Sphaerococcini*. Anal ring hairless. (*Sphaerococcus*.)
 - (2.) *Dactylopiini*. Anal ring hairy, hairs normally 6. (*Dactylopius*, etc.)

Species which were in the original list, here repeated to indicate varieties, synonyms, etc., have the original numbers.

Since the Check-List was written, the following new writers have described and named *Coccidae*. To facilitate correspondence I give their addresses:

Bogue, E. E., Stillwater, Oklahoma.

Cooley, R. A., Agricultural College, Amherst, Mass.

*Article XI, Vol. V., of this series.

- Charmoy, D. d'Emmerez de, Port Louis, Mauritius.
 Elmhorn, E. M., Mountain View, Sta. Clara Co., Cal.
 Fuller, Claude, Department of Agriculture, Cape Town,
 S. Africa.
 Hunter, S. J., Lawrence, Kansas.
 Ihering, H. von, S. Paulo, Brazil.
 King, G. B., Lawrence, Mass.
 Leonardi, G., Portici, Italy.
 Lidgett, J., Myrmiong, Victoria, Australia.
 Newell, W., Ames, Iowa.
 Pergande, Theo., Dept. Agriculture, Washington, D. C.
 Tinsley, J. D., Mesilla Park, New Mexico.

I may also permit myself to mention that my own address is now Mesilla Park, New Mexico. (Not Mesilla, nor Las Cruces.)

COCCIDLE.

- | | |
|--|---|
| <p>Monophlebinae.</p> <p><i>Callipappus</i>, Guér.⁽¹⁾</p> <p>798. <i>larinosus</i>, Full.
 799. <i>bufo</i>, Full.</p> <p><i>Protortonia</i>, Towns.⁽²⁾</p> <p>800. <i>mexicanorum</i>, Ckll.
 801. <i>primitiva</i>, Towns.</p> <p><i>Icerya</i>, Sign.</p> <p>39. <i>purchasi</i>, Mask.
 <i>c. maskelli</i>, Ckll.
 <i>c. crawii</i>, Ckll.</p> <p>42. <i>seychellarum</i>, Westw.
 <i>c. albolutea</i>, Ckll.</p> <p>802. <i>formicarum</i>, Newst.
 <i>s. g. Proticerya</i>, Ckll.</p> <p>803. <i>littoralis</i>, Ckll.
 <i>c. mimosa</i>, Ckll.</p> <p><i>Crypticerya</i>, Ckll.</p> <p>804. <i>nudata</i>, Mask.
 805. <i>ewarti</i>, Newst.
 806. <i>hempeli</i>, Ckll.</p> | <p>807. <i>townsendi</i>, Ckll.
 <i>c. pluchea</i>, Ckll.</p> <p>Margarodinae.</p> <p><i>Margarodes</i>, Guibl.</p> <p>57. <i>formicarum</i>, Guibl.
 <i>c. rileyi</i>, Giard.</p> <p>808. <i>trimeni</i>, Giard.
 <i>s. g. Spharaspis</i>, Giard.</p> <p>809. <i>capensis</i>, Giard.</p> <p>Ortheziinae.</p> <p><i>Orthezia</i>, Bose.</p> <p>810. <i>delavauxi</i>, Thibb.
 811. <i>artemisiae</i>, Ckll.
 812. <i>cheilanthi</i>, Tinsl.
 813. <i>graminis</i>, Tinsl.
 814. <i>monticola</i>, Ckll.
 815. <i>garryae</i>, Ckll.</p> <p><i>Ortheziola</i>, Sulc.</p> <p>816. <i>signoreti</i>, Haller.
 817. <i>fodiens</i>, Giard.</p> |
|--|---|

(1.) Mr. Fuller states that *Celostoma australe*, *immuta* and *rufiginosum*, of Maskell, belong to *Callipappus*.

(2.) The name *Ortonia* is preoccupied.

Coccinae.**Coccus, L.**^(3.)

818. *opuntiae*, Licht. MS. Ckll.
? s. of *tomentosus*, Lam.
v. *newsteadi*, Ckll.
819. *acaciae*, Mask.

Eriococcus, Targ.

820. *formicicola*, Newst.
821. *thymelaeæ*, Newst.
822. *devoniensis*, Green.
823. *greeni*, Newst.
824. *gilletti*, Tinsl.
825. *arenosus*, Ckll.
826. *tinsleyi*, Ckll.
827. *adenostomæ*, Ehrh.
828. *spiniger*, Mask.
829. *simplex*, Mask.
v. *dealbata*, Mask.
84. *paradoxus*, Mask.
v. *simplex*, Mask.
v. *indica*, Mask.
830. *exiguus*, Mask.
831. *graminis*, Mask.
832. *elegans*, Full.
833. *apiomorphæ*, Full.
834. *hakeæ*, Full.
835. *imperfectus*, Full.
836. *tricarinatus*, Full.
837. *agonis*, Full.
838. *cypreæformis*, Full.

Olliffia, Full.

839. *eucalypti*, Full.

Rhizococcus, Sign.

840. *tripartitus*, Full.
100. *casuarinæ*, Mask.
v. *mancus*, Mask.

Lachnodius, Mask.

203. *eucalypti*, Mask.
841. *lectularius*, Mask.
842. *hirtus*, Mask.

Dactylopius, Costa.

843. *syringæ*, Mask.

844. *edgeworthiæ*, Ckll.
845. *hirsutus*, Newst.
846. *prospoidis*, Ckll.
847. *gutierrezæ*, Ckll.
848. *dasyliirii*, Ckll.
175. *sorghiiellus*, Forbes.
v. *kingii*, Ckll.
v. *neomexicanus*, Tinsl.
849. *lichtensioides*, Ckll.
850. *pseudonipæ*, Ckll.
851. *claviger*, King & Tinsl.
852. *quaintancii*, Tinsl.
853. *azaleæ*, Tinsl.
854. *eockerelli*, King & Tinsl.
855. *bambusæ*, Green.
856. *rimulæ*, Green.
857. *lanigerus*, Full.
858. *macrozamiæ*, Full.
859. *similans*, Lidgett.
194. *graminis*, Mask.
v. *orientalis*, Mask.
205. *calceolaria*, Mask
v. *minor*, Mask.
177. *virgatus*, Ckll.
s. *ceriferus*, Newst.
s. *talini*, Green.

Phenacoccus, Ckll.

860. *comari*, Knowl.
861. *solenopsis*, Tinsl.
862. *americanæ*, King & Ckll.
140. *helianthi*, Ckll.
v. *gossypii*, Towns. & Ckll.
1121. *miimus*, Tinsl.

Ripersia, Sign.

863. *europæa*, Newst.
864. *tumida*, Newst.
865. *filicicola*, Newst.
866. *montana*, Newst.
867. *kingii*, Ckll.
868. *lasii*, Ckll.
869. *flaveola*, Ckll.
870. *blanchardii*, King & Ckll.
871. *euneiformis*, Green.
872. *myrmecophila*, Mask.

(3.) Mr. E. E. Green informs me that *Coccus lauræ* v. W. F. Kirb., is *Walkeriana floriger*.

1122. *minima*, *Tinsl. and King.*
 873. *villosa*, *Ehrh.*
s. g. Apterococcus, *Newst.*
 121. *fraxini*, *Newst.*
s. g. Cryptoripersia, *Ckll.*
 874. *arizonensis*, *Ehrh.*
s. g. Pseudoripersia, *Ckll.*⁽⁴⁾
 89. *turgipes*, *Mask.*
- Tylococcus*, *Newst.*
 875. *madagascariensis*, *Newst.*
- Ceroputo*, *Sulc.*
 876. *pilosella*, *Sulc.*
- Rhizæcus*, *Künck.*
 877. *eloti*, *Giard.*
- Solenococcus*, *Ckll.*⁽⁵⁾
 878. *koebeleri*, *Ckll.*
 879. *ornatus*, *Green.*
 880. *coloradensis*, *Ckll.*
- Cerococcus*, *Comst.*
 881. *corticis*, *Townsend & Ckll.*
- Porococcus*, *Ckll.*
 882. *tinctorius*, *Ckll.*
 883. *pergandei*, *Ckll.*
- Carpochloroides*, *Ckll.*
 884. *viridis*, *Ckll.*
- Capulinia*, *Sign.*
 885. *jaborticalba*, *van Thier.*
- Malloccoccus*, *Mask.*
 (Mallophora, *Mask.*, preocc.)
 886. *sinensis*, *Mask.*
- Ourococcus*, *Full.*
 887. *cobbii*, *Full.*
 888. *eucalypti*, *Full.*
 889. *casuarinae*, *Full.*
- Kermicus*, *Newst.*
 890. *wroughtoni*, *Newst.*
s. g. Chatococcus, *Mask.*⁽⁶⁾
 318. *bambusæ*, *Mask.*
 891. *graminis*, *Mask.*
- Sphaerococcus*, *Mask.*
 892. *rugosus*, *Mask.*
v. elongatus, *Mask.*
 893. *pulehellus*, *Mask.*
 894. *socialis*, *Mask.*
 319. *acaciae*, *Mask.*
v. melaleuca, *Full.*
 895. *leaii*, *Full.*
 896. *tepperi*, *Full.*
 897. *ethelæ*, *Full.*
 898. *morrisoni*, *Full.*
 899. *obscuratus*, *Mask.*
 323. *inflatus*, *Mask.*
v. simplicior, *Mask.*
 900. *populi*, *Mask.*
 901. *parvus*, *Mask.*
 1120. *sylvestris*, *Ckll. & King.*
- Olliffiella*, *Ckll.*
 902. *cristicola*, *Ckll.*
- Cylindrococcus*, *Mask.*
 903. *gracilis*, *Full.*
 331. *amplior*, *Mask.*
s. Crocidocysta froggatti,
Rübs.
- Asterolecaniinae.**
- Lecaniodiaspis*, *Targ.*
 904. *tessellatus*, *Ckll.*
 905. *artemisiae*, *Ckll.*
 906. *mimosæ*, *Mask.*
 907. *radiatus*, *Ckll.*
 908. *manihotis*, *Townsend.*
 909. *atherospermae*, *Mask.*
 910. *melaleuca*, *Full.*

(4.) New subgenus. Well distinguished by the very peculiar legs, as figured by Maskell, *Trans. N. Z. Inst.*, Vol. XXV.

(5.) New name for *Solenophora*, preoccupied. A *Solenophora* (?) *dryandra* was published without description by Fuller; the author now wishes to withdraw it.

(6.) *Chatococcus* has only 8 (sometimes 6?) hairs on the anal ring; *Kermicus* proper has 17. Otherwise they hardly differ. The larva is *Dactyloptine*.

Asterolecanium, Targ.

912. algeriense, *Newst.*
 913. ilicis, *Newst.*
 914. petrophila, *Full.*
 915. hakeæ, *Full.*
 254. bryoides, *Mask.*
 v. stellata, Mask.
 255. bambusæ, *Boisd.*
 v. bambusulæ, Ckll.

Tachardiinae.**Tachardia**, Blanch.

916. nigra, *Towns. & Ckll.*
 917. fulvoradiata, *Ckll.*

Brachyscelinae.**Apiomorpha**, Rûbs.⁽⁷⁾

918. helmsii, *Full.*
 919. maliformis, *Full.*
 920. cucurbita, *Full.*
 300. karschi, *Rûbs.*
 v. fletcheri, Full.
 292. thornstoni, *Frog.*
 v. nux, Full.
 283. conica, *Frog.*
 s. regularis, Tepp.
 s. similis, Rûbs.
 275. munita, *Schrad.*
 s. cornifex, Rûbs.
 v. tricornis, Frog.
 297. strombylosa, *Tepp.*
 s. crispa, Full.
 294. urnalis, *Tepp.*
 v. schraderi, Full.
 921. excupula, *Full.*

Ascellis, Schrad.

922. melaleuca, *Full.*

Opisthoscelis, Schrad.

923. conica, *Full.*

Cystococcus, Full.

924. echiniformis, *Full.*

Lecaniinae.**Kermes**, Auctt.

925. austini, *Ehrh.*
 926. pettiti, *Ehrh.*
 927. ceriferus, *Ehrh.*
 928. kingii, *Ckll.*
 929. nivalis, *King & Ckll.*
 930. pubescens, *Boque.*
 931. bognei, *Ckll.*
 932. cockerelli, *Ehrh.*
 933. nigropunctatus, *Ehrh. & Ckll.*
 934. concinnulus, *Ckll.*
 935. grandis, *Ckll.*

Aclerda, Sign.

936. distorta, *Green.*
 1123. berlesii, *Enfla.*

Lecanopsis, Targ.

937. lineolata, *King & Ckll.*

Lecanium, Illig.

938. ceratonia, *Genn.*
 ? *s. of hesperidum, L.*
 939. perlatum, *Ckll.*
 446. hesperidum, *Linn.*
 s. patelliformis, Curt.⁽⁸⁾
 v. alienum, Dougl.⁽⁹⁾
 447. minimum, *Newst.*
 v. pinicola, Mask.
 449. tessellatum, *Sign.*
 v. swainsonæ, Ckll.
 v. perforatum, Newst. (450.)
 940. flaveolum, *Ckll.*
 941. ventrale, *Ehrh.*
 942. impar, *Ckll.*
 943. rhizophora, *Ckll.*
 944. chilaspidis, *Ckll.*
 945. erythrina, *von Iher.*
 946. perconvexum, *Ckll.*
 947. tuberculatum, *Towns. & Ckll.*
 948. townsendi, *Ckll.*
 486. scrobiculatum, *Mask.*

(7.) The changes in the synonymy are made on the authority of Mr. Fuller.

(8.) So given on Mr. Newstead's authority.

(9.) So given on Mr. Green's authority.

- v. leve*, *Mask.*
v. pingue, *Mask.* (485.)
 949. *strachani*, *Ckll.*
 950. *castilloa*, *Ckll.*
 469. *viride*, *Green.*
v. africanum, *Newst.*
 951. *ficus*, *Mask.*
 952. *globulosum*, *Mask.*
 953. *notatum*, *Mask.*
 954. *mirificum*, *Mask.*
 955. *macrozamia*, *Full.*⁽¹⁰⁾
 956. *melaleuca*, *Mask.*
 957. *casuarina*, *Mask.*
 487. *baccatum*, *Mask.*
v. marmoreum, *Full.*
 958. *tubuliferum*, *Ckll.*
 959. *turgidum*, *Ckll.*
 960. *parvicorne*, *Ckll.*
s. g. Pseudokermes, *Ckll.*
 961. *armatum*, *Ckll.*
s. g. Eulecanium, *Ckll.*
 528. *quercitronis*, *Fitch.*
s. kermoides, *Tyrrrell.*
 498. *berberidis*, *Schr.*
v. major, *Mask.*
 962. *nigrofasciatum*, *Pergande.*
 963. *magnoliarum*, *Ckll.*
 964. *pubescens*, *Ehrh.*
 965. *crawii*, *Ehrh.*
 966. *kingii*, *Ckll.*
 967. *macluratum*, *Ckll.*
 968. *caryarum*, *Ckll.*
 969. *perditum*, *Ckll.*
 970. *subaustrale*, *Ckll.*
- Ceroplastes**, *Gray.*
 409. *irregularis*, *Ckll.*
v. rubidus, *Ckll.*
 426. *rubens*, *Mask.*
v. minor, *Mask.*
 407. *rusei*, *Linn.*
s. carica, *Fonse.*
s. testudineus, *Costa.*
- s. testudinata*, *Targ.*
 971. *nerii*, *Newst.*
 972. *angulatus*, *Ckll.*
 973. *coloratus*, *Ckll.*
 974. *minutus*, *Ckll.*
 975. *roseatus*, *Tourns. & Ckll.*
 976. *confluens*, *Ckll. & Tinsl.*
 977. *personatus*, *Newst.*
- Inglisia**, *Mask.*
 978. *fossilis*, *Mask.*
 400. *foraminifer*, *Mask.*
v. loranthi, *Full.*
 979. *malvacearum*, *Ckll.*
- Platinglisia**, *Ckll.*
 980. *noacki*, *Ckll.*
- Ctenochiton**, *Mask.*
 981. *aztecus*, *Tourns. & Ckll.*
 982. *nuytisia*, *Full.*⁽¹¹⁾
- Ceronema**, *Mask.*
 983. *dryandra*, *Full.*
 984. *japonicum*, *Mask.*
- Pulvinaria**, *Targ.*
 985. *salicis*, *Bouché.*
 361. *bigeloviae*, *Ckll.*
v. maruorata, *Ckll.*
 986. *amygdali*, *Ckll.*
 987. *acericola*, *Walsh & Riley.*
 359. *immuerabilis*, *Rathr.*
s. acericoorticis, *Fitch.*
v. occidentalis, *Ckll.*
v. tiliae, *King & Ckll.*
 988. *rhois*, *Ehrh.*
 989. *cellulosa*, *Green.*
 990. *thompsoni*, *Mask.*
 372. *maskelli*, *Olliff.*
v. viminaria, *Full.*
v. nuytisia, *Full.*
 991. *floccifera*, *Westw.*

(10.) Mr. Fuller tells me this is probably a variety of *L. frenchii*.

(11.) Mr. Fuller no longer considers this valid.

s. g. *Philephedra*, Ckll.

992. ephedrae, Ckll.

s. g. *Protospulvinaria*, Ckll.

378. pyriformis, Ckll.

s. newsteadi, Leon.

Lichtensia, Sign.

993. mimosa, Towns, and Ckll.

994. crescentiae, Ckll.

995. hakearum, Full.¹²

Pseudophilippia, Ckll.

996. quaintancii, Ckll.

Conchaspinae.

Conchaspis, Ckll.

997. socialis, Green.

998. newsteadi, Ckll.

Diaspinae.

Aspidiotus, Bouché.

548. hederæ, Vall.¹³

? s. capparîs, Vall.

s. nerii, Bouché.

s. allinis, Targ.

s. ceratonia, Sign.

s. ericæ, Boisd.

s. denticulatus, Targ.

s. genistæ, Westw.

s. guidii, Sign.

s. corinocarpi, Colvè.

s. hieis, Sign.

s. lentisei, Sign.

s. oleæ, Colvè.

s. villosus, Targ.

s. aloës, Boisd.

s. budleie, Sign.

s. cycadicola, Boisd.

s. epidendri, Bouché.

s. myrsinæ, Sign.

s. obliquus, Costa.

s. palmeæ, Targ.

s. palmarum, Bouché.

s. vriesiae, Sign.

s. carpodeti, Mask.

999. transparentis, Green.

v. simillimus, Ckll.

1000. persearum, Ckll.

1001. britanicus, Newst.

1002. fraxini, "Altum," Henry.

1003. maculatus, Newst.

1004. excisus, Green.

1005. putearius, Green.

1006. moorei, Green.

1007. artocarpi, Green.

1008. bilobis, Mask.

1009. implicatus, Mask.

1010. virescens, Mask.

1011. dryandra, Full.

1012. niveus, Full.

626. eucalypti, Mask.

v. conatus, Mask.

s. g. *Morganella*, Ckll.

1013. maskelli, Ckll.

s. ornatus, Mask.

s. g. *Targionia*, Sign.

1014. bigeloviae, Ckll.

1015. dearnessi, Ckll.

1016. yuccarum, Ckll.

s. g. *Odonaspis*, Leon.

(*Spatheaspis*, Leon.)

1017. inusitatus, Green.

1018. bambusarum, Ckll.

560. secretus, Ckll.

v. lobulatus, Mask.

1019. canaliculatus, Green.

s. g. *Schenaspis*, Ckll.

603. articulatus, Morg.

v. celastri, Mask.

s. g. *Phaulaspis*, Leon.

1020. hakeæ, Mask.

s. g. *Chentropsis*, Leon.

622. unilobis, Mask.

s. g. *Aspidiella*, Leon.

612. sacchari, Ckll.

¹² Described as a doubtful *Lectinodiaspis*. I have specimens from Fuller.

¹³ The synonymy, except the first name, is after Berlese and Leonardi. The names cited as synonyms doubtless represent at least several good varieties. *A. hederæ* is the type of subg. *Eraspidiotus*, Leonardi.

- s. g. *Pseudaonidia*, Ckll.
 620. trilobitiformis, *Green*.
 s. darutyi, d'Emmercz de Charmoy.
 s. g. *Diaspidiotus* (Berl. & Leon.), Ckll.
 579. perniciosus, *Comst.*
 v. andromelas, Ckll.
 v. albopunctatus, Ckll. (785.)
 ? *v. eucalypti, Full. (14)*
 1021. fernaldi, *Ckll.*
 v. albiventer, Hunter.
 1022. osborni, *Newell & Ckll.*
 1023. coniferarum, *Ckll.*
 584. ancyllus, *Putn.*
 v. serratus, Newell & Ckll.
 587. asculi, *W. G. Johns.*
 v. solus, Hunter.
 589. juglans-regiae, *Comst.*
 v. kaffa, Ckll.
 1024. jatrophae, *Towns. & Ckll.*
 1025. subsimilis, *Ckll.*
 s. g. *Hemiberlesia*, Ckll.
 (*Aspidites, Berl. & Leon. preocc.*)
 568. rapax, *Comst.*
 s. evonymi, Targ.
 1026. ulmi, *W. G. Johns.*
 1027. tricolor, *Ckll.*
 588. cydoniae, *Comst.*
 v. tectus, Mask.
 1028. crawii, *Ckll.*
 1029. greenii, *Ckll.*
 1030. cupressi, *Ckll.*
Chrysomphalus, *Ashm.*
 1031. reniformis, *Ckll.*
 606. dietyospermi, *Morg.*
 v. mangiferae, Ckll. (607.)
 1032. longissimus, *Ckll.*
 1033. agavis, *Towns. and Ckll.*
 1034. koebeleii, *Towns. and Ckll.*
 1035. albopictus, *Ckll.*
 v. leouis, Towns. and Ckll.
 1036. rhizophorae, *Ckll.*
 s. g. *Melouaspis*, Ckll.
 1037. setiger, *Mask.*
 1038. lilacinus, *Ckll.*
 1039. calurus, *Ckll.*
 s. g. *Myctaspis*, Ckll.
 604. personatus, *Comst.*
 s. g. *Aonidiella*, Berl. & Leon.
 570. aurantii, *Mask.*
Pseudodiaspis, Ckll.
 1040. larreae, *Ckll.*
 1041. dentilobis, *Ckll.*
Comstockiella, Ckll.
 638. sabilis, *Comst.*
 v. mexicanus, Ckll.
Cryptophyllaspis, Ckll.
 619. occultus, *Green.*
Maskellia, Full.
 1042. globosa, *Full.*
Xerophilaspis, Ckll.
 1043. prosopidis, *Ckll.*
Gymnaspis, *Newst.*
 1044. achmeae, *Newst.*
 1045. bullata, *Green.*
Greeniella, Ckll.
 772. cornigera, *Green.*
Aonidia, *Sign.*
 1046. loranthi, *Green.*
 1047. obscura, *Green.*
 1048. messuae, *Green.*
 1049. ebeni, *Green.*
 1050. planchonoides, *Green.*
 1051. elavagnus, *Mask.*
 1052. banksiae, *Full.*
 1053. distinctissima, *Newst.*

(14.) I do not think Fuller's *eucalypti* belongs to *perniciosus*. Mr. Fuller kindly sent me two slides of it, but on these are apparently three different things: the one which I suppose to be *eucalypti* is immature.

- Poliaspis**, Mask.
 (Maskelliella, Leon.)
 1054. pini, *Mask.*
 1055. nitens, *Full.*
 1056. intermedia, *Full.*
- Fiorinia**, Targ.
 757. fioriniæ, *Targ.*
 s. palmae, Green.
 s. pinicola, Mask.
 v. minor, Mask.
 755. acaciæ, *Mask.*
 v. bilobis, Full.
 757. rubra, *Mask.*
 v. propinqua, Mask.
 1057. casuarinæ, *Mask.*
 1058. signata, *Mask.*
 1059. tenuis, *Mask.*
 1060. similis, *Green.*
 1061. bambusæ, *Mask.*
 1062. nephelii, *Mask.*
- Ischnaspis**, Dougl.
 680. longirostris, *Sign.*
 s. filiformis, Dougl. (752.)
- Leucaspis**, Sign.
 1063. japonica, *Ckll.*
- Parlatoria**, Sign.
 1064. alinis, *Newst.*
 666. theæ, *Ckll.*
 v. eonymi, Ckll.
 668. proteus, *Curt.*
 s. orbicularis, Targ.
 v. pergandei, Comst. (667.)
 v. virescens, Mask.
 v. palmae, Mask.
 1065. cingala, *Green.*
 1066. mytilaspiformis, *Green.*
 1067. aonidiformis, *Green.*
 1068. sinensis, *Mask.*
 1069. perpusilla, *Mask.*
 1070. viridis, *Full.*
1071. dryandrae, *Full.*
- Pseudoparlatoria**, Ckll.
 1072. noacki, *Ckll.*
 1073. serrulata, *Tourns. & Ckll.*
- Mytilaspis**, Sign.⁽¹⁵⁾
 675. pomorum, *Bouché.*
 v. saliceti, Bouché.
 1124. confusus, *Horvath.*
 s. abietis, Sign. nec Schr.
 1074. ceratonie, *Genn.*
 1075. minima, *Newst.*
 1076. ampelodesmæ, *Newst.*
 1077. serrifrons, *Leon.*
 1078. machili, *Mask.*
 676. crawii, *Ckll.*
 v. canaliculata, Mask.
 678. citricola, *Pack.*
 v. tasmanicæ, Mask.
 1079. perlonga, *Ckll.*
 1080. mexicana, *Ckll.*
 1081. argentata, *Ckll.*
 1082. bambusicola, *Ckll.*
 1083. cocculi, *Green.*
 685. pallida, *Green.*
 v. maskelli, Ckll.
 689. pallens, *Mask.*
 v. alba, Mask.
 692. spinifera, *Mask.*
 v. major, Mask.
 1084. acaciæ, *Mask.*
 v. albida, Mask.
 1085. banksiæ, *Mask.*
 1086. melaleucæ, *Mask.*
 1087. maideni, *Mask.*
 1088. defecta, *Mask.*
 v. tineta, Mask.
- Pinnaspis**, Ckll.
 705. pandani, *Comst.*
 v. alba, Ckll.
- Hemichionaspis**, Ckll.
 718. aspidistræ, *Sign.*

(15) Leonardi has separated from *Mytilaspis* groups which he treats as genera, named *Phaenomytilus*, *Coccomytilus* and *Trichomytilus*. I have proposed the subg. *Opuntiaspis* for *M. philorœcus*.

- c. braziliensis*, *Sigu.* (720.) 1101. *chinensis*, *Ckll.*
c. theae, *Mask.* (734.) 1102. *latissima*, *Ckll.*
c. lata, *Ckll.* (716.) 1103. *aucubae*, *Cooley.*
 722. *minor*, *Mask.* 1104. *wistariae*, *Cooley.*
 1105. *cockerelli*, *Cooley.*
- Chionaspis*, *Sigu.*⁽¹⁶⁾**
712. *salicis*, *Leon.*⁽¹⁷⁾
 s. alni, *Sigu.* (708.)
 s. fraxini, *Sigu.* (713.)
 1089. *striata*, *Newst.*
 1090. *berlesii*, *Leon.*
 1091. *quercus*, *Comst.*
 1092. *caryae*, *Cooley.*
 1125. *platanii*, *Cooley.*
 725. *furfurus*, *Fitch.*
 c. ulmi, *Ckll.*
 c. fulva, *King.*
 726. *salicis-nigrae*, *Watsch.*
 s. bruneri, *Ckll.*⁽¹⁸⁾
 728. *pinifoliae*, *Fitch.*
 c. heterophyllae, *Cooley.*
 c. semiaurea, *Ckll.*
 730. *spartinae*, *Comst.*
 c. natalensis, *Mask.*
 731. *linterii*, *Comst.*
 c. betulae, *Cooley.*
 733. *prunicola*, *Mask.*⁽¹⁹⁾
 c. theae, *Mask.*
 1093. *agonis*, *Full.*
 1091. *ethele*, *Full.*
 1095. *xanthorrhoeae*, *Full.*
 1096. *saccharifolii*, *Zehntner.*
 1097. *depressa*, *Zehntner.*
 1098. *howardi*, *Cooley.*
 1099. *lounsburyi*, *Cooley.*
 1100. *simplex*, *Green.*
- Aulacaspis*, *Ckll.***
658. *roseae*, *Bouché.*
 c. spinosa, *Mask.*
 659. *boisduyahi*, *Sigu.*
 c. maculata, *Ckll.*
 1106. *montana*, *Ckll.*
 1107. *miranda*, *Ckll.*
 1108. ? *elegans*, *Leon.*
- Diaspis*, *Costa.***
1109. *gennadii*, *Leon.*
 1110. *oleae*, *Colvée.*
 651. *amygdali*, *Tryon.*
 c. rubra, *Mask.*
 1111. *persimilis*, *Ckll.*
 1112. *baccaridis*, *Townsend & Ckll.*
 1113. *phoradendri*, *Ckll.*
 1114. *crawii*, *Ckll.*
 1115. *fagraeae*, *Green.*
 1116. *loranthi*, *Green.*
 s. g. Epidiaspis, *Ckll.*
 1117. *piricola*, *Del Guercio.*
 s. fallax, *Horroth.*
 1118. *snowii*, *Hunter.*⁽²⁰⁾
- Howardia*, *Berl. & Leon.***
719. *bielavis*, *Comst.*
- Protodiaspis*, *Ckll.***
1119. *parvulus*, *Ckll.*

(16.) *Phenacaspis*, *Cooley* and *Ckll.*, will be a new genus to include *P. nigra*, *chinensis*, *angustata*, etc., hitherto placed in *Chionaspis*. Mr. *Cooley* and the present writer agree that these forms have no genetic relationship with genuine *Chionaspis* except through *Aulacaspis* and *Diaspis*. I leave Mr. *Cooley* to publish the generic characters and classify the species.

(17.) Mr. *Cooley* is responsible for the synonymy.

(18.) According to Mr. *Cooley*.

(19.) Mr. *Cooley* finds that specimens of *c. prunicola* from Mr. *Maskell* are *Diaspis angustata*. It is just possible that *Maskell* accidentally mixed the *Diaspis* with a genuine *Chionaspis*, however, and that *prunicola* may still be valid.

(20.) This could very well pass for *Aspidiotus amygdali*, did it not have a *Diaspis* male scale? *D. piricola*, in Europe, was long confounded with *Aspidiotus ostryaefornis*.

7710

BULLETIN

OF THE

ILLINOIS STATE LABORATORY

OF

NATURAL HISTORY,

URBANA, ILLINOIS.

VOLUME V.

ARTICLE VIII.—A STATISTICAL STUDY OF THE PARASITES OF THE UNIONIDE.

BY H. M. KELLY, A. M.

Illinois State Laboratory of Natural History,
URBANA, ILLINOIS,
March, 1899.

STATE LABORATORY OF NATURAL HISTORY.

LABORATORY STAFF.

PROFESSOR STEPHEN ALFRED FORBES, PH. D.,
Director of State Laboratory, and State Entomologist.

CHARLES ARTHUR HART,
Systematic Entomologist and Curator of Collections.

FRANK SMITH, A. M.,
Assistant Zoölogist.

CHARLES ATWOOD KOFOLD, PH. D.,
Zoölogist, and Superintendent of Biological Station.

WALLACE CRAIG, B. S.,
Zoölogical Assistant.

MARY JANE SNYDER,
Secretary.

HENRY CLINTON FORBES,
Business Agent and Librarian.

LYDIA MOORE HART,
Artist.

ARTICLE VIII. *A Statistical Study of the Parasites of the Unionidae.* BY H. M. KELLY.

The studies on the quantitative occurrence of parasites in different species of the *Unionidae* which form the basis of the present paper were made at the Illinois Biological Station, at Havana, early in the summers of 1896 and 1897 and continued both seasons at Mt. Vernon, Ia., and at Lewisburg and Phoenixville, Pa., the material used being secured in the above mentioned localities and examined while fresh. It was the purpose of the investigation to determine, if possible, under what conditions infestation would be found to vary in a series of closely related species of a given locality or of several localities, and to what extent this variation could be regarded as a specific characteristic.

The Illinois, Iowa, and Pennsylvania waters from which collections were made are indicated in Table I., and for the purposes of this paper may be briefly characterized as follows: (1) The Illinois River at Havana is a large sluggish stream with alluvial banks and largely muddy bottom, full of organic matter of various origin. (2) Spoon River, a tributary of the Illinois, is at Bernadotte and Duncan's Mills, where collections were made, small, with rapid current and rocky bottom. It drains a purely agricultural region, and is subject to frequent and sudden floods. (3) Quiver Creek, near Havana, is a smaller tributary to the Illinois, draining a sandy plain. (4) Thompson's Lake is a shallow body of water about six miles long and one mile wide, lying in the low alluvial flood plain of the Illinois River, with very muddy bottom and little change of water except as affected by change of level in the river, with which it is connected. (5) The Cedar River, near Mt. Vernon, Ia., is a rapid shallow stream with shifting sandy bottom for the most part, draining

a rolling prairie region. (6) Abbey Creek is a small, sluggish, and muddy tributary of the Cedar, flowing through a wooded region of rich black soil. (7) The Schuylkill River at Phoenixville, Pa., is rapid and shallow, with a rocky bed. Its waters are largely contaminated with the sewage of the populous region through which it flows, with manufacturers' wastes, and with the acid pumpings of anthracite coal mines. (8) Pickering Creek, a tributary of the Schuylkill, is an uncontaminated, swift-flowing stream, constant in volume, and draining a restricted rocky area. (9) French Creek, a near-by branch of the Schuylkill, is of similar size, but traverses a country of clay soils, and is subject to frequent inundations. (10) The West Branch of the Susquehanna River is, upon most of its course, a large but shallow mountain stream with rapid current. It is quiet for some miles at Lewisburg, Pa., where it crosses one of the fertile valleys of the Appalachian system.

Fifteen hundred and thirty-seven individual unios from the above localities, belonging to forty-four species, were personally examined by me with reference to their parasites; and with the data thus obtained I have incorporated the results of an examination of seventy-seven individuals, belonging to eighteen species, made by Dr. C. A. Kofoid in 1895 and 1896, which were placed at my disposal. It is unfortunate that my material did not furnish equal representation for each host species, and that the examination extended over such a long period of time. For control on both these points an effort was made to examine, if possible, about twenty individuals of each species which were all taken at the same time from the same locality and under the same conditions.

Whenever it was practicable individuals of or above the adult average in size and age were chosen for examination. Only ninety-seven of the sixteen hundred and fourteen individuals examined could be regarded as immature, and these were well distributed among the several species. The inclusion of records for these younger and smaller individuals would presumably reduce somewhat both the probability of and capacity for infestation. However, in the case of

TABLE I. GEOGRAPHICAL DISTRIBUTION OF UNIONIDE EXAMINED.

NAMES OF SPECIES.	ILLINOIS.		IOWA.				PENNSYLVANIA.				Total No. of Individuals.	
	No. of Individual.	Illinois River.	Spoon River.	Quiver Creek.	Thompson's Lake.	Cedar River.	Abney Creek.	Schuykill River.	Preckitts Creek.	French Creek.		Susquehanna River.
<i>Quadrula multiplicata</i> Lea.	28	26	2									2
<i>tuberculata</i> Bar.	41	18	21			2						3
<i>metanevra</i> Raf.	36	2				34						2
<i>lachrymosa</i> Lea.	29		29									1
<i>asperrima</i> Lea.	21	21										1
<i>pustulata</i> Lea.	20	20										1
<i>granifera</i> Lea.	1	1										1
<i>pustulosa</i> Lea.	87	29	28			30						3
<i>plicata</i> Say.	89	45	8			36						3
<i>trigona</i> Lea.	27	22	5									2
<i>rubiginosa</i> Lea.	40	1	1			38						3
<i>ebeana</i> Lea.	23	23										1
<i>Unio gibbosus</i> Bar.	35	25	10									2
<i>complanatus</i> Sol.	137							62	14	20	41	4
<i>heterodon</i> Lea.	4							1	1	2		3
<i>Alasmodonta confragosa</i> Say.	35	34	1									2
<i>complanata</i> Bar.	64	11	8			37	8					4
<i>rugosa</i> Bar.	18		1			17						2
<i>marginata</i> Say.	51					1		30	20			3
<i>undulata</i> Say.	3								3			1
<i>tappaniana</i> Lea.	1							1				1
<i>Strophitus edentulus</i> Lea.	36	12	2			18	2	1		1		6
<i>Anodonta imbecilis</i> Say.	49	47				2						2
<i>suborbiculata</i> Say.	20					20						1
<i>grandis</i> Lea.	8		3			5						2
<i>corpulenta</i> Coop.	45	35				10						2
<i>Obliquaria reflexa</i> Raf.	32	26	1			5						3
<i>Plagiola securis</i> Lea.	5	5										1
<i>elegans</i> Lea.	48	25	3			20						3
<i>donaciformis</i> Lea.	37	21	3			13						3
<i>Lampsilis parvus</i> Bar.	31	25					6					2
<i>ellipsis</i> Lea.	14	3				11						2
<i>higginsii</i> Lea.	1	1										1
<i>ligamentinus</i> Lam.	91	24	2			65						3
<i>luteolus</i> Lam.	25	11	2	10		2						4
<i>nasutus</i> Say.	1							3		1		2
<i>anodontoides</i> Lea.	62	49	4			9						3
<i>rectus</i> Lam.	49	10	2			37						3
<i>ochraceus</i> Say.	1									1		1
<i>ventricosus</i> Bar.	108	10	2	40		56						4
<i>alatus</i> Say.	60	38	3			19						3
<i>levissimus</i> Lea.	4	1	3									2
<i>gracilis</i> Bar.	89	40	16			33						3
<i>tenuissimus</i> Lea.	5					5						1
Totals } Individuals.	1611	1661	160	50		30455	16	68	45	47	12	
} Species.	44	32	24	2		2	23	3	5	3	6	2

Quadrula pustulosa,* where the highest proportion of under-sized individuals is included in the tabulation,—twenty out of eighty-seven,—it appears that the infestation of these younger hosts did not differ materially in kind or degree from that of the larger individuals.

The sex of fourteen hundred and eighty-three individuals of the sixteen hundred and fourteen examined was determined by microscopical examination, seven hundred and eighty-two being males and seven hundred and one females. In one hundred cases the determination of sex was not attempted. In the thirty-one remaining, it was indeterminate by microscopic examination, all but five being infested by *Bucephalus* or other cercaria forms to the utter destruction of the proper reproductive tissue. From the shape of the shells eight of these thirty-one individuals were pronounced males and two females. Others, also belonging to species in which the shells of the two sexes are normally characteristic, had shells of such shape as to render the sex problematical and to suggest that infestation by *Bucephalus* or other cercaria, when early acquired and long continued, may so alter the form of the shell of the female as to cause it to resemble that of the male or, if acquired later, may produce an intermediate form. Moreover, females infested with *Bucephalus* or other cercaria rarely (in but three observed cases) carried glochidia, though examined when the marsupia of other females of their species were normally inflated with young. This is especially noteworthy in *Lampsilis gracilis*, in which determination of the sex of the clam by the form of the shell is usually certain. Of the eighty-nine individuals of this species examined, thirteen were infested with *Bucephalus* or other cercaria. Of these, seven appeared to be males, one was a female with glochidia in the gill, three were doubtfully regarded as females although no germinal tissue was discernible, while the sex of two was problematical.

In thirty-eight of the forty-four species examined the num-

* For the convenience of those who have not followed the recent changes in unionid nomenclature a list of the names mentioned in this article is given in the first column below, each name being followed in the second column by the one

ber of infested males and females for each species did not differ materially. The exceptions are as follows :

Unio heterodon,	4 males,	0 females.
Anodonta suborbiculata,	18 males,	2 females.
Plagiola securis,	5 males,	0 females.
Lampsilis parvus,	0 males,	31 females.
Lampsilis levissimus,	4 males,	0 females.
Lampsilis tenuissimus,	5 males,	0 females.

The disparity of the sexes in these few species has no significance, however, in this connection, for in no case where both sexes were liberally represented in the host species could a different capacity for infestation be established for the two sexes. The only seeming exception, in the case of

previously in common use. The specific names remain the same, except that *cornutus* becomes *reflexa*, and *plana* is now considered a form of *grandis*.

Quadrula multiplicata.....	Unio multiplicatus	
tuberculata	tuberculatus	
metanevera	metanever	
lachrymosa	lachrymosus	
asperrima	asperrimus	
pustulata	pustulatus	
granifera	graniferus	
pustulosa	pustulosus	
plicata	plicatus	
trigona	trigonus	
rubiginosa.....	rubiginosus	
ebena.....	ebenus	
Unio gibbosus.....	gibbosus	
complanatus.....	complanatus	
heterodon.....	heterodon	
Alasmodonta confragosa.....	Margaritana confragosa	
complanata.....	complanata	
rugosa.....	rugosa	
marginata.....	marginata	
undulata.....	undulata	
tappaniana.....	Unio tappanianus	
Strophitus edentulus.....	Anodonta edentula	
Anodonta imbecilis.....	imbecilis	
suborbiculata.....	suborbiculata	
grandis.....	plana	
corpulenta.....	corpulenta	
Obliquaria reflexa.....	Unio cornutus	
Plagiola securis.....	securis	
elegans.....	elegans	
donaciformis.....	donaciformis	
Lampsilis parvus.....	parvus	
ellipsis.....	ellipsii	
higginsii.....	higginsii	
ligamentinus.....	ligamentinus	
luteolus.....	luteolus	
nasutus.....	nasutus	
anodontoides.....	anodontoides	
rectus.....	rectus	
ochraceus.....	ochraceus	
ventricosus.....	ventricosus	
alatus.....	alatus	
levissimus.....	levissimus	
gracilis.....	gracilis	
tenuissimus.....	tenuissimus	

infestation by *Bucephalus*, has already been explained as the result of the unsexing of the host.

Though this study was instituted primarily with the trematodes alone in mind, record was made of all parasites whose presence did not appear to be accidental. I have presented in Table II. a concise record of these parasites and of the species and number of their hosts, while the relations of the one to the other are set forth in the discussion which follows.

Aspidogaster conchicola von Baer, the most common parasite of the *Unionidae*, is confined for the most part to the pericardial and nephridial cavities of the host. In four hundred and thirty-five cases it was found in the pericardium only, in seventy in the kidneys only, and in one hundred and thirty-four cases both cavities contained the parasite. In only one host species showing any considerable degree of infestation, *Lampsilis parrus*,—where twenty out of thirty-one individuals examined were parasitized,—were the flukes restricted wholly to one cavity (the pericardium), and here the small size of the host may perhaps account for such restriction. As a rule, though there are many exceptions, flukes appear in both chambers only when the parasites are very numerous; and as the number in the pericardium is usually much larger than that in the kidneys, and as the pericardial infection is the more frequent, it would seem that only in excessive parasitism is the nephridial cavity invaded. A single *Aspidogaster* was found encysted in the lateral wall of the visceral mass of the host. In four cases only, in all of which the pericardium was ruptured in opening the shell, were individuals of this species detected in other than the usual localities, and then their positions were always such as to suggest escape from the broken pericardium. This parasite was most frequently found in the adult stage, but eggs and embryos in abundance and young of varying sizes were found when the parasitism was considerable. The presence of the mature trematode in the pericardium and of eggs within the nephridia is not infrequent.

Cotylaspis insignis Leidy is found adherent to the surface

of the host in the angle between the inner gill and the visceral mass. Its range is usually restricted to this axilla, and the number infesting one host is small. In one case, however,—that of *Auodonta corpulenta*, recorded by Dr. Kofoid,—where the number reached the unparalleled extreme of ninety-two, the flukes extended well out upon the inner surface of the gill; and in another, under my own observation, some of them were crowded down upon the abdominal surface. In *A. suborbiculata*, in which *Cotylaspis* attains its maximum average, thirty-eight to each host, not only are the axillæ and the adjacent surfaces of both inner gill and visceral mass invaded, but some are usually found within the tubes of the inner gill, and occasionally even in those of the outer gill. Such migration from the usual seat of infestation to immediately adjacent regions is perhaps to be expected in cases of overcrowding such as are instanced. In a single *Lampsilis ellipsis*, one *Cotylaspis* unmistakably occurred in the pericardium along with twenty-three specimens of *Aspidogaster*. Since *Cotylaspis* normally frequents the region of the nephridial openings, an invasion of the pericardium by way of the nephridia might not be impossible. All the *Cotylaspis* found were adults varying little in size. Eggs were not infrequently observed in the surface slime collected in the vicinity of the parasites.

Four forms of *Distomidae* have been found, probably of as many different species, all immature, and none sufficiently developed for specific determination. One of these forms—referred to in the table as “Free Distomata”—is found in loose salmon-colored masses either upon or slightly within the tissue of the mantle, along or near the dorsal fold. In *Quadrula*, *Unio*, *Plagiola*, and *Lampsilis* this parasite is most frequently located immediately between the cardinal teeth, less commonly between the lateral teeth, or, again, upon the sides, extending over the external surface of the mantle on a line parallel to its attachment to the viscera. In the genera *Strophitus* and *Auodonta* the distribution of this parasite is lateral, as just described, often extending over the mantle surface like a large widely-open inverted V, with its

apex just below the umbo and its arms reaching even beyond and below the anterior and posterior adductor muscles.* This trematode has not in my experience been found singly, the number associated having varied from four to many hundreds. They are habitually loosely adherent by their suckers to the mantle surface and to each other, but may be slightly insinuated within the loose tissue of the mantle, especially when found between the hinge teeth. The position of this parasite is usually marked by rusty stains in and upon the naere, by malformation of the shell or of the hinge teeth, and not infrequently by a number of dark, poorly formed pearls. Though these conditions of the superimposed shell do not always accompany infestation by this trematode, and though similar abnormalities are found without its presence being discerned, yet these malformations are very constant where the mass of the parasites is considerable, and the size and location of the ferruginous stain or injury correspond to those of the infesting colony. When but few are present and there is no injury to the naere, the irritation is no doubt too slight or too recent for much interference with the normal secretion of the mantle. A malformation characteristic of the presence of this parasite but unaccompanied by it, would seem to imply desertion for another host. Such implication is strengthened by the fact that in the case of some of the host species, individuals are frequently found in which none of these salmon-colored masses of trematodes are present, but which nevertheless present malformations of considerable size in which the rusty, altered, and diseased naere is covered with a normal layer of later deposit. The parasite is, moreover, uniformly immature, no matter at what season it is observed.

The other three species of *Distomum* were found encysted in the following situations respectively: (1) in the pericardium of a single individual in each of the species *Quadrula rubiginosa*, *Plagiola elegans*, and *Lampsilis anodontoides*; (2) in the ventral muscular margin of the mantle in four

*H. L. Osborn (98, Zool. Bull., Vol. I, No. 6) describes in like manner this parasite and its mode of infestation in *Anodonta piana* (= *grandis*) and *Strophitus edentulus* from Chautauqua Lake, N. Y.

individuals of *Lampsilis ligamentinus*; and (3) within the ovary of a single specimen of *Lampsilis ventricosus*. These are evidently all immature forms, the clam serving them only as an intermediate host.

Bucephalus polymorphus von Baer and two other cercaria forms were found within the viscera of the host. These usually occurred in such abundance as to obliterate totally the normal tissue of the sexual glands, rendering the whole abdomen as granular as fish roe, or fibrous with the sporocysts of the *Bucephalus*. Extensive infestation with the latter parasite also involves the nephridia, which may be much swollen, their ducts being nearly obliterated by the tangled fibers of sporocysts. This unsexing of the host, and the accompanying changes in the form of the shell have already been referred to.

Various species of *Atax* are common ectoparasites of the *Unionidae*. Their favorite situations are upon the body surfaces, between the gills or between the gills and abdomen, between the labial palps, or among the papillæ fringing the mantle edges at the inhalent siphon. Their eggs are laid either in the body wall, the gills, or the mantle.

Dr. Robert H. Wolcott, to whom a part of the *Atax* material collected in the course of this study was sent, kindly furnished the determinations of the species of this genus included in the following table, which indicates the host species from which these different parasites were derived, and also the total number of individuals of each species of *Atax* found in a given host species.

Conchophthirus hirtus Ehrbg. and *C. anodontæ* Ehrbg., ciliated Infusoria, inhabit the slime investing the body surfaces. In the accompanying tables no attempt is made to separate the two species.

Chaetogaster limuæi von Baer, an oligochaete, is also found in the slime of the various surfaces and in the kidneys.

The frequent presence of leeches and planarians upon the shell and on the mantle edges, at times indeed within the branchial chamber, was regarded as accidental, and they are consequently not included in the accompanying tabulations.

HOST SPECIES.	<i>Atax abnormis</i> Wolfc.	<i>Atax arcuata</i> Wolfc.	<i>Atax fossulatus</i> Koenike.	<i>Atax infulatus</i> Wolfc.	<i>Atax serratus</i> Wolfc.	<i>Atax stricta</i> Wolfc.	<i>Atax psilophorus</i> Bonz.
<i>Quadrula tuberculata</i>						363	
<i>lachrymosa</i>						12	
<i>asperrima</i>						5	
<i>pustulosa</i>						115	
<i>plicata</i>						43	
<i>Alasmodonta rugosa</i>							4
<i>marginata</i>		18					
<i>Anodonta imbecilis</i>	11			8		5	3
<i>suborbiculata</i>							37
<i>corpulenta</i>							16
<i>Obliquaria reflexa</i>						10	
<i>Lampsilis anodontoïdes</i>	26						
<i>rectus</i>						8	
<i>ventricosus</i>	14		6			1	
<i>alatus</i>			6	78		636	
<i>levissimus</i>			6				
<i>gracilis</i>	3	30		82		1	
Sp. ?					8		

Table II. is an exhibit of the results of all the examinations, the body of the table giving the number of individuals of the various host species examined, and the number of such hosts infested by each of the nine parasites named in the headings. The footings of the columns and the subjoined percentages give the number and per cent. of species and individuals infested. On the right, one column gives the number of kinds of parasites found in each host species, and another the total number of individuals in the species examined which were infested to any degree. A comparison of the data in these two columns, note being taken of the number of individuals examined in the several species, as given in the first column, shows a marked variation among the different host species in the number of kinds of parasites harbored and in the number of individuals of each species infested. It is seen that *Aspidogaster* is by far the most widely distributed and abundant parasite; that *Cotylaspis*, *Atax*, and *Conchophthirus* must be classed as very frequent; that the free distomid and *Bucephalus* are less common; and that the remaining three parasites occur but occasionally. It is remarkable that at least two sufficiently examined

TABLE II. SPECIFIC DISTRIBUTION OF PARASITES.

HOST SPECIES. NAMES.	No. of individual unions examined	NO. OF HOSTS INFESTED WITH								Kinds of parasites.	No. of individuals infested.	
		Aspidogaster.	Corythospis.	Free Distomata.	Eggs of Distomata.	Ceraria.	Bucephalus.	Max.	Conchoph- thrus.			Chocogaster.
<i>Quadrula multiplicata</i>	28	3						3	8		3	11
<i>tuberculata</i>	41	33	12	2				23	5		5	38
<i>metanevra</i>	36	12	1	20				12			4	28
<i>laehrymosa</i>	29	21						7			2	22
<i>asperrima</i>	21	21		1				9	13		4	21
<i>pustulata</i>	20	5	11					16			3	18
<i>granifera</i>	1	1						1	1		3	1
<i>pustulosa</i>	87	28	9	6		1		50	6		6	59
<i>plicata</i>	89	62				1		36	5		4	70
<i>trigona</i>	27	3	4						4		3	10
<i>rubiginosa</i>	40	10		1				3	2		4	15
<i>ebena</i>	23	7									1	7
<i>Unio gibbosus</i>	35	9		1		1		1	17		5	21
<i>complanatus</i>	137	37				1		111	3		4	120
<i>heterodon</i>	4	1							1		2	1
<i>Alasmodonta confragosa</i>	35	9	3					1	1	2	5	12
<i>complanata</i>	64	10	2			1	3	21	6		6	36
<i>rugosa</i>	18					1	1	9	8	3	5	13
<i>marginata</i>	51	9				4		39	33		4	47
<i>nodulata</i>	3											
<i>tappaniana</i>	1											
<i>Strophitus edentulus</i>	36	6	5	3			6	3	10		6	26
<i>Anodonta imbecilis</i>	49	25	17					1	28	33	5	46
<i>suborbiculata</i>	20	20	18					15	19		4	20
<i>grandis</i>	8	8	5	5				1	5		5	8
<i>corpulenta</i>	45	37	40	21			1	32	21		6	43
<i>Obliquaria reflexa</i>	32	3						13	6	1	4	19
<i>Plagiola securis</i>	5								2		1	2
<i>elegans</i>	48	3		1			3	4	1		5	10
<i>donaciformis</i>	37	21		1			1	1		1	5	22
<i>Lampsilis parvus</i>	31	20	2							2	3	21
<i>ellipsis</i>	14	12	11	10				1			4	14
<i>higginsii</i>	1	1									1	1
<i>ligamentinus</i>	91	13		4	5	12	20	9			6	51
<i>luteolus</i>	25	3	4	3				2	12	1	6	17
<i>nasutus</i>	4	1	1						2		3	3
<i>anodontoides</i>	62	47	18		1		2	38	15		6	54
<i>rectus</i>	49	7	21	11		3	3	32	18		7	44
<i>ochraceus</i>	1							1			1	1
<i>ventricosus</i>	108	30	24	58	1		10	72			5	94
<i>alatus</i>	60	49	27	4				48	26		5	57
<i>levissimus</i>	4	3						2			2	3
<i>gracilis</i>	89	77	46			1	13	57	11		6	86
<i>tenuissimus</i>	5	5	3								3	5
No. of individuals infested.....	644	297	146	8	17	60	586	398	40		1197	
No. of species infested.....	37	24	14	5	8	15	35	30	5		42	
Percentage of individ. infested.....	40	18	90.4	1	4	36	25	2			74	
Percentage of species infested.....	84	55	32	11	18	34	80	68	11		95	

species, *Alasmodonta rugosa* and *Lampsilis ligamentinus*, show no infestation with the generally prevalent *Aspidogaster*, and this is especially noteworthy in the case of the latter, whose infestation with other parasites is both frequent and severe.

Table III. brings into comparison the number of kinds of parasites found infesting individuals of each host species and

TABLE III. DEGREE OF INFESTATION OF INDIVIDUAL HOSTS.

HOST SPECIES.		Kinds of parasites infesting host species.	PERCENTAGE OF INDIVIDUALS INFESTED.					
NAMES.	No. of individuals examined.		To any degree.	With 1 kind.	With 2 kinds.	With 3 kinds.	With 4 kinds.	With 5 kinds.
<i>Quadrula multiplicata</i>	28	3	39	29	11
<i>tuberculata</i>	41	5	93	20	59	15
<i>metanevra</i>	36	4	78	33	42	3
<i>lachrymosa</i>	29	2	76	55	21
<i>asperrima</i>	21	4	100	33	24	43
<i>pustulata</i>	20	3	90	25	55	10
<i>pustulosa</i>	87	6	68	32	26	8	1
<i>plicata</i>	89	4	79	43	34	2
<i>trigona</i>	27	3	37	33	4
<i>rubiginosa</i>	40	4	38	35	3
<i>ebena</i>	23	1	30	30
<i>Unio gibbosus</i>	35	5	60	40	17	3
<i>complanatus</i>	137	4	88	64	24
<i>Alasmodonta confragosa</i>	35	5	34	26	6	3
<i>complanata</i>	64	6	56	44	13
<i>rugosa</i>	18	5	72	28	39	6
<i>marginata</i>	51	4	92	31	47	14
<i>Strophitus edentulus</i>	36	6	72	58	6	8
<i>Anodonta imbecilis</i>	49	5	94	18	39	27	10
<i>suborbiculata</i>	20	4	100	5	30	65
<i>corpulenta</i>	45	6	96	9	11	20	36	20
<i>Obliquaria reflexa</i>	32	4	59	50	6	3
<i>Plagiola elegans</i>	48	5	21	17	4
<i>donaciformis</i>	37	5	59	48	11
<i>Lampsilis parvus</i>	31	3	68	58	10
<i>ellipsis</i>	14	4	100	57	43
<i>ligamentinus</i>	91	6	56	43	11	2
<i>luteolus</i>	25	6	68	52	4	8	4
<i>anodontoides</i>	62	6	87	18	40	19	10
<i>rectus</i>	49	7	89	24	31	20	12	2
<i>ventricosus</i>	108	5	87	25	37	19	6
<i>alatus</i>	60	5	95	13	22	33	27
<i>gracilis</i>	89	6	97	16	45	23	13
Totals	1577	74	32	25	10	5	0.6

the number harbored by each species considered as a unit. In this table and in the succeeding one the data regarding host species in which less than fourteen individuals were examined are not included. While the comparisons between the species included are thus rendered the more reliable, it will be seen that the general conclusions deduced from Tables III. and IV. only confirm the findings of the more general statistics of Table II. While nine kinds of parasites are here listed for the *Unionidae*, no species of the family was found to harbor more than seven, and the average was but four or five. Moreover, in but four species—*Quadrula lachrymosa*, *Q. cbeua*, *Q. pustulata*, and *Anodonta suborbiculata*—were individuals found with the maximum variety of parasites listed for its species, and in these the maximum variety is four or less. It is perhaps futile to imagine what variety of parasites an individual host might successfully sustain, but it is noticeable that in this table the mean individual infestation lies closer to the species minimum than to its maximum. A close inspection of the data of all examinations further confirms the inference that the individual host is unable to realize the maximum capacity of its species for infestation, since in no case is the presence of an unusual number of one parasite accompanied either by like severe infestation by another or by a considerable variety of parasites. It is true that one individual of *Lampsilis gracilis* with sixteen specimens of *Aspidogaster* in the pericardium and six in the nephridia, harbored also two of *Cotylaspis* and one each of *Atax* and *Bucephalus*, and that one *Lampsilis ventricosus* infested with thirty-one specimens of *Aspidogaster* contained large numbers of *Bucephalus*; but these are exceptional cases, and even in these individuals, when we consider the size of the host and the established maximum capacity of their species, the extreme limit can hardly be said to be reached. The ectoparasites probably require but little from their hosts, but they rarely occur in numbers upon clams exhausted by *Bucephalus*.

Table IV. gives the percentage of the hosts which were infested with *Aspidogaster*, *Cotylaspis*, and *Atax*, the most

abundant parasites, and also the maximum, minimum, and average number of these parasites found in the hosts. The frequency of occurrence of any one of these parasites in relation to the total infestation of a species is to be learned by a comparison of Tables III. and IV. Thus in a total of fifteen hundred and seventy-seven examinations,—in which seventy-four per cent. were in some measure infested (Table

TABLE IV. COMPARISON OF INFESTATION BY DIFFERENT PARASITES.

HOST SPECIES.	Individuals examined.	Percentage of hosts infested with			Number of parasites in one host.			Average No. of parasites in one host.		
		Aspidogaster.	Colytaspis.	Atax.	Aspidogaster.	Colytaspis.	Atax.	Aspidogaster.	Colytaspis.	Atax.
<i>Quadrula multiplicata</i> ...	28	11	...	11	1-5	...	1-2	2	...	1
<i>tuberculata</i> ...	41	80	29	56	1-19	1-8	1-78	6	3	23
<i>metanevra</i> ...	36	33	3	33	1-6	1	1-2	2	1	2
<i>lachrymosa</i> ...	29	72	...	24	1-41	...	1-6	12	...	2
<i>asperrima</i> ...	21	100	...	44	2-13	...	1-3	6	...	2
<i>pustulata</i> ...	20	25	55	80	1-5	1-7	1-4	2	3	2
<i>pustulosa</i> ...	87	32	11	57	1-5	1-2	1-18	2	1	3
<i>plicata</i> ...	89	70	...	40	1-20	...	1-20	4	...	6
<i>trigona</i> ...	27	11	15	...	1-6	1-2	...	3	2	...
<i>rubiginosa</i> ...	40	25	...	8	1-6	...	1	4	...	4
<i>ebena</i> ...	23	30	1-24	6
<i>Unio gibbosus</i> ...	35	26	...	3	1-7	...	1	2	...	1
<i>complanatus</i> ...	137	27	...	1	1-28	...	1	3	...	1
<i>Alasmodonta confragosa</i> ...	35	26	9	3	1-75	1-4	Eggs	27	3	Eggs
<i>complanata</i> ...	64	16	3	33	1-85	1	1-6	11	1	1
<i>rugosa</i> ...	18	50	1-3	2
<i>marginata</i> ...	51	18	...	76	1-12	...	1-7	3	...	3
<i>Strophitus edentulus</i> ...	36	17	14	8	1-10	1-2	1-22	3	1	8
<i>Anodonta imbecilis</i> ...	49	51	35	20	1-9	1-7	Eggs	3	2	Eggs
<i>suborbiculata</i> ...	20	100	90	75	1-37	1-86	1-8	13	38	3
<i>corpulenta</i> ...	45	82	88	71	1-50	1-92	1-75	8	12	8
<i>Obliquaria reflexa</i> ...	32	9	...	41	1	...	1-3	1	...	2
<i>Plagiola elegans</i> ...	48	63	...	83	1-6	...	1-6	4	...	2
<i>donaciformis</i> ...	37	57	...	3	1-7	...	1	2	...	1
<i>Lampsilis parvus</i> ...	31	65	7	...	1-26	1	...	5	1	...
<i>ellipsis</i> ...	14	86	79	7	1-63	1-5	4	14	2	4
<i>ligamentinus</i> ...	91	...	14	22	...	1-8	1-4	...	3	2
<i>luteolus</i> ...	25	12	16	48	1	1-5	1-8	1	2	3
<i>anodontoides</i> ...	62	76	29	61	1-33	1-6	1-12	6	2	4
<i>rectus</i> ...	49	14	43	65	1-5	1-9	1-20	2	4	3
<i>ventricosus</i> ...	108	28	22	67	1-134	1-15	1-9	18	3	3
<i>alatus</i> ...	60	82	45	80	1-63	1-10	1-108	16	2	50
<i>gracilis</i> ...	89	87	52	64	1-77	1-12	1-31	15	3	5
Totals.....	1577	41	18	37

III.),—forty-one per cent. were parasitized by *Aspidogaster*, eighteen per cent. by *Cotylaspis*, and thirty-seven per cent. by *Atax*—as shown in Table IV. It may be seen from the tables under discussion, as well as from Table II., that there is a marked difference between the several host species in capacity for infestation in both kind and degree.

The range in number of parasites infesting one host, and their average number, may depend to some extent upon the size of the host,—*Anodonta suborbiculata* and *A. corpulenta* showing high numbers and *Strophitus edentula* and *Anodonta imbecilis* low,—and this applies with force in case of occupation of the pericardial and nephridial cavities by *Aspidogaster*, where the volumes of the organs closely limit the possible number of invading parasites. But size is not the sole determining factor, else *Lampsilis lutcolus* and *L. anodontoides*, *L. ligamentinus* and *L. alatus*, *Quadrula multiplicata* and *Lampsilis ventricosus*, and *Quadrula plicata* and *Lampsilis gracilis* should harbor similar, rather than so widely different, numbers of parasites, and little *Lampsilis parvus* should not show such large infestation and such a wide range in the number of parasites harbored.

The tables seem to indicate in the different species a general correspondence between the frequency of infestation, the variety of parasites, and the average number of individual parasites harbored by a given host. Thus *Quadrula tuberculata*, *Anodonta suborbiculata*, *A. corpulenta*, *Lampsilis ellipsis*, *L. ventricosus*, *L. alatus*, and *L. gracilis*, all figuring largely in the tables, are frequently parasitized, carry a large variety of parasites, and, in proportion to their size, a high average number individually; while the statistics concerning *Quadrula multiplicata*, *Q. trigona*, *Q. ebena*, *Unio gibbosus*, *Obliquaria reflexa*, and *Plagiola elegans* show a like uniformity in infrequent infestation, little variety in kinds of parasites, and a low average number harbored by the individual host.

In the light of the latest views upon the natural classification of the *Unionidae* it may be said that closely related species exhibit somewhat similar capacities for infestation. In general the species of *Anodonta* and also those of *Lamp-*

sis are of large parasite capacity; those of *Unio* (restricted) and of *Plagiola* are of low capacity; while within the genera *Quadrula* and *Alasmodonta* we find wide extremes of infestation. Within the limits of the above genera this correspondence is more or less evident between members of groups of closely related species, especially when taken in considerable numbers in similar situations. For example, we may note the correspondence between *Lampsilis ligamentinus* and *L. luteolus*; *Quadrula ebena*, *Q. trigona*, and *Q. rubiginosa*; *Lampsilis alatus* and *L. gracilis*; and *Quadrula lachrymosa* and *Q. asperima*.

Seasonal changes have been found to modify the distribution of the parasites in the case of *Atax* and *Conchophthirus* only. As the water grew colder in late October and November, the examinations of *Unionide* from the Cedar River gave relatively fewer adult *Atax* and more abundant eggs. The presence of these eggs was regarded as potential infestation, and therefore these data may properly be included in the tabulation. The reliability of the tabulations may be somewhat vitiated by the fact that *Conchophthirus* is much more plentiful in the warmer months, during which the greater part of my collections were made.

TABLE V. GEOGRAPHICAL DISTRIBUTION OF PARASITES.

		LOCALITIES.									
		ILLINOIS.				IOWA.		PENNSYLVANIA.			
		Illinois River.	Spoon River.	Quiver Creek.	Thompson's Lake.	Cedar River.	Abey Creek.	Schuykill River.	Plecker's Creek.	French Creek.	Susquehanna River.
Hosts.	Individuals examined	661	160	50	30	495	16	68	45	47	42
	Species	32	24	2	2	23	3	5	3	6	2
Parasites.	<i>Aspidogaster</i>	×	×	×	×	×	...	×	×	×	×
	<i>Cotylaspis</i>	×	×	×	×	×	...	×
	Free Distomata	×	...	×	×	×
	Encysted Distomata	×	×
	<i>Cercaria</i>	×	×	×	×
	<i>Bucephalus</i>	×	×	×	...	×	×
	<i>Atax</i>	×	×	×	×	×	×	...	×	×	×
<i>Conchophthirus</i>	×	×	...	×	×	...	×	×	×	×	
<i>Chaetogaster</i>	×	×	
Kinds of parasites		9	6	5	5	9	1	3	4	5	3

Table V. indicates the range of the different parasites in the several localities supplying the material. In all probability the blanks opposite the more usual parasites are due to the absence of the proper host species or to the examination of an insufficient number of these species rather than to peculiarities in the localities themselves, for the variety of parasites listed for any situation varies with the number of individuals and the variety of species examined from each locality. Thus the absence of *Atax* from the Schuylkill and its occurrence in the tributary French and Pickering creeks may be accounted for by the fact that with the exception of a single occurrence, this parasite was never found by me, in any locality, in the particular species examined from the Schuylkill. Again, an examination of twenty individuals of *Anodonta corpulenta* from Abbey Creek, Ia., made since these tabulations were completed, has increased the list of unionid parasites from that stream to six, adding *Aspidogaster*, *Cotylaspis*, free *Distomata*, *Bucephalus*, and *Conchophthirus*, the smaller number of parasites reported in the table being due in a large degree to the particular species of *Unionidae* previously examined from the stream. An examination of Table VI. shows, however, that there is quite a great variation in the infestation of the same species in different localities. This variation is the greatest, as would be expected, in the host species least frequently parasitized, and especially in the case of those parasites that are infrequent or unusual in a given host. Again in the case of the larger streams as compared with the smaller ones, whenever a given host is especially plentiful and *Unionidae* in general are abundant the infestation is relatively larger and a greater variety of parasites occur. For example, in the Illinois and Cedar rivers, both large streams, a large proportion of the *Unionidae* are excessively parasitized, but in the Spoon River, a smaller stream, only such species are extremely infested as are abundant or dominant, as, for example, *Quadrula tuberculata*, *Unio gibbosus*, and *Lampsilis gracilis*. The fact that *Unio complanatus* from the Schuylkill River is but slightly parasitized in comparison with individuals from its tributaries,

TABLE VI. COMPARISON OF LOCAL INFESTATION.

HOST SPECIES.	Locality.	Number examined.	PERCENTAGE INFESTED WITH						comparative lituris.
			Aspid. gaster.	Corymbis	Discomata	Pez. Discomata	Leptoth. albus.	Hicoph. albus.	
Quadrula tuberculata.	Illinois Riv.	17	76	71	12			29	29
	Spoon Riv.	21	81					86	...
Quadrula pustulosa.	Illinois Riv.	29	45	31	7			90	21
	Spoon Riv.	28	29					64	...
Quadrula plicata.	Cedar Riv.	30	23		13		3	20	...
	Illinois Riv.	45	76					67	11
	Spoon Riv.	8	63					20	...
Unio gibbosus.	Cedar Riv.	36	61					3	...
	Illinois Riv.	25	20		4			4	56
Unio complanatus.	Spoon Riv.	10	40			10		...	30
	Susquehanna Riv.	17	59						94
	Schuylkill Riv.	20	15						70
	Pickering Cr.	14	43						86
Alasmodonta complanata.	French Cr.	20	30				5	5	80
	Illinois Riv.	11	27	18				18	55
	Spoon Riv.	8						38	...
Alasmodonta marginata.	Cedar Riv.	37	19			3	5	27	3
	Abbey Cr.	8						67	...
Strophitus edentulus.	Pickering Cr.	30	27			10		80	70
	French Cr.	20	5			5		75	60
Anodonta grandis.	Illinois Riv.	12	25	33	25		8	8	17
	Cedar Riv.	14	21	7			29	7	29
Anodonta corpulenta.	Spoon Riv.	3	100					33	33
	Cedar Riv.	5	100	100	100			80	...
Plagiola elegans.	Illinois Riv.	20	90	95	75		5	85	65
	Thompson's L.	10	90	100	40			90	60
Plagiola douaciformis.	Illinois Riv.	25	12			4		8	4
	Cedar Riv.	20					5	15	...
Lampsilis ellipsis.	Illinois Riv.	21	67	5	5		5	5	...
	Cedar Riv.	13	54						...
Lampsilis ligamentinus.	Illinois Riv.	3	100	100	67				...
	Cedar Riv.	11	82	73	73			9	...
Lampsilis luteolus.	Illinois Riv.	24		50				37	4
	Cedar Riv.	65		2		6	8	18	17
Lampsilis anodontoides.	Illinois Riv.	10	30	20	10			90	...
	Quiver Cr.	10			10		10	30	...
Lampsilis rectus.	Illinois Riv.	20	100	55			5	75	60
	Spoon Riv.	4							50
Lampsilis ventricosus.	Cedar Riv.	9	22	11		11			...
	Illinois Riv.	10	60	60	30				60
Lampsilis alatus.	Quiver Cr.	40	18	5	48		23	13	...
	Cedar Riv.	56	29	29	63		2	82	...
Lampsilis gracilis.	Illinois Riv.	20	95	80				95	95
	Spoon Riv.	18	94	11	22			77	39
Lampsilis gracilis.	Illinois Riv.	40	83	83			13	78	25
	Spoon Riv.	16	94				25	75	...
Lampsilis gracilis.	Cedar Riv.	33	85	36			3	24	60
	Cedar Riv.	3						60	3

French and Pickering creeks, and from the Susquehanna River, may be due to the very peculiar conditions, referred to on page 400, which exist in the Schuylkill. Again, in *Alasmodontia marginata* the extensive amount of parasitism in the material from Pickering Creek as compared with that from French Creek, is explained by the fact that this is an abundant and dominant species in Pickering Creek, while it is relatively infrequent in French Creek.

Some attempt was made to discover whether purely local conditions in the habitat, such as the character of the bottom and association with other species of *Unionidae*, bear any relation to the character and degree of infestation. The examination of representatives of nine species taken at one time from a restricted locality below a bar in the Illinois River, where *Unionidae* were unusually abundant and at least twenty-nine species represented, gave results which did not differ materially or in any one direction—save in the slightly larger infestation to be expected because of the hosts' unrivaled opportunities for infestation—from those obtained from the same species collected in other localities.

A purely qualitative examination of the food of the various species of *Unionidae* showed no differences that could be correlated with their capacities for infestation. The nature of the food would hardly determine to any appreciable degree the parasites of other organs than those closely connected with the alimentary canal, and least of all those whose lodgment would be effected by mere entrance to the branchial chamber.

In conclusion, the results arrived at by the foregoing studies may be summed up as follows: The host species seem to exhibit unlike capacities for infestation, both as to the number of individuals and the kinds of parasites present. It appears that the differences shown are attributable only in a minor degree to the age and size of the host, the size of the stream, and the density of the unionid population. They are not sufficiently accounted for by the seasonal variation,—which is shown to exist to some degree at least in the case of certain parasites,—nor by the very slight difference in

general structure between the various host species. The evidence therefore seems to indicate that the capacity for infestation in each host species is to a large extent a specific characteristic.

I am indebted to Prof. S. A. Forbes, Director of the Illinois State Laboratory of Natural History, for opportunities of study and of publication; to Dr. C. A. Kofoid, Superintendent of the Illinois Biological Station, for many suggestions of value; and to Mr. C. A. Hart, of the Laboratory and Station staff, Dr. H. A. Pilsbry, of the Philadelphia Academy of Sciences, and Mr. C. T. Simpson, of the United States National Museum, for assistance in the determination and nomenclature of the *Unionidae*.

Just before going to press the nomenclature and systematic arrangement of the host species have been revised by Mr. Hart to bring them into accord with the more natural classification which is now being elaborated for this group.

CORNELL COLLEGE, MT. VERNON, IA.

January, 1899.

7710.

BULLETIN

OF THE

ILLINOIS **S**TATE **L**ABORATORY

OF

NATURAL HISTORY

URBANA, ILLINOIS.

VOLUME V.

*ARTICLE IX. PLANKTON STUDIES. III. ON PLATY-
DORINA, A NEW GENUS OF THE FAMILY VOLVOC-
IDÆ, FROM THE PLANKTON OF THE ILLINOIS RIVER.*

BY C. A. KOFOID, PH. D.

Illinois State Laboratory of Natural History,
URBANA, ILLINOIS.
December 28, 1899.

ARTICLE IX.—*Plankton Studies. III. On Platylorina, a new Genus of the Family Volvocidae, from the Plankton of the Illinois River.* By C. A. KOFOD.

The family *Volvocidae* is well represented in the plankton of fresh-water ponds and streams. Indeed, with the possible exception of *Stephanosphaera*, all of the colonial forms included in the subfamily *Volvocinae*—*Spondylomorom*, *Gouium*, *Stephanosphaera*, *Pandorina*, *Pleodorina*, and *Volvox*—are pelagic in habit and are found only in the fresh-water environment. For the past four years, during the summer and autumn months, a colonial form belonging to this subfamily has occurred in plankton collections from the Illinois River and its adjacent waters, to which I have given the name of *Platylorina caudata*. It appears as early as June 15, and becomes abundant in the months of August and September, diminishing in numbers in October, and disappearing in November. It thus attains its greatest development toward the close of the maximum period of summer heat, when the temperature of the water in which it is found often reaches 36° C. This species has occurred in all the waters examined in the course of the operations of the Illinois Biological Station; viz. in the Illinois River, in Thompson's, Quiver, Flag, Mantanzas and Phelps Lakes, at Havana, Ill., and in the Illinois River and Meredosia Lake at Meredosia, Ill. During the summer and fall of 1899 it was also found in abundance near Urbana, Ill., in Salt Fork, a small stream tributary to the Embarras River—a confluent of the Wabash. It was not equally plentiful in all these localities, but showed a decided preference for shallow water free from vegetation, reaching its maximum development when the turbid water was but a few feet, or even less than a foot, deep. In such situations the shallowness of the water and the absence of vegetation conduce to a maintenance of the high temperatures which seem to favor its multiplication. The bottom of the lakes in question is usually composed of soft mud, rich in decaying organic matter and often covered by a mat of *Oscillaria*, but otherwise quite free from vegetation. At Havana

we have found *Platydorina* in greatest numbers in Phelps Lake, which in 1896, '97, and '98 afforded the conditions above described. It was likewise abundant in Thompson's Lake in the late summer and early fall of 1897 and '98, when the lake was at a low level and contained little vegetation. In the shallow open waters of Matanzas Lake it was much more abundant than in Quiver Lake, where there was usually a large amount of vegetation. At the time of the maximum abundance of *Platydorina* in Salt Fork in September the stream was reduced by drouth to a series of stagnant pools with no vegetation. In the early part of August it was full of algæ and other aquatic vegetation, and *Platydorina* was then present in considerable numbers, although not so abundant as it was in the following month.

On August 2, 1888, Professor H. Garman, while conducting a biological survey of the aquatic life, in the vicinity of Quincy, Ill., in the bottoms of the Mississippi River (see Garman '90), found a specimen of this interesting species in the waters of Libby Lake. He records and sketches it in notes now on file at this Laboratory, but published nothing concerning it.

The occurrence of this new genus in the waters of the Wabash, Illinois, and Mississippi river systems and its recurrence in our collections for several successive years indicate its wide distribution and firm establishment in the Mississippi Valley in waters of some permanency. It has not yet been noted in temporary pools.

The associates of *Platydorina* in the plankton have varied with the season, the locality, and the year. It may be said, in a general way, that the plankton in which it occurs is characterized by an abundance of flagellates, of rotifers,—especially *Brachionida*,—and of immature *Copepoda*. A water-bloom composed largely of *Euglena*, *Trachelomonas*, *Carteria*, and other green flagellates, often appears at the surface of waters where *Platydorina* is abundant. *Gonium* is frequently associated with it in large numbers, as are also *Pandorina*, *Eudorina*, and *Pleodorina*, though these three genera may also be plentiful in the early summer, when *Platydorina* may

be absent or rare. *Pleodorina californica* was extremely abundant in Salt Fork in August, but had almost entirely disappeared by the time that *Platydorina* had reached its maximum. A few specimens of *Volvox*, which, in this locality, is common in the spring months, were also noted, while perhaps the most interesting associate in Salt Fork was *Ceratium kumaonense*, discovered by Carter ('71) in Hindostan. Other chlorophyll-bearing associates frequently seen are *Pediastrum*, *Scenedesmus*, *Actinastrum*, and *Closterium*. Among the diatoms, *Melosira*, *Fragillaria*, and *Sarirella*, were to be seen; and among the *Peridiniidae*, *Peridinium tabulatum* was almost always represented.

The zoöplankton associated with *Platydorina* is not less varied than the phytoplankton. The *Protozoa* were usually represented by *Arcella*, *Difflugia*, and occasionally by pelagic *Amoeba*; by *Synura*, *Mallomonas*, *Dinobryon*, and *Uroglena*; and by *Codonella* and *Coleps*. Among the *Rotifera* the order *Ploima* was well represented: *Triarthra* and the *Brachionidae*—notably *Brachionus militaris*, *B. angularis*, *B. punctatus*, and *B. bakeri*, and its varieties—were most common during the summer months, while the *Synchaetidae* increase in numbers in the early autumn. *Polyarthra* was frequently abundant, and *Rotifer*, *Philodina*, *Asplanchna*, *Euchlanis*, *Cathypna*, *Distyla*, *Monostyla*, and *Pterodina*, were often represented by one or more species. The paucity of *Entomostraca* stands in sharp contrast with the abundance of rotifers, the former group being represented by relatively few species and few adult individuals. The nauplii of *Cyclops* were, however, as a rule abundant, but only occasional specimens of adult *Cyclops*, *Diatomus*, *Bosmina*, *Chydorus*, *Ceriodaphnia*, *Daphnia*, and *Cypridopsis* were to be seen.

Platydorina caudata n. g., n. sp.

The species here described consists of a horse-shoe shaped cœnobium or colony (Pl. XXXVIII, Fig. 1) of 16 or 32 biflagellate cells, the anterior end corresponding to the toe of the horse-shoe and the truncate posterior end to the heel, the

latter carrying 3 or 5 prolongations or tails formed by the gelatinous substance of the cœnobium. The colony is plate-like, and flat except that the plate is slightly twisted in a left spiral. This spiral is scarcely noticeable in a face view (Fig. 1) except by focusing with a high-power objective, but it can be easily detected in a side view (Fig. 3). It varies from one eighth to one thirty-second of a turn of the spiral, and in twenty-five colonies especially examined on this point it was invariably a left spiral, with the location of the twisting always in a definite relation to the colony, the right anterior and the left posterior regions of the colony in face view being high, while the left anterior and the right posterior are low. Repeated examinations of specimens, both living and preserved, indicate that this spiral form is a constant feature of structure; that it is not reversed in direction; and that it is subject to but slight variation in the degree of the torsion. No movement within the colony which would produce or vary the spiral was noted in living individuals. The form of *Platydorina* seems to be as constant and as characteristic as that of other genera of the family.

The size of the colony varies with the age, with the number of cells present, and also, perhaps, with the locality and the season. Colonies of 32 cells in which the first division leading to the formation of daughter colonies is taking place, average about 150 μ in length, 130 μ in width, and 20 μ in thickness. The largest colonies are about $165 \times 145 \times 25 \mu$, and the smallest free-swimming ones about $25 \times 21 \times 4 \mu$. Colonies of 16 cells are smaller than those of 32 cells, and are also narrower in proportion to their length, measuring about $70 \times 43 \times 16 \mu$.

The colors of *Platydorina* are quite as striking as those of related forms. The cells, which are imbedded in the transparent gelatinous matrix of the colony, are a bright chlorophyll-green, and each has, as a rule, a red stigma, or eyespot, of unusual brilliancy.

The substance in which the cells of the colony are imbedded is similar in appearance to that in *Eudorina*. It is a transparent colorless substance of considerable consistency, show-

ing in the living condition, as a rule, no trace of differentiation. The gelatinous nature of the substance is shown by the great numbers of bacteria which swarm within it in moribund specimens. Colonies killed in formalin and stained in Delafield's hæmatoxylin exhibit a difference in the intensity of coloration, indicating the presence of a denser peripheral layer or sheath 3-4 μ in thickness (Pl. XXXVIII., Fig. 1, 4, *p. sh.*). This is apparent along the edges of the colony, and presumably extends over its faces. In several living colonies a granular differentiation of this outer layer was noted about the margin. This sheath is similar to that of *Eudorina* and *Pleodorina*, but shows no trace of the concentric layers so prominent in *Pandorina*.

One of the most characteristic features of the colony is the presence, upon the posterior border, of 3 or 5 projections or tails, which are merely extensions of the sheath. Colonies of 16 cells have but three tails, while those of 32 cells have uniformly five. These projections are bluntish finger-like processes without structural differentiation, tapering somewhat to a rounded or pointed end. Occasionally the outermost pair, and more rarely the inner one, are slightly divergent. In the 16-cell colony there are two latero-posterior tails and one median one (Fig. 2), the former being better developed, and measuring 15 to 20 μ in length. The median tail is variable in length, being sometimes a mere rudiment appearing on a slight elevation on the margin. Its average length is about one third that of the adjacent pair, though it occasionally attains two thirds their length. The latero-posterior tails are upon each side of the colony directly behind the marginal row of cells, while the median tail is midway between the central rows. In the 32-cell colony (Fig. 1) there is, in addition to the three tails above noted, another pair which may be designated as the lateral pair. These tails are slightly divergent, arising at the outer posterior angles of the marginal row of cells, between the last transverse quartet and the last sextet of cells. They are from 10 to 15 μ in length, and are often of the same size as the median tail of the colony. The other three tails occupy

the same position with respect to the posterior quartet of cells that they do in the 16-cell colony, but are as a rule much larger, the postero-lateral pair measuring from 20 to 30 μ in length, while the median one reaches only a length of 15 to 18 μ . The five tails do not lie in one plane, but share in the spiral of the colony, at times, indeed, exceeding it in the degree of the twisting. These structures are all subject to considerable variations and irregularities of development (Fig. 5), such as suppression, inequality of members of pairs, differences in size and relative development, in attenuation, and in degree of divergence. These irregularities are often correlated with the loss of cells in the colony due to parasites or other causes. The tails, nevertheless, exhibit such a constancy of position and so much of symmetry and regularity of development that they cannot for a moment be considered as ephemeral features of little structural importance. In their position they recall the protuberances noted by me ('98) at the posterior end of *Pleodorina illinoisensis*. In *Pleodorina*, however, these structures are apparent only in disintegrating maternal colonies, and it may be that they also indicate the point at which the embryonic cup closes. On the other hand, in *Platydorina caudata* these tails are present upon the colonies at the time of their escape from the maternal matrix and persist throughout the life of the adult, being permanent structures, characteristic of the species.

Within the outer sheath is a homogeneous gelatinous matrix (Fig. 1, *m.*) which in Delafield's hæmatoxylin stains less readily than the sheath. In the living colony no differentiation of this matrix is to be seen, but, after staining, a delicate sheath showing deeper color is demonstrated about each of the cells. In most places a considerable space intervenes between this secondary sheath (Fig. 4, *s. sh.*) and the inclosed cell, so that the sheaths crowd upon each other and appear to divide the field of the matrix into irregular polygonal areas. These areas, as a rule, fill the greater part of the plate, leaving unoccupied only a few corners, principally about the second transverse row. The two poles of this swollen secondary envelope are not of equal size, the inner being somewhat

the smaller, and slightly overlapped by those of the contiguous cells. This is due to the intercalation of the cells of the two sides of the plate, and to the fact that the outer ends of the cells are slightly nearer the surface of the plate than are the inner ones. The gelatinous substance within the secondary sheaths does not differ in structure or stainibility from that of the surrounding matrix. As a result of the form of the colony, the amount of the matrix substance is much less in *Platydorina* than in related forms such as *Eudorina*.

The cells of the colony are all of one type, alike in structure, and approximately similar in size. Each is biflagellate and has a central body of protoplasm with a nucleus, two contractile vacuoles, one stigma, and one chromatophore with a single pyrenoid.

The number of cells in the colony is either 16 or 32; at least no normal colony with cells of any other number has been detected among the hundreds, if not thousands, of colonies examined. Colonies are frequently seen which, by reason of parasites or from other causes, have lost one or more cells, indeed in some cases all but one or two; but the form of these colonies is usually preserved, and the empty secondary sheaths frequently remain as evidence of the original complement of cells. The 16-cell colonies are not mere stages in the development of the 32-cell form, for division of the cells of this type in observed cases leads to the development of new colonies and not to the formation of the 32-cell stage. As in other nearly related genera of the family—for example, *Eudorina*, *Paudorina*, and *Pleodorina*—the number of cells in the colony varies, within narrow limits, in the ratio of geometrical progression. In *Platydorina*, however, this pleomorphism is manifested not only by this difference in the number of cells in the colony, but also by a structural distinction—the presence of three tails in the 16-cell, and five tails in the 32-cell, colony. Inasmuch as the two types always occur together, and since this pleomorphism is in some respects similar to that of related genera, it does not seem justifiable to regard the two as distinct species of the genus. They are, I believe, two forms of one species.

The arrangement of the cells is characteristic, and is strikingly different from that of any other genus of the family. The gelatinous matrix and sheath conform to the horse-shoe-shaped plate of cells, and even the caudal appendages bear a fixed relation to the plan of cell arrangement. The 32-cell colony is composed of a marginal U-shaped row of 12 cells about three sides of a 20-celled somewhat rectangular plate, which, in turn, consists of an outer row of 12 cells on three sides of a row of four pairs of cells. The colony might also be regarded as made up of three U-shaped rows of 12, 12, and 8 cells respectively, nested in such a fashion that the inner two project one cell beyond the outermost. The cells also fall into six quite irregular transverse rows of 4, 6, 6, 6, 6, and 4 cells respectively, and into the same number of corresponding longitudinal ones. As before stated, the lateral tails are posterior to the marginal row, while the posterolaterals are behind the first row within the marginal, and the median one midway between the innermost rows. In the colony of 16 cells (Fig. 2) the marginal row has but 10 cells and the central plate but six. The cells fall into four somewhat irregular transverse rows, and there are the same number of longitudinal ones of 4 cells each. The horse-shoe shape, however, masks somewhat this simple *Gonium*-like arrangement. The plate-like form of the colony and the arrangement of the cells, especially in the 16-cell form, give this new genus a superficial resemblance to *Gonium*. It is, however, fundamentally different, for in *Platydorina* the two faces of the plate are exactly alike, while in *Gonium* the face anterior in locomotion bears all the flagella, and the other face presents only the bases of the cells. This similarity of the two faces in *Platydorina*, neither of which is anterior or posterior, is brought about by the fact that every other cell upon either face presents to that face the pole which bears the stigma and the flagella, while the intervening cells present the opposite pole, with its pyrenoid. This alternation of stigma and pyrenoid is constant, and can be followed in any row of cells except the diagonal ones (*cf.*, Fig. 1). The cells of the marginal row, in both the 16- and 32-cell colonies, point

obliquely outward, the direction alternating, however, in conformity with the arrangement of cells in the central area, as may be seen in a view of the edge of the colony (Fig. 3). The alternation of the cells in the colony as a whole is the same whichever face is presented, the right-hand cell of the posterior row of four cells always presenting the basal end uppermost. From this as a starting point the regular alternation of stigma and pyrenoid can be traced from cell to cell throughout the whole colony. An examination of twenty-five colonies showed that all conformed to the same plan of alternation, there being no case of reversal. In the arrangement of the cells in the colony, *Platydorina* is thus more like *Eudorina* than like *Gonium*, being, not a simple plate like the latter genus but, in reality, a flattened ellipsoid so much compressed that the cells of the two faces intercalate regularly, and thus give to the colony its superficial resemblance to *Gonium*.

The individual cells are all substantially alike in size and structure. They have the form of an oblate spheroid, slightly larger in the outer hemisphere.* Some cells, especially the marginal ones, often exhibit a slight flattening or even a depression at the outer pole. In the full-grown colony the cells have an equatorial diameter of 15–20 μ and a polar one of 15–18 μ . The cells of young colonies still within the maternal matrix do not exceed 4–6 μ in diameter. I do not find that the cells of the 16-cell colonies are appreciably larger than those of the 32-cell.

The protoplasm is small in amount, consisting of a very thin pellicle (Fig. 4, *p.*) on the surface of the cell on the outside of the chromatophore, and an axially-placed knob-shaped mass (*pr.*) located somewhat nearer the outer pole than the inner one. Near the center of this mass lies the spherical nucleus (Fig. 4, *n.*), containing a single spherical nucleolus (*ncl.*). Within this protoplasmic mass lie the two contractile vacuoles (*c. v.*) and the stigma (*st.*), while from the outer end of the cell arise the two flagella (*f.*).

* As in the case of *Eudorina* and *Pleodorina*, the terms "outer" and "inner" are used to designate respectively the ends which bear the stigma and the pyrenoid.

There is but a single, cup-shaped chromatophore (Fig. 4, *chr.*), which is inclosed within the pellicle above noted and itself contains the knob-shaped protoplasmic mass. It is of a brilliant chlorophyll-green color, and contains numerous small granules of irregular and somewhat angular outline. Towards the inner end of the cell, imbedded in the thickest part of the chromatophore, there is a single spherical pyrenoid, having a diameter of 4-6 μ .

The stigma, or eye-spot, seen from above is circular in outline, but in lateral view has the form shown in Fig. 4, *s.* The slightly convex outer surface appears to project somewhat beyond the rounded contour of the cell. The color is usually a bright reddish brown, often brightest in the anterior and marginal cells and rarely entirely faded in the posterior ones. The stigma is a homogeneous body, showing no trace of structure beyond the well-defined contour line, which is best seen in fading and moribund cells. It is normally present in all cells of the colony, and may readily be demonstrated by full illumination. The position of the stigmata in the cells is somewhat unusual, and is significant of the pronounced polarity of the organism. The customary position in other genera is adjacent to the bases of the flagella. In *Platydorina*, however, the location of the stigma is not constant with respect to the flagella, but seems rather to bear a definite relation to the form of the colony, since it lies towards the peripheral and posterior region of the cell (Fig. 1), while the flagella are centrally located and project outward in the usual manner. This relation appears not only in the marginal regions but also in the central. The physiological significance of this arrangement is not apparent, but it seems to be correlated with the pronounced polarity of the organism. *Platydorina* is positively phototactic. A miscellaneous plankton collection placed in a window with southern exposure in an aquarium six inches in diameter was, after ten minutes, quite barren of *Platydorina* except along the margin towards the window. On the other hand, this species avoids bright light. This was very evident in collections fresh from the field when examined under low power (75 diameters), a very

slight increase above a moderate illumination causing them to leave the field of view with considerable rapidity. In one case, where twenty-eight colonies were in the field when placed under the microscope, only one of them remained after an exposure of twenty-five seconds. A very slight decrease in the amount of light would invariably insure their return to the field with almost equal rapidity, the number increasing as the intensity of the illumination was decreased. It may be that the asymmetrical position and the somewhat unusual arrangement of the stigmata are connected with the pronounced phototaxis of this organism. At least, the asymmetrical position has a tendency to place the long axis of the stigma parallel to the main axis of the colony, with the outer end directed towards the source of light in negative, and away from it in positive, phototaxis.

The flagella are uniformly two in number for each cell, are similar in the same cell and in different parts of the colony, and are in the adult colony 20-25 μ in length. From the outer pole of the cell they pass through the matrix, leaving the appearance of a tube-like structure in the gelatinous substance (Fig. 4). When not in activity the flagella project beyond the sheath in a position perpendicular to the surface of the colony at the place of exit. As in other genera of this family, the flagella persist after the division of the cell to form the daughter colony, and even after the divisions are completed still provide locomotion for the maternal organism. In some instances the flagella could be seen passing through the matrix toward that cell of the daughter colony which bears the largest eye-spot.

The contractile vacuoles (Fig. 4, *c. c.*) are two in number, and are located in the peripheral layer of protoplasm, near the outer end of the cell. They lie in the outer part of the knob-shaped mass of protoplasm, upon either side of the place of origin of the flagella, being somewhat widely separated. At diastole the vacuoles of an adult colony have a diameter of 1.5-2 μ . The contraction is rhythmical, and the two vacuoles usually alternate at regular and equal intervals. At a temperature in the laboratory of 20° C. each vacuole

contracted at intervals of forty-five to fifty seconds. In rare instances the contractions of the two vacuoles were separated by unequal intervals, being almost coincident in one case observed.

The method of locomotion in *Platydorina* is similar in many respects to that of other genera of the family. The lashing of the flagella produces a forward movement of the colony and causes its rotation about the major axis, either from left over to right or from right over to left. The rounded end of the colony is uniformly directed forward in locomotion; at least no instance in which the caudal end led was noticed. The forward movement is, as a rule, accompanied by the rotation of the colony, though the amount of rotation varies somewhat with the individual, the freedom of movement, and the speed of locomotion. When locomotion is blocked by obstructions the rotation continues, as in *Pleodorina*, with frequent reversals in direction. In fact, obstruction to progress seems frequently, though not uniformly, to act as a stimulus to the reversal of the direction of rotation.

The two directions of rotation are not equally prevalent, that from right over to left having a marked predominance. Thus, of twenty-five colonies observed in motion twenty were rotating from right over to left and but five from left over to right. In another twenty-five the corresponding numbers were nineteen and six respectively. Keeping a single colony under observation for some time, it is found to rotate from right over to left about four fifths of the period and to turn in the opposite direction the balance of the time, this proportion representing the totals of the periods of rotation, while the individual periods vary greatly in length, that from left over to right lasting at times but a few seconds.

This predominance of one direction in locomotion is doubtless correlated with the torsion of the colony, whose shape is such that the rotation would necessarily be from right over to left in forward locomotion, as a result of the resistance of the water, unless, of course, there should be some disturbing factor. The immediate and most potent cause of the direc-

tion of rotation is doubtless the coördinated action of the flagella, since reversal of direction does not seem to be accompanied by any change in the direction of the torsion of the colony. The evidence upon this point is not conclusive, but repeated efforts have failed to detect any change in the form of the plate when the direction of rotation is reversed in the living and moving colony; and, again, colonies when killed suddenly have always the usual form of spiral, though some of them were moving in the reverse direction. When the usual direction of rotation is reversed, the forward motion still continues in spite of the fact that then the form of the plate favors a backward movement; the form of the colony, therefore, does not control the direction of rotation though it is correlated with the direction which predominates. The fact that the rotation from right over to left predominates also in *Pleodorina illinoisensis* and *Eudorina elegans*, where there are no structural features favoring such a predominance, suggests the possibility that the form of the colony in *Platydorina* is the result and not the cause of this predominance, and that the function of turning from right over to left predominantly preceded the structure which favors it. The organization of *Platydorina* suggests a descent from a *Eudorina*-like form, in which event the systematic series and the phylogenetic series alike afford evidence of a function arising in an organism before the structure with which it is correlated appears.

In another connection ('98) the subject of locomotion and polarity in the different genera of the *Volvocinæ* was reviewed and discussed. It will suffice, therefore, for the present to give a brief résumé of the facts. In the lower genera of the family, *Stephanosphaera* and *Gonium*, as also in *Pandorina*, the rotation seems to be indifferently to the right or left, while in *Eudorina* and especially in *Pleodorina illinoisensis* it is oftenest to the left, rotations to the right in observed cases of the latter species being to those to the left as 100 to 117-138. With respect to *Volvox* there are no data at hand. In *Platydorina*, we find by far the most pronounced predominance of one direction of rotation, the ratio in observed cases being

100 rotations from left over to right to 355 from right over to left. In this respect, then, so far as there is evidence, *Platydorina* is the most highly differentiated genus of the family.

The polarity of the lower genera, *Stephanosphaera* and *Gonium*, is likewise of the simplest form, being merely physiological, the same pole or face of the colony always leading in locomotion. In *Pandorina*, *Eudorina*, and *Volvox*, however, there is the added feature of the greater brightness of the anterior stigmata, and in *Pleodorina* the two poles are differentiated by the two types of cells as well as by the characters found in the genera just mentioned; but *Platydorina* is the only genus of the family in which polarity is expressed by the arrangement of the cells and by structural features of the envelope. In regard to polarity, also, the new genus is thus the most highly specialized member of the *Volvocineæ*.

The reproduction of *Platydorina* has been observed by me repeatedly in the past five years, but only the asexual phase has thus far been discovered. All of the cells of the organism are gonidial, each dividing to form a daughter colony. The sequence of the divisions and the position of the successive planes are of the type found in *Eudorina* and *Pleodorina*, the resemblance being so close that the figures illustrating the asexual development of *Pleodorina illinoisensis* ('98, Pl. XXXVII.) might almost be used for cleavage in *Platydorina*. There is one difference, however, for in *Platydorina* the curved plate of cells, which becomes first cup-shaped and then ellipsoidal, subsequently flattens, the cells of the two faces intercalating during the process. The daughter colony acquires the adult form, including the tails and the torsion of the plate, before it escapes from the maternal matrix, the young colonies moving about for some time in the disintegrating matrix before making their escape through the ruptured outer sheath. The secondary sheath surrounding the gonidial cell becomes the outer or primary sheath of the new colony. No stages of sexual reproduction have been seen, though the collections examined represent a considerable range of season and locality. It may be that these are to be sought upon

the bottom rather than in the superjacent strata of water where plankton collections are usually made. Aquaria about to dry up were also searched in vain for sexual stages of *Platydorina*.

The mode of development of *Platydorina* is significant of its systematic position and its relationships. The number and the original arrangement of the cells, the type of development, and the character of the envelope, all indicate that *Platydorina* is a more highly specialized form descended from some *Eudorina*-like ancestor, and that it is more closely allied to *Eudorina* than to any other existing genus.

Throughout this paper the customary term "colony" has been used to designate the organism herein described and others related to it. The wide use of the term in the literature of the subject is doubtless due to the fact that, as a rule, the organisms are composed of similar cells arranged in symmetrical form with no pronounced axial differentiation, without contact or protoplasmic connection, separated from each other by a non-living gelatinous matrix, and each capable of performing all the functions necessary for its own life and the continuance of the species. Furthermore, the destruction of individual cells does not impair the life of the other cells of the organism, for so long as a single cell remains it continues its customary activity. The use of the term colony is, however, objectionable. A number of facts militate against this conception of the organism, and the discovery of the new genus here described adds to the array. (1) The cells are not always similar, for in all forms with poles physiologically or otherwise differentiated the anterior stigmata are brighter than the posterior, and in *Pleodorina* there are two kinds of cells, the vegetative and the gonidial, the former distinctly smaller than the latter. (2) There is in all of the higher genera a well-defined physiological polarity accompanied by the difference in the anterior and posterior stigmata, and also, in *Platydorina*, by a differentiation of the poles by the arrangement of the cells and the structure of the envelope, and by the further differentiation of a transverse axis. (3) In *Pseudorina* the cells are almost in contact, and in

Volvox they are actually connected by protoplasmic processes. (4) The beginnings of histological differentiation are also evident in the cells composing the so-called colony. In *Eudorina*, according to Carter ('58), the cells are differentiated into male and female in definite regions, the male cells developing from the anterior quartet and the remainder becoming female; in *Volvox* sexual and asexual reproduction alike are limited to a few of the cells; and in *Pleodorina* the asexual process is confined to the posterior hemisphere. The cells of the organism are thus histologically and functionally differentiated in this particular in these higher genera. Although the degree of differentiation is slight, it is nevertheless appreciable. (5) In the matter of locomotion the activities of the individual cells of the organism are not independent of each other but are correlated, the flagella acting together to produce rotation, its reversal, or its cessation. The predominance of the direction in the higher genera plainly exhibits the phenomenon of correlated locomotor activities of the constituent cells.

The facts above cited emphasize the desirability of regarding each of these so-called colonial flagellates of the sub-family *Volvocine* as a unit, with an organization of its own, and not as a colony, that is, an aggregation of independent and similar cells associated merely as a result of descent from a common parental cell, the form being a matter of chance or circumstance. The group of cells as a whole, and not each of the constituent cells, is the unit of descent, of form, and of function, and the word colony can be applied to it only by the license of usage and as a matter of convenience.

Reference has been made frequently in the preceding pages to the prevalence of colonies whose symmetry has been disturbed by loss of cells. In most instances only the empty secondary sheath remains, giving no clue to the cause of the loss of its contents. In collections made in Phelps Lake, Havana, Ill., in August, 1896, however, colonies were often found which were parasitized by one of the *Sporochytriaceae*, which upon examination proves to be *Dangardia mamillata*, described by Schröder ('98) as a parasite of *Pandorina*

morum. As these infested colonies frequently showed a loss of one cell or more and exhibited all stages in the destruction of the cell, it seems probable that the loss was due to the parasite. *Eudorina elegans* and *Pandorina morum* occurred in the same collection and were similarly infested. Two additional genera, *Platydorina* and *Eudorina*, are thus to be added to the list of hosts of *Dangeardia*.

For the convenience of systematists a brief statement of the generic and specific characters of the form herein described is now given, followed by a key to the genera and species of the *Volvocineae* for the assistance of students of this interesting and not uncommon group of fresh-water organisms. Species not as yet reported, to my knowledge, from Illinois are indicated by an asterisk when found elsewhere in this continent, and by a dagger when not as yet reported from it. It is not at all improbable that all the species here listed will yet be found within this State.

Platydorina n. g.

Colony flattened, the two faces compressed so that the cells of the two sides intercalate; flagella upon both faces on alternate cells. Anterior and posterior poles of major axis differentiated by the arrangement of the cells and by the structure of the envelope. Long and short transverse axes differentiated by the flattening of the colony. Cells similar, biflagellate, each with stigma, chromatophore, and pyrenoid. Asexual reproduction by repeated divisions of all of the cells, each forming a daughter colony.

P. caudata n. sp.

Colony flattened, horse-shoe shaped, twisted about one eighth of a turn from right over to left; cells 16 or 32, arranged in a marginal row of 10 or 12 and a central area of 6 or 20; posterior end with 3 or 5 prolongations or tails formed by extension of the common outer sheath.

Known habitat, lakes and streams in central Illinois. Types in the collections of the Illinois State Laboratory of Natural History and deposited in the United States National Museum.

KEYS TO THE GENERA AND SPECIES OF THE SUBFAMILY
VOLVOCINÆ.

Cells arranged in cœnobia of definite forms varying with the species, biflagellate, with stigma and one or more chromatophores; surrounded by a gelatinous envelope whose development separates them to a greater or less degree; number not uniform, varying in the different species, often, but not always, definite. Asexual reproduction by repeated divisions of gonidial cells, which constitute the whole or only a part of the parental organism, to form daughter organisms; sexual reproduction in some species (in others unknown) by the conjugation of male and female gametes, resulting in the formation of a resting stage which later develops into a new organism.

Genera.

- | | | |
|---|---|---|
| 1 | { | Cells arranged in form of plate with flagella upon one face only. 2. |
| | | Cells arranged in spherical, ellipsoidal, or flattened colonies, flagella not confined to one face. 3. |
| 2 | { | Cells in a squarish plate, envelope closely adherent. <i>Gonium.</i> |
| | | Cells in a rounded plate, envelope swollen, oval, or spherical. <i>Stephanosphaera.</i> |
| 3 | { | Colony ellipsoidal or spherical, cells crowded together, conical, reaching towards center, outer membrane of concentric layers. <i>Paulorina.</i> |
| | | Cells not crowded together, nor reaching towards center of colony. 4. |
| 4 | { | Colonies ellipsoidal or flattened, cells uniform in size. 5. |
| | | Colonies spherical or spheroidal, or, if ellipsoidal, with small vegetative and large gonidial cells. 6. |
| 5 | { | Colony ellipsoidal or spherical, poles not differentiated by arrangement or size of cells, or by structure of envelope. <i>Eudorina.</i> |
| | | Colony flattened, horse-shoe-shaped, with poles differentiated by arrangement of cells, posterior end with tails. <i>Platydorina.</i> |

- 6 { Cells not connected by protoplasmic processes, of two sizes, smaller vegetative at anterior pole and larger gonidial at posterior. *Pleodorina*.
 Cells connected by protoplasmic processes, not markedly different in size. *Volvox*.

*Species.***Gonium.**

- { Cells, 4. *sociale* (Duj.).[†]
 Cells, 16. *pectorale* Müll.

Stephanosphæra.

Represented by a single species, characterized as follows:
 Cells 4 or 8, ovoid or spindle-shaped, with numerous processes. *pluvialis* Collm.^{*}

Pandorina.

Represented by a single species, characterized as follows:
 Cells 16 or 32, crowded, each with a single chromatophore and pyrenoid. *morum* Bory.

Eudorina.

Represented by a single species, characterized as follows:
 Cells 32, 16, or 64, similar, not crowded together, common outer membrane without marked concentric structure. *elegans* Ehrb.

Platydorina.

Represented by a single species, characterized as follows:
 Cells 16 or 32, arranged in a horse-shoe-shaped plate, those of the two faces intercalated. Posterior end with 3 or 5 tails. *caudata* Kofoid.

Pleodorina.

- { Cells 64 or 128; gonidial cells about 2-3 times the diameter of vegetative cells, which constitute about one half the total number and lie in anterior hemisphere. *californica* Shaw.
 Cells 32, rarely 16 or 64; gonidial cells not more than twice the diameter of the vegetative cells, which constitute the anterior quartet. *illinoisensis* Kofoid.

Volvox.

- Cells about 10,000 (minimum 1,500, maximum 22,000), angular, with stout connecting protoplasmic processes into which the chromatophore may enter. Diameter of colony about 700 μ (minimum 400, maximum 1,200); diameter of cell body 3-5 μ . *globator* L.
- Cells 500-1,000 (minimum 200, maximum 4,400), rounded, with slender connecting protoplasmic processes into which the chromatophore does not enter. Diameter of colony 170-850 μ ; diameter of cell body 5-8 μ . *aureus* Ehrb.

Urbana, Ill., Dec. 5, 1899.

LITERATURE CITED.

Carter, H. J.

- '58. On Fecundation in *Eudorina elegans* and *Cryptoglena*. Ann. Mag. Nat. Hist., Ser. 3, Vol. II, pp. 237-253, Pl. VIII.
- '71. Note on a Fresh-water Species of *Ceratium* from the Lake of Nynsee (Naini) Tal in Kumaon. Ann. Mag. Nat. Hist., Ser. 4, Vol. VII., pp. 229, 230.

Garman, H.

- '90. A preliminary Report on the Animals of the Mississippi Bottoms near Quincy, Illinois, in August, 1888, Part I. Bull. Ill. State Lab. Nat. Hist., Vol. III., pp. 123-184.

Kofoed, C. A.

- '98. Plankton Studies, II. On *Pleodorina illinoisensis*, a new Species from the Plankton of the Illinois River. Bull. Ill. State Lab. Nat. Hist., Vol. V., pp. 273-293, Pl. XXXVI., XXXVII.

Schröder, B.

- '98. *Daugeardia*, ein neues Chytridieen genus auf *Pandorina morum* Bory. Ber. d. deutsch. Bot. Gesellsch., Jahrg. 1898, Bd. XVI., pp. 314-321, Taf. XX.

EXPLANATION OF PLATE.

ABBREVIATIONS.

<i>A.</i> , anterior pole.	<i>p. sh.</i> , outer or primary sheath
<i>c. v.</i> , contractile vacuole.	<i>P.</i> , posterior pole.
<i>chr.</i> , chromatophore.	<i>p.</i> , outer pellicle of protoplasm.
<i>f.</i> , flagellum.	<i>pr.</i> , knob-shaped mass of protoplasm
<i>m.</i> , matrix.	<i>pyr.</i> , pyrenoid.
<i>n.</i> , nucleus.	<i>s. sh.</i> , secondary sheath.
<i>ncl.</i> , nucleolus.	<i>st.</i> , stigma.

PLATE XXXVIII.⁴

- FIG. 1. *Platydorina caudata*, face view of 32-cell colony. \times 550.
 FIG. 2. Face view of 16-cell colony. \times 628.
 FIG. 3. Edge view of 32-cell colony. \times 350.
 FIG. 4. Lateral view of one of the marginal cells. \times 1400.
 FIG. 5, a-e. Outline of the posterior ends of several deformed colonies.
 \times 280.

⁴ Figures drawn by C. A. Kofoid and inked by Miss L. M. Hart.

PLATE XXXVIII.

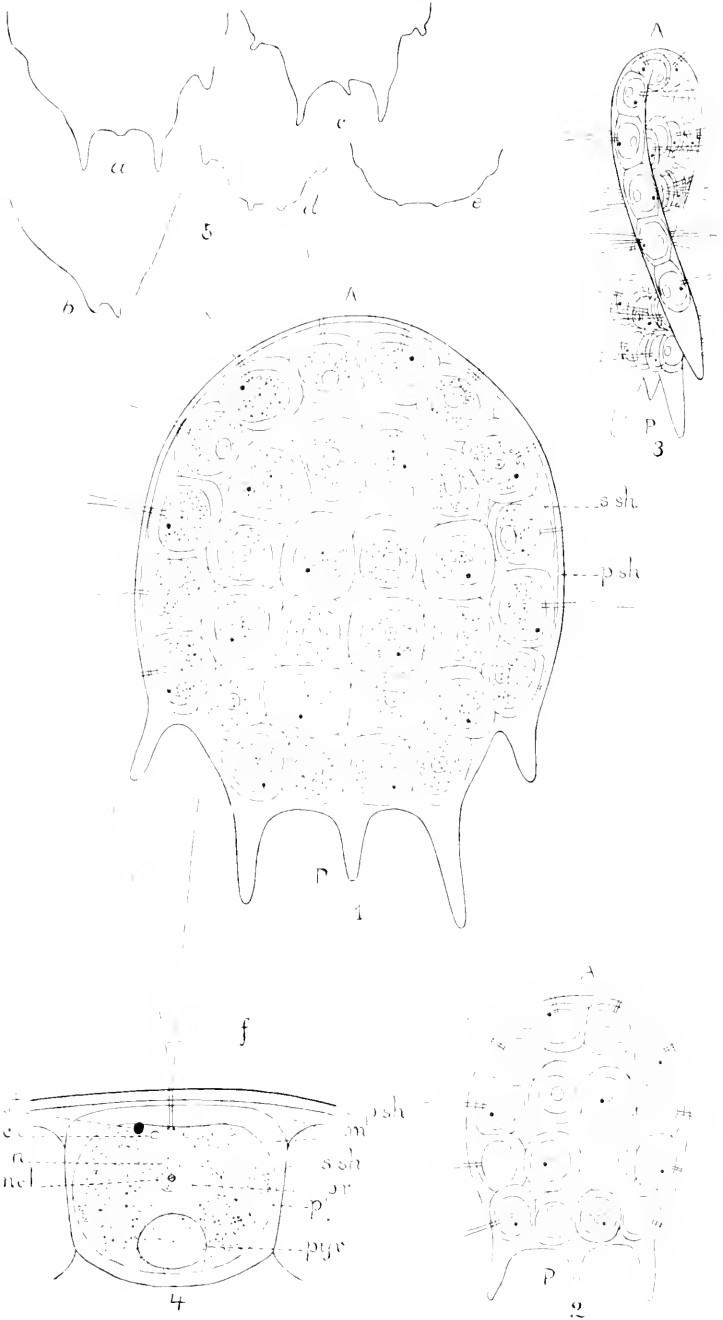

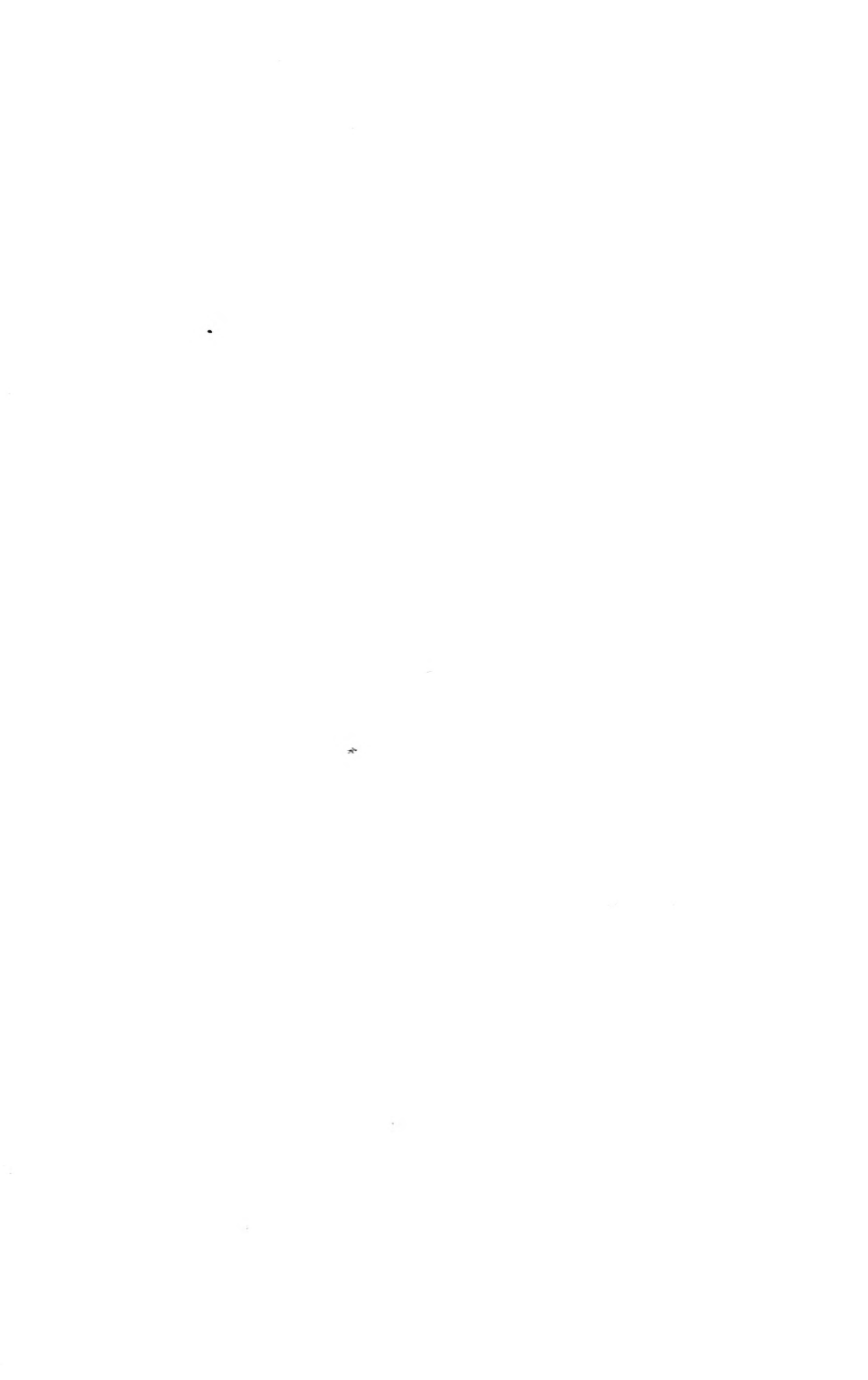

1710

BULLETIN

OF THE

ILLINOIS STATE LABORATORY

OF

NATURAL HISTORY

URBANA, ILLINOIS.

VOLUME V.

*ARTICLE X. NOTES ON SPECIES OF NORTH AMERICAN
OLIGOCHETA. III. LIST OF SPECIES FOUND IN
ILLINOIS, AND DESCRIPTIONS OF ILLINOIS TUBIFIC-
IDÆ.*

BY FRANK SMITH, A. M.

Illinois State Laboratory of Natural History.
URBANA, ILLINOIS.
March 21, 1900.

ARTICLE X.—Notes on Species of North American Oligochaeta.
III. List of Species found in Illinois, and Descriptions
of Illinois Tubificidae. By FRANK SMITH.

The study of Illinois *Oligochaeta* has been mostly confined to collections of the Illinois State Laboratory of Natural History, made near the Biological Station at Havana, Ill., and in the vicinity of the University of Illinois, at Urbana; it is probable, therefore, that several species occur in the State which are not included in the following list. Thus far no attention has been given to the *Discodrilidae* and but little to the *Enchytraeidae* of the State.

A list of the earthworms found in North America was published in 1888 by Garman in Vol. III. of this Bulletin, in which those mentioned as occurring in Illinois are three species of *Lumbricidae*, one of *Acanthodrilidae*, and one of *Pericheta* which had become established in the University greenhouses. To these must now be added seven other species, most of which have been described since Garman's paper appeared.

The species recorded have all been identified by the writer, but a considerable part of the detailed study of sections of the two new species of *Tubificidae* here described has been made by a student of the University of Illinois, Miss Ella V. Engstrom, whose careful work has been of material assistance in the preparation of this paper. The drawings for the figures were made by Miss Lydia M. Hart, Artist of the Illinois State Laboratory of Natural History.

LIST OF SPECIES.¹

Lumbricidae.

- Lumbricus herculeus* Savigny. Urbana; infrequent.
Allolobophora fetida Savigny. Urbana; abundant.
Allolobophora rosea Savigny.² Urbana; frequent.
Allolobophora profuga Rosa. Urbana; abundant.

¹ The classification of families is that adopted by Beddard in his Monograph.

² *A. mucosa* Eisen.

Allolobophora caliginosa trapezoides Dugès.¹ Urbana and Havana; abundant.

Allolobophora sp.² Urbana and Havana; frequent.

Geoscolicidae.

Sparganophilus ciscui Smith. Urbana and Havana; abundant.

Acanthodrilidae.

Diplocardia communis Garman. Urbana; abundant.

Diplocardia riparia Smith. Havana; abundant.

Diplocardia singularis Ude. Urbana and Havana; frequent.

Diplocardia sp.³ Havana; frequent.

Lumbriculidae.

Thinodrilus inconstans Smith. Havana; abundant.

Mesoporodrilus asymmetricus Smith. Havana; infrequent.

Phreoryctidae.

Phreoryctes emissarius Forbes. Urbana, infrequent; Havana, abundant.

Enchytraeidae.

Fridericia agilis Smith. Havana; abundant.

Tubificidae.

Tubifer rivalorum Lamarek. Urbana and Havana; abundant.

Limnodrilus claparidianus Ratzel. Urbana and Havana; abundant.

¹ *A. bargida* Garman, non Eisen.

² A species closely allied to *A. giesleri* Ude, but its exact relationship has not yet been determined.

³ A species closely allied to *D. verrucosa* Ude. Exact relationship not yet determined.

Rhizodrilus lacteus n. g. et n. sp. Havana; abundant locally.

Emboolocephalus multisetosus n. sp. Havana; abundant locally.

Naidomorpha.¹

Nais lacustris Linnaeus. Urbana and Havana; abundant.

Nais clinguis O. F. Müller. Urbana and Havana; abundant.

Nais lurida Timm. Havana; frequent.

Nais serpentina O. F. Müller. Havana; frequent.

Dero limosa Leydig. Havana; abundant.

Dero obtusa D'Udekem. Havana; abundant.

Dero vaga Leydig. Havana; abundant.

Dero furecata Oken. Havana; frequent.

Pristina leidy Smith. Havana; abundant.

Pristina flagellum Leydig. Havana; one specimen.

Chaetogaster limnæi v. Baer. Havana; abundant.

Chaetogaster diaphanus Gruithuisen. Urbana and Havana; abundant.

Chaetogaster diastrophus Gruithuisen. Havana; abundant.

Eolosomatidae.

Eolosoma hemprichii Ehrenberg. Urbana and Havana; frequent.

Eolosoma tenebrarum Vejdovsky. Havana; abundant.

Eolosoma sp.² Havana; abundant.

DESCRIPTIONS OF TUBIFICIDÆ.

As the first two species of *Tubificidæ* in our list are well-known European forms which have been described at length by previous writers, a brief recapitulation of some of their more important characters will suffice in this connection.

¹ But little attention has been given to the *Naidomorpha* of Urbana.

² A species with colorless integumental globules, not yet described.

Tubificer rivulorum Lamarek.

Length 25-50 mm.; number of somites 50-60. Dorsal bundles with three kinds of setae: capilliform setae, four or five per bundle anterior to clitellum, decreasing in number posteriorly and absent from the last few somites; pectinate setae, in somites anterior to the clitellum; and uncinata setae in other regions. Ventral bundles with four or five uncinata setae in anterior part and fewer posteriorly. In Illinois specimens the ventral bundles sometimes contain pectinate setae. No ventral setae on XI. Clitellum on XI and most of XII. Alimentary tract spiral-like in appearance, but with dorsal vessel on the upper side throughout its course. One pair of "hearts" in VIII. First nephridium in VII. Penis with a very short delicate chitinous sheath near tip.

Limnodrilus claparedianus Ratzel.

Length 40-70 mm.; number of somites 145-160. Setae all uncinata; five to seven per bundle in anterior part, fewer posteriorly. Clitellum on XI and XII. "Hearts" in VIII. Penis with chitinous sheath .5-1 mm. in length, which is twenty to thirty times its diameter.

Rhizodrilus lacteus n. g. et n. sp.

The species bearing this name is fairly abundant in Flag Lake, one of the larger bodies of water occurring in the bottom-lands of the Illinois River near Havana, Ill. Nothing is known of its distribution in other regions. Specimens have been found in considerable numbers among the roots of submerged or partially submerged *Sagittaria variabilis*, but thus far in no other situation. They are sexually mature in July.

The worm is rather sluggish in habit, and the body is usually contorted and in an almost inextricable tangle. It varies from 70 to 100 mm. in length in sexually mature individuals; is quite slender, varying from .4 to .6 mm. in diameter; and is largest in the region of the reproductive organs. The body is nearly white, owing to the great number

of coelomic corpuseles with which the coelomic fluid is crowded, and which are readily visible through the delicate walls. In nine specimens, apparently complete, the number of somites varies from 215 to 365, the average number being 281.

The setae, except the genital ones, are all of the ordinary uncinata, or cleft, type, and have the usual arrangement of four bundles to each somite. Anterior to the clitellum the number of setae in each bundle is usually five or six, but posterior to it, throughout the greater part of the length, the number is commonly four, while near the posterior end it is more frequently one to three. The ordinary uncinata setae are slightly enlarged at a point about one third of their length from the outer extremity. They are usually .09 to .1 mm. in length and about .005 mm. in diameter at the middle. The genital setae are of two kinds. On the ventral side of IX, in place of each bundle of ordinary setae, there is a specially modified seta (Pl. XXXIX., Fig. 4, b, and Pl. XL., Fig. 6—viewed in different planes) .12 mm. in length and about .01 mm. in diameter at its largest part, which is near the proximal end. These setae are in close relation to the openings of a pair of glands to be described later. In one specimen ventral setae of the same sort were present in X. The ventral bundles of XI each consist of four to six peculiarly shaped setae entirely different from the ventral setae of IX, the outer end of each being spatulate and rather abruptly bent (Fig. 4, c). These setae are from .14 to .16 mm. in length, and the diameter is about .009 mm. at the inner end and .006 mm. near the expanded outer end, while the outer end itself is about .01 mm. in width.

The clitellum is of the same general character as the clitellum present in other *Tubificidae*, and extends from about the middle of X to the posterior part of XII, in some individuals encroaching on XIII. It is incomplete ventrally. The prostomium is relatively large and subconical.

The brain has a slightly convex anterior margin, without any such median anterior extension as is present in some *Tubificidae*. There are two posterior lobes extending backwards, one from each side of the middle of the ventral margin.

The pharynx extends through somites II and III, and its dorsal and ventral walls are of about equal thickness. The œsophagus extends backwards into VI, where the epithelium gradually assumes the character of that of the intestine. In VII the alimentary tract increases in diameter, and the intestine may be regarded as commencing in that somite. Septal glands are present in IV and V, those of the latter somite being the smaller. Cœlomic corpuscles are very numerous in the cœlomic spaces not otherwise filled. They are spherical and mostly without granular contents, although some contain a few rather large spherical granular bodies.

The circulatory system cannot be studied in the living worm because of the opacity due to the numerous corpuscles, and our knowledge of it is chiefly derived from a study of transverse and longitudinal sections. The dorsal and ventral vessels do not divide in the anterior region of the body to form supra- and sub-intestinal trunks. In the posterior part of each of somites VII-X a pair of large lateral vessels, or "hearts," is present, connecting the dorsal and ventral vessels directly, without giving off branches to the body wall as is the case in *Ilyodrilus*. These vessels are approximately equal in the somites mentioned. The diameter of the lateral vessels of VI is only about one fifth as great as that of the corresponding vessels of VII.

The nephridia have been studied with reference to character and arrangement in but three individuals, and in these only in the anterior twenty somites. These organs first appear in VIII, but in VIII, IX, and somites posterior to XI only one nephridium is present in each somite, and that is in the left side of the body in all cases observed. In sexually mature individuals nephridia are absent in X and XI. The ventral vessel lies in the left side of the body, and is closely invested by the expanded glandular part of each nephridium, the relation between them being much like that described by Goodrich as existing in *Vermiculus pilosus* ('95, p. 258). The nephridium enlarges almost immediately behind the anterior septum, forming a mass of considerable size, through which the duct passes in a tortuous course, finally leaving the

main mass at a point a little anterior to the middle and extending to the body wall in a latero-ventral and posterior direction, opening a little anterior to the inner margin of the ventral bundle. Absence of nephridia from one side of the body in several successive somites has been frequently observed in *Naidomorpha* (Benham, '93, p. 385, and Smith, '96, p. 398) and occasionally in the *Tubificidae* (Stole, '88, p. 23). In nearly all the species of *Tubificidae* studied by this latter observer he found rare cases in which one of the nephridia of some somites was entirely degenerate, and others in which a whole row of nephridia on one side, especially in the last somites, was less developed than the row of the other side. In *Rhizodrilus lacteus* this degeneration has gone still further, so that a row of nephridia on one side is entirely wanting.

The testes are in the anterior part of X, in the usual position, and the spermiducal funnels are in the posterior part of this somite, the sperm-ducts leading from them into XI and opening on its ventral side. Following the sperm-duct backwards from the point of entrance into XI, it is at first of small diameter, with relatively thin walls, and extends posteriorly and somewhat ventrally for a distance equal to one sixth the length of the somite. Bending then abruptly toward the dorsal side of the somite it passes directly upward to the dorsal wall, and then extends in a posterior direction to a point slightly beyond the middle of the somite, where it bends toward the ventral side, opening on the antero-lateral wall of a spermiducal chamber into which opens also the sperm-duct of the other side. (Pl. XXXIX., Fig. 5.) From the point at which the sperm-duct bends towards the dorsal wall throughout the rest of its course the lumen remains of small diameter. From this same point on, for nearly its whole length, the walls are greatly thickened, so that the diameter of the duct is nearly one third that of the entire somite. A short distance from the spermiducal pore the walls become thin again. There is no enlargement of the lumen to form an atrium, nor any modification of the wall in any special region to form a prostate gland, nor is there a penis. The great diameter of the duct throughout most of its length is

due to the glandular peritoneal layer which is formed of much-elongated cells.

The spermiducal chamber, already mentioned, is formed by an invagination of the mid-ventral wall of XI posterior to the middle of the somite. Its lateral walls are connected with the body wall by muscular strands which control their movements. When the form of this chamber is normal the innermost part is transversely elongated, and the outer part has its greatest length parallel with the long axis of the body; but at times the lateral walls may be pulled far apart, the chamber thus becoming merely a ventral depression. It seems probable, therefore, that the structures are chiefly functional during copulation. The wall of the chamber includes a cuticula, continuous with that of the body wall, a layer of hypodermis but slightly modified, and a layer beneath the hypodermis which is quite thick and includes many large cells, perhaps of a glandular nature, the contents of which are usually nearly transparent, though sometimes of a granular character. The peculiar genital setae already referred to as constituting the ventral bundles of XI are borne on the posterior wall of the spermiducal chamber, into which they project.

But one sperm-sac is present. It extends from its opening in the dorsal part of septum X/XI into XV or XVI. In the somites posterior to XI it is included in the ovisac. The anterior septum of X is sometimes pushed far forward into IX, but there is no anterior sperm-sac.

Ovaries are present in the usual situation, in the anterior part of XI. The oviducal funnels and oviducts are small but fully developed, and situated between XI and XII. The single ovisac extends backwards from its opening in the dorsal part of septum XI/XII into XVII or XVIII. The ova develop in the same manner as in the majority of the *Tubificidae*, and not as in *Hyodrilus* and *Naidomorpha*.

Two spermathecae are present in the anterior part of X. Each of them has a sac, nearly spherical in outline, which communicates with the exterior through a short duct (Pl. XL, Fig. 7) opening on the anterior margin of X at a point

dorsad of a line connecting the ventral bundles of one side. The interval between the two spermathecal pores is about one fourth of the circumference of the body. The spermatozoa in the spermathecae are present in loose masses. No signs of spermatophores have as yet been found.

A pair of elongate tubular glands is present in IX, their openings being in close relation to the peculiar genital setae of that somite (Pl. XL., Fig. 6). In the specimen previously referred to as having genital setae on X similar to those on IX, a pair of such glands is also present in X, having similar relations to the setae of the somite. These glands are about equal in length to the somite, and their diameter, which is nearly uniform throughout their length, is about one eighth the diameter of the somite. The diameter of the lumen is about .01 mm. and the walls are .03 mm. in thickness. The wall consists of two layers of cells, the outermost being very thin and composed of flattened epithelial cells, while the inner layer is formed of relatively large glandular cells, largest at their distal ends, in which the nucleus is commonly situated. The openings of these glands and the associated setae are on prominent rounded elevations of the ventral wall of the somite (Pl. XL., Fig. 6) and in line with the ventral setae of adjacent somites. On the summit of these elevations the hypodermis is modified as it is in the genital papillae of some earthworms; for example, *Diplocardia* and *Allolobophora*.

For the sake of greater convenience in the comparison of *R. lacteus* with other forms I give the following summary of its more important characters:

The number of somites is 215-365.

All the setae are uncinata except the genital ones, which are of two kinds, one form in IX and the other in XI.

The clitellum extends from the middle of X to the posterior part of XII.

Celomic corpuscles are very numerous.

Supra- and sub-intestinal vessels are wanting, and the lateral vessels or "hearts," which connect the dorsal and ventral vessels in VII-X, are enlarged, nearly uniform in size, and do not give off branches to the body wall.

The nephridia closely invest the ventral vessel, and, so far as observed, but one nephridium is contained in a somite.

The sperm-ducts have no prostate gland, atrium, or penis, and open into a median spermiducal chamber on the ventral side of XI.

A pair of spermathecae is present in the anterior part of X, and the spermathecal pores are a considerable distance from each other.

A pair of elongated tubular glands is present in IX, opening in close relation with the genital setae of that somite.

No attempt has been made to distinguish between generic and specific characters, since only one species of the genus is known. From the foregoing it is apparent that *Rhizodrilus lacteus* is somewhat closely related to *Lumbriculus spiralis* of Leidy ('52a, p. 285) in respect to length, number of somites, form and character of setae, color, and habits; but as Leidy's description is entirely inadequate for the purpose of identification, and as he left no type specimens of his species, the relationship between the two forms cannot be determined. It is unfortunate that the description of a new species of *Tubificidae* so frequently involves the description of a new genus, but according to present ideas of the classification of this family the character of the species under discussion will not permit its inclusion in any existing genus. The presence of two distinct kinds of highly modified genital setae and the presence of such setae in the ninth somite distinguish this worm from all other described forms of *Tubificidae*. In the absence of distinct prostate glands and in the presence of a common spermiducal chamber it differs from most *Tubificidae* but resembles *Vermiculus*. There is a further resemblance to the latter genus in the simplicity of the longitudinal blood-vessels and in the absence of both supra- and sub-intestinal vessels, but the relation of the lateral vessels of the anterior somites to other parts is very different in the two genera. In *Vermiculus pilosus*, in II-X there is no direct communication between the dorsal and ventral vessels, the single pair of branches of the dorsal vessel in each of those somites breaking up into a capillary network in the body wall, from which

the blood is conducted to the ventral vessel through two pairs of vessels in each somite, of which the posterior pair is the larger. In *V. limosus*, recently described from Japan by Hatai ('98, p. 110), the same general relation exists between these lateral vessels and the body wall, except that there is but one pair of lateral branches of the ventral vessel in each of the somites referred to, and that there is a slight difference in the number of somites in which such vessels occur. Goodrich ('95, p. 262) regarded this condition of the circulatory system as distinguishing *Vermiculus* from all other *Tubificidae*. The circulatory system of *Ilyodrilus coccineus*, as described and figured by Stole ('88, p. 15, Tab. II., Fig. 9), seems to constitute a very interesting intermediate type between that of *Vermiculus* and such forms as *Rhizodrilus*. As Stole's paper is unfortunately written in Czech, it has been inaccessible to most students of the *Oligocheta*. Through Mr. L. F. Miskovsky, of Oberlin College, I have been so fortunate as to obtain a very careful translation of this admirable paper, and quote here that part which treats of the vascular arches of *Ilyodrilus*.

"In the following segments, i. e., in the fourth to the ninth inclusive, the dorsal artery is united with the ventral always through one pair only of lateral arteries, which issue before the posterior septum of each somite from the dorsal artery and gradually swell behind until in the last three of the named segments they assume the largest proportions, resembling thus the swelled lateral arteries (so-called hearts) which are found in the remaining genera of the *Tubificidae*. The lateral arteries here described do not, however, open simply into the ventral artery. Each one of the lateral arteries approaches closely to the lateral diameter of the body and sends several branches into the integument. The branches running through the integument form in each segment an elegant vascular network which is connected through numerous anastomoses with the plexuses of the other segments. The sanguineous fluid after coursing through this integumentary network returns into the ventral vein through two special veins, which, issuing out of the integument from the lateral

diameter of the body, after a short course, empty into the ventral vein."

Figure 9 of Plate II in Stole's paper is a diagrammatic representation of the circulatory system in the anterior part of *I. coccineus*. Through some typographical error that part of the description of plates dealing with this figure is headed *Bothrioneuron vejtdorskyanum*, and is thus somewhat confusing. A comparison of this figure with that of the corresponding organs of *Vermiculus pilosus* (Goodrich '95, Pl. XXVI., Fig. 5) and *Rhizodrilus lacteus* (Pl. XL., Fig. 8) will readily suggest a common derivation for the different types. For convenience in making such comparison Figures 9 and 10 of Plate XL. have been prepared from the figures by Goodrich and Stole.

Embolocephalus multisetosus n. sp.

Worms of a species of *Tubificidae* not hitherto described are found in great abundance in the vegetable débris at the bottom of Flag Lake, and are occasionally met with in the vegetation along the banks of the Illinois River and the bottom-land lakes in the vicinity of Havana.

Well-extended individuals are 19 to 35 mm. in length. At the time of sexual activity a few somites at the anterior end, including the reproductive organs, are much enlarged, the diameter of the worm in this region being then two and a half or three times that of the remainder of the worm. In a rather large specimen the diameter in the region of the tenth somite is .8 mm., that of the middle of the worm is .3 mm., and at a distance from the posterior end equal to one fourth the length of the body the diameter is .2 mm. The number of somites varies from 49 to 106 in specimens examined, but 75 to 80 is more common. The main part of the body is of a dark grayish color, but the posterior end is lighter and less opaque. A sheath formed in part of foreign particles cemented together envelops the anterior part of the body, making it quite opaque. It adheres very closely to the surface of the worm and is removed with great difficulty. It is wanting in the posterior part of the body, which is extended into the open water and

is, as in many *Tubificida*, the principal respiratory region. Non-retractile sense papillæ similar to those described for *Embolecephalus*, *Spirosperma*, and a few other *Tubificida*, are present in this species. They are arranged in two rows on each somite, one row coinciding with that of the setæ bundles of the somite, and the other one being usually in the plane of the septum (Pl. XXXIX., Fig. 1). A few papillæ representing a third, very incomplete, row are often present.

When a specimen is examined with a lens, one is strongly reminded of some of the marine annelids by the dense clusters of elongated setæ in the dorsal bundles. The dorsal setæ are of two kinds; long capilliform setæ, often .5 mm. in length, and palmate or comb-like setæ .16 to .18 mm. in length (Pl. XXXIX., Fig. 2, c, d.). In the anterior bundles capilliform setæ vary in number from three to fourteen per bundle. Throughout most of the remainder of the body the number is but one to three per bundle, while the last ten to twenty somites usually have no dorsal setæ whatever. The palmate setæ are regularly found in only a few anterior somites, where the number varies from one to five per bundle. In the dorsal bundles of the greater part of the body back of the first ten or twelve somites, palmate setæ are usually lacking, though occasionally one such may be found in one or more bundles posterior to the middle of the worm. The relative number of capilliform setæ and palmate setæ per bundle is extremely variable. Some individuals have setæ of the two kinds in equal numbers, while others having a relatively large number of capilliform setæ have only one to three palmate setæ per bundle. Ventral setæ, usually two in each bundle, are present in all the somites except the first, eleventh, and last. They are sigmoid, uncinatè, and slightly enlarged at a distance from the distal end about equal to one third the length of the setæ. The ventral setæ of the anterior region are longer and less strongly curved than those of the posterior part of the body (Pl. XXXIX., Fig. 2, a, b).

There is no well-developed clitellum on any of the specimens in our collection, none of which seem to be at the height of sexual activity, but in a few individuals the

hypodermis of XI is slightly modified. The prostomium and anterior somite are very sensitive and thin-walled, and at the slightest irritation are so retracted that the first setigerous somite seems to form the end of the worm.

The brain is concave posteriorly, and its anterior part is prolonged into a process on each side of the median line. The alimentary tract has no special features distinguishing it from other *Tubificidae*. The pharynx occupies somite II and part of III; the wall of the dorsal side is somewhat thicker than that of the ventral side; the transition from the oesophagus to the intestine is gradual; and chlorogogue cells appear rather abruptly in the anterior part of VI. The inner epithelium becomes like that of the intestine in the posterior part of VI, while the diameter of the alimentary tract becomes considerably enlarged in VII. Posterior to this somite there is no great change in the diameter of the intestine or in the character of its walls. The colomic corpuscles are very few in number and of irregular form.

The circulatory system cannot be studied in the living specimens, and it has proved an especially difficult task to work out its anatomy from sections. One pair of "hearts" is present in VIII, and in one specimen examined there were additional lateral vessels nearly as large in IX. The "hearts" communicate with the dorsal vessel, and no traces of a supra- or sub-intestinal vessel have been found. Anterior and posterior to the region of the reproductive organs the alimentary tract is invested by an extensive system of blood sinuses connected by a median ventral sinus or vessel, which, however, seems to have no direct connection with the ventral vessel nor to have the relations of a sub-intestinal vessel.

Paired nephridia are present in VII-IX, wanting in X-XIII, and begin again in XIV. The nephridiopores are in line with the ventral setae and a short distance in front of them.

The reproductive organs are similar in structure and arrangement to those of many other *Tubificidae*. The testes, spermatheca, and spermiducal funnels are in X, and the ovaries, sperm-ducts, and spermiducal glands in XI, on which somite are the spermiducal pores. The sperm-duct

is somewhat elongated and occasionally protrudes backward into the sperm-sac as far as the posterior part of XII. The diameter of that part of the duct nearest the funnel is very small (.01mm.), and that of its lumen not over .003 mm. The diameters of duct and lumen both gradually increase as the spermiducal gland is approached, and the course of the duct becomes more tortuous. That part of the duct to which the spermiducal gland is attached is expanded into an elongated chamber or "atrium" (Pl. XXXIX., Fig. 3), of which the diameter is about .05 mm., that of its lumen being .025 mm. Between the spermiducal gland and the pore the sperm-duct is about .03 mm. in diameter where smallest. The duct terminates in a protrusible penis, which is destitute of a chitinous sheath. The spermiducal pores are in line with the ventral setæ of adjacent somites, and also with that row of papillæ which is associated with the setæ. As before stated, there are no ventral setæ on XI. There are two median sperm-sacs, lying dorsad of the alimentary tract; an anterior one in IX, and a posterior one in XI-XIV. In some cases the latter extends into XV.

One pair of spermathecae is present in X, and in one of the sectioned specimens there is an additional spermatheca in the right side of IX, which is similar in every way to those of X except that it is slightly smaller. In the specimens examined none of the spermathecae contained any traces of spermatophores. The spermathecal duct is nearly uniform in diameter, and its length is one and a half to two times as great as the diameter of the sac. In each case observed the sac appeared like a hollow sphere with a broad invagination of one side, but whether or not this collapsed appearance is the normal one has not been determined. There seems to be no difference in the character of the wall in the different parts of the sac, and no glands have been found in connection with the spermathecal duct. The male organs are well developed in all the sectioned specimens studied, but the ovaries have not contained large ova, nor have there been any traces of ovisacs or oviducts. These specimens were collected in October, and the height of sexual activity is probably attained at some other time of the year.

The relation of the species under consideration to other *Tubificidae* cannot be finally determined in the light of our present knowledge of the anatomy of this species and of nearly related forms. In the presence of prominent non-retractile papillæ it resembles *Peloscolex*, *Spirosperma*, *Hemitubificæ*, and *Embolocephalus*. It probably is closely allied to Leidy's *Peloscolex variegatus* ('52, p. 124), but the meager description of that form and the lack of type specimens make it impossible to determine this point. The absence of a chitinous sheath about the penis distinguishes it from *Spirosperma* and *Hemitubificæ*, but there are no characters given in the description of *Embolocephalus* Randolph ('93, p. 472), which exclude it from that genus. The description includes, however, no account of the circulatory system in the anterior part of the worm nor any statement as to the presence or absence of a chitinous penis sheath. Sections of *E. plicatus* kindly sent me by Dr. Randolph furnish no evidence of the presence of this sheath in that species, but as they include none of the first eight somites it is impossible to compare the anatomy of the circulatory systems of the two species in that region. In view of the above facts I have included the Illinois species in the genus *Embolocephalus*, giving it the species name *multisetosus*. It differs from *E. retutus* in having two kinds of dorsal setæ; and from *E. plicatus* in having palmate setæ in the dorsal bundles, and in other particulars as follows: (1) In *plicatus* the dorsal bundles are said to contain usually but six capilliform setæ and three uncinæ ones, and no statement is made to indicate that there is any considerable variability in the number in different regions of the body. In *multisetosus*, however, the dorsal bundles of the anterior region each contain from eight to sixteen setæ, while in the middle of the body the number is much smaller, and the posterior somites usually have no dorsal setæ whatever. (2) The papillæ of *plicatus* are in two rows, equally distant from the septa, while in *multisetosus* one row is in the plane of the setæ and the other in the plane of the septa. The papillæ of *multisetosus* are also much larger and more conspicuous than those of *plicatus*. (3) The diameter of the lumen of the sperm-duct of *plicatus* is nearly uniform throughout, while that of *multisetosus* is several times greater in the region of the atrium than elsewhere.

LITERATURE CITED.

Beddard, F. E.

'95. A Monograph of the Order of Oligocheta. 769 pp., 5 pls.

Benham, W. B.

'93. Note on a New Species of the Genera Nais. Quart. Journ. Micr. Sci., Vol. XXXIV., pp. 383-386, Pl. XXXIII.

Garman, H.

'88. On the Anatomy and Histology of a New Earthworm (*Diplocardia communis*, gen. et sp. nov.). Bull. Ill. State Lab. Nat. Hist., Vol. III., Art. IV., pp. 45-77, Pl. I-V.

Goodrich, E. S.

'95. On the Structure of *Vermiculus pilosus*. Quart. Journ. Micr. Sci., Vol. XXXVII., Pt. 3, pp. 253-267, Pl. XXVI-XXVIII.

Hatai, S.

'98. On *Vermiculus limosus*, a New Species of Aquatic Oligocheta. Annot. Zool. Japon., Vol. II., P. IV., pp. 103-111. 5 fig.

Leidy, J.

'52. Description of two New Genera of Vermes. Proc. Acad. Nat. Sci. Phila., Vol. V., pp. 124-126.

'52a. Corrections and Additions to former Papers on Helminthology. Proc. Acad. Nat. Sci. Phila., Vol. V., pp. 284-290.

Randolph, H.

'93. Beitrag zur Kenntnis der Tubificiden. Jena. Zeitschr. f. Naturwiss., Bd. XXVI., pp. 463-476. Taf. XVII.-XIX.

Smith, F.

'96. Notes on Species of North American Oligocheta. II. Bull. Ill. State Lab. Nat. Hist., Vol. IV., Art. XIV., pp. 396-413, Pl. XXXV.-XXXVIII.

Stolc, A.

'88. Monografie Českých Tubificidů. Morfologická a Systematická Studie. Abh. Böhm. Ges. 2) VII., pp. 1-45, Tab. I-IV.

EXPLANATION OF PLATES.

ABBREVIATIONS.

<i>at.</i> , atrium.	<i>n. c.</i> , nerve cord.
<i>clit.</i> , clitellum.	<i>pr.</i> spermiducal gland.
<i>col.</i> , coelom.	<i>p. v. l. v.</i> , posterior ventral lateral vessel.
<i>d. l. v.</i> , dorsal lateral vessel.	<i>sep.</i> , septum.
<i>d. v.</i> , dorsal vessel.	<i>sp. ch.</i> , spermiducal chamber.
<i>g. p.</i> , genital papilla.	<i>sp. d.</i> , sperm-duct.
<i>g. s.</i> , genital seta.	<i>sp. th.</i> , spermatheca.
<i>g. s. gl.</i> , gland of genital seta.	<i>sp. s.</i> , sperm-sac.
<i>l. v.</i> , lateral vessel.	<i>v. n.</i> , integumental vascular network.
<i>m.</i> , muscles.	<i>v. v.</i> , ventral vessel.
<i>m. c. l. v.</i> , median ventral lateral vessel.	<i>po.</i> , spermiducal pore.

PLATE XXXIX.

Embolocephalus multisetosus.

- FIG. 1. Anterior part. × 18.
 FIG. 2. Setae. × 250.
 a and b, from ventral bundles.
 c, palmate seta from dorsal bundle.
 d, distal end of same.
 FIG. 3. Sections of sperm-duct. × 180.

Rhizodrilus lacteus.

- FIG. 4. Setae. × 250.
 a, ordinary unciniate seta.
 b, genital seta from IX.
 c, genital setae from XI.
 FIG. 5. Transverse section through spermiducal chamber. × 70.

PLATE XL.

Rhizodrilus lacteus.

- FIG. 6. Sagittal section through genital papilla, seta, and gland of IX., combined from several sections. × 180.
 FIG. 7. Transverse section through spermatheca. × 70.
 FIG. 8. Diagram of blood-vessels in VII-IX.

Hydovrilus coccineus.

- FIG. 9. Diagram of blood vessels in V-VIII., adapted from a figure by Stole.

Vermiculus pilosus.

- FIG. 10. Diagram of blood-vessels in IV-VI, from a figure by Goodrich. Those of VII-X are similar.

PLATE XXXIX.



1

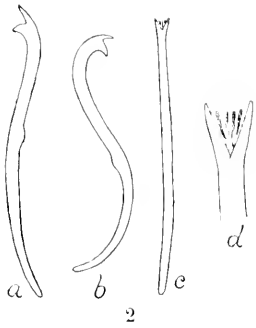

2



3

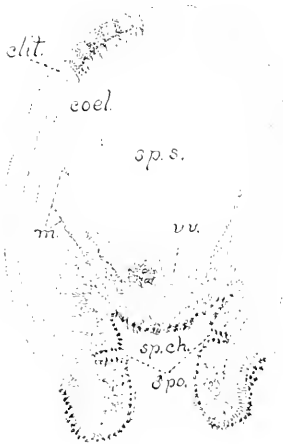

5

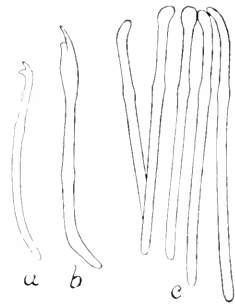

4

PLATE XL.

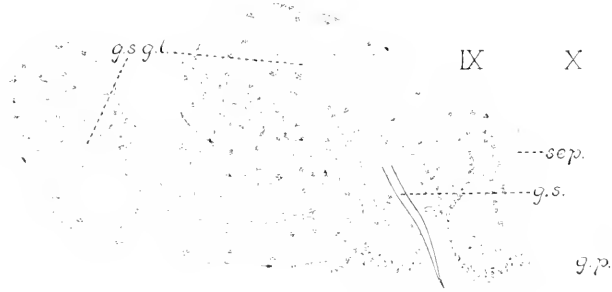

6

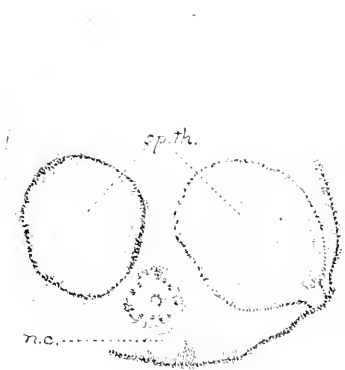

7

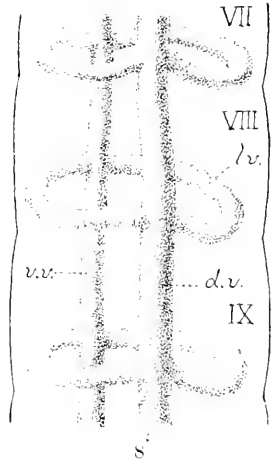

8

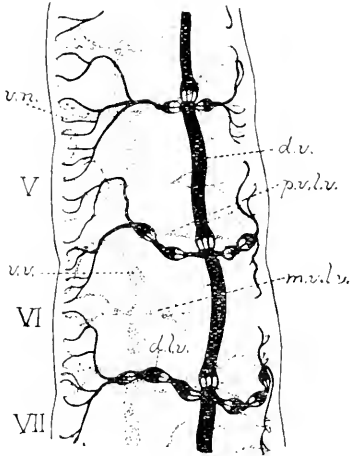

10

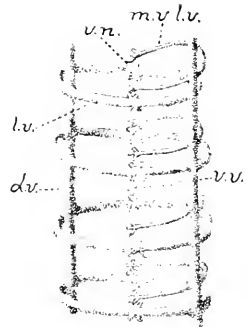

9

BULLETIN

OF THE

7710
ILLINOIS STATE LABORATORY

OF

NATURAL HISTORY

URBANA, ILLINOIS.

VOLUME V.

*ARTICLE XI. NOTES ON SPECIES OF NORTH AMERICAN
OLIGOCHÆTA. IV. ON A NEW LUMBRICULID GENUS
FROM FLORIDA, WITH ADDITIONAL NOTES ON THE
NEPHRIDIAL AND CIRCULATORY SYSTEMS OF MESO-
PORODRILUS ASYMMETRICUS SMITH.*

BY FRANK SMITH, A. M.

Assistant Professor of Zoölogy, University of Illinois.

Illinois State Laboratory of Natural History.

URBANA, ILLINOIS.

June 9, 1900.

JUN 25 1900

ARTICLE XI.—Notes on Species of North American Oligochaeta.
IV. On a New Lumbricid Genus from Florida, with
Additional Notes on the Nephridial and Circulatory Sys-
tems of *Mesopodrilus asymmetricus* Smith. BY FRANK
SMITH.

Premnodrilus palustris n. g. et n. sp.

The worms here described were found by Mr. Adolph Hempel in a decayed stump in a marsh in Polk county, Florida, in March, 1897. The collection consists of eight sexually mature individuals and a few others that are imperfect or immature. The worms were killed in corrosive sublimate and preserved in alcohol, and are in excellent condition for study. All of the facts pertaining to this species which are presented in this paper have necessarily been obtained from an examination of this preserved material.

Sexually mature specimens, well extended, average about 50 mm. in length and 1 mm. in diameter at the tenth somite, where the diameter is greatest. The body gradually decreases in diameter toward the posterior end, where the somites are relatively smaller and less distinct. The anterior end terminates in a proboscis about .15 mm. in length, its diameter being .07 mm. at the base and .035 mm. at the middle. In these preserved specimens it is bent upwards. In five apparently complete individuals the number of somites varies from 155 to 177, the average number being 167.

The clitellum extends from the anterior part of VIII to the middle of XII, and is developed on the ventral surface. The spermiducal pores are on the ventral side of IX (Pl. XLI, Fig. 1); the oviducal pores are in the groove between somites X and XI and in line with the ventral setæ; and the spermathecal pores are on the ventral side of VIII, a short distance posterior to the ventral setæ of that somite. It will be noted that the external openings of the reproductive organs are further forward by one somite than is usual in the *Lumbriculidæ*. The three sectioned specimens which form the

basis of this description show uniformity throughout in the position of the various reproductive organs.

There are four pairs of setæ in each of the setigerous somites, the interval between the dorsal and ventral bundles of one side of a somite being five sevenths as great as that between the two ventral bundles and one half as great as that between the two dorsal bundles of the same somite. The setæ are of the ordinary sigmoid form, without a cleft at the outer extremity, and are somewhat variable in length, but average about .2 mm. There are no genital setæ.

The brain consists of two lateral masses, each with its longest axis dorso-ventral, the two being connected by a stout fibrous commissure. The surface layer of each mass, except in the ventral region, consists of a thick layer of nerve cells. The commissures extending to the ventral cord and the large nerve trunks leading to the prostomium are given off from the ventral side of the lateral masses.

No marked peculiarities have been noticed in the alimentary tract. There is a gradual transition from pharynx to intestine without any well-marked intermediate œsophagus. The anterior part of the pharynx is capacious, with a dorso-ventral diameter considerably greater than the lateral one. The ventral wall of the pharynx is quite thin, while a thick glandular wall extends over the dorsal, and somewhat more than half over the lateral, region. Toward the posterior part of the pharynx the dorso-ventral diameter decreases, as does also the extent of the thin ventral wall, and in the anterior part of IV the walls are uniform in thickness and circular in outline. The thickened part of the pharyngeal wall is ciliated. Chloragogue cells first appear in the sixth somite. There are no pharyngeal glands, but there are a few deeply staining cells on some of the muscular strands in a few anterior somites. On the anterior face of septum VI/VII and on both faces of septum VII/VIII are borne rather small masses of cells which do not stain very deeply. They may correspond to the septal glands of some *Oligochaeta*. In that part of the body containing the reproductive organs the lateral diameter of the intestine is greatly reduced (Pl.

XII., Fig. 3), so that the lumen is a mere slit and the lateral walls are almost in contact.

The study of the circulatory system in this species, necessarily confined to sections of preserved material, has been incomplete and somewhat difficult. The dorsal vessel contains an extensive "Herzkörper" of nearly uniform diameter, and similar structures are present in the lateral vessels of X and of a few preceding somites. The ventral vessel forks near the septum III-IV. In each of somites II-IX a single pair of lateral vessels connects the dorsal vessel with the ventral vessel or with its anterior branches. These vessels have a somewhat tortuous course and are without chloragogue cells. The lateral vessels of VIII follow the spermathecae into IX and sometimes farther, while those of IX extend inside the sperm-sacs through a considerable number of the succeeding somites. In somite X there are two pairs of lateral vessels, the anterior pair connecting the dorsal vessel with the ventral part of an extensive plexus of vessels in the intestinal wall, and each vessel of the posterior pair extending posteriorly, through several somites, between the corresponding sperm-sac and its inclosing membrane, and connecting the dorsal and ventral vessels. In somite XI and in each succeeding one there are two similar pairs of lateral vessels, which pass from the dorsal vessel outward and downward near the body wall, and enter the intestinal plexus on the ventral side of the intestine. A short blood-vessel connects the ventral vessel with that part of the intestinal plexus into which the lateral vessels of the anterior pair open, and a similar vessel connects the ventral vessel with the corresponding region of the plexus into which open the vessels of the posterior pair. The lateral vessels of XI and of succeeding somites have caecal diverticula, and those of somites posterior to XI are invested with a layer of chloragogue cells. In each of a few somites at the posterior end there is but one pair of lateral vessels.

The nephridia are quite similar in structure to those of other members of this group, the funnel being situated in the posterior part of one somite, and the remainder of the

nephridium in the somite next following, with the nephridiopore a little anterior to the ventral setæ. On the duct, a short distance posterior to the funnel, is a compact glandular mass through which ramify minute ductules that seem to be branches of the main duct. A considerable part of the coiled region of the nephridium is in close relation to the dorsal part of the ventral vessel.

The arrangement of the nephridia is an unusual one, or, at least, different from that ordinarily assumed to exist in the *Lumbriculidæ*. In one of the sectioned specimens there are no nephridia anterior to XIV, while in the other two there are nephridia in VI–VIII but none in the following somites anterior to XII, the first nephridiopores posterior to the reproductive organs being in XII. In each of the two individuals having nephridia anterior to the reproductive organs there is but one pair so situated, and the funnels of these nephridia are in V, the nephridiopores in VI, and the main masses of the organs extend along the dorsal side of the ventral vessel into VII and VIII. Posterior to the clitellum there is ordinarily but one nephridium in each somite,—an examination of over a hundred somites affording but two exceptions to this rule,—and the more common arrangement is one in which there is on each side of the body, alternately, a single nephridium in each of several successive somites.

In the three specimens studied there is but one pair of testes in each, and these are borne on the posterior face of septum VIII IX; but since there is a pair of spermiducal funnels in VIII as well as in IX, it seems probable that there has also been at some time a pair of testes in VIII.

The spermiducal apparatus is quite complex and somewhat similar to that of *Eclipidrilus* and *Mesoporodrilus* (Eisen, '95, pp. 87–89; Smith '96, pp. 404, 405). It will perhaps be advantageous to mention briefly the principal structures composing it before giving a detailed description. As already stated, there are two pairs of spermiducal funnels, one on the posterior septum of VIII and the other similarly situated in IX (Pl. XLI., Fig. 1). The two sperm-ducts of either side extend backward to the posterior part of X or to the anterior

part of XI, where they enter the wall of the anterior end of a long sperm-reservoir which extends backward through six to eight somites. After passing through the muscular layer of this wall the ducts pass between it and the inner epithelium to the posterior end of the reservoir, where they open into its cavity. The anterior part of the reservoir is continued as a much narrowed and often considerably contorted duct, which is continuous with the inner end of a large muscular penial apparatus, the spermiducal pores being situated on the posterior part of the ventral side of IX.

We can now go a little more into detail in describing the spermiducal structures. As already stated, there are no testes in VIII, although that somite contains a pair of spermiducal funnels. The presence of an abundance of spermatozoa in the sperm-reservoir and spermathecae and of well-developed ova bears evidence that the animals had at least reached a state of sexual activity, and yet the most careful examination revealed not the slightest trace of testes in VIII. A similar condition of affairs is described by Beddard ('92, p. 196) as existing in *Sutrou alpestris*, in which species he found spermiducal funnels in IX and X but no trace of testes in the former somite. The smaller and more variable size of the funnels in VIII and the smaller diameter of their ducts—which is only a third of that of the posterior ones—may reasonably be regarded as indicating a degenerate condition, and that the complete disappearance of the testes has preceded that of the funnels and ducts.

Each of the sperm-ducts leading from the anterior funnels bends abruptly down, passing through the testis close to its attachment to the septum. It then turns posteriorly and passes into the extensive mass of muscular tissue surrounding the ventral part of the penial structure. After emerging from this mass it extends upward for a short distance alongside the muscular investment of the penis, passing along its ental surface, and then extends across to the muscular duct between the penial organ and the sperm-reservoir, which it follows to the latter organ, and, as before stated, passes between its muscular layer and inner epithelial lining, along

the ventral side of its cavity. Each of the sperm-ducts connected with the posterior funnels extends at first directly downward, and then, bending posteriorly, takes a quite direct course to the muscular duct, which it follows to the sperm-reservoir. Passing then through the muscular coat of that organ it extends posteriorly, having the same relation to the muscle layer and lining epithelium as has the duct from the anterior funnel, except that it lies on the dorsal instead of the ventral side of the cavity and opens into the chamber at a point nearly opposite the opening of the anterior duct.

Each sperm-reservoir lies in the sperm-sac of its own side, and extends from the posterior part of X or the anterior part of XI for a distance of six to eight somites. This organ has powerful muscular walls, which are not constricted by the septa, and which consist of a thin inner epithelial layer, a thin layer of circular muscle fibers, and an outer and much thicker layer of muscle fibers which are nearly longitudinal but have a somewhat spiral course. Numerous large cells, apparently glandular in nature, lie outside the reservoir, and are connected with its wall by elongated narrowed extensions which presumably function as ducts, but have not been followed beyond the superficial portion of the muscular wall. The cells are altogether similar to those figured and described by Eisen ('95, p. 88) as being numerous about the anterior end of the "storage chamber" of *Eclipidrilus frigidus*. In *Premnodrilus palustris*, however, they are more abundant near the posterior end of the chamber, and much less frequent at the anterior end. Besides these large prostate glands, following Eisen's nomenclature, there is a more or less interrupted layer of smaller cells much like those called by Eisen small prostate glands. The inner epithelium is everywhere thin and the cell walls are indistinguishable.

Throughout the greater part of its length the sperm-reservoir, exclusive of the layer of prostate cells, has a diameter of about .25 mm., that of its lumen being about .08 to .09 mm. The diameter of the reservoir diminishes more gradually toward the anterior end than toward the posterior, and the chamber tapers off into a muscular duct

about 1 mm. in length, of which the diameter is .015 to .025 mm., while that of its lumen is .005 to .010 mm. The walls of this duct include an inner epithelium, layers of circular and longitudinal muscles, and an outer layer of small, more or less isolated cells, like that already described for the sperm-reservoir. This duct is usually contorted in its course, and passes through the muscular wall of the inner end of the penial apparatus and opens into the inner end of the greatly elongated penis. There is no "prostate" nor "atrium" as in *Eclipidrilus frigidus*, and the muscular duct, which is perhaps comparable to the "bridge" of *E. frigidus*, connects the sperm-reservoir directly with the penis.

The proportions and relations of the penis in *Premnodrilus palustris* can best be understood by reference to Fig. 1, Pl. XLI. The penial apparatus includes an elongated sac lined with epithelium, continuous with the outer epithelial layer of the penis proper, and, adjacent to this, a thick layer of longitudinal muscle, outside of which is a delicate epithelium. No layer of circular fibers is developed. In a specimen in which the penis is not much protruded the penial sac extends upward and backward into the anterior part of XII, the posterior septa of IX, X, and XI being forced back with it. Strong muscular bands connect the free end of the sac with the dorsal body wall of XII-XV, the strongest band being in the posterior part of XIV. The long slender penis is inclosed by the walls of the muscular sac, but is nowhere connected with it except at its inner end. Its entire length is 1.25 mm., of which .4 mm. is protruded from the body in one of the specimens studied. Its diameter varies from .015 mm., near the tip, to .08 mm., near the point of attachment, and at the middle is about .04 mm. Its unusual length is doubtless correlated with the correspondingly long spermathecal duct, to be described later.

The lumen of that portion of the sperm-duct which forms the penis has a nearly straight course and is of small diameter, being but .005 mm. at a point midway of its length. The penis is covered superficially by an epithelial layer continuous

with that of the muscular sac inclosing it, while the lumen of the sperm-duct which passes through it is surrounded by an epithelial layer continuous at the inner end with that of the muscular duct, and at the tip with the epithelium covering the outer surface. Between these two epithelial layers is a tissue composed of elongated cells, slightly inclined to the long axis, which connect the inner and outer epithelial layers. The cells are not as closely packed as are those of muscle layers, and the tissue which they compose probably corresponds to the "fibrous tissue" which is present in the atrium of *E. frigidus*.

A pair of large elongated sperm-sacs extends backward from the posterior septum of IX through twelve to eighteen somites. A sperm-reservoir and its connecting ducts are situated in the anterior part of each, and in one specimen the spermatheca also were included in the anterior part of the sperm-sacs (Pl. XLII, Fig. 3). The posterior part of each sperm-sac is constricted by the septa, and in the specimens studied the cavities were filled with spermatozoa.

One pair of ovaries is present in the anterior part of X, and a pair of oviducal funnels is borne on the posterior septum of that somite, opening to the exterior in the groove between X and XI. Large ova were present in but one specimen and were contained in X. From the posterior part of that somite a thin sheath of cells extends backward, enveloping the sperm-sac, and including in the cavity between them the posterior pair of lateral vessels of X. The posterior limits of this sheath have been difficult to determine, and there is certainly no appreciable space between it and the posterior end of the sperm-sac, neither have any signs of ova been found within it. It may be, however, that it represents an ovisac into which ova might pass at a later stage of development.

There is one pair of spermatheca, opening on the posterior part of the ventral surface of somite VIII. These organs are unusually long and much differentiated in their structure. In two specimens they push the septum VIII/IX backwards into IX, forming contorted masses, while in the other specimen each spermatheca extends posteriorly into the corre-

sponding sperm-sac, and lies dorsad of the sperm-reservoir and parallel with it (Fig. 3), one extending into XII and the other as far as XVII. In two specimens, in which careful measurements were made, the entire length of each spermatheca was a little over 3 mm., the greatest diameter being .25 mm. The general form and proportions of these organs can be readily seen in Fig. 2.

Each spermatheca includes three distinct regions, which may be designated respectively as duct, storage region, and glandular region. The duct is about 1 mm. in length, and has comparatively thick walls, which consist chiefly of longitudinal muscle fibers. The muscular layer is thickest in the middle of the duct and gradually thins out near the beginning of the storage region. The diameter of both duct and lumen is subject to considerable variation as shown by the following measurements, which are very nearly the same for the two spermathecae most carefully studied. At a distance of .25 mm. from the pore the diameter of the duct is .1 mm. and that of the lumen .05 mm., and in this region the lining epithelium is thrown into numerous high transverse folds, which nearly fill the cavity. The diameter of the duct .4 mm. from the pore is .1 mm., while that of its lumen is reduced to .02 mm. From this point to the beginning of the storage region the diameter of the duct gradually decreases to .045 mm., while the lumen at first increases to .045 mm., next decreases to .02 mm., and then enlarges into the cavity of the storage region. The storage region is about .5 mm. in length and has a diameter of .15 mm. for the first half, then widens out to .22 mm., and is next constricted to .14 mm. where the division between the second and the third region occurs. Its walls are quite thin in the part nearest the duct, but gradually become thicker and more glandular and like those of the third region. This third, or glandular, region is about 1.85 mm. in length, and its diameter is pretty nearly uniform, varying only from .2 mm. to .25 mm., while that of its lumen varies from .12 to .18 mm. The storage region and the glandular region are not sharply differentiated, but the former is filled with spermatozoa while the latter con-

tains but few or none, and the walls of the two regions are decidedly different in structure except in the parts adjacent.

The spermathecal wall consists of outer and inner epithelial layers, in addition to which layers of muscle tissue are present in the duct. The outer epithelium is everywhere thin, and composed of flattened cells except near the middle of the duct, where this layer is considerably thickened and the cells are columnar in character. The inner epithelial layer is of moderate thickness in the duct and in the greater part of the storage region, and its cells stain quite deeply in hæmatoxylin. In the remainder of the storage region and in the glandular part this layer becomes quite thick, and is composed of columnar cells having their nuclei in the basal portion and staining only slightly in Ehrlich's hæmatoxylin. A layer of circular muscle fibers, which lies next to the inner epithelial layer and is comparatively thin, is present throughout the whole length of the duct. Between this layer and the outer epithelium there is a layer of longitudinal muscle fibers which is quite thick in the greater part of the duct, but thins out, and finally disappears in the part nearest the storage region.

From the foregoing description it is evident that *Premnodrilus palustris* belongs to that branch of the *Lambriculida* which includes the peculiar genera *Eclipidrilus* and *Mesopodrilus*. For the purpose of studying the relationships of these different forms, a more extended examination of the nephridial and circulatory systems of *Mesopodrilus asymmetricus* has been made, the results of which are next recorded.

Nephridial and Circulatory Systems of Mesopodrilus asymmetricus Smith.

In the original description of this species the only reference to the nephridia is to the effect that the first pair is in VII, and that the nephridiopores are in front of the ventral setæ (Smith '96, p. 404). A re-examination of the material studied, however, with more careful attention to the nephridia, shows that the main masses of the pair belonging to VII extend

alongside the ventral vessel into IX; that there are no other nephridia until we reach XII; and that in this somite and in each of the following ones there is but one nephridium, the order of occurrence being that common in *Premnodrilus palustris*, in which, as before stated, there is on each side of the body, alternately, a single nephridium in each of several successive somites. The asymmetry found to exist in these two species suggests that possibly the views ordinarily held as to the universality of the paired arrangement of the nephridia in the *Lumbriculidæ* may be due to the lack of a careful examination of their distribution. On the other hand, in *Thinodrilus inconstans*, in a species of *Sutroa* from Yellowstone Park, and in *Eclipidrilus frigidus*,—the only other species of *Lumbriculidæ* which have been accessible to the author for study,—the nephridia are paired.

Our knowledge of the circulatory system is necessarily incomplete, since the material for the study of this species is limited to serial sections of parts of two specimens; but it has been possible to ascertain several facts concerning it.

As in many other aquatic *Oligochæta*, branches of the vascular system are freely distributed to the wall of the intestine, taking either the form of extensive plexuses or of sinuses of considerable extent. The ventral vessel is forked near the septum V VI, and in each of somites II-V its branches are connected with the dorsal vessel by one pair of perigastric vessels.¹ In the anterior part of each of somites VI-IX a pair of lateral vessels invested by gland cells connects the ventral vessel with the dorsal part of the intestinal plexus, while in the posterior part of each, a pair of slender lateral vessels without investing gland cells and having a somewhat tortuous course connects the dorsal and ventral vessels. The relations of the lateral vessels in X are similar to those existing in VI-IX, except that the posterior vessels extend backward through several somites.

Before describing further the course of these vessels, it

¹ The terms perigastric and gastric are applied as by Eisen, who calls lateral vessels lying in the coelomic cavity perigastric, and those closely associated with the wall of the alimentary tract gastric.

becomes necessary to correct the statement made in the original description that there is but one sperm-sac (Smith '96, p. 405), for while it is true concerning the specimen of which transverse sections were made and in which the reproductive organs were somewhat degenerate, in the other specimen there are two sperm-sacs, one containing the sperm-reservoir and the greater part of the spermiducal apparatus, and the other, a considerably smaller one, belonging to the other side of the worm, containing no trace of a sperm-duct. Each of the posterior pair of lateral vessels of X extends backward into the sperm-sac of its own side, forming long loops in its course. In the specimen of which transverse sections were made and in which there is but one sperm-sac the posterior lateral vessel of X which is in the side containing the sperm-sac extends posteriorly into that organ for a distance of several somites, while the corresponding vessel of the other side extends posteriorly for a similar distance, and is closely invested by a layer of tissue which doubtless represents a degenerate sperm-sac.

In the individual most carefully studied somites XI–XVII have no perigastric vessels, but there seem to be two pairs of gastric vessels in each (Pl. XLI., Fig. 4). There is an anterior pair of lateral vessels without coeca in each of somites XVIII–XXIII, which leave the dorsal vessel as perigastric vessels but unite with the intestinal plexus instead of the ventral vessel. There is considerable variability in the positions at which these vessels enter the intestinal wall. It may be anywhere from the ventral part of the intestine to a position two thirds of the way from the ventral to the dorsal region (Fig. 5). The posterior pair of lateral vessels in each of these somites are gastric vessels. In each somite the ventral vessel is connected with the ventral part of the intestinal plexus in the two regions that are most closely related to the two pairs of lateral vessels. A considerable number of somites posterior to XXIII have not been sectioned, but of some of the posterior ones sections have been made, the most anterior of which has two pairs of perigastric vessels with coecal diverticula: an anterior pair, connecting the dorsal vessel with the ventral

part of the intestinal plexus; and a posterior pair, connecting the dorsal and ventral vessels. In several somites nearest to the posterior end, both pairs of perigastric vessels have caeca and connect the dorsal vessel with the ventral part of the intestinal plexus.

Thus far, our knowledge of the *Lumbriculidae* of North America has been limited to species collected in very restricted and widely separated regions. Two species of *Sutroa* and one of *Eclipidrilus* from California have been described by Eisen ('81, '88, '92, and '95); one species each of *Mesoporodrilus* and *Thinodrilus* from Illinois, by the writer ('95 and '96); and this paper contains the description of a species from Florida, for which still another genus name is proposed, namely, *Premnodrilus*.¹ Of these, *Thinodrilus* is much more nearly allied to *Lumbriculus* and certain other European forms than to its North American associates that have thus far become known, while *Sutroa* seems in certain particulars intermediate between the European genus *Rhyuchelmis* (Vejdovský, '76) and the peculiar group of North American *Lumbriculida* which includes *Eclipidrilus*, *Mesoporodrilus*, and *Premnodrilus*. The species included in these three genera are much more nearly related to each other, so far as the structure of their reproductive organs is concerned, than is any one of them to species of other genera of the family, and yet the differences between them seem to the writer too great to be considered as merely specific. Thus, at present, six species of North American *Lumbriculida* are known, and they have been placed in five different genera.

Such a condition of things, in which we have in a comparatively small group of animals a number of genera nearly or quite as great as the number of species, may be due to one or more of several causes; and in this case it may be owing to the fact that at present our knowledge of the *Lumbriculida* is insufficient to make it possible to determine which

¹ Leidy's descriptions of species presumably belonging to the *Lumbriculida* are inadequate and must be disregarded.

characters should be regarded as generic and which as of specific value merely. It is possible that an unusual variability in the reproductive organs exists in worms of this group, and that in a similar length of time and under similar differences of conditions there might be a greater amount of divergence in the character of these organs than there would be in worms of other groups, as, for example, the earthworms, and hence that differences which among the latter would be generic ought perhaps to be considered as only specific when found among the *Lumbriculidae*. On the other hand, it may be that species which now form the only members of the genera to which they belong, will after a time, by the discovery of other species, become types of genera which will each contain two or more species more closely related to each other than are the species now known, and thus the establishing of so many genera may be justified. In the case of the three genera last referred to, when we consider that a distance of a thousand miles intervenes between Florida and Illinois and two thousand miles between Illinois and California, and that nothing whatever is known of the *Lumbriculidae* of the intermediate regions, it seems reasonable to suppose that subsequent collections from the intervening territory may bring to light other species more nearly related to one or more of them than they are to each other. Until future collections and study shall disclose the facts, it seems best to the writer not to include in one genus species which differ so widely as do *Eclipidrilus frigidus*, *Mesoporodrilus asymmetricus*, and *Premnodrilus palustris*.

A comparison of these three species will be facilitated by the use of the following table, which includes characters that are of more or less importance from the systematic standpoint.

	<i>E. frigidus.</i>	<i>M. asymmetricus.</i>	<i>P. palustris.</i>
Setae.	Not cleft at outer extremity.	The same.	The same.
Sperm-reservoirs ("storage chambers").	One pair, extending through several somites and having thick muscular walls.	A single one, etc.	One pair, etc.
Eversible penes.	One pair in X.	A single one in X.	One pair, very long in IX.
Clitellum.	Posterior part of IX to the middle of XIV.	Middle of IX to the middle of XIII.	Anterior part of VIII to middle of XII.
Prostomium.	Without proboscis.	With proboscis.	With proboscis.
Anterior nephridia.	One pair in each of somites IV-VIII.	One pair in VII, extending into VIII and IX; pores in VII.	Absent, or one pair in VI, extending into VII and VIII; pores in VI.
Posterior nephridia.	Paired, beginning in XIII.	Single, beginning in XII.	Single, beginning in XII or XIV.
Testes.	Two pairs—in IX and X.	one pair—in X.	One pair—in IX.
Spermiducal funnels.	Two pairs—in IX and X.	A single one—in X.	Two pairs—in VIII and IX.
Prostate and atrium.	Differentiated parts of sperm-duct connected with sperm-reservoir by narrowed part of sperm-duct ("bridge") having muscular walls.	The same.	Absent.
Spermiducal pores.	A pair, posterior part of X.	One; on median line in posterior part of X.	A pair; posterior part of IX.
Sperm-sacs.	One pair, extending back from IX thro' several somites; not inclosing sperm-reservoirs.	One pair, extending back from X thro' several somites; small one with no corresponding sperm-duct, and larger one inclosing sperm-reservoir.	One pair, extending back from IX thro' several somites; inclosing sperm-reservoirs.
Ovaries.	One pair—in XI.	One pair—in XI.	One pair—in X.
Oviducal pores.	Anterior part of XII.	XI-XII.	X-XI.
Spermatheca.	One pair, in IX.	Two; in IX, on same side of somite, one posterior to the other.	One pair; in VIII, of unusual length.
Spermathecal pores.	Posterior to ventral seta of IX.	On mid ventral line of IX, one behind the other.	Posterior to ventral seta of VIII.

The principal features of the circulatory system of *M. asymmetricus* and of that of *P. palustris* having already been described at length in this paper, it has seemed unnecessary to tabulate the characters of this system for all three genera, and, instead, a summary from Eisen's description of *E. frigidus* ('81, p. 3) is subjoined.

There is in *E. frigidus* but one pair of lateral vessels in each of somites I-IX, and they are perigastric, connecting the dorsal and ventral vessels, those of IX and X extending posteriorly through several somites in connection with the spermiducal organs. A considerable number of somites following X contain only gastric vessels, of which there is but one pair in each somite. Each of about thirty posterior somites contains two pairs of perigastric vessels, which are connected with the dorsal vessel and end blindly in the coelomic cavity, all being short, and all more or less imperfectly forked or branched. There are no gastric vessels in these somites.

An examination of the foregoing table shows that sperm-reservoirs ("storage chambers") are present in all three genera. These are specially modified regions of the spermducts, which are found in no other members of the family. Other characters common to the three genera, but not so distinctive, are the simple setae, the eversible penes, and the great extent of the sperm-sacs. These four characters taken together may be regarded as distinguishing the subfamily *Eclipidrilinae* from other *Lumbricul. s. s.*. As the three included genera contain but one species each, the definition of genera and species is not attempted.

E. frigidus is distinguished from the other two members of the subfamily by the absence of a prostomium and by the presence of (1) several pairs of nephridia anterior to the reproductive organs, (2) paired nephridia posterior to XII, (3) but one pair of lateral vessels in each somite—excepting thirty or more posterior ones in which are two pairs of perigastrics ending blindly in the coelomic cavity, (4) two pairs of testes, (5) paired spermiducal pores on X, (6) paired spermathecae and spermathecal pores in IX, and (7) paired

oviducal pores in the anterior part of XII. These differences seem sufficient to warrant the recognition of the species as generically distinct from the other two.

M. asymmetricus and *P. palustris* are more closely related to each other than is either of them to *E. frigidus*. They, alike, have (1) a prostomium, (2) but one pair of nephridia anterior to the reproductive organs, (3) unpaired nephridia posterior to XII, (4) one pair of testes, (5) two pairs of lateral vessels in each of the somites posterior to X, and (6) no perigastrics ending blindly in the cœlom. They differ from each other in several important respects, as follows: (1) in the position of the anterior nephridia, (2) in the position of all the reproductive organs, (3) in the number of sperm-ducts and spermiducal funnels, (4) in that the prostate and atrium of *M. asymmetricus* seem to be replaced in *P. palustris* by a greatly developed penial apparatus, (5) in the position of the spermiducal pores, (6) in the symmetry or asymmetry of the sperm-sacs, (7) in the structure and proportions of the spermatheca, (8) in the position of the spermathecal pores, and (9), in a marked manner, in the relations of the lateral vessels. As already intimated, only future collections and study can make it possible to determine whether these differences ought to be regarded as generic or as merely specific; but, all things considered, it seems the wiser plan at present to regard the two species as generically distinct.

The writer takes this opportunity to acknowledge his obligations to Mr. Hempel for his kindness in obtaining the specimens of the new species described; to Dr. Gustav Eisen for several specimens of *Eelipidrilus*; and to Prof. S. A. Forbes for the opportunity to study a species of *Satrania* collected by him in Yellowstone Park. The drawings for the figures were made by Miss Lydia M. Hart, Artist of the Illinois State Laboratory of Natural History.

University of Illinois, May 19, 1900.

LITERATURE CITED.

Beddard, F. E.

- '92. A Contribution to the Anatomy of *Sutroa*. Trans. Roy. Soc. Edinb., Vol. XXXVII. Pt. 1, No. 13, pp. 195-202. 1 pl.

Eisen, G.

- '81. Eclipidrilida; and their Anatomy. A New Family of the Lini-
colide Oligochata. Nova Act. Reg. Soc. Upsala, III., pp. 1-10. 2 pls.
- '88. On the Anatomy of *Sutroa rostrata*, a New Annelid of the
Family Lumbriculina. Mem. Calif. Acad. Sci., Vol. II., No. 1, pp.
1-8. 2 pls.
- '92. Anatomical Notes on *Sutroa alpestris*, a New Lumbriculide
Oligochate from Sierra Nevada, California. Zool., Vol. II., pp.
321-334. Pl. XIV.-XVI.
- '95. Pacific Coast Oligochata, I. Mem. Calif. Acad. Sci., Vol. II.,
No. 4, pp. 63-90. Pl. XXX.-XLV.

Smith, F.

- '95. Notes on Species of North American Oligochata. Bull. Ill. State
Lab. Nat. Hist., Vol. IV., Art. VIII., pp. 285-297.
- '96. Notes on Species of North American Oligochata. II. Bull. Ill.
State Lab. Nat. Hist., Vol. IV., Art. XIV., pp. 396-413. Pl. XXXV.
XXXVIII.

Vejdovský, F.

- '76. Anatomische Studien an *Rhynchelmis Limosella* Hoffm. (*Euaxes*
filirostris Grube). Zeit. f. wiss. zool., Bd. XXVII., 3 Heft, pp. 332-
361, Taf. XXI-XXIV.

PLATE XII.

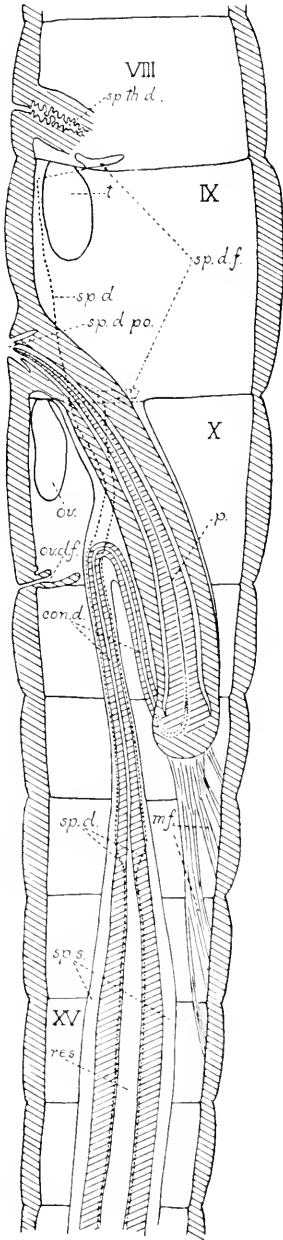

1

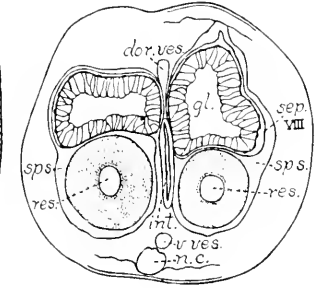

3

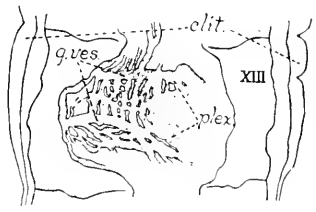

4

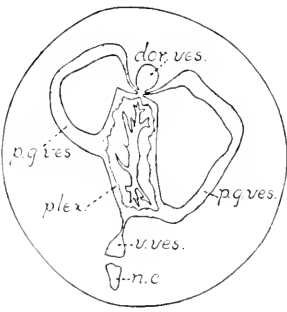

5

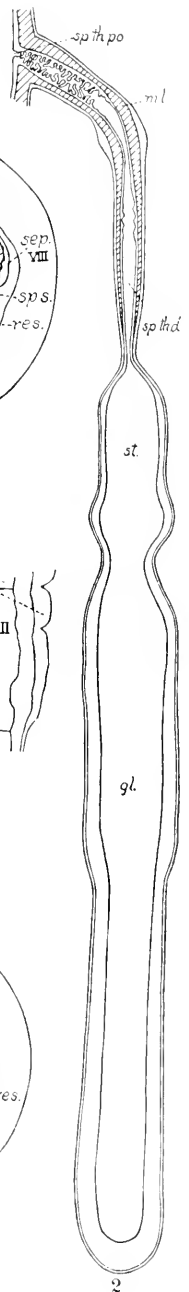

2

EXPLANATION OF PLATES.

ABBREVIATIONS.

<i>con. d.</i> , duct connecting reservoir and terminal portion of penial apparatus.	<i>p.</i> , penis.
<i>clit.</i> , clitellum.	<i>plex.</i> , intestinal plexus.
<i>dor. res.</i> , dorsal vessel.	<i>p. g. res.</i> , perigastric vessel.
<i>gl.</i> , glandular region of sperm- atheca.	<i>res.</i> , sperm-reservoir.
<i>g. res.</i> , gastric vessel.	<i>sep. VIII.</i> , septum of VIII.
<i>int.</i> , intestine.	<i>sp. d.</i> , sperm-duct.
<i>m. f.</i> , muscular fibers.	<i>sp. d. f.</i> , spermiducal funnel.
<i>m. l.</i> , muscular layer of sperm- athecal duct.	<i>sp. d. po.</i> , spermiducal pore.
<i>n. c.</i> , nerve cord.	<i>sp. s.</i> , sperm-sac.
<i>ov.</i> , ovary.	<i>sp. th. d.</i> , spermathecal duct.
<i>ov. d. f.</i> , oviducal funnel.	<i>sp. th. po.</i> , spermathecal pore.
	<i>st.</i> , storage region of sperm atheca.
	<i>t.</i> , testis.
	<i>v. res.</i> , ventral vessel.

PLATE XLI.

Premnodrilus palustris.

FIG. 1. A diagrammatic representation of a part of the reproductive organs. $\times 35$.

FIG. 2. A diagrammatic longitudinal section of a spermatheca, reconstructed from a series of sections. $\times 50$.

FIG. 3. A transverse section of XI, from a specimen in which the posterior parts of the spermatheca were included within the sperm-sacs. $\times 45$.

Mesoporodrilus asymmetricus.

FIG. 4. From a longitudinal section through XIII, showing a part of the circulatory system. $\times 85$.

FIG. 5. A part of the circulatory system in XXI, composed from several transverse sections. $\times 75$.



1901
7710
BULLETIN

OF THE

ILLINOIS STATE LABORATORY

OF

NATURAL HISTORY

URBANA, ILLINOIS.

VOLUME V.

ARTICLE XII. THE HIRUDINEA OF ILLINOIS.

By J. PERCY MOORE.

Illinois State Laboratory of Natural History
URBANA, ILLINOIS.
February, 1901.

ARTICLE XII.—*The Hirudinea of Illinois.* BY J. PERCY MOORE.

This paper is a partial descriptive catalogue of the leech fauna of Illinois. It is founded on collections gathered from time to time during the past twenty-five years by the Illinois State Laboratory under the direction of Prof. S. A. Forbes, of which material by far the most important part, as regards both number of species and individuals and state of preservation, is that taken by Prof. Frank Smith and other members of the staff of the Illinois Biological Station. For the opportunity of studying this material I am indebted to the interest and courtesy of Professors Forbes and Smith. No doubt other species occur in this region; indeed several others have already been recorded from the State.

No general morphological questions are discussed herein, though the specific descriptions include some evidence pointing to several generalizations of fact and theory which will be evident to the reader. The nomenclature of somites and annuli used, is that suggested in two recent papers (Moore '98 and 1900). Some differences (in the enumeration of somites of certain species) between this paper and the earlier one just mentioned are due to the recognition of an additional somite in the preocular lobe, as pointed out by Apathy ('88) and Whitman ('92), and the adoption of the neuromeric standard for the determination of somite limits as maintained by Castle (1900) and Moore (1900). A sharp distinction has not always been made between the different kinds of cutaneous sense organs, unless such distinctions are readily discernible in surface views. Eyes are described as single if they appear so in surface views, even though sections show them to be compound. In the figures the pigment cups alone of the eyes are exhibited, so that in some cases they are indicated in somites different from those which furnish their sensory cells. In fact, with very few exceptions, the descriptions have purposely been restricted to such features as are

visible under a good dissecting lens, though nearly all of the species have been sectioned and the distribution of sensillæ, etc., verified in that way. It has also been thought best to omit full synonymical tables (partly because of the doubt which attaches to some descriptions) and to include just sufficient names to connect the species under consideration with the previous descriptive literature. Blanchard's opinion has been followed with regard to the names of European forms. The order in which the species are considered does not express the writer's view of their relationships. The brief notes on habits are the results of observations made chiefly in the neighborhood of Philadelphia, where most of the species occur.

GLOSSIPHONIDÆ.

PLACOBDELLA BLANCHARD.

Placobdella parasitica (SAY).

Hirudo parasitica Say ('24).

Diagnosis.—Somites I and II are included in the preocular lobe, which may or may not exhibit a furrow separating them; one pair of small pigmented eyes on the large anterior annulus of III; the furrow $Va\ 1/a\ 2$ is much less distinct than $Va\ 2/a\ 3$; cutaneous warts and papillæ are numerous but low and often inconspicuous, and the median series is feebly developed; the epididymes and ducti ejaculatorii form a close coil chiefly confined to somite XI.

General Description.—This tortoise leech reaches a large size, occasionally attaining a length in extension of more than four inches. Such huge individuals are, however, rare, and the ordinary examples are seldom more than one half that size. In the resting state the outline is rather broadly oval, the anterior ends being only slightly less broadly rounded than the posterior. The body is depressed, with sharp margins and gently convex dorsum. When fully extended—and the capacity for extension is very great—the

body is widest near the posterior end and very slender anteriorly. Under such circumstances the head may be much wider than the constricted region immediately following it and has a somewhat cordate form.

The dorsal surface is provided with numerous sensory papillæ or cutaneous warts (Pl. XLII., Fig. 4). Except toward the margins, where they are arranged somewhat in two rows, they form a single series across each annulus. On many specimens none of the papillæ are at all conspicuously elevated, and the surface may appear quite smooth; in others each annulus bears from ten to twenty quite large warts which in general correspond in position with the larger warts of *P. rugosa*, but have very different proportions. The median series, so prominent in the latter, is in this species almost obsolete. The largest and most constant are those which overlook the dorso-lateral sensillæ. In all cases they are low, smooth, and rounded, and seldom bear more than a single sense organ; never a rough rosette-like aggregation at the summit.

The shape of the head differs much according to conditions of contraction and extension. Generally in the larger individuals it partakes of the even outline of the body and is broadly rounded anteriorly. In the younger specimens, especially in extension, it is somewhat expanded beyond a neck-like constriction, and the preocular lobe is somewhat sharply pointed. In such, also, the annuli are very clearly differentiated, and in a few cases the preocular lobe, which is generally simple, is distinctly subdivided into two rings (Pl. XLII., Fig. 1).

A single pair of eyes—they are really compound—(Pl. XLII., Fig. 1), frequently united in a common pigment spot, is situated on the posterior part of the second (occasionally the third) distinct annulus. Then follow a short annulus, a very large one, again a distinct short one, which forms the posterior rim of the sucker below, and then two imperfectly separated annuli V ($a_1 + a_2$) which completely unite ventrally to constitute the postoral ring. On the ventral surface of the sucker and lip most of these furrows may be readily

recognized, and under some conditions are very deep. The mouth is relatively small, and placed far forward on a median thickening of the rim of the sucker beneath the preocular lobe.

There is no distinct clitellum, and the gonopores have the usual glossiphonid position of XI/XII for the male and XII α 2/ α 3 for the female. The nephridial openings, of which there are 16 pairs, are situated on low papillæ a little anterior to the middle of the annulus α 2 on somites VIII to XXIII.

Compared with *P. rugosa* the posterior sucker is relatively large, its anterior margin reaching to XXII and the posterior largely free. It is circular, flat, and smooth. The anus is large and at XXVII/XXVIII.

Annuli and Somites (Pl. XLII., Fig. 1).—The annulation of this species is especially interesting and suggestive, inasmuch as it presents the strongest kind of confirmation of the comparison recently made (Moore, 1900) between the biannulate somite of *Microbdella* and the triannulate of the glossiphonids. Even in the largest specimens, and more or less obviously in all parts of the body, the annuli α 1 and α 2 are evidently more closely associated than are α 2 and α 3. In young examples and toward the extremities of the body, the neuromeric limits of the somites and the more primitive relations of their component annuli become extremely clear. The gradations between the biannulate and the triannulate types are so gentle that the exact number of complete somites cannot be definitely stated; it is impossible to decide just where the biannulate type ends and the triannulate begins. Of course this is more or less true of many leeches, but one can usually rest satisfied with a decision that a particular furrow is to be described as incipient or as complete. Not so, however, with this species. The different values of these furrows have, however, not been brought out in the plate.

I and II are preocular and are rarely separated by a recognizable furrow. In some cases the furrow II/III is very faint. At least one pair of metameric sensillæ are constantly

discernible; the others are obscure and must be sought for in sections.

III is biannulate. The first annulus is large and generally divided by an incipient cross-furrow, posterior to which are the eyes and a full set of metameric sensillae. The second annulus ($a\ 3$) is smaller, and loses its individuality at the margins.

IV is also biannulate, the annulus ($a\ 1 + a\ 2$) being very large, but sometimes scarcely more visibly divided than its preceding homologue. All of the four pairs of sensillae except the dorso-median are very distinct. This somite forms most of the lateral margins of the sucker, and its posterior ring contracts suddenly and sweeps caudad and mesiad as the narrow posterior ventral rim of the latter.

V. When the head is expanded as described above, this somite forms its posterior limit. The furrow $a\ 1/a\ 2$ is more evident than in somite IV, but $a\ 1$ and $a\ 2$ together may still be regarded as a single large and incompletely divided annulus. In no case does this furrow extend beyond the margins of the body, so that the ventral surface of the annulus is entirely undivided. The dorsal metameric sensillae occupy the posterior constituent ($a\ 2$). The small annulus $a\ 3$ is a trifle more than half the length of the large one, and the furrow $a\ 2/a\ 3$ is very much deeper and more distinct than $a\ 1/a\ 2$, though somewhat less so than V/VI; it is also fully developed ventrally.

VI may be provisionally and arbitrarily regarded as complete, but even in this somite the furrow $a\ 1/a\ 2$ is dorsally much less obvious than $a\ 2/a\ 3$ and becomes on the ventral side very faint, and in small specimens especially obsolete. These two potential annuli are also smaller and more intimately associated on the ventral than the dorsal surface. Viewed from either above or below the marginal curvatures of $a\ 1$ and $a\ 2$ are more homogeneous and the emarginations much less deep and abrupt than between $a\ 2$ and $a\ 3$, thus further indicating the closer growth relations of the former two.

Much the same conditions prevail in succeeding somites,

but become gradually less and less obvious as $a 1$ becomes relatively larger and more completely dissociated from $a 2$. At the same time all of the furrows and the emarginations become more uniform; but in some specimens of large size and in a great many of the smaller ones the intersomitic furrows remain more distinct and $a 1/a 2$ less distinct for the entire length of the body, and especially is this so on the ventral surface. The external limits of the somites are often quite as distinctly indicated as in *Microbdella*.

On the fully developed somites of the middle region $a 3$ is always the largest annulus (Pl. XLII., Fig. 4), but, except in the posterior somites of large individuals, there is no indication of further subdivision into $b 5$ and $b 6$. Anteriorly, and especially in young individuals, $a 2$ is longer than $a 1$, but in the middle region it is only equal to or slightly less than this. Unlike *P. rugosa* this relative size of the annuli is the same ventrally and dorsally, and the ventral furrows are either exactly continuous with the dorsal or all are slightly and equally in advance of them at the margins.

At the posterior end, somite XXIII is triannulate above; but below the furrow $a 1/a 2$ becomes more or less reduced. Dorsally the marginal curvatures and emarginations present the features described for the anterior end, and $a 3$ is slightly shorter than $a 1$.

XXIV. Although the annulus $a 3$ unites with $a 2$ mesially and $a 1$ remains distinct for its entire width, contrary to the relative disposition of these annuli anteriorly, the marginal curvatures and emarginations still associate $a 2$ more closely with its predecessor than with its successor. Marginally, at least, $a 1$ is the largest component. On the ventral side all three annuli unite more or less completely into one.

XXV is very incomplete; $a 1$ and $a 2$ are inseparable and $a 3$ is distinct only marginally. XXVI is still more faintly biannulate at the margins or even entirely unianulate. XXVII is unianulate.

Reproductive Organs.—The six pairs of testes lie in the posterior parts of somites XIII to XVIII, extending somewhat into the succeeding somite in each case. The vasa

deferentia are ventrad and laterad of the testes. A slightly enlarged coiled region of the ducts in somite XI corresponds to the epididymes and ducti ejaculatorii, which latter become constricted before opening into the somewhat enlarged prostate cornua. The latter are quite distinct from one another except where they join beneath the nerve cord at the small bursa. There is no true muscular atrium.

Alimentary Canal.—The protrusible pharynx is very slender and when at rest reaches into somite X, where at its base it receives the pair of common ducts of the pharyngeal glands. There are two of these much lobulated glands on each side. The larger one extends by the side of the pharynx from a point opposite to the female pore in XII to the middle of IX. The main duct arises in this lobe at the junction of its anterior and middle thirds. The second gland is smaller. Beginning in a short duct which joins the middle of the principal one, it extends forward, dipping beneath the pharynx, as far as the anterior end of the main gland, where it emerges from beneath the pharynx and continues forward a short distance. Very frequently, but apparently not invariably, a median annectant lobe joins the lateral halves across the ventral face of the pharynx.

The lateral caeca are exceedingly well developed and their numerous lateral divisions reach almost to the margins of the body. Six pairs correspond very nearly to as many somites (XIII to XVIII). Except the first, they are arranged as a series of overlapping chevrons with the angles directed posteriorly. A seventh much larger pair of caeca arises in XIX and continues backward parallel with the intestine to about XXIII. The intestine bears four pairs of long simple caeca which are directed laterad dorsal to the last described.

Color.—*Placobdella parasitica* is very richly colored. On the dorsal surface the ground color of brown, greenish brown, or olive green is variously spotted, striped, and blotched with bright yellow, which replaces the ground color more or less extensively. Two specimens entirely alike can scarcely be found, so that a description applicable to all cannot easily be framed in a few words. The following, however, probably

includes the most essential features: The preocular region is very light colored, with a bright orange spot, sometimes including the eyes. The light yellow areas are chiefly confined to a median-longitudinal stripe, to marginal spots, and to a pair of series of spots or blotches between these two. Sometimes the median band is continuous for the whole length, sometimes its middle part disappears, and sometimes small remnants of it remain at the ends only. It is of very irregular width, alternately expanding widely at intervals of about three somites and contracting between. The marginal spots are generally very regular, of somewhat triangular shape, and extend over the two annuli which lie between the successive neural annuli, the latter being dark colored at the margins. It is only at the ends of the body that they suffer modification. The intermediate series are the most variable. They may be formed of small spots including the dorso-lateral sensille, and occurring on the neural-annuli of every somite or only on every second or third somite; they may extend over *a* 3 as well as *a* 2 or they may become large irregular blotches reduced in number and extending over several somites; they may coalesce more or less into irregular longitudinal stripes which are likely to be constricted on *a* 1; and they may unite in various ways with the marginal spots or with the median band. The ground color may greatly predominate or almost disappear.

Habits.—This very common leech is found most frequently adhering to the plastron or naked parts of the skin of various species of turtles, to which it clings very tenaciously. In the early spring, before and during the period of production of spermatophores and oviposition, they feed eagerly and gorge themselves with blood. Like other species of similar habit they not infrequently kill their host by thus draining its blood. At other seasons they may be kept for months without food. Not infrequently this species is also found on floating wood in ponds and ditches or under stones in streams, where it feeds on small oligochaetes, etc.

Placobdella rugosa (Verrill).

Clepsine ornata var. *rugosa* Verrill (74).

Diagnosis.—Somites I and II distinctly and completely separated, usually strictly uniamulate; the single pair of eyes very close together on the posterior part of the large annulus of III; the furrow $V a 1/a 2$ quite as distinct on the dorsal side as $V a 2/a 3$; cutaneous papillæ numerous, mostly very large and rough and the median series very conspicuous; reproductive organs essentially as in *P. parasitica*.

General Description.—Although reaching a large size the largest individuals probably do not equal the largest of *P. parasitica*. Generally the length is from one to two inches. When resting this is the broadest and flattest of our leeches, the whole body being excessively depressed and foliaceous. A living individual in this state measures twenty-two millimeters long by fourteen broad. Incapable of the great degree of extension possible to *P. parasitica* it never becomes very slender.

The integuments have a peculiar translucent appearance, quite different from the opacity of *P. parasitica*. The whole dorsal surface of the body is exceedingly rough, in large living examples being clothed with a veritable forest of papillæ from which the eye readily picks out three longitudinal series of more prominent ones, conspicuous not only because of their large size but because of the regularity and constancy of their occurrence. One of these is median, the others about half-way to the margin. Toward the anterior end they become smaller and fewer; at the posterior, the median series ceases and several very prominent papillæ appear in a short series on each side of the median line. Further details are given below under the description of a typical somite.

Under all conditions of contraction or extension the anterior sucker partakes of the regular curvature of the body and never appears as an appreciably expanded disc. In preserved specimens it is deeply concave, with a high but thin posterior margin formed by IV, and thicker lateral margins. Anteriorly the preocular lobe is rather narrow and more or less inrolled

ventrally, where it is continuous with a thick rounded ridge which extends to about the middle of the sucker and ends at a deep curved furrow continuous laterally with III/IV. The mouth is a minute pore placed near the anterior end of the ridge beneath the overhanging preocular lobe. Metameric sensillae on the preocular region have not been detected in surface view, though they can be demonstrated readily enough in sections. The eyes are essentially as in *P. parasitica*.

No clitellum has been found. The male sex pore is at XI/XII and the female at XII a_2/a_3 , but a_3 is enlarged mesially and pushes forward into an emargination in a_2 , so that the female pore generally lies rather more within the latter. The male orifice is the larger and is surrounded by more or less prominent rugosities. The most anterior nephridial openings which have been detected are on VIII, the last on XXIII.

Although of smaller size than in *P. parasitica* the posterior sucker is rather large and has a longitudinal diameter slightly exceeding the transverse. It extends anteriorly to XXIII. The entire free dorsal surface bears papillae which are numerous and rough on the posterior exposed part, where four to six radiating rows are larger than the others. Anus XXVII/XXVIII.

Annuli and Somites (Pl. XLII., Fig 2).—I and II constitute the preocular lobe.

III is biannulate, with the large anterior ring very faintly divided by an incipient cross-furrow, posterior to which are the closely approximated eyes, two pairs of metameric sensillae, and one pair of warts which apparently belong to the dorso-lateral series. The second annulus bears a full set of the characteristic papillae or warts, but they are of very small size.

IV differs from III dorsally in that a_1 is more distinctly differentiated from a_2 by a furrow which is always distinct marginally but may disappear mesially. The anterior annulus (a_1) thus indicated is smaller than a_2 , and bears no papillae except in the case of two exceptionally rough individuals from Tinicum Island, near Philadelphia. The a_2 constituent bears all of the dorsal sensillae except the dorso-

median and the supra-marginal, and the more characteristic papillæ belonging to this ring. $A\ 3$ is about half the length of the larger double annulus, bears its characteristic papillæ, and forms the margin of the posterior rim of the sucker.

V is triannulate dorsally, $a\ 2$ is slightly wider than $a\ 3$, and the latter than $a\ 1$, but all furrows are equally well developed, until at the margin $a\ 1/a\ 2$ suddenly disappears, leaving two ventral annuli of approximately equal size.

Eighteen somites (VI to XXIII) are completely triannulate. A curious feature of these (Pl. XLII., Fig. 3) is that the relative lengths of the annuli differ dorsally and ventrally; above, $a\ 2$ is the largest, $a\ 3$ slightly less, and $a\ 1$ obviously the smallest; below, $a\ 2$ is the shortest, and $a\ 3$ just appreciably shorter than $a\ 1$. This is readily explained by comparison of the relative positions of the furrows. Along the margins of the body is an exceedingly thin expansion, crenulated in correspondence to the annuli. Set in the emarginations between successive lobes are narrow wedge-shaped pieces which in the contracted leech assume the position of more or less vertical folds uniting the dorsal and ventral furrows. When the leech is extended these pieces of course become horizontal, and the dorsal and ventral furrows assume the following relative positions; $a\ 3/a\ 1$ is ventrally in advance of its dorsal part, $a\ 1/a\ 2$ is ventrally slightly behind, and $a\ 2/a\ 3$ again ventrally in advance. This lack of alignment characterizes all furrows from about VI/VII to XXIV/XXV.

On the dorsal surface some very faint transverse wrinkles pass between the principal papillæ and are about equally apparent on all of the annuli. Ventrally $a\ 1$ and $a\ 2$ may be more or less divided, the portions toward the ends of the somites being the smaller; $a\ 2$ very rarely shows faint traces of such a division. In this feature and in the rough cutaneous papillæ the species resembles *Hementeria officinalis*.

The disposition of the papillæ on a typical complete somite is shown in the figure (Pl. XLII., Fig. 3), and is as follows: On the dorsal surface of each annulus are two rows of small smooth sense papillæ separated by the transverse wrinkles

above mentioned and differing somewhat in size and distance apart. They are generally single but here and there are grouped in twos, threes, or fours. The number in a transverse row counted singly or as groups is from thirty to fifty on the middle region of the body. A few others may be scattered between the rows or even form a third broken row between the larger papillæ, particularly on $\alpha 3$. Along the margins large numbers may be aggregated. The large rough papillæ are prominent wart-like elevations of the integuments, some of which measure more than a millimeter in height in living examples. They appear not to contract under ordinary stimuli, but are sometimes very much less elevated in preserved material. They are generally conical in shape, their summits bearing a ring of from four to twenty smaller sense papillæ arranged around a central larger one. When the number is greater than eight or nine they are likely to form a less regular ring and to extend further down the sides of the wart, while the central one becomes replaced by two or three. A relation between the size of the wart and the number of papillæ in its crown seems to exist. Of the median series (*mp*) that on $\alpha 2$ is the largest and often bears twice as many sense organs as that on $\alpha 1$, which is the smallest. The next series counting laterad (*mlp*) is always represented by a very large wart on $\alpha 3$, by a much smaller, frequently absent, one on $\alpha 1$, and on $\alpha 2$ is replaced by a rather prominent but smooth papilla which supports the dorso-median sensilla (*md*). This cannot be confounded with the rough papillæ. The next important series (*llp*) is made up of a large one on $\alpha 2$, a smaller one on $\alpha 3$, and a very much smaller one or none on $\alpha 1$. Just external to the large one on $\alpha 2$ is the dorso-lateral sensilla (*ll*), which is somewhat elongated transversely and is little elevated above the surface. At the margin are two rows so imperfectly developed that they are probably better described as a single irregular row (*dmp*) sometimes represented by two warts on a single annulus. Warts of smaller size are generally present, but are more irregularly distributed than the fairly constant ones just described. They are most frequent on $\alpha 1$, where one such is likely to be present

between the median and dorso-median rows, two between the latter and the dorso-lateral, and two between this and the marginal. *A 2* sometimes bears one internal and one external to the dorso-median sensilla. The marginal sensillæ are small.

At the posterior end somite XXIII, though triannulate, shows some peculiarities. The median papilla on *a 2* is much reduced in size or absent, and on each side of the middle line appears a very large rough wart not represented on any of the anterior somites. In surface views no trace of the dorso-lateral sensillæ can be found, but it is suspected that they have been raised to the top of the large warts just described, where a truncated clear area is sometimes visible. Annulus *a 3* is somewhat shortened, but in all other respects this somite is typical.

On XXIV the same features appear somewhat exaggerated; the papillæ are as described for XXIII, and annulus *a 3* is distinctly smaller and mesially joined to *a 2*.

XXV, XXVI, and XXVII show successive steps toward a simpler condition. The first is generally divided into two annuli nearly or quite to the middle; the second, for a greater or less distance from the margin; and the third, just at the margin or not at all. In all of these cases the anterior annulus is the larger and bears a rather large median wart; the peculiar pair of warts of XXIII and XXIV is wanting; and the reduction in size of all other warts leads to the relatively greater prominence of the dorso-lateral series.

Reproductive Organs.—The genital organs differ in no important respect from those of *P. parasitica*. The only difference apparent in a number of dissections is that the prostate cornua of this species are rather longer.

Alimentary Canal.—Only two minor characters in which the digestive tract of this species differs from *P. parasitica* need be mentioned: the pharyngeal glands have no median annectant lobe; and the cæca are less finely and numerously divided.

Color.—The colors of living examples of this species generally impress one as a pepper-and-salt mixture of various

light and dark browns, yellows, and greens, which, owing to the translucency of the integuments, are seldom sharply defined. They appear to be more definite on preserved specimens, and certain metameric features and resemblances to the plan of coloration of *P. parasitica* are recognizable. The light marginal spots are present with the same regularity as in that species. The light median stripe may usually be distinguished at the anterior, and less frequently at the posterior, end. It is constricted or quite interrupted by the dark color of the neural annuli, which encroaches on it, while in the intervals between them the light color extends in narrow bands more or less laterad. In the middle region of the body short longitudinal median brown or brownish green lines alternate with light spots. The former correspond to the constrictions, the latter to the expansions, of the median stripe of *P. parasitica*. Sometimes there is a very distinct continuous narrow median dark brown line. The rest of the dorsal surface is generally variegated browns, with the papillæ light yellow or green and the position of the dorso-lateral sensillæ indicated by rather large and conspicuous light spots.

Habits.—A species of sluggish habit; abundant in running waters, where it is found clinging to the under sides of stones. It also attaches itself to the under side of floating wood in ponds and ditches. Particles of mud cling to the mucous secretion on the body and render it inconspicuous, and the leeches frequently bury themselves partially beneath the sediment at the bottom. They seldom swim, but creep along the surface to which they are attached. If thrown into the water they roll up and sink to the bottom. They carry the eggs or young in early spring, a habit which is common to most members of the family.

GLOSSIPHONIA JOHNSON.

Glossiphonia complanata (LINNÆUS) JOHNSON.*Hirudo complanata* Linnæus (1758).*Clepsine elegans* Verrill ('74).

Diagnosis.—Somites I to IV each uniannulate, II and III often imperfectly separated and IV sometimes faintly subdivided; three separate pairs of pigmented eyes in somites II, III, and IV, the first pair commonly crossed by the furrow II/III; V is biannulate; male pore at XI₁/XII, female pore at XII a 2/a 3; dorsal cutaneous papillæ low and inconspicuous, principally in four series, no median series; epididymis folded into a long loop which reaches into somite XVIII or XIX; nine pairs of testes (XIV to XXI).

This is a species well known in Europe, of which figures may be found in Moquin-Tandon ('46, Plate XII.), and diagrams of the annulation and a description in Blanchard ('96), while Verrill describes the colors of American specimens. It abounds in certain localities under stones in running water, is very active but rolls itself into a ball when disturbed, and feeds chiefly on small snails and annelids.

Glossiphonia lineata (VERRILL).*Clepsine papillifera*, var. *lineata* Verrill ('74).? *Glossiphonia triserialis* E. Blanchard ('49).? *Helobdella triserialis* R. Blanchard ('96).

This species is almost certainly *G. triserialis*, and I hesitate to give it that name only because R. Blanchard ('96) has stated that the male pore of his specimens is situated at 23, 24 (XI/XII) instead of one annulus further caudad as in the form here described.

Diagnosis.—Somites I and II uniannulate, III and IV biannulate, and V triannulate; the single pair of very large eyes situated in IV; male pore at XII a 1/a 2, female pore at XII a 2/a 3; dorsal cutaneous papillæ conspicuous (owing to black color), generally in three (sometimes in five) longitudinal

series, of which the median is the best developed; epididymis forming a loop which reaches into somite XV.

General Description.—A small species seldom over half an inch in length, but capable of moderate extension. In the resting state broad and slightly convex above but not foliaceous, the body being rather thick; when extended, strongly convex.

The anterior sucker is of moderate size and has a rather thick margin into which the annulations extend. It is deeply concave and presents no central elevation. The mouth is large and situated just behind the anterior rim of the sucker, apparently in somite II. Occasionally it is succeeded by a transverse fold. The eyes, of which there is a single pair, are of remarkable size, their diameter being nearly equal to the length of annulus IV ($a\ 1 + a\ 2$) in which they lie. They are simple and correspond to the second pair of *G. complanata*. The genital pores are separated by but a single annulus, the neural annulus of somite XII; they consequently both lie within the limits of that somite.

The posterior sucker is large but relatively little exposed, elliptical in form, and with a thick margin. It reaches forward to XXIII *a* 2.

Annuli and Somites (Pl. XLII., Fig. 6).—I and II are uniannulate and constitute the undivided anterior lobe.

III is biannulate, the anterior ring being somewhat the larger. No sensillæ are visible in surface views, but sections show that the eyes are derived from this somite.

IV is biannulate, but the anterior annulus is relatively larger and is faintly subdivided; it bears the very conspicuous pair of eyes. At the margin this somite becomes uniannulate and forms the posterior rim of the sucker.

V is triannulate above. *A*2 is much longer than *a* 1, especially mesially, where it appears to be almost subdivided. The furrow *a* 2/*a* 3 is the deepest in this neighborhood and defines the posterior limits of the head very sharply. Ventrally *a* 1 and *a* 2 unite while *a* 3, as usual, remains distinct.

VI is the first of the fully triannulate somites, and all three annuli are distinct ventrally as well as dorsally. In all of the

complete somites *a* 2 is somewhat wider than its fellows, dorsally at least, and is rendered further conspicuous owing to the papillæ which it alone bears, its slightly protuberant margins, and the white spots which characterize it.

The arrangement of the cutaneous papillæ, though variable in detail, is very characteristic of the species among local forms. But three constant and conspicuous series exist (Pl. XLII., Fig. 6); a median (*mp*) and a pair of dorso-laterals (*dlp*) situated nearly half-way to the margins. The median series begins sometimes as far forward as somite VI or VII, but seldom becomes prominent before IX or X, from which it continues to XXVI. This is really not a strictly median series, as the papillæ comparatively seldom lie exactly in the median line but usually a little to the right or the left. Very frequently the single conical papilla is replaced by two which are placed more or less close together, in contact or even united into a bilobed or a transversely elongated one. The whole appearance of the series must lead one to recognize its dual character. All of these papillæ are prominent, sharp-pointed, simple cones, whose black color amid white or pale surroundings renders them doubly conspicuous. They are largest in the middle of the series and diminish toward the ends, that on XXVI being very small and some of the anterior ones minute.

In every important feature the dorso-lateral series is similar to the median. The papillæ begin further back and are seldom conspicuous anterior to XIII, from which point they continue to XXVI or XXVII, the last two or three being small. They are somewhat smaller than the median ones and are more likely to be absent from a somite. Though forming a nearly perfect series anteriorly, they present an even greater tendency toward irregularity and doubling posteriorly.

Occasionally one or two isolated papillæ are found between the median and dorso-lateral series, and remnants of a very imperfect supra-marginal series occur more frequently on several of the posterior somites. Very few and faint papillæ occur on the sucker. The dorsal surface of the body

is everywhere roughened by projecting cutaneous sense organs.

The anterior metameric sensillæ (Pl. XLII., Fig. 6) are very difficult to make out in surface views, but about X or XI they become very conspicuous and continue so to the posterior end. Here they appear as eight dorsal series of clear white spots. The dorso-medians (*md*) are placed on each side of the median papillæ, separated by a distance about two thirds of that which intervenes between them and the dorso-laterals. The latter (*dl*) are just about half-way between the mesion and the margins, or a trifle nearer to the latter, and consequently are external to the dorso-lateral papillæ. The dorso-marginals (*dm*) are well back from the margins, being about as far from the dorso-laterals as are the dorso-medians, except on the incomplete somites, where the former distance is less. The supra-marginals (*sm*) are very minute and on the exact margins as viewed from above, except on the incomplete posterior somites, on which they are somewhat removed from the margins. The ventral sensillæ have not been studied.

Reproductive Organs.—In most respects resembling the species of *Placobdella* the reproductive organs differ from theirs and resemble those of *G. complanata* in one important feature: the enlarged portion of the sperm-duct (epididymis and ductus ejaculatorius), instead of simply coiling up, extends caudad in a long straight loop which lies ventrad to the gastric caeca and reaches at least as far as ganglion XV.

Alimentary Canal.—The proboscis is of relatively much greater diameter than in the two species of *Placobdella* described, and the gastric caeca are of small size and scarcely lobed. There are but six pairs of these caeca, which increase in size caudally, and the first of which (in XIV) is rudimentary or sometimes absent. In all of these respects this species is intermediate between *G. complanata* and *G. stagnalis*.

Color.—The colors are here described from preserved material. They are very simple and effective. Below, a plain ash-color; above, the same color marked by eleven or twelve longitudinal stripes of brown which are further com-

pounded of narrow brown lines, the number of which varies according to the width of the stripe. The longitudinal stripes correspond with the arrangement of the musculature as described for other species by Graf ('99). On many specimens these stripes are more or less interrupted on *a* 2 of each somite by transverse whitish spots which occur almost constantly in two, four, or six longitudinal series, of which the most constant lie just external to the dorso-lateral papillae, the next on the flanks of the median papillae, and the third near the margins. The extreme of this arrangement results in a handsome metameric pattern in which *a* 2 becomes conspicuously marked by a row of white spots which on the posterior somites unite to form a band. In such specimens the ground color becomes a pale brown marked by numerous narrow dark brown or almost black lines, of which a pair near the middle line are very conspicuous. The white spots are least developed anteriorly, but become more extensive and closer together posteriorly. Individuals differ greatly as to the exact manner and extent of the complementary development of light and dark elements in the pattern. The entire preocular region is beautifully white, while brown rays on a white ground mark the sucker.

Habits.—In habits *G. lineata* resembles *G. complanata*, with which it is frequently found. Probably this species inhabits colder brooks than any other of our glossiphoniids.

Glossiphonia stagnalis (LINNÆUS).

Hirudo stagnalis Linnæus (1758).

Hirudo bioculata Bergmann (1757).

Clepsine modesta Verrill ('74).

Diagnosis.—Somites I to III included in preocular region; single pair of eyes on anterior annulus of IV, which is obscurely biannulate; V biannulate; VI to XXIV triannulate; XXV and XXVI biannulate, the latter somewhat united to XXVII; genital orifices as in *G. lineata*; a dorsal chitinoid glandular bursa situated at VIII *a* 1/*a* 2; gastric ceca small, simple, variable, never more than six pairs, of which any or all of the first three may be absent; size small and form con-

vex, capable of great extension; no papillæ nor conspicuous markings.

This widely distributed species is figured by Moquin-Tandon ('46, Pl. XIII., Fig. 16-26), and the annulation of the anterior end by Blanchard ('96).* The species is exceedingly abundant everywhere in the shallow waters of rivers, lakes, and ponds, in small streams, pools, and ditches, in fact everywhere where comparatively warm shallow fresh waters are found. It is found clinging to the under sides of stones, and between the ensheathing leaf stalks of aquatic plants, fallen leaves, etc. When disturbed it creeps actively to a place of concealment. The favorite food is small annelids and gastropods, but blood is also taken from injured fish, frogs, etc. The breeding season lasts all through the spring and early summer.

HEMICLEPSIS VEJDOVSKÝ.

Hemiclepsis carinata (VERRILL).

Clepsine papillifera, var. *carinata* Verrill ('74).

Diagnosis.—Somites I and II rather distinctly biannulate; the single pair of eyes on III; the widely expanded head pedicellate on a wide pedicle formed by VI; annulus *a* 3 of complete somites much larger than *a* 1 or *a* 2 and unequally subdivided at the margins; the dorsum bears three prominent papillated keels; the epididymis and ductus ejaculatorius form a few simple coils in XI and XII.

General Description.—A medium-sized glossiphonid of striking appearance. It seldom reaches a length of more than one and one half inches when partially extended in the act of creeping. The shape of this species is entirely characteristic among known Illinois leeches. In the large size, distinctness, free margin, and pedicellate attachment the head resembles that of the *Ichthyobdellide*. The body is more slen-

* By far the best description of this species extant has recently been published by Castle, in Bull. Mus. Comp. Zool., XXXVI, (1900), pp. 21-33.

der and less flattened and foliaceous than in other glossiphonids of equal size. It is never very wide and depressed, but on the contrary rather strongly convex dorsally. Capable of great extension and contraction the body may become very slender, especially anteriorly, or short, thick, and elliptical, and very convex above. In both states the head stands out clearly and sharply as a distinct region. This is an excellent character for distinction from the other leeches described in this paper.

Viewed from above the head is very broadly cordate, the bluntly rounded apex being anterior. Below, the very free posterior margin is entire and slightly convex or straight. This margin appears to be formed by the very strong downward and backward development of V, which becomes much enlarged below and whose ventral sensillæ are visible on the lateral parts of the posterior margin of the sucker. Dorsally the surface of the head or sucker is strongly annulated. At the margins the annuli are supplemented by a narrow but distinct undivided rim. The ventral surface is smooth, with sometimes two or three faint transverse furrows. Just inside of the anterior border is the small mouth, apparently in II. The labial sense organs are exceptionally well developed around the entire margin of the sucker.

The posterior limit of the head is clearly defined both above and below by the furrow V/VI. This is followed by two small annuli (which are regarded as a divided VI *a* 1) which form a short neck embraced anteriorly and concealed below by V *a* 3. Ventrally they become still smaller and perhaps united. Posterior to this point the body increases rapidly in width and the posterior part of VI is equal to IV, the widest part of the sucker.

The most striking characteristic of the species, however, is the presence of three prominent carinæ which extend from just behind the head to the posterior sucker. These are formed chiefly of high and closely appressed papillæ, the tips of which produce a sharp erect serrate crest.

There is no true clitellum, and the genital pores have the usual situations at XI/XII and XII *a* 2/*a* 3. Sixteen pairs of

nephridiopores have been determined on somites VIII to XXIII inclusive.

The posterior sucker is exactly circular, with a finely but distinctly denticulated margin. It is, though not of large size, widely exposed behind, and reaches anteriorly to XXIII *a* 1. Its pedicle of attachment is unusually small, permitting great freedom of movement.

Annuli and Somites (Pl. XLII, Fig. 5).—I forms the apex of the head and is divided dorsally into two small rings by a cross-wrinkle.

II is quite distinctly biannulate and bears evident dorso-median and dorso-lateral sensillae.

III consists of two large annuli, of which the anterior is slightly divided by a faint cross-furrow which is confined to the median region. It bears the eyes, which are separated by a space about equal to their own diameter, and three pairs of sensillae, one of which is remarkable by reason of its position directly above the eyes. Sections of this species have not been studied.

IV closely approaches the triannulate condition, *a* 1 having very nearly the typical relations. Three or sometimes four pairs of sensillae are easily discernible.

V. This somite presents several interesting features. It consists of two annuli of about equal size, both enlarged at the margins, where the anterior one is somewhat divided into *a* 1 and *a* 2. Three pairs of sensillae are present on *a* 2, but the dorso-medians are wanting, while on *a* 3, almost directly behind the dorso-laterals, appear what seem to be an extra pair of these sense organs.

VI is also peculiar in that *a* 1 is completely divided on the dorsal side into two small annuli which appear as one ventrally.

VII is fully triannulate and the annuli present the typical proportions. *a* 1 is the smallest, *a* 2 intermediate, and *a* 3 the largest. *a* 1 and *a* 3 exhibit shallow ventral furrows across their entire width, and the furrow of *a* 3 continues on to the dorsal side, from the margin almost to the dorso-lateral carinae. It cuts the annulus posterior to the sensillae. XXII,

the last triannulate somite, lacks this subdivision, but it exists on all other complete somites.

XXIII, in addition to the differences of papillation already mentioned, shows peculiarities in annulus *a* 3, which is the smallest of all and is differentiated from *a* 2 at the margins only.

On XXIV the complete individuality of all three annuli is suppressed, their boundaries being evident only at the margins. On XXV only the marginal notches *a* 2/*a* 3 are indicated.

XXVI and XXVII are uniannulate and contracted to form the supporting pedicle of the sucker.

The arrangement of the papillæ is as follows: The median series (*mp*) begins in small isolated papillæ of about equal size, usually on VI *a* 2 and *a* 3. By about IX they are well established on all three annuli, *a* 3 bearing the largest, *a* 2 the next in size, and *a* 1 a very small one, and this relative size is maintained throughout the series. A few somites caudad they are higher, more prominent, crowded, and elevated on a ridge. Nearing the posterior end the ridge increases in height and the papillæ on *a* 2 and *a* 3 increase in size, but the crowding becomes relieved and the papillæ on *a* 1 smaller or more frequently absent. Both the ridge and its papillæ cease completely and abruptly on XXII *a* 3.

The paired carinæ (*dlp*) are slightly nearer to the margins than to the middle line. In essentials they are precisely similar to the median one, but present the following special features: the carinæ as a whole are slightly less prominent; they require a greater distance in which to become fully established, i. e., the papillæ are not supported on a continuous ridge, nor present on every annulus until about XII or XIII; scattered papillæ of small size are found on *a* 1 and *a* 2 as far forward as VI, but they are very small; in the region of full development the papilla on *a* 2 is by far the largest of this series and generally larger than any of the middle series, and the papilla on *a* 1 is very small and frequently absent, especially in the posterior region. The

last papilla of the series is on XXII *a*3 and is displaced slightly mesiad.

On somites XXIII to XXVI the carinæ are absent and are replaced by four pairs of large papillæ. These form two short series which if continued forward would pass midway between the median and lateral carinæ. The first pair, situated on the larger annulus of XXIII, is the largest, the next somewhat smaller, while the others diminish rapidly and converge posteriorly. Very minute papillæ may occur on the preanal somite.

All of the papillæ enumerated are of prominent conical form, sharp-pointed, and high. Their summits bear a contractile apex, which in some cases is almost filiform in extension, in others short truncate in contraction. Around the base of this appendage a few smaller points may be clustered.

In addition to those more prominent papillæ which have been described, a more or less complete irregular series of small papillæ forms a dorso-marginal line, external to which a few are scattered along the margin and a still smaller number on the internal side. None of these are ever elevated on a ridge.

The metameric sensillæ have the following positions (Pl. XLII., Fig. 5). The dorso-medians (*md*) are just a little way to the mesial side of the middle of the area between the median and the dorso-lateral carinæ, and are quite easily traced as far forward as II. A curious* circumstance which requires investigation is that a pair appears to lie on the integument directly above the eyes. In the middle body region the papillæ of this series are slightly elevated and they are everywhere the most conspicuous. The dorso-lateral sensillæ (*dl*) are almost as evident on the head as the dorso-median, but much less so on most of the body somites. They are just external to the large papillæ of the dorso-lateral series, but after the suppression of their guardian papillæ, on XXIII, they stand out much more prominently in their isolation. The dorso-marginals (*dm*) become visible on III and continue

* Inasmuch as the eyes seem to be the representatives of the dorso-median sensillæ of somite III and to have undergone no shifting.

distinct to XXV, on which latter they approach very close to the dorso-laterals. By the fusion of the sensillæ of these two series on XXVI and XXVII but three pairs remain. Very minute supra-marginals (*sm*) are also present on most of the annuli. Near the margin of the sucker one or two very regular circles of eight sensillæ are ranged.

Reproductive Organs.—The six pairs of testes are in the anterior ends of somites XIV to XIX, extending somewhat into the preceding somites. The enlarged region of the sperm-duct (epididymis and ductus ejaculatorius) forms a coil or two, and its full length when extended laterally scarcely reaches to the margin of the body at the male pore. The prostate cornua are short and wide. The anterior and dorsal lobe of the ovary, which represents the closed end of the sac, is large and prominently projecting.

Alimentary Canal.—Pharynx slender and very extensible, its glands small. The same number and general arrangement of the gastric cæca as in *P. parasitica* are found in this species, but they are much less subdivided and branched.

Color.—The colors of this species are generally dull and uniform. Very commonly the entire body is a light or darker green or brownish green with a few flecks or lines of deep green and an obscure pale yellow border. Sometimes the pattern is more definite, as in the following case: The entire central region of the dorsum is of a brownish green color which on the neural annuli extends to the margins in the form of narrow sharp-pointed projections, by which a series of large yellow marginal spots are separated from one another and thus barely escape forming a continuous yellow border. Six or seven elongated light yellow spots form a median series and alternate with short dark greenish brown longitudinal lines. Smaller, more or less confluent light yellow spots mark the lateral carinæ. The head is marked by an irregular green-edged dark brown "spread eagle" figure, which leaves a large anterior and a pair of posterior lateral light spots.

Habits.—This species to a great degree lacks the social instincts of most glossiphonids. A far larger number of specimens are found singly than in company. In the neigh-

borhood of Philadelphia they are most frequently found in meadow brooks, adhering to stones, or attached to frogs and, during the spring, to toads. They frequently enter the shells of living mussels, which they probably attack. During the spring at least they are voracious blood-suckers, and along the Delaware River congregate at points where fish are cleaned and the waste thrown into the water.

ICHTHYOBDELLIDÆ.

The collection contains several specimens of a small species of *Piscicola* and another probably of *Piscicolaria*, both parasitic on several species of small fishes. The material is not sufficiently well preserved to permit of determination or description. This family is further represented only by

ACTINOBDELLA gen. nov.

Generic Characters.—The head small, not explanate; the posterior sucker large, hemispherical, with a marginal circle of slender processes; the complete somites with six secondary annuli of unequal size.

Actinobdella inequiannulata sp. nov.

Diagnosis.—A median series of papillæ on annuli *b* 3 and *b* 5; annulus *b* 5 the longest, *b* 4 the shortest, in complete somites; male orifice at XI/XII, the female at XII *b* 4; acetabular papillæ about thirty, provided with adhesive glands.

General Description.—The single specimen representing this species is of small size; the total length is 9.7 mm., the greatest width 1 mm., and the diameter of the posterior sucker about 1.8 mm. The sexual organs are very inconspicuously developed, and it is possible that the species may reach a somewhat larger size.

The form is slender (Pl. XLIII, Fig. 8), with the margins of the body parallel for almost its entire length, but suddenly contracted posteriorly to constitute the narrow pedicle of

the conspicuous sucker, and gently tapering anteriorly to the broadly rounded upper lip. Depressed throughout, with the dorsum convex and venter flat; the margins somewhat sharp.

There is no expanded anterior sucker (Pl. XLIII., Fig. 8) or head as in typical ichthyobdellids, but this end of the body is formed like a glossiphonid or, excepting the character of the mouth, more like a nephelid. The lip is broad and rounded and in this example is turned in ventralward. On the dorsal side it is divided into annuli as described under the caption *Annuli and Somites*. The ventral surface presents a very deep cavity from out of which rises a prominent rounded elevation, near the summit of which the pore-like mouth is situated. The posterior boundary of the sucker is formed by somite V. No pigmented eyes can be detected, but an opaque spot on the third and fourth rings may possibly be eyes, though appearing more like a gland.

No clitellum is developed. The male genital orifice (Pl. XLIII., Fig. 8, ♂) is a minute pore situated in a transversely extended elliptical disc at XIXII; but on the ventral side the annuli XII *b* 1 and *b* 2 are obsolete and the male disc therefore somewhat overspreads annulus *b* 3. The female pore (♀) is in the form of a small transverse slit in annulus XII *b* 4 and, owing to the great reduction of *b* 1 and *b* 2, appears to be separated from the male opening by only one and one half annuli.

Most remarkable of all of the external features of this leech is the posterior sucker (Pl. XLIII., Fig. 8-10). It is much wider than any part of the body, of hemispherical form, largely free on all sides, and supported by a narrow central pedicle. The ventral surface (Pl. XLIII., Fig. 10) is very deeply cupped, and in the specimen described the rim is somewhat contracted, making the diameter of the opening somewhat less than that of the internal cavity. From the inner face of the sucker, a short distance back from the sharp margin, spring about thirty (exactly thirty in this example) slender finger-like processes, which project more or less freely into the cavity. Owing to their contractile nature they may vary in length and diameter, but when extended

are about .4 to .5 mm. in length and perhaps .1 in diameter. Each one (Pl. XLIII., Fig. 11) contains a central gland duct or perhaps a group of ducts surrounded by a sheath of muscle fibers springing from muscular ridges which pass like radii down the inner face of the sucker. The gland ducts arise from a circle of glands which appear as a ring of whitish spots arranged around the sucker about half-way between the margin and the pedicle, and which raise the outer face into a slightly marked encircling ridge. The anus is inconspicuous and appears to be situated in the usual position posterior to somite XXVII.

Annuli and Somites.—It is obviously unsafe to assign to a species all of the details of annulation exhibited by a single specimen. The arrangement of the annuli in certain regions is so obscure and appears so differently under different conditions of fixation and preservation, and, moreover, is so subject to individual variation, that the typical conditions in many species can be determined only by the careful study of many individuals. What follows, therefore, must be considered as applying in entirety only to the type specimen. The characters of the complete somites and the composition of most of the incomplete somites will in all probability be confirmed by the study of further material.

As the type specimen is interpreted the somites are constituted as follows (Pl. XLIII., Fig. 8, 9):—

I to IV are uniannullate and the furrows which separate the first three annuli are faint. No sensillæ are recognizable.

V, VI, and VII are biannulate, with three pairs of distinct sensillæ on the first annulus of each. In each case the second annulus is somewhat the larger.

VIII is triannulate, and *a* 3 is somewhat larger than its fellows and subdivided by a faint furrow. The sensillæ are on *a* 2.

On IX we find *a* 1 subdivided equally into *b* 1 and *b* 2 by a shallow furrow, *a* 2 more distinctly split into a larger anterior and a smaller posterior ring, of which the former bears the three pairs of sensillæ, and *a* 3 subdivided equally.

X is similar to IX except that *b* 5 is considerably larger

than *b* 6 and the secondary furrows are more nearly equal to the primary.

XI is a typically complete somite and presents characters which are found with some slight individual variations as far back as XXIV inclusive. In all of these the annuli are very clearly indicated both on the dorsal and ventral surfaces. *A* 1 is divided equally into *b* 1 and *b* 2, which are quite short rings unmarked by any papillæ; *a* 2 is very distinctly divided into a long *b* 3, which bears a large median cutaneous papilla and the three pairs of metamerie sensillæ, and a *b* 4, of half the size or less, which is the smallest annulus of the somite and bears no papillæ; *a* 3 is cut into *b* 5 and *b* 6, of which the former is the largest annulus of the somite, both in length and breadth, and which bears a large papilla similar to that on *b* 3, while *b* 6 is a simple unadorned ring equal to *b* 1 or *b* 2. Thus each complete somite is divided into six annuli of unequal size, and, leaving out of sight the limits of the somites, this region of the body exhibits a regular alternation of groups of three equal small rings with groups composed of two large rings separated by a very small one. Each of the large rings is marked by three cross ridges which appear to be due to transverse muscle bands, while the narrow rings present only two such ridges, *b* 4 sometimes only one ridge.

The cutaneous papillæ (Pl. XLIII., Fig. 8) are rather conspicuous conical elevations with the long axes of their elliptical bases directed longitudinally. In the middle region they are strictly confined to the annuli indicated, but posteriorly somewhat overlap the succeeding secondary annuli. On other specimens they will probably be found to begin further forward than on the type, as opaque thickenings of the integuments appear in the proper regions of somites X and IX, though there are no elevations.

Of the dorsal sensillæ (Pl. XLIII., Fig. 8) the supra-marginals cannot be distinguished, but the dorso-marginals (*dm*), dorso-laterals (*dl*), and dorso-medians (*md*) are obvious, and are very regularly arranged on all somites from V to XXVI. Peripherad of these points they have not been traced.

The distances separating the two dorso-medians and the dorso-laterals from the dorso-marginals are about equal and somewhat less than that between the dorso-medians and dorso-laterals.

XXV exhibits very much less distinct secondary furrows, the annuli all of about equal size, and the somite practically triannulate. This is also the last somite to bear distinct papillæ.

XXVI is strictly triannulate, with the sensillæ on *a* 2, but lacking any distinct papillæ and secondary furrows. In the figure, XXVII is represented as divided into three narrow rings, but owing to a distortion of this region it is quite impossible to make a satisfactory determination. In some lights and positions there appear to be three rings here, in others two, and two drawings made at different times and independently illustrate the two interpretations.

The color has faded to a uniform gray. Nothing of the internal organization could be learned by studying the specimen, either stained or unstained, in various clearing media, and consequently this description leaves much to be desired. The position of the ganglia and lateral nerves was determined by a partial dissection of the mid-ventral region of two somites.

HIRUDINIDÆ.

MACROBDELLA VERRILL.

Macrobdeella decora (SAY) VERRILL.

Hirudo decora Say ('24).

Hirudo decora Leidy ('68).

Diagnosis.—Copulatory glands opening by four pores arranged in a quadrate figure on XIII *b* 6 and XIV *b* 1 and *b* 2; male pore at XI/XII or XII *b* 1, female, at XII/XIII or XIII *b* 1; somite XXVI has annuli (*a* 1 + *a* 2) + *a* 3; annuli VII *a* 3 and VIII *a* 1 relatively large and partly subdivided dorsally; atrium short and spherical; alimentary canal with extensively developed cæca; denticles small, about 65 on each jaw, and monostichodont; color pattern metameric.

General Description.—This fine leech is so well known and has been so fully described by Say ('24), Leidy ('68), Verrill ('74), and Brooks ('82), that only a few notes on certain features need to be added.

The anterior sucker is provided with a rather wide unsegmented and very mobile border which materially increases its capacity for expansion. Anteriorly a distinct median emargination corresponds with a deep ventral sulcus, which divides the upper lip and is flanked by a pair of scarcely less deep sulci. When strongly contracted the upper lip is folded and turned into the buccal chamber, where it is almost entirely concealed by the lateral lobes formed by the margins of somite IV.

A well-marked clitellum is seldom present. In one example it is firm and thick and extends over eighteen annuli, from the posterior half of X *b* 5 to XIV *b* 2. In the fully retracted state the male pore appears as a rather large opening on the furrow XI/XII, into which the surrounding rugosities are converged and inflected, forming a small sinus perhaps comparable with the pit of *Philobdella*. These inflected parts may be everted, in which event they form a prominent conical organ having deeply fluted sides and the small male aperture at the apex. As protrusion of the parts takes place annulus XII *b* 1 becomes relatively longer at the middle and comes to support almost the entire base of the papilla, so that the male pore now lies well within the boundaries of this annulus. I have never seen any other penial organ protruded.

When fully developed each of the four copulatory gland pores lies in the center of a prominent rugous area, the four being arranged in the form of a square. The anterior pair extends half over annulus XIII *b* 6 and equally over XIV *b* 1, and the posterior pair holds a similar relation to XIV *b* 1 and *b* 2. The pores consequently open on the line of the furrows separating these annuli.

Annulation.—The external annulation differs but slightly from the closely allied species *M. sestertia*, figured by Whitman ('86). The principal differences (characters stated as they occur in *M. decora*) are as follows: 1. The annulus IV (*a* 1 +

a 2)—that bearing the third pair of eyes—is distinctly longer than *IV a 3*, and in some examples the furrow *a 1/a 2* is more or less distinctly discernible. 2. The annuli *VII a 3* and *VIII a 1* are relatively very much longer, and on the dorsal side the secondary annuli and furrows are distinctly developed. 3. *XXVI a 1* is always marginally and sometimes completely separated on the dorsal side from *a 2*. 4. The relative lengths of the annuli of complete somites differ in the two species. In *M. sestertia* the neural annulus (*a 2*) is figured as of equal or greater size than the secondary annuli, while in *M. decora* it is typically shorter than any of these in the same somite.

Reproductive Organs.—Testes (Pl. XLIV., Fig. 23, *t*)—ten pairs, situated at XIII/XIV to XXII/XXIII inclusive. The vasa deferentia (*vd*) are glandular, and follow sinuous courses. In somite XI they become narrow and lose their glandular coating. Opposite to ganglion XI they turn abruptly into the compact, massive, much convoluted epididymes (*ep*). From the posterior end of each of the latter a wide somewhat folded and coiled ductus ejaculatorius (*de*) leads to the terminal organ. Just before plunging into the outer glandular and muscular wall of the latter the ducti become constricted, and then form a pair of slightly enlarged sacs which proceed upward side by side to open together into the end of the male invagination (Pl. XLIV., Fig. 22). This terminal male organ (Pl. XLIV., Fig. 23), which is evidently intermediate in its structure and character between the atrium of *Hæmopsis* and the genital pit of *Philobdella*, is, when entire, spherical in shape; but when its external coat of muscle fibres and prostate glands (*pg*) is stripped off, the lining sac is found to be somewhat pyriform (*ati*).

The ovaries (Pl. XLIV., Fig. 23, *ov*) are large and globular, situated just behind ganglion XII, and ventral to the nerve cord. Short paired oviducts (*od*) unite in a common oviduct (*ode*) without any evident gland at the point of junction. The vagina (*va*) is short, of irregular diameter, and bent on itself.

The copulatory glands (Pl. XLIV., Fig. 23, *cgl*), the external

openings of which have been described, form a conspicuous mass occupying the posterior half of XIII and the entire region of the floor of XIV included between the vasa deferentia.

Alimentary Canal.—The jaws differ greatly from those of *Philobdella* and resemble those of *Hirudo*; they are more than twice as long as high and each bears about sixty-five fine monostichodont teeth. The remainder of the canal is very like that of *Diplobdella*. Each somite from X to XVIII inclusive is provided with two pairs of caeca which are very spacious from XIII caudad. The large posterior pair, which arise from the stomach in XIX, reach backward clear into XXIV or XXV.

Habits.—*Macrobdella* is probably strictly aquatic and is a true blood-sucker. It attacks man, cattle, turtles, frogs, fishes, etc., which enter its domain, and is frequently found gorged with blood. However, this is not its exclusive food. In the spring great numbers of frogs' eggs are devoured. In the neighborhood of Philadelphia these are sucked from the masses of jelly after the gelatinous envelopes have been cut by the leech's teeth. Large numbers of tubificid worms have also been found in the caeca. Whitman ('86) gives an account of the sensory reactions of this species.

PHILOBDELLA VERRILL.

Philobdella gracile sp. nov.

Philobdella floridana Moore ('98), not Verrill ('74).

Diagnosis.—Copulatory gland pores in two nearly counter-part groups related respectively to the male and female genital orifices; male pore at XII *b* 2/a 2, in mature examples opening into a conspicuous deep pit, female pore at XIII *b* 1; alimentary canal of *Hæmopsis* type, the denticles about 35, partly distichodont; annulation essentially as in *Hæmopsis marmoratis*; color partly non-metameric blotches.

General Description.—The largest extended specimen has the following measurements:—

	mm.
Total length,	84.
Length to male pore,	19.
Greatest width (about XX),	7.8
Width at male pore,	7.
Width at anus,	3.
Depth at XX,	2.5
Depth at male pore,	2.8
Depth at anus,	1.5
Diameter of posterior sucker,	4.3

This is a very pretty leech of moderate size and slender graceful form. The preserved specimens are depressed throughout, except just posterior to the mouth, the ventral surface is flat, the dorsal gently convex, with an evident tendency to rise to a rounded median ridge. In some examples the middle two thirds, or so, of the body remains of nearly uniform width; in others the outline tapers gently and regularly from the place of greatest width forward to the mouth.

Probably the body of the living leech has a texture about like *Hæmopsis lateralis*, as the muscles and botryoidal tissue display a similar relative degree of development. Except for a few wrinkles and the very slightly elevated sensillæ the surface is quite smooth.

All of the annuli are clearly marked by smooth even furrows, but owing to the absence of any well-marked transverse ridges they are not angulated and the margins of the body do not appear denticulate. Most of the annuli, however, do show a faint incipient transverse furrow, dividing them into approximately equal halves, the posterior one of which may be marked by a very faint raised line.

As in *Hirudo*, but unlike *Hæmopsis*, there is a distinct very narrow unsegmented margin or border to the anterior sucker (Pl. XLIV., Fig. 13), which is separated on the ventral side by a shallow trench from the actual mouth rim. The mouth and sucker are small. A median sulcus divides the ventral

surface of the upper lip deeply into two halves, but fades out posteriorly; at least one fainter sulcus appears on each side. Somites I-IV constitute the lip and sucker, and the united annuli of V form the postoral annulus.

The five pairs of eyes (Pl. XLIV., Fig. 12, 19) present the arrangement usual in the family, except that the second and third pairs are closely approximated, owing to the position of the latter very close to the anterior border of somite IV. The fourth pair also is somewhat in advance of the line of sensillae.

No specimens have been seen in which the clitellum is sufficiently developed to permit of the determination of its form and extent.

As Verrill ('74) long ago pointed out, the external genital region (Pl. XLIV., Fig. 16) is very remarkable; in some respects, indeed, unique among known leeches. This is true not only of the elaborate adhesive arrangements, which are probably important aids to successful copulation, but also of the location of the genital apertures. The features of this region have been described by Moore ('98) from examples collected in Louisiana, but are now figured for the first time. The figure is a composite of the three specimens which this collection contains and which differ from one another in certain particulars.

Comparison of the previous account with this figure will bring to notice some disparity in minor details, due to the fact that almost every specimen presents some individual peculiarities. It is very probable that this results not more from individual variability than from the temporary, seasonal, and developmental character of the structures concerned.

In specimens sexually inactive the male pore appears near the anterior margin of XII *a* 2; the female pore, on XIII *b* 1. They are surrounded by a more or less wrinkled area in which appear a variable number of copulatory gland pores more or less conspicuously developed. Omitting consideration of intermediate states the active condition is represented in Pl. XLIV., Fig. 16. The surface immediately surrounding and succeeding the male pore is inflected as a deep pit

(♂), on the anterior face of which the male pore is carried and concealed by the slightly overhanging* margin. Thus is formed, probably through the contraction of the dorso-ventral muscles, a sort of genital sinus inclining dorsad and cephalad deeply into the body and opening by a wide mouth on to the surface of annuli XII *a* 2 and *b* 5.

The neighborhood of the female pore is reciprocally elevated as a sugar-loaf shaped papilla, inclining caudad and ventrad and consequently well adapted to occupy the male pit, in which event the female pore (+), situated at its apex, would come into contiguity with the male pore near the bottom of the pit.

The copulatory gland pores (*cgp*) are much more conspicuous than in the individuals first described, but are subject to much variation. Typically they are arranged as follows: In the male system (♂ *cgp*) a pair (concealed in the figure) is placed symmetrically beside the male pore; a second pair, and sometimes an additional median one, is situated just in front of the anterior border of the pit; on the furrow XII *a* 2/*b* 5, just external to the pit, is a third pair; a fourth pair is found just abreast of the last but on the lateral walls of the pit within its mouth; and, finally, a median pore appears on the sloping posterior face of the pit cephalad of the third and fourth pairs.

An almost exact reversed counterpart of the male system is found in the female system of adhesive organs (+ *cgp*). It is described in the order in which the pores are supposed to correspond with those of the male system as respectively enumerated. The first pair occupies the sides of the female papilla close to the genital orifice; the second is found on annulus XIII *b* 2, caudad and laterad of the papilla and sometimes accompanied by a median one; the third and fourth pairs of the male system are represented by a single pair in the female system, which is just caudad of the male pit on annulus XII *b* 6. A median pore situated just posterior to these completes the parallelism.

*The ventral surface being turned uppermost.

Besides those mentioned, two or three additional pairs are located far from the middle line on annuli XIII *b* 2, *a* 2, and *b* 5.

Each of these pores is the crescentic or slit-like external orifice of a little subcutaneous bursa, usually filled with a more or less hardened substance which may raise the integuments into a small papilla and is probably the secretion of a mass of glands (*gbl*) occupying the whole of the middle region of somites XII and XIII and covering the walls of the male pit internally.

Seventeen pairs of nephridiopores (Pl. XLIV., Fig. 13, 14) are situated on small papillæ near the posterior margins of annuli VII *a* 1 to XXIV *b* 2 inclusive. The posterior are entad, the anterior ectad, of the ventro-lateral sensillæ.

Annuli and Somites (Pl. XLIV, Fig. 12-15, 18, 19).—Except in a few minor respects the incomplete somites possess the same number of rings as in *Macrobodella* and *Hemopsis marmoratis*.

Fifteen somites (IX to XXIII inclusive) are complete and quinqueannulate, *b* 1 + *b* 2 + *a* 2 + *b* 5 + *b* 6. In each of these, except IX, *a* 2 is just perceptibly shorter than the others and is less likely than they to show the depressed transverse line, though the raised line just behind the sensillæ is quite as distinct.

The sensillæ are very regular in arrangement but very small. They appear as white circular spots, and, in the best preserved examples, are distinctly but very slightly elevated above the surface. They encircle the exact middle of the annulus. The dorso-medians (*md*) are very close together, scarcely an annulus length apart. About twice this distance separates these from the dorso-laterals (*dl*); from the dorso-laterals to the dorso-marginals (*dm*) and also from the latter to the supra-marginals (*sm*) the distances are slightly greater than that first mentioned. Owing to the flatness of the ventral surface the relative positions of the sensillæ as shown in Figures 13 and 14 represent accurately the distances which separate them.

There are eight incomplete somites at the anterior end.

I is incompletely separated from II and bears but one pair of metameric sensillæ. II is a narrow imperfectly differentiated annulus bearing the first pair of eyes and, externally to these, three pairs of sensillæ. III is also uniammulate, and the second pair of eyes which it bears represents the dorso-lateral sensillæ, the other three pairs being unmodified.

IV is biammulate $(a1 + a2) + a3$. The first ring is wider than the second, and its composition is indicated by an interrupted furrow which passes across the third pair of eyes but anterior to the other sensillæ. V differs from IV only in its somewhat greater length and its relation to the mouth.

VI and VII are each triammulate; the latter is considerably the larger, but in each the annulus $a3$ is dorsally about two fifths of the entire length of its somite and in VII shows a slight furrow all around. The furrow VI $a1/a2$ disappears ventrally.

VIII is quadriammulate; $a1$ is longer than $a2$ and faintly subdivided all around, but is not equal to VII $a3$; $b5$ and $b6$ are fully developed and about equal to $a2$.

In IX the relative size of the annuli is $b1 - b2 < a2 < b5 - b6$; in X, $b1 - b2 - a2 < b5 - b6$; and in XI and succeeding somites $b1 - b2 - b5 - b6 > a2$. The posterior annuli of XII and the anterior of XIII are somewhat contracted in length.

In XXIII, $b5$ and $b6$ are relatively slightly shorter, while in XXIV they are no longer distinct, the separating furrow being very shallow, so that this is counted as a quadriammulate somite. $b1$ and $b2$ are longer than $a2$.

XXV is a contracted quadriammulate somite in which the following relative proportion exists in the lengths of the annuli of the specimens examined: $b1 - a3 > a2 = b2$.

XXVI presents the following variations: In the specimen drawn it is a single large annulus, particularly long at the sides, where a faint emargination and slight dorsal depression indicate an incipient division at about the middle. The sensillæ are fully developed and lie well toward the posterior margin of the ring. Another example from the same lot has this somite very distinctly and completely divided on the dorsal side into two annuli, of which the anterior is almost

twice the length of the posterior, except at the margins, where they are more nearly equal. The sensillæ are very distinct and are all placed very close to the anterior margin of the second annulus which, therefore, in spite of its smaller size, is regarded as (*a2-a3*).

XXVII is irregular and more or less divided into two rings, especially at the margins. The anus cuts into the posterior margin of the somite, which at that point is irregularly lobed. The sensillæ are close to the furrows by the side of the anus and the dorso-medians are widely separated. XXVIII is somewhat distinct from the sneker and bounds the anus posteriorly.

Reproductive Organs.—Two examples were dissected, and the small size of the organs renders it probable that they were taken at a time when these were not in full activity. The internal organs of generation (Pl. XLIV., Fig. 17) are very simple.

But seven pairs of small testes (*t*) were found at the anterior ends of somites XIV to XX. The very slender vasa deferentia (*vd*) reach to ganglion XI, where they bend back on themselves and become almost immediately much enlarged and thrown into several folds (*ep, de*). This region appears to correspond to both the epididymes and ducti ejaculatorii of *Hæmopsis*. The two ducts immediately open together into a small thin-walled bursa, and the bursa communicates with the pit as above described. There is no muscular atrium and no penis. Numerous muscular fibers pass between the ventral integuments in the neighborhood of the pit and the dorsal integuments. Ganglion XII is crowded caudad from its normal position to the posterior end of its somite.

The female organs (Pl. XLIV., Fig. 17, 21) are of the *Hirudo* type. In the specimens examined they are symmetrically related to the body axis. The ovaries (*ov*) are sausage-shaped and each is folded on itself. Separate slender oviducts (*or*) lead to an unpaired organ, into the large end of which they open. There is no evident external distinction between glandula albuginea, oviductus communis, and vagina, but the three together are combined in a slender claviform

organ, which is doubled on itself forward and opens by a duct on the external papilla.

Alimentary Canal.—Except for the jaws the alimentary canal is most like that of *Hæmopsis*. It is straight and simple, with one pair of large posterior caeca and numerous small pockets, usually two pairs per somite along the middle region. The jaws, however, are of a very different form, resembling those of *Diplobdella*. They are very high and prominent, the height being greater than the length. The denticles are small, sharp, and in part at least ranged in paired series (Pl. XLIV., Fig. 20). It is quite possible to draw them apart with needles and to display the groove which divides the two rows.

Color.—The colors are described from alcoholic specimens which are evidently somewhat faded and otherwise altered. Light brownish drab above, yellowish below. A distinct continuous narrow yellow line marks the dorsimesion, becoming very faint anteriorly while posteriorly it is more or less broken by intrusion of the ground color. A pair of rather broader but less distinct yellow lines mark the margins. Between the dorso-marginal and dorso-lateral sensillae on each side is a row of small irregular deep brown spots, generally well separated but at intervals becoming aggregated and more or less confluent. A very few faint and suffused brown spots are scattered over the dorsal surface. Ventrally the only markings are some rather larger reddish brown spots which are chiefly aggregated along the margins and become in places confluent.

Habits.—That this leech feeds in part at least on weaker creatures is shown by the presence of remains of earthworms (*Allolobophora*) in the canal. One of Verrill's specimens of *P. floridana* was captured in the act of swallowing a small lumbricoid worm. The structure of the alimentary canal would also indicate a diet of this character varied by an occasional meal of blood.

HÆMOPIS SAVIGNY.

Hæmopis marmoratis (SAY).

Hirudo marmorata Say ('24).

Aulostomum lacustre Leidy ('68).

Diagnosis.—Annuli VII *b* 5 and *b* 6 and VIII *b* 1 and *b* 2 indicated on the enlarged primary annuli but not fully developed; ♂ pore on 32 (XI *b* 6) or 31/32 (XI *b* 5/*b* 6), + pore on 37 (XII *b* 6) or 36/37 (XII *b* 5/*b* 6); atrium and vagina reaching into somite XVII; ovaries just behind ganglion XIV.

General Description.—This species reaches a greater size than is attained by any of the Illinois examples, the largest of which measures:—

	mm.
Total length,	104.
Length to ♂ pore,	22.
Greatest width, (XVII),	15.5
Width at ♂ pore,	12.
“ “ anus,	7.7
Depth at XVII,	6.5
“ “ ♂ pore,	3.8
“ “ anus,	2.5
Diameter of posterior sucker,	6.5

Owing to the great development of botryoidal tissue the body is exceedingly soft and consequently varies greatly in shape, when alive, according to the various states of rest and activity, in preserved specimens, as a result of the different methods adopted for fixation and preservation. When actively swimming, and especially when the stomach is empty, the body is elongated and flattened but never very slender. (This is nearly the condition of the example measured.) The width is generally greatest at about the middle of the body, but differs very little between the clitellum and the last complete somite. In preserved specimens the clitellum is frequently the widest part of the body. Anterior to the clitellum the body tapers rapidly to the broadly rounded

prostomium and is less flattened. When exploring, but not swimming, the form is much less depressed and more terete, and may become much more extended and slender. The resting attitudes are varied and interesting. The body may be contracted to an ovoidal form, the upper lip is usually inflected, and the anterior end of the body variously inrolled or folded on the ventral surface.

Living specimens held in the fingers are so soft and hang so limp that they appear more like pieces of dead tissue than living animals. This peculiarity also enables them to squeeze into the most narrow clefts and thus often to escape from confinement. None of the cutaneous sense organs are elevated upon papillæ, so that the surface appears perfectly smooth.

Both living and well-preserved specimens are strongly annulated (Pl. XLV., Fig. 24), and in the latter each annulus is raised into a transverse ridge situated about one third of the length of the annulus from its posterior border. As a result the margins of the body usually appear rather decidedly serrate. In some specimens such elevated ridges extend around the entire circumference of the body.

The anterior sucker (Pl. XLVI., Fig. 34) is mobile and comparatively large, but without any definitely expanded disc. The mouth is large. The upper lip is broad and bluntly rounded, crenulate on the margin, but almost perfectly smooth and undivided ventrally. Several rows of labial sense organs are situated around its margin and on the pre-ocular and oral annuli. Dorsally the furrows which divide it into annuli may be very faint, but are usually discernible for a portion of its width (Pl. XLVI., Fig. 33).

Of the five pairs of eyes (Pl. XLVI., Fig. 33) the first three pairs are conspicuous and arranged in a regular arc on the 2d, 3d, and 4th annuli; while the fourth and fifth pairs are more widely separated on the 6th and 9th annuli respectively, and are increasingly smaller and deeper and, as a consequence, more obscure. Their optical axes are variously directed; the first pair forward and slightly outward, the second decidedly outwards and forwards, the third directly outwards, the fourth outwards and backwards, and the fifth backwards and some-

what outwards; thus, together, they cover an arc of perhaps 160° .

Annulus 6—V ($a 1 + a 2$)—unites with 7 (V $a 3$) ventrally to form the broad postoral ring; but the immediate oral ring or lower lip is a rim, more or less narrow and more or less distinct from 6, which is contributed by 5 (IV $a 3$). At the sides the mouth is bounded by the 4th and 5th annuli, which coalesce laterally (Pl. XLVI., Fig. 33).

In mature examples the clitellum (Pl. XLV., Fig. 24) is very distinct and equally well developed dorsally and ventrally. It is smooth, thick, and firm, and at its posterior end as wide or wider than the succeeding annuli. Posteriorly it is straight, anteriorly concave; and it extends over fifteen annuli (X $b 5$ —XIII $a 2$ inclusive).

The Illinois specimens exhibit no variation in the position of the genital pores, which are, invariably, the male in XI $b 6$ and the female in XII $b 6$. The male orifice is situated close to the anterior border of its annulus, which enlarges mesially and encroaches slightly on the preceding annulus. Occasionally the region immediately surrounding the orifice is elevated as a low broad papilla. The size of the actual opening, as well as its form, differs according to the state of retraction or protrusion of the penis and related parts. The female pore is rounded or slit-like, is smaller than the male, and, like that, is usually close to the anterior border of its annulus though more liable to shift as far as half its width caudad. The annulus is enlarged and its anterior furrow becomes obsolete in its middle part.

The relatively small posterior sucker is circular, broadly attached, thick posteriorly, and projects by about one third of its diameter beyond the body, its anterior margin reaching to XXV $a 2$. Just anterior to it is the large anus with its much wrinkled margin cutting into XXVII. Prolapsus of the rectum frequently occurs in individuals which contract excessively as a result of irritation.

There are 17 pairs of nephridiopores situated just anterior to the posterior margins of the $b 2$ region of somites VIII to XXIV inclusive (Pl. XLVI., Fig. 34). Each is in a faint

depression bounded anteriorly by a slight forward displacement of the transverse ridge. The anterior pores are exactly in line with or very slightly mesiad of the ventro-lateral sensillæ, while the posterior lie well inside of this line.

Annuli and Somites (Pl. XLVI., Fig. 33, 34).—Somite I can seldom be distinguished as a distinct ring, but in well-preserved preparations a pair of dorso-median sensillæ may always be found anterior to and a little mesiad of the first pair of eyes. Sometimes the furrow may be discerned at and near the middle line, but it is always very faint and incomplete. This region bears numerous labial sense organs, which are arranged in about eight transverse rows; but, except in one case in which two were found, only the one pair of segmental sensillæ can be distinguished.

Somite II consists of a single narrow annulus imperfectly distinguished from the preceding and succeeding annuli. The posterior furrow sometimes extends quite to the lateral margins of the lips, but is usually very faint and imperfect. This somite bears the first pair of eyes, together with dorso-median, dorso-lateral, and dorso-marginal sensillæ, the latter being very difficult to distinguish from the labial sense organs.

III is also uniannulate but is more distinct, though here again the furrows are frequently incomplete. The dorso-median sensillæ are small but distinct, while the lateral and marginal pairs are quite evident. A few goblet-shaped sense organs form a broken transverse series.

IV is biannulate, the two annuli uniting at the margins to form the lateral boundaries of the mouth. The anterior annulus is somewhat the wider and bears the eyes and the full set of sensillæ toward its posterior part. It is consequently regarded as potentially constituted of the two primary annuli $\alpha 1$ and $\alpha 2$. Each annulus bears one row of goblet-shaped organs.

V is a more fully elaborated biannulate somite. The anterior annulus is decidedly the larger, and exhibits on the dorsal side two transverse series of goblet-shaped organs which are ventrally united into one. A full set of metameric

sensilla is present on the posterior portion of the dorsal surface, but the ventral ones have escaped notice, if present. The second, smaller annulus (*a* 3) has one series of goblet-shaped organs.

On VI a partial furrow indicates the line of division between the constituents *a* 1 and *a* 2 of the much enlarged anterior annulus. The extent of this furrow is variable. It extends from the dorsal mid-line, where it is deepest, laterad sometimes as far as the dorso-marginal or even to the supra-marginal sensilla, but may reach as far as the eyes only. All of the sensilla, both ventral and dorsal, are well developed and, including the 5th pair of eyes, are on the *a* 2 constituent. Annulus *a* 3 is the last on which a complete row of goblet-organs is distinguishable.

VII is triannulate, *a* 1 being slightly shorter than *a* 2 and *a* 3 much longer, the latter constituting about two fifths of the total length of the somite. Occasionally in large specimens a very evident furrow divides this annulus into two equal halves on the dorsal surface, and at least a shallow furrow is always present. The sensilla are normal and on *a* 2.

VIII is quadriannulate. *A* 1 is slightly wider than VII *a* 3, and like the latter shows a partial division into the secondary annuli. *A* 2 bears the sensilla and *a* 3 is completely divided into *b* 5 and *b* 6, each of which equals *a* 2 in size.

The series of complete quinqueannulate somites begins with IX and ends with XXIII, making 15 in all. The five annuli of each of these are of equal length. The sensilla are small but very conspicuous on properly prepared material; but the exact size of the sensory areas is difficult to figure, as they appear as circular white spots in small unpigmented areas the limits of which are rather vaguely defined. All of the sensilla are much subject to variation, even the dorso-medians and dorso-laterals being frequently subdivided, changed in position, or entirely wanting. But the two marginal series are especially prone to subdivision; and they are very commonly represented by a chain of contiguous smaller sensory areas, not infrequently made up of four or five members.

Somite XXIV is quadriannulate, but it is the posterior end (*a* 3) which is least developed, instead of the anterior end (*a* 1) as in the quadriannulate somite VIII. In some examples the large posterior annulus (*a* 3) is marked by a slight furrow, which is more frequent on the ventral surface.

XXV. Because of its variations this normally triannulate somite is one of the most interesting. *A*1 is always longer than XXIV *a* 3. In four specimens it exhibits no trace of a subdivision dorsally or ventrally; in six there is more or less evidence of a ventral furrow; four examples, while lacking any trace of a furrow, show two distinct integumental ridges at the margins of this annulus; two others have both the marginal ridges and the furrow; and in one individual of large size the furrow extends even half way around the dorsal side. The remaining annuli *a* 2 and *a* 3 are of equal size and present no noteworthy features.

XXVI is uniamnulate above, and the sensillæ, with the exception of the dorso-median, which are at about the middle of its length, are situated close to the posterior border. On the ventral side a partial annulus is developed in many cases posterior to the line of sensillæ.

XXVII. For the reason just stated the short preanal annulus is regarded as XXVII *a* 1, while *a* 2 and *a* 3 are united in a single sensilliferous annulus which is cut into by the anus. The furrow *a* 1/*a* 2 is sometimes incomplete mesially.

The dorsal surface of the sucker is marked by a variable number of concentric furrows crossed and connected by irregular wrinkles. The sensillæ are difficult to distinguish, but generally about three belonging to each of the dorsal series are present.

Reproductive Organs.—The dissection represented in the figure (Pl. XLV., Fig. 26) was made upon a well-extended mature specimen of medium size. In this the nerve cord passes to the right side of both the genital orifices, and the unpaired portions of the genital ducts lie to its left. The dissection of a number of specimens of this species from several localities shows that while this relation between the

nerve cord and the genital apparatus usually obtains, it is not constant and diagnostic of the species. Cases have been found in which the nerve cord passes to the left of the genital exits or to the right of one and the left of the other, or in which the atrium or vagina crosses the nerve cord dorsally and lies partly on each side of it.

Ten pairs of testes (*t* 1, *t* 3), belonging to somites XIV to XXIII inclusive, appear to be constant. Each occupies the first two annuli of its somite and the posterior annulus, or even two annuli, of the preceding somite. They are largest in the middle of the series, and become smaller toward both ends. The twenty short vasa efferentia are similar in structure and appearance to the paired vasa deferentia into which they empty. Each of the latter (*vd*) is a rather conspicuous glandular tube of yellowish color which takes a more or less sinuous course just entad of the line of nephridial vesicles. When about opposite to the male pore it turns sharply caudad, having become narrower and of firmer, less glandular, texture, and soon passes into a much convoluted region, the epididymis (*ep*). The latter is neither compact nor massive, and in the posterior part of XIII opens into the sperm sac (*ss*), a fusiform enlargement with which the ductus ejaculatorius (*de*) begins. Throughout its greater part the latter is a delicate tube which extends forward to a point opposite to the male pore and then again bends on itself sharply caudad to open into the fundus of the atrium or penial sheath (*at*) at the anterior limit of somite XV. Throughout its entire length the ductus ejaculatorius has firm glistening muscular walls. Generally the right ductus passes beneath the nerve cord at its anterior turning point behind ganglion XI, but occasionally it is the left which makes this crossing.

The atrium or penis sheath (*at*) is very long and slender. Beginning at the anterior end of somite XV it reaches caudad to ganglion XVII, bends sharply on itself, and passes directly cephalad to the male orifice. In the specimen figured, which measures 92 mm. in total length, the atrium has a length of 40 mm., the ratio between the short and long limbs being as

1 to 2.3. The organ is of firm consistency and very muscular. In shape it is terete with the closed end slightly enlarged and provided with an ensheathing layer of prostate glands (*gp*). The protruded penis is a long filiform organ reaching a length of at least 30 mm., though this condition is not exhibited by any of the Illinois examples.

The female organs are equally and correspondingly specialized. A pair of ovaries (*ov*) lie on the 2d pair of testes dorsal to the nerve cord and in the posterior end of XIV. Very short oviducts pass from them to a common meeting place, where they are enveloped by the large glandula albuginea (*ga*), from which the common oviduct emerges. This narrow firm-walled tube (*odc*) leads to a large pyriform ovisac (*os*), which it joins a short distance from the extremity of the narrow end. The vagina (*va*) begins near the large end of the ovisac at the posterior end of somite XVI. It is long, slender, and terete, about 2-3 times the diameter of the common oviduct, of an appearance similar to the latter, and with muscular walls. The coil and whorls into which it is thrown are sufficient to give it, when straightened out, a total length equal to the penis sheath.

Alimentary Canal.—The lip is separated by a slight circular sulcus and fold from the three jaws. Each of the latter is the anterior termination of a pharyngeal fold which here becomes slightly more prominent and curves peripherally into a little pocket into which the jaw may be retracted, so that the whole tooth-bearing ridge may be concealed. The jaws are low and rounded, not at all compressed on the free edge and very little prominent. They bear a double file of large coarse teeth (Pl. XLII., Fig. 7) arranged in from 12 to 16 pairs. The individual denticles have bilobed bases and sharp, slightly hooked, apices, those of each pair meeting in a common ridge above the groove which separates their bases. From each side of the pharyngeal folds, which continue the jaws caudad, somewhat lower folds arise, and in the intervals between these three triad systems additional single or double folds may arise. Thus the pharynx is thrown into from nine to twelve, or even more, longitudinal

ridges extending throughout its entire length. The pharynx reaches into somite X.

A long narrow straight stomach reaches to XIX, where a pair of large lateral cæca arise and pass caudad to XXII or XXIII. Along the course of the stomach are numerous small lateral cæca, as many as two or three pairs per somite; and just posterior to the origin of the large posterior pair are two or three pairs of quite large, short, globular cæca which extend laterad dorsal to the principal cæca.

Color.—Many color varieties of this species occur, some of which have been indicated by Verrill ('74); but only the blotched kinds are represented in the Illinois collection. During life the ground color in such is generally some shade of olive-green or greenish brown, blotched with irregular intermixed spots of lighter grays and darker browns and black. The former kind are likely to predominate on the ventral side, from which the darker pigments may be altogether absent. The darker markings may be scattered and distant or so close as to become confluent and give to the animal an almost black color. Most of the Illinois examples are only moderately blotched. Preservation always causes the loss of the green pigments. No metameric features have been detected in the pigmentation of this species, nor is there any evident close relation between the disposition of the pigment and the arrangement of the muscles.

Habits.—In the neighborhood of Philadelphia this so-called horse-leech lives in the mud by the sides of pools, ditches, and streams. At times it leaves the water in search of earthworms, which constitute part of its food. Various kinds of aquatic insects and their larvæ, aquatic oligochaetes, gastropods, and lamellibranchs are eagerly eaten, and large quantities of mud containing organic matter are swallowed. When the opportunity arises this leech will take blood, attaching itself to drinking cattle or to the legs of boys wading in its haunts.

Hæmopsis lateralis (SAY).*Hirudo lateralis* Say ('24).*Macrobodella valdiviana* Philippi ('72).*Semiscolca terrestris* Forbes ('90).

Diagnosis.—VII *b* 5 and *b* 6 and VIII *b* 1 and *b* 2 are fully developed, so that VII is quadriannulate and VIII quinqueannulate. The male pore is on annulus 34 (XI *b* 6), the female on 39 (XII *b* 6); the vagina and atrium extend to the anterior part of XIV; the ovaries lie between the female pore and ganglion XII.

General Description.—Many of the characters of this large leech have been described by Forbes ('90). It reaches a size much larger than *H. marmoratis*, some examples of the terrestrial variety from Illinois measuring as contracted alcoholic specimens nearly 8 in. in length and $\frac{7}{8}$ in. wide. The smallest specimen in the collection measures 38 mm., the largest 190 mm., in length. A medium-sized individual from which the drawings were made, measures:—

	mm.
Total length,	103.
Length to ♂ pore,	21.
Width at ♂ pore,	10.5
Greatest width (just anterior to 17th nephridiopore),	13.5
Width at anus,	about 5.
Diameter of posterior sucker,	6.
Depth at ♂ pore,	about 4.
Depth at last nephridiopore,	5.5
Depth at anus,	2.5

Living aquatic examples which I have watched assume the attitudes and shapes described for *H. marmoratis*, but *H. lateralis* is much more slender and capable of much greater elongation. The greatest width is further back (about XXII), from which point the body tapers gently forward. Compared with *H. marmoratis* the ventral surface seems flatter, the dorsal more abruptly, but still gently, arched, and the anterior region more terete. As in that species the surface of the body is perfectly smooth, without

any papillæ, but unlike that species the metameric sensillæ are exceedingly difficult to detect, and I am not yet satisfied that they have been correctly identified in surface views. A better developed muscular system gives the body of this species a somewhat firmer consistency.

The annuli (Pl. XLVI., Fig. 28-32) are remarkably distinct, which results chiefly from the presence on each of a strong welt or ridge which encircles it and causes the margins to stand out like so many serræ. Just anterior to the ridge a faint furrow appears on many of the secondary annuli.

The upper lip (Pl. XLVI., Fig. 29, 32) is rather slender and pointed and its ventral surface divided by a slight median and several lateral longitudinal grooves. The mouth and sucker are relatively smaller than in the horse-leech. A slight constriction is usually evident between the fourth and fifth pairs of eyes. The eyes (Fig. 28) are arranged as in *H. marmoratis*.

Very few examples exhibit a well developed clitellum, but when present it has a form and extent similar to that of *H. marmoratis*. Although the male and female pores are situated on the annuli homologous to those bearing them in *H. marmoratis*, two more annuli intervene between them and the anterior end than in that species. This results from the presence of an additional annulus in each of somites VII and VIII. The orifices are also situated further caudad on their respective annuli (though seldom beyond the middle) than in that species.

The usual seventeen pairs of nephridiopores (Pl. XLVI., Fig. 29) are situated on the annulus *b* 2 of somites VIII to XXIV inclusive. As in *H. marmoratis* they open just posterior to the transverse ridges, which at each pore are pushed forward as short spout-like projections which may serve to direct the flow of the excreted fluid. The distance separating the two pores of a pair is almost exactly half the width of the body at that point.

Annuli and Somites.—Owing to its distinctness the annulation (Pl. XLVI., Fig. 28-32) is very easy to work out, but on account of the difficulty or impossibility of detecting the

metameric sensillæ in surface views the metamerism is less readily determined. Comparison with *H. marmoratis* brings to light some interesting points of distinction between the two species. No differences of any consequence are noticeable in the first five somites.

In VI, $a3$ is relatively much longer, and occasionally a faint subdivision appears on its dorsal surface.

VII presents a similar condition in $a1$, while $a3$ is represented by the fully developed secondary annuli $b5$ and $b6$, which are completely separated both dorsally and ventrally, making this somite quadriannulate, with the formula $a1+a2+b5+b6$, or $(b1+b2)+a2+b5+b6$.

VIII is quinqueannulate, owing to the complete separation of $b1$ and $b2$. This species presents, therefore, one more complete somite—having the formula $b1+b2+a2+b5+b6$ —than does *H. marmoratis*.

In most of the complete somites, usually from about X to XXI, a characteristic relative size of the component annuli is maintained. $a2$ is always the shortest, $b1$ and $b2$ are equal and slightly longer, and $b5$ and $b6$ are equal and still longer. The faint depressed line which is mentioned above as crossing most of the annuli is rarely discernible on $a2$, while on the secondary annuli it is usually quite evident.

In XXIV, which is the last complete somite, the relative size of the annuli anterior and posterior to the neural annulus ($a2$) is reversed, $b1$ and $b2$ being larger than $b5$ and $b6$.

XXV is triannulate, $a3$ being distinctly smaller than $a1$ or $a2$, especially on the ventral side, where it becomes somewhat approximated to $a2$ and the dividing furrow less deep.

XXVI is biannulate, the first annulus being dorsally as long as the second at the margins, or even longer, but relatively smaller mesially. By displacing the sucker the second ring is seen to include on each side a remnant of a very narrow posterior ring, which in one specimen is well developed both dorsally and ventrally. As the supposed sensillæ are found on the anterior part of the second ring this is regarded as representing $a2$ and $a3$.

XXVII is biannulate and includes the anus.

Fortunately, in the posterior region of some aquatic individuals from Ohio the sensillæ are comparatively distinct, so that the determination of the values of the annuli and of the limits of the somites is accomplished with greater ease and confidence than would otherwise be possible.

Reproductive Organs.—The reproductive organs also have been described by Forbes, to whose account a few notes may be added. The nerve cord may pass to the right of the genital exits, as described by Forbes, or to the left, as here figured. In two out of three dissections the latter condition prevailed; but the number is of course insufficient to determine which is the more usual.

The figure (Pl. XLV., Fig. 27) will serve to show the marked contrast in several respects between these organs in *H. lateralis* and *H. marmoratis*, in most of which the former approaches nearer to the *H. sanguisuga* of Europe. The sperm-sacs (*ss*) and epididymes (*ep*) of *H. lateralis* are confined to the distance between ganglia XI and XII, and the latter are massive and compact and closely molded around the sperm-sacs. The atrium (*at*) of this species is much shorter, its posterior turn being at ganglion XIV; the relative lengths of the short to the long limb is as 1 to 1.7. The penis is not protruded in any of the Illinois specimens, but in the aquatic variety from Ohio is essentially similar to that of *H. marmoratis*.

Unlike the latter species the ovaries (*ov*) of this are situated far in advance of the second pair of testes. Sometimes, at least, they lie beneath the nerve cord and between the female exit and ganglion XII. Similarly to the atrium, the vagina is relatively short and never extends posterior to ganglion XIV.

Alimentary Canal.—Counting the rudimentary denticles which complete the series posteriorly the number on each jaw is from 20 to 25 pairs (Pl. XLV., Fig. 25), arranged, as in *H. marmoratis*, in two contiguous series. They are of more irregular shape than in that species and of smaller size, but their greater number causes them to occupy an approximately equal distance on the jaws.

Color.—Forbes ('90) has described the colors from living

specimens of the terrestrial variety. On living aquatic examples from Ohio the dorsal black stripe may be conspicuous, but is more frequently faint and obscure, broken into small spots, or totally wanting.

Habits.—The habits of this species have been briefly described by Say ('24) and Forbes ('90).

HERPOBDELLIDÆ.

*ERPOBDELLA BLAINVILLE.

Erpobdella punctata (LEIDY).

Nephele punctata Leidy ('70).

Nephele lateralis Bristol (in part) ('98).

It has been found impossible to certainly identify this with any of Verrill's species. There is little doubt that *Nephele lateralis* Verrill and *Nephele quadristriata* Verrill are founded on two distinct species which are common in New England and both of which are quite distinct from Leidy's species; but *N. quadristriata* Verrill (not Grube) may be in part synonymous with *E. punctata*.

Diagnosis.—Complete somites quinqueannulate, *b* 6 sometimes slightly larger than the other annuli but not typically divided in the middle by a cross-furrow; pigmented eyes three pairs, the first situated on II, the second and third on IV; genital orifices, male at XII *b* 2/*a* 2, female at XII *b* 5/*b* 6; atrium deeply cleft, the prostate cornua prominent, and the anterior loops of the vasa deferentia reaching to ganglion XI.

General Description.—Bristol ('98) has given an excellent description of the external characters, the annulation, and the neural metamerism of this species, most of which need not be repeated, especially as the external features distinguishing species of this family are mostly slight and obscure. The number and arrangement of the external annuli may be

*Blainville's original spelling is here followed. Blanchard has changed this to *Herpobdella*, and separated the family from the *Hirudinida*.

almost exactly the same in several species, which are nevertheless readily distinguished by other and very obvious characters, and especially by the terminal portion of the male genital ducts.

Erpobdella punctata reaches a large size and has a more robust form than any other of our common nephelids. In preserved specimens the dorsal surface is rougher and the posterior lateral margins thinner than in most other species. The body is very muscular and has a firm feel.

For the purpose of comparison with the species of *Dina* which are described below some features of the complete somites may be mentioned. Of these there are seventeen, VIII to XXIV inclusive. All of the five annuli are of nearly equal size, but *b*6 is frequently slightly enlarged. This is, however, never very obvious, and the annulus is never marked by a transverse furrow except in strongly contracted specimens in which all of the annuli are equally affected. *A*2 is noteworthy as being rougher than the secondary annuli, and its papillae are frequently larger and more numerous, extend further marginally, and are more subject to conrescence into a transverse ridge. When fully extended all of the annuli are free from cross-furrows or wrinkles, but when contracted irregular and interrupted transverse furrows may appear on all of the annuli. These may occur anterior to the papillae only, or both anterior and posterior, in which latter case the annulus is more or less completely divided into three parts, of which the middle bears the principal papillae. Such transient subdivisions must not be mistaken for the true tertiary annuli which appear in *Dina*, etc.

Reproductive Organs.—The external male organ when fully extruded has the form of a low circular disc occupying nearly the entire median width of two annuli. It consists of a marginal rim fitting closely around a transverse elliptical central cushion of about twice the height of the rim. The terminal openings of the sperm-ducts appear well separated on the sides of the cushion.

The testes extend through six and one half somites

(posterior part of XVIII to the anterior part of XXIV). In one specimen in which they were counted the number varied from fifty to sixty on each side of each somite. They are small pyriform or globose bodies grouped about the vas deferens, into which they empty, in most cases by separate ducts. The vas deferens (Pl. XLVII., Fig. 35, *rd*) is an extremely fine, straight tube reaching to ganglion XVIII. At this point the duct suddenly enlarges into a very conspicuous epididymis or sperm-sac (*ss*). This much convoluted tube continues through several somites but gradually diminishes in diameter. By somite XV it has become only one half or one third of its greatest size, and in XIV the convolutions become more open and soon the duct is merely wavy. This region is the ductus ejaculatorius (*de*), which passes forward in a long loop to ganglion XI, at which point it turns sharply mesiad and caudad and returns to the terminal organ. Regarding all of the latter as the atrium, it consists of two more or less elongated curved conical horns (*p*) directed longitudinally. At their bases they rest on a pair of swollen pedestals covered with a layer of prostate glands, which also extend somewhat on to the bases of the cornua themselves. This basal region, the two halves of which embrace the nerve cord between them, may be separated quite to the basal integuments, where each half communicates by a separate orifice with a small bursa. The median part of the atrium appears to be represented by these two basal halves of the cornua.

The ovaries (Pl. XLVII., Fig. 35, *ov*) are a pair of long slender sacs, each doubled on itself, with both ends in somite XII, and the loop reaching far back along the median line, ventral to the alimentary canal, to the neighborhood of ganglion XVII. From somite XIV to somite XVII the two ovarian sacs lie side by side; just anterior to ganglion XIV they diverge, the closed end of each arching upwards around the pharynx; and they end close together, near the median line. The external ends of each, on the other hand, retain their ventral position and join beneath the nerve cord at the common external opening (\mp).

Habits.—The favorite food of this species is small aquatic oligochaetes. Bristol ('98) and Leidy ('70) have given some account of its habits.

DINA R. BLANCHARD.

Dina fervida (VERRILL).

Nepheleis fervida Verrill ('74).

Nepheleis fervida is supposed to have been described from individuals of this species having eight eyes, a variation which frequently occurs. The species here described is abundant in the Lake region from which Verrill's types were taken, and has the size, form, and color of that species.

Diagnosis.—Compleat esomites quinqueannulate, *b* 6 being distinctly enlarged and divided by a cross-furrow into two equal halves; pigmented eyes normally three pairs, the first situated on III; genital orifices at XII *b* 2/*a* 2 and XII *b* 5/*b* 6; median chamber of atrium of medium size and not deeply cleft, the prostate cornua prominent, and the vasa deferentia not reaching anterior to their ends in somite XII.

General Description.—A single small specimen represents this species in the Illinois collections, and the following notes are derived from numerous examples in my own collection received from Ohio and Michigan and from the well-preserved series taken by Professor Reighard during his recent exploration of Lake Erie.

None of the large number of specimens examined reaches a length of much more than two inches. The body is depressed posteriorly; the mouth is relatively large and the lip blunt. The posterior sucker is relatively larger than in most small nephelids, with its anterior margin more broadly free and reaching as far forward as XXV *a* 2. The body is not of particularly firm consistency. The clitellum extends over fifteen annuli, X *b* 5 to XIII *a* 2.

The annulation and metamerism are essentially as in *E. punctata*, except that the first pair of eyes is placed on the third instead of the second annulus, and that in the com-

plete somites *b* 6 is subdivided. In addition to these there are some incipient differences, but they are too minute to be used in this connection. The larger size and subdivision of the annulus *b* 6 is a very obvious and constant character. It is true that many of the other annuli at times show faint cross-furrows, but these lack the constancy, depth, and completeness of the diagnostic one.

Reproductive Organs.—The testes are larger and fewer than in *E. punctata*. In one specimen they average thirty-two to each side of each somite. As in that species, they extend from the posterior part of XVIII to XXIV. The vasa deferentia (*vd*), sperm-sacs (*ss*), and the greater part of the ducti ejaculatorii (*de*, Pl. XLVII., Fig. 36) exhibit no important differences; but the anterior ends of the latter stop short at the anterior limit of somite XII, where they join the apical ends of the prostate cornua. When the copulatory organ is fully retracted the ducti form no loops whatever anterior to these cornua; but when it is protruded the latter are drawn somewhat caudad, leaving a short sweep of the ductus anterior to it on each side. The prostate cornua (*p*), though prominent, are shorter than in *E. punctata* and diverge more widely laterally. A third important difference is found in the presence of a well-developed median atrial chamber (*at*). This is quite undivided in the median line, where the nerve cord, instead of sinking between two separated lobes, is raised some distance above the body floor. The prostate glands cover the dorsal portion of this chamber as well as the bases of the prostate cornua.

The protruded male copulatory organ differs in some details from that of *E. punctata*. It is relatively larger and especially higher. It is supported on a broad pedicle which projects freely through the male pore. Around the entire edge of the disc is a groove which divides it into a proximal and distal circular ridge. The latter bears a delicate ring-like flange which probably corresponds to the muscular border here present in *E. punctata*. The central cushion is subcircular, and instead of two widely separated openings has

a single large crescentic one, into the deep ends of which the prostate cornua open.

The female organs present no important differential characters, although the ovaries (*ov*) of all of the specimens dissected reached to ganglion XVIII.

Color.—Living specimens, according to Verrill's description and a water-color sketch sent me by Professor Reighard, are pale red with some darker cloudings.

Preserved specimens may be separated into two groups according to the amount of pigment present. One group, which includes the smaller and a portion of the larger ones, lacks pigment entirely; the other, which includes most of the larger examples, has the dorsal surface marked with more or less numerous minute black flecks which differ greatly in number and somewhat in arrangement. Many specimens have so little pigment as to appear light-colored, with a faint dark band on either side of a median clear band; in others the dark bands are very broad; and still others appear quite dark, the pigment specks being very numerous and close and extending continuously over the median region. In all cases the margins, including the region of the lateral vessels, are unpigmented; and in no case does the pigment assume any other form than that of minute flecks more or less closely placed.

***Dina microstoma* sp. nov.**

Diagnosis.—Complete somites quinqueannulate, *b* 6 enlarged and subdivided; first pair of eyes in III; male orifice at XII *b* 2 *a* 2, female orifice at XII, XIII; median chamber of atrium relatively large and without median groove: prostate cornua inconspicuous, shorter than diameter of median chamber; vasa deferentia lacking anterior loop and ending abruptly at the atrium.

General Description.—This is a generally slender species. Well-preserved specimens are nearly terete and in extension linear. An average specimen measures:—

	mm.
Total length,	42.
Length to male pore,	10.
Width at male pore,	3.4
Greatest width (middle),	4.2
Width at anus,	3.5
Depth at male pore,	about 1.5
Depth at middle,	about 2.
Depth at anus,	1.2
Diameter of posterior sucker,	2.5

The width is greatest at about the middle of the body but varies little in the entire postclitellal region. The margins of the body are rounded except just about the anal region, where lateral flanges begin at about XXIII and become more and more prominent until they terminate in a pair of thin expansions which embrace the base of the sucker. A curious feature which appears in a great many specimens is a short contracted region just behind the clitellum, where the body becomes perfectly terete and bellies ventralward. From the genital region forward the body tapers quite rapidly to a point just posterior to the mouth and then rapidly contracts into the narrow lip. As in nephelids generally, the entire body is covered with small sensory papillae arranged in zones on every annulus.

The mouth is small, even in specimens which have been killed in a much relaxed condition. In most specimens the upper lip is extended, slender, and prominent, and is often most sharply distinguished from the succeeding annuli by a deep furrow which passes behind the postoral ring. Dorsally it is smooth, divided into distinct but very narrow rings, and provided around the margins very richly and above sparingly with labial sense organs.

There are three pairs of eyes, of which the first are the largest and are situated on somite III, instead of on II as in most nephelids. Sometimes one or each of these is represented by two. The second and third pairs are on IV, the dorsalmost slightly in advance.

The male gonopore is situated as usual at XII *b* 2 *a* 2, the female at XII XIII, three annuli consequently intervening. The former is a large and conspicuous opening usually surrounded by a thin integumental disc which spreads over about one half of the contiguous annuli. The female pore is small and usually concealed. A strongly developed clitellum is generally present. It is thick both dorsally and ventrally, sharply defined, and extends over fifteen annuli, from X *b* 5 to XIII *b* 2. The nephridiopores are as usual.

Even for a nephelid the posterior sucker is weak and small. It is very broadly attached, with scarcely any free margin anteriorly, where it reaches only as far forward as XXVI. Eight low radiating ridges or lines of papillæ disposed in pairs mark its upper surface. Anus large, with a much wrinkled margin, XXVI XXVII.

Annuli and Somites.—The external features of metamerism in this species differ but little from those of *E. punctata*, but as Bristol has adopted another standard of enumeration in his description of that species it seems best to give a brief account of the present species.

I is the wide anterior region of the lip.

II is a narrow preocular annulus bearing one row of sensory papillæ.

III is a single wide annulus faintly subdivided and bearing a complete row of sense organs posteriorly and an incomplete row anteriorly. The large pair of eyes are on its extreme anterior part and are separated by a distance of about three times their width.

IV is biannulate, the first ring being distinctly subdivided and separated from the second dorsally but united to it ventrally. In many cases its posterior furrow is very deep and limits the head region as noted above. The second group of eyes is borne by this somite, the ventral pair being on the furrow *a* 2 *a* 3, the dorsal just in advance of it.

V is also biannulate, the first annulus bearing two rows of sense organs and being somewhat wider than the second.

VI is triannulate. *a* 1 and *a* 3 are each slightly wider than

a 2, bear two rows of sense organs, and are faintly divided marginally.

VII is quadriannulate, the fourth annulus being double; but as none of the other annuli show any indication of further division the formula is regarded as $b\ 1 + b\ 2 + a\ 2 + (b\ 5 + b\ 6)$.

VIII to XXIII inclusive are complete somites. In these the relative widths of the annuli and the subdivision of *b* 6 are not such constant and obvious features as in *Dina ferrida*, but careful measurements of a large number of cases show the approximate equality of the first four annuli, while *b* 6 proves to be about twenty per cent. larger. In many of the best-preserved specimens this relative proportion appears with great constancy and regularity, but in others is more or less obscured. In well-extended specimens a dividing furrow cuts *b* 6 approximately into two equal sub-rings, but in contracted examples this is also obscured by the development of transient wrinkles as described for *E. punctata*. Of the more distinct sensory papillæ there are on each ring from fourteen to eighteen above and about an equal number of smaller ones below. These are arranged in an irregular transverse row along which smaller sense organs are scattered. Frequently a median longitudinal dorsal tract is entirely free from them, and they always become more evident marginally. On *a* 2 the papillæ are usually more prominent, especially so, as Bristol has observed, on some of the posterior somites. On *b* 6 two rows of papillæ appear. These are especially distinct at the margins of large individuals.

XXIV is sometimes complete, and is always quinqueannulate so far as observed. In most cases it differs from the complete somites only in the relatively smaller size of *b* 6 and the tendency, sometimes quite evident, for *b* 5 and *b* 6 to unite on the ventral side.

XXV is usually quadriannulate, sometimes only triannulate, but it has been found impossible to find any inherent clue to the exact values of the annuli. Analogy with other species would point to the first form as being composed of $b\ 1 + b\ 2 + a\ 2 + a\ 3$; the second, of $a\ 1 + a\ 2 + a\ 3$.

XXVI is biannulate, the wide anterior annulus showing

two rows of papilla. The anus cuts the second, which bears but very few papillæ. XXVII is postanal and biannulate.

Reproductive Organs.—The numerous small testes are found in somites XVIII to XXIII, but their number was not determined. The vasa deferentia, sperm-sacs, and ducti ejaculatorii are sufficiently indicated in the figure (Pl. XLVII, Fig. 37). The latter end abruptly, without any preatrial loop whatever, at the prostate horns, into the ends of which they empty.

The atrium is a very characteristic one and differs from that of any other species of American nephelid which I have examined. It may be remarked in passing that the efferent male apparatus of this species and *Dina ferrida* have many characters in common which distinguish them from *D. mexicana* Dugès, which Blanchard regards as being co-specific with the type of the genus. The median chamber (*at*) is a thick-walled sac of relatively large size. It stands up prominently from the body floor, raising the nerve cord with it and barely marked by a median groove. Its transverse diameter is much greater than the antero-posterior and about equal to its height, but in immature specimens the organ is spherical.

The prostate cornua (*p*) are small,—when straightened, less than the shortest diameter of the median chamber,—and their attachments are far apart on the dorsal surface of this chamber, with which they remain in close contact as they curve strongly ventrad on each side. At their lowest point at the sides they become continuous with the ducti ejaculatorii as above described.

The ovaries (*ov*) present no peculiar features, and their form and relations are sufficiently indicated in the figure.

Color.—Not one of many examples of both young and old shows any pigment. This would indicate that during life they are red, the color of the blood showing through the integuments.

Small tubificid worms have been found in the stomachs of those examined.

Note on Discodrilidæ.—The collection sent me includes three bottles of *Discodrilidæ* comprising altogether about sixty specimens of *Bolledrilus philadelphicus* (Leidy) Moore. This species was originally described by Leidy under the name of *Astacobdella philadelphia* in the Proceedings of the Philadelphia Academy of Sciences for 1851, page 209. Some additional notes on it may be found in two papers by Moore in the "Journal of Morphology," Vol. X., page 498, and Vol. XIII., page 327 et seq. The Illinois specimens were taken from the exterior of *Cambarus diogenes* and *C. blandingii*.

University of Pennsylvania, August, 1900.

BIBLIOGRAPHY.

Apathy, Stefan.

- '88. Analyse der äusseren Körperform der Hirudineen. Mittheil. Zool. Station Neapel, Bd. VIII., pp. 153-232.

Blanchard, Emile.

- '49. Gay's Historia fisica y politica de Chile. Zoologia, Tomo III., pp. 43-50. Paris.

Blanchard, Raphael.

- '92. Description de la Glossiphonia sexoculata (Bergmann). Bull. Soc. Zool. de France, Vol. XVII., pp. 178-182.

- '96. Hirudineés de la Prusse Orientale. Bull. Soc. Zool. de France. Vol. XXI., pp. 118-120.

- '96a. Viaggio del dott. A. Borelli nella Republica Argentina e nel Paraguay, Hirudineés. Boll. Mus. Zool. Anat. comp. R. Univ. di Torino, Vol. XI., N. 263, pp. 1-24.

Bristol, C. L.

- '98. The Metamerism of Nephelis. Journ. Morph., Vol. XV., pp. 17-72.

Brooks, W. K.

- '82. Handbook of Invertebrate Zoölogy, pp. 160-167. Boston.

Castle, W. E.

1900. The Metamerism of the Hirudinea. Proc. Amer. Acad. Arts and Sciences, Vol. XXXV., pp. 285-303.

Forbes, S. A.

- '90. An American Terrestrial Leech. Bull. Ill. State Lab. Nat. Hist., Vol. III., pp. 119-122.

Graf, Arnold.

- '99. Hirudineenstudien. Abh. der Kaiserl. Leop.-Carol. Deutschen Akad. der Naturf., Bd. LXXII., pp. 213-404.

Leidy, Joseph.

- '68. Notice of some American Leeches. Proc. Acad. Nat. Sci. Phila., 1868, pp. 229, 230.

- '70. Description of Nephelis punctata. Proc. Acad. Nat. Sci. Phila., 1870, p. 89.

Moore, J. Percy.

- '98. The Leeches of the U. S. National Museum. Proc. U. S. Nat. Mus., Vol. XXI., pp. 543-563.

1900. A Description of *Microbdella biannulata* with especial regard to the Constitution of the Leech Somite. Proc. Acad. Nat. Sci. Phila., 1900. pp. 50-73.

Moquin-Tandon, A.

- '46. Monographie de la famille des Hirudinées. Paris, 2d ed., 1846.

Philippi, R. A.

- '72. *Macrobdella*, ein neues Geschlecht der Hirudineen. Zeitsch. für die gesamt. Naturwiss. (2), Bd. VI., pp. 439-442.

Say, Thomas.

- '24. Narrative of Expedition to the Source of the St. Peter's River, etc., Vol. II., Appendix, pp. 266-268. Philadelphia.

Verrill, A. E.

- '74. Synopsis of the North American Fresh-water Leeches. Rep. U. S. Comm. of Fish and Fisheries for 1872-73, pp. 666-689.

Whitman, C. O.

- '86. The Leeches of Japan. Quar. Journ. Micr. Sci., Vol. XXVI., pp. 317-416.

- '92. The Metamerism of *Clepsine*. Festschr. zur 70 ten Geburtstage R. Leuckart's, 1892, pp. 385-395.

EXPLANATION OF PLATES.

The somites and ganglia are indicated by Roman numerals I to XXVII; and the annuli of individual somites by letters (*a*, *b*, etc.) which indicate the successive generations by which they multiply from the triannulate type, the indices (1, 2, etc.) being their theoretical number in an antero-posterior series.

With the exception of a few modifications which are explained in the text the lettering is uniform for all of the figures.

The metameric sensille: *md*, dorso-median; *dl*, dorso-lateral; *dm*, dorso-marginal; *sm*, supra-marginal; *sbm*, sub-marginal; *vl*, ventro-lateral; *vm*, ventro-median.

The cutaneous papilla: *mp*, median; *mdp*, dorso-median; *dip*, dorso-lateral; *dmp*, dorso-marginal; *smp*, supra-marginal.

General: *a*, anus; *at*, median atrium or penis sheath; *atf*, internal elevation resulting from male pit (false atrium), covered by a layer of copulatory and prostate glands; *ati*, lumenal coat and sac of atrium; *c*, clitellum; *egl*, copulatory glands; *egp*, copulatory gland pores, ♂ of male and ♀ of female system; *de*, ductus ejaculatorius (variously modified and not always strictly homologous as indicated in the several figures); *ep*, epididymis (remark under *de* applies to this also); *g*, cutaneous glands; *g* XI to XVIII, ganglia of the ventral chain, numbered to agree with their somites; *gp*, (or *pg*), prostate glands and prostate region of penial sheath; *ga*, glandula albuginea; *np* 1 to 17, nephridial openings of pairs indicated by the numerals; *od*, oviduct; *ode*, common oviduct; *of*, closed end of ovarian sac; *os*, ovisac (uterus); *ov*, ovary or ovarian sac; *ov'* (in Fig. 27), position of ovary; *p*, prostate cornua of atrium; *pg* (or *gp*), prostate glands and prostate region of penial sheath; *ss*, sperm-sac; *t* 1, 2, etc., testes, numbered by pairs from before backwards; *va*, vagina; *vd*, vas deferens; ♂, male genital orifice or its position; ♀, female genital orifice or its position.

Unless otherwise stated all of the figures are made from specimens in the Illinois collection and have been copied to scale as nearly as possible after the originals, which were drawn upon camera tracings. Diagrams are indicated.

PLATE XLII.

FIG. 1. *Placobdella parasitica*. Dorsal view showing the metamerism and annulation of the twelve anterior somites: the cutaneous papillae are not indicated. The color pattern is shown, the stippled parts being the brown or olive background and the plain areas the yellow spots and band. × 5.

FIG. 2. *Placobdella rugosa*. Similar representation of the anterior ten somites (except X a3). The principal cutaneous papillae are shown. From a specimen taken near Philadelphia. × 5.

FIG. 3. *Placobdella rugosa*. Details of papillation, etc., of the right half of the dorsal surface of somite XIX of a large example. The lines to the right indicate the relative positions of the ventral furrows. $\times 5$.

FIG. 4. *Placobdella parasitica*. A similar view of onehalf of somite XIX, but of a much smaller specimen. $\times 5$.

FIG. 5. *Hemiclepsis carinata*. The principal features of the external morphology of the dorsum of somites I to XII. Drawn mostly after a specimen from Venice, Ohio, and very slightly diagrammatic. $\times 4.5$.

FIG. 6. *Glossiphonia lineata*. A slightly diagrammatic figure showing the external morphology of the dorsum of somites I to X. The annulation is originally derived from young; the sensillæ and papilla added as determined in adults. The young, $\times 30$.

FIG. 7. *Haemopis marmoratis*. Surface view of denticles from median jaw. $\times 112$.

PLATE XLIII.

Actinobdella inequiannullata.

FIG. 8. The dorsal external morphology of the entire leech (somites XIII to XXI) omitted. Somewhat diagrammatic in that the furrows are made to appear more regular than in the original. $\times 35$.

FIG. 9. Side view of the posterior end, showing the sucker with some of its papillæ projecting. $\times 35$.

FIG. 10. Outline of the sucker from below, with the circle of papillæ somewhat diagrammatically shown. $\times 35$.

FIG. 11. A small portion of the sucker rim showing the muscular ribs and four of the papillæ. The glandular ducts of the latter are stippled. $\times 130$.

PLATE XLIV.

Philobdella gracile.

FIG. 12, 13. Dorsal and ventral views respectively of the anterior nine somites, showing the chief features of external morphology. $\times 5$.

FIG. 14, 15. Ventral and dorsal views respectively of the posterior end of the body; the dark spots are outlined. $\times 5$.

FIG. 16. The ventral surface of somites XII and XIII showing the various features of the region of the genital orifices. A combination drawing from several specimens. $\times 5$.

FIG. 17. Reproductive organs dissected and partly displayed. $\times 4$.

FIG. 18, 19. Posterior and anterior ends respectively from the left side. $\times 5$.

FIG. 20. Surface view of a posterior portion of the tooth series of the median jaw with the outline of the jaw partly shown. $\times 56$.

FIG. 21. Female reproductive organs dissected and viewed from the right side. From the same dissection as figure 12. $\times 4$.

PLATE XLII.

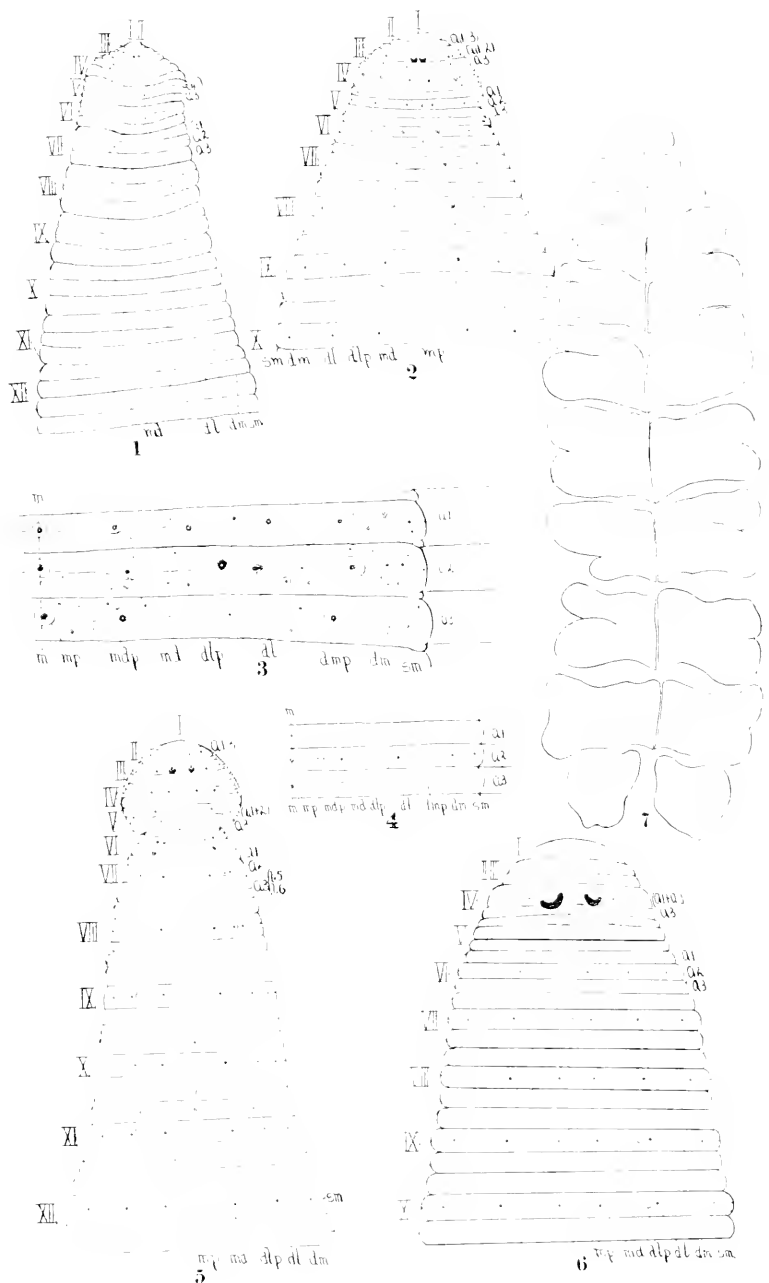

GLOSSIPHONIDÆ HIRUDINIDÆ.

PLATE XLIII

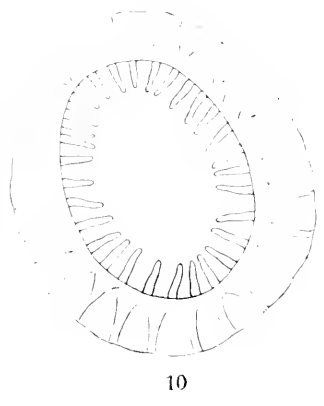
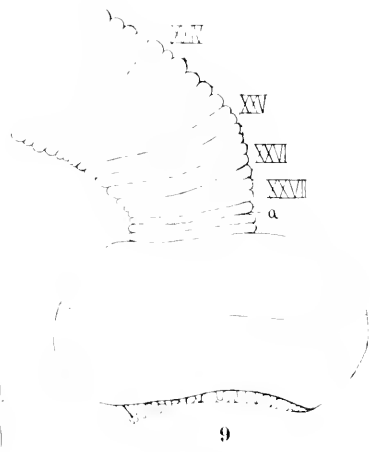
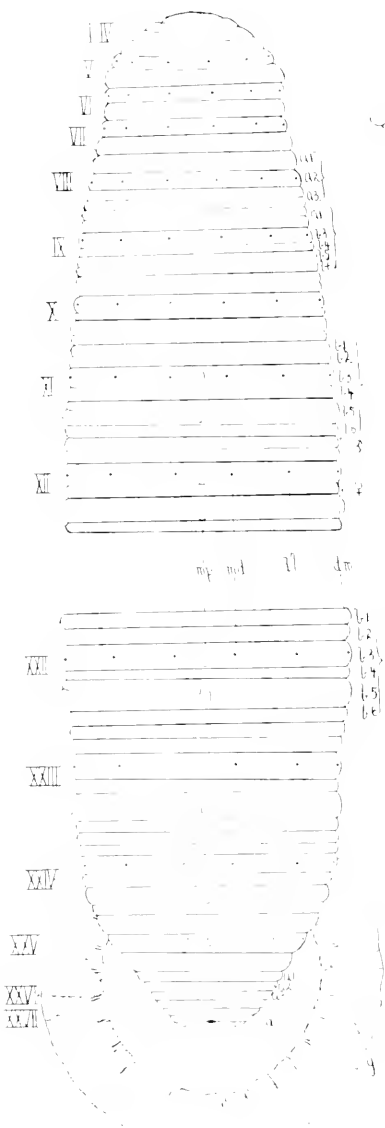

ACTINOBDELLA INAEQUIANULATA.

PLATE XLV.

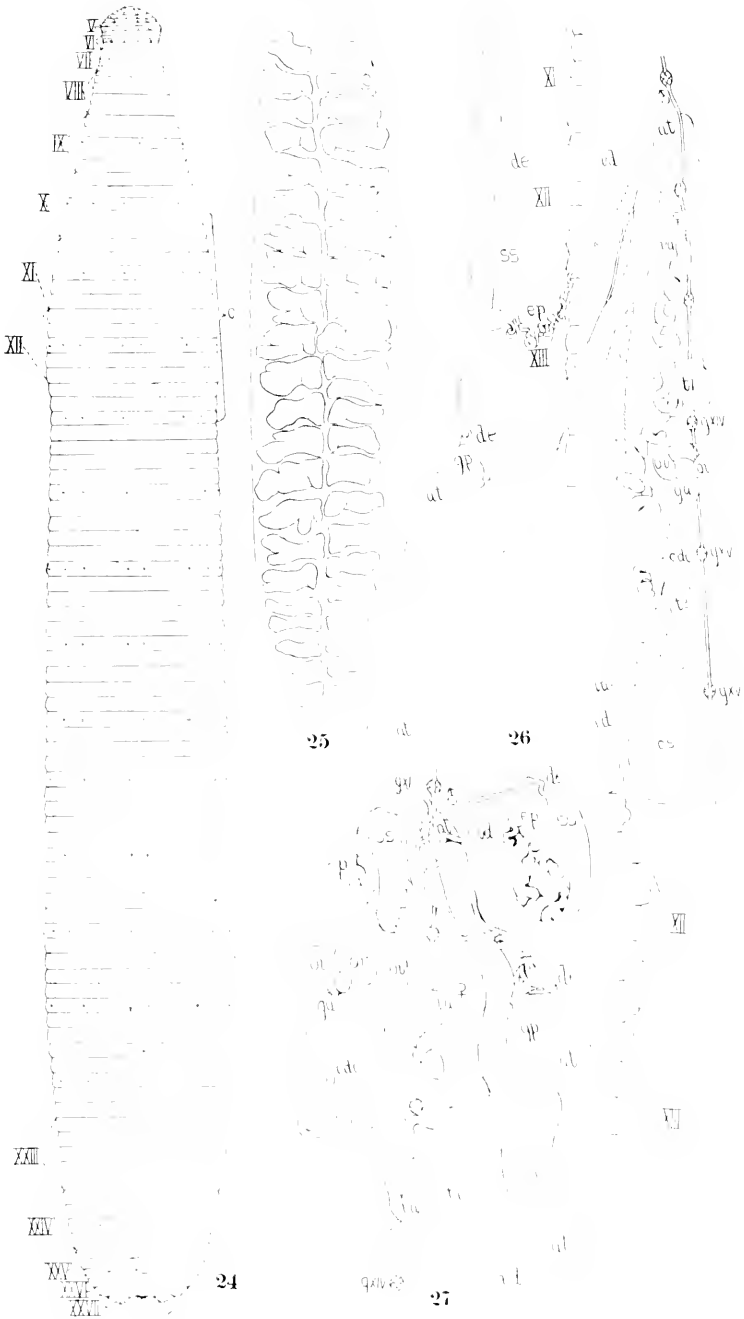

HEMIPIS MARMORATIS, H. LATERALIS.



PLATE XLVI.

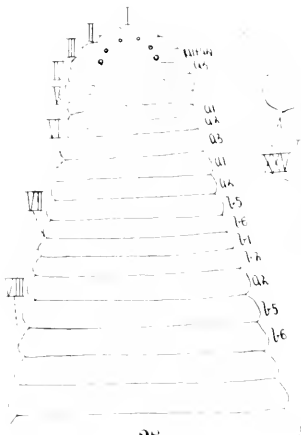

28

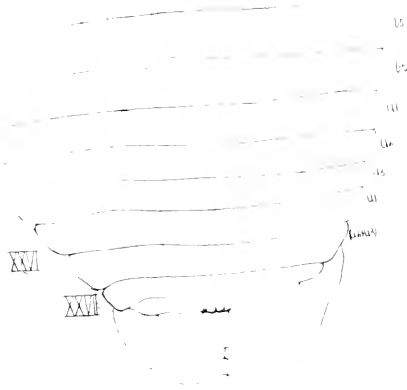

31

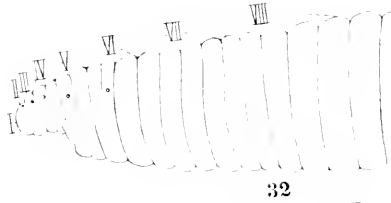

32

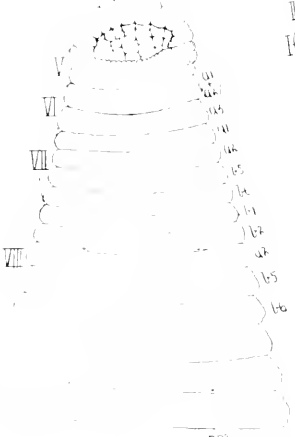

29

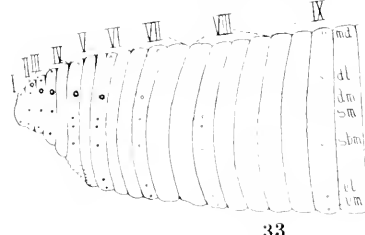

33

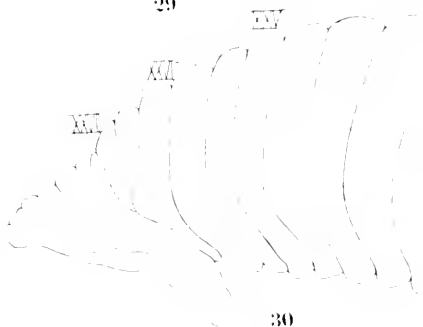

30

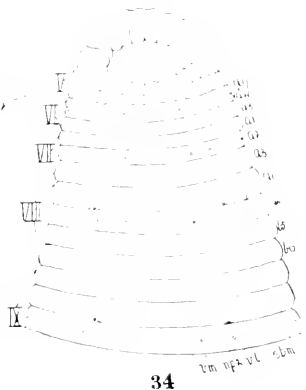

34

HEMOPIS MARMORATIS, H. LATERALIS.

PLATE XLVII.

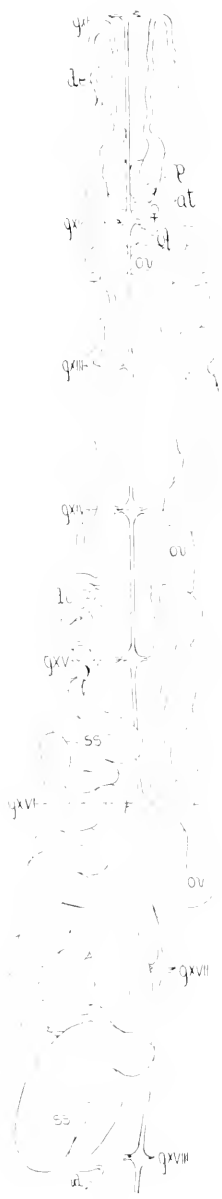

35



36



37

Macrobdella decora.

FIG. 22. The male organs dissected and viewed from the right side. The left sperm-duct has its natural position, the right has been displaced upwards. The dotted line indicates the form of the atrium before the removal of a layer of muscles and prostate glands. $\times 4$.

FIG. 23. The greater part of the reproductive organs dissected and viewed from above. From a specimen from the Fulton Lakes, New York. $\times 4$.

PLATE XLV.

FIG. 24. *Hamopis marmoratus*. Diagram of the entire dorsal annulation, showing also the sensilla, eyes, etc. $\times 2$.

FIG. 25. *Hamopis lateralis*. Surface view of denticles of median jaw. $\times 112$.

FIG. 26. *Hamopis marmoratus*. Reproductive organs dissected and partly displayed in dorsal view. The female organs are shown nearly in situ: the atrium with the left ductus ejaculatorius and epididymis has been displaced far to the left and only a portion of the right ductus is shown: three testes of the left side are included. $\times 3.5$.

FIG. 27. *Hamopis lateralis*. Reproductive organs dissected and displayed as in figure 26. The ovaries and oviducts are displaced to the left, but the proper position of the left ovary is indicated in outline *orl.* The atrium is withdrawn somewhat to the right and the epididymes and ducti ejaculatorii of both sides are shown, as well as the anterior end of the right vas deferens and the first testis $\times 3.5$.

PLATE XLVI.

FIG. 28, 29, 32. *Hamopis lateralis*. Dorsal, ventral, and left lateral views respectively of the anterior eight \pm somites. $\times 5$.

FIG. 30, 31. *Hamopis lateralis*. Right lateral and dorsal views respectively of the posterior end. $\times 5$.

FIG. 33, 34. *Hamopis marmoratus*. Respectively left lateral and ventral views of somites I to VIII and part of IX.

PLATE XLVII.

The three figures of this plate represent similar dorsal views of dissections which were selected because of the equality in size and apparent equality of sexual activity of the individuals. In each case almost exactly the same extent of body is represented, as indicated by the numbered ganglia, and the somites containing the testes are omitted. All, $\times 7.5$.

FIG. 35. *Eryobdella punctata*. The left ovary and the right sperm duct have been removed.

FIG. 36. *Dina ferrida*.

FIG. 37. *Dina microstoma*.

7710

BULLETIN

OF THE

Illinois State Laboratory

OF

NATURAL HISTORY,

URBANA, ILLINOIS.

VOLUME V.

*CONTRIBUTIONS TO A KNOWLEDGE OF THE NATURAL
HISTORY OF ILLINOIS.*

1897-1901.

Illinois State Laboratory of Natural History,
Urbana, Ill.
1902.

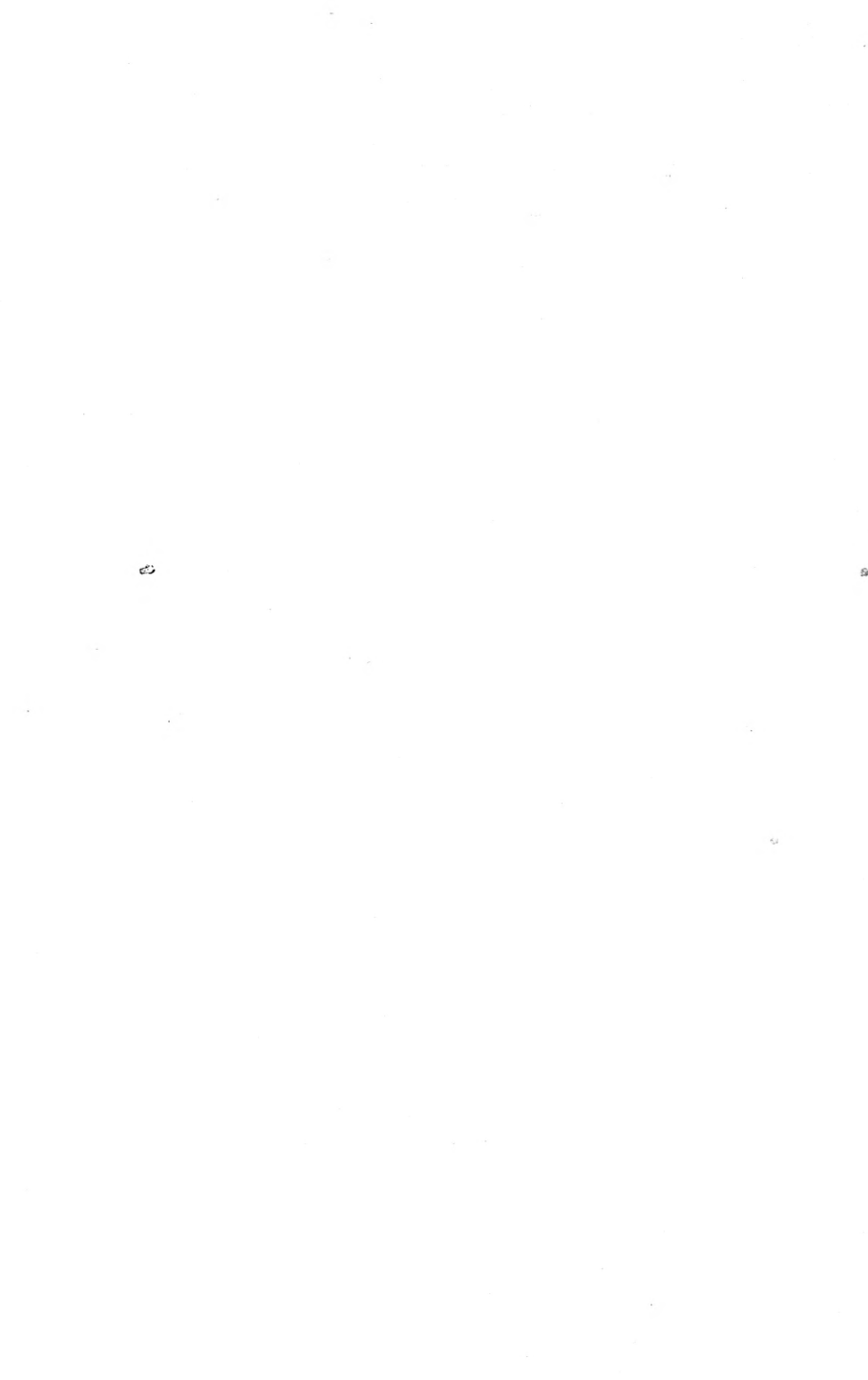

INDEX.

A

- abnormipes, Atax, 408.
Acanthodrilidae, 444.
 found in Illinois, 442.
Acineta, 342.
 food of, 311.
 mystacina, 342.
 food of, 342.
Acinetidae, 341.
Actinastrum, 421.
Actinobdella, generic characters
 of, 504.
 inequiannulata, 504 508.
 annuli and somites of, 506 508.
 color of, 508.
 diagnosis of, 504.
 general description of, 504 506.
Actinophrys, 321.
 sol, 313, 322.
Actinosphaerium, 322.
 eichhornii, 313, 322.
Actinurus neptunius, 363.
aculeata, Anuraea, 353, 355, 383.
 Centropyxis, 320.
 Diffugia, 313, 314, 320.
 valga, Anuraea, 383.
acuminata, Diffugia, 313, 319.
 Metopidia, 377.
 Notholca, 353, 355, 383.
 Trachelomonas, 313, 325.
acus, Euglena, 313, 324.
Adinetidae, 357.
Æolosoma, 443.
 hemprichii, 443.
 tenebrarum, 443.
Æolosomatidae found in Illinois,
 443.
affinis, Cyclops, 29, 65.
 Temora, 225.
 Temorella, 225.
 agilis, Cyclops, 29.
 Fridericia, 442.
Alasmodonta, capacity for infesta-
 tion exhibited by, 414.
 complanta, 401, 403.
 parasites of, 400, 410, 412, 416.
 confragosa, 401, 403, 412.
 parasites of, 400, 410.
 marginata, 401, 403.
 parasites of, 408, 409, 410, 412,
 416, 417.
 rugosa, 401, 403, 410, 412.
 parasites of, 408, 409, 410.
 tappaniana, 401, 403.
 parasites of, 409.
 undulata, 401, 403.
 parasites of, 409.
alatus, Lampsilis, 401, 403, 408, 409,
 410, 412, 413, 414, 416.
 Unio, 403.
albidus, Cyclops, 29, 47, 62, 63, 64.
alboflavicans, Megalotrocha, 361.
albuquerqueensis, Diaptomus, 08,
 101, 113, 115, 146, 179, 183, 184.
Algae eaten by Monostyla cornuta,
 375.
 filamentous, as food of Euchla-
 nis, 374.
alienum, Lecanium hesperidum, as
 located on authority of Green,
 393.
alveolata, Euglypha, 321.
Allobophora, 440.
 as food of Philobdella gracile,
 518.
 caliginosa trapezoides, 442.
 fertida, 441.
 giesleri, 442.
 mucosa, 441.
 profuga, 441.

- Allobophora—*Continued.*
 rosea, 441.
 sp., 412.
 turgida, 442.
alpestris, Sutroa, 463.
ambiguus, Diaptomus, 177.
Amblyophis, 325.
 viridis, 325.
 American Naturalist cited, 233, 263,
 266, 267.
americanus, Cyclops, 37, 38, 42.
Amœba, 305, 306, 314, 317, 421.
 food of, 311.
 proteus, 317.
 radiosum, 317.
 Amœbidae, 314, 317.
Amphaskandria, 102.
Amphileptinae, 331.
Amphileptus, 331.
 anser, 331.
 amygdali, Diaspis, 398.
 ancylus, Aspidiotus, 398.
 angularis bidens, Brachionus, 354,
 381.
 Brachionus, 353, 354, 380, 421.
Animalcule, bell, 309, 338.
 slipper, 332.
Animalcules, sun, 321.
 swan, 331.
Amelida, 356.
Amelids as food of *Glossiphonia*
 complanata, 493.
 of *Glossiphonia stagnalis*,
 498.
annulatus, Cyclops, 33, 35.
annulosa, Taphrocampa, 369.
Anodonta, capacity for infestation
 exhibited by, 413.
 corpulenta, 401, 403.
 parasites of, 405, 408, 409, 410,
 412, 413, 415, 416.
 edentula, 403.
 grandis, 401, 403, 406.
 parasites of, 409, 416.
 imbecilis, 401, 403.
Anodonta imbecilis *Continued.*
 parasites of, 408, 409, 410, 412,
 413.
 parasites of, 405.
 plana, 403, 406.
 suborbiculata, 401, 403.
 parasites of, 405, 408, 409, 410,
 411, 412, 413.
anodontæ, *Conchophthirus*, 333,
 407.
anodontoides, *Lampsilis*, 401, 403,
 406, 408, 409, 410, 412, 413, 416.
 Unio, 333, 403.
anser, *Amphileptus*, 331.
 Dileptus, 332.
Anthophysa, 322.
 vegetans, 323.
Anuraea, 274, 352, 382.
 aculeata, 355, 383.
 seasonal distribution of, 353.
 valga, 383.
 cochlearis, 355, 383.
 as food of rotifers, crotchie,
 and catfish, 351.
 eaten by *Asplanchna bright-*
 wellii and *A. herrickii*, 364,
 365.
 seasonal distribution of 353.
 hypelasma, 382.
 serrulata, 383.
 tecta, 354, 382.
 as food of rotifers, 351.
 eaten by *Asplanchna bright-*
 wellii and *A. priodonta*, 364,
 365.
 seasonal distribution of, 353.
Anuraeidae, 359, 382.
Apathy, Stefan, Analyse der äus-
 seren Körperform der Hirudi-
 neen, cited, 479.
Aphrothoraca, 315, 321.
Apiomorpha spp., changes in sy-
 nonymy of, 393.
Apstein, C., 6, 7.

Apstein, C.—*Continued.*

- Das Plankton des Süßwassers und seine quantitative Bestimmung, cited, 2, 3, 4, 5, 8.
- Das Süßwasserplankton, Methode und Resultate der quantitativen Untersuchung, cited, 2, 3, 4, 5.
- Ueber die quantitative Bestimmung des Plankton im Süßwasser, cited, 3, 4, 5.
- aptera, Polyarthra, 367.
- arbuscula, Zoothamnium, 330.
- Arcella, 305, 306, 312, 318, 421.
dentata, 313, 314, 318.
food of, 311.
vulgaris, 313, 314, 318.
angulosa, 313, 314, 318.
discoides, 313, 314, 318.
- Arcellidae, 315, 318.
- arcuata, Atax, 408.
- areolatus, Gomphogaster, 368.
- armata, Trachelomonas, 325.
- armatus, Diaptomus, 133, 135, 136.
- Aromochelys odoratus, Opercularia irritabilis found on, 340.
Tokophrya quadripartita recorded from, 342.
- articulata, Opercularia, 340.
- Asellus, Carchesium granulatum found on, 330.
- ashlandi, Diaptomus, 98, 100, 111, 120, 124, 158, 167, 183, 260, 265.
- asperrima, Quadrula, 401, 403, 408, 409, 410, 412, 414.
- asperrimus, Unio, 403.
- Aspidogaster, 410, 414.
conchicola infesting Unionidae, 404.
infesting Lampsilis ellipsis, 405.
Lampsilis gracilis and L. ventricosus, 411.
Unionidae, 408, 409, 411, 412, 413, 415, 416.
- Aspidiotus ancylus, resemblance to Diaspis snowi, 308.
eucalypti as variety of A. perniciosus, 306.
hederae, synonymy of, 305.
as type of Evaspidiotus, 305.
ostreaformis, resemblance of, to Diaspis piricola, 308.
perniciosus, synonymy of, 306.
- Aspirotricha, 307, 316, 332.
- Asplanchna, 344, 347, 364, 365, 421.
brightwellii, 354, 355, 364.
food of, 351, 364.
Codonella cratera as food of, 336.
ebbesbornii, 354, 364.
type of trophi of, 345.
girodi, 365.
herrickii, 354, 365.
food of, 351, 365.
parasites of, 365.
priodonta, 354, 364, 365.
food of, 351, 365.
- Asplanchnidae, 357, 364.
seasonal distribution of, 352.
- Asplanchnopus, 365.
Codonella cratera as food of, 336.
myrmeleo, 365.
food of, 351, 365.
quantity of food taken by, 345.
- Astacobdella philadelphica, 542.
- Asterionella, Diplosiga frequentissima found on, 328.
rays of, eaten by rotifers, 351, 364, 365.
- Astrosiga, 328.
radiata, 329.
- asymmetricus, Mesopodrilus, 442, 468, 472, 473, 474, 475.
- Atax abnormipes infesting Unionidae, 408.
arcuata infesting Unionidae, 408.
fossulatus infesting Unionidae, 408.
indistinctus infesting Unionidae, 408.

- Atax* — *Continued*.
 infesting Unionidæ, geographical distribution of, 414, 415.
serratus infesting Unionidæ, 408.
 spp. infesting Unionidæ, 407, 408, 409, 411, 412, 413, 414, 416.
stricta infesting Unionidæ, 408.
ypsilophorus infesting Unionidæ, 408.
ater, Cyclops, 29, 49, 62, 64.
Aulastomum lacustre, 510.
aurelia, Paramæcium, 307, 313, 332.
aureus, Volvox, 276, 285, 287, 438.
aurita, Eosphora, 324, 370.
Notommata, 360.
australe, *Celostoma*, 390.
- B**
- bacillifer*, *Diaptomus*, 107.
bakeri, *Brachionus*, 353, 380, 421.
brevispinus, *Brachionus*, 380
barretti, *Stentor*, 313, 334.
 Barrois, Thu., and Daday, E. v., description of *Brachionus caudatus*, cited, 381.
Bdelloidrilus philadelphicus, 542.
 found on *Cambarus blandingii* and on *C. diogenes*, 542.
Bdelloida, 356, 357, 358, 362.
 Beddard, F. E., A Contribution to the Anatomy of *Sutroa*, cited, 463.
 A Monograph of the Order of *Oligochaeta*, cited, 441.
 on spermiducal structures of *Sutroa alpestris*, 463.
 Bell animalcule, 399, 338.
 Benham, W. B., Note on a New Species of the Genus *Nais*, cited, 447.
 Berlese and Leonardi's synonymy of *Aspidiotus hederæ*, 395.
Bibliotheca Zoologica, cited, 250.
bicolor, Cyclops, 29, 62, 63, 64.
bicornis, *Mastigocerca*, 371.
bicristata, *Mastigocerca*, 352, 371.
bicuspidatus, *Colurus*, 376.
 Cyclops, 29, 30, 44, 53, 62, 63, 64.
bidens, *Brachionus*, 381.
bioculata, *Hirudo*, 497.
 Biological Experiment Station established by the University of Illinois and the Illinois State Laboratory of Natural History, 30. (See also Biological Experiment Station of the University of Illinois, and Biological Station, Illinois, of the University of Illinois, Methods and Apparatus in Use in Plankton Investigation at the, 1—25.
 Station, Illinois, 28, 63, 137, 146, 220, 233, 234, 390, 418, 441, 479.
Bipalpus lynceus, 368.
biraphis, *Diglena*, 371.
 Birge, E. A., 173.
birgei, *Diaptomus*, 99, 108, 117, 172.
bisetosus, Cyclops, 29.
 Blainville, H. D. de, 532.
 Blanchard, Raphael, 480, 532.
Hirudinées de la Prusse Orientale, cited, 493, 498.
 on *Dina mexicana*, 541.
 on situation of male pore in *Glossiphonia triserialis*, 493.
blandingii acutus, *Cambarus*, 340, 342.
Cambarus, 542.
 Bogue, E. E., description of *Cocceidæ* by, cited, 380.
 Borgert, A., Ein einfaches Netz zum Fischen von Plankton bei schneller Fahrt, cited, 8.
Bosmina, 274, 421.
 as food of *Asplanchna herrickii*, 395.
Bothrioneuron vejtdovskyanum, 452.
 Brachionidæ, 359, 378, 420, 421.

- Brachionus, 274, 347, 352, 378.
 angularis, 354, 380, 421.
 bidens, 354, 381.
 seasonal distribution of, 353.
 bakerei, 380, 421.
 brevispinus, 380.
 seasonal distribution of, 353.
 bidens, 381.
 caudatus, 381.
 dorcus, 354, 379.
 spinus, 354, 379.
 seasonal distribution of, 353.
 militaris, 355, 381, 421.
 eaten by *Asplanchna herrieki*,
 351, 395.
 seasonal distribution of, 353.
 mollis, 354, 378.
 pala, 354, 355, 378.
 seasonal distribution of, 353.
 varieties of, 378.
 punctatus, 354, 379, 421.
 seasonal distribution of, 353.
 rubens, 379.
 urceolaris, 379.
 seasonal distribution of, 353.
 type of trophii of, 345.
 variabilis, 354, 380.
 bractea, *Metopidia*, 377.
 Brady, G. S., 68.
 Braun, A., *Betrachtungen ueber die*
 Erscheinung der Verjüngung
 in der Natur, insbesondere
 in der Lebens- und Bildungs-
 geschichte der Pflanze, cited,
 284.
 on rotation of *Pandorina*, 284.
 Ueber einige Volvocineen, cited,
 288.
 brevicorne, *Ceratium*, 313, 330.
 brevispinus, *Cyclops*, 39, 41.
 brightwellii, *Asplanchna*, 351, 354,
 355, 364.
 Bristol, C. L., 539.
 on papille of *Dina micros-*
 toma, 549.
- Bristol, C. L.—*Continued.*
 The Metamerism of *Nephele-*
 cited, 532, 535.
 Brooks, W. K., *Handbook of In-*
 vertebrate Zoölogy, cited, 509.
 Bucephalus infesting *Unionida*,
 402, 404, 408, 409, 411, 416.
 geographical distribution of,
 414, 415.
 polymorphus infesting *Union-*
 ida, 407.
 Bütschli, O., 301.
 on locomotion of *Gonium*, 283.
 Protozoa, cited, 274, 283, 284, 314.
 compilation of Synopsis of
 higher groups of Protozoa
 from, 314.
 Buffalo-fish, 351.
 bulba, *Monostyla*, 375.
 Bulletin of the Illinois State Lab-
 oratory of Natural History
 cited, 225, 237, 380, 441.
 of the Museum of Comparative
 Zoölogy cited, 498.
 Zoölogical, cited, 406.
- C
- Calanus, 237.
 californica, *Pleodorina*, 273, 274,
 276, 277, 279, 280, 281, 283, 286,
 290, 313, 328, 421, 437.
 caliginosa trapezoides, *Allobooph-*
 ora, 442.
 Callidina, 364.
 elegans, 364.
 Callipappus, species belonging to,
 390.
 Cambarus blandingii acutus and *C.*
 diogenes, *Opercularia irri-*
 tabilis found on, 310.
 Tokophrya quadripartita re-
 corded from, 312.
 and *C. diogenes*, *Bdellodrilus*
 philadelphicus found on, 542.
 Cambridge Natural History cited,
 344.

- campanula, Vorticella, 338.
 Candacidae, 104.
 Canthocamptus, 62, 225.
 capilliferus, Cyclops, 51.
 Carchesium, 338.
 granulatum found on Asellus, 339.
 lachmanni, 338.
 polypinum found on Lemnaceae,
 338.
 carinata, Hemicleipsis, 498.
 Mastigocerca, 371.
 caroli, Diaptomus, 181.
 Carp, 351.
 Carter, H. J., Note on a Fresh-water
 Species of Ceratium
 from the Lake of Nynce
 (Naini) Tal in Kumaon,
 cited, 421.
 On Fecundation in Eudorina
 elegans and Cryptoglena,
 cited, 284, 434.
 Carteria, 420.
 Castle, W. E., description of Glossi-
 phonia stagnalis cited, 498.
 The Metamerism of the Hi-
 rudinea, cited, 479.
 castor, Diaptomus, 98, 106, 130.
 catellina, Diglena, 370.
 Catfish, Amurea cochlearis eaten
 by, 351.
 Cathypna, 374, 375, 421.
 leontina, 374.
 luna, 374.
 stokesii, 375.
 Cathypnidae, 359, 374.
 seasonal distribution of, 353.
 Cattle attacked by Hamopsis mar-
 moralis, 527.
 by Macrobdella, 511.
 caudata, Platydorina, 419, 421, 435,
 437.
 Trachelomonas, 313, 325.
 caudatus, Brachionus, 381.
 Centrifuge, Purdy Electric, 20.
 Centropages, 235, 244.
 grimaldii, 238, 242.
 hamatus, 244.
 Centropagidae, 98, 103, 244.
 collections and literature at com-
 mand in preparation of
 Schacht's paper on, 228, 229.
 first published reference to, 97.
 modification of description of
 family of, 101.
 synopsis of the relationships
 of the genera Osphranticum,
 Limnocalanus, Diaptomus, and
 Epischura, of the family of, 102.
 The North American, belonging
 to the Genera Osphranticum,
 Limnocalanus, and Epischura,
 225-260 (Special index, p. 270.)
 Centropagina, 103.
 Centropyxis aculeata, 320.
 Cephalosiphon, 360.
 limias, 360.
 Ceratium, 307, 320.
 brevicorne, 313, 330.
 hirundinella, 330.
 kumaonense, 421.
 ceratophylli, Limnias, 360.
 Ceratophyllum, 234, 302, 349, 354.
 Floscularia ornata found on, 360.
 Limnias ceratophylli found on, 360.
 Megalotrocha albollavicans
 found on, 361.
 Oecistes intermedius found on, 361.
 Cercaria infesting Unionidae, 402,
 407, 409, 416.
 geographical distribution of,
 414.
 Ceriodaphnia, 421.
 Chaetococcus and Keranicus, differ-
 ence between, 392.
 Chaetogaster diaphanus, 443.
 diastrophus, 443.
 infesting Unionidae, 409.
 geographical distribution of,
 414.

- Chaetogaster*—*Continued*.
linmæi, 443.
 infesting Unionidæ, 407.
- Chaetonotus* as food of Protozoa, 311.
- Chalarathoraca*, 315, 322.
- Chambers, V. T., Two New Species of Entomostraca, cited, 97, 132.
- Charmoy, D. d'Emmerez de, descriptions of Coccidæ by, cited, 390.
- Chelydra serpentina*, *Opercularia irritabilis* found on, 340.
Tokophrya quadripartita recorded from, 342.
- Chionaspis prunicola*, validity of, 398.
- Chlamyodontidæ*, 332.
- Chloropeltididæ*, 326.
- Choanoflagellata*, 315, 328.
- Chrysomonadidæ*, 326.
- Chydorus*, 19, 421.
 as food of *Asplanchnopus myrmeleo*, 351.
 of rotifers, 345, 351, 366.
- Ciliata, 307, 316, 330.
 as food of *Acineta mystacina*, 342.
- Cladocera, 12, 19, 62.
- claparedi*, *Strombidiun*, 335.
- claparedianus*, *Limnodrilus*, 442, 444.
- Claus, C., 27, 98.
 Neue Beobachtung über die Organisation und Entwicklung von Cyclops. Ein Beitrag zur Systematik der Cyclopiden, cited, 29.
 on basal segment of rudimentary foot of *Cyclops viridis*, 40.
 Ueber die Antennen der Cyclopiden und die Auflösung der Gattung *Cyclops* in Gattungen und Untergattungen, cited, 29.
- Claus, C.—*Continued*.
 Weitere Mittheilungen über die Antennengliederung und über die Gattungen der Cyclopiden, cited, 29.
clavipes, *Diaptomus*, 98, 101, 108, 119, 127, 178, 184.
Clepsine elegans, 493.
modesta, 497.
ornata var. *rugosa*, 487.
papillifera var. *carinata*, 498.
 var. *lineata*, 493.
- Cleve, P. T., Microscopic Marine Organisms in the Service of Hydrography, cited, 12.
- Clinton, G. P., *Pleodorina* in Illinois, cited, 273.
- Closterium*, 421.
closterocerca, *Monostyla*, 376.
clupeiformis, *Coregonus*, 237.
- Cocaine-spirit mixture, formula for, 350.
- Coccidæ, First Supplement to the Check-List of the, 380-398.
- Coccinæ, divisions of, 380.
- coccineus*, *Hyodrilus*, 451, 452.
- Coccini, 380.
- Coccomytilus* as new genus for certain species of *Mytilaspis*, 397.
- Coccus*, 380.
laniger, as synonym of *Walkeriana floriger*, 391.
- cochlearis*, *Amurea*, 351, 353, 355, 364, 385.
- Cockerell, T. D. A., First Supplement to the Check-List of the Coccidæ, 380-398.
- Codonella*, 274, 330, 421.
 as food of rotifers, 312.
cratera, 312, 313, 335, 336.
 as food of rotifers, 330, 351, 364, 365.
- Codonosiginae*, 328.
- Celopus*, 372.

- Cælopus*—*Continued*.
porcellus, 372.
 seasonal distribution of, 352.
tenuior, 372.
- Cælostoma australe*, *C. immane*,
 and *C. rubiginosum*, Fuller's lo-
 cation of, 390.
- cæruleus*, *Diaptomus*, 99, 101, 107.
Stentor, 313, 334, 348.
- Colm, F., *Observations sur les Vol-
 vocinées*, cited, 285.
 Ueber eine neue Gattung aus
 der Familie der Volvocineen,
 cited, 283.
- Colepinae*, 330.
- Coleps*, 330, 421.
hirtus, 312, 331.
- Collared monads, 328.
- Coluridae*, 359, 376.
- Colurus*, 376, 377.
bicuspidatus, 376.
deflexus, 376.
 food of, 351.
obtusus, 376.
 seasonal distribution of, 353.
- communis*, *Diplocardia*, 442.
- complanata*, *Alasmodonta*, 401, 403,
 409, 410, 412, 416.
Glossiphonia, 403, 404, 406, 407.
Hirudo, 403.
Margaritana, 403.
- complanatus*, *Unio*, 401, 403, 409,
 410, 412, 415, 416.
- couchicola*, *Aspidiogaster*, 404, 405.
- Conchophthirus*, 333.
anodontæ, 333.
 found on *Unionidae*, 333, 407.
 infesting *Unionidae*, 408, 409, 414,
 416.
 geographical distribution of,
 414, 415.
hirtus infesting *Unionidae*, 407.
- confragosa*, *Alasmodonta*, 401, 403,
 409, 410, 412.
Margaritana, 403.
- Conochilus*, 303, 362.
dossuarius, 354, 362.
leptopus, 362.
 resemblance to *Megalotrocha
 albollavicans*, 361.
 seasonal distribution of, 352.
unicornis, 354, 362.
- Cooley, R. A., description of *Coc-
 cidæ* by, cited, 380.
 on *Chionaspis*, 308.
- Copepoda, 27, 98, 420.
 mode of collection of, by Dr.
 Augustin Kramer, 12.
- Coregonus clupeiformis*, *Limno-
 calanus* as food of, 237.
- Cori, C. J., Ueber die Verwendung
 der Centrifuge in der Zoologi-
 schen Technik und Beschreibung
 einer einfachen Handcentrifuge,
 cited, 20.
- Cornell College, 418.
- cornuta*, *Monostyla*, 375.
- cornutus*, *Unio*, 403.
- corona*, *Difflugia*, 313, 314, 320.
- corpulenta*, *Anodonta*, 401, 403,
 405, 408, 409, 410, 412, 413, 415,
 416.
- Cothurnia*, 341.
curva found on *Umatella gra-
 cilis*, 341.
- Cotylaspis*, geographical distribu-
 tion of, 414.
 infesting *Unionidae*, 408, 409, 411,
 412, 413, 416.
insignis as parasite of *Unionidae*,
 404.
- Cragin, F. W., 39.
 A Contribution to the His-
 tory of the Fresh-water
 Copepoda, cited, 225.
 description of *Cyclops per-
 armatus* cited, 60.
 on distribution of *Cyclops
 prasinus*, 57.

Cragin, F. W.—*Continued.*

- on occurrence of Heterocope in North America, 225.
- Craspedomonadidae, 328.
- crassicaudis, Cyclops, 20.
- cratera, Codonella, 312, 313, 335, 336, 351, 364, 365.
- Difflugia, 336.
- Crayfishes, examination of, for Protozoa, 310.
- Opercularia irritabilis found on, 340.
- Croppie, Anuraea cochlearis eaten by, 351.
- Crustacea, 355.
- as food of rotifers, 345.
- examination of, for Protozoa, 310, 312.
- rotifers as food of, 351.
- Cryptomonadidae, 328.
- Cryptomonas, 328.
- ovata, 313, 328.
- Ctenochiton nuytisiae, Fuller on validity of, 304.
- curva, Cothurnia, 341.
- Cyclodiniinae, 331.
- Cyclopidae, A Contribution to a Knowledge of North American Fresh-water, 27-82. (Special Index, p. 83.)
- explanation of plates of, 81, 82.
- from high lakes and ponds, 62.
- list of articles consulted in E. B. Forbes's article on, 66-81.
- list of North American species of, 63-65.
- most abundant species of, in Great Lakes, 62.
- of the Illinois River at the Illinois Biological Station, 63.
- preservative of, 31.
- specific characters of, 29, 31.
- Cyclops, 27, 28, 31, 63, 97, 100, 105, 106, 132, 141, 225, 234, 271, 421.

Cyclops—*Continued.*

- affinis, 20, 31, 65.
- agilis, 20.
- albidus, 20, 47-40, 62, 63, 64.
- description of, 48.
- distribution of, 48.
- synonymy of, 48.
- americanus, 37, 38, 42.
- annulatus, 33, 35.
- ater, 20, 40, 51, 62, 64.
- bicolor, 20, 62, 63, 64.
- bicuspidatus, 20, 30, 44-47, 53, 62, 63, 64.
- description of, 45.
- distribution of, 47.
- synonymical discussion of, 44.
- bisetosus, 20.
- brevispinosus, 30, 41.
- capilliferus, 51.
- crassicaudis, 20.
- Diaptomus, and Osphranticum, relative hardihood of, 100.
- dybowski, 20, 62, 63.
- edax, 33-36, 62, 63.
- description of, 35.
- distribution of, 35.
- synonymy of, and comparison with other species, 33.
- fimbriatus, 20.
- var. poppei, 63, 65.
- fluviatilis, 57.
- forbesi, 41, 45.
- fuscus, 20, 64.
- general distribution of, in North America, 62.
- gigas, 20, 37.
- gyrinus, 47, 48.
- helgolandicus, 20.
- hyalinus, 20.
- ingens, 37.
- insectus, 37, 38, 39, 41.
- insignis, 20, 63.
- lacustris, 20.
- leenwenhoeckii, 31, 35.
- leuckarti, 20, 31-33, 34, 36, 63.

Cyclops—Continued.

- levis*, 37.
longicornis, 130, 132.
macrurus, 29.
magnoctavus, 57.
minnilus, 44, 45.
modestus, 29, 51-53, 62, 63, 64.
 description of, 52.
 synonymy and distribution of,
 51.
nanus, 29.
navus, 44, 45.
oithonoides, 29, 63.
 on movements of, 235.
parvus, 38, 41, 42.
pentagonus, 57.
perarmatus, 59, 60.
phaleratus, 29, 30, 59-62, 63, 65.
 best character for ready recog-
 nition of, 62.
 description of, 60.
 distribution of, 59.
prasinus, 57-59, 63, 65.
pulehellus, 29, 44.
robustus, 29.
scutifer, 29.
serratus, 44, 45.
serrulatus, 29, 30, 54-57, 62, 63,
 65.
 description of, 55.
 synonymy, variation, and dis-
 tribution of, 54.
 var. *elegans*, 54.
 var. *montanus*, 54, 55.
signatus, 29.
 var. *tenuicornis*, 47.
strenuus, 29.
thomasi, 44, 45.
Tokophrya cyclopum found on,
 341.
uniangulatus, 39, 41.
varicans, 29, 63, 64.
vernalis, 29, 64.
viridis, 29, 30, 37-40, 41, 43, 48,
 62, 63, 64.

Cyclops viridis—Continued.

- description of, 39.
 basal segment of rudimentary
 foot, different authors
 quoted on, 40.
 synonymical discussion of
 37-39.
 var. *brevispinosus*, 39, 41, 62,
 63, 64.
 var. *insectus*, 31, 41, 44, 62, 63,
 64.
Cyclopsina, 97, 105.
cyclopum, Tokophrya, 341.
Cypridopsis, 421.
cyrtopus, Notommata, 369.
Cystoflagellata, 305, 315.

D

- Dactylopiinae*, 389.
Dactylopiini, 389.
Dactylopius, 389.
Dangeardia mamillata as parasite
 of *Platydorina caudata*, *Pandori-*
 na morum, and *Eudorina ele-*
 gans, 434, 435.
Daphnia, 421.
Daphnids as food of Protozoa, 311.
decora, Hirudo, 508.
 Macrobdella, 508.
deflexa, Euchlanis, 345, 374.
deflexus, Colurus, 376.
deitersi, Diaptomus, 99.
Dendromonadinae, 322.
dentata, Arcella, 313, 314, 318.
Dero furcata, 443.
 limosa, 443.
 obtusa, 443.
 vaga, 443.
Desmids as food of Protozoa, 311.
Desmothoraca, 315.
diaphanus, Chaetogaster, 443.
Diaptomus, 62, 100, 103, 132, 134,
 141, 225, 230, 234, 237, 250, 265,
 421.

Diaptomus Continued.

- albuquerqueensis, 98, 101, 113, 115, 146-149, 176, 184.
and *D. mississippiensis*, means of distinguishing males of, 149.
distribution of, 183.
- ambiguus, 177.
- armatus, 133, 135, 136.
- ashlandi, 98, 111, 120, 124, 158, 167-169, 260, 265.
distribution of, 168, 183.
females of, 100.
- bacillifer, 107.
- birgei, 99, 108, 117, 172-173.
- caroli, 181.
- castor, 98, 106, 130.
- clavipes, 98, 101, 108, 110, 127, 178-181.
distribution of, 181, 184.
similarity to *D. piscinae* and *D. leptopus*, 181.
- ceruleus, 99, 101, 107.
color of, 138.
- Cyclops, and Osphranticum, relative hardness of, 100.
- deitersi, 99.
- diagnosis and remarks on genus of, 105-107.
- distribution of the American species of, 182-184.
- drieschi, 99.
- eggs of, 228.
- eiseni, 98, 101, 110, 115, 162-164, 166.
distribution of, 183.
- first establishment of genus of, 97.
- franciscanus, 98, 110, 118, 132, 160-162, 166, 182.
distribution of, 183.
- fresnanus, 176, 178, 184.
- gibber, 99, 101.
- giganteus, 138.
- glacialis, 101.

Diaptomus Continued.

- gracilis, 98, 173, 182.
compared with *D. siciloides*, 155.
- graciloides, 98.
- incongruens, 99.
- kentuckyensis, 97, 130, 132.
- leptopus, 97, 112, 117, 130-132, 135, 181.
distribution of, 182.
fifth pair of legs of male of, contrasted with those of *D. piscinae*, 125, 127.
synonymy of, 132.
- lintoni, 113, 118, 127, 129, 134, 160.
contrasted with *D. stagnalis*, 129.
distribution of, 182.
- literature of, 97.
- lobatus, 101.
- longicornis, 132.
var. *leptopus*, 130, 132.
var. *similis*, 132, 162, 182.
- minnetonka, 133, 135, 136, 138.
- minutus, 98, 106, 111, 116, 129, 134, 156-158, 160, 260, 265.
distribution of, 100, 157, 158, 183.
normal habitat of, 100.
synonymy of, 158.
- mirus, 101.
- mississippiensis, 98, 100, 122, 173-176.
and *D. albuquerqueensis*, means of distinguishing males of, 149.
distribution of, 184.
- most favorable seasons for collecting, 97.
- North American species of, 97-207. (Special Index, p. 208.)
collections examined in preparation of Schacht's article on, and localities represented, 99.

- Diaptomus, North American species of *Continued*.
 on descriptions in Schacht's article on, 101.
 explanation of plates of, 205-207.
 introduction to Schacht's article on, 97-101.
 key to, based on characters of female, 114-122.
 key to, based on characters of male, 107-114.
 keys of, in Schacht's article on, plan and use of, 100, 101.
 literature accessible in preparation of Schacht's article on, 99.
 material at command for Schacht's article on, 99.
novamexicanus, 99, 111, 116, 149-151.
 distribution of, 183.
 number of recognized North American species of, 97.
 on distinguishing characters of sex in, 100.
 on movements of, 235.
 on specific distinctions of males in, 100.
oregonensis, 100, 110, 124, 151-154, 170, 171, 220, 265.
 distribution of, 154, 183.
Osphranticum, *Limnocalanus*, and *Epischura*, discussion of structural similarities and differences indicative of relationships of the genera, 226.
 general bibliography of genera of, 185-204; additions to, 268.
 synopsis of the relationships of the genera, 102-105.
- Diaptomus Continued*.
pallidus, 108, 121, 124, 137, 144-146, 265.
 distribution of, 183.
 females of, 100.
 var. *sicilis*, 122.
piscinae, 98, 100, 116, 118, 125-127, 181.
 distribution of, 182.
 fifth pair of legs of male of, contrasted with those of other species, 125, 127.
reighardi, 98, 100, 121, 160-171.
 distribution of, 184.
roubaui, 166.
salinus, 98.
sanguineus, 97, 112, 117, 120, 133-138, 160, 166, 234.
 and *D. stagnalis* compared, 136.
 color of, 138.
 distribution of, 183.
 peculiarity in structure of, 134.
 synonymy of, 135.
 variation in, 136, 137.
serricornis, 162.
shoshone, 110, 116, 127, 141-143, 164.
 distribution of, 143, 183.
sicilis, 97, 100, 111, 121, 122-124, 145, 167, 168, 169, 182, 220, 264.
 compared with *D. siciloides*, 155.
 details of structure distinguishing from *D. ashlandi* and *D. pallidus*, 124.
 distribution of, 124, 182.
 females of, 100.
 variation in structure of, 124.
 var. *imperfectus*, 124, 158, 167, 169.
siciloides, 98, 100, 114, 121, 124, 137, 146, 154-156, 157, 165, 166, 181, 182, 220, 265.
 compared with *D. caroli*, *D. gracilis*, and *D. sicilis*, 155, 182.

- Diaptomus siciloides* *Continued.*
 distribution of, 183.
 eggs of, 155.
 females of, 100.
signicauda, 98, 114, 120, 157, 159,
 160, 164, 166.
 distribution of, 183.
signicaudatus, 164.
similis, 132, 182.
 species of, insufficiently de-
 scribed, 181.
stagnalis, 97, 101, 113, 115, 136,
 138, 141, 142, 164.
 contrasted with *Diaptomus*
lintoui, 120.
 distribution of, 183.
theeli, 101.
tryboni, 98, 112, 120, 158, 160, 166.
 distribution of, 183.
tyrrelli, 99, 108, 119, 162, 176-
 178.
 distribution of, 184.
wierzejskii, 101, 107.
zachariasi, 99.
- Diaspis amygdali*, possible syno-
 nym of, 398.
piricola, resemblance to *Aspidio-*
tus ostreaformis, 398.
snowi, resemblance to *Aspidio-*
tus ancylus, 398.
- diastrophus*, *Chaetogaster*, 443.
- Diatoms, 12, 311, 421.
 as food of *Opercularia irritabilis*,
 340.
 of Protozoa, 311.
 of Rotifera, 351, 373.
- Didinium*, 331.
nasutum, 313, 331.
- Difflugia*, 274, 305, 306, 312, 318, 421.
aculeata, 313, 314, 320.
acuminata, 313, 319.
 as food of fishes, 312.
corono, 313, 314, 320.
cratera, 336.
 food of, 311.
- Difflugia* *Continued.*
fragosa, 312, 313, 320.
 figures of, 321.
globulosa, 312, 313, 314, 318, 320.
 as food of rotifers, 351, 364.
lobostoma, 313, 314, 319, 320.
pyriformis, 313, 314, 319.
 compressa, 319.
 vas, 319.
tuberculosa, 313, 320.
urceolata, 319.
- Diglena*, 370.
biraphis, 371.
catellina, 370.
forcipata, type of trophi of, 345.
grandis, 370.
dilatata, *Euchlanis*, 374.
- Dileptus*, 331.
 anser, 332.
- Dina*, 533, 535.
fervida, 535, 537, 540, 541.
 annulation and metamorphism of,
 compared with those of *Erpob-*
della punctata, 535.
 color of, 537.
 diagnosis and general descrip-
 tion of, 535.
 reproductive organs of, com-
 pared with those of *Erpob-*
della punctata, 536.
mexicana, 541.
microstoma, 537, 541.
 annuli and somites of, 539, 541.
 color and reproductive organs
 of, 541.
 diagnosis of, 537.
 general description and metam-
 erism of, 537, 539.
- Dineutes*, *Megalotrocha* semibul-
 lata eaten by, 361.
- Dinifera*, 329.
- Dinobryon*, 274, 323, 421.
sertularia, 312, 313, 323.
angulatum, 323.
divergens, 323.

- Dinobryon sertularia—*Continued*.
 Salpingoeca minuta found on
 loricae of, 329.
 undulatum, 323.
 Dinobryoninae, 323.
 Dinocharidae, 358, 372.
 Dinocharis, 372.
 food of, 351.
 pocillum, 372.
 seasonal distribution of, 352.
 Dinoflagellata, 307, 315, 329.
 diogenes, Cambarus, 340, 342, 542.
 Diplobdella, 511, 518.
 Diplocardia, 449.
 communis, 442.
 riparia, 442.
 singularis, 442.
 sp. 442.
 verrucosa, 442.
 Diplosiga, 328.
 frequentissima, 328.
 found on rays of Asterionella,
 328.
 Discodrilidae, 441.
 note on, 542.
 Distomidae, encysted and free, in-
 festing Unionidae, 405,
 406, 407, 408, 409, 416.
 geographical distribution
 of, 414, 415.
 Distyla, 375, 421.
 gissensis, 375.
 hornemanni, 375.
 ohioensis, 375.
 cultures of, 348.
 stokesii, 375.
 diversicornis homoceros, Schizo-
 cerca, 382.
 Schizocerca, 382.
 Dolley, C. S., the Planktonokrit, a
 Centrifugal Apparatus for the
 Volumetric Estimation of the
 Food-Supply of Oysters and
 other Aquatic Animals, cited,
 20.
 donaciformis, Plagiola, 401, 403,
 409, 410, 412, 416.
 Unio, 403.
 dorcas, Brachionus, 353, 354, 379.
 spinosus, Brachionus, 354, 379.
 dossuarius, Conochilus, 354, 362.
 drieschi, Diaptomus, 99.
 Dufour & Company, 3.
 dybowskii, Cyclops, 29, 62, 63.
- ## E
- Earthworms as food of Haemopsis
 marmoratis, 527.
 of Philobdella gracile, 518.
 of North America, list of, by
 Garman, cited, 441.
 ebbesbornii, Asplanchna, 345, 354,
 364.
 ebena, Quadrula, 401, 403, 409, 410,
 411, 412, 413, 414.
 ebenus, Unio, 403.
 Eclipidrilinae, distinguishing char-
 acters of, 474.
 Eclipidrilus, 462, 468, 471, 475.
 frigidus, 460, 465, 466.
 circulatory system of, 474.
 Mesoporodrilus asymmetricus,
 and Premnodrilus palustris
 compared, 472, 475.
 edax, Cyclops, 33, 62, 63.
 edentula, Anodonta, 403.
 edentulus, Strophitus, 401, 403, 406,
 409, 410, 412, 413, 416.
 Ehrhorn, E. M., descriptions of
 Coccidia by, cited, 390.
 Eisen, G., 155, 162, 164, 166, 178,
 475.
 Anatomical Notes on Sutroa
 alpestris, a New Lumbricu-
 lide Oligochaete from Sierra
 Nevada, California, cited,
 471.
 Eclipidrilidae and their Anat-
 omy, cited, 471, 474.

- Eisen, G. *Continued.*
 On the Anatomy of *Sutroa rostrata*, a New Annelid of the Family Lumbriculina, cited, 471.
 on the application of terms gastric and perigastric, 460.
 on the circulatory system of *Eclipidrilus frigidus*, 474.
 on the prostate glands of *Eclipidrilus frigidus*, 464.
 Pacific Coast Oligochaeta. I., cited, 462, 464, 471.
eiseni, *Diaptomus*, 98, 101, 110, 115, 162, 166, 183.
Sparganophilus, 442.
 Eggs of *Aspidiogaster conchicola*, 404.
 of *Atax*, 407, 414.
 of *Cotylaspis insignis*, 405.
 of frogs eaten by *Macrobdella decora*, 511.
 of Rotifera, 347.
 of *Sacculus*, 366.
ehrenbergii, *Gastropus*, 368.
eichhornii, *Actinosphaerium*, 313, 322.
Stephanoceros, 345.
elegans, *Callidina*, 364.
Clepsine, 493.
Eudorina, 273, 277, 286, 431, 435, 437.
Plagiola, 401, 403, 406, 409, 410, 412, 413, 416.
Raphidiophrys, 322.
Unio, 403.
ellipsis, *Lampsilis*, 401, 403, 405, 409, 410, 412, 413, 416.
Unio, 403.
elinguis, *Nais*, 443.
elliptica, *Metopidia*, 377.
Elodea, 354.
elongata, *Mastigocerca*, 371.
Embolocephalus, 453, 456.
multisetosus, 443.
- Embolocephalus multisetosus*
 = *Continued.*
 description of, 452-455.
 relation of, to other Tubificidae, 456.
plicatus, 456.
velutinus, 456.
emissarius, *Phreocytes*, 442.
 Enchelidae, 330.
 Enchytraeidae, 441.
 found in Illinois, 442.
 Engstrom, Ella V., 441.
 Entomostraca, 10, 97, 225, 228, 351, 421.
 species of *Rhabdostyla* found on, 340.
 Eospora, 370.
aurita, 324, 370.
Epischura, 97, 103, 166, 225, 226, 237, 240, 251, 267.
 distribution of, 251.
 doubtful species of, 265.
 discussion of published figures and descriptions of, 266, 267.
 eggs of, 228.
fluvialilis, 226, 250, 265, 267.
 synonymy of, 266.
 key to the species of, 251.
lacustris, 228, 229, 240, 250, 251, 252, 260, 265.
 associate species and distribution of, 264, 265.
 compared with *E. nevadensis*, 264.
 with *E. nordenskiöldii*, 254, 255, 256.
 on descriptions and figures of, 263, 264.
Limnocalanus, and *Osphranticum*, North American Centropagide belonging to the genera, 225, 270.
nevadensis, 98, 168, 229, 249, 250, 251, 256, 260, 262.

- Epischura nevadensis*—*Continued*.
columbiæ, 256, 258, 259.
 compared with *E. lacustris*, 264.
 with *E. nordenskiöldii*, 254, 255, 256.
 distribution of, 260.
 on descriptions and figures of, 259.
nordenskiöldii, 98, 240, 250, 251, 252-256.
 compared with *E. lacustris* and *E. nevadensis*, 254, 255, 256.
 on figures of, 254.
 on habitat of, 226.
Osphranticum, *Limnocalanus*, and *Diaptomus*, discussion of structural similarities and differences indicative of the relationships of the genera, 226-228.
 general bibliography of genera of, 185-204; additions to, 268.
 synopsis of the relationships of the genera of, 102-105.
- Epistylis*, 312, 339, 340, 341.
flavicans, 339.
plicatilis, 342.
 found on shells of water-snails, 339.
- Eriococcini*, 389.
Eriococcus, 389.
- Erpobdella*, 532.
punctata, 532, 535, 536, 539, 540.
 and *Dina fervida*, differences in annulation, metamerism, and reproductive organs of, 535, 536.
 diagnosis and general description of, 532.
 food of, 535.
- Erpobdella punctata*—*Continued*.
 habits of, 535.
 reproductive organs of, 533.
eucalypti, *Aspidiotus perniciosus*, 396.
Euchlanidae, 359, 373.
Euchlanis, 274, 373, 375, 421.
deflexa, 374.
 type of trophi of, 345.
dilatata, 374.
 food of, 351, 374.
lynceus, 368.
pyriformis, 374.
 seasonal distribution of, 352.
triquetra, 374.
- Eucyclops*, 54, 65.
- Eudorina*, 274, 275, 276, 277, 278, 280, 284, 286, 287, 288, 420, 422, 423, 425, 427, 431, 432, 433, 434, 435, 436, 437.
 disease of, 280.
elegans, 273, 277, 286, 431, 435, 437.
 parasite of, 435.
 polarity and locomotion of, 284, 285, 431, 432.
 possible *Pleodorina* stage of, 286, 287.
- Euglena*, 274, 301, 306, 313, 323, 325, 420.
acus, 313, 324.
 as food of *Opercularia*, 311.
 of *Opercularia irritabilis*, 340.
 of protozoans, 324.
 of rotifers, 312, 324.
oxyuris, 313, 324.
spirogyra, 313, 324.
torta, 313, 324.
viridis, 312, 313, 324, 325.
- Euglenidae*, 323, 325.
Euglenoidina, 323.
Euglypha, 305, 306, 321.
alveolata, 321.
Euglyphidae, 315, 321.
Enrytemora, 225.
herdmani, 226.

- eustala, Salpina, 352, 373.
 Evaspidiotus, type of, 395.
 Evermann, B. W., and Meek, S. E.,
 259.
- F**
- fervida, Dina, 535, 540, 541.
 Nephelis, 535.
 fimbriatus, Cyclops, 20.
 var. poppei, Cyclops, 63, 65.
 Fish, 504.
 Fishes attacked by Macrobdella,
 511.
 parasitized by Piscicola, 504.
 Protozoa as food of, 312.
 Flagellata, 304, 306, 315, 322, 420.
 flagellum, Pristina, 443.
 flavicans, Epistylis, 339.
 floridana, Philobdella, 511, 518.
 floriger, Walkeriana, 391.
 Floscularia, 360.
 ornata, found on Ceratophyllum,
 360.
 seasonal distribution of, 352.
 Flosculariæ, 356, 360.
 fluviatile, Tintinnopsis, 335.
 fluviatilis, Cyclops, 57.
 Epischura, 226, 250, 265.
 [Epischura] Lamellipodia, 265.
 fetida, Allolobophora, 441.
 Forbes, E. B., 98.
 A Contribution to a Knowl-
 edge of North American
 Cyclopida, 27-82.
 Forbes, S. A., 29, 31, 37, 38, 48, 98,
 124, 127, 185, 263, 301, 303,
 418, 475, 479.
 An American Terrestrial
 Leech, cited, 528, 531, 532.
 A Preliminary Report on the
 Aquatic Invertebrate
 Fauna of the Yellowstone
 National Park, Wyoming,
 and of the Flathead Region
 of Montana, cited, 126, 127,
 143, 244, 250, 263, 267.

- Forbes, S. A.—*Continued.*
 adaptation and compilation
 from MS. of, 102.
 Biennial Report as Director
 of the Illinois State Labo-
 ratory of Natural History
 for 1893-94, cited, 3.
 description of Cyclops in-
 sectus, cited, 38.
 of Diaptomus lintoni, 127-
 129.
 of Diaptomus piscinæ, 125-
 126.
 of Diaptomus shoshone,
 141-143.
 of Epischura nevadensis
 columbiæ, cited, 250.
 of Osphranticum labro-
 nectum, 233.
 descriptions and figures of
 Epischura lacustris cited,
 263-264.
 List of Illinois Crustacea,
 with Descriptions of New
 Species, cited, 97, 135, 138.
 on color of Diaptomus stag-
 nalis, 140.
 on distribution of Limnocal-
 anus macrurus, 244.
 on habitat and movement of
 Osphranticum, 226, 234,
 235.
 on Hæmopsis lateralis, 528,
 531, 532.
 on parasites of Asplanchna
 herrickii, 365.
 on segmentation of antennæ
 of Osphranticum labronec-
 tum, and on its color, 234.
 On some Entomostraca of
 Lake Michigan, cited, 97,
 124, 135, 140, 233, 263.
 On the Food of Young White-
 fish (Coregonus), cited, 233,
 244.

- Forbes, S. A.—*Continued.*
 On the Food Relations of
 Fresh-Water Fishes: A
 Summary and Discussion,
 cited, 237.
 Preliminary Report upon
 the Invertebrate Animals
 inhabiting Lakes Geneva
 and Mendota, Wisconsin,
 with an Account of the
 Fish Epidemic in Lake
 Mendota in 1884, cited, 169,
 244, 264.
 The First Food of the Com-
 mon White-fish (*Corego-
 nus clupeiformis* Mitch.),
 cited, 237.
forbesi, Cyclops, 44, 45.
forcipata, Diglena, 345.
forcicula, Furcularia, 370.
 F o r h a n d l i g a r i V idenskabs-Sel-
 skabet i Christiana, cited, 242.
fossulatus, Atax, 408.
foveolata, Gastroschiza, 368.
Fragillaria, 19, 274, 421.
fragosa, Diffugia, 312, 313, 320.
franciscanus, Diaptomus, 98, 110,
 118, 132, 160, 166, 182, 183.
frenchii, Lecanium, 394.
frequentissima, Diplosiga, 328.
 Fresenius, G., on locomotion of
Gonium, 283.
 Ueber die Algengattungen
Pandorina, *Gonium*, und
Raphidium, cited, 283.
fresnanus, Diaptomus, 176, 178, 184.
Fridericia agilis, 442.
frigidus, Eclipidrilus, 464, 465, 466,
 469, 472, 473, 474, 475.
 Frogs attacked by *Macrobdella*, 511.
 eggs of, eaten by *Macrobdella*
decora, 511.
Hemiclepsis carinata found at-
 tached to, 504.
fucosus, Potomocichetor, 230, 233.
- Fuller, Claude, as authority for
 changes in synonymy of
Apiomorpha spp., 393.
 descriptions of *Coccidæ* by,
 cited, 390.
 on *Lecanium macrozamiæ* as
 a variety of *L. frenchii*, 394.
 on species belonging to *Calli-
 pappus*, 390.
 on validity of *Ctenochiton* (?)
nuytsiæ, 394.
 slides of *Aspidiotus pernicio-
 sus eucalypti* from, 396.
 withdrawal of *Solenophora*
dryandriæ by, 392.
furcata, Dero, 443.
Furcularia, 370.
forcicula, 370.
longiseta, 370.
 type of trophi of, 345.
fuscus, Cyclops, 29, 64.
- ### G
- Garman, H., A Preliminary Report
 on the Animals of the Mis-
 sissippi Bottoms near
 Quincy, Illinois, in August,
 1808. Part I., cited, 420.
 list of North American earth-
 worms cited, 441.
 notes on and sketches of *Pla-
 tydiorina* cited, 420.
 Gastropods as food of *Glossiph-
 onia stagnalis*, 408.
 of *Hæmopsis marmoratis*, 527.
Gastropus ehrenbergii, 368.
Gastroschiza foveolata, 368.
lynceus, 368.
Geoscolicidæ found in Illinois, 442.
gibber, Diaptomus, 99, 101.
gibbosus, Unio, 401, 403, 409, 410,
 412, 413, 415, 416.
 Giesbrecht, W., 102.
 on a common character of the
 Copepoda, 228.

- Giesbrecht, W. *Continued.*
 on a distinguishing character of the Copepoda, 226.
 on specific distinctions of males in *Diaptomus*, 100.
 Systematik und Faunistik der pelagischen Copepoden des Golfs von Neapel und der angrenzenden Meeresabschnitte, cited, 98, 101, 226, 228.
 Ueber pelagische Copepoden des Rothen Meeres, gesammelt von Marinestarbzt Dr. Augustin Krämer, cited, 12.
- giganteus*, *Diaptomus*, 138.
gigas, *Cyclops*, 29, 37.
- Gissler, C. F., Note regarding Change of Color in *Diaptomus sanguineus*, 138.
 Variations in a Copepod Crustacean, cited, 138.
- giesleri*, *Alloobophora*, 442.
gigantea, *Vaginicola*, 341.
girodi, *Asplanchna*, 365.
gissensis, *Distyla*, 375.
glacialis, *Diaptomus*, 101.
Glaucea, 97, 105.
globator, *Volvox*, 276, 285, 287, 312, 313, 327, 365, 438.
globulosa, *Diffugia*, 312, 313, 314, 318, 320, 351, 364.
Glossiphonia, 493.
complanata, 494, 496, 497.
 diagnosis of, 493.
 food of, 493.
lineata, 493-497.
 alimentary canal, color, and reproductive organs of, 496.
 annuli and somites of, 494-496.
 diagnosis of, 493.
 general description of, 494.
 habits of, 497.
stagnalis, 496, 497.
 breeding season of, 498.
- Glossiphonia stagnalis* *Continued.*
 diagnosis of, 497.
 food of, 498.
triserialis, 493.
 situation of male pore in, 493.
- Glossiphonidae*, 480.
Gomphogaster areolatus, 368.
Gonium, 419, 420, 426, 427, 436, 437.
 locomotion and polarity of, 283, 431, 432.
 pectorale, 437.
 sociale, 437.
- Goodrich, E. S., On the Structure of *Vermiculus pilosus*, cited, 446, 451, 452.
- Goroschankin, J., Genesis im Typus der palmellenartigen Algen. Versuch einer vergleichenden Morphologie der Familie der Volvocinea, cited, 284, 288.
- Gosse, P. H., 372, 373.
 On *Mastigocerea bicristata*, 371, 372.
 and Hudson, C. T. See Hudson and Gosse.
- gracile*, *Philobdella*, 511.
gracilis, *Diaptomus*, 98, 155, 173, 182.
Lampsilis, 401, 402, 403, 408, 409, 410, 411, 412, 413, 414, 415, 416.
Unio, 403.
Urnatella, 341.
- graciloides*, *Diaptomus*, 98.
- Graf, Arnold, Hirudineenstudien, cited, 497.
- grandinella*, *Halteria*, 313, 335.
grandis, *Anodonta*, 401, 403, 406, 409, 416.
Diglena, 370.
- granifera*, *Quadrula*, 401, 403, 409.
graniferus, *Unio*, 403.
granulatum, *Carchesium*, 339.
- Green, E. E., as authority for location of *Lecanium hesperidum alienum*, 393.

- Green, E. E. — *Continued.*
 says *Coccus laniger* is Walk-
 eriana floriger, 391.
- Gregarina, 306.
 grimaldii, Centropages, 238, 242.
 Linnocalanus, 226, 229, 230, 242,
 243.
- Guerne, Jul. de, Description of
 Centropages grimaldii,
 Copépode nouveau du golfe
 de Finlande, cited, 242.
 et Richard, J., 99, 160, 176, 236.
 description and figures
 of *Epischura lacustris*
 cited, 263.
 diagnosis of *Diaptomus*
 and remarks upon gen-
 us by,— translation,
 105, 106, 107.
 on *Diaptomus minutus*,
 157.
 on *Diaptomus tyrrelli*,
 178.
 on differences between
Linnocalanus sinensis
 and *L. macrurus*, 249.
 on length of *Linnocala-
 nus sinensis*, 248.
 on number of segments
 in antennæ of *Osp-
 hranticum labro-
 nectum*, 234.
 on second pair of anten-
 næ of *Linnocalanus*
macrurus, 236.
 on synonymy of *Linnoc-
 alanus macrurus*, 242.
 Révision des Calanides
 d'eau douce, cited, 97,
 100, 101, 146, 153, 154,
 155, 157, 158, 160, 162,
 164, 166, 177, 178, 185,
 206, 233, 236, 237, 238,
 242, 243, 254, 256, 259,
 263, 264.
- Gymnoplea*, 102.
Gymnostomata, 306, 316, 330.
gyrinus, *Cyclops*, 47, 48.
- ## II
- Hæmenteria officinalis*, 480.
Hæmopsis, 510, 511, 512, 517, 518, 519.
lateralis, 512, 528-532.
 alimentary canal, color, and
 reproductive organs of, 531.
 annuli and somites of, 529-531.
 diagnosis, general description,
 and measurements of, 528.
 habits of, 532.
marmoratis, 511, 515, 519-527,
 528, 529, 530, 531.
 alimentary canal of, 526.
 annuli and somites of, 522-524.
 color and habits of, 527.
 diagnosis, general description,
 and measurements of, 519-
 522.
 food of, 527.
 reproductive organs of, 524-
 526.
sanguisuga, 531.
- Halteria*, 335.
grandinella, 313, 335.
- Halteriidae*, 335.
- hamatus*, Centropages, 244.
- Hart, C. A., 303, 418.
 mention of collaboration in
 preparation of Hempel's
 List of the Protozoa and
 Rotifera found in the Illi-
 nois River and Adjacent
 Lakes at Havana, Ill., 301.
- Hart, Lydia M., 23, 98, 303, 440, 441,
 475.
- Hatai, S., On *Vermiculus limosus*,
 a New Species of Aquatic Oligo-
 chaeta, cited, 451.
- hederae*, *Aspidiotus*, 395.
- helgolandicus*, *Cyclops*, 29.
- Heliozoa*, 306, 315, 321.

- Helobdella triserialis*, 493.
Hemiclepsis, 498.
carinata, 498-504.
 alimentary canal, color, habits,
 and reproductive organs of,
 503.
 annuli and somites of 500-503.
 diagnosis and general descrip-
 tion of, 498-500.
 found attached to frogs and
 toads and in shells of living
 mussels, 504.
Hemitubifex, 456.
 Hempel, Adolph, 28, 31, 98, 148,
 175, 176, 459, 475.
 A List of the Protozoa and
 Rotifera found in the Illinois
 River and Adjacent Lakes
 at Havana, Ill., 301-388. (See
 Hart, C. A.)
hemprichii, *Æolosoma*, 443.
 Henfrey, A., Notes on some Fresh-
 water Confervoid Algæ New
 to Britain, cited, 274.
 on arrangement of cells in
 Eudorina, 274.
 Hensen, V., 1, 3.
 Methodik der Untersuchung
 bei der Plankton-Expedi-
 tion, cited, 2.
 Ueber die Bestimmung des
 Planktons oder des im Meere
 treibenden Materials an
 Pflanzen und Thieren, cited,
 2, 13.
herculeus, *Lumbricus*, 441.
 Herdman, W. A., Thompson, I. C.,
 and Scott, Andrew, On the Plank-
 ton collected continuously dur-
 ing two Traverses of the North
 Atlantic in the Summer of 1897;
 with Descriptions of New Co-
 pepoda; and an Appendix on
 dredging in Puget Sound, cited,
 226.
 herdmani, *Eurytemora*, 226.
Herpobdella, 532.
Herpobdellidæ, 532.
 Herrick, C. L., 28, 38, 39, 45.
 A Final Report on the Crus-
 tacea of Minnesota, cited
 132, 135, 182, 225, 266.
 Contribution to the Fauna of
 the Gulf of Mexico and
 the South. List of Fresh-
 water and Marine Crus-
 tacea of Alabama, with
 Descriptions of the New
 Species and Synoptical
 Keys for Identification,
 cited, 225, 266.
 A New Cyclops, cited, 97,
 132.
 descriptions and figures of
 Epischura lacustris, cited,
 263.
 descriptions and figures of
 Epischura fluviatilis cited
 and discussed, 266, 267.
 description of *Diaptomus*
 novamexicanus (compiled
 by Schacht), 149-151.
 description of *Potamoiche-*
 tor fucosus cited, 233.
 Habits of Fresh-water Crus-
 tacea, cited, 135.
 Heterogenesis in the Co-
 pepod Crustacea, cited,
 267.
 Heterogenetic Development
 in *Diaptomus*, cited, 266.
 Micro-Crustacea from New
 Mexico, cited, 151.
 Microscopic Entomostraca,
 cited, 132, 146.
 on color of *Cyclops prasinus*,
 59.
 on color of *Diaptomus min-*
 netonka and *D. sanguin-*
 eus, 138.

- Herrick, C. L.—*Continued.*
 on *Cyclops serrulatus* var. *elegans*, 54.
 on *Diaptomus caroli*, 182.
 on *Diaptomus minnetonka*, 136.
 on *Diaptomus siciloides*, resemblances, 182.
 on distribution of *Cyclops ater*, 51.
 on distribution of *Cyclops prasinus*, 57.
 on habitat of *Osphranticum*, 226, 234.
 on identity of *Scopiphora vagans* and *Epischura lacustris*, and on description of the former, 263.
 on inner rami of fifth pair of feet of male *Diaptomus sicilis*, 124.
 on occurrence of *Temora affinis* (—" *Temorella affinis* "), 225.
 on segmentation of antennæ of *Osphranticum labro-nectum*, 234.
 Papers on the Crustacea of the Fresh Waters of Minnesota, cited, 37, 135, 233.
 and Turner, C. H., Synopsis of the Entomostraca of Minnesota, 37, 38, 54, 124, 132, 136, 138, 149, 151, 154, 158, 181, 254, 266.
herrickii, *Asplanchna*, 351, 354, 364.
hesperidum alienum, *Lecanium*, 393.
Heterarthrandia, 102.
Heterochætina, 104.
Heterocope, 99, 225, 267.
heterodon, *Unio*, 401, 403, 409.
Heteromonadidæ, 322.
Heterotricha, 308, 316, 333.
Hexagenia larvæ, *Tokophrya quadripartita* recorded from, 342.
higginsii, *Lampsilis*, 401, 403, 409.
Unio, 403.
hirtus, *Conchophthirus*, 407.
Coleps, 312, 331.
hirudinella, *Ceratium*, 330.
 Hirudinidæ, 508.
 Hirudinea of Illinois, The, 479-547.
 bibliography in Moore's article on, 543.
 explanation of plates in Moore's article on, 545-547.
 Hirudinidæ, 532.
Hirudo, 511, 512, 517.
bioculata, 497.
complanata, 493.
decora, 508.
lateralis, 528.
marmorata, 519.
parasitica, 480.
stagnalis, 497.
hispidæ, *Trachelomonas*, 326.
 Hoek, P. P. C., comparison of figures of *Cyclops leeuwenhoekii* published by, with *C. edax*, 35.
 on basal segment of rudimentary foot of *Cyclops viridis*, 40.
 Holophryinæ, 330.
 Holotricha, 307.
 Holst, N. O., 157.
Homocyclops, 29, 49, 64.
hornemanni, *Distyla*, 375.
 Horse-leech, 527, 529. See *Hæmopsis marmoratis*.
 Hudson, C. T., Diagram of typical trophi of rotifers and a summary of distinguishing features of their types, 344, 345.
 on Affinities and Classification of the Rotifera, cited, 355.

- Hudson, C. T. - *Continued.*
 and Gosse, P. H., 301, 367.
 on types of trophi of Rotifera, 344.
 The Rotifera or Wheel Animalcules, cited; also Supplement to same, 356.
- Hunter, S. J., description of Coccidae by, cited, 300.
- hyalinus, Cyclops, 20.
- Hydatina, 368.
 senta, 368.
 cultures of, 318.
 distribution of, 350.
- Hydatinidae, 358, 368.
- Hydra, 308.
 Trichodina parasitic on, 337.
 viridis, Trichodina pediculis frequent on, 337.
- hypelasma, Anuraea, 382.
- Hypotricha, 308, 316, 336.
- I**
- Ichthyobdellidae, 408, 504.
- Idiococcinae, 380.
- igneus, Stentor, 334.
- Ihering, H. von, descriptions of Coccidae by, cited, 300.
- Illinois Biological Station, 28, 63, 137, 146, 220, 233, 234, 309, 418, 441, 470.
 State Laboratory of Natural History, 28, 99, 185, 228, 229, 233, 242, 259, 268, 290, 441.
- illinoisensis, Pleodorina, 273, 274, 290, 424, 431, 432, 437.
 Tintinnopsis, 313, 335.
- Iloricata, 357.
- Hyodrilus, 446, 448.
 coccineus, circulatory system of, 451, 452.
- imbecillis, Anodonta, 401, 403, 408, 409, 410, 412, 413.
- Imhof, O. E., 98.
 immane, Cœlostoma, 390.
 incongruens, Diaptomus, 99.
 inconstans, Thiodrilus, 442, 460.
 indistinctus, Atax, 406.
 inequiammulata, Actinobdella, 504.
 Infusoria, 304, 307, 309, 315, 330.
 ciliated, as parasite of Unionidae, 407.
 ingens, Cyclops, 37.
 Insect larvae, aquatic, examination of, for Protozoa, 310.
 Insects, aquatic, as food of Hamopsis marmoratis, 527.
 insectus, Cyclops, 37, 38, 39, 41.
 insignis, Cotylaspis, 404, 405.
 Cyclops, 20, 63.
 intermedius, Cœcistes, 361.
 irritabilis, Opercularia, 340, 342.
 Isomastigoda, 326.
- J**
- Jennings, H. S., A List of the Rotatorio of the Great Lakes and of some of the Inland Lakes of Michigan, cited, 366, 375.
 on Cathypna stokesii, 375.
- Journal of Morphology cited, 542.
- Juday, Chancey, 220.
- Jurine, L., Histoire des Monocles qui se trouvent aux environs de Genève, cited, 97.
- K**
- Kellicott, D. S., 305.
- Kelly, H. M., A Statistical Study of the Parasites of the Unionidae, 399, 418.
- Kent W. Saville, 301.
 Manual of the Infusoria, cited, 314.
- kentuckyensis, Diaptomus, 97, 130, 132.
- Kermicus and Chatococcus, difference between, 392.

- Kermicus*—*Continued*.
 dactylopiine character of larva of, 392.
- King, G. B., descriptions of *Cocci-*
dæ by, cited, 390.
- Klebs, G., Ueber die Organisation
 der Gallerte bei einigen Algen
 und Flagellaten, cited, 276.
- Klein, L., Morphologische und bio-
 logische Studien über die
 Gattung *Volvox*, cited, 276,
 285, 287.
 Neue Beiträge zur Kenntniss
 der Gattung *Volvox*, cited, 287.
 on polar differentiation and ro-
 tation of *Volvox*, 285.
 Vergleichende untersuchungen
 über Morphologie und Biolo-
 gie der Fortpflanzung bei
 der Gattung *Volvox*, cited,
 285, 287.
- Koch, C. L., Deutschlands Crus-
 taceen, Myriapoden, und Arach-
 niden, cited, 97.
- Kofoid, C. A., 23, 229, 303, 313, 329,
 400, 418, 440.
 on *Cotylaspis insignis* as para-
 site of *Anodonta corpulenta*, 405.
 On the Occurrence of *Trocho-*
sphaera solstitialis in the
 Illinois River, cited, 362.
 on Hempel's *Tintinnopsis*
illinoisensis, 335.
 Plankton Studies. I. Meth-
 ods and Apparatus in Use
 in Plankton Investigations
 at the Biological Experi-
 ment Station of the Uni-
 versity of Illinois, 1-25.
 Plankton Studies. II. On
Pleodorina illinoisensis, a
 New Species from the
 Plankton of the Illinois
 River, 273-293; cited, 431.
- Kofoid, C. A.—*Continued*.
 Plankton Studies. III. On
Platydorina, a New Genus
 of the Family *Volvocidæ*,
 from the Plankton of the
 Illinois River, 419-440.
kumaonense, *Ceratium*, 421.
- L
- Labidesthes sicculus*, *Limonocalanus*
 as food of, 237.
labronectum, *Osphranticum*, 227,
 230.
lachmanni, *Carchesium*, 338.
lachrymosa, *Quadrula*, 401, 403, 408,
 409, 410, 411, 412, 414.
lachrymosus, *Unio*, 403.
lacunculata, *Notommata*, 367.
Lacrymaria, 330.
truncata, 330.
lacteus, *Rhizodrilus*, 443, 444.
lacustre, *Aulastomum*, 519.
lacustris, *Cyclops*, 29.
Epischura, 228, 229, 249, 250, 251,
 252, 254, 255, 256, 260.
Nais, 443.
levissimus, *Lampsilis*, 401, 403, 408,
 409.
Unio, 403.
- Lamellibranchs as food of *Hæmo-*
pis marmoratis, 527.
- Lamellipodia, 267.
 [*Epischura*] *fluviatilis*, 265.
- Lampsilis alatus*, 401, 403.
 parasites of, 408, 409, 410, 412,
 413, 414, 416.
anodontoides, 401, 403.
 parasites of, 406, 408, 409, 410,
 412, 413, 416.
 capacity for infestation exhib-
 ited by, 413.
ellipsis, 401, 403.
 parasites of, 405, 409, 410, 412,
 413, 416.
gracilis, 401, 403.

- Lampsilis gracilis* *Continued.*
 parasites of, 402, 408, 409, 410, 411, 412, 413, 414, 415, 416.
higginsii, 401, 403.
 parasite of, 400.
laevissimus, 401, 403.
 parasites of, 408, 409.
ligamentinus, 401, 403, 410.
 parasites of, 407, 409, 410, 412, 413, 414, 416.
luteolus, 401, 403.
 parasites of, 409, 410, 412, 413, 414, 416.
nasutus, 401, 403.
 parasites of, 409.
ochraceus, 401, 403.
 parasite of, 400.
 parasites of, 405, 408.
parvus, 403.
 parasites of, 404, 409, 410, 412, 413.
rectus, 401, 403.
 parasites of, 408, 409, 410, 412, 416.
tenuissimus, 401, 403.
 parasites of, 409.
ventricosus, 401, 403.
 parasites of, 407, 408, 409, 410, 411, 412, 413, 416.
- Lande, A., on basal segment of rudimentary foot of *Cyclops viridis*, 40.
- laniger*, Coccus, 391.
- lata*, *Mastigocerca*, 372.
- lateralis*, *Hæmopsis*, 512, 528.
Hirudo, 529.
Nephelis, 532.
- Lecaniodiaspis*, 395.
- Lecanium frenchii*, 394.
hesperidum alienum as located by Green, 393.
macrozamiæ, Fuller on, 394.
patelliformis as located by Newstead, 393.
- Leeches, 407, 479-546.
leeuwenhoekii, *Cyclops*, 34, 35.
- Leidy, Joseph, 301, 305, 471.
 Corrections and Additions to former Papers on Helminthology, cited, 450.
 description of *Astacobdella philadelphica* cited, 542.
 Description of *Nephelis punctata*, cited, 535.
 Description of two New Genera of Vermes, cited, 456.
 Fresh-water Rhizopods of North America, cited, 314.
 Notice of some American Leeches, cited, 509.
- leidyi*, *Pristina*, 443.
- Lemna*, 234, 310.
- Lemmaceæ*, 349.
Carchesium polypinum found on, 338.
- lenticulare*, *Plesoma*, 368.
- Leonardi, G., description of *Coccidæ* by, cited, 390.
 on dismemberment of *Mytilaspis*, 397.
 See also Berlese and Leonardi.
- leontina*, *Cathypna*, 374.
- Lepocinclis*, 274.
- leptopus*, *Conochilus*, 362.
Diaptomus, 97, 112, 117, 125, 127, 130, 135, 181, 182.
- leuckarti*, *Cyclops*, 29, 31, 34, 36, 62, 63.
- Leuckartiina*, 104.
- levis*, *Cyclops*, 37.
- Lidgett, J., descriptions of *Coccidæ* by, cited, 390.
- ligamentinus*, *Lampsilis*, 401, 403, 407, 409, 410, 412, 413, 414, 416.
 Uno, 403.
- Lilljeborg, W., 98, 153, 160, 162, 166, 178, 220, 250.
 description of *Diaptomus ciseni* and remarks upon, 162-164.

Lilljeborg, W.—*Continued.*

- description of *Diaptomus franciscanus* and remarks upon, 160-162.
- description of *Diaptomus fresnanus* (= *tyrrelli*), 176.
- description of *Diaptomus minutus*, 156.
- description of *Diaptomus oregonensis* cited, 154.
- description of *Diaptomus siciloides*, 154.
- description of *Diaptomus signicauda* and remarks upon, 164-166.
- description of *Diaptomus trybomi*, 153-160.
- on length of *Epischura nordenskiöldi*, 254.
- limnæi*, *Chaetogaster*, 407, 443.
- Limnias*, 360.
- ceratophylli*, 360.
- found on *Ceratophyllum* and *Potamogeton*, 360.
- limnias*, *Cephalosiphon*, 360.
- Limnocalanus*, 104, 225, 226, 235-238.
- as food of fishes, 237.
- eggs of, 228.
- Epischura*, and *Osphranticum*, The North American *Centropagidae* belonging to the Genera, 225-270.
- establishment of genus of, 236.
- grimaldii*, 220, 230, 242, 243.
- synonym of, 226.
- habits of, 237.
- key to the species of, 238.
- macronyx*, 226.
- macrurus*, 227, 220, 235, 236, 237, 238-244, 264.
- auctus*, 230, 241.
- difference between, and *L. sinensis*, 240.
- distribution of, 237, 244.
- habitat of, 226.

Limnocalanus macrurus — *Continued.*

- on illustrations of, 243.
- Osphranticum*, *Epischura*, and *Diaptomus*, discussion of structural similarities and differences indicative of relationships of genera of, 226-228.
- general bibliography of genera of, 185-204; additions to, 268.
- synopsis of the relationships of the genera, 102-105.
- sinensis*, 90, 220, 235, 236, 238, 245-249.
- differences between, and *L. macrurus*, 240.
- distribution of, 237.
- habitat of, 226, 237.
- locality from which the species is recorded, 240.
- Limnodrilus claparedianus*, 442.
- description of, 444.
- limosa*, *Dero*, 443.
- limosus*, *Vermiculus*, 451.
- lineata*, *Glossiphonia*, 403, 407.
- lintoni*, *Diaptomus*, 113, 118, 127, 134, 160, 182.
- lobatus*, *Diaptomus*, 101.
- lobostoma*, *Difflugia*, 313, 314, 319, 320.
- longicauda*, *Phacus*, 313, 326.
- longicaudum*, *Scaridium*, 373.
- longicornis*, *Cyclops*, 130, 132.
- Diaptomus*, 132.
- var. *leptopus*, *Diaptomus*, 130, 132.
- var. *similis*, *Diaptomus*, 132, 162, 182.
- longiseta*, *Furcularia*, 370.
- Triarthra*, 352, 367.
- longispina*, *Notholca*, 383.
- Loricata*, 358.
- Lumbricidae*, 441.
- found in Illinois, 441.

- lumbricoid worm eaten by *Philobdella floridana*, 518.
Lumbriculidae, 450, 462, 168, 469, 172, 474.
 found in Illinois, 442.
 North American, described species of, 471.
 variability in reproductive organs of, 472.
Lumbriculus, 471.
 spiralis, relationship of *Rhizodrilus lacteus* to, 450.
Lumbricus herculeus, 441.
luna, *Cathypna*, 374.
lunaris, *Monostyla*, 375.
lurida, *Nais*, 443.
luteolus, *Lampsilis*, 401, 403, 409, 410, 412, 413, 414, 416.
 Unio, 403.
lynceus, *Bipalpus*, 368.
 Euchlanis, 368.
 Gastroschiza, 368.
 Pleurostoma, 352, 354, 368.
- M**
- Macrobdella*, 508, 515.
 decora, 508, 511.
 alimentary canal and habits of, 511.
 anulation of, compared with that of *M. sestertia*, 509-510.
 diagnosis of, 508.
 food of, 511.
 general description of, 509.
 reproductive organs of, 510.
 valdiviviana, 528.
Macrocyclops, 47, 64.
macronyx, *Linnocalanus*, 226.
macrostyla, *Philodina*, 363.
macrozamia, *Lecanium*, 304.
macrurus auctus, *Linnocalanus*, 239, 244.
 Cyclops, 20.
 Linnocalanus, 226, 227, 229, 235, 236, 237, 238, 249, 264.
 macrurus—*Continued*.
 Rotifer, 363.
magnocyclops, *Cyclops*, 57.
Mallomonas, 274, 421.
mamillata, *Daugeardia*, 434.
Margaritana complanata, 403.
 confragosa, 403.
 marginata, 403.
 rugosa, 403.
 undulata, 403.
marginata, *Alasmodonta*, 401, 403, 408, 409, 410, 412, 416, 417.
 Margaritana, 403.
marmorata, *Hirudo*, 519.
marmoratis, *Hæmopsis*, 511, 515, 519, 528, 529, 530, 531.
Marsii, C. D., 38, 68, 171.
 description and figures of
 Diaptomus pallidus cited, 146.
 description and figure of
 Epischura lacustris cited, 263, 264.
 description of *Diaptomus birgei* and remarks upon, 172, 173.
 on description of *Scopiphora vagans*, 267.
 on *Diaptomus mimnetonka*, 136.
 on *Diaptomus reighardi*, length of and localities for, 171.
 on distribution of *Cyclops ater*, 51.
 of *Cyclops phaleratus*, 60.
 of *Diaptomus sicilis*, 124.
 of *Linnocalanus macrurus*, 244.
 and synonymy of *Cyclops prasinus*, 57.
 and synonymy of *Diaptomus minutus*, 158.

- Marsh, C. D. — *Continued.*
 on identity of *Scopiphora vagans* and *Epischura lacustris*, 263.
 on occurrence of *Diaptomus mississippiensis*, 176.
 On the Cyclopidae and Calanidae of Central Wisconsin, cited, 124, 136, 153, 154, 160, 244, 264.
 On the Cyclopidae and Calanidae of Lake St. Clair, Lake Michigan, and certain of the Inland Lakes of Michigan, cited, 160, 244, 264.
 on the habits of *Limnocalanus*, 237.
 on the Limnetic Crustacea of Green Lake, cited, 237.
 On two New Species of Diaptomus, cited, 173, 175.
 Preliminary List of Deep-Water Crustacea, cited, 97.
- Mastigocerca*, 371.
bicornis, 371.
bicristata, 371.
 seasonal distribution of, 352, 371.
 specific characters of, 371.
carinata, 371.
elongata, 371.
 food of, 351, 371.
lata, 372.
stylata, 371.
- Mastigophora*, 306, 315, 322.
- Meek, S. E., and Evermann, B. W., 259.
- Megalotrocha*, 303, 361.
alboflavicans, 361.
 found on *Ceratophyllum*, 361.
 resemblance of, to *Conochilus*, 361.
semibullata, 361.
 eaten by *Dinectes*, 361.
 seasonal distribution of, 352.
megalotrocha, *Philodina*, 363.
- Melicerta ringens*, type of trophi of, 345.
- Melicertidae, 357, 360.
- Melosira, 274, 421.
- Mesoporodrilus, 462, 468, 471.
asymmetricus, 442.
 Eclipsoidrilus frigidus, and *Premmodrilus palustris* compared, 472-475.
 nephridial and circulatory systems of, 468-471.
- metanever, *Unio*, 403.
- metanevra, *Quadrula*, 401, 403, 409, 410, 412.
- Metopidia, 377.
 food of, 351.
 acuminata, 377.
 bractea, 377.
 elliptica, 377.
 oblonga, 377.
 oxystemum, 377.
 rhomboides, 377.
 seasonal distribution of, 353.
 solidus, 377.
 triptera, 377.
- mexicana*, *Dina*, 541.
- Microbdella*, 482, 484.
- Microcodonidae, 357.
- Microcyclops, 64.
- microstoma*, *Dina*, 537.
 Vorticella, 338.
- Migula, W., *Beiträge zur Kenntniss des Gonium pectorale*, cited, 283.
 on locomotion of *Gonium*, 283.
- militaris*, *Brachionus*, 351, 353, 355, 365, 381, 421.
- Milne-Edwards, H., *Extrait d'un Mémoire sur la distribution géographique des Crustacés*, cited, 97.
- Minnesota Academy of Sciences, 233.

- minnetonka, *Diaptomus*, 133, 135, 136, 138.
 minutus, *Cyclops*, 44, 45.
 Minnows, 351.
 minuta, *Salpingoeca*, 329.
 minutus, *Diaptomus*, 98, 100, 106, 111, 116, 120, 134, 156, 160, 183, 260, 265.
 mirum, *Pedalion*, 353, 355, 384.
 mirus, *Diaptomus*, 101.
 Miskovsky, L. F., 451.
 mississippiensis, *Diaptomus*, 98, 100, 122, 140, 173, 184.
 modesta, *Clepsine*, 407.
 modestus, *Cyclops*, 20, 51, 62, 63, 64.
 mollis, *Brachionus*, 354, 378.
 Monostyla, 376.
 Mollusks, 351.
 Monadina, 322.
 Monads, collared, 328.
 Monoculus, 97, 105.
 quadricornis var. *albidus*, 47.
 var. *viridis*, 37.
 Monostyla, 375, 421.
 as food of *Asplanchnopus myrmeleo*, 366.
 bulba, 375.
 closterocera, 376.
 cornuta, 375.
 algæ eaten by, 375.
 food of, 351.
 lunaris, 375.
 mollis, 376.
 quadridentata, 376.
 Moore, J. Percy, A Description of *Macrobdeella blannulata* with especial regard to the Constitution of the Leech Somite, cited, 479, 482.
 Notes on *Bdellodrilus philadelphicus*, cited, 542.
 The Hirudinea of Illinois, 479-547.
 The Leeches of the U. S. National Museum, cited, 479, 513.
 Moquin-Tandon, A., Monographie de la Famille des Hirudinées, cited, 493, 498.
 morum, *Pandorina*, 273, 284, 327, 435, 437.
 Mottier, D. M., *Pleodorina* in Indiana, cited, 273.
 mucicola, *Cecistes*, 361.
 mucosa, *Allolobophora*, 441.
 Müller, O. F., *Entomostraca seu Insecta testacea quæ in aquis Danicæ et Norvegiæ reperit, descripsit et iconibus illustravit*, cited, 97.
 multiplicata, *Quadrula*, 401, 403, 406, 410, 412, 413.
 multiplicatus, *Unio*, 403.
 multisetosus, *Emboloccephalus*, 443, 452.
 Murray, John, 12.
 Museu Paulista, 301.
 Musk-turtles, *Opercularia irritabilis* found on, 340.
 Mussels, shells of living, entered by *Hemiclepsis carinata*, 504.
 myrmeleo, *Asplanchnopus*, 351, 365.
 Notommata, 365.
 mystacina, *Acineta*, 342.
 Mytilaspis, new genera separated from, 397.
 philococcus, subgenus *Opuntiaspis* proposed for, 397.
 mytilus, *Stylonichia*, 337, 348.

N

- Nägeli, C. W. von, on rotation of *Pandorina*, 284.
 Naidomorpha, 447, 448.
 found in Illinois, 443.
 Nais elinguis, 443.
 lacustris, 443.
 lurida, 443.
 serpentina, 443.
 nanus, *Cyclops*, 20.

- Nassula*, 332.
 ornata, 332.
Nassulinae, 332.
nasutum, *Didinium*, 313, 331.
nasutus, *Lampsilis*, 401, 403, 409.
 Unio, 403.
navus, *Cyclops*, 44, 45.
Nelumbo, 302.
Nephelis fervida, 535.
 lateralis, 532.
 punctata, 532.
 quadristriata, 532.
neptunius, *Actinurus*, 303.
 Rotifer, 363.
nevadensis columbiae, *Epischura*,
 256, 258.
 Epischura, 08, 163, 220, 240, 250,
 251, 254, 255, 256, 262, 264.
 Newell, W., descriptions of *Cocci-*
dæ by, cited, 300.
 New Mexico Agricultural Experi-
 ment Station, 380.
 Newstead, R., as authority for lo-
 cation of *Lecanium patelliformis*,
 393.
 Nicolet, H., *Crustaceos*, cited, 97.
nordenskiöldi, *Epischura*, 08, 240,
 250, 251, 252.
 Nordqvist, O., 08, 236.
 die Calaniden Finlands Bidrag
 till Kännedom af Finlands
 Natur och Folk, cited, 236,
 242, 243.
 on second pair of antennæ of
 Limnocalanus macrurus, 230.
 on synonymy of *Limnocalanus*
 macrurus, 242.
Noteus, 382.
 quadricornis, 382.
 seasonal distribution of, 353.
Notholca, 352, 383.
 acuminata, 355, 383.
 seasonal distribution of, 353.
 food of, 351.
 longispina, 383.
Notommata, 360.
 aurita, 360.
 cyrtopus, 360.
 lacunculata, 360.
 myrmeleo, 365.
 tripus, 360.
Notommatidae, 358, 360.
 seasonal distribution of, 352.
novamexicanus, *Diaptomus*, 09, 111,
 116, 140, 183.
nutans, *Opercularia*, 340.
nuytsiæ, *Ctenochiton*, 394.
Nymphæa, 302.
 Nyström, C., 157, 254.
- O**
- Oberlin College, 451.
Obliquaria reflexa, 401, 403.
 parasites of, 408, 409, 410, 412,
 413.
oblonga, *Metopidia*, 377.
obtusa, *Dero*, 443.
obtusus, *Colurus*, 376.
ochraceus, *Lampsilis*, 401, 403,
 409.
 Unio, 403.
odoratus, *Aromochelys*, 340, 342.
Oëcistes, 360.
 intermedius found on *Cerato-*
 phyllum, 361.
 mucicola found on *Rivularia*,
 361.
officinalis, *Hæmenteria*, 480.
ohioensis, *Distyla*, 348, 375.
oithonoides, *Cyclops*, 20, 63.
Oligochaeta, 460.
 Notes on Species of North Amer-
 ican. III. List of Species found
 in Illinois, and Descriptions of
 Illinois Tubificidæ, 441-458.
 explanation of plates in above
 article on, 458.
 literature cited in above article
 on, 457.

Oligochaeta Continued.

- Notes on Species of North American. IV. On a New Lumbricid Genus from Florida, with Additional Notes on the Nephridial and Circulatory Systems of *Mesopodrilus asymmetricus* Smith, 459-478.
 explanation of plates in above article on, 477.
 literature cited in above article on, 476.
- Oligochaete parasite of Unionidae, 407.
 aquatic, as food of *Erpobdella punctata*, 535.
- Oligochaetes, aquatic, as food of *Haemopsis marmoratis*, 527.
- Oligotricha, 308, 316, 335.
- Opercularia, 311, 312, 340.
articulata, 340.
 food of, 311.
irritabilis, 342.
 occurrence of, on various animals, 340.
 food of, 340.
nutans found on a *Planorbis*, 340.
rugosa, 340.
- Opuntiaspis* proposed as new subgenus for *Mytilaspis philococcus*, 397.
- oregonensis*, *Diaptomus*, 100, 110, 124, 151, 170, 171, 183, 220, 265.
- ornata*, *Floscularia*, 352, 360.
Nassula, 332.
 var. *rugosa*, *Clepsine*, 487.
- Orthocyclops*, 20, 51, 64.
- Ortonia* preoccupied; replaced by *Protortonia*, 330.
- Osborn, H. L., on distomid parasite of *Anodonta plana* (= *grandis*) and *Strophitus edentulus*, 406.
- Oscillaria*, 10, 419.
- Osphranticum*, 97, 104, 225, 226, 229, 237.

Osphranticum Continued.

- Diaptomus*, and *Cyclops*, relative hardihood of, 100.
- Diaptomus*, *Epischura*, and *Limnocalanus*, discussion of structural similarities and differences indicative of the relationships of the genera, 226-228.
 general bibliography of genera of, 185; additions to, 268.
 synopsis of the relationships of the genera, 102-105.
 eggs of, 228.
labronectum, 227, 230-235.
 distribution, color, and variations of, 234.
 on movements of, 235.
- Limnocalanus*, and *Epischura*, The North American *Centropagide* belonging to the genera, 225-270.
 on localities preferred by, 226, 234.
- ostreaeformis*, *Aspidiotus*, 308.
- ovata*, *Cryptomonas*, 313, 328.
- Overton, E., *Beitrag zur Kenntniss des Gonium pectorale*, cited, 287.
- oxystemum*, *Metopidia*, 377.
- Oxytrichidae*, 336.
- oxyuris*, *Euglena*, 313, 324.

P

- pala*, *Brachionus*, 353, 354, 355, 378.
- pallida*, *Raphidiophrys*, 313, 322.
- pallidus*, *Diaptomus*, 100, 108, 121, 124, 137, 144, 183, 205.
 var. *sicilis*, *Diaptomus*, 122.
- palustris*, *Premnodrilus*, 459, 468, 469, 472, 473, 474, 475.
- Pandorina*, 275, 276, 278, 280, 284, 286, 287, 327, 419, 420, 423, 425, 433, 436-437.

- Pandorina Continued.*
 as food of rotifers, 312.
 polarity and direction of rotation of, 284, 431, 432.
 disease of, 289.
 morum, 273, 327, 435, 437.
 direction of rotation of, 284.
 parasite of, 434.
papillifera var. *carinata*, Clepsine, 498.
 var. *lineata*, Clepsine, 493.
Paracyclops, 59, 65.
Paramæciidae, 332.
Paramæcium, 332.
 aurelia, 307, 313, 332.
 Parasite of *Eudorina elegans*, 435.
 of fishes, 504.
 of *Hydra*, 337.
 of *Pandorina morum*, 434.
 Parasites of *Platydorina caudata*, 425, 434.
Parasites of Asplanchna herrickii, 365.
 of the Unionidae, A Statistical Study of the, 399-418;
 summary of results reached, 417.
 comparison of infestation by different, 412.
 comparison of local infestation by, 416.
 degree of infestation of individual hosts by, 410, 411, 415.
 geographical distribution of, 414.
 relation of local conditions to number of, and to character of infestation, 417.
 situation of, and manner of infestation, 404-407.
 specific distribution of, 409.
 effect of seasonal changes on, 414.
parasitica, *Hirudo*, 480.
- parasitica Continued.*
Placobdella, 480, 487, 488, 491, 492, 503.
parvus, *Cyclops*, 38, 41, 42.
parvus, *Lampsis*, 401, 403, 404, 409, 410, 412, 413.
 Unio, 337, 403.
patelliformis, *Lecanium*, 393.
 Patten, Wm., on distribution of *Heterocope*, 225.
patina, *Pterodina*, 353, 378.
 Peck, J. I., The Sources of Marine Food, cited, 13, 21.
pectinata, *Synchaeta*, 352, 354, 355, 366.
pectorale, *Gonium*, 437.
Pedalion, 346, 355, 383.
 mirum, 355, 384.
 seasonal distribution of, 383.
Pedalionidae, 359, 383.
Pedetes, 368.
 saltator, 368.
Pediastrum, 421.
 as food of rotifers, 351, 365.
pediculis, *Trichodina*, 337.
Pelomyxa, 317.
 villosa, 317.
Peloscolex, 456.
 variegatus, 456.
pentagonus, *Cyclops*, 57.
perarmatus, *Cyclops*, 59, 60.
 Pergande, Theo., descriptions of *Coccidae* by, cited, 300.
Perichaeta, 441.
Peridimidae, 329, 421.
Peridinium, 397, 329.
 tabulatum, 313, 329, 421.
Peritricha, 308, 309, 316, 337.
periculosus ? *eucalypti*, *Aspidiotus*, 396.
 Pfeffer, W., *Locomotorische Richtungsbewegungen durch chemische Reize*, cited, 283.
 on locomotion of *Gonium*, 283.
Phacus, 274, 326.
 longicauda, 313, 326.

- Phacus *Continued*.
 pyrum, 313, 326.
 triquetrum, 326.
- phaleratus, Cyclops, 20, 30, 50, 63, 65.
- Phaulomytilus as new genus for certain species of *Mytilus* pis, 397.
- Phenacaspis as new genus for certain species of *Chionaspis*, 398.
- Philadelphia Academy of Sciences, 418.
- philadelphica, Astacobdella, 542.
- philadelphicus, Bdelloidrilus, 542.
- Phillips, C. E., 98.
- Philobdella, 500, 510, 511.
 floridana, 511.
 lumbricoid worm eaten by, 518.
 gracile, 511-518.
 alimentary canal, color, and habits of, 518.
 annuli and somites of, 515.
 diagnosis of, 511.
 food of, 518.
 general description and measurements of, 512-515.
 reproductive organs of, 517.
- philococcus, *Mytilaspis*, 307.
- Philodina, 363, 421.
 macrostyla, 363.
 megalotrocha, 363.
 roseola, type of trophi of, 345.
 seasonal distribution of, 352.
 tuberculata, 363.
- Philodinidae, 357, 359, 362.
- Phreoryctes emissarius, 442.
- Phreoryctidae, 442.
 found in Illinois, 442.
- Physa, *Epistylis plicatilis* found on shells of, 339.
- Pickering, C., generic description of *Scopiphora vagans*, 263.
- Pieronitic acid, formula for, 349.
- pilosus, *Vermiculus*, 446, 450, 452.
- Pilsbry, H. A., 418.
- piricola, *Diaspis*, 308.
- Piscicola parasitic on small fish, 504.
- Piscicolaria, 504.
- piscinae, *Diaptomus*, 98, 100, 116, 118, 125, 181, 182.
- Placobdella, 480, 496.
 parasitica, 480-486, 487, 488, 491, 492, 503.
 alimentary canal and color of, 485.
 annuli and somites of, 482-484.
 compared with *P. rugosa*, 482.
 diagnosis of, 480.
 general description of, 400-482.
 habits of, 486.
 reproductive organs of, 484.
- rugosa, 481, 482, 484, 487-492.
 alimentary canal, color, and reproductive organs of, 491.
 annuli and somites of, 488-491.
 diagnosis and general description of, 487.
 habits of, 492.
- Plagiola, capacity for infestation exhibited by, 414.
- donaciformis, 401, 403.
 parasites of, 400, 410, 412, 416.
- elegans, 401, 403.
 parasites of, 405, 406, 409, 410, 412, 413, 416.
- securis, 401, 403.
 parasite of, 409.
- Plagiotomidae, 333.
- plana, *Anodonta*, 403, 406.
- Planarians, 407.
- Plankton, centrifugal machine used in volumetric determination of, 19, 20.
 description of apparatus used in oblique-haul method of collecting, 3-10.
 in pumping method of collecting, 13-16.

Plankton—*Continued.*

- enumerative or counting method of determining, 21.
- gravimetric method of determining, 18.
- and volumetric method of determining, combined, 18.
- oblique-haul method of collecting, difficulties encountered in, 11.
- operation of, 2, 10.
- preservation and examination of, 17-21.
- pumping method of collecting, 2, 12-17.
- advantages of, 17.
- operation of, 16.
- quantitative examination of, 18.
- settling and centrifugal methods of volumetric determination of, 19, 20.
- Studies. I. Methods and Apparatus in Use in Plankton Investigations at the Biological Experiment Station of the University of Illinois, 1-25.
- bibliography in, 22-23.
- explanation of plates in, 23-25.
- Studies. II. On *Pleodorina illinoisensis*, a New Species from the Plankton of the Illinois River, 273-293.
- bibliography in, 291-292.
- explanation of plates in, 293.
- Studies. III. On *Platydorina*, a New Genus of the Family Volvocidae, from the Plankton of the Illinois River, 410-440.
- explanation of plate in, 440.
- literature cited in, 437.
- variations in, at Havana, Ill., 11.

Plankton—*Continued.*

- vertical-haul method of collecting, 2.
- inapplicable in Station waters at Havana, Ill., 3.
- work on the Illinois River and Adjacent waters, scope of, 1.
- Planorbis, Opercularia nutans* found on, 340.
- Plate, Ludwig, Beiträge zur Naturgeschichte der Rotatorien, cited, 367.
- on *Brachionus bidens*, 381.
- on *Triarthra terminalis*, 367.
- Platydorina*, 436, 437.
- A new Genus of the Family Volvocidae from the Plankton of the Illinois River, article on, 410-440.
- associates of, 420-421.
- caudata, 410, 437.
- arrangement of cells of, 426.
- characteristic features of colony of, 423.
- description of, 421-435.
- parasite of, 425, 434.
- size of colony of, 422, 425.
- specific characters of, 435.
- type of cells of, 425, 427.
- colors of, 422.
- discussion of term colony as applied to, 433.
- explanation of plate in Kofoid's article on, 440.
- generic characters of, 435.
- literature cited in Kofoid's article on, 430.
- locomotion of, 430.
- systematic position and relationships of, 433.
- reproduction of, 432.
- platyptera euryptera, *Polyarthra*, 367.
- Polyarthra*, 340, 352, 354, 355, 367.

- Pleodorina, 273, 277, 286, 327, 410, 420,
 424, 425, 427, 432, 433, 434, 437.
 californica, 273, 274, 276, 279, 280,
 281, 313, 328, 421, 437.
 locomotion and polarity of, 283.
 relationship of, 286.
 synoptic characters of, 200.
 illinoisensis, 424, 432, 437.
 a New Species from the Plank-
 ton of the Illinois River.
 Plankton Studies, II., 273-
 293.
 bibliography in Kofoid's ar-
 ticle on, 291-292.
 description of, 274-281.
 disease of, 280.
 distribution of, 273.
 explanation of plates in Ko-
 foid's article on, 293.
 hypothetically considered as
 stage in life cycle of Eudori-
 na, 286.
 locomotion of, 281-285, 431.
 reproduction of, 287-280.
 synoptic characters of, 200.
 synoptic characters of, 200.
 Pleurotrichinae, 336.
 plicata, Quadrula, 401, 403, 408, 409,
 410, 412, 413, 316.
 plicatilis, Epistylis, 339, 342.
 plicatus, Embolocephalus, 456.
 Uno, 403.
 Plesoma, 357, 368.
 lenticulare, 368.
 lynceus, 354, 368.
 seasonal distribution of, 352.
 Ploima, 356, 357, 364, 421.
 pluvialis, Stephanosphaera, 437.
 pocillum, Dinocharis, 352, 372.
 Podoplea, 105.
 polipinum, Carchesium, 338.
 Polyarthra, 274, 346, 366, 421.
 aptera, 367.
 platyptera, 354, 355, 367.
 euryptera, 367.
 Polyarthra platyptera—*Continued.*
 Rhabdostyla found on, 340,
 367.
 seasonal distribution of, 352.
 polymorphus, Bucephalus, 407.
 Stentor, 313, 334.
 Pond snails, examination of, for
 Protozoa, 310.
 Pontellidae, 102.
 Poppe, S. A., 29, 98, 99, 177, 178,
 229, 234, 248.
 description of Limnocalanus
 sinensis cited, 237.
 on differences between Lim-
 nocalanus sinensis and L.
 macrurus, 249.
 porcellus, Cyclops, 372.
 Potamogeton, 349.
 Linnias ceratophylli found on,
 360.
 Potamoichetor, 229, 230.
 Potomoichetor, 229.
 fucosus, 230, 233.
 prasinus, Cyclops, 57, 63, 65.
 Premnodrilus, 471.
 palustris, 469.
 description of, 459-468.
 Eclipsoidrilus frigidus, and Mes-
 oporodrilus asymmetricus
 compared, 472-475.
 priodonta, Asplanchna, 351, 354,
 364, 365.
 Pristina flagellum, 443.
 leidyi, 443.
 Proceedings of the Philadelphia
 Academy of Sciences, 542.
 profuga, Allohobophora, 441.
 proteus, Amœba, 317.
 Protortonia superseded by Ortonia,
 390.
 Protozoa, 14, 304, 342, 348, 351, 421,
 and Rotifera found in the Illinois
 River and Adjacent Lakes
 at Havana, Ill., A List of,
 301-388.

- Protozoa and Rotifera—*Continued.*
 collections examined in preparation of Hempel's article on, with brief description of waters collected from, 301-303.
 literature consulted in preparation of Hempel's article on, 385, 388.
 methods of collection and preservation of, 303.
 as food of rotifers and fishes, 312.
 classification of, 314.
 food relations of, 314, 324.
 geographical distribution of, 311.
 local distribution of, 312-314.
 methods of capture and study of, 310.
 species of, found in open water, 313.
 synopsis of the higher groups of, 314.
 typical forms of, 305-310.
prunicola, *Chionaspis*, 308.
Pseudoripersia proposed as new subgenus and a distinguishing character given, 302.
Pterodina, 274, 377, 421.
patina, 378.
 seasonal distribution of, 353.
valvata, 378.
Pterodinidae, 358, 359, 377.
pulchellus, *Cyclops*, 20, 44.
 Pump, Thresher Tank, used in collection of plankton, 13.
punctata, *Erpobdella*, 532, 535, 539, 539, 540.
 Nepheleis, 532.
punctatus, *Brachionus*, 353, 354, 379, 421.
 Purdy Electric Centrifuge, 20.
pustulata, *Quadrula*, 401, 403, 409, 410, 411, 412.
pustulatus, *Unio*, 403.
pustulosa, *Quadrula*, 401, 402, 403, 408, 409, 410, 412, 416.
pustulosus, *Unio*, 403.
pyriformis compressa, *Diffugia*, 310.
 Diffugia, 313, 314, 310.
 Euchlanis, 374.
 vas, *Diffugia*, 310.
pyrum, *Phacus*, 313, 326.
- Q
- quadricornis*, *Noteus*, 353, 382.
 var. *albidus*, *Monoculus*, 47.
 var. *viridis*, *Monoculus*, 37.
quadridentata, *Monostyla*, 376.
quadripartita, *Tokophrya*, 310, 339, 341.
quadristriata, *Nepheleis*, 532.
Quadrula asperrima, 401, 403.
 parasites of, 408, 409, 410, 412, 414.
 capacity for infestation exhibited by, 414.
ebena, 401, 403.
 parasites of, 409, 410, 411, 412, 413, 414.
granifera, 401, 403.
 parasites of, 409.
lachrymosa, 401, 403, 414.
 parasites of, 408, 409, 410, 411, 412.
metanevra, 401, 403.
 parasites of, 409, 410, 412.
multiplicata, 401, 403.
 parasites of, 409, 410, 412, 413.
 parasites of, 405.
plicata, 401, 403, 409.
 parasites of, 408, 410, 412, 413, 416.
pustulata, 401, 403.
 parasites of, 410, 411, 412.
pustulosa, 401, 402, 403.
 parasites of, 408, 409, 410, 412, 416.

Quadrula—*Continued.*

- rubiginosa, 401, 403, 414.
 parasites of, 406, 409, 410, 412.
 trigona, 401, 403.
 parasites of, 409, 410, 412, 413, 414.
 tuberculata, 401, 303.
 parasites of, 408, 409, 410, 412,
 413, 415, 416.

R

- Rabot, Ch., 158.
 radiata, *Astrosga*, 329.
 Radiolaria, 306, 315.
 radiosum, *Amoeba*, 317.
 Rafter, G. W., *The Microscopical Examination of Potable Water*, cited, 13, 21.
 Randolph, H., 456.
 Bei trag zur Kenntniss der Tubificiden, cited, 456.
 Raphidiophrys, 322.
 elegans, 322.
 pallida, 313, 322.
 Rattulidae, 358, 371.
 rectus, *Lampisilis*, 401, 403, 408, 409, 410, 412, 416.
 Unio, 403.
 reflexa, *Obliquaria*, 401, 403, 408, 409, 410, 412, 413.
 Reighard, J. E., 8, 535.
 A Biological Examination of Lake St. Clair, cited, 2, 3, 4, 5, 19.
 on color of *Dina fervida*, 537.
 reighardi, *Diaptomus*, 68, 109, 121, 169, 184.
 Report of the Biological and Natural History Survey of Minnesota, cited, 132, 233.
 Massachusetts State Board of Health, cited, 13.
 Rhabdostyla, 340.
 found on Entomostraca, on *Polyarthra platyptera*, and on aquatic worms, 340, 367.

- Rhizodrilus*, 451.
 lacteus, 443.
 circulatory system of, compared with that of *Ilyodrilus coccineus* and *Vermiculus pilosus*, 452.
 comparison of, with other Tubificidae, 450-452.
 description of, 444-449.
 distinguishing characters of, 450.
 found on *Sagittaria variabilis*, 444.
 summary of important characters of, 449.
Rhizopoda, 304, 305, 313, 314, 317.
 Rhizota, 356, 358, 360.
 rhomboides, *Metopidia*, 377.
 Rhynchelmis, 471.
 Riballier des Isles, 158.
 Richard, J., on basal segment of rudimentary foot of *Cyclops viridis*, 40.
 See de Guerne and Richard.
 ringens, *Melicerta*, 345.
 riparia, *Diplocardia*, 442.
 Rivularia, (*Ceistes mucicola* found on, 361.
 rivulorum, *Tubifex*, 442, 444.
 robustus, *Cyclops*, 20.
 roeselli, *Stentor*, 334.
 rosea, *Allolobophora*, 441.
 roseola, *Philodina*, 345.
 Ross, L. S., 28, 31, 98, 126, 156, 181.
 Rotifer, 362.
 macrurus, 363.
 neptunius, 363.
 tardus, 363.
 vulgaris, 363.
 Rotifera, 12, 14, 16, 304, 310, 342-384, 420, 421.
 affinities and classification of, 355.
 and Protozoa found in the Illinois River and Adjacent Lakes at Havana, Ill., A List of the, 301-388. See under Protozoa and Rotifera.

Rotifera — *Continued.*

- as food of Protozoa, 311.
 diagram of types of trophi of, and
 a summary of their distinguishing
 features, 344, 345.
 eggs of, 347.
 food of, 324.
 quantity of, 345.
 relations of, 350.
 geographical distribution of, 350.
 littoral and pelagic forms of,
 353.
 local distribution of, 353-355.
 methods of capture and study of,
 348-350.
 modes of locomotion, 356.
 seasonal distribution of, 351-353.
 synopsis of the families of, 356-
 359.
 vitality of, 347.
 geographical distribution of, 350.
 roubaui, *Diaptomus*, 166.
 Rousselet, C. F., 350.
 On a Method of preserving
 Rotatoria, cited, 304.
 Second Note on a Method of
 preserving Rotatoria,
 cited, 304.
 rubens, *Brachionus*, 379.
 rubiginosa, *Quadrula*, 401, 403, 406,
 409, 410, 412, 414.
 rubiginosum, *Coelostoma*, 390.
 rubiginosus, *Unio*, 403.
 rugosa, *Alasmodontia*, 401, 403, 408,
 409, 410, 412.
 Margaritana, 403.
 Opercularia, 340.
 Placobdella, 481, 482, 484, 487.

S

- Sacculus*, 366.
 viridis, 366.
Sagittaria, 302.
 variabilis, 444.
salinus, *Diaptomus*, 98
Salpina, 373.
 eustala, 373.
 seasonal distribution of, 352.
Salpingoeca, 320.
 minuta, 320.
 found on loriceæ of *Dinobryon*
 sertularia, 320.
Salpingoecinae, 320.
Salpinidae, 358, 373.
saltator, *Pedetes*, 368.
sanguineus, *Diaptomus*, 97, 112,
 117, 120, 133, 160, 166, 183, 234.
sanguisuga, *Hæmopsis*, 531.
Sarcodina, 305, 306, 314, 317.
 Sars, G. O., 20, 31, 37, 98, 220, 236,
 242.
 on second pair of antennæ
 of *Limnocalanus macrurus*
 and of *L. grimaldii*, 236.
 Oversigt af de indenlandske
 Ferskvands copepoder,
 cited, 236, 242.
 Pelagic Entomostraca of the
 Caspian Sea, cited, 242.
 Say, Thomas, Narrative of Expe-
 dition to the Source of the St.
 Peter's River, etc. Appendix of
 Vol. II., cited, 509, 532.
Scaridium, 373.
 longicaudum, 373.
Scenedesmus, 421.
 Schacht, F. W., 31.
 The North American Cen-
 tropagidæ belonging to the
 Genera *Osphranticum*,
 Limnocalanus, and *Epi-*
 schlura, 225-266. (Special
 index, p. 270.)
 The North American Species
 of *Diaptomus*, 97-207.
 (Special index, 208.)
 Schewiakoff, Wl., Ueber die geo-
 graphische Verbreitung der
 Süßwasser-Protozoen, cited,
 320, 340.

- Schewiakoff, Wl. — *Continued.*
 on *Opercularia rugosa*, 310.
- Schizocerca, 382.
diversicornis, 382.
homoceros, 382.
 seasonal distribution of, 353.
- Schmeil, Otto, 20, 31, 37, 38, 44, 45, 98, 185.
 description of *Cyclops viridis*, 39.
- Deutschlands freilebende Süßwasser Copepoden. I. Teil, cited, 27, 185.
 III. Teil, Centropagidae, cited, 99.
 Nachtrag, cited, 259.
- on antennae of *Cyclops prasinus*, 58.
 on basal segment of rudimentary foot of *Cyclops viridis*, 40.
 on description of *Scopiphora vagans*, 263.
 on *Epischura fluviatilis*, 267.
 on *Epischura nevadensis*, 259, 260.
 on Herrick's *Temora* or *Temorella affinis*, 226.
 on identity of *Epischura nevadensis* and *E. nevadensis columbiana*, 259.
 on oviducts of *Cyclops pleuratus*, 61.
 on specific distinctions of males in *Diaptomus*, 100.
 on synonymy of *Cyclops leuckarti*, 34.
- Schröder, B., Dangeardia, ein neues Chytridineen genus auf *Pandorina morum* Bory, cited, 134.
- Scirpus, 302.
- Scirtopoda, 356, 359, 383.
- Scopiphora, 249, 263.
vagans, 260, 263.
- Scopiphora vagans* — *Continued.*
 generic description of, 263.
- Scott, Andrew. See Herdman, W. A., Thompson, I. C., and Scott, Andrew.
- scutifer, *Cyclops*, 20.
- Sceplhidia, 337.
 sp., 337.
 found on *Unio parvus*, 337.
- securis, *Plagiola*, 401, 403, 409.
Unio, 403.
- semibullata, *Megalotrocha*, 352, 361.
- Semiscollex terrestris, 528.
- senta, *Hydatina*, 348, 350, 368.
- serpentina, *Chelydra*, 340, 342.
Nais, 443.
- serratus, *Atax*, 408.
Cyclops, 44, 45.
- serricornis, *Diaptomus*, 162.
- serrulata, *Anuraea*, 383.
- serrulatus, *Cyclops*, 20, 30, 54, 62, 63, 65.
 var. *elegans*, *Cyclops*, 54.
 var. *montanus*, *Cyclops*, 54, 55.
- sertularia angulatum, *Dinobryon*, 232.
Dinobryon, 312, 313, 323.
divergens, *Dinobryon*, 323.
undulatum, *Dinobryon*, 323.
- sestertia, *Macrobdella*, 500.
- Sharpe, R. W., 31.
- Shaw, W. R., On locomotion of *Pleodorina californica*, 283.
 on relationships of *Pleodorina*, 286.
Pleodorina, a New Genus of the Volvocinae, cited, 273, 276, 277, 279, 280, 281, 283, 286.
- shoshone, *Diaptomus*, 110, 116, 127, 141, 164, 183.
- sicculus, *Labidesthes*, 237.
- sicilis, *Diaptomus*, 97, 100, 111, 121, 122, 145, 155, 167, 168, 169, 182, 220, 264.

- sicilis—*Continued*.
 var. imperfectus, Diaptomus, 124, 158, 167, 169.
 siciloides, Diaptomus, 98, 100, 114, 121, 124, 137, 146, 154, 157, 165, 166, 181, 182, 183, 265.
 signatus, Cyclops, 20.
 var. tenuicornis, Cyclops, 47.
 signicauda, Diaptomus, 98, 114, 120, 157, 159, 160, 164, 183.
 signicaudatus, Diaptomus, 164.
 similis, Diaptomus, 132, 182.
 Vorticella, 338.
 Simpson, C. T., 418.
 sinensis, Limmocalanus, 99, 220, 235, 236, 237, 238, 245.
 singularis, Diplocardia, 442.
 Slipper animalcule, 332.
 Smith, Frank, 1, 98, 228, 229, 303, 348, 479.
 List of the Protozoa and Mollusca observed in Lake St. Clair in the Summer of 1893, cited, 313.
 Notes on Species of North American Oligochaeta. II., cited, 447, 462, 468, 470, 471.
 Notes on Species of North American Oligochaeta. III. List of Species found in Illinois, and Descriptions of Illinois Tubificidae, 441-458.
 Notes on Species of North American Oligochaeta. IV. On a New Lumbriculid Genus from Florida, with additional Notes on the Nephridial and Circulatory Systems of Mesoporodrilus asymmetricus Smith, 459-478.
 on occurrence of Rhizopoda in surface collections, 313.
 Snails as food of Glossiphonia complanata, 493.
 Snapping turtles, Opercularia irritabilis found on backs of, 340.
 snowi, Diaspis, 398.
 sociale, Gonium, 437.
 sol, Actinophrys, 313, 322.
 Solenococcus proposed as new name for Solenophora, 392.
 Solenophora (?) dryandrae withdrawn by Fuller, 392.
 Solenococcus proposed as new name for, 392.
 solidus, Metopidia, 377.
 solstitialis, Trochosphaera, 362.
 Sparganophilus eiseni, 442.
 Sphaerococcini, 389.
 Sphaerococcus, 480.
 spiralis, Lumbriculus, 450.
 Spirogyra, 354.
 as food of Mastigocerca, 371.
 spirogyra, Euglena, 313, 324.
 Spirosperma, 453, 456.
 Spirostomum, 333.
 teres, 333.
 Spirotricha, 308, 316, 333.
 Spondylomorurum, 419.
 Sporochytriaceae, one of the, as parasite of Platydorina caudata, 434.
 Sporozoa, 305, 306, 315.
 stagnalis, Diaptomus, 97, 101, 113, 115, 120, 136, 138, 142, 164, 183.
 Glossiphonia, 496, 497.
 Hirudo, 497.
 Stentor, 308, 333.
 barretti, 313, 334.
 caeruleus, 313, 334.
 culture of, 348.
 igneus (?) 334.
 polymorphus, 313, 334.
 roeselii, 334.
 sp., 334.
 Stentoridae, 333.
 Stephanoceros eichhornii, type of trophi of, 345.

- Stephanosphaera, 410, 436.
 locomotion and polarity of, 283,
 431, 432.
 pluvialis, 437.
 Stokes, A. C., 305.
 stokesii, Cathypna, 375.
 Distyla, 375.
 Stolic, A., description and figures
 of circulatory system of
 Hyodrilus coccineus cited,
 451, 452.
 on vascular arches of Hyodri-
 lus, 451.
 Monografie Ceskych Tubifici-
 cidu. Morfologicka a Sys-
 tematicka Studie, cited, 447,
 451.
 strenuus, Cyclops, 29.
 stricta, Atax, 408.
 Strombidium, 335.
 claparedi, 335.
 Strophitus, parasite of, 405.
 edentulus, 401, 403.
 parasites of, 406, 400, 410, 412,
 413, 416.
 stylata, Mastigocerca, 371.
 Synchaeta, 352, 354, 366
 Stylonichia, 300, 336.
 mytilus, 337.
 cultures of, 348.
 suborbiculata, Anodonta, 401, 403,
 405, 408, 400, 410, 411, 412, 413.
 Suckers, 351.
 Suctoria, 307, 300, 317, 341.
 Sun animalcules, 321.
 Suirella, 421.
 Sutroa, 469, 471, 475.
 alpestris, 463.
 Swan animalcules, 331.
 Synchaeta, 274, 366.
 pectinata, 354, 355, 366.
 seasonal distribution of, 352.
 stylata, 354, 366.
 seasonal distribution of, 352.
 Synchaetidae, 358, 366, 421.
 Synura, 274, 326, 421.
 uvella, 327.
- T**
- tabulatum, Peridinium, 313, 320,
 421.
 Taphrocampa, 360.
 annulosa, 360.
 tappaniana, Alasmodonta, 401, 403,
 409.
 tappanianus, Unio, 403.
 tardus, Rotifer, 363.
 tecta, Amraea, 351, 353, 354, 364,
 365, 382.
 Temora, 225.
 affinis, 225.
 Temorella, 99, 225.
 affinis, 225.
 Temorina, 103.
 tenebrarum, Aeolosoma, 413.
 tenuior, Cyclops, 372.
 tenuissimus, Lampsilis, 401, 403,
 400.
 Unio, 403.
 teres, Spirostomum, 333.
 terminalis, Triarthra, 354, 355, 367.
 terrestris, Semiscolex, 528.
 Testacea, 315.
 theeli, Diaptomus, 101.
 Thinodrilus, 471.
 inconstans, 442, 460.
 thomasi, Cyclops, 44, 45.
 Thompson, I. C. See Herdman,
 W. A., Thompson, I. C., and
 Scott, Andrew.
 Tinsley, J. D., descriptions of Coc-
 cidae by, cited, 300.
 Tintinnidae, 335.
 Tintinnopsis, 335.
 fluvatile, 335.
 illinoisensis, 313, 335.
 Toads, Hemiclepsis carinata found
 attached to, 504.
 Tokophrya, 309, 310, 311.
 cyclopus found on Cyclops, 341.

- Tokoplrya*—*Continued*.
 food of, 311.
 quadripartita, 330, 341.
 found attached to small animals, 342.
 method of preservation of, 310.
 torta, Euglena, 313, 324.
 Trachelomonas, 326.
 Tracheliidae, 331.
 Trachelomonas, 274, 325, 420.
 acuminata, 313, 325.
 armata, 325.
 caudata, 313, 325.
 hispida, 326.
 torta, 326.
 urceolata, 326.
 Trematode, 404, 406.
 Triarthra, 346, 367, 421.
 longiseta, 367.
 seasonal distribution of, 352.
 terminalis, 354, 355, 367.
 Triarthridae, 358, 366.
 Trichodina, 337.
 pediculis, 337.
 frequent on *Hydra viridis*, 337.
 Trichomytilus as new genus for certain species of *Mytilaspis*, 307.
 Trichostomata, 307, 316, 332.
 trigona, *Quadrula*, 401, 403, 400, 410, 412, 413, 414.
 trigonus, *Unio*, 403.
 triptera, *Metopidia*, 377.
 tripus, *Notommata*, 360.
 triquetra, *Phacus*, 326.
 triquetra, *Euchlanis*, 374.
 triserialis, *Glossiphonia*, 403.
 Helobdella, 403.
 Trochosphaera, 356, 361.
 solstitialis, 362.
 truncata, *Lacrymaria*, 330.
 Trybom, F., 154, 160.
 trybomi, *Diaptomus*, 98, 112, 120, 158, 166, 183.
 tuberculata, *Philodina*, 363.
 tuberculata—*Continued*.
 Quadrula, 401, 403, 408, 409, 410, 412, 413, 415, 416.
 tuberculatus, *Unio*, 403.
 tuberculosa, *Difflugia*, 313, 320.
 Tubifex rivulorum, 442.
 description of, 444.
 Tubificidae, 445, 447, 448, 450, 451, 452, 453, 454, 456.
 description of, 443, 456.
 found in Illinois, 442.
 Illinois, Descriptions of, and List of Species of North American Oligochaeta found in Illinois, 441-458.
 Tubificid worms found in caeca of *Macrobdella decora*, 511.
 found in stomachs of *Dina microstoma*, 541.
 turgida, *Allolobophora*, 442.
 Turner C. H., and Herrick, C. L., Synopsis of the Entomostraca of Minnesota, cited, 37, 38.
 Turtles attacked by *Macrobdella*, 511.
 examination of, for Protozoa, 310, 312.
 Tyrrell, J. B., 177.
 tyrrelli, *Diaptomus*, 99, 108, 119, 160, 176, 184.
- U**
- Underwood, L. M., List of the described Species of Fresh-water Crustacea from America North of Mexico, cited, 67.
 undulata, *Alasmiodonta*, 401, 403, 409.
 Margaritana, 403.
 uniangulatus, *Cyclops*, 30, 41.
 unicornis, *Conochila*, 354, 362.
 Unio alatus, 403.
 anodontoides, 403.
 Conchophthirus anodontae found among gills of, 333.

Unio - Continued.

- asperrimus, 403.
 capacity for infestation exhibited by, 414.
 complanatus, 403, 410, 416.
 parasites of, 400, 412, 415, 416.
 cornutus, 403.
 donaciformis, 403.
 ebenus, 403.
 elegans, 403.
 ellipsis, 403.
 gibbosus, 401, 403.
 parasites of, 400, 410, 412, 413, 415, 416.
 gracilis, 403.
 graniferus, 403.
 heterodon, 401, 403.
 parasites of, 400.
 higginsii, 403.
 lachrymosus, 403.
 lævissimus, 403.
 ligamentinus, 403.
 luteolus, 403.
 metanever, 403.
 multiplicatus, 403.
 nasutus, 403.
 ochraceus, 403.
 parasite of, 405.
 parvus, 403.
 Scyphidia sp. found on, 337.
 plicatus, 403.
 pustulatus, 403.
 pustulosus, 403.
 rectus, 403.
 rubiginosus, 403.
 securis, 403.
 tappanianus, 403.
 tenuissimus, 403.
 trigonus, 403.
 tuberculatus, 403.
 ventricosus, 403.
- Unionida, A Statistical Study of the Parasites of the, 399-418;
 summary of results reached, 417.

Unionida - Continued.

- changes in nomenclature of, 402, 403.
 comparison of infestation of, by different parasites, 412.
 of local infestation of, 416.
 examined in study of parasites, geographical distribution of, 401.
 geographical distribution of parasites of, 414.
 relation of infestation of, to abundance of given species of, 415.
 to natural classification, 413.
 to local conditions, 417.
 relative number of parasites on males and females of, 403.
 sex of individuals examined in study of parasites of, 402.
 specific distribution of parasites of, 400.
 waters in which collections were made for Kelly's study of parasites of, 390, 400.
- U. S. Fish Commission, 28, 160, 250.
 National Museum, 200, 418.
- University of Illinois, 20, 27, 185, 225, 229, 268, 348, 441.
 of Indiana, 220.
 of Pennsylvania, 542.
 of Upsala, Zoölogical Museum of, 164.
- Urceolarinae, 337.
- urceolaris, *Brachionus*, 345, 353, 379.
- urceolata, *Difflugia*, 319.
Trachelomonas, 326.
- Umatella gracilis, *Cothurnia curva* found on, 341.
- Uroglena, 274, 421.
- Utricularia, 349.
- uvella, *Synura*, 327.

V

- vaga, Dero, 443.
 vagans, Scopiophora, 260, 263.
 VanDervoort, W. H., machine for precipitating plankton devised by, 20.
 Vaginicola, 341.
 gigantea, 341.
 valdiviviana, Macrobdella, 528.
 valvata, Pterodina, 378.
 variabilis, Brachionus, 354, 380.
 Sagittaria, 444.
 varicans, Cyclops, 20, 63, 64.
 variegatus, Peloscolex, 456.
 vegetans, Anthophysa, 323.
 Vejdovsky, F., Anatomische Studien an Rhynchelmis Limosella Hoffm. (= *Euaxes filirostris* Grube), cited, 471.
 vejdoskyanum, Bothrioneuron, 452.
 velutinus, Embolocephalus, 456.
 ventricosus, Lampsilis, 401, 403, 407, 408, 409, 410, 411, 412, 413, 416.
 Unio, 403.
 Vermes, 356.
 Vermiculus, distinguishing character of, 451.
 limosus, 451.
 pilosus, 416, 450.
 circulatory system of, 452.
 resemblance of *Rhizodrilus lacteus* to, 450.
 vernalis, Cyclops, 20, 64.
 Verrill, A. E., 518.
 description of colors of *Glossiphonia complanata*, cited, 403.
 on color of *Dina fervida*, 537.
 Synopsis of North American Fresh-water Leeches, cited, 500, 513, 527.
 verrucosa, Diplocardia, 442.
 villosa, Pelomyxa, 317.
 viridis, Amblyophtis, 325.
 viridis—*Continued*.
 Cyclops, 20, 30, 37, 41, 43, 48, 62, 63, 64.
 Euglena, 312, 313, 324, 325.
 Hydra, 337.
 Sacculus, 366.
 var. *brevispinosus*, Cyclops, 30, 41, 62, 63, 64.
 var. *insectus*, Cyclops, 31, 41, 62, 63, 64.
 Vivipara, Epistylis plicatilis found on shells of, 339.
 Volvocidae, 327.
 New Genus of the family of, from the Plankton of the Illinois River, 410-440.
 Volvocine, 419, 432, 434.
 keys to genera and species of the subfamily of, 435, 436-438.
 locomotion and polarity of, 431, 432.
 term colony as applied to the, 434.
 Volvocineæ, 273, 282, 287.
 Volvox, 141, 274, 278, 280, 285, 286, 288, 301, 327, 410, 421, 431, 434, 437.
 as food of rotifers, 312, 351.
 aureus, 276, 287, 438.
 globator, 276, 285, 287, 312, 313, 327, 438.
 as food of *Asplanchna priodonta* and *A. herrickii*, 365.
 locomotion and polarity of, 285, 431, 432.
 Vorticella, 309, 310, 311, 312, 338, 339.
 campanula, 338.
 V. microstoma, and *V. similis* on or among Lemnaceæ, 338.
 food of, 311.
 found on roots of Lemna and on fixed aquatic plants, 310.
 microstoma, 338.
 similis, 338.

- Vorticellidae, 311, 337.
 Vorticellinae, 337.
vulgaris angulosa, Arcella, 313, 314.
 Arcella, 313, 314, 318.
 discoides, Arcella, 313, 314, 318.
 Rotifer, 350, 363.
- W**
- Walkeriana floriger*, Coccus luniger a synonym for, 301.
 Ward, H. B., A Biological Examination of Lake Michigan in the Traverse Bay Region, cited, 2, 3, 10.
 A New Method for the Quantitative Determination of Plankton Hauls, cited, 18.
 Water-bloom, 321, 420.
 Water-snails, *Epistylis plicatilis* found on shells of, 339.
 Westwood, J. O., establishment of genus *Diaptomus*, 97.
 Whitman, C. O., The Leeches of Japan, cited, 509, 511.
 The Metamerism of *Clepsine*, cited, 479.
 Wierzejski, A description of *C. annulatus* (= *edax*) cited, 35.
wierzejskii, *Diaptomus*, 101, 107.
 Wills, A. W., On the Structure and Life History of *Volvox globator*, cited, 276, 285.
- Wolcott, Robert H., determination of Atax collections by, 407.
 Worms, aquatic, species of *Rhabdostyla* found on, 340.
- Y**
- ypsilophorus*, Atax, 408.
- Z**
- Zacharias, O., 98.
 Beobachtungen am Plankton des Gr. Plöner See's, cited, 313.
 Forschungsberichte aus der Biologischen Station zu Plön, Theil I.-IV., cited, 2.
 Faunistische Mittheilungen, cited, 304.
 Ueber die Wechselnde Quantität des Planktons im Grossen Plöner See, cited, 18.
zachariasii, *Diaptomus*, 99.
 Zograf, N., Essai d'Explication de l'origine de la Faune des lacs de la Russie d'Europe, cited, 226.
 Zoölogical Bulletin cited, 406.
 Zoologisches Centralblatt cited, 226.
 Zoothamnium, 339.
 arbuscula, 339.

ERRATA.

Page 136, line 2, and page 182, line 17 from bottom, for '05*a* read '05.

Page 226, line 2, page 263, line 17 from bottom, and page 267, lines 2 and 15, for '98, read '00.

Page 233, line 15 from bottom, for '82 read '82*a*.

Page 355, line 2 from bottom, for C. E. Hudson read C. T. Hudson.

Page 389, foot-note, for Vol. I, read Vol. II.

Page 457, line 5, for *Genera* read *Genus*.



3 2044 106 261 217

Date Due

~~22 Oct '49~~

10 Dec '49

~~DEC 1951~~

MAY 3 1952

~~DEC 1952~~

~~JAN 3 1953~~

JAN 3 1953

JAN 4 1958

