



Digitized by the Internet Archive  
in 2010 with funding from  
University of Toronto



HANDBOUND  
AT THE



UNIVERSITY OF





Bulletin of the Museum of Comparative Zoölogy

AT HARVARD COLLEGE.

VOL. XL. No. 3.

---

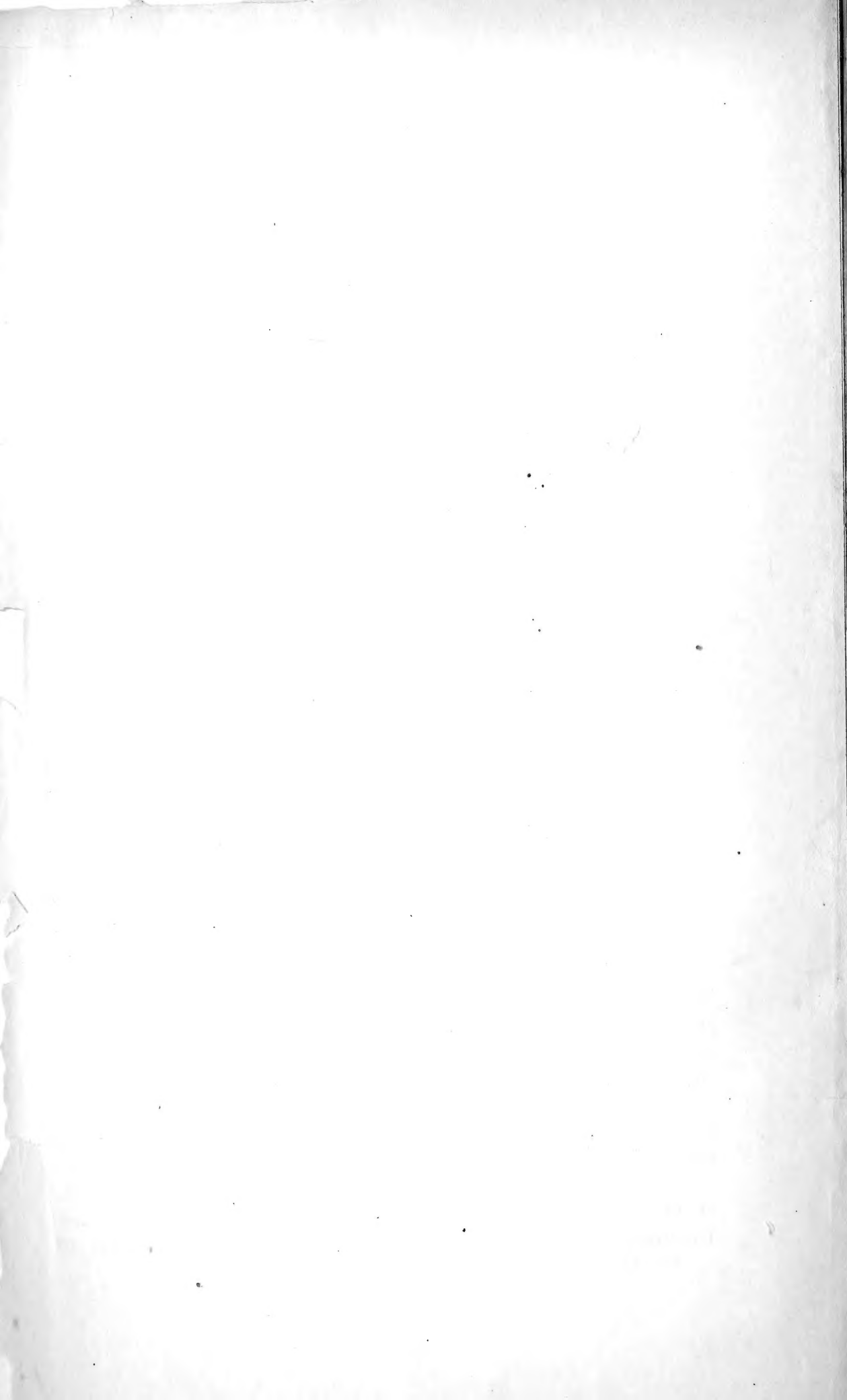
THE DEVELOPMENT OF THE DEFINITIVE FEATHER.

By R. M. STRONG.

WITH NINE PLATES.

CAMBRIDGE, MASS., U. S. A. :  
PRINTED FOR THE MUSEUM.

OCTOBER, 1902.





93  
6858  
I

BULLETIN

OF THE

Harvard University.  
" MUSEUM OF COMPARATIVE ZOOLOGY

AT

HARVARD COLLEGE, IN CAMBRIDGE.

VOL. XXXIX.

---

CAMBRIDGE, MASS., U. S. A.

1901-1904.

QL

I  
H3

V.39-40

UNIVERSITY PRESS:  
JOHN WILSON AND SON, CAMBRIDGE, U. S. A.

613345

4.7.55

# CONTENTS.

---

	PAGE
No. 1. — Some Reptiles and Batrachians from Australasia. By SAMUEL GARMAN. (2 Plates.) November, 1901 . . . . .	1
No. 2. — Chiriqui Mammalia. By OUTRAM BANGS. April, 1902 . . . . .	15
No. 3. — Some Carboniferous Cestraciant and Acanthodian Sharks. By C. R. EASTMAN. (7 Plates.) June, 1902 . . . . .	53
No. 4. — Illustrations of Odonata:— Argia. By HERMANN A. HAGEN. With a List and Bibliography of the Species. By PHILIP P. CALVERT. (2 Plates.) November, 1902 . . . . .	101
No. 5. — Crabs from the Maldive Islands. By MARY J. RATHBUN. (1 Plate.) December, 1902 . . . . .	121
No. 6. — Birds and Mammals from Honduras. By OUTRAM BANGS. July, 1903 . . . . .	139
No. 7. — Carboniferous Fishes from the Central Western States. By C. R. EASTMAN. (5 Plates.) July, 1903 . . . . .	161
No. 8. — Some Fishes from Australasia. By SAMUEL GARMAN. (5 Plates.) August, 1903 . . . . .	227
No. 9. — Medusae from the Maldive Islands. By HENRY B. BIGELOW. (9 Plates.) April, 1904 . . . . .	243



No. 1. — *Some Reptiles and Batrachians from Australasia.*

By SAMUEL GARMAN.

MANY of these specimens were taken, at various localities, by members of Mr. Alexander Agassiz's Expeditions to the Great Barrier Reef of Australia and to the Fiji and Samoan Islands, and a large number were donated by Mr. E. A. C. Olive, who had made Cooktown, Queensland, the point of departure for his collecting excursions. Among them there are certain types that are particularly interesting, since they are closely allied to others, already described, from the southern and the western parts of Australia, and yet are sufficiently distinct to demand descriptions and names, on account of importance in considerations of distribution and derivation. While some of them appear to be new, all of them have close affinities with species more or less widely distributed in the region. In the collection there are thirty-four species, and these pertain to twenty-two genera of fourteen families.

*Gymnodactylus pelagicus* BOUL.

*Heteronota pelagica* GIR.

Individuals taken on the Barrier Reefs, by the members of the expedition, and at Cooktown, by Mr. Olive, agree well with the original description drawn from those taken on the Fiji and Navigator Islands. The rows of tubercles vary in number from sixteen to eighteen; the small scales of the dorsum have three or more keels; and on some the labials number eight upper and six lower.

*Gymnodactylus Olivii*, sp. nov.

Plate 1, Fig. 1-1d.

Head large, depressed, widest across the space between the ears and the eyes, three-fourths as wide as long, tapering from the postocular region to the snout. Snout nearly one-third longer than the space between the orbits and the ear, blunt. Forehead slightly concave. Ear opening small, subtriangular. Body moderately depressed; limbs moderate; digits depressed at the base, compressed in the distal portion, with broad transverse plates under the basal joint;

tail one-seventh longer than the body; slender, round, tapering regularly. Head scales granular, crown from the eyes backward with numerous minute tubercular scales. Rostral large, wider than high, joined on the upper edge by two nasals and a smaller subquadrangular internasal. Nostril edged by the rostral, nasal, a small scale joining the latter, four or five granules, and the first labial. Labials thirteen; lower labials eleven; mental large, pentagonal, wedged between two large chin shields, which latter meet for a considerable distance behind the angle of the mental. Smaller chin shields decrease in size backward, from the anterior, at the lower edges of the labials. Throat with granules. Back covered with granules, in which there are twenty-four longitudinal series of small tubercular scales, of which those near the thighs and tail are more elongate, and rise in a low blunt point or short depressed keel. Abdominal scales larger, flat, smooth, imbricate, rounded on the free edges, in twenty-eight longitudinal rows. Upper caudal scales similar to those of the hinder portion of the back; scales of the lower surfaces of the tail, flat, smooth, irregular in shape and in width, many of them reaching across the entire lower side.

Light grayish brown with transverse bands of darker, white below. Top of head light, with small streaks and spots of brown; a dark band with darker edges from the end of the snout through the eye above the ear behind the occiput crossing the nape; a similar band across the space between the shoulders, three across the body between the arms and the legs, and one across the space between the hips. Similar bands cross the tail, where they are darker, and the difference in depth of color in edges and median portions disappears. Name in honor of Mr. E. A. C. Olive.

This form differs from *G. pelagicus* in tubercles, chin shields, abdominal scales and markings.

Queensland, near Cooktown; Mr. Olive.

### *Phyllurus cornutus* OGIL.

*P. lichenosus* GÜNT.

In Mr. Olive's collection there is a specimen rather smaller than the type and exhibiting some variation from the original description. The transverse bands of brownish on the tail completely encircle that organ, and are quite as distinct on the lower side as on the upper. On the median portion of the ventral surface of the tail the five white interspaces are much wider and whiter than the white blotches on the back of the body. The diameter of the eye is half the length of the snout. The conical tubercles on the keel at the sides of the abdomen readily distinguish this form from *P. platurus*, as also the scallops. The type of *P. cornutus* was about eight and one-fourth inches in length, that of *P. lichenosus* was about five and one-eighth, a present specimen is intermediate between the two, and, as it appears to me, conclusively establishes the identity of these species.

*Cedura Mayeri*, sp. nov.

Plate 2, Fig. 2-2c.

Form similar to that of *C. marmorata*; depressed, elongate, transversely banded. Head depressed, large, long, subtriangular, pointed in front, widest between the ears and the eyes, concave on the forehead; snout as long as the distance from eye to ear, blunted at the end, one and one-half times the length of the orbit. Ear opening oblique, two-thirds as wide as the eye. Limbs medium, depressed, in large specimens as broad as the apical expansions, narrower in the young. Apical expansions broader than long, with a pair of rounded plates. Four pairs and a number of undivided infradigital plates. Head plates small, flat, smooth, nearly uniform in size, irregularly polygonal in shapes, larger between the eye and the nasal plates. Rostral large, eight sided, about twice as wide as high, with a slight median cleft above. Nostril surrounded by six plates, rostral, first labial and four nasals; upper two nasals large, anterior largest and meeting the opposite nasal behind the rostral. Eleven labials; nine lower labials. Mental subtriangular, truncated and in contact with a heptagonal submental which separates the first pair of lower labials; enlarged submentals in contact with all the lower labials, their sizes decreasing regularly to the small subgulars. Back, sides, and belly covered with small hexagonal to subcircular smooth scales larger than those of the head; scales of the belly larger; caudal scales broader than long, subhexagonal. Femoral pores twenty. Tail long, five sixths as long as the body, slightly depressed, thickened anteriorly, tapering backward to a point, not as wide as the body. A single rounded and flattened tubercular scale at each side of the base of the tail.

Adults are brown to light grayish brown, with a whitish band from the end of the snout below the eye across the ear and around the occiput on the nape, top of head lighter, four narrow transverse bands of light color across the back and six around the tail. The anterior of the bands on the body is above the shoulder, and the posterior is above the vent. The lower surfaces are whitish. On young specimens the brown is nearly black and the transverse bands are whiter and, the sides being brown, are more distinctly separated from the white of the lower surfaces.

This differs from the *C. marmorata* in the separated infralabials, the larger submental scales, the greater number of femoral pores and the longer more slender tail. Named in honor of Dr. A. G. Mayer.

Queensland; Dr. A. G. Mayer and Mr. E. A. C. Olive.

*Gehyra oceanica* GRAY.*Gecco oceanicus* LESS.

Fijis: Samoa.

***Gehyra variegata* BOUL.***Hemidactylus variegatus* D. B.

In one case the six pores of the right side are the only ones present, a possible indication of bisexual internal conditions.

***Woodworthia*, gen. nov.**

Geconiform, with rounded tapering tail. Digits strongly dilated, median slightly webbed at their bases, inner and outer free; distal phalanx of inner digit raised, supporting two plates with the claw between as in *Ædura*, basal phalanges with broad undivided transverse lamellæ; distal phalanges of the other four digits compressed, raised, and clawed as in *Hoplodactylus*. Body covered above with uniform granular scales, inferiorly with larger slightly imbricated scales. Pupil vertical.

On the types four digits of each foot resemble those of *Naultinus* or *Hoplodactylus*, while the fifth digit has a distal portion more like that of *Ædura*, being provided with a large pad at each side of the claw below the extremity.

Generic name in honor of Dr. W. McM. Woodworth.

***Woodworthia digatata*, sp. nov.****Plate 1, Fig. 2-2f.**

Outlines resembling those of *Hemidactylus*; with tail moderately long and slender. Head oval, snout narrowed, blunt, little longer than the distance between the eye and the ear; ear opening large, narrow, oblique; eye large, prominent. Body and limbs moderate, feet large. Digits broad, outer and inner on each foot free, others united by a rudimentary web; basal dilatations large, inferiorly with a single series of transverse lamellæ; distal phalanges strong, compressed, raised and clawed on four of the digits; distal phalanx on the fifth digit differing from that of the others in being broad and bearing inferiorly a pair of large plates between which the claw rests, Plate 1, Fig. f. Twelve or thirteen lamellæ under the fourth toe. Snout covered with granules, larger between the rostral and each orbit, becoming largest and plate-like toward the rostral and the labials. Twelve labials; thirteen lower labials. Rostral more than twice as broad as high, cleft at the upper edge. Nostril pierced between the rostral, first labial, and four nasals. Three scales across the snout behind the rostral between the nostrils, median smallest. Two scales behind the mental between the lower labials of the first pair. Two small scales behind each of the first pair of lower labials, and one or two behind each of the second pair. Behind those mentioned the scales gradually decrease in size to the granules. On the back and the limbs the granules are uniform and



very small; on the lower surfaces they are larger and subimbricate; on the tail they are broader and arranged in rings. There is a small tubercular scale behind each thigh at each side of the base of the tail, and a group of larger ones behind the vent. Neither femoral nor preanal pores are discovered on these specimens.

Light reddish brown, with five irregular transverse ashy blotches across the body and about eight across the tail. A light area from the supraorbitals backward, lighter specks, spots, cloudings or mottlings on face, flanks and limbs. On some the ashy blotches are indistinct or absent, and the spaces between them appear as darker edged transverse bands.

“New Zealand; Mr. Edwards.”

### *Lepidodactylus lugubris* Fitz.

*Platydactylus lugubris* D. B.

One specimen from Suva has two tails, a smaller more perfect tail rising on the top of a much larger stump, above the anterior caudal vertebræ, some distance forward of the end, instead of at the extremity, as in the more common reproductions.

Suva and Wailagilala, Fiji Islands, and Upolu, Samoa; Dr. Woodworth.

### *Delma reticulata*, sp. nov.

Plate 2, Fig. 1-1 f.

Body elongate, slender; tail much longer; head long, less than one-eighth of the length from snout to vent, subquadrangular in transsection, pointed, tapering from midway between the eyes and the ears, bluntly rounded at the end of the snout; jaws nearly equal. Snout hardly as long as the space between the orbit and the ear. Earopening oblique, less than half as long as the eye. Rudimentary limbs two-thirds as long as the snout, three-fourths as wide as long, with five scales, 2 + 2 + 1. Rostral scale subtriangular, nearly twice as wide as high; a pair of frontonasals; nostril pierced between the frontonasal, the nasal, and the first labial; labials five or six, third elongate, below the orbit and separated from it by a series of small scales, second separated from prefrontal and loreal by two small scales; prefrontals wide, wider than long; frontal large, longer than wide, octagonal; postfrontal not so large as the frontal, heptagonal, in contact with two large supraorbital shields, the outer edges of which rest against three or four smaller supraciliaries; small scales separate the loreal and the postorbitals from the eye; parietals larger than the postfrontal, hexagonal; post parietals small, separated on the median line by two lozenge-shaped cells; mental shield larger than the rostral, with three angles; lower labials four or five, anterior of opposite sides in contact behind

the mental, second largest and meeting a smaller scale on the median line, third long and narrow and in contact with a larger plate at the lower edge. Thirteen or fourteen small gular scales between the chin and the enlarged ventral scutes. Scales smooth, in fourteen rows around the body, and in twenty rows around the middle of the neck. Fifty-two pairs of ventral scutes from gulars to vent; each scute twice the size of the dorsal scales, or larger, less than twice as wide as long. Preanal scales three, outer two larger, middle one triangular acute-angled backward. Scutes below the tail in a single series for a considerable distance, thence smaller and irregularly placed. Tail less than twice as long as head and body.

Back reddish brown, belly whitish, chin and throat white. The white of the throat extends upward in pointed areas on the sides of the head. Top of head with three transverse blotches of black narrowly separated by two streaks of white; broadest band across the space between the ears, a narrower band immediately back of the ears on the nape, and the third across the interorbital space. Snout dark in the upper portion, with an indistinct transverse line of lighter color across the forward end of the frontal. The darker color on the first and second labials encroaches on the lower labials, as also is the case with the black band through the eye. The edges of the scales are little darker, forming reticulations.

Queensland; Mr. Olive.

#### **Diporophora bilineata** GRAY.

One specimen of a light reddish brown color, with numerous transverse bands of brownish on the upper side of the tail, and with darker bands of brownish at the sides of the neck and along the flanks.

Queensland.

#### **Chlamydosaurus Kingi** GRAY.

On several of the smaller specimens the frill is very short, occupying but two-sevenths of the length from the end of the snout to the end of the frill.

Queensland; Mr. Olive.

#### **Brachylophus fasciatus** WAGL.

##### *Iguana fasciata* BRONGN.

From Levuka, Ovalau Island, and Suva, Viti Levu, of the Fiji Islands. The specimen from Levuka has five enlarged sharp-edged scales directed down below the proximal joint of the third toe of the hind foot; on the second and the third toes the enlarged scales are smaller and fewer in number, three to four. It has sixteen femoral pores on each side. On an individual from Suva there are six enlarged scales below the third toe, the scales below the first and second

toes are similar but smaller, and there are nineteen femoral pores on each side. A note by the captor remarks: "In life the colors change rapidly from green to green with blue-grey bands," which raises the question whether it is right to state that the male is banded and the female uniform in color. In one case there are fourteen femoral pores on one side and fifteen on the other; in another there are twelve on one side and fourteen on the other.

**Lygosoma tenue** BOUL.

*Tiliqua tenuis* GRAY.

Scales in twenty-eight rows around the body.  
Cooktown; Mr. Olive.

**Lygosoma noctua** P. D.

*Scincus noctua* LESS.

Upolu, Samoa; Dr. Woodworth.

**Lygosoma fuscum** BOUL.

*Heteropus fuscus* D. B.

The present variety was collected by Mr. Olive near Cooktown. It has a dark band from the snout through the eye to the shoulders, which is white-edged and longer in the young. On some large specimens the line between the eye and shoulder is very black, and is broken by narrow streaks of white into several blotches. In cases there are white specks scattered over the flanks. Commonly the tail is lighter in color than the body and more red; it is thick at the base and tapers somewhat abruptly. Another variety taken at "Cairns" by Dr. A. G. Mayer is dark olive, and has thirty-four rows of scales around the body, instead of thirty-six as in the first form.

**Lygosoma æratum**, sp. nov.

Lacertiform; the distance from the end of the snout to the arm is one-third of the length from snout to vent. Head moderate, rather pointed at the snout, subquadrangular in transsection; snout short, one and one-half times the length of the eye, blunt. Lower eyelid with a large undivided transparent disk, larger than the earopening. Nostril pierced in a single nasal. Frontonasal wider than long, broadly in contact with the rostral, narrowly in contact with the frontal. No supranasal. Frontal in contact with two supraorbitals, shorter than the frontoparietal. Prefrontals not in contact, larger than the interparietal. Interparietal small, subtriangular, edges convex. Parietals forming a suture. A

pair of broad nuchals. A large temporal shield in contact with each parietal. Lower labials six. Anterior submental very broad, with a blunt angle in front, followed by a pair of large shields forming a suture behind it, this pair followed by another pair separated by a small shield, and these again by a third pair separated by three scales. Labials five or six, eye over the third or the fourth, which is much elongated. Supraorbitals four, second largest, first shortest and smallest. Postnasal short, oblique. Loreal comparatively large. Earopening smaller than the eye, elongate, hidden by sharp lobules from the upper side and from the lower. Scales smooth, in twenty-two rows around the body, largest on the back, smallest on the flank. In six or seven of the anterior series the subcaudal scales are small, behind these there is a median series of much broader ones. Limbs moderate, hardly meeting when adpressed; anterior with four digits, posterior with five. Fourth toe with about eighteen subdigital lamellæ. Tail one and three-fifths times the length of head and body.

Light bronzed olive on back and sides, lustrous whitish to light olivaceous below; each scale of back and sides with several darker streaks, resembling keels in effect, spreading into larger blotches on the tail; lighter patches on scales of the sides of the tail. Frecklings or small spots on lips, sides of throat and belly, and below the pelvic region and the tail. Limbs freckled with white.

Near Cooktown; Mr. Olive.

This species is allied to *L. læve* Oudem., 1894: it differs in labials, in number of rows of scales, and in the large eye-disk.

### *Lygosoma cyanurum* BOUL.

*Scincus cyanurus* LESS.

Taviuni Island, Fiji; Dr. W. McM. Woodworth.

### *Lygosoma samoense* BOUL.

*Eumeces samoensis* DUM.

An individual taken on Viti Levu, Fiji, by Dr. Mayer may represent a variety of this species, since it possesses but twenty-eight rows of scales around the body, while the species is characterized by thirty or more. Other specimens collected by Dr. Woodworth on Suva have thirty-two rows.

### *Lygosoma atromaculatum*, sp. nov.

Form similar to that of *L. isolepis* Boul. Body elongate, slightly depressed; limbs short, rather weak, not meeting by the length of the arm when adpressed; feet pentadactyl; tail one and one-half times as long as head and body, thick,

round, tapering regularly. Distance from snout to fore-leg contained one and one-half times in the distance from axilla to vent. Snout short, shorter than the space between the eye and the ear. Lower eyelid scaly, transparent. Rostral hexagonal, wider than high, truncate, in contact with the frontonasal. Nostril pierced in a single nasal; no supranasal. Nasal quadrangular, in contact with the first labial; postnasal in contact with second labial; loreal in contact with second and third labials. Labials seven, fifth and sixth below the eye. Frontal one and one-half times as long as wide, broadly in contact with the frontonasal and with the anterior two pairs of supraoculars; prefrontals small; frontonasal broader than long, octagonal; frontoparietals moderate, little larger than the interparietal; parietals large, meeting behind the interparietal. Three to four pairs of nuchals, twice as wide as the shields behind them. A large shield and a much smaller one at the outer side of each parietal. Four supraorbitals, second widest. Five or six broad shields between the eye and the ear. Seven or eight supraciliaries. Mental shield large, broad, in contact with two labials and a submental. Anterior submental broader than long, in contact with five shields, followed on each side by four broad submentals, the anterior pair of which meet on the median line, the second pair are separated by a single small scale, and the third pair are separated by three scales. Earopening subelliptical, oblique, little smaller than the eye, with several hardly noticeable lobules on the anterior border. Scales smooth, in twenty-four rows around the body, dorsals larger and laterals little smaller than the ventrals; a pair of enlarged preanals. Below the tail the scales are somewhat larger than those on the upper surfaces. Rostral, nasals, first labial and mentals have in most cases the appearance of being thicker than the other head scales or of having retained the slough. Digits weak, slightly compressed; subdigital lamellæ forming a low keel, nineteen under the fourth toe.

Bronzed olive on the back, more or less lightly sprinkled with black spots which become more numerous toward and on the tail and on the limbs. Belly and lower side of tail uniform whitish. Scales of sides and lower surfaces of head and throat with black spots, those of labials and submentals most intense. Entire flanks closely spotted with small black spots; in cases the spots of sides and back become longitudinal streaks. On some individuals the back is more thickly covered with spots which are smaller forward and on the back of the head, and each labial bears a white vertical bar in the middle, the black spots being situated on the sutures and covering a portion of each scale.

Differs from *L. isolepis* Boul. and *L. elegantulum* Pet. & Dor. in the smaller number of scales.

Barrier Reef, Australia; G. B. R. Exp.: Queensland; Mr. Olive.

#### ***Ablepharus heteropus*, sp. nov.**

Head medium; snout short blunt, rounded, slightly projecting. Eye surrounded by granules. Rostral slightly swollen, largely in contact with the frontonasal; frontal moderate, hexagonal, in contact with frontonasal, inter-

parietal, prefrontals, and two anterior supraoculars. Prefrontals about half as large as the frontal, not in contact. Frontoparietal large, much larger than the frontal. Interparietal distinct, small, hardly as large as a prefrontal. Four supraoculars, anterior smallest, second largest. Labials six, fourth long and below the orbit. Parietals broad, in contact behind the interparietal. Two pairs of broad nuchals. Earopening small, nearly hidden by sharp lobules from the upper and the lower edges. Scales smooth, in twenty-four rows around the body, scales of flank smallest. Preanals small. Limbs short, anterior tetradactyl, posterior pentadactyl, not meeting when adpressed. Digits short, outer on the hind foot very short. Tail longer than head and body.

Brownish olive above, lighter toward the belly, with small spots of brown below the hinder part of the abdomen, under the tail, on the limbs, along the lower edges of the flanks, and on the lips and the sides of the throat; belly, throat, and lower surface of tail white.

Near *A. Greyi* Gray, of Western and Southern Australia.

Great Barrier Reef, Queensland; G. B. R. Exp.

### ***Ablepharus eximius* GARM.**

*Cryptoblepharus eximius* GIR.

Specimens captured by Dr. Woodworth at Nai Robu, Niue Lagoon, and Moala Island, Fijis, are of a very lustrous dark brown, with black flanks, and dark olive on the lower surfaces; the light streak above the eye is faint and extends but little farther back on the flank than the almost obsolete line below the eye. The mental shield alone of the lower surface is white.

Another locality is represented by a type which agrees with the preceding from the Fijis except in having the light color of the mental shield carried backward to about the middle of the abdomen. It was taken by Dr. Mayer in the neighborhood of Cooktown.

### ***Ablepharus virgatus*, sp. nov.**

Form and size like those of *A. lineo-ocellatus* D. B. or *A. tæniopleurus* Pet.; tail as long as head and body. Head medium; snout short, blunt, rostral shield not projecting. Eye incompletely surrounded by granules. Rostral largely in contact with frontonasal, which is widely separated from the frontal. Frontal less than half as large as the frontonasal, in contact with the interparietal by a narrow suture. Interparietal three or more times the size of the frontal, fused with frontoparietals. Four supraorbitals, second largest and in contact with frontal and frontoparietal. Four supraoculars, anterior largest, elongate. A pair of very broad nuchals followed by other pairs, not quite so broad, the widths of which gradually decrease to the neck. Four labials anterior to the subocular. Earopening small, hardly half the size of the pupil,

without lobules. Scales in twenty rows around the body, smooth or with faint indications of keels, broader on back and tail, very broad below the tail. Four enlarged preanal shields. Limbs pentadactyl, hinder reaching three-fifths of the distance to the axilla.

Light yellowish brown, edge of head plates brown, with keel-like marks of brown on the median dorsal rows of scales, with a white band from the supraoculars on each side of the body, distinctly and regularly edged by a band of brown on the back and another through the eye to the base of the tail. Lower parts of flanks and upper portion of limbs and toes mottled with small spots of brown and of white. Entire ventral surface white.

Cooktown; Mr. Olive.

#### ***Ablepharus heterurus*, sp. nov.**

A larger species than *A. excimius*, with the head less rounded. Head moderate; snout pointed, rostral not projecting. Eye incompletely surrounded by granules, two to three small scales representing the upper eyelid. Rostral in contact with frontonasal; frontal less than half as large as the latter and widely separated from it, in contact with two supraorbitals. Four supraorbitals, second largest. Frontoparietals and interparietal fused and forming a plate about four times as large as the frontal. Frontal and frontoparietals meeting in a short transverse suture. Four supraciliaries, anterior elongate. Parietals large, meeting behind the interparietal. A pair of very large nuchals, followed by a smaller pair, back of which the width gradually decreases on the neck. No supranasals; a suture from the nostril backward in the nasal. Five labials anterior to the large subocular. Earopening small, without lobules. Scales smooth or feebly keeled, in twenty-four to twenty-six rows around the body, those of belly and flanks subequal, those of the back and tail much larger, those of the median subcaudal row largest. Tail longer than head and body.

Lustrous greenish olive; with a rather indistinct stripe of greenish white on each side of the back, irregularly edged with somewhat fused spots of brown, from supraorbital to tail; back, flanks, limbs, digits, and tail freckled with small spots of brown and of white. Ventral surfaces greenish white to greenish yellow, more green under chin and throat. Mental and rostral white. The distal one-third or two-fifths of the tail is colorless in alcoholic specimens. Probably it was red or yellow in life; the contrast with the darker colors of the anterior part of the tail and the body is very marked.

Apaiang, Gilbert Islands; Andrew Garrett.

#### ***Typhlops Wiedii* PET.**

The colors of *T. Wiedii* are described as "buff above, yellowish inferiorly." The form represented in this collection is brown on the back, with ten longitudinal streaks of light color on the edges of the scales, and is whitish on the

lower surface, except under the tail, where the color is like that of the back. A few spots of brown appear on the chin. From mouth to end of snout, whitish. A streak of light color, parallel with the margin but at a distance from the suture, forms a horse-shoe-shaped mark on the rostral; behind this, at each side, there is a streak on the nasal near the hinder edge, from the labials upward. Tail dark brown above and beneath.

Cooktown; Mr. Olive.

### **Enygrus Bibronii H. J.**

Rows of scales around the body, 31; scutes, 213 + 55; labials, 12 above, 14 below.

Levuka, Ovalau Island, Fiji; Mr. Alexander Agassiz.

### **'Dendrophis calligaster GÜNT.**

Length, 332 + 153 millim. Rows, 13; scutes, 180, anal divided, plus 134 pairs of subcaudals. Back nearly uniform light brown; edges of scales narrowly bordered with darker; ventral keels in a whitish line; abdomen sprinkled with small spots of black.

Cooktown; Mr. Olive.

### **Platurus colubrinus GIR.**

*Hydrus colubrinus* SCHN.

The expedition brought back a number of specimens from the Fijis. On three of those counted the rows of scales are 23, 24, 23, and the scutes are 233, anals two pairs, plus 40 subcaudals, 234, anals two pairs, plus 36 subcaudals, and 208, anals two pairs, plus 40 subcaudals. The bands of black on four specimens are 31 + 5, 31 + 3, 29 + 5, and 27 + 4.

### **Pseudelaps diadema JAN.**

*Calamaria diadema* SCHL.

Length 163 + 33 millim. Rows, 15; scutes, 175, anal divided, plus 53 pairs of subcaudals. Brownish red; darker on head and nape, with a transverse yellowish occipital band. Belly yellowish to the upper edge of the second dorsal row. Upper edge of next to outer row and both edges of other dorsal rows, except outer, longitudinally marked with brown, forming zigzag vittæ, of which the median two on the dorsum are confluent.

Cooktown; Mr. Olive.



*Denisonia vagrans*, var. nov.

Body cylindrical; belly rounded; tail nearly one-fifth of the total, slender, tapering. Head scarcely distinct from the neck, angular, flattened on the crown. Scales smooth, dorsals in 17 rows; 161 ventrals; a divided anal; 49 subcaudals, entire. Eye longer than its distance from the end of the snout. Rostral broader than deep, visible from above, in contact with six scales. Internasals broadly in contact with the rostral, little shorter than the prefrontals. Frontal twice as long as broad, one and one-half times as wide as the supraocular, one and one-third times as long as its distance from the end of the snout, shorter than the parietals. Nasal entire, elongate, in contact with the single preocular. Prefrontals bent downward on the side of the face. Preocular in contact with the second and the third labials, the nasal, the prefrontal, and the supraocular. Third and fourth labials below the orbit; fifth labial largest, longer than the sixth. Lower of the two postoculars resting in a notch between the fourth and the fifth labials. Temporals, two plus two, upper anterior largest, lower wedged between the fifth and the sixth labials. Lower labials seven, second smallest, fourth largest, anterior three in contact with the first chin shields, first separating the anterior submental from the mental. Posterior submentals longest, separated from the anterior ventral plates by three longitudinal series of three small scales each.

Uniform brownish olive on the back; belly olivaceous, slightly darkened under chin and throat, whiter under the tail. A narrow band of white behind the eye, shorter than the head. A narrow obsolescent streak below the nostril to the angle of the mouth.

Total length, 0.389 m.; tail, 0.071 m.

Dunk Island, off N. E. coast of Queensland; Dr. W. McM. Woodworth.

The Dunk Island snake is so closely allied to *D. signata* Jan. that it may be placed as a variety. The most prominent differences appear in the frontal shields, the sixth labial, and the coloration. *D. signata* has a darker color in the middle of the ventral surface which is not seen in the present type. The absence of this dark color beneath is what might be expected in a locality with more of vegetation as compared with an arid or desert region.

*Crocodilus Johnsoni* KREFFT.

Cooktown; Mr. Olive.

**Rana Dæmeli** GARM.*Hylorana Dæmeli* STEIND.

There is no doubt whatever of identity of the present form with that figured and described by Steindachner, but it differs so widely from Lesson's figure and description of *Rana papua* as to afford no warrant for union with that species.

Cooktown ; Mr. Olive.

**Limnodynastes dorsalis** GÜNT.*Cystignathus dorsalis* GRAY.

Cooktown ; Mr. Olive.

**Hyla gracilentia** PET.

As represented here the tympanum is distinct, the pollex rather distinct and prominent, and there are no light lines on the sides of the head.

Cooktown ; Mr. Olive.

**Hyla cærulea** BOUL.*Rana cærulea* WHITE.

Color uniform blue-green above, unspotted ; a line of light color along the tarsus and along the forearm and the hand. Chin white, with a blue-green band extending forward near the lip from the shoulder, not quite reaching the symphysis of the lower jaws. Lower surfaces light, the color separated from the white tarsal and carpal lines by darker.

Port Bowen and Townsville ; Dr. Woodworth.



PLATE 1.

Fig. 1. *Gymnodactylus Olivii*.

Fig. 1<sup>a</sup>. Upper view of snout.

Fig. 1<sup>b</sup>. Lower view of snout.

Fig. 1<sup>c</sup>. Side view of snout.

Fig. 1<sup>d</sup>. Lower view of foot.

Fig. 2. *Woodworthia digitata*.

Fig. 2<sup>a</sup>. Upper view of snout.

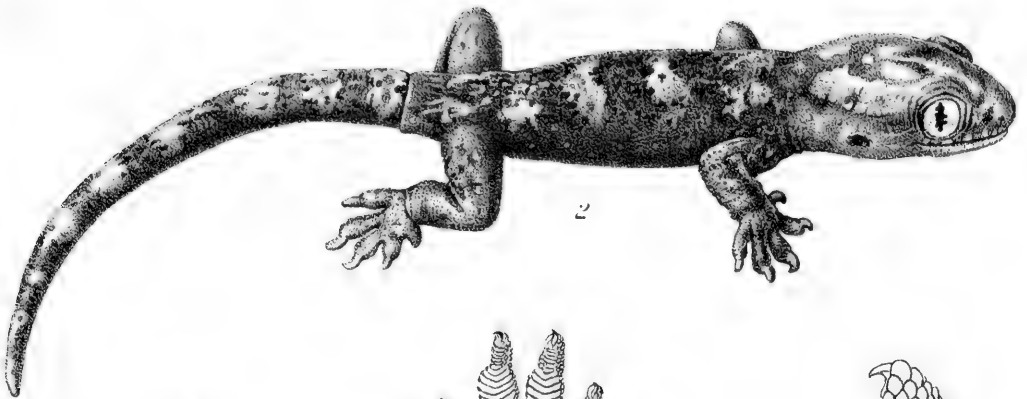
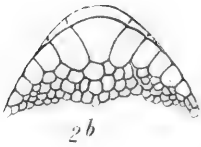
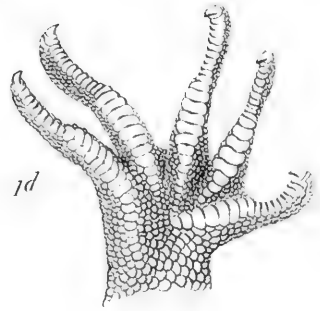
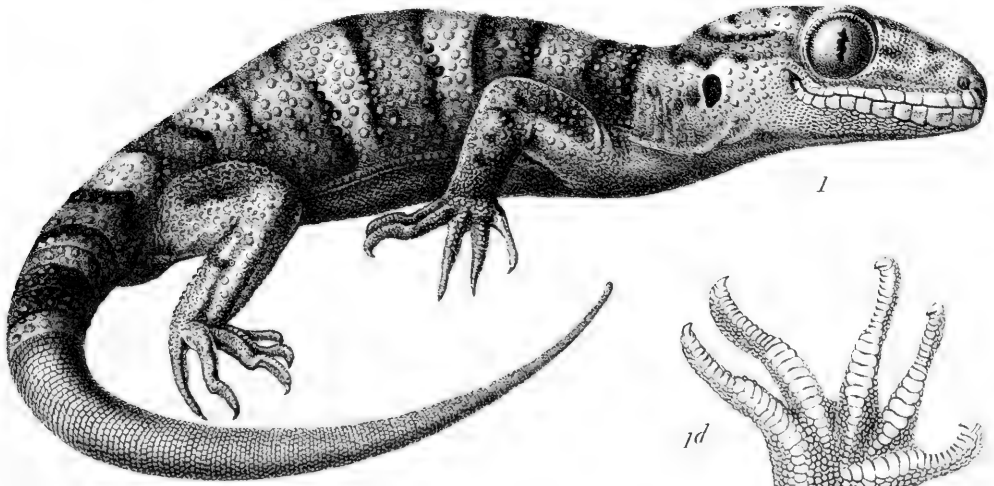
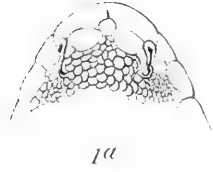
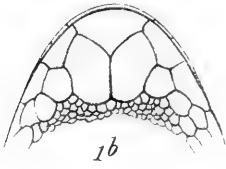
Fig. 2<sup>b</sup>. Lower view of snout.

Fig. 2<sup>c</sup>. Side view of snout.

Fig. 2<sup>d</sup>. Lower view of foot.

Fig. 2<sup>e</sup>. Side view of toe.

Fig. 2<sup>f</sup>. Lower view of inner digit.



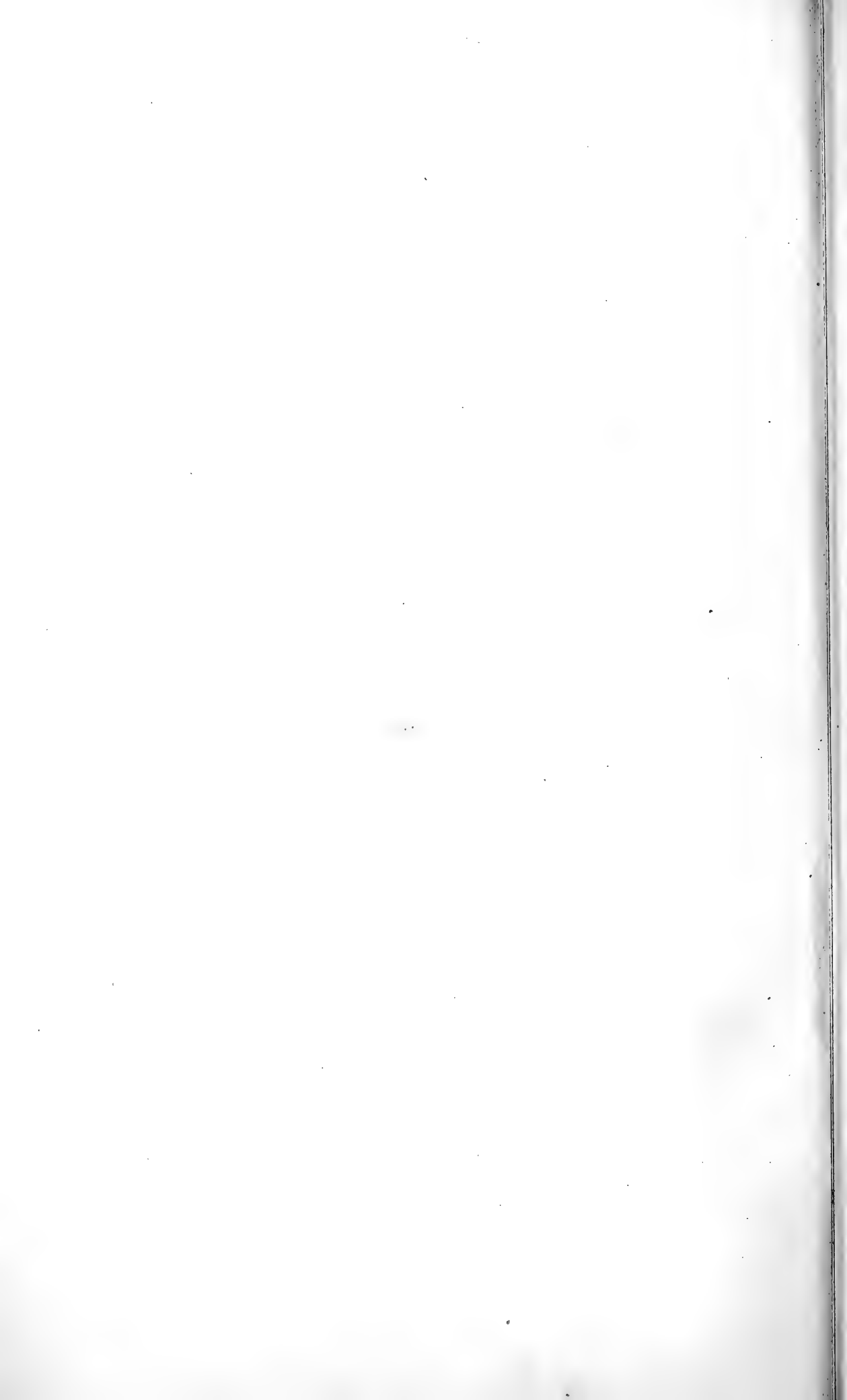
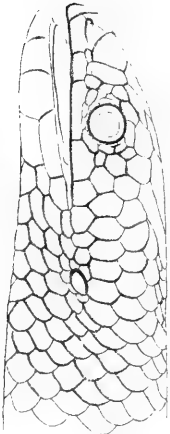




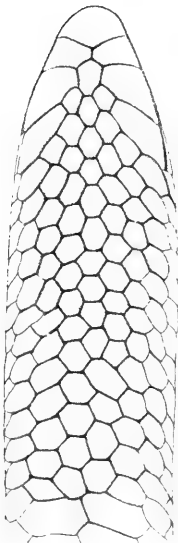
PLATE 2.

- Fig. 1. *Delma reticulata*.  
Fig. 1<sup>a</sup>. Upper view of head.  
Fig. 1<sup>b</sup>. Side view of head.  
Fig. 1<sup>c</sup>. Lower view of head.  
Fig. 1<sup>e</sup>. Side view of ventral region.  
Fig. 1<sup>f</sup>. Lower view of ventral region.
- Fig. 2. *Edura Mayeri*.  
Fig. 2<sup>a</sup>. Upper view of snout.  
Fig. 2<sup>b</sup>. Lower view of snout.  
Fig. 2<sup>c</sup>. Side view of snout.





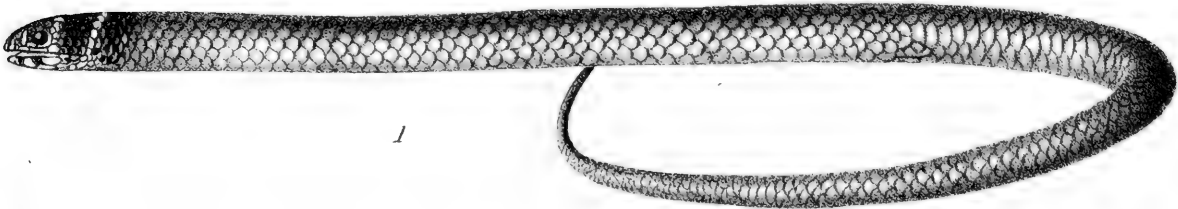
1b



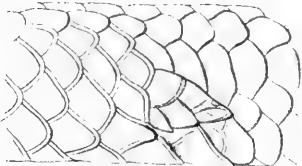
1c



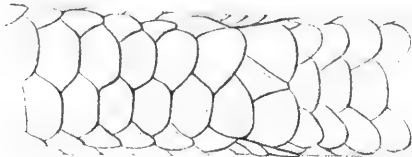
1a



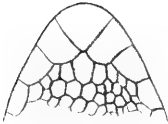
1



1e



1f



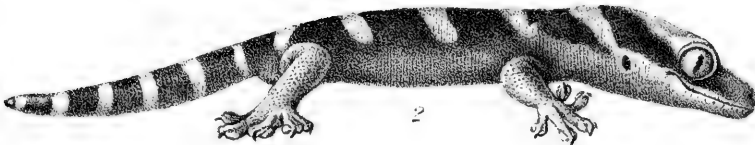
2b



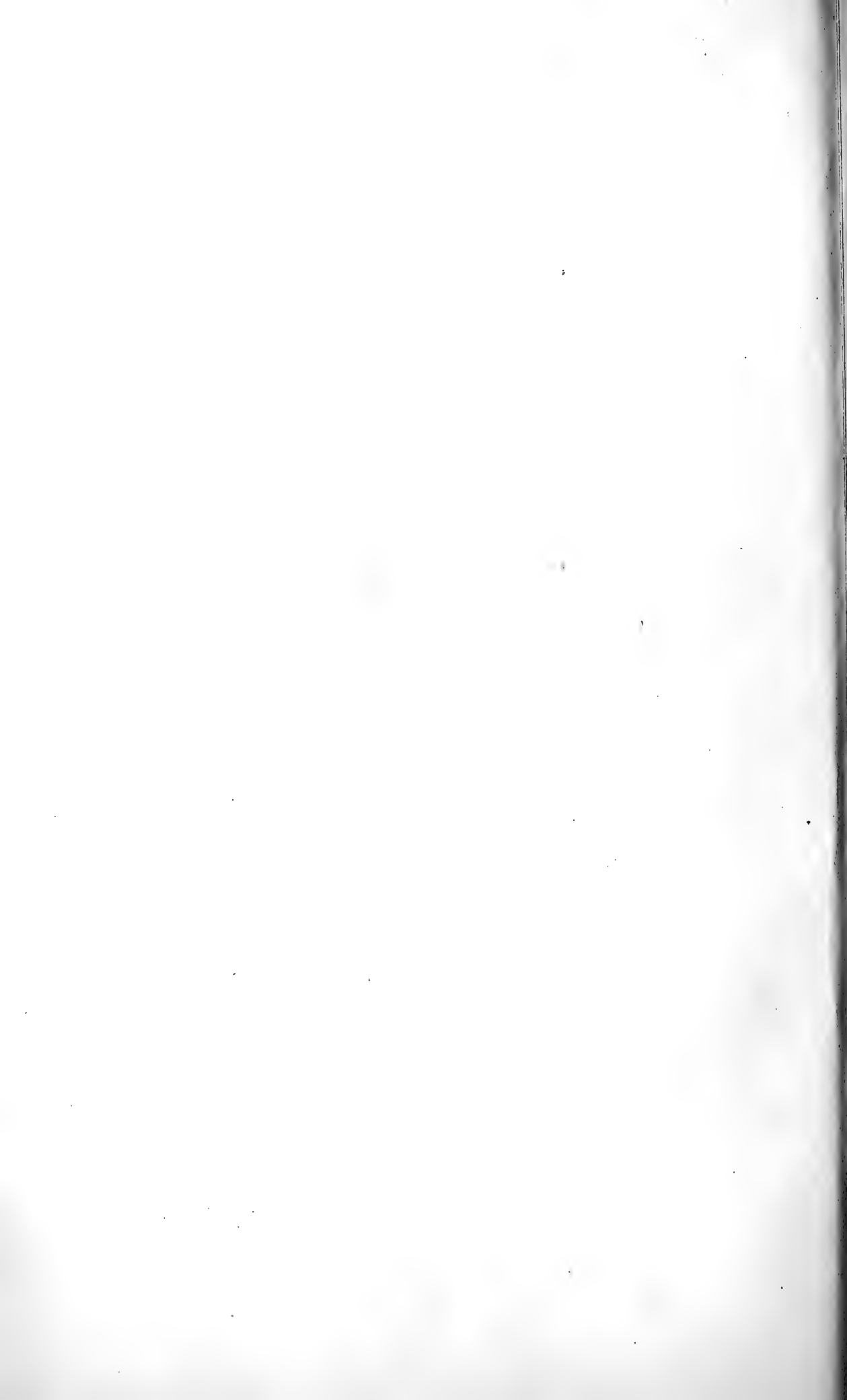
2c



2a



2



Bulletin of the Museum of Comparative Zoölogy

AT HARVARD COLLEGE.

VOL. XXXIX. No. 2.

---

CHIRIQUI MAMMALIA.

BY OUTRAM BANGS.

CAMBRIDGE, MASS., U. S. A. :  
PRINTED FOR THE MUSEUM.

APRIL, 1902.



No. 2. — *Chiriqui Mammalia*. By OUTRAM BANGS.

FOR nearly a year Mr. W. W. Brown, Jr., collected in Chiriqui for my brother, Edward A. Bangs, and myself. During this time he obtained, in addition to an extensive series of birds, an account of which I have already published,<sup>1</sup> upwards of 500 mammals. These have been presented to the Museum of Comparative Zoölogy, and form the subject of the present paper.

Chiriqui is a region of considerable interest, both from its position between Costa Rica and Panama, and from the lofty Volcan de Chiriqui, which rises to a height of 11,500 feet, and with its slopes and foot-hills forms the principal part of the small province of Chiriqui. Our present knowledge of the mammals is confined wholly to those of the foot-hills with an altitude of from 600 to 800 feet. Mr. H. J. Watson, the owner of extensive plantations at Bogaba, has sent many mammals to the British Museum. From this source Dr. Oldfield Thomas has described a number of new species, and Mr. G. S. Miller, Jr., one species. Unfortunately Dr. Thomas has not published a list of the species sent him; he has described such as were new, and his descriptions are not only scattered, but extend over a period of several years.

The stations at which Mr. Brown collected are as follows: Divala, situated in the lowland forested country, practically sea level; Pedregal on the Pacific coast; Bogaba, in the foot-hills of the Volcan de Chiriqui, 600 feet altitude, aneroid (800 feet according to Dr. Oldfield Thomas); Boquete, on the southern slope of the Volcan de Chiriqui, 3,000 to 5,000 feet altitude (some specimens even up to 7,000 feet, labelled "Boquete," were taken directly above that little village); and the summit of the Volcan de Chiriqui at and near timber line, 10,000 feet and upwards. Thus Mr. Brown covered the various life zones of the Volcan de Chiriqui and the results are of the greatest interest.

<sup>1</sup> Auk, Vol. XVIII. pp. 355-370, Oct. 1901, and Proc. New Eng. Zoöl. Club, Vol. III. pp. 15-70, Jan. 30, 1902.

The forms from the top of the Volcano are very different from those of the lowlands and foot-hills. In my paper in the Proceedings of the New England Zoölogical Club I give extracts from Mr. Brown's itinerary, which, though of interest to mammalogists as well as ornithologists, need not be repeated here.

Mr. Brown took the altitudes with an aneroid.

The mammals that have been described from Chiriqui are as follows: *Caluromys laniger pallidus* Thomas, *Tylomys watsoni* Thomas, *Oryzomys tectus* Thomas, *Proechimys centralis chiriquinus* Thomas, *Dasypterus ega panamensis* Thomas, *Artibeus watsoni* Thomas and *Promops nanus* Miller, all from Bogaba, while *Sciurus melania* (Gray) was named from Point Burica, Costa Rica, just north of Chiriqui, and *Galera barbara biologiæ* (Thomas) was founded on a specimen from Calovevora, Veragua, Panama, just south of Chiriqui. Mr. Brown secured specimens of all of these except *Oryzomys tectus*, *Dasypterus ega panamensis*, *Artibeus watsoni*, and *Promops nanus*.

In the present paper I describe as new one genus, *Syntheosciurus*, and fourteen species and four subspecies: — *Tayassu crasnigrum*, *Sciurus æstuans chiriquensis*, *Sciurus browni*, *Syntheosciurus brochus*, *Megadontomys flavidus*, *Peromyscus cacabatus*, *Nyctomys nitellinus*, *Sigmodon austerulus*, *Oryzomys devius*, *Oryzomys vegetus*, *Reithrodontomys australis vulcanius*, *Reithrodontomys creper*, *Akodon teguina apricus*, *Akodon xerampelinus*, *Macrogeomys cavator*, *Macrogeomys pansa*, *Heteromys repens*, *Agouti paca virgatus*.

The systematic sequence is that of Miller and Rehn in their recent list. All the measurements are in millimeters, and except the skull measurements, which are mine, are those of the collector. Color names are according to Ridgway's nomenclature. As descriptions of skulls are frequently inadequate, I give figures, from the drawings of Dr. J. C. McConnell, in all cases of importance.

In the identification of the species I have been assisted by Mr. Gerrit S. Miller, Jr., Mr. E. W. Nelson, and Mr. W. H. Osgood, to all of whom I express my sincerest thanks. Dr. J. A. Allen, of the American Museum of Natural History, and Dr. C. Hart Merriam, of the United States Biological Survey, have most kindly loaned specimens that were of the utmost importance.

**Marmosa mexicana** (MERRIAM).

Four specimens, an old adult ♂ from Boquete, 4,000 feet, and three young from Bogaba, 600 feet, February and July.

These appear to be identical with specimens from Southern Mexico, States of Chiapas and Vera Cruz. The old ♂ is much larger than any Mexican example I have seen, but is much older also, and the difference in size seems to be wholly due to age. *M. mexicana* is a very distinct species, differing from the South American forms of the *M. murina* series in its reddish chestnut coloring, without olive shades, and certain cranial characters; the nasals are short and truncate posteriorly, the interorbital region wide, the supraorbital beading slight; a still more marked character is the two parallel temporal ridges, extending the length of the brain case and ending one on each side of supraoccipital.

*M. mexicana* is wholly different from *M. fulviventris*, lately described by me from San Miguel Island, Bay of Panama.

The old adult ♂ No. 10,154, measures, total length, 370; tail vertebræ, 195; hind foot, 25; ear, 25. Skull, basal length, 38.4; occipitonasal length, 41; zygomatic width, 22.2; length of nasals, 17.8.

**Caluromys laniger pallidus** (THOMAS).

*Type Locality.* — Bogaba, Chiriqui.

Six adults, both sexes. Bogaba and Divala, November, December, and July.

**Metachirus fuscogriseus** ALLEN.

Four adults, both sexes, Boquete, 4,500 feet, and Bogaba, March and July. These specimens are referable in every way to Dr. Allen's species, the type locality of which was not known. Dr. Allen, however, later refers Nicaraguan examples to it; thus the range of *M. fuscogriseus* extends certainly from Nicaragua to Chiriqui. The largest individual, No. 10,146, ♂ old adult, measures, total length, 620; tail vert., 315; hind foot, 47; ear, 33.

**Didelphis richmondi** ALLEN.

*Type Locality.* — Greytown, Nicaragua.

Six adults, both sexes, Boquete, 4,000 to 5,800 feet, March.

Dr. Allen now refers Costa Rican specimens, that he formerly called *D. aurita*, here. Mr. Brown's record carries the range of the species a little farther south. All the examples agree in every way — size, color, color pattern, skull characters — with Dr. Allen's description.

**Choloepus hoffmanni** PETERS.

Five specimens, both sexes, young and adult, Boquete, 4,000 to 4,800 feet, and Bogaba, March, April, and July.

**Cyclopes dorsalis** (GRAY).

Nine specimens, both sexes, young and adult. Divala and Bogaba, December and July.

Although in September, 1900, Dr. Oldfield Thomas pointed out anew the differences between the Central American *C. dorsalis* and the typical *C. didactylus* of Guiana, and though it had stood in Trouessart's Catalogue as a subspecies, it is omitted by Miller and Rehn in their recent list.

**Uroleptes sellata** (COPE).

Two specimens; adult ♀, Divala, December; adult ♂, Volcan de Chiriqui, 5,000 feet, May.

**Myrmecophaga tridactyla** LINN.

One adult, Divala, December.

**Tayassu crusnigrum**, sp. nov.

Type. — Mus. Comp. Zoöl., No. 10,163. Young ad. ♂, Boquete, April 13, 1901, 4,000 feet.

Three specimens, both sexes, one young, one young adult, one old adult, Boquete, 4,000 to 5,800 feet, March and April.

*Characters.* — Probably nearest to *T. angulatus humeralis* Merriam (Mexico, Colima to Tehuantepec), but much darker throughout; legs and arms almost wholly black; dorsal black band wide; shoulder stripes wide and conspicuous, tawny in color; pelage rough and coarse; skull wider above and narrower below; rostral portion wider; palate much narrower, tooth rows nearer together.

*Color.* — Legs, arms, central dorsal, and central ventral stripes, black; rump mostly black, a few of the hairs (bristles) annulated with tawny; conspicuous shoulder stripes, tawny; sides of head and of body, mixed tawny and black; all the hairs annulated with these colors; hairs on outer surface of ears mostly black, those on inner surface mostly tawny, the general effect being that of a very dark, richly colored peccary.



*Measurements* —

No.	Sex.	Total length.	Hind foot (with hoof).	Ear.
10,162	old ad. ♀	1030	170	80
10,163	type; young ad. ♂	860	145	76
10,164	young ♀	775	135	72

Skull, No. 10162, old adult ♀, from Boquete 5,800 feet, basal length, 197; occipitonasal length, 222; zygomatic width, 103; greatest width across squamosals posteriorly, 98; palatal length to palatal notch, 140; breadth of basioccipital between bullæ posteriorly, 19; length of upper molariform series, 64.

*Remarks.* — I do not give this fine new peccary as a subspecies of *Tayassu angulatus* (Cope) because the relationships of the North American forms and the South American *T. tajacu* are not as yet clearly understood. It is very different from any of the forms lately described by Doctor Merriam, and is even more widely separated from my *T. torvus* of the Santa Marta region of Colombia. The two younger specimens agree in coloration, but the old ♀, No. 10,162, is slightly different; the bristles of the rump are rather more annulated, and the color of the lighter rings on the bristles here and on the sides is paler — yellowish white instead of tawny. The color of the shoulder stripes and the head and neck is as in the other species. It is in rather worn pelage, and as these differences may be due to actual fading, I select a younger individual, in fine pelage for the type.

A white-lipped peccary also occurs in Chiriqui. Mr. Brown saw them several times, but those wounded escaped in the dense jungle.

*Odocoileus*<sup>1</sup> sp. ?

One young ♂, Boquete, 4,000 feet, April 10. This specimen is in the spotted pelage, and is too young to identify. The species was rare, but was well known to the native hunters.

*Mazama sartorii* (SAUSSURE).

Three adults, two males and a ♀, Boquete, 4,000 to 4,800 feet, March and April.

*Measurements* —

No.	Sex.	Total length.	Tail vert.	Hind foot.	Ear.
10,158	old ♂	1330	. .	260	84
10,159	old ♂	1340	100	255	76
10,160	old ♀	1360	105	240	78

<sup>1</sup> For use of *Dama* instead of *Odocoileus*, see Allen, Bull. Am. Mus. N. H., Vol. XVI. pp. 18-20, Feb. 1, 1902. I am as yet not satisfied as to the correctness of Dr. Allen's contention.

**Elasmognathus bairdii** GILL.

One fine old adult ♂, Boquete, 5,000 feet, March.

**Sciurus (Echinosciurus) melania** (GRAY).

Twenty-one specimens, adults of both sexes, and young, Divala, Bogaba, and Boquete, 2,000 feet, November, December, January, and July.

This fine, large black squirrel, described by Gray in 1867 from Point Burica, Costa Rica, was unknown to Nelson when he wrote his Revision of the Squirrels of Mexico and Central America. In a foot-note on page 74 he says: "This may be a valid species or subspecies, but the type was evidently a melanistic specimen, and in the absence of material I refer it here" (to *Sciurus adolphei dorsalis* (Gray)). The large series collected by Brown shows that Gray's type was not melanistic, and that the animal is a fine distinct species. It probably has a very restricted range; so far as I know, it has not been taken in Costa Rica, north of the very southern part, bordering Chiriqui, the locality of Gray's type. It is a low land species, and not found high up the Volcan de Chiriqui, 2,000 feet being the extreme altitude at which Mr. Brown saw it, and but once so high as that. About Bogaba (600 feet) and Divala, it is common and generally distributed in suitable places.

In normal, fresh pelage it is nearly black all over, the back only being a dark chocolate. As the pelage becomes shabby from wear, the back and tail fade to a dull yellowish brown color, the rest of the animal remaining dull black. In many of these faded specimens, fresh hairs appear in patches, and these are of the normal, beautiful dark chocolate color. *Sciurus melania* is a beautiful squirrel, the pelage has a sheen quite peculiar, and the chocolate of the back is very rich, an unusual color in mammals. The young are like the adults. Fully adult specimens usually measure, total length, 500; tail vertebrae, 260; hind foot, 63; ear, 30. The very largest have a total length of 560.

**Sciurus (Guerlinguetus) æstuans chiriquensis**, subsp. nov.

Type. — Mus. Comp. Zoöl. No. 10,044, ad. ♂, Divala, Nov. 18, 1900.

Forty-one specimens, both sexes, young and adult, Divala, Boquete, and Volcan de Chiriqui, 4,000 to 7,500 feet, and Bogaba, November, December, February, March, April, and July.

*Characters.* — Very similar to *S. æstuans hoffmanni* Peters from Costa Rica in all respects, except a constant, well-marked difference in general coloration. The under parts, paler, yellower, less brick-red; the upper parts more olivaceous, less brick-red. A large series of the two forms shows this difference in color to be well marked at all seasons.

*Color and Pelage.* — Pelage, short and rather hispid, with scarcely any under-fur. Upper parts, finely mixed (owing to the annulations of the hairs) blackish brown (perhaps nearest mummy brown) and tawny, the tawny color predominating on sides, the dark brown color along middle of back; orbital ring, back of ear and a small spot just behind ear clear tawny; under parts tawny, becoming yellower, about raw sienna on under side of neck and head, and often the breast similarly colored; tail much the same as back, but with the tawny annulations wider; deeply fringed along sides with clear tawny, under side darker than upper.

*Variations in Color.* — The large series before me presents very little color variation, and apparently no seasonal variation in color; a few specimens only in very worn pelage are duller, more rusty brown above, due to actual fading; the amount of the yellowish color (raw sienna to ochraceous) that always occupies the under side of head and neck varies in different individuals — in two extreme specimens, Nos. 10,416, and 10,038, ♀ and ♂ adults, it covers the whole under parts, there being no tawny. There are also three albinistic specimens, irregularly marked with white on under parts and feet.

Skins from the Volcan de Chiriqui from upwards of 4,000 feet altitude are more woolly with decidedly more under fur than lowland examples, but otherwise they do not differ.

*Measurements* (ten adults type and topotypes)—

No.	Sex.	Total length.	Tail vert.	Hind foot.	Ear.
10,044 type	♂	400.	190	52	20
10,038 topotype	♂	460	190	55	18
10,042 do.	♂	460	220	55	24
10,040 do.	♂	440	185	53	20
10,047 do.	♂	440	185	54	22
10,041 do.	♂	425	190	57	23
10,036 do.	♀	410	180	55	23
10,045 do.	♀	410	180	54	23
10,043 do.	♂	410	180	56	24
10,039 do.	♂	395	185	54	24

Skull, type, adult ♂, basal length, 46.2; occipitonasal length, 54; zygomatic width, 31.4; length of nasals, 16.4; length of palate, to palatal notch, 23.2; to end of pterygoid, 30.

*Remarks.* — This new form which is found apparently throughout Chiriqui, in suitable places, is a slightly differentiated southern race of *S. hoffmanni* of Costa Rica. It is distinguished by paler under parts, which are much yellower, less brick-red, and by the different shade of the upper parts. I do not believe that *S. hoffmanni* is a subspecies of *S. æstuans* of South America, but as this has been the view taken by recent reviewers of the group, for the sake of uniformity I so treat it here.

*Sciurus (Microsciurus) browni*,<sup>1</sup> sp. nov.

Type. — Mus. Comp. Zool., No. 10,404, old ad. ♂ Bogaba, July 15, 1901.

Five specimens, both sexes, Bogaba, July.

*Characters.* — Probably nearest to *S. alfari* Allen, from Costa Rica, but differing in many respects from that species. Pelage *much* thinner, less woolly; upper parts decidedly more olivaceous — lacking the reddish brown of *S. alfari*; tail thinly washed with grayish white instead of dull rusty; nose, forehead, and orbital ring more tawny; under parts *much* paler; in the new species dull gray slightly washed with buffy in some specimens, yellowish white in others, on under side of neck and middle of belly, in *S. alfari* the under parts are dull rusty on under side of neck and breast with a thin wash of this color extending back over belly, which has a dull brown shade.

The skull is similar to that of *S. alfari*, but the brain case is narrower, more rounded and without so marked a constriction in front of the occiput, and with the mastoid region less prominent.

*Color and Pelage.* — Pelage short and thin, rather harsh and with but little under fur.

Upper parts, a fine mixture of tawny olive and bistre, produced by the dark brown bases and tawny olive tips of the hairs; nose, forehead, and orbital ring tawny; tail with the hairs dark reddish brown basally then black and tipped with grayish white, a small black pencil; under parts dull gray to grayish white, slightly washed with buffy or yellowish (in some specimens, very slightly in the type) on under side of neck and middle of belly; under sides of legs darker — more nearly like upper parts.

*Measurements* —

No.	Sex.	Total length.	Tail vert.	Hind foot.	Ear.
10,404 type	♂ ad.	260	120	38	14
10,405	♀ ad.	255	100	38	14
10,407	♀ ad.	232	110	38	13
10,406	♀ ad.	250	110	36	14
10,408	♂ youngish	245	110	37	13

Skull, type, adult ♀, basal length, 29; occipitonasal length, 36; zygomatic width, 21.2; interorbital width, 12.4; palatal length, to palatal notch, 13.4; to end of pterygoid, 20.2; length of nasals, 11; length of upper molar series, 5.8.

*Remarks.* — Mr. Brown found this little squirrel in the forest about Bogaba, at 600 feet altitude. It was rare and exceedingly hard to get, on account of its small size and dull coloring, and only by devoting much time and energy to the chase did he succeed in taking five specimens.

Mr. E. W. Nelson has compared very carefully these five specimens with the type of *Microsciurus alfari* Allen, and agrees with me as to the specific differences between these two tiny tree squirrels.

<sup>1</sup> Named for Mr. W. W. Brown, Jr.

**Syntheosciurus**,<sup>1</sup> gen. nov.Type: *Syntheosciurus brochus*, sp. nov.

*Characters.* General external appearance much as in *Microsciurus*, but ear still smaller, hardly standing up above the fur, and very woolly; pelage very long, dense, and woolly; size larger than usual in *Microsciurus*; skull and teeth peculiar; skull very thin and papery, with very small, feeble, constricted rostrum, with the upper outline (of rostrum) straight; audital bullæ small; molar teeth as in *Microsciurus* and peg-like premolar present; incisors very slender and projecting outward (not curved under as usual in tree squirrels); upper incisors with a well-marked central groove down each.

**Syntheosciurus brochus**,<sup>2</sup> sp. nov.

Type. — Mus. Comp. Zoöl., No. 10,402, ad. ♂, Boquete, April 30, 1901. 7,000 ft.

Two adults, ♂ and ♀, Boquete, 7,000 ft. altitude, taken together on April 30.

*Characters.* — Size intermediate between *Microsciurus* and *Guerlinguetus*; tail a little less than length of head and body, full and bushy; ear very low, round, and woolly; pelage very long, soft, and woolly, with very thick under fur; general coloration dark reddish olive, with under parts varying from orange rufous to ferruginous; no distinct line of demarcation between colors of upper and under parts; skull and incisor teeth peculiar (as pointed out in the description of genus).

*Color.* — Upper parts finely mixed olivaceous bistre and dull tawny olive — the hairs olivaceous bistre, tipped with dull tawny olive; under fur dark mouse-gray; orbital ring, sides of nose and chin tawny olive; tail similar to back, fringed along sides with pale rusty and slightly more reddish, less olivaceous below; under parts, especially along middle line, strongly suffused with orange rufous in the type (ferruginous in No. 10,403, nursing female).

*Measurements* —

No.	Sex.	Total length.	Tail vert.	Hind foot.	Ear.
10,402 type	♂ ad.	320	150	46	17
10,403	♀ ad.	315	145	46	16

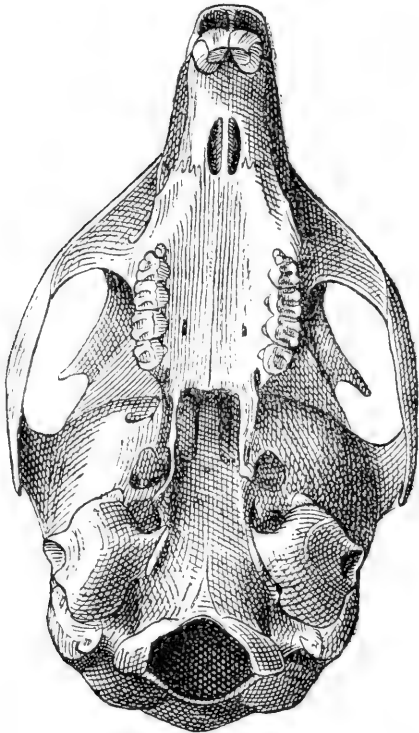
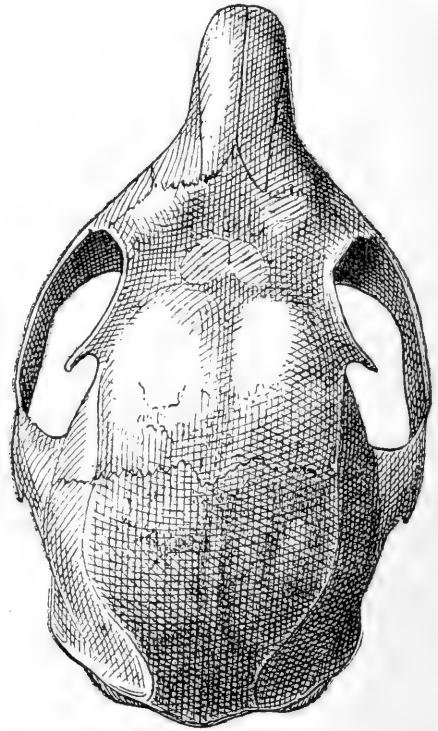
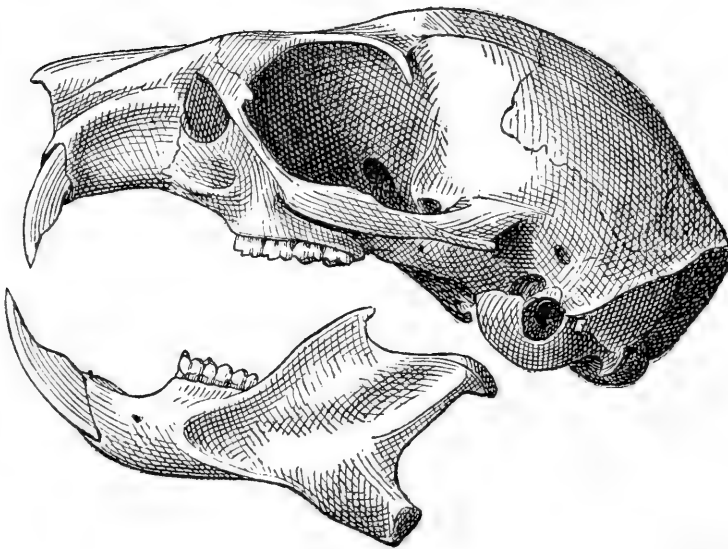
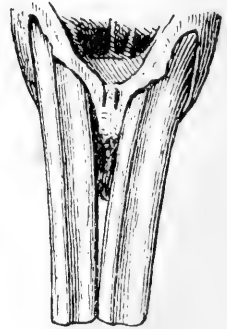
Skull type, adult ♂, basal length, 35.6; occipitonasal length, 44; zygomatic width, 25.2; interorbital width, 12.6; palatal length, to palatal notch, 20; to end of pterygoid, 27.4; length of nasals, 13; width of nasals, 5.8; length of upper molar series, 7.6; length of single half of mandible, 27.

*Remarks.* — Mr. Brown met with this remarkable squirrel but once, when he took the pair described. It was unknown to the native hunters who ac-

<sup>1</sup> Σκιουρος = squirrel, and Σύνθετος = combined.

<sup>2</sup> *Brochus*, with projecting teeth.

accompanied him, and who expressed much astonishment on being shown the two examples. Judging by the long, dense fur, even at this time of year —

1.  $\times 1\frac{1}{4}$ 2.  $\times 1\frac{1}{4}$ 3.  $\times 1\frac{1}{4}$ 4.  $\times 4$ 

FIGS. 1, 2, 3, AND 4. *Syntheosciurus brochus*. Type.

April 30 — when the female was nursing young, it is evidently an animal of high elevations only.

Among tree squirrels, *Syntheosciurus brochus* has no very near ally; its light, papery skull recalls that of *Sciuropterus*, but the audital bullæ are much smaller. Its peculiarly straight, slender rostrum, weak, projecting, and grooved incisors at once distinguish the genus from any other.

### *Mus rattus* Linn.

One youngish ♀, Boquete, 4,800 ft. Mar.

### *Megadontomys*<sup>1</sup> *flavidus*,<sup>2</sup> sp. nov.

Type. — Mus. Comp. Zool. No. 10,331, ad. ♂, Boquete, April 12, 1901. 4,000 ft.

Twenty-seven specimens, Boquete, 3,000 to 5,000 ft., February and April.

*Characters.* — A large species, much paler and yellower than *M. thomasi* Merriam, Mountains near Chilpancingo, Mexico, 9,700 ft., and *M. nelsoni* Merriam, Jico, Mexico, altitude 6,000 ft.; skull with much more rounded and elevated and less flattened brain case; palatal slits very wide; audital bullæ decidedly small; ears small.

*Color.* — Upper parts brownish cinnamon, usually rather more rusty toward rump, brighter, inclining toward orange-buff along lower sides; a large, conspicuous blackish patch on each side of head at base of whiskers; whiskers mixed black and colorless; underparts white, the gray basal portion of the hairs showing through; a slight collar yellowish or buffy; feet and hands whitish, marked with brown about ankles and wrists; tail sparsely clothed with short stiff hairs, dusky above, grayish below; ears nearly naked, dusky outside, slightly silvery inside. Young examples differ from the adults in being darker and duller brown above; the under parts more grayish, less purely white.

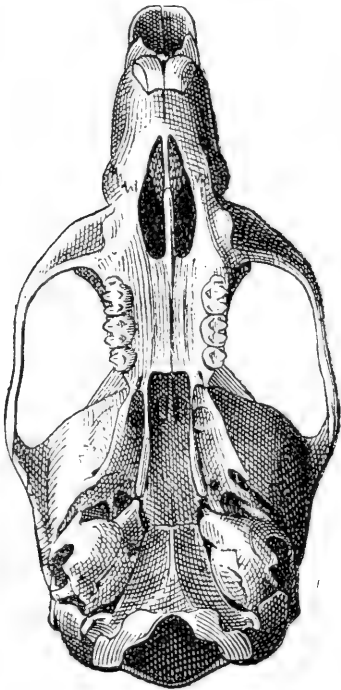
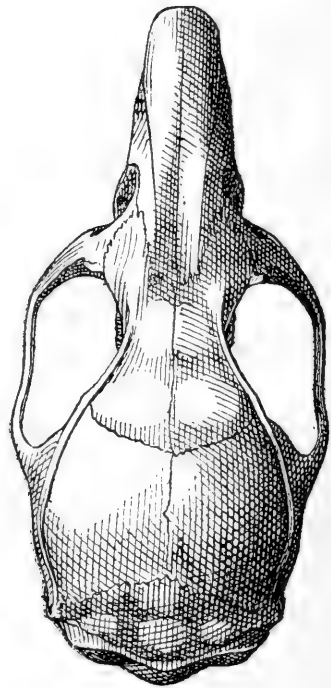
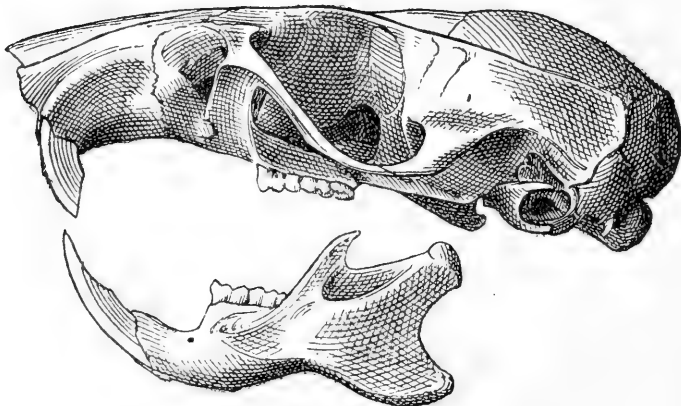
*Measurements* (of ten adults, type and topotypes) —

No.	Sex.	Total length.	Tail vert.	Hind Foot.	Ear.
10,327	♂ old ad.	375	205	31	23
10,329	♂ old ad.	355	195	32	23
10,333	♂ old ad.	350	185	32	24
10,339	♂ ad.	345	185	32	22
10,336	♂ ad.	345	187	32	23
10,331 type	♂ ad.	336	180	31	23
10,328	♂ ad.	335	155	32	20
10,338	♂ ad.	330	185	32	22
10,342	♂ ad.	325	170	31	23
10,330	♀ ad.	320	165	33	22

<sup>1</sup> Though described by Dr. Merriam as a subgenus of *Peromyscus*, *Megadontomys* is entitled to generic rank, on account of the unwieldy proportions of *Peromyscus*.

<sup>2</sup> *Flavidus*, yellowish.

Skull type, ♂ adult, basal length, 35.4; occipitonasal length, 40.2; zygomatic width, 19.6; mastoid width, 15; length of nasals, 17.8; width of nasals, 4.8; length of palatal slits, 7.4; width of palatal slits, 3.4; length of palate, to palatal notch, 17; to end of pterygoid, 24.4; length of upper molar series 5.6; length of single half of mandible, 21.8.

5.  $\times 1\frac{3}{4}$ 6.  $\times 1\frac{3}{4}$ 7.  $\times 1\frac{3}{4}$ FIGS. 5, 6, AND 7. *Megadontomys flavidus*. Type.

*Remarks.* — The Volcan de Chiriqui is thus far the southernmost point from which a species of this well-marked group of Vesper Rats has been recorded. *Megadontomys flavidus* was common in the upland forest from 3,000 to 5,000



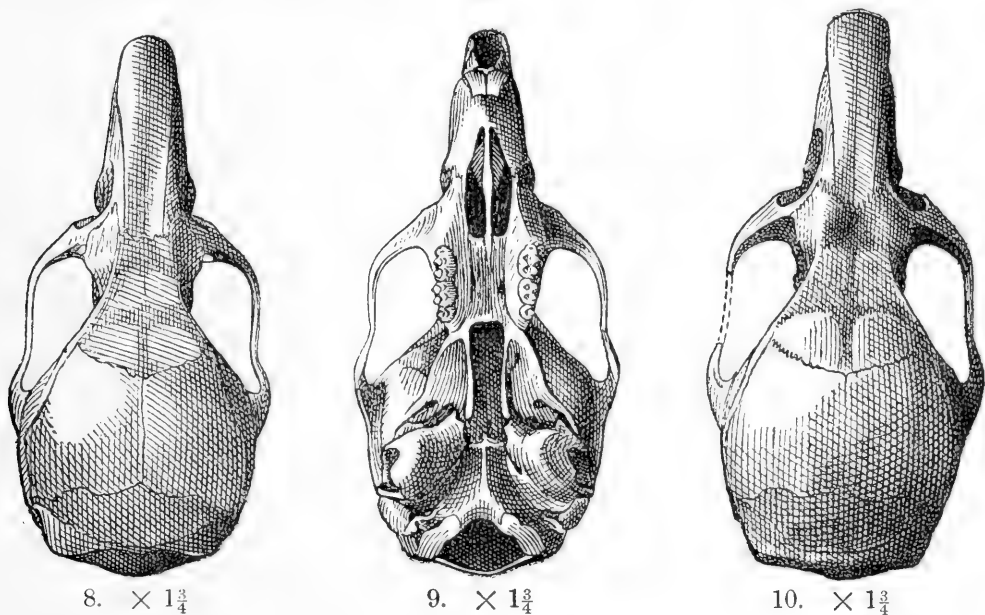
feet, but was not taken above or below these heights. While showing the group characters quite as strongly as either of its Mexican congeners, *M. flavidus* is very different specifically; its yellowish coloration and rounded elevated brain case at once distinguishing it.

*Peromyscus cacabatus*,<sup>1</sup> sp. nov.

Type. — Mus. Comp. Zoöl., No. 10,225, ad., ♀ Boquete, April 22, 1901. 5,000 feet.

One hundred and thirty-one specimens, Boquete, 4,000 to 7,500 feet, January to April.

*Characters.* — Probably nearest to *P. guatemalensis* Merriam (Todos Santos, Guatemala, 10,000 feet), tail shorter and colors not so dark; palatal slits shorter and wider; nasals in old age, more expanded at tips, like those of *P. furvus* Allen and Chapman.



FIGS. 8 AND 9. *Peromyscus cacabatus*. Type.

FIG. 10. *P. cacabatus*, very old ♂. No. 10,202, to show expansion of nasals in old age.

*Color.* — A broad dorsal band sooty, becoming less intense and browner on sides of back and gradually passing into dull orange-buff on lower sides; sides of nose, at base of whiskers, dull grayish or buffy white; top of nose, space between base of whiskers and eye, and orbital ring black; under parts — a broad pectoral collar, dull orange-buff, rest of under parts varying from dull grayish white to strong pinkish buff, — usually with chin and throat grayish white, and belly grayish white, washed with pinkish buff —; feet and hands, whitish; ears, nearly naked, dusky; tail nearly naked, dusky above, usually pale, yellowish gray below (the tail is very variable, the paler color below is

<sup>1</sup> *Cacabatus*, sooty (color).

often in patches, or spots, sometimes occupying nearly the whole of the under surface, sometimes wholly wanting; and in some specimens the upper surface also is patched with whitish). Very old examples are paler above with the sooty dorsal stripe, less well marked; younger specimens are darker, often with most of the back sooty.

*Measurements* (of ten adults, type and topotypes). —

No.	Sex.	Total length.	Tail vert.	Hind foot.	Ear.
10,204	♂ old adult	270	135	26	21
10,202	♂ old ad.	265	128	26	21
10,218	♀ old ad.	265	130	25	21
10,211	♂ old ad.	265	125	25	20
10,199	♂ ad.	260	126	26	20
10,225	♀ ad. (type)	260	128	26	20
10,205	♂ ad.	257	125	26	20
10,212	♂ ad.	255	120	26	20
10,244	♀ ad.	255	120	27	21
10,198	♂ ad.	252	120	26	21

Skull, type, adult ♀, basal length, 28.8; occipitonasal length, 32.4; zygomatic width, 15.6; mastoid width, 13.6; length of nasals, 13; width of nasals, 3.4; length of palatal slits, 6.2; width of palatal slits, 3.2; length of palate, to palatal notch, 12.8; to end of pterygoid, 19; length of upper molar series, 5; length of single half of mandible, 17.4.

*Remarks.* — *Peromyscus cacabatus* was by far the commonest small mammal of the mountain forest belt of the Volcan de Chiriqui. It does not appear to occur below 4,000 feet, and extends from thence upward to the limit of the life zone it occupies, roughly speaking, about 8,000 feet, 7,500 feet is the highest altitude marked on any of the labels. The Mount Chiriqui *Peromyscus*, is most nearly allied to *P. guatemalensis* and *P. furvus*, but is quite distinct. It is the most southern member of the genus thus far recorded.

### *Nyctomys*<sup>1</sup> *nitellinus*,<sup>2</sup> sp. nov.

Type. — Mus. Comp. Zool., No. 10,249, old ad. ♀, Boquete, Feb. 8, 1901. 4,000 feet.

Six specimens, Boquete, 4,000 to 6,000 feet, January, February, and March.

*Characters.* — Apparently a very distinct species, though nearest to *N. decolorus* (True) from Rio de las Piedras, Honduras. Color of back, pale and yellowish, but decidedly darker than in *N. decolorus*. Also larger than *N. decolorus*; tail more hairy; skull much larger, with narrower posterior part;

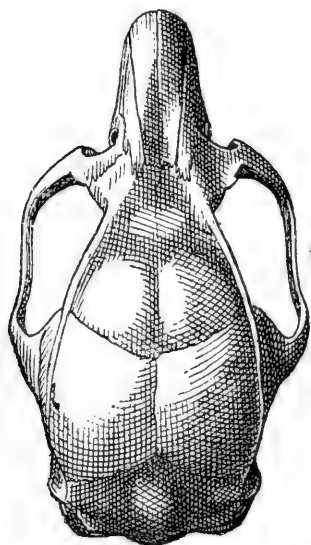
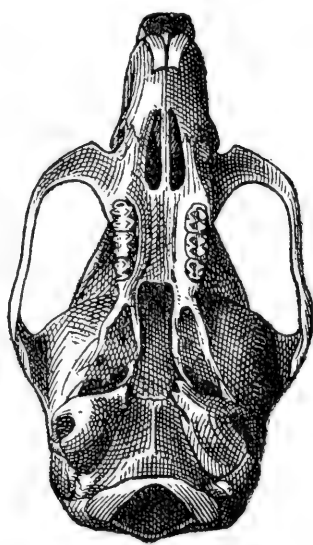
<sup>1</sup> I think all mammalogists must now regard the very well marked Central American hairy-tailed Vesper rats, as generically distinct from *Rhipidomys*. The important characters are four instead of six mammae, very slender, short rostrum, exceedingly short palatal slits and peculiarly expanded brain case. The synonymy is: *Nyctomys* Sauss. 1860; type, *N. sumichrasti*; *Myoxomys* Tomes, 1861; type, *M. salvini*.

<sup>2</sup> *Nitellinus*, like a dormouse.

interparietal narrower; palatal slits much narrower and longer — less rounded in shape.

From *N. sumichrasti* or *N. salvini* (probably distinct species, as suggested by True, Proc. U. S. Nat. Mus., Vol. XVI. p. 690), the new species differs in its much yellower less ferruginous color above, in its blackish ears and tail, and in its larger size.

*Color.* — Upper parts, yellowish cinnamon, duller, more isabella color on top of head, darkened along middle of back, head, and rump by a slight admixture of brown tipped hairs; lower sides brighter, decidedly shaded with orange-buff; orbital ring and space between base of whiskers and eye black; top of nose pale isabella color; whiskers, very long, mixed black and colorless; under parts, pure, snowy white to base of hairs; ears, sparsely haired dusky; tail

11.  $\times 1\frac{3}{4}$ 12.  $\times 1\frac{3}{4}$ FIGS. 11 AND 12. *Nyctomys nitellinus*. Type.

well haired, the hairs gradually becoming longer toward tip, and ending in a pencil, unicolor, blackish; hands white; feet — toes and sides of tarsus white, central portion of tarsus, dark brown.

The type and Nos. 10,245 and 10,246 are practically alike in color, the other three, all younger, are paler, grayer, more isabella color above; the lower sides are cinnamon without the bright orange-buff shade of the older specimens.

*Measurements* —

No.	Sex.	Total length.	Tail vert.	Hind foot.	Ear.
10,247	♀ ad.	250	120	25	17
10,248	♀ ad.	250	125	25	17
10,249 type	♀ old ad.	260	125	24	17
10,250	♂ young	215	90 <sup>1</sup>	23	16
10,246	♂ old ad.	240	107 <sup>1</sup>	22	17
10,245	♂ ad.	185	55 <sup>1</sup>	25	17

<sup>1</sup> End of tail gone.

Skull, type, ♀ old adult, basal length, 28; occipitonasal length, 32.4; zygomatic width, 18; mastoid width, 13; interorbital width, 11; length of nasals, 10.6; width of nasals, 3.2; length of palatal slits, 4.6; width of palatal slits, 2.2; length of palate, to palatal notch, 12.4; length of upper molar series, 4.8; length of single half of mandible, 18.

*Remarks.* — I have compared the series of *N. nitellinus* with the type of *N. decolorus* and the other species of this group in the United States National Museum, and while most nearly allied to the species from Honduras, I find excellent specific characters, both external and cranial for the separation of *N. nitellinus*.

### *Tylomys watsoni* THOMAS.

O. Thomas, Ann. and Mag. of N. H., 7th Series, IV., p. 278, 1899.

Type locality. — Bogaba, Chiriqui.

Four specimens; adult ♂ and ♀ and a young ♂, Bogaba, July, and a half grown young one from Boquete, 5,600 feet, March.

The specimens from Bogaba are not only topotypes, but were caught on the banks of the same stream as the type.

*Measurements* of the four specimens —

No.	Sex.	Total length.	Tail vert.	Hind foot.	Ear.
10,254	♀ old ad.	455	235	40	27
10,251	♂ old ad.	440	235	42	25
10,252	♂ yg. Boquete.	380	195	35	22
10,253	♂ very yg.	260	125	32	18

### *Sigmodon borucæ*, ALLEN.

Three adults, Bogaba, July.

These appear to be identical with Allen's *S. borucæ* of Boruca, Costa Rica. The measurements are —

No.	Sex.	Total length.	Tail vert.	Hind foot.	Ear.
10,287	♀ old ad.	280	105	32	19
10,285	♂ ad.	260	110	30	17
10,286	♂ yg. ad.	245	100	30	18

### *Sigmodon austerulus*,<sup>1</sup> sp. nov.

Type. — Mus. Comp. Zoöl., No. 10,288, ad. ♂, Volcan de Chiriqui, June 1, 1901.  
10,000 feet.

*Characters.* — About the size of *S. borucæ*; tail longer; pelage much more hispid; colors all much paler; skull similar.

<sup>1</sup> *Austerulus*, somewhat harsh.

*Color.* — Upper parts cinnamon brown darkened along middle by the admixture of dark brown tipped hairs, somewhat shaded with russet on rump and flanks; under parts white washed with pale buff, sharply contrasted against color of upper parts; ears dusky with some hairs on both surfaces colored like those of the back; feet and hands yellowish gray (much paler than in *S. boruceæ*), tail thickly clothed with short, stiff, close hairs, dusky above, gray below.

*Measurements.* — Type, adult ♂, total length, 260; tail vertebræ, 120; hind foot, 32; ear, 17.

Skull (an adult with somewhat worn teeth; unfortunately it was broken by the trap directly across between the orbits) — mastoid width, 14.8; upper molar series, 6; length of single half of mandible, 19.2.

*Remarks.* — The *Sigmodon* of the low lands of Chiriqui is a small dark colored species with very soft pelage, that I cannot distinguish from *S. boruceæ* of the low lands of Costa Rica.

When Dr. Allen described that animal he spoke of specimens from San José 5,000 feet altitude, that had hispid pelage, but otherwise did not differ.

The one example from the top of the Volcan de Chiriqui, differs from *S. boruceæ* of the adjacent low lands not only in having much more hispid pelage, a much paler coloration throughout, but also a longer tail.

In the forest belt of the Volcan, where Mr. Brown did much trapping, he did not find *Sigmodon*, and for that reason I give full specific rank to the form of the summit of the Volcan de Chiriqui. It has been my experience that *Sigmodons* love open fields, savannahs, brushy places, and waste land, and avoid the dense forest.

### *Oryzomys alfaroi* (ALLEN).

Fourteen specimens, Boquete, 4,000 feet, February and April; Divala, December.

I have compared this series with specimens from Tins, Costa Rica (the type locality of the species is San Carlos, Costa Rica) sent me by Dr. Allen, and can detect no differences.

*Measurements* (of six adults from Boquete) —

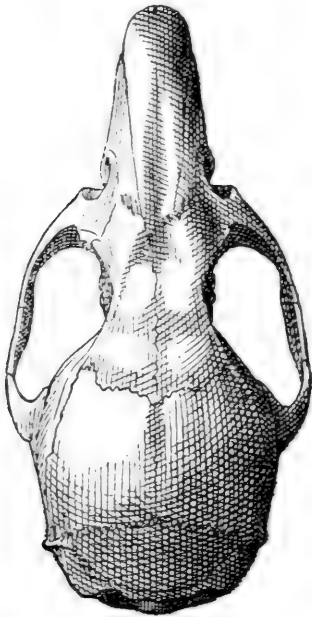
No.	Sex.	Total length.	Tail vert.	Hind foot.	Ear.
10,315	♀	235	120	26	16
10,322	♂	225	110	26	16
10,311	♂	225	105	26	15
10,314	♂	215	105	23	15
10,316	♀	215	110	26	15
10,320	♂	210	105	25	15

*Oryzomys devius*,<sup>1</sup> sp. nov.

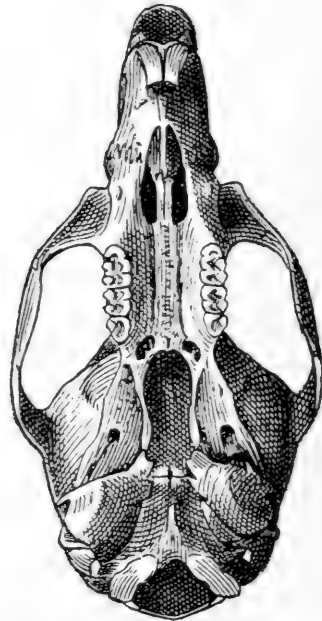
Type. — Mus. Comp. Zool., No. 10,324. Young ad. ♀, Boquete, Jan. 29, 1901.  
5,000 feet.

Four specimens, Boquete, 4,000–5,000 feet altitude, January and February.

*Characters.* — A large species belonging to the *Oryzomys meridensis* group. Externally quite like *O. childi* of the Bogota region of Colombia, except in the color of the under parts, which are white and fulvous in patches, instead of being white and gray in patches. The skull shows many good characters distinguishing it from that of *O. meridensis*. It is slightly larger, with longer rostrum, wider between orbits; the palatal slits are about the same length, but much wider; audital bullæ larger.



13.  $\times 1\frac{3}{4}$ .



14.  $\times 1\frac{3}{4}$ .

FIGS. 13 AND 14. *Oryzomys devius*. Type.

*Color.* — Upper parts, rich, lustrous russet-brown, slightly darkened along middle of back by sprinkling of dark brown tipped hairs, paler, brighter, more rufous on sides; top of nose, base of whiskers and region about eye, blackish; upper surface of legs and arms dusky brown; under parts variable (as in all members of this group), under side of head and neck grayish white, a pectoral and a ventral patch, white; the hairs scarcely gray at base, the region between these patches grayish white in No. 10,340, strong ochraceous buff, the hairs deep gray at base in the other three skins; ears large, nearly naked, black; feet and hands yellowish white; tail nearly naked, dusky above, grayish below.

<sup>1</sup> *Devius*, dwelling in lonely places, etc.

*Measurements* —

No.	Sex.	Total length.	Tail vert.	Hind foot.	Ear.
10,340	♂ old ad.	360	195	35	22
10,326	♀ ad.	345	185	36	23
10,324 type	♀ yg. ad.	335	180	33	22
10,325	♀ yg. ad.	333	165	33	22

*Skull.* — Type, ♀, young adult, basal length, 31.6; occipitonasal length, 36; zygomatic width, 18; mastoid width, 13.8; interorbital width, 5.6; length of nasals, 14.2; width of nasals, 3.8; length of palatal slits 5.6; width of palatal slits, 2.6; length of palate, to palatal notch 15.6; upper molar series, 5.4; length of single half of mandible, 20.

*Remarks.* — *Oryzomys meridensis* Thomas, originally described from Merida, Venezuela, has a very extended distribution in South America, and several names have been bestowed upon it in different parts of its range. Dr. Thomas does not look with much favor upon these supposed races, and is inclined to unite them all. Those that I have seen specimens of are, *O. childi* of the Bogota region of Colombia and *O. maculiventer* Allen, of the Santa Marta district of Colombia. I cannot see that these two differ in any way. The Chiriqui form is also similar to these externally, except for the somewhat differently colored under parts; it has, however, good cranial characters to distinguish it.

***Oryzomys (Oligoryzomys) costaricensis* ALLEN.**

Five specimens, Boquete, 3,800 to 4,800 feet, April and March, Bogaba, July.

The type locality of this species is El General, Costa Rica, 2,150 feet altitude. To it I refer five out of the eighteen specimens of Pigmy *Oryzomys* that Mr. Brown took in Chiriqui; the other thirteen represent quite a different form.

*Measurements* —

No.	Sex.	Total length.	Tail vert.	Hind foot.	Ear.
10,294	♀ old ad.	200	105	21	11
10,293	♂ old ad.	190	106	20	. .
10,296	♂ ad.	190	105	22	14
10,307	♀ ad.	190	105	21	12
10,299	♂ yg. ad.	180	100	21	12

***Oryzomys (Oligoryzomys) vegetus*,<sup>1</sup> sp. nov.**

Type. — Mus. Comp. Zoöl., No. 10,298, old ad. ♀, Boquete, April 16, 1901. 4,000 feet.

Thirteen specimens, Boquete, 4,000–4,800 feet, February and April.

*Characters.* — Larger than *O. costaricensis*; hind foot larger; ear larger; color above darker, redder, below buffy instead of white; skull larger and

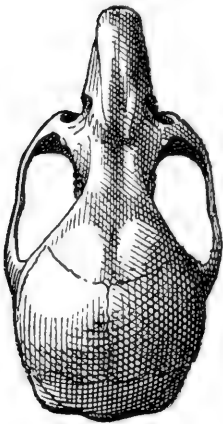
<sup>1</sup> *Vegetus*, active, sprightly.

heavier, wider, especially across forward part of zygoma incisor teeth orange (yellow in *O. costaricensis*).

*Color.* — Upper parts bright yellowish red brown, darkest along middle of back, and becoming strong orange rufous on rump and sides, sides of head and at base of whiskers; top of nose and head duller and more mixed with dark brown-tipped hairs; chin and under side of neck whitish, rest of under parts ochraceous buff, not sharply contrasted with color of sides; feet and hands yellowish white; ears dark brown outside, inside with hairs — rather sparse — colored like the back; tail dusky above, grayish below. Young examples differ little from the adults, except in being rather duller in color throughout.

*Measurements* —

No.	Sex.	Total length.	Tail vert.	Hind foot.	Ear.
10,304	♂ old ad.*	235	130	24	13
10,306	♀ old ad.	220	130	24	13
10,303	♂ ad.	215	120	25	13
10,298 type	♂ old ad.	210	120	25	14
10,302	♂ ad.	208	115	24	13
10,297	♂ ad.	206	120	24	13
10,295	♂ ad.	205	120	24	13
10,300	♂ yg. ad.	200	118	24	13
10,310	♂ yg. ad.	190	115	24	12
10,305	♂ yg. ad.	190	110	25	12
10,309	♂ yg.	170	98	22	12



× 1 $\frac{3}{4}$

FIG. 15. *Oryzomys vegetus*. Type.

*Skull.* — Type, old ad. ♂, basal length, 20.2; occipito-nasal length, 24.4; zygomatic width, 12.6; mastoid width, 11; interorbital width, 3.4; length of nasals, 9; upper molar series, 2.8; length of single half of mandible, 12.4.

*Remarks.* — *O. vegetus* may prove to be only a northern subspecies of *O. dryas humilior* Thomas of Colombia, Bogota region to Santa Marta region. Though closely allied, the Chiriqui form has a shorter tail, is rather redder above, and slightly paler below, and its skull is decidedly heavier throughout.

On the Volcan de Chiriqui the two species of pigmy *Oryzomys* occur together. In the Santa Marta Mountains, where two species, *O. dryas humilior* and *O. navus*, also occur, the former was found from 8,000 to 9,000 feet only, and the latter from 3,000 to 8,000, their ranges just overlapping.



*Zygodontomys cherriei* (ALLEN).

One youngish ♀, Bogaba, July 3.

I have compared this example with topotypes, kindly loaned by Dr. Allen, and can find no differences. The type locality of the species is Boruca, Costa Rica, in the low lands.

The present specimen, not full grown, measures, total length, 195; tail vertebrae, 75; hind foot, 23; ear, 13.

*Zygodontomys chrysomelas* (ALLEN).

Three specimens, Bogaba, July.

It is possible that the Chiriqui form may prove to be subspecifically different from true *Z. chrysomelas* of Costa Rica (type locality Suerre). One specimen loaned by Dr. Allen from San Carlos, differs from the Bogaba examples in being smaller, with smaller skull, lighter rostrum, and broader palatal slits. Additional material, however, may show these differences to be individual.

The Vesper rats, related to *Z. chrysomelas*, of which there are several in South America, form quite a distinct group in the genus *Zygodontomys*, differing from the more typical members, in their very dark coloration, reddish bellies, nearly naked, dusky feet and hands, with white nails, and in their wider skulls — especially wide between the orbits — with strongly marked, overhanging superciliary beading.

*Measurements* (of the three Bogaba skins) —

No.	Sex.	Total length.	Tail vert.	Hind foot.	Ear.
10,290	♂ old ad.	240	100	27	..
10,291	♀ ad.	230	90	28	..
10,292	♂ yg. ad.	215.	90	27	14

*Reithrodontomys australis* ALLEN.

Two specimens, adult ♂ and ♀, Boquete, 4,000 feet, April 30.

These I have compared with the type of *R. australis* from Volcan de Irazú, Costa Rica, loaned by Dr. Allen. In color they exactly agree, except that the upper surface of the feet is darker, more grayish — the feet being whitish in the type. The skulls of the two Boquete specimens, are heavier throughout especially the rostral part, and in this character they are intermediate between true *R. australis* and the form described below from the summit of the Volcan de Chiriqui.

*Measurements* (of the two Boquete skins) —

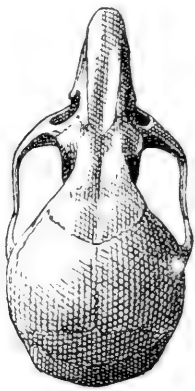
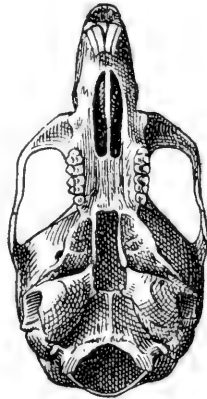
No.	Sex.	Total length.	Tail vert.	Hind foot.	Ear.
10,282	♀ ad.	165	85	18	14
10,283	♂ ad.	155	75	19	12

*Reithrodontomys australis vulcanius*, subsp. nov.

Type. — Mus. Comp. Zoöl., No. 10,281, ad. ♂, Volcan de Chiriqui, May 26, 1901. 10,300 feet.

*Characters.* — Pelage extremely long and silky; colors much darker and grayer than in true *R. australis*; skull heavier, especially rostral portion; palatal slits longer and wider.

*Color.* — Broad dorsal band strong sepia, paling off on sides to isabella color, somewhat shaded with cinnamon; top of nose and head paler, grayer than back; under parts isabella color, strongly shaded with cinnamon between arms and about vent; feet and hands grayish; ears well haired, sepia (about the same shade as darker parts of back); tail well clothed with short, close hairs dusky above, grayish below.

16.  $\times 1\frac{3}{4}$ 17.  $\times 1\frac{3}{4}$ FIGS. 16 AND 17. *Reithrodontomys australis vulcanius*. Type.

*Measurements.* — Type, adult ♂, total length, 170; tail vertebræ, 95; hind foot, 19; ear, 14. Skull, basal length, 19.4; occipitonasal length, 22.8; zygomatic width, 11.4; mastoid width, 11; interorbital width, 3.4; length of nasals, 8.2; width of nasals, 2.6; length of palate to palatal notch, 9.2; length of palatal slits, 5; width of palatal slits, 1.8; upper molar series, 3.2; length of single half of mandible, 11.4.

*Remarks.* — *R. australis vulcanius* is a well marked alpine form, very different from true *R. australis* in color, and also in its exceedingly long, silky pelage. The skull is slightly different.

**Reithrodontomys costaricensis** ALLEN.

Thirty specimens, Boquete, 4,000 to 6,000 feet, January, February, April, and June.

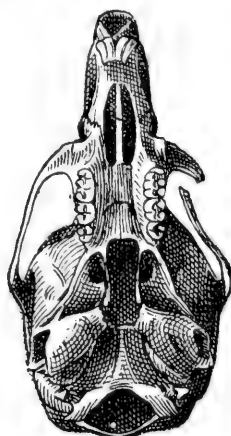
I have compared this series with specimens from the type locality — La Carpintera, Costa Rica — loaned by Dr. Allen, and cannot find that the Chiriqui animal is at all different. They vary a good deal individually in color, ranging from strong brownish orange rufous, without darker dorsal band to raw umber with darker dorsal band: below the color ranges from white to dull fulvous. Young individuals are always darker and duller than adults.

*R. costaricensis* was one of the commoner small mammals of the forest belt of the Volcan de Chiriqui.

**Reithrodontomys creper**,<sup>1</sup> sp. nov.

Type. — Mus. Comp. Zoöl., No. 10,284 ad. ♀ Volcan de Chiriqui, June 2, 1901.  
11,000 feet.

*Characters.* — Belonging to a peculiar group of large-sized species with curious bird-like skulls, — very long slender rostrum and large round brain case. Pelage exceedingly long, dense, and silky; colors all very dark; hind foot very

18.  $\times 1\frac{3}{4}$ .19.  $\times 1\frac{3}{4}$ .FIGS. 18 AND 19. *Reithrodontomys creper*. Type.

large; tail, long. (Dr. Merriam has lately described several species of this group from Mexico. These should properly, I think, have a subgeneric name. None of them, however, are closely related specifically to the present one.)

*Color.* — Upper parts, middle of back, bistre, shading on sides to raw umber; face rather more dusky, especially about eyes and at base of whiskers; under parts dark cinnamon, without marked line of demarcation, but shading grad-

<sup>1</sup> *Creper*, dusky, dark.

ually into color of sides; toes and fingers, whitish; upper surface of feet and hands, brownish; ears, dusky; tail, dusky all round for two thirds of its length, white all around for the terminal third.

*Measurements.* — Type, adult ♀, with unworn teeth, total length, 215; tail vertebræ, 130; hind foot, 23; ear, 15. Skull, basal length, 21.4; occipito-nasal length, 25.4; mastoid width, 11.6; length of nasals, 8.8; length of palate to palatal notch, 10; length of palatal slits, 4.8; upper molar series, 4.2; single half of mandible, 13.6.

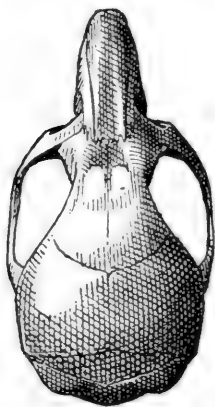
*Remarks.* — The type and only specimen of this remarkable little animal, is an adult ♀, but with unworn teeth, so probably it is not full grown, and old adults would be still larger. Externally it bears a somewhat superficial resemblance to the woolly *Oryzomys*, of the subgenus *Erioryzomys*. The single specimen was caught on the cold, barren summit of the Volcan de Chiriqui.

***Akodon teguina apricus*,<sup>1</sup> subsp. nov.**

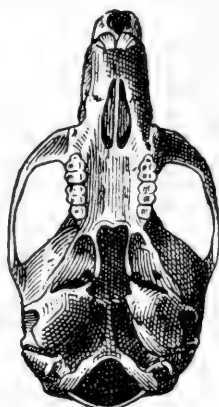
Type. — Mus. Comp. Zoöl., No. 10,236, old ad. ♀, Boquete, February 24, 1901.  
4000 feet.

Five specimens, Boquete, 4,000 to 5,000 feet, February and April.

*Characters.* — Colors not so black as in true *A. teguina* (the rump and thighs in true *A. teguina* are blackish, in the new form they are scarcely darker than



20.  $\times 1\frac{3}{4}$ .



21.  $\times 1\frac{3}{4}$ .

FIGS. 20 AND 21. *Akodon teguina apricus*. Type.

the rest of the upper parts); tail, longer; ears, larger; skull, heavier; rostrum, heavier; molar-form teeth much heavier; tooth rows not so parallel, — much more divergent anteriorly. Pelage, short, close, and fine with decided gloss.

*Color.* — Upper parts vandyke-brown, slightly more dusky on top of head and along middle of back; under parts dull cinnamon rufous; hands, feet, ears, and tail blackish.

<sup>1</sup> *Apricus*, exposed to the sun, hence, southern.

*Measurements* —

No.	Sex.	Total length.	Tail vert.	Hind foot.	Ear.
10,236 type	♀ old ad.	142	58	18	13
10,235	♀ old ad.	140	55	18	13
10,237	♀ old ad. <sup>1</sup>	140	55	18	13
10,234	♂ old ad. <sup>1</sup>	125	50	18	13
10,238	♀ ad.	125	55	18	13

Skull, type, old ad. ♀, basal length, 20.2; occipitonasal length, 23; zygomatic width, 12; mastoid width, 10.8; interorbital width, 4.6; length of nasals, 9; width of nasals, 2.8; length of palate, to palatal notch, 9.6; upper molar series, 4; length of single half of mandible, 12.8.

*Remarks.* — Through the kindness of Dr. Merriam I was able to compare the series taken by Mr. Brown with a fine adult ♂, No. 76,353, of true *A. teguina* taken by Mr. E. W. Nelson at Ocuilapa, Chiapas, Mexico. This comparison showed that the Chiriqui animal is quite distinct — though it is perhaps better to regard it as a subspecies.

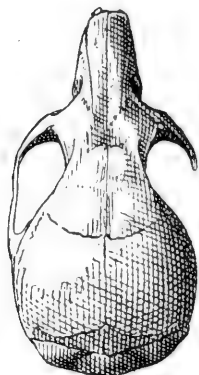
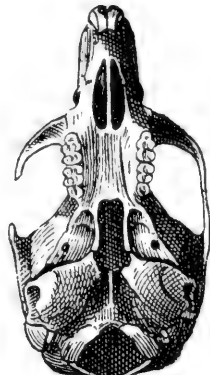
Mr. Brown caught all five of these curious dark brown little creatures, in open rocky places.

*Akodon xerampelinus*,<sup>2</sup> sp. nov.

Type. — Mus. Comp. Zoöl., No. 10,240, old ad. ♂, Volcan de Chiriqui, May 26, 1901. 10,300 feet.

Three specimens, Volcan de Chiriqui, 10,300 feet. May and June.

*Characters.* — Apparently specifically distinct from *A. teguina*. Size of that

22.  $\times 1\frac{3}{4}$ .23.  $\times 1\frac{3}{4}$ .FIGS. 22 AND 23. *Akodon xerampelinus*. Type.

species; tail, longer; pelage very long and fluffy with but little lustre; colors, paler — more yellowish, less reddish brown; under parts grayish (strong cin-

<sup>1</sup> Teeth much worn.

<sup>2</sup> *Xerampelinus*, of the color of dry vine leaves.

namon rufous in *A. teguina*); skull lighter and more delicate; rostrum lighter; nasals narrower; palatal slits rather wider; audital bullae slightly larger; molar-form teeth heavier — wider.

*Color.* — Upper parts uniform dark yellowish brown (a color that might, perhaps be called tawny burnt-umber) under parts, broccoli-brown; hands, feet, tail, and ears, blackish (slightly grayer, less intense black than these parts in *A. teguina apricus*; due to greater hairiness).

*Measurements* —

No.	Sex.	Total length.	Tail vert.	Hind foot.	Ear.
10,240 type	♂ old ad.	145	65	17	14
10,239	♂ ad.	140	65	17	13
10,241	♂ yg. ad.	127	56	18	13

Skull. ♂ old ad. type, basal length, 19.2; occipitonasal length, 22.6; zygomatic width, 11.6; mastoid width, 10.8; interorbital width, 4.2; length of nasals, 8.6; width of nasals, 2.6; length of palate, to palatal notch, 9.6; upper molar series, 4; length of single half of mandible, 13.

*Remarks.* — The little Akodon of the summit of Volcan de Chiriqui is very different from the one found at lower altitudes and is entitled to full specific rank. The three examples were taken on the desolate top of the Volcano, a little below actual timber line, but still where the forest had become stunted and sparse. Like *A. teguina apricus* they were found in open rocky country.

***Macrogeomys cavator*,<sup>1</sup> sp. nov.**

Type. — Mus. Comp. Zool., No. 10,881, old ad. ♂, Boquete, Mar. 9, 1901.  
4,800 feet.

Twenty-six specimens, both sexes, Boquete, 4,000 to 7,000 feet. February, March, and April.

*Characters.* — Differs from the four known Costa Rican species, though nearest *M. dolichocephalus* Merriam. Compared with the type of that species, the skull is shorter and wider across zygoma; nasals, longer; distance from postorbital process to back of zygomatic arch, shorter; audital bullæ, flatter; sagittal and lambdoidal crests, heavier; zygomatic arch heavier and more angulated, standing widely and squarely out from skull. Color, very dark and nearly uniform — not pied as in the other species. Pelage, short, close, and rather harsh.

*Color.* — Upper parts dark seal-brown — almost black; under parts similar but slightly grizzled, the pelage sparse, so that the skin shows through; a small white anal patch, and sometimes small white patches under chin and on under side of wrists; whiskers colorless; feet, hands, and tail, naked — in dried skin yellowish brown to dusky, the end of the tail black. In many

<sup>1</sup> *Cavator*, one who hollows out or excavates.

specimens there are longer hairs scattered through the pelage, some of which are silvery, others brown like the general color of the back.

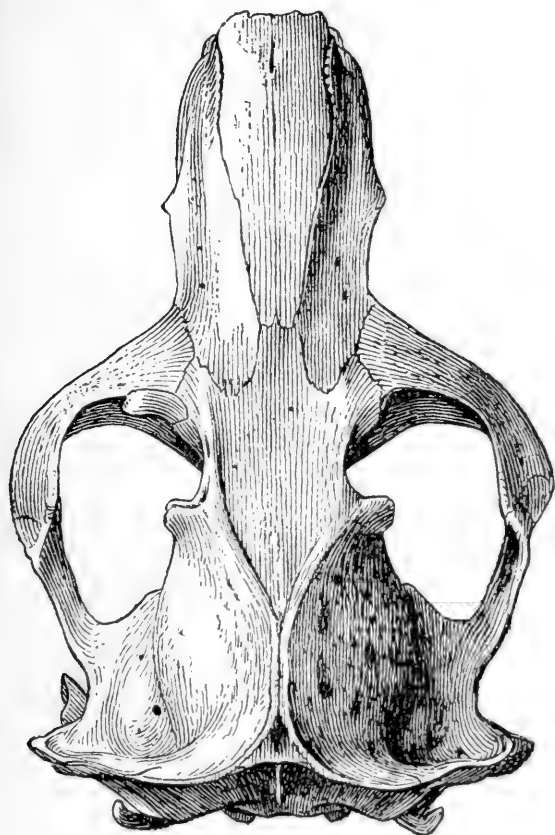
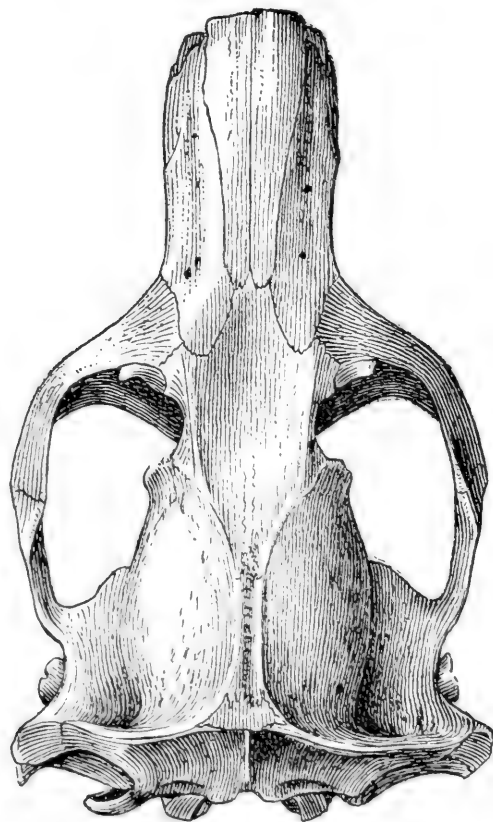
24.  $\times 1\frac{1}{4}$ .25.  $\times 1\frac{1}{4}$ .

FIG. 24. *Macrogeomys cavator*. Type, old ♂.

FIG. 25. *Macrogeomys cavator*. Topotype, old ♀. No. 10,389.

*Measurements* (twelve adults) —

No.	Sex.	Total length.	Tail vert.	Hind foot.	Ear.
10,370	♂ old ad.	410	118	54	8
10,378	♂ old ad.	390	125	53	8
10,392	♂ old ad.	390	110	50	7
10,371	♂ old ad.	385	118	51	7
10,381 type	♂ old ad.	375	120	52	8
10,385	♂ yg. ad.	360	110	47	8
10,380	♀ old ad.	400	108	50	7
10,392	♀ old ad.	390	110	50	7
10,389	♀ old ad.	380	110	49	8
10,376	♀ old ad.	375	115	52	7
10,375	♀ yg. ad.	350	110	48	7
10,377	♀ yg. ad.	350	105	48	7

Skull, type, No. 10,381, ♂ old ad. (not quite so large as some of the very old specimens) basal length, 64; occipitonasal length, 67.8; zygomatic width, 45.8; mastoid width, 33.4; interorbital width, 11; length of nasals, 28; length of palate to palatal notch, 44.6; upper molar series, 15.4; length of single half of mandible, 51.2.

Old adult ♀, topotype, No. 10,389, basal length, 61.4; occipitonasal length, 63.4; zygomatic width, 40; mastoid width, 32; interorbital width, 10; length of nasals, 25.4; length of palate to palatal notch, 41.4; upper molar series, 15; length of single half of mandible, 48.

*Remarks.* — This very distinct new species, was abundant on the slopes of the volcano from 4,000 to 7,000 feet, but was not seen below 4,000 feet. It hardly needs comparison with any of the four previously known species from Costa Rica.

*Macrogeomys pansa*,<sup>1</sup> sp. nov.

*Type.* — Mus. Comp. Zool., No. 10,364, old ad. ♀, Bogaba, July 6, 1901.

Eight specimens, both sexes, Bogaba, July.

*Characters.* — Much smaller than the alpine, *M. cavator*; hind foot propor-

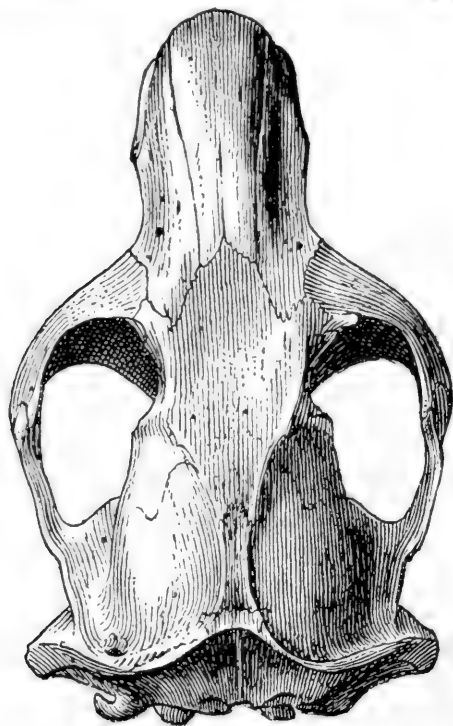


FIG. 26. *Macrogeomys pansa*. Type, old ♀.  $\times 1\frac{1}{4}$ .

tionally much larger (actually nearly the same size); colors duller and browner, more grayish white on belly; pelage short, close, very sparse on under parts,

<sup>1</sup> *Pansa*, broad-footed.



nose and sides of head and neck where the skin shows through. Skull much smaller and weaker throughout, with less spread to zygoma; nasals, shorter; interorbital width greater; molar-form teeth much smaller.

*Color.* — Upper parts dull, dusky, chocolate-brown; under parts grizzled, the belly whitish: whiskers mostly colorless; feet, hands, and tail naked (in dried skin) yellowish brown, the tip of the tail dusky.

*Measurements* —

No.	Sex.	Total length.	Tail vert.	Hind foot.	Ear.
10,369	♂ adult.	325	110	48	7
10,368	♂ yg. ad.	320	105	50	6
10,362	♀ old ad.	330	110	52	5
10,364 type	♀ old ad.	320	110	48	6
10,366	♀ ad.	320	100	46	7
10,363	♀ ad.	330	100	47	6
10,365	♀ yg. ad.	320	110	47	6
10,367	♂ young	300	95	47	4

Skull, type, ♀ old adult, basal length, 54; occipitonasal length, 57.6; zygomatic width, 36; mastoid width, 27.8; interorbital width, 11.8; length of nasals, 23; length of palate, to palatal notch, 37; upper molar series, 13; length of single half of mandible, 41.

*Remarks.* — In July, when Mr. Brown was at Bogaba, birds were moulting and mostly unfit for specimens; consequently he spent considerable time searching for suitable places for future work, trapping mammals, and collecting a few examples of some of the rarer birds. On one of his long rides he came upon a single isolated colony of pocket gophers. It was in the foot-hills, about 600 feet altitude, and was the only colony he found in the whole region. The members of this colony were rather hard to trap, as pocket gophers sometimes are, and unfortunately the only old ♂ secured was caught in the trap by the head and the skull crushed. The species is very different from the large, black species found so abundantly on the higher slopes of the Volcan de Chiriqui.

### *Heteromys repens*,<sup>1</sup> sp. nov.

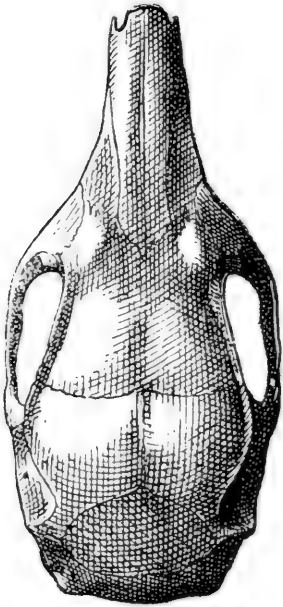
*Type.* — Mus. Comp. Zool., No. 10,356, old ad. ♀, Boquete, April 8, 1901. 4,000 feet.

Six specimens, Boquete, 4,000 to 5,800 feet, February and April.

*Characters.* — Apparently a very distinct species. Hind feet large, soles naked, six pads. These characters at once distinguish it from the Costa Rican *H. salvini nigrescens* Thomas. From *H. adpersus* Peters, from Panama, it differs in its longer hind feet and strong cranial characters, the skull being very much wider between the orbits; the nasals longer than the ascending branches of premaxilla (shorter in *H. adpersus*); the supraorbital beading

<sup>1</sup> *Repens*, unexpected, unlooked-for.

more overhanging, and not so S-shaped. From the large South American species (*H. anomalus* Thompson, *H. melanoleucus* Gray, and *H. jesupi* Allen) it can be separated by its shorter, wider skull, — much wider between orbits, and lighter rostrum.



× 1 $\frac{3}{4}$ .

FIG. 27. *Heteromys repens*. Type.

*H. longicaudatus* Gray, from "Mexico," I do not know, and the description is wholly inadequate. Dr. Thomas says it belongs to this group. Possibly it may be somewhat like the present species, though if from Mexico this is improbable.

*Color.* — Upper parts, — top of nose and face to eyes grayish dusky; shoulders and sides finely mixed, dark, dusky, brown, and tawny ochraceous; median parts of rump and lower back darker, more dusky; no yellowish or fulvous line along lower sides; under parts, including upper lip, under side of nose, inner side of legs, and under side of arms, pure white; outer surface of legs dusky; upper surface of arms gray; feet and hands white; ears dusky, sparsely haired, with a slightly perceptible whitish border; tail thinly clothed with short, stiff hairs, dusky above, white below, and with a slight whitish pencil.

No. 10,360, young ♀, is in the slaty pelage of the very young, the whole upper parts being slaty. No. 10,361 ♀, also young, has in the middle of the back a large sized patch of hairs colored like those of the adult, the rest of the upper parts being slaty.

In No. 10,358 there are a good many wholly white spines scattered through the upper surface, and in the other three adults a very few of these white points can be seen.

*Measurements* —

No.	Sex.	Total length.	Tail vert.	Hind foot.	Ear.
10,359 <sup>1</sup>	♂ old ad.	300	155	33	15
10,355 <sup>1</sup>	♂ old ad.	285	150	32	14
10,358 <sup>1</sup>	♂ old ad.	285	145	33	15
10,356 <sup>1</sup> type	♀ old ad.	282	150	33	15
10,361	♀ young	247	130	32	15
10,360	♀ young	235	115	30	12

Skull, type, ♀ old adult, basal length, 31.4; occipitonasal length, 35.4; zygomatic width, 16.4; mastoid width, 14.8; interorbital width, 9.2; length of nasals, 14.8; width of nasals, 4.2; upper molar series, 4.8; length of single half of mandible, 17.2.

*Remarks.* — From Peters's careful description and plate it is perfectly clear that the Chiriqui *Heteromys* is distinct from *H. adspersus*. It is also clear

<sup>1</sup> All with worn teeth.

from Dr. Thomas's description that it is not his *H. salvini nigrescens*, but what Gray's *H. longicaudatus* may be I can only conjecture. The type is extant in the British Museum, but although Dr. Thomas has stated that it is a good species, he has never given any clue to its identity. Gray's original description is so meagre that it is unfortunate that Dr. Thomas did not characterize the species when he reinstated it.

***Proechimys centralis chiriquinus* THOMAS.**

Thirty-one specimens, Divala, November and December, and Bogaba, July; those from the latter place are topotypes.

Though very common in the low lands and the foot-hills of the Volcan de Chiriqui, the spiny rat certainly does not ascend the Volcano to any great height, as Mr. Brown did not find it at Boquete.

***Dasypsecta isthmica* ALSTON.**

Nine specimens, young and adults, Divala, November, Boquete, 3,500 feet, June, and Bogaba, July.

***Agouti paca virgatus*, subsp. nov.**

Type, and only specimen. — Mus. Comp. Zool., No. 10,079, old ad. ♂, Divala, December 16, 1900.

*Characters.* — The Central American *paca* differs from the Brazilian form, true *A. paca* (Linn.), in being larger, with larger hind foot; in having the second stripe on the sides much less broken into spots; all the spots above the two lateral stripes smaller; the ground color of upper parts richer brown. Skull much larger; palate narrower; audital bullæ flatter.

*Color.* — Ground color of upper parts, walnut-brown; feet, hands, and cheeks duller, paler, and shaded with wood-brown; under parts white; on the lower sides a white stripe extending from hip to shoulder; above this another white stripe, a little shorter than the first; these two bands break up on sides of the neck and on flanks into series of white spots, which are much smaller on the flanks; above the white bands two rows of small white spots, the lower one reaching from sides of neck to flanks; the upper one very short — made up of only six or seven indistinct spots.

*Measurements.* — Type, old ad. ♂, total length, 740; tail vertebræ, 22; hind foot, 130; ear, 43. Skull, type, basal length, 139.6; occipitonasal length, 151; zygomatic width, 104; mastoid width, 54.8; interorbital width, 47.2; length of nasals, 51.2; width of nasals, 26; length of palate, to palatal notch, 76; width of palate at middle of second molar-form tooth, 7; at middle of last molar-form tooth, 10.2; upper molar series, 29.6; length of single half of mandible, 107.

*Remarks.*—I cannot find that the Central American paca has ever been named. The Museum has a large series of skulls of true *A. paca* from Brazil, and several specimens, skins and skulls, of the northern form from Costa Rica, collected by Gabb. One adult ♀ taken by Mr. Brown, at Santa Marta, Colombia, and Venezuelan examples in the United States National Museum, are apparently referable to true *A. paca*. I have not seen any specimens from Panama, but all examples from Costa Rica and Chiriqui belong to a race that is easily separable from true *A. paca* of Brazil.

The paca is said to be variable in color everywhere, light and dark individuals occurring together, but in spite of this I think the northern form averages much darker, richer brown. It certainly has the upper of the two lateral white stripes much less broken up into spots, and all the white spots much smaller. Besides these differences in color and pattern, the Central American animal is larger, with longer hind feet, and has a much larger skull, with narrower palate and flatter audital bullæ. Skulls of the paca vary a good deal individually in regard to the roughening of the upper surface. In some old skulls the upper surface is excessively roughened, while in others of about the same age it is comparatively smooth.

#### **Lepus (Tapeti) gabbi (ALLEN).**

Nine specimens, Divala, November and December. Boquete, 3,400 to 4,500 feet, March and April, and Bogaba, July.

The seasonal differences in color are well shown by this series. July specimens are much redder, with but few black-tipped hairs in the back, than autumnal examples.

#### **Felis bangsi costaricensis MERRIAM.**

One female, Boquete, 4,000 feet, April 22, the type of Dr. Merriam's new form.

#### **Felis pardalis LINN.**

One fine adult ♂, Boquete, 4,000 feet, April 10.

#### **Conepatus<sup>1</sup> mapurito (GML.).**

Two specimens, ♂ and ♀ adults, Boquete, 4,000 and 4,500 feet, February and March.

<sup>1</sup> I am aware of the proposed change in the generic names of the skunks, but, not having reached a definite decision, use the old name.

**Galera barbara biologiæ** (THOMAS).

One male, Bogaba, July 9. The black-headed Central American form is a very strongly marked subspecies; in addition to this specimen the Museum has skins from Costa Rica collected by Gabb.

**Putorius (Ictis) affinis** (GRAY).

Three specimens, two adult and one young males, Boquete, 4,000 to 5,800 feet, February, March, and April. These examples agree very well with Gray's description; they vary somewhat among themselves in color; the young one, No. 10,114, has a wholly black head, the other two have small irregular (not the same on both sides) white patches, behind the eye, in front of the ear, and above the corner of the mouth. In No. 10,114, the under parts, except the chin, which is whitish in all three, are intense orange-rufous; in No. 10,112, the under parts are a paler shade of the same color; and in No. 10,113 paler still and more yellowish.

*Measurements* —

No.	Sex.	Total length.	Tail vert.	Hind foot.	Ear.
10,112	♂ old ad.	480	170	52	23
10,113 <sup>1</sup>	♂ ad.	400	143	43	20
10,114	♂ young	355	125	47	20

**Potos caudivolvulus** (SCHR.).

Three specimens, two males and a ♀, Bogaba, July. I do not think the Central American form is the same as true *P. caudivolvulus* of Surinam, but I have not sufficient material to decide the question.

**Nasua narica** (LINN.).

Six specimens, both sexes, Boquete, 3,800 to 5,800 feet, April and March. The nasuas separate naturally into many geographic races. These, as proper material accumulates, are gradually coming to be understood; the name *narica* is used here provisionally.

**Procyon lotor hernandezii** (WAGLER).

One male, Pedregal, July 25.

<sup>1</sup> I suspect this specimen was wrongly sexed, and is an adult ♀; judged by the skull it is not much younger than No. 10,112.

**Myotis nigricans (WIED).**

One ♀, Bogaba, July 1.

**Eptesicus fuscus miradorensis (H. ALLEN).**

One ♂, Boquete, 4,800 feet, March 23.

**Lasiurus borealis mexicanus (SAUSSURE).**

One ♂, Boquete, 4,000 feet, February 18.

**Rhogeessa tumida H. ALLEN?**

One ♂, Bogaba, July 6. Mr. Miller, to whom I submitted this specimen, is a little doubtful as to its identity with *R. tumida*, but on the strength of a single specimen preferred to so determine it.

**Hemiderma brevicaudum (WIED).**

Thirteen specimens, Bogaba, July. This series presents a wide range in the color of the upper parts, varying from hair-brown to russet, with every intermediate shade.

**Glossophaga soricina (PALLAS).**

One ♀, Bogaba, July 2.

**Artibeus intermedius J. A. ALLEN.**

Three specimens, an old ♀, and youngish ♂ and ♀, Bogaba, July. The younger specimens are more sooty, with the facial stripes less well indicated and have smaller skulls, and thus agree with the young described by Dr. Allen. I must confess, however, that I was at first inclined to regard these as belonging to a different species from the old one. The difference in size is great and the skulls do not show the degree of immaturity that one would expect with the difference in size.

**Vampyrops helleri PETERS.**

Six specimens, Bogaba, July.

*Sturnira lilium* (E. GEOFF.).

One adult ♀, Volcan de Chiriqui, 7,500 feet, February 17, 1901.

*Desmodus rotundus* (E. GEOFF.).

Three specimens, Bogaba, July.

*Alouatta palliata* (GRAY).

Three specimens, adult ♂ and ♀, and a youngish ♀, Boquete, 4,000 feet, April.

*Saimiri oerstedii* (REINH.).

Five specimens, both sexes, Bogaba, July.

The squirrel monkey is common in the scrubby forest of the foot-hills of the Volcan de Chiriqui. It was very tame, and Mr. Brown states that often little parties of them, would follow him about in the underbrush, chattering, and allowing him to come so near that he could almost put his hand on them. It is a beautiful creature, with a long tasselled tail, and is admirably shown in Alston's plate in the *Biologia Centrali-Americana*. Mr. Brown states that he never saw a creature that he disliked so to kill, and after he had secured five specimens, nothing would induce him to molest the little troupes that accompanied him on his rambles over the foot-hills.

*Cebus hypoleucus* (HUMBOLDT).

Two adult females, Boquete, 4,000 feet, March, and Bogaba, July.





Bulletin of the Museum of Comparative Zoölogy

AT HARVARD COLLEGE.

VOL. XXXIX. No. 3.

---

SOME CARBONIFEROUS CESTRACIANT AND ACANTHODIAN  
SHARKS.

BY C. R. EASTMAN.

WITH SEVEN PLATES.

CAMBRIDGE, MASS., U. S. A. :  
PRINTED FOR THE MUSEUM.  
JUNE, 1902.



No. 3. — *Some Carboniferous Cestraciont and Acanthodian Sharks.* By C. R. EASTMAN.

COINCIDENT with the marked increase of *Pelmatozoa* and certain families of *Brachiopods* during the Lower Carboniferous all over the world, a race of sharks armed with crushing teeth suddenly acquired dominance, became exceedingly diversified, and finally all but passed away towards the close of the Palæozoic. Of the very extensive group represented by the *Cochliodontidæ* and *Cestraciontidæ*, which is at least as ancient as the Devonian, only one genus, the so-called Port Jackson shark, survives at the present day. With this all of the fossil forms agree in having a similar but more or less specialized dentition, in consequence of which this creature stands in the same relation to the host of Carboniferous sharks with crushing teeth that *Nautilus* does to fossil *Cephalopods*.

Some interesting specimens from the Carboniferous described in the present paper throw new light on the structure and relations of *Campodus* and the series of *Edestus*-like forms, all of which are to be regarded as members of the *Cestraciontidæ*. Spines belonging to the first and second dorsal fins of *Ctenacanthus*, from the Kinderhook limestone of the Mississippi Valley, and new species of *Acanthodes* from the Coal Measures of Mazon Creek, Illinois, are here illustrated and described for the first time. A list is also given of the fossil vertebrate fauna known to occur at the Mazon Creek locality, including some species not previously reported.

I. ON THE NATURE OF EDESTUS AND RELATED FORMS.

Notwithstanding the extensive literature concerning the peculiar ichthyic remains known as *Edestus*, *Helicoprion* and the like, their nature, functions, and relations are admitted by most authors to be still highly problematical. Occurring as they do singly, and always in the detached condition, these objects have been most frequently looked upon as *Selachian* fin-spines, although their correspondence to dental structures

has been patent to nearly all writers. Perhaps the most novel conjecture as to their function is that recently advanced by Karpinsky,<sup>1</sup> who, as an alternative hypothesis to regarding them as caudal spines, refers the thrice-coiled spiral of *Helicoprion* to the snout region, and supposes it to have been a powerful weapon for attack and defence, each individual possessing but a single organ of this kind (*cf.* text-figure 1). The Russian Director's main reason for excluding these spirals from the mouth cavity, namely on account of their large size (26 cm. in diameter), is not, in the opinion of at least two of his critics, an insurmountable objection, nor can any argument for an external position be based on the presence of so-called "placoid scales" over and around the bases of the

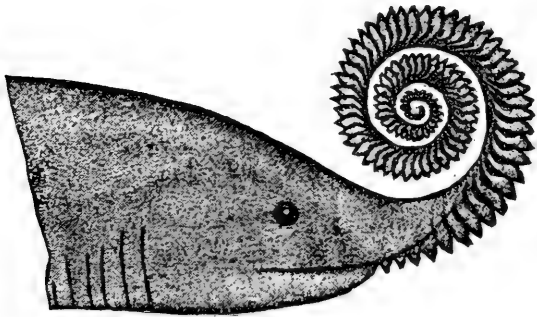


FIG. 1.

Karpinsky's conjectural restoration of *Helicoprion bessonowi*, from the Russian Permian Carboniferous (after Karpinsky).  $\times \frac{1}{10}$ .

segments or teeth, when it is evident from the author's beautiful figures that he has mistaken calcified cartilage for shagreen granules.

In the reviews which have appeared of Dr. Karpinsky's memoir,<sup>2</sup> it is admitted that much evidence has been brought forward in favor of the view that *Edestus* and *Helicoprion* should be looked upon as Palæozoic sharks

with sharp piercing teeth, which were never shed, but became fused into whorls as the animal grew. And quite recently it has been claimed by the present writer<sup>3</sup> that positive proof of the odontological nature of *Edestus*, *Campyloprion*, and *Helicoprion* is furnished by comparison with the dental armature of *Campodus*. According to this view, the curved or coiled "spines" of *Edestus* and *Helicoprion* are not dermal defences at all, but veritable teeth corresponding to the symphyseal series of *Protodus*, *Campodus*, the existing *Cestracion*, *Carcharias*, *Chlamydoselache* and other forms, only more modified with respect to curvature. Initial stages in the coiling of symphyseal or intermandibular

<sup>1</sup> Karpinsky, A., Ueber die Reste von Edestiden, und die neue Gattung *Helicoprion*. Verhandl. k. russ. Mineral. Ges. St. Petersburg, Vol. XXXVI., p. 467, 1899.

<sup>2</sup> Woodward, A. S., *Helicoprion*, — Spine or Tooth? *Geol. Mag.* (4), Vol. VII., p. 33, 1900. — Eastman, C. R., Karpinsky's Genus *Helicoprion*: a Review. *Amer. Nat.*, Vol. XXXIV., p. 579, 1900.

<sup>3</sup> *Science*, n. s., Vol. XIV. (1901), p. 795. — *Geol. Mag.* (4), Vol. IX. (1902), p. 148.

teeth are displayed by numerous diverse forms, such as *Protodus*, *Glossodus*, *Sandalodus*, *Cochliodus*, *Periplectroodus*, *Onychodus* and other Palæozoic fishes. Amongst these the type-specimen of "*Helodus coxanus*" Newberry, which is in reality the symphysial series of *Cochliodus latus*, exhibits only a slight inrollment, and is hence indicative of a primitive stage. A more advanced stage is represented in another family by the corresponding series of *Campodus variabilis* and the various species of *Edestus*. *Campyloprion*, as the name indicates, is a more arcuate form and possesses more numerous segments; and finally, in the completely coiled *Helicoprion*, we observe the most extreme specialization in this direction.

### Campodus.

(Plates 1-3.)

The best account of the dentition of this genus is that given by Max Lohest<sup>1</sup> in 1883, who pointed out the close similarity between it and the living Cestracion (*Heterodontus*), and corrected certain errors in the earlier restorations of St. John and Worthen.<sup>2</sup> The observations of all these writers were based upon a unique specimen from the Missourian of Osage County, Kansas, referred by them to the left ramus of the lower jaw, and comprising upward of 450 teeth arranged in eighteen transverse rows. This specimen was deficient at its anterior extremity, where the individual teeth are greatly diminished in size: and no information was afforded respecting the nature of the union of this ramus with its fellow, or the presence or absence of symphysial teeth. The gape of the mouth being thus entirely conjectural, the jaws were restored by St. John and Worthen after the fashion of *Raja*, with the forward ends apposed to one another in a nearly straight line; and inferentially the structure of *Campodus* was supposed by them to have conformed to the type of modern rays.

Were there a reasonable basis for this view, it would be of some moment in considering the question of the origin of rays. For although the Batoid type is regarded as a comparatively modern derivative, not antedating the Jurassic<sup>o</sup> so far as known, nevertheless we cannot deny the existence at even so remote a period as the Devonian of offshoots from the primitive Elasmobranch stem, which approximated the modern ray type in certain notable respects. That such early approxi-

<sup>1</sup> Lohest, M., Recherches sur les poissons des terrains paléozoïques de Belgique. Ann. Soc. Géol. Belg., Vol. XI., p. 314, 1883.

<sup>2</sup> St. John, O., and Worthen, A. H., Pal. Illinois, Vol. VI., p. 318, Pl. VIII., 1875.

mations to typical rays as *Tamiobatis*, *Archæobatis*, *Psammodus*, *Janassa*, etc., are genetically related to the Batoidei, as commonly recognized, may perhaps be questioned, and indeed is even denied by Dr. O. P. Hay,<sup>1</sup> since we should expect to find greater differences than obtain between modern sharks and rays, had their divergence taken place at an extremely remote period. There is no difficulty in supposing the dentition, general configuration of the body, and most minor characters of rays to have been paralleled in the Palæozoic by adaptation to similar conditions, such as bottom-living, amongst specialized groups which later became extinct; and we are obliged to affirm that at present there is no evidence to show that the essential feature of rays, namely the attachment of fin-supports to the side of the head, was originated until well along in the Mesozoic.

But with respect to *Campodus*, we may dismiss the question of its supposed affinities to rays on the ground that all available evidence points to a close relationship to *Cestracion*, the arrangement of teeth being essentially similar, and the mouth-cleft long and narrow, instead of wide and transverse. The two rami of either jaw probably included about the same angle between them as in *Cestracion*. *Orodus* and related Palæozoic genera undoubtedly possessed a *Campodus*-like dentition; and while these, together with more specialized forms such as *Edestus*, etc., failed to survive the Palæozoic, the primitive *Cestraciont* type manifested great longevity.

The lateral series of teeth belonging to *Campodus* are already sufficiently well known, thus rendering further description superfluous. We need only remark that the orientation of detached teeth may be readily determined from the following characters: (1) The coronal buttresses are invariably directed outward, and the longitudinal ridge on the oral surface is slightly ectad of the middle line of the crown; (2) the antero-lateral and postero-lateral series increase in size on passing toward the middle of each ramus, where one of the series is sensibly enlarged; (3) the coronal eminences are more elevated in one jaw, presumably the lower, than in the other; (4) interposed between the foremost of the antero-lateral series on either side are the most anterior, or as we shall hereafter term them, symphyisial teeth, immediately to be described.

*Symphyisial dentition.* — There are at present but two specimens known of the symphyisial dentition, both of which are illustrated in the accompanying figures, which are reproduced from photographs. That shown in

<sup>1</sup> *Hay, O. P.*, The Chronological Distribution of the Elasmobranchs. *Trans. Amer. Phil. Soc.*, Vol. XX., p. 74, 1901.

Plates 2 and 3 was obtained a number of years ago by Mr. G. C. Merrill from the Upper Coal Measures of Osage County, Kansas, and is preserved in the Museum of Comparative Zoölogy at Cambridge (Cat. No. 749). The second example, shown in Plate 1, was derived from the Upper Coal Measures of Cedar Creek, Nebraska, and belongs to the Museum of the Nebraska State University at Lincoln. To Professor Edwin H. Barbour, Director of the University Geological Survey of Nebraska, the writer is greatly indebted for the privilege of studying and describing this and numerous other Carboniferous fish remains which have been collected during the prosecution of the Survey. Acknowledgments are also due to Miss Carrie A. Barbour, of Lincoln, through whose skill and zeal these specimens have been beautifully prepared or otherwise rendered available for study.

It is stated by Professor Barbour that when his specimen of the symphysial dentition of *Campodus* was discovered, it was in almost perfect condition, and the slight injury it sustained on being extricated from the matrix was subsequently repaired by his sister. For instance, a number of the coronal buttresses on one side, and several of the coronal apices were broken off; such of these as could not be mended from the original fragments are now restored in plaster. As seen in Plate 1, the two posterior coronal apices, and also the fourth and fifth counting from the proximal end, are partly restored; the remainder are in their original condition. Weathering has removed most of the enamel from this specimen, and indications of wear during life are not readily discernible.

The Nebraska specimen is important from the fact that it first led to an adequate understanding of the earlier known Kansas example, which in turn disclosed a wealth of information respecting ancient types of Cestraciont dentition, and furnished the solution of a number of debated problems. For in the state in which the Kansas dentition originally came to the Harvard Museum, all of the coronal apices having been broken away, the complete form of the symphysial teeth was not revealed, and their relations to *Edestus* were unsuspected. That this specimen long ago challenged the attention of palæichthyologists, although no record of their views concerning it has come to light, is witnessed by the fact that plaster casts were taken from it at the direction of Mr. Orestes St. John, while he was Assistant in Palæontology at the Museum under Professor Agassiz. Some of these replica, together with casts of the lateral series described by St John and Worthen in 1875, have since found their way into other collections.

From this statement regarding the history and condition of these

two examples of symphyisial dentition, we may pass on to their detailed description; and as they fortunately supplement each other, and occupied without doubt the same position in the mouths of two precisely similar individuals, it will be more convenient to consider them together instead of separately. In the first place, however, we must conceive of the dentition of *Campodus* having been developed as follows: as the newly formed successional teeth were pushed up from the supporting cartilage, they were carried forward in regular order, gradually increasing in size with the age of the individual, while the functional teeth which they replaced were not shed, but became rotated over on to the outer side of the jaws. Everywhere, except in front, the unrolling of these series proceeded in a more or less spiral fashion, after the manner of *Cestracion*. And as in this recent genus, also, the symphyisial series were bilaterally symmetrical and coiled in a single plane. The number of symphyisial teeth, and curvature of the series, is practically the same in both genera.

It is interesting to note in this connection, that a relic of ancestral conditions still persists in *Cestracion*, in that occasionally the median azygous series of the lower jaw is somewhat enlarged, while opposed to it in the upper jaw, two corresponding series, one on either side, are also slightly enlarged. *Chlamydoselache* and some other recent sharks possess a median azygous series in the lower jaw, opposed to which is a paired series in the upper. The selfsame arrangement is very conspicuous in *Campodus*, where the two examples before us obviously represent the unpaired median series, and, as shown by marks of wear, played against a corresponding paired series in the opposite jaw. These two corresponding series were, however, separated by an interval, so as to include the azygous series for a greater part of its width between them when the jaws were closed. So far as we may depend on analogy, the conclusion is warranted that the two specimens of symphyisial dentition before us pertain to the lower jaw, and that examples of paired series belonging to the upper jaw have not as yet been encountered.

Two facts deserve to be specially noted, for reasons which will at once present themselves. In the first place we observe that the symphyisial dentition of *Campodus* is bilaterally symmetrical and curved or inrolled in a single plane. And, secondly, the symphyisial teeth are very disproportionately enlarged with respect to the antero-lateral series, the disparity being in fact greater than is known to occur in any other genus, recent or fossil.



Now, with respect to inrollment or coiling, we need only repeat that this character pervades numerous sharks, both those with piercing and those with crushing teeth. Indeed, some forms are known, such as *Cochliodus*, *Psephodus*, etc., which have posterior dental plates adapted for crushing, and feebly prehensile symphyseal teeth (*e. g.*, "*Helodus coxanus*" Newberry). In *Campodus* the anterior series are only moderately arched, and the individual teeth scarcely override one another. But in *Edestus*, *Campyloprion*, and *Helicoprion*, not only is the coiling carried to a remarkable degree, but the teeth are angulated so that their bases either override or ensheath one another.

Respecting the disproportionate enlargement of the symphyseal as compared with adjacent antero-lateral series, this condition appears to have been peculiar to Palæozoic Cestracionts. We can almost certainly predicate its existence in *Orodus*, owing to the close similarity of its teeth to those of *Campodus*. And although the lateral dentition of *Protodus*, *Edestus*, *Campyloprion*, and *Helicoprion* has not yet been identified as such, nevertheless it follows from our interpretation of this class of remains that transverse rows of smaller teeth were present along the sides of each ramus of the jaws. An understanding of *Campodus* having once enlightened us as to the disparity between the symphyseal and lateral series of early Cestracionts, we are enabled to avoid the rather formidable conception of giant sharks in the Carboniferous, armed each with a mouthful of *Edestus*-like or completely coiled spirals, since there is no evidence to show that *Edestus*, *Campyloprion*, or *Helicoprion* possessed more than one series, and this is to be relegated to the median line in front. Absence of marks of wear in the symphyseal teeth of the three last-named genera, together with the difficulty of accommodating a paired series larger than that of *Campodus* in the upper jaw, favor the hypothesis that each individual possessed but a single arch, which was located presumably in the lower jaw. Although corresponding in position to the intermandibular arch of *Onychodus*, and to the pre-symphyseal bone of *Saurodon* and *Saurocephalus*, it is obvious that no homology exists, as has already been shown by Newberry and others in commenting on Miss Hitchcock's interpretation.<sup>1</sup>

That the office of the symphyseal dentition of *Campodus* was chiefly

<sup>1</sup> Ann. N. Y., Acad. Sci., Vol. IV. (1888), p. 118. Since the discovery of *Helicoprion* by Karpinsky and its reference by him to the snout region of an Elasmobranch, Jaekel has sought to revive Miss Hitchcock's original interpretation of *Edestus*, regarding these structures "als Stossorgane, die aus dem Unterkiefer vorgestreckt waren." Zeitschr. deutsch. geol. Ges., Vol. LI., 1899, p. 297.

masticatory is proved by the deeply worn facettes along the lateral surface of the crowns on either side. These marks of contact with an opposed paired series are most conspicuous on the first four or five teeth counting from the front, indicating that these remained functional for a considerable period, while those following were just beginning to come into play. From the fact that the front face of the smaller anterior tooth is deeply worn, it is clear that the series has been preserved intact in this direction ever since the creature was alive, and this polished front face cannot be accounted for except as caused by abrasion against hard foreign objects, such as sharks of bottom-feeding habits might encounter. It appears practically certain that the eleven teeth which are still preserved in the Nebraska specimen, and thirteen in the Kansan, *were altogether retained within the mouth cavities* of their respective owners, and did not protrude relatively further forward than do the anterior series of the modern Cestracion.

The considerations which uphold the views just stated are as follows: (1) In the Kansan specimen the supporting cartilage to which the individual teeth are attached, and which forms part of the symphysis itself, is continued so far as the anterior (distal) tooth, which at the same time is the most worn of the series; (2) in addition, the cartilage referred to is studded with numerous small "teeth," or more properly speaking, irregular enamel-covered bosses, tubercles, or patches of dentine.<sup>1</sup> These would not be present along the bases of the median series if the latter had projected freely beyond the mouth region; (3) if the worn anterior portion of the arch had become so far displaced by successional teeth as to have protruded from the mouth, those teeth which in their turn became functional would exhibit prominent indications of wear; whereas, in fact all behind the first four or five are but slightly abraded.

The worn facettes along the sides of the anterior, or as they may properly be termed, functional teeth, are not plane, but slightly concave; and each tooth is bevelled at a slightly independent angle from the rest. The enamel has of course been entirely worn through, so that the underlying dentine tubules are displayed in section. The enamelled prominences which have been referred to as flanking the lateral extremities of the median series have their oral surfaces likewise abraded. Although the enamel is not preserved on any of the coronal apices of

<sup>1</sup> Similar bodies are figured by St. John and Worthen in connection with the lateral series, and interpreted by them as "placoid scales." Pal. Ill., Vol. VI. (1875), p. 315.

the median series, it is considered remarkable that the apices themselves, which are sharp-edged and non-blunted, should be comparatively unworn. Biting as they did between the inner faces of the paired series of the opposite jaw, they would have become very obtuse had the creature's fare consisted of hard-shelled prey, such as mollusks or echinoderms. This leads to the inference that *Campodus* and its congeners were sharks which subsisted chiefly on vegetation which flourished in the Carboniferous lagoons, or else upon soft animal prey.

The coronal eminences of the median series in *Campodus* rise vertically above the rest of the tooth in the middle line, and are but slightly compressed from side to side. The anterior and posterior edges are prominent, and although faint wrinkles occasionally appear, the edges are not serrated, in which respect they differ from *Edestus* and more specialized forms. In two other directions is *Campodus* less specialized than the *Edestus*-type: the symphyseal teeth are, in their entirety, but little laterally compressed; and, secondly, although their crowns are inclined forward at a steep angle, they do not override one another, and their roots are not produced.

*Antero-lateral series.* — We come now to a consideration of perhaps the most important feature displayed by the Kansas example, and that is the natural association of the symphyseal with three of the antero-lateral series belonging to either side of the jaw. If, after all that has been said, any doubt remained whether the principal series were truly median and anterior in position, it would be dispelled by a mere inspection of the smaller associated series. It is evident at a glance that the latter are scarcely at all displaced with reference to the median series, except in so far as the cartilaginous rami of the lower jaw have been pressed together prior to fossilization, and hence partly close over the median series behind. The continuity of the calcified cartilage, which supports not only the median but also the antero-lateral series on either side, positively identifies this as the symphyseal region. Let the paired antero-lateral series with their supporting cartilage be imagined as opened out horizontally on either hand so as to include about the same angle between them as the jaws of *Cestracion*, and let these series be continued behind by 18 or more transverse rows of lateral teeth, we shall then have an adequate presentment of the lower dentition of *Campodus*.

The antero-lateral series on the right-hand side of the symphyseal are more perfectly preserved than those on the left, and are identical in all respects with the teeth occupying a corresponding position in the splendid

specimen of St. John and Worthen. Twelve teeth are now visible in the foremost row on the right-hand side of the Cambridge specimen; 13 are to be seen in the second row; and of the third row, which has been

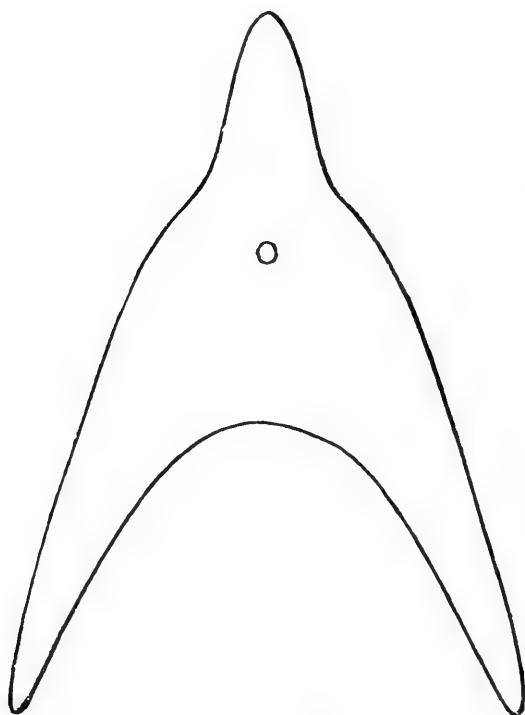


FIG. 2.

*Campodus variabilis* (N. & W.). Missourian; Osage County, Kansas. Generalized cross-section of a symphysial tooth.  $\times \frac{5}{6}$ .

fractured across, and hence appears only in section, only 6 remain. The largest tooth in the foremost of the anterolateral series has a length of 2.1 cm.; the largest in the second row, 3 cm. Other measurements that may be conveniently recorded here are as follows: A straight line drawn from the apex of the posterior to the anterior symphysial tooth in the Kansas specimen measures 20 cm.; and a line joining the terminal apices of the Nebraska specimen has a length of 16.5 cm. The maximum width of the symphysial series is 6 cm. in the former example, and 6.2 cm. in the latter. The conformation of the individual teeth being sufficiently evident from the fig-

ures and cross-sections, further description here is superfluous. The cross-section shown in text-figure 2 is taken through the fourth tooth from the front in the Kansan specimen, except that the vertical thickness in the median line is estimated from the most anterior tooth, which is the only one displaying this dimension. In the Nebraska specimen the vasodentine of the roots is largely decomposed.

### Campyloprion.

(Plate 4.)

This genus was established for the reception of certain forms occupying an intermediate position between *Edestus s. s.* and *Helicoprion*. The latter genus is known at present only by the type species, *H. bessonowi* Karpinsky, from the Permo-Carboniferous of Russia. *Edestus* in its

restricted sense comprises four species from the Coal Measures of America, *E. heinrichi*,<sup>1</sup> *E. minor*, *E. giganteus*, and *E. vorax*, — the last-named being the type; and a doubtful one from the European Carboniferous, — *E. carbonarius* (Germar). *E. minor* and *E. heinrichi* also occur in the Russian Carboniferous, the latter having been described by Trautschold both as a distinct genus and species. *Campyloprion* includes three species, two of which, *C. davisii*<sup>2</sup> and *C. lecontei*<sup>3</sup> were originally referred to *Edestus*, and the third, *C. annectans*,<sup>4</sup> is taken as the type. It need scarcely be remarked that all of the species here enumerated are known only by their symphysial dentition; many are founded on unique specimens, and the majority are in a more or less fragmentary state of preservation. Nevertheless these forms taken together constitute a remarkable series, in which the progress of evolution is readily traceable. They signalize themselves as a group of Cestracons, which early established the habit of retaining their worn symphysial teeth instead of shedding them. Later on, as these teeth became enlarged through specialization in various genera, the difficulty of accommodating them without their proving an encumbrance to the creature was overcome by the simple device of coiling, — the same mechanical contrivance which had already been carried to a remarkable perfection amongst Nautiloids, and was never afterwards abandoned amongst Ammonites except with disastrous or fatal results. In this parallelism between the coils of *Helicoprion* and involute Cephalopods we observe the culmination of efforts expended along a certain direction, the design being to accommodate a large number of segments in a minimum of space and at the same time to provide for a maximum rigidity.

It remains for us now to describe the type-specimen of *Campyloprion annectans*, shown of two-thirds the natural size in Plate 4. The original was first brought to the writer's attention by his friend Dr. J. S. Kingsley, of Tufts College, in whose custody it has been for many years. There is unfortunately no record of its history beyond the fact that it was originally obtained for the Tufts Museum by the late Professor J. P. Marshall; but as to either horizon or locality from which it was derived we are without information. No one can reasonably suppose, however, that the age of the fossil antedates the Coal Measures, or is younger than Permo-

<sup>1</sup> The commonly accepted orthography "*E. heinrichsi*," is incorrect. Other instances of misspelled specific titles are *Cladodus hertzeri* and *Dinichthys hertzeri* instead of *C.* and *D. herzeri* respectively.

<sup>2</sup> Woodward *H.*, Geol. Mag. (3), Vol. III. (1886), p. 1, Pl. i.

<sup>3</sup> Dean, *B.*, Trans. N. Y. Acad. Sci., Vol. XVI. (1897), p. 62, Pl. iv.

<sup>4</sup> Eastman, *C. R.*, Geol. Mag. (4), Vol. IX. (1902), p. 151.

Carboniferous. Its color is grayish yellow, not unlike that of *Campodus* and other fossils from the Missourian series of this country; but on the other hand the individual teeth undeniably approach *Helicoprion* in form, and hence are suggestive of a corresponding horizon.

Why, then, if the teeth are of similar form, should not the specimen be referred directly to *Helicoprion*? The answer is that such a course would be objectionable for several reasons. In the first place the complete symphysial dentition of the latter genus consists of approximately three and one-half whorls, the largest known example measuring 26 cm. in diameter, and comprising upwards of 150 teeth. There is no evidence to show that the present series of twenty or more teeth was ever coiled into a complete spiral, any more than was the case with *C. davisii*, for instance; and certainly no marks of contact with a preceding inner whorl are visible along the base. Secondly, the occurrence of irregular patches of enamel-covered dentine along the base of the series recalls conditions we have already become familiar with in *Campodus*, and suggests that the arch was supported directly by cartilage as in that genus, and not spirally inrolled. Furthermore, if we assume this to be only a fragment of a complete volution, and that the inner whorls have been broken away, we shall find on continuing the indicated curvature that the diameter of the complete spiral exceeds that of the largest known example of *Helicoprion*, while at the same time the individual teeth are proportionally smaller, which is contrary to what we should expect them to be. This statement can be readily verified by a comparison of the accompanying illustration with the figures given by Karpinsky, especially text-figure no. 47, opposite page 426 of his memoir. And finally, we note there are no lateral grooves extending along the series near the base, as in the Russian genus. There would thus appear to be ample justification for placing the present example, and also the type of *Edestus davisii*, which was included by Karpinsky with *Helicoprion*, in a separate genus as we have done.<sup>1</sup>

It is to be regretted that the fossil under discussion should have been

<sup>1</sup> It is evident that *C. lecontei* belongs in the neighborhood of *C. annectans* and *C. davisii*, rather than with *Edestus*, owing to its more strongly arched condition and greater number of segments. Although the form of the anterior teeth is obscured by faulty preservation, they apparently had the same general configuration as the rest, and the base is longitudinally channelled. For an opportunity to examine the type-specimen of the Nevada form, the writer is indebted to the kindness of his friend, Dr. J. C. Merriam, of California State University. The type of *Edestus minor* is preserved in the Cabinet of Amherst College, and that of *E. heinrichi* in the Illinois State University at Urbana.

injured considerably by weathering and other destructive agencies. In all, portions of about 20 fused teeth are preserved, but only four of this number still remain in their entirety or nearly so. These occur near the distal end, and have been utilized for the construction of the adjoining text-figures nos. 3 and 4, which may be instructively compared with Karpinsky's text-figures nos. 23-34, or with Dr. Henry Woodward's illustrations of *C. davisii*. The teeth are much laterally compressed, closely apposed, and their lower portions are curved forward in such manner as to override one another. The latter character is more pronounced than in *Campodus*, less so than in *Edestus* and other species of *Campyloprion*. That the angulation or curvature of the teeth is toward the front instead of posteriorly, is demonstrated from the arrangement known to obtain in *Campodus* and *Helicoprion*. A forward inflection is attributable to *Campyloprion davisii* and *C. lecontei*, where the smallest teeth of the series are unquestionably the oldest; and it is unlikely that the segments of *C. annectans* were reflected in the contrary direction.

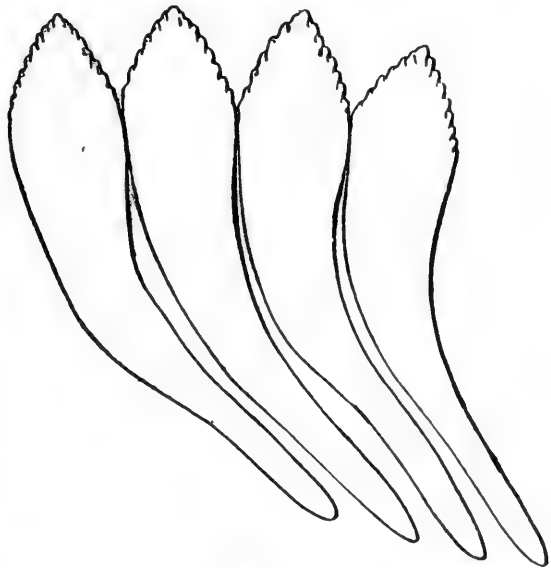


FIG. 3.

*Campyloprion annectans* Eastm. Lateral aspect of four of the anterior symphyseal teeth, their serrated apices partly restored.  $\times \frac{2}{3}$ .

The whole of the lateral surface of the crown appears to have been covered with enamel, but this has been removed in most places subsequent to fossilization. In like manner the curiously curved patches of dentine occurring along the sides of the principal series toward the base have been largely denuded of their enamelled coating. Some of the symphyseal teeth are worn, especially toward the proximal (posterior) end, but hardly to such an extent as to suggest attrition against mutually interlocking series of the opposite jaw. The coronal outlines are everywhere smooth and regular, except along the apical margin, which appears to have been coarsely serrated. This serration is best indicated on the opposite side of the series from that shown in the photograph, and is represented somewhat diagrammatically in text-figure 3. Making due

allowance for wear, it will still be observed that the coronal apices differ from those of *Helicoprion* in that they are more obtuse, more coarsely serrated, and the posterior margin is not more steeply inclined than the anterior (*cf.* Karpinsky's text-figure no. 66). A line passing through the apex of a given tooth and dividing the crown into halves will intersect the base of the second tooth behind. Such a line dropped from the apex of the seventh tooth from the distal end, which happens at the

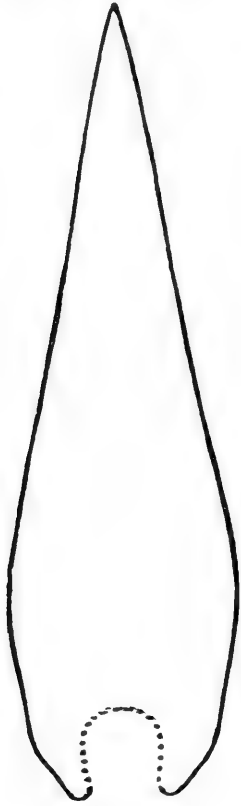


FIG. 4.

*Campyloprion annectans* Eastm.  
Transverse section.  $\times \frac{9}{10}$ .

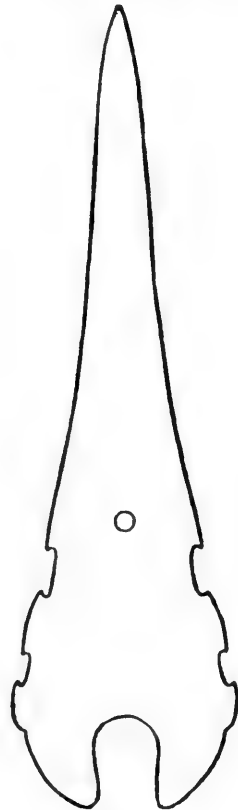


FIG. 5.

*Helicoprion besonowi* Karp.  
Transverse section.  $\times \frac{4}{3}$ .

same time to be the largest to the point of intersection, measures 8 cm. It is along this line that the cross-section given in text-figure 4 is taken, where the total height is 9.5 cm, and the maximum width 3 cm. The extreme length of the specimen, measured in a straight line from end to end, is 23 cm.

Reference has already been made to the series of protuberances flanking the lower extremities of the principal teeth. That these are of the same nature as dental structures is obvious, and the corresponding bodies



in *Campodus* may to all intents and purposes be considered as teeth, which probably formed a mosaic-like pavement. It would appear very doubtful, however, if these outgrowths of dentine in the present specimen ever functioned as teeth, although they may have served as a sort of cingulum; and their origin is probably attributable to an excessive supply of dentine-forming material, which was deposited adjacent to the larger series. That they are closely related to the principal teeth is evident from the fact that they partake of the same curvature toward the front as these. One of the distinguishing characters of Karpinsky's genus consists in the presence of a double groove extending along the lateral faces of the crown near the base. Nothing of this nature appears in the present example, nor in either of the other species of *Campyloprion*.

The last point we have to consider is the base, by which is meant the mass of vasodentine that served as a common support for the series. Just as the teeth are fused into a continuous series, and their extremities pass by insensible gradations into a common base, so the latter may be said to correspond, in part, at least, to fused roots. We say "fused," for the reason that no traces of segmentation are visible: a condition which is also true of *Helicoprion*, but not of *Edestus*, although in the latter genus the basal segments are sometimes obscure. As in the other species of *Campyloprion*, and also in the completely coiled genus, the base is channelled below by a longitudinal canal of considerable size. The dimensions and form of cross-section of this channel appear to have been about the same as in *C. davisii* and *Helicoprion bessonowi*, although comparisons are difficult, owing to mechanical compression and partial removal of the lateral walls. Longitudinal striæ extending along the base, and also a generally perforated appearance, such as are here in evidence, are characters not uncommonly presented by the roots of sharks' teeth, and are correlated with the attachment of the series in the supporting symphyseal cartilage. The enormously developed basal segments (roots) of *Edestus* exhibit a more vascular structure than the compact vasodentine base of *Campyloprion*.

#### Comparison of Genera possessing an *Edestus*-like form of Dentition.

The principal characters of the four genera of Cestraciant sharks whose dentition has been described in the preceding pages, may be summarized as follows:

*Campodus*. — Symphysial dentition consisting of a median azygous arched series of fused teeth in one jaw, presumably the lower, opposed to which in (presumably) the upper is a paired series of similar teeth slightly separated from each other and interlocking with the first. These series consist of at least thirteen greatly enlarged teeth which are but little laterally compressed, whose coronal buttresses are directed anteriorly (ectad), and whose crowns are inclined in the same direction, but without being bent so as to override one another. Coronal apices very stout and prominent, rather obtuse, their anterior and posterior margins sharp and smooth, or but faintly wrinkled. Lateral dentition consisting of about 18 transverse series of Orodus-like teeth, arranged after the same general pattern as in Cestracion. Spines and scales unknown. Carboniferous. Type, *C. agassizianus* de Koninck.

*Edestus*. — Symphysial dentition consisting of a moderately arched series of fused teeth, which are fewer in number (5–8) than in the preceding genus, and more laterally compressed. The segments are bent forward in such manner that the base of each tooth ensheathes those lying next in front. Coronal apices prominent, usually acuminate, and with coarsely serrated anterior and posterior margins, the latter more steeply inclined than the former. Remainder of crown (portion corresponding to the lateral extensions of *Campodus*) greatly reduced. Lateral series and other parts of the skeleton unknown. Coal Measures. Type, *E. vorax* Leidy.

*Campyloprion*. — Symphysial dentition consisting of a strongly arched series of fused teeth, which are relatively more numerous (14–20 or more) than in the preceding genera, higher-crowned, and more laterally compressed. Teeth reflected forward so as to override one another toward their extremities, and fused for the greater portion of their length. Coronal apices acuminate, serrated, and more closely apposed to one another than in preceding genera. Series traversed by a median longitudinal canal along the base, but without lateral grooves. Lateral dentition and other parts of the skeleton unknown. Carboniferous. Type, *C. annectans* Eastman.

*Helicoprion*. — Symphysial series consisting of upwards of 150 fused teeth, very similar to the last in form, but coiled approximately into  $3\frac{1}{2}$  whorls. The teeth are much laterally compressed, bent forward so as to override one another toward the base, and traversed by a double lateral groove as well as by a median longitudinal channel along the base. Coronal apices acuminate, finely serrated along their anterior and posterior margins, and closely apposed to one another. Lateral dentition and other parts of the skeleton unknown. Permo-Carboniferous. Type and only known species, *H. bessonowi* Karpinsky.

The ancient family of Cestraciontidæ, to which these genera belong, shares with the *Ceratodus*-class of Dipnoans the distinction of having enjoyed a continuous range from the Devonian to the present day, certainly a most remarkable longevity. If we are right in regarding *Protodus scoticus* (Newton) as founded on the symphysial dentition of

forms related to *Campodus*, this family makes its first appearance in the Lower Devonian of Canada and Great Britain. That it had attained considerable specialization at least as early as the Mesodevonian, is proved by the occurrence of formidable fin-spines, such as *Otenacanthus wrighti*, in the Hamilton; and forms like *Helodus gibberulus* in the Chemung indicate that the divergence of the Cochlodont branch took place at a period considerably antedating the Carboniferous. As the group of Cladodont sharks, which is remarkable for its manifold varieties of piercing teeth, frequented the clear water of open seas and was undoubtedly of carnivorous habits, so, on the other hand, the groups armed with crushing teeth, such as are typified by Psammodont, Cochlodont, and Cestraciont sharks, early became adapted to bottom-living conditions, their fare probably consisting of hard-shelled prey such as mollusks, arthropods, and echinoderms. In all likelihood it is to the generalized Cestraciont type that we must look for the derivation of rays, which after all are not morphologically very different from sharks. A much depressed form of body is indicated by the arrangement of teeth in such forms as *Psammodus*, *Copodus*, and *Archæobatis* from the Carboniferous, and *Janassa* from the Permian.<sup>1</sup> The Devonian *Tamiobatis* is held to represent an intermediate type between sharks and rays; hence there is considerable reason to suppose that the modern ray-type was foreshadowed at even so remote a period as the Devonian.

*Form and Orientation of Segments.* — Interesting inquiries might be made respecting the mode of growth of the series in these four related genera, and into the processes of segmentation and fusion of the individual teeth; but we can only briefly touch upon these topics in the present paper. That various speculations have been entertained as to how the successional teeth were developed in *Edestus*, and that confusion still exists in the case of some species, regarding which are the oldest and which the newest formed segments, cannot be gainsaid. Dean's theory of a metameral origin for these bodies, and all others which fail to recognize their odontological nature, are of course to be dismissed in the light of our present information. Without a knowledge of the arrangement of the symphysial teeth in *Campodus* and *Helicoprion*, the orientation of incomplete series would still be conjectural in many cases, such as in the species of *Campyloprion* just described, and the types of *Edestus vorax*, *E. minor*, *E. giganteus*, etc. This difficulty has been

<sup>1</sup> On the form of body in *Janassa* and other Petalodonts, cf. *Jaekel, O.*, Ueber die Organisation der Petalodonten. *Zeitschr. deutsch. geol. Ges.*, Vol. LI, 1899, pp. 258-298, Pl. xiv., xv.

appreciated by most writers on *Edestus*, and is thus ably summarized by Karpinsky :<sup>1</sup>

“ Als Endzähne, Scheitelzähne oder älteste Zähne (oder Segmente) fasst man bei den Edestiden mit Recht die von relative geringster Grösse auf. So ist es nicht schwer, bei den vorliegenden Resten von *Ed. lecontei* und *H. davisii* das Gipfelende und das Basalende zu unterscheiden. Allein an den erhaltenen Exemplaren zusammengewachsener Segmente von *Edestus minor*, *E. heinrichi*, und *E. giganteus* bleibt sich die Grösse der Zähne beinahe gleich und als das Scheitelende (das älteste) dieser ‘Ichthyodorulithen’ betrachtet man meist das rechte in Figure 3 [=type of *E. minor*] und das linke in Figure 5 [=type of *E. heinrichi*]. Mit andern Worten, man nimmt an, die Basis (Wurzel) eines jeden Zahnes richte sich von diesen nach der Seite der grössern Zähne (Segmente) hin. Die Vergleichung mit den Spiralsegmenten von *Helicoprion* dagegen führt uns zu dem entgegengesetzten Schlusse, dass die meisselförmige Basis der Zähne nach der Seite des Scheitelendes des Organs gekehrt sei.”

The above interpretation of the three species of *Edestus* just enumerated is open to criticism on the ground that it assumes the segments are reflected in the reverse direction from that known to obtain in *Campodus*, *Campyloprion*, and *Helicoprion*, all of which have their teeth bent forward toward the base. About this there can be no question. A consideration of Dr. Newberry's views on the same subject of orientation and mode of growth in *Edestus* may not be out of place in this connection, and we quote from his latest published opinion as follows :<sup>2</sup>

“ *Edestus davisii* is more like the intermandibular crest of *Onychodus* than are the other species of the genus. It is much more curved, and the arch of bone from which the denticles arise is laterally compressed or longitudinally grooved. Taken by itself, it renders the suggestion of Miss Hitchcock quite plausible. But it cannot be taken by itself; for wherever that species goes, *E. minor*, *E. heinrichi* and *E. giganteus* must follow; and while we can imagine a fish ten feet long with an arch of bone like *E. davisii* held between the extremities of the mandibles, it requires a much greater stretch of the imagination to conceive of a shark of such size that this relatively insignificant organ was twenty inches long and seven or eight inches wide [*i.e.*, deep]. Certainly such a monster would seem very much out of place in the lagoons of the coal marshes. Again, *E. heinrichi* is nearly straight, a foot long, rounded and massive at one end, thin and acute at the other; but the succession of denticles was by additions to the acute end, which must have been behind, for if it was situated in the symphysis, the blunt, rounded end would have formed the apex of the arch of the lower jaw; a condition of things scarcely comprehensible. If, now, we transfer this spine to the position of the post-

<sup>1</sup> *Loc. cit.*, p. 449.

<sup>2</sup> *Monogr. U. S. Geol. Surv.*, Vol. XVI. (1889), p. 222.

dorsal fin, and bury it in the soft parts, all except the denticles, the elongation backward by the successive addition of sheaths and denticles becomes intelligible and natural."

Correct in his determination of the anterior and posterior extremities in *E. heinrichi* as such, Newberry yet deemed it "scarcely comprehensible" that any form of symphyseal teeth should have their roots so enormously produced and enlarged in front; and accordingly he rejected this for the spine hypothesis of Leidy and Owen. The latter theory, however, involved certain difficulties of its own, which the same author thus comments upon:<sup>1</sup>

"It is also apparent that the growth of this organ was by additions to the summits of successive sheaths, each of which carried a denticle. This is strikingly different from the mode of growth of all sharks' spines known, as these increase by additions to the base, and are thus pushed upwards and lengthened. The same is true of all rostra which are used as weapons of defence or offence. If we consider the segments of *Edestus* as the homologues of a dental series we encounter the same difficulty. . . . We are therefore compelled to conclude that the spine was buried in the integuments throughout its entire length, the enamelled denticles alone projecting above the surface to form a saw, which would be a terrible weapon if placed upon some flexible portion of the body where it could be used with freedom and power. The extremity of the spine may have lain in a sheath, from which it could be partially erected by muscular action and used as the lancet of the surgeon fish (*Acanthurus*) is."

It is rather curious that so close an observer as Newberry, and following him Miss Hitchcock, should have entertained the idea that some of the segments of *Edestus* were freely movable upon one another, and possibly erectile. To notice Miss Hitchcock's theory<sup>2</sup> briefly, in passing, it must be said that in so far as she conceived *Edestus* to be homologous with the intermandibular arch of *Onychodus*, — a Crossopterygian ganoid, — her interpretation was at fault; but at the same time her reference of the series to the median line, in front of the lower jaw, was a close approximation to the truth, as has been finally revealed through a study of *Campodus*. And certainly without a knowledge of the latter, comparisons of *Edestus* with the symphyseal series of *Cestracion*, *Carcharias* and other recent sharks, would have appeared fantastic in the extreme.

The way is now prepared for a more intimate comparison of the seg-

<sup>1</sup> *Loc. cit.* (1889), p. 223.

<sup>2</sup> *Proc. Amer. Assoc. Adv. Sci.*, 1887 (1888), p. 260. *Amer. Nat.*, Vol. XX. (1887), p. 847.

ments in these four closely related genera, more especially between *Campodus* and *Edestus*. Starting with *Campodus* as the least specialized member of the series, we find that the symphyssial teeth are but little differentiated from those of the lateral series, except that they are greatly enlarged. They are only moderately compressed from side to side, the lateral extensions of their crowns are directed simply forward without appreciable curvature toward the base, and their fused roots are supported by the symphyssial cartilage of the jaws without being anteriorly elongated. The coronal apices are very stout, rather obtuse, and with sharp, non-crenulated cutting edges, although faint wrinkles sometimes appear in the youngest-formed teeth. The longitudinal ridge extending over the coronal surface, so prominent in the lateral series, is obsolescent in the symphyssial teeth. A continuous nutritive canal appears to have perforated the series in the median line immediately below the base of the apical portion, or in about the same relative position as shown by Karpinsky in *Helicoprion* (*cf.* this author's fig. 39). And, finally, the curvature of the series is not greater than in the corresponding arch of *Cestracion* or other existing sharks having the symphyssial cartilage well developed (*Lamnidae*, *Carchariidae*), nor is there any difference in the number of segments.

In the evolution of *Edestus* and the more strongly coiled genera, the symphyssial teeth have become considerably differentiated in form from the lateral series, their chief modifications consisting in a greater compression of the crown from side to side (*cf.* text-figure 6) with serration of the apical margins, a pronounced forward curvature toward the base, and in *Edestus*, an extreme elongation of the latter into a succession of gouge-like troughs or sheaths. With increasing compression of the segments, their basal portions become more closely crowded together, and more intimately fused at their extremities into a common mass of vasodentine, in consequence whereof spiral enrollment of the series follows almost as a matter of necessity, since the individual segments can no longer be shed with age. In *Helicoprion* the lateral compression, fusion, multiplication, and spiral enrollment of symphyssial teeth is carried to an extreme degree, and the progressive stages which lead up to this condition are indicated by the three species of *Campyloprion* in the order named, — *C. lecontei*, *C. davisii*, and *C. annectans*.

Progressive modification takes place in two directions amongst these genera, starting with *Campodus*. In the three species of *Campyloprion* just enumerated, and one of *Helicoprion*, the tendency is toward enlargement of the apical at the expense of the basal portion of the teeth,

with increase in the number of segments. A divergent series, however, is represented by the species of *Edestus*, in which the relatively few segments are not very intimately fused, while their coronal portions become reduced *pari passu* with the enormous development of the base. In fact, about all the remains of the crown in *Edestus* is the

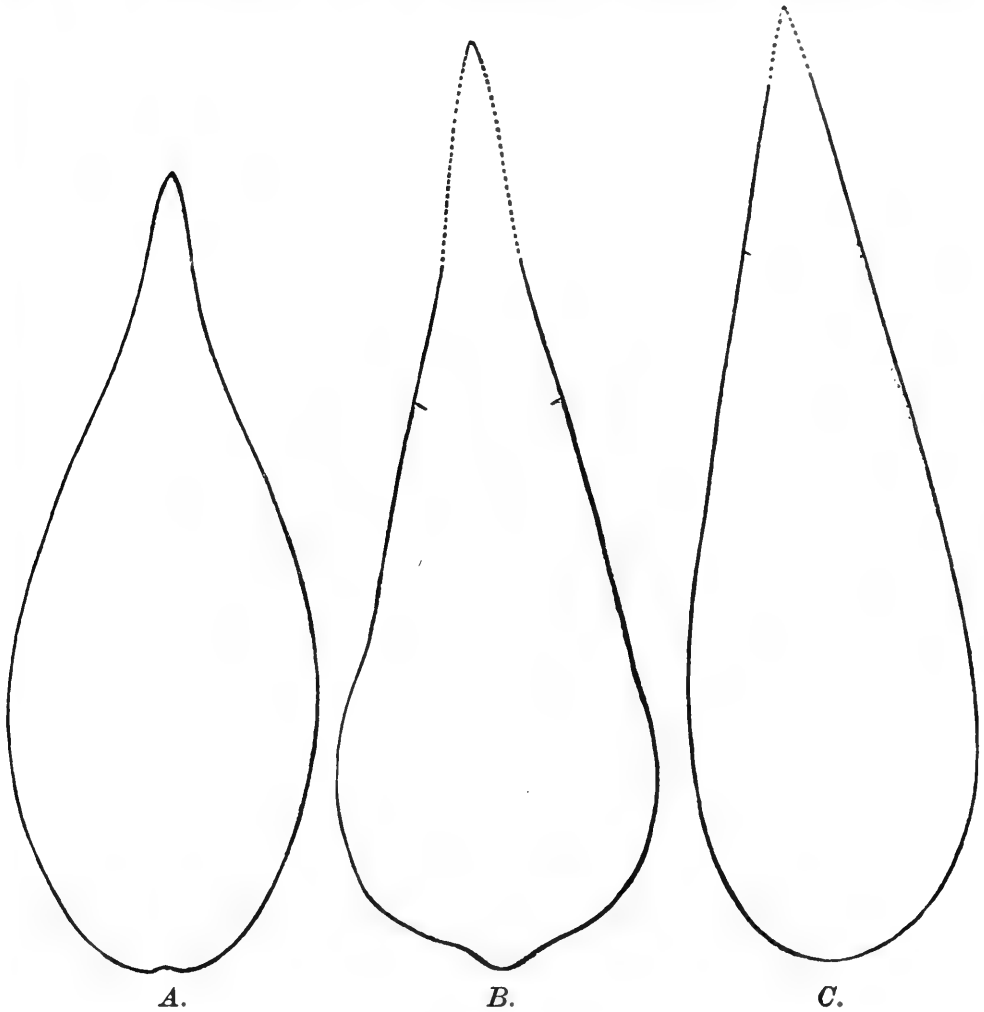


FIG. 6.

Cross-sections of symphysial teeth of *Edestus*. A, Type of *E. heinrichi* N. & W.  $\times \frac{1}{4}$ . B, Type of *E. vorax* Leidy (after Leidy).  $\times \frac{3}{4}$ . C, Type of *E. giganteus* Newb., taken vertically through the penultimate tooth of the series.  $\times \frac{1}{2}$ .

apical portion, the two processes corresponding to the buttressed lateral faces of *Campodus* appearing as slender prolongations (*cf.* text-fig. 7). The relative compression amongst these various forms is apparent from their cross-sections, of which figures are given herewith. It will be

noticed that in one species, *E. giganteus*, the cross-section is slightly asymmetrical. Whether this is due to accidental deformation, or is indicative of a paired series referable to the upper jaw, there are at present no means of determining. *Campodus* is the only genus in which the teeth exhibit marks of contact with opposing series.

Information regarding the mode of growth in *Edestus* is afforded by the detached segments of *E. heinrichi* and *E. minor*<sup>1</sup> which are known. Successional teeth are formed in the same way as in *Campyloprion* and *Helicoprion*, the only difference being that the bases of the newer formed segments ensheath the older to a much greater extent. The first-formed or "terminal segment" of *E. heinrichi* is not a "solid bone," as stated by Newberry,<sup>1</sup> but possesses a gouge-like base the same as the

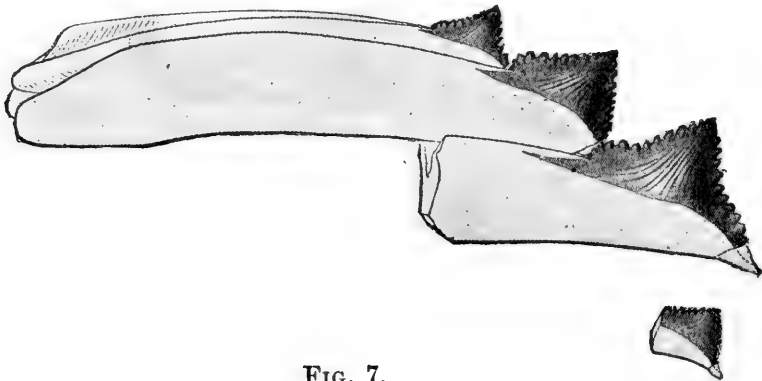


FIG. 7.

*Edestus heinrichi* N. & W. Coal Measures; Carlinville, Illinois. Series of segments belonging to a single individual.  $\times \frac{1}{2}$ .

rest. In the specimen figured by him as a supposed terminal segment, only the "denticle" [crown] is preserved, and the carbonaceous matrix which originally filled the interior of the sheath might readily be mistaken at first sight for "bone" or vasodentine. In text-figure 7 are shown several segments belonging to a single individual of *E. heinrichi*, in which the mode of succession is clearly discernible. The original, which forms part of the A. H. Worthen Collection in the Museum of Comparative Zoölogy, is from the Coal Measures ("roof of no. 5 coal") at Carlinville, Illinois. The segments fit snugly into one another in their natural position, but are shown slightly separated in the drawing. Associated with this specimen either naturally or accidentally was a fragmentary fin-spine of *Ctenacanthus* having a very coarse ornamenta-

<sup>1</sup> Ann. N. Y. Acad. Sci., Vol. IV., 1888, p. 120, Plate V., Figure 2a — Monogr. U. S. Geol. Surv., Vol. XVI. (1889), p. 223, Plate XXXIX., Figure 2a.



tion, and whose total length was probably about 15 cm. It is to be hoped that eventually a correlation may be established between *Edestus* and some of the huge dermal defences, such as *Oracanthus*, for instance, which accompany it in the Carboniferous.

## II. ON SPINES OF CTENACANTHUS FROM THE MISSISSIPPIAN SERIES.

It is customary to recognize *Ctenacanthus* as a distinct genus, for although the spines are indistinguishable from those of *Hybodus*, they are not associated with *Hybodus*-like teeth in the Devonian and Carboniferous, none such having been found in rocks older than the Mesozoic. Newberry has brought forward some evidence to show that *Orodus* possessed spines of this nature, and this association is entirely consonant with the fact that *Orodus* and *Campodus* are Palæozoic forerunners of *Hybodus*. In view, however, of the almost universal occurrence of the spines of *Ctenacanthus* in a detached condition, it is proper to retain this as a provisional genus of *Cestraciontidæ* until such time as its relations have been definitely established.

Of primary importance in the distinction of species is the general conformation of the spine, especially its curvature, form of cross-section and length of inserted portion. Next in order are to be considered the number, shape, and direction of the longitudinal costæ, with the ornamentation of the same; and still further distinctive characters are to be found in the nature of the posterior face and anterior margin, or "cut-water." Sometimes weight has been placed on the above characters in reverse order from that indicated, and this has led to the establishment of doubtful species, or even genera of *Ctenacanthus*-like spines, such as *Anaclitacanthus semicostatus*, *Eunemacanthus costatus*, the types of *Acondylacanthus xiphias*, *Ctenacanthus limaformis*, etc.

Species of *Ctenacanthus* are especially numerous in the Kinderhook limestone of Iowa in the vicinity of Burlington, and elsewhere along the Mississippi River; and these may be divided into two general groups. The series formed by *C. varians*, *C. spectabilis*, *C. deflexus*, *C. solidus*, *C. clarki*, and *C. brevis* is characterized by abbreviate, stumpy proportions, by a similar pattern of ornamentation, and by having been inserted very obliquely in the integument. Spines of this nature are to be regarded as having pertained to the second (posterior) dorsal fin. They contrast strongly with the group of slender, elongated and tapering

spines constituted by *C. formosus*, *C. sculptus*, *C. depressus*, *C. venustus*, *C. vetustus*, *C. denticulatus* and numerous others, which unquestionably belonged to the first dorsal fin.<sup>1</sup> Bearing this generalization in mind, we may pass on to a discussion of some new or little known species of this "genus," chiefly from the Kinderhook division of the Subcarboniferous. For the opportunity to describe the types belonging to the United States National Museum at Washington, the writer is greatly indebted to Mr. Frederic A. Lucas, Curator in charge of the Department of Comparative Anatomy.

SPECIES FOUNDED ON SPINES BELONGING TO THE ANTERIOR  
DORSAL FIN.

*Ctenacanthus longinodosus*, sp. nov.

Plate 5, Fig. 2.

As type of this species is selected a unique specimen belonging to the United States National Museum (Cat. No. 3393), and derived from the Kinderhook Limestone of the Mississippi Valley, probably from near Burlington, Iowa. It was formerly in the private collection of Mr. L. A. Cox, of Keokuk, Iowa. The spine is unfortunately not preserved in its entirety, the distal third or fourth and nearly all of the inserted portion having been broken away. It has also been subjected to some deformation, especially in the distal portion, prior to or during fossilization, and the walls of the pulp cavity have been forced inward by pressure.

Notwithstanding these imperfections, the spine is of much interest, and its unique style of ornamentation serves to distinguish it at once from all other species. About sixteen broad, flattened and highly polished costæ have their origin along the base of insertion, and are continuous throughout the length of the spine. They are parallel and non-bifurcating, and only a few small and incomplete adventitious ridges are intercalated between them, or engrafted upon their sides. The principal costæ are not all of uniform width or thickness, nor are they separated by regular intervals, some being narrower and more closely spaced than others. The intercostal spaces are plane and covered with fine longitudinal rugæ of precisely the same appearance as those of the inserted portion. The costæ are remarkable for their development at

<sup>1</sup> Science, n. s., Vol. XIV. (1901), p. 795.

fairly regular intervals of sculptured eminences or nodes (text-Fig. 8 *A*), a very unusual character in this genus, and in allusion to which the specific title is bestowed. As regards ornamentation, a certain resemblance will be observed to *Oracanthus* and the spines described by St. John and Worthen as *Glymmatacanthus rudis*, and *Batacanthus baculiformis*.

The longitudinal costæ of *Ctenacanthus* are commonly described as being "interrupted" by transverse ridges or swellings, implying that the latter are of subordinate importance, and that the truly essential structures are the longitudinal ridges. A study of the mode in which the ornamentation originates in the present specimen is sufficient to

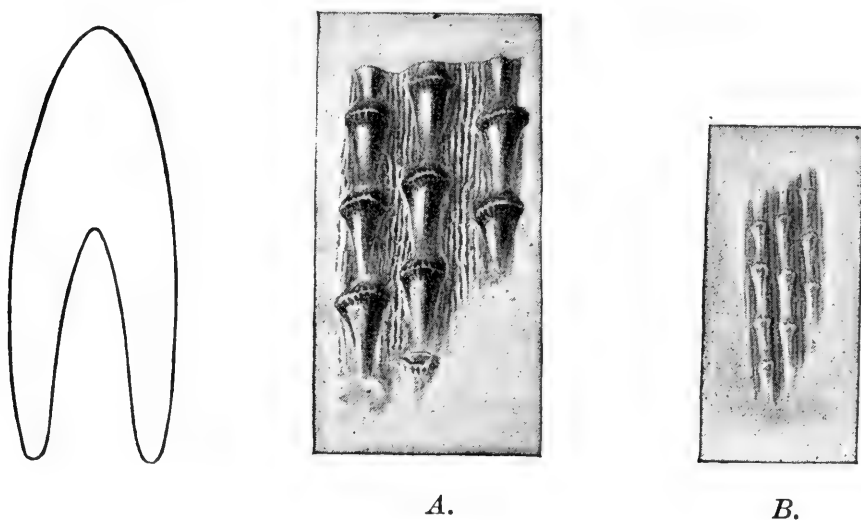


FIG. 8.

*Ctenacanthus longinodosus* sp. nov. Cross-section of spine.  $\times \frac{1}{4}$ . *A*, Portion of surface ornamentation of type-specimen.  $\times \frac{1}{4}$ . *B*, Same of a young individual, from near Burlington, Iowa.  $\times \frac{1}{4}$ .

convince one that this is not the correct interpretation. For, on directing our attention to the youngest part of the spine, that is to say, to the area along the line of insertion and along the border of the open pulp cavity, we find that growth of the costæ proceeds in the following manner: Small, irregular tubercles of vasodentine are deposited at intervals along the line of insertion, and although their summits are smooth at first, they soon become angulated and striated. As the spine protrudes more and more from the integument, these tubercles become widened somewhat, and at the same time their bases are elongated in a longitudinal direction. Should two of the newly formed tubercles become sufficiently approximated, either their summits or bases coalesce.

And sometimes, when a tubercle arises in an intercostal space and does not fuse with its neighbors on either side, its base may become elongated, other tubercles succeed behind it, and thus a new longitudinal ridge is formed. Owing to the increase in width of the spine toward the base, it rarely happens that after a ridge is once formed it is crowded out.

The slight concavity of the anterior margin, as seen in the type, might lead one to suppose that the spine was actually curved forward, but this appearance is in all probability due to distortion. The spine is preserved for a length of 16 cm., and has a maximum width of 4.5 cm. Its thickness at the base where the cross-section shown in text-figure No. 8 is taken, was probably about 1.8 cm.,—making due allowance for the effects of crushing; and the pulp cavity remains open for a distance of 12.5 cm. The two parallel costæ extending along the anterior margin—it is not sharp enough to be called an edge—differ in no respect from the rest.

To this species is also referred a smaller and more fragmentary specimen belonging to the Wachsmuth Collection in the Museum of Comparative Zoölogy, obtained thirty years ago from the Kinderhook beds of Burlington, Iowa. That it is a young example, and not the distal end of a fully grown spine, is apparent from several reasons, such as the position of the pulp cavity as seen in cross-section, the straight course of the longitudinal costæ, and general delicacy of the specimen. As many as twelve parallel costæ occupy a space only 7 mm. wide. The nodes are separated by about the same intervals relative to the size of the costæ, as in the adult spine just described; their striation, however, is much obscured by weathering or wear. An enlarged view of its ornamentation is shown in text-figure 8 *B*.

*Formation and Locality.*—Kinderhook Limestone; Iowa.

### *Ctenacanthus lucasi*, sp. nov.

#### Plate 6, Fig. 1.

The spine which is shown of slightly less than the natural size in Plate 6, Fig. 1, unfortunately lacks the greater part of the exerted portion, but so far as can be judged from the curvature, form of cross-section, and oblique line of insertion, it was of the same general form as *C. depressus* and *C. venustus* from the same horizon. Hence its position may be interpreted as having been in advance of the first

dorsal fin. From other described species it is readily distinguished by its peculiar ornamentation.

The lateral face is ornamented with twenty regularly spaced longitudinal costæ, which continue perfectly straight without bifurcation, and are surmounted by conical or rounded tubercles separated by intervals equal to their own diameters. Some of the tubercles belonging to the anterior costæ show a tendency to become obliquely elongated, as in *C. solidus* and *C. decussatus*, and those of the posterior costæ are often delicately striated. None of the costæ exhibit a tendency toward posterior deflection, such as commonly occurs amongst other species; and the peculiar beaded appearance of the tubercles is quite remarkable for this genus. The passage of tubercles into transverse ridges, such as we have observed in the newly formed costæ of *C. longinodosus*, or in the latest formed portions of older costæ, is not evident in the present species, where the primitive tuberculated style of ornament seems to have been permanently retained. No costæ appear along the rounded anterior margin, which has been worn quite smooth prior to fossilization. The spine is preserved for a length of 12.5 cm., and the inserted portion has a maximum width of 3.4 cm. The cross-section shown in text-figure 9 is taken across the line of fracture where the rest of the spine has been broken away; the width here is 3 cm. and the thickness 1.4 cm.

The specific title is bestowed in honor of Mr. Frederic A. Lucas, of Washington, to whom the writer is indebted for many courtesies, and for the loan of much valuable material. The original is preserved in the United States National Museum (Cat. No. 4844), and was collected by Mr. L. A. Cox from the Kinderhook Limestone, presumably in Iowa.

*Formation and Locality.* — Kinderhook Limestone; Iowa (?)

### *Ctenacanthus venustus*, sp. nov.

#### Plate 3, Fig. 2.

Two examples are known of this species, the larger of which belongs to the Worthen Collection in the Museum of Comparative Zoölogy, and is selected as the type. The smaller spine, shown in Plate 3, Figure 2, belongs to the United States National Museum (Cat. No. 3385), and was formerly the property of Mr. L. A. Cox, of Keokuk, Iowa. Both



FIG. 9.

*Ctenacanthus lucasi*, sp. nov. Cross-section of spine.  $\times \frac{1}{2}$ .

specimens are from the Kinderhook group, and presumably from Iowa, although their exact locality is uncertain.

The general form and proportions of these spines agree with Newberry's description of the type of *C. depressus*,<sup>1</sup> which is likewise from the Kinderhook, and is now preserved in the Walker Museum of Chicago University. As the latter specimen is more or less abraded, it might be supposed that we have to do here with more perfect examples of the same species. It is certainly true that they all possess one character in common: and that is the extreme obliquity of the line of insertion, which extends for fully two-thirds the length of the spine. But unless both the description and drawing of Newberry are at fault, the differences immediately to be pointed out are sufficient to warrant the recognition of a distinct species.

According to Newberry, the lateral faces of *C. depressus* are "marked with about thirty longitudinal ridges," the tuberculation of which is "inconspicuous;" and it is further stated that "along the anterior border the ridges are set with closely approximated, simple and plain tubercles; on the sides the longitudinal ridges are nearly or quite smooth." But the two specimens here placed in a distinct species have much finer and more numerous longitudinal costæ than are represented as occurring in *C. depressus*, and these can by no means be described as "inconspicuously tuberculose." On the contrary, they are very prominently decussated, the transverse ridges being sharp and fine, and so closely crowded that as many as from seventeen to twenty are to be counted within the length of one centimeter. These decussations, when completely formed, extend entirely across the costæ in a transverse or oblique direction, but their growth is frequently arrested, so that they appear as denticulations spaced at intervals of their own length along either side of the costæ. The ten filiform costæ lying next to the posterior margin are so closely apposed as to be almost contiguous, and these are surmounted by small conical tubercles, none of which are striated, however. Nor are any of the other transverse ridges striated.

The remarkably oblique line of insertion is fully 10 cm. long in the type, and the pulp cavity remains open for the whole of this distance, or for more than half of the total length of the spine. The section shown in text-figure no. 10 *A* is taken at the point where the line of insertion meets the posterior margin. The latter is beset from this point onward to the apex with very small and closely spaced conical protuber-

<sup>1</sup> Newberry, *J. S.*, Trans. New York Acad. Sci., Vol. XVI. (1897), p. 291.

ances, which are larger than the adjacent tubercles, but not sufficiently developed to be styled denticles. A prominent median ridge extends along the posterior face from the opening of the pulp cavity to the apex. The cross-section shown in text-figure 10 is taken at a distance of 8 cm. from the tip of the inserted portion, that in 10 *A* at a distance of 15 cm., and that in No. 10 *B* at a distance of 22 cm.

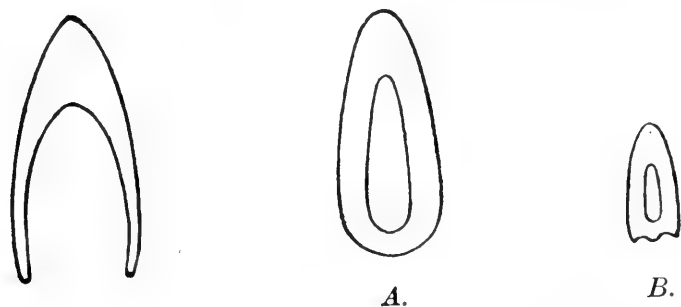


FIG. 10.

*Ctenacanthus venustus*, sp. nov. Cross-sections near the base, middle (*A*), and distal portion (*B*), of the type-specimen.  $\times \frac{1}{2}$ .

About 55 longitudinal costæ are to be counted along the line of insertion in the larger specimen, which has a total length of 34 cm. and about 40 in the original of Plate 3, Figure 2, which is preserved for a length of a little over 14 cm. The type of *C. depressus* Newberry, which is intermediate between these two examples in size, has only 30 continuous longitudinal costæ, and is apparently less laterally compressed. As representatives of the group of slender, elongated spines, which are supposed to be correlated with the anterior dorsal fin, the species known as *C. depressus*, *C. venustus*, and *C. lucasi* stand in the same mutual relationships as do the stumpy and abbreviated spines from the same horizon, such as *C. spectabilis*, *C. varians*, *C. deflexus*, *C. solidus*, etc., those of either group being distinguished from one another chiefly by ornamental details.

*Formation and Locality.* — Kinderhook Limestone; Iowa (?).

#### *Ctenacanthus*, sp. indet.

A very large spine, evidently of this genus, was obtained by Mr. L. A. Cox from the Keokuk limestone in the vicinity of Keokuk, Iowa, and is now preserved in the United States National Museum (Cat. No. 3480). It is much abraded, and only the exerted portion remains.

This has much the same form as *C. acutus* from the same horizon, being very straight and gradually tapering, only it is about thrice the size of the latter. It exhibits a length of 28 cm., a maximum width of 3.5 cm. on the lateral faces, and a thickness of over 3 cm. It is too imperfect, however, for closer identification. The type of *C. acutus* is preserved in the United States National Museum.

*Formation and Locality.* — Keokuk Limestone; Keokuk, Iowa.

*Ctenacanthus decussatus*, sp. nov.

Plate 6, Fig. 2.

The specimen shown of the natural size in Plate 6, Figure 2, bears the United States National Museum catalogue number 4846, and was obtained from the Kinderhook limestone at an uncertain locality, but presumably from either Iowa or Illinois. It is preserved for a length of 12 cm., shows the whole of the inserted portion, and sufficient of the

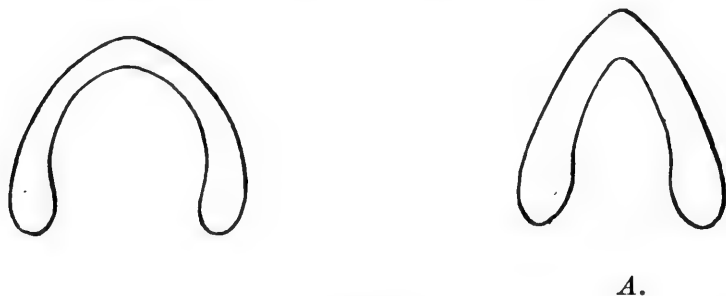


FIG. 11.

*Ctenacanthus decussatus*, sp. nov. Cross-sections of spine near point of insertion and middle portion (A).  $\times \frac{1}{2}$ .

exserted to afford a fair idea of its form and surface ornamentation. The spine is remarkably robust, being almost as thick as it is wide; and in this respect it contrasts strongly with other species from the same horizon, the majority of which are much laterally compressed.

In cross-section (*cf.* text-figure 11) the spine resembles *C. buttersi* from the Lower Coal Measures, and *C. pellensis* from the St. Louis limestone, but the ornamentation is different from both. The general outline was probably of the same elongated nature as *C. denticulatus*, *C. depressus*, and *C. venustus*, the last two being likewise from the Kinderhook group. The sides are ornamented with prominent decussated longitudinal costæ, about 24 of which are to be counted along



the line of insertion, and but 17 along the line of fracture where the section shown in text-figure No. 11 *A* is taken. The costæ increase in number by bifurcation, and diminish gradually in width on approaching the posterior margin. *Pari passu* with the diminution in width of the costæ, the transverse ridges which cross them become less and less elongated, until in the latest formed costæ they are almost tubercular. None of the transverse crests are striated, and they are spaced at approximately regular intervals apart. Occasionally the decussations belonging to several consecutive costæ extend across the intercostal spaces and become fused.

The anterior margin is rounded and bears a somewhat wider longitudinal ridge than the rest, from which only one or two bifurcations are given off. The posterior walls of the pulp cavity appear to be slightly swollen, and the cavity itself is slightly open throughout the entire length of the part preserved. No other examples of this species have as yet fallen under the writer's observation.

*Formation and Locality.* — Kinderhook Group; Iowa or Illinois.

#### *Ctenacanthus gracillimus* N. and W.

1866. *Ctenacanthus gracillimus* Newberry and Worthen, Pal. Ill., Vol. II., p. 126. Plate XIII., Figure 3.  
 1866. *Leptacanthus* (?) *occidentalis* Newberry and Worthen, *ibid.*, p. 116, Plate XII., Figure 2.  
 1875. *Acondylacanthus occidentalis* St. John and Worthen, *op. cit.* Vol. VI., p. 433.  
 1883. *Ctenacanthus gracillimus* St. John and Worthen, *op. cit.*, Vol. VII., p. 238, Plate XXIV., Figure 1.  
 1889. *Acondylacanthus occidentalis* J. S. Newberry, Monogr. U. S. Geol. Surv., Vol. XVI., p. 206, Plate XXV., Figure 6.

Although this is one of the most abundant ichthyodorulites occurring in the St. Louis limestone, and a number of more or less perfect examples have been obtained, confusion exists regarding both its generic and specific titles. There can be no doubt as to the correctness of Messrs. St. John and Worthen's conclusion that the spines described as "*Leptacanthus* (?) *occidentalis*" by Newberry and Worthen in Vol. II. of the Palæontology of Illinois are only worn or imperfect examples of the same species as *Ctenacanthus gracillimus* N. and W., likewise published in Volume II. (1866). These authors had then to decide which of Newberry and Worthen's figured specimens should be selected as the type, and by which of the two names the species should be

designated. It is a well-established principle of nomenclature that in cases like this, or as between names the equal pertinency of which may be in question, "preference shall be given to that which is open to least doubt" (*A. O. U. Code*, Canon XVII.).

As a matter of fact, when these two "species" were united by St. John and Worthen in 1883, some slight doubt was expressed as to their identity, and the authors very properly chose for their common designation that which was founded on the most perfect specimen, and hence was open to least doubt, namely, *C. gracillimus*. By this decision the spine figured in Plate XIII. Figure 3 of the Illinois Palæontology, Vol. II., was definitely established as the type-specimen, and the only question is whether it actually belongs to *Ctenacanthus*, or should be removed to *Acondylacanthus* as was proposed by Newberry in 1889.



FIG. 12.

*Ctenacanthus gracillimus* N. & W. St. Louis Limestone; Missouri. Portion of ornamentation.  $\times \frac{1}{4}$ .

The latter author rests his claim upon a worn, immature, and distorted specimen, now in the Museum of Columbia University, and very much inferior in point of preservation to the spine figured by St. John and Worthen in Vol. II. of the Illinois Palæontology, to which no reference is made by Newberry.

The correctness of St. John and Worthen's determination is confirmed by several additional specimens which have come under the writer's observation, all of which show tuberculated costæ, and the absence of this character in Newberry's spine is probably due to abrasion. One example in particular, from the St. Louis limestone, and belonging to the Museum of Comparative Zoölogy, exhibits the finer ornamentation very distinctly in its proximal portion (*cf.* text-figure 12) where the tubercles are seen to be small, stellated, and rather widely spaced in proportion to the extreme fineness of the costæ.

Just as *C. xiphias* (St. J. and W.), from the Keokuk limestone was first assigned to *Acondylacanthus* on the evidence of a worn specimen, so the true relations of *C. gracillimus* were rendered obscure by faulty preservation. In the same connection it may be remarked that another very interesting group of spines from the St. Louis limestone has been for the same reason misinterpreted by various authors. These are referable to the same species as occurs in the Carboniferous Limestone of Armagh and Gloucestershire, and described as *Physonemus arcuatus* by M'Coy.<sup>1</sup> Examples denuded of their

<sup>1</sup> *Ann. Mag. Nat. Hist.* (2), Vol. II. (1848), p. 117.

surface ornamentation have been figured by St. John and Worthen<sup>1</sup> as *Drepanacanthus reversus*, and by Newberry<sup>2</sup> as *Physonemus stellatus*.

The theoretical association of *Physonemus*, including *Xystracanthus*, *Drepanacanthus*, and *Batacanthus*, with the teeth of various species of *Petalodonts*, as proposed by Jaekel (*loc. cit.*, p. 285), may be considered as negated by the discordant distribution in the Mississippian series of these two classes of remains.

*Formation and Locality.*—St. Louis limestone; Missouri, Illinois, Indiana, and Michigan.

#### SPECIES FOUNDED ON SPINES BELONGING TO THE POSTERIOR DORSAL FIN.

##### *Ctenacanthus coxianus* St. John and Worthen.

1883. *Ctenacanthus coxianus* St. John and Worthen, Pal. Illinois, Vol. VII., p. 233, Pl. XXI., Fig. 1.

This species was founded on a unique but fragmentary and abraded spine from the Keokuk limestone of Iowa, and no further examples have been recorded from this or from other horizons. An imperfect spine, denuded of most of its ornamentation, but apparently referable to this species, is preserved in the Worthen Collection in the Museum of Comparative Zoölogy, and was derived from the Kinderhook limestone of Iowa. Considerable resemblance is to be observed between this species and *C. furcicarinatus* from the Waverly sandstone of Kentucky.

*Formation and Locality.*—Kinderhook and Keokuk Groups; Iowa.

##### *Ctenacanthus spectabilis* St. John and Worthen.

###### Plate 5, Fig. 1.

1875. *Ctenacanthus spectabilis* St. John and Worthen, Pal. Illinois, Vol. VI., p. 420, Pl. XV., Figs. 1a-1e.

This species was founded on a unique spine from the Kinderhook limestone of Legrande, Iowa, the more salient characters of which were stated to consist in its "great breadth along the oblique line of insertion and the abrupt posterior deflection in the curvature of the costæ,

<sup>1</sup> Pal. Ill., Vol. VI. (1875), p. 456, Plate XIX., Figure 5 (*non* Figure 6). — *Ibid.*, Vol. VII. (1883), p. 253, Plate XXIV., Figure 5.

<sup>2</sup> Monogr. U. S. Geol. Surv., Vol. XVI. (1889), p. 200, Plate XXI., Figure 12.

producing a frayed appearance in that portion of the posterior margin." From *C. varians* and *C. brevis* it is distinguished by certain details of its ornamentation. In particular, its anterior margin is described as bearing a "prominent, eccentric marginal ridge, from which frequent bifurcations are sent off on either side, each offshoot being more attenuated and curved posteriorly on approaching the posterior margin, forming throughout closely approximated, rounded ridges, of which there are about fifty, counting along the inferior margin, and less than half that number two-thirds the distance to the apex."

There can be no hesitation in referring to this species the original of Plate 5, Fig. 1, which is from the same horizon, and belongs to the United States National Museum (Cat. No. 4845). This spine displays the general outline and ornamentation very satisfactorily, notwithstanding it has been much laterally compressed by mechanical agencies. It has a total length of 15 cm., and maximum breadth of 3 cm. A sharp and prominent marginal ridge extends for the entire length of the anterior border, and forty or more longitudinal costæ terminate along the very oblique line of insertion. The only noteworthy particular in which it differs from the type relates to the ornamentation, which is of the decussated instead of the tuberculose pattern. Isolated and well-marked tubercles predominate in the type, although it is stated that along the anterior margin "they present the appearance of closely approximated decussations, apparently the result of abrasion, the entire crest of the ridges [costæ] being reduced to a smooth polished surface." But in the example before us distinct tubercles are almost entirely wanting, and the costæ are crossed by exceedingly numerous transverse ridges, the crests of which were apparently sharp and smooth.

That this difference in ornamental details is of minor importance is proved by the conditions existing in *C. varians*, where tubercles of diverse shape are variously disposed in different parts of the spine. They frequently surmount the costæ in double or even triple rows, and the "pairs of nearly circular tubercles often coalesce, forming a single transverse tubercle, which latter is the prevailing, if not persistent form in the posterior costæ."<sup>1</sup> A similar fusion of adjacent tubercles to form a single transverse ridge has already been noticed in *C. longinodosus* (*v. supra*, p. 80), hence it is not surprising that this process should be observed in a varying degree amongst different species, being sometimes limited to particular spines of the same species, and sometimes to different portions of a single spine.

*Formation and Locality.* — Kinderhook Group; Iowa and Illinois.

<sup>1</sup> *Loc. cit.* (1875), p. 422.

**Ctenacanthus varians** St. John and Worthen.

1875. *Ctenacanthus varians* St. John and Worthen, Pal. Illinois, Vol. VI., p. 422, Pl. XVI., Fig. 2.  
 1875. *Ctenacanthus speciosus* St. John and Worthen, *ibid.*, p. 424, Pl. XIV., Figs. 3, 4.

*Type.* Fractured spine; Museum of Comparative Zoölogy.

Regarding the type-specimen of *C. varians*, now preserved in the Cambridge Museum, Messrs. St. John and Worthen speak as follows (Pal. Illinois, Vol. VI., p. 423): "The solitary example which we have examined of the present form represents a spine probably seven inches in length, and though broken and parts are missing, sufficient remains, together with the perfect condition of the external characters, to show its distinctive features as contrasted with other forms. . . . Compared with *C. speciosus*, with which it has in common the same general outline and similar style of ornamentation, its distinguishing peculiarities consist in its more robust proportions and greater lateral thickness, the double row of tubercles along the anterior ridges, and the more prominent denticles arming the postero-lateral angles."

The same authors, in describing *C. speciosus*, again call attention to the close resemblance between the latter form, of which they possessed several fragments besides the type, and the unique specimen of *C. varians*. From comparisons of a large series of Selachian fin-spines, the present writer has been led to the conclusion that the supposed differences between *C. varians* and *C. speciosus* are of too trifling nature to be considered of specific importance; hence the latter title had best be abandoned.

*Formation and Locality.*—Kinderhook Group; Flint River, near Burlington, Iowa.

**Ctenacanthus semicostatus** St. John and Worthen.

1875. *Anaclitacanthus semicostatus* St. John and Worthen, Pal. Illinois, Vol. VI., p. 443, Pl. XVI., Fig. 14.

*Type.* Abraded and distorted spine; Museum of Comparative Zoölogy.

This species is founded on a much abraded and distorted spine which is now preserved in the Museum of Comparative Zoölogy at Cambridge, and whose relations are evidently with the genus *Ctenacanthus* instead of *Anaclitacanthus*. Traces remain in some places of the original tuber-

ulation of the costæ, and it is evident that the latter increased by bifurcation, and were much deflected along the posterior margin. These conditions are characteristic of the group represented by *C. varians* and *C. spectabilis* from the Kinderhook, which was most prolific at the beginning of the Lower Carboniferous, and entered almost immediately thereafter upon its decadence.

*Formation and Locality.*—Upper Burlington Group; Burlington, Iowa.

***Ctenacanthus solidus*, sp. nov.**

**Plate 7, Figure 3.**

*Type.* Spine referred to the posterior dorsal fin: United States National Museum.

Three spines from the Kinderhook of Iowa have come under the writer's observation, which belong to the group represented by *C. varians*, *C. spectabilis*, *C. deflexus*, etc., and yet differ from all these in certain details by which they may be specifically distinguished. Two of these specimens belong to the United States National Museum, the more perfect of which bears the catalogue number 3383, and is selected as typical. The smaller spine is shown nearly of the natural size in Plate 7, Figure 3, and is catalogued as number 4843. The third specimen referred to forms part of the A. H. Worthen Collection in the Museum of Comparative Zoölogy at Cambridge.

The spines referred to this species are very similar in proportion and general outline to those of *C. spectabilis*, but their ornamentation is coarser, and there are fewer longitudinal costæ. These do not exhibit the abrupt posterior deflection on approaching the line of insertion, which is so conspicuous a feature of *C. spectabilis* and *C. varians*, and the line itself is shorter and less oblique than in those forms. The costæ, in addition, are occupied in the present species by prominent, well-separated tubercles, which may be either rounded or obliquely elongated, and whose summits are distinctly wrinkled or striated. Another distinguishing character is furnished by the anterior margin. In *C. spectabilis* this is more or less angular, and bears a prominent sharp ridge, from which "frequent bifurcations are sent off on either side, and these again bifurcate descending, each offshoot being more attenuated and curved posteriorly on approaching the posterior margin," forming in all about fifty rounded ridges to be counted along the line of insertion. The present species has a more rounded anterior margin (*cf.* text-

figure 13) than *C. spectabilis*, and the sharp marginal ridge of that species is here replaced by a row of tubercles somewhat coarser or more elongated than the rest. This latter condition approximates that observed in *C. coxianus* from the Keokuk limestone.

In *C. mayi* about a dozen longitudinal costæ are to be counted along the line of insertion; in *C. coxianus* as many as 18 or 20; in *C. solidus* upwards of 30; in *C. spectabilis* about 50; and in *C. varians* 80 or more. Amongst these only *C. varians* agrees with the species under discussion in having sculptured or striated tubercles, and this character is also common to *C. brevis* from the Lower Carboniferous of Ireland, and to *C. longinodosus*, as described above. It is thus apparent that the number and direction of the costæ are of prime importance in the distinction of species.

The spine shown in Plate 7, Figure 3, is preserved for a length of 9.5 cm. and has a maximum width of 3.5 cm. The type-specimen belonging to the United States National Museum has the costæ more perfectly preserved than either of the co-types. Its cross-section, shown in the accompanying text-figure 13, is well displayed by the fracture across the base, but the thickness at this point is exceeded by both of the co-types. None of these spines retain traces of posterior denticles, although it is very probable that such were formerly present.

*Formation and Locality.* — Kinderhook; Iowa and Illinois.

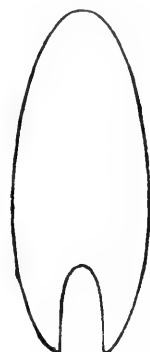


FIG. 13.

*Ctenacanthus solidus*, sp. nov. Cross-section of type-specimen in its basal portion.  $\times \frac{1}{2}$ .

#### LIST OF SPECIES OF CTENACANTHUS OCCURRING IN THE MISSISSIPPIAN SERIES.

NAME OF SPECIES.	Kinderhook.	Burlington.	Keokuk.	St. Louis.	Chester.
1. <i>C. coxianus</i> St. J. and W. . . . .	X	—	X	—	—
2. <i>C. decussatus</i> Eastm. . . . .	X	—	—	—	—
3. <i>C. depressus</i> Newb. . . . .	X	—	—	—	—
4. <i>C. longinodosus</i> Eastm. . . . .	X	—	—	—	—
5. <i>C. lucasi</i> Eastm. . . . .	X	—	—	—	—

LIST OF SPECIES OF CTENACANTHUS OCCURRING IN THE MISSISSIPPIAN SERIES (*continued*).

NAME OF SPECIES.	Kinderhook.	Burlington.	Keokuk.	St. Louis.	Chester.
6. <i>C. sculptus</i> St. J. and W. . . . .	X	—	—	—	—
7. <i>C. semicostatus</i> (St. J. and W.) . . . . .	X	—	—	—	—
8. <i>C. solidus</i> Eastm. . . . .	X	—	—	—	—
9. <i>C. spectabilis</i> St. J. and W. . . . .	X	—	—	—	—
10. <i>C. varians</i> St. J. and W. . . . .	X	—	—	—	—
11. <i>C. venustus</i> Eastm. . . . .	X	—	—	—	—
12. <i>C. (?) burlingtonensis</i> St. J. and W. . . . .	—	X	—	—	—
13. <i>C. gradocostatus</i> St. J. and W. . . . .	—	X	—	—	—
14. <i>C. acutus</i> Eastm. . . . .	—	—	X	—	—
15. <i>C. cylindricus</i> Newb. . . . .	—	—	X	—	—
16. <i>C. excavatus</i> St. J. and W. . . . .	—	—	X	—	—
17. <i>C. keokuk</i> St. J. and W. . . . .	—	—	X	—	—
18. <i>C. xiphias</i> (St. J. and W.) . . . . .	—	—	X	—	—
19. <i>C. costatus</i> N. and W. . . . .	—	—	—	X	—
20. <i>C. deflexus</i> St. J. and W. . . . .	—	—	—	X	—
21. <i>C. gemmatus</i> St. J. and W. . . . .	—	—	—	X	—
22. <i>C. gurleyi</i> Newb. . . . .	—	—	—	X	—
23. <i>C. harrisoni</i> St. J. and W. . . . .	—	—	—	X	—
24. <i>C. littoni</i> Newb. . . . .	—	—	—	X	—
25. <i>C. pellensis</i> St. J. & W. . . . .	—	—	—	X	—
26. <i>C. angulatus</i> N. and W. . . . .	—	—	—	—	X
27. <i>C. canaliratus</i> St. J. and W. . . . .	—	—	—	—	X
28. <i>C. similis</i> St. J. and W. . . . .	—	—	—	—	X

## III. ON ACANTHODIAN REMAINS FROM THE COAL MEASURES OF MAZON CREEK, ILLINOIS.

Representatives of the Acanthodii are extremely rare in the Palæozoic rocks of North America, and the only species hitherto described are restricted to the Devonian of the United States and Canada. If we neglect the detached spines of Machæracanthus, and the indeterminate mass of scales described by Dr. J. M. Clarke<sup>1</sup> as *Acanthodes(?) pristis*, American Acanthodians are limited to but one species each of

<sup>1</sup> Bull. U. S. Geol. Survey, No. 16 (1885), p. 42.



Acanthodes and Mesacanthus, namely *A. concinnus* Whiteaves and *M. affinis* (Whiteaves) from the Upper Devonian of Scaumenac Bay, Canada.

The occurrence of a new and very large species of Acanthodes in the Coal Measures of Mazon Creek has been previously reported by the writer,<sup>1</sup> but descriptions of the same have been reserved until now. The material upon which the following diagnoses are based belongs to the S. S. Strong collection in the Peabody Museum of Yale College. Nearly all of the vertebrate remains in this handsome collection, comprising several hundred specimens of the usual concretionary type, were very generously placed in the writer's hands for investigation by the late Professor O. C. Marsh, and quite recently a number of additional nodules have been loaned for the same purpose by Dr. C. E. Beecher. It is hoped that the structure of certain Coelacanth, Platysomids, and Palæoniscids, of which several complete examples exist in the same collection, may be elucidated in a future publication.

*Acanthodes marshi*, sp. nov.

Plate 6, Fig. 3; Plate 7, Figs. 1, 2.

To this species are referred a number of large fin-spines, one of them having the dermal rays attached, and also a mass of shagreen granules of correspondingly large size. All these specimens are preserved in ironstone nodules from the well-known Mazon Creek locality in Grundy County, Illinois. The scale-bearing nodule, upon which the species is founded, is shown in Plate 7, Figure 1. The shagreen granules occupy a space of several square centimeters, and present the following characters:

Scales in the form of quadrate granules averaging about one square millimeter in size, smooth and polished externally, gently convex or rounded on both the outer and attached surfaces. Internal structure consisting of fine layers of dentine arranged in quadrate fashion about a small central pulp-cavity. Attached surface of some scales crossed by a shallow diagonal groove.

Not only are the scales much coarser than those of *A. bronni* and *A. wardi*, which attain as large a size as any, but the fin-spines are considerably longer and stouter, averaging about 9 cm. long, and from 5 to 8 mm. wide. The spines are gently curved backward throughout their length, have tapering distal extremities, and are faintly grooved

<sup>1</sup> Science, n. s., Vol. IX. (1899), p. 642; *ibid.*, Vol. XI. (1901), p. 795.

along the anterior and sometimes also the posterior margin. In fractured specimens the central longitudinal cavity is seen to be infiltrated with a white silicious substance.

In Plate 6, Figure 3, is shown a very interesting pectoral fin preserved in counterpart (Yale Museum Cat. No. 295), and retaining the actinotrichia in natural association with the spine. The latter is preserved for a length of 8 cm., has a width of 8 mm., and thickness of 4 mm. The fibrous rays are quite long and numerous as compared with other species, and extend well up towards the proximal end of the spine. There is no trace here of a basal cartilage abutting against the side of the spine, owing to deficient preservation in this region, hence the present specimen is unable to throw any light on the partly conjectural restorations of Reis,<sup>1</sup> Fritsch,<sup>2</sup> Jaekel,<sup>3</sup> and others. In view of the extreme interest attaching to the endoskeletal structure of the paired fins, it is tantalizing to find just those parts missing which are most needed to clear up certain problematical details. Neither does this specimen display any of the dermal granules with which the fin-membrane was stiffened, but these are well exhibited in a smaller fin, possibly identifiable as the dorsal fin of a young individual, shown in Plate 5, Figure 3. In this specimen the limit of the exoskeletal part, or which is the same thing, the outline of the body-wall, is very distinctly shown. Although the spine is only 2.5 cm. long, it is about as wide in proportion as the adult spines. The smaller fin is preserved in counterpart like the majority of fossil remains found in concretions.

The specific title is dedicated to the honored and enduring memory of the late Professor Othniel Charles Marsh.

*Formation and Locality.* — Coal Measures; Mazon Creek, Illinois.

### *Acanthodes beecheri*, sp. nov.

#### Text-figure 14.

A very small species, attaining an extreme length of about 5.5 cm. Body elongated and slender, the maximum depth being contained about nine times

<sup>1</sup> Reis, O. M., Ueber *Acanthodes bronni*, Agassiz. *Morphol. Arb.*, Vol. VI. (1896), Plate VI., Fig. 11.

<sup>2</sup> Fritsch, A., *Fauna der Gaskohle*, Vol. III. (1893), p. 71.

<sup>3</sup> Jaekel, O., Ueber die primäre Zusammensetzung des Kieferbogens und Schultergürtels. *Verhandl. deutsch zool. Ges.* (1899), p. 256, text-fig. 2. — On the microscopic structure of *Acanthodian* scales, see the articles by Reis already cited, and Rohon's Memoir on Die Obersilurischen Fische von Oesel (*Mém. Acad. Imp. Sci. St. Petersburg*, Vol. XLI., 1893, No. 5, p. 22).

in the total length. Pectoral spines not much stouter or longer than the others; pelvic fins small, slightly nearer the pectorals than the anal; anal fin slightly larger than the dorsal, which is placed immediately behind. Length of dorsal and anal spines greater than maximum depth of the trunk. Caudal lobe remarkably elongate. Scales very minute.

This species is represented by two nearly complete individuals preserved in counterpart, one of which has a total length of about 5.5 cm. (Yale Museum Cat. No. 630), and the other about 5 cm. (Cat. No. 114). Neither of these exhibits the caudal region in its entirety, however, and the heads are not satisfactorily preserved. Only the dorsal and anal fin-spines, with their dermal rays, are displayed by the larger specimen; but in the smaller individual all the fin-spines are preserved, although the dorsal is slightly displaced and the distal ends of the pectorals are wanting. The accompanying text-figure 14 is of composite nature, being based upon both specimens; it represents the general outline and proportions of the fins, the restored parts being shown in dotted lines.

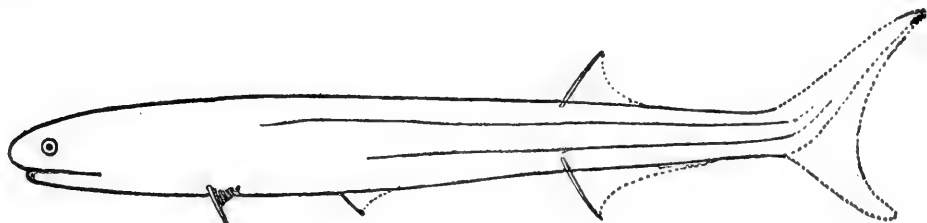


FIG. 14.

*Acanthodes beecheri*, sp. nov. Coal Measures; Mazon Creek, Ill. Restored outline.  $\times \frac{2}{3}$ .

In size and general configuration this species resembles the Devonian Mesacanthi, especially *Mesacanthus mitchelli* (Egerton) from the Scottish Old Red Sandstone, and *M. affinis* (Whiteaves) from the Upper Devonian of Scaumenac Bay, Canada, but differs from them as well as from other species of *Acanthodes* in the position and relative proportions of the fins. The most marked characteristic of the present form consists in the small size of the pectorals as compared with the pelvic, dorsal, and anal fins. In this respect it furnishes an exception to the generalization that in the course of geological time the pectoral fins of Acanthodians become enlarged at the expense of the pelvic, while the two pairs become approximated. In the Lower Permian *A. bronni* the pelvic fins are greatly reduced, and in the so-called Traquairia, from the same formation, they are entirely wanting. We have in the species under

discussion a survival of the primitive conditions observed in *Mesacanthus*, with the exception that the free spines between the paired fins have become lost. Whereas in most Acanthodians the dorsal exceeds the anal more or less in size, in this case it is the anal that is slightly the larger.

The squamation is very fine indeed, and on this account the individual granules can scarcely be recognized. The lateral line, however, is very distinctly shown in both examples. In the larger specimen the calcified meckelian cartilage is preserved on one side, and is substantially of the same form as shown by Jaekel<sup>1</sup> and Reis<sup>2</sup> in *A. bronni*. The smaller specimen exhibits a displaced "extramandibular spine" with long fine rays, such as occurs in *A. bronni* and *A. (Traquairia) pygmaea*. Teeth are absent. By an odd chance a small Pleuracanthus tooth has happened to lodge directly over the posterior part of the cranium in the larger specimen, thus increasing the obscurity of this region. The compact structure of the fin-spines and mandibular calcifications leaves no room for doubt that these are adult individuals, notwithstanding their small size.

The species is named in honor of Professor Charles E. Beecher as a slight tribute of personal esteem, and in grateful appreciation of his many friendly courtesies.

*Formation and Locality.* Coal Measures; Mazon Creek, Illinois.

<sup>1</sup> *Jaekel, O.*, Ueber die primäre Zusammensetzung des Kieferbogens und Schultergürtels. Verhandl. deutsch. zool. Ges. (1899), p. 252, text-fig. 1. — Zeitschr. deutsch. geol. Ges., Verhandl., Vol. LI., 1899, p. 56, text-fig. 1.

<sup>2</sup> *Reis, O. M.*, *loc. cit.*, Plate VI., Figs. 1, 3, 4.

LIST OF CARBONIFEROUS VERTEBRATES OCCURRING AT  
MAZON CREEK, ILLINOIS.

AMPHIBIA.

1. *Amphibamus grandiceps* Cope.

ELASMOBRANCHII.

2. *Pleuracanthus (Diplodus) compressus* Newb. (Occurs also at Linton, Ohio, and  
in Indiana.)  
3. " " *latus* Newb. (Occurs also in Ohio and Indiana.)  
4. " " *lucasi* Hay  
5. *Acanthodes beecheri*, sp. nov.  
6. " *marshi*, sp. nov.  
7. *Campodus scitulus* (St. J. and W.) *vide* O. H. St. John.

DIPNOI.

8. *Ctenodus* sp. indes.  
9. *Sagenodus foliatus* Cope.<sup>1</sup>  
10. " *lacovianus* Cope.<sup>1</sup>  
11. " *occidentalis* (Newb. and W.)<sup>1</sup> (Occurs also at Linton, Ohio.)  
12. " *quadratus* (Newb.)<sup>1</sup> (Occurs also at Linton, Ohio.)  
13. " *quincunciatus* Cope.<sup>1</sup>  
14. " *reticulatus* (Newb. and W.)<sup>1</sup>  
15. " *textilis* Hay.<sup>1</sup>

CROSSOPTERYGII.

16. *Rhizodopsis* (?) *mazonius* Hay.<sup>1</sup>  
17. *Coelacanthus exiguus*, Eastm.  
18. " *robustus* Newb.<sup>1</sup> (Occurs also at Linton, Ohio.)

ACTINOPTERYGII.

19. *Eurylepis*, sp. indet., *vide* J. S. Newberry.  
20. *Rhadnichthys gracilis* (Newb. and W.).  
21. *Elonchthys hypsilepis* Hay.  
22. " *peltigerus* Newb.<sup>2</sup> (Occurs also at Linton, Ohio).  
23. " *perpennatus* Eastm.  
24. *Platysomus circularis* Newb. and W.  
25. " *lacovianus* Cope.  
26. " *orbicularis* Newb. and W.

<sup>1</sup> Founded on scales.

<sup>2</sup> Including also the so-called "*Amblypterus macropterus*" Newb. and W.

## EXPLANATION OF PLATES.

## PLATE 1.

*Campodus variabilis* (Newb. and W.) Coal Measures; Cedar Creek, Nebraska. Symphyisial dentition, belonging presumably to the lower jaw, and displaying eleven fused teeth, viewed from the right-hand side. Reproduced from a photograph by Mr. A. Hyatt Verrill without retouching. Original preserved in the Museum of the State University of Nebraska.  $\times \frac{4}{3}$ .

## PLATE 2.

*Campodus variabilis* (Newb. and W.). Coal Measures; Osage County, Kansas. Symphyisial dentition belonging presumably to the lower jaw, with naturally associated antero-lateral series, viewed from the right-hand side. Coronal apices of all except the posterior tooth have been broken away. Reproduced from a photograph by Mr. C. H. Currier without retouching. Original preserved in the Museum of Comparative Zoölogy at Cambridge, Mass. (Cat. No. 749).  $\times \frac{5}{8}$ .

## PLATE 3.

- Fig. 1. *Campodus variabilis* (Newb. and W.). Coal Measures; Osage County, Kansas. Oral aspect of same specimen shown in Plate 2, with the anterior extremity shown uppermost.  $\times \frac{5}{8}$ .
- Fig. 2. *Ctenacanthus venustus*, sp. nov. Kinderhook limestone; Iowa (?). Lateral aspect of spine referred to the anterior dorsal fin, and belonging to an immature individual. Original preserved in the United States National Museum at Washington. (Cat. No. 3385).  $\times \frac{1}{1}$ .

## PLATE 4.

*Campyloprion annectans* Eastm. Carboniferous or Permo-Carboniferous; locality unknown. Symphyisial dentition, showing portions of about 20 fused teeth, viewed from the left-hand side. Reproduced from a photograph by Mr. C. H. Currier without retouching. Original preserved in the Museum of Comparative Zoölogy at Cambridge, Mass.  $\times \frac{2}{3}$ .

## PLATE 5.

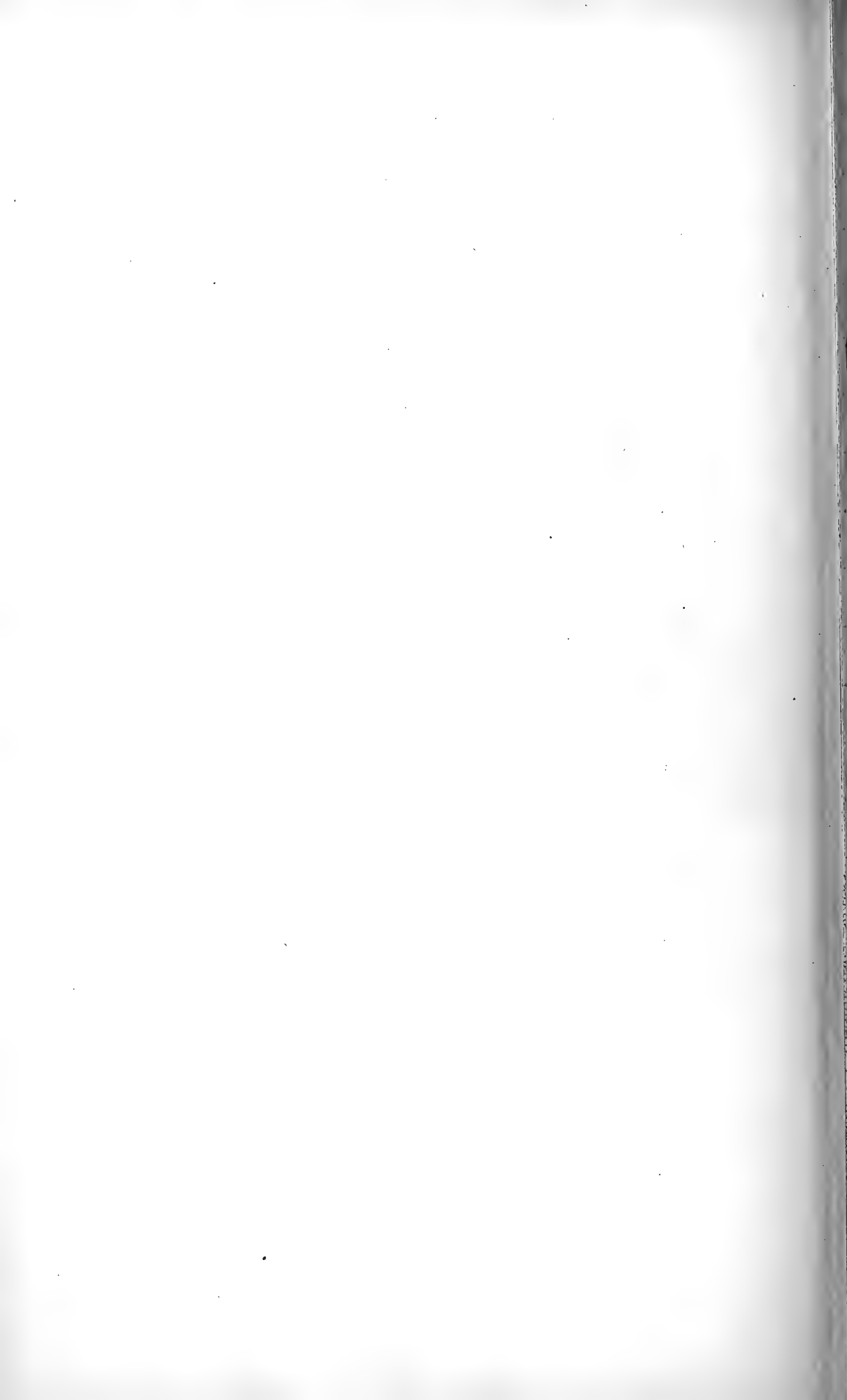
- Fig. 1. *Ctenacanthus spectabilis* St. J. and W. Kinderhook Limestone; Mississippi Valley. Left lateral aspect of spine referred to the second dorsal fin. Original preserved in the U. S. National Museum. (Cat. No. 4845).  $\times \frac{1}{4}$ .
- Fig. 2. *Ctenacanthus longinodosus*, sp. nov. Kinderhook Limestone; Mississippi Valley. Basal portion of spine referred to the first dorsal fin. Original preserved in the U. S. National Museum. (Cat. No. 3393).  $\times \frac{1}{4}$ .
- Fig. 3. *Acanthodes marshi* (?), sp. nov. Coal Measures; Mazon Creek, Illinois. Fin belonging presumably to a young individual of same species as shown in Plate 6, Figure 3, with attached spine and calcified fin-membrane. Original preserved in Yale Museum.  $\times \frac{1}{4}$ .

## PLATE 6.

- Fig. 1. *Ctenacanthus lucasi*, sp. nov. Kinderhook Limestone; Mississippi Valley. Basal portion of spine referred to the first dorsal fin. Original preserved in the U. S. National Museum. (Cat. No. 4844).  $\times \frac{1}{4}$ .
- Fig. 2. *Ctenacanthus decussatus*, sp. nov. Kinderhook Limestone; Mississippi Valley. Proximal portion of spine referred to the first dorsal fin. Original preserved in the U. S. National Museum. (Cat. No. 4846).  $\times \frac{1}{4}$ .
- Fig. 3. *Acanthodes marshi*, sp. nov. Coal Measures; Mazon Creek, Illinois. Impression of nearly complete pectoral fin preserved in counterpart, showing fin-spine and actinotrichia, but without supporting basal element. Original in Yale University Museum.  $\times \frac{1}{4}$ .

## PLATE 7.

- Fig. 1. *Acanthodes marshi*, sp. nov. Coal Measures; Mazon Creek, Illinois. Nodule containing a portion of the dermal covering (shagreen), the granules of which are preserved in their natural arrangement, and present the structure shown in Fig. 2. Original in Yale University Museum.  $\times \frac{1}{4}$ .
- Fig. 2. *Acanthodes marshi*, sp. nov. Enlarged drawing of some of the shagreen granules from the type-specimen shown in Fig. 1.  $\times \frac{6}{4}$ .
- Fig. 3. *Ctenacanthus solidus*, sp. nov. Kinderhook Limestone; Mississippi Valley. Proximal portion of spine referred to the second dorsal fin. Original preserved in the U. S. National Museum. (Cat. No. 4843).  $\times \frac{1}{4}$ .

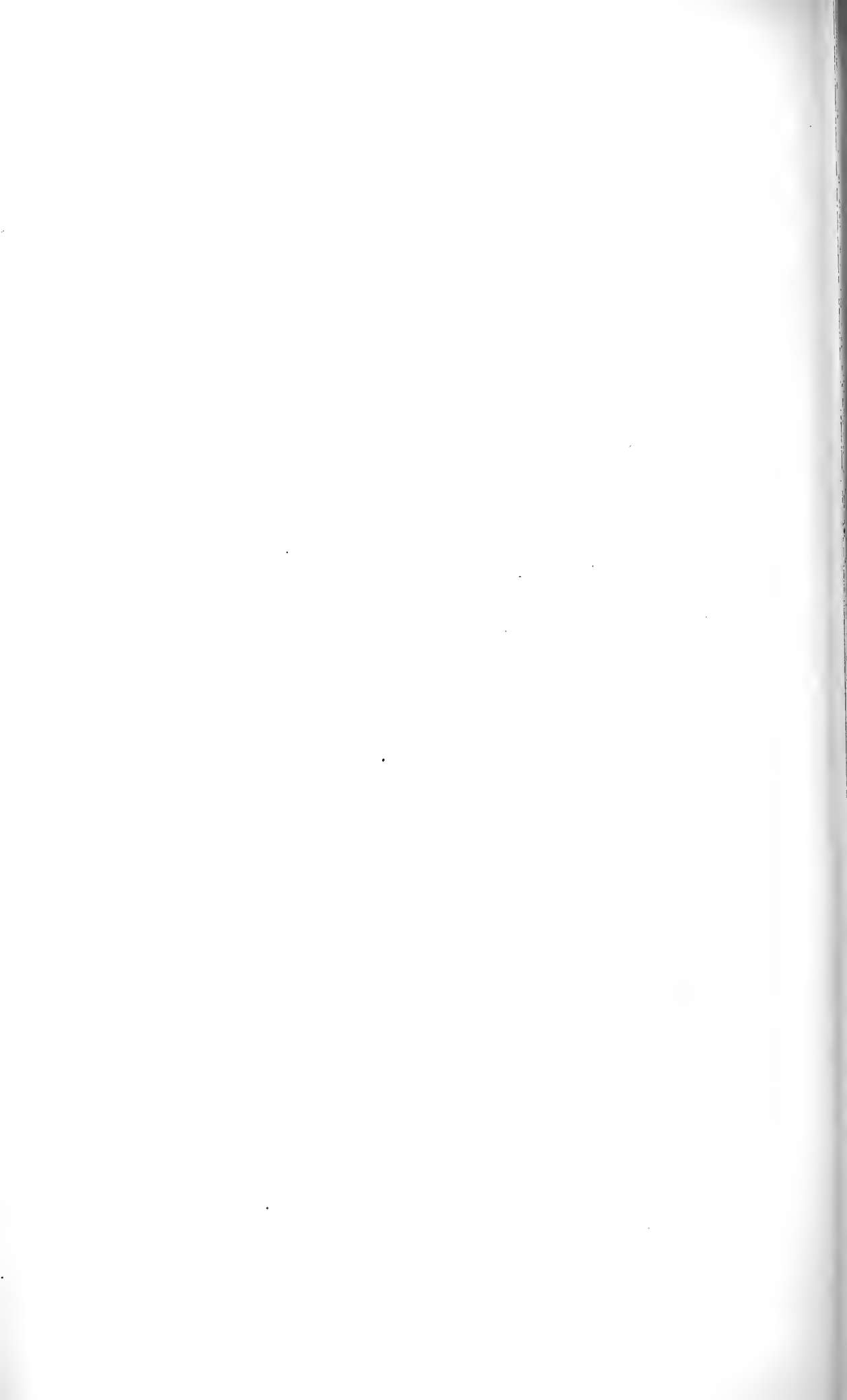


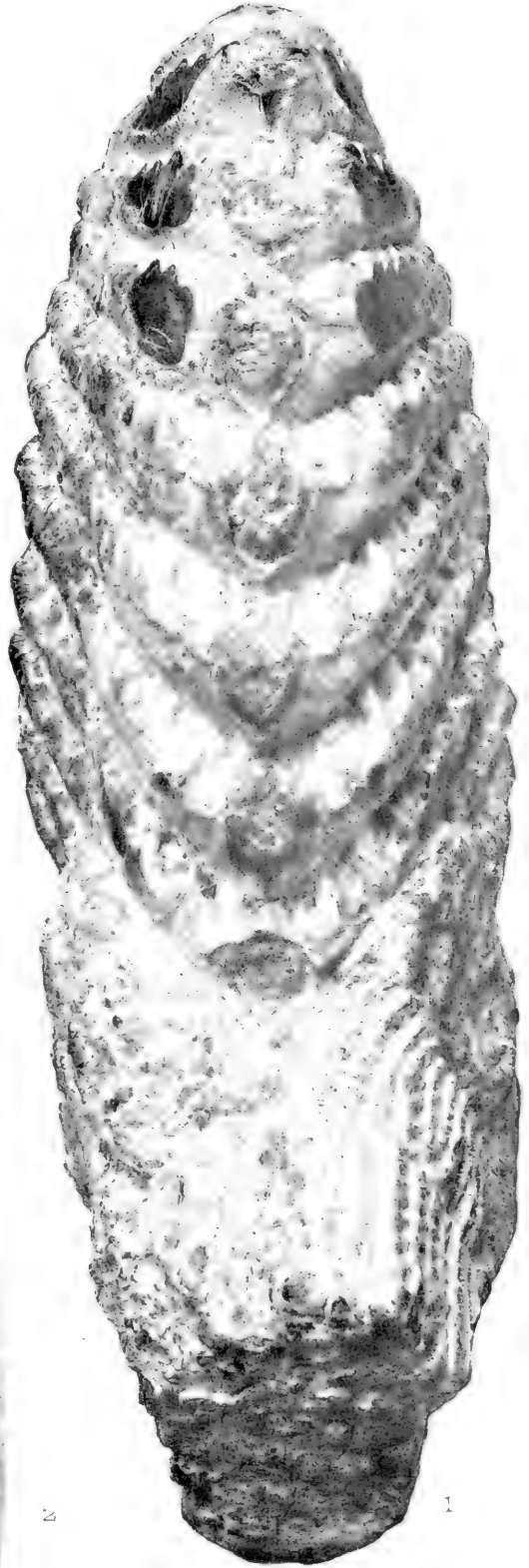






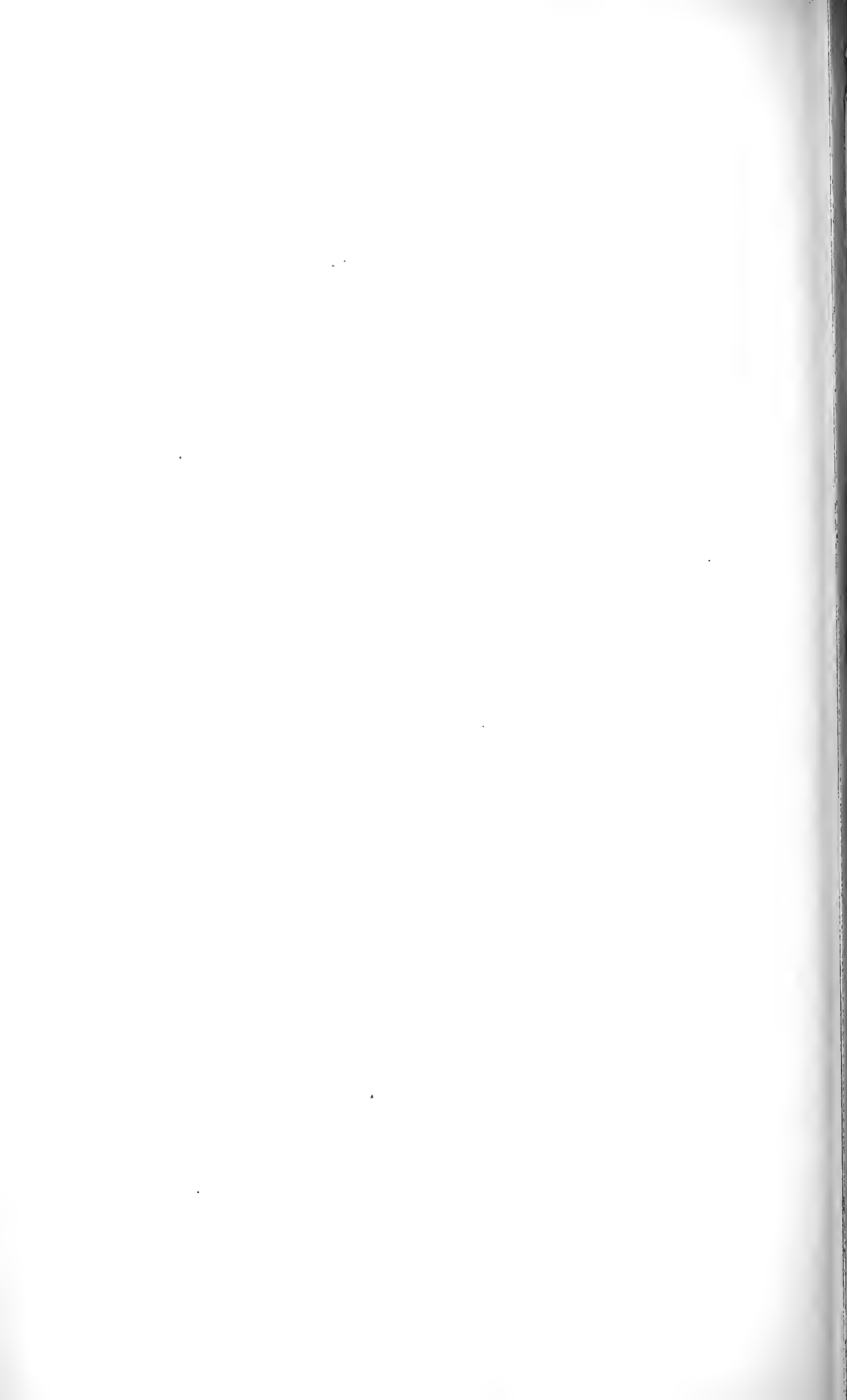


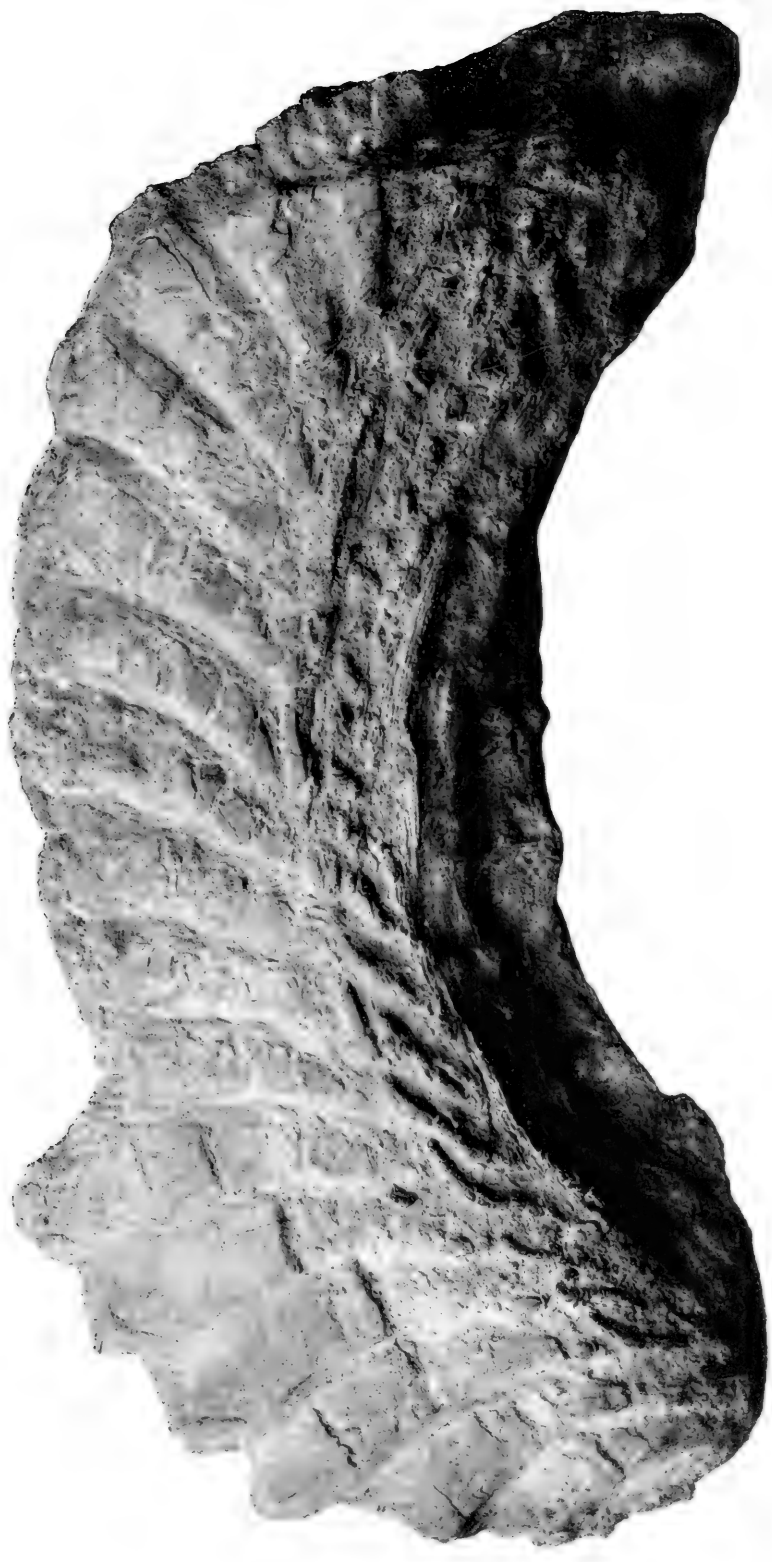




2

1

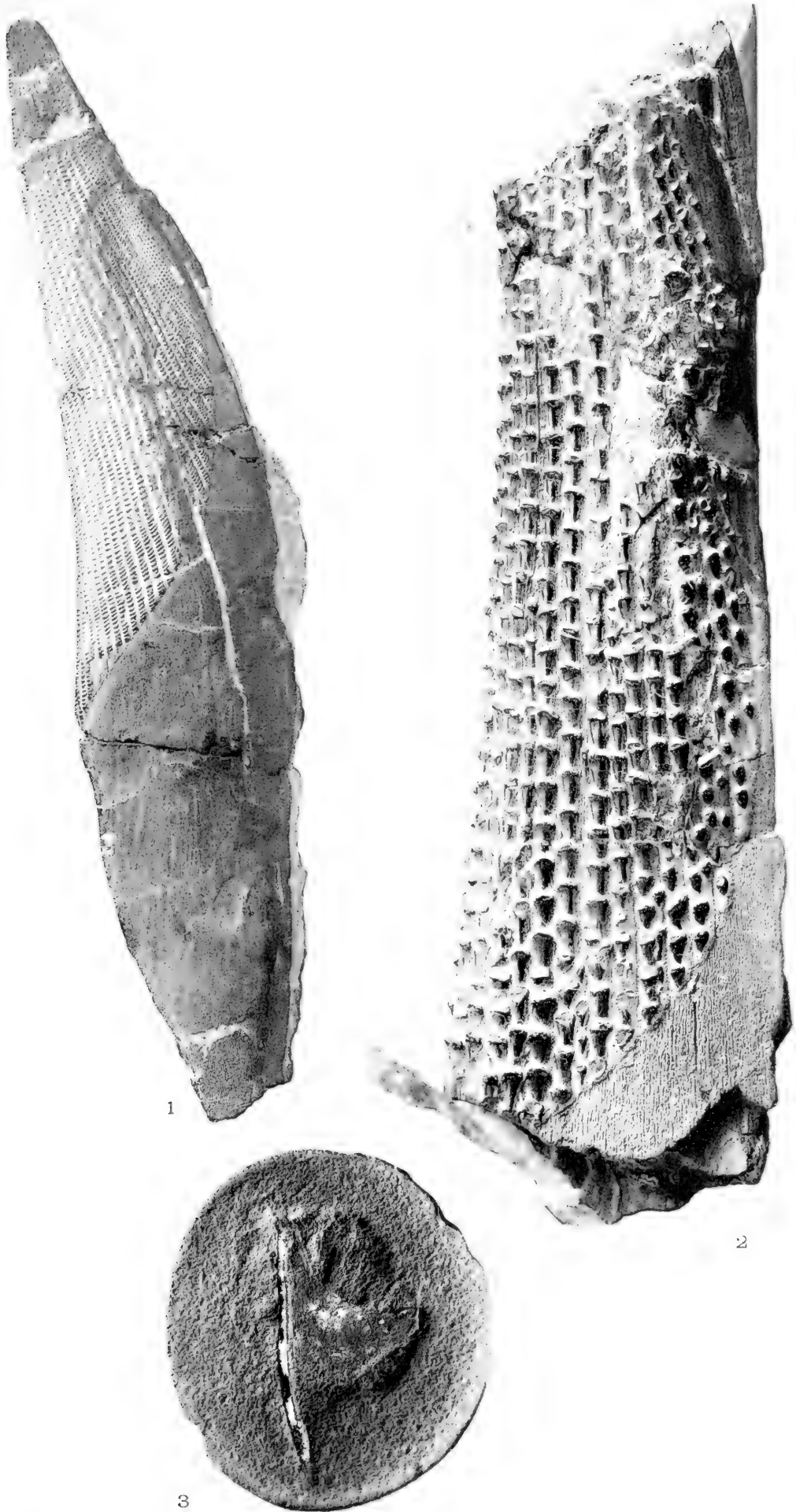




HELIOTYPE CO., BOSTON



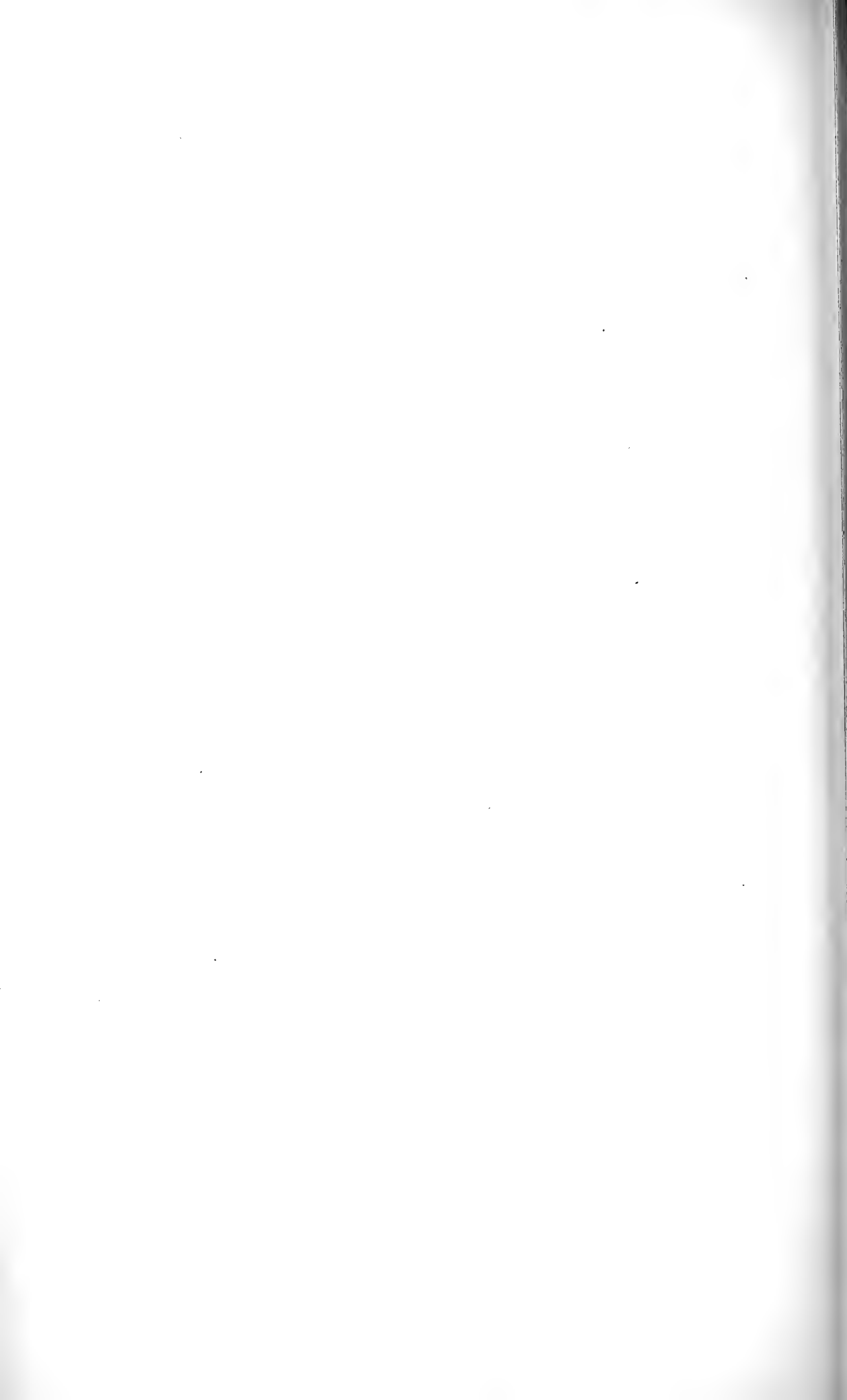




1

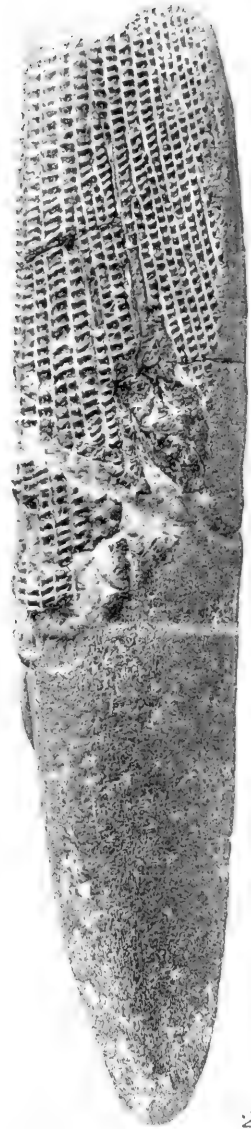
2

3





1

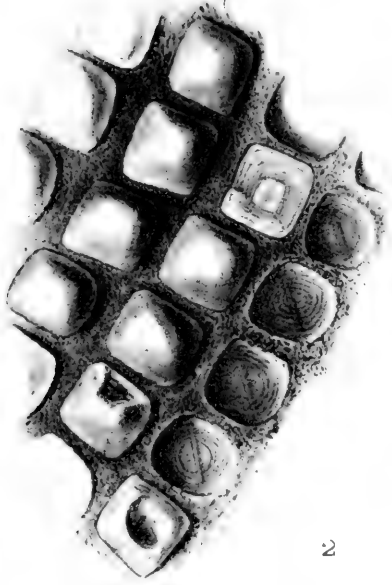


2

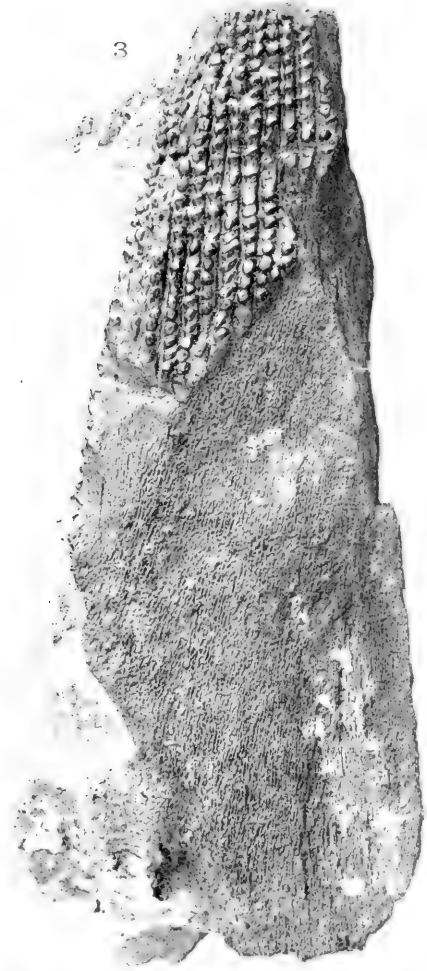


3





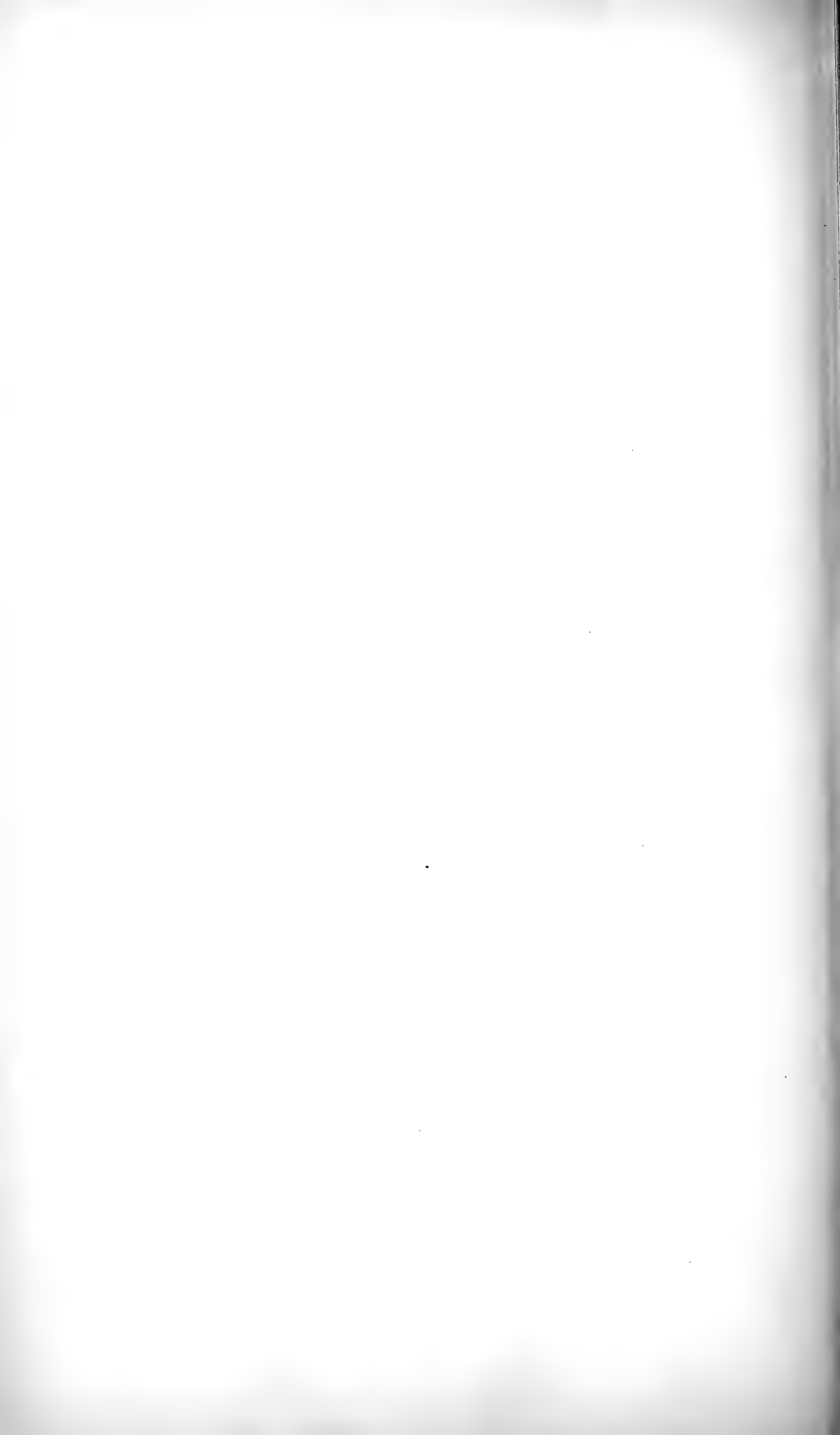
2



3



1



Bulletin of the Museum of Comparative Zoölogy  
AT HARVARD COLLEGE.  
VOL. XXXIX. No. 4.

---

ILLUSTRATIONS OF ODONATA:—ARGIA.

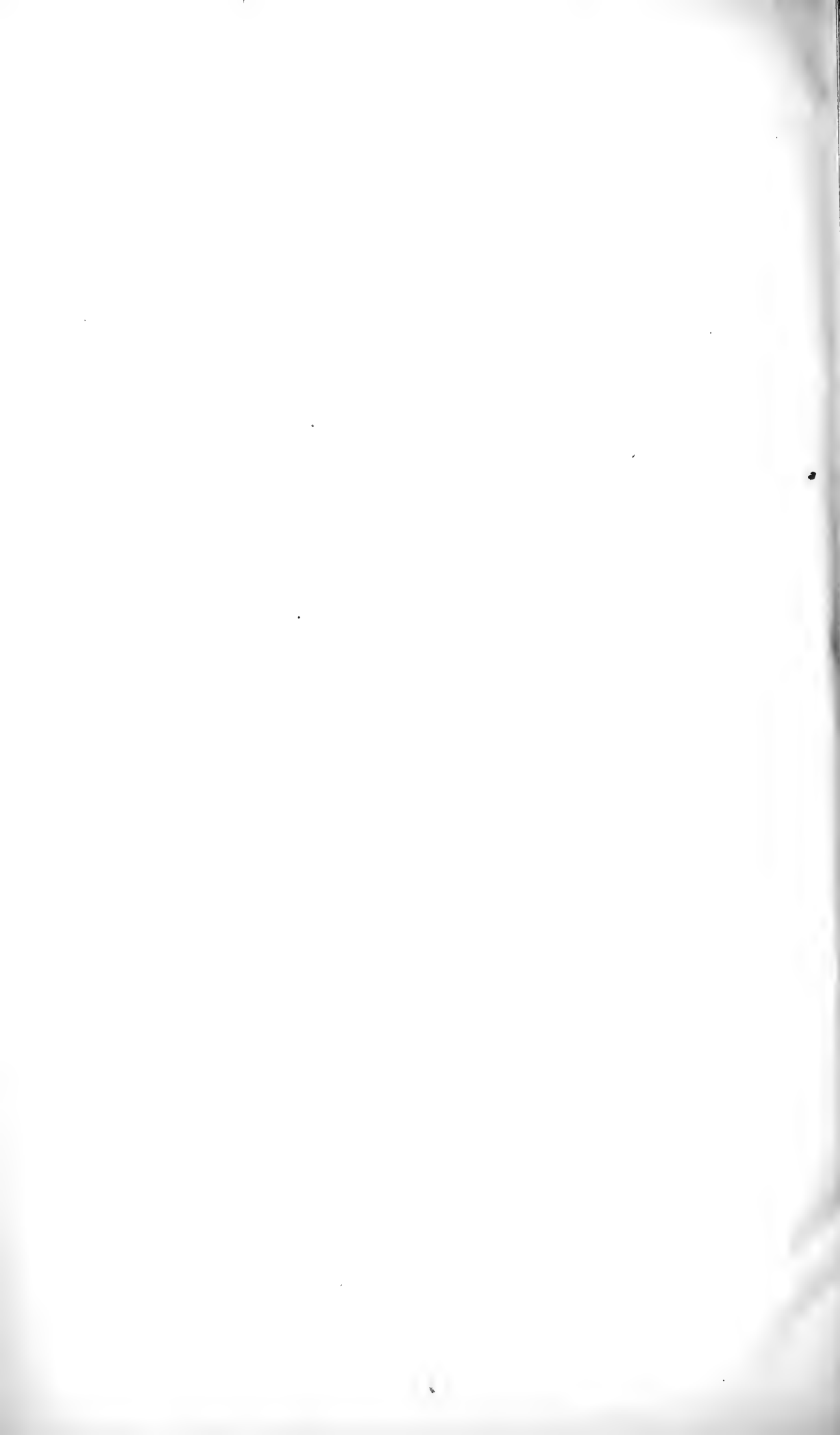
BY HERMANN A. HAGEN.

WITH A LIST AND BIBLIOGRAPHY OF THE SPECIES.

BY PHILIP P. CALVERT.

WITH TWO PLATES.

CAMBRIDGE, MASS., U. S. A. :  
PRINTED FOR THE MUSEUM.  
NOVEMBER, 1902.





No. 4. — *Illustrations of Odonata: Argia.* By HERMANN A. HAGEN. *With a list and bibliography of the species.* By PHILIP P. CALVERT.<sup>1</sup>

THE illustrations herewith presented require some words of explanation. De Selys and Hagen intended publishing a Monograph of the Agrioninæ, following a Synopsis of this subfamily, as they had for the Calopteryginæ and the Gomphinæ. The Synopsis appeared in instalments from 1860 to 1877. Hagen made drawings for the Monograph which was never published, if indeed it ever was written. These, before his death, were given to his friend and successor in the Museum of Comparative Zoölogy, Mr. Samuel Henshaw. Some of these drawings — those referring to the “grande genre *Argia*” — have recently been lent to the present writer to be used in the study of material for the Odonate part of the *Biologia Centrali-Americana*. So useful have they thus proved, so desirable does it seem that others should have the opportunity of using them, that they are here published.

If justification were needed for this proceeding, it may be found in these words of De Selys from the Synopsis of *Argia*, page 381 :

“De grandes difficultés se présentent pour donner les diagnoses des quarante-six espèces américaines, dont plusieurs sont très-voisines les unes aux autres. Les appendices anals des mâles et les lames du devant du thorax des femelles fournissent, il est vrai, pour la plupart, des caractères positifs ; mais ils eussent rendu les diagnoses très-longues, et ces organes ne peuvent être bien vus qu’avec un certain grossissement, j’ai cherché dans les diagnoses de ce Synopsis, à me passer de ces caractères, qui seront réservés pour une monographie spéciale.”

As to the figures themselves, the original sheets on which they were made bear the signature “H. Hagen del. 1864.” As far as known, they were executed without the aid of a camera lucida. It may be admitted that they are not in all cases perfectly satisfactory, due partly to the fact that the structures they depict were not sufficiently spread apart to be clearly seen, as in Plate 2, Figs. 6 *a*, 14 *a*. It must also be borne

<sup>1</sup> The second-named author is responsible for the entire *text* of this article.

in mind by those using them that the apparent shape of the appendages of the males depends very largely on the particular angle at which they are viewed, and that the appendages themselves are capable of a considerable degree of rotation. The seeming differences between the two figures of *Argia tibialis*, Plate 2, Figs. 7, 7 *a* and 8, 8 *a*, are readily explained in this way, as any one who will compare them with a male of this species may convince himself. Yet no one who has attempted the study of this difficult genus will question the value of the aid which these figures offer in elucidating the species all too briefly described in the Synopsis of 1865, remembering also that their originals are scattered through several museums of Europe and America. The arrangement of these illustrations on the plates has been chiefly guided by two ideas: to place similar shapes near together for ease of comparison, and to associate species which from personal knowledge are believed to be related.

It has been thought desirable to accompany these figures with a list and bibliography of all the known species of this group. The list has been arranged alphabetically for convenience' sake, since the writer has too little acquaintance with the South American species to attempt to place them in their proper relationships, while, on the other hand, for reasons given elsewhere, he cannot subscribe to the classification employed in the Synopsis of 1865. It is hoped that the bibliography embraces references to all descriptions and figures, but mere locality lists are not necessarily included. The distribution of each species is given in a general way; details will be found in the authors quoted. Two works which together contain descriptions of all the known species are cited in abbreviations. These are: De Selys-Longchamps, Synopsis des Agrionines, 5me légion: Agrion, Le grand genre *Argia* (Bulletin Acad. Roy. Belg. — 2 — XX., pp. 375-417, 1865), which is quoted simply as "*Argia*;" since the paging of the separate copy is different, the page number of this latter is also given, but in parentheses ( ). While this Synopsis is published as under the authorship of De Selys, many of the descriptions were written by Hagen, and in such cases due credit is given to the latter. The other work is Calvert: Odonata in Biologia Centrali-Americana, Neuroptera, pp. 17 *et seq.*, London, 1901-02, here shortened to "B. C. A."

As far as possible, the present location of the types of each species is given from personal knowledge and from the literature.

The two closely related genera *Hyponeura* and *Onychargia* have been included.

LIST AND BIBLIOGRAPHY OF SPECIES.

HYPONEURA.

SELYS, Monog. Calopt., p. 275 (1854); Argia, p. 381 (9), (1865). HAGEN, Syn. Neur. N. Am., p. 95 (1861). KIRBY, Cat. Odon., p. 137 (1890). CALVERT, B. C. A., p. 65 (1901).

Type: *H. funcki*.

*H. funcki*.

SELYS, Monog. Calopt., p. 275 (1854); Argia, p. 381 (9) (1865). CALVERT, B. C. A., p. 67 (1901). ♂ ♀.

*Agrion lugens*, HAGEN, Syn. Neur. N. Am., p. 95 (1861).

Hab.: Mexico, Guatemala, Colombia. Types in Coll. Selys.

*H. lugens*.

(Plate 2, Fig. 22.)

*Agrion lugens* HAGEN, Syn. Neur. N. Am., p. 95 (1861).

*Hyponeura lugens* SELYS, Argia, p. 382 (10) (1865). CALVERT, B. C. A., p. 66 (1901).

♂ ♀.

Hab.: New Mexico, Arizona, Mexico. Type ♀ in M. C. Z.<sup>1</sup>

ARGIA.

RAMBUR, Névr., p. 254 (1842). SELYS [and HAGEN] Argia, p. 382 (10) (1865). KIRBY, Cat. Odon., p. 137 (1890). CALVERT, B. C. A., p. 67 (1901).

Type: *A. fumipennis*.

*A. adamsi*.

CALVERT, B. C. A., pp. 70, 80, pl. iv. f. 35, 35 s (apps. ♂) (1901-'02). ♂.

Hab.: Panama. Types in Colls. Adams, Godman.

*A. agrioides*.

CALVERT, Proc. Calif. Acad. Sci. (2), iv. p. 476, pl. xv. f. 14 (apps. ♂) (1895); B. C. A., pp. 72, 74, 98, pl. iv. ff. 26 (mest. lam. ♀), 62, 62 s (apps. ♂) (1901-'02). ♂ ♀.

Hab.: California, Baja California, Arizona, Texas, Nuevo Leon (Mexico). Types in Colls. Calif. Acad. Sci. and Calvert.

<sup>1</sup> Abbreviation for Museum of Comparative Zoölogy, Cambridge, Mass.

*Var. nahuana.*

CALVERT, B. C. A., pp. 72, 74, 99, pl. iv. f. 62 ss (apps. ♂) (1901-'02). ♂ ♀.  
 Hab.: Mexico. Types in Colls. Calvert, Adams, McLachlan, etc.

*A. albistigma.*

(Plate 2, Figs, 14, 14 a.)

HAGEN in SELYS, *Argia*, p. 402 (30) (1865). ♂ ♀.  
 Hab.: Montevideo. Types in M. C. Z.

*A. apicalis.*

(Plate 2, Figs. 21, 21 a, 21 b.)

*Agrion apicalis* SAY, Jour. Acad. Nat. Sci. Phila., viii. p. 410 (1839). HAGEN, Syn. Neur. N. Am., p. 91 (1861).  
*Argia apicalis* SELYS, *Argia*, p. 414 (42) (1865). CALVERT, Trans. Am. Ent. Soc., xx. p. 233 (1893). KELLICOTT, Odon. Ohio, p. 26 (1899). WILLIAMSON, 24 Rep. Geol. Ind., p. 264, pl. vii. f. 9 (apps. ♂) (1900). ♂ ♀.

Hab.: Maine to Virginia, west to Michigan and Kansas and south to Texas. Type of Say supposedly lost, of Hagen in M. C. Z.

*A. barretti.*

CALVERT, B. C. A., pp. 71, 87, pl. iv. ff. 46, 46 s (apps. ♂) (1901-'02). ♂.  
 Hab.: Nuevo Leon (Mexico). Type in Coll. Calvert.

*A. bipunctulata.*

(Plate 2, Figs. 19, 19 a.)

*Agrion bipunctulatum* HAGEN, Syn. Neur. N. Am., p. 90 (1861).  
*Argia bipunctulata* SELYS, *Argia*, p. 415 (43) (1865). CALVERT, Trans. Am. Ent. Soc., xx. p. 234 (1893). ♂ ♀.  
*Argia bipustulata* KIRBY, Cat. Odon., p. 139 (1890).

Hab.: New York to Florida (specimens from North Carolina, by Morrison, are in the M. C. Z.).

Types in M. C. Z.

*A. calida.*

(Plate 1, Figs. 13, 13 a.)

*Agrion calidum* HAGEN, Syn. Neur. N. Am., p. 93 (1861) (♂ only).  
*Argia calida* SELYS, *Argia*, p. 390 (18) (1865). CALVERT, B. C. A., p. 75 (1902). ♂.

Hab.: Tampico (Mexico). Types ♂ in M. C. Z.

*A. chelata.*

CALVERT, B. C. A., pp. 71, 88, pl. iv. ff. 47, 47 s (apps. ♂) (1901-'02). ♂.

Hab.: Irazu (Costa Rica). Type in Coll. R. McLachlan, London.

*A. Claussenii.*

(Plate 2, Figs. 1, 1 a.)

SELYS, Argia, p. 386 (14) (1865). ♂ ♀.

Hab.: Minas Geraes (Brazil). Types in Colls. Selys, M. C. Z.

*A. collata.*

(Plate 2, Fig. 10 a.)

SELYS, Argia, p. 395 (23) (1865). ♂ ♀.

Hab.: Para (Brazil), Surinam. Types ♂ in Coll. Selys, ♀ in Mus., Berlin.

*A. concinna.*

(Plate 2, Figs. 16, 16 a.)

*Agrion concinnum* RAMBUR, Névr., p. 270 (1842).

*Argia concinna* SELYS, Argia, p. 391 (19) (1865). ♂ ♀.

Hab.: Cape of Good Hope. Types in Coll. Selys. No one appears yet to have confirmed or disproven this anomalous habitat.

*A. croceipennis.*

(Plate 2, Figs. 4, 4 a.)

SELYS, Argia, p. 393 (21) (1865). ♂ ♀.

Hab.: Brazil. Types in Coll. Selys.

*A. cupraurea.*

CALVERT, B. C. A., pp. 71, 85, pl. iv. ff. 24 (mest. lam. ♀), 42 (apps. ♂) (1901-'02).  
♂ ♀.

Hab.: Panama, Venezuela. Types in Coll. Calvert.

**A. cuprea.**

(Plate 1, Figs. 8, 8a.)

*Agrion cupreum* HAGEN, Syn. Neur. N. Am., p. 96 (1861).*Argia cuprea* SELYS, *Argia*, p. 407 (35) (1865). CALVERT, B. C. A., p. 84, pl. iv. ff. 22 (mest. lam. ♀), 41, 41 s (apps. ♂) (1902). ♂ ♀.Nec. *A. cuprea* CALVERT, Proc. Calif. Acad. Sci. (2), iv. p. 479 (1895).

Hab.: Mexico, Guatemala. Type in M. C. Z.

**A. deami.**

CALVERT, B. C. A., pp. 71, 90, pl. iv. ff. 13 (mest. lam. ♀), 52, 52 s (apps. ♂) (1901-'02). ♂ ♀.

Hab.: Mexico. Types in Colls. Adams, Deam.

**A. difficilis.**SELYS *Argia*, p. 413 (41) (1865). CALVERT, B. C. A., p. 84, pl. iv. f. 15 (mest. lam. ♀) (1902). ♀.

Hab.: Panama, Venezuela, Ecuador, Peru. Type in Coll. Selys.

**A. dimissa.**

(Plate 2, Fig. 9a.)

SELYS, *Argia*, p. 388 (16) (1865). ♂ ♀.

Hab.: Tijuca (Brazil). Types in Coll. Selys.

**A. eliptica.**

(Plate 1, Figs. 15, 15a.)

SELYS, *Argia*, p. 393 (21) (1865). ♂. (♀?).

Hab.: Brazil. Type in Coll. Selys.

**A. extranea.**

(Plate 1, Figs. 6, 6a.)

*Agrion extraneum* HAGEN, Syn. Neur. N. Am., p. 92 (1861).*Argia extranea* SELYS, *Argia*, p. 399 (27) (1865). CALVERT, Proc. Calif. Acad. Sci., (3), Zool. i. p. 380, pl. xxv. f. 8 (apps. ♂) (1899); B. C. A., p. 92, pl. iv. ff. 3, 4 (mest. lams. ♀), 56, 56 s, 56 i, 56 ii (apps. ♂) (1902). ♂ ♀.? *Argia variabilis* SELYS, *Argia*, p. 406 (34) (1865) (♀ only).

Hab.: Mexico, Guatemala, Costa Rica, Colombia, Guiana. Type in M. C. Z.

*A. fissa.*

(Plate 2, Figs. 13, 13 a.)

SELYS, *Argia*, p. 401 (29) (1865). CALVERT, *Proc. Calif. Acad. Sci.* (3), *Zool.* i. p. 381, pl. xxv. f. 11 (apps. ♂) (1899); *B. C. A.*, p. 89, pl. iv. ff. 12 (mest. lam. ♂), 50, 50 s (apps. ♂) (1902). ♂ ♀.

Hab.: Mexico, Guatemala, Costa Rica, Colombia. Types in Coll. Selys.

*A. fumigata.*

SELYS, *Argia*, p. 394 (22) (1865) ♀.

Hab.: Essequibo (Guiana). Type in Mus. Copenhagen.

*A. fumipennis.*

(Plate 1, Figs. 18, 18 a, 18 b, 18 c.)

*Agrion fumipenne* BURMEISTER, *Handb. Ent.*, ii. p. 819 (1839). HAGEN, *Syn. Neur. N. Am.*, p. 97 (1861). CALVERT, *Trans. Am. Ent. Soc.*, xxv. p. 38 (1898).

*Argia fumipennis* SELYS, *Argia*, p. 403 (31) (1865). ♂ ♀.

*Argia obscura* RAMBUR, *Névr.*, p. 256, pl. viii. f. 1 (entire insect) (1892).

Hab.: Kentucky, Georgia, Florida. Type ♀ in M. C. Z.

*A. funebris.*

(Plate 1, Figs. 4, 4 a.)

*Agrion funebre* HAGEN, *Syn. Neur. N. Am.*, p. 92 (1861).

*Argia funebris* SELYS, *Argia*, p. 398 (26) (1865). CALVERT, *B. C. A.*, p. 97, pl. iv. f. 59 (1902). ♂.

Hab.: Mexico. Type in M. C. Z.

*A. harknessi.*

CALVERT, *Proc. Calif. Acad. Sci.* (3), *Zool.* i. p. 378, pl. xxv. f. 6 (apps. ♂) (1899); *B. C. A.*, p. 87, pl. iv. ff. 21 (mest. lam. ♀), 45, 45 i (apps. ♂) (1902). ♂ ♀.

Hab.: Western slopes of Mexico. Types in Coll. Calif. Acad. Sci.

*A. herberti.*

CALVERT, *B. C. A.*, pp. 70, 82, pl. iv. ff. 37, 37 s (apps. ♂) (1901-'02). ♂.

Hab.: Guerrero (Mexico). Type in Coll. Godman.

**A. immunda.**

(Plate 2, Figs. 12, 12 a.)

*Agrion immundum* HAGEN, Syn. Neur. N. Am., p. 93 (1861).*Argia immunda* SELYS, Argia, p. 401 (29) (1865). CALVERT, B. C. A., p. 97, pl. iv. ff. 60, 60 s (apps. ♂) (1902). ♂ ♀.? *Argia vivida* SELYS, Argia, p. 406 (34) (1865) (♀ only).

Hab.: Texas, Mexico. Types in M. C. Z.

**A. impura.**

RAMBUR, Névr., p. 255 (1842). SELYS, Argia, p. 397 (25) (1865). ♂ (♀ ?).

Hab.: North America (?) ♂, Amazon (♀). Types in Coll. Selys.

**A. inculta.**

(Plate 2, Figs. 18, 18 a.)

HAGEN in SELYS, Argia, p. 400 (28) (1865). ♂.

Hab.: Lima (Peru). Type in Mus. Copenhagen.

**A. indicatrix.**

CALVERT, B. C. A., pp. 70, 73, 82, pl. iv. ff. 8 (mest. lam. ♀), 38, 38 s (apps. ♂) (1901-'02). ♂ ♀.

? *Argia tinctipennis* KIRBY, Ann. Mag. N. H., (7) iii. p. 371 (1899).

Hab.: Southern Mexico, Nicaragua. Types in Colls. Godman and U. S. Nat. Mus.

**A. infumata.**

(Plate 1, Figs. 11, 11 a.)

SELYS, Argia, p. 392 (20) 1865. ♂ ♀.

Hab.: Para. Types in Coll. Selys.

**A. insipida.**

(Plate 1, Figs. 3, 3 a.)

HAGEN in SELYS, Argia, p. 389 (17) (1865). KIRBY, Ann. Mag. Nat. Hist. (6), xiv. p. 268 (1894). ♂ (♀ ?).

Hab.: Guiana, St. Vincent, and Grenada (West Indies). Type in M. C. Z.



**A. jocosa.**

SELYS, *Argia*, p. 408 (36) (1865). ♂.

Hab.: Bogota. Type in M. C. Z.

**A. kurilis.**

HAGEN in SELYS, *Argia*, p. 400 (28) (1865). ♀.

Hab.: Kurile Is. Type in M. C. Z.

**A. lacrymans.**

*Agrion lacrymans* HAGEN, *Syn. Neur. N. Am.*, p. 95 (1861).

*Argia lacrymans* SELYS, *Argia*, p. 386 (14) (1865). CALVERT, *B. C. A.*, p. 88, pl. iv.  
ff. 16 (mest. lam. ♀), 49, 49 s (apps. ♂) (1902). ♂ ♀.

Hab.: Mexico. Types ♀ in M. C. Z.

**A. lilacina.**

(Plate 2, Figs. 17, 17a.)

SELYS, *Argia*, p. 405 (33) (1865). ♂ ♀.

Hab.: Brazil. Types in Coll. Selys.

**A. medullaris.**

(Plate 1, Figs. 2, 2a.)

HAGEN in SELYS, *Argia*, p. 412 (40) (1865). ♂. CALVERT, *B. C. A.*, p. 92, pl. iv.  
ff. 6 (mest. lam. ♀) 54, 54 s (apps. ♂) ? (1902).

Hab.: Bogota. Type in M. C. Z. Calvert, *l. c.*, suggests the identity of this species and *variabilis*.

**A. modesta.**

(Plate 2, Figs. 5, 5a.)

SELYS, *Argia*, p. 388 (16) (1865). ♂ ♀.

Hab.: Brazil, Trinidad (HART, *Ann. Rep. Roy. Botan. Gard., Trinidad*, June, 1891, p. 9). Types in Coll. Selys.

**A. moesta.**

*Agrion moestum* HAGEN, Syn. Neur. N. Am., p. 94 (1861).

*Argia moesta* SELYS, Argia, p. 384 (12) (1865). CALVERT, B. C. A., p. 76, pl. iv. ff. 20 (mest. lam. ♀), 29, 29s (apps. ♂) (1902). ♂ ♀.

Hab.: Texas, Arizona, Northern Mexico. Types in M. C. Z.

*Var. putrida.*

(Plate 2, Figs. 15, 15a.)

*Agrion putridum* HAGEN, Syn. Neur. N. Am., p. 96 (1861).

*Argia putrida* SELYS, Argia, p. 385 (13), 1865. CALVERT, Trans. Am. Ent. Soc., xx. p. 232 (1893). KELLCOTT, Jour. Cincin. Soc. Nat. Hist., xvii. p. 202 (1895); Odon. Ohio, p. 23 (1899). WILLIAMSON, 24th Rep. Dept. Geol. Indiana, p. 261, pl. iv. f. 2 (1st leg.), pl. vii. f. 7 (apps. ♂) (1900).

Hab.: Quebec to Virginia, west to Wisconsin and Illinois; Florida, Arkansas, Texas. Types in M. C. Z.

**A. mollis.**

(Plate 1, Figs. 14, 14a.)

HAGEN in SELYS, Argia, p. 398 (26) (1865). ♂.

Hab.: Minas Geraes (Brazil). Type in Coll. Selys.

*munda* = var. *vivida*, *q. v.*

*nahuana* = var. *agrioides*, *q. v.*

**A. oculata.**

(Plate 1, Figs. 12, 12a.)

HAGEN in SELYS, Argia, p. 409 (37) (1865). CALVERT, B. C. A., p. 81, pl. iv. ff. 11 (mest. lam. ♀), 36, 36s, 36i, 36ii (apps. ♂) (1902). ♂ ♀.

Hab.: Mexico to Venezuela. Type ♂ in M. C. Z.

**A. oenea.**

HAGEN in SELYS, Argia, p. 407 (35) (1865). CALVERT, Proc. Calif. Acad. Sci., (2) iv. p. 481, pl. xv. ff. 21, 22 (apps. ♂) (1895); B. C. A., p. 85, pl. iv. ff. 10 (mest. lam. ♀), 43, 44, 44s (apps. ♂) (1902). ♂ ♀.

Hab.: Mexico, Guatemala, Colombia (?) Type ♂ in M. C. Z.

**A. optata.**

(Plate 1, Figs. 19, 19 a.)

HAGEN in SELYS, *Argia*, p. 390 (18) (1865). ♂.

Hab.: Obi (Molluccas). Type in Mus. Leyden. This species, whose appendages seem to indicate some other relationship than *Argia*, has been suggested to belong to *Onychargia* by SELYS, *Ann. Mus. Genova*, xiv. pp. 316, 317. One also thinks of the legion *Platycnemis*, SELYS, near *Coelliccia*, KIRBY (*Trichocnemis* SELYS).

**A. orichalcea.**

(Plate 1, Figs. 7, 7 a.)

HAGEN in SELYS, *Argia*, p. 408 (36) (1865). ♂ ♀. KIRBY, *Ann. Mag. Nat. Hist.*, (7), iii. p. 371 (1899). CALVERT, *B. C. A.*, pp. 71, 86 (1902).  
*A. cupreum*, var. HAGEN, *Syn. Neur. N. Am.*, pp. 97, 312 (1861).

Hab.: Panama, Venezuela. Types in M. C. Z.

**pallens** = var. **violacea**, *q. v.***A. percellulata.**

CALVERT, *B. C. A.*, pp. 70, 72, 74, pl. iv. ff. 5 (mest. lam. ♀), 27 (apps. ♂) (1901-'02). ♂ ♀.

Hab.: Vera Cruz (Mexico). Types in Coll. Godman.

**plana** = var. **vivida**, *q. v.***A. popoluca.**

CALVERT, *B. C. A.*, pp. 70, 73, 82, pl. iv. ff. 8 (mest. lam. ♀), 38, 38 s (apps. ♂) (1901-'02). ♂ ♀.

Hab.: Tabasco (Mexico). Types in Coll. Godman.

**A. pulla.**

(Plate 1, Figs. 16, 16 a.)

HAGEN in SELYS, *Argia*, p. 410 (38) (1865). KIRBY, *Ann. Mag. Nat. Hist.* (7), iii. p. 371 (1899). CALVERT, *Proc. Calif. Acad. Sci.* (3), *Zool.*, i. p. 382, pl. xxv. f. 4 (apps. ♂) (1899); *B. C. A.*, p. 79, pl. iv. ff. 33, 33 s, 33 ss (apps. ♂) (1902).

Hab.: Mexico to Venezuela. Types in Colls. M. C. Z., SELYS.

*A. putrida* = variety of *moesta*, *q. v.*

*A. reclusa.*

(Plate 2, Figs. 20 a, 20 b.)

SELYS, *Argia*, p. 395 (23) (1865). ♂.

Hab.: Para. Type in Coll. Selys.

*A. rhoadsi.*

CALVERT, B. C. A., pp. 72, 92, pl. iv. ff. 55, 55 s (apps. ♂) (1901-'02). ♂.

Hab.: Nuevo Leon (Mexico). Type in Coll. Godman.

*A. rogersi.*

CALVERT, B. C. A., pp. 70, 83, pl. iv. ff. 40, 40 s (apps. ♂) (1901-'02). ♂.

Hab.: Costa Rica. Type in Coll. Godman.

*A. sedula.*

(Plate 1, Figs. 10, 10 a.)

*Agrion sedulum* HAGEN, *Syn. Neur. N. Am.*, p. 94 (1861).

*Argia sedula* SELYS, *Argia*, p. 411 (39) (1865). KELLICOTT, *Jour. Cincin. Soc. Nat. Hist.*, xvii. p. 203 (1895); *Odon. Ohio*, p. 27 (1899). WILLIAMSON, 24th Ann. Rep. Dept. Geol. Indiana, p. 263 (1900). CALVERT, B. C. A., p. 78, pl. iv. ff. 7 (mest. lam. ♀) 32 (apps. ♂) (1902). ♂ ♀.

Hab.: Virginia, Ohio, Indiana, Arkansas, Texas, Arizona, Nuevo Leon (Mexico). Types in M. C. Z.

*A. serva.*

(Plate 2, Figs. 2, 2 a.)

HAGEN in SELYS, *Argia*, p. 387 (15) (1865). ♂ ♀.

Hab.: Brazil. Types ♂ in M. C. Z., ♀ in Mus. Berlin.

*A. sordida.*

(Plate 1, Fig. 20; Plate 2, Figs. 3, 3 a, 23.)

HAGEN in SELYS, *Argia*, p. 387 (15) (1865). ♂ ♀.

Hab.: Brazil, Buenos Aires. Types in M. C. Z.

**A. tarascana.**

CALVERT, B. C. A., pp. 71, 74, 90, pl. iv. ff. 14 (mest. lam. ♀), 51, 51 s (apps. ♂)  
(1901-'02). ♂ ♀.

Hab.: Mexico. Types in Colls. Godman, U. S. Nat. Mus., Adams, Calvert.

**A. tezpi.**

CALVERT, B. C. A., pp. 70, 73, 77, pl. iv. ff. 19 (mest. lam. ♀), 31, 31 s (apps. ♂)  
(1901, '02). ♂ ♀.

*Argia cupraea* CALVERT, Proc. Calif. Acad. Sci., (2) iv. p. 479, pl. xv. f. 12 (apps.  
♂) (1895).

Hab.: Lower California, western slopes of Mexico. Types in Colls. Godman,  
Calif. Acad. Sci., McLachlan, Calvert.

**A. thespis.**

(Plate 2, Figs. 11, 11 a.)

HAGEN in SELYS, *Argia*, p. 397 (25) (1865). ♂ ♀.

Hab.: Bahia (Brazil). Types in M. C. Z.

**A. tibialis.**

(Plate 2, Figs. 7, 7 a, 8, 8 a.)

*Platynemis tibialis* RAMBUR, Névr., p. 241 (1842).

*Trichocnemis tibialis* SELYS in SAGRA, Ins. Cuba, p. 464 (1857). HAGEN, Syn. Neur.  
N. Am., p. 72 (1861).

*Argia tibialis* SELYS, *Argia*, p. 413 (41) (1865). CALVERT, Trans. Am. Ent. Soc.,  
xx. p. 233 (1893). KELLCOTT, Odon. Ohio, p. 26 (1899). WILLIAMSON,  
24th Rep. Dept. Geol. Indiana, p. 263, pl. vii. f. 8 (apps. ♂) (1900).

*Agrion fontium* HAGEN, Syn. Neur. N. Am., p. 91 (1861).

*Agrion binotatum* WALSH, Proc. Acad. Nat. Sci. Phila., 1862, p. 387.

Hab.: New Jersey to Florida, west to Michigan and Texas. (Specimens  
from Morganton, North Carolina, by MORRISON are in the M. C. Z.) Type  
in Coll. Selys.

**A. tinctipennis.**

(Plate 2, Figs. 6, 6 a.)

SELYS, *Argia*, p. 396 (24) (1865). ♂ ♀.

*A. tractipennis* KIRBY, Cat. Odon., p. 136 (1890).

Hab.: Amazon valley. Types in Coll. Selys. See also *A. indicatrix*, *supra*.

*A. tonto.*

CALVERT, B. C. A., pp. 71, 73, 89, pl. iv. ff. 17 (mest. lam. ♀), 48, 48 s (apps. ♂) (1901, '02). ♂ ♀.

Hab. : Arizona. Types in Coll. Calvert.

*A. translata.*

(Plate 1, Figs. 9, 9 a.)

HAGEN in SELYS, *Argia*, p. 410 (38) (1865). CALVERT, 27th Ann. Rep. New Jersey State Board Agric., Suppl., p. 68 (1900); B. C. A., p. 76, pl. iv. ff. 18 (mest. lam. ♀), 30, 30 s (apps. ♂) (1901, '02). ♂ ♀. GRAF, *Ent. News*, xiii. p. 113 (1902).

Hab. : New York to Venezuela. Types in M. C. Z.

*A. ulmea.*

CALVERT, B. C. A., pp. 70, 73, 80, pl. iv. ff. 9 (mest. lam. ♀) 34, 34 s, 34 i (apps. ♂) (1901, '02). ♂ ♀.

Hab. : Mexico, Honduras. Types in Colls. Calvert, Godman.

*A. variabilis.*

(Plate 1, Figs. 1, 1 a.)

SELYS, *Argia*, p. 406 (34) (1865) (♂ only). CALVERT, B. C. A., p. 91, pl. iv. f. 53 (apps. ♂) (1902). ♂ ♀.

Hab. : Mexico to Costa Rica. Types in Colls. Selys and M. C. Z. See also *A. medullaris* and *A. extranea*, *supra*.

*A. violacea.*

(Plate 1, Figs. 17, 17 a.)

*Agrion violaceum* HAGEN, *Syn. Neur. N. Am.*, p. 90 (1861).

*Argia violacea* SELYS, *Argia*, p. 404 (32) (1865). CALVERT, *Trans. Am. Ent. Soc.*, xx. p. 233 (1893). KELLICOTT, *Jour. Cincin. Soc. Nat. Hist.*, xvii. p. 203 (1895), *Odon. Ohio*, p. 25 (1899). WILLIAMSON, 24th Ann. Rep. Dept. Geol. Indiana, p. 262 (1900).

Hab. : Maine to Virginia, west to Michigan and Illinois; Texas, New Mexico. Types in M. C. Z.

*Var. pallens.*

CALVERT, B. C. A., pp. 72, 74, 98, pl. iv. ff. 25 (mest. lam. ♀), 61, 61 s (apps. ♂), (1901, '02).

Hab.: Arizona, Mexico. Types in Colls. Adams, Godman, Deam.

**A. vivida.**

(Plate 1, Figs. 5, 5 a.)

HAGEN in SELYS, *Argia*, p. 406 (34) (1865) (♂ only). CALVERT, *Proc. Calif. Acad. Sci.*, (2) iv. p. 478, pl. xv. f. 13 (apps. ♂) 1895; B. C. A., p. 94, pl. iv. ff. 1, 2 (mest. lam. ♀), 57, 57 s, 57 ss (apps. ♀) (1902). ♂ ♀.

Hab.: Montana to Vera Cruz; California, Lower California. Types in M. C. Z. See also *A. immunda*, *supra*.

*Var. plana.*

CALVERT, B. C. A., p. 96, pl. iv. f. 58 (apps. ♂) (1902). ♂ ♀.

Hab.: Arizona, Mexico. Types in M. C. Z.

*Var. munda.*

CALVERT, B. C. A., p. 96 (1902). ♂ ♀.

Hab.: Arizona, Mexico. Types in M. C. Z.

**A. wilsoni.**

CALVERT, B. C. A., pp. 70, 75, pl. iv. ff. 28, 28 s (apps. ♂). (1901, '02). ♂.

Hab.: Guatemala. Type in M. C. Z.

**ONYCHARGIA.**

HAGEN in SELYS, *Argia*, p. 416 (44) (1865). KIRBY, *Cat. Odon.*, p. 139 (1890).

Type: *O. atrocyana*.

**O. atrocyana.**

(Plate 2, Figs. 24, 24 a, 24 b.)

SELYS, *Argia*, p. 416 (44) (1865). ♂ ♀.

Hab.: Singapore, Sumatra, Borneo, Ceylon (KIRBY). Type in Coll. Selys.

**O. flavovittata.**

SELYS, Mitth. Mus. Dresden, iii. p. 321 (1878); Ann. Mus. Genov., xiv. p. 316 (1879). ♀.

ab. : New Guinea. Type ♀ in Coll. Selys.

**O. rubropunctata.**

SELYS, Mitth. Mus. Dresden, iii. p. 321 (1878); Ann. Mus. Genov. xiv. p. 315 (1879). ♂.

Hab. : New Guinea. Type ♂ in Coll. Selys.

**O. vittigera.**

SELYS, Argia, p. 417 (45) (1865). Ann. Mus. Genova (2), x. p. 508 (1891).  
KRÜGER, Stett. Ent. Zeit., 1898, p. 118.

Hab. : Sumatra, Java, Singapore, Birma, Sylhet (India). Type in Coll. Selys.



## EXPLANATION OF PLATES.

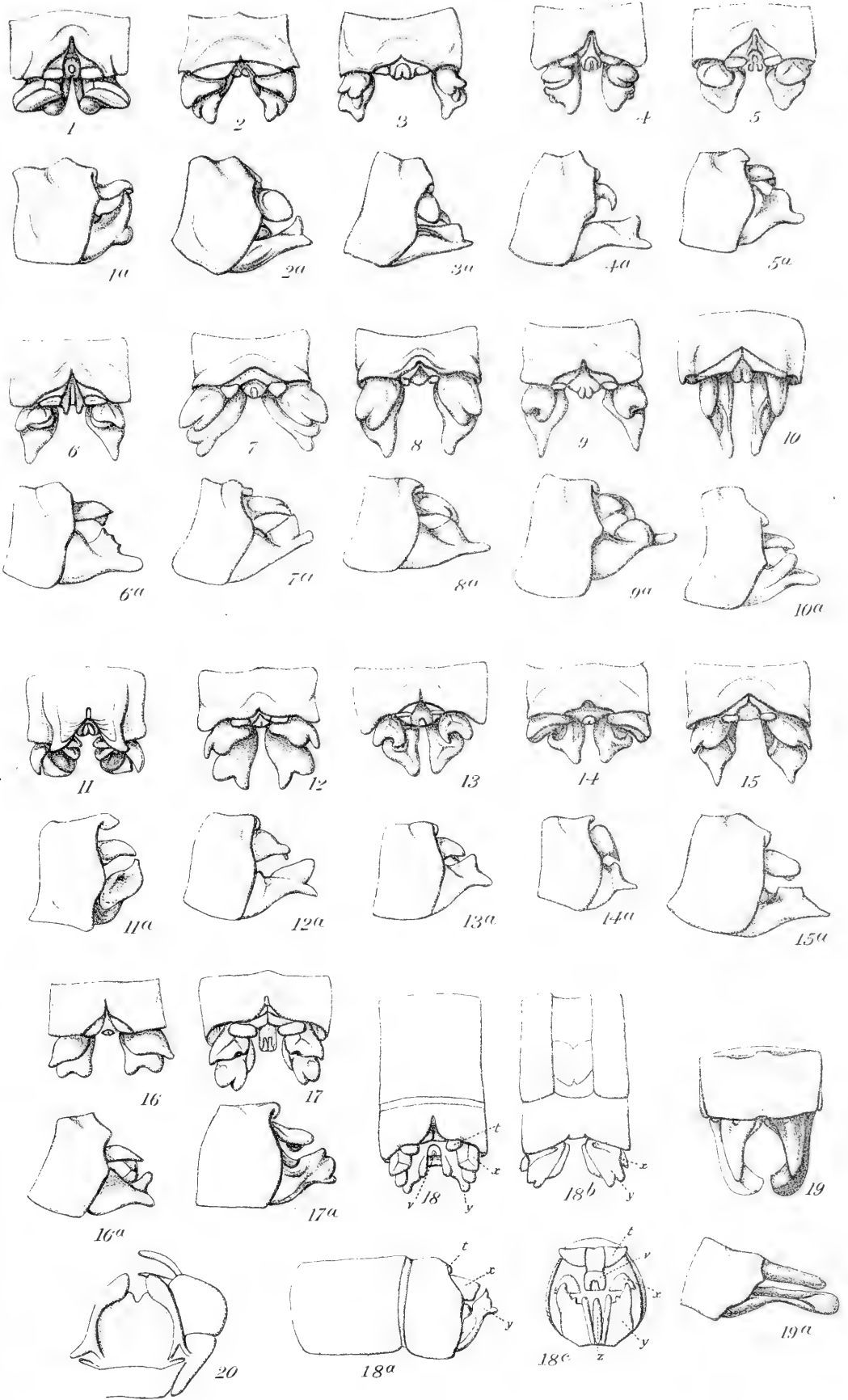
Except where otherwise stated, the figures represent the apex of the abdomen and the appendages of the males. For most species two views are given, a dorsal and a left profile; the former is designated by an arabic numeral, the latter by the same numeral, followed by the letter *a*.

## PLATE 1.

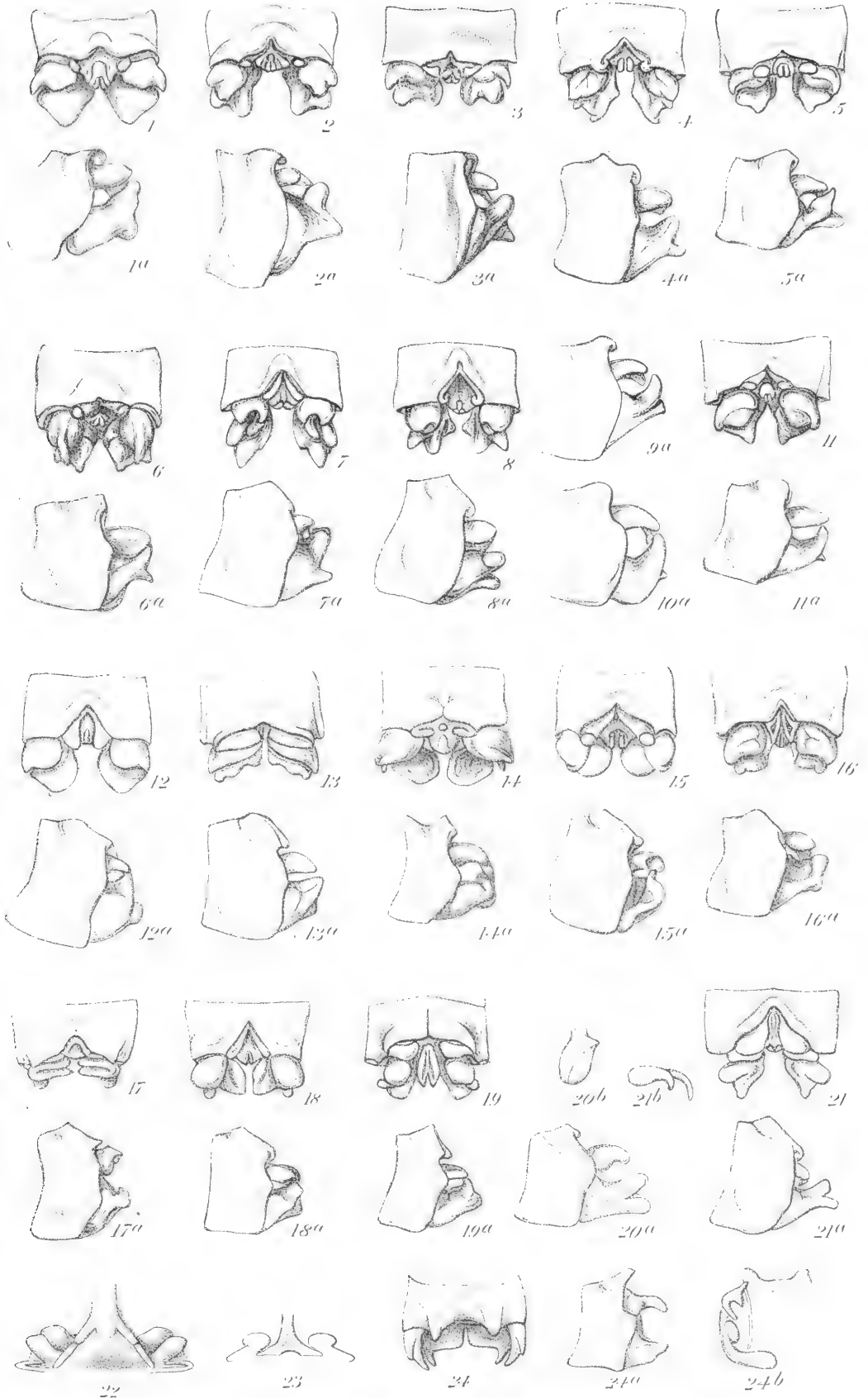
- Figs. 1, 1 *a*. *Argia variabilis*.  
 Figs. 2, 2 *a*. " *medullaris*.  
 Figs. 3, 3 *a*. " *insipida*.  
 Figs. 4, 4 *a*. " *funebri*.  
 Figs. 5, 5 *a*. " *vivida*.  
 Figs. 6, 6 *a*. " *extranea*.  
 Figs. 7, 7 *a*. " *orichalcea*.  
 Figs. 8, 8 *a*. " *cuprea*.  
 Figs. 9, 9 *a*. " *translata*.  
 Figs. 10, 10 *a*. " *sedula*.  
 Figs. 11, 11 *a*. " *infumata*.  
 Figs. 12, 12 *a*. " *oculata*.  
 Figs. 13, 13 *a*. " *calida*.  
 Figs. 14, 14 *a*. " *mollis*.  
 Figs. 15, 15 *a*. " *eliptica*.  
 Figs. 16, 16 *a*. " *pulla*.  
 Figs. 17, 17 *a*. " *violacea*.  
 Figs. 18, 18 *a*. " *fumipennis*, 18 *b*, ventral, and 18 *c*, posterior view of same: *t*, tubercle on posterior surface of tenth segment; *v*, appendix dorsalis of Heymons (Grundzüge der Entwicklung u. des Körperbaues von Odonaten u. Ephemeriden, Anhang Abhdl. königl. preus. Akad. Wiss. 1896) = "inferior appendage" of authors in the Odonata Anisoptera; *x*, superior appendage of authors (processus caudalis of Heymons); *y*, inferior appendage of authors (appendix lateralis of Heymons); *z*, anal aperture.  
 Figs. 19, 19 *a*. " *optata*.  
 Fig. 20. " *sordida*, major part of labium.

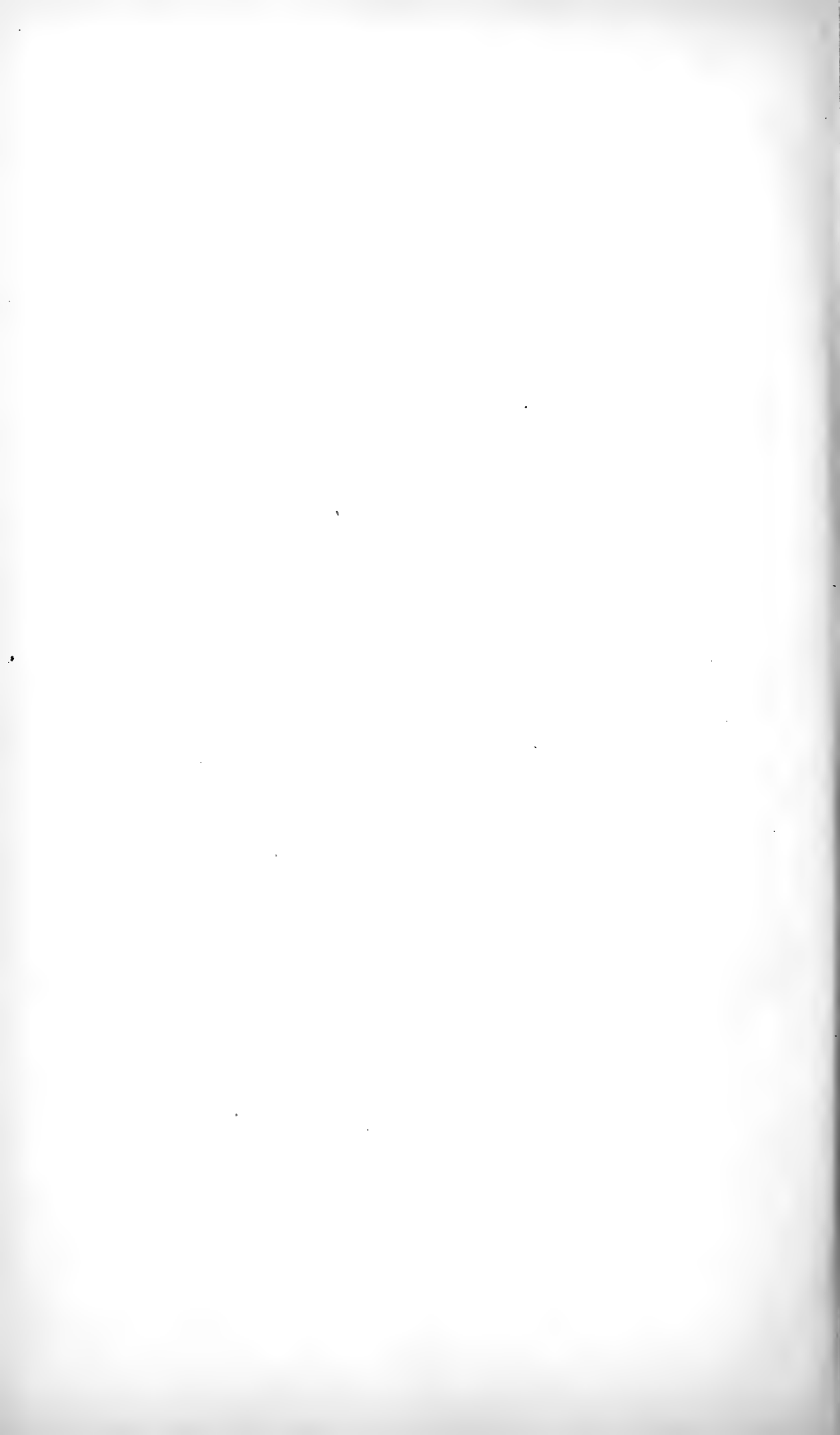
## PLATE 2.

- Figs. 1, 1 *a.* *Argia Claussenii*.  
 Figs. 2, 2 *a.* " *serva*.  
 Figs. 3, 3 *a.* " *sordida*.  
 Figs. 4, 4 *a.* " *croceipennis*.  
 Figs. 5, 5 *a.* " *modesta*.  
 Figs. 6, 6 *a.* " *tinctipennis*.  
 Figs. 7, 7 *a.* " *tibialis* (*fontium*).  
 Figs. 8, 8 *a.* " " (*binotatum*).  
 Fig. 9 *a.* " *dimissa*.  
 Fig. 10 *a.* " *collata*.  
 Figs. 11, 11 *a.* " *thespis*.  
 Figs. 12, 12 *a.* " *immunda*.  
 Figs. 13, 13 *a.* " *fissa*.  
 Figs. 14, 14 *a.* " *albistigma*.  
 Figs. 15, 15 *a.* " *putrida* (= variety of *moesta*).  
 Figs. 16, 16 *a.* " *concinna*.  
 Figs. 17, 17 *a.* " *lilacina*.  
 Figs. 18, 18 *a.* " *inculta*.  
 Figs. 19, 19 *a.* " *bipunctulata*.  
 Fig. 20 *a.* " *reclusa*; 20 *b.* dorsal view of a single superior appendage.  
 Figs. 21, 21 *a.* " *apicalis*; 21 *b.* end view of a single superior appendage.  
 Fig. 22. *Hyponeura lugens* ♀ "les lames du devant du thorax" (= mesostigmal laminae of Calvert).  
 Fig. 23. *Argia sordida* ♀, *ibid.*  
 Figs. 24, 24 *a.* *Onychargia atrocyana*; 24 *b.* end view of same showing the appendages of the left side only.









Bulletin of the Museum of Comparative Zoölogy

AT HARVARD COLLEGE.

VOL. XXXIX. No. 5.

---

CRABS FROM THE MALDIVE ISLANDS.

BY MARY J. RATHBUN.

WITH ONE PLATE.

CAMBRIDGE, MASS., U. S. A.:  
PRINTED FOR THE MUSEUM  
DECEMBER, 1902.





No. 5. — *Crabs from the Maldive Islands.*

BY MARY J. RATHBUN.

THIS collection, aside from a few land crabs and swimming crabs taken at the surface, was obtained in the lagoons of the Maldive atolls in depths of from sixteen to thirty fathoms by the expedition of Alexander Agassiz in 1901–1902. The majority come from Nallandu, Miladummadulu Atoll. Of a total of twenty-eight species, six species seem to be new. Major Alcock has described nearly all the known forms in his "Materials for a Carcinological Fauna of India;" therefore the references to synonymy are not repeated here except where different conclusions have been reached as to the identity of species.

It will be noted that our list furnishes several additions to the Land Crustaceans, Portunidæ, and Xanthidæ given by Borradaile in Gardiner's Fauna and Geography of the Maldive and Laccadive Archipelagoes, I. 1901–1902.

The drawings were made by Miss A. A. McKnew.

OCYPODIDÆ.

*Ocypode ceratophthalma* (PALLAS).

*Ocypoda ceratophthalma* ALCOCK, Journ. Asiatic Soc. Bengal, LXIX. 345, 1900, and synonymy.

*Ocypode ceratophthalma* BORRADAILE, Fauna Maldive Arch., I. part I. pp. 67 and 96, 1901.

Male, December 23; 2 young. Kolumadulu, December 30; 9 young.

*Uca tetragonon* (HERBST).

*Gelasimus tetragonum* ALCOCK, Journ. Asiatic Soc. Bengal, LXIX. 357, 1900, and synonymy.

Male, December 23; 5 males.

This species is subject to considerable variation in the following directions:—The front may be an oblong lobe, as figured by Milne Edwards,<sup>1</sup> or may be

<sup>1</sup> Ann. Sci. Nat. (3), XVIII. pl. III. fig. 9, 1852.

triangular and subacute, as represented by de Man ;<sup>1</sup> the outer margin of the beveled edge is more or less spatuliform. The granular line defining the lateral margin may be present for two-thirds the length of the margin or may be evident only near the antero-lateral angle, without regard to sex. In all the specimens I have examined (27 from 9 localities), the granules of the carpus of the large claw, though small, are visible to the naked eye. The inner surface of the palm is more or less coarsely granulate ; the immobile finger more or less strongly curved.

The color of the Maldive examples in alcohol is dark green or blue, with patches of yellow speckled with mulberry at the antero-lateral angles ; large cheliped yellow with large brick-red patch at base of pollex ; smaller cheliped and legs light mulberry.

### **Macrophthalmus verreauxi** MILNE EDWARDS.

*Macrophthalmus verreauxi* ALCOCK, Journ. Asiatic Soc. Bengal, LXIX. 377, 1900, and synonymy.

Gan Island, Addu Atoll, at anchorage, 20 fathoms, January 6 ; one female, 13.5 mm. wide, and 9.1 mm. long, in which the eyes project beyond the carapace for *more than half* ( $\frac{57}{100}$ ) of their length.

### **Goneplax maldivensis**, sp. nov.

**Figs. 3-5.**

The length of the carapace is nearly two-thirds of its greatest width. The lateral margins are provided with a strong acute tooth at their anterior fourth, which projects outwardly beyond the antero-lateral angle.

Front wider than orbit, margin sinuous, with a shallow median tooth and a notch at the outer angle in which the antenna is lodged ; an impressed line just above the margin.

The supra-orbital margin is sinuous and slopes backward and outward ; its outer angle is blunt.

The posterior width of the carapace is nearly three-fourths of the fronto-orbital width.

The surface is punctate under the lens, and closely covered with finer wrinkles. The H-shaped depression in the centre is very shallow.

The eyes almost attain the outer angle of the orbit, the cornea is light-colored in alcohol, and on the under side extends one-half the length of the stalk.

The lower margin of the orbit has a shallow lobe near its middle.

The antero-external angle of the merus of the outer maxillipeds is produced, the anterior margin is excavate.

<sup>1</sup> Notes Leyden Mus., XIII. pl. II. fig. 6, 1891.

The chelipeds are massive, unequal; the larger one is about twice as long as the carapace. The upper margin of the merus has a few denticles and a blunt subterminal tooth; the posterior margin and inferior surface are crossed by a subterminal groove. The inner angle of the carpus forms a blunt, almost rectangular tooth. The palm is nearly as wide as the length of its upper margin; the dactylus is shorter than that margin in the larger cheliped, and longer in the smaller one. The lower margin of the propodus has a shallow sinus between palm and finger. The fingers are broad, white, not gaping, occludent margins irregularly dentate, tips crossing, outer and inner surface each with two lines of larger punctæ.

The surface of the chelipeds is similar to that of the carapace except that the fine wrinkles are interrupted by minute transverse irregular smooth patches.

The merus joints of the ambulatory legs are devoid of a spine on the upper margin. The propodus and dactylus of the last pair are considerably shorter and broader than in the three preceding; the propodus is wider than half of its length measured on the anterior margin; the dactylus is straight, not curved, on its anterior margin.

The first segment of the abdomen of the male is hidden under the carapace; the second is narrowed at the sides and does not fully cover the sternum; the third reaches the coxæ of the fifth pair of legs; the remaining segments are very narrow, the terminal one much longer than broad.

*Dimensions.* — Length of carapace, 5.1 mm.; width at exorbital angles, 7.5 mm.; greatest width, 7.8 mm.; posterior width, 5.5 mm.; width of front between the antennal notches, 2.5 mm.; width of front between the supra-orbital margins, 3.4 mm.

*Type locality.* — Gan Island, Addu Atoll, at anchorage, 20 fathoms, January 6; one male.

This species differs from *G. rhomboides* (Linnaeus) of Europe, in its wider front and shorter eyes, in the carapace being widest at the line of the lateral teeth, in the absence of a spine from the legs, in the much narrower abdomen of the male.

## GRAPSIDÆ.

### *Metasesarma rousseauxi* MILNE EDWARDS.

*Metasesarma rousseauxii* ALCOCK, Journ. Asiatic Soc. Bengal, LXIX. 427, 1900, and synonymy.

*Metasesarma rousseauxi* BORRADAILE, Fauna Maldive Arch., I. part I. pp. 68 and 97, 1901.

Marco, Fadiffolu Atoll, at anchorage; one male, one female with ova. In the male, 9.2 mm. long by 10.2 mm. wide, the fingers when apposed, gape except at the tips.

## GECARCINIDÆ.

*Epigrapsus politus* HELLER.

*Epigrapsus politus* ALCOCK, Journ. Asiatic Soc. Bengal, LXIX. 443, 1900, and synonymy.

Marco, Fadiffolu Atoll, at anchorage; one small male 7.8 mm. long and 9.5 mm. wide, in which the lateral tooth is faintly indicated.

## PALICIDÆ.

*Palicus jukesii* (WHITE).

*Palicus jukesii* ALCOCK, Journ. Asiatic Soc. Bengal, LXIX. 451, 1900, and synonymy. CALMAN, Trans. Linn. Soc. London (2), Zool., VIII. 29. pl. I. figs. 9-13, 1900.

Hanimadu, Tiladummati Atoll, at anchorage, 16 fathoms, January 19; one female with ova.

Nallandu Island, Miladummadulu Atoll, at anchorage, 24 fathoms, January 18; one immature male.

*Palicus contractus*, sp. nov.

Figs. 7-8.

Carapace wider anteriorly than posteriorly, and about as long as its width measured between the bases of the third and fourth pairs of legs.

Surface thrown into five transverse wrinkles; the first depression runs directly across the carapace just behind the orbits; the second is the cervical suture; the third is parallel to, and not far from, the second, the fourth is behind the cardiac region. There is a short deep longitudinal depression either side of the mesogastric area. The surface is covered with scabrous granules which are larger on the more elevated portions.

Front cut into two broad rounded lobes. Antero-lateral border with three teeth, including the orbital angle, the third rudimentary. Second tooth projecting laterally more than the first. Behind the second tooth, the margins are sinuous and convergent. Posterior border raised, entire.

Upper border of the orbit with two notches, the inner one the deeper; anterior margins of inner and outer orbital angles concave; lower border with two broad and deep notches. The end of the basal joint of the antenna forms a large lobe visible in a dorsal view, either side of the front. There are three lobules on the eye-stalk, and a large bilobed one at the antero-external angle

of the buccal cavern. The two ridges on the ischium of the outer maxillipeds are further apart than in *P. jukesii*.

The chelipeds of the immature male are equal and very slender, scarcely stouter than the last pair of legs, and about as long as the carapace. The palm is a little shorter than the ischium and nearly twice as long as the fingers, which are bent down, deeply grooved, and meet throughout their length.

In the first three pairs of legs the merus is stout and broad, with a granular dorsal surface and coarsely and unevenly serrulate edges, the anterior edge ending in a crest-like tooth. The carpus is dorsally bicarinate and its anterior border has the form of a two-lobed carina. The propodus and dactylus are edged with thin sharp carinæ, that on the anterior margin of the carina of the second and third pairs being plumed. The fourth pair are cylindrical and finely granular, the dactylus considerably shorter than the propodus, the latter having a posterior marginal border of setæ.

The first pair of ambulatory legs are a little longer, the fourth pair a little shorter, than the carapace, the second and third pairs about one and a half times as long as the carapace.

In the male all the abdominal terga except the last are transversely carinate, the carinæ of the second and third terga being most conspicuous. Also on either side of the sternum there are two crests, one behind the base of the last pair of legs, the other almost in a line with the third abdominal carina.

*Dimensions.* — Male, length of carapace, 6.4 mm.; width between outer orbital angles, 6.9 mm.; width between tips of next lateral teeth, 7.7 mm.; width between bases of second and third legs, 6 mm.

*Color.* — In alcohol there are traces of dark speckles; there is a larger circular spot on each protogastric region and each cardiac lobule.

*Type locality.* — Nallandu, at anchorage, 24 fathoms, January 18; two males, immature.

This species can be separated at sight from all others by the carapace being wider in front than behind.

## PILUMNIDÆ.

### *Carpilodes pediger* ALCOCK.

*Carpilodes pediger* ALCOCK, Journ. Asiatic Soc. Bengal, LXVII. 83, 1898. Illus. Zool. Investigator, Crust., part VII. pl. XXXVI. fig. 4, 1899.

Male, at anchorage, January 11; one male.

Nallandu, at anchorage, 24 fathoms, January 18; two females, one with ova.

The specimens are all small, the female with ova measuring 3.7 mm. long and 5.8 mm. wide; its carapace is a light yellowish red in alcohol, with lateral teeth gray and mottlings of gray on the posterior half.

***Actæa spinosissima* BORRADAILE.**

*Actæa spinosissima* BORRADAILE, Fauna Maldive Arch., I. part 3. p. 256. fig. 55, 1902.

Nallandu, at anchorage, 24 fathoms, January 18; two young.

***Xanthias alcocki*, sp. nov.**

**Figs. 9-10.**

The surface of the carapace is granular, the granules coarse on the anterior and antero-lateral portions, very fine on the posterior part. Fronto-orbital region marked off by a sinuous groove. Regions well delimited. There is a short transverse crest on each epigastric, protogastric, hepatic and anterior branchial region.

The front is marked by a double edge, the lower or true edge not visible in a strictly dorsal view, outer angle very slightly marked. Notches of supra-orbital margin minute.

Antero-lateral margin cut into four teeth besides the inconspicuous outer angle of the orbit; the first and fourth teeth are very small, the second and third of good size, triangular, the tip of the second pointing a little forward, the third directed outward. A subhepatic protuberance is visible between the orbital and the first antero-lateral tooth.

The chelipeds in the female are nearly equal, stout, less than twice the length of the carapace. Outer surface covered with scaly granules. Merus nearly hidden under the carapace, margins finely serrulate. Carpus with a few larger granules. Granules of hand larger above than below, some of them disposed to form longitudinal rows. Fingers rather long, deflexed, grooved, tips crossing; light brown in alcohol, the color on the pollex not reaching quite to the palm; dactylus of right or larger hand with a large tooth at its base.

Ambulatory legs finely granular; upper margins of meral and carpal joints serrulate. Dactyli pubescent, propodal joints sparsely so.

*Dimensions.* — Length of carapace of female, 3 mm.; width, 4.4 mm.

*Type locality.* — Nallandu, 24 fathoms, at anchorage, January 18; one mature and one young female.

***Pilumnus woodworthi*, sp. nov.**

**Figs. 11-12.**

Carapace nearly three-fourths as long as broad, deeply areolated, covered with a short dense pubescence mixed with longer hairs; when this is removed, fine granules may be seen on the anterior portion of the gastric region and

towards the antero-lateral margin. The frontal and orbital region is set off by a sinuous groove.

Fronto-orbital width greater than length of carapace; front divided by a deep median notch into two broad oblique rounded lobes having at their outer ends a small triangular tooth.

The superior margin of the orbit has two triangular notches, the outer one much the larger; a broad gap below the outer angle. No subhepatic tooth. Antennal flagellum sparingly fringed with hair.

The lateral margin is cut into three teeth besides the outer orbital; the last one has a spinule at the extremity.

Chelipeds unequal. Chelipeds and legs pubescent and hairy, except the lower distal portion of the larger palm which is bare, and also the extremity of the digits. The surface of the wrist is smooth except toward the inner angle where it is spinulose; the angle itself is tipped by a small spine. The outside of the palms is covered with subacute granules or tubercles arranged largely in rows, and becoming smaller toward the lower margin; similar granules ornament the fingers except towards the end. The thumb is short, in the large cheliped shorter than its height.

The legs are rather broad, pubescent, and beset with long hairs on the margins.

*Dimensions.* — Length of mature female, 5.4 mm.; width, 7.6 mm.; fronto-orbital width, 6 mm.; lower width of front, 2.9 mm.

*Type locality.* — Nallandu, at anchorage, 24 fathoms, January 18; one female.

This species is near *P. sluiteri* de Man,<sup>1</sup> but is distinguished by its wider carapace, relatively wider across the front and orbits, forming straighter sides, its deeper areolation and shorter immovable finger.

### *Pilumnus hirsutus* STIMPSON?

*Pilumnus hirsutus* STIMPSON, Proc. Acad. Nat. Sci. Phila., X. 37 [34], 1858. Not *P. hirsutus* HASWELL, 1882, nor BORRADAILE, Proc. Zool. Soc. London, 1900, p. 581. pl. XLII. fig. 9, and Fauna Maldives Arch., I. pt. III. 245, 1902.

One young specimen, 3.2 mm. wide, from the centre of Male Lagoon, 30 fathoms (December 26), seems to be nearer *P. hirsutus* than any other species.

The following is Stimpson's description extracted from his unpublished report on the Crustacea of the North Pacific Exploring Expedition:

"Body and feet hirsute above, not very thickly, with setæ of variable but moderate length. Carapax scarcely areolate, broad; proportion of length to breadth, 1: 1.43; surface nearly smooth. Antero-lateral margin short, with four sharp teeth, including the angle of the orbit; no subhepatic tooth. Inferior margin of orbit denticulated. Eyes with rather long peduncles. Front emarginate, with a row of long setæ just above the margin. Chelopoda rather small; larger hand

<sup>1</sup> See Alcock, Journ. Asiatic Soc. Bengal, LXVII. 194, 1898.

irregularly tuberculose above, smooth below; smaller hand (the left one) spinulose above, and sparsely granulose on the outer side; fingers pale brownish.

"Color a clear light brick-red. Beneath pale red; sternum white. Fingers with brown tips. Eyes straw-colored. Dimensions of a female;—length of carapax, 0.31; breadth, 0.43 inch.

"The carapax of the specimen taken at Ousima is more swollen than that of the others, and less hairy;—there are a few tufts of long hairs, 4 or 6 to each tuft; two on the gastric region are most conspicuous.

"De Haan's description of his *P. minutus* (Fauna Japonica, Crust. p. 50) applies very well to our species; but his figure (Pl. III. f. 2) is by no means a good representation of it. The body in that figure is smooth, the feet very slender and little hairy. The postero-lateral margin is represented as convex, while it is rather concave in our species.

"Dredged in the Northern China Sea, from a shelly bottom in twenty fathoms. Also found among dead corals taken from a sandy bottom in 30 fathoms off the east coast of Ousima. A single specimen, probably of this species, was taken at the Bonin Islands."

In 1896, the "Albatross" collected in Hakodate Bay, Japan, 11½ fathoms (station 3656), a single male, 5.5 × 7.3 mm., which is referred here. The lobes of the front are oblique, finely denticulate, and at their outer end there is a small spine. The tubercles of the palms are arranged somewhat in rows and are sharp—rather stout spines than tubercles. Wrists also spinous. The ambulatory legs have a few spines on anterior margin of merus.

The young *Pilumnus* from Male agrees in all respects with the male from Hakodate Bay, as far as its size permits, except that the tubercles of the larger palm extend a little lower down on its outer surface.

I am not sure that this is the *P. hirsutus* of Alcock, described as having frontal lobes shaped as in *P. vespertilio*.

## PORTUNIDÆ.

### *Portunus sanguinolentus* (HERBST).

*Neptunus sanguinolentus* ALCOCK, Journ. Asiatic Soc. Bengal, LXVIII. 32, 1899, and synonymy.

West of Goadu, Miladummadulu Atoll, surface, January 19; one young male.

### *Portunus (Xiphonectes) longispinosus* (DANA).

*Neptunus (Hellenus) longispinosus* ALCOCK, Journ. Asiatic Soc. Bengal, LXVIII. 40, 1899, and synonymy. BORRADAILE, Fauna Maldive Arch., I. part I. p. 208, 1901.

Male, at anchorage, January 11; one mature female. In this specimen the median sinus of the front is shallower and broader than the submedian.



Two types (♂ and ♀) of Dana's *Xiphonectes longispinosus* are preserved in the Museum of Comparative Zoology. The surface of the carapace is very uneven, the frontal teeth rounded, the intervening sinuses shallow and of equal depth, a well-marked sinus below the outer orbital angle, the inner suborbital angle rounded, the merus of the maxilliped reaches part way along the inner suborbital tooth. Width of male between tips of lateral spines, 14.2 mm., of female, 12.8 mm.

### *Thalamita oculea* ALCOCK.

*Thalamita oculea* ALCOCK, Journ. Asiatic Soc. Bengal, LXVIII. 76 and 91, 1899.  
Illus. Zool. Investigator, Crust., pt. VIII. pl. XLVIII. figs. 3. 3a, 1900.

Gan Island, Addu Atoll, 20 fathoms, at anchorage, January 6; one immature male.

Nallandu Island, 24 fathoms, at anchorage, January 18; one young.

In the male (5.9 mm. long), the fourth lateral tooth is much smaller than the fifth. That spine on the outer margin of the upper surface of the hand which is remote from the finger, though smaller than the other spines, is well marked. The length and breadth of the sixth abdominal somite are subequal.

In the young specimen the fourth lateral tooth is rudimentary, the fifth is subequal to the third.

### ? *Archias*,<sup>1</sup> sp.

Nallandu Island, 24 fathoms, January 18. Two very young specimens, one 2.6 mm. long and 3.2 mm. wide, are not referable to any known species. The carapace is quadrate or *Thalamita*-like, while the narrow, elongated basal joint of the antenna and the remoteness of the inner suborbital angle from the front, place the species in the neighborhood of *Archias*, *Lupocyclus*, and *Carupa*.

The carapace is somewhat granulous and traversed by two transverse ridges, one across the gastric region, the other further back, connecting the posterior of the lateral teeth. The intra-orbital width is a little over half the width of the carapace; the margin of the front is divided into four shallow lobes, the inner pair about one-third as wide as the outer, and slightly more advanced. Inner supra-orbital angles obscurely defined.

The antero-lateral margins are straight and parallel to each other, cut into 4 subequal, sharp-pointed teeth with a rudiment of another between the last two. The postero-lateral margins are concave and moderately convergent.

The orbits are very large (as also the eyes), with slight dorsal inclination; no fissures visible on the margin. The inner end of the lower margin is angular but not prominent, projecting very little beyond the buccal cavity.

The basal joint of the antenna is more than twice as long as broad, it widens

<sup>1</sup> *Archias* Paulson, Crustacea of the Red Sea, 1875, p. 56.

very slightly towards the distal end, and lies for nearly its whole length in the broad orbital hiatus; the second joint reaches the margin of the front.

The buccal cavity widens considerably at its anterior end. The merus of the outer maxilliped is not dilated at its antero-external angle.

The chelipeds are stouter and not so long as the legs, the arm and the hand of about equal thickness. Three spines on inner border of arm; the customary spine (of good size) at inner angle of wrist, and a few smaller spines on its outer surface; three spines on palm, one at angle of wrist, and two side by side nearer the fingers. Dactylus longer than upper surface of palm.

First three pairs of legs slender, also the basal segments (including the carpus) of the last pair; merus of last pair with a spine toward the end of its lower margin.

It is probable that the adult of this species will prove to have the same relation to *Archias* that *Thalamita* has to *Charybdis*.

## CANCRIDÆ.

### *Kraussia nitida* STIMPSON.

Fig. 13.

*Kraussia nitida* STIMPSON, Proc. Acad. Nat. Sci. Phila., X. 40 [37], 1858. MIERS, Crust. Alert, 235, 1884. ? CALMAN, Trans. Linn. Soc. London (2), Zool., VIII. 24, 1900. Not *K. nitida* HENDERSON, Trans. Linn. Soc. London (2), V. 379. pl. XXXVII. fig. 9, 1893, nor ALCOCK, Journ. Asiatic Soc. Bengal, LXVIII. 98, 1899.

*Kraussia integra* BORRADAILE, Fauna Maldive Arch., I. pt. III. p. 270, 1902. Not *K. integra* DE HAAN.

Nallandu, 24 fathoms, at anchorage, January 18; two males, one female.

*Distribution.* — North China Sea, lat. 23°, 24 fathoms, and Kagosima Bay, Japan, 20 fathoms (Stimpson). Thursday Island, Torres Straits, 4–5 fathoms (Miers).

A comparison of Stimpson's unpublished figure with that of Henderson seems to indicate two distinct species. The Maldive specimens agree sufficiently with Stimpson's figure. The fronto-orbital width is nearly two-thirds the full width of the carapace, the frontal lobes are subequal and equally produced; in Henderson's species, as represented by his figure and by a specimen in the United States National Museum from Samoa, the fronto-orbital width is only half as great as that of the carapace, the median lobes of the front are much narrower and less advanced than the lateral pair.

In the Samoan specimen of *K. nitida* Henderson (which I will call *K. hendersoni*), a large male, 17.5 mm. long and 20.5 mm. wide, fronto-orbital width 10.6 mm., the outer surface of the palm is faintly rugulose, the dactylus serrulate, the inner angle of the wrist has sharp granules, and the adjacent margin

is spinulose, the last three joints of the legs are provided with denticulations. According to Alcock, who may have had small specimens, the chelipeds are quite smooth except for a few granules at the inner angle of the wrist, and the last three joints of the legs are without any denticulations or have only a trace of them on the propodite.

In the Maldivian examples of *K. nitida* Stimpson, the surface of the chelipeds and legs is similar to that of *K. hendersoni*, the rugæ of the palm being a little more distinct. The dactyli of the legs are considerably longer and slenderer; in the second pair they are 4 times, in *K. hendersoni* 3 times, as long as wide. Furthermore, in *K. nitida*, the notch below the outer angle of the orbit is more pronounced, the basal antennal joint is narrower, the color of the thumb does not run back on the palm as in *K. hendersoni*.

*Dimensions.* — Male from Nallandu: Length, 7.7 mm.; width, 8.4 mm.; fronto-orbital width, 5.4 mm.

### MAIIDÆ.

#### *Oncinopus aranea* DE HAAN.

*Oncinopus aranea* ALCOCK, Journ. Asiatic Soc. Bengal, LXIV. 183, 1895, and synonymy.

Nallandu, 24 fathoms, at anchorage, January 18; one young male.

#### *Halimus tenuicornis* (Pocock).

*Hyastenus tenuicornis* ALCOCK, Journ. Asiatic Soc. Bengal, LXIV. 215, 1895, and synonymy. Illus. Zool. Investigator, part VI. pl. XXXIII. fig. 4, 1898.

Nallandu, 24 fathoms, at anchorage, January 18; 2 females (one with eggs).

#### *Halimus agassizii*, sp. nov.

##### Fig. 6.

Carapace oblong-triangular, slightly pointed behind, the regions well-defined, sparsely setose, tuberculated, or spinulose, as follows:—7 sharp tubercles or spinules disposed in a cross on the gastric region, 3 on the median line, 4 forming a Y on the cardiac region, one near the lateral boundary of that region, one on the intestinal region, 3 spines near the outer margin of the branchial region, 2 smaller spines further in, one marginal hepatic spine. Posterior margin granulate; parallel to it another row of granules.

The rostrum consists of 2 slender slightly divergent spines, which in the male are one-half as long as the carapace proper; margins rough with fine spinules and fringed with setæ.

The angles of the supra-ocular cave are produced, the anterior is acuminate,

the posterior acute; between it and the post-ocular lobe there is a small tooth on the orbital margin.

The basal antennal joint has a spine at its anterior outer angle visible from above. The merus of the outer maxillipeds is expanded at the antero-external angle.

The chelipeds and legs are more or less roughened. The chelipeds of the male are a little stouter than the trunk-legs and one and a third times as long as the carapace, exclusive of rostrum. The palm has on its outer face 2 longitudinal furrows which are continued on the fingers; these are gaping for two-thirds their length.

The first ambulatory leg is two and a third times as long as the carapace (rostrum excluded); though longer than the second pair, there is hardly more difference than between the second and third. The fourth leg is missing. The merus joints are armed with 3 or 4 long slender spines, the carpal joints with two. Dactyli very slender and spinulous.

The ridges of the sternum and abdomen are granulated.

*Dimensions.* — Length of carapace exclusive of horns, 4.7 mm., width, 3.4 mm., length of horns, 2.3 mm.

*Type locality.* — One male was taken at Nallandu at the anchorage in 24 fathoms, January 18.

The tooth on the superior orbital margin connects this species with the genus *Naxioides*; the spines on the legs separate it from other species of *Halimus*.

## PARTHENOPIDÆ,

### *Lambrus* (*Rhinolambrus*) *longispinis* MIERS.

*Lambrus* (*Rhinolambrus*) *longispinis* ALCOCK, Journ. Asiatic Soc. Bengal, LXIV. 266, 1895, and synonymy.

Centre of Male Lagoon, 30 fathoms, December 26; one female with ova, 7.7 mm. long, 7.2 mm. wide.

### *Lambrus* (*Rhinolambrus*) *bispinosus*, sp. nov.

**Figs. 1-2.**

Carapace nearly as long as wide; 2 strong median spines, one gastric, the other cardiac; a blunt oblique ridge on the branchial region, between which and the gastric and cardiac regions are two pits; postero-lateral angle strongly elevated; irregular granules distributed sparingly on the branchial ridge and between it and the cardiac region, on the slopes of the cardiac region, on the anterior half of the gastric region, hepatic region slightly roughened, a single granule on the genital region. Otherwise the carapace is almost smooth.

The rostrum is broad, prominent, declivous, blunt.

The orbital margin is prominent, above finely crenulate, on the outside fluted and denticulate. The postorbital constriction is strongly pronounced.

The hepatic region is well marked off, its margin is sub-rectangular, with two or three shallow teeth.

The branchial region has on the antero-lateral margin 6 teeth with finely crenulated edges, and on the postero-lateral margin about 4 irregular lobes. The blunt tooth or spine at the extremity of the branchial ridge is the most elevated point of that region, but the carapace is widest at the first tooth outside the ridge.

Posterior margin subentire.

The chelipeds in the adult female are one and a half times as long as the carapace, and unequal. The inner and outer margins of the arm are each bordered by about 8 irregular lobes, of which 2, one at the middle and one at the distal end of the outer margin, are the largest; upper surface with one tubercle and a few granules in a longitudinal series.

The surface of the wrist is rough; there is a prominent lobe at the middle of the outer margin; a tubercle on the inner margin.

The upper surface of the hand has 2 strong laminate lobes near the wrist, the outermost pointing backward and outward, the innermost further from the wrist and directed forward and inward. The inner and outer surfaces are crossed by an obliquely longitudinal line of tubercles of which 2 or 3 are enlarged. Otherwise, except for a few granules, the surface is smooth and punctate. Lower margin of arm and hand denticulate.

The fingers are somewhat gaping when closed, in the larger cheliped, their extreme margins, as well as a carina on the outer surface are granulate; the proximal half of upper margin of dactylus denticulate; occludent margins dentate, 3 large teeth on the pollex of the larger claw.

The ambulatory legs increase in width from the first to the fourth; the first is very slender and about as long as the carapace, and has a few tubercles on the margins, most noticeable on the margins of the merus and the lower margin of the propodus. The second is a little shorter and stouter, with larger tubercles. The third and fourth are bordered by laminiform lobes. The dactyli of all the legs are long, slender, and pubescent.

*Dimensions.* — Female with ova: Length of carapace, 10.6 mm.; width, 10.9 mm.

*Type locality.* — Nallandu, 24 fathoms, at anchorage, January 18; one female with ova.

Allied to *L. confragosus* Calman, from which it is readily separated by the strongly upturned branchial angles, the absence of a spine behind the cardiac spine, the wider hepatic lobe, and the presence of only one lobe on the upper outer margin of the hand.

## CALAPPIDÆ.

*Calappa gallus* (HERBST).

*Calappa gallus* ALCOCK, Journ. Asiatic Soc. Bengal, LXV. 146, 1896, and synonymy.

Nallandu, 24 fathoms, at anchorage, January 18; one young.

## LEUCOSIIDÆ.

*Persephona brevimana* (ALCOCK).

*Myra brevimana* ALCOCK, Journ. Asiatic Soc. Bengal, LXV. 206, 1896, and synonymy.

Nallandu, 24 fathoms, at anchorage, January 18; one young female.

*Persephona darnleyensis* (HASWELL).

*Myra darnleyensis* ALCOCK, Journ. Asiatic Soc. Bengal, LXV. 207, 1896, and synonymy.

Fulidu, 18 fathoms, January 18; one female with ova, 13.4 mm. long, 10.7 mm. broad.

*Porcellanella triloba* WHITE.

*Porcellanella triloba* WHITE, in Macgillivray's Voyage H. M. S. Rattlesnake, II. Appendix No. VI. p. 394. pl. V. fig. 2, 1851.<sup>1</sup> HENDERSON, Challenger Anomura, 112, 1888; Trans. Linn. Soc. London (2), V. 429, 1893.

*Porcellana triloba* HASWELL, Cat. Austral. Crust., 149, 1882.

Nallandu, 24 fathoms, at anchorage, January 18; one small male, with bopyrid parasite lodged in the branchial cavity.

*Distribution.* — Off Cape Capricorn, East Australia, 15 fathoms (White). Celebes Sea, 10–20 fathoms (Henderson). Port William, Falkland Islands, 5–12 fathoms (Henderson). Rameswaram, India (Henderson).

<sup>1</sup> The title-page bears the date 1852, but the work appeared in December, 1851. See Athenæum, London, Dec. 6, 1851, p. 1280, and Jardine's Contributions to Ornithology in 1851, p. 6.

## PAGURIDÆ.

*Dardanus*, sp.

At Hanimadu, Tiladummati Atoll, 16 fathoms, at anchorage, a young hermit crab was collected, which approaches very near *Dardanus scabrimanus* (Dana).

The lateral teeth of the front are more advanced than the middle. Eyes stout, two and a half times as long as wide, equalling two-thirds of the width of the front; cornea green in alcohol, and occupying one-third the length of the stalk; eyes surpassing a little the stalk of the outer antennæ, subequal to that of the inner antennæ. Eye scales somewhat obcordate, having a sinus on the middle of the anterior margin.

The claws and legs as well as the body are sparsely clothed with long hair. Claws very unequal. Upper and outer surface of wrist of left cheliped and distal end of arm spinulous; upper margin of wrist and hand spinous; outer face of hand sparingly spinulous and granulous, lower half almost smooth; lower margin with a row of small spines. Fingers broken. Smaller cheliped more spinulous and hairy than the larger.

Second and third pairs of feet with the last three segments roughened above, dactyli much longer than propodi, and having a longitudinal groove on the outside. Propodus of left third foot roughest.

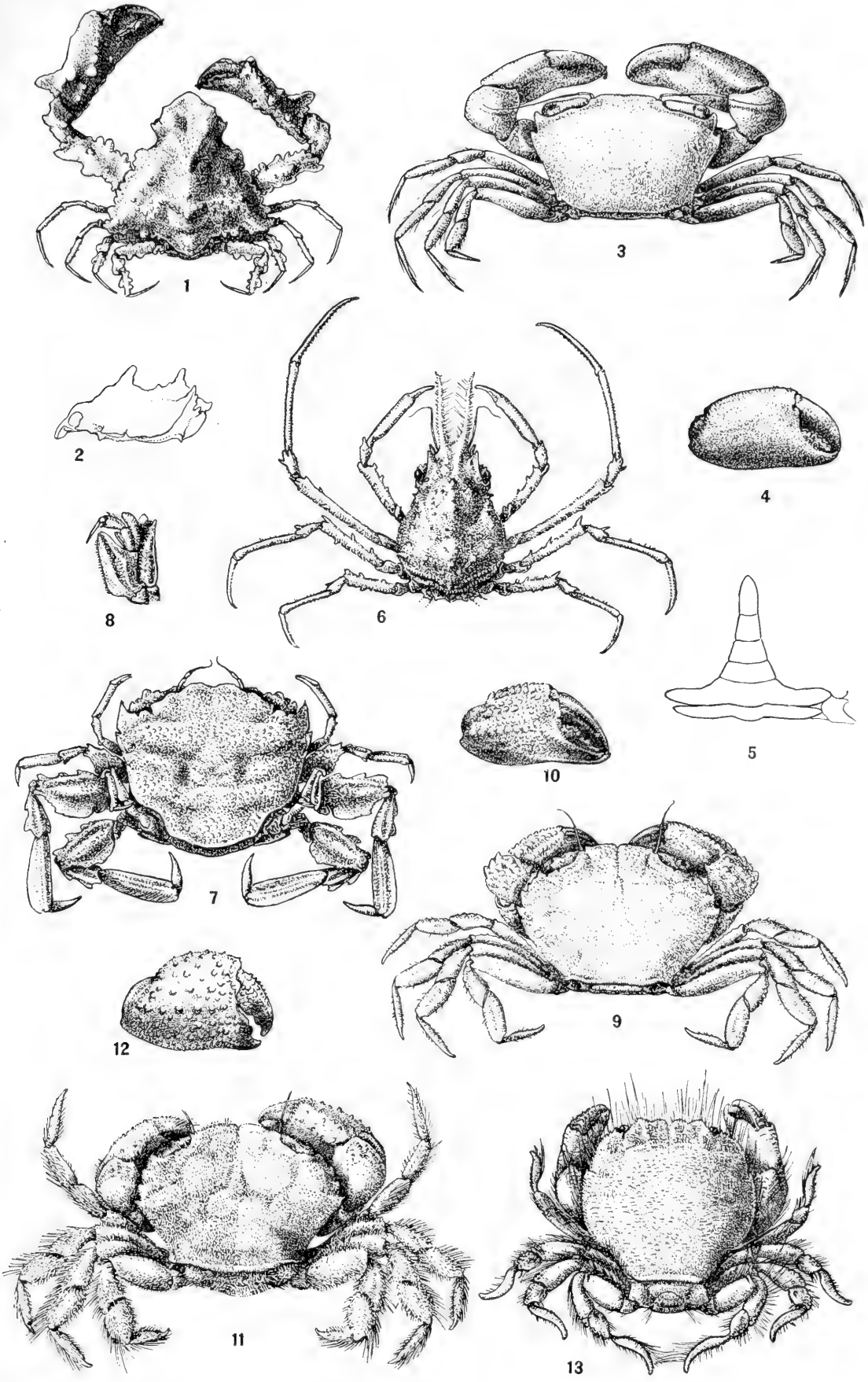
Length of carapace, about 4.5 mm.

## EXPLANATION OF PLATE.

- 
- Fig. 1. *Lambrus (Rhinolambrus) bispinosus*, ♀, × 2.  
 Fig. 2. " " " ♀, profile, × 2.  
 Fig. 3. *Goneplax maldivensis*, ♂, ×  $3\frac{1}{2}$ .  
 Fig. 4. " " ♂, outer surface of larger chela, ×  $3\frac{1}{2}$ .  
 Fig. 5. " " ♂, abdomen, ×  $6\frac{2}{3}$ .  
 Fig. 6. *Halimus agassizii*, ♂, × 4.  
 Fig. 7. *Palicus contractus*, ♂, ×  $3\frac{1}{2}$ .  
 Fig. 8. " " outer maxilliped, ×  $4\frac{4}{5}$ .  
 Fig. 9. *Xanthias alcocki*, ♀, ×  $5\frac{3}{5}$ .  
 Fig. 10. " " ♀, outer surface of right chela, ×  $6\frac{2}{3}$ .  
 Fig. 11. *Pilumnus woodworthi*, ♀, ×  $3\frac{3}{5}$ .  
 Fig. 12. " " ♀, outer surface of larger chela, ×  $3\frac{3}{5}$ .  
 Fig. 13. *Kraussia nitida*, ♂, ×  $2\frac{4}{5}$ .



Rathbun, — Maldive Crabs.





Bulletin of the Museum of Comparative Zoölogy  
AT HARVARD COLLEGE.  
VOL. XXXIX. No. 6.

---

BIRDS AND MAMMALS FROM HONDURAS.

BY OUTRAM BANGS.

CAMBRIDGE, MASS., U. S. A. :  
PRINTED FOR THE MUSEUM.  
JULY, 1903.



No. 6. — *Birds and Mammals from Honduras.*

By OUTRAM BANGS.

IN the early winter of 1902, Mr. W. W. Brown, Jr., started on a short trip to the coast of Honduras. He collected for a few weeks in January, at Ceiba (on some maps Laceiba), situated on the hot coastal plain at about sea level. In February he prepared, with the aid of an assistant, for the exploration of the little known mountain range that extends, parallel with the coast, some twenty miles inland from Ceiba. After a few days' work at Yaruca (1,000 ft.), Mr. Brown had the misfortune to lose his assistant, and though among unfriendly Indians, continued to collect there for a few weeks. He was obliged, however, to abandon his mountain trip.

The birds and mammals secured belong, for the most part, to well-known species; there are, however, a few rare and interesting forms in the series, and the distribution of some of the birds is considerably extended. A complete list of the species collected follows.

## BIRDS.

### *Butorides saturatus* RIDG.

One adult ♂; Yaruca. This skin is referable to the form first described from Swan Island.

### *Micrastur guerilla* CASS.

Four specimens, young and adult; Ceiba and Yaruca.

### *Accipiter bicolor* (VIEILL.).

One adult ♂; Yaruca.

*Morphnus guianensis* (DAUD.).

One young ♂; Ceiba. This record extends the range of this species from Panama to Honduras.

*Tinamus robustus fuscipennis* (SALVADORI).

One ♀; Yaruca.

*Crypturus soui modestus* (CAB.).

Two specimens, ♂, ♀; Yaruca.

*Heliornis fulica* (BODD.).

Two females; Ceiba.

*Actitis macularia* (LINN.).

One ♀; Ceiba.

*Tringa minutilla* VIEILL.

One ♂; Ceiba.

*Asarcia variabilis* (LINN.).

Two males, young and adult; Ceiba.

*Columba speciosa* GML.

One ♂; Ceiba.

*Columbigallina rufipennis rufipennis* (Bp.).

One ♀; Ceiba.

*Claravis pretiosa* (FERRARI-PEREZ).

Two males; Ceiba.

*Leptotila plumbeiceps* SCL. AND SALV.

Three specimens, both sexes; Ceiba.

*Leptotila vinaceiventris* (RIDG.).

Four specimens, both sexes; Yaruca.

***Piaya cayana thermophila* (SCL.).**

Eleven specimens, both sexes ; Ceiba and Yaruca.

***Crotophaga sulcirostris* SWAINS.**

Seven specimens, both sexes ; Ceiba and Yaruca.

***Amazona autumnalis* (LINN.).**

Three males ; Ceiba.

***Pionus senilis* (SPIX.).**

Four specimens, both sexes ; Ceiba.

***Pionopsittacus haematotis haematotis* (SCL. AND SALV.).**

Three specimens, both sexes ; Yaruca.

Salvadori referred the Chiriqui skins in the British Museum to this form, and I followed him in my paper (*Auk*, 1901, Vol. XVIII., p. 359). On re-examining the specimens, I consider this identification erroneous, and the Chiriqui birds, though somewhat intermediate, belong with the southern form, *P. haematotis coccineicollaris* (Lawr.). All my Chiriqui skins have the characteristic olive-brown markings on the pileum (the northern bird having reddish edges to these feathers). None of my Chiriqui specimens have complete red collars, but all have red feathers scattered through the olive green of the under side of the neck, a characteristic not shown in any northern skin I have examined. The southern form is larger than the northern — strangely enough Salvadori gave no measurements for the southern bird, *P. haematotis coccineicollaris*.

***Prionornis carinatus* (DU BUS.).**

One adult ♂ ; Ceiba.

***Eumomota superciliaris* (SANDB.).**

One adult ♂ ; Ceiba.

***Momotus lessoni* LESS.**

Seven specimens, both sexes ; Ceiba and Yaruca.

***Ceryle amazona* (LATH.).**

One adult ♀ ; Ceiba.

***Ceryle americana septentrionalis* SHARPE.**

One adult ♂; Yaruca.

***Glaucidium griseiceps* SHARPE.**

Two specimens, ♂ & ♀; Yaruca.

***Nyctidromus albicollis* (GML.).**

One ♂; Ceiba.

***Phaethornis longirostris longirostris* (LESS. AND DELATT.).**

One adult ♂; Ceiba.

***Amazilia tzacatl dubusi* (BOURC. AND MULS.).**

Six specimens, both sexes; Ceiba and Yaruca.

***Amazilia cyanocephala* (LESS.).**

One adult ♀; Yaruca. After studying all the material in Washington, — collections U. S. National Museum and Division of Biological Survey, — I cannot satisfactorily separate by external characters or geographic range the subspecies *A. guatemalensis* Gould. The present example is true *A. cyanocephala*.

***Thalurania townsendi* RIDG.**

One adult ♂; Yaruca. This very distinct species is still a rare bird in collections, and so far as known has a very restricted range.

***Heliothrix barroti* (BOURC. AND MULS.).**

Two males; Ceiba and Yaruca.

***Trogon melanocephalus* GOULD.**

Seven specimens, both sexes; Ceiba.

***Trogon caligatus caligatus* GOULD.**

Five specimens, both sexes; Yaruca. On comparing these and Mexican specimens with skins from Panama, I find that the latter represent a very well-marked subspecies, differing from the more northern bird — true *C. caligatus* —



in being smaller, and in having the belly and under-tail coverts deep orange, (these parts being cadmium yellow in true *C. caligatus*). The Panama bird is *Trogon caligatus concinnus* (Lawr.) type locality, Isthmus of Panama.<sup>1</sup>

***Galbula melanogenia* SCL.**

Two males ; Ceiba and Yaruca.

***Rhamphastos brevicarinatus* GOULD.**

Three specimens, both sexes ; Ceiba.

***Pteroglossus torquatus* (GML.).**

Seven specimens, both sexes ; Ceiba and Yaruca.

***Chloronerpes simplex allophyeus*,<sup>2</sup> subsp. nov.**

*Type* (and only specimen) from Yaruca, Honduras, 1,000 feet altitude, adult ♂, No. 10,349, Coll. E. A. and O. Bangs, collected Feb. 11, 1902, by W. W. Brown, Jr.

*Characters.* — Similar to *C. simplex simplex*, but considerably smaller, bill smaller, the throat marked with yellowish instead of plain, the general coloration below richer yellow, the spots on lower neck and breast larger and less round in shape, and the blackish bands on belly narrower.

*Color.* — Adult ♂, pileum and malar stripe crimson ; auriculars and upper parts yellowish olive-green, some of the feathers of back with small spots and bands of orange-buff ; upper-tail coverts and sides of rump broadly banded with buff-yellow ; lining of wing deep ochraceous-buff ; primaries ochraceous-rufous with dark olive-green spots on outer webs, greenish dusky bands on inner webs, and greenish dusky tips ; secondaries and tertials similar, but broadly edged on outer webs with yellowish olive-green like back, so that when the wing is closed the ochraceous-rufous color shows only along the inner edges of the wings ; tail greenish dusky with narrow olive-green edges, the outer rectrix spotted toward base of outer web and longitudinally marked toward end along both webs near quill with ochraceous-rufous ; throat dull olive-green narrowly banded on lower part with dull yellow ; lower neck and breast dull olive-green each feather with a yellowish tip and a large spot of yellowish running nearly across the middle ; belly, sides, and under-tail coverts, strong buff-yellow with a greenish tinge irregularly barred with narrow bands of dusky.

*Measurements.* — Adult ♂, type, wing, 108. ; tail, 62. ; tarsus, 16. ; exposed culmen, 18.5.

<sup>1</sup> *Trogon concinnus* Lawrence, Ann. Lyc. Nat. Hist. N. Y., 1862, Vol. VII., p. 463.

<sup>2</sup> *Allophyeus*, of another race.

*Remarks.* — True *Chloronerpes simplex* Salvin was originally described from Bugaba, and the type is a female; since 1870 its range has been traced northward through Costa Rica to La Libertad, Chontales, Nicaragua.<sup>1</sup> It is probably everywhere a rare bird; Mr. Brown never saw it during the time he was in Chiriqui, and the U. S. National Museum has but one or two specimens from Costa Rica. The form just described appears to be, so far as can be determined from a single specimen, a very well-marked northern race, much smaller and otherwise different. It must also be a very rare bird, as I do not find it listed in any of the published accounts of collections made in Honduras.

**Melanerpes pucherani (MALH.).**

Seven specimens, both sexes; Yaruca.

**Melanerpes santacruzi pauper (RIDG.).**

Twelve specimens, both sexes; Ceiba.

**Sphyrapicus varius (LINN.).**

Two females; Ceiba.

**Veniliornis caboti (MALH.).**

One adult ♂; Yaruca.

**Campophilus guatemalensis buxans BANGS.**

One adult ♂; Yaruca.

**Ceophloeus scapularis (VIG.).**

Three specimens, both sexes; Ceiba and Yaruca.

**Picumnus dimotus,<sup>2</sup> sp. nov.**

Two specimens, adult ♂ & ♀; Ceiba.

*Type.* — From Ceiba, Honduras, sea level, adult ♂, No. 10,328, Coll. of E. A. and O. Bangs. Collected Jan. 21, 1902, by W. W. Brown, Jr.

*Characters.* — Nearest to the geographically remote *Picumnus olivaceus olivaceus* Lafr. of the Bogota region of Colombia; the male with the crown

<sup>1</sup> Salvin and Godman, Biol. Cent. Amer. Aves, Vol. II., p. 410. The type specimen is shown on Plate 59, Fig. 2.

<sup>2</sup> Dimotus, separated, removed.

spotted with scarlet as in that form; differs in being much more greenish, less brownish throughout; throat greenish white instead of fulvous; sides of breast and back much greener, less brown, striping of belly less well marked, the dusky stripes paler in color and much less distinct.

*Color.* — Adult ♂, type, pileum black with small, round white spots on occiput, and brilliant orange-scarlet tips to the feathers of crown and forehead, back dull olive-green without brownish tinge; wings dusky, the lesser coverts edged like back; secondaries and tertiaries edged with rather paler, more yellowish green; central upper-tail coverts yellowish; tail black, the inner webs of central rectrices yellowish white and the two outer pairs much marked with the same color; lining of wing dull greenish white; throat and malar region greenish white slightly marked with blackish; auriculars dusky brown; breast dull olive-green; belly, sides, and under-tail coverts, pale, dull olive-yellow striped with dull olive — the striping rather indistinct and irregular.

The adult ♀ differs from the ♂ only in having the whole pileum black with small, round white spots.

*Measurements.* — Adult ♂, type, wing, 52.; tail, 26.5; tarsus, 11.8; exposed culmen, 12.2. Adult ♀ topotype, No. 10,329; wing, 52.; tail, 27.; tarsus, 13.; exposed culmen, 11.4.

*Remarks.* — The new form ranges through Honduras and Nicaragua, though its exact limits are not at present known. It is, however, wholly isolated from the South American species it most nearly resembles, by *Picumnus olivaceus flavotinctus* Ridg., which occupies Panama, Chiriqui, and Costa Rica. In the large series I have examined (my specimens from Panama, Chiriqui, and Honduras and the considerable series in the U. S. National Museum) I find no sign of intergradation between *P. olivaceus flavotinctus* and *P. dimotus*.

Much confusion of the various races of this group of *Picumnus* has prevailed, until very recently, when Hartert (*Novitates Zoologicae*, 1902, Vol. IX., pp. 606 and 607) distinguished them in a masterly way. The northern form which I have just described appears, however, to have been wholly unknown to Hartert.

#### *Todirostrum cinereum* (Linn.).

Two males; Ceiba and Yaruca.

#### *Myiopagis placens placens* (Scl.).

One ♂; Ceiba.

#### *Elainea flavogastra subpagana* (Scl. and Salv.).<sup>1</sup>

Two specimens, ♂ and ♀; Ceiba.

<sup>1</sup> Lönnberg, *Ibis*, April, 1903, pp. 241-242.

**Myiozetetes similis superciliosus (Br.).**

Twelve specimens, both sexes; Ceiba and Yaruca.

**Pitangus derbianus (KAUP.).**

Twenty-eight specimens, both sexes; Ceiba and Yaruca. This series represents a form slightly different from Mexican specimens upon which *P. derbianus* was founded. The Honduras birds average a little smaller, and brighter yellow below and darker, less rusty above. The differences, however, are slight, and only show when large series are compared. I suppose it is the *Sduraphagus guatemalensis* Lafr., a hardly well enough defined form to recognize by name.

**Megarhynchus pitangus mexicanus (LAFR.).**

Four specimens, both sexes; Ceiba and Yaruca.

**Myiobius sulphureipygius (SCL.).**

One ♂; Yaruca.

**Empidonax traillii traillii (AUD.).**

Two specimens, ♂ and ♀; Ceiba.

**Empidonax flaviventris (BAIRD).**

Two males; Yaruca.

**Myiarchus crinitus (LINN.).**

Two males; Ceiba.

**Myiarchus mexicanus mexicanus (KAUP.).**

One adult ♂; Ceiba.

**Myiarchus lawrencii lawrencii (GIRAUD).**

Twenty-five specimens, both sexes; Ceiba and Yaruca.

**Tyrannus melancholicus satrapa (LICHT.).**

Seven specimens; Ceiba. Some of these approach *T. m. couchi*.

***Pipra mentalis mentalis* (SCL.).**

Eight specimens, both sexes; Ceiba. This series compared with the birds Mr. Brown collected in Chiriqui emphasizes the differences between the northern and southern races, the skins being of the same "make," and proves my *Pipra mentalis ignifera* to be a very well-marked form.

***Manacus candei candei* (PARZUD).**

Nine specimens, both sexes; Ceiba.

***Scotothorus veraepacis veraepacis* (SCL.).**

One adult ♀; Yaruca.

***Tityra semifasciata personata* (JARD. AND SELB.).**

Five specimens, both sexes; Ceiba and Yaruca.

***Tityra albitorques fraserii* (KAUP).**

One adult ♂; Yaruca.

***Platypsaris aglaiae obscurus* RIDG.**

Five specimens, both sexes; Ceiba. I have compared these with the type of *P. obscurus*, and they appear to belong to this very dark form. The adult males in the present series are, however, rather blacker, less slaty above, and not quite so dark below.

***Pachyrhamphus cinnamomeus* (LAWR.).**

One adult ♂; Yaruca.

***Lipaugus holerythrus* SCL. AND SALV.**

Two specimens, ♂ and ♀; Yaruca.

***Attila citreopygius* (BP.).**

One ♂; Ceiba.

***Cotinga amabilis* GOULD.**

Fifty-one specimens, adults of both sexes, and young males changing into the blue dress; Ceiba. All these were shot in one tree, the fruit of which they were feeding upon; and where, Mr. Brown tells me, he might have shot very many more.

**Carpodectes nitidus** SALV.

Five adult males; Ceiba. This record extends the range of the species from eastern Nicaragua to central, eastern Honduras. Mr. Brown took these five males from one dead tree, on different occasions. He tells me he never passed this tree without seeing one or more snow-white Cotingas sitting motionless in it. No females or young males were seen. Only once did he see the species elsewhere, and then but one adult male in the forest, that he was unable to get within shot of.

**Thamnophilus transandeanus** SCL. +  
**Thamnophilus melanocrissus** SCL.

One adult ♂; Ceiba. This specimen is intermediate between *T. transandeanus* and *T. melanocrissus*. The under-tail coverts are tipped with white, but not so broadly as in southern examples — true *T. transandeanus*.

**Thamnophilus naevius** (GML.).

One male; Ceiba.

**Thamnophilus doliatus** (LINN.).

Eight specimens, both sexes; Ceiba. These specimens of course represent the so-called *T. intermedius* of Ridgway, but I cannot see how that bird differs from true *T. doliatus*. The size of the bill varies much, but perhaps the bills of the Central American birds average a trifle larger than in typical *T. doliatus* from Guiana; still individual specimens cannot be picked out by this or any other character. One of my Honduras skins — a fully adult ♂ — has actually a smaller bill than any specimen from Guiana with which I have compared it.

**Automolus cervinigularis** (SCL.).

Three specimens, both sexes, Yaruca.

**Dendroornis nana confinis**, subsp. nov.

*Type* (and only specimen) from Ceiba, Honduras, sea level, adult ♂ No. 10,432, Coll. of E. A. and O. Bangs, collected Jan. 24, 1902, by W. W. Brown, Jr.

*Characters.* — Similar to *D. nana nana* Lawr. of Panama and *D. nana costaricensis* (Ridg.), of Costa Rica and Chiriqui, but differing from either in having the throat much paler, nearly white; the shaft-stripes on breast paler, more

whitish; the shaft-spots on pileum larger; and the shaft-stripes on nape and upper back much larger and more conspicuous.

*Measurements.* — Type, adult ♂, wing, 99.; tail, 86.5; tarsus, 22.5; exposed culmen, 34.

*Remarks.* — I have lately examined and studied with great care a large series (my specimens and all those in Washington) of *Dendrornis nana* and find the supposed great amount of variation in this species to be geographical and not individual. Any series of specimens from one place varies surprisingly little. Three very well-defined subspecies can easily be made out, as follows: —

*Dendrornis nana nana* LAW. R.

*Type locality*; Panama.

Throat and shaft-stripes on breast dull ochraceous-buff; ground color of breast, belly, and sides dull raw umber.

*Dendrornis nana costaricensis* (RIDG.).

*Type locality*; Tucurrique, Costa Rica (extending southward into Chiriqui and northward into Nicaragua).

Throat and shaft-stripes on breast, buff yellow; ground color of breast, belly, and sides dull tawny olive.

*Dendrornis nana confinis* BANGS.

*Type locality*; Ceiba, coast of Honduras.

Throat, cream buff; shaft-stripes on breast buff; ground color of breast, belly, and sides, pale raw-umber; shaft-spots of pileum and shaft-stripes on nape and upper back much larger and more conspicuous than in either of the preceding.

*Dendrornis erythropygia* SCL.

One adult ♀; Yaruca.

*Picolaptes compressus* (CAB.).

Seven specimens, both sexes; Ceiba and Yaruca. Honduras examples seem best referred to true *P. compressus*, though they show an approach to *P. compressus insignis* Nels. of southeastern Mexico, both in the markings of the back and in measurements. *P. compressus insignis* has a larger bill as well as a longer tail than true *P. compressus*.

*Dendrocolaptes sanctithomae* (LAFR.).

One adult ♀; Yaruca.

*Galeoscoptes carolinensis* (LINN.).

Eight specimens, both sexes; Ceiba and Yaruca.

*Merula grayii grayii* (BR.).

Twelve specimens, both sexes; Ceiba and Yaruca.

*Hylocichla mustelina* (GML.).

Seven specimens, both sexes; Ceiba and Yaruca.

*Thryothorus maculipectus umbrinus* RIDG.

Eight specimens, both sexes; Ceiba and Yaruca.

*Henicorhina prosthaleuca* SOL.

Two specimens, ♂ & ♀; Yaruca.

*Tachycineta albilinea* (LAWR.).

Three specimens, both sexes; Ceiba and Yaruca.

*Setophaga ruticilla* (LINN.).

Three males; Ceiba.

*Wilsonia mitrata* (GML.).

Five specimens, both sexes; Ceiba and Yaruca.

*Icteria virens virens* (LINN.).

Six specimens, both sexes; Ceiba and Yaruca.

*Geothlypis trichas brachidactyla* (SWAINS.).

One adult ♂; Ceiba.

*Seiurus motacilla* (VIEILL.).

One ♂; Yaruca.



**Seiurus noveboracensis notabilis** RIDG.

Two males; Ceiba and Yaruca. Both specimens are placed with this subspecies, the one from Ceiba being typical, the other is a little smaller and more yellowish below and may have been bred in an intermediate region, but it is rather nearer to *notabilis* than to true *noveboracensis*.

**Dendroica coronata** (LINN.).

Three males; Ceiba, none of them in full plumage.

**Dendroica maculosa** (GML.).

Three specimens, both sexes; Ceiba and Yaruca.

**Chrysocantor**<sup>1</sup> *aestiva aestiva* (GML.).

Three males; Ceiba.

**Mniotilta varia** (LINN.).

Two males; Ceiba.

**Cyanerpes cyaneus** (LINN.).

Seven specimens, females and young males, but no adult males; Ceiba. Ridgway in Bulletin of the United States National Museum No. 50, Part II., does not recognize the Central American subspecies *carneipes*, and I have followed him in calling these true *cyaneus*.

**Cyanerpes lucida** (SCL. AND SALV.).

Twenty specimens, both sexes; Ceiba.

**Chlorophanes spiza guatemalensis** (SCL.).

Seven specimens, both sexes; Ceiba.

**Icterus prothemelas** (STRICK.).

Thirty-two specimens, both sexes; Ceiba and Yaruca.

<sup>1</sup> I use the generic name proposed for the Golden wood warblers by C. J. Maynard (The Warblers of New England, Part III., 1901, p. 58), because these compose a well-defined group, quite as well entitled to generic rank as other "genera" long recognized in the family.

*Icterus spurius* (Linn.).

Six specimens, both sexes ; Ceiba.

*Icterus galbula* (Linn.).

Eleven specimens, both sexes ; Ceiba.

*Gymnostinops montezuma* (Less.).

Three specimens, both sexes ; Ceiba.

*Phoenicothera rubica rubicoides* (Laf.).

Six specimens, both sexes ; Yaruca.

*Phoenicothera salvini salvini* Berl.

Eighteen specimens, both sexes ; Ceiba and Yaruca.

*Eucometis spodocephala spodocephala* (Bp.).

Four specimens, both sexes ; Ceiba.

*Lanio aurantius* Laf.

One adult ♀ ; Yaruca.

*Ramphocelus passerinii* Bp.

Thirty-nine specimens, both sexes ; Ceiba and Yaruca.

*Phlogothraupis sanguinolenta* (Less.).

Eight specimens, both sexes ; Ceiba and Yaruca.

*Piranga rubra rubra* (Linn.).

Nineteen specimens, both sexes ; Ceiba and Yaruca.

*Piranga leucoptera leucoptera* Trudeau.

One adult ♂ ; Yaruca.

**Tanagra cana** SWAINS.

Fourteen specimens, both sexes; Ceiba.

**Tanagra abbas** LICHT.

Eighteen specimens, both sexes; Ceiba and Yaruca.

**Calospiza lavinia** (CASS.).

Two specimens, ♂ and ♀; Ceiba. This is the most northern record for the species, previously traced only to southern Nicaragua, — Chontales. The present specimens are not typical, and I have no doubt that they represent a well-defined northern race. In color they do not differ from southern specimens, but they are much larger, and have very long, slender bills. I prefer, however, not to name a subspecies on mere differences of size and proportions without a much greater amount of material. The two skins measure as follows: No. 10,024, ♂, Ceiba, Honduras, Jan. 9, 1902; wing, 73.; tail, 50.5; tarsus, 19.; exposed culmen, 12.4; no. 10,025, ♀, Ceiba, Honduras, Jan. 20, 1902; wing, 70.; tail, 48.; tarsus, 17.2; exposed culmen, 12.

**Calospiza larvata larvata** (DU BUS.).

Eighteen specimens, both sexes; Ceiba and Yaruca.

**Euphonia hirundinacea** BR.

One adult ♂; Ceiba.

**Euphonia gouldi** SCL.

Six adults, both sexes; Ceiba.

**Chlorophonia occipitalis** (DU BUS.).

Two specimens, ♂ & ♀; Ceiba. Previous to Mr. Brown's taking this pair, *Chlorophonia occipitalis* was known only from southeastern Mexico and the highlands of Guatemala. The Guatemalan bird has been named by Dubois, *C. cyaneidorsalis*, but has since been generally refuted. My two Honduras specimens differ from any others I have seen in the very small area occupied by the blue crown patch, and may eventually prove distinct.

**Saltator atriceps atriceps** LESS.

One adult ♂; Yaruca.

***Saltator magnoides medianus* RIDG.**

Twelve specimens, both sexes; Yaruca.

***Saltator grandis* (LICHT.)**

Two adult males; Ceiba.

***Zamelodia ludoviciana* (LINN.).**

Two males; Ceiba.

***Guiraca caerulea caerulea* (LINN.).**

Three specimens, both sexes; Ceiba and Yaruca.

***Oryzoborus funereus* SCL.**

One ♀; Ceiba.

***Cyanospiza cyanea* (LINN.).**

One ♀; Yaruca.

***Cyanospiza ciris* (LINN.).**

Five adult males; Ceiba. These birds, taken in January, are paler red below and have darker, more dusky blue heads, than breeding specimens from the southern United States.

***Sporophila corvina* (SCL.).**

Five adult males; Ceiba and Yaruca.

***Sporophila morelleti* (BP.).**

Three specimens, both sexes; Ceiba.

***Arremon aurantirostris* LAFR.**

Two adult males; Yaruca.

***Arremonops conirostris centratus*, subsp. nov.**

Three specimens, one ♂ and two females; Ceiba, January, 1902.

*Type*. — From Ceiba, Honduras, sea level, adult ♀, No. 10,141, Coll. of E. A. and O. Bangs, collected Jan. 24, 1902, by W. W. Brown, Jr.

*Characters.* — Nearest to *Arremonops conirostris richmondi* Ridg. but slightly smaller, especially the bill; darker in color throughout; breast and sides darker and purer gray; flanks less suffused with olive-green or brownish; tail and wings much darker green, wholly lacking the reddish or brownish olive of those parts in *A. conirostris richmondi*; back much darker — true olive-green; bend of wing and lining of wing paler yellow. From *Arremonops chloronotus* (Salv.) the new form differs in larger size, and in the crown stripes being wholly black unmixed with brown.

*Measurements:* —

No.	Sex.	Wing.	Tail.	Tarsus.	Exposed Culmen.
10,141 Type	♀ ad.	72.	67.	27.	15.0
10,139 Topotype	♀ ad.	72.	57.5	28.	16.2
10,140 do.	♂ ad.	70.5	68.	27.5	15.8

*Remarks.* — *Arremonops conirostris centratus* is intermediate between *A. conirostris richmondi* and *A. chloronotus*, but different enough from either to deserve a name. In the birds of North and Middle America, Ridgway<sup>1</sup> records *A. conirostris richmondi* from southern Honduras (Segovia River), and *A. chloronotus* from northern Honduras (San Pedro Sula), but specimens of the genus were not available from between these two regions, the area occupied by the new form.

## MAMMALS.

### *Didelphis yucatanensis* ALLEN.

One young adult ♀; Yaruca, 1,000 feet, Feb. 13, 1902. This specimen differs somewhat from true *D. yucatanensis*, and more material might prove the Honduras animal to be separable. The large opossums, on the other hand, are so variable that the peculiarities of this example may be only individual. The skull and teeth are slightly larger than in true *D. yucatanensis*, and the rostrum more swollen; the under fur also is buffy, or ochraceous to, in places yellowish.

Dr. Merriam has very kindly compared the specimen for me with the original series of *D. yucatanensis*, where he was unable to match it exactly. The flesh measurements taken by the collector are as follows: total length, 590; tail vert., 320; hind foot, with claw, 60; ear from notch, 45.

### *Cyclopes dorsalis* (GRAY).

One ♀; Ceiba, January 22.

<sup>1</sup> Bull. U. S. Nat. Mus., 1901, No. 50, Part I., pp. 452 and 454.

**Sciurus (Echinosciurus) boothiae GRAY.**

Seven specimens; Ceiba and Yaruca.

This series is intermediate between true *S. boothiae* and *S. boothiae belti* Nelson, two skins being typical of the former and two of the latter, with the other three variously intermediate.

**Sciurus (Baiosciurus) deppei PETERS.**

Twenty-four specimens; Ceiba and Yaruca. Among these skins there is a wide range of individual variation in color, — from pure white to yellowish rusty, below; above, the tone differs considerably in different individuals.

**Nyctomys decolorus (TRUE).**

Eleven specimens, three of which are young; Yaruca, 1,000 feet. The type locality of this species is Rio de las Piedras, northern Honduras. In cranial characters the present series agrees very well with the type. In color, a comparison can hardly be made, the type being in poor condition. The present form is quite distinct from *N. nitellinus*, lately described by me<sup>1</sup> from Chiriqui, though possibly the two intergrade and are only subspecies. Comparing the Chiriqui series with the present one, the following differences are evident: the skull of *N. decolorus* is lighter and relatively wider posteriorly than that of *N. nitellinus*; *N. decolorus* has narrower and lighter nasals that end behind in a rounding point (the nasals of *N. nitellinus* are square posteriorly). In color the two forms are nearer than I had supposed by an examination of the type alone; they differ chiefly in *N. nitellinus* having a much more conspicuous and larger black whisker patch and broader black orbital ring.

**Sigmodon hispidus borucae (ALLEN).**

Twenty-two specimens, all from Yaruca, 1,000 feet.

In important characters these specimens do not differ from more southern examples of *S. hispidus borucae*, from Costa Rica and Chiriqui, but in color they average a little paler; individuals can be selected, however, from the two series that correspond exactly.

**Sigmodon hispidus furvus, subsp. nov.**

*Type* (and only specimen) from Ceiba; Honduras, sea level, adult ♂, No. 10,665, Coll. Mus. Comp. Zool., collected Jan. 16, 1902, by W. W. Brown, Jr.

*Characters.* — Nearest to *Sigmodon hispidus saturatus* Bailey of Teapa, Tabasco, Mexico, but darker in color; less rusty above; tail blacker, and under

<sup>1</sup> Bull. M. C. Z., 1902, Vol. XXXIX., p. 30.

parts redder; skull similar, except audital bullae wider and flatter and basi-occipital longer and narrower.

*Color.* — Upper parts, dark rich brown, between mummy brown and burnt umber, rather redder on rump, the head, back, and rump darkened and varied by a copious sprinkling of brownish black tipped hairs; under parts strong, buffy ochraceous; feet and hands dark brown, the hairs colored about like those of the back; ears blackish, nearly naked externally, sparsely haired inside, the color of these hairs about like those of the back; tail black, nearly unicolor, being only just perceptibly paler below.

The specimen is in long, fresh, unworn pelage, and there are a few pure white hairs scattered at irregular intervals along the back and sides.

*Measurements.* — Adult ♂, type, total length, 265; tail vert., 105 (the tip of the tail is gone, probably 5 to 10 mm.); hind foot, with claw, 32; ear, from notch, 18. Skull, basal length, 31.4; occipitonasal length, 35.8; zygomatic width, 20.4; mastoid width, 15.2; interorbital width, 5; length of nasals, 12.6; length of palate to palatal notch, 16.2; length of upper molar series, 6.; length of single half of mandible, 20.

*Remarks.* — Mr. Vernon Bailey kindly compared the two forms of *Sigmodon* contained in the present collection for me, with the Mexican series in the collection of the Biological Survey, and we agree that the one from the coast is a new form most closely related to *S. hispidus saturatus*; and that the form from farther inland is not separable from *S. hispidus borucae*, which thus has a wide range for a member of this group.

#### **Oryzomys couesi** (ALSTON).

Thirty-six specimens; Yaruca, 1,000 feet.

#### **Oryzomys rhabdops** MERRIAM.

Nineteen specimens; Yaruca. Among the skulls of this series there is a tendency to a peculiar swelling between the orbits; several specimens, however, do not show this at all, and apart from this tendency the specimens from Honduras are exactly like the type series from Calel, Guatemala.

#### **Heteromys griseus** MERRIAM.

Two specimens, ♂ & ♀; Yaruca. Dr. Merriam has compared these with his extensive Mexican material, and they prove to be identical with *H. griseus* from the mountains near Touala, Chiapas, Mexico.

#### **Dasyprocta punctata** GRAY.

Two adult females; Yaruca.









Bulletin of the Museum of Comparative Zoölogy

AT HARVARD COLLEGE.

VOL. XXXIX. No. 7.

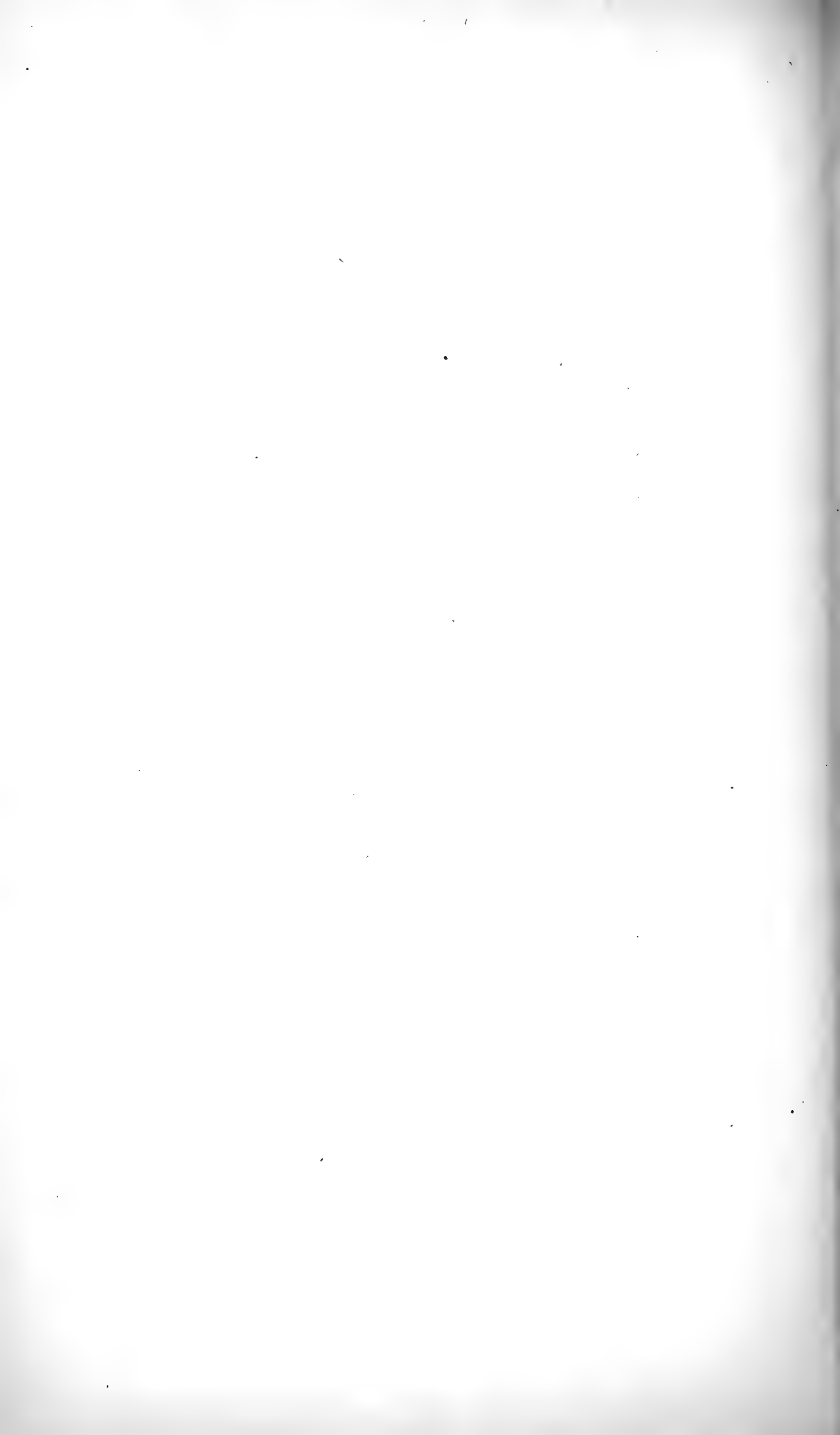
---

CARBONIFEROUS FISHES FROM THE CENTRAL  
WESTERN STATES.

BY C. R. EASTMAN.

WITH FIVE PLATES.

CAMBRIDGE, MASS., U. S. A. :  
PRINTED FOR THE MUSEUM.  
JULY, 1903.



No. 7. — *Carboniferous Fishes from the Central Western States.*

By C. R. EASTMAN.

THE present contribution embodies the results of investigations of an extended series of Carboniferous fishes from the Mississippi and Missouri Valley region, and is essentially a continuation of "Some Carboniferous Cestraciont and Acanthodian Sharks."<sup>1</sup> With regard to faunal relations, the subject-matter of the following pages falls naturally into a threefold division. Attention is first claimed by the Upper Carboniferous fish-fauna of Kansas and Nebraska, which is one of great interest palaeontologically and morphologically. The Coal Measure fish-fauna of Mazon Creek, Illinois, is considered next, and the structure of several new and little-known forms illustrated. Last in order of discussion are certain new or little-known species from the Mississippian series, which appear worthy of notice either on account of their morphologic interest, or because of their relations to other well-known forms. The greater part of the material upon which the following observations are based is preserved in the Museum of Comparative Zoölogy at Cambridge, and so far as possible the location of types and figured specimens is given under the caption of the several species, in the case of all those belonging to other institutions.

I. THE UPPER CARBONIFEROUS FISH-FAUNA OF  
KANSAS AND NEBRASKA.

Altogether, about fifteen species of Upper Carboniferous fishes have been described from Kansas and Nebraska in the writings of J. Leidy,<sup>2</sup> O. H. St. John,<sup>3</sup> St. John and Worthen,<sup>4</sup> and S. W. Williston.<sup>5</sup> To

<sup>1</sup> Bull. Mus. Comp. Zoöl., Vol. XXXIX., 1902, No. 3.

<sup>2</sup> Extinct Vert. Fauna Western Territ. Rept. U. S. Geol. Surv. Territ., Vol. I., 1873, pp. 311-313.

<sup>3</sup> Hayden's Final Rept. U. S. Geol. Surv. Nebraska, 1872, pp. 239-245.

<sup>4</sup> Palaeontology of Illinois, Vol. VI., 1875; *ibid.*, Vol. VII., 1883.

<sup>5</sup> Kansas Univ. Quart., Vol. VIII., 1899, p. 178.

these must be added also a single tooth of a Cladodont shark from the Permo-Carboniferous of Blue Springs, Nebraska, which is made by Cope<sup>1</sup> the type of his so-called *Styptobasis knightiana*. The Missourian fish-fauna of Kansas and Nebraska consists almost exclusively of Elasmobranchs, and is directly successional to the Lower Coal Measure and Mississippian assemblages occurring throughout a wide area to the eastward of these States, its relations with the Chester fauna of Kentucky, Illinois, and Missouri being not its least striking feature.

During the last few years a considerable quantity of new material has been brought to light, chiefly through the activity of Prof. Edwin H. Barbour, Director of the Nebraska University Geological Survey, and his sister, Miss Carrie A. Barbour, of the State University at Lincoln. The writer owes it to the kindness of Dr. and Miss Barbour that all of the specimens collected by them have passed through his hands, and that a number of them are illustrated in the present paper. Acknowledgments are also due to Dr. S. W. Williston of Chicago University, and to Prof. W. C. Knight of Wyoming State University, for the generous loan of material under their charge. Having these facilities at one's command, it seems desirable to present a synopsis of the trans-Missourian fish-fauna which shall be as complete as the present state of our knowledge permits, and this is the endeavor of the following pages.

The stratigraphy and palaeontology of the eastern parts of Kansas and Nebraska have been studied in great detail by a number of geologists during the last few years with special reference to the question of the homotaxial relations of the so-called Permian beds. The discovery of supposed Permian fossils from this region was first reported by Swallow in 1858, and in the spirited controversy which followed, Meek, Swallow, Hawn, Shumard, Hayden, Newberry, Marcou, Geinitz, and others participated, arguing either for or against the recognition of the Permian as a distinct epoch in North American geology. Later the subject was discussed by White and Broadhead to some extent, and more recently Prosser, Cragin, Cummins, Keyes, Tarr, Haworth, Knight, Darton, and Frech have made important contributions to the literature of the Permian question.

It seems to have been established that there are from 1000 to 1350 feet of fossiliferous sediments overlying the Upper Coal Measures (Missourian series) of the Kansas-Nebraskan area, in which faunas succeed one another uninterruptedly from base to summit, as was first contended by Meek. The lower 400 feet (Neosho and Chase formations) con-

<sup>1</sup> Proc. U. S. Nat. Mus., Vol. XIV., 1891, p. 447.

stitute a distinct terrane, — often referred to as the Permo-Carboniferous, — the majority of its species being common to the Upper Coal Measures, and perhaps one-half of the species occurring in the succeeding 300 or 400 feet (Sumner stage of Cragin) being also common to them. But in the upper terrane, the so-called “Red Beds” or Cimarron series, which exhibit a thickness further southward of from 1000 to perhaps 2200 feet, no fossils have been found which are at all closely related to those of the Coal Measures, and writers are pretty generally agreed in correlating this series with the Upper Permian (Neo-Dyas) of Europe.

In the same way there appears to be good reason for believing that the lower part of the Big Blue series (Chase and Neosho strata) correspond to the Artinsk stage, which is the oldest Permian of Russia. Owing to the absence of Cephalopods, however, and general transitional character of the Neosho, no distinct line of separation between the Lower Permian and Carboniferous can be said to exist. The demarcation between the two systems is drawn by Frech<sup>1</sup> at the base of the Chase stage, and this limit for the Lower Permian is also accepted by Prosser,<sup>2</sup> who places the Neosho member at the summit of the Missourian. In Prosser's original description of these formations, however, the line of separation between the Upper Coal Measures and Permian was doubtfully drawn between the Cottonwood and Neosho formations, an arrangement in which a number of writers have concurred.

Regarding the transitional faunal characters, it is remarked by Keyes<sup>3</sup> that “the most noteworthy feature of the organic remains, viewed as a whole, is the gradual replacement of a purely marine type by a shore and brackish water phase, as the change from open sea to closed water conditions took place, and finally to those in which life could not exist. . . . In this region as in Russia, the gradual replacement of a brachiopodous fauna by a Permian lamellibranch fauna follows the local change of open to closed sea conditions. The Permian element of these forms was merely a shallow water facies of the more typical Carboniferous fauna.”

In Nebraska the so-called Permo-Carboniferous (Chase and Neosho) strata form the northern continuation of the Kansas beds, and agree with them in all essential characters. The area is described by Knight<sup>4</sup>

<sup>1</sup> *Lethaea Palaeozoica*, Vol. II., 1899, p. 378.

<sup>2</sup> Revised Classification of the Upper Palaeozoic Formations of Kansas. *Journ. Geol.*, Vol. X., 1902, p. 711.

<sup>3</sup> *Journ. Geol.*, Vol. VII., 1899, p. 354, *et seq.*

<sup>4</sup> *Ibid.*, p. 360.

as "of flat-iron shape, with the broad end to the south resting upon the Kansas-Nebraska line. The northern limit is probably in the vicinity of Roca, Lancaster County. On the east the boundary has only been approximated, . . . but it is supposed that it extends from Roca south and east into Johnston County, thence southward through the western end of Pawnee County into Kansas. The western boundary, from Roca to Beatrice, is also buried beneath a very thick bed of loess, but from Beatrice southward it is traced with considerable accuracy." An understanding of the stratigraphic relations of the Upper Palaeozoic rocks in

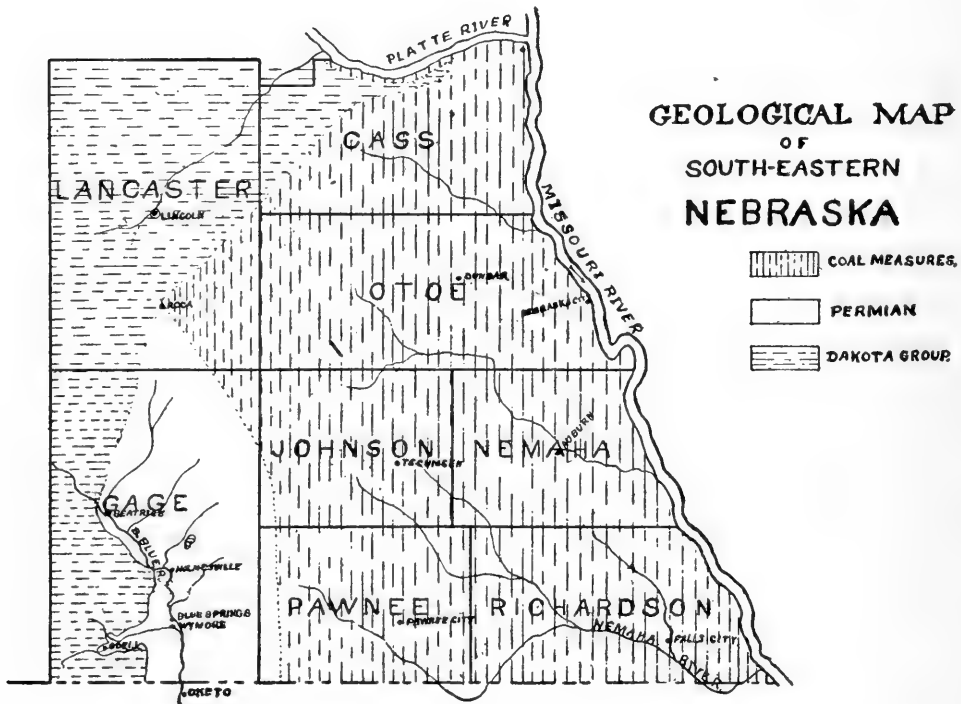


FIG. 1.

A Geological Map of Southeastern Nebraska (after Knight).

Nebraska will be facilitated by an inspection of the accompanying sketch-map and section, taken from Professor Knight's article, and of the following table of formations. The stratigraphy of the Kansas Coal Measures is described in the report of the University Geological Survey of Kansas, particularly in Volume III. by E. Haworth.

Nearly all of the fish-remains described in the present paper are from the Atchison shales, the principal localities being in Cass, Gage, Lancaster, Nemaha, and Sarpy counties. According to Dr. Barbour, the exposures at Cedar Creek, Louisville, South Bend, and Table Rock



may be referred to the summit of the Atchison, and those at Richfield and Springfield to its base. At Manhattan, Kansas, both the Atchison and Cottonwood are exposed.

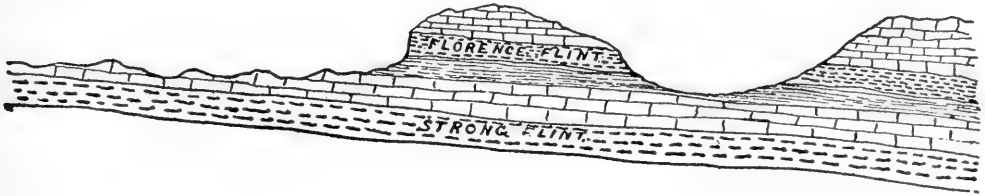


FIG. 2.

A Geological Section of the Nebraska Permo-Carboniferous south and east from Beatrice to the Kansas line (after Knight).

SECTION OF THE UPPER PALAEOZOIC IN KANSAS AND NEBRASKA.

Permian System	{ Cimarron series { Big Blue series (" Permo-Carboniferous ")	{ Kiger shales { Salt Fork shales	
		{ Wellington shales { Marion limestone { Chase limestone { Neosho shales	{ Florence flint { Strong flint
Carboniferous System (Upper part only)	{ Missourian series	{ Cottonwood limestone { Atchison shales { Forbes limestone { Platte shales { Plattsmouth limestone { Lawrence shales	

With these general remarks, we may now pass on to a consideration of the fish-fauna of the Kansas-Nebraska area in systematic order.

**ELASMOBRANCHII.**

**PLEURACANTHIDAE.**

**Pleuracanthus (Diplodus) compressus NEWBERRY.**

- 1856. *Diplodus compressus* J. S. Newberry, Proc. Acad. Nat. Sci. Philad., p. 99.
- 1866. *Diplodus compressus* Newberry and Worthen, Pal. Illinois, Vol. II., p. 60, Pl. IV., Fig. 2.
- 1870. *Diplodus compressus* O. St. John, Proc. Amer. Phil. Soc., Vol. XI., p. 432.

1872. *Diplodus compressus* O. St. John, Hayden's Final Rept. U. S. Geol. Surv. Nebraska, p. 240, Pl. IV., Fig. 19.  
 1873. *Diplodus compressus* J. S. Newberry, Rept. Geol. Surv. Ohio, Vol. I., Pt. ii., p. 335.  
 1875. *Diplodus compressus* J. S. Newberry, *Op. cit.*, Vol. II., Pt. II., p. 45, Pl. LVIII., Fig. 2.

A single tooth of this species, from the Missourian of Rulo, Nebraska, is described and figured by St. John (1872), but no other examples have since been reported from this region. The species also occurs in the Upper Coal Measures of south-western Iowa, Indiana, and Ohio. Teeth of *D. platypternus* Cope are abundant in the Permian "Red Beds" of Texas.

## CLADODONTIDAE.

### *Cladodus occidentalis* LEIDY.

(Plate 2, Figs. 3, 8, 9.)

1859. *Cladodus occidentalis* J. Leidy, Proc. Acad. Nat. Sci. Philad., p. 3.  
 1866. *Cladodus mortifer* Newberry and Worthen, Pal. Illinois, Vol. II., p. 22, Pl. I., Fig. 5.  
 1870. *Cladodus mortifer* O. St. John, Proc. Amer. Phil. Soc., Vol. XI., p. 431.  
 1872. *Cladodus mortifer* O. St. John, Hayden's Final Rept. U. S. Geol. Surv. Nebraska, p. 239, Pl. III., Fig. 6, Pl. VI., Fig. 13.  
 1873. *Cladodus occidentalis* J. Leidy, Rept. U. S. Geol. Surv. Territ., Vol. I., p. 311, Pl. XVII., Figs. 4-6.  
 1897. *Cladodus mortifer* J. S. Newberry, Trans. N. Y. Acad. Sci., Vol. XVI., p. 285, Pl. XXII., Fig. 2.

The best description of this species is that given by St. John in 1872, who reports its occurrence in the Missourian of the Nebraska City section, Manhattan, Kansas, and south-western Iowa. Teeth of this species occur also in the Coal Measures of Illinois and Indiana.

A number of fragmentary teeth have been obtained by Professor Barbour from the Permo-Carboniferous of Roca, and Atchison shales (Missourian) of Table Rock, Nebraska, three of which are shown in the accompanying illustrations.

### *Cladodus knightianus* (COPE).

(Plate 2, Fig. 4.)

1891. *Styptobasis knightiana* E. D. Cope, Proc. U. S. Nat. Mus., Vol. XIV., p. 447, Pl. XXVIII., Fig. 2.

*Type.* — Imperfect crown; Museum of the State University of Nebraska.

The solitary example upon which Cope based his definition of this species was obtained by W. C. Knight from the "Florence Flint" (Chase formation)

of Blue Springs, Nebraska, and is shown of the natural size in Plate 2, Fig. 4. Inspection shows that Cope mistook the worn base of the crown for a truncate root, in allusion to which the name *Styptobasis* was given; and so far as may be judged from the form and ornamentation of the crown, it differs from the foregoing species merely in the fact of being somewhat more robust. The shallow median depression at the base of the crown on its outer face likewise occurs in *C. occidentalis*. Another Cladodont tooth, scarcely distinct from the latter species, is described by O. P. Hay under the name of *C. girtyi*, from the Coal Measures of Colorado.

*Formation and Locality.* — Permo-Carboniferous; Blue Springs, Nebraska.

### **Phoebodus knightianus, sp. nov.**

(Plate 4, Figs. 40, 40 a.)

*Type.* — Imperfect tooth; Museum of Comparative Zoölogy.

From the same locality as the preceding, Professor Knight secured some years ago one nearly perfect tooth and the root of a second specimen, which he cited as "*Diplodus*, sp. nov." in his faunal list of the Kansas and Nebraska Permo-Carboniferous.<sup>1</sup> Through the courtesy of their discoverer, these specimens have come into the possession of the Museum of Comparative Zoölogy, and form the basis of the following description. It is stated in a letter from Professor Knight that his attempt to remove some of the adherent matrix from the more perfect tooth resulted in some injury to the latter, and the broken parts were unfortunately not preserved. He had, however, observed that the three principal cones were all of the same height, and that the base was symmetrically developed. Accordingly, in the figures here given of the fractured specimen, its original outline is restored on Professor Knight's authority.

Teeth of moderate size, the median and two outer cones of equal height, and no intermediate denticles. All three cusps stout and erect, convex on both faces, with sharp lateral carinae, and a few delicate, slightly curved striae extending for a short distance upward from the base. Attached surface of root nearly plane, with a single pad-like prominence directly underneath the median cone; postero-superior surface with a rounded "button."

The root agrees in size and general form with that of *Diplodus platypternus* Cope, except that both the posterior button and antero-inferior prominence are of relatively smaller size. From *Phoebodus politus* Newb. and other Devonian species the present form is distinguished by the absence of intermediate denticles, a character in which it agrees with the Triassic *P. brodiei*. The type specimen is shown of four times the natural size in Plate 4, Figures 40 and 40 a, but in these illustrations the anterior boss on the lower surface of the root

<sup>1</sup> Journ. Geol., Vol. VII., 1899, pp. 366, 372, 374, 491.

is represented a little too conspicuously. In Figure 39 of the same plate is shown a tooth belonging to another species of *Phoebodus*. A good figure of *P. politus* Newb., from the Cleveland Shale of Ohio, may be found in the *Journal of Geology*, Vol. VII., 1899, p. 492.

*Formation and Locality.* — Permo-Carboniferous; Blue Springs, Nebraska.

## PETALODONTIDAE.

Fortunate discoveries of *Janassa* afford the means for a clear understanding of the dentition and form of body in the ray-like creatures belonging to this family. *Janassa* exhibits a ray-shaped trunk covered with smooth, rounded, quadrate granules, and large pectoral fins which extend forward to the head, the pelvic pair being separated from them by an interspace. There are no fin-spines, the mouth-cleft is very narrow, as in rays, and the tail is slender. There can be no doubt that forms like this, or like *Tamiobatis*, *Copodus*, *Psammodus*, *Archaeobatis*, etc., were early approximations to the modern ray type, whether we consider them as genetically related to the latter or not.

The dentition of *Janassa*, as determined with entire accuracy by Hancock and Howse in *J. bituminosa*, is similar in both jaws, and consists of a median or symphyisial, and three pairs of lateral series, each having from four to seven teeth, the lateral series diminishing regularly in size from the center outwards. The lower dentition is more strongly arched and at the same time less extended from side to side than the upper, and the cutting-margins of the lower functional teeth bite inside those of the opposite jaw. The teeth of the outermost lateral series in the upper jaw slightly exceed those of the corresponding lower rows in width. The manner of succession is peculiar in that the oldest-formed teeth, after they have ceased to be functional, become piled upon one another in front of and away from the oral margin, thus affording firm support for the functional ones (*cf.* Text-fig. 3). The teeth of each series are closely wedged together and interlock with those of adjoining rows, the whole forming a very compact mass.

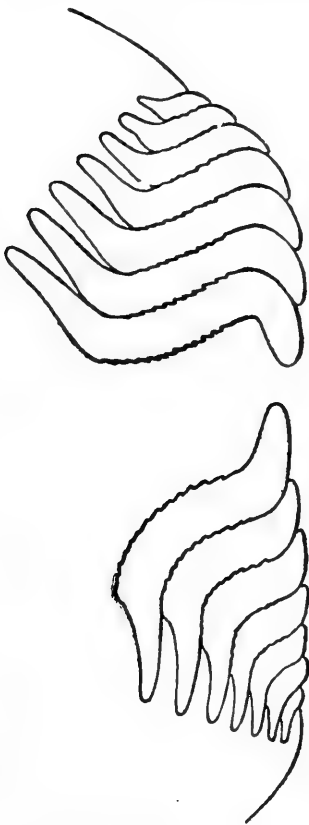


FIG. 3.

Diagram showing arrangement of upper and lower dentition in *Janassa bituminosa* Schloth. (Slightly modified after the restorations by Hancock and Howse, and O. Jaekel.)  $\times \frac{3}{4}$ .

The arrangement of teeth in *Janassa* is well illustrated in the figures given

by Hancock and Howse over thirty years ago,<sup>1</sup> and more recently by Jaekel,<sup>2</sup> the latter author reaffirming the correctness of his predecessors' conclusions. According to these writers, the strongly reflected, scoop-like extremity of the crown served for a cutting-margin, and the pavement-like, rugose, or imbricated portion as a triturating surface. This interpretation appears plausible enough in the case of some species, but must not be supposed to be of universal application amongst Petalodonts, very different conditions having existed in certain other genera. Teeth of *Petalodus* and *Petalorhynchus* have been found in successional series, the crowns overlapping and more or less erect (cf. Text-fig. 4), but it is not known how many of such series constituted the complete dentition. In these genera, as in *Janassa*, the median series are larger than the rest and bilaterally symmetrical, those of the lateral series more or less oblique. It was long ago observed by Hancock and Howse<sup>3</sup> that *Petalodus* was provided with both symmetrical and oblique rows of teeth, and that examples had been "found lying in regular order, as if forming a portion of a vertical row." Consequently we must express ourselves as at variance with Jaekel's conjecture that the teeth of *Petalorhynchus* probably represent the symphyseal series of *Petalodus*, their disparity in size and discordant distribution clearly entitling them to recognition as distinct genera. There are also excellent reasons for dissenting from his proposed union of *Petalodus* and *Ctenoptychius*, and from his theoretical association of the fin-spines known as *Stichacanthus* and *Physonemus* (including *Xystracanthus* and *Batacanthus*), with *Polyrhizodus* and *Petalodus* respectively. Not only do the facts of distribution militate with this last assumption, but the absence of fin-spines in *Janassa* renders it extremely improbable that such defences were present in other members of the same family.

It is inferred by Hancock and Howse from the fineness of the cutting-edge in two species of *Janassa* that the food must have consisted of soft material. They state of *J. bituminosa* that "the scoop-like cutting-margin is certainly much used, for it is almost always greatly worn in a regular manner; only in one instance have we seen it a little broken. It would be an efficient instrument in cutting vegetable substances, and these might afterwards require the aid of the crushing-disk." The presence of a carbonaceous mass in the abdominal region of certain specimens also suggests to them herbivorous habits. Jaekel, on the other hand, in discussing the probable food of the Permian *J. bituminosa*,



FIG. 4.

*Petalorhynchus psittacinus* (M'Coy). Lower Carboniferous; Armagh, Ireland. Naturally associated series of seven teeth. Outer face,  $\times \frac{1}{4}$ .

<sup>1</sup> Hancock, A., and Howse, R., On *Janassa bituminosa*, Schlotheim. Ann. Mag. Nat. Hist. (4), Vol. V., 1870, p. 47, Pl. II., III.

<sup>2</sup> Jaekel, O., Ueber die Organisation der Petalodonten. Zeitschr. deutsch. geol. Ges., Vol. LI., 1899, p. 258.

<sup>3</sup> Loc. cit., p. 61.

argues from the worn condition of the triturating surface that the fare consisted of hard-shelled prey, such as Brachiopods and Pelecypods, and cites an example preserved in the Bergakademie in Berlin where a number of Productae are contained within the abdominal cavity. It is reasonable to suppose that the relative tenuity or thickness of the cutting-edge amongst different species of *Janassa* furnishes an approximate indication of their having subsisted on soft or hard shelled prey, as the case may be.

*Janassa maxima*, sp. nov.

(Plate 2, Fig. 21; Plate 3, Fig. 24.)

*Type.* — Imperfect crown; University of Nebraska.

Teeth extremely large and robust, with very high and strongly reflexed crown and thick cutting-margin. Posterior two-thirds of oral surface convex and covered with numerous prominent oblique plicae displaying indications of wear during life. Anterior face strongly convex, smooth, the posterior two-thirds elevated into two abrupt longitudinal ridges which are separated by a broad median longitudinal channel. Anterior face showing marks of contact with next oldest underlying tooth, the only indications of wear during life being directly along the cutting-margin.

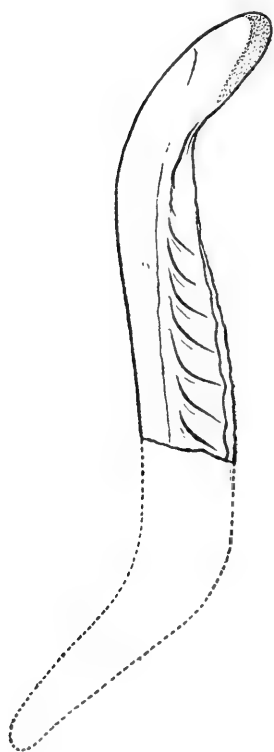


FIG. 5.

*Janassa maxima*, sp.  
nov. Profile,  $\times \frac{1}{4}$ .

Of this species only the unique tooth shown of the natural size in the accompanying illustrations is known at present. This is at least twice the size of the Permian *J. bituminosa* (Schloth.), the largest previously known species, which it approaches more closely than any others. In fact, the relations of this new species are altogether with those of Permian, rather than with those of Carboniferous age.

The whole of the root and posterior portion of the crown are missing, and a portion of the cutting-edge of the crown has also been broken away. Even in its mutilated condition, however, the crown exhibits a total length of nearly 5 cm. Its lateral borders are straight, proving that the tooth was not deformed by interlocking with those of adjoining series. As to the position in the mouth occupied by this tooth, the marks of wear indicate very clearly that it belonged in one of the principal series to the left of the symphysial in the upper jaw. The tooth opposed to it in the lower jaw played inside its cutting-edge, and slightly to the left instead of squarely against it. The asymmetrically worn condition of the cutting-edge in

*J. bituminosa* is very distinctly shown in Hancock and Howse's figures,<sup>1</sup> and also in Jackel's.<sup>2</sup> There can be little doubt that the action of the jaws upon one another was similar to that obtaining in modern Gymnodonts and Chimaeras. It has been stated in the definition of this species that the anterior face of the crown exhibits marks of contact with the next older tooth which it displaced. These markings are of two kinds. In the first place a raised line extending parallel with the cutting-edge at a distance of about a centimeter behind it (Pl. 3, Fig. 24) demarcates the area overlapped by the preceding tooth; in other words, it divides the exposed cutting-edge from the covered portion. Secondly, the longitudinal ridges on the anterior face display a number of parallel facettes caused by the impress of the oblique folds on the triturating surface of the next older tooth which this one displaced. Similar markings have been observed on the anterior face of teeth belonging to *J. bituminosa*, and this interpretation is given of them by Messrs. Hancock and Howse.<sup>3</sup> The thickness of the cutting-margin (*cf.* Text-fig. 5) and generally stout condition of the present specimen render it probable that the creature subsisted on hard-shelled prey.

*Formation and Locality.* — Atchison shales (Missourian); Richfield, Nebraska.

***Janassa unguicula*, sp. nov.**

(Plate 2, Fig. 13.)

*Type.* — Imperfect tooth; University of Nebraska.

Teeth delicate and of moderate size; crown much reflexed, regularly arched from side to side, and with a knife-edge trenchant margin. Outer coronal face smooth, posterior face entirely covered with fine longitudinal striae. Form of triturating surface and root unknown.



FIG. 6.

*Janassa unguicula*, sp. nov. Outer face of crown,  $\times \frac{1}{2}$ . A, Vertical section. B, Oral aspect, viewed from above,  $\times \frac{1}{2}$ .

This species is represented by a unique specimen from the Missourian of Cedar Creek, Nebraska, shown of the natural size in Plate 2, Fig. 13, and Text-fig. 6. Only the cutting portion of the crown is preserved, the crushing surface (if one was indeed present) and root having been broken away. The size

<sup>1</sup> Ann. Mag. Nat. Hist. (4), Vol. V., 1870, Pl. II., Fig. 2.

<sup>2</sup> Zeitschr. deutsch. geol. Ges., Vol. LI., 1899, Pl. XIV., Fig. 2.

<sup>3</sup> *Loc. cit.*, p. 55.

is approximately that of *J. clavata* from the British Carboniferous Limestone, the width being 1.4 cm., and the height 0.9 cm. The cutting-margin is compressed to a sharp edge, and the thickness at the base of the crown is only 2 mm. From the general symmetry of the crown, and shallow sinus in the middle of the cutting-edge, it is to be inferred that the tooth occupied a position in the symphysial series. The area overlapped by the tooth immediately preceding on the anterior face of the crown is very plainly demarcated. The darker colored band along the cutting-margin appears to be due to fortuitous mineralization.

The present species does not appear to be at all closely related to other American or European forms, and only remotely resembles certain teeth described from the St. Louis and Chester formations under the names of *Tanaodus sculptus* and *T. polymorphus* St. J. and W. The general delicacy of the specimen is suggestive of *Peltodus unguiformis* N. and W., from the Coal Measures of Illinois, but the form and surface markings are different. *Tanaodus* and *Peltodus* are probably both synonyms of *Janassa*. Cope's original descriptions of *J. strigilina* and *J. gurleyana* have recently been republished with figures by E. C. Case, in the *Journal of Geology*, Vol. VIII., 1900.

*Formation and Locality.* — Atchison shales (Missourian); Cedar Creek, Nebraska.

#### FISSODUS ST. JOHN and WORTHEN.

The chief distinguishing character between this genus and *Janassa* is that the trenchant margin is cleft or divided into two or three broad acuminate points. The so-called *Cholodus*, comprising the single species *C. inaequalis*, was held by St. John and Worthen to be distinct from *Fissodus* in that the cutting-margin was eccentrically lobed. The circumstance that the imperfect specimens studied by these authors were unsymmetrically worn is attributable to their having occupied a position among the lateral series of the mouth in *Fissodus*.

#### *Fissodus inaequalis* (ST. JOHN and WORTHEN).

(Plate 2, Fig. 11; Plate 3, Fig. 26.)

1875. *Cholodus inaequalis* St. John and Worthen, Pal. Illinois, Vol. VI., p. 416, Pl. XIII., Figs. 4, 5.

There can be no question that the well-preserved crown shown in the accompanying illustrations is specifically identical with the fragmentary teeth from the Upper Coal Measures of Iowa and Illinois, described by St. John and Worthen as *Cholodus inaequalis*. The symmetrically formed outlines of the present specimen indicate its having pertained to the symphysial series, and by the same token those figured by St. John and Worthen occupied a lateral position. The root has been broken away from the specimen in hand, but the imbricated belt corresponding to the triturating surface in *Janassa* is well



preserved, and exhibits four prominent, posteriorly curved folds which have become worn either by attrition during life, or by postmortem abrasion, or both.

Indications of at least one pair of rudimentary lobes appear along the lateral border half-way between the terminal apices and the plicated area. The cutting-margin is moderately thin, and below it for some distance on either face the dentine tubules have become exposed through atmospheric erosion. The marks of overlap by the tooth immediately preceding this are rather indistinctly shown. A shallow longitudinal depression occupies the middle portion of the anterior face opposite the imbricated area, a condition similar to that observed in *Janassa maxima*.

*Formation and Locality.* — Missourian; Peru and Louisville, Nebraska; Topeka, Kansas; also in Iowa, Illinois, and Missouri.

### **Fissodus dentatus, sp. nov.**

(Plate 2, Fig. 12.)

*Type.* — Detached crown; Museum of Comparative Zoölogy.

*Definition.* — Teeth of comparatively small size, oval in general outline, with faintly serrated lateral border and cutting-margin divided by a median cleft into two strong, acuminate cusps. Anterior face smooth, uniformly and strongly convex in a vertical direction, more gently arched from side to side. About one-half of the anterior face overlapped by the next older tooth in front.

A small, beautifully preserved crown from the Missourian of Topeka, Kansas, collected by the late S. A. Miller, and now belonging to the Museum of Comparative Zoölogy, is taken as the type of this species, which differs from other *Fissodus* teeth in having serrated lateral margins. This character is of interest inasmuch as it determines *Fissodus* to be intermediate in position between *Janassa* and *Ctenoptychius*. The general configuration of the crown resembles that of *F. tricuspoidatus*, but on the other hand it agrees with *F. bifidus* in possessing a deeply cleft, equilobed cutting-margin. There are three tolerably distinct serrations along the upper third of the lateral margin on either side, below which are several faint crimpings of the delicate edge. The posterior face is concealed by matrix, and the root has been broken away. The total height of the crown is a fraction over, and the extreme width a fraction under 7 mm.

*Formation and Locality.* — Missourian; Topeka, Kansas.

### **PETALODUS OWEN.**

The teeth of this genus have petal-shaped crowns which are much elongated from side to side, and shortened in the opposite direction. The cutting-margin is smooth or at most delicately crenulated, but not serrated, and the

base of the crown has several narrow imbricating folds of dentine descending lower on the posterior than on the anterior face. The root is relatively large in typical species, with a tumid and truncated lower extremity, and is longest and broadest in teeth belonging to the symphyseal series. The shortness of the root in some species has led to the establishment of such genera as "Antliodus" and "Chomatodus," which are best included under the same head as the more typical forms.

Although the teeth of *Petalodus* are scarcely distinct from those of *Ctenoptychius*, as already observed by Traquair,<sup>1</sup> practical reasons render it desirable to retain the former as a provisional genus, and besides, the uniformly entire condition of the cutting-margin in *Petalodus* seems to be a character of more than specific value. A serrated cutting-margin is simulated only amongst unequally worn teeth, usually belonging to the lateral series, in some species. In *Ctenoptychius* the teeth of both upper and lower jaws are distinctly serrated, in *Peripristis* only those of the upper jaw. The teeth of *Petalodus* are known to have been arranged in series closely similar to those of *Janassa*, the larger and symmetrically formed teeth occupying a symphyseal position, and the lateral series diminishing in size, besides becoming more oblique, on passing from the center. Jaekel's conjecture that the symphyseal series were of the form known as *Petalorhynchus* is clearly untenable.

### *Petalodus alleghaniensis* LEIDY.

(Plate 2, Figs. 17, 18; Plate 3, Fig. 27.)

1853. *Petalodus ohioensis* J. M. Safford, Amer. Journ. Sci. (2), Vol. XVI., p. 142.  
[Insufficiently defined.]
1856. *Sicarius extinctus* J. Leidy, Proc. Acad. Nat. Sci. Philad., Vol. VII., p. 414.  
[Insufficiently defined.]
1856. *Petalodus alleghaniensis* J. Leidy, Journ. Acad. Nat. Sci. Philad. (2), Vol. III., p. 161, Pl. XVI., Figs. 4-10.
1866. *Petalodus destructor* J. S. Newberry and Worthen, Pal. Illinois, Vol. II., p. 35, Pl. II., Figs. 1-3.
1870. *Petalodus destructor* O. H. St. John, Proc. Amer. Phil. Soc., Vol. XI., p. 433.
1872. *Petalodus destructor* O. H. St. John, Hayden's Final Rept. U. S. Geol. Surv., Nebraska, p. 241, Pl. III., Fig. 5.
1873. *Petalodus alleghaniensis* J. Leidy, Rept. U. S. Geol. Surv. Territ., Vol. I., p. 312, Pl. XVII., Fig. 3.
1875. *Petalodus alleghaniensis* J. S. Newberry, Rept. Geol. Surv. Ohio, Vol. II., p. 52, Pl. LVIII., Fig. 13.
1875. *Petalodus alleghaniensis* St. John and Worthen, Pal. Illinois, Vol. VI., p. 396.
1895. *Petalodus securiger* O. P. Hay, Journ. Geol., Vol. III., p. 561, Figs. 1, 2.
1896. *Petalodus alleghaniensis* C. R. Eastman, Journ. Geol., Vol. IV., p. 174.
1899. *Petalodus* sp. O. Jaekel, Zeitschr. deutsch. geol. Ges., Vol. LI., p. 287, Fig. 6 A.

<sup>1</sup> Geol. Mag. (3) Vol. V., 1888, p. 85.

A large series of this exclusively Upper Carboniferous species have come under the writer's observation, a study of which shows a wide range of variation to exist between the large, symmetrically formed, symphyseal teeth, such as is represented in Pl. 2, Fig. 17, and the low-crowned, short-rooted, often quite asymmetrical teeth belonging to the outermost of the lateral series. The form of the root is even more variable than that of the crown, as one may satisfy himself by comparison of Figs. 17 and 18 of Plate 2, or the other figures of this species contained in the literature. Dr. O. P. Hay has commented on the fact that in Newberry and Worthen's figures of *P. destructor* the lateral angles of the crown are acutely terminated, and notes that in the specimen named by him *P. securiger* they are rounded off, at which point the enamel folds become flexed upward. This appears to be the normal condition manifested by all perfectly preserved teeth, but the root being extremely attenuated close to the lateral angles, the edges are rarely found entire. And it is perfectly evident from Newberry and Worthen's Figs. 1-3 that none of the lateral angles in their specimens have escaped injury.

The imbricated enamel folds at the base of the crown are sometimes distinctly raised on both faces, and usually appear smoother on the anterior than on the posterior face, as if from contact with adjacent older teeth of the same series. The extent to which the teeth of a single series overlapped one another seems to have been greater than in *Janassa*, and equals that in *Petalorhynchus*<sup>1</sup> and *Ctenoptychius*.<sup>2</sup> Marks of wear also seem to show that the upper and lower dentition interlocked by a comparatively small margin.

Besides the single tooth of this species described by St. John from the Missourian of Rock Bluff, Nebraska, numerous examples have been obtained by Professor Barbour from the same formation at Richfield and Table Rock, and from the Permo-Carboniferous of Roca, Nebraska.

*Formation and Locality.* — Coal Measures; Pennsylvania, Ohio, Illinois, Iowa, Nebraska, Arkansas. Permo-Carboniferous; Nebraska.

### *Petalodus* (*Chomatodus*) *arcuatus* (ST. JOHN).

1870. *Chomatodus arcuatus* O. H. St. John, Proc. Amer. Phil. Soc., Vol. XI, p. 435.

1872. *Chomatodus arcuatus* O. H. St. John, Hayden's Final Rept. U. S. Geol. Surv. Nebraska, p. 243, Pl. VI., Fig. 14.

1875. *Chomatodus arcuatus* St. John and Worthen, Pal. Illinois, Vol. VI., Pl. X., Fig. 23.

Low-crowned teeth of the form commonly ascribed to *Chomatodus* (*pars*) in all probability represent the postero-lateral series of *Petalodus*, and it would seem that this genus possessed a larger number of transverse series than *Janassa*, as well as a more elongated mouth-cleft. The narrow, ray-like mouth-cleft in *Janassa* is regarded by Jaekel as evidence of specialization.

<sup>1</sup> Cf. J. W. Davis, On the fossil Fishes of the Carboniferous Limestone Series, Trans. Roy. Dublin Soc. (2), Vol. I., 1883, p. 426, Pl. LXI., Fig. 16.

<sup>2</sup> Cf. St. John and Worthen, Pal. Illinois, Vol. VI., 1875, Pl. XII., Fig. 9.

A single tooth of this species is described by St. John from the Missourian near Nebraska City, and another is figured by St. John and Worthen from a corresponding horizon in Adams County, Iowa. Professor Barbour has also obtained a solitary example from the Atchison shales of Peru, Nebraska.

*Formation and Locality.* — Missourian; Iowa and Nebraska.

**Ctenoptychius occidentalis** (ST. JOHN and WORTHEN).

(Plate 2, Fig. 10.)

1875. *Ctenopetalus occidentalis* St. John and Worthen, Pal. Illinois, Vol. VI., p. 401, Pl. XII., Fig. 14.

This species is founded on very delicate, gently arched teeth with relatively few (10-12) and obtuse coronal serrations, the broad basal band on the outer face being sharply set off from the exposed portion of the crown. The two examples known to the authors of this species were derived from the Lower Coal Measures in the vicinity of Fort Dodge, Iowa. The trivial title of *occidentalis* was bestowed by the same authors upon still another species of *Ctenoptychius*, which they placed in the now obsolete genus "Harpacodus." The form occurs in the St. Louis limestone of Illinois and Missouri, and so closely resembles *C. compactus* (St. J. and W.) from the Chester Group, that we have no hesitation in uniting it with that species. A single detached crown of *C. occidentalis*, somewhat weathered, was obtained by Professor Barbour from the Atchison shales of Richfield, Nebraska.

*Formation and Locality.* — Productive Coal Measures; Iowa. Missourian; Nebraska.

PERIPRISTIDAE.

PERIPRISTIS ST. JOHN.

Proc. Amer. Phil. Soc., Vol. XI., 1870, p. 434.

*Hoplodus* R. Etheridge, jun., Geol. Mag. (2), Vol. II., 1875, p. 243.

*Diodontopsodus* J. W. Davis, Brit. Assoc. Rept., 1881, p. 646.

*Pristodus* J. W. Davis (*ex Agassiz MS.*), Trans. Roy. Dublin Soc. (2), Vol. I., 1883, p. 519.

**Peripristis semicircularis** (NEWBERRY and WORTHEN).

(Plate 2, Figs. 5-7; Plate 3, Fig. 25.)

1866. *Ctenoptychius semicircularis* Newberry and Worthen, Pal. Illinois, Vol. II., p. 72, Pl. IV., Fig. 18.

1870. *Peripristis semicircularis* O. H. St. John, Proc. Amer. Phil. Soc., Vol. XI., p. 434.

1872. *Peripristis semicircularis* O. H. St. John, Hayden's Final Rept. U. S. Geol. Surv. Nebraska, p. 242, Pl. III., Figs. 3, 4, Pl. IV., Fig. 20.  
 1875. *Ctenoptychius semicircularis* J. S. Newberry, Rept. Geol. Surv. Ohio, Vol. II., p. 52, Pl. LVIII., Fig. 14.  
 1902. *Peripristis semicircularis* C. R. Eastman, Geol. Mag. (IV.), Vol. IX., p. 389, Text-fig. 1.

It is evident from marks of contact that the relations between the supposed upper and lower teeth of this species are identical with those known to obtain in *P. falcatus*, a specimen of the latter having been found which displays the



FIG. 7.

*Peripristis semicircularis* (N. & W.). Chester Group, Kentucky. Lower tooth, in profile and front view,  $\times \frac{1}{2}$ .

dental plates of both jaws in natural association. The tooth which may be provisionally referred to the lower jaw in all these forms is the one which fitted inside that of the opposite jaw when the mouth was closed, this condition having been ascertained to hold in the case of *Janassa*, and being true among sharks generally. The lower tooth of *P. semicircularis* differs from the upper



FIG. 8.

*Peripristis semicircularis* (N. & W.). Chester Group, Kentucky. Upper tooth, in profile and front view,  $\times \frac{1}{2}$ .

in having the serrations of the cutting-edge obsolete, or nearly so, and the basal border deflected downward in the median line in front, as shown in Text-figure 7. It also has a longer root than the upper tooth. The coronal margin of the latter is always strongly serrated in the unworn condition (Text-fig. 8), there being usually four denticulations on one side of the median line and five on the other. The coronal cavity of the upper tooth exhibits a deep pit in the median line at the junction of the horizontal and vertical portions of the posterior face, but there is no groove extending from it on either side as in *P. falcatus*. In one specimen, that shown in Plate 2, Fig. 7, the pit is de-

veloped into a perforation passing entirely through the horizontal portion of the crown, a condition which is sometimes observed in *P. falcatus*. The Yorkshire species known as *P. benniei* (Etheridge) differs from both *P. falcatus* and *P. semicircularis* in that the coronal margin of the upper tooth is not dentated but smooth, and rises into an acuminate apex in front.

The original of Plate 2, Fig. 5, possesses some pathologic interest, inasmuch as it became deformed during life, either as the result of injury or of irregularity in growth. It is an upper tooth shown here in left lateral aspect, and both root and crown on the side away from the observer are strongly indented. Fine parallel scratches resulting from the attrition of food, and preserved as distinctly as in a fresh individual, extend in the same direction over both the inner and outer coronal face on the uninjured side, and their obliquity to the vertical axis indicates that the tooth stood slantwise in the jaw, only about half the cutting-margin functioning against the lower tooth. Had its position been erect in the jaw, these markings would of course have been vertical, as in all normally formed teeth. The serrations of the cutting-margin have become almost effaced through wear. The triangular form of the root (as seen in profile) is natural, and the sublunate surface for its attachment to the crown is well shown in the original of Plate 2, Fig. 7. The latter tooth is detachable from the matrix, thus exposing a mold of the posterior face. Impressions in the matrix show that the cutting-margin was prominently serrated, as in the original of Fig. 6 of the same plate, the root of which has not been freed from the matrix. For comparison with the Nebraska specimens shown in Plate 2, an illustration is given in Plate 3, Fig. 25, and also in Text-figure 8, of a large upper tooth from the summit of the Chester limestone in Kentucky. The originals of this and also of the lower tooth shown in Text-figure 7 were found by Mr. E. O. Ulrich in such close proximity at the same outcrop near Montgomery Switch, Caldwell County, as to leave scarcely any doubt that they pertained to a single individual.

*Formation and Locality.* — Atchison shales (Missourian); Bellevue, Nebraska City and South Bend, Nebraska. Productive Coal Measures; Ohio and Indiana. Chester Group; Caldwell County, Kentucky.

## COCHLIODONTIDAE.

### PLATYXYSTRODUS HAY.

The name *Platyxystrodus* has been proposed by O. P. Hay as a substitute for the preoccupied title of *Xystrodus*, the latter having been employed by Plieninger two years prior to the application of the term in 1860 by Morris and Roberts.

**Platyxystrodus occidentalis** (ST. JOHN).

1870. *Xystrodus* (?) *occidentalis* O. H. St. John, Proc. Amer. Phil. Soc., Vol. XI., p. 436.  
 1872. *Xystrodus* (?) *occidentalis* O. H. St. John, Hayden's Final Rept. U. S. Geol. Surv. Nebraska, p. 244, Pl. IV., Fig. 18.

This species is founded upon a single imperfect tooth, doubtfully of this genus, from the Missourian of Aspinwall, Nebraska. The general form is suggestive of *Deltodus*, but the coronal surface is described by St. John as exhibiting the characteristic punctations of *Platyxystrodus*.

**Deltodus angularis** NEWBERRY and WORTHEN.

(Plate 2, Fig. 19.)

1866. *Deltodus angularis* Newberry and Worthen, Pal. Illinois, Vol. II., p. 97, Pl. IX., Fig. 1.  
 1870. *Deltodus* (?) *angularis* O. H. St. John, Proc. Amer. Phil. Soc., Vol. XI., p. 437.  
 1872. *Deltodus* (?) *angularis* O. H. St. John, Hayden's Final Rept. U. S. Geol. Surv. Nebraska, p. 244, Pl. VI., Fig. 18.  
 1883. *Orthopleurodus carbonarius* St. John and Worthen, Pal. Illinois, Vol. VII., p. 192, Pl. XIII., Fig. 7 (*non* Figs. 6, 8).

The forms cited in the above synonymy all plainly belong to the genus *Deltodus*, and hence we find ourselves unable to agree with St. John and Worthen in their proposed union of this species with *Sandalodus*, on the basis of three fortuitously associated teeth described by them in Volume VII. of the Illinois Palaeontology. A small posterior dental plate was obtained by St. John from the Missourian of Nebraska City, and the larger one shown in Plate 2, Fig. 19, is from the same horizon near Louisville, Nebraska.

*Formation and Locality.* — Missourian; Kansas, Nebraska, Iowa, and Missouri. Lower Coal Measures; Illinois and Indiana.

**Sandalodus carbonarius** NEWBERRY and WORTHEN.

1866. *Sandalodus carbonarius* Newberry and Worthen, Pal. Illinois, Vol. II., p. 104, Pl. X., Figs. 4, 5.  
 1883. *Orthopleurodus carbonarius* St. John and Worthen. *Op. cit.*, Vol. VII., p. 192, Pl. XIII., Figs. 6, 8.  
 1889. *Orthopleurodus carbonarius* J. P. Lesley, Rept. Geol. Surv. Penn., Vol. II., pp. 568, 920, Pl. 4.  
 1895. *Orthopleurodus carbonarius* J. P. Lesley, Summary Geol. Penn., Vol. III., Pl. LXXI.

Examples of this species determined by St. John and Worthen as "long posterior teeth of the upper jaw" are reported by these authors from the "Upper Coal Measure strata near Topeka, Kansas."

## STREBLODUS AGASSIZ.

Streblodus may be conveniently retained as a provisional genus in the sense intended for its employment by Agassiz. A different interpretation has been suggested by St. John and Worthen,<sup>1</sup> who distribute the dental plates referred to Streblodus amongst the genera Cochliodus, Deltoptychius, and Chitonodus, but confirmation of their views by direct evidence is lacking. The same may be said regarding their theoretical reconstruction of the dentition in Deltoptychius, and we agree with Woodward<sup>2</sup> and others in preferring to adopt the interpretation of M'Coy<sup>3</sup> as amended by Davis.<sup>4</sup>

**Streblodus angustus, sp. nov.**

(Plate 2, Fig. 20, Text-figure 9.)

*Type.* — Posterior dental plate; Museum Nebraska State University.

*Definition.* — Posterior dental plate narrow and elongate, obliquely truncated in front, outer margin broadly arched, and postero-lateral border forming an acute angle with the inner margin. Posterior tumid portion of coronal surface sharply separated by an abrupt elevation from the anterior portion, and exceeding the latter in extent. Anterior portion crossed by a narrow, angulated, and very oblique ridge, with a slight thickening of the antero-lateral margin.



FIG. 9.

*Streblodus angustus*,  
sp. nov. Posterior  
dental plate,  $\times \frac{1}{2}$ .

The posterior dental plate upon which this species is founded has a total length of 2 cm., and width in the middle portion of 7 mm., the form being quite narrow and antero-posteriorly elongated as compared with other species. It bears a rather remote resemblance to *S. obliquus* (St. J. and W.) from the St. Louis limestone of Missouri, but is more attenuated and lacks the prominent fold along the antero-lateral border.

*Formation and Locality.* — Atchison shales (Missourian); South Bend, and Cedar Creek, Nebraska.

**Helodus rugosus NEWBERRY and WORTHEN.**

(Plate 2, Fig. 14.)

1870. *Helodus rugosus* Newberry and Worthen, Pal. Illinois, Vol. IV., p. 359, Pl. II., Fig. 10.

A detached tooth obtained by Professor Barbour from the Missourian of Table Rock, Nebraska, exhibits all the characters described for this species,

<sup>1</sup> Pal. Illinois, Vol. VII., 1883, p. 92.

<sup>2</sup> Cat. Foss. Fishes Brit. Museum, Pt. i., 1889, p. 212.

<sup>3</sup> Brit. Palaeoz. Foss., 1855, p. 621.

<sup>4</sup> Trans. Roy. Dublin Soc. (2), Vol. I., 1883, p. 432.



except that the coronal surface is not roughened or vermiculated. The latter appearance may be perhaps attributed to varying conditions of wear and preservation, and is doubtfully of specific value.

### PHYSONEMUS AGASSIZ.

The mostly small, highly tuberculated Ichthyodorulites known as *Physonemus*, *Erismacanthus*, *Gampsacanthus*, *Dipriacanthus*, etc., interpreted as lateral head-spines, may be provisionally referred to the *Cochliodontidae*.

#### *Physonemus asper*, nom. nov.

1859. *Xystracanthus arcuatus* J. Leidy, Proc. Acad. Nat. Sci. Philad., p. 3.  
 1873. *Xystracanthus arcuatus* J. Leidy, Rept. U. S. Geol. Surv. Territ., Vol. I., p. 312, Pl. XVII., Fig. 25.  
 1875. *Xystracanthus arcuatus* St. John and Worthen, Pal. Illinois, Vol. VI., p. 457.

The type species of *Physonemus* having been named *P. arcuatus* by M'Coy in 1848, it becomes necessary to designate the type of Leidy's so-called "Xystracanthus" by a new specific title on removing it to *Physonemus*. The name *P. asper* is accordingly proposed for it in allusion to the coarsely tuberculated style of its ornamentation. Jaekel's theoretical association of spines of this character with the teeth of *Petalodus* and *Polyrhizodus*, and also with the dermal tubercles of *Petrodus*, has not been proved by any direct evidence, and militates with the facts of distribution.

*Formation and Locality.* — Missourian ; Leavenworth, Kansas.

## CESTRACIONTIDAE.

### ORODUS AGASSIZ.

#### *Orodus intermedius*, sp. nov.

(Plate 4, Figs. 35, 36.)

*Type.* — Detached tooth ; Museum of Comparative Zoölogy.

Teeth of medium size, upwards of 3 cm. in length. Coronal contour gradually rising into a nearly smooth dome-shaped median eminence ; longitudinal crest low, slightly wavy, giving off several groups of branching transverse wrinkles extending on either side, and forming slight buttresses on the outer coronal margin ; base of crown faintly crenulated along the inner margin.

The unique tooth answering to the above description was obtained by the late Mr. Samuel A. Miller from the Upper Coal Measures on the opposite side

of the river from Leavenworth, Kansas, near Weston, in Platte County, Missouri. The name by which it may be designated has reference to the intermediate characters which it displays between *Orodus* and *Campodus*. The coronal surface is elevated into a median prominence, and is marked with the longitudinal and transverse ridges which are so conspicuous a feature of *Orodus*, but at the same time the outer coronal margin, which at the most is only faintly crenulated in other species of *Orodus*, is here differentiated after the manner of *Campodus*. It is obvious that the two genera are very closely related, but the characters by which they may be provisionally distinguished appear to warrant their separation, at least until such time as we shall have obtained a more perfect knowledge of the arrangement of the dentition in both forms.

*Formation and Locality.* — Missourian; Missouri River Valley.

### CAMPODUS DE KONINCK.

#### *Campodus variabilis* (NEWBERRY and WORTHEN).

(Plate 1, Fig. 1; Plate 2, Figs. 15, 16.)

1870. *Lophodus variabilis* Newberry and Worthen, Pal. Illinois, Vol. IV., p. 361, Pl. IV., Figs. 4, 5, 11.
1875. *Agassizodus variabilis* St. John and Worthen, *Op. cit.* Vol. VI., p. 318, Pl. VIII., Figs. 1-22.
1883. *Agassizodus variabilis* M. Lohest, Ann. Soc. Geol. Belg., Vol. XI., p. 305, Text-figs. 1, 3.
1901. *Campodus variabilis* C. R. Eastman, Science, Vol. XIV., p. 795.
1902. *Campodus variabilis* C. R. Eastman, Geol. Mag. (4), Vol. IX., p. 148, Pl. VIII., Fig. 1.
1902. *Campodus variabilis* C. R. Eastman, Bull. Mus. Comp. Zool., Vol. XXXIX., p. 57, Pls. I. II., Pl. IV., Fig. 1.

Detached teeth of this species are of not infrequent occurrence in the Missourian of Iowa, Kansas, and Nebraska, and in two or three instances a large part of the dentition has been found in natural association. The complete dentition of one jaw (presumably the lower) is known from a series of interesting specimens, the most important of which was first described by St. John and Worthen in Volume VI. of the Palaeontology of Illinois, and has been since re-investigated by Max Lohest and the present writer. The original of this magnificent specimen is now preserved in the private collection of Mr. Frank Springer, and casts made from it by St. John in 1874 are in existence in a number of museums. One of these plaster casts was utilized in the construction of the model shown in Plate 1, which represents the restored dentition, the symphyseal series in front being photographed from an actual specimen belonging to the Museum of Nebraska State University.

The nearly complete ramus of the lower jaw described by St. John and

Worthen exhibits upwards of 450 teeth disposed in about 18 transverse series, the smallest teeth occurring toward the extremities, and increasing gradually in size toward the middle of the ramus. The series are arranged after the same general pattern as in Cestracion, as is evident from a comparison of the two figures given in Plate 1, Fig. 2 being from a photograph of the lower jaw of *Cestracion francisci* Girard.

For a description of the two examples of the symphyisial series which are known, reference may be had to a previous number of the Museum Bulletin, Vol. XXXIX., No. 3, and it need only be restated here that each individual

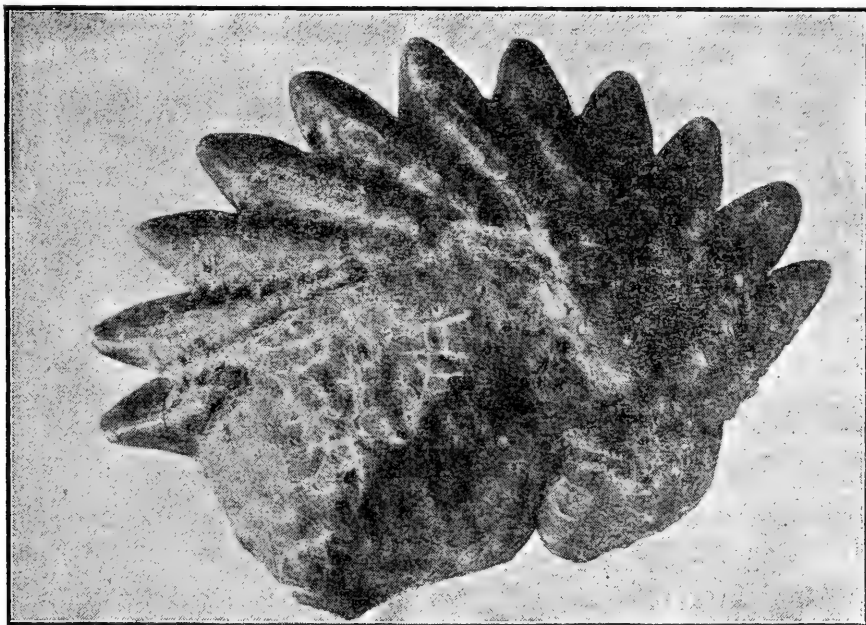


FIG. 10.

*Campodus variabilis* (N. & W.). Atchison shales, Cedar Creek, Nebraska. Lower symphyisial dentition,  $\times \frac{1}{3}$ .

of *Campodus* possessed at least three series of coalesced anterior or symphyisial teeth. As indicated by the marks of contact, there was a median arched azygous series in one jaw, presumably the lower, opposed to which in (presumably) the upper were two corresponding series separated from each other by a slight interval and mutually interlocking with the former. Each of these series (Text-fig. 10) comprises from 11 to 13 enormously enlarged teeth which are fused into an arch corresponding to that of *Edestus* and *Campyloprion*, and to the thrice-coiled spiral of *Helicoprion*, all of which genera are to be regarded as highly specialized Cestraciont sharks.

This enlargement of the symphyisial series seems to be a hypertrophic character peculiar to Palaeozoic forms, first appearing in the Devonian *Protodus*,

and disappearing, so far as known, with *Helicoprion* in the Permian of Russia, India, and Japan. Occasionally the median azygous series of the lower jaw in *Cestracion philippi* is slightly enlarged, possibly through atavism. The ancient family of Cestraciontidae to which all these forms belong is remarkable not only for its astonishing longevity, almost unparalleled amongst fishes, but also for its prolific offshoots during Palaeozoic and Mesozoic times. The great groups of Cochliodonts, Orodonts, Acrodonts, and Hybodonts may all be considered as derivatives from the Cestraciont stem, and it is probable that the modern ray-type is also descended from the same lineage.

The great variety in form manifested by the lateral teeth of *C. variabilis*, as implied by the specific title, has been well illustrated by St. John and Worthen. Some of the posterior series bear a strong resemblance to those of *Orodus*, but are distinguished by the buttressed condition of the coronal border and the less acuminate character of the series of lateral teeth. Only Jaekel has expressed an opinion that *Orodus* and *Campodus* are not generically distinct, and are intimately related to *Psephodonts* and *Psammodonts*.<sup>1</sup> Examples of detached teeth of *C. variabilis* are shown in Plate 2, Figs. 13 and 14, the latter agreeing very closely with St. John and Worthen's Plate VIII., Fig. 4, of the sixth volume of the Illinois Palaeontology.

*Formation and Locality.* — Missourian; Kansas, Nebraska, Iowa, and Illinois.

### **Ctenacanthus amblyxiphias** COPE.

(Plate 2, Figs. 22, 23.)

1891. *Ctenacanthus amblyxiphias* E. D. Cope, Proc. U. S. Nat. Museum, Vol. XIV., p. 449, Pl. XXVIII., Fig. 3.

This species was originally described from the Permian of Texas, and does not appear to have been recognized up to the present time outside of the typical locality. The two fragmentary spines obtained by Professor Barbour are from the Missourian of South Bend and Louisville, respectively, in Nebraska. This form has a more angular cross-section than most of the Mississippian species of *Ctenacanthus*.

## **DIPNOI.**

### **CTENODONTIDAE.**

#### **Sagenodus copeanus** WILLISTON.

1899. *Sagenodus copeanus* S. W. Williston, Kansas Univ. Quart., Vol. VIII., p. 178, Pl. XXXV.-XXXVII.

This species is known by the upper dentition and a number of associated bones from the Missourian of Brown County, Kansas.

<sup>1</sup> Zeitschr. deutsch. geol. Ges., Vol. LI., 1899, p. 296.

## CROSSOPTERYGII.

## OSTEOLEPIDAE.

*Megalichthys macropomus* COPE.

1902. *Megalichthys macropomus* E. D. Cope, Proc. Amer. Phil. Soc., Vol. XXX., p. 226, Pl. VIII.

It is stated in the original description that this species is "established on the greater part of an individual from the Carbonic system of Kansas," then contained in the private collection of R. D. Lacoë. Fragments of another individual from the Leavenworth Coal near Lansing, Kansas, were obtained by Mr. O. H. St. John a number of years ago, and are now preserved in the Museum of Comparative Zoölogy. Two other species of *Megalichthys* have been described by Cope from the Permian of Texas.

## LIST OF FOSSIL FISHES OCCURRING IN THE UPPER CARBONIFEROUS OF KANSAS AND NEBRASKA.

## ELASMOBRANCHII.

- |   |   |
|---|---|
| 1. <i>Pleuracanthus (Diplodus) compressus</i> Newb. | 11. <i>Ctenoptychius occidentalis</i> St. J. and W. |
| 2. <i>Cladodus occidentalis</i> Leidy.              | 12. <i>Peripristis semicircularis</i> (N. and W.).  |
| 3. " <i>knightianus</i> (Cope).                     | 13. <i>Platyxystrodus occidentalis</i> (St. John).  |
| 4. <i>Phoebodus knightianus</i> Eastman.            | 14. <i>Deltodus angularis</i> N. and W.             |
| 5. <i>Janassa maxima</i> Eastman.                   | 15. <i>Sandalodus carbonarius</i> N. and W.         |
| 6. " <i>unguicula</i> Eastman.                      | 16. <i>Streblodus angustus</i> Eastman.             |
| 7. <i>Fissodus dentatus</i> Eastman.                | 17. <i>Helodus rugosus</i> N. and W.                |
| 8. " <i>inaequalis</i> (St. J. and W.).             | 18. <i>Physonemus asper</i> Eastman.                |
| 9. <i>Petalodus alleghaniensis</i> Leidy.           | 19. <i>Orodus intermedius</i> Eastman.              |
| 10. <i>P. (Chomatodus) arcuatus</i> (St. John).     | 20. <i>Campodus variabilis</i> (N. and W.).         |
|   | 21. <i>Ctenacanthus amblyxiphias</i> Cope.          |

## DIPNOI.

22. *Sagenodus copeanus* Williston.

## CROSSOPTERYGII.

23. *Megalichthys macropomus* Cope.

## II. THE CARBONIFEROUS FISH-FAUNA OF MAZON CREEK, ILLINOIS.

Of the thousands of fossiliferous ironstone nodules of Coal Measure age, occurring at Mazon Creek, near Morris, in Grundy County, Illinois, only a small percentage yield indications of vertebrate remains, and these consist principally of detached fish-scales. Occasionally, however, complete individuals of fossil fishes, and in still fewer instances, Amphibian skeletons have been brought to light, but all told the number of even tolerably perfect specimens preserved in different museums is very insignificant. Probably the two finest series of Mazon Creek nodules ever brought together are the Lacoe collection, belonging to the United States National Museum at Washington, and the S. S. Strong collection, purchased by the late Prof. O. C. Marsh for the Yale Museum. Shortly before the decease of Professor Marsh, nearly all of the fossil fishes in the Strong collection were placed by that gentleman in the hands of the writer for investigation; and more recently some additional material has been loaned for the same purpose by Prof. C. E. Beecher, to whom grateful acknowledgments are hereby rendered.

Mazon Creek fish-scales have been exhaustively studied by E. D. Cope<sup>1</sup> and O. P. Hay,<sup>2</sup> and the latter has also described a nearly perfect example of a Palaeoniscid fish, named by him *Elonichthys hypsilepis*. Other Palaeoniscids and Platysomids have been described by Cope,<sup>3</sup> Newberry and Worthen,<sup>4</sup> and the present writer,<sup>5</sup> and the latter has also published descriptions of one Coelacanth and two Acanthodian species.<sup>6</sup> These citations complete the literature references on Mazon Creek fishes. In the following paragraphs a few new species are described, and the structure of certain Ganoids is examined more in detail than has been done heretofore.

### DIPNOI.

#### CTENODONTIDAE.

##### *Sagenodus cristatus*, sp. nov.

(Plate 3, Fig. 30.)

*Type*. — Palatine dental plate; Yale Museum.

Upper dental plate relatively short and broad, attaining a length of about 5 cm. and a maximum breadth of 3.5 cm. Outer margin nearly straight; coronal

<sup>1</sup> Proc. Amer. Phil. Soc., Vol. XXXVI., 1897, pp. 71-82.

<sup>2</sup> *Ibid.*, Vol. XXXIX., 1900, pp. 96-120.

<sup>3</sup> Proc. U. S. Nat. Museum, Vol. XIV., 1891, p. 462.

<sup>4</sup> Pal. Illinois, Vol. II., 1866, and Vol. IV., 1870.

<sup>5</sup> Journ. Geol. Vol. X., 1902, p. 450.

<sup>6</sup> Bull. Mus. Comp. Zool., Vol. XXXIX., 1902, pp. 93-94.

surface slightly concave, with at least seven prominent, rather broad and coarsely tuberculated ridges, the tubercles gradually decreasing in size from the abrupt outer towards the narrow inner margin.

This species is represented by a unique upper dental plate belonging to the Yale Museum, which is readily distinguished from other species by its abbreviate form and nearly straight parallel ridges. The tuberculations of the latter are coarser and less acuminate than in *S. vabasensis* Cope,<sup>1</sup> and the ridges resemble some species of *Ctenodus* in their non-radiating character. A narrow and elongate cranial plate, having the dimensions of 5 by 10 cm., and belonging to the same collection, may perhaps be correlated with this species. All other Dipnoan remains from the Mazon Creek locality are founded on detached scales.

*Formation and Locality.* — Coal Measures; Mazon Creek, Illinois.

## CROSSOPTERYGII.

### COELACANTHIDAE.

#### COELACANTHUS AGASSIZ.

J. S. Newberry<sup>2</sup> records having received from Mazon Creek "a single specimen each of *Eurylepis* and *Coelacanthus*, probably not distinct from those found at Linton," Ohio. No examples of the former genus have come under the writer's observation, but ornamented scales and head-plates referable to *Coelacanthus* sometimes occur in Mazon Creek nodules, and very rarely there are found complete fishes of small size, evidently quite distinct from those occurring elsewhere. In most specimens the posterior dorsal, anal, and pectoral fins are wanting, and one might be led to suppose at first that the second dorsal had become lost through specialization. A single example preserved in the Museum of Comparative Zoölogy shows it very distinctly, however, and the absence of this and the anal fin in other examples is therefore attributable to faulty preservation.

#### *Coelacanthus exiguus* EASTMAN.

(Plate 5, Fig. 48.)

1902. *Coelacanthus exiguus* C. R. Eastman, Journ. Geol. Vol. X., p. 538, Text-fig. 3.

*Type.* — Complete individual; Yale Museum.

A small species, attaining a maximum length of about 4.5 cm. Trunk narrow and elongated, the head occupying about one-fourth of the total length. First dorsal consisting of relatively few stout rays, and situated slightly in

<sup>1</sup> Journ. Geol. Vol. VIII., 1900, p. 704, Pl. 1, Fig. 7.

<sup>2</sup> Mon. U. S. Geol. Surv., Vol. XVI., 1889, p. 215.

advance of the pelvic pair; second dorsal midway between the anterior dorsal and principal caudal; the latter comprising nine stout rays above and below. Scale structure and ornamentation of head-bones not observed.

This species is represented by ten specimens in the Yale and one in the Harvard Museum, most of them being only about 3 cm. long, and very deficient in preservation. They agree in having a narrow, gradually tapering body, which terminates in an equilobate caudal fin, with indications that the axis was prolonged into a supplementary caudal. The anterior dorsal and caudal, owing to their firmer attachment, are preserved in nearly all specimens, but the remaining fins have in most cases become lost. The first dorsal has usually seven or eight stout rays, and is situated near the middle of the trunk. Ten long, hollow rays are to be counted in the single specimen displaying the posterior dorsal, and nine above and below in the symmetrical caudal. The neural and haemal spines are very long in the abdominal and caudal regions. The ossifications of the axial skeleton are continued nearly to the termination of the principal caudal. The squamation must have been exceedingly delicate, as no indications of scales are to be observed in any of the specimens, nor do any of them have the cranial elements satisfactorily preserved.

*Formation and Locality.* — Coal Measures; Mazon Creek, Illinois.

## ACTINOPTERYGII.

### PALAEONISCIDAE.

#### ELONICHTHYS GIEBEL.

Two closely related species are already known from Mazon Creek, *E. peltigerus* Newberry, and *E. hypsilepis* Hay. A study of the type specimen of Newberry and Worthen's so-called "*Amblypterus macropterus*," now preserved in the Yale Museum, leaves no doubt that this is only a mutilated individual of *E. peltigerus*. The type of *Rhadinichthys gracilis* (Newberry and Worthen) is also preserved in the Yale Museum.

#### *Elonichthys perpennatus* EASTMAN.

(Plate 5, Fig. 49.)

1902. *Elonichthys perpennatus* C. R. Eastman, Journ. Geol., Vol. X., p. 539, Text-fig. 4.

*Type.* — Complete individual; Museum of Comparative Zoölogy.

A very small species, having a total length of about 2.5 cm. of which the head occupies a little less than one fourth. Fins extremely well developed, the pectorals unusually long, and anal much extended; fulcra minute. Scales relatively small, obliquely striated; dorsal ridge-scales enlarged.



The solitary known and probably immature example of this species is shown of twice the natural size in Plate 5, Fig. 49. The head is poorly preserved, and the extremities of nearly all the fins are either broken away or obscured by matrix. Nevertheless sufficient characters remain for the recognition of this as a distinct species of *Elonichthys*, its chief peculiarity consisting in the remarkable development of all the fins. The pectorals are fully one fourth as long as the entire body, and the anal has a more extended base-line than in any other species of the genus. The dorsal appears to have been high and acuminate, but is largely concealed by matrix. The caudal is also unfavorably exposed, and flexed out parallel with the main axis, but it is plain that the upper lobe was much prolonged, and covered with very large, striated ridge-scales. The dorsal fin-rays appear to have been widely jointed; the articulations of the other fins are not clearly discernible. The dermal rays of the anal and lower lobe of the caudal are directly supported by the enlarged haemal spines, which are firmly united with their arches. The squamation is nowhere well preserved, but is best indicated in the anterior part of the trunk. The cranial structure does not admit of particular description.

### *Elonichthys disjunctus*, sp. nov.

(Plate 3, Fig. 31.)

*Type.* — Distorted individual; Yale Museum.

A species of about the same size as *E. peltigerus* and *E. hypsilepis*, and resembling them in general form and ornamentation, but differing in the position of the anal and structure of the paired fins. The latter are relatively shorter in the present species, and have fewer rays. The dorsal and anal are of about equal size, triangular and acuminate, and each with 25 or more rays. The anal is inserted opposite the middle of the dorsal, and its base-line terminates at a distance in advance of the caudal at least as great as the depth of the caudal pedicle. Caudal fin deeply forked and very finely divided; fulcra minute.

Several examples of this species are preserved in the Yale Museum, the smallest having a length of only 2.5 cm., and the largest upwards of 11 cm. While exhibiting the same proportions as *E. peltigerus* and *E. hypsilepis*, it differs in the less remote position of the anal fin. One specimen in the collection shows very perfectly the two series of piercing teeth, and about 14 branchiostegal rays. The original of Plate 3, Figure 31, which is selected as the type, has the body flexed in such wise as to present the ventral aspect of the head and greater portion of the trunk, while the region behind the anal fin is seen from the right-hand side. The caudal is very well shown; the anal, on the other hand, is somewhat distorted, and the dorsal and paired fins are wanting.

*Formation and Locality.* — Coal Measures; Mazon Creek, Illinois.

## PLATYSOMATIDAE.

Three unique specimens from the Mazon Creek locality, all more or less imperfectly figured and described, have been referred to as many species of *Platysomus*, and a fourth species has been described by Cope (*P. palmaris*) from the Permian of the southern part of Indian Territory. The characters of the so-called *P. orbicularis* Newberry and Worthen have never been defined, and the type specimen is here regarded as pertaining to *Cheirodus*.

*Platysomus circularis* NEWBERRY and WORTHEN.

(Plate 5, Fig. 51.)

1870. *Platysomus circularis* Newberry and Worthen, Pal. Illinois, Vol. IV., p. 347, Pl. IV., Fig. 2.

*Type.* — Complete fish; Illinois State University, Urbana.

A very small species, attaining a maximum length of about 4 cm. Outline of body elliptical, greatest depth of trunk exceeding its length from the pectoral arch to the base of the caudal fin, and more than twice as long as the head with opercular apparatus; dorsal margin gibbously rounded from the occiput to the narrow caudal pedicle, ventral margin regularly rounded. Dorsal and anal fins arising considerably behind the middle of the back, relatively high, and extending close to the origin of the caudal fin. Scales finely striated, the striae being parallel, even, and regular, vertical on those situated nearest to the ventral margin in advance of the anal fin, but oblique on the remaining longitudinal rows.

In the original figure of this species, the squamation is very distinctly shown, and the scales are described as being "oblong in outline, smooth, those on the sides three to six times as high as long." An examination of the type, however, kindly permitted by Prof. C. W. Rolfe, reveals the fact that the scales are very inaccurately drawn, and that their striated condition was overlooked by the authors. Several examples, clearly belonging to this species, are preserved in the Yale Museum, one of which has been selected for illustration in the accompanying plates, and the definition of the species has been amended in conformity with characters displayed by the additional material. The dorsal and anal fins are stated by Newberry and Worthen as consisting of forty and thirty dermal rays, respectively, but it is probable that even more than this number were present.

*Formation and Locality.* — Coal Measures; Mazon Creek, Illinois.

## CHEIRODUS M'COY.

*Cheirodus orbicularis* (NEWBERRY and WORTHEN).

(Plate 5, Fig. 52.)

1870. *Platysomus orbicularis* Newberry and Worthen, Pal. Illinois, Vol. IV., Pl. III., Fig. 1. (No description.)

A number of specimens in the Yale Museum agree with the figure published by Newberry and Worthen in having an orbicular body with scales arranged in very narrow vertical bands. The identity of these specimens with the type of *Platysomus orbicularis* is further confirmed by the fact that one of them is so labelled in Newberry's handwriting. The unsatisfactory illustration of this species induces a suspicion that the type was very imperfectly preserved, in which case it is not to be wondered that the authors failed to observe the dorsal and ventral peaks exhibited by other specimens. A study of all available material enables me to give the following amended definition of this species.

A small species, attaining a maximum length of about 4.5 cm. Trunk deep, orbicular in outline, the dorsal margin elevated into a prominent peak at about its middle point, and the ventral margin angulated to a somewhat lesser extent at a point about midway between the branchial apparatus and the narrow caudal pedicle. Facial contour of head steep, cranial plates granulated and striated; the head with opercular apparatus contained about two and one-half times in the total length to the base of the caudal fin. Dorsal and anal fins arising at a considerable distance behind the marginal peaks, and extending close to the origin of the caudal fin; the latter nearly equilobate, its upper lobe with well-developed fulcra, and its width at distal extremity equaling about one third the maximum depth of trunk. Dorsal fin with fifty or more rays, caudal and anal each with a somewhat lesser number. (Paired fins not observed.)

Scales ornamented externally with faint longitudinal striae and usually one longitudinal ridge situated near the anterior border of each scale; attached surface coarsely striated, the striae being nearly vertical on the deeper flank-scales, but oblique on those situated dorsally and ventrally and in the caudal region. Scales of the anterior part of the trunk arranged in nearly vertical narrow bands, those toward the tail showing a slight downward and backward obliquity, and those at the base of anal fin reflexed forwards toward the ventral margin.

*Formation and Locality.* — Coal Measures; Mazon Creek, Illinois.

LIST OF CARBONIFEROUS FISHES OCCURRING AT MAZON  
GREEK, ILLINOIS.

ELASMOBRANCHII.

1. *Pleuracanthus (Diplodus) compressus* Newb. (Occurs also at Linton, Ohio, and in Indiana.)
2. " " *latus* Newb. (Occurs also at Linton, Ohio, and in Indiana.)
3. " " *lucasi* Hay.
4. *Acanthodes beecheri* Eastm.
5. " *marshi* Eastm.
6. *Campodus scitulus* (St. J. and W.).

DIPNOI.

7. *Ctenodus* sp. *indes.*
8. *Sagenodus cristatus* Eastm.
9. " *foliatus* Cope.<sup>1</sup>
10. " *lacovianus* Cope.<sup>1</sup>
11. " *occidentalis* (Newb. and W.)<sup>1</sup> (Occurs also at Linton, Ohio.)
12. " *quadratus* (Newb.)<sup>1</sup> (Occurs also at Linton, Ohio.)
13. " *quincunciatus* Cope.<sup>1</sup>
14. " *reticulatus* (Newb. and W.)<sup>1</sup>
15. " *textilis* Hay.<sup>1</sup>

CROSSOPTERYGII.

16. *Rhizodopsis (?) mazonius* Hay.<sup>1</sup>
17. *Coelacanthus exiguus* Eastm.
18. " *robustus* Newb.<sup>1</sup> (Occurs also at Linton, Ohio.)

ACTINOPTERYGII.

19. *Eurylepis*, sp. *indet.* (*vide* J. S. Newberry).
20. *Rhadinichthys gracilis* (Newb. and W.).
21. *Elonichthys disjunctus* Eastm.
22. " *hypsilepis* Hay.
23. " *peltigerus* Newb.<sup>2</sup> (Occurs also at Linton, Ohio).
24. " *perpennatus* Eastm.
25. *Platysomus circularis* Newb. and W.
26. " *lacovianus* Cope.
27. *Cheirodus orbicularis* (Newb. and W.).

<sup>1</sup> Founded on scales.

<sup>2</sup> Including also the so-called "*Amblypterus macropterus*" Newb. and W.

### III. SPECIES OF FOSSIL FISHES FROM THE MISSISSIPPIAN SERIES.

Under this head descriptions are given of several new species from the Kinderhook and Keokuk limestones of the Mississippi Valley, and the structure and systematic relations of certain others are considered concerning which a difference of opinion amongst authors has existed. For an opportunity to examine some of the type specimens described in the Palaeontology of Illinois the writer is indebted to the courtesy of Prof. C. W. Rolfe, of the State University at Urbana, and to Mr. C. H. Crantz, Curator of the State Museum at Springfield, Illinois.

The following table shows the commonly accepted subdivisions of the Mississippian series for this region:—

#### SECTION OF THE LOWER CARBONIFEROUS.

Mississippian Series.	}	Genevieve Group or Stage.	}	Chester limestone and shales (including the "Kaskaskia limestone").
				St. Louis limestone.
				Warsaw limestone (in part).
		Augusta (Osage) Group or Stage.	}	Keokuk limestone.
				Burlington limestone.
		Kinderhook Group or Stage.	}	Chouteau limestone.
				Hannibal shales.
				Louisiana limestone.

## ELASMOBRANCHII.

### PLEURACANTHIDAE.

#### PHOEBODUS ST. JOHN and WORTHEN.

Of this genus three species are represented in the Devonian of this country, two in the Mississippian series, and one in the Permo-Carboniferous, including those described in the present paper. It is probable, however, that at least two forms ascribed by Newberry and Worthen to the "genus" *Diplodus*, namely, *D. incurvus* and *D. duplicatus*, should be referred to *Phoebodus* as commonly understood.

**Phoebodus dens-neptuni, sp. nov.**

(Plate 4, Fig. 39.)

*Type.* — Detached tooth; Museum of Comparative Zoölogy.

Teeth of moderate size, with three principal cones less than one cm. in height. Median cone erect, gradually tapering, lateral cones of unequal height, gently curved outward toward the apex; all three delicately striated, subcircular in cross-section, the median broader than the others.

This species is founded upon a unique tooth from the Keokuk limestone of Iowa, which seems to be intermediate in character between the so-called *Dip-lodus incurvus* and *D. duplicatus* of Newberry and Worthen accompanying it in the same horizon. From the former it is distinguished by its more slender form and striated cones, and from the latter by its possession of three principal cones instead of four, as in that species. The nature of the base is not determinable from the solitary example that is known of the present species.

*Formation and Locality.* — Keokuk limestone; Keokuk, Iowa.

## COCHLIODONTIDAE.

A deal of confusion exists regarding the nomenclature of certain species of *Sandalodus*, *Deltodus*, and *Deltoptychius* occurring in the Carboniferous rocks of the Mississippi Valley, a state of affairs which is attributable to the imperfect preservation of the greater number of their remains. A study of a large collection of Cochliodont teeth belonging to the Museum of Comparative Zoölogy and the United States National Museum has suggested the following synonymy in the case of several disputed species.

## SANDALODUS NEWBERRY and WORTHEN.

***Sandalodus laevis-simus* NEWBERRY and WORTHEN.**

(Text-figure 11.)

1866. *Sandalodus laevis-simus* Newberry and Worthen, Pal. Illinois, Vol. II., p. 104, Pl. X., Figs. 6-8.
1866. *Sandalodus grandis* Newberry and Worthen, *Ibid.*, p. 105, Pl. X., Fig. 9.
1866. *Deltodus grandis* Newberry and Worthen, *Ibid.*, p. 101, Pl. IX., Fig. 9.
1866. *Cochliodus ? crassus* Newberry and Worthen, *Ibid.*, p. 91, Pl. VIII., Fig. 2.
1866. *Psammodus ? semicylindricus* Newberry and Worthen, *Ibid.*, p. 109, Pl. XI., Fig. 4.
1866. *Psammodus ? rhomboideus* Newberry and Worthen, *Ibid.*, p. 110, Pl. XI., Fig. 6.
- (?) 1879. *Deltodus grandis* J. S. Newberry, Ann. Rept. Geol. Surv. Indiana, 1876-78, p. 344.

1883. *Sandalodus laevisissimus* St. John and Worthen, Pal. Illinois, Vol. VII., p. 186, Pl. XII., Figs. 8, 9 (and 5?).
1897. *Deltodus grandis* J. S. Newberry, Trans. N. Y. Acad. Sci., Vol. XVI., p. 297.
1900. *Sandalodus laevisissimus* C. R. Eastman, Amer. Nat., Vol. XXXIV., p. 581, Fig. 1.
1902. *Sandalodus laevisissimus* O. H. St. John, Amer. Nat., Vol. XXXVI., p. 659.

This species is very abundant in the Keokuk limestone of Iowa, Illinois, and Missouri, numerous perfect examples being known of both the posterior and anterior dental plates of upper and lower jaws. Most of the posterior dental plates have suffered the loss of the initial coiled portion, which is remarkable for being wound upon itself one and one-half times before expanding into the functional grinding surface characterizing the adult, as shown in the adjoining text-figure. The upper posterior dental plate resembles in a general way that of *S. morrisii* Davis, and is much less plicated than the lower. There can be no doubt as to the correctness of St. John and Worthen's conclusion that the type of *Deltodus grandis* Newb. and Worth. is identical with this species, hence we are unable to agree with the views expressed on this subject in the posthumous paper of Newberry.<sup>1</sup>

Dr. O. P. Hay is evidently mistaken in his remark that no type of the genus *Sandalodus* has been specified,<sup>2</sup> for *S. laevisissimus* is expressly designated as such by St. John and Worthen in their general observations on teeth of this form.<sup>3</sup> Dr. Hay is also in error, we believe, when he discards the specific title of *S. laevisissimus* in favor of *S. crassus*. But possibly this may be due to an oversight on his part, since the original description of *S. laevisissimus* with its accompanying illustrations—that which heads the list in the above synonymy—is omitted by him in his citations of the literature references.<sup>4</sup>

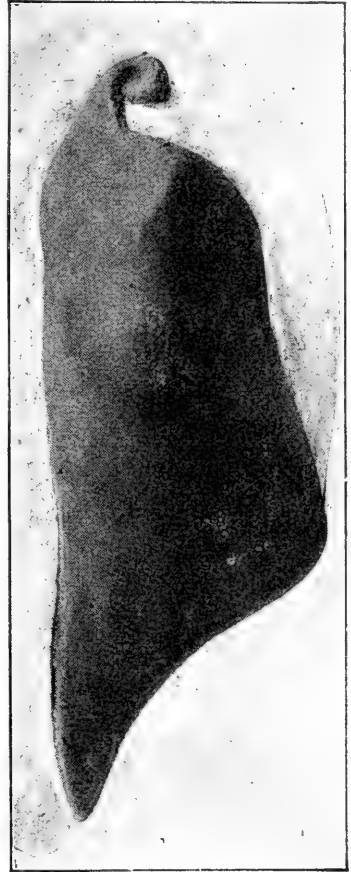


FIG. 11.  
*Sandalodus laevisissimus* N. and W. Keokuk limestone, Keokuk, Iowa. Posterior dental plate of left mandibular ramus,  $\times \frac{2}{3}$ .

<sup>1</sup> Trans. N. Y. Acad. Sci., Vol. XVI., 897, p. 297.

<sup>2</sup> Bibliography and Catalogue of the Fossil Vertebrata of North America. Bull. U. S. Geol. Surv., No. 179 (1902), p. 288.

<sup>3</sup> Pal. Illinois, Vol. VII. (1883), p. 184.

<sup>4</sup> *Loc. cit.*, p. 289.

**Sandalodus complanatus** (NEWBERRY and WORTHEN).

1866. *Deltodus complanatus* Newberry and Worthen, Pal. Illinois, Vol. II., p. 98, Pl. IX., Fig. 4.  
 1866. *Trigonodus major* Newberry and Worthen, *Ibid.*, p. 112, Pl. XI., Figs. 3, 9.  
 1870. *Deltodus complanatus* Newberry and Worthen, *Ibid.*, Vol. IV., Pl. III., Figs. 5, 8 (and 12?).  
 1883. *Sandalodus complanatus* St. John and Worthen, *Ibid.*, Vol. VII., p. 184, Pl. XII., Figs. 1-4.

Much discussion has arisen as to whether the fragmentary teeth described as "*Deltodus complanatus*" are truly referable to that genus, or belong to *Sandalodus*. A study of a considerable amount of material from the Burlington Group has convinced the writer that the above synonymy, which is taken from St. John and Worthen, is correct, and that the teeth figured as *D. complanatus* in the posthumous paper of Newberry<sup>1</sup> are fragments of *D. occidentalis* N. and W.

**DELTODUS AGASSIZ.**

Two species of *Deltodus* are found in mutual accompaniment throughout both the Burlington and Keokuk divisions of the Mississippian, and although their extreme forms are quite distinct (Plate 4, Figs. 38, 42), they are connected by intermediate gradations (Plate 5, Fig. 53), so that in the case of fragmentary teeth it is sometimes difficult to determine which of the two species is represented. Generally speaking, the teeth from the Burlington limestone are less perfectly preserved than those from the Keokuk, and chiefly for this reason the synonymy has become more or less involved. We propose to recognize the two forms under the names of *D. spatulatus* Newb. and Worth. and *D. occidentalis* (Leidy) respectively. The first-named ranges from the Kinderhook to the Keokuk inclusive, and the latter from the Burlington to the St. Louis Group, being particularly abundant in the Keokuk and Warsaw beds.

**Deltodus spatulatus** NEWBERRY and WORTHEN.

(Plate 4, Figs. 41, 42; Plate 5, Fig. 55.)

1866. *Deltodus spatulatus* Newberry and Worthen, Pal. Ill., Vol. II., p. 100, Pl. IX., Fig. 7.  
 1870. *Deltodus spatulatus* Newberry and Worthen, *Op. cit.*, Vol. IV., Pl. III., Fig. 11.  
 1870. *Deltodus alatus* Newberry and Worthen, *Ibid.*, p. 368, Pl. II., Fig. 6.  
 1870. *Cochliodus costatus (pars)* Newberry and Worthen, *Ibid.*, p. 364, Pl. III., Fig. 12 (*non* Fig. 10).  
 1879. *Deltodus spatulatus* J. S. Newberry, Ann. Rept. Geol. Surv. Indiana, 1876-78, p. 346.

<sup>1</sup> Trans. N. Y. Acad. Sci., Vol. XVI., 1897, p. 298, Pl. XXIV., Figs. 1-7.



1883. *Deltodopsis ? convolutus* St. John and Worthen, Pal. Illinois, Vol. VII., p. 165, Pl. XI., Figs. 11, 12.  
 1883. *Cochliodus costatus (pars)* St. John and Worthen, *Ibid.*, p. 167.  
 1897. *Deltodus spatulatus* J. S. Newberry, Trans. N. Y. Acad. Sci., Vol. XVI., p. 299, Pl. XXIV., Figs. 8-11.

This species was originally described from the Burlington limestone of Quincy, Illinois, and the fact that it possessed a continuous range from the Kinderhook to the Keokuk inclusive has not previously been made known. In the earliest horizon the teeth are sparse and of relatively small size; in the Burlington group it is perhaps the most profuse of all *Deltodus* teeth; and although moderately large forms, such as is shown in Plate 4, Fig. 41, are occasionally met with in the Keokuk limestone, none are found in subsequent formations.

Of the posterior dental plates, the more strongly arched forms may be provisionally referred to the lower, and the less strongly arched to the upper jaw. The anterior dental plates belonging to this species have not been heretofore definitely recognized as such, no specimens having been found which show the two principal plates in natural association. An examination of a considerable amount of perfect material, however, has satisfied the writer that the strongly inrolled teeth described by St. John and Worthen under the name of *Deltodopsis ? convolutus*, and by Newberry and Worthen as the "second" tooth of *Cochliodus costatus*, fulfil all theoretical requirements for the anterior dental plate of *D. spatulatus*, and may be referred with utmost confidence to that species. The superficial characters of the two forms are identical, as already observed by St. John and Worthen, they are of corresponding proportions and curvature, and there is a perfect coadaptation of their grooved lateral edges, as any one may be convinced by fitting the two forms together in their natural position.

According to the view here advocated, the species known as *Deltodopsis ? convolutus* St. J. and Worthen becomes synonymous with *D. spatulatus*; and on removing from the so-called *Cochliodus costatus* Newb. and Worth. the form described by these authors as the "second" tooth, there remains as type of the latter species the narrow, doubly plicated form described by them as the "third" tooth. St. John and Worthen have expressed the opinion that the original authors were mistaken in regarding this as a "third," or posterior dental plate, believing it to represent the anterior of the two principal grinding plates; but evidence is lacking for associating it with any degree of assurance with other described species.

From the circumstance that the antero-lateral margin of the "second" or anterior dental plate in *D. spatulatus* is deeply grooved, as if for ligamentous union with a contiguous plate, Newberry and Worthen were led to infer the existence of a single dental element in advance of this "second" plate, thus postulating one more than the number of grinding organs characterizing the dentition of all *Cochliodonts* so far as known. *Cochliodus latus* Leidy furnishes us with perhaps the most complete example of *Cochliodont* dentition

that has come to light, and analogy with this form leads us to expect in advance of the anterior dental plate a series of *Helodus*-like teeth on either side above and below, and in front of these at the symphysis in at least one jaw, a series of bilaterally symmetrical teeth, arched in a single plane, and corresponding to the form described by Newberry as *Helodus coxanus*.<sup>1</sup> We are not yet in possession of adequate material, however, to attempt a theoretical restoration of the dentition of *Deltodus*, and the final solution of the problem must await the discovery of naturally associated parts.

In order that students may observe for themselves the nature of the material upon which the above identifications and conclusions are based, several specimens of *Deltodus* teeth are figured in the accompanying plates. In Plate 4, Fig. 38, is shown a small-sized but very perfect example of the posterior dental plate of *D. occidentalis*; in Plate 5, Fig. 53, a specimen of the form corresponding to the so-called *D. latior* St. J. and Worth. which we regard as a variety of *D. occidentalis* transitional between that species and *D. spatulatus*; and in Plate 4, Figs. 41, 42, are shown two rather large-sized examples of the posterior dental plate of *D. spatulatus*, one from the Burlington, and one from the Keokuk beds. Finally, in Plate 5, Fig. 55, a very excellent example is represented of the anterior dental plate of *D. spatulatus*, according to our interpretation of the so-called *Deltodopsis? convolutus* St. J. and W. As to the size attained by the posterior dental plates of *D. spatulatus*, we can only affirm that no specimens are known exceeding that figured by Newberry and Worthen under the name of *D. alatus*, but one of almost equal proportions is preserved in the Museum of the State University of Iowa at Iowa City.

*Formation and Locality.* — Kinderhook, Burlington, and Keokuk Groups; Iowa, Illinois, and Indiana.

### *Deltodus occidentalis* (LEIDY).

(Plate 4, Fig. 38; Plate 5, Fig. 53.)

1857. *Cochliodus occidentalis* J. Leidy, Trans. Amer. Phil. Soc. (2), Vol. XI., p. 88, Pl. V., Figs. 3-16.  
 1866. *Deltodus stellatus* Newberry and Worthen, Pal. Illinois, Vol. II., p. 97, Pl. IX., Fig. 2 (non Fig. 3?).  
 1883. *Deltodus occidentalis* St. John and Worthen, *Op. cit.*, Vol. VII., p. 150, Pl. IX., Fig. 9 (non Fig. 10).  
 1883. *Deltodus latior* St. John and Worthen, *Ibid.*, p. 145, Pl. IX., Figs. 11, 12.  
 1883. *Deltodus intermedius* St. John and Worthen, *Ibid.*, p. 153, Pl. IX., Figs. 14, 15.  
 1897. *Deltodus complanatus* J. S. Newberry, Trans. N. Y. Acad. Sci., Vol. XVI., p. 298, Pl. XXIV., Figs. 1-7.

The teeth referred to this species exhibit a wide range of variation, and while the more common expressions are quite distinct, there are arched forms like the type of the so-called "*D. latior*" which appear to connect the species

<sup>1</sup> Trans. N. Y. Acad. Sci., Vol. XVI, 1897, p. 301, Pl. XXIV., Fig. 24.

with *D. spatulatus*. In Plate 4, Fig. 38, is shown a very perfect posterior dental plate of the typical form, rather under the average size. Some very large examples have a width along the antero-lateral margin of nearly 6 cm., and in these much worn teeth the coronal contour is decidedly flatter than in immature specimens.

Messrs. Newberry and Worthen have figured the supposed anterior dental plate belonging to this species,<sup>1</sup> but the specimen appears to be too strongly enrolled for coadaptation with the antero-lateral margin of the posterior dental plate, and the same criticism applies to the specimen referred by St. John and Worthen<sup>2</sup> to a corresponding position. There is no record of the two principal dental plates of this species ever having been found in natural association, and it will require the careful study of much additional material before we can be fully satisfied as to the characters of the anterior components of the dentition. It is to be noticed that the initial coiling is much less marked in the teeth of this species than in most forms of *Deltodus* and *Sandalodus*.

*Formation and Locality.* — Burlington, Keokuk, Warsaw, and St. Louis Groups; Iowa and Illinois.

#### *Deltodus costatus* (NEWBERRY AND WORTHEN).

1870. *Cochliodus costatus* Newberry and Worthen, Pal. Illinois, Vol. IV., p. 364, Pl. III., Fig. 10 (*non* Fig. 12).

1883. *Cochliodus costatus* St. John and Worthen, *Op. cit.*, Vol. VII., p. 167.

This species has not been previously reported from a higher horizon than the Burlington division of the Mississippian, but several examples from the Keokuk limestone are preserved in the United States National Museum and in the collections belonging to the State University of Iowa. Very similar teeth also occur in the Warsaw beds, and have been described as *Deltodus trilobus* by St. John and Worthen.<sup>3</sup> A tooth of the same general nature is also referred by the same authors to *D. occidentalis*, and is supposed by them to represent the anterior dental plate belonging to that species.<sup>4</sup> It is evident that the Warsaw forms last referred to are anterior dental plates, but attempts to correlate them with the posterior dental plates of other known forms are necessarily attended with great uncertainty.

*Formation and Locality.* — Burlington and Keokuk Groups; Iowa. (? Warsaw beds; Illinois.)

<sup>1</sup> Pal. Illinois, Vol. II., 1866, Pl. IX., Fig. 3.

<sup>2</sup> *Ibid.*, Vol. VII., 1883, Pl. IX., Fig. 10.

<sup>3</sup> *Ibid.*, Vol. VII., 1883, p. 148, Pl. IX., Fig. 8.

<sup>4</sup> Pal. Illinois, Vol. VII., 1883, Pl. IX., Fig. 10. (Warsaw limestone; Warsaw, Illinois.)

**Deltodus contortus** (ST. JOHN and WORTHEN).

(Plate 4, Figs. 37, 43.)

1883. *Taeniodus contortus* St. John and Worthen (*ex* L. G. de Koninck MS.), Pal. Illinois, Vol. VII., p. 76.

*Type.* — Posterior dental plate; Museum of Comparative Zoölogy.

The genus *Taeniodus*, with the type species of *T. contortus*, was held by its founders to be closely related to *Psephodus*, from which it was stated to be chiefly distinguished "by the pronounced differentiation of the coronal contour." Three species from the Mississippian series, besides the type, which is from the Lower Carboniferous of Belgium, were included under this genus by the original authors, but are distributed by A. S. Woodward in his Catalogue of Fossil Fishes between the genera *Psephodus* and *Deltodus*. We must express our complete concurrence with Dr. Woodward's views, and in order that others may judge of what the type species of *Taeniodus* is like, we here figure it for the first time, and would call attention to the close resemblance between it and the species of *Deltodus* illustrated in Plates IX. and X. of the seventh volume of the Illinois Palaeontology. These forms are interesting in that they show very distinctly the outlines of the individual teeth of which the large principal dental plates are composed.

*Formation and Locality.* — Lower Carboniferous limestone; Visé, Belgium.

**POECILODUS** M'COY.

This genus is peculiar in having the two posterior series of teeth in each jaw fused into a single much enrolled plate, the coronal surface of which is marked by more or less distinct transverse ridges and furrows. St. John and Worthen supposed that plates of this character pertained solely to the upper jaw, and regarded the triangular plates commonly referred to the genus *Deltoptychius* as constituting the lower dentition of *Poecilodus*. This idea, however, is not shared by any subsequent writers, and there is abundant evidence to show that the dentition of each jaw of *Poecilodus* was transversely ribbed. Accordingly, the species described by St. John and Worthen as "*Poecilodus springeri*" and *P. wortheni*, in the seventh volume of the Illinois Palaeontology, are properly transferred to the genus *Deltoptychius* of Agassiz.

**Poecilodus rugosus** NEWBERRY and WORTHEN.

1866. *Poecilodus rugosus* Newberry and Worthen, Pal. Illinois, Vol. II., p. 94, Pl. VIII., Fig. 13.

1866. *Poecilodus ornatus* Newberry and Worthen, *Ibid.*, p. 95, Pl. VIII., Fig. 14.

1883. *Chitonodus rugosus* St. John and Worthen, *Op. cit.*, Vol. VII., p. 112, 119.

The specimens at the command of Newberry and Worthen at the time of their original description of this species were very fragmentary, and more per-

fect material in the hands of St. John and Worthen in 1883 enabled them to add to our knowledge of it. The latter authors were, however, mistaken in their correlation of *Deltoptychius* plates with the lower dentition of this species, as is proved by the occurrence in the Keokuk limestone of two forms of teeth determinable as the upper and lower dental plates of *P. rugosus*. The lower dental plates are more strongly enrolled than the upper, and have more strongly marked transverse ridges. Some specimens appear to indicate, also, that the fusion between the two parts corresponding to the anterior and posterior dental plates of *Cochliodus* is less intimate in the lower than in the upper dentition. The largest of the compound upper dental plates examined by the writer exhibits a length along the inner margin of 4.5 cm., and a width along the antero-lateral border of 2 cm.

*Formation and Locality.* — Keokuk limestone; Iowa and Illinois.

### **Poecilodus tribulis** (ST. JOHN AND WORTHEN).

1883. *Chitonodus tribulis* St. John and Worthen, Pal. Illinois, Vol. VII, p. 117, Pl. VII, Figs. 18-21.

A specimen belonging to the United States National Museum (Cat. No. 3496), and pertaining without doubt to this species, exhibits the characteristic fusion and transverse ribbing of *Poecilodus*, thus warranting its transfer to that genus. It appears not unlikely that the fragment described by Newberry and Worthen as *P. convolutus*<sup>1</sup> falls under the same specific limits as *P. tribulis*, but we are not prepared to unite the two under one head without the evidence of further material.

*Formation and Locality.* — Keokuk limestone; Iowa and Illinois.

### ANTERO-LATERAL AND SYMPHYSIAL TEETH OF UNDETERMINED COCHLIODONTIDAE.

Under the provisional generic names of *Helodus*, *Chomatodus*, and *Venus-todus*, a large number of species have been described from the Mississippian series which are held to represent the anterior dentition of various *Cochliodonts*, but in only a few instances are they capable of correlation with the principal grinding plates by which these forms are best known.

In the case of *Cochliodus latus* Leidy, this species has been definitely ascertained to possess at least one, and possibly more than one series of elongated *Helodus*-like teeth in advance of the large grinding plates in the upper and lower jaws, and also a symphyisial series which has received the separate name of *Helodus coxanus* Newberry. Other teeth, which from their resemblance to "*Helodus coxanus*" may be referred to a corresponding position in the mouth, have been described under the names of *Chomatodus comptus* (*pars*) St. J. and

<sup>1</sup> Pal. Illinois, Vol. IV., 1870, p. 366, Pl. II., Fig. 9.

Worth., *Psephodus reticulatus* (*pars*) St. J. and Worth., *Helodus coniculus* Newb. and Worth., *H. triangularis*, and *H. acutus* Davis. To these must also be added the symmetrical tooth described below as *Helodus incisus*, sp. nov.

It has been shown by Traquair that the teeth named *Helodus planus* by Agassiz are certainly referable to *Psephodus magnus*, and Smith Woodward supposes that "most of the teeth from the Bristol Bonebed, named *Helodus laevis-simus*, doubtless pertain to *Psephodus laevis-simus*." The other teeth assigned to *Helodus*, however, are regarded by the same author as "probably common to one or more genera or species, and it is thus convenient, upon present evidence, to retain their provisional determinations." For the same reason, also, it is convenient to retain in a provisional sense most of the species which have been described under the name of *Chomatodus*.

### **Chomatodus inconstans** ST. JOHN and WORTHEN.

(Plate 4, Figs. 32-34.)

1875. *Chomatodus inconstans* St. John and Worthen, Pal. Illinois, Vol. VI., p. 360, Pl. X., Figs. 5-14.  
 1875. *Chomatodus varsouviensis* St. John and Worthen, *Ibid.*, p. 363, Pl. X., Figs. 1-4.  
 1875. *Chomatodus chesterensis* St. John and Worthen, *Ibid.*, p. 363, Pl. X., Figs. 15-17.

This species occurs typically in the St. Louis limestone, but it was noted by the Illinois palaeontologists that very similar forms are found also in the underlying Warsaw beds, and in the Chester limestone above, to which the names *C. varsouviensis* and *C. chesterensis* were given respectively. There can be little impropriety in assigning to the same species teeth of the form shown in Plate 4, Figs. 32-34, which are from the Keokuk Group, thus indicating a continuous existence from this horizon onward throughout the Lower Carboniferous. The original of the accompanying figures belongs to the United States National Museum, and a second specimen is preserved in the Museum of Comparative Zoölogy.

*Formation and Locality.* — Keokuk to Chester Groups; Mississippi Valley.

### **Helodus incisus**, sp. nov.

(Plate 5, Fig. 54.)

*Type.* — Isolated tooth; Museum of Comparative Zoölogy.

Teeth small, bilaterally symmetrical, more or less triangular in cross-section, the crown rising abruptly into a slightly recurved median eminence. Coronal surface uniformly smooth; posterior face strongly convex, anterior face very gently arched or almost plane, with a large  $\Lambda$ -shaped incision; faint ridges extend along the borders of the cavity on either side, and a third extends ver-

tically from the angle where they meet to the coronal apex. Lateral expansions of crown short, slightly tumid at their extremities.

The tooth represented in the accompanying figures, which corresponds to the above description, is of the same general form as those known under the names of *Helodus coxanus* Newb., *H. triangularis*, and *H. acutus* Davis, all of which may be referred with little hesitation to the symphyseal series of Cochliodont sharks. The slightly recurved apex in the species under discussion indicates that the series was feebly prehensile, and the triangular excavation to which the trivial title has reference, together with markings on the anterior face, show that the individual teeth of the series were very closely applied and slightly overrode one another. One other specimen, besides that shown in the figures, is preserved in the Cambridge collections, both having been obtained from the Subcarboniferous limestone of Salem, Indiana.

*Formation and Locality.* — Subcarboniferous; Salem, Indiana.

#### ICHTHYODORULITES PRESUMABLY REFERABLE TO COCHLIODONTIDAE.

The most plausible interpretation which has been given of the peculiar Ichthyodorulites known as *Physonemus*, *Erismacanthus* (including *Gampsacanthus* and *Leocracanthus*), *Dipriacanthus*, and certain forms of *Oracanthus*, is that they are head-spines corresponding to those already observed on either side of the head in the Permian *Menaspis*, and in one example of *Oracanthus armigerus* Traquair from the Calciferous sandstone of Eskdale, Dumfries. In our opinion the genus *Stethacanthus* should be placed in the same category with the above, and all these forms may be provisionally grouped with the Cochliodontidae. Various forms of *Physonemus* spines are arbitrarily distributed between *Petalodus* and *Polyrhizodus* by Jaekel,<sup>1</sup> but the evidence of actual association of parts, which is necessary for the confirmation of this conjecture, has not yet been forthcoming.

#### PHYSONEMUS M'Cor.

Very interesting stages of modification are displayed by the group of *Physonemus*-like spines throughout their existence in the Lower Carboniferous. The earliest and most primitive forms of *Physonemus* itself are found in the Kinderhook accompanied by small forms of *Stethacanthus*. The only known species, those described in the following pages, are of diminutive size, hook-shaped, and nearly destitute of surface ornamentation. *Erismacanthus* is also represented in the Kinderhook by two small comparatively unornamented species, and it is noteworthy that these have quite rudimentary anterior

<sup>1</sup> *Jaekel, O.*, Ueber die Organisation der Petalodonten (*Zeitschr. deutsch. geol. Ges.*, Vol. LI., 1899, p. 285.

branches. The Burlington species of *Physonemus* and *Stethacanthus* display a marked increase in size, but they are feebly ornamented, and remain so throughout the stage represented by the Keokuk limestone. *Stethacanthus* seems to have attained its maximum size in the Keokuk Group, as *Physonemus* did in the Burlington, and a considerable falling off in this respect is true of both genera in the St. Louis division. The spines of *Stethacanthus* remain unornamented from the time of their first appearance in the Berea grit of Ohio until their extinction near the close of the Subcarboniferous, but those of *Physonemus* and *Erismacanthus* increase in complexity of ornamentation throughout the Mississippian series, ultimately displaying remarkable elaboration. An inspection of the forms illustrated in Plate XXII. of the sixth volume of the Illinois Palaeontology, and of the spines figured in the present contribution, will convince any one as to the correctness of these generalizations.

The spines in the typical species and in others resembling it are much laterally compressed, strongly arched or hook-shaped, with a broad base of insertion; the sides of the exerted portion are more or less ornamented with tuberculated longitudinal ridges, and small denticles are present upon the concave (posterior) border. This description applies to *P. arcuatus* M'Coy (the type species), *P. attenuatus* Davis, and *P. hamatus* (Agassiz), from the Carboniferous Limestone of Great Britain; and to the American forms described as *P. stellatus* Newberry, and *Drepanacanthus reversus* St. John and Worthen. Another group of spines which may be referred provisionally to the same genus is typified by such forms as the so-called *Drepanacanthus gemmatus* Newb. and Worth., *D. anceps* Newb. and Worth., *Xystracanthus acinaciformis* St. J. and Worth., *Physonemus gigas* Newb. and Worth., and the defences theoretically associated with the teeth of *Polyrhizodus rossicus* by A. Inostranzew<sup>1</sup> and O. Jaekel.<sup>2</sup> It is characteristic of the latter group of spines that they are forwardly curved, instead of backwardly, as in most Ichthyodorulites, a circumstance which appeared so anomalous to Newberry and Worthen as to warrant a generic separation from *Physonemus*. Transitional stages, however, showing the reversal of curvature from a posterior to an anterior direction, are to be observed in various species of *Stethacanthus* and *Oracanthus*, and for the present it seems best to extend the definition of *Physonemus* so as to include both groups. The two rod-like species from the Kinderhook limestone immediately to be described differ from all others in their more slender form and absence of ornamentation. They are undoubtedly to be interpreted as head-spines, a determination which is applicable to nearly all species of this genus.

<sup>1</sup> Travaux Soc. Nat. St. Petersb., Vol. XIX., 1888, pp. 1-18.

<sup>2</sup> Zeitschr. deutsch. geol. Ges., Vol. LI., 1899, p. 281, Fig. 5.



**Physonemus hamus-piscatorius, sp. nov.**

(Plate 5, Figs. 45, 46.)

*Type.* — Exserted portions of spines; Museum of Comparative Zoölogy.

Small hook-shaped spines, circular in cross-section, traversed by a small central pulp-cavity, and maintaining a nearly uniform diameter for the greater part of their length. External surface smooth or slightly roughened but not tuberculated, and no denticles present on either side. Inserted portion not observed.

The peculiar unciform spines shown in Plate 5, Figs. 45 and 46, from the Kinderhook limestone of Iowa, are the only examples at present known of this species. Both specimens are slightly abraded and afford no clue as to the nature of the inserted portion. The larger one is also fractured longitudinally for a considerable distance in such manner as to expose the tubular pulp-cavity, which in contrast to most species occupies a central position. The most striking differences displayed by the present form, however, are its circular cross-section and almost total absence of ornamentation. A small spine from the St. Louis limestone described by Messrs. St. John and Worthen as *Physonemus falcatus*, but which is probably the young of *P. arcuatus*, approaches the present form in its general outline, but differs notably in cross-section and other features. There is no reason to suppose that these spines are abnormally recurved, but on the contrary they may be looked upon as at once the most primitive, as they are also the earliest known representatives of *Physonemus*.

*Formation and Locality.* — Kinderhook limestone; Burlington, Iowa.**Physonemus pandatus, sp. nov.**

(Plate 5, Fig. 44.)

*Type.* — Complete spine; Museum of Comparative Zoölogy.

Small, narrow, laterally compressed spines, the exserted portion erect and scarcely tapering for two thirds of its length, then becoming suddenly bent, more or less at right angles, but not deurved. External surface apparently unornamented, and denticles absent along the concave margin.

The unique example upon which this species is founded exhibits the whole of the exserted portion, and is broken off at the expanded base, the inference being that it was buried only to a slight extent in the integument. It is distinguished from the preceding species principally by its great lateral compression, and in its abrupt flexure without being curved downward toward the distal extremity. No traces are to be observed of superficial ornamentation, nor of denticles along the concave margin. This species, like the last, may be looked upon as a primitive forerunner of the group typified by *P. arcuatus*, immediately to be considered.

*Formation and Locality.* — Kinderhook limestone; Burlington, Iowa.

*Physonemus arcuatus* M'Coy.

(Text-figure 12.)

1848. *Physonemus arcuatus* F. M'Coy, Ann. Mag. Nat. Hist. (2), Vol. II., p. 117.  
 1855. *Physonemus arcuatus* F. M'Coy, Brit. Palaeoz. Foss., p. 638, Pl. III., Fig. 29.  
 1875. *Drepanacanthus reversus* St. John and Worthen, Pal. Illinois, Vol. VI., p. 456, Pl. XIX., Fig. 5 (non Fig. 6).

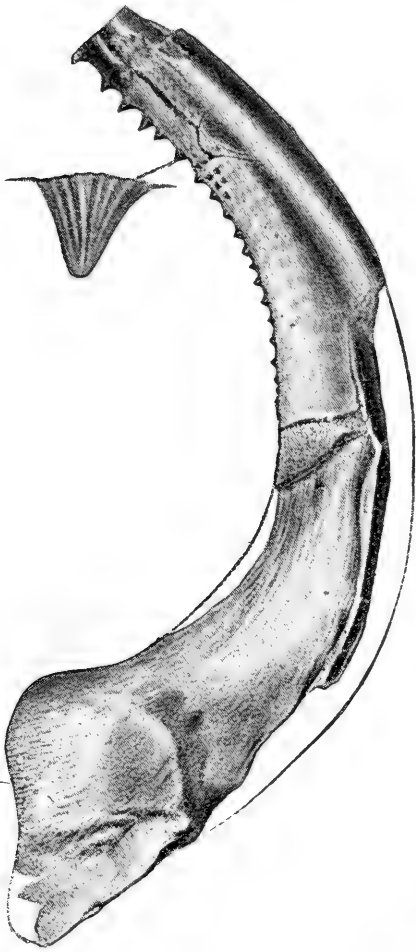


FIG. 12.

*Physonemus arcuatus* M'Coy. St. Louis limestone, Alton, Ill. Lateral aspect of spine,  $\times \frac{1}{7}$ , and single denticle,  $\times \frac{7}{7}$ .

1883. *Physonemus arcuatus* J. W. Davis, Trans. Roy. Dublin Soc. (2), Vol. I., p. 367, Pl. XLVII., Fig. 8.  
 1883. *Physonemus falcatus* St. John and Worthen, Pal. Illinois, Vol. VII., p. 252, Pl. XXIV., Fig. 6.  
 1883. *Drepanacanthus reversus* St. John and Worthen, *Ibid.*, p. 253, Pl. XXIV., Fig. 5.  
 1899. *Physonemus stellatus* J. S. Newberry, Monogr. U. S. Geol. Surv., Vol. XVI., p. 200, Pl. XXI., Fig. 12.  
 1902. *Physonemus arcuatus* C. R. Eastman, Bull. Mus. Comp. Zoöl., Vol. XXXIX., p. 87.

All of the spines referable to this species which have been previously figured are imperfect in this respect, that the superficial ornamentation has been very largely denuded, and the denticles along the concave margin either worn or broken away, thus obscuring their true relations. Although the example shown in the adjoining Text-figure has been somewhat injured, its general outline is well displayed, and enough of the ornamentation remains to leave no doubt as to its identity with the type species of this genus. The double row of striated denticles bordering the concave margin is fully as prominent as in typical examples, although abrasion has reduced many of the tubercles in size. One of the latter is represented seven times the natural size in the figure to the left of the spine.

Owing to the worn condition of the basal portion, it is not apparent to what depth the spine was inserted in the integument, but from some other specimens the writer has seen it is probable that it was not deeply implanted. There

can be no question that the spines belonging to this species are homologous with the compressed posterior branch of *Erismacanthus*, and reasoning from analogy, it is natural to suppose that in the group typified by *P. arcuatus* the spines were curved in the normal direction, that is to say, posteriorly. In *P. gemmatus*, *P. stellatus*, and *P. gigas*, on the other hand, appearances are in favor of Newberry's conclusion that the usual curvature was reversed, the anterior margin being concave, and the posterior convex. Enlightenment as to how this reversal may have been accomplished is furnished by a study of the conditions in *Stethacanthus* and the Kinderhook specimens of *Oracanthus vetustus*.<sup>1</sup>

*Formation and Locality.* — St. Louis limestone; Illinois, Missouri, and Indiana. Lower Carboniferous Limestone; Great Britain.

#### ***Physonemus gemmatus* (NEWBERRY and WORTHEN).**

1866. *Drepanacanthus gemmatus* Newberry and Worthen, Pal. Illinois, Vol. II., p. 123, Pl. XIII., Fig. 1.  
 1889. *Drepanacanthus gemmatus* J. S. Newberry, Monogr. U. S. Geol. Surv., Vol. XVI., p. 195.

A spine as perfect as the type of this species is preserved in the United States National Museum, and agrees with it in the form of the inserted portion. This, according to Newberry, affords proof that the spine was curved forwards with the concave margin toward the front, as in *P. gigas* and some other forms. We are inclined to think that Newberry was correct in this view, but mistaken in supposing that *P. arcuatus* was curved in the same direction. The propriety of including these two species in the same genus has already been suggested by Newberry and Smith Woodward.

Spines of the present species are not altogether uncommon in the Keokuk limestone, and good examples may be seen in the Cambridge and Iowa State Museums. Apparently the tubercles along the concave margin never attained a size sufficient to be called denticles. As in *P. stellatus* Newb. and Worth., the pulp-cavity is not central in position, but placed slightly nearer the convex margin.

*Formation and Locality.* — Keokuk limestone; Iowa.

#### ***Physonemus stellatus* (NEWBERRY and WORTHEN).**

1866. *Drepanacanthus* (?) *stellatus* Newberry and Worthen, Pal. Illinois, Vol. II., p. 125, Pl. XII., Fig. 7.  
 1875. *Batacanthus stellatus* St. John and Worthen, *Ibid.*, Vol. VI., p. 470, Pl. XXI., Figs. 1-3.

Complete spines of this species have never been figured. Newberry and Worthen were acquainted with but a single fragment of the distal portion, but

<sup>1</sup> Newberry, *J. S.*, Trans. N. Y. Acad. Sci., Vol. XVI., 1897, p. 285, Pl. XXII., Fig. 3.

noticed its resemblance in ornamentation to that of *P. gemmatus* from the same horizon. The specimens figured by St. John and Worthen are likewise from the distal third of the spine. The total length, as shown by one or two good examples in Iowa City, is really much longer than these authors supposed, and the breadth nearly equals that of *P. gemmatus*. The proportions of the two species are in fact very similar, the chief differences consisting in ornamental details, form of cross-section, and the greater development of tubercles along the concave border in the present species. In the distal portion of the spine these tubercles frequently appear as strong acuminate denticles. The pulp-cavity remains open for a short distance on the convex side near the base, and continues close to this side throughout the spine until near the tip. Like the preceding species, it is extremely probable that the spines of *P. stellatus* were curved forwards.

*Formation and Locality.* — Keokuk limestone; Iowa and Illinois.

#### LIST OF NORTH AMERICAN SPECIES OF PHYSONEMUS.

Name of Species.	Kinderhook.	Burlington.	Keokuk.	St. Louis.	Chester.	Coal Measures.
1. <i>P. hamus-piscatorius</i> Eastman . . .	X	—	—	—	—	—
2. " <i>pandatus</i> Eastman . . . . .	X	—	—	—	—	—
3. " <i>gigas</i> Newb. and Worth. . . .	—	X	—	—	—	—
4. " <i>gemmatus</i> (Newb. and Worth.) .	—	—	X	—	—	—
5. " <i>stellatus</i> (Newb. and Worth.) .	—	—	X	—	—	—
6. " (?) <i>baculiformis</i> (St. J. and Worth.)	—	—	X	—	—	—
7. " (?) <i>necis</i> (St. J. and Worth.) . .	—	—	X	—	—	—
8. " <i>arcuatus</i> M'Coy . . . . .	—	—	—	X	—	—
9. " <i>acinaciformis</i> (St. J. and Worth.)	—	—	—	—	—	X
10. " <i>anceps</i> (Newb. and Worth.) . .	—	—	—	—	—	X
11. " <i>asper</i> Eastman . . . . .	—	—	—	—	—	X

#### ERISMACANTHUS M'Coy.

The two European and one American species of this genus that have been described are evidently very closely related to the type of *Physonemus*, but differ in that the spines are divaricated, the two branches extending in opposite directions in the same vertical plane. The imperfect *Ichthyodorulites* known

as *Gampsacanthus*, *Lecracanthus*, and *Dipriacanthus* appear to be of the same general nature, and may be provisionally regarded as the dissociated anterior branches belonging to *Erismacanthus*. The Kinderhook species of this genus are small and exceedingly primitive as compared with the highly ornamented spines occurring in the St. Louis limestone, some of which attain the astonishing length of over 20 cm., and are provided with very large-sized denticles along the anterior arm. The forms included under this genus are referable to the head region with even greater certainty than those of *Physonemus*, and evidently occurred in pairs, whereas the latter would seem to have occupied a median position.

***Erismacanthus barbatus*, sp. nov.**

(Plate 5, Fig. 47.)

*Type.* — Isolated and fragmentary spine; Museum of Comparative Zoölogy.

Spines small, very much laterally compressed, smooth or with faint longitudinal striae, and without denticles or tuberculations of any kind. Principal portion of spine gently arched, gradually tapering, and giving off two spiniform branches of unequal size from the convex margin.

This peculiar and in many respects primitive form of *Erismacanthus* is known by the solitary example shown of the natural size in the accompanying figure. It is excessively flattened, and consists of a gently arched portion corresponding to the denticulated posterior branch of other species, and of two rudimentary anterior branches, each with a thickened border and elevated ridge. A slight differentiation in the superficial ornament, which in later species becomes very pronounced, is already indicated in this early form, in that the main or posterior branch is feebly striated and the two anterior projections quite smooth.

*Formation and Locality.* — Kinderhook limestone; Burlington, Iowa.

***Erismacanthus maccoyanus* St. JOHN and WORTHEN.**

1875. *Erismacanthus maccoyanus* St. John and Worthen, Pal. Illinois, Vol. VI., p. 461, Pl. XXII., Figs. 1, 2, 4 (*non* Fig. 3).

This species has been known hitherto by only a few very diminutive spines from the St. Louis limestone, none of the specimens in the hands of Messrs. St. John and Worthen exceeding one inch in length. Whether all of the examples figured by these authors pertained to a single species was indeed questioned by them, on account of differences in the form and arrangement of the posterior denticles. Their views concerning the imperfect spine shown in Plate XXII., Fig. 3, of the seventh volume of the Illinois Palaeontology are thus expressed: "Whether the approximate arrangement of the denticles observed in the above specimen is indicative of specific distinctness from its associates we have not the means for determining; it is, however, probable that these closely arranged

denticles gradually merge into the widely spaced and finally obtuse tubercles occurring near the base of the spine, as shown in fig. 1 a, and fig. 4 a."

Specimens that have come to light since the time of St. John and Worthen lead to the conclusion that the original of their Plate XXII., Fig. 3, which is peculiar in having "approximated denticles" along the posterior spine, is the young of a gigantic species recently described as *E. formosus*. It need only be remarked here that the additional material proves conclusively that the spines of *Erismacanthus* occurred as rights and lefts, and are presumably referable to the head-region.

The occurrence of *E. maccoyanus* in other formations than the St. Louis limestone has not been previously reported. A small branched spine, however, from the Kinderhook limestone of Le Grand, Iowa, belonging to the Museum of Comparative Zoölogy, appears referable to this species, notwithstanding its weathered condition. At all events, it agrees with the latter in size and form, but we are unfortunately left in doubt with regard to the superficial ornamentation.

*Formation and Locality.* — Kinderhook Limestone; Iowa. St. Louis Limestone; Missouri.

### *Erismacanthus formosus* EASTMAN.

(Text-figure 13.)

1875. *Erismacanthus maccoyanus* (errore) St. John and Worthen, Pal. Illinois, Vol. VI., p. 461, Pl. XXII., Fig. 3.

1902. *Erismacanthus formosus* C. R. Eastman, Amer. Nat., Vol. XXXVI., p. 850, Text-fig. 1.

This, the largest known species of *Erismacanthus*, is interesting on account of its relatively gigantic size, being nearly seven times as large as *E. maccoyanus*,

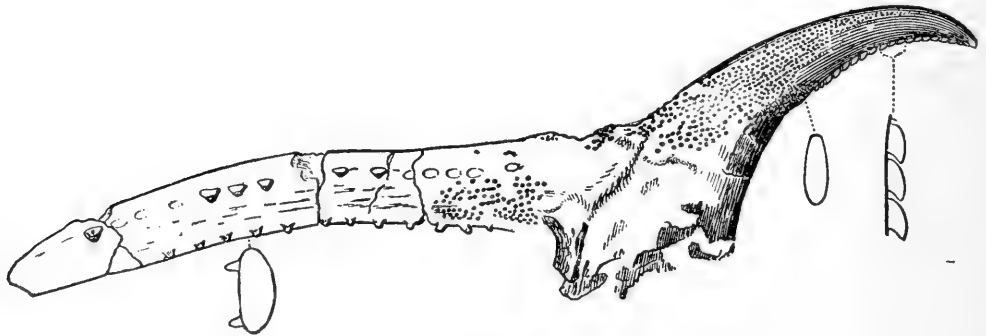


FIG. 13.

*Erismacanthus formosus* Eastm. St. Louis limestone, St. Louis, Mo. Outer face of cephalic spine belonging to the left side of the head,  $\times \frac{1}{2}$ .

which it accompanies in the same formation, and twice the size of *E. jonesi* M'Coy, the largest European species. It is also interesting in having paralleled

the condition observed in certain Mesozoic Teleosts, such as *Coccodus* from the Lebanon Cretaceous, in which very similar head-spines are developed, and oriented in the same way, one on either side of the head. Appearances suggest that the long and stout anterior branch in the present form was for the most part buried in the integument, only the double row of robust conical denticles protruding, but the posterior spine was probably entirely exposed. The typical example of this species, shown in Text-figure 13 and now deposited in the Museum of Comparative Zoölogy, exhibits a total length of no less than 21.5 cm.

*Formation and Locality.* — St. Louis Limestone; Missouri.

### STETHACANTHUS NEWBERRY.

*Definition (emend.).* — Spines broad, much laterally compressed, triangular or falcate in outline, deeply inserted. The elongated basal portion thin-walled and occupied by a very large internal cavity which extends upward nearly to the apex; exserted portion terminated at one end by a strong, often tumid shoulder, and rising at the other by a gradual curve into an acuminate summit. Surface of spine having a rough, fibrous appearance and marked in the basal portion by coarse vascular impressions. Internal structure distinctly fibrous, owing to the fan-shaped radiation of numerous fine tubules from the apex toward the basal portion. Apex usually inclined posteriorly (*i. e.*, away from the tumid "shoulder"), but sometimes erect, or even slightly inclined forwards.

The peculiar class of dermal structures which are recognized under the name of *Stethacanthus* display quite uniform characters throughout their range from the Waverly to near the summit of the Mississippian series. They were regarded as pectoral fin-spines by Newberry,<sup>1</sup> who was under the mistaken impression that they were not bilaterally symmetrical, and was further misled by the fortuitous association on the same slab of a spine of *S. tumidus* with fin-rays of an Actinopterygian fish. There is no reason for supposing that they were situated elsewhere than in the median line of the body, either along the back or at the base of the head.

On considering the probable relationships of *Stethacanthus*, we are struck immediately with its resemblance to *Physonemus*, especially such forms as *P. gigas*, nor can a certain similarity be denied to the remarkable Kinderhook spine described by Newberry as *Oracanthus vetustus*, to which reference has already been made. In the latter form the base is much produced in an anterior direction, forming a most efficient anchorage in the soft parts for the exserted portion, and it is noteworthy that the tip of the exserted portion is slightly curved forwards. The same condition of things is developed to a somewhat lesser extent in *Physonemus gigas*, in which there is even an incipient "shoulder" at the base of the concave (anterior) margin. A more

<sup>1</sup> Monogr. U. S. Geol. Surv., Vol. XVI., 1889, p. 198.

advanced stage of modification than this is exemplified by the various species of *Stethacanthus*, the basal portion having become much elongated and the anterior "shoulder" very conspicuous. In the more primitive forms the summit projects but slightly above the line of insertion, and the concave margin is very gently curved. Gradually the summit becomes more strongly and abruptly elevated, finally assuming an erect or even recurved position, as in *S. altonensis* and some other species.

The anterior tumid portion or "shoulder" which terminates the exerted portion in the line of the body-wall in front, doubtless served as a buttress for strengthening the attachment of the spine in the soft parts and forms the initial portion of the cutwater. The depth to which the spine was inserted, or, in other words, the line of the body-wall, is denoted by the regular termination of the coarse vascular impressions which are limited to the basal portion. The latter is always more or less produced in advance of the anterior shoulder, and in some species it is also produced posteriorly beyond the point where the exerted portion enters the integument, as shown in Newberry's figure of *S. altonensis*.<sup>1</sup> This author's observation that "the base shows the outline of what seems to be a spheroidal head that fitted into the socket of an articulation" may be dismissed as having no foundation of fact, and probably arose from deceptive appearances.

The Devonian spines known as *Acantholepis* and *Phlyctaenacanthus* also exhibit a very large internal cavity, and appear to have been inserted in an essentially similar manner.

#### *Stethacanthus altonensis* (ST. JOHN and WORTHEN).

1875. *Physonemus altonensis* St. John and Worthen, Pal. Illinois, Vol. VI., p. 454, Pl. XIX., Figs. 1-3.  
 1875. *Drepanacanthus reversus* (*errore*) St. John and Worthen, *Ibid.*, p. 457, Pl. XIX., Fig. 6 a.  
 1889. *Stethacanthus altonensis* J. S. Newberry, Monogr. U. S. Geol. Surv., Vol. XVI., p. 198, Pl. XXIV.

This, the typical species, appears to be restricted to the St. Louis limestone, and in its larger size and nearly erect summit represents a more advanced stage of modification than the Burlington species. A specimen larger than any described belongs to the private collection of Dr. G. Hambach, in St. Louis, and has a total length of 24 cm., the basal portion being conspicuously produced beyond the limits of the exerted part both in front and behind. The walls have a uniform thickness of about 2 mm. throughout, except along the cutwater and posterior margin of the exerted portion. Newberry's statement that these spines exhibit a want of bilateral symmetry is clearly erroneous.

*Formation and Locality.* — St. Louis limestone; Illinois and Missouri.

<sup>1</sup> Monogr. U. S. Geol. Surv., Vol. XVI., 1889, Pl. XXIV.



**Stethacanthus productus** NEWBERRY.

(Text-figure 14.)

1875. *Physonemus gigas (errore)* St. John and Worthen, Pal. Illinois, Vol. VI., Pl. XVII., Figs. 7-9.  
 1897. *Stethacanthus productus* J. S. Newberry, Trans. N. Y. Acad. Sci., Vol. XVI., p. 291, Pl. XXIII., Figs. 2, 2.  
 1897. *Stethacanthus compressus* J. S. Newberry, *Ibid.*, p. 292, Pl. XXIII., Figs. 3, 4.

*Type.* — Imperfect spine; Museum of Chicago University.

The spines referred to this species are characterized by having the concave margin very gently curved, in consequence of which the apex is much inclined backwards. The smaller spines described by Newberry as *S. compressus* appear to be the young of the species under discussion, and it need scarcely be remarked that their correlation by this author with the pectoral and pelvic fins is entirely fanciful. Spines having the same form as *S. productus*, but of much smaller size, occur in the Kinderhook limestone of Iowa. The species described by Messrs. St. John and Worthen as *Physonemus depressus*, *P. carinatus*, and *P. gigas* (in part) are distinguished from one another and from *S. productus* in only minor details, and the types are extremely fragmentary. Nevertheless, it is convenient to regard the Kinderhook species as distinct from the Burlington, provisionally at least, and as representing the earliest and most primitive expressions of the genus. The Burlington species exhibit a marked increase in size, and in the next succeeding formation, the Keokuk, the maximum appears to have been attained by spines such as the one represented in the accompanying Text-figure.

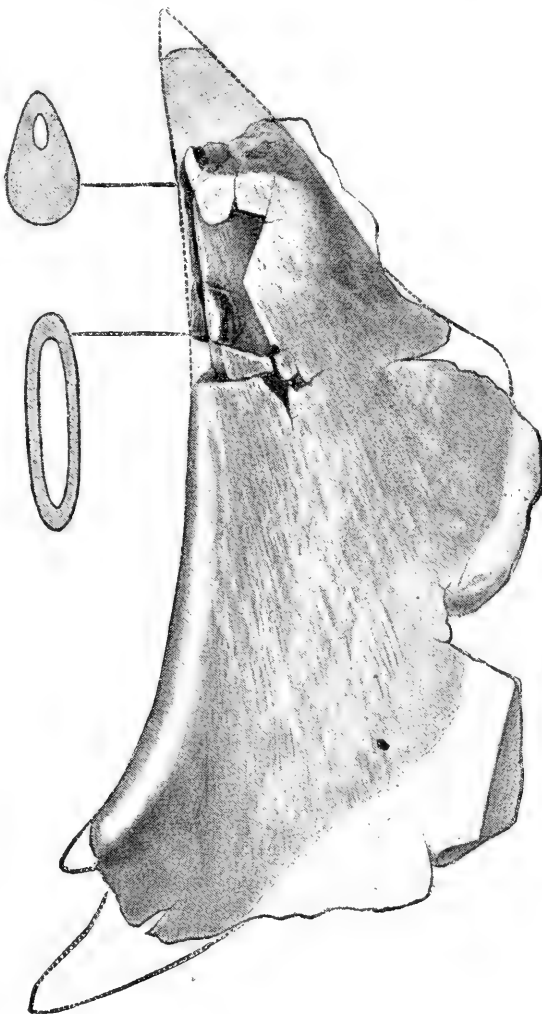


FIG. 14.

*Stethacanthus productus* Newb. Keokuk limestone, Keokuk, Iowa. Lateral aspect of spine, with cross-sections of summital portion,  $\times \frac{1}{3}$  (approximately).

The original of this figure belongs to the United States National Museum at Washington, and was collected by Mr. L. A. Cox from a quarry in the Keokuk limestone on Cedar Street in the city of Keokuk. The spine was nearly perfect when found, but was injured in extricating it from the matrix. The shaded portion of the summit is now to be observed only in impression on the underlying slab, and the extreme tip is restored from a pencil sketch made by Mr. Cox according to his recollection. The dotted lines which are intended to show the anterior "shoulder" and basal projection as they occur in most species, are to be understood as conjectural, and a reliable index as to the elevation of the summital portion is therefore wanting. The width across the anterior shoulder at the point where it is broken off is no less than 3.7 cm., and it is in this region that the greatest thickness of the walls occurs. The thickness of the exerted portion is indicated by the two sections that are given, the upper one of which shows the approximation of the pulp-cavity toward the concave margin. The total length of the part preserved is 32 cm., and the total height 12 cm. Some hesitation is felt in referring this specimen to *S. productus*, but this course seems preferable to recognizing it as a distinct species.

*Formation and Locality.*— Burlington and Keokuk Groups; Iowa.

### *Stethacanthus depressus* (ST. JOHN AND WORTHEN).

(Text-figure 15.)

1875. *Physonemus depressus* St. John and Worthen, Pal. Illinois, Vol. VI., p. 452, Pl. XVIII., Fig. 3.

Only a few imperfect examples of this species were known to its authors, all of them under two inches in length, and recognized as distinct from other

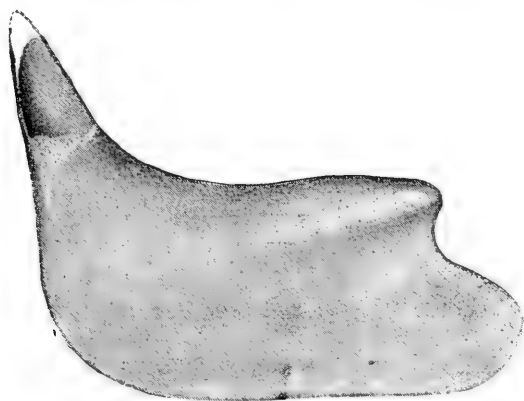


FIG. 15.

*Stethacanthus depressus* (St. J. and W.). Waverly sandstone, Marshall, Mich. Right lateral aspect of spine,  $\times \frac{1}{2}$ .

forms chiefly on account of the "shoulder" being broadly rounded from side to side, and the concave margin of the exerted portion being very gently curved. The complete outline of the spines belonging to this species is well shown in several specimens from the Kinderhook of Le Grand, Iowa, now in the collections of the United States National Museum at Washington. It is also well displayed in the original of Text-figure 15, which belongs presumably to the same species, and is from the Waverly sandstone of Marshall,

Calhoun County, Michigan. Although the actual substance of this spine has

been considerably removed by chemical decomposition, yet where the surface is preserved it is seen to be covered with vascular impressions extending well up toward the superior margin, thus indicating that the spine was deeply implanted.

*Formation and Locality.* — Kinderhook ; Iowa. Waverly sandstone ; Michigan.

### *Stethacanthus erectus*, sp. nov.

(Plate 3, Fig. 29.)

*Type.* — Imperfect spine ; United States National Museum.

A species of about the same size as *S. depressus*, and differing from it in having the concave margin more abruptly curved, the exerted portion rising into a narrow and acuminate apex.

It is unfortunate that the specimen selected as the type of this species is not more perfectly preserved, as it seems to represent an intermediate stage in the modifications affecting the exerted portion of these peculiar spines, being in fact transitional between low forms like *S. compressus*, *S. carinatus*, *S. depressus*, etc., and those in which the apex is recurved, like *S. proclivus* and *S. altonensis*. The anterior shoulder and greater part of the basal portion of this unique specimen have been broken away, but it is probable that the complete outline would show that the base was produced for some distance posteriorly beyond the hinder wall of the summital portion, as in *S. altonensis* and some other species. The total height of the part preserved is 3 cm., thus indicating a species of about the same size as the preceding.

*Formation and Locality.* — Kinderhook limestone ; Iowa.

## CESTRACIANTIDAE.

### HOMACANTHUS AGASSIZ.

This genus, which is evidently closely akin to *Ctenacanthus*, is thus defined by A. S. Woodward : "Dorsal fin-spines of small size, slender, more or less arched, laterally compressed, and gradually tapering distally ; sides of exerted portion ornamented with few, large, smooth, widely spaced longitudinal ridges ; a similar ridge also forming a large anterior keel ; posterior face with a double series of large, downwardly curved denticles." The only American species that have been referred to *Homacanthus* have since been removed to other genera, but true representatives of this genus are apparently indicated by the spines described in the following paragraphs.

**Homacanthus delicatulus, sp. nov.**

(Plate 3, Fig. 28; Plate 5, Fig. 59.)

*Type.* — Isolated spine; Museum of Comparative Zoölogy, Cambridge.

*Definition.* — Spines very diminutive, erect, deeply inserted; base of exserted portion relatively broad, distal extremity acute, sides ornamented with not more than five or six straight longitudinal ridges.

The very minute and nearly perfect specimen which is here referred to *Homacanthus* might at first sight be assumed to belong to a young individual of *Ctenacanthus*, in which case it would correspond to the extreme tip of an adult spine. But even the distal extremity of all *Ctenacanthus* spines is distinctly tuberculated, and moreover, the costae appear too divergent, and the base of insertion too broad for this specimen to be regarded as a young form of *Ctenacanthus*. Besides, the Kinderhook species of *Ctenacanthus* are pretty well known, and there are none to which this small form corresponds even approximately, hence we may look upon it as belonging to *Homacanthus*.

The spine has a total length of about 1.8 cm., and maximum width of only 3 mm. The inserted portion is relatively very long and tapering, and the exserted portion has a narrow triangular form, the two portions being separated by a very oblique and prominently marked line of insertion. The lateral face is occupied by five smooth and continuous longitudinal costae, and two or three additional ones unite to form the anterior keel. Growth of the costae seems to have taken place by the coalescence of dentine tubercles formed just below the line of insertion, as shown in Plate 5, Fig. 59. The absence of denticles along the posterior margin is to be accounted for by the effects of weathering or abrasion, or both. Some resemblance is to be noted between this spine and one of those figured by J. W. Davis as *H. microdus* from the Lower Carboniferous limestone of Armagh, Ireland (Trans. Roy. Dublin Soc. (2), Vol. I., 1883, Pl. XLVIII., Fig. 8.)

*Formation and Locality.* — Kinderhook limestone; Le Grand, Iowa.

**Homacanthus acinaciformis, sp. nov.**

(Plate 5, Fig. 58.)

*Type.* — Exserted portion of spine; Museum of Comparative Zoölogy.

Spines comparatively small, slender, gradually tapering, gently and uniformly arched; lateral surface with five or six smooth continuous longitudinal ridges; posterior denticles slender, rather widely spaced.

This species is noticed here principally for the sake of comparison with the preceding, and to illustrate the difference in degree of curvature pervading various spines included under the same genus. Indeed, if we may depend upon the determinations of J. W. Davis, spines belonging even to a single

species of *Homacanthus* vary considerably in curvature.<sup>1</sup> The present form may also be compared with the spines referred by Davis and Newberry to the genus *Hoplonchus*, which is scarcely distinct from *Homacanthus*. The single American species assigned to *Hoplonchus* was originally described by Newberry as *Ctenacanthus parvulus*, and occurs in the Cleveland Shale (Upper Devonian) of Ohio.

*Formation and Locality.* — Chemung Group; Warren, Pennsylvania.

### CTENACANTHUS AGASSIZ.

In a recent number of this Bulletin (Vol. XXXIX., No. 3), several species of *Ctenacanthus* were described from material belonging to the United States National Museum, and derived from the Kinderhook limestone of Iowa. Some of these spines had formed part of the Government display at the Omaha and other expositions, previous to their coming to Cambridge, and when placed in the hands of the writer for description the authorities at Washington were unable to furnish a record of the exact locality whence they were obtained. Since their description was published, however, information has been received from Mr. Charles Schuchert, who purchased the specimens, that the types of *C. longinodosus*, *C. lucasi*, *C. decussatus*, and *C. solidus*, together with the figured specimens of *C. spectabilis* and *C. venustus*, were collected by a Mr. McCabe from the Kinderhook quarries at Le Grand, near Marshalltown, in Marshall County, Iowa. A description of the formation as exposed in this vicinity will be found in Volume VII., pp. 221-226, of the Iowa Geological Survey Annual Reports (1896).

### FRAGMENTS OF DERMAL ARMOR AND OTHER UNIDENTIFIED REMAINS.

Portions of calcified cartilage, detached tubercles, bosses, and dermal plates are of not infrequent occurrence in nearly all members of the Mississippian series, being particularly abundant in the Kinderhook and St. Louis limestones; and in a few instances nearly complete cartilaginous and osseous jaws have been brought to light, some of them dentigerous. None of these fragmentary remains are capable of satisfactory determination, although the more characteristic of them have received provisional designations, such as *Petrodus*, *Stemmatias* (*Stemmatodus* St. J. and Worth. *non* Heckel), *Mazodus*, etc. The wide range of form and ornamentation displayed by these bodies is remarkable, and it is evident that Carboniferous fishes possessed a much more varied external covering than their Devonian predecessors.

The survival of moribund Arthrodires during at least a part of the Kinderhook is witnessed by occasional dermal plates displaying the structure and tuberculation characteristic of this group. An examination of weathered and

<sup>1</sup> Trans. Roy. Dublin Soc. (2), Vol. I., p. 361, Pl. XLVIII., Figs. 7-9.

fractured specimens reveals the interesting fact that the growth of these plates was by secretion of new layers of bony tissue on both sides of the old, above and below, thus proving that the entire plate was covered by the integument. In no other way can we explain the presence of successive tuberculated layers underneath the external one, nor the regularly laminated structure of the plates as seen in cross-section. A number of undoubted Arthrodire plates from the Kinderhook near Burlington, Iowa, were collected many years ago by Messrs. Giles, Wachsmuth, and St. John, and are now preserved in the Cambridge Museum of Comparative Zoölogy.

As if in mimicry of the tuberculated covering of Arthrodires, rugose dermal plates were developed by their Elasmobranch contemporaries in the Kinderhook, probably through concrescence and fusion of shagreen granules; and their resemblance to the former is often so close that an examination of the microscopical structure is necessary to distinguish them. An example of such a plate, with symmetrical outlines and simulating the tuberculation of Arthrodires, is shown in Plate 5, Fig. 50. The more common form of dermal tubercles,

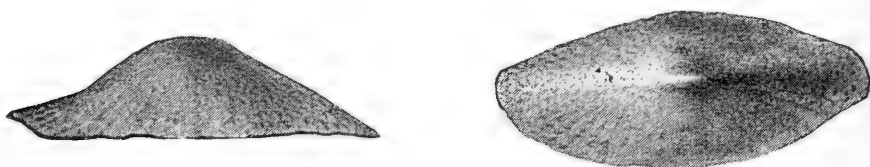


FIG. 16.

Dermal Plate of an undetermined Elasmobranch, in lateral and superior aspects,  
 $\times \frac{2}{3}$ . Kinderhook limestone, Burlington, Iowa.

however, is acutely or obtusely conical, as exemplified by *Petrodus* or by the spiniform bodies shown in Plate 5, Figs. 56 and 57. Occasionally bodies are found having the form of elongated eminences, either symmetrical like that shown in Text-figure 16, or abruptly truncated on one side, as if they had been disposed in pairs, and recalling the dermal head plates of *Myriacanthus* and other Chimaeroids. Many of these tuberculated plates may be referred with considerable confidence to Chimaeroids, notwithstanding the fact that they are unaccompanied by dental plates. It is a remarkable circumstance that Chimaeroid jaws, which occur in great profusion in the Middle and Upper Devonian, are wholly unknown in rocks of Carboniferous age, and Dipnoans are conspicuously absent in the lower members of the same series. An explanation of their sudden disappearance at the close of the Devonian is possibly to be found in the change that took place from shallow to deep water conditions with the resultant migration of littoral forms.

In Text-figure 17 is shown of twice the natural size a peculiar fossil from one of the "fish-beds" near Burlington, Iowa, stratigraphically near the dividing line between Upper Devonian and typical Kinderhook. It is one of a score or more precisely similar bodies which were collected by St. John, Wachsmuth,

S. A. Miller, and others at this locality a number of years ago, and more recently Prof. J. A. Udden has collected further specimens of the same sort near Burlington. The nature of these bodies is entirely problematical, some of the best-known palaeontologists who have examined them being unable to express any decided opinion concerning them. Their finely laminated structure does not in the least indicate them to be of vertebrate origin, nor can they be satisfactorily classed with plant remains. The suggestion that they may have to do with Molluscan remains is as compatible as any with the internal structure, but we are at a loss to identify them with the usual hard parts, not even excepting the beaks of Nautiloids. Any attempt to homologize them with any known Crustacean structure is equally baffling. Owing to the not uncommon occurrence of these bodies in accompaniment with fish-remains in the Kinderhook, they are at least worthy of passing notice, and the accompanying figure is given in the hope that some clue may be found concerning their true nature.

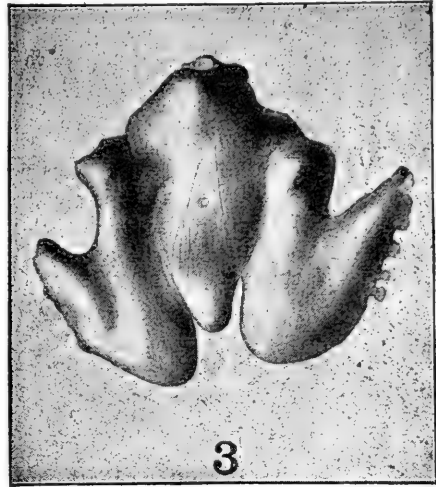


FIG. 17.

Problematical fossil from the Kinderhook limestone of Burlington, Iowa,  
 $\times \frac{3}{1}$ .

## EXPLANATION OF PLATES.

## PLATE 1.

- Fig. 1. *Campodus variabilis* (N. and W.). Missourian; Kansas and Nebraska. Supposed lower dentition,  $\times \frac{1}{3}$ . The symphyseal series is photographed from an actual specimen obtained by Prof. E. H. Barbour from the Atchison shales of Cedar Creek, Cass County, Nebraska; the mandibular rami are photographed from a plaster cast of the specimen described by St. John and Worthen in the sixth volume of the Illinois Palaeontology. The original of the latter specimen was derived from the Missourian of Topeka, Kansas, and is now preserved in the private collection of O. H. St. John, at Raton, New Mexico.
- Fig. 2. *Cestracion francisci* Girard. Recent; Pacific Ocean. Lower dentition,  $\times \frac{1}{4}$ . The cuspidate anterior and symphyseal teeth are well shown by this specimen.

## PLATE 2.

All figures are of the natural size, and photographed from the original specimens without retouching.

- Fig. 3. *Cladodus occidentalis* Leidy. Atchison shales (Missourian); Table Rock, Nebraska. Outer coronal face of imperfect tooth, the lateral denticles and a portion of the root being broken away.
- Fig. 4. *Cladodus knightianus* (Cope). Chase formation (Permo-Carboniferous); Blue Springs, Nebraska. Inner coronal face of imperfect specimen.
- Fig. 5. *Peripristis semicircularis* (Newb. and Worth.). Atchison shales (Missourian); South Bend, Nebraska. Uninjured side of pathologic upper tooth.
- Fig. 6. *Peripristis semicircularis* (Newb. and Worth.). Atchison shales (Missourian); Louisville, Cass County, Nebraska. Anterior aspect of upper dental plate, the root partially embedded in matrix.
- Fig. 7. *Peripristis semicircularis* (Newb. and Worth.). Atchison shales (Missourian); South Bend, Cass County, Nebraska. Anterior aspect of upper dental crown, tilted slightly upward.
- Fig. 8. *Cladodus occidentalis* Leidy. Neosho formation (Permo-Carboniferous); Roca, Lancaster County, Nebraska. Apical portion of crown, showing striated inner face.



- Fig. 9. *Cladodus occidentalis* Leidy. Atchison shales (Missourian); Springfield, Sarpy County, Nebraska. Fragmentary basal portion viewed from the inner face, with lateral denticles preserved on one side, and showing prominent nutrient foramina of root.
- Fig. 10. *Ctenoptychius occidentalis* (St. J. and Worth.). Atchison shales (Missourian); Richfield, Sarpy County, Nebraska. Outer coronal face of a weathered specimen, the root broken away.
- Fig. 11. *Fissodus inaequalis* (St. J. and Worth.). Atchison shales (Missourian); Peru, Nemaha County, Nebraska. Inner coronal face of same specimen as shown in Plate 3, Fig. 26.
- Fig. 12. *Fissodus dentatus*, sp. nov. Missourian; Topeka, Kansas. Outer coronal face of tooth, the root broken away. Marks of contact with next older tooth are distinctly shown, serrations of lateral edges but faintly, in the photograph.
- Fig. 13. *Janassa unguicula*, sp. nov. Atchison shales (Missourian); Cedar Creek, Cass County, Nebraska. Outer coronal face of tooth, the root broken away. The portion overlapped by next older tooth in front is indicated by the darker area at the base of crown.
- Fig. 14. *Helodus rugosus* Newb. and Worth. Base of Cottonwood or summit of Atchison shales (Missourian); Table Rock, Pawnee County, Nebraska. Inner face of nearly perfect tooth.
- Fig. 15. *Campodus variabilis* (Newb. and Worth.). Neosho formation (Permo-Carboniferous); Roca, Lancaster County, Nebraska. Coronal surface of supposed postero-lateral tooth, differing somewhat from any described by St. John and Worthen.
- Fig. 16. *Campodus variabilis* (Newb. and Worth.). Atchison shales (Missourian); Louisville, Cass County, Nebraska. Coronal surface of a slightly asymmetrical tooth with feebly developed buttresses along the outer margin, and most nearly agreeing with the tooth figured by St. John and Worthen in Pl. VIII., Fig. 4, of the sixth volume of the Illinois Palaeontology.
- Fig. 17. *Petalodus alleghaniensis* Leidy. Atchison shales (Missourian); South Bend, Cass County, Nebraska. Anterior (outer) face of a broad-rooted and symmetrical tooth presumably situated in the azygous series in front. The opposite face of the same specimen is shown in Plate 3, Fig. 27.
- Fig. 18. *Petalodus alleghaniensis* Leidy. Base of Cottonwood or summit of Atchison shales (Missourian); Table Rock, Pawnee County, Nebraska. Posterior aspect of fragmentary specimen showing difference in form of root as compared with teeth occupying a position in the median azygous in front.
- Fig. 19. *Deltodus angularis* Newb. and Worth. Permo-Carboniferous; Blue Springs, Gage County, Nebraska. Coronal surface of posterior dental plate referred to the right mandibular ramus.
- Fig. 20. *Streblodus angustus*, sp. nov. Atchison shales (Missourian); South Bend, Cass County, Nebraska. Coronal surface of posterior dental plate referred to the left ramus of the upper jaw.
- Fig. 21. *Janassa maxima*, sp. nov. Atchison shales (Missourian); Richfield, Sarpy County, Nebraska. Posterior (inner) coronal face of a fractured and

unsymmetrically worn specimen, presumably referable to one of the antero-lateral series of the upper jaw. The opposite face of the same specimen is shown in Pl. 3, Fig. 24.

- Fig. 22. *Ctenacanthus amblyxiphias* Cope. Atchison shales (Missourian); South Bend, Cass County, Nebraska. Left lateral aspect of fragmentary spine referable to the first dorsal fin.
- Fig. 23. *Ctenacanthus amblyxiphias* Cope. Atchison shales (Missourian); Louisville, Cass County, Nebraska. Left lateral aspect of fragmentary spine showing characteristic ornamentation.

The original of Fig. 12 is preserved in the Museum of Comparative Zoölogy at Cambridge, the remainder in the Museum of Nebraska State University at Lincoln.

### PLATE 3.

[All figures are of the natural size.]

- Fig. 24. *Janassa maxima*, sp. nov. Anterior (outer) coronal aspect of same specimen as shown in Pl. 2, Fig. 21.
- Fig. 25. *Peripristis semicircularis* (N. and W.) Summit of Chester limestone; Montgomery Switch, Caldwell County, Ky. Lateral aspect of upper tooth, the root partially imbedded in matrix.
- Fig. 26. *Fissodus inaequalis* (St. J. and Worth.) Lateral aspect of same specimen as shown in Pl. 2, Fig. 11.
- Fig. 27. *Petalodus alleghaniensis* Leidy. Posterior (inner) face of same specimen as shown in Pl. 2, Fig. 17.
- Fig. 28. *Homacanthus delicatulus*, sp. nov. Kinderhook limestone; Le Grand, Iowa. Spine referred to the first dorsal fin of a very small individual. An enlarged view of the same specimen is shown in Pl. 5, Fig. 59.
- Fig. 29. *Stethacanthus erectus*, sp. nov. Kinderhook limestone; Le Grand, Iowa. Left lateral aspect of fragmentary spine.
- Fig. 30. *Sagenodus cristatus*, sp. nov. Coal Measures; Mazon Creek, Grundy County, Illinois. Oral surface of dental plate.
- Fig. 31. *Elonichthys disjunctus*, sp. nov. Coal Measures; Mazon Creek, Grundy County, Illinois. Complete but somewhat distorted individual.

The originals of Figs. 25 and 28 are preserved in the Museum of Comparative Zoölogy at Cambridge; those of Figs. 24, 26, and 27, in the Museum of Nebraska State University; of Fig. 29 in the United States National Museum; and of Figs. 30 and 31 in the Museum of Yale University.

### PLATE 4.

- Figs. 32-34. *Chomatodus inconstans* Newb. and Worth. Keokuk limestone; Keokuk, Iowa. Coronal surface, anterior face, and transverse section of tooth,  $\times \frac{3}{2}$ .
- Figs. 35, 36. *Orodus intermedius*, sp. nov. Missourian; Weston, Platte County, Missouri. Anterior aspect and coronal surface of tooth,  $\times \frac{3}{2}$ .

- Fig. 37. *Deltodus contortus* (St. J. and Worth.). Lower Carboniferous limestone; Visé, Belgium. Posterior dental plate referred to the right ramus of the lower jaw, viewed from the postero-lateral margin,  $\times \frac{1}{2}$ .
- Fig. 38. *Deltodus occidentalis* Newb. and Worth. Keokuk limestone; Keokuk, Iowa. Posterior dental plate referred to the right ramus of the lower jaw,  $\times \frac{1}{2}$ .
- Fig. 39. *Phoebodus dens-neptuni*, sp. nov. Keokuk limestone; Keokuk, Iowa. Outer coronal face,  $\times \frac{1}{2}$ .
- Figs. 40, 40 a. *Phoebodus knightianus*, sp. nov. Florence Flint, Chase formation (Permo-Carboniferous); Blue Springs, Gage County, Nebraska. Lateral and anterior aspects of imperfect crown, showing prominent projection of the base in the median line in front,  $\times \frac{1}{2}$ .
- Fig. 41. *Deltodus spatulatus* Newb. and Worth. Keokuk limestone; Keokuk, Iowa. Posterior dental plate referred to the right ramus of the lower jaw.
- Fig. 42. *Deltodus spatulatus* Newb. and Worth. Burlington limestone; Burlington, Iowa. Posterior dental plate referred to the right ramus of the lower jaw,  $\times \frac{1}{2}$ .
- Fig. 43. *Deltodus contortus* (St. J. and Worth.). Coronal surface of same specimen as shown in Fig. 37,  $\times \frac{1}{2}$ .

The originals of Figs. 35-43 are preserved in the Museum of Comparative Zoölogy; the single tooth represented in Figs. 32-34 belongs to the United States National Museum.

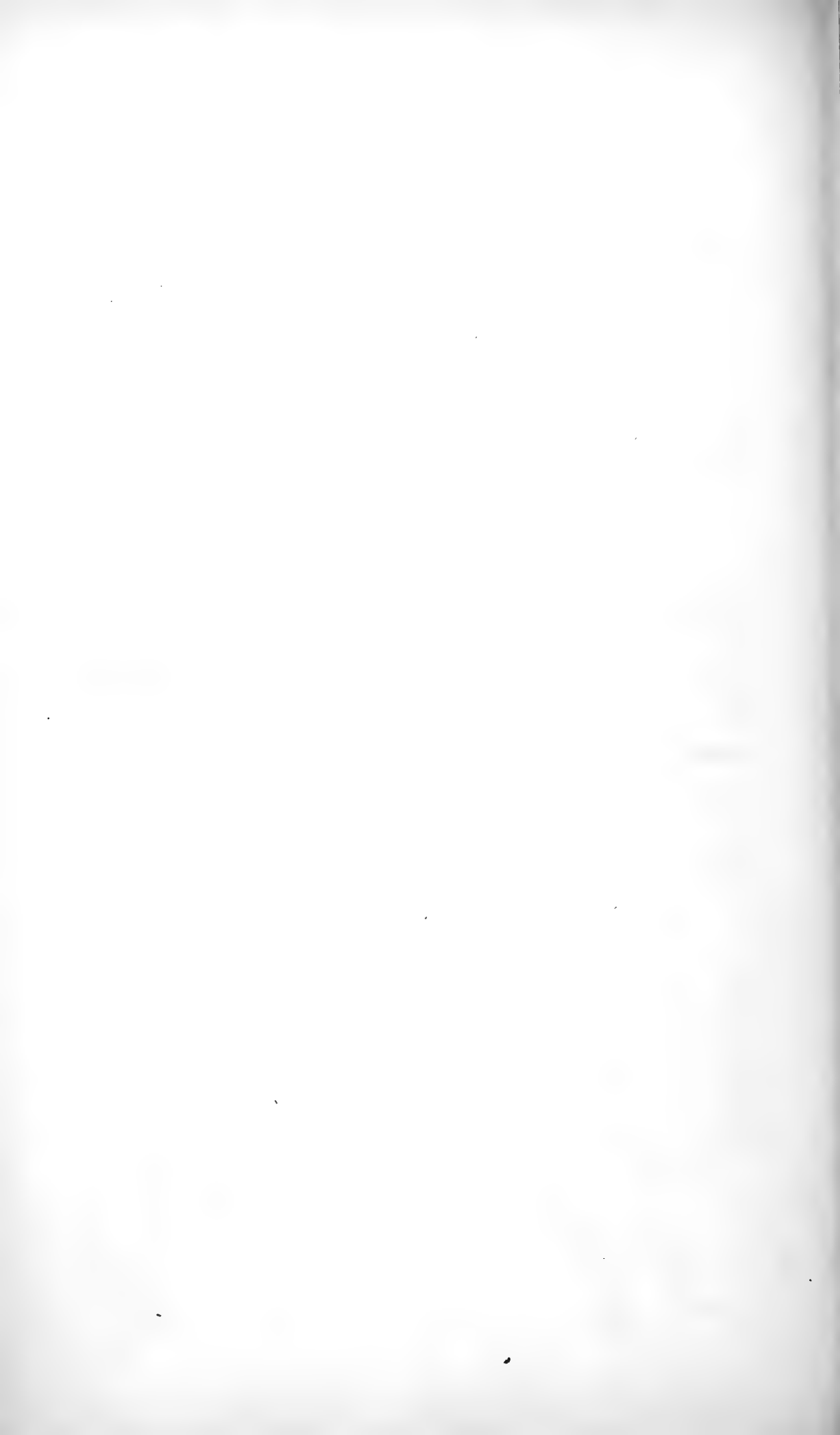
## PLATE 5.

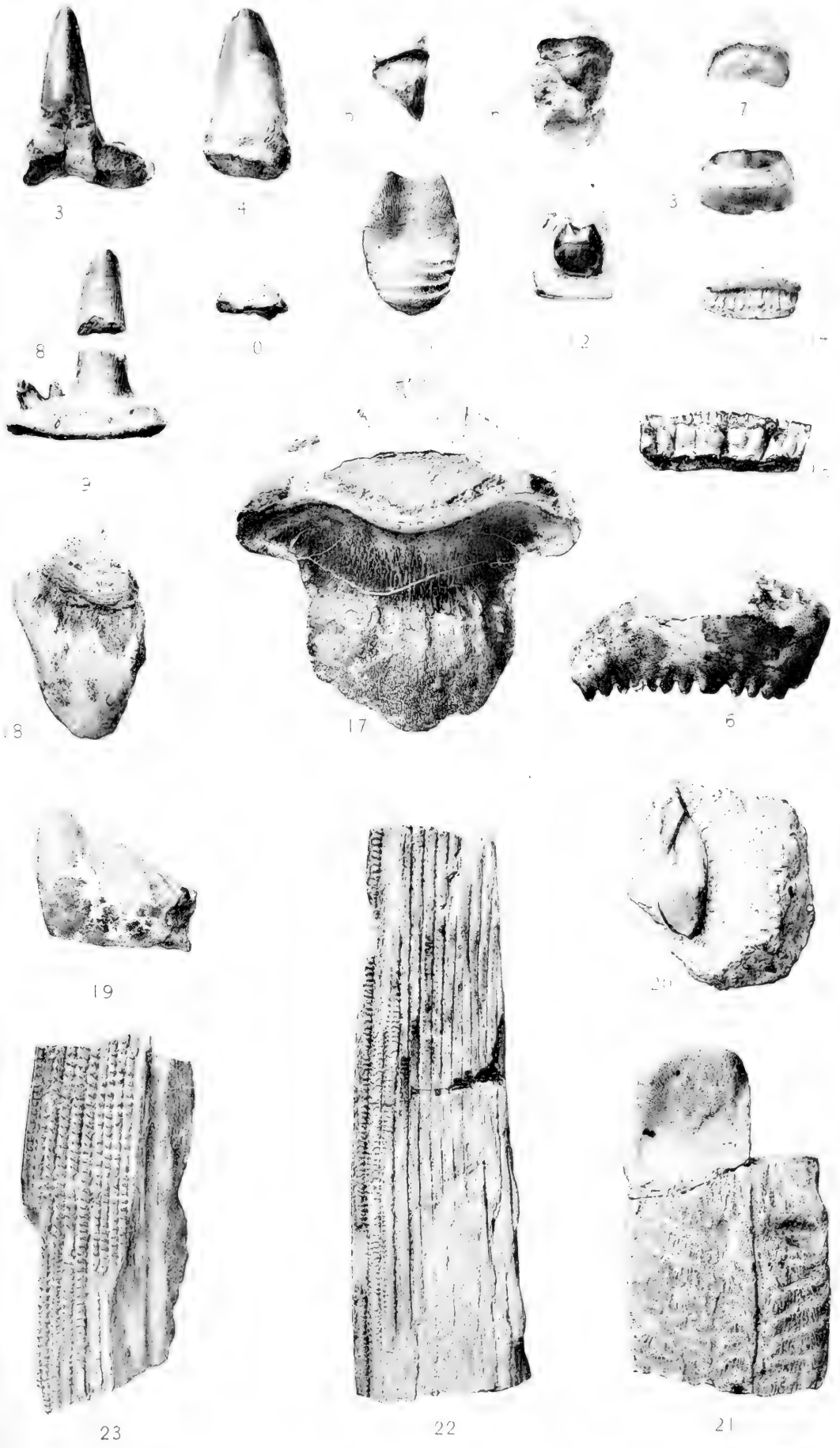
- Fig. 44. *Physonemus pandatus*, sp. nov. Kinderhook limestone; Burlington, Iowa. Lateral aspect of spine,  $\times \frac{1}{2}$ .
- Fig. 45. *Physonemus hamus-piscatorius*, sp. nov. Kinderhook limestone; Burlington, Iowa. Lateral aspect and cross-section of exerted portion of spine,  $\times \frac{1}{2}$ .
- Fig. 46. *Physonemus hamus-piscatorius*, sp. nov. Kinderhook limestone; Burlington, Iowa. Exerted portion of spine in lateral aspect, with rugose distal extremity, and a portion of the substance removed by fracture, exposing tubular pulp-cavity,  $\times \frac{1}{2}$ . A tooth of *Helodus biformis* N. and W. is imbedded in the same block of limestone in immediate juxtaposition to this spine.
- Fig. 47. *Erismacanthus barbatus*, sp. nov. Kinderhook limestone; Burlington, Iowa. Fragmentary spine with rudimentary anterior branches,  $\times \frac{1}{2}$ .
- Fig. 48. *Coelacanthus exiguus* Eastm. Coal Measures; Mazon Creek, Grundy County, Illinois. Complete individual of average size,  $\times \frac{1}{2}$ .
- Fig. 49. *Elonichthys perpennatus* Eastm. Coal Measures; Mazon Creek, Grundy County, Illinois. Complete fish, probably of a young individual, with downwardly flexed caudal fin, fine fulcra on the pectorals, and impressions of the axis showing through the delicate squamation,  $\times \frac{2}{3}$ .
- Fig. 50. Tuberculated dermal plate belonging to an undetermined Elasmobranch. Kinderhook limestone; Burlington, Iowa,  $\times \frac{1}{2}$ .

- Fig. 51. *Platysomus circularis* Newb. and Worth. Coal Measures; Mazon Creek, Grundy County, Illinois. Complete fish with well-preserved fins and squamation,  $\times \frac{5}{3}$ .
- Fig. 52. *Cheirodus orbicularis* (Newb. and Worth.). Coal Measures; Mazon Creek, Grundy County, Illinois. Complete fish with well-preserved fins and dorsal and ventral peaks,  $\times \frac{5}{3}$ .
- Fig. 53. *Deltodus occidentalis* Newb. and Worth. (var. *D. latior* Newb. and Worth.). Keokuk limestone; Keokuk, Iowa. Posterior dental plate referred to right ramus of the lower jaw.
- Figs. 54, 54 a, 54 b. *Helodus incisus*, sp. nov. Mississippian; Salem, Indiana. Supposed symphysial tooth corresponding to the form known as "*Helodus coxanus*" Newb. Seen in anterior, posterior, and lateral aspects,  $\times \frac{1}{2}$ .
- Fig. 55. *Deltodus spatulatus* Newb. and Worth. Burlington limestone; Burlington, Iowa. Anterior dental plate referred to the left ramus of the lower jaw, and described by Messrs. St. John and Worthen as a distinct species ("*D. convolutus*"),  $\times \frac{1}{2}$ .
- Fig. 56, 56 a. Tuberculated dermal plate of an undetermined Elasmobranch. Kinderhook limestone; Burlington, Iowa. The unsymmetrical cross-section near the base is shown in Fig. 56 a,  $\times \frac{1}{2}$ .
- Fig. 57. A spiniform dermal tubercle of the same nature as that shown in Fig. 56, the external surface much corroded and displaying the fibrous internal structure,  $\times \frac{1}{2}$ .
- Fig. 58. *Homacanthus acinaciformis*, sp. nov. Chemung Group; Warren, Pennsylvania. Lateral aspect of spine lacking inserted portion,  $\times \frac{1}{2}$ .
- Fig. 59. *Homacanthus delicatulus*, sp. nov. Kinderhook limestone; Le Grand, Iowa. The same spine as shown in Plate 3, Fig. 28, four times enlarged.

The originals of Figures 48, 51, and 52 are preserved in the Peabody Museum of Yale University; the remainder in the Museum of Comparative Zoölogy.

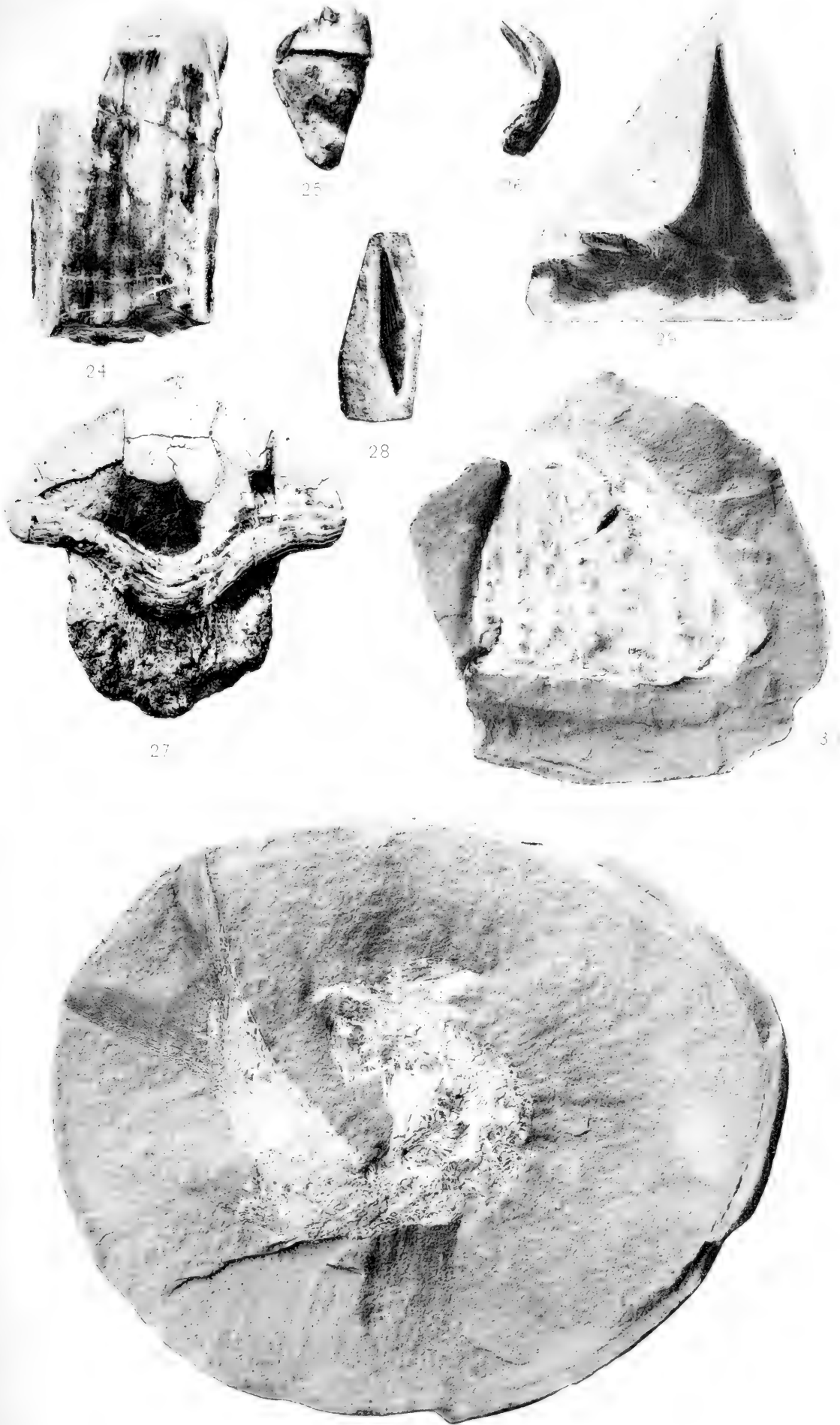


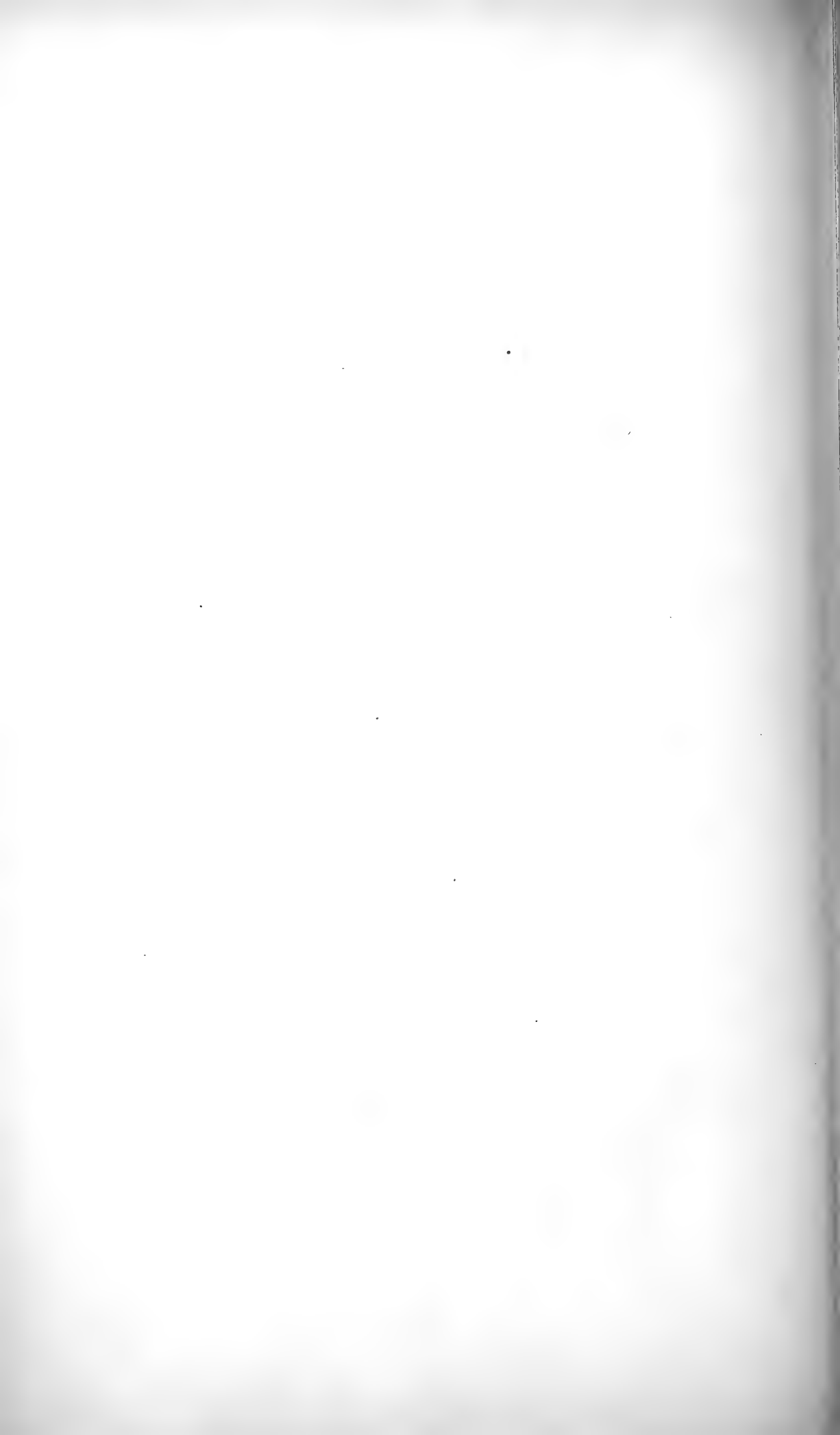






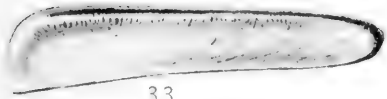




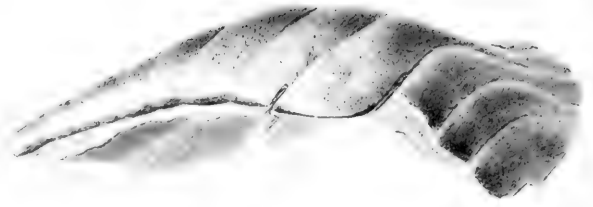




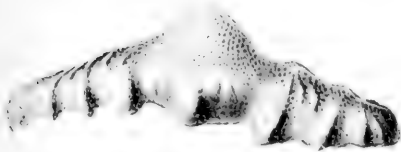
32



33



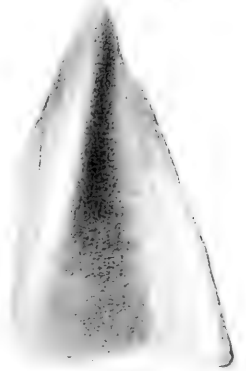
37



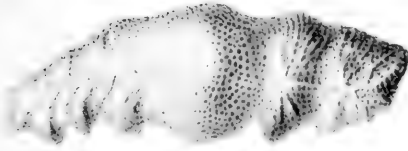
35



39



38



36



40

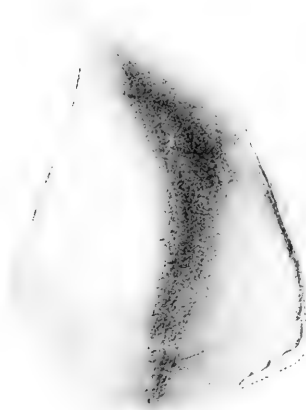
34



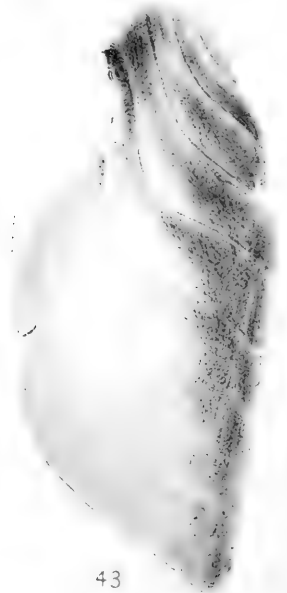
40a



41

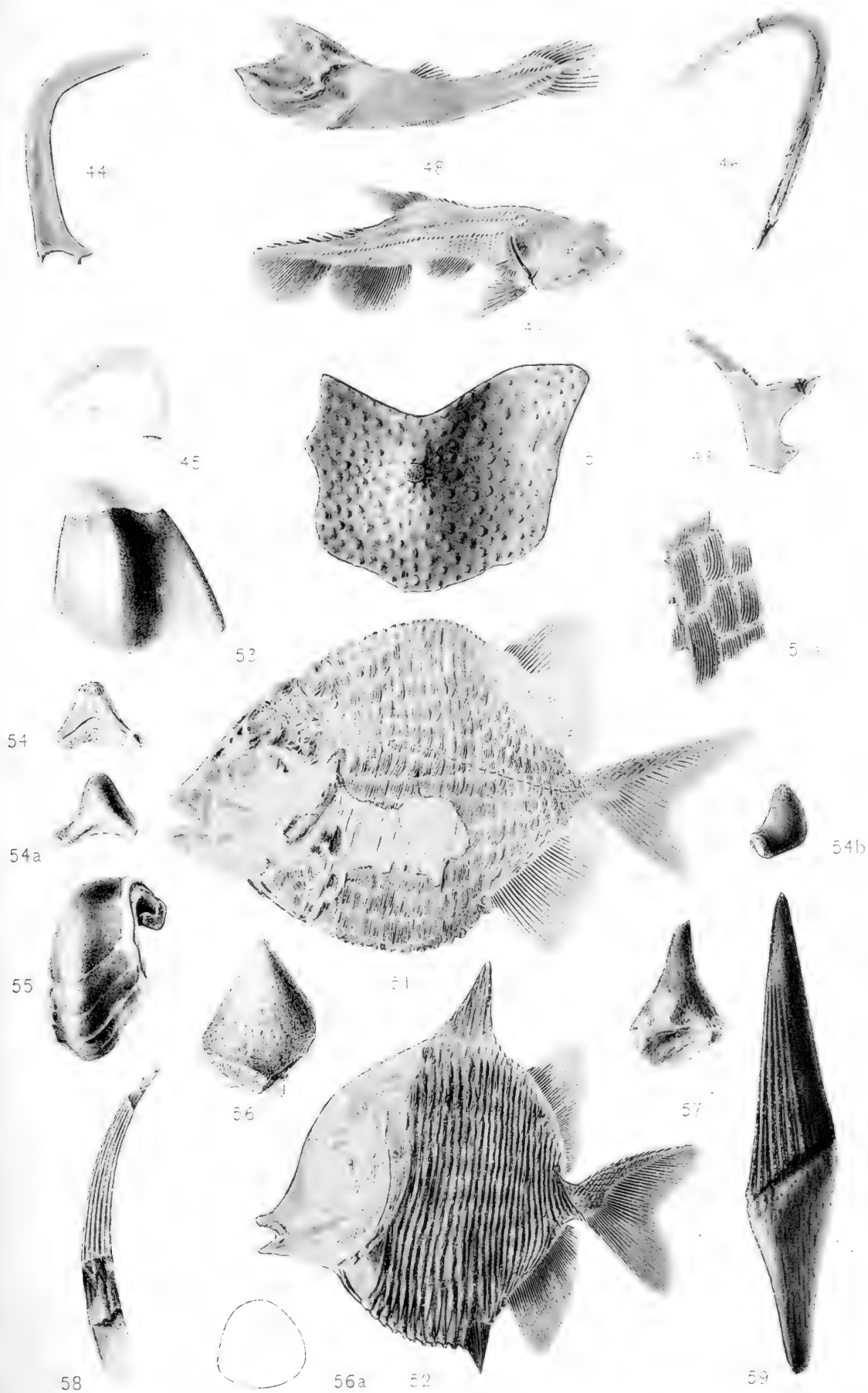


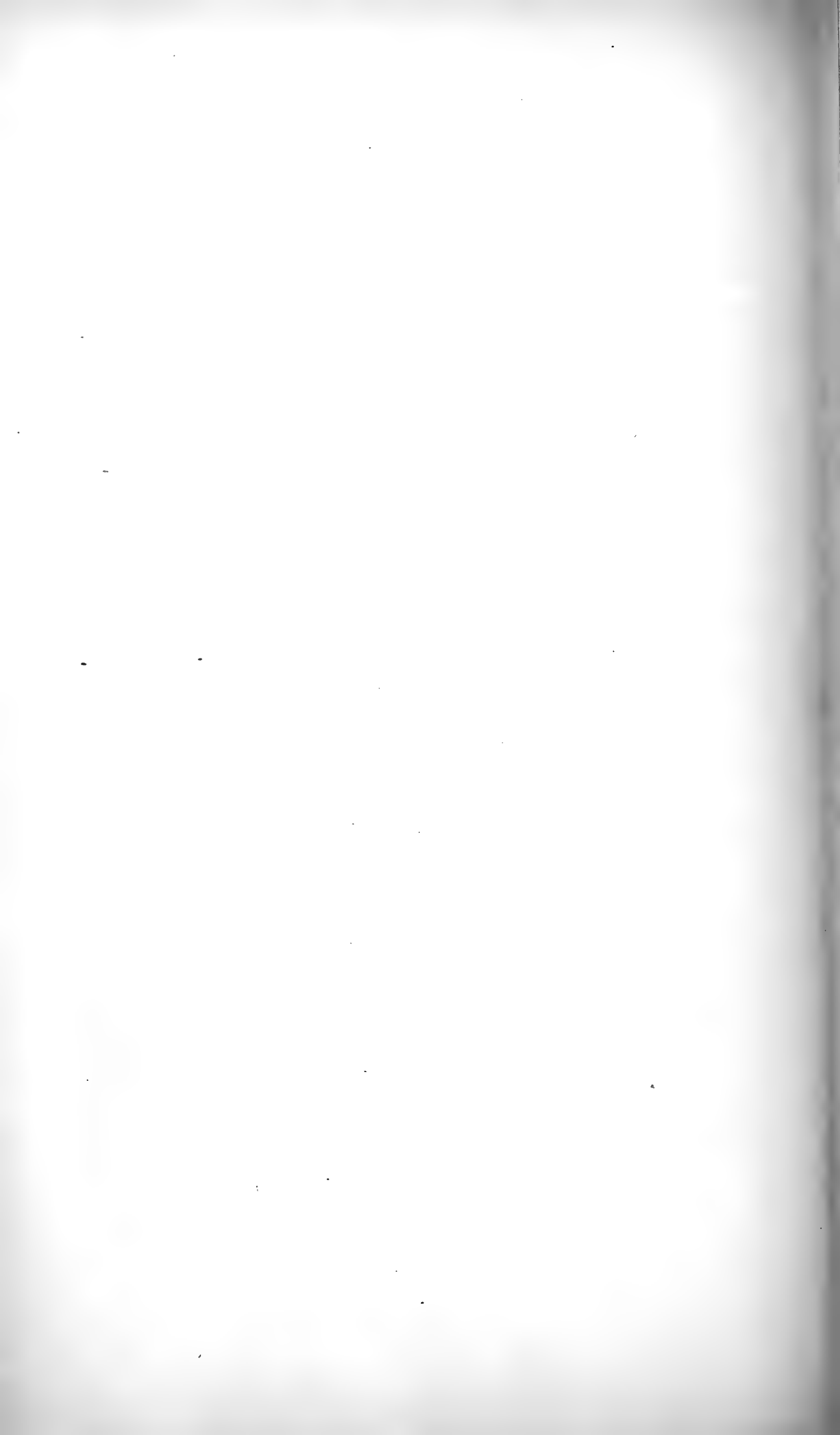
42



43







Bulletin of the Museum of Comparative Zoölogy  
AT HARVARD COLLEGE.  
VOL. XXXIX. No. 8.

---

SOME FISHES FROM AUSTRALASIA.

BY SAMUEL GARMAN.

WITH FIVE PLATES.

CAMBRIDGE, MASS., U. S. A. :  
PRINTED FOR THE MUSEUM.  
AUGUST, 1903.





No. 8. — *Some Fishes from Australasia.* By SAMUEL GARMAN.

THE notes and descriptions subjoined are based on specimens taken by Mr. Alexander Agassiz and members of his party on his recent expeditions to the Islands and Coral Reefs of Fiji and to the Great Barrier Reefs of Eastern Australia. Owing to the fact that no special attempts were made to collect fishes, the collection is not very large. Such individuals as came in the way while collecting invertebrates were preserved. Among them are some that belong to species ranging throughout Polynesia, to China and the Red Sea; there are others that probably have been identified with species tolerably well known on account of close affinities, but which, because of differences lost sight of under former arrangement, are now given descriptions and names, and still others that have escaped notice hitherto. Only species inhabiting the shoals around the islands or the reefs or the upper waters of the open sea are represented.

*Epinephelus merra* BLOCH.

D. 11 + 17; A. 3 + 9; V. 6; P. 16; Ll. 91.

Taken on the reef at Suva, Fiji Islands. The markings vary some from those of the published figure. Certain of the spots are darker than the others and their arrangement is such as to form transverse bands, of which one crosses the nape and descends to the operculum, another passes downward, including the second to the fifth spinous rays of the dorsal, across the flank, a third goes down from the hindmost three of the same spines and a fourth crosses from the middle rays of the soft portion of this fin to the anal. Three or four larger and blacker spots are to be seen on the basal portions of the pectoral rays.

*Apogon nubilus*, sp. nov.

Plate 1, Fig. 1.

Br. r. 7; D. 7 + 10; A. 2 + 8; V. 6; P. 12; Ll. 26; Ltr. 2 + 6.

Form short, stout, compressed; depth nearly one-third of total length. Head deep, short, in length equal to depth of body; crown depressed, nearly flat. Snout blunt, short, half as long as the eye. Eye large, two-sevenths as

long as head. Mouth large, rising obliquely forward; maxillary widened backward, bearing a low ridge, reaching below the middle of the eye. Teeth very small, in narrow villiform bands on the jaws, in a single doubly curved series on the vomer, and in groups of a few each on the ends of the palatines. The space between the dorsals is nearly equal to the length of the snout. The anterior dorsal spine is short, the second is not quite as long as the third, and the last is equal to the spine of the second dorsal, to the second spine of the anal, or to the length of the eye. Scales broad, minutely spinose on and near the hind margin, those of the lateral line with a rounded ridge and separated from the dorsals by the width of a single scale or from the vertebral line of the caudal pedicel by two scales. Caudal notch shallow, fin appearing truncate when spread.

Color brownish, head darker, darker on crown and back; with seven silvery bands across the flanks below the dorsals and a blackish spot on the lateral line about three scales from its end, forward from the bases of the caudal rays. A dark streak passes from below the middle of the eye backward and down to the hinder angle of the preoperculum.

Allied to *A. monochrous* of Bleeker, but readily distinguished by the markings. From *A. lineatus* of Schlegel it differs in the larger eye, shorter maxillary, the notch in the caudal, the shapes of the fins, and the caudal spot.

Taken at Suva, Fiji Islands.

#### *Apogon crassiceps*, sp. nov.

D. 6, 1 + 9; A. 2 + 9; V. 6; P. 13; Ll. 23; Ltr. 9.

To some extent the shape of this species resembles that of *A. nubilus*, but the lower jaw is shorter, the caudal region is longer, and the foremost portions of the fins are longer and more angular. The outline from the snout to the dorsal is slightly arched at the crown of the head. Head large, thick, equal in length to the depth of the body, little less than one-third of the total, convex on the occiput. Snout blunt, three-fourths as long as the eye. Eye large, more than one-third of the head. Mouth large, cleft rising forward, jaws about equally prominent, maxillary wider backward and reaching to or beyond a vertical from the hind margin of the eye. Teeth small, equal, in villiform bands on jaws, vomer, and palatines. A weak opercular spine. Space between dorsal fins short, one-third the length of the snout. First ray of spinous dorsal short, second ray stronger and longer than any of the other rays; hinder spines decreasing rapidly in length and strength. Spine of soft dorsal slender, three-fifths of the length of the first soft ray in dorsal or anal, one-third shorter than longest ray of first dorsal. As the lengths of the soft rays in anal and soft dorsal decrease rapidly backward, these fins have an angular appearance. Caudal notch deep, lobes rather sharp. Preopercle with a ridge near the finely serrated posterior margin. Scales large, ctenoid, about

twenty-three in a longitudinal and about nine in a transverse series; two rows above the lateral line.

Color whitish (in life reddish or yellowish), dark on the crown and along the back, with punctulations of dark along the middle of the side in the hinder half of the caudal region and on the outer extremity of the caudal fin; fins light.

From Suva Reef, Viti Levu, Fiji Islands.

### *Scorpaena erinacea*, sp. nov.

#### Plate 1, Fig. 2.

Br. r. 7; D. 13 + 9; A. 3 + 6; V. 6; P. 19; Ll. 43.

Body stout, depth equal length of head or two-sevenths of the total length, back subregularly and strongly curved from snout to end of dorsal fin. Cephalic ridges and spines strong and sharp; no depressed space on the crown; top of head covered by scales; orbital ridges high; interorbital space narrow, deep. Snout shorter than the eye, less than one-fourth of the head, blunt. Eye large, little less than one-third of the head. Mouth large; maxillary reaching to a vertical from the hind border of the orbit, hind margin strongly curved; lower jaw little longer. Anterior nostril tubular, inner edge with a broadened flap bearing numerous filaments. Prominent filaments appear at and behind the spines of the head and the dorsal fin. Scales of the lateral line with a ridge and a filament. Scales ctenoid, large on the body, smaller on the top and sides of the head. Pectorals about as long as the head, rays scaly on the basal half. Posterior edge of caudal very convex.

Color brown (reddish in life), mottled and blotched with darker; a dark blotch on the operculum; a transverse band, more or less completely divided into two, at the bases of the caudal rays; a similar band across the flank from soft dorsal to anal; a series of four to six spots at each side of the dorsum extends on the dorsal fin; caudal, anal, and dorsal with irregular narrow transverse bands or transverse series of spots or blotches of brown; pectorals and ventrals with numerous small spots of brown, basal portions dark; breast and belly spotted; flanks with numerous more or less indistinct and irregular spots and blotches. The spots on the fins are separated by areas of lighter ground color. There are less distinct indications of bands below and behind the eye and behind the operculum; these may be described as a narrow darker band from the interorbital space through the eye to the branchiostegal rays, another parallel with it at the hind edge of the orbit and a third passing in front of the dorsal to the base of the pectoral. There are several indistinct spots along the lower edge of the gill cover and some small spots of white on the lateral line.

Suva Reef, Viti Levu, Fiji Islands.

**Pterois zebra** C. V.

D. 12 + 9 ; A. 3 + 6 ; V. 6 ; P. 17 ; Ll. 50 ; Ltr. 8 + 20.

Of this specimen the dermal flaps and filaments are especially prominent. The flap at the inner side of each anterior nostril is long and pointed ; there are two barbel-like flaps, and a symphysial flap, above the edge of the intermaxillary ; below the orbit above the angle of the mouth above the maxillary there is a broad leaf-like flap ; at the lower edge of the preopercle there are two broad fan-shaped narrow based ones ; and above the orbit on each side there is a prominent flap with fringes.

Suva, Fiji Islands.

**Synanceia verrucosa** BL. SCHN.

On a large and apparently very old specimen of this species taken at Thuvu, Fiji Islands, the extremities of the rays on the pectoral, ventral, and anal fins are encased in hardened callosities. The skin is thick and so rough and warty over body and fins, and the coloration is such, that the fish bears a close resemblance to a piece of coral rock.

**Caranx parasitus**, sp. nov.<sup>1</sup>

Br. r. 7 ; D. 8 + 23-24 ; A. 2 + 20 ; Ll. 43 (on the straight portion).

Several individuals of this *Caranx* at Cairns, Barrier Reef, Australia, "from among the tentacles of Rhizostome Medusa, *Crambessa mosaica* Haeck." In shape they approach *C. hippos*. The lower outline is rather more arched than the upper. Height of body equal length of head, or two-sevenths of the total length. Eye large, near one-third of the head. Teeth on the jaws in a single series. Lateral line strongly curved anteriorly, straight from below the fifth ray of the soft dorsal, keeled plates rather small.

Body and head yellow ; back and top of head tinted with olive ; chest and lower part of abdomen white ; a large black opercular spot ; anterior dorsal blackish ; margin of second dorsal and margins and ends of caudal black.

From the formulae this species appears closely allied to *Caranx calla* C. V. It differs in coloration.

**Caranx regularis**, sp. nov.

Br. r. 7 ; D. 8 + 23 ; A. 2 + 20 ; P. 21 ; Ll. 35 (in the straight portion).

The upper outline of this species differs little from the lower in curvature. The body is greatly compressed, the depth being more than one-third of the total length. Head as deep as long, one-fourth of the total ; snout longer than

<sup>1</sup> Recorded as *Trichiurus declivis* Jenyns, Bull. Mus. Comp. Zoöl., XXXII., p. 18.

the eye, blunt; mouth medium, maxillary hardly reaching a vertical from the front border of the orbit; teeth small in narrow bands on jaws and vomer and in a single series on the palatines; eye large, one-fourth of the head. The curve of the lateral line is moderately strong and regular until it reaches the straight portion, near a vertical from the sixth ray of the second dorsal; there are thirty-seven broad, sharply keeled plates in the posterior section. Fins of medium size; longest ray of either spinous dorsal, soft dorsal or anal less than twice the orbital length; excepting half a dozen of the anterior soft ones, the rays of dorsals and anal are short. Breast naked.

Color olivaceous to grayish yellow on the back, lighter below; back crossed by five broad vertical bands of black, descending to about the middle of the flank, the posterior one of which continues back on the top of the caudal pedicel to a dark area on the bases of the caudal rays. The first band crosses the spinous dorsal, which is black; the second passes through the space between the two dorsals; the third lies below the highest portion of the second dorsal, and the fourth and fifth lie below the short rays of the same fin. The fins, except the first dorsal, are light colored with dusky margins. There is a small and comparatively faint spot at the upper angle of the operculum. No band through the eye.

Captured at Suva, Fiji Islands.

#### *Percis tetracanthus* LA C.

Br. r. 6; D. 3 + 20; A. 17; V. 5; P. 18; Ll. 63; Ltr. 8 + 14.

The orbits are black; there is a large spot of black below the base of each pectoral and a black spot in the anterior part of the lower half of the caudal.

Suva Reef, Fiji Islands.

#### *Gobius atriclypeus*, sp. nov.

Plate 2, Fig. 1.

D. 6 + 12; A. 12; Ll. 25; Ltr. 10.

Body compressed, elongate, depth one-seventh and caudal fin near two-sevenths of the total length. Head about one-fifth of the total; interorbital space very narrow. Snout short, two-thirds as long as the eye, pointed as seen from the side, subtruncate as seen from above. Mouth wide, oblique, rising steeply forward; maxillary subtending anterior one-third of eye. Teeth small, in bands, with one or two canines at each side above and below. Eyes large, more than one-third of the head, prominent, very close together on the top of the head, longer than the snout. Occiput covered with scales, to the ridges behind the orbits. Scales large, ctenoid with minute teeth. Fin rays flexible, elongate. First dorsal spine above the axil of the pectoral; depth of first dorsal less than that of the body; height of second dorsal greater than

that of the first. Caudal long pointed, ending in a filament. Anal origin below that of soft dorsal. Pectorals long, ending in a filament above the fourth or fifth ray of the anal.

Color light brownish, fins darker; ventrals black; a series of small spots of brown along the middle of the flank from the cheek to a black spot on the bases of the caudal rays.

Secured in the Bay of Moala, Fiji Islands, on the east side, in twenty-five fathoms depth.

*Gobius waitii*, sp. nov.

Plate 3, Fig. 3.

D. 6 + 10; A. 10; Ll. 27; Ltr. 10.

Body short and thick, depth nearly one-fourth of the total length. Head short and broad, five-seventeenths of the total length. Snout short, little longer than the eye. Mouth medium, nearly vertical; canine teeth rather small. Eye one-fourth as long as the head. Bases of dorsal fins united by membranes. Caudal of moderate length, pointed. Ventrals short, disk broader than long, subcircular. Scales large and ctenoid on the body, hidden on the head by dermal growths that give the appearance of being roughened by short sharp points or flaps of skin.

Color yellowish, slightly browned toward the back, lighter below head and abdomen and near the edges of the fins. Caudal apparently with an edging of dark. No spots or bands.

From Cairns, Great Barrier Reef, Australia.

Specific name given in honor of the Australian ichthyologist, Edgar R. Waite, F. L. S.

*Gobiodon atrangulatus*, sp. nov.

Plate 2, Fig. 2.

D. 7 + 11; A. 10; P. 19.

Body much compressed, deeper anteriorly, tapering backward; width two-fifths of the depth; depth more than one-third of the total length. Head three-fifths as long as deep, narrow above the orbits, swollen on the cheeks, strongly arched from mouth to nape. Snout short, blunt, rounded, as long as the orbit. Eye less than one-fourth of the length of the head. Nostrils with raised margins. Gill openings as wide as the bases of the pectorals and situated immediately in front of them. Dorsal origin above the base of the pectoral. First dorsal short, little if any more than half as high as the second; second larger and higher than the first, from which it is not separated, angles rounded or blunt. Anal rounded, deeper than first dorsal. Caudal deep, hind margin convex. Pectorals broad, subround. Ventrals twice as long as the eye.

Color brownish, probably light red or yellow in life. The only spot or

mark appears to be a small black one on the upper angle of the gill cover. This spot resembles that in the same position on *G. citrinus* and may indicate kinship, but there are no traces of the characteristic vertical streaks of that species, and the dorsals are not separated.

Found off Nairai, Fiji Islands.

*Gobioides totoyensis*, sp. nov.

Plate 3, Figs. 1 and 2.

Br. r. 4; D. 6 + 45; A. 45; V. 5; P. 7 + 6.

Body compressed, depth one-eighth and body cavity one-third of the total length. A fold below the abdomen behind the ventrals, somewhat like the tropic fold in certain sharks. Head short, about one-sixth of the entire length, narrow above, apparently with a swollen tract or cushion on the forehead, from occiput to mouth. Snout short, upper jaws shorter, lower jaws stronger, chin protruding. Mouth medium, cleft rising obliquely forward; maxillary reaching to a point below the eye; lips thick; teeth small, in villiform bands, a very small canine at each side above and below. Eyes minute. No barbels. Gill openings wider than the bases of the pectorals, upper angle of each opening forward of the middle of the base of the fin. Dorsal, anal, and caudal continuous; the skin enveloping them not especially thick. Anterior dorsal spine above the mid-length of the pectoral fin; first six rays of the fin lower and closer together than the following rays, but not separated from the balance of the fin by a space. Caudal elongate, one-seventh of the total, pointed, united by membrane with dorsal and anal. Anal origin below the eleventh ray of the dorsal. Ventrals short, longer than the pectorals, subtruncate, parallel, close together, with inner edges joined together and to the body, appearing externally as if containing but four rays each. Pectorals not extending as far backward as the ventrals, twice as wide as long, with protruding rays, in two sections of which the lower—six rays—is truncate, and the upper, of eight or nine rays, is longer and pointed. Lateral line distinct on the head, in a median tube anteriorly on the flank and backward to the scaly portion, below the thirty-fifth ray of the dorsal, where in a series of larger scales it has the ordinary appearance on bony fishes. Scales cycloid, appearing to be absent from the anterior three-fifths of the body; backward they are comparatively large.

Color uniform brownish white, probably yellowish or flesh color in life.

Taken in Totoya, Fiji Islands, outside of Kini-kini and inside of thirty fathoms depth.

*Periophthalmus schlosseri* PALL.; BL. SCHN.

D. 8 + 13; A. 11.

The descriptions of *P. schlosseri* do not mention several transverse bands which cross the back, passing down and obliquely forward on the flanks of

these specimens. The first dorsal is dark brown and has a light edging. Second dorsal, pectorals, and caudal have transverse series of small elongate spots of brown. The ventral disk is similar to that figured by Pallas on his type, from Amboyna. On immature specimens of an inch and a quarter in length the disk is as perfect as on the large ones.

Suva, Fiji Islands; Keppel Bay, Australia.

**Periophthalmus koelreuteri** PALL. ; C. V.

D. 7-13 + 12-13 ; A. 12-13 ; Ll. 64-78 ; Ltr. 18.

The fishes placed here were captured on the Great Barrier Reef, Australia. Apparently of a single species, they exhibit a wide range in variation. The rays in the first dorsal number seven in the smallest individuals, and eight, nine, ten, and fourteen on larger ones. The largest have a black band in the upper half of the same fin; it is represented by a black spot on the hinder rays in the smallest of the lot. There are seven or eight scales between the dorsals on the larger and nearly twice as many on the smallest specimens. Commonly there are seven or eight bands of brown separated by spaces of lighter color about equal in width, crossing the back and passing down and forward on the flank. The ventrals are separate at all ages.

**Blennius canescens**, sp. nov.

**Plate 4, Fig. 1.**

D. 10 + 16; A. 17; V. 2; P. 15.

Outlines in some degree resembling those of *B. maoricus* Kner, 1867, but the head is more pointed and less convex in the frontal region, and the filament above the orbits is shaped differently. Body compressed, robust, depth equal to length of head and contained three and two-thirds times in the length without the caudal. Head short, blunt-pointed at the snout, with a low arch above the orbits. Snout short, half as long as the eye. Mouth medium, cleft rising slightly forward, maxillary reaching below the anterior one-fourth of the eye. A canine on each of the lower jaws and two smaller ones near the symphysis on each upper jaw. Eye large, less than three times in the length of the head. A short slender filament above each eye (not shown in figure); no filament and no crest on the nape; a short nasal filament on each side. Dorsal notched, spinous portion originating above the base of the pectoral; rays in spinous portion shorter. Pectorals broad, rounded on hind margin. Caudal slightly notched, little shorter than the head. Lateral line extending to a point below the first spine of the second dorsal.

Color uniform light brownish, white or yellow; a brown band across the occiput from eye to eye; a brown spot above the orbits.

From the eastern entrance of Mbengha Passage, Fiji Islands.



**Petroscirtes obliquus**, sp. nov.

Plate 4, Fig. 3.

D. 12 + 19 ; A. 22 ; V. 2 ; P. 13.

Moderately elongate, compressed, depth nearly one-sixth and length of head nearly one-fifth of the total length. Head deeper than wide ; cheeks swollen ; crown rising somewhat high on the interorbital space longitudinally and rather flattened transversely ; without either crest or filaments. Snout rounded, blunt, half as long as the eye. Margins of nostrils prominent. Mouth comparatively narrow, maxillary reaching little below the forward part of the orbit. Teeth strong, fixed, in a single series, with very strong canines behind each series ; those of the lower jaws a little stronger than those of the upper series. Eye large, one-third as long as the head, very prominent above the forehead. Gill openings small, above the bases of the pectorals. Rays of soft dorsal longer than the spinous rays. First dorsal ray above the gill opening. First ray of the anal below the eleventh ray of the dorsal. Caudal subtruncate, free from dorsal and anal. Pectorals medium, pointed, lower rays averaging longer than the upper. Ventrals slender, of two rays which are separate for half their length, inner ray one-third longer than the outer. Lateral line marked by three or four pores, the hindmost of which is below the third ray of the dorsal.

Color light olivaceous brown ; a black spot behind the eye and several transverse bands on the lower half of the head ; a series of bars of brown on the flanks, the anterior of which incline forward, the posterior, backward ; a couple of spots at the base of the tail ; a series of small spots near the bases of the dorsal ; first dorsal clouded or spotted ; anal fin with spots along its base and with a darker margin ; ventrals, white ; pectorals, dusky ; abdominal cavity showing dark through its walls.

Locality, Suva, Fiji Islands.

**Salarias sertatus**, sp. nov.

Plate 4, Fig. 2.

D. 15 + 23 ; A. 2 + 27 ; V. 3 (4) ; P. 14.

The outlines of body and fins have a remote resemblance to those of *S. periophthalmus* ; the most prominent differences appear in the length of the caudal, in the depth of the notch between the dorsals, and in the frontal filaments. Body elongate, slender, depth or length of head one-seventh of the total length. Head short, as wide as deep, very blunt, nearly vertical in front of the eyes. A low crest on the nape. Eyes large, prominent, one-fourth as long as the head. Mouth wide, inferior. Teeth very numerous, small, movable, in single series ; no canines. Gill membranes continuous and free across

the throat, extending higher than the bases of the pectorals. A short, flattened, fringed postorbital tentacle ; no other filaments. Dorsal origin above bases of pectorals ; dorsal notch very shallow ; extremities of rays protruding beyond the membrane. Anal origin below the tenth ray of the dorsal, rays of the fin exerted ; the membranes descend from ray to ray, forming a serrated margin. Pectorals broad, nearly straight on the upper border, convex on the hinder edge, broadly rounded on the lower margin. Caudal one-fifth of the total length, medium rays longest, separated from dorsal and anal. The rays protrude on all the fins.

Color uniform dark olivaceous, lighter on the belly, anal, ventrals, and pectorals ; each of the fins except the caudal with a whitish edge. Very young with more of light color on lower surfaces and fins.

Found "hopping about on the rocks above high tide" on Solo Island, North Astrolabe Reef, Fiji Islands.

•            ***Salarias fasciatus*** BL.; C. V.

D. 12 + 17; A. 21; V. 2 (3); P. 14.

In all likelihood this fish belongs to Bloch's species, though the figure given by that author neglects the fringed filaments on the nape, the nasal filaments, and the short barbel below each angle of the mouth. The bands on our fish are less numerous and extend but halfway up on the dorsal ; thence they are broken into small spots.

Near Suva, Fiji Islands.

***Dascyllus aruanus*** LINN.; C. V.

D. 12 + 12; A. 12; V. 6; P. 16; Ll. 25; Ltr. 3 + 10.

Suva, Fiji Islands.

***Glyphidodon uniocellatus*** Q. G.

D. 13 + 13; A. 2 + 12; V. 6; P. 18; Ll. 26 (17 pores); Ltr. 2 + 9.

Suva, Fiji Islands.

***Hemirhamphus laticeps*** GÜNT.

D. 15; A. 15.

On the middle of the flank of very young specimens of this fish there is a longitudinal streak of brown, becoming wider and more noticeable from the ventrals to the base of the caudal. Another streak of brown extends along the median line of the ventral surface. On the middle of the back there is a vertebral line of very small dots with a line of similar dots immediately

at each side of it, and at each side of the three there is a line of much larger dots. The beak is black and the black extends back on each side of the head to below the eye. The upper jaw and the orbits are black. The crown is dotted and punctulate with black.

Suva, Fiji Islands.

*Zenarchopterus maculosus*, sp. nov.

Plate 5, Fig. 4.

D. 11 ; A. 10 ; Ll. 44 ; Ltr. 8.

Length of head two and two-fifths times in the total length, or two and one-sixth times in the length to the caudal. Length of lower jaws, forward of intermaxillary, one-fourth of the total without the caudal. Intermaxillaries as wide as the eye, wider than long, rounded in front. A tubular nostril. Eye large, one-eighth of the entire head, little less than supraorbital width, equal width of upper jaws. Beak with a dermal expansion below and a prolongation at the tip. Dorsal in the hindmost one-fourth of the total length; first ray forward of that of the anal; base less than two-thirds as long as the head. Base of anal little more than half the length of that of the dorsal; first ray of the fin below second ray of dorsal. First ray of ventral at hindmost one-third of the total; fin not reaching the anal. Bases of ventrals little nearer to bases of pectorals than to base of caudal. Caudal rounded.

Black of jaws extending on the side of the face to below the eye. A broad band of blackish from opercle to base of caudal on the middle of the flank, inferiorly fading to round spots in each of which there is a central dot of light color, white or bluish. Back and belly lighter, dotted with brown. Dorsal blackish toward its margins.

Suva, Fiji Islands.

*Gymnothorax nebulosus* AHL; BL. SCHN.

Suva Reef, Fiji Islands.

*Gymnothorax pictus* AHL; BL. SCHN.

Suva Reef; Nukulau Island, Fiji Islands.

*Syngnathus conspicillatus* JEN.

Plate 5, Fig. 2.

Three miles south of Suva lightship.

*Ichthyocampus* sp.

Plate 5, Fig. 3.

Six miles east of Suva.

*Balistes aculeatus* LINN.

Suva Reef, Fiji Islands.

*Alutera armata*, sp. nov.

Plate 5, Fig. 1.

D. 2 + 44; A. 46; P. 14; C. 14.

Elongate, slender, much compressed, deep in front of dorsal and anal; greatest depth equal length of caudal, little less than one-third of the total length. Length of head hardly one-fourth of the total. Snout blunt, slightly concave in upper outline as seen from the side, two and one-third times as long as the eye. Eye large, three and one-half times in the head. Gill opening as wide as the eye, oblique, below the orbit, above the base of the pectoral. Lower edge of breast and belly thin, blade-like, very convex. Squamation villiform. Both dorsal spines above the orbit; anterior strong, long, more than twice the length of the eye, with four series of sharp hooks directed toward the base, the anterior two of which are close together; second spine very small, close to the first. Second dorsal and anal opposed, latter originating by several rays farther forward. Caudal pedicel slender; fin long, pencil-shaped, wide. Pelvic bone rather rigid; pelvic spine continuous with the bone, immovable. Pectorals small, broad, and short, as long as the eye, longer in their upper halves.

Light yellowish or olivaceous brown, darker on head and back; with transverse blotches of brown on forehead, first spine, and back; with irregular subvertical series of brown blotches on flanks and tail, arranged in pairs, the first pair being below the space between first dorsal and second, the second pair below the anterior twelve or fourteen rays of the soft dorsal, and the third farther back toward the end of the fin, while the fourth is on the caudal pedicel. The spots on the caudal are comparatively large; the tip of the fin is dark.

Suva, Fiji Islands.

## EXPLANATION OF PLATES.

---

  
PLATE 1.

- Fig. 1. *Apogon nubilus*, sp. nov.  
Fig. 2. *Scorpaena erinacea*, sp. nov.

## PLATE 2.

- Fig. 1. *Gobius atriclypeus*, sp. nov.  
Fig. 2. *Gobiodon atrangulatus*, sp. nov.

## PLATE 3.

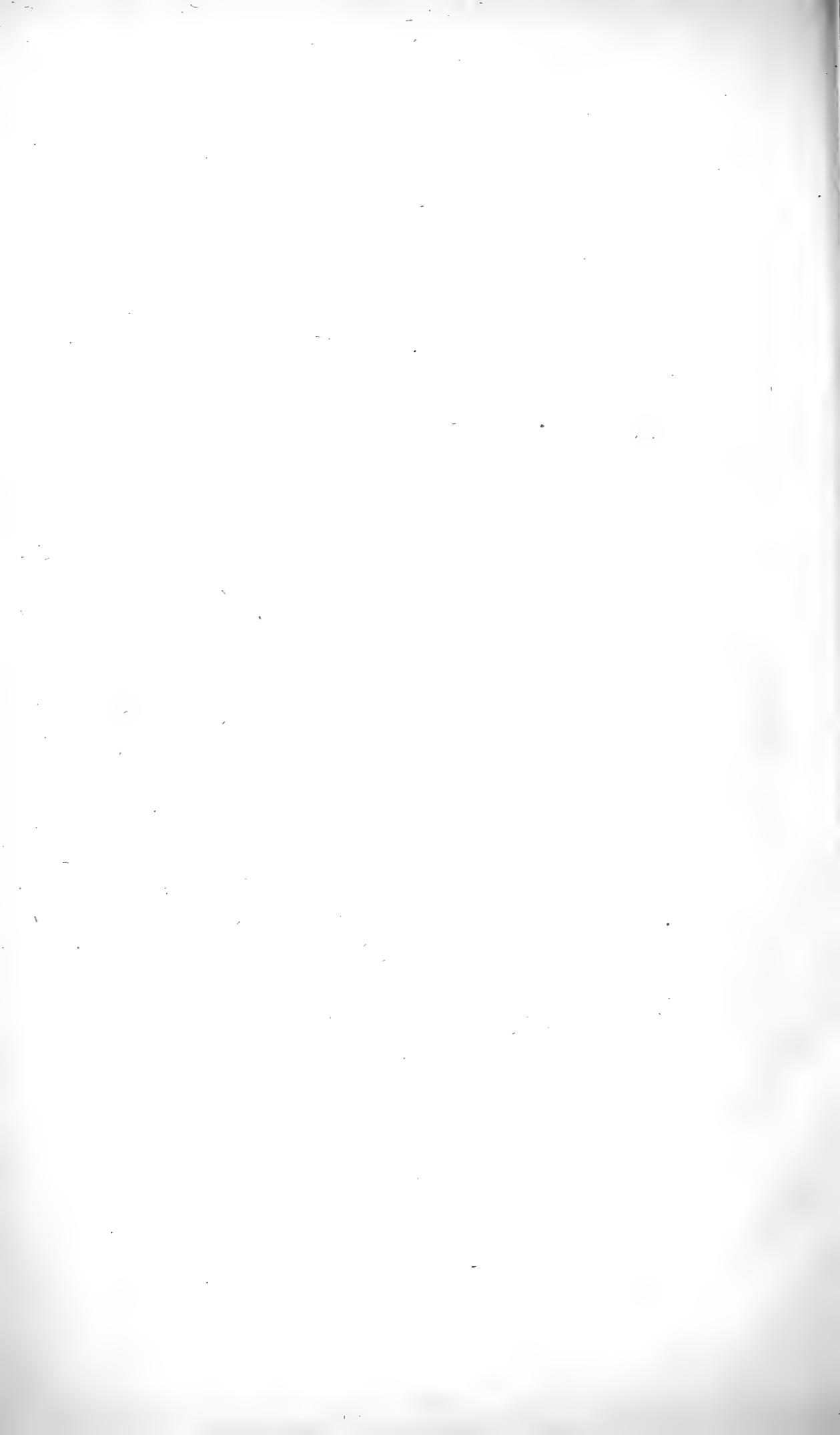
- Fig. 1. *Gobioides totoyensis*, sp. nov.  
Fig. 2. *G. totoyensis*, lower surface.  
Fig. 3. *Gobius waitii*, sp. nov.

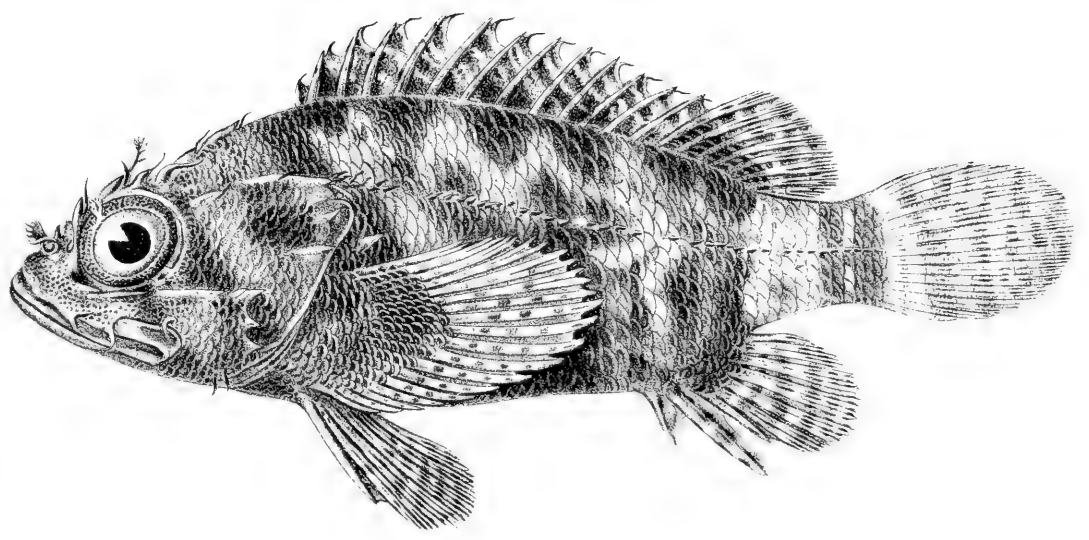
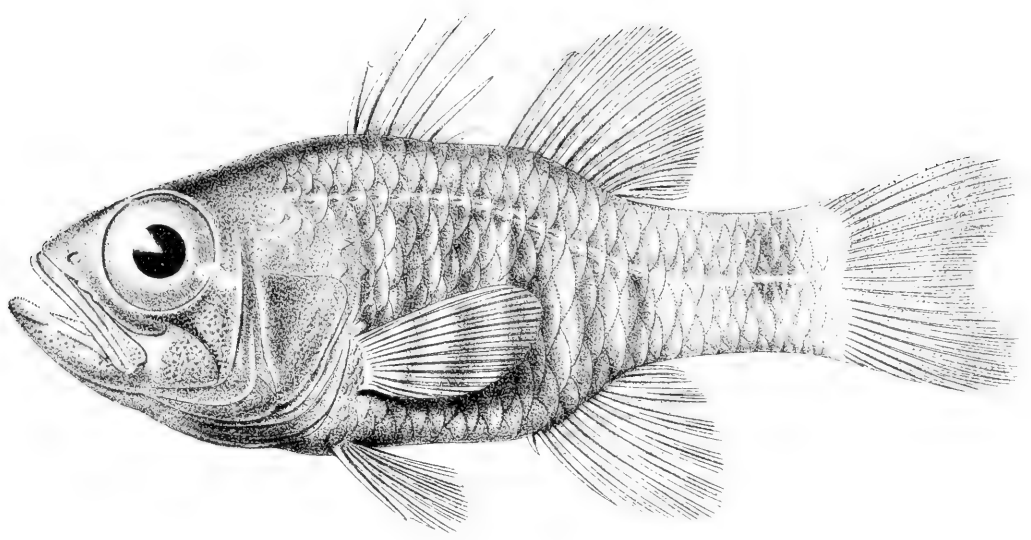
## PLATE 4.

- Fig. 1. *Blennius canescens*, sp. nov.  
Fig. 2. *Salarias sertatus*, sp. nov.  
Fig. 3. *Petroscirtes obliquus*, sp. nov.

## PLATE 5.

- Fig. 1. *Alutera armata*, sp. nov.  
Fig. 2. *Syngnathus conspicillatus* Jen.  
Fig. 3. *Ichthyocampus* sp.  
Fig. 4. *Zenarchopterus maculosus*, sp. nov.





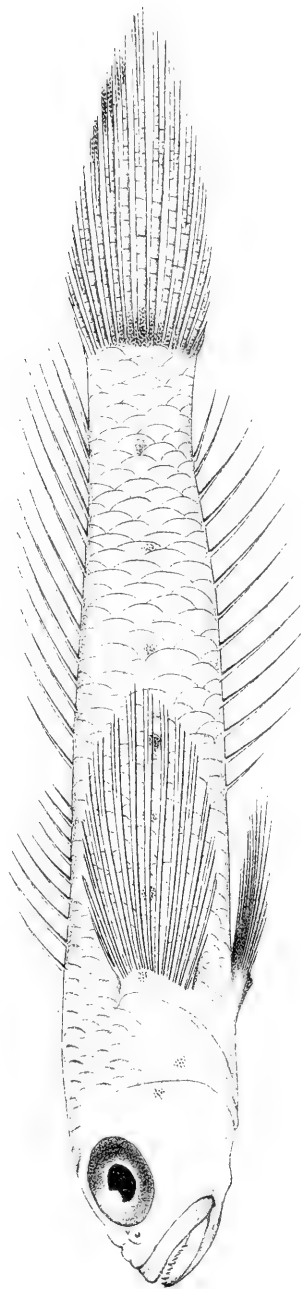
2

2

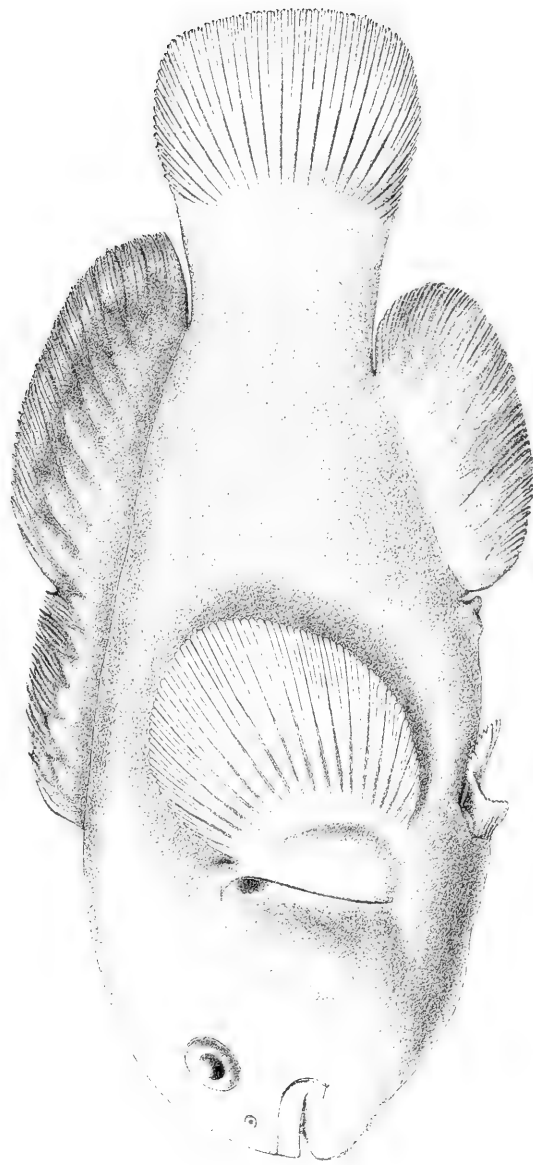


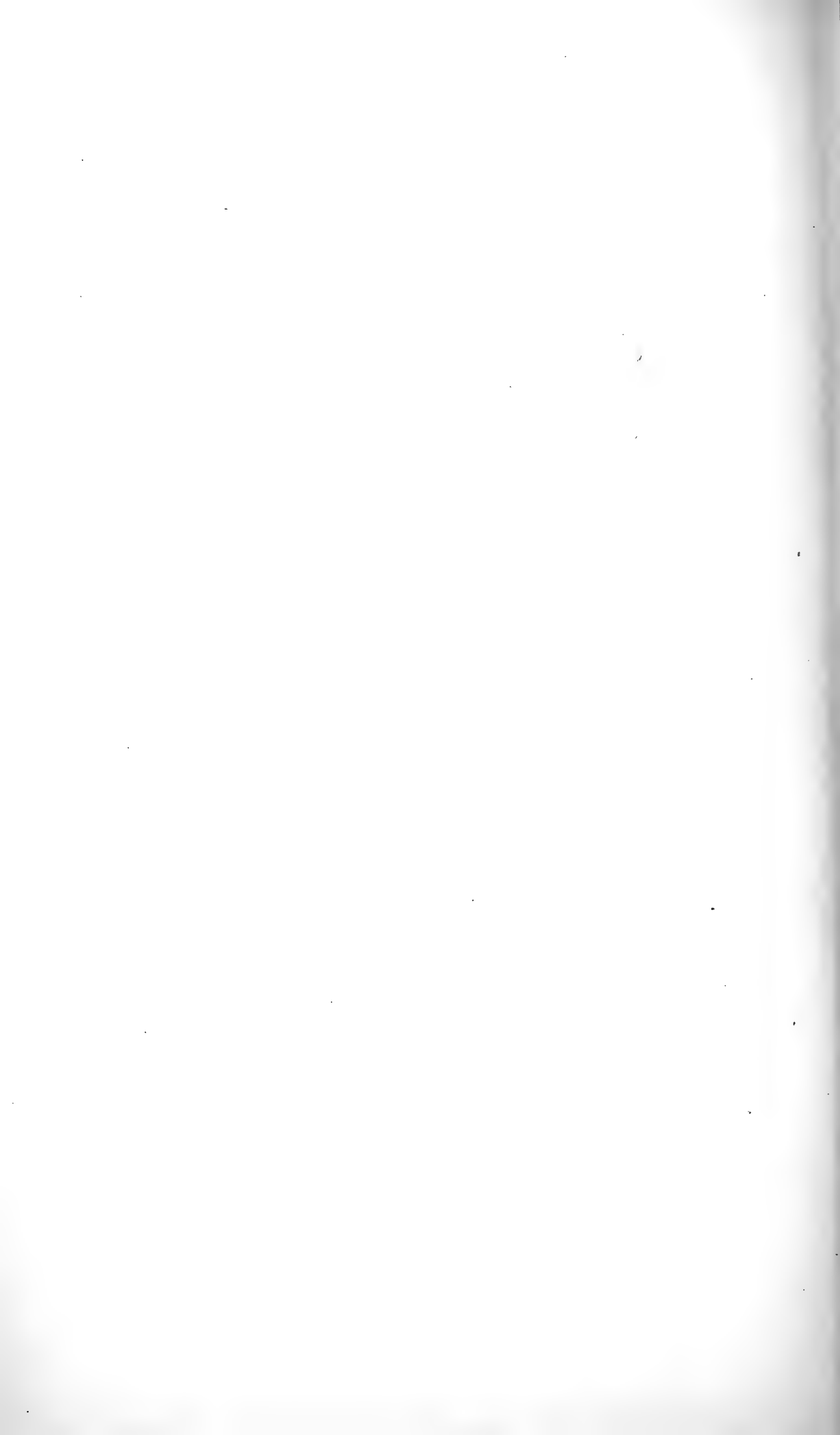


1



2

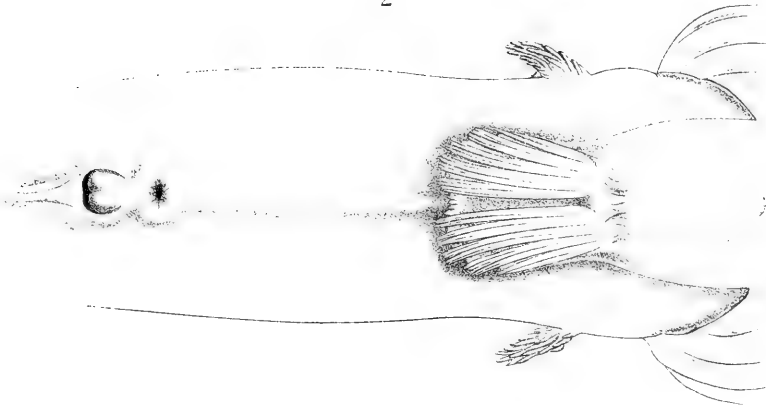




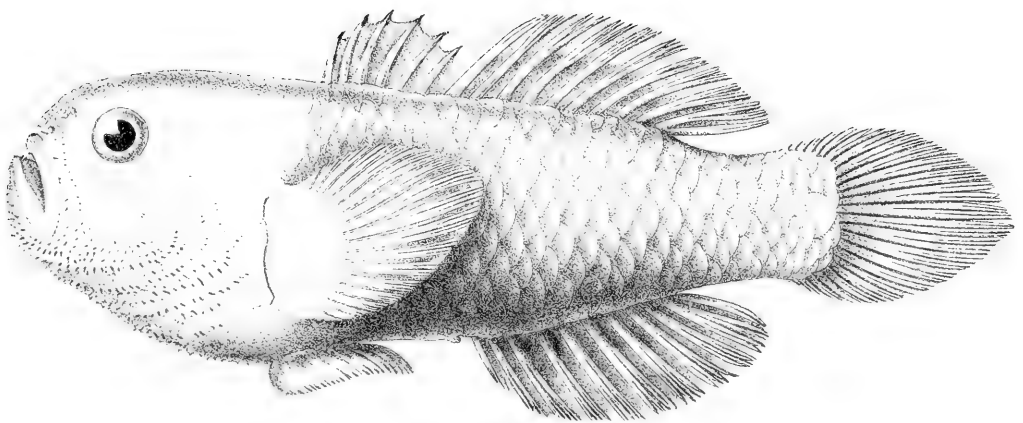
1

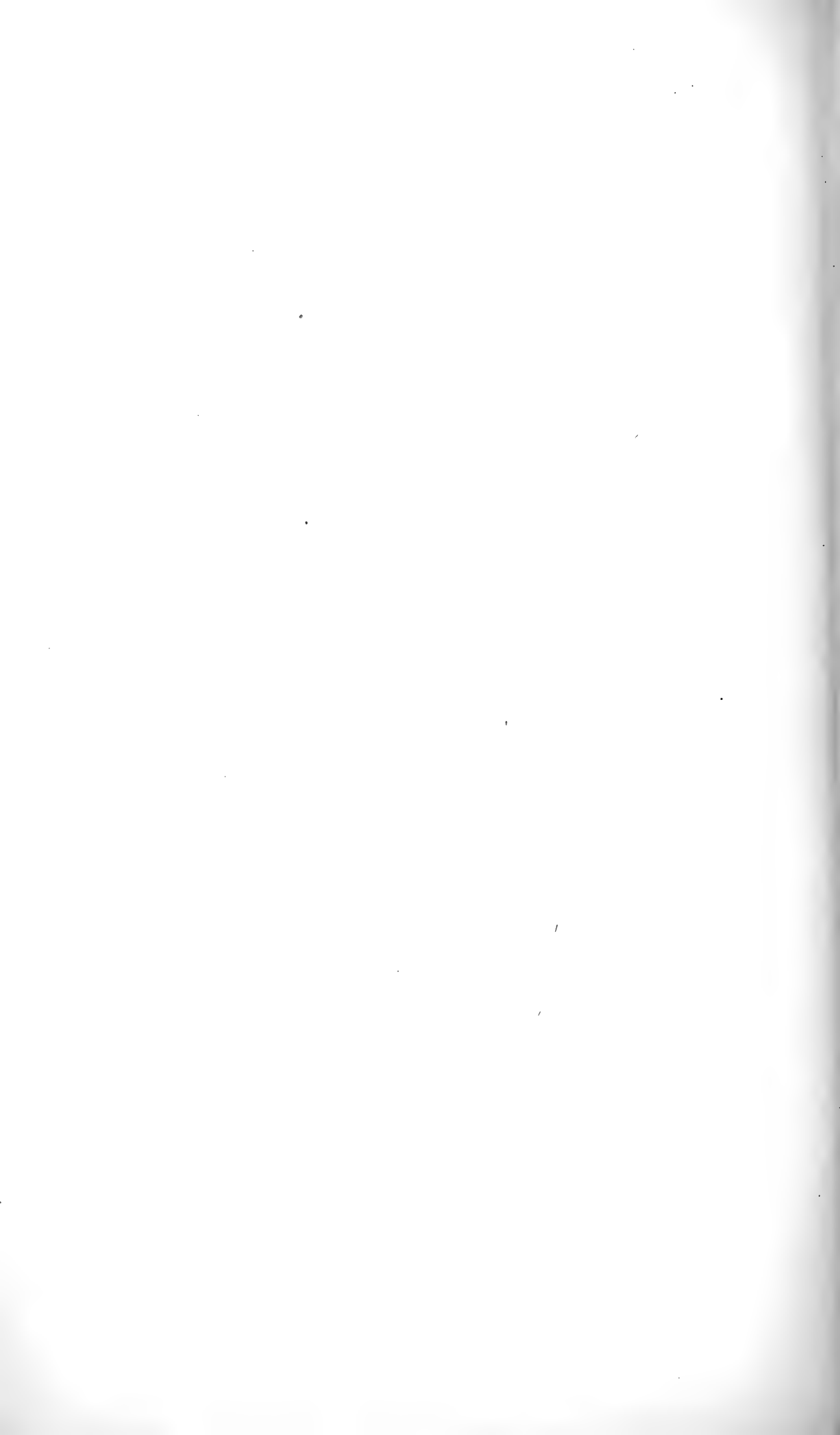


2



3

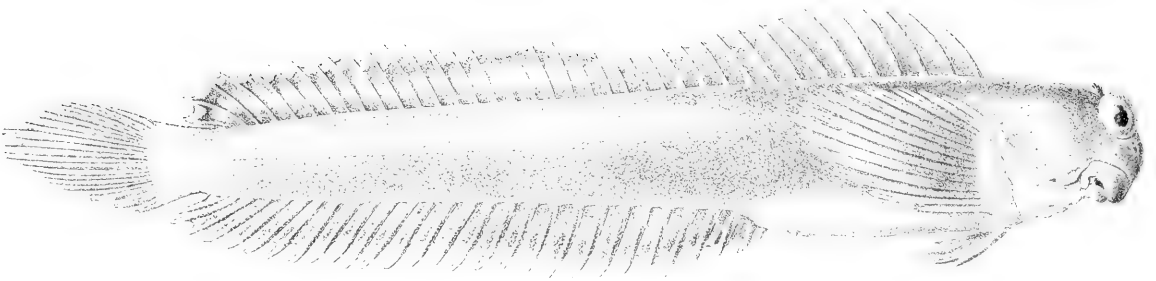




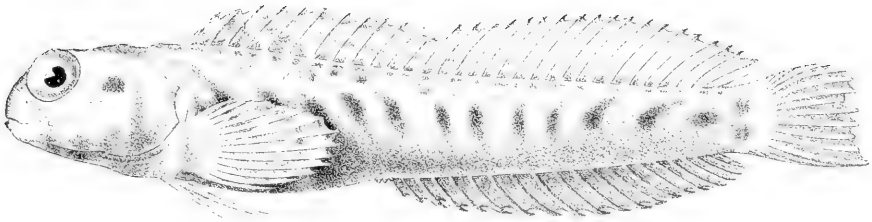
1



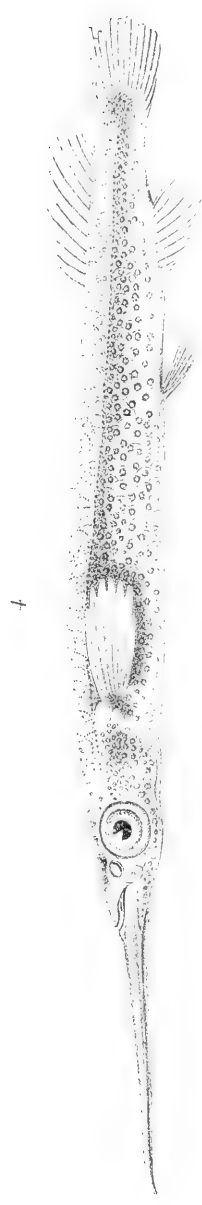
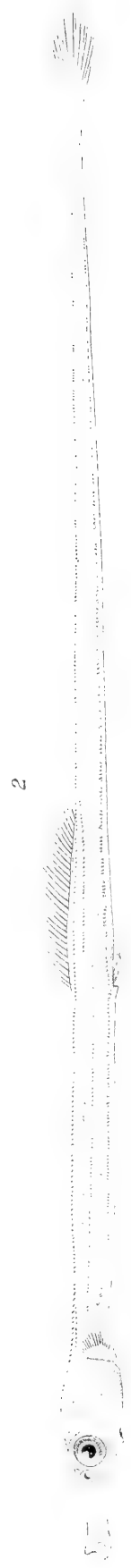
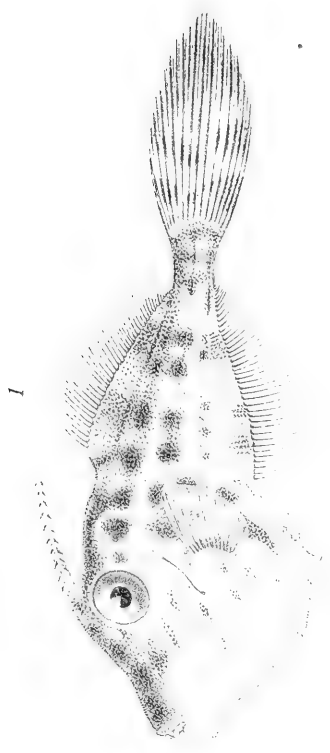
2



3











Bulletin of the Museum of Comparative Zoölogy

AT HARVARD COLLEGE.

VOL. XXXIX. No. 9.

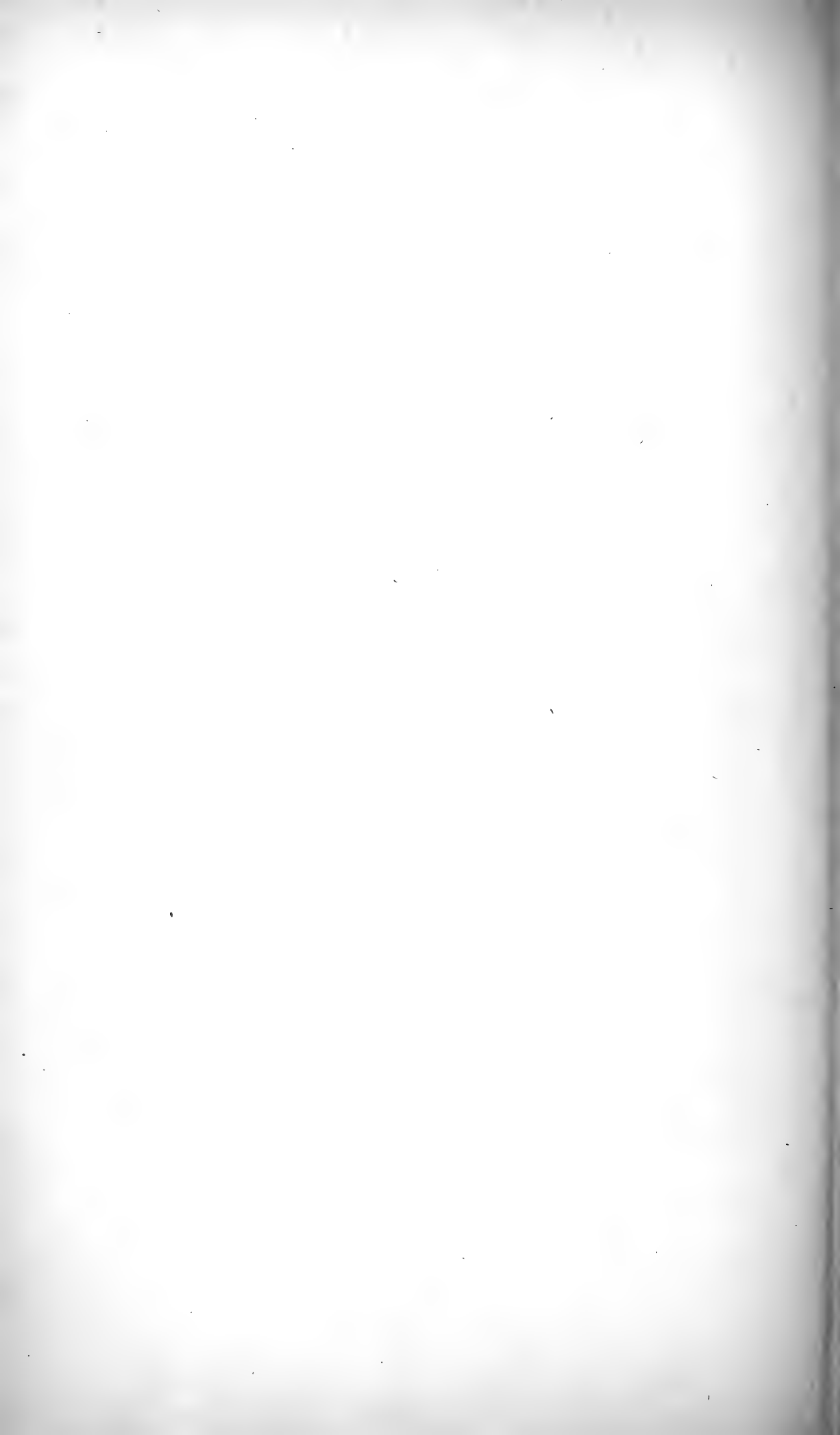
---

MEDUSAE FROM THE MALDIVE ISLANDS.

BY HENRY B. BIGELOW.

WITH NINE PLATES.

CAMBRIDGE, MASS., U. S. A. :  
PRINTED FOR THE MUSEUM.  
APRIL, 1904.



No. 9.—*Medusae from the Maldivé Islands*. By HENRY B. BIGELOW.

THE Medusae described in the following pages were taken during the exploring trip of the steamer "Amra" to the Maldivé islands, carried out by Mr. Alexander Agassiz during the months of December, 1901, and January, 1902. I accompanied the expedition as assistant to Mr. Agassiz, and during the cruise the capture and preservation of the Medusae fell to my special care. The original drawings for the figures accompanying this article were made on the spot, from life.

I wish to express my gratitude to Mr. Agassiz for his kindness in giving me the opportunity to visit the islands; and also for his assistance in the preparation of the manuscript and illustrations for this paper.

The Maldivé islands, which comprise thirteen main atolls and several smaller ones, occupy the greater part of a submarine plateau the area of which is about thirty-five thousand square miles. The islands themselves extend from 8° north to 1° south latitude; and the long axis of the group nearly coincides with the 73d meridian of east longitude. The peculiarly open condition of the larger atolls, especially of the more northern ones, which has already been described by Mr. Agassiz (*Amer. Journ. Science*, March, 1901), allows free access to the water on all sides, and strong currents sweep through the passages and lagoons in all directions. This, as is noted later, has had a considerable influence on the distribution of the Medusae. During our visit, which lasted from December 25, 1901, until January 22, 1902, we made surface hauls at seventeen stations, in eleven atolls, and intermediate hauls at three stations, off the easterly faces of Kolumadulu, Haddummati, and Suvadiva atolls. The surface towing was done with a small net, at our nightly anchorages within the lagoons. The strong currents, which ran almost continuously, made it possible for us to tow when the ship was at anchor, by merely lowering the net overboard and letting the water run through it.

The intermediate hauls were all made with large open nets, at depths from near the surface to one hundred fathoms. We took Medusae at

every station, and in every haul; but the inside hauls were uniformly much more productive than those made at sea. This is probably in large measure due to the fact that the former were always made at about nine o'clock in the evening, an hour which seems particularly favorable for Medusae to come to the surface, and when the water was always very calm. The surface of the ocean itself was usually rather barren during the daytime; but on one occasion, on January 19, while we were sounding to the eastward of Guradu island, we found it very rich, taking *Physalia*, *Porpita*, *Cestus*, *Aurelia*, *Oceania*, *Aglaura*, and swarms of Copepods, Amphipods, Pteropods, and Heteropods.

The small number of our outside hauls makes it impossible to draw any comparison, between the Medusa fauna of the lagoons and of the open sea, more comprehensive than the following correlation between the open character of the atolls, with their free circulation of water, and the fact that there was no *Trachomedusa* which we took outside, and did not take commonly inside as well. Of the nineteen species of *Hydromedusae* which we collected, eleven were *Leptolinae*, and eight *Trachylinae*, a proportion of *Trachylinae* forms which at first sight seems large, considering that by far the greater number of hauls were made in shallow, enclosed waters within the lagoons. The explanation for this condition again is found in the free circulation through the atolls, which is constantly sweeping the adjacent surface water of the ocean through them to an unusual degree.

We took in all sixteen genera of *Hydromedusae*, two of *Scyphomedusae*, three of *Siphonophorae* and four of *Ctenophorae*, making a total of twenty-five genera, represented by twenty-nine species: of these one genus and fifteen species are new: nine species are already known, while four, represented each by a single specimen, were too fragmentary for determination. The number of *Siphonophores*, when compared with similar collections from other tropical waters, is surprisingly small. That so few of the species known to occur off the coast of Ceylon (*Haeckel*, *Siphonophorae* of the "Challenger" Expedition) exist also in the Maldives is very improbable, and the smallness of our catch must be attributed to some other cause.

The distribution of the fifteen new species is as follows: of the eleven *Leptolinae*, all, with one possible exception (*Dipurena*), are new; of the eight *Trachylinae* four are new; of the two *Discomedusae*, one; and of the four *Ctenophorae*, all, with one possible exception, are new. All of the *Siphonophores* belong to well-known and widely distributed species. The geographical occurrence of the nine known species is

shown in the following table. The mark 0 signifies that the species is represented by an exceedingly closely allied, if not identical form.

Species.	Atlantic.	Pacific.	Indian.
? <i>Dipurena fragilis</i> Mayer.	0		+
<i>Messonema coerulescens</i> Brandt.		+	+
<i>Rhopalonema typicum</i> Maas.	0	+	+
<i>Aglaura prismatica</i> Maas.	0	+	+
<i>Aeginella dissonema</i> Haeckel.	+	+	+
<i>Nausithoe punctata</i> Kölliker.	+	0	+
<i>Porpita lutkeana</i> Brandt.			+
<i>Diphyopsis appendiculata</i> Agass. & [Mayer	0	+	+
<i>Physalia megalista</i> Péron.	0		+

Considered from the standpoint of morphology, many of the new species are of interest, since they differ from their nearest allies in important structural characters. Such species are: *Euphysa tetrabrachia*, the only *Euphysa* possessing three prominent short tentacles; *Timoides agassizii*, the only *Leptomedusa* possessing blind centripetal canals in the bell wall; *Aurelia maldivensis*, the only *Aurelia* with long pendent mouth parts. Taken as a whole, the new species uniformly show a very decided separation from their near allies in the Atlantic and Pacific, and there is only one, *Dipurena fragilis*, which seems to be a geographic race of a well-known Atlantic form.

The Maldive islands form in every respect a typical tropical coral reef region, and a comparison of their Medusa fauna with that of similar regions in the Pacific and Atlantic is therefore of interest. Such other regions, of which the Medusae have been studied, by A. Agassiz and A. G. Mayer (see Mayer, Bull. Mus. Comp. Zoöl., vol. 37, and Agassiz and Mayer, Bull. Mus. Comp. Zoöl., vol. 32, no. 9), are the Fiji Islands and the Tortugas.

Taking first Fiji, we find the following conditions. The two areas have in common the following thirteen genera: *Aeginella*, *Aglaura*, *Bougainvillia*, *Eirene*, *Eutimeta*, *Gonionemus*, *Liriope*, *Oceania*, *Aurelia*, *Nausithoe*, *Beroe*, *Diphyopsis*, and *Physalia*. But of these thirteen only four are represented by the same species. These are *Aeginella*

dissonema Haeckel, Aglaura prismatica Maas, Nausithoe punctata Kölliker, and Diphyopsis appendiculata Agassiz and Mayer. These are all forms of very general distribution, and all either occur in the Atlantic or are represented there by exceedingly close allies. Of the thirteen genera common to both regions, not one is peculiarly Pacific; and the most characteristic Pacific forms, the Rhizostomae, were not found at all in the Maldives. This is of interest in view of their common occurrence in the Red Sea and the Persian Gulf, and off Zanzibar. (Vanhöffen, E. Untersuch. über Semaestome und Rhizostome Medusen. Bibl. Zoöl., bd. 1, heft 3, 51; and Chun, Beitrag. Zum. Kenntniss öst Afric. Medusen, etc., Mittheil. Nat. Mus. Hamburg, jahrg. 13, p. 5, 1896.)

If we turn now to the Tortugas in the tropical Atlantic (Mayer, A. G., Bull. Mus. Comp. Zoöl., vol. 37, no. 2), we find they have in common with the Maldives the following fifteen genera: Aeginella, Aglaura, Bougainvillia, Dipurena, Gonionemus, Liriope, Oceania, Aurelia, Nausithoe, Diphyopsis, Physalia, Porpita, Beroe, Bolina, and Ocyroe. Of these, however, four only are represented by identical or even by exceedingly closely allied forms; these are Dipurena fragilis, Aeginella dissonema Haeckel, Aglaura hemistoma Haeckel, and Nausithoe punctata Kölliker.

A similar comparison with the Mediterranean shows twenty-one genera in common, but only two species, Aeginella dissonema Haeckel and Nausithoe punctata Kölliker; with two more, Rhopalonema typicum Maas and Aglaura prismatica Maas, represented by very closely allied forms. With the exception of the new genus Timoides, every genus found in the Maldives is well known in the Atlantic, and the following typically Atlantic genera, not recorded from the Pacific, were taken in the Maldives. These are Berenice, Turritopsis, and Ocyroe.

### General Conclusions.

The Medusa fauna of the Maldives shows a very general resemblance to that of the Tortugas in the Atlantic and Fiji in the Pacific, as shown by the large number of genera which they possess in common. But the fact that very few of these genera are represented by identical species, and, still more important, that all such identical species are forms well known to be of very wide distribution throughout the tropical waters of the globe, is good evidence that this Maldivian fauna has no recent relationship to either of the other areas. The general resemblance of the

three is to be explained on the ground that they all belong to the characteristic "coral reef" type. Evidence that this cannot be considered a truly representative tropical type is found in the fact that the Canaries in the tropical Atlantic, whose physical characteristics, apart from the temperature of the water, are very different from those of any of the three other areas already considered, possess a Medusa fauna of markedly different characters.

As I have already stated, all of the Leptoline Hydromedusae from the Maldives, with one possible exception, are new. At the same time all of the Trachylinae which belong to the families Geryonidae and Peganthidae, whose members are well known to be local in their distribution, are also new. In other words, all the "local" forms, with one possible exception, are new, and the only species of Hydromedusae already known are those distributed, or at least represented, by exceedingly close allies throughout the tropical oceans of the globe. This same rule holds good for the Discomedusae, Aurelia, and Nausithoe, the Siphonophores and Ctenophores. We reasonably expect to find traces of such a condition in almost any region. The striking thing in the Maldives is the extent to which it is seen; for not only do we find nearly all the local forms new, but we find them separated from their nearest allies by very considerable divergences which amount often nearly to generic importance. The frequent occurrence in the Maldives of very aberrant species in genera which until now have been very homogeneous is a striking feature. The main conclusions which I wish to draw from these facts are two:—first, the very large proportion of new forms among those groups whose members are known to be of somewhat local distribution, particularly the Leptolina, and the fact that none of the typical Atlantic or Pacific Leptolina were found, points to the conclusion that, so far as the Medusa fauna is concerned, the Maldives are an area of geographic isolation. The very considerable degree of divergence from their near allies shown by the new species, and the frequent occurrence of aberrant members in otherwise very homogeneous genera, points to the second important conclusion, that this condition of isolation has lasted for a considerable period.

The fact that all but one of the genera of Acalephs found in the Maldives occur in the Atlantic, while only about two thirds of them are known to occur in the Pacific; and that while we found no typically Pacific genus, we did take five genera not previously recorded, except from the Atlantic, — seems to point to a closer connection with the Atlantic than with the Pacific. This connection, if it exists, is of very great

interest in view of the well-known general resemblance between the Pacific and Indian oceans, as shown by their Fishes, and particularly their Echinoderms, of which the same species are known to occur off Zanzibar, and off the west coast of South America.

## ALPHABETICAL LIST OF SPECIES.

HYDROMEDUSAE.		PAGE
<i>Aeginella dissonema</i> Haeckel . . . . .		261
<i>Aglaura octagona</i> , sp. nov. . . . .		257
<i>Aglaura prismatica</i> Maas . . . . .		257
<i>Berenice</i> , sp. ? . . . . .		252
<i>Bougainvillia</i> , sp. ? . . . . .		252
<i>Dipurena fragilis</i> Mayer . . . . .		251
<i>Eirene danduensis</i> , sp. nov. . . . .		254
<i>Euphysa tetrabrachia</i> , sp. nov. . . . .		251
<i>Eutimeta lactea</i> , sp. nov. . . . .		253
<i>Gonionemus pelagicus</i> , sp. nov. . . . .		256
<i>Liriope hemisphericus</i> , sp. nov. . . . .		259
<i>Liriope indica</i> , sp. nov. . . . .		258
<i>Messonema coerulescens</i> Brandt . . . . .		256
<i>Oceania brunescens</i> , sp. nov. . . . .		253
<i>Oceania virens</i> , sp. nov. . . . .		252
<i>Pegantha simplex</i> , sp. nov. . . . .		260
<i>Rhopalonema typicum</i> Maas . . . . .		256
<i>Timoides agassizii</i> , gen. et sp. nov. . . . .		254
<i>Turritopsis</i> , sp. . . . .		252
SCYPHOMEDUSAE.		
<i>Aurelia maldivensis</i> , sp. nov. . . . .		261
<i>Nausithoe punctata</i> Kölliker . . . . .		263
SIPHONOPHORAE.		
<i>Diphyopsis appendiculata</i> Agassiz and Mayer . . . . .		265
<i>Physalia megalista</i> Péron et Lesueur . . . . .		265
<i>Porpita lutkeana</i> Brandt . . . . .		264
CTENOPHORAE.		
<i>Beroë</i> , sp. . . . .		267
<i>Bolina ovalis</i> , sp. nov. . . . .		265
<i>Bolina</i> sp. . . . .		266
<i>Cestus pectenalis</i> , sp. nov. . . . .		267
<i>Ocyroe pteroessa</i> , sp. nov. . . . .		266



## DESCRIPTION OF THE SPECIES.

## I. HYDROMEDUSAE.

*Dipurena fragilis*.

*Dipurena fragilis* Mayer, A. G., 1900. Bull. Mus. Comp. Zoöl., vol. 37, p. 28, plate 17.

This Medusa, if not identical with *Dipurena fragilis* Mayer, from the Tortugas, is very closely allied to it. It appears to differ from it in being colorless, and in having the swollen regions on the proboscis much less prominent. The fact that only one specimen was taken makes me hesitate to separate it specifically.

January 2. Suvadiva atoll, near Dandu island; surface.

The occurrence of *Dipurena* in the Indian Ocean is of interest, since this genus has never been taken in the tropical Pacific, though in the tropical Atlantic and Mediterranean it is represented by numerous species.

*Euphysa tetrabrachia*, sp. nov.

## Plate 1, Fig. 1.

I have rather doubtfully referred the present species to *Euphysa*, to which genus it shows more resemblance than to *Corymorpha*. The bell is four mm. high by two and one half broad; pear-shaped, with a low and broad apical projection, and it is perfectly symmetrical. The single long tentacle is well developed, and is about four times as long as the bell is high. The other three, instead of being mere rudiments, are of considerable size, about one third as long as the bell height, and are equally developed. All four are ringed with nettle cells, about three rings on each of the short, and six or eight on the long, tentacle.

There is an ocellar bulb borne at the base of each tentacle. The proboscis is flask-shaped, its upper portion distended by the swollen half-spherical masses of gonads, arranged in eight fairly distinct rows. The mouth hangs below the bell opening, and bears no lips.

The bell is colorless and very transparent, the gonads brownish yellow, the proboscis slightly pinkish, and the ocellar bulbs and rings of nettle cells rose pink.

One specimen, January 7, in Suvadiva atoll. Surface.

The generic position of this very distinct species seems doubtful. It agrees with *Euphysa* in the symmetry of the bell, and in the arrangement of the gonads, which correspond very well to the figures of *Euphysa virgulata*, given by Alexander Agassiz (North American Acalephae, 1865, p. 190, fig. 317).

It differs, however, from both *Euphysa* and *Corymorpha* in the considerable and equal development of the three short tentacles, and further study may prove it to be representative of a new genus.

#### ***Turritopsis*, sp.**

A single young specimen of *Turritopsis* was taken in the tow on January 10, in Felidu atoll. Species undetermined.

#### ***Bougainvillia*, sp.**

A single specimen of *Bougainvillia*, in a very fragmentary condition, was taken in the tow on December 30, off the east face of Kolumadulu atoll, in an open net at one hundred fathoms.

#### ***Berenice*, sp.**

A single specimen of *Berenice* was taken in the tow on the night of January 8, in Haddummati atoll. It was too fragmentary for description.

#### ***Oceania virens*, sp. nov.**

##### **Plate 1, Figs. 3, 4.**

The bell is lenticular, with rather thin but firm gelatinous substance, about twelve mm. in diameter and one third as high. There are between sixteen and twenty tentacles, the exact number being variable, irregularly arranged. Each tentacle is thick, swollen at the base, only slightly contractile, and about one half as long as the bell-height. Besides the tentacles there are from thirty to forty rudimentary tentacular bulbs borne on the bell margin, two or three between each two tentacles. These knobs, however, are irregularly arranged, and vary greatly in number in different specimens. They appear never to be developed into anything more than the mere rudiments of tentacles or cirri. The proboscis is short, flask-shaped, very distensible, and bears four simple pointed lips. The gonads are long for this genus, occupying the distal half of the radial canals.

There are thirty-two otocysts, two or three between each pair of tentacles, but rather irregularly distributed. Each contains one or two spherical otoliths.

The bell is colorless. The gonads, proboscis, and tentacles are light yellowish green.

Several specimens, December 26, Male atoll, near Male island, and January 2 in Suvadiva atoll, near Dandu island, surface.

In form, arrangement of the gonads and otoliths, and in general appearance,

this species much resembles *Oceania pacifica* Agassiz and Mayer (Bull. Mus. Comp. Zool., vol. 32, no. 9), from Fiji. It differs from it strikingly, however, in the possession of rudimentary tentacular bulbs on the bell margin, in which respect it resembles *Oceania carolinae* Mayer, from the western Atlantic, from which species it is clearly distinguished by the shape of the bell and the size and position of the gonads.

*Oceania brunescens*, sp. nov.

Plate 1, Fig 2.

The bell is low and flat, about two mm. in diameter and one third as high. There are about thirty short thick tentacles, much swollen at the base. The bell margin does not bear tentacular bulbs. The proboscis is very short and broad, and the mouth bears four simple lips. The most distinctive feature of this Medusa are the gonads, which are exceedingly thick and prominent, and nearly hemispherical (Plate 1, Fig. 2). They occupy the proximal third of the radial canals.

There are from thirty-two to forty small otocysts, each with one or two otoliths, scattered irregularly along the bell margin.

The bell is colorless and very transparent. The canals and gonads are greenish yellow. The tentacles are colorless, but at the base of each there is a prominent brown pigment spot.

Two specimens, January 15, near the southern end of Malosmadulu atoll. The very large, hemispherical gonads and prominent brown pigment spots clearly distinguish this Medusa from all described species of *Oceania*.

*Eutimeta lactea*, sp. nov.

Plate 2, Figs. 7, 8.

The bell is thin, slightly conical, nine mm. in diameter, and about one half as high. There are eight permanent and well-developed tentacles, of which the four opposite the radial canals are about as long as the diameter of the bell, and the other four slightly shorter. Small lateral spurs are borne at the bases of the tentacles, and there are in addition about twenty-four papillae on the bell margin. None of these bear lateral cirri. There are eight otocysts, each of which contains four or five otoliths. The peduncle of the proboscis is slender and slightly shorter than the bell diameter. The proboscis is cylindrical and as long as  $\frac{2}{3}$  of the bell height. The mouth bears four slightly foliated lips. The position of the gonads is somewhat distinctive. They are borne on the radial canals, and occupy the central two thirds of the peduncle, as figured by Haeckel for *Eutimeta gentiana* (System der Medusen, 1880, plate 12, fig. 7). In *Eutimeta levuka* Agassiz and Mayer, from Fiji, they are found near the circular canal. The gonads are of considerable size, and form four swollen ridges.

This species is nearly colorless : the tentacles and manubrium are of a very faint bluish tinge, and the gonads are opaque milky white.

Several specimens, Male atoll, near Male island, December 26, surface.

This species is most closely allied to *Eutimeta gentiana* Haeckel, from the Canaries, but differs from it in the form of the bell, and in having much smaller marginal cirri. The gonads are more prominent, but occupy a shorter portion of the peduncle. In the form of the bell it resembles *Eutimeta levuka* Agassiz and Mayer, but the peripheral position of the gonads in the latter is an important point of difference.

***Eirene danduensis*, sp. nov.**

**Plate 1, Fig. 5. Plate 2, Fig. 6.**

The bell is flatter than a hemisphere, somewhat conical in outline, with rather thin gelatinous substance : it is twenty-five mm. in diameter and about one third as high. There are thirty-two tentacles, of which the four opposite the radial canals are at least one fourth longer than the others. Each tentacle bears two lateral cirri at its base, and there are also about seventy small papillae scattered irregularly along the bell margin. There are thirty-two otcysts, eight to each quadrant, and each contains about five spherical otoliths. The peduncle, the most distinctive feature of this form, is long for the genus, reaching well below the bell opening, and is conical in outline. The proboscis is about one half as long as the peduncle. It may be extended to nearly double this length, but cannot be retracted within the bell opening. The mouth bears four simple lips.

The spindle-shaped gonads occupy the distal two thirds of the radial canals. The bell is colorless. The gonads are bluish green.

A single specimen was taken on January 8, off the east face of Haddummati atoll, in an open net, at two hundred fathoms.

This Medusa is distinguished from all described species of *Eirene* by the very considerable length of the peduncle and proboscis.

***Timoides agassizii*, gen. et sp. nov.**

**Plate 3, Figs. 10, 11.**

*Timoides* forms a new genus of Eucopidae, belonging to that division of the family characterized by possessing numerous otcysts and tentacles, and numerous cirri on the bell margin. The gonads are borne on the radial canals, but are wholly restricted to the peduncle, which is very long. The lips are large and form an important feature. By far the most characteristic feature of this genus, which in the main resembles *Tima*, is the presence, between the radial canals, of blind centripetal canals arising from the ring canal.

The Medusa is bell-shaped, of much the same outline as *Tima formosa* Agassiz. The gelatinous substance of the bell is very thick. The extreme diameter is

twenty mm.; and the bell is two thirds as high as broad. The tentacles may be extended to nearly a foot in length, and are exceedingly flexible and contractile. When retracted they are usually coiled spirally, and this coiling may take place at any point in their length without affecting the rest of the tentacle. In life they stream out far behind the bell. They are thirty-two in number, arranged in four series. First, four, opposite the radial canals; second, four alternating with these; third, eight, alternating with the eight already mentioned. Every tentacle of these three series is opposite a canal, blind or radial; but the sixteen of the fourth series alternate with the canals. The bell margin also bears numerous cirri (Plate 4, Fig. 11), which, as well as the tentacles, are spirally coiled when retracted. Neither cirri nor tentacles bear lateral spurs.

The blind canals, which are the most important structural features of the Medusa, are arranged in two series, the first of four, alternating with the radial canals, and reaching up for two thirds the height of the bell; the second of eight, about one half as long, and alternating with the radials and blind canals of the first series. They are all in free communication with the ring canal, and each is opposite a tentacle.

The peduncle hangs below the bell opening for a distance at least equal to the height of the bell cavity. Throughout most of its length it is nearly cylindrical, but at its base it is somewhat funnel-shaped. At its distal end it passes, without any external separation, into the stomach, which is barrel-shaped in outline, and bears four prominent lips. These lips are, in life, the most striking feature of the Medusa. They are very long, and so extensible that they may reach a length considerably greater than that of peduncle and stomach combined. They are rather narrow, and their edges are thrown into innumerable constantly changing folds.

The gonads consist of a great number of simple and branched papilliform processes so closely crowded on the alternate sides of the radial canals that they form four prominent double ridges. They occupy slightly more than the distal half of the peduncle, and their relative extension seems, in adult specimens, to be practically invariable.

The coloring of this Medusa is exceedingly brilliant. The gelatinous substance of the bell is faintly tinged with blue: the gonads are rich Indian yellow, changing in certain lights to ruddy orange. In sharp contrast to them, the stomach and mouth arms are pink-violet; the radial canals and tentacles are rose pink, and there is a pink pigment spot at the base of every tentacle.

Abundant in Haddummati atoll, near Gadu island, on January 8. It appeared on the surface in great numbers at about four o'clock in the afternoon, when the bright colors and long streaming tentacles of the animals made them very conspicuous objects.

The fact that blind canals have never before been detected in the adult of any species of Eucopidae is at once sufficient to separate *Timoides* generically. The number of these canals and the relative extension of the gonads will probably prove to be of specific importance.

*Gonionemus pelagicus*, sp. nov.

Plate 4, Figs. 12, 13, 14.

The bell is rounded, but low and thin. It is about twenty mm. in diameter, and one third as high as broad. There are about fifty long, straight, flexible tentacles, each of which forms a slight elbow near the tip, in the manner characteristic of the genus. These elbows, however, are so inconspicuous in life that the tentacles resemble *Melicertum* rather than *Gonionemus*. At the elbow each tentacle bears a small almost rudimentary sucking disc, and they are ringed throughout their whole length. At the base of each there is a cluster of brown pigment spots. There are sixteen otocysts.

The proboscis is flask-shaped, nearly as broad as long. It is exceedingly flexible, but cannot be retracted. The mouth bears four fimbriated lips. The gonads, which occupy the distal third of the radial canals, consist of simple papilliform processes closely crowded together, as in *Gonionemus murbachi*, from Woods Holl, Mass.

The bell is colorless: the proboscis and tentacles are yellowish green, the pigment spots at the bases of the tentacles vandyke brown, and the gonads rose pink.

In life this Medusa bears little resemblance to other species of *Gonionemus*. It swims freely by frequent contractions of the bell, the tentacles streaming behind at full length. The flexible tentacles are continually contracting and expanding and swaying to and fro in the water. The Medusa showed no inclination to attach itself, nor did it swim to the surface, sink, and then swim up again in the manner so characteristic of the genus. The anatomical structure of the tentacles also points to this habit of life, which has led me to give it the name "pelagicus." It differs from all other species of *Gonionemus*, to which genus it certainly belongs, in the rudimentary condition of the sucking discs. One specimen, January 7, near Gadu island, Suvadiva atoll, surface.

*Messonema coerulescens* BRANDT.

Brandt, 1838, Mem. Acad. Imp. St. Pétersbourg, ser. 6, vol. 4.

A single specimen of *Messonema* was taken on January 8, in Haddummati atoll. It probably belongs to this species, but was too fragmentary for accurate determination.

*Rhopalonema typicum* MAAS.

Homoeonema typicum Maas, 1897, Mem. Mus. Comp. Zoöl., vol. 22, p. 22, taf. 3.

Two specimens of this species were taken on January 8, in Haddummati atoll.

*Aglaura prismatica* MAAS.

*Aglaura prismatica* Maas, 1897, Mem. Mus. Comp. Zoöl., vol. 12, p. 24, taf. 3.  
*Lessonia radiata*? Eydoux et Souleyet, 1841-52, Voyage de la Bonité, vol. 2,  
Zoöphytes, plate 2.

A species of *Aglaura* apparently identical with the *Aglaura prismatica* of Maas was one of the most abundant Medusae in the tow. We took it at almost every station, both inside and outside the atolls, often in large numbers. All our specimens were quite colorless and transparent, a condition similar to that observed by Agassiz and Mayer in several specimens from Fiji (Bull. Mus. Comp. Zoöl., vol. 32, p. 165, plate 4, fig. 13).

*Aglaura octagona*, sp. nov.

## Plate 2, Fig. 9.

The bell is distinctly octagonal, lantern-shaped, and flattened at the top; it is three mm. high, and about one half as broad. The walls, although exceedingly thin, are very rigid, and the vellum is provided with a series of circular muscles. There are about thirty-two tentacles, which in our specimens were all broken short off, leaving stumps behind. The peduncle is three fourths as long as the bell is high and cannot be retracted within the bell cavity. The stomach is short and globular, and the mouth bears four simple lips, which hang nearly on a level with the bell opening. The gonads are egg-shaped, and are borne at the junction of the radial canals with the stomach. There are eight interradial otocysts. The whole Medusa is perfectly colorless.

Two specimens, December 30, off the east face of Kolumadulu atoll, in an open net at about one hundred fathoms. *Aglaura octagona* is very closely allied to *Aglaura laterna* Haeckel, from the Canary Islands. It differs, however, in the following particulars: The peduncle is longer, the gonads are egg-shaped instead of spherical, and the tentacles seem rather more numerous. (*Aglaura laterna* has usually from sixteen to twenty-four.) The form of the bell in both species is identical, and in other general proportions they are very similar. The genus *Aglaura* falls into two well-marked divisions, one represented by *Aglaura hemistoma*, with the closely allied varieties, *prismatica* Maas, from the Pacific, *nausicaa* Haeckel and *vitrea* Fewkes, from the Atlantic, characterized by the short peduncle; and the other represented by *Aglaura laterna* Haeckel, from the Canaries, and *Aglaura octagona*, sharply distinguished by the long peduncle and lantern-shaped bell. I think it is probable that these may all prove to be merely geographical races of two well-defined species.

*Liriope* LESSON, 1843.

In the "Craspedoten Medusen der Deutschen Tiefsee-expedition," p. 79, Dr. Ernst Vanhöffen has given an able analysis of this genus which he, follow-

ing Maas and Metschnikoff (Arb. Zoöl. Inst., Vienna, vol. 6), widens to include all Geryonidae with four radial canals. He thus includes Haeckel's genera *Glossocodon* and *Glossocoenus* (Haeckel, System der Medusen, 1879), of which the distinctive character, the presence in the adult state of blind centripetal canals, has been shown by Maas to be a developmental feature of little systematic importance. Although knowledge of the young stages of most species of *Liriope* is entirely lacking, or very fragmentary, Maas, writing of the collections of the Plankton Expedition (Craspedoten Medusen der Plankton Ex. 18), was able to say: "Of all the material of the expedition, no single species of the Geryonidae can be named, of which it can safely be said that it has no centripetal canals."

Our catch included two species of *Liriope*, both of which appear to be new.

*Liriope indica*, sp. nov.

Plate 5, Figs. 17, 18.

This species is one of the medium-sized members of the genus, measuring in diameter fourteen mm., and in height about nine. The outline of the bell is almost an exact segment of a circle (Plate 5, Fig. 17), and the gelatinous substance is of medium thickness, thus agreeing well with Vanhöffen's statement that the thickness of the gelatinous walls of members of this genus correspond in general to their size. The eight permanent tentacles are very unequal; the four opposite the radial canals are hollow, flexible, ringed with nettle cells, about as long as the bell diameter. Although they are moved actively, they seem only very slightly contractile, so that their length varies but little. Alternating with them are four others, only about one fourth as long, which are solid, stiff, and curved outwards. Their centripetal surfaces are set with ridges of nettle cells, which extend around about one half the circumference of the tentacle. The ring canal does not give rise to any blind canals, but opposite each of the short tentacles it becomes abruptly broader, forming a triangular spur (Plate 5, Fig. 18). The peduncle is nearly cylindrical, about as long as the bell is high, and hangs far below the bell opening. The stomach is one third as long as the peduncle, and does not bear a stomatostyle. The mouth is a simple, square opening, without lips. The gonads, which occupy nearly the whole length of the radial canals, are shield-shaped, and so broad that they occupy one third of the surface of the subumbrella. The eight otocysts are borne one at the base of each tentacle. Their position, however, differs: the ones corresponding to the short tentacles occurring directly above them, while the four connected with the long tentacles are at one side (Plate 5, Fig. 17). The Medusa is perfectly transparent and colorless, except that the gonads are opaque yellowish, and the nettle knots on the short tentacles reddish brown.

Four specimens, January 2, in Suvadiva atoll, near Dandu island, surface. This Medusa in several respects resembles the *Liriope hyalina* of Agassiz and



Mayer (Bull. Mus. Comp. Zool., vol. 30, p. 166, plate 9). Mayer's figure appears to be taken from an immature individual, and in his description he makes no mention of the form of the gonads, so it is possible that the two species may prove to be identical. Both are closely allied to *Liriope scutigera* McCrady (Proc. Elliott Soc. Nat. Hist., vol. 1, p. 208, 1859), from Charleston Harbor, South Carolina.

*Liriope hemisphericus*, sp. nov.

Plate 4, Figs. 15, 16.

The bell is nearly hemispherical, with rather thick walls. It is eight mm. in diameter and slightly more than half as high as broad. The bell cavity is flatter than a hemisphere. There are two kinds of chymiferous tubes. There are four radial canals, and alternating with these are four broad, arrow-shaped canals which arise from the ring canal and end blindly in the bell wall at about one half the height of the cavity. Corresponding to these two kinds of canals are two kinds of tentacles. The four opposite the radial canals are hollow, flexible, about as long as the bell is high, and ringed with nettle cells throughout their length. Alternating with these, and opposite the blind canals, are four others which are only slightly shorter, but are solid, stiff, and carried curved sharply outward. Instead of being ringed, they bear a series of clusters of nettle cells on their centripetal surfaces (Plate 4, Fig. 16). The cylindrical peduncle, which is very flexible, is nearly as long as the diameter of the bell, and so hangs far below the opening. Its distal end is prolonged into a pointed stomatostyle. The stomach is nearly cylindrical and the mouth bears four simple lanceolate lips which are usually recurved. The gonads are heart-shaped, rather narrow, and occupy the proximal half of the radial canals. They occupy hardly more than one eighth of the surface of the subumbrella. The eight otocysts, which are all similar, are arranged radially and interradially, the radials being at one side of the tentacles, the interradials directly above their bases (Plate 4, Fig. 16). This Medusa is colorless, except that the gonads are opaque whitish, and the nettle cells on the short tentacles Vandyke brown.

Three specimens, December 26, Male atoll, near Male island, surface. This species differs in important particulars from all known members of that division of the genus *Liriope* whose adult members normally possess centripetal canals, in having only one of the latter to each quadrant, — a condition characteristic of the young of other species. In general appearance it most resembles *Liriope tenuirostris* Agassiz, from the Atlantic coast of North America. A striking characteristic of the species is the large size of the interradial canals.

Although our specimens were sexually mature, it is by no means certain that the number of blind canals had reached its maximum. Studies on a species of *Olindias* from Bermuda have shown a condition in which the number of these canals and of the tentacles nearly doubles with the increase in size of the Me-

dusa after sexual maturity is reached; and it is by no means improbable that the same may be true here. As in the case of the velar canals of *Charybdea*, so here the number and even form of the blind centripetal canals are probably chiefly dependent upon age, and cannot be considered of much systematic importance.

*Pegantha simplex*, sp. nov.

Plate 5, Figs. 19, 20.

This Medusa has the form characteristic of the genus. The bell consists of a thick, lenticular central portion, surrounded by a dependent ring or collar, from which it is divided by a shallow furrow. The margin of the collar is divided into eight lappets, each of which is in turn subdivided into two by a shallow groove. The lappets are very flexible, and can be curved inward, so that they nearly close the bell opening. The bell is about three mm. in diameter, and one half as high as broad. There are only eight tentacles, a much smaller number than has been reported for any other species of the genus; and this number seems to be constant. They arise from the periphery of the central disc, alternating with the eight marginal lappets, and corresponding to the grooves between them. They are broadly conical at the base, solid, carried curved stiffly outward, and are slightly longer than the bell is high. They taper very rapidly, and toward the tips are very delicate. A characteristic feature of this Medusa, in which there are no radial canals, is the large size of the stomach. This organ, which is lenticular in cross-section and provided with a broad, simple mouth without lips, extends to the periphery of the central disc. In outline it is somewhat octagonal, the angles being opposite the tentacles, and from the middle of each side (alternating with the tentacles) it throws out a narrow canal running to the corresponding gonad, one of which lies at about the middle of each marginal lappet. The gonads are sac-shaped bodies, of considerable size, suspended from the surface of the subumbrella. In this Medusa they are simple, although in most other species of the genus they are subdivided into three or more secondary lobes. There are about two hundred otocysts, situated on the edges of the marginal lappets, about twenty-five to each lappet. Each otocyst arises from a low and broad "auditory papilla," which is thickly set with short stiff ciliae. The otocysts themselves are oval, and contain three rather long prismatic otoliths. At their bases they bear club-shaped processes, about twice as long as the otocyst, which extend up into the substance of the bell. When the lappets are retracted over the bell opening, these processes alone are visible.

The Medusa is altogether colorless. An abundant species: numerous specimens, December 26, Male atoll, near Male island; January 2, off the east face of Kolumadulu atoll, in an open net at fifty and one hundred fathoms; January 15, Malosmadulu atoll, surface. One of the few species which appeared to be equally common inside and outside the atolls.

This form seems quite distinct from all other species of *Pegantha*, to which genus it undoubtedly belongs. Its two striking peculiarities are the small number of tentacles, and the fact that the gonads are not subdivided. The smallest number of tentacles described from any species of the genus is fourteen, in *Pegantha martagon* (Haeckel, System, 1879).

*Aeginella dissonema* HAECKEL.

Haeckel, 1879, Syst. der Medusen, p. 340, taf. 20, fig. 16.

We took one specimen of this Medusa in South Malosmadulu atoll, January 15, surface. Drawings made from life agree perfectly with the figures given by Haeckel (System, taf. 20), and by Mayer (Bull. Mus. Comp. Zoöl., vol. 37, plate 14, fig. 30), except that our specimen was altogether colorless, instead of having green pigment spots on the stomach. The only other described species, *Aeginella bitentaculata* Quoy et Gaimard, seems to differ very slightly from *Aeginella dissonema* Haeckel.

II. SCYPHOMEDUSAE.

*Aurelia maldivensis*, sp. nov.

Plates 6 and 8, Figs. 22, 23, 27.

This Medusa is by far the most aberrant species of *Aurelia*, to which genus I rather doubtfully refer it. The bell is disc-shaped, of very solid consistency, and rather thick; it is about two hundred and fifty mm. in diameter, and slightly more than one third as high as broad. Its outline is broken by eight deep indentations, forming eight marginal lappets, each of which bears a slight central depression at its margin. At the base of each of the eight indentations lies a prominent sense organ (Plate 6, Fig. 23). In their proportions these sense organs differ considerably from those of *Aurelia flavidula* Pér. et Less., although they agree with them in general structure. They differ, however, in their connection with the stomach, which here consists of a single straight radial canal, which instead of opening into a broad circular cavity, connecting on either side of the sense organ with the ring canal, spreads but slightly, forming only a small cavity, which sends out two narrow branches, one on either side of the sense organ, to the ring canal. No other chymiferous vessels open into this enlarged cavity, except that it usually anastomoses with the neighboring radial canal on either side. This condition is, however, not constant. There are three short canals which arise from under the floor of the expanded cavity. One of these is broad, short, and runs to the otocyst; the other two form a horseshoe, embracing the otocyst, and run into the two

marginal papillae, near the outer edges. These papillae are large and prominent, but extend only slightly, if at all, beyond the margin of the bell. The otocyst itself, containing a number of minute spherical otoliths, is covered over by a curtain-like structure (Plate 6, Fig. 23).

The tentacles, borne on the exumbrella, some distance from the bell margin, are short, very numerous, about five hundred in number, and alternate with as many small dorsal lappets. There are about forty-eight chymiferous tubes in the region of the stomach, but they branch frequently, and occasionally anastomose, so that at the bell margin there are about one hundred and seventy to one hundred and seventy-five. The eight canals running to the sense organs do not branch, nor do the eight which run to the middle of the marginal lappets. The mouth arms are long and broad, fringed with innumerable minute tentacles, and in life they hang slightly below the bell opening, but do not extend outward beyond its margin. The structure of the mouth parts, and their complexity, separates this Medusa from every other member of the genus. The mouth itself is a simple cruciform opening, but it is surrounded by elongated lips, which hang far below the bell opening, suggesting in appearance a small or immature Cyanea. These lips, which are undivided, and form an extremely sensitive and mobile curtain completely surrounding the mouth, are thrown into four main folds, rendering them cruciform in cross-section, and alternating in position with the gonads. They bear in addition numerous complex lesser folds, increasing in number toward the free margins. The living Medusa constantly contracts and expands the mouth parts with every motion of the bell, and a photograph taken at the time shows them much further extended than I have figured them. The four gonads are of the horseshoe form typical of *Aurelia*, and are rather small. But owing to their bright color they are very conspicuous. The subgenital pits are widely opened.

This Medusa is extremely brilliant and striking in the water. The entire bell is of a delicate lilac tinge; the canals and tentacles are pinkish violet, and the gonads, and in mature specimens the edges of the mouth arms and lips are bright violet. The color varies much, — some specimens showing more pink, others more violet or blue.

Abundant on the surface on several occasions. We found it first on January 1, off the east face of Suvadiva atoll, and inside the atoll, when it was so abundant that it filled regular lanes in the water, and the tow brought in nothing else. After that we found it in nearly every other atoll.

*Aurelia maldivensis* bears little resemblance in appearance to any other *Aurelia*, and this is especially important in a genus where all the other species are extremely closely allied. The most striking feature of this Medusa is, of course, the great development of the mouth parts, which, as I have noted, suggest in their structure the young of *Cyanea*; but the arrangement of the chymiferous tubes and the structure of the sense organs are also both distinctive.

*Nausithoe punctata* KÖLLIKER.

Kölliker, 1853, Zeit. für Wiss. Zoologie, bd. IV.

*Nausithoe punctata*, var. *Pacifica*, Agassiz & Mayer, 1902, Mem. Mus. Comp. Zoöl., vol. 26.

## Plate 6, Fig. 21.

In the descriptions and figures of this genus, given by Kölliker, Agassiz and Mayer, Mayer, Haeckel, and Gegenbauer, there has been a great deal of confusion as to the relative radial positions of the marginal tentacles, gonads, and groups of gastric cirri. Kölliker, who established the genus, figures *Nausithoe punctata* with the gastric cirri and gonads in the tentacular radii (Zeit. für Wiss. Zool., bd. 4, p. 323). Gegenbauer, who has given the best figures of this species, followed his example (Arch. Anat. and Phys., 1853, p. 239). Haeckel (System, part 2, 1879) says that the gastric cirri are in the radii of the sense organs (gonads and tentacles adradial); while Mayer says of *Nausithoe punctata* that the gastric cirri lie in the radii of the marginal sense organs, but in his figures they are in the tentacular radii! (Bull. Mus. Comp. Zoöl., vol. 37, no. 2.) Finally, Agassiz and Mayer (Mem. M. C. Z., vol. 26, no. 3, 1902) figure *Nausithoe punctata* var. *pacifica* and *Nausithoe picta* with them in the tentacular radii.

In our specimens the arrangement was as follows. The four angles of the mouth, and the four groups of gastric cirri which alternate with them, are in the radii of the eight marginal sense organs. The eight gonads lie in the radii of the eight tentacles. There are thus sixteen distinct radii, eight tentacular, in which lie the eight gonads, and eight ocellar, corresponding to the four groups of gastric cirri, and the four arms of the cruciform mouth. This agrees with Haeckel's statement and Mayer's description.

The bell is flat, of the Ephyra-like outline typical of the genus, seven to nine mm. in diameter. There are eight stiff, solid tentacles arising from the clefts between the eight marginal lobes. Each marginal lobe is subdivided into two lappets, and between each two lappets there is a sense organ. Each sense organ contains a spherical otocyst and a proximal dark-brown ocellus, provided with two nerve fibres and a lens. The mouth is cruciform, and alternating with the arms of the cross there are four groups of gastric cirri, from two to five in each group. The eight gonads are pale reddish-brown. There is a ring of circular muscle fibres, occupying most of the subumbrella between the bases of the tentacles and the periphery of the stomach, and a strand of radial fibres runs from near the stomach out into each of the sixteen marginal lappets.

Seven specimens of different ages. December 26, Male atoll, near Male island, surface. January 2, Suvadiva atoll, near Dandu island, surface.

This form is very close to *Nausithoe punctata*, from which it differs only in the brighter color of the gonads, and the rarity of yellow pigment spots on the exumbrella, features of which the systematic importance is too slight to warrant the establishment of a new variety.

## III. SIPHONOPHORAE.

*Porpita lutkeana* BRANDT.

Brandt, 1825, Mem. Acad. Imp. St. Petersbourg Sci. nat. ser. 6, tome IV.

Plate 7, Figs. 24, 25, 26.

It is with considerable hesitation that I refer our specimens of this genus to the *Porpita lutkeana* of Brandt, which seems, however, to fit them better than any other described species of *Porpita*. The Pacific and Indian forms of the genus have always been in confusion, owing to the fact that most of the early descriptions are altogether insufficient for identification. Haeckel (*Siphonophorae* of the "Challenger" Expedition) recognizes, besides the well-known Atlantic forms, *Porpita lutkeana* Brandt, to which he gives the synonym, *Porpita indica* (see *ibid.*); *Porpita pacifica* Lesson = *Porpita gigantea* Péron et Lesueur; *Porpita australis* Haeckel (*System der Siphonophoren*); and *Porpita fungia* Haeckel (*Siphonophorae* of the "Challenger" Exped.).

*Porpita lutkeana* agrees in general with our specimens, although Brandt's description is so meagre that an accurate determination is very difficult.

The disc, in the largest specimen, measured forty-five mm. in diameter and five mm. in thickness. The upper, external surface of the exumbrella bears a series of minute knobs and corrugations, making it rough to the touch. The central chamber and the eight primary radial chambers are large, and communicate with the exterior by prominent stigmata. Over the rest of the exumbrella the stigmata are very irregularly arranged. There are thirty-two circular partitions, at nearly equal distances, dividing the pneumatocyst into as many circular chambers, which are in communication with each other through openings in the circular partitions. The floor of the float cavity is thrown into a series of deep radial furrows and ridges, which interlock with the underlying ridges and furrows of the liver. These corrugations arise at the centre as eight folds, which by branching come to number about sixty. In addition to these and alternating with them, a series of shorter folds, arising at the periphery, runs centripetal for a short distance between the original centrifugal ridges, making the total number at the margin about one hundred and twenty.

The liver is of considerable thickness, completely filling the space between the bottom of the float cavity and the lower surface of the disk, where it communicates with the bases of the reproductive polypites.

There are about two hundred tentacles, arranged in about four or five concentric rows, instead of the nine rows described by Brandt. When fully extended they are about as long as the diameter of the disc. Each tentacle bears three distinct rows of knobs, in the manner typical of the genus. At the tip of the tentacle there is a cluster of four, and this number appears invariable. In each row there are about ten knobs.

The central sterile polypite is large, with smooth walls, and very distensible.

The remainder of the lower surface of the disc, between the central polypite and the tentacular zone, is completely covered by the long, slender feeding and reproductive polypites, bearing at their bases clusters of Medusae in all stages of development. These Medusae agree very well with the figures given by Alexander Agassiz for *Porpita linneana*. (Mem. Mus. Comp. Zoöl., vol. 8, no. 3.) Scattered among the reproductive polypites are a few of larger size, which seem to be sterile. Their heads are rounded and surrounded by four clusters of nettle cells. Our preserved specimens are unfortunately too imperfect to allow of histological investigation, so I have been unable to trace the number or position of the tracheae.

The characteristic external features of this species are: first, its intense Prussian blue color; second, the large size and extreme flatness of the disc; third, the shortness of the tentacles, and fourth, the great length of the feeding and reproductive polypites.

#### ***Diphyopsis appendiculata* AGASSIZ and MAYER.**

*Diphyes appendiculata* Eschscholtz, 1829, Syst. der Acalephs, p. 138, taf. 12, fig. 7.

*Diphyes appendiculata* Huxley, 1859, Oceanic Hydrozoa, p. 34, plate 1, figs. 2-2c.

*Diphyopsis appendiculata* Agassiz, A., and Mayer, A. G., 1899, Mem. Mus. Comp. Zoöl., vol. 26, no. 3, p. 160, plate 9.

A species of *Diphyopsis*, apparently identical with the *Diphyopsis appendiculata* of Agassiz and Mayer, was one of the most abundant Acalephs in the tow, and was taken at almost every station. The only distinction between it and the Pacific variety is that all our specimens were colorless, instead of having the polypites and nematocyst batteries yellowish or pinkish.

#### ***Physalia megalista* PÉRON ET LESUEUR.**

*Physalia megalista* Péron, F., et Lesueur, C. A., 1807, Voyage aux terres Australes, Mollusques et Zoophytes, plate 29, fig. 1.

*Physalia megalista* Haeckel, E., 1888, "Challenger" Report, Zoöl., vol. 28.

One specimen of *Physalia* belonging to this species was taken on January 19, off Tiladummati atoll. The pneumatocyst measured twenty-five mm. in length and was deep Prussian blue in color.

### III. CTENOPHORAE.

#### ***Bolina ovalis*, sp. nov.**

**Plate 8, Fig. 28.**

This species appears closely allied to *Bolina microptera* A. Agassiz (N. Amer. Acalephs, 1865), and may prove to be identical with it. But the

absence of figures of *B. microptera* leaves me in doubt. The animal is about fifty mm. in length, and in the broad diameter nearly half as wide. In general outline it resembles *Bolina vitrea* rather than *Bolina septentrionalis* Mertens. The lobes are, however, at least one third shorter than in *Bolina vitrea*, and the digestive cavity is proportionately longer, one third longer than the lobes. The auricles are similar in shape to those of *Bolina vitrea*. The apical sense organ is situated at the bottom of a deep cleft, and is provided with a series of radiating muscle fibres. There are from fifteen to eighteen vibratile combs in each of the short, and thirty to thirty-five in each of the long ciliary bands. Unfortunately in our single specimen the lobes were so damaged that the course of the chymiferous tubes could not be traced with accuracy. Enough, however, remained to show that they were no more complicated than in *Bolina vitrea*. This is the only point in which it disagrees with A. Agassiz's description of *Bolina microptera*.

#### *Bolina*, sp. ?

On January 19, near Guradu Island, we took a single immature Ctenophore, which is probably a young *Bolina*. It is in the Pleurobrachia stage, figured by Chun (Mon. Ctenophoren), but the lateral lobes have already begun to appear, and the tentacles are short. The rows of vibratile combs extend nearly to the bases of the lobes. The mouth is a simple slit.

#### *Ocyroe pteroessa*, sp. nov.

##### Plate 8, Fig. 29.

The polar diameter of the animal is about twenty-five mm. The body is so much flattened that the narrow diameter is only one half the broad. The lateral lobes form large wing-like structures, one third longer than the polar diameter. The movements of the animal are effected by their vigorous flappings. The ciliated bands are short, containing but few combs. The auricles are short, being only one half as long as the polar diameter, and are always pointed upward. Their edges are lined with a series of stout cilia, set at considerable intervals. The digestive cavity is large, variable in form, but is not normally lobed. The windings of the chymiferous tubes are simple, much more so than in *Ocyroe crystallina*. The "spots" so characteristic of the lobes of *Ocyroe maculata* are wanting, but most of the substance of the lobes is occupied by stout muscle fibres which radiate to the periphery.

*Ocyroe pteroessa* is most closely allied to *Ocyroe crystallina* Rang, of which Fewkes and Mayer both give good figures (Bull. Mus. Comp. Zool., vol. 9, plate 1, and Bull. Mus. Comp. Zool., vol. 38, plate 31), but differs from it in several important particulars. The lobes are proportionately larger, the body narrower, the auricles very much shorter, about one half as long. The outline of the stomach is simple instead of lobed, and it is much shorter. The



windings of the chymiferous tubes are much less complex, and the muscle fibres occupy more nearly the whole substance of the lobes.

*Beroe*, sp.

One young specimen of this genus was taken on January 19, near Guradu island, on the surface. It had arrived at nearly mature form, except that the rows of vibratile combs extended only about halfway from the apical pole to the mouth. The chymiferous tubes were put into communication by an extremely simple network similar to that described by Agassiz and Mayer for *Beroe australis* (Bull. Mus. Comp. Zoöl., vol. 32, p. 177, plate 16). It may be the young of that species.

*Cestus pectenalis*, sp. nov.

Plate 8, Fig. 30.

A species of *Cestus* was exceedingly abundant on January 19, on the surface near Guradu island, and on examination proved to be a wholly distinct species. In general form, as well as in its movements, it closely resembles *Cestus veneris*, but differs from it in the possession of a large and prominent orange spot at either end, and in the extent and structure of the ciliary bands. These extend from near the apical sense organ along the aboral edge of the band, following the chymiferous tube to the extremity of the lobe. They do not extend along the oral edge of the lobe, but come to an end at its extremity. The vibratile combs are comparatively few in number, and set at considerable distances from one another. The cilia are very long and rigid, presenting a comb-like appearance. The lateral flattening of the animal is excessive. The digestive cavity is broad, but short. The longest specimen captured measured one metre, by forty mm. in breadth; but the size was very variable. No *Cestus* with pigment patches has ever been described, and the comb-like structure of the ciliary bands, and their restriction to the aboral edge of the animal, are of even greater importance. It seems probable that further investigation may prove them to be of generic significance. Like *Cestus veneris*, this species is extremely graceful in the water, moving in slow, ribbon-like undulations, and shining with brilliant violet iridescence.

## EXPLANATION OF PLATES.

---

*oc.*, otocyst; *m. s.*, marginal sense organ.

---

## PLATE 1.

- Fig. 1. *Euphysa tetrabrachia*.  
 Fig. 2. *Oceania brunescens*.  
 Fig. 3. " *virens*.  
 Fig. 4. " " bell margin.  
 Fig. 5. *Eirene danduensis*, bell margin.

## PLATE 2.

- Fig. 6. *Eirene danduensis*.  
 Fig. 7. *Eutimeta lactea*.  
 Fig. 8. " " bell margin.  
 Fig. 9. *Aglaura octagona*.

## PLATE 3.

- Fig. 10. *Timoides agassizii*.  
 Fig. 11. " " bell margin.

## PLATE 4.

- Fig. 12. *Gonionemus pelagicus*.  
 Fig. 13. " " bell margin.  
 Fig. 14. " " tip of tentacle.  
 Fig. 15. *Liriope hemisphericus*.  
 Fig. 16. " " bell margin.

## PLATE 5.

- Fig. 17. *Liriope indica*.  
 Fig. 18. " " bell margin.  
 Fig. 19. *Pegantha simplex*.  
 Fig. 20. " " oral view.

PLATE 6.

- Fig. 21. *Nausithoe punctata*.  
Fig. 22. *Aurelia maldivensis*, radial canals, showing one octant of subumbrella.  
Fig. 23. " " marginal sense organ.

PLATE 7.

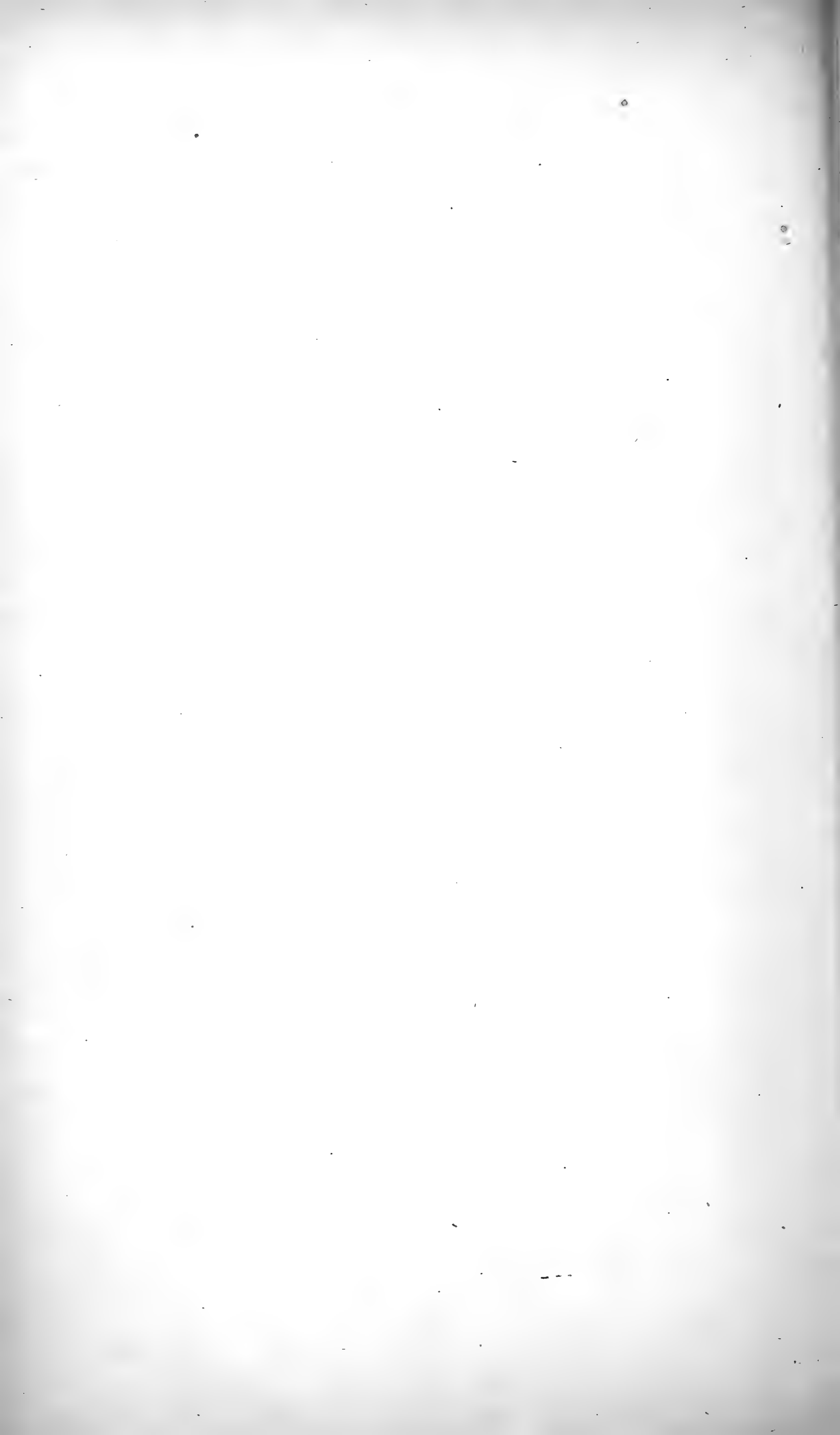
- Fig. 24. *Porpita lutkeana*.  
Fig. 25. " " vertical section of disk; *s*, central stigmata; *cav.*, central chamber; *c.*, circular partition; *R.*, white tubules; *H.*, brown hepatic tubules.  
Fig. 26. *Porpita lutkeana*, reproductive polypite with budding *Medusae*.

PLATE 8.

- Fig. 27. *Aurelia maldivensis*.  
Fig. 28. *Bolina ovalis*.  
Fig. 29. *Ocyroe pteroessa*.  
Fig. 30. *Cestus pectenalis*.

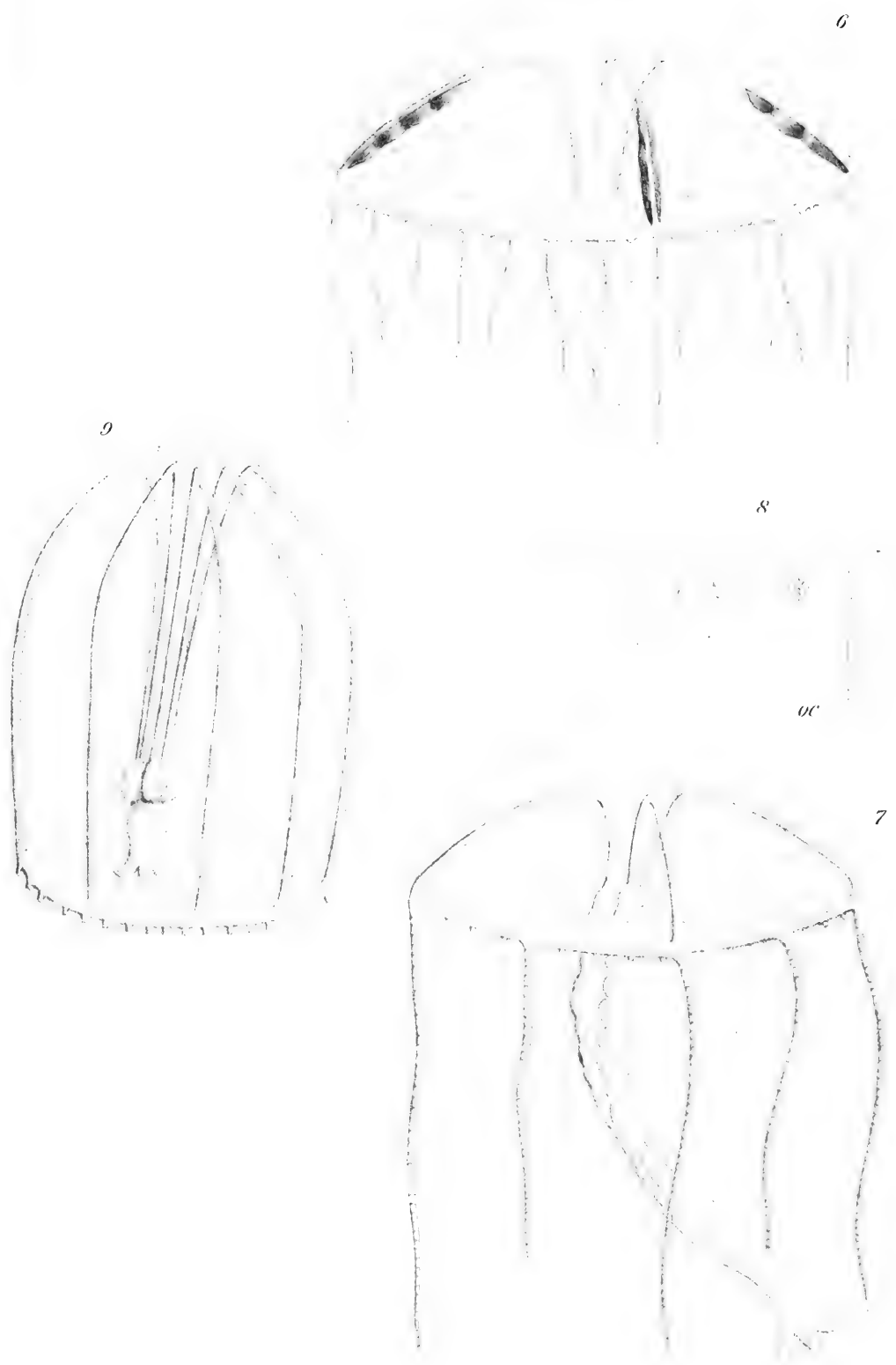
PLATE 9.

Chart of the Maldive Archipelago, showing the track of the "Amra."  
Reduced from Admiralty Charts 66 *a*, 66 *b*, 66 *c*; Sheets 1-3; Scale, 3.5" = sixty miles corrected to May, 1903. Northern, Central, and Southern Maldives.



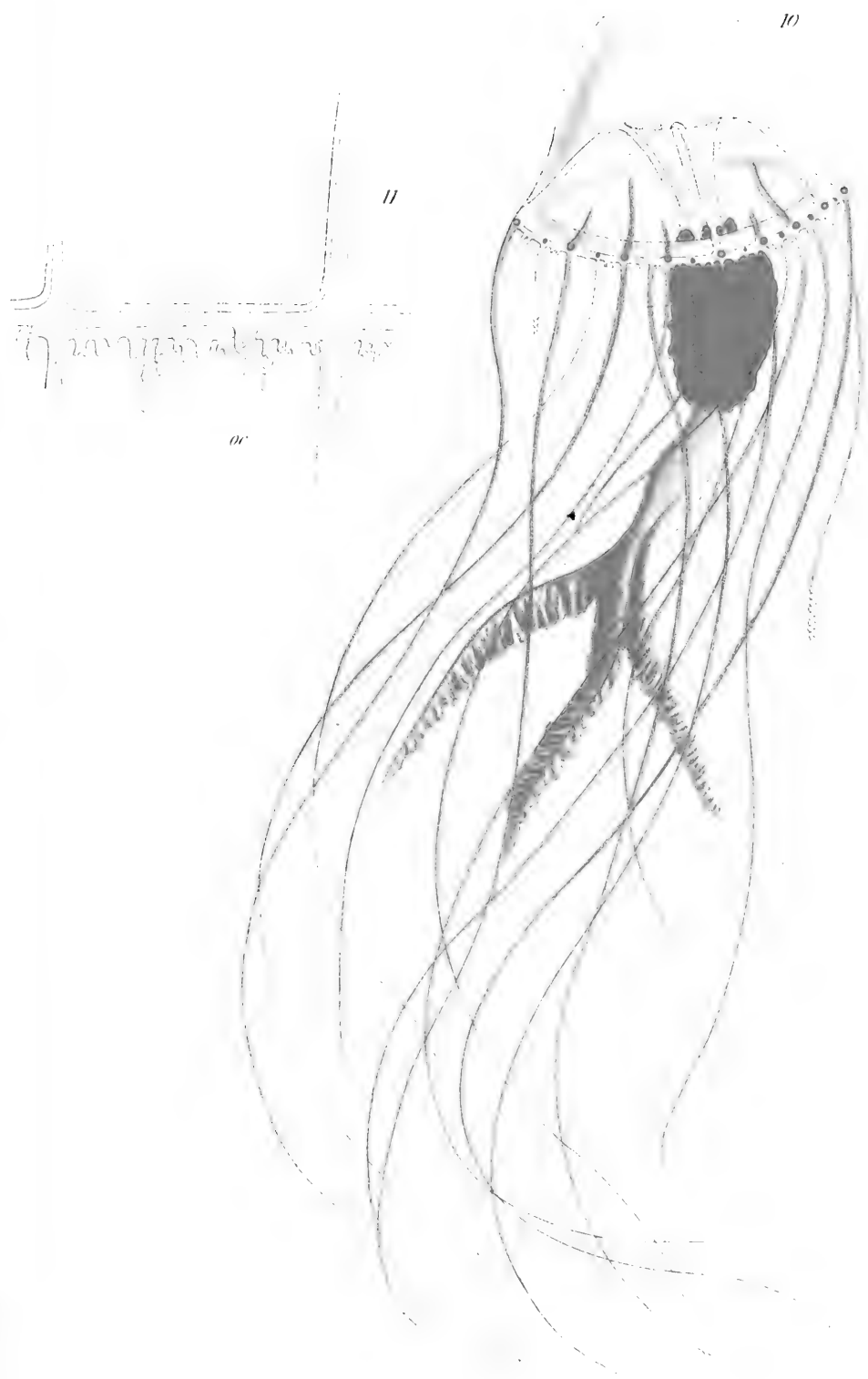




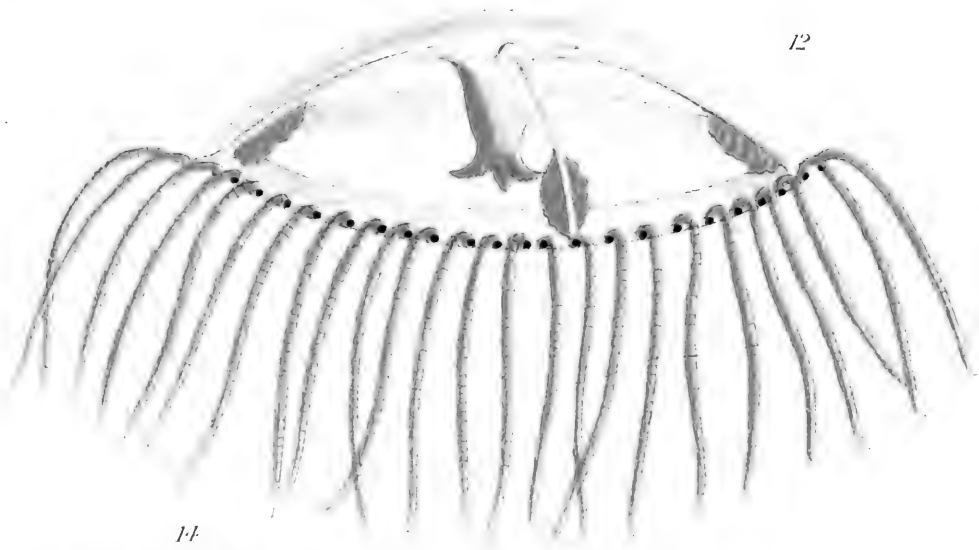




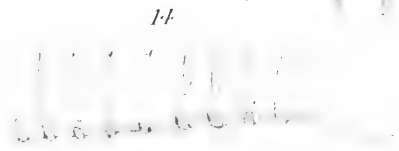




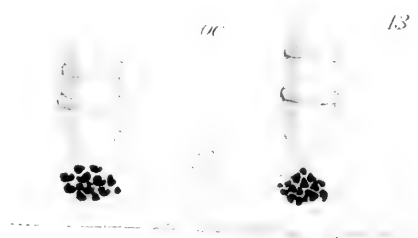




12



14



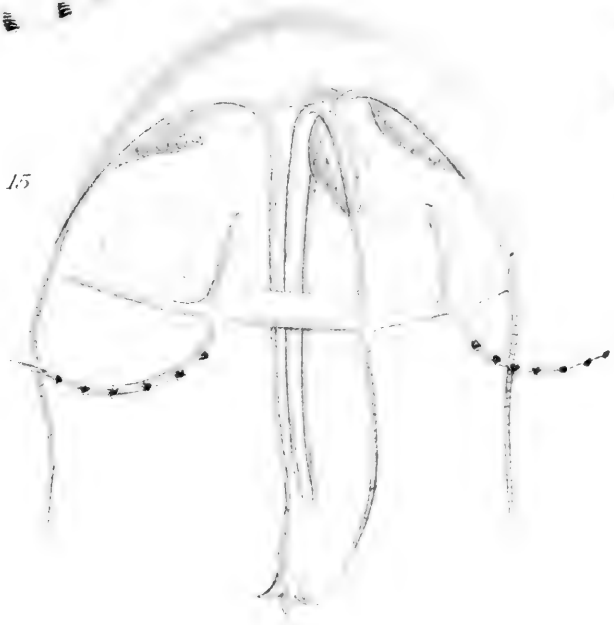
or

13

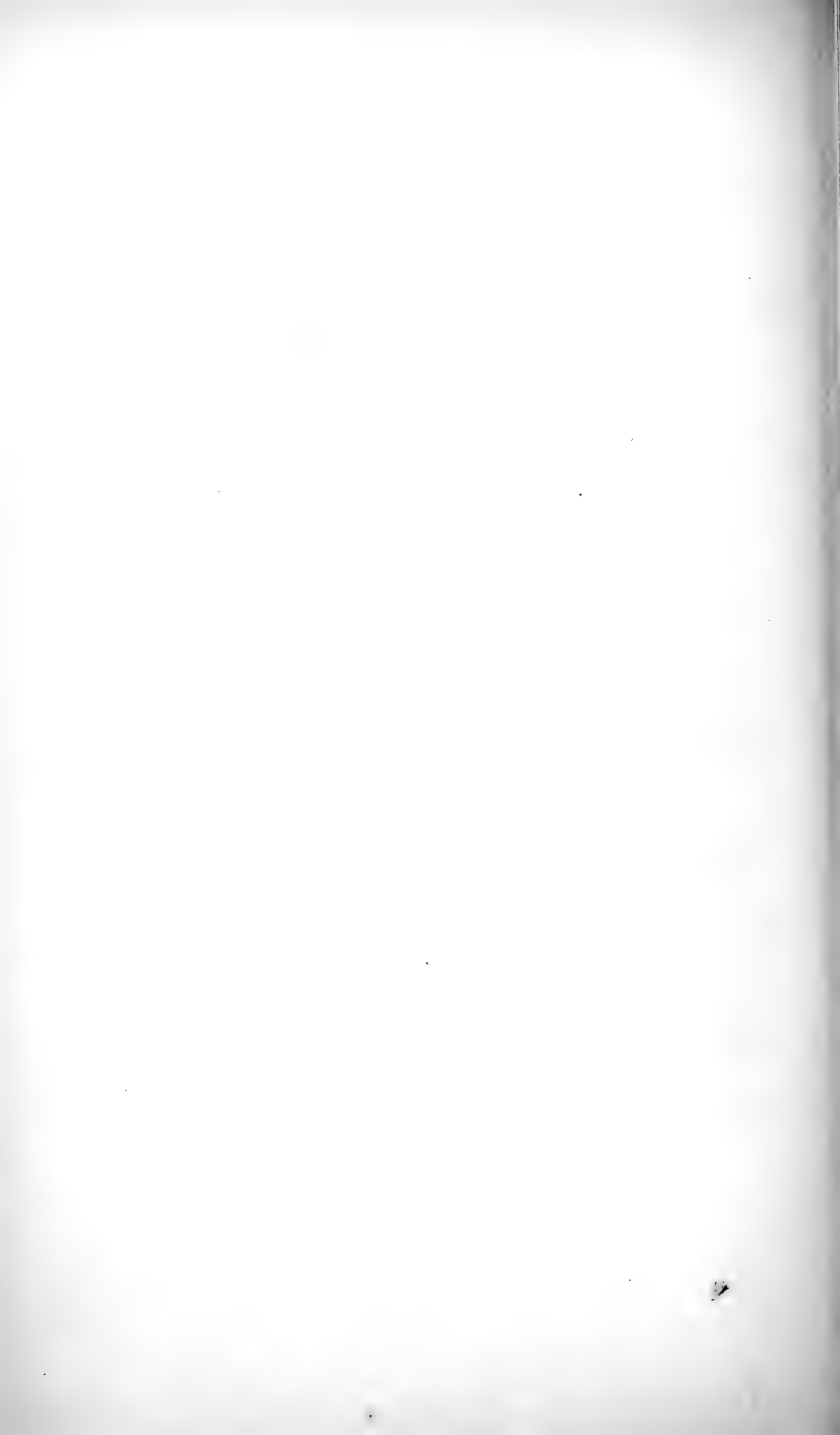


or

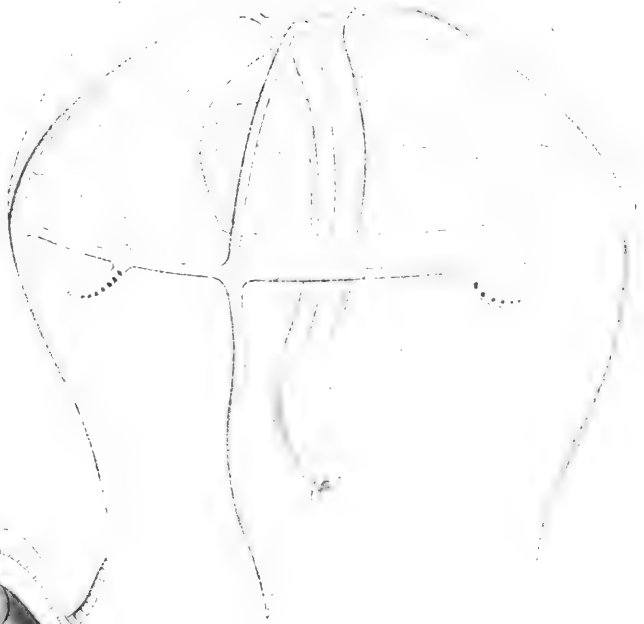
16



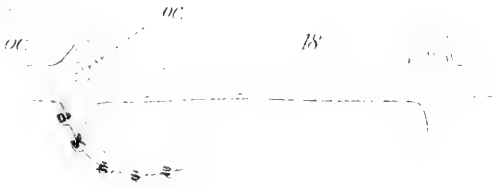
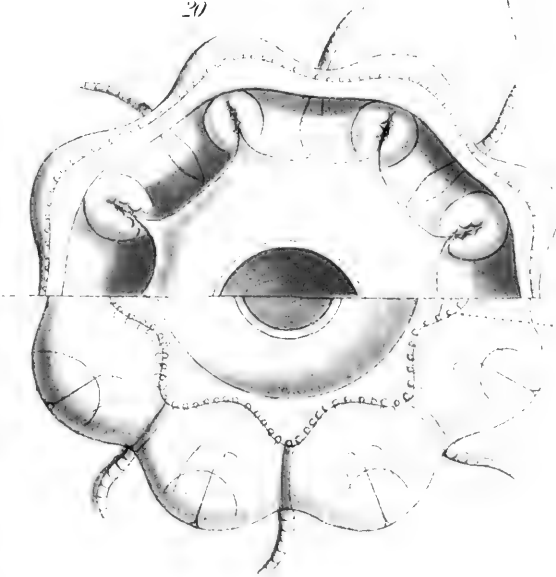
15



17



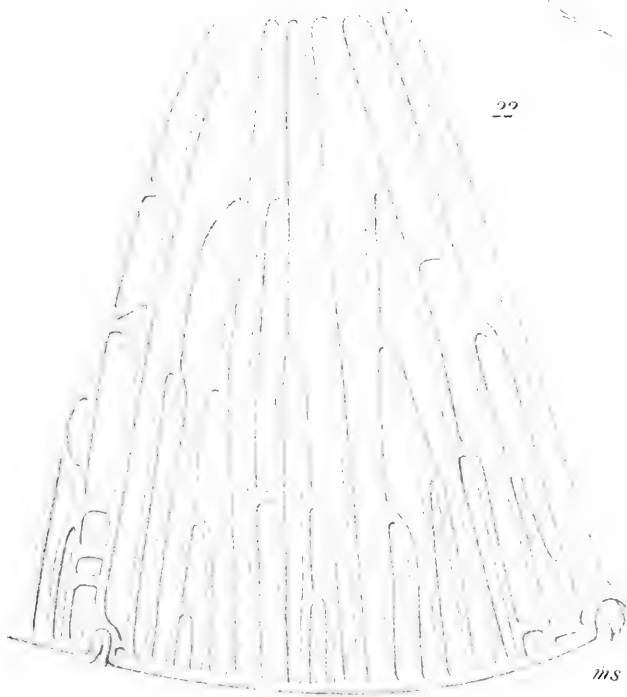
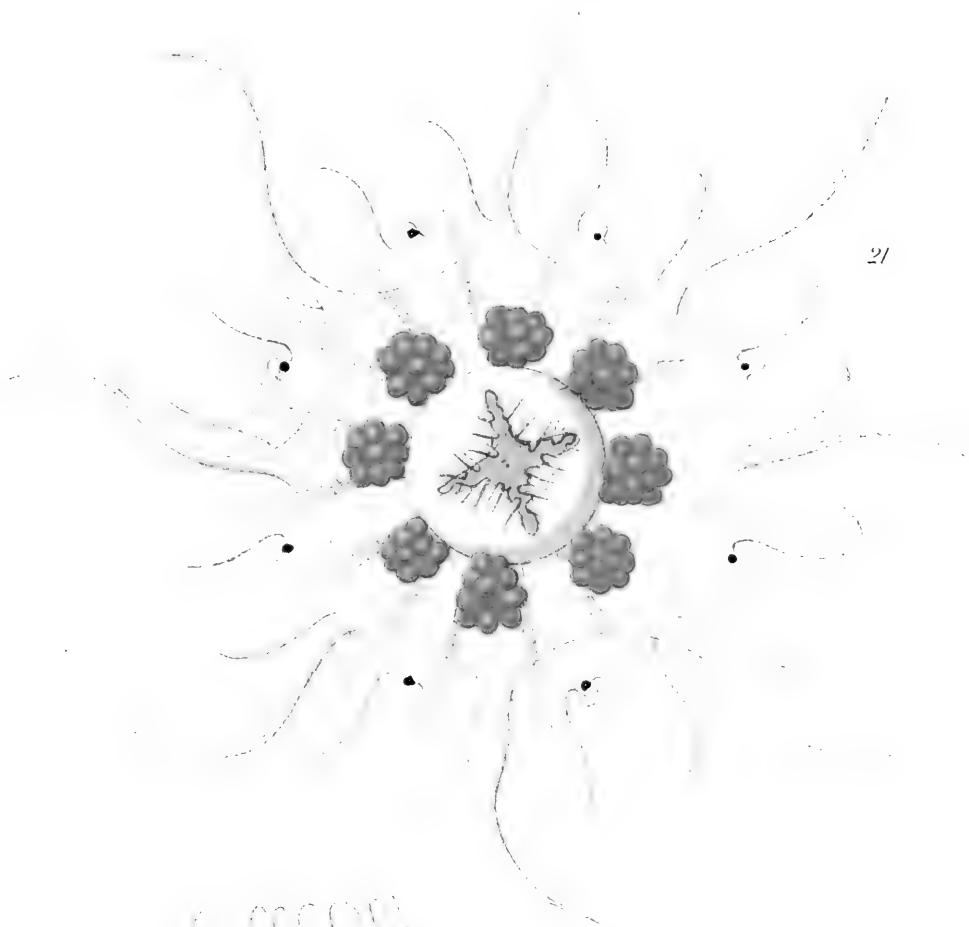
20



19

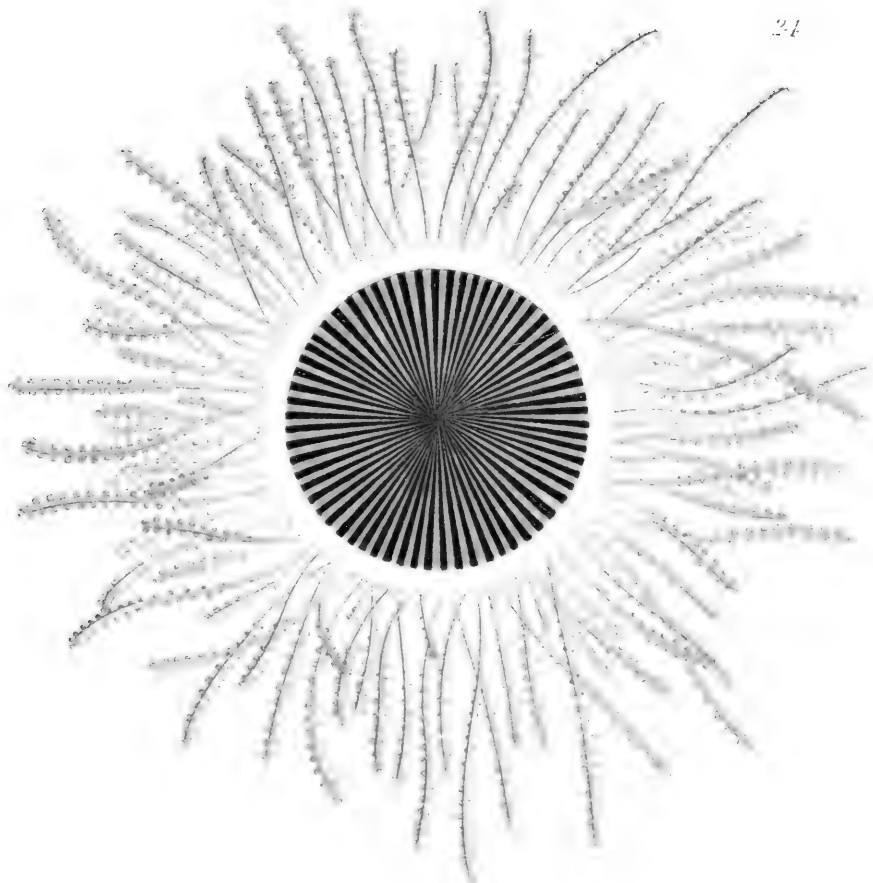






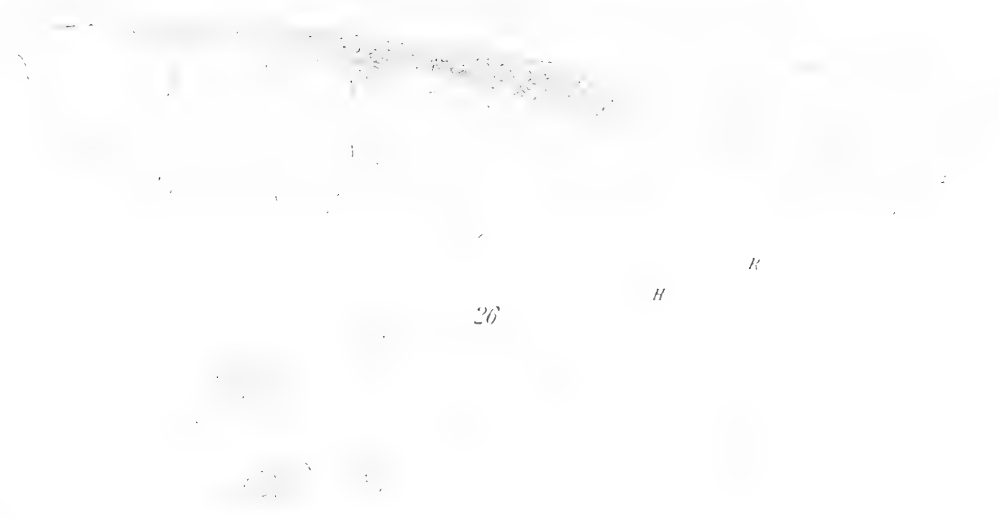






24

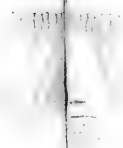
s  
cur  
c  
25



26

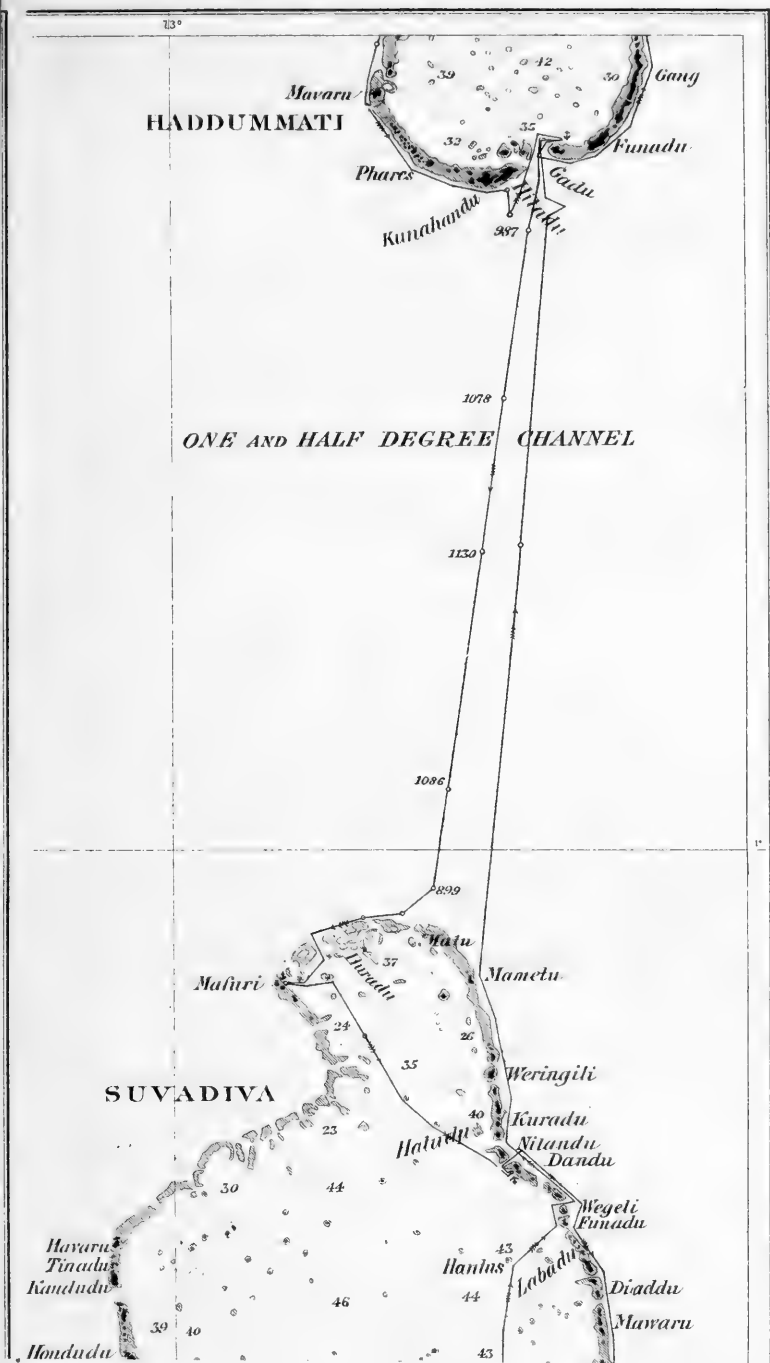
H  
R







SOUTHERN MALDIVES





# BULLETIN

OF THE

## MUSEUM OF COMPARATIVE ZOÖLOGY

AT

HARVARD COLLEGE, IN CAMBRIDGE.

VOL. XL.

---

CAMBRIDGE, MASS., U. S. A.

1902-1903.

UNIVERSITY PRESS:  
JOHN WILSON AND SON, CAMBRIDGE, U. S. A.

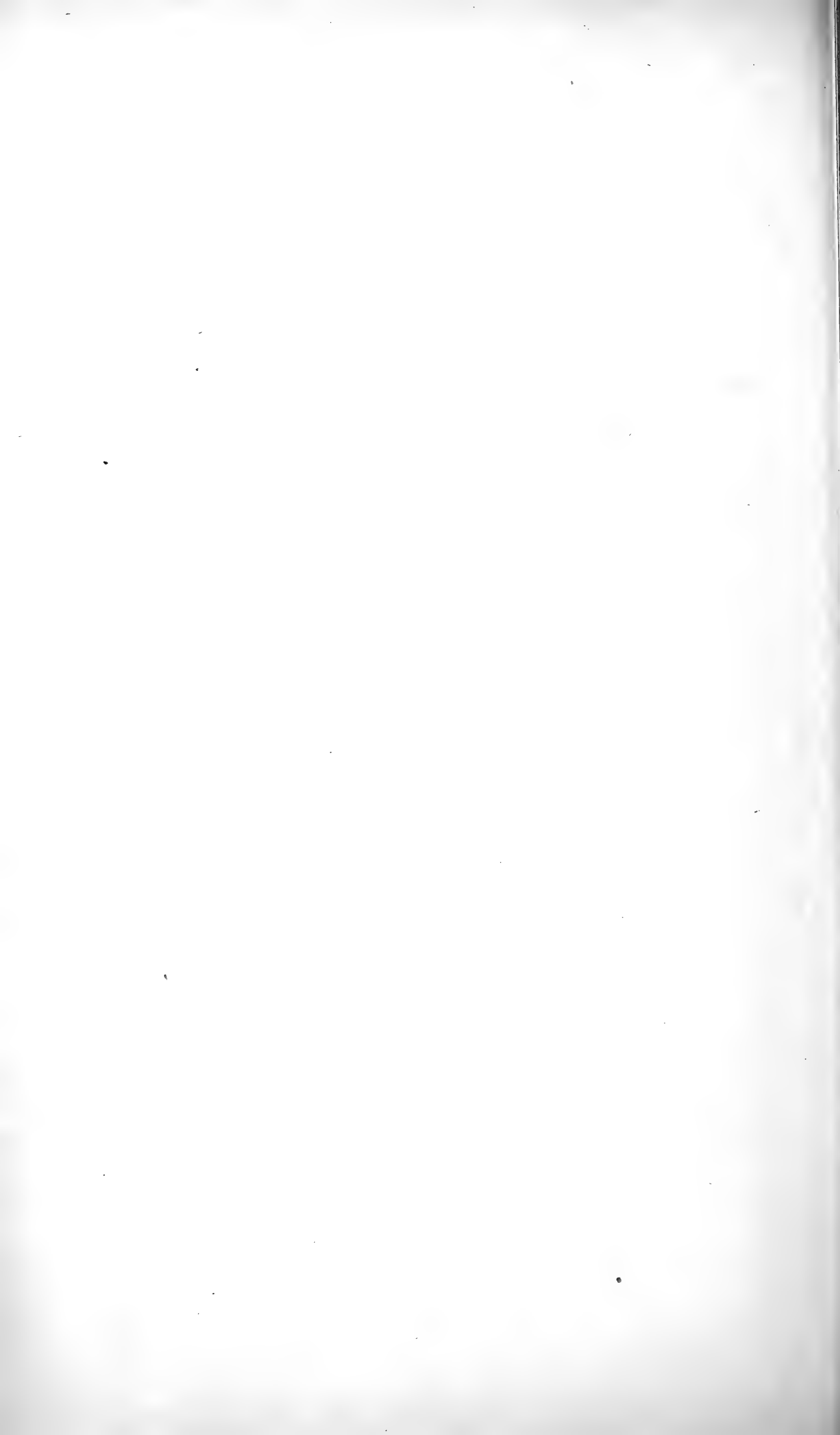


# CONTENTS.

---

CONTRIBUTIONS FROM THE ZOÖLOGICAL LABORATORY OF THE  
MUSEUM OF COMPARATIVE ZOÖLOGY AT HARVARD  
COLLEGE, UNDER THE DIRECTION OF E. L. MARK.

	PAGE
No. 1. — Changes accompanying the Migration of the Eye and Observations on the TRACTUS OPTICUS and TECTUM OPTICUM in PSEUDOPLEURONECTES AMERICANUS. By STEPHEN R. WILLIAMS. (5 Plates.) May, 1902 . . .	1
No. 2. — The Early Development of LEPAS. A Study of Cell-Lineage and Germ Layers. By MAURICE A. BIGELOW. (12 Plates.) July, 1902 . . .	59
No. 3. — The Development of the Definitive Feather. By R. M. STRONG. (9 Plates.) October, 1902 . . . . .	145
No. 4. — The Heredity of Sex. By W. E. CASTLE. January, 1903 . . . .	187
No. 5. — The Optic Chiasma in TELEOSTS and its Bearing on the Asymmetry in the HETEROSOMATA (Flatfishes). By G. H. PARKER. (1 Plate.) January, 1903 . . . . .	219
No. 6. — POLYDACTYLISM in Man and the Domestic Animals, with especial reference to Digital Variation in Swine. By C. W. PRENTISS. (22 Plates.) April, 1903 . . . . .	243
No. 7. — The Changes which occur in the Muscles of a Beetle, THYMALUS MARGINICOLLIS CHEVR., during Metamorphosis. By ROBERT S. BREED. (7 plates.) October, 1903 . . . . .	315



Bulletin of the Museum of Comparative Zoölogy

AT HARVARD COLLEGE.

VOL. XL. No. 1.

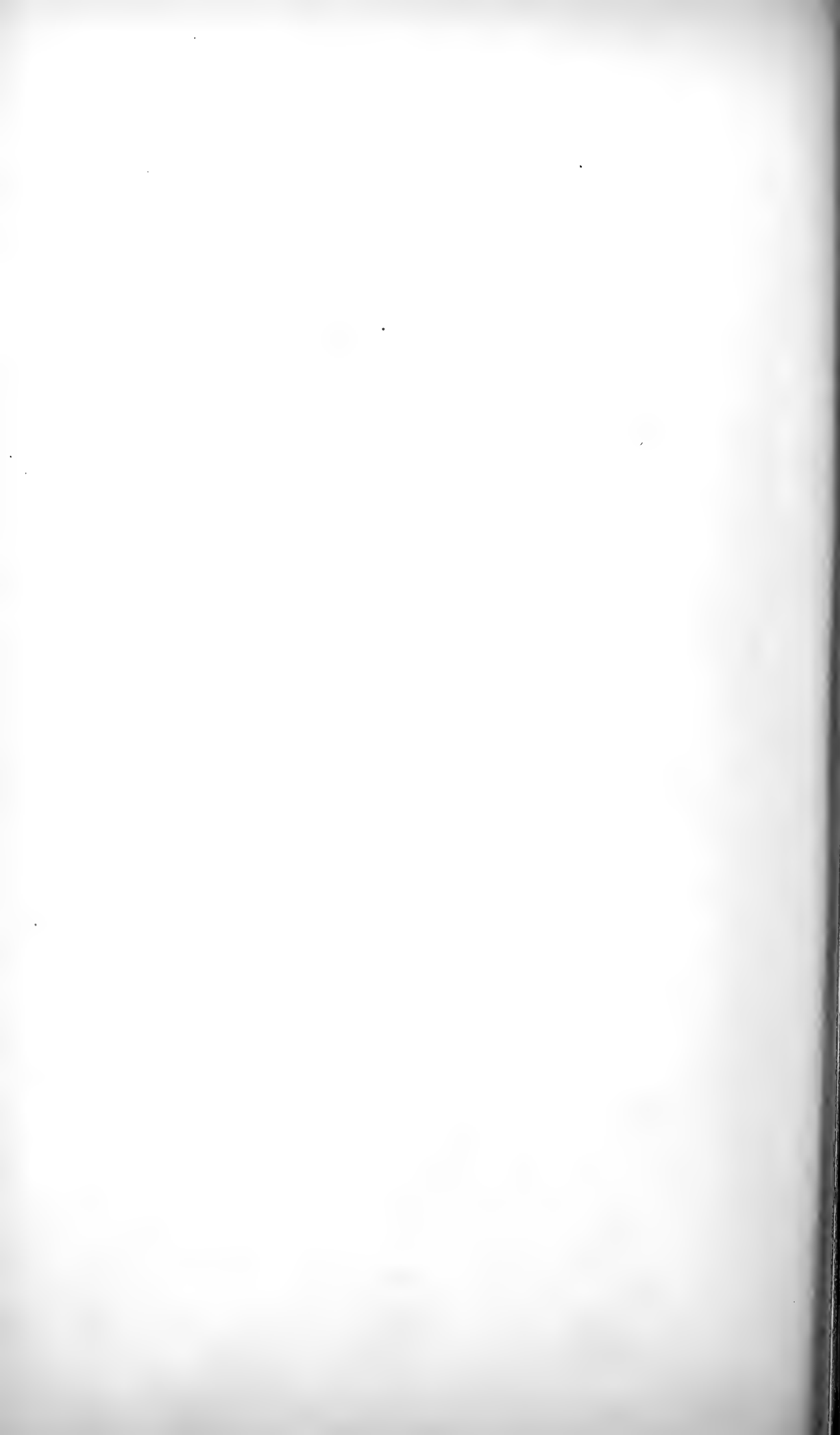
---

CHANGES ACCOMPANYING THE MIGRATION OF THE EYE  
AND OBSERVATIONS ON THE TRACTUS OPTICUS AND  
TECTUM OPTICUM IN PSEUDOPLEURONECTES  
AMERICANUS.

BY STEPHEN R. WILLIAMS.

WITH FIVE PLATES.

CAMBRIDGE, MASS., U. S. A. :  
PRINTED FOR THE MUSEUM.  
MAY, 1902.



No. 1—CONTRIBUTIONS FROM THE ZOÖLOGICAL LABORATORY OF THE MUSEUM OF COMPARATIVE ZOÖLOGY AT HARVARD COLLEGE, UNDER THE DIRECTION OF E. L. MARK, No. 130.

*Changes accompanying the Migration of the Eye and Observations on the Tractus opticus and Tectum opticum in Pseudopleuronectes americanus.* By STEPHEN R. WILLIAMS.

TABLE OF CONTENTS.

	PAGE		PAGE
I. Introduction . . . . .	1	f. Comparison of Bothus with Pseudopleuronectes americanus . . . . .	28
II. Material . . . . .	2	g. Discussion of Pfeffer's work . . . . .	30
III. Methods . . . . .	6	h. Résumé . . . . .	32
IV. Migration of the eye and changes in the cartilaginous skull . . . . .	6	V. The optic portion of the central nervous system . . . . .	33
1. Summary of previous studies on the migration of the eye . . . . .	6	1. General condition in the adult . . . . .	33
2. Description of stages . . . . .	9	2. The optic nerves . . . . .	35
3. Homologies of the anterior bones of the skull . . . . .	11	3. The chiasma and tracts with related ganglia . . . . .	37
4. Changes in the cartilaginous skull . . . . .	15	4. The tectum opticum . . . . .	40
a. Stage I. . . . .	15	VI. Theoretical considerations . . . . .	47
b. " II. . . . .	16	VII. Summary . . . . .	49
c. " III <i>a</i> . . . . .	19	Bibliography . . . . .	51
d. " III <i>b</i> . . . . .	22	Explanation of Plates . . . . .	56
e. " IV. . . . .	25		

I. Introduction.

THE strange want of symmetry in the head region of flounders has attracted much attention especially because in adults both eyes occupy the same side of the head. The peculiarity is the more remarkable because, for some time after hatching, the eyes and all other parts of the head are as symmetrical as in any other fish, and consequently this asymmetrical condition is brought about afresh in the individuals of each generation, instead of once for all, as is the case with most variations.

Regarding the migration of the eye, with a single exception (Pfeffer, '86, '94), only such phenomena have been recorded as can be observed from surface study or dissections. It has seemed desirable therefore to

learn from careful preparations of specimens in transition stages whether there was merely a mechanical twisting of the facial region in an otherwise normal fish, or a more elaborate rearrangement of the parts with reference to each other, and especially whether any histological changes accompany the more obvious external modifications.

## II. Material.

The most of my work has been on the so-called winter flounder (*Pseudopleuronectes americanus* Walbaum), a dextral flatfish, but I have also used for the sake of comparison a sinistral species, the sand-dab (*Bothus maculatus* Mitchill).

My material was all collected at Wood's Hole, Mass., during the years 1898 and 1899. I obtained a series of developing eggs and young *Pseudopleuronectes* from the hatchery of the United States Fish Commission in April, 1898. Adult fishes can be taken by nets at any time through the year. The larval stages at or about the time of the migration of the eye are to be obtained during the month of June only. Early in the month only a few are at the point of assuming the adult position, and after June 20th, all the fish of this species taken were already metamorphosed.

These larvæ were caught by surface towing with a coarse scrim tow-net near the wall of the "outer basin" of the U. S. F. C. wharf during the rising tide. They are most abundant on clear days when the wind is on shore and the tide comes in from the east. On very calm or very rough days they are not plentiful. My most successful skimmings were made early in June, and twice I obtained as many as 100 young fish during the inward flow of the current (3-4 hours). I was able to save a few of the young fish alive by frequently emptying the tow-net and placing the uninjured specimens in as pure water as possible.

In the summer of 1898 the sand-dab larvæ were taken more abundantly than the winter flounders, while in 1899 the winter flounders were about ten times as numerous as the sand-dabs.

I kept the young fish in the "outer basin"<sup>1</sup> in large lamp chimneys,

<sup>1</sup> The granite inclosure for the protection of smaller boats belonging to the United States Fish Commission is divided by projecting parts of the dock into the "inner" and "outer" basin. There are numerous openings in the stone walls to allow the free circulation of the water, and near one of these the float was moored, thus securing as nearly normal conditions of water and food as consistent with protection from violent wave action.

which were made into separate aquaria by tying netting over the ends and were supported by a floating frame. After they had remained here for a time they were removed to the laboratory and kept under observation in running water.

The period at which the eye turns is one of great mortality among the young fish captured, so that most of those in this stage died before removal from the net. Since there is as yet no bony orbit, the eyes are absolutely unprotected. As the eye which is to change its relative position must for a time be on the dorsal side of the head, held in position merely by the skin and a limited amount of connective tissue, it is not strange that in a number of instances young fish were taken alive which had lost the migrating eye some time before their capture.

The actual turning is a comparatively rapid process in the species I have observed, though, as will be seen later, a long preparation is made for it. For instance, those fishes taken in which the migrating eye had reached the sagittal plane of the head swam in an upright position, though they came to rest more often on the future eyeless side. *Within three days* after the capture of a fish in this stage both the orientation in swimming and the position of the eyes became essentially that of the adult.

The growth of the fish after turning is rapid. A sand-dab measuring 10 mm. in length and 5 mm. in depth (*i. e.*, the measurement taken along the dorso-ventral axis) was confined in a lamp-chimney aquarium for 11 days and then was found to measure 22 mm. in length and 12 mm. in depth. If the third dimension, the breadth or thickness of the fish, be assumed to increase in the same proportion, which is a reasonable assumption, the volume of this individual increased more than ten-fold during the 11 days. The winter flounder of corresponding stages, according to my observations, does not grow quite so rapidly. It reaches a length of about 75 mm. by the end of August, when it is at most 7 months old.

There are six species of flatfishes comparatively common at Wood's Hole, according to Smith ('98). Three of these, *Pseudopleuronectes americanus*, *Limanda ferruginea*, and *Achirus fasciatus*, are dextral (*i. e.*, the fish lies normally with the right side uppermost), and three, *Paralichthys dentatus*, *Paralichthys oblongus*, and *Bothus maculatus* are sinistral.

Of these six species, *Paralichthys dentatus* probably breeds in the open sea, as small fish are not found. *Paralichthys oblongus* and *Bothus*

breed in May and the sole about the end of June. I can find no account of the breeding time of *Limanda*. *P. americanus* breeds from the middle of February to the first week of April.

In the summer of 1899, when *P. americanus* was especially plenty, metamorphosed fish of two different lengths were taken in the tow. These were about equally abundant. The smaller measured not over 8-9 mm. at the end of metamorphosis. The larger was a more bulky fish with slightly more pigment and it was found swimming upright until it reached a length of 13-14 mm., when it also turned left side down. I found no specimen intermediate between the two lengths. The larger, more pigmented specimens may have been either the larvæ of the black-bellied variety or possibly the young of *Limanda*. The more important specific differences between *Limanda* and *Pseudopleuronectes* are the following: The anterior part of the lateral line of *Limanda* is more arched and this species has more fin-rays in both dorsal and ventral fins. But it is difficult in the young fishes to establish a satisfactory division on the basis of the number of fin-rays. According to Bumpus ('98), *P. americanus* at Wood's Hole averages 66.1 fin-rays to the dorsal and 49.6 to the ventral fin. Jordan and Evermann ('96-00) give for *Limanda* 85 dorsal and 62 ventral fin-rays. The specimens of *Limanda* I have counted at Wood's Hole vary from 81 to 78 in the dorsal and 61 to 47 in the ventral. I counted the fin-rays in six small fishes, three of each type, and found that in two of these—they belonged to the 14 mm. type—the rays corresponded to the formula for *Limanda*, and that in one (9 mm. long) they agreed with *P. americanus*, there being 64 dorsal and 47 ventral rays. The number of rays in the other three were absolutely intermediate, two (8.5 mm. long) having respectively 71-54 and 76-51 rays, the remaining one 75-56 rays.

The work of Kyle ('98) at the St. Andrews laboratory is valuable for comparison at this point. There are five dextral flounders on the Scotch coast which may be confused with one another. The ones most like our species are *Pleuronectes flesus*, the flounder, *P. platessa*, the plaice, and *P. limanda*, the dab. Of these, when metamorphosis is completed, the flounder is the shortest (about 8 mm., according to Petersen), the plaice next and the dab the longest. The plaice may vary in length from 13 to 16 mm.; the dab from 16 to 19 mm. at metamorphosis. In Danish waters (Petersen, '94, p. 14) the metamorphoses of these two species are complete when the fish is from 4 to 6 mm. shorter.

As the plaice and dab overlap each other in length, their fin formulæ were ascertained by Kyle in the hope of finding there a distinctive



character. These also overlap, the dorsals varying in both forms from 68 to 77 and the anals from 50 to 61, the dab usually presenting the higher number. The flounder has from 58 to 64 dorsal rays and from 38 to 46 anal rays.

*Pseudopleuronectes* is intermediate in the number of fin rays between *P. flesus* and *P. platessa*. It also turns at an intermediate length. Taking Petersen's figures for Denmark, *P. flesus* turns at 8 mm. and *P. platessa* at from 10 to 11 mm. The length at which my shorter larvæ turned was from 8 to 9 mm. No individuals longer than this were found metamorphosing until the length of about 14 mm. was reached.

*Limanda ferruginea* has more fin-rays than *P. limanda*. If I am correct in the assumption that the larger, more bulky fish, which turns at a length of 14 to 15 mm., is the young of *Limanda*, its length at metamorphosis would be intermediate between those found for *P. limanda* by Kyle and by Petersen.

If this fish is the young of *Limanda*, another problem would be solved. How is it that, with two such distinct sizes at metamorphosis, the small flatfishes seined a month later are about uniform in size? *Limanda* is a comparatively deep-water fish, being found in the deepest parts only of Vineyard Sound; the young may have returned by the last of July to the region where the adults live, so that there would be left only the young of the on-shore species, *P. americanus*.

That I took only a few specimens of these problematical coarser larvæ in June, 1898, and that half the larvæ taken in the same month of the next year were of this kind, leads me to believe that the breeding seasons of *P. americanus* and *Limanda* may not always exactly coincide. This question can very easily be settled by breeding the fish, and satisfactorily only in that way. It may be that the phenomena we have to deal with here are explainable in another way. Looss ('89) found that tadpoles metamorphosed in "waves," a part only of a brood changing at a time. There might be something of this sort here, metamorphosis at the one length or at the other depending on the advancement of development.

I wish to thank Mr. Alexander Agassiz for the privilege of occupying one of the Museum tables at the U. S. F. C. laboratory during parts of the summers of 1898 and 1899, and Mr. W. A. Willard for a number of brains of adult fishes. The work on the nervous anatomy was done, in part, under the direction of Dr. G. H. Parker. I am deeply indebted to Dr. E. L. Mark, at whose suggestion the work was undertaken, for useful advice and the supervision of the whole work.

### III. Methods.

The killing fluids used were (1) 10% formol, (2) Flemming's stronger fluid, (3) Vom Rath's picro-sublimate mixture, (4) bichromate of potassium, (5) Gilson's fluid, arranged in the order of their value. I failed to get successful preparations with Vom Rath's platinic chloride mixture. Where decalcification was necessary Flemming's mixture gave very good results. The usual methods of further procedure for sections by the paraffin process were used. Heidenhain's iron hematoxylin gave the best stain, though Delafield's and Ehrlich's hæmatoxylin also gave successful preparations. These were followed by Congo red or acid fuchsin to differentiate fibre tracts. The acid fuchsin has the further advantage that it stains developing bone and fibrous connective tissue. The Weigert stain with copper and the Weigert-Pal method were both used in nerve study. Both adult brains and the larvæ proved to be refractory material for the Golgi method. The rapid method was used, but not more than 5 per cent of the specimens gave any impregnation whatever. A sojourn of three days in the Golgi fluid and more than two in the silver bath were found to give the most successful preparations. Material was left in the silver until wanted for sectioning, though much of it was sectioned after an exposure of two days to the silver nitrate.

### IV. Migration of the Eye and Changes in the Cartilaginous Skull.

Before proceeding to describe the conditions which I have found in *Pseudopleuronectes americanus*, I shall give a brief account of the main results reached by previous observers, omitting for the present those of Pfeffer.

#### 1. SUMMARY OF PREVIOUS STUDIES ON THE MIGRATION OF THE EYE.

It was suggested about the middle of the last century, that the Pleuronectidæ, though unsymmetrical as adults, are, in their young stages, bilateral animals like other fish. The brief accounts of Van Beneden ('53) and Malm ('54), who found young fish quite similar in markings to adult flatfishes, but with eyes in a different position, seemed to indicate the possibility that one of the eyes migrated around the head from one side to the other.

The first paper which really describes a method of transition of the eye in flatfishes is that of Steenstrup ('63). According to Wyville Thomson ('65), on whose abstract of Steenstrup's paper I have relied (see also Steenstrup, '64), this author contends that the final position of the eyes cannot be explained as simply the result of a torsion of the front part of the head; and there is, in his (S.'s) opinion, a penetration of the tissues of the head by one of the eyes. This process Steenstrup described carefully from alcoholic specimens of different sizes of the young forms which he provisionally termed *Plagusia*. In this species development resulted in a sinistral flounder, *i. e.*, one in which the left side during adult life is uppermost. The right eye was slightly in advance of, as well as dorsal to, the left eye. The mouth became oblique toward the blind side, and the posterior part of the face, where the normal eye is located, seemed pressed "upward" toward the future eye-side. The right eye no longer projected from its own side of the head in a large orbit, but was deeply imbedded in the tissues, so that it had only a small orbit-opening on the right side. Later, an opening was made on the left side and for a time the eye had two orbits. The original orbit soon closed, and as the eye reached the surface level on the left side of the head the new orbit increased in size. This second orbit was described by Thomson as a bony one in the adult fish, being formed, so Thomson contended, by the frontal and prefrontal of both sides.

Schiödte ('68), working on other species, showed that the passage of the eye around the head is a normal method of development. The penetration of the eye through the tissues of the head is restricted to a few fishes whose larval forms were once considered adults, and given the name *Plagusia*.

He observed a *Pleuronectes platessa* — a dextral flounder — 10 millimetres long, of which he says, "The right eye stands over the beginning of the lower third of the maxillary bone. The left eye stands at the top of the head, so much inclined to the right that from the left side only slightly more than one-third of the pupil can be seen; it stands in front of the dorsal fin, so that the latter is just behind the end of the left and [the] beginning of the middle thirds of the eye." In a 14 mm. specimen the pupil of the left eye had become invisible from the left side and the dorsal fin touched the left margin of this eye, the foremost ray being a little in advance of the extreme posterior margin of the eye. In a 40 mm. fish the right eye had moved so that it stood over the lower end of its maxillary bone and the left eye had followed it, so that they were almost as close to each other as in the last stage, the left eye being

a little farther back than the right. In this specimen the dorsal fin reached as far forward as the middle of the left eye.

Schiödte held from these observations that the dorsal fin kept its position and that the left eye migrated forward around it and then passed backward to its final position. His implied argument, if I understand him rightly, is, that the right eye moves backward from a position over the lower (posterior) third of the maxillary bone to one over its lower (posterior) extremity, and that the left eye moves backward still further proportionally, because in the end (the 40 mm. specimen) it is not only above but "a little behind" the right eye. This conclusion was in his opinion confirmed by the observation that the rays in the dorsal fin of young specimens corresponded in number with those of the adult.

He described under the name *Bascanius tædifer*, n. s., a peculiar flounder (evidently sinistral), which had a semilunar depression between the right eye and dorsal fin. Here the body was so thin that, *if incautiously handled*, it broke in pieces or separated itself from the dorsal fin. In that case a part of the right eye appeared through the hole, giving the animal the appearance of possessing two eyes and a half.

Agassiz ('78) described definitely for the first time the two methods of development by which the eyes of flatfishes change position. His description of the method by migration *around* the head is briefly as follows (p. 5): "The first change—and the process is identical, whether we take a dextral or sinistral flounder—is the slight advance toward the snout of the eye about to be transferred. . . . This movement of translation is soon followed by a slight movement of rotation; so that, when the young fish is seen in profile, the eyes of the two sides no longer appear in the same plane,—that on the blind side being slightly above and in advance of that on the [future] colored side. With increasing age, the eye on the blind side rises higher and higher toward the median longitudinal line of the head; a larger and larger part of this eye becoming visible from the colored side where the embryo is seen in profile, until the eye of the blind side has, for all practical purposes, passed over to the colored side."

Later the dorsal fin finds its way forward toward the nose, dorsal to the transposed eye.

Agassiz also well described the method by penetration discovered by Steenstrup in *Plagusia*. The change was followed day by day in fishes kept captive in his Newport laboratory. He pointed out that these two methods are merely two extremes of the same process; probably the

peculiar fish described by Schiödte was an example of an intermediate method.

Only two other descriptions of intermediate methods of eye-transition need be noticed. Ehrenbaum ('96) has discussed, among other points, metamorphosis in the flatfishes of the German Ocean. Stages of the larvæ of the commoner species in which the eye passes around the head are given. In the larva of *Arnoglossus laterna*, which strongly resembles the so-called *Plagusia*, the dorsal fin extends to the nostril while the fish is yet symmetrical, so that the eye *must* pass under the dorsal fin as in *Plagusia*. The prolongation of the dorsal fin to the nasal pit and the position of the right eye close to the lower margin of the fin (after migration) prove, in Ehrenbaum's opinion, that the right eye is shoved through *under the dorsal fin* from the right to the left side.

Recently a Japanese zoölogist, T. Nishikawa ('97), found a case where the dorsal fin extended along the head as far as the end of the snout in close contact with, but not fused to, the skin. There were no fin rays located in the eye region. The right eye passed through a slit between the fin and the head in one day, passing thus from one side completely to the other. Unfortunately the fish died, so that it is not known whether the fin would have fused later to the dorsal part of the head or not.

## 2. DESCRIPTION OF STAGES.

For convenience of description four stages of development may be recognized in *Pseudopleuronectes americanus*.

Stage I., the recently hatched fish, is represented (Plate 1, Fig. 1) by a specimen 3.5 mm. long and 12 days old. Owing to its wide dorsal and ventral fins being so transparent as to be scarcely visible, the living animal resembles, in its general appearance, a very minute pin with an elongated head. It is essentially symmetrical. I have sectioned the eggs as well as the young fish and find a close resemblance to the figures given by Fullarton ('91) in his work on the development of the plaice, *Pleuronectes platessa*, which is the nearest European representative of our flatfish. His drawings, too, show the eyes to be symmetrical in position. There are few pigment cells in the body of an animal of this stage and they are arranged in much broken longitudinal lines.

The largest of the recently hatched fishes are nearly as long as the smallest of the pelagic larvæ (Stage II., Plate 1, Fig. 3), which were taken the first of June; but between the two there is a great difference

in depth and bulk. To this stage are assigned all those fishes which, in a strictly lateral view from either side, exhibit only one eye. The shorter, proportionately deeper, larvæ metamorphose when they reach 8 or 9 mm. in length. The degree of symmetry can better be seen in a front view (Fig. 4) of a fish 4 mm. long, the only trace of asymmetry at this stage being the slight elevation of the left nasal pit and the lack of absolute bilateral symmetry in the shape of the mouth. The upper lip is slightly drawn upward on the right side directly opposite the right nasal pit (*fv. olf.*).

Stage III. (Fig. 2) has been made to include those fishes in which the eye of the blind side had so far migrated as to be visible when the fish was viewed in profile from the ocular side. At this stage the eye lies in the median plane in a depression immediately in front of the dorsal fin, which has grown forward since the preceding stage. There is also a noticeable change in the direction of the urostyle<sup>1</sup> (*ur'stl.*).

In the last stage, IV., the eye has completed its migration, and, so far as regards the distortion of the head, the fish is essentially in the adult condition. Changes after this are merely accentuations of what is found here. Figure 6 shows the dorsal fin (*pin. d.*) at this stage extending as far forward as the middle of the eye. On the body are to be seen the beginnings of the pigment areas which later color the right side of the fish.

The sinistral fish, *Bothus*, is at first symmetrically pigmented. The lower side does not become colorless until the disappearance of the first color pattern and the establishment of the much lighter adolescent color, which comes after the turning. *P. americanus*, on the contrary, is essentially non-pigmented until it is ready to become a bottom feeder.

The front view of *P. americanus* at this stage (Fig. 5) — the completely turned fish — is most instructive in bringing out the want of symmetry. The left eye has moved through an arc of about 115 degrees, as may be seen by comparing this view with that of Stage II. (Fig. 4). The left nostril has moved dextrad and dorsad, as if in the passage of the eye it, too, had become involved. The angle of the mouth on the right side bends sharply ventrad; and the upper lip of the right side is apparently drawn dorsad toward the right nasal pit. From this point the mouth opening has the form of a long slit which extends to the left and ventrad in a nearly straight line.

In *Paralichthys oblongus* and in *Bothus* the mouth remains nearly horizontal and symmetrical.

<sup>1</sup> For the development of the caudal fin of the flounder, see Agassiz ('78).

## 3. HOMOLOGIES OF THE ANTERIOR BONES OF THE SKULL.

The changes in the cartilaginous facial skeleton will be more easily set before the reader, if the homologies of the bones of the face as explained by the more recent writers be first made clear.

The papers of Pfeffer ('86, '94), which deal with the cartilaginous skeleton, are also reviewed here.

Traquair ('65) has given a careful account of the adult skulls of flounders of both dextral and sinistral types. The greatest changes, as compared with a symmetrical fish, the cod, he finds in the facial region; the brain case remaining nearly symmetrical, except with regard to the position of the ridges and wings on the bodies of the bones for the attachment of muscles.

The adult skulls of (1) the halibut, (2) the pole flounder, and (3) the plaice (*Platessa vulgaris*) form a series, in which he shows that there is a progressive modification, especially of the frontal bones. In the halibut, though the main part of the frontal of the "eyeless" side is back of the migrating eye, a thin curved process from it extends between the two eyes and with the corresponding interocular process of the frontal of the ocular side (to which it is closely applied) forms a part of the orbit of the migrating eye. In the case of the pole flounder this process from the frontal of the eyeless side is reduced to an exceedingly thin curved strip. Finally, in the common flounder even this thin strip has entirely disappeared, so that the frontal of the eyeless side is now joined with the front of the head exclusively by means of the great external connection, since called by German writers the "Brücke."<sup>1</sup>

Steenstrup ('63), according to Thomson ('65), considered the "Brücke" the principal frontal of the eyeless side.

Thomson himself thought that it represented the prefrontal of the eyeless side, and that the partition between the eyes was the frontal of the ocular side.

Malm ('68) at first held the "Brücke" to be infraorbital, but later adopted Steenstrup's view.

Reichert ('74), disregarding the beliefs of previous authors, decided that the frontal formed two infraorbital processes, which then fused with the latent "Brücke" to form the orbital ring. The parts between the eyes he thought were normal.

<sup>1</sup> This is a new and peculiar bridge or bar (pseudomesial) of bone which has no (single) equivalent in the crania of symmetrical fishes.

Klein ('68) called the outer edge of the "Brücke" prefrontal, and the inner and hinder part of the same, principal frontal.

Traquair ('65, pp. 276, 277) summarizes the changes from the condition of the symmetrical type of skull as follows:

"(1) The mesial vertical plane of the cranium has become inclined over to the now binocular side, very slightly in the posterior part of the cranium, very much in the region of the eyes (so that the original vertical interorbital septum becomes now nearly horizontal), returning in the nasal region nearly to its original vertical position in the turbot, but never doing so in the halibut or plaice.

"(2) In consequence of this, the middle line of the base of the skull remains still comparatively straight; while the middle line of the upper surface, diverging from the apparent or pseudomesial line, curves round between the eyes, . . . and returns to the middle in front. Having got in front of the eyes and nasal fossæ in the turbot, it again coincides, or nearly so, with the apparent middle line; but in the halibut, and still more in the plaice, the apparent and morphological middle lines, if produced, would cross each other.

"(3) In the anterior part of the cranium, the parts on the eyeless side of the middle line of the *base* are, in all the Pleuronectidæ, more developed than on the ocular side. . . .

"(4) On the top of the head the interocular parts of the frontal and prefrontal bones are more developed on the ocular side. The interocular process of the frontal of the ocular side is always much stouter than that of the other [eyeless side] bone, and always articulates with a corresponding process sent back from the prefrontal. But the prefrontal of the eyeless side sends back no process to articulate with the frontal of the same side, whose interocular part, if examined in a series of flatfishes, gets smaller and smaller, till in the plaice it seems almost gone. The same condition affects the morphologically mesial plate of cartilage forming the anterior part of the interocular septum, which cartilage we have already seen to be chiefly developed on the ocular side.

"(5) To accommodate the two eyes, now both on one side of the head, the anterior parts of the frontal bones remain as a narrow bar, never widening out into a broad arch as in the cod and other fishes. Accordingly, to maintain the requisite stability of the cranium, a new bar or bridge of bone is formed (pseudomesial) by the union of a process sent forwards from the anterior external angle of the frontal of the eyeless side with one sent back from the corresponding prefrontal. By means of this bar the upper eye becomes closed round by a bony orbit, whose boundaries in the turbot consist of the interocular process of the frontal of the eyeless side, the external angular process of the same bone, the external angular process of the corresponding prefrontal, and a small portion of cartilage in front. In the halibut and plaice, however, the nasal bone comes to take part in the boundary of the orbit principally by a development from its eyeless side; and in the latter fish, owing to the atrophy of the inter-



ocular portion of the frontal of the eyeless side, the corresponding part of the other frontal forms almost the entire external boundary of the orbit.

“(6) The olfactory foramen and the place of suspension of the anterior sub-orbital bone are further forward on the ocular side. . . . The articulation of the epitympanic bone to the cranium, in the halibut and plaice, likewise extends further forward on the ocular side.

“(7) The axis of the keel of the cranium . . . points . . . to the eyeless side.”

Pfeffer in a preliminary paper ('86) without illustrations, has described the larval stages of development in one of the Pleuronectidae. As he is the only writer who speaks of the conditions in the interior of the head, his conclusions are given in some detail.

The young fish has an entirely cartilaginous cranium, in which the eye sockets are separated below by the sphenoid, and above by the inter-orbital roof (*Zwischenaugen-Decke*); but between these the sockets communicate freely with each other. The ethmoid, constituting the anterior part of the cranium, develops a wing on each side, the place where the wings join the body of the ethmoid being marked by the presence of the nasal openings. In very young animals the *bulbi olfactorii* are embraced by the ethmoidal roof; but later they are forced backward behind it.

Over the interorbital and ethmoidal regions runs a ridge-like dermal bone, which is triangular in cross section, and stands vertically; it supports the dorsal fin, and is at first free from the cranium. It is the “principal frontal” of authors.

In the second stage examined by Pfeffer, the migratory eye has risen so that half of it is above the level of the interorbital roof. The brain capsule remains unchanged, except that it has received the *bulbus olfactorius*, which has been forced backward by the migration of the eye. The interorbital roof is bent outward toward the eye side and somewhat twisted on its long axis. At the same time the frontal, now grown fast to the interorbital, makes with it a great bend. However, only a broad band — its basal portion — remains, while the greater, vertical part of it is for the most part resorbed by the migrating eye. There now remains between the migrating eye and the eye side only the translucent, thin outer skin which previously covered the dermal bone. The front part of the ethmoidal region is symmetrical; but the upper part of the wing of the eye side has fused to the fronto-orbital and is now continuous with the developing supraorbital cartilage [bone?], while the whole rim of the wing of the blind side remains free.

The transposed eye at a later stage occupies a pit which opens upward and toward the eye side and is surrounded by a high rim of thin

dermal bones. The previously upper side of the eye now lies on the interorbital septum, therefore most ventral; whereas the previously lower side of the eye is now near the dorsal fin, therefore highest. The eye has thus rotated 180 degrees. The side of the migrating eye that is turned toward the blind side of the head is now closed in by the formation of new dermal bones. The socket is completely open in the region of the optic nerve. By the migration of the eye, the anterior oblique eye muscles, which arise from the hinder border of the ethmoid, are laid bare; a thin covering of dermal bone grows over these also. The wing of the ethmoid on the eyeless side, is fused to a part homologous with the supraorbital cartilages; these grow upward and inward, the latter helps in forming the anterior wall of the new orbit.

Pfeffer says that, though the ossification is a continuous process, one may distinguish, if he will, three stages in the development of the parostotic cranial bones of fishes, characterized by —

- (1) The first delicate osseous investment of the cartilage;
- (2) The dermal ossification which establishes approximately the permanent forms of the bone;
- (3) The ridges, crests, wings, and the like, — entirely superficial additions, — which are probably always connected with muscular action.

In the flounder the rotation begins while the frontal region of the young fish is in the first of these stages. Soon the frontal (cartilaginous) is in quite another place, under quite another region of the skin. When it has changed its position, there is dermal bone produced over it in its new position; but there is not the least reason why the skin under which it would normally have lain should suddenly lose the power of producing bone, — and in fact it does not, for it produces the bridge. The bony bridge, then, is the parostotic ossification of a precise region of the cutis, and if the cranium had remained symmetrical, it would have fused to the frontal; but inasmuch as there is a displacement of the region of the (cartilaginous) skull, this dermal ossification has become attached to those bones which took a position directly beneath this bone-producing region of the cutis after the displacement of the (cartilaginous) skull.

Pfeffer's final paper, so far as I know, has not yet appeared; but in a short note ('94) the author states again that the interorbital septum twists on its long axis, and adds: (1) that the migrating eye, when it reaches the mid-line, loses the thin patch of skin which has separated the cornea from the outer world, and (2) that the dorsal fin, the muscles and the bones develop along the physiological axis of the body, the continuation of the spinal column.

## 4. CHANGES IN THE CARTILAGINOUS SKULL.

In order to have freshly in mind the normal condition of the cartilaginous skull in fishes with which to compare the youngest flounder skulls, I give a brief statement of the essential parts of Parker's ('73) paper on the skull of the salmon:

In a salmon of the second week, according to Parker, the cartilaginous skeleton is fully formed. There is a large fossa on the top of the head over the mid-brain. In front, the skull is roofed over with a thin cartilaginous plate, the ethmoidal "tentorium," or tegmen cranii. Anteriorly this is directly continuous with the ethmoid; its posterior lateral corners are connected with the cartilage of the auditory region by the supra-orbital bars, which curve upward and outward. The ethmoid is continuous with the trabeculæ cranii, — now fused together in front, but diverging behind, — which run backward forming a partial floor to the skull cavity. The superior and inferior oblique eye muscles have their origin on the posterior face of the ethmoid. The recti originate from a lamina on the hinder part of the parasphenoid.

I have projected upon the frontal plane the cartilages of the facial region of *Pseudopleuronectes* in each of the four stages. But because of the great length of the dorso-ventral axis of the older stages, this method needs to be supplemented either by projections upon the sagittal plane or by some other process. The most satisfactory reconstruction is, of course, the model. Accordingly with the aid of sections I have modelled in wax by Born's method the facial region of Stages II., III., and IV., and cuts made from photographs of these models are given in the text.

a. *Stage I.*

A dorsal view of the cartilages of the facial region in Stage I. is shown in Figure 7 (Plate 1) as they appear in frontal projection. As in the salmon (Parker, '73), the first cartilages to form are the trabeculæ cranii and Meckel's cartilage. The slight want of uniformity in the shape of Meckel's cartilage on the two sides may be merely an individual variation. Certainly this cartilage is essentially symmetrical. The line passing through the middle (third) brain ventricle and between the lobes of the tectum and cerebrum I have assumed to lie in the sagittal plane in a normal fish of this stage. This plane, represented in projection in the figure by the two ends of a fine line, cuts lengthwise the fused trabeculæ, dividing the mass at the anterior end, which is to be

the future ethmoid, nearly into halves. The line falls midway between the two arms of the trabeculæ, where they diverge to allow space for the pituitary body. In front the ethmoidal mass overlaps slightly, on either side, Meckel's cartilage a little behind its points of sharpest curvature.

In the flatfishes there is no distinct "tentorium," or tegmen cranii, extending backward from the ethmoid to roof over the front part of the brain case, as there is in the salmon.

b. *Stage II.*

Between Stages I. and II. there is an interval of six weeks and the manner of differentiation of the many cartilages and projections found

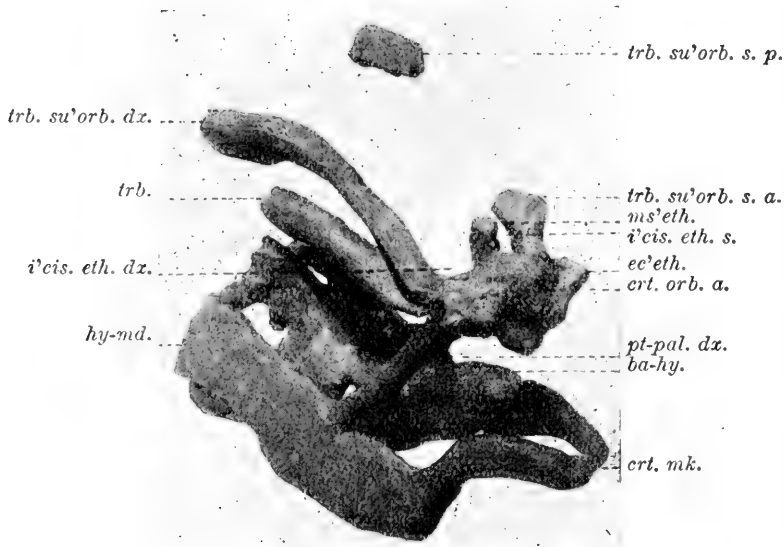


FIG. A.

Oblique view of the facial cartilages of *P. americanus*, Stage II. Photographed from a wax model (Born's method) seen from a point midway between sagittal and transverse planes and about 30° above the horizontal plane.  $\times 75$ . For meaning of lettering, see Abbreviations under Explanation of Plates.

in Stage II. (Fig. A and Plate 2, Fig. 10) cannot be traced here. Figure 10 is a dorsal view of the facial cartilages of this stage. But, as it gives a less complete view than the model of the same specimen (Fig. A), I call attention to the two supraorbital bars only — the complete one on the right (*trb. su'orb. dx.*), fastened to the right ethmoid wing, and the two parts (*a.* and *p.*) of the left one, between which is

the space through which later the eye must pass. Figure *A* is from a photograph of the model of the front part of the cartilaginous cranium of a 3.5 mm. fish, viewed obliquely from the front, the right side, and above. The line of vision makes an angle of about 30 degrees with the horizontal plane. *Meckel's cartilage* no longer forms a simple bow lying in the horizontal plane. The anterior end is curved slightly ventrad, and the bar of either side in passing backwards bends sharply ventrad to join, nearly at right angles, a series of cartilaginous masses (Fig. *A hy-md.*) representing the future quadrate, articular, symplectic, and hyomandibular bones. In cross section these cartilaginous masses have, in general, the form of an elongated oval, the axis of which inclines dorsad and mesiad; the ventral margin is slightly thicker than the upper. The space occupied by each separate cartilage in this series is not indicated in the models, though in the sections the boundaries can be determined by the presence of the connective-tissue sheaths which limit the cartilages.

The *pterygo-palatine* bars (*pt-pal.*) extend ventrad and caudad from each side of the ethmoid to the quadrate region (compare also Fig. 10). At this stage the fish has a very small gape. The hyoid and gill-arch cartilages are present in their general shape, occupying most of the space between the right and left hyomandibular-quadrate masses, and ending in front just beneath the body of the ethmoid in the basi-hyal (*ba-hy*).

From the ethmoid mass arise also the *supraorbital bars*. These, in the salmon, extend backward from the ethmoid, curving upward and outward above the eyes, to the heavy cartilaginous mass of the otic capsules. In the flatfish of this stage, as shown in the reconstruction, there is but one complete supraorbital bar (the right), the left being represented by two remnants, an anterior and a posterior; the anterior (*trb. su'orb. s. a.*) is a process extending backward from the dorsal left-hand corner of the ethmoid; the posterior (*trb. su'orb. s. p.*) extends forward from the left otic capsule. It is through the space between these two projections that the left eye migrates. While, as yet, there is no external sign of an asymmetrical position of the eyes, internally preparations for such a condition are clearly established, for the middle portion of the left supraorbital bar has disappeared.

I have sectioned only a few individuals of *P. americanus* in which the left supraorbital bar is still continuous, and even in them at the region corresponding to a transverse plane passing through the middle of the two eyes the bar is so reduced in thickness as to show in cross section only one or two cartilage cells.

Since *Bothus* spawns in May, I was able to get specimens which were certainly not more than one month old. The one shown in frontal section in Figure 14 (Plate 3) was 2 mm. long. However, as *P. americanus* grows much more slowly than *Bothus*, it is not possible to compare ages on the basis of relative lengths. In *Bothus* at this stage both supraorbital bars are present and there is as yet no sign of reduction in either of them. In the sinistral flounder (*Bothus*) it is, of course, the right supraorbital bar which disappears to give passage for the eye, whereas in *P. americanus* it is the left. Since in the middle of the bar its plane slants inward and downward, and since the bar in its course from ear capsule to ethmoid is also slightly convex dorsally, it is evident that no one section in any plane could show the whole bar. Both bars extend over the eyes, as can be seen from the position of the dotted lines shown in the figure (Plate 3, Fig. 14), which represent the location of the eyes, as seen in a more ventral section, accurately projected upon the plane of this section.

Appearances of degeneration in *P. americanus* taken after June 1 are rare. The youngest fish must be at least six weeks old at that time, and only the most nearly symmetrical of the smallest fishes sectioned show any trace of the left supraorbital bar, either normal or degenerating. Figure 15 (Plate 3) shows the appearance, in frontal section, of the anterior degenerating end of the posterior remnant in *P. americanus* at Stage III. *a*, extending forward from the region of the ear capsule. The whole section of the bar has been drawn, so as to show the difference in appearances at the two ends. The cell bodies (*cl. crt.*) at the anterior end of the bar are much shrunken and the intercellular ground substance has for the most part disappeared. The nuclei are much crowded, have lost the characteristic form seen in most normal nuclei, and are angular and dense in appearance.

The degenerating portion of the cartilage is darker than the unchanged cartilage cells next to it. The connective-tissue sheath (*tu. co'nt. tis.*) around the cartilage is, however, persistent and can be traced to the ethmoid.

In this specimen there is a coagulum filling the space in which the degenerated portion of the cartilage bar formerly lay. The presence of this coagulum is easily accounted for on the assumption that the sheath has retained the material resulting from the degeneration of the cartilage cells, and that the killing fluid has caused it to be precipitated. This condition is similar to that observed by Looss ('89) in the resorp-

tion of cartilage in the tail of the tadpole. In that case, according to Looss's interpretation, it was the chorda sheath which restricted the diffusion of some of the products of the degenerating cells. He, too, found that the intercellular substance was the first to disappear in resorption.

Whether the cartilage nuclei, when set free by the disintegration of the intercellular substance, degenerate completely, or join the nuclei of the connective tissue, I cannot determine. There is much resemblance between the compact nuclei of degenerating cells and those of the sheath.

Since the bar disappears first in the middle region, there are, for a short time, two degenerating regions, one which will end at the ethmoid and the other at the persistent stub in front of the ear capsule. The location of these will be evident by reference to Plate 2, Figure 10 (*trb. su'orb. s. a.* and *p.*).

When in *P. americanus* the frontal of the eyeless side is formed, its main body takes the position of this posterior stump of the left supra-orbital bar. It is significant that there is no more space provided by this degeneration than is barely necessary for the ready passage of the eye.

The body of the ethmoid is very irregular in shape. Besides the two wings with which the supraorbitals are connected, there is a median elevation in the sagittal plane of the fish (*ms'eth.*, Fig. A), and a forward knob-like projection (*crt. orb. a.*) in the same plane. The two olfactory pits lie just in front of the wings of the ethmoid, and the olfactory nerves pass to them through the two deep notches (*i'cis. eth. dx.* and *s.*) seen on the dorsal surface of the cartilage. The right nerve passes between the supraorbital bar of the right side and the median elevation; the left nerve between the left supraorbital stub and the median elevation. In this left notch the superior oblique muscle of the left eye takes its origin, and in some cases the superior oblique muscle of the right eye has its origin also close to that of the left eye, therefore at the left of the sagittal plane.

### c. Stage III a.

Figure B is photographed from the model of the cartilages of a fish of Stage III. (Plate 1, Fig. 2), where the left eye could be barely seen projecting over the top of the head as the fish lay on its left side. The left wing of the ethmoid cartilage (*ec'eth. s.*) has no longer any trace of the projection representing the anterior portion of the left supraorbital bar. The posterior portion of the bar (*trb. su'orb. s. p.*) projects forward from

the ear capsule substantially as in Stage II., there being just room for the eye — now, of course, increased in size — to pass between the front end of it and the ethmoid. The right supraorbital becomes a little more arched as the fish increases in depth. The wings of the ethmoid extend out from the mid-line farther proportionally and are more flattened antero-posteriorly. Upon the surface of these wings of the ethmoid cartilage the ect-ethmoid bones, or pre-frontals, are later formed.

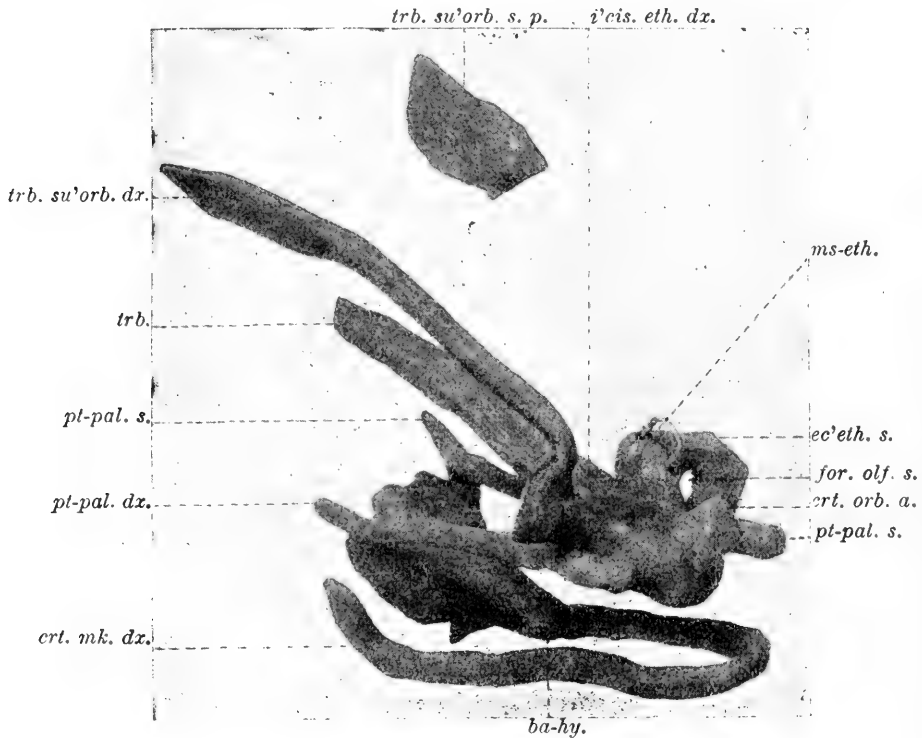


FIG. B.

\* Oblique view of the facial cartilages of *P. americanus*, Stage III. Photographed from a model, as in the case of Fig. A.  $\times$  circa 75.

For meaning of lettering, see Abbreviations under Explanation of Plates.

The gape has been greatly increased by the growth in length of all the facial cartilages, but these have not increased in diameter proportionately. The pterygo-palatine bars, which from the first support the upper jaw, in lengthening have come to lie nearly parallel to Meckel's cartilage, and their articulation with the quadrates is so far posterior that the one of the left side alone falls within the region modelled. At this stage these cartilages are in some instances so reduced in diameter toward their posterior ends, as to show in cross sections only one cartilage cell. A process from the left wing of the ethmoid has fused with the



median region of the ethmoid, thus bridging over the left ethmoid notch and leaving between the mes-ethmoid and the region of the anterior end of the right supraorbital cartilage an orifice (*for. olf. s.*), which corresponds to the notch on the right. In other specimens I find that both wings of the ethmoid have sent out processes to fuse with the mes-ethmoid, thus converting both notches into foramina for the passage of the olfactory nerves to their capsules on the front of the ethmoid.

In this model a bent wire is inserted into the mes-ethmoid in the median plane to aid in locating the position of that plane, — the plane in which the future interorbital septum is to develop. There is as yet no trace of this septum in the specimen modelled; but Figure 18 (Plate 4) shows a cross section of the head of a fish (*P. americanus*) of this stage, which does indicate the position of the future interorbital septum. The fine vertical lines outside the figure represent the projection of the sagittal plane of the fish. A small bar of cartilage (*arc. eth. m.*) is seen in cross section above the mes-ethmoid. Traced anteriorly a few sections, this fuses with the ethmoid. Traced posteriorly it soon unites with the thin fused trabeculæ cranii not far from where they pass over into the ethmoid. It is, then, a slanting bar, or arch, from near the anterior end of the trabeculæ cranii to the posterior face of the ethmoid. In another specimen (Figure *C'*, p. 24) this arch has become larger and appears as the forward prolongation of the trabeculæ (*trb.*). In the space beneath this arch lie the oblique eye muscles, two of which (the right and left inferior oblique) appear in Figure 18. The same figure shows that the migrating eye may exert pressure directly on the cartilage, for the left eye-ball is indented by the left wing of the ethmoid.

In another specimen of this stage, which had lost the migrating eye in the process of turning, there were certain peculiarities worthy of consideration. This fish, too, had a well-developed median arched cartilage on the posterior face of the ethmoid. The right superior oblique muscle had its origin at the angle produced by the junction of the arch and the body of the ethmoid. The inferior oblique was attached lower, at the angle made by the union of the ethmoid and the trabeculæ. The posterior face of the ethmoid is the usual place of attachment for these muscles, though a specimen of *B. maculatus* had both the inferior and superior oblique muscles attached on the median arched bar. The most noticeable peculiarity of this specimen was shown in the origin of the supraorbitals. As I have said, there was no eye present on the left side. The anterior end of the left supraorbital bar still persisted in this specimen in the form of a stub projecting backward and slightly upward

from the left wing of the ethmoid, though unmated individuals whose cartilages were otherwise in a like stage of advancement showed no traces of it. Furthermore, the stub, instead of disappearing by a gradual reduction of its diameter in the region midway between the ethmoid and the ear-capsule, through which the eye normally passes, preserved the bar-like shape — the flat side being directed towards the top of the head — until its abrupt disappearance behind the middle region of what should have been the path of the migratory eye. Both supraorbitals, instead of being backward extensions of the wings of the ethmoid, as in most other specimens examined, took their origin from a mes-ethmoid enlargement which extended backward directly above the median arch that indicates the position of the future interorbital septum. In this specimen there was, therefore, a suggestion of a tegmen cranii, such as has been described by Parker for the salmon. This, instead of being a complete roof, however, was a comparatively narrow plate of cartilage which extended backward toward the brain region.

In describing the model of Stage II., a prominence (Figure *A*, *crt. orb. a.*) on the front face of the ethmoid was mentioned. This prominence is really a separate cartilaginous mass, resting in a socket of the ethmoid. There is also a pair of small labial cartilages in front of and below this plate; but owing to their small size and the difficulty of preserving small detached processes on the wax plates, they have been omitted from the models. In Stage III. this large cartilaginous mass has become rounded and projects further forward from the body of the ethmoid. Its future history will be given in connection with the description of the most advanced stage modelled (Figure *D*).

#### d. Stage III b.

The forms of the cartilages change very rapidly at this stage of development, and it is with some difficulty that one finds a cranium exhibiting a condition intermediate between Stage III *a* (Fig. *B*) and Stage IV. (Fig. *D*), which shows the completely twisted head. However, I found one fish, larger than many of the recently metamorphosed specimens, which I have designated as Stage III *b*, to distinguish it from the more common condition just described as Stage III *a*.

In this specimen (Figs. *C* and *C'*) the left eye lies in the sagittal plane, even though the fish is 15.5 mm. long, the eye usually being transformed when the fish reaches a length of 13.5 to 14 mm. There is no trace of the left supraorbital bar. The right supraorbital (*trb.*

*su'orb. dx.*), as but now described for the specimen that had lost the left eye, is the backward extension of a plate of cartilage which connects the right ect-ethmoid with the median mes-ethmoid arch. This flattened anterior portion of the right supraorbital cartilage corresponds to the tegmen cranii of the right side of the head in the salmon. The median mes-ethmoid arch is, at its anterior end, fused to this plate or partial

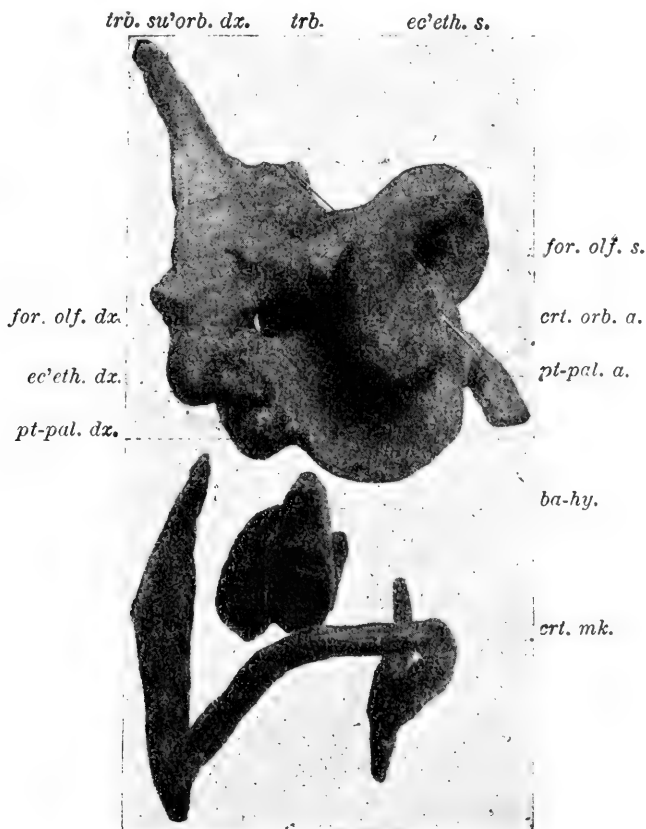


FIG. C.

From photograph of wax model of the facial cartilages of a large specimen of *P. americanus* intermediate between the stages shown in Fig. B. and Fig. D. Viewed from a point nearly in front, only a little to the right of the sagittal and a little above the horizontal plane.  $\times 45$ .

For meaning of lettering, see Abbreviations under Explanation of Plates.

tegmen, but from the short region of fusion backward for some distance the two cartilages are merely crowded closely together, a distinct line of perichondrial connective tissue being found between them. The cartilages then diverge, as may be seen in Figure C', and the median mass continues backward as the fused trabeculæ cranii, while the higher, lateral portion, the right supraorbital bar (*trb. su'orb. dx.*, Figs. C and C'), passes upward and backward to the ear capsule.

In older specimens this *right* supraorbital begins now to disappear, the disappearance progressing from behind forward as the ensheathing ocular-frontal takes its place and function. The remnant of this cartilage (*ham. eth.*), as it appears at a later stage, when it has been forced into the horizontal position (vertical as the fish lies on its side), is shown in Figure *D*. There is no longer a region of close appression without

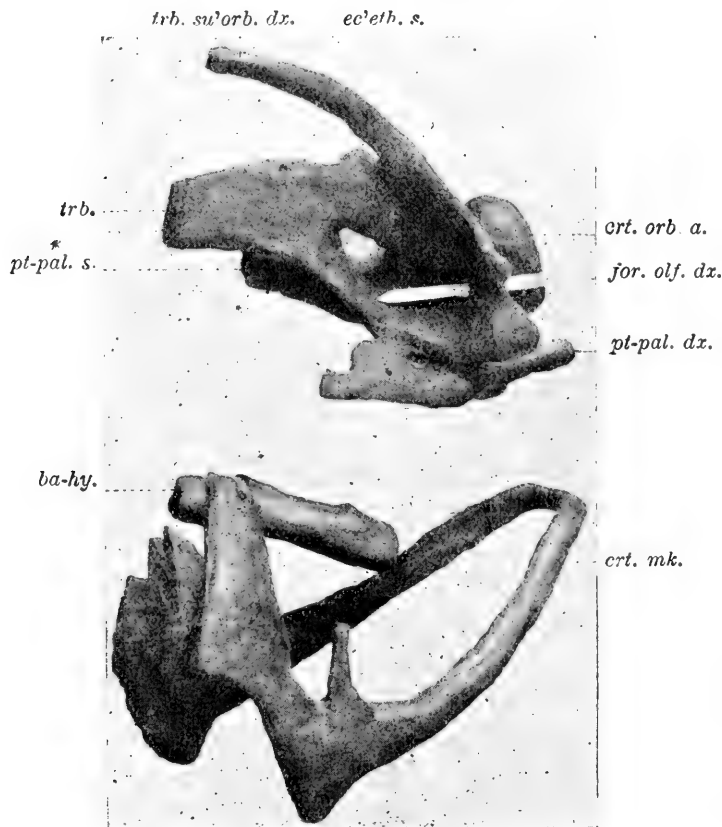


FIG. *C'*.

Same model as that shown in Fig. *C*, viewed obliquely from right side and behind. A probe is thrust through the right olfactory foramen.  $\times 45$ . For meaning of lettering, see Abbreviations under Explanation of Plates.

fusion between it and the median arch, but the hook arises directly from the arch.

In Figure *C* a bristle is shown passing through the left olfactory foramen, to indicate the axis of the opening, which now is not parallel to the longitudinal axis of the fish, — as the right olfactory foramen still is, — but makes with it an angle of about 45 degrees, being directed caudad, mediad, and dorsad. In Figure *C'* a white probe marks the position and direction of the right opening.

There is also indicated at this stage a beginning of the forward rotation of the dorsal margin of the ect-ethmoid cartilages about a transverse axis passing through them. The end of the bristle (Fig. *C*) over the trabeculae cranii is, therefore, not greatly posterior to the outer end, which is seen against the left pterygo-palatine as a background. The final result of this rotation of the ect-ethmoids about the axis connecting them is to make the axes of both foramina transverse instead of longitudinal. Consequently in an oblique view from the right side, as in Figure *D*, one is looking at the olfactory foramina from that face of the ect-ethmoids which at an earlier stage (Figs. *A*, *B*) was directed posteriad. Instead, therefore, of seeing the ends of the olfactory nerves which are *distal* to the foramina, as would be the case if the cartilages were viewed from the same direction at an earlier stage (Figs. *A*, *B*, and *C*) one would now see their *proximal* ends.

A twisting of the ethmoids (in a clockwise direction when viewed from behind) about the antero-posterior axis of the fish, greater than is indicated in Figure *C*, results in the further elevation of the ect-ethmoid, olfactory foramen, and pterygo-palatine of the left side, while the supra-orbital, the ect-ethmoid, the olfactory foramen and the pterygo-palatine of the right side are correspondingly depressed.

#### e. Stage IV.

The oldest facial region modelled (Fig. *D*) — that of a small fish (Plate 1, Figs. 5, 6) having the eyes in the adult position — represents my Stage IV.

The eyes are located one on each side of the flat hook-like plate of cartilage (Fig. *D*, *ham. eth.*) which, with the previously mentioned median arch (*arc. eth. m.*), runs back along the morphologically median plane (the plane between the eyes). The interorbital septum of connective tissue is continuous with these two cartilaginous processes, filling the space between them and extending thence backward. That this occupies the morphologically median plane, is proven by the position of the olfactory nerves, which lie one on each side of this septum. Anteriorly the left nerve passes through the opening (*for. olf. s.*) seen in the left (now upper) wing of the ethmoid and ends in the nasal capsule, which lies immediately in front of it. The right nerve comes from below the hook-shaped cartilage and passes through a foramen (*for. olf. dx.*) in the anterior part of the ethmoid to the right nasal capsule, which is located somewhat in front of the ethmoid and near the anterior end of the right pterygo-palatine.

The external opening of the left nasal pit is about  $30^\circ$  higher in Stage IV. (Fig. 5) than in Stage II. (Fig. 4).

The superior oblique muscles of the eyes have their origins at or near the junction of the median arch with the mes-ethmoid. The inferior oblique of the right eye is attached to the ethmoid on the dorsal (morphologically left) side of this median arch and that of the left eye im-

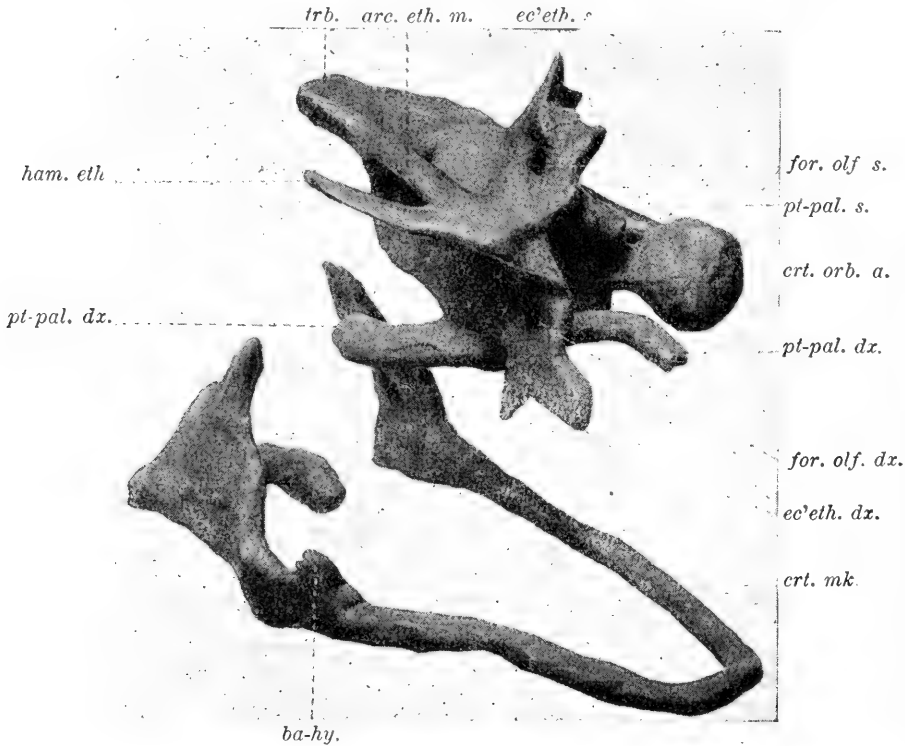


FIG. D.

Oblique view of the facial cartilages of *P. americanus*. Stage IV. Viewed from the same direction as in Figs. A. and B.  $\times 70$ .

For meaning of lettering, see Abbreviations under Explanation of Plates.

mediately behind that of the right. The large passage<sup>1</sup> between the ethmoid in front, the median arch at the right (morphologically dorsal), and the trabeculae cranii at the left (ventral) shown in Figures C' and D has therefore in the growth of the cartilage been left to accommodate the oblique eye muscles, just as the olfactory foramina in the ethmoid were left because of the presence of the olfactory nerves.

The now ventrally projecting right ect-ethmoid partially hides in a

<sup>1</sup> This passage is seen in Figure C' directly above the pointed end of the probe inserted through the right olfactory foramen; it is indicated in Figure D by a triangular area at the right of the dotted line, *arc. eth. m.*

lateral view the pterygo-palatine of its own side. The pterygo-palatine (Fig. *D*) ends abruptly at its posterior end, since the membrane bones which are to supersede it in supporting the upper jaw are already developed there.

The left pterygo-palatine (*pt-pal. s.*) is visible in Figure *D* only in the region between the left ect-ethmoid and the cartilage sphere (*crt. orb. a.*) in front of the ethmoid. This terminal spherical mass of cartilage (*crt. orb. a.*) can be traced to its position in the adult skull. In a fish two inches long the ethmoid cartilage had pushed its way under this spherical cartilage, which had elongated in antero-posterior direction, but was still located between the nasal pits. I regard it, therefore, as the cartilage which forms in the adult the median anterior portion of the single orbit in which the left eye is to be found. The nasal bones lie on either side of it, and the rest of the orbit is made up of the right frontal, the left frontal and the left pre-frontal, or ect-ethmoid, bones.

By comparing the position of the olfactory openings in Figures, *B*, *C*, and *D*, it is plain that there has been a twisting of the ethmoid region from left to right, through an arc of 90 degrees. The line joining the centres of the ect-ethmoids in Figure *B* is horizontal, whereas in Figure *C* it makes with the horizon an angle of more than 30 degrees, and in Figure *D* is vertical. But with this twisting about the longitudinal axis the plane of the ethmoids has also revolved from a transverse position into one nearly coinciding with the sagittal plane, — possibly due to the pressure caused by the increase in the size of the eyes, — so that the axes of the olfactory foramina, which at first were parallel to the long axis of the fish, now pass from right to left. Accompanying these torsions, there has been a shifting in the relative positions of the olfactory foramina and surrounding cartilages till those of the right side are considerably in advance of those of the left. It is, however, the twist about the longitudinal axis which makes the migration of the eye seem rapid. This occupies in my experience not over three days, and according to Nishikawa ('97) it was completed in the fish which he observed in twenty-four hours.

The whole of the cartilaginous system of the facial region has been supported up to this time by two cartilage rods, the fused trabeculæ cranii (*trb.*, Figures *A-D*; Plate 1, Fig. 7; Plate 2, Fig. 10; Plate 3, Fig. 17) and the right supraorbital bar (*trb. su'orb. dx.*, Figures *A-D*; Plate 2, Fig. 10; Plate 4, Fig. 18).

The twisting is greatest in the optic region, the brain case showing

little of it, and the anterior part of the ethmoid, as seen by the final position of the anterior ends of the pterygo-palatines, having turned not more than 45 degrees.

In the turbot, according to Traquair ('65, p. 276), the nasal region is nearly normal in position, the sagittal plane of the anterior part of the head nearly coinciding with that of the body.

f. *Comparison of Bothus with Pseudopleuronectes americanus.*

The nearest representative in American waters of the sinistral turbot is *Bothus*, the sand-dab, and I shall now compare briefly its turning with that of *P. americanus*. The sand-dab is much deeper than the flounder, but being thinner, though of the same length, it weighs about the same as that fish. Its translucency has gained for it the name of window-pane.

Traquair's statement that the turbot is less unsymmetrical than the plaice holds as truly here, the sand-dab being less distorted than the winter flounder. The mouth is straight and the length of the jaw on the ocular and eyeless sides is more nearly equal. The mouth is much larger and the gape greater than that of the winter flounder. The nasal pits are very nearly symmetrical, that of the right side being, however, a little the higher (Plate 3, Fig. 13). The transposed eye is not at all posterior to its mate, as is the case in *P. americanus*. The dorsal fin in this species reaches forward entirely past the right eye (Plate 3, Figs. 13, 16, *cr. pin. d.*). After the passage of the eye, the bases of the fin rays arise nearly over the right wing of the ethmoid.

The ethmoid is relatively a much more slender cartilage in *Bothus* than in *P. americanus*. The cross section of its anterior end (Plate 3, Fig. 13) has the shape of an inverted letter T, and its dorsal margin is turned not more than 20 degrees to the left from the sagittal plane. In the posterior region (Fig. 16) the ethmoid is turned about 45 degrees. The relation of the cartilage marked *trb. su'orb. s.* to the ethmoid mass in Figure 16 indicates the angle, though the median bar itself is farther forward. The wings of the ethmoid fuse to the median bar in a peculiar way. The right wing (*ec'eth. dx.* Fig. 13) points toward the rays of the dorsal fin which lie next it. It does not connect with the basal part of the ethmoid directly, but merely with the median upright part. The left wing has a process running anteriorly into the region of the lip at the level of the basal part of the ethmoid, with which this wing is fused. It then passes around the olfactory nerve of its own side, be-



coming much thinner as it does so, and unites with the upright bar. Thus the foramen for the left nerve (*I. s.*, Fig. 16) has a very thin outer wall; while for the right olfactory nerve (*I. dx.*, Fig. 16) there is no foramen. The olfactory nerves pass under the wings of the ethmoid to the capsules, which are located on the front faces of the wings.

Since the head of *Bothus* is less unsymmetrical than that of *P. americanus*, there is a corresponding difference in the conditions of the supraorbitals. The right supraorbital (Fig. 16, *trb. su'orb. dx.*) is crowded over until it comes to lie directly over the median bar of the ethmoid, which is continued backward into the interorbital septum. There it persists for a distance equal to nearly one-half the diameter of the eye in all the specimens of Stage IV. (*Bothus*) which I have sectioned. It should be said that *Bothus* reaches this turned stage at a much earlier age than does *P. americanus*.

The left supraorbital is proportionately of larger diameter than the persisting supraorbital in *P. americanus*, and it also lies nearer the mesial arch, with which it is often connected. Such a connection sometimes occurs in the winter flounder, the condition of which has been previously described.

In the older specimens there is no separate supraorbital, but the upper end of the upright mesial cartilage bears a wedge-shaped enlargement on the side toward the left eye (Plate 3, Fig. 16, *trb. su'orb. s.*). When, in the more posterior sections, the mesial cartilage ends, this enlargement persists, and can be followed until it reaches the ear region, thus showing that it is the supraorbital cartilage. The cartilage forming the mesial arch is heavier and extends farther back between the eyes than in *P. americanus*. The result is as if some of the space between the hook and the trabecular cartilage in Stage IV. of *P. americanus* (*ham. eth.*, Fig. *D*) were filled out solid, and the whole plate were thickened.

In the transformation of the cartilaginous skull into the typical condition of the adult teleost, the skull bones, as is well known, may be formed (1) by ossification in the subcutaneous fibrous tissue (parostosis), or (2) by ossification between perichondrium and superficial cartilage cells, gradually replacing both by bone (ectostosis). There are no dermostoses, and, as in the case of the salmon (Parker, '73), I saw no indications of endostosis. Of the bones directly involved in the turning, the frontals originate as parostoses and the pterygo-palatines and pre-frontals as ectostoses.

g. *Discussion of Pfeffer's Work.*

I have purposely omitted, up to this point, any comparisons with Pfeffer's work. He is the only author I have found who deals with the twisting in the larval Pleuronectidæ from other than the external point of view. Unfortunately, he does not give the name of the species on which his statements are based, nor are his papers illustrated.

In his earlier article ('86, p. 4) he describes the general conditions to be found in very young Pleuronectidae. The general topography is that of other young fish. The eye sockets — separated below by the sphenoid [trabeculæ cranii?], above by the "Zwischenaugen-Decke" — communicate freely with each other in the intervening region. In the interorbital and ethmoid regions there is a vertical ridge-like dermal bone, having in cross-section the form of an elongated triangle, and supporting the dorsal fin, which, in Pfeffer's specimens, reaches to the ethmoid. This bone is still free from the cranium, and is the *frontale principale* of authors.

The *bulbus olfactorius*, which at first is lodged in the "Zwischenaugen-Decke," becomes crowded backward into the brain capsule. The "Interorbital-Decke" [supraorbital bar?] is bent out toward the eye side and twisted somewhat on its long axis, so that its transverse axis, previously horizontal, now becomes oblique, slanting downward and outward toward the ocular side, while the chief part, which was vertical, is mostly resorbed by the migrating eye. As a consequence there now remains between the migrating eye and the surface of the head on the ocular side only the thin, glass-like, scarcely perceptible outer skin which previously covered the dermal bones. At the same time the dermal bone known as the *frontale principale* has grown fast to the interorbital roof-piece, and its course, at first straight from the median crest of the brain capsule to the ethmoid, now makes a great bend. Only its basal part, in the form of a broad band remains, while the vertical (and at first the larger) part has been resorbed. The upper part of the wing of the ethmoid on the ocular side has fused with the fronto-orbital, and the upper part of its outer margin is continuous with the now developing supraorbital cartilage or bone, while the wing of the eyeless side remains free on all sides, not forming any connection with the supra-orbital of its own side.

This description of the relations of the wings of the ethmoid to the supraorbitals resembles the condition which I have found in Stage III *a* of *P. americanus* (Figure *B*, pp. 19, 20); but in *P. americanus* and

in *Bothus* the dermal frontal is not yet present in the region through which the eye passes, and therefore cannot be resorbed. At Stage IV., *i. e.*, after the migration is practically completed, there is to be found in *P. americanus* under the surface of the skin behind the eye region a thin plate of bone, which I take to represent the left frontal. The supra-orbital cartilage of the side from which the migrating eye comes lies in the region to which Pfeffer assigns the degenerating frontal in his species, and we have seen that this bar is resorbed. Perhaps in his species the dermal bone (frontal) is formed relatively earlier than in *P. americanus*.

Pfeffer's statement that the transposition of the eye is accompanied by a rotation on its own axis through an arc of 180 degrees is not quite correct for our species. The arc in *P. americanus* varies slightly in different individuals, but is approximately 120 degrees.

Neither will his theory of the formation of the "Knochenbrücke" fit the facts in *Pseudopleuronectes*. His argument (p. 8) is that when the frontal bone of the blind side changes its position, dermal bone is produced, not only over it in its new position, but also in the region of the integument beneath which the frontal was originally located, the latter dermostosis being known as the "Brücke." In our species at least, the frontal, when once formed, does not change its position. So its ontogenetic location does not explain the formation of the "Brücke."

In Pfeffer's more recent paper ('94) he states, as before, that very young symmetrical *Pleuronectidæ* have cartilaginous crania. The "Interorbitalbalken" [Interorbital-Decke?] twists on its long axis, its dorsal edge toward the future ocular side. One eye moves downward while the other comes to lie upon the "Interorbitalbalken." If any sheathing bone is already formed on the "Interorbitalbalken," the elevated eye resorbs the part of the bone which is in its way. Then, on the side of the upper eye corresponding to the blind side of the adult fish there is formed a bony orbit, which fuses with the gradually developing dermal bones, so that the skull of such an individual leaves the false impression that the eye has traversed some of the bones of the skull.

The upper eye does not, according to Pfeffer, travel around to the other side of the skull, but ascends only a little, until on a level with the part of the skull between the eyes; however, from this time forward it looks in the direction of the ocular side. At the same time the thin piece of skin ("Körperhaut") now separating the cornea from the outer world, disappears.

In regard to the last point, I may say that in both species I find a

layer of epidermis over the corneas of both eyes in the oldest fishes which I have sectioned, as indeed one would expect; so that Pfeffer's statement apparently would have been more accurate if he had said "Lederhaut" instead of "Körperhaut."

Unless the conditions in the species described by Pfeffer are totally different from those found in *P. americanus* and *Bothus*, Pfeffer has not distinguished between the cartilaginous supraorbital bar, which may be in direct connection with the cartilaginous wings of the ethmoid, and the dermal frontal bone, which fuses with ectostotic bone-tissue formed on the wings of the ethmoid.

#### h. *Résumé.*

The twisting which takes place in the ethmoid region of the skull of Pleuronectidae can best be explained by reference to the three mutually perpendicular axes of the head of the symmetrical young. There are two important torsions of about 90 degrees each. The most evident change (incidentally described by those who have discussed the migration of the eye) is that twisting of the ethmoids which can be represented by the revolution of the horizontal transverse axis until it approximately coincides with the original dorso-ventral axis.

The second change (limited to the upper part of the ethmoid mass) results in carrying the dorsal end of the dorso-ventral axis forward, so that it coincides with the longitudinal axis of the head. This change is probably due to growth along the anterior face of the ethmoids and resorption of the posterior dorsal margin, which is pressed upon by the eyes, or to a gradual displacement of the cartilage, due to the pressure referred to, without absorption.

In *Pseudopleuronectes* there is a further complication due to a slight retrocession of the parts on the eyeless side, amounting to about 30 degrees. This obliquity does not exist in *Bothus*.

The changes which have been described in the head of the flounder all take place in the cartilaginous skull, ossification occurring only after the shifting is complete. Therefore I cannot accept Pfeffer's view that a portion of the "frontale principale" lying in the path of the migrating eye is resorbed. The history of the two supraorbital cartilages links together to some extent the cartilaginous and bony conditions. The supraorbital cartilage bar next the migrating eye (the left in *P. americanus*, the right in *Bothus*) degenerates in its middle region, and the eye is carried through the gap thus made by the unequal growth of the facial cartilages of the two sides.

Later the ect-ethmoid of the "blind" side is formed as an ectostosis around the cartilage of that wing of the ethmoid and sends back a process along the line which the supraorbital cartilage had occupied. This meets and fuses with a forward process of the frontal of that side, thus forming the "Brücke," which becomes in the adult fish the most voluminous bony support of the nasal region.

The supraorbital of the other side keeps its connection with the ear-capsule much longer. Since the non-migrating eye moves downward to only a slight degree, the supraorbital has small space for movement to evade the pressure of the tissues in front of the migrating eye. So we find, in the latest stages in which this supraorbital appears at all, that the structures of the median plane have been crowded over upon the supraorbital and that this now appears as the cartilage "hook" (*ham. eth.*, Fig. *D*), which extends backward between the eyes and is at this time the chief tissue separating them.

In *Bothus* each frontal bone, when formed, sends forward a slender process between the eyes, but in *P. americanus* the process arises from the frontal of the ocular (right) side only.

## V. The Optic Portion of the Central Nervous System.

### 1. GENERAL CONDITION IN THE ADULT.

If the brain of the cod be taken for comparison, the axis of the cerebrospinal part of the nervous system of *P. americanus* shows bendings that seem not to exist in the cod. There is in the spinal cord a bend which is convex upward (dorsad) and is apparently induced by the size of the digestive organs. In front of this, in the region of the medulla, occurs a bend which is convex ventrad (Plate 1, Fig. 6). Finally there is also a decided bend which is convex towards the eyeless side (Plate 2, Fig. 11). The muscles of the eyeless side being less developed, that side is more nearly flat than the ocular side, which is convex.

Figure 8 (Plate 2) is a dorsal view of the brain of a fish (*P. americanus*) three inches long. The curves mentioned are not yet emphasized. An evident sign of asymmetry is seen in the inequality in the size of the olfactory lobes, that of the right side being much the larger. This lobe may, in the adult, have six times the volume of that of the left side (compare Fig. 11). The relative sizes of the lobes of the cerebrum is different in different individuals. In the specimens shown in Figures 8 and 9 (Plate 2) and in Figure *F* (p. 36) the left lobe is the larger; but in a number of adult fishes the right lobe was the larger.

The optic lobe of the left side is usually cut first in cross-sections, when one begins the cutting at the anterior end of the animal, as is plain from the relative positions of the two in this specimen (Fig. 8). The course of the optic nerve to the transposed (left) eye is shown by dotted lines (*II. s.*) in the figure. Its slack condition allows the eyes to be thrust upward when the fish is buried in the mud or sand. One or two movements of the fins will cover a fish with loose sand; except for the projecting eyes, the animal is then entirely concealed. This protrusion of the eyes is done by means of the so-called orbital heart. This organ, mentioned by Agassiz in his description of the developing flounder, is described as the recessus orbitalis by Holt ('94). It is shown in cross section at *rec. orb.* in Figure 18 (Plate 4).

A side view of the same brain as that shown in Figure 8 (Plate 2) is seen in Figure 9, which makes clearer the position of the brain with reference to the eyes; but in the dissection the left eye has been raised somewhat from its normal position in order to show the eye muscles and the location of the optic nerves, which are purposely shaded somewhat darker than the surrounding muscles.

In all the flatfishes which I have examined, the optic nerve from the transposed eye is dorsal (anterior) in the chiasma. In *P. americanus* the right optic tract and the left optic nerve are anterior (dorsal) to the corresponding parts of the opposite sides (Fig. 12), whereas in *Bothus* the left tract and the right nerve are anterior (dorsal).

Figure 11 is drawn from a dissection of the adult fish. The oculomotor nerve (*III.*) supplying the transposed eye passes toward the eyeless side before it divides into the four customary branches. The fourth cranial nerve (*IV.*) is still more noticeably changed in its direction. In the cod this nerve lies near the median plane, at a distance from and above the eyeball; but in the flounder the fourth nerve of the migrating eye lies in contact with the eyeball and rests on the dorsal rectus muscle. The optic nerve (Figs. 8, 11) also shows before reaching the eyeball a bending in the same direction as that which the eye-muscle nerves exhibit. These alterations in the directions of the nerves in the adult indicate the nature and the place of the transposition which we have followed in the larvæ, and show that nerves retain throughout life, as far as possible, their phylogenetically normal position. I was unable to find from my dissections that the flounder, *P. americanus*, has a cutaneous branch of the fifth nerve. If it has, the nerve must be small. The fifth has a mandibular, a maxillary and a superior ophthalmic branch. The large ophthalmicus profundus of the cod is represented in the flounder

by a few twigs only (*V. opt. p'fnd.*, Fig. 11). The left superior ophthalmic of the flatfish (*V. opt. su.*), after emerging from the skull with the rest of the fifth nerve, as in the cod, runs from left to right (Fig. 11) *through* the passage formed by the "Brücke," which results from the fusion of the posterior angle of the pre-frontal and the corresponding anterior angle of the left frontal. It then takes the regular median path between the eyes to its distribution on the snout. The bone is formed around the nerve in its new position after the migration of the eye.

The seventh nerve in both the cod and the flounder emerges from the skull with the fifth. The ninth in the cod lies between the two chief roots of the tenth, with which it passes out. In the flounder the ninth nerve lies in front of the tenth and passes through the ear capsule to its distribution on the hyoid and first gill arch.

## 2. THE OPTIC NERVES.

In the cross-section of a fish in Stage I. (Plate 3, Fig. 17), one section,  $10\mu$  thick, contained the whole length of both optic nerves from the blind spot to the chiasma. The blind spot is very near the outer ventral

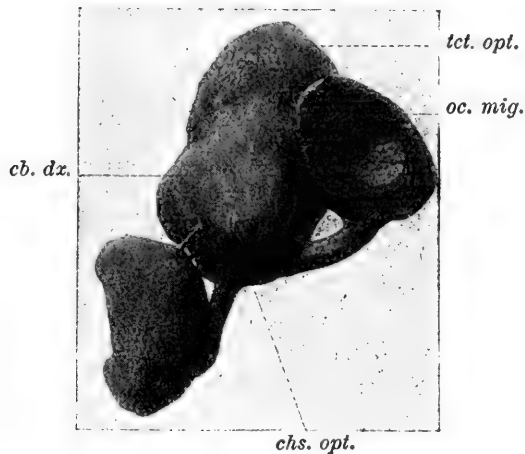


FIG. E.

A precisely front view of the fore part of the brain, the optic nerves and a portion of each of the optic cups, modelled in wax (Born's method) from a specimen in Stage III.  $\times 50$ .

For explanation of lettering, see Abbreviations under Explanation of Plates.

edge of the retina and in about the middle of the eye antero-posteriorly. Therefore the chiasma is in the transverse plane which passes through the middle of the eyes. There is, as yet, scarcely any want of symmetry, the left eye being only slightly higher than the right.

I have no corresponding illustration of the condition of the optic nerves in Stage II., but a model of the anterior part of the brain and the optic nerves of a specimen in Stage III. *a* is shown in Figure *E* (the anterior portion of the left optic cup has been omitted in the model; the cut surface being indicated by horizontal lines). The left eye is higher than the forebrain; its ventral edge is at the same level as the dorsal

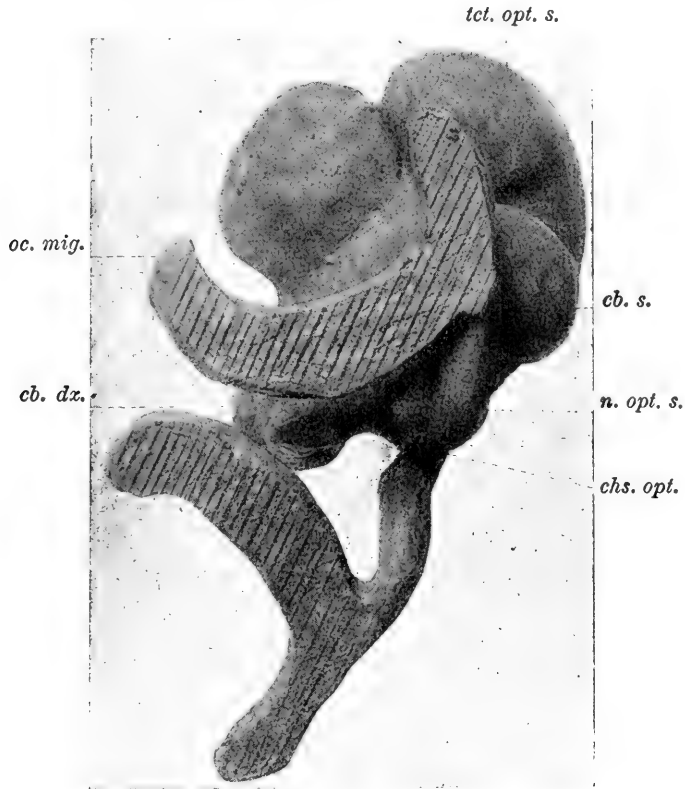


FIG. F.

Front view of the fore part of the brain, the optic nerves and portions of the optic cups in Stage IV. From a model (Born's method).  $\times 50$ . Compare Fig. *E*.

For meaning of lettering, see Abbreviations under Explanation of Plates.

side of the right eye, and the transverse plane tangent to its posterior surface would cut the right eye about midway between its anterior and posterior faces. The right eye may have moved slightly ventrad from the position which it occupied in Stage I. The slackness of the nerves is shown by the curve that they take as they pass forward and outward. The whole of the midbrain and most of the forebrain have lost their earlier position between the eyes, owing to the growth in length of the facial cartilages. Figure 9 (Plate 2), a side view of the brain of a fish three inches long, shows this antero-posterior separation between



brain and eyes farther advanced, and Figure 11 (from an adult) shows it completed.

In the essentially adult condition of Stage IV., as shown in a front view of the modelled brain and optic nerves (Figure *F*), the left eye has passed so far to the right side that, taking into consideration the high degree of mobility of the eye its field of vision almost coincides with that of the right eye. The optic nerves curve still more in their passage from chiasma to eye, and the distance is proportionately greater. The right cerebral lobe (*cb. dx.*) is seen in the figure between the eyes, and the left cerebral lobe (*cb. s.*) is seen on the right, behind the left eye, and below the tectum. The left olfactory lobe is covered by the left eye, but the right olfactory lobe — modelled as a continuation forward of the right cerebral lobe — is seen between the two eyes. The left optic lobe (*tct. opt. s.*) in both these instances (Figures *E* and *F*) extends farther anteriorly than the right. This is seen in the dorsal view of the brain (Fig. 8). This figure also shows why in making cross-sections the left lobe of the cerebrum is cut before its olfactory lobe in case one begins at the anterior end.

The optic nerve — round in cross-section in the larvæ — becomes thrown into folds in the adult (Plate 5, Fig. 24). This condition is also figured by Studnicka ('97) for one of the Pleuronectidæ. The cross-section may show as many as six or seven folds closely pressed together. Small neuroglia nuclei are scattered throughout the length of the nerve.

### 3. THE CHIASMA AND TRACTS WITH RELATED GANGLIA.

The optic crossing is complete as in all teleosts. There is no interlacing of fibres, as can be seen in Figure 19 (Plate 4), which is from a fish in Stage IV. This is an approximately transverse section, which, however, cut the left side of the fish somewhat farther caudad than it did the right side. The plane of the section also inclines a little backward and upward, so that it coincides with the plane of the anterior part of the left optic tract, which slants in Figure 19 backward and upward on its way to the tectum. The right tract is cut crosswise, nearly at right angles to its course. (This is by mistake lettered *n. opt. s.* in Figure 19. Of course, as it is posterior to the chiasma, it should have been labeled *trt. opt. dx.* For the second section anterior to this the label *n. opt. s.* would be correct.) The median, dorsal portion of the tract (*trt. opt. d.*) passes upward through the nidulus corticalis (to be described later) on its way to the median portion of the tectum. The

external, ventral portion (*trt. opt. v.*) passes outward and around to its distribution on the posterior, lateral, and ventral tectal surfaces.

The geniculate body (Figs. 20, 21, *cp. gnic.*) lies in the angle between the two portions of the Y-shaped tract, but almost entirely in front of their plane. There is some indication of a division of the corpus geniculatum into anterior and posterior parts.

In both Weigert and Congo-red preparations it could be seen that a few optic fibres entered the geniculate bodies (Plate 4, Fig. 21). C. L. Herrick ('92, p. 430) found no ending of optic fibres before reaching the tectum. This ending has been demonstrated, however, by Mayser ('81) in Cyprinoids, by Auerbach ('88) in the trout, by Haller ('98) in *Salmo*, and by Krause ('98), who used Marchi's method for degenerate nerves, in *Cyprinus auratus*. Edinger ('96, p. 126), makes the following statement for vertebrates. "Im Genuculatum [laterale] endet ein Theil des Sehnerven mit mächtiger Aufsplitterung, und mitten in diese Faserung tauchen die Dendriten langgestreckter Doppelpyramiden. Das mediale Ende dieser Pyramidenzellen splittert auf in einem Zuge, der wahrscheinlich auch dem optischen System angehört."

I have no Golgi preparations which show optic fibres actually fibrillating in these bodies. There was, however, in the geniculate bodies but one type of cell impregnated with the chrome-silver. This was a small unipolar cell (Plate 5, Fig. 22) with a short process ending in very thick short fibrillations directed towards the end of the geniculate body into which the optic fibres enter. In a single exceptional instance, a cell, otherwise like the ones described, had another short but unbranched process extending in the opposite direction (see diagram of tectum, Plate 5, Fig. 22, *cp. gnic.*).

Fusari ('87), after a study of *Carassius*, *Macropodus*, *Anguilla*, and *Lopodogaster*, stated that in his opinion fibres from the tractus pass through the corpus geniculatum and unite again with the tract to fibrillate in the tectum. No preparations of *P. americanus* indicated such a possibility.

No other bundle of fibres could be found to leave the tract before it reached the tectum itself. Mayser ('81) describes a small bundle passing into the thalamus at about the point of origin of the paraphysis. Auerbach ('88), Mirto ('96), and Haller ('98) also indicate a thalamus bundle, and Haller describes a small bundle running to the fore-brain. In my opinion Mayser, Auerbach, Mirto, and Haller have mistaken a portion of the ventral division of the tract, which bends outward sharply in its course to the ventral posterior part of the optic lobes, for a thala-

mus bundle. In parasagittal sections the cut ends of this portion of the tract appear to be pointing into the thalamus. But no one of these authors has described fibrillations or cell endings for this thalamus bundle, and the absence of degeneration in Krause's experiment would indicate that Mayser's thalamus root was non-optic.

A frontal section (Plate 4, Fig. 20) shows the relation of the thalamus ganglia to the tectum. The geniculate bodies lie anterior to the lobes of the tectum, and between them are the ganglia habenulæ (*gn. hab.*), which bound the third ventricle, and are separated from each other by the pineal-gland region. A few sections dorsal to the one shown in this figure the habenular commissure appears.

As Haller ('98) has found in the case of *Salmo*, the habenulæ are symmetrical, in the young fish at least. Because of the want of symmetry in older brains it is impossible to obtain single sections in which one is certain that the habenulæ are cut in like planes. In a cross section which passes through both ganglia the left ganglion has a greater dorso-ventral diameter than has the right, while the right ganglion measures more from side to side than the left.

In Figure 20 the fibres of the two parts of the optic tracts are shown in cross-section behind the edges of the geniculate bodies. Also behind the geniculate bodies lie large cells which belong to the nidulus corticalis of Fritsch, the "Dachkern" of Eninger and others.

Since fibres from this nidulus enter the tectum, I will describe its location more particularly in the two *Pleuronectidæ* studied. There are two symmetrically placed groups of very large ganglionic cells lying at the front part of the tectum; they extend anteriorly from the angle of the optic ventricles, where the lobe of the tectum and the axial portion of the midbrain meet, to the outer surface of the brain above and outside the geniculate bodies. There is no difficulty in identifying the cells of the nidulus (*nid. ctx.*, Plate 5, Fig. 23), as they are pear-shaped and many times larger than those of the gray layer of the tectum, into which the posterior portion of the nidulus extends.

The nucleus lies in the blunt end of the pear-shaped cell, at the end opposite the coarse cell process. Since these processes gather into bundles in the middle layers of the tectum, the nucleated ends of the cells are directed towards the surface when the cells are more superficial, but toward the optic ventricles if they are deep (compare Fig. 22).

There is a similar nidulus, consisting of a few (20-30) even larger cells, which lies ventral and exterior to the nidulus corticalis; it lies

posterior to, but in contact with the optic tract. This possibly is the nidulus anterior of Edinger, though I have traced no fibres from it. A few cells of this nidulus are shown between the two portions of the tract in Figure 19 (Plate 4).

In one instance I found a cell of the nidulus corticalis which sent a fine process, probably a neurite, ventrad with the other fibres of the optic tract (Plate 5, Fig. 22). This could be followed nearly to the chiasma, but whether it continued to the eye or bent backwards into one of the post-optic commissures, I cannot say.

I can confirm C. L. Herrick ('91-'92) in his statement that the commissura horizontalis (*coms. hz.*, Plate 5, Fig. 22) arises from the nidulus corticalis. The fibres forming this bundle were fine and took the same quality of Golgi impregnation as the single fibre just described from one of the cells of the same nidulus which passed downward through the tractus opticus. The fibres composing this bundle can be followed in two or three parasagittal sections to the nucleus rotundum of the same side; they pass through this nucleus, and then turn forward and cross to the opposite side behind the chiasma as the horizontal commissure.

#### 4. THE TECTUM OPTICUM.

Since the tectum is that portion of the brain in which the optic tracts terminate, it should be the place in which the transition from sensory to association or motor neurons takes place.

There are certain points of interest which can be shown from a surface view. At the anterior ends of the tectal lobes, in *P. americanus*, but not in *Bothus*, there is an exterior furrow or sulcus (*sul. tct. opt.*, Plate 2, Fig. 11), much like one that is found in the cerebrum of simple type—in that of a turtle, for example. This gradually disappears toward the posterior region of the tectum. Cross-sections in the anterior region show that this sulcus is due to a lateral horizontal depression in each optic lobe, which divides it into almost equal dorsal and ventral parts. The ventral portion of the tractus supplies the ventral half of the lobe and the dorsal portion the dorsal half. The geniculate bodies lie in the region of greatest constriction of the tectum.

For convenience, I divide the tectum into seven layers, indicated by the numerals 1-7 (Plate 5, Figs. 22, 23), in addition to the membranes of the brain, which are the vascular connective-tissue layer (the arachnoid, *mb. ach.*) and, beneath this, a very thin membrane, the pia, to which the endings of the ependymal cells reach, and along which is found here and there a nucleus.

Passing from without inward, the tectal layers are as follows:

(1) A thin outer layer, composed principally of nerve fibrillations with a few nerve cells. In this layer the ependymal fibrillations end. A corresponding layer is recognized by writers on the finer anatomy of the tectum in the bony fishes, from Stieda ('67) onwards, except by Fusari ('87, '96) and Van Gehuchten ('95). Fusari ('87) described a layer of vascular connective tissue beneath the pia, and later ('96) his first layer of the tectum was made to embrace this vascular layer and the optic-fibre layer.

(2) The layer of the medullated optic fibres. This is the continuation of the optic tract and is recognized as a separate layer by all writers on the tectum.

(3) A layer of optic fibrillations. This is not made a distinct layer by Stieda ('67), but Mayser ('81) and nearly all writers since his time have emphasized its presence.

(4) A spindle-cell layer.

(5) The fillet layer, composed of longitudinal fibres and cross commissural fibres. Stieda considered the fibres, which here run in two directions, as two layers. C. L. Herrick ('91-92) describes a layer of commissural fibres *beneath the fillet* connecting the two optic lobes.

(6) The "gray" layer.

(7) The reticulate and ependymal layer. Some authors consider that this is composed of two distinct layers. The reticulate portion is not described at all by Neumayer ('95), Van Gehuchten ('95) nor Elinger ('96).

Mirto ('96) based his division of the tectum into layers on the *shapes* of the cells which he was able to demonstrate by the Golgi method. Following Cajal's work on the tectum of birds, he describes fourteen layers.

The degeneration methods did not yield much of importance in my hands, although the flounder, owing to its habit of protruding the eyes, is a favorable fish on which to operate. The animals, even the very small metamorphosed fishes, stand the shock of the removal of the eye well and bleed very little from the operation. The specimens tried by the Marchi method were very brittle, and demonstrated but one point clearly, that the sixth (nerve-cell) layer was reduced. Fusari ('96), who used the Weigert-Pal staining method on a Cyprinoid, concluded that all the tractus fibres degenerated when the eye was removed. Krause ('98), after the Marchi treatment of fish from which the eyes had been removed, found that about one-tenth of the tract — mostly distributed

in the dorsal root, which spreads on the roof of the tectum — did not degenerate. In a very old one-eyed fish both the geniculate ganglion and the torus longitudinalis were, he found, much atrophied and the fillet was reduced. The spindle-cell layer contained fewer cells than were found in fishes more recently operated on.

Turning next to the finer anatomy of the tectum a diagrammatic representation of a parasagittal section is shown in Figure 22 (Plate 5). This exhibits the types of cells found in the tectum by the aid of the silver method.

In layer 1 few cells were impregnated. Of these the more common type (Fig. 22, *a*) was oval and bipolar, its two processes running parallel to the fibres of layer 2. In some instances, however, the cell had a third and even a fourth process. Similar cells have been described by Fusari, except that the cell bodies described by him were spherical. Neumayer ('95) has shown elongated bipolar cells with processes parallel to layer 2, and also rounded cells whose neurites fibrillated in the layer of optic fibres. Mirto ('96) indicated cells in corresponding positions, but with triangular bodies. I, also, have found a few pear-shaped cells (Fig. 22, *β*) in this layer. These lay near the surface and sent off their processes from their deeper, smaller ends. Some of these processes passed through the optic layer (2) into layer 3, while others turned at right angles and ran in layer 1 parallel to the surface.

Layer 2 is composed of the medullated fibres which enter the tectum as the optic tract. At the beginning of the tectal region the fibres of the tract, after having passed beneath the geniculate body, bend toward the surface of the brain to form this second layer. Some of the cells of the nidulus corticalis (*nid. ctx.*) lie in this layer, since the nidulus extends from ventricle to surface. The bulk of the dorsal bundle of fibres from the tractus passes too near the sagittal plane to touch the nidulus corticalis, and the ventral division does not reach as far dorsally as the nidulus. So there is little disturbance in the course of the fibres of the tractus in passing these very large cells. The diminution in the thickness of the optic-fibre layer in passing from before backwards, which is due to the fibres continually spreading out over more of the surface of the optic lobe, and to the termination of many of them in anterior regions, is shown in Figure 25 (Plate 5).

Here and there other cells, besides those of the nidulus corticalis, which lie at the anterior end of the tectum, are seen in the optic layer; these have fibres, some of which extend inward, others outward. The cell-body of one of these (Fig. 22, *γ*) was pear-shaped, the smaller end

being directed outward. From this smaller end processes ran both anteriorly and posteriorly, the most of them parallel to the surface; one, however, took an oblique direction, running forward and inward, and reached layer 3. Neumayer represents in this optic layer spindle-shaped cells, the upper ends of which fibrillate in layer 1, and the lower in layer 3.

The third layer contains cells of many shapes. (a) Short spindle-shaped cells (Fig. 22,  $\delta$ ) with one process directed outward and fibrillating in layer 1, and one or more processes directed inward. Cells like these are described by Fusari, Neumayer, and Mirto, and the last two authors say that the neurites are directed inward and reach the fillet layer. Fusari also describes a type of cell which is spindle-shaped with processes extending downwards and fibrillating just above the fillet layer. A neurite of one of these cells is figured running through the corona radiata of Gottsche<sup>1</sup> into the torus semi-circularis. (b) Pyriform cells (Fig. 22,  $\epsilon$ ) with all the processes directed inward and the ends of the fibrillations reaching into layer 4. (c) Rounded cells (Fig. 22,  $\zeta$ ) with rather long sparsely branched processes, the outward process having been followed in one case into the optic-fibre layer. (d) Cells (Fig. 22,  $\eta$ ) the reverse of those denominated  $\epsilon$  in this layer, with fibrillations having the opposite direction and reaching to, or even through, the optic layer into layer 1. (e) Lying near the boundary between this (3) and the next deeper (4) layer were found a few cells (Fig. 22,  $\theta$ ) flattened in a direction perpendicular to the surface of the optic lobes. Each of these possessed a process running from either end parallel to the surface of the tectum and sometimes a third one passing out towards the surface. At or near this transitional region between layers 3 and 4 the fibres from most cells send off short branches parallel to the surface.

I have separated layers 2 and 3 because in the anterior portion of the tectum some fibres from the optic tract take a direct course into layer 3 without first bending outward into layer 2. In the posterior portion of the tectum, however, it is not possible to distinguish these two layers.

Bundles of large processes from the nidulus corticalis (*nid. ctx.*) enter the anterior portions of these two layers and form a prominent fibrillation, traceable for some distance backward. These coarse, wavy processes are much larger than the fine fibres, which I have shown (p. 40) to be the neurites which make up the horizontal commissure, and there may be two or three of them from one cell. These coarse processes can be

<sup>1</sup> This is the "Stabkranz," the descending fillet fibres.

followed backward for some little distance along distinct paths in layers 3 and 4, and the general appearance of the fibrillations farther back indicates that these processes, branching continually, pass backward through the tectum much farther than continuity can be directly traced. A dendrite may branch and follow the fibrillar paths in each of the two layers.

A large system of fibres also enters the same general region of the tectum from the axial part of the mid-brain; some of these cross from the opposite side of the brain in the lower part of the posterior commissure. These fibres may constitute the most anterior portion of the commissura mesencephali (Herrick's sylvian commissure) or, as I think more likely, they may come from the motor regions, possibly Haller's anterior connective. I have not succeeded in tracing these fibres to any cells.

In layer 4 appear the cells which are most characteristic of the tectum (Fig. 22, *ι*). They were impregnated in most of the Golgi preparations. They are spindle-shaped, being much elongated in a radial direction, and have fibrillations which extend outward as far as layer 2. Sometimes there is an impregnated process which goes from the deeper end of the cell into layer 5, and sometimes there is not. Neumayer and Mirto each state that the neurites of these spindle cells are traceable to the fillet layer and the fibrillations to the optic layer. Mirto describes cells with the same processes but with much more slender bodies. The spindle-shaped bodies are shown by my hematoxylin preparations to be very abundant indeed in this layer, only a few taking the Golgi impregnation in a single specimen. In this layer (4) there were also found sparingly cells (Fig. 22, *κ*) with rounded bodies and processes which fibrillate inwards and extend into the fillet layer (5). A very few pyriform cells lie near the deep surface of this layer (4) and send their processes outward (Fig. 22, *λ*). Fusari shows irregular, large-bodied cells with many processes and neurites, when such are present, extending into layer 5. A bifurcate cell is figured by Mirto with its telodendrites in layer 3. My flounder impregnations produced neither of these types.

I have spoken of layer 5 as the fillet layer because it is composed chiefly of fibres which pass backward and medianward, forming the so-called corona radiata of Gottsche, the lemniscus or fillet system.

This layer is composed of cross and longitudinal fibres which, seen in tangential section, form a meshwork over the whole of the dorsal part of the tectum. In front of the optic ventricles bundles of fibres (Plate 5, Fig. 22, *lmn.*) can be followed from the axial part of the mid



brain through the region of the nidulus corticalis into the longitudinal fibre layer. Most of the cross-lying fibre bundles, which form the commissura mesencephali, lie below the longitudinal layer. Some of these cross bundles seem to turn longitudinally after crossing the mid-line. It may be that the uncrossed fibres of the fillet are a continuation of these. The longitudinal fibres, at any rate, pass back in bundles to the region of the anterior peduncles of the cerebellum. In any section which cuts through the whole thickness of the tectum, whether cross or parasagittal, some bundles will be shown (Plate 5, Fig. 25, *lmn.*). As the tectum is dome-shaped, the more nearly median parasagittal sections will cut the fibre bundles at the anterior and posterior ends of the tectum, whereas the more lateral sections will show the fibres of the middle of the tectum cut longitudinally. There is a rather distinct portion of the fillet which arises from the anterior ventral part of the tectum and, slanting upwards and inwards, passes through the nidulus-corticalis region back towards the cerebellum, beneath and behind the median boundary of the optic ventricles. The fillet fibres may be roughly likened to the slightly curved fingers of an open hand, palm inward, wrist beneath the cerebellum, grasping the most of the gray layer of the tectum. The gray of the posterior portion of the tectum seems, however, to be outside the region surrounded by the fillet-fibre bundles.

The fibres of the commissura mesencephali cross just above the gray layer in the anterior part of the tectum in the region of the torus longitudinalis. According to Herrick they form a continuation of the series found in the posterior commissure.

Besides these fibres, there are in layer 5 a number of different forms of cells: (*a*) Cells with rounded bodies (Plate 5, Fig. 22,  $\mu$ ) of the same size as those (Fig. 22,  $\rho$ ) in the next deeper layer (6) — the gray layer — and with processes which may fibrillate into any one or all of the more superficial layers (1-4) of the tectum. (*b*) Spindle-shaped cells (Fig. 22,  $\nu$ ) like those (*t*) characteristic of layer 4. When an axonic process can be followed from the deep end of such a cell, it finds its way into the fillet layer, but whether into the cross or longitudinal system I cannot determine. (*c*) Long triangular cells (Fig. 22, *o*) with a single process extending toward the periphery, and from each of the corners of the deep end a process running parallel to the fillet layer. (*d*) Rounded cells (Fig. 22,  $\pi$ ) with fibres which turn immediately into the fillet layer and with very short dendritic processes.

The next layer (6) is the gray molecular or granular layer. This is

the most noticeable portion of the tectum, especially in young animals. The nuclei are closely crowded together, with a definite arrangement due to the radially directed processes of the ependymal cells, which pass through all the layers from the ventricle to the pia. Only one type of cell body (Fig. 22,  $\rho$ ) is evident, that being the small and rounded form; in Golgi preparations, it is slightly pear-shaped, and resembles much the ependymal cell. But since the cells of this layer have processes of a number of types, they cannot all be, as Fusari ('96) maintained, ependymal cells. They may fibrillate in any or all of the layers outside the sixth. In Golgi preparations a very few spindle cells, like those in layers 4 and 5, appear. Some of the peripheral cells (Fig. 22,  $\sigma$ ) of this layer, as well as the very deep ones, may send to the surface a process which ends in branching fibrillations beneath the pia. The fibres from other cells were found to break up in layers 3, 4, and 5. These fibres are often impregnated when none of their processes take the silver, or vice versa. The cells next to adjacent layers, whether the deeper or those nearer the periphery, are more likely to become impregnated than those in the middle of the layer.

The innermost layer (7), less dense than any of the preceding, is composed of the bodies of the ependymal cells and the basal portions of their processes. A reticulate portion of this layer (next to layer 6) is not apparent in young specimens, and so I have not recognized it as a separate layer, but have included in layer 7 all that lies between the gray layer (6) and the ventricle.

In the adult brain there are scattered through this loose layer a few large-bodied very irregular cells (Fig. 22,  $\tau$ ), each having a multitude of long beaded processes. I was unable to discover any neurite connected with these cells.

In order to simplify the diagram (Fig. 22), I have omitted in all cases the free fibrillations. In most impregnations where there are any at all, there are so many that only a few can be traced to any definite medullated layer. Layer 3, however, certainly contains, among other fibrillations, free branches from the optic layer (2). In layers 3 and 4 free fibrillations of fibres from cells in layer 5 are doubtful, because any one of the many cells in the granular layer (6) may have its fibre impregnated though itself remaining clear.

Between the fillet layer (5) and the optic layer (2) there are two especially dense fibrillar regions corresponding in general to the two bundles of dividing processes which arise from the cells of the nidulus corticalis.

For the purpose of comparing the impregnation of the tectal region in these Pleuronectidæ with that of the same region in a symmetrical fish, in order to ascertain whether there are any noticeable histological differences, I have applied the Golgi method to the brain of *Fundulus heteroclitus*, the mud minnow. These were found to take the stain very much more easily than do flounders; but there was also more of the silver precipitate carried inward from the surface. I conclude, therefore, that the tissue in *Fundulus* must be more open. Except as to the size of certain cells and the relative thickness of some fibre bundles, the two brains correspond closely. The cells of the *nidulus corticalis* in the minnow are much smaller proportionately, though their tectal processes can be followed in layers 3 and 4 as far as in the Pleuronectidæ. The spindle-shaped cell found most abundantly in layer 4 was again in the minnow the most noticeable cell impregnated, and was found most often. A triangular cell in layer 5, very similar to the cell *o* found in the corresponding layer of the flatfish, had its outward process extended to layer 1, where it fibrillated like an ependymal cell.

Most of the cells of layers 3, 4, and 5 in *Fundulus* had neurites traceable into layer 5, the fillet layer.

## VI. Theoretical Considerations.

The conditions in the tectum are the same as those found in the optic lobes of typical Teleostei. The division of the tectum into layers is of importance as a means of more precise description. There must be a place where the fibres of the optic tract, which come in as layer 2, end; that region is layer 3. There must be an association system connecting with the posterior motor regions, and the fibres of this system are either a part or the whole of layer 5. If only a part, then the purpose of the *commissura mesencephali* is to put the two optic lobes in communication with each other. The cells in layers 3, 4, and 6, especially the spindle cells in layers 3 and 4, probably serve to receive and transmit optic stimuli.

The *nidulus corticalis*, developing early, as it does, is probably one of the most effective association centres of the brain. Lying at the entrance to the tectum, with a strong bundle of neurites running through the two *niduli rotundi* in the ventral part of the brain, and with its numerous large dendrites passing into layers 3 and 4 of the tectum, it should be able to connect the optic sensory region with the motor areas quickly, and thus account for the extreme rapidity of movement of these larvæ.

The "why" of the peculiar metamorphosis of the Pleuronectidæ is an unsolved problem. The presence or absence of a swim bladder can have nothing to do with the change of habit of the young flatfish, for *P. americanus* must lose its air-bladder before metamorphosis begins, since sections showed no evidence of it, whereas in *Bothus* the air-sac can often be seen by the naked eye up to the time when the fish assumes the adult coloration, and long after it has assumed the adult form.

Cunningham ('92-97) has suggested that the weight of the fish acting upon the lower eye after the turning would press it towards the upper side out of the way. But in all probability the planktonic larva rests on the sea bottom little if at all before metamorphosing. Those taken by me into the laboratory showed in resting no preference for either side until the eye was near the mid-line.

That the change in all species is repeated during the development of each individual fish, has been used to support the proposition that the flatfishes as a family are a comparatively recent product. They are, on the other hand, comparatively ancient. According to Zittel ('87-90, pp. 315-316) flatfishes of species referable to genera living at present, *Rhombus* and *Solea*, are found in the Eocene deposits. These two genera are notable in that *Rhombus* is the least and *Solea* the most unsymmetrical of the Pleuronectidæ.

The degree of asymmetry can be correlated with the habit of the animal. Those fishes, such as the sole and the shore-dwelling flounders, which keep to the bottom, are the most twisted representatives of the family, while the more freely swimming forms, like the sand-dab, summer flounder and halibut, are more nearly symmetrical. Asymmetry must be of more advantage to those fishes which grub in the mud for their food than to those which capture other fishes; of the latter, those that move with the greatest freedom are the most symmetrical.

This deviation from the bilateral condition must have come about either as a "sport," or by gradual modification of the adults. If by the latter method, — the change proving to be advantageous, — selection favored its appearing earlier and earlier in ontogeny, until it occurred in the stages of planktonic life. Metamorphosis at an age younger than this would be a distinct disadvantage, because of the lack of the customary planktonic food at the sea-bottom. At present some forms of selection are probably continually at work fixing the limit of the period of metamorphosis by the removal of those individuals which attempt the transformation at unsuitable epochs, — for instance, at the time of hatching. That there are such individuals is shown by Fullarton ('91), who figures

a fish just hatched "anticipating the twisting and subsequent unequal development exhibited by the head of Pleuronectids." Those larvæ which remain pelagic until better able to compete at the sea bottom become the adults which fix the time of metamorphosis on their progeny.

### VII. Summary.

1. The young of *Limanda ferruginea* are (probably) in the larval stage at the same time as those of *Pseudopleuronectes americanus*.

2. The recently hatched fish, both *P. americanus* and *Bothus*, are symmetrical, except for the relative positions of the two optic nerves.

3. The first observed occurrence in preparation for metamorphosis in *P. americanus* is the rapid resorption of the part of the supraorbital cartilage bar which lies in the path of the eye. This is probably due to pressure from the migrating eye.

4. Correlated with this is an increase in the distance between the eyes and the brain, caused by the growth of the facial cartilages.

5. The migrating eye moves through an arc of about 120 degrees.

6. The greater part of this rotation (three-fourths of it in *P. americanus*) is a rapid process, taking not more than three days.

7. The anterior ethmoidal region is not so strongly influenced by this twisting as the ocular region.

8. The location of the olfactory nerves shows that the morphological mid-line follows the inter-orbital septum.

9. The cartilage mass lying in the front part of the orbit of the adult eye is a separate anterior structure in the larva.

10. With unimportant differences, the process of metamorphosis in the sinistral fish is parallel to that in the dextral fish.

11. The original location of the eye is indicated in the adult by the direction first taken, as they leave the brain, by those cranial nerves having to do with the transposed eye.

12. The only well-marked asymmetry in the adult brain is due to the much larger size of the olfactory nerve and lobe of the ocular side.

13. There is a perfect chiasma.

14. The optic nerve of the migrating eye is always anterior to that of the other eye.

15. The optic tract is divided into dorsal and ventral portions.

16. There are fibres from the tract which enter the geniculate body. No other bundles of fibres leave the tract before it reaches the tectum.

17. The ganglia habenulæ are symmetrical, at least in the larva before metamorphosis.

18. There is a notable sulcus on the lateral side of the adult optic lobe, which increases the surface area of the tectum.

19. The *nidulus corticalis* is the origin of the horizontal commissure and of a large bundle of nerve fibres which pass into layers 3 and 4 of the tectum.

20. The most important receiving cells for the fillet layer are probably the large spindle cells in layer 4.

## BIBLIOGRAPHY.

Agassiz, A.

- '78. On the Young Stages of Bony Fishes. II. Development of the Flounders. Proc. Amer. Acad. Arts and Sci., Vol. 14, pp. 1-25, 8 pls. (3-10).

Auerbach, L.

- '88. Die Lobi optici der Teleostier und die Vierhügel der höher organisierten Gehirne. Morph. Jahrb., Bd. 14, pp. 373-393, Taf. 16.

Bellonci, J.

- '81. Ueber den Ursprung des Nervus opticus und den feineren Bau des Tectum opticum des Knochenfische. Zeit. f. wiss. Zool., Bd. 35, pp. 23-29, Taf. 1, 2.

Bellonci, J.

- '88. Ueber die centrale Endigung des Nervus opticus bei den Vertebraten. Zeit. f. wiss. Zool., Bd. 67, pp. 1-46, Taf. 1-8, und 4 Holzsch.

Beneden, J. P. van. See VAN BENEDEEN.

Bumpus, H. C.

- '98. On the Identification of Fish Artificially Hatched. Am. Nat., Vol. 32, No. 388, pp. 407-412, 2 figs.

Cunningham, J. T.

- '92. The Evolution of Flatfishes. Nat. Sci., Vol. 1, No. 3, pp. 191-199.

Cunningham, J. T.

- '97. Recapitulation. Science Progress, Vol. 6, No. 5, pp. 483-510.

Edinger, L.

- '96. Vorlesungen über den Bau der nervösen Centralorgane des Menschen und der Thiere. 5te. Aufl. xii + 386 pp., 258 Abbild. Leipzig, F. C. W. Vogel.

Ehrenbaum, E.

- '96. Eier und Larven von Fischen der deutschen Bucht. Wiss. Meeresunters., N. F., Bd. 2, Heft 1, Abt. 1, pp. 253-324, Taf. 3-6.

Fritsch, G.

- '78. Untersuchungen über den feineren Bau des Fischgehirns mit besonderer Berücksichtigung der Homologien bei anderen Wirbelthierklassen. 94 + XV pp., 13 Taf., 16 Textfig. Berlin.

Fullarton, J. H.

- '91. On the Development of the Plaice (*Pleuronectes platessa*). (Preliminary Report.) 9th Ann. Rep. Fish. Board for Scotland, Part III, pp. 311-316, pl. 7-9.

Fusari, R.

- '87. Untersuchungen über die feinere Anatomie des Gehirnes der Teleostier. Internat. Monatsschr. für Anat. und Histol. Bd. 4, pp. 275-300, Taf. 9-11.

Fusari, R.

- '96. La terminazione centrale del nervo ottico nei Teleostei. Riv. patol. nervosa e mentale. Anno 1, Vol. 1, fasc. 8, pp. 300-302.

Gehuchten, A. See VAN GEHUCHTEN.

Goode, G.

- '84. The Flatfishes and Flounders. The Fisheries and Fishery Industries of the United States, Sect. 1, Natural History of Useful Aquatic Animals, pp. 175-199, pls. 41-57.

Haller, B.

- '98. Vom Bau des Wirbelthiergehirns. I. Theil. Salmo und Scyllium. Morph. Jahrb., Bd. 26, Hefte 3 u. 4, pp. 345-641, Taf. 12-22, 23 Textfig.

Herrick, C. J.

- '91. Siluridæ. Jour. Comp. Neur., Vol. 1, pp. 211-228, pl. 17. In: Herrick, C. L. and C. J., '91-92.

Herrick, C. L.

- '91. The Commissures and Histology of the Teleost Brain. Anat. Anz., Bd. 6, pp. 676-681, 3 figs.

Herrick, C. L.

- '91-92. Studies on the Brain of some American Fresh-water Fishes. Journ. Comp. Neur., Vol. 1, pp. 228-245, pl. 19-21; pp. 333-358, pl. 24-25; Vol. 2, pp. 21-72, pl. 4-12. In: Herrick, C. L. and C. J., '91-92.

Herrick, C. L.

- '92. Additional Notes on the Teleost Brain. Anat. Anz., Bd. 7, Nr. 13 u. 14, pp. 422-431, 10 figs.

Herrick, C. L. and C. J.

- '91-92. Contributions to the Morphology of the Brain of Bony Fishes. Journ. Comp. Neur., Vol. 1, pp. 211-245, pl. 19-21; pp. 333-358, pl. 24-25; Vol. 2, pp. 21-72, pl. 4-12.

Holt, E. W. L.

- '94. Studies in Teleost Morphology from the Marine Laboratory at Cleethorpes. Proc. Zoöl. Soc. Lond., pp. 413-446, pl. 28-30. [II. On the Recessus Orbitalis, an Accessory Visual Organ in Pleuronectid Fishes.]



Jordan, D. S., and B. W. Evermann.

- '96-00. The Fishes of North and Middle America, etc. Bull. United States Nat. Mus., No. 47, lx + xxx + xxiv + ci + 3312 pp., 392 pl. [Flounders, Part 3, pp. 2602-2692.]

Klein.

- '68. Der Kopf der Pleuronectæ. Jahreshefte des Vereins f. nat. Naturkunde in Württemberg, Jahrg. 24, pp. 271-308, Taf. 6. (Stuttgart.)

Krause, K.

- '98. Experimentelle Untersuchungen über die Sehbahnen des Goldkarpfen (*Cyprinus auratus*). Arch. f. mikr. Anat., Bd. 51, pp. 820-839, Taf. 27.

Kyle, H. M.

- '98. The Post-Larval Stages of the Plaice, Dab, Flounder, Long Rough Dab, and Lemon Dab. 16th Ann. Rep. Fish. Board for Scotland (for 1897), Part 3, pp. 225-247, pls. 10, 11.

Looss, A.

- '89. Ueber Degenerations-Erscheinungen im Thierreich, besonders über die Reduction des Froschlärvenschwanzes und die im Verlaufe derselben auftretenden histolytischen Prozesse. Preisschriften der Jablonowski'schen Gesellschaft zu Leipzig, [No.] 27, 116 pp., 4 Taf. Leipzig.

Malm, A. W.

- '54. De flundre-artade fiskarnas kroppsbyggnad är mera skenbart än verkligt osymmetrisk. Ofvers. Kgl. Sv. Vetensk. Acad. Förhandl., 1854, pp. 173-183.

Malm, A. W.

- '68. Bidrag till kännedom af pleuronektoidernas utveckling och byggnad. Kgl. Sv. Vetensk. Acad. Handl., N. F., Bd. 7, Nr. 4, pp. 28, Taf. 2.

Mayser, P.

- '81. Vergleichend anatomische Studien über das Gehirn der Knochenfische mit besonderer Berücksichtigung der Cyprinoiden. Zeit. f. wiss. Zool., Bd. 36, Heft 2, pp. 259-364, Taf. 14-23.

McIntosh, W. C., and A. T. Masterman.

- '97. The Life Histories of the British Marine Food Fishes. 467 pp., 20 pls. and Frontispiece. London, C. J. Clay & Sons.

Mirto, D.

- '95. Sulla fina anatomia del tetto ottico dei pesci teleostei e sull' origine reale del nervo ottico. Riv. sper. di frenatria e di med. legale. Vol. 21, fasc. 1, pp. 136-148, pl. 2, 3.

Mirto, D.

- '96. La terminazione centrale del nervo ottico nei Teleosti (In risposta alla nota d. R. Fusari). Riv. patol. nervosa e mentale, Vol. 1, fasc. 10, pp. 394-396. (= Arch. Ital. per le Malattie nervose e mentale, Anno 32.)

**Neumayer, L.**

- '95. Histologische Untersuchungen über den feineren Bau des Centralnervensystems von *Esox lucius* mit Berücksichtigung vergleichend-anatomischer Verhältnisse. Arch. f. mikr. Anat., Bd. 44, Heft 3, pp. 345-365, Taf. 23.

**Nishikawa, T.**

- '97. On a Mode of the Passage of the Eye in a Flatfish. Annot. Zool. Japon., Vol. 1, Pars 3, pp. 76-96, 2 figs.

**Parker, W. K.**

- '73. On the Structure and Development of the Skull in the Salmon (*Salmo salar*, L.). Phil. Trans. Roy. Soc. London, Vol. 163, pp. 95-145, pl. 1-8.

**Pfeffer, G.**

- '86. Ueber die Schiefheit der Pleuronectiden. Referat über ein Vortrag, u. s. w. Abhandl. Naturw. Verein, Hamburg. Bd. 9, Heft 1, pp. 41-48.

**Pfeffer, G.**

- '94. Ueber die Wanderung des Auges bei den Plattfischen. Verh. Deutsch. Zool. Gesell. 3ten Jahresversam. zu Göttingen, 1893, Nr. 3, p. 83.

**Petersen, C. G. J.**

- '94. Report of the Danish Biological Station to the Home Department. IV. [For] 1893. v + 146 pp.; 2 Tav., 18 Tabel. Reprinted from Fiskeri-Beretningen, 1893-94.

**Raffaele, F.**

- '88. Le uova galleggianti e le larve dei Teleosti nel golfo di Napoli. Mitth. Zool. Stat. Neapel, Bd. 8, Heft 1, pp. 1-84, Taf. 1-5.

**Reichert, C. B.**

- '74. Ueber den asymmetrischen Bau des Kopfes der Pleuronectiden. Arch. f. Anat. Physiol. u. wiss. Med., Jahrg. 1874, pp. 196-216, Taf. 5, 6.

**Sanders, A.**

- '78. Contributions to the Anatomy of the Central Nervous System in Vertebrate Animals. Ichthyopsida. Pisces. Teleostei. Phil. Trans. Roy. Soc., London, Vol. 169, pp. 735-776, pl. 58-65.

**Schiödte, J. C.**

- '68. On the Development of the Position of the Eyes in Pleuronectidæ. Ann. Mag. Nat. Hist., Ser. 4, Vol. 1, pp. 378-383.

**Smith, H. M.**

- '98. The Fishes found in the Vicinity of Woods Hole. Bull. U. S. Fish. Com., Vol. 17, for 1897, pp. 86-111, pl. 3.

**Steenstrup, J. J. S.**

- '63. Bidrag til en rigtigere Opfattelse af Skjaevheden hos Flynderne (Pleuronectides) og til Forklaring af begge Oines Fremkomst paa samme Side af Kroppen. Oversigt Kgl. danske Videnskab. Selsk. Forh., 1863, pp. 145-193, 16 wdets. and 1 pl.

*Also separate:* Om Skjævheden hos Flynderne og navnlig om Vandringen af det övre Öie fra Blindsiden til Öiesiden tvers igjennem Hovedet, m. m. Kjøbenhavn, 1864. Saerskilt Aftryk af Oversigt over d. Kgl. danske Videnskab. Selsk. Forhandl. i Nov. 1863. 52 pp.

*Extract in:* Arch. sc. phys. et nat. Genève. Nouv. période, T. 25, 1866, p. 175-179.

See also Thomson, W., '65.

**Steenstrup, [J. J. S.]**

'64. Observations sur le développement des Pleuronectes, extraites d'une lettre adressée à M. Milne-Edwards. Ann. Sci. Nat., Sér. 5, Tom. 2, pp. 253-258, pl. 19, B.

**Stieda, L.**

'67. Studien über das centrale Nervensystem der Knochenfische. Zeit. f. wiss. Zool., Bd. 18, Heft 1, pp. 1-70, Taf. 1, 2.

**Studnicka, F. K.**

'97. Untersuchungen über den Bau des Sehnerven der Wirbeltieren. Jena Zeitschr. Bd. 31, Heft 1, pp. 1-28, Taf. 1, 2.

**Thomson, W.**

'65. Notes on Prof. Steenstrup's Views on the Obliquity of Flounders. Ann. Mag. Nat. Hist., Ser. 3, Vol 15, pp. 361-371, pl. 18. (Contains abstract of Steenstrup, '63.)

**Traquair, R. H.**

'65. On Asymmetry of the Pleuronectidæ, as elucidated by an Examination of the Skeleton of the Turbot, Halibut, and Plaice. Trans. Linn. Soc. London, Vol. 25, Part 2, pp. 263-296, pl. 29-32.

**Van Beneden, P. J.**

'53. Note sur la symétrie des poissons Pleuronectes, dans leur jeune âge Bull. Acad. Roy. Belgique, Tom. 20, Part 3, pp. 205-210, 1 pl.

**Van Gehuchten, A.**

'95. Contribution à l'étude du système nerveux des téléostéens. La Cellule, Tom. 10, pp. 255-295, 3 pl.

**Winslow, G. M.**

'98. The Chondrocranium in the Ichthyopsida. Bull. Essex Inst., Salem, Mass., Vol. 28, pp. 87-141, 4 pl.

*Also, '98<sup>a</sup>, Tufts Coll. Studies, No. 5, pp. 147-200, 4 pl.*

**Zittel, K. A. von.**

'87-90. Handbuch der Palæontologie, Bd. 3, Vertebrata, xii + 900 pp. 719 Abbild.

## EXPLANATION OF PLATES.

Figures 13, 14, and 16 are of *Bothus maculatus*. All others are of *Pseudopleuronectes americanus*. All except Figure 11 were outlined with the camera lucida.

## ABBREVIATIONS.

<i>a.</i> . . . . .	: . . . . .	Anterior.	<i>gl. pin.</i> . . . . .	Pineal gland.
<i>an.</i> . . . . .		Anus.	<i>gn. hab.</i> . . . . .	Ganglion habenula.
<i>arc. eth. m.</i> . . . . .		Mesial cartilage arch of the ethmoid.	<i>ham. eth.</i> . . . . .	Ethmoid hook in mid-line over me- sial cartilage arch.
<i>ba-hy.</i> . . . . .		Basi-hyal.	<i>hy-md.</i> . . . . .	Hyomandibular.
<i>can. smi'crc.</i> . . . . .		Semicircular canals.	<i>i'cis. eth. (dx., s.)</i> . . . . .	Ethmoid notch (right, left).
<i>cb. (dx., s.)</i> . . . . .		Cerebrum (right lobe, left lobe).	<i>lmn.</i> . . . . .	Lemniscus (fillet).
<i>cbl.</i> . . . . .		Cerebellum.	<i>lob. olf.</i> . . . . .	Olfactory lobe.
<i>chs. opt.</i> . . . . .		Optic chiasma.	<i>lob. opt. (dx., s.)</i> . . . . .	Optic lobe (right, left).
<i>cl. crt.</i> . . . . .		Degenerating carti- lage cells.	<i>mb. ach.</i> . . . . .	Arachnoid mem- brane.
<i>coms hz.</i> . . . . .		Commissura hori- zontalis.	<i>ms'eth.</i> . . . . .	Mesethmoid.
<i>cp. gnic.</i> . . . . .		Genuiculate body.	<i>nid. ctx.</i> . . . . .	Nidulus corticalis (Fritsch).
<i>crt. mk. (dx., s.)</i> . . . . .		Meckel's cartilage (right, left).	<i>nid. rot.</i> . . . . .	Nidulus rotundus.
<i>crt. orb. a.</i> . . . . .		Antorbital cartilage.	<i>n. opt. (dx., s.)</i> . . . . .	Optic nerve, right, left).
<i>crt. pin. d.</i> . . . . .		Rays of dorsal fin.	<i>ob. inf.</i> . . . . .	See <i>obl. inf.</i>
<i>ec'eth. (dx., s.)</i> . . . . .		Ect-ethmoid or pre- frontal (right, left).	<i>obl. inf. (dx., s.)</i> . . . . .	Inferior oblique muscle (right, left).
<i>eth.</i> . . . . .		Ethmoid.	<i>obl. su.</i> . . . . .	Superior oblique muscle.
<i>eth-f.</i> . . . . .		Diagrammatic rep- resentation of the pseudomesial bar formed by the union of ect-eth- moid and pre- frontal.	<i>ob. sv.</i> . . . . .	See <i>obl. su.</i>
<i>for. olf. (dx., s.)</i> . . . . .		Foramen for olfac- tory nerve (right, left).	<i>oc. mig.</i> . . . . .	Migrating eye.
<i>fv. olf. (dx., s.)</i> . . . . .		Olfactory pit (right, left).	<i>p.</i> . . . . .	Posterior.
			<i>pall.</i> . . . . .	Pallium.
			<i>pa'sph.</i> . . . . .	Parasphenoid.
			<i>pia</i> . . . . .	Pia mater.
			<i>pin. an.</i> . . . . .	Anal or ventral fin.
			<i>pin. d.</i> . . . . .	Dorsal fin.
			<i>pin. plv.</i> . . . . .	Pelvic fin.

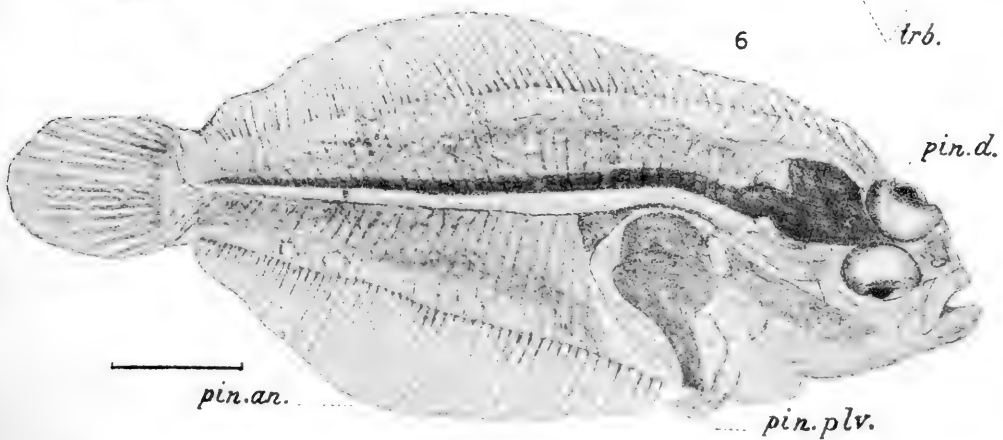
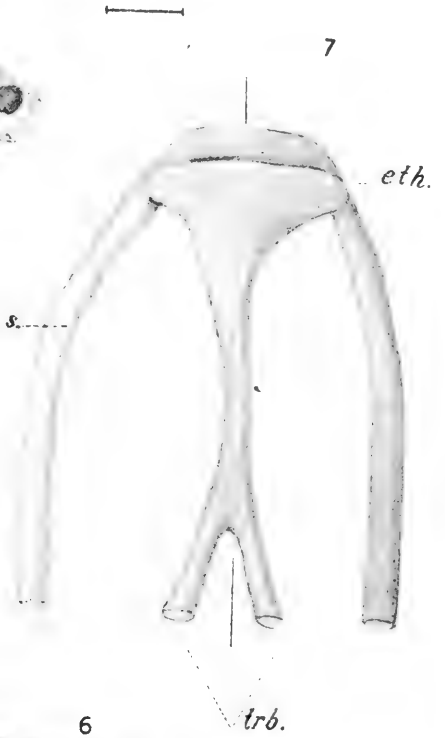
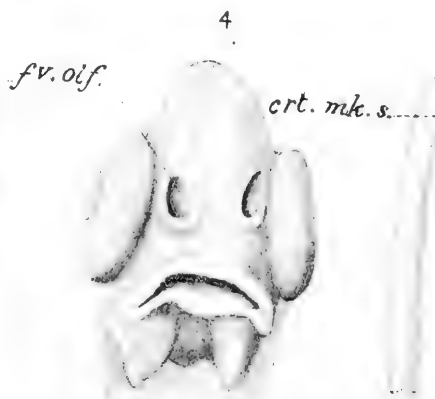
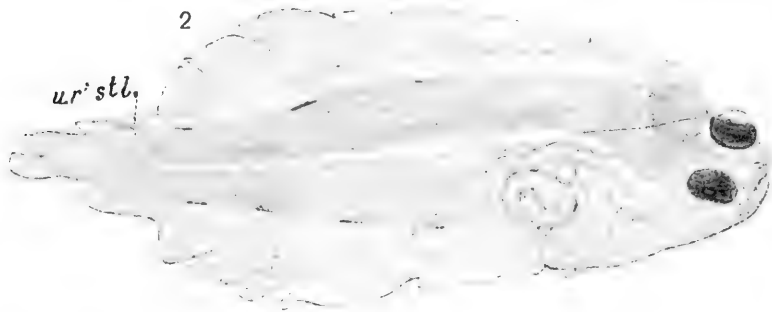
<i>pt-pal. (dx., s.)</i>	Pterygo-palatine cartilage (right, left).	<i>trb. su'orb. s. p.</i>	Posterior part of left supraorbital bar.
<i>rec. orb.</i>	Recessus orbitalis.	<i>trt. opt. (d., v.)</i>	Optic tract (dorsal, ventral part).
<i>rt. a.</i>	Anterior rectus muscle.	<i>tu. co'nt. tis.</i>	Connective tissue sheath.
<i>rt. d.</i>	Dorsal rectus.	<i>ur'stl.</i>	Urostyle.
<i>rt. p.</i>	Posterior rectus.	<i>vnt. opt.</i>	Optic ventricle.
<i>rt. v.</i>	Ventral rectus.	<i>I, . . . X</i>	First, . . . tenth cranial nerves.
<i>sul. tct. opt.</i>	Sulcus of <i>tct. opt.</i>	<i>I. (dx., s.)</i>	Olfactory nerve (right, left).
<i>tct. opt. (dx., s.)</i>	Optic tectum (right, left).	<i>II. (dx., s.)</i>	Optic nerve (right, left).
<i>tct. opt. 1</i>	Outer layer.	<i>II. d.</i>	Dorsal portion of optic tract.
2	Optic fibre layer.	<i>II. v.</i>	Ventral portion of optic tract.
3	Optic fibrillar layer.	<i>V. opt. su.</i>	Superior ophthalmic branch of nerve V.
4	Granular layer.	<i>V. opt. pfnd.</i>	Deep ophthalmic branch of nerve V.
5	Fillet, longitudinal and cross layers.		
6	Gray layer.		
7	Reticulate and ependymal layer.		
<i>trb.</i>	Trabeculae cranii.		
<i>trb. su'orb. (dx., s.)</i>	Supraorbital bar (right, left).		
<i>trb. su'orb. s. a.</i>	Anterior part of left supraorbital bar.		

For explanation of Greek letters, see text.

PLATE 1.

(*Pseudopleuronectes americanus*.)

- Fig. 1. Recently hatched fish (12 days old) from right side. × 30.  
NOTE. — The line indicating the length of this specimen is  $\frac{1}{2}$  millimetre too long. The length of the fish was 3.5 millimetres.
- Fig. 2. Fish of Stage III. × 10.  
Fig. 3. Fish of Stage II. × 10.  
Fig. 4. Fish of Stage II, face view. × 35.  
Fig. 5. Fish of Stage IV, face view. × 8.  
Fig. 6. Fish of Stage IV, from right side. × 8.  
Fig. 7. Facial portion of the cartilaginous cranium of a recently hatched fish, Stage I, projected on the frontal plane. × 200.







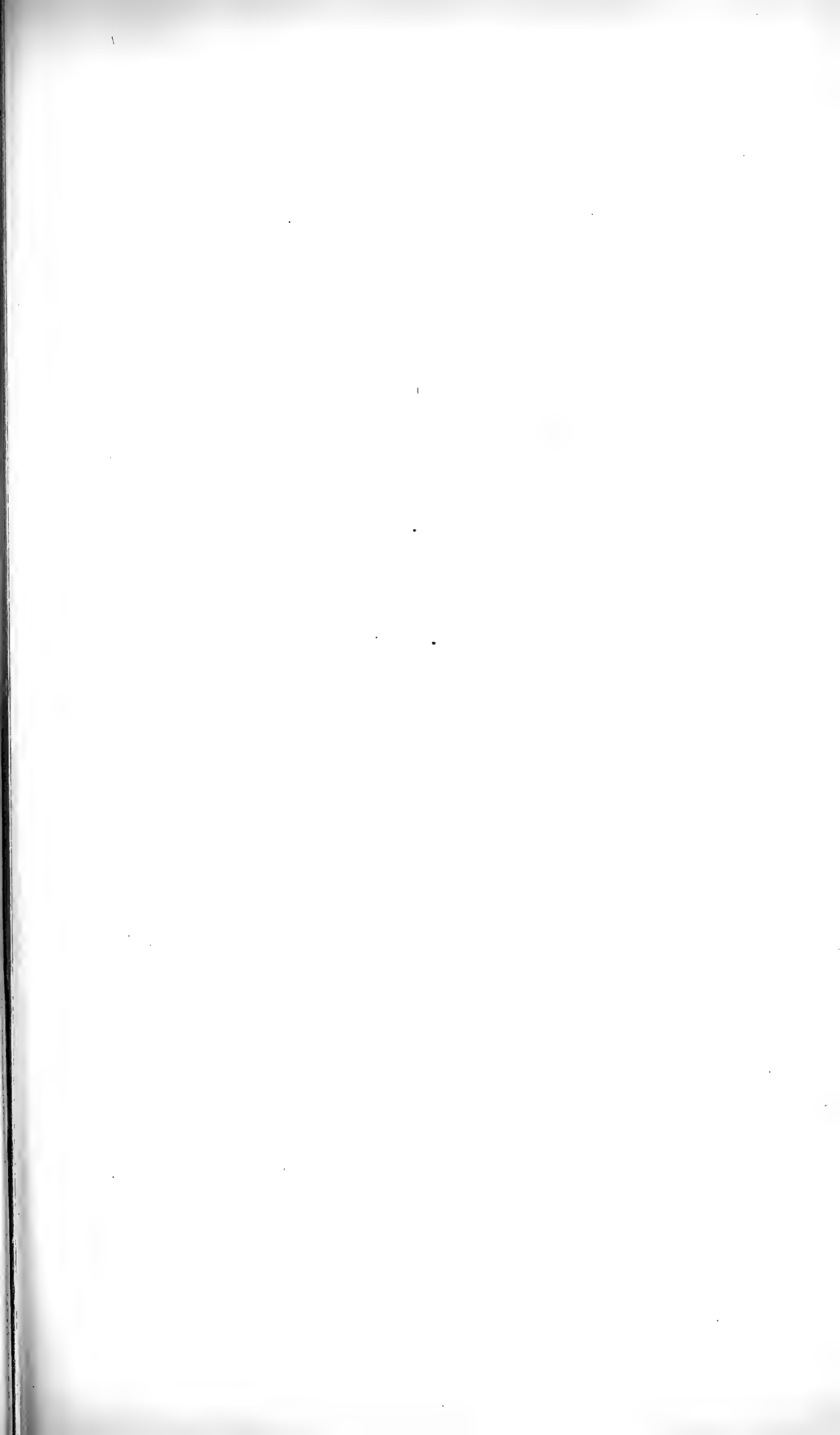


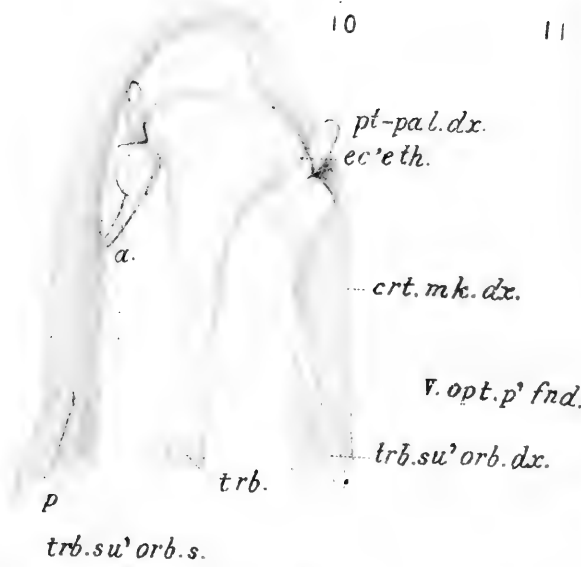
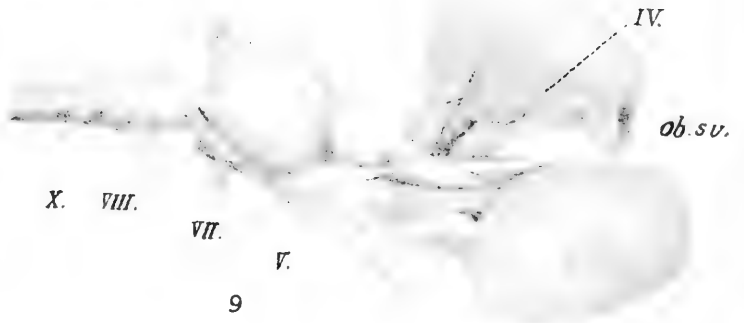
PLATE 2.

(*Pseudopleuronectes americanus*.)

- Fig. 8. Brain of fish 75 millimetres long, dorsal view.  $\times 8$ .  
NOTE. — *ob. inf.* should have been *obl. inf.*
- Fig. 9. Same brain viewed from right side.  $\times 8$ .  
NOTE. — *ob. sv.* should have been *obl. su.*
- Fig. 10. Facial cartilages of fish of Stage II. as seen from above.  $\times 100$ .  
NOTE — Meckel's cartilage does not extend as far caudad as the lettering, *crt. mk. dx.*, which is placed opposite the quadrate-hyomandibular mass.
- Fig. 11. Dorsal view of brain, transposed eye and cranial nerves of adult. From a dissection.  $\times 2$ .
- Fig. 12. Chiasma of a fish at Stage I. seen from in front.  $\times 760$ .

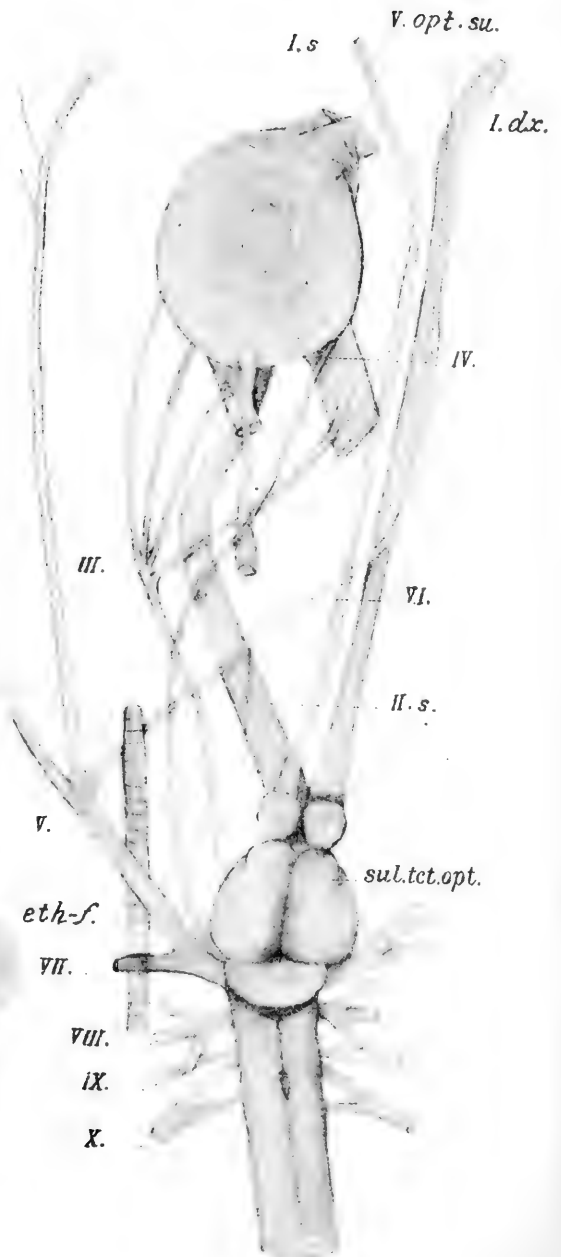


8

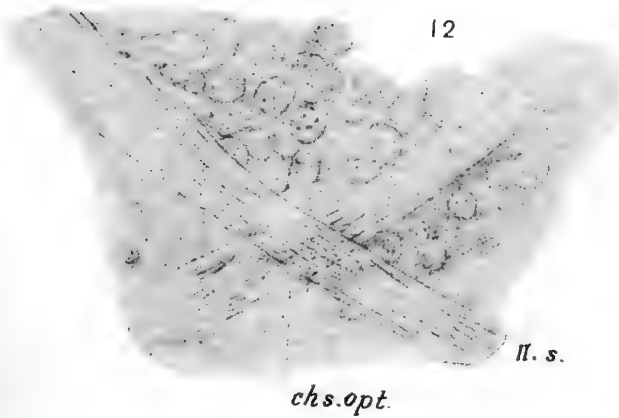


10

11



12



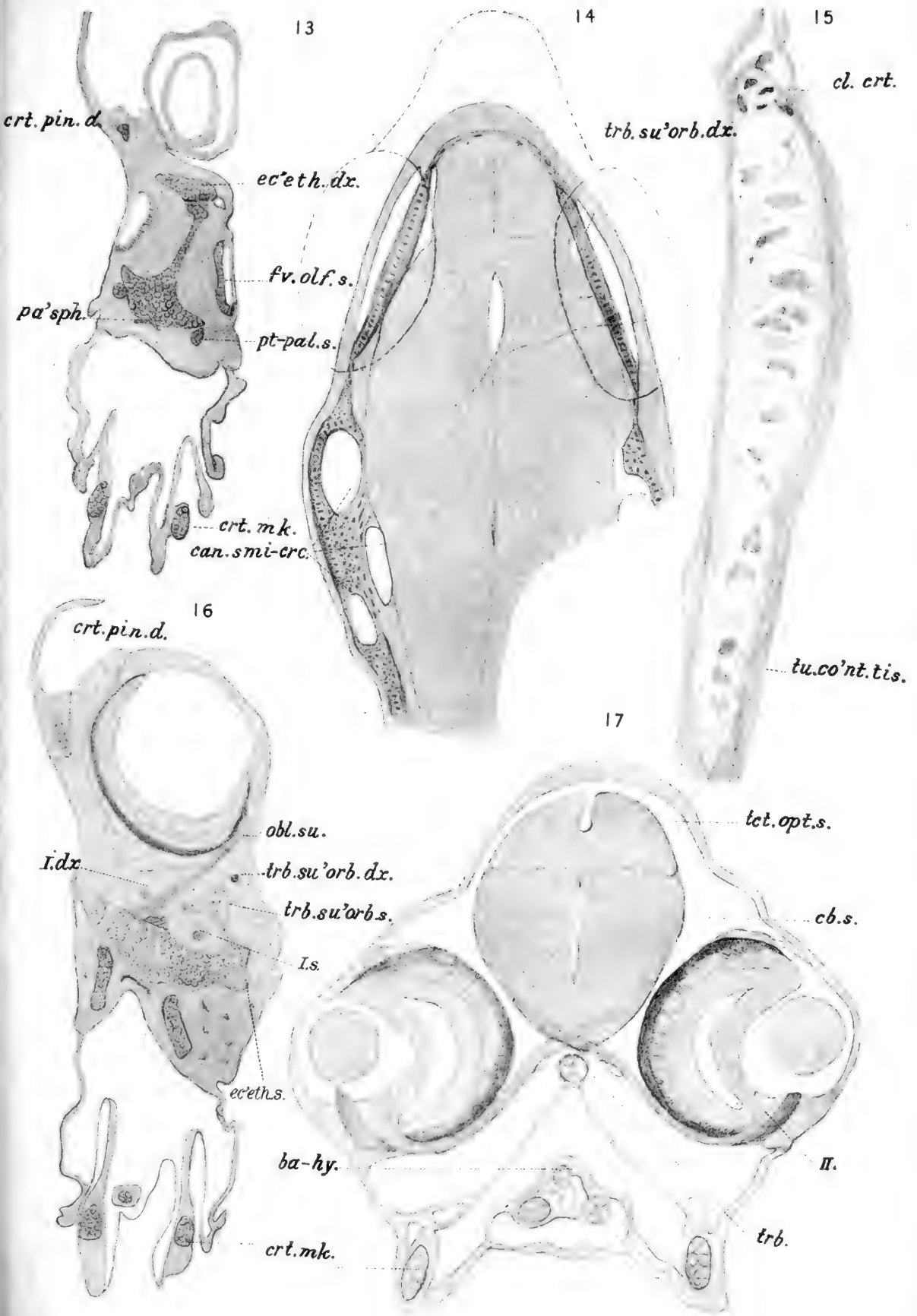
chs. opt.

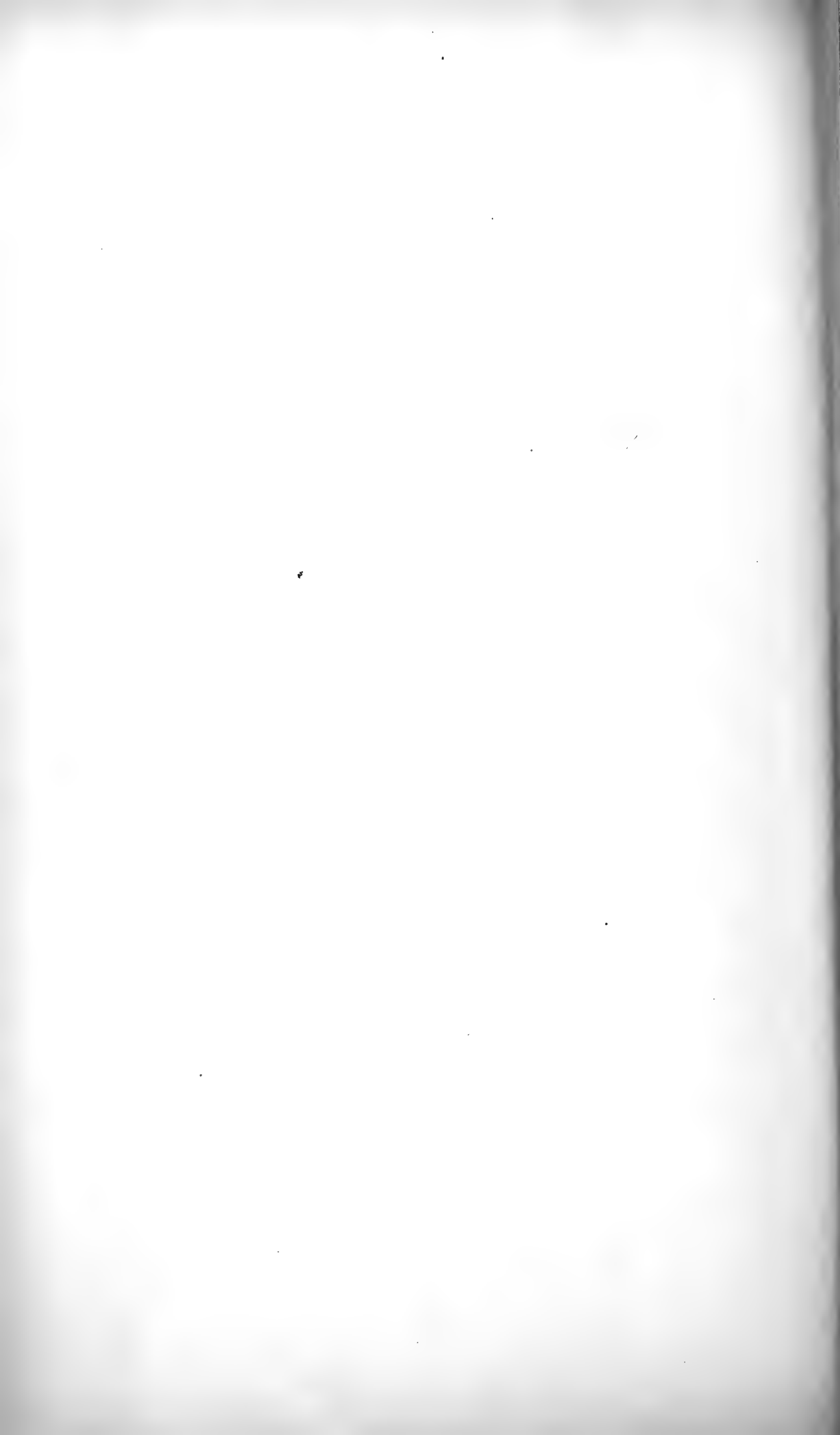




PLATE 3.

- Fig. 13. *Bothus*. Anterior face of a cross-section through the nasal pits of a fish in Stage IV.  $\times 40$ .
- Fig. 14. *Bothus*. Dorsal aspect of a frontal section through a fish of Stage II.  $\times 100$ .
- Fig. 15. *Pseudopleuronectes*. Supraorbital bar cut in frontal section showing signs of resorption.  $\times 760$ .
- Fig. 16. *Bothus*. Anterior face of a cross-section from the same individual as in Fig. 13.  $\times 40$ .
- Fig. 17. *Pseudopleuronectes*. Anterior face of a cross-section of the head of a fish in Stage I.  $\times 200$ .







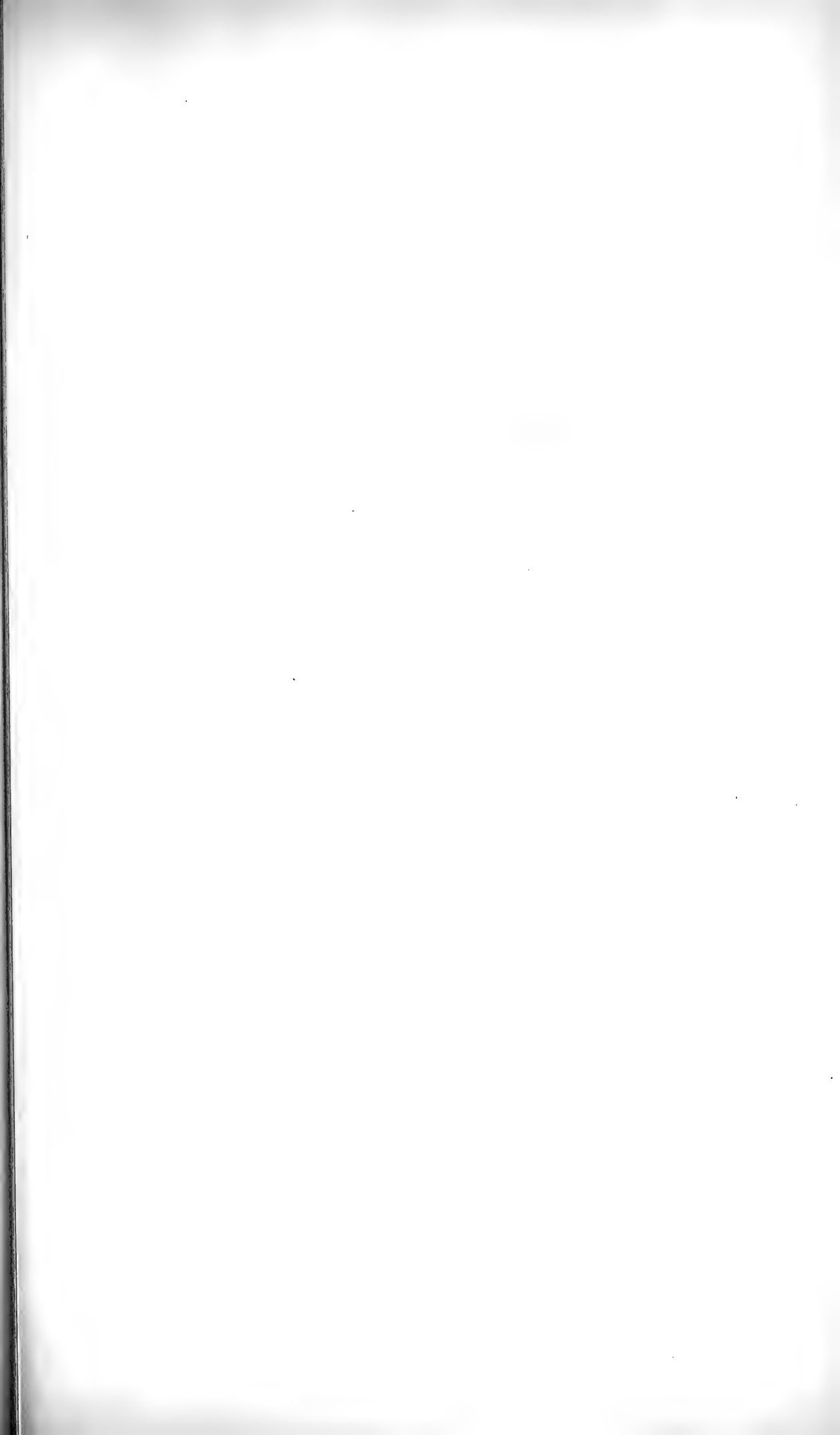


PLATE 4.

(*Pseudopleuronectes americanus*.)

Fig. 18. Anterior face of a cross section through the head of a fish of Stage III.  
× 100.

NOTE. — *ob. inf. s.* should have been *obl. inf. s.*

Fig. 19. Portion of a slanting cross section through cerebral lobes and diencephalon. × 100.

NOTE. — The letters *n. opt. s.* in this figure should be changed to *tr. opt. dx.*

Fig. 20. Frontal section through habenulæ and geniculate bodies. × 100.

Fig. 21. Parasagittal section through geniculate body and optic tract. × 100.

18

*trb. su' orb. dx.*

*ec'eth.s.*

19

*trt.opt.d.*

*nid.ctx.*

*arc.eth.m.*

*ob.inf.s.*

*rec.orb.*

*pt-pal.*

*crt.mk.*

*trt.opt.v.*

20

*gl. pin.*

*n.opt.s.*

*gr.hab.*

21

*tct.opt. 1. 2. 3. 4. 5. 6.*  
*cp.gnc.*

*trb. su' orb. s.*

*nid.ctx.*

*trt.opt.v.*

*l.mn.*

*trt.opt.d.*

*trt.opt.*



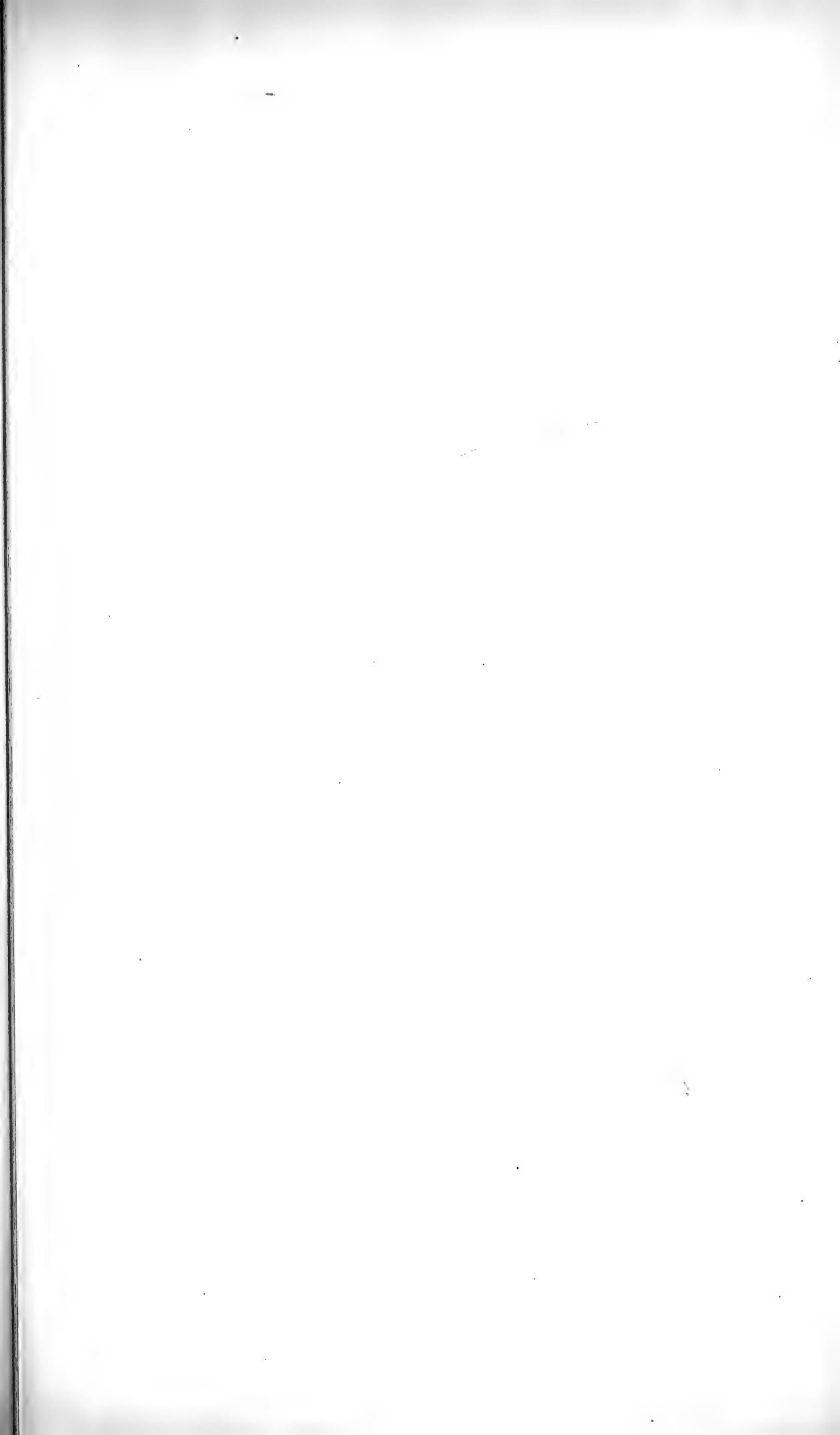


PLATE 5.

(*Pseudopleuronectes americanus*.)

- Fig. 22. Diagram of parasagittal section of tectum. × 57.  
Fig. 23. Portion of a parasagittal section of tectum from the anterior part of the optic ventricle to the surface. × 223.  
Fig. 24. Cross section of optic nerve. × 50.  
Fig. 25. Parasagittal section of diencephalon and part of metencephalon. × 18.



tel opt  
1  
2  
3  
4  
5  
6  
7

nd.ctr

sp. qv.

comz. lz.

lcn

lcn. opt. h

pull

sp. qv.

lcn

vnt. opt.

vnt. opt.

nd. r. st.

nd. ctr

no. and  
jct

INSERT  
LID-OUT  
R MAP  
HERE!





Bulletin of the Museum of Comparative Zoology  
AT HARVARD COLLEGE.  
VOL. XL. No. 2.

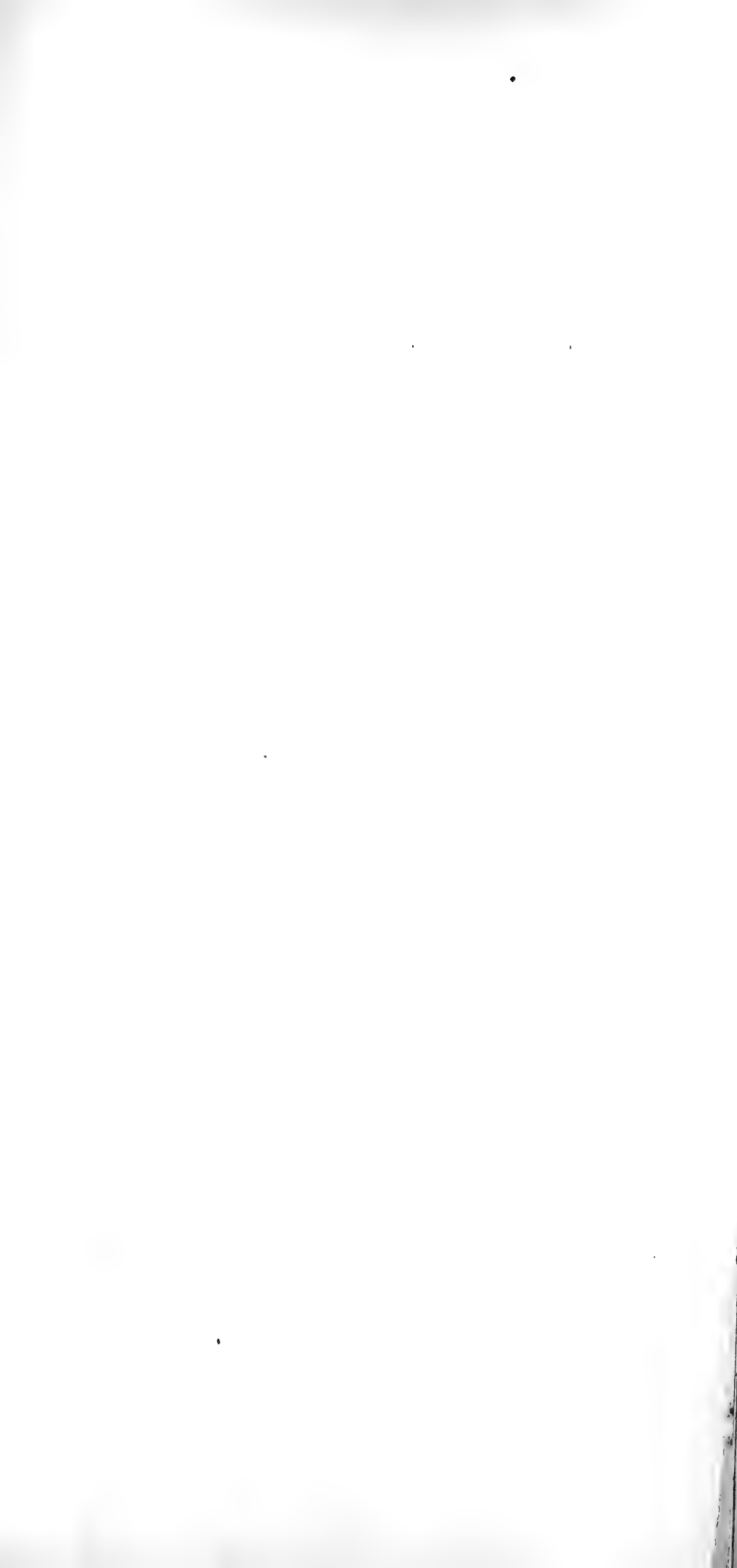
---

THE EARLY DEVELOPMENT OF LEPAS. A STUDY OF  
CELL-LINEAGE AND GERM-LAYERS.

BY MAURICE A. BIGELOW.

WITH TWELVE PLATES.

CAMBRIDGE, MASS., U. S. A.:  
PRINTED FOR THE MUSEUM.  
JULY, 1902.



CONTRIBUTIONS FROM THE ZOÖLOGICAL LABORATORY  
 OF THE MUSEUM OF COMPARATIVE ZOÖLOGY AT HARVARD  
 COLLEGE. E. L. MARK, DIRECTOR. No. 132.

*Early Development of Lepas. A Study of Cell-Lineage  
 and Germ-Layers.*

By MAURICE A. BIGELOW.

TABLE OF CONTENTS.

	PAGE		PAGE
Introduction . . . . .	62	11. Review of literature	
Historical . . . . .	63	on late stages of cleavage,	
Materials and methods . . . . .	64	on closing of blastopore and on	
Maturation and fertilization.		differentiation of the	
The unsegmented ovum . . . . .	68	germ-layers . . . . .	113
Review of literature on		a. Late stages of	
maturation and fertilization . . . . .	71	cleavage . . . . .	113
General sketch of cleavage		b. Closing of blastopore . . . . .	114
and germ-layers . . . . .	73	c. Differentiation of	
Nomenclature of cleavage . . . . .	74	the germ-layers . . . . .	114
Cleavage . . . . .	77	12. Determinate cleavage . . . . .	116
1. Introductory . . . . .	77	13. Notes on cleavage and	
2. First cleavage. Two cells . . . . .	77	germ-layers in <i>L. fascicularis</i> . . . . .	117
3. Review of the literature on first cleavage . . . . .	85	VIII. Extension of the mesoblast and entoblast. Later development of the germ-layers . . . . .	119
4. Second cleavage. Four cells . . . . .	89	IX. Formation of the appendages of the Nauplius, and development of the organs . . . . .	121
5. Review of the literature on the second and succeeding cleavages . . . . .	91	X. General considerations on cleavage and cell-lineage. . . . .	122
6. Third cleavage. Eight cells . . . . .	98	XI. Comparison of the germ-layers of <i>Lepas</i> with those of other Crustacea . . . . .	127
7. Fourth cleavage. Sixteen cells . . . . .	100	XII. General summary, with table of cell-lineage of <i>Lepas</i> . . . . .	133
8. Fifth cleavage. Thirty-two cells . . . . .	102	Addendum . . . . .	136
9. Sixth cleavage. Sixty-two cells. Closing of the blastopore. The germ-layers . . . . .	104	Bibliography . . . . .	138
10. Seventh cleavage. The mesoblast . . . . .	111	Explanation of Plates . . . . .	143

### I. Introduction.

In the inception of this work on the barnacles of the genus *Lepas* it was planned to make a careful investigation of the early development with reference to the origin and fate of the germ-layers. With this object in view the methods of workers on cell-lineage were adopted, because detailed studies seemed necessary in order to determine accurately the origin of the germ-layers. These studies were not undertaken with any expectation of extending or testing the accuracy of the generalizations which have come from the epoch-making investigations on cell-lineage in the eggs of annelids, mollusks, and other animals. Whatever opinion may be held regarding the fundamental importance of the generalizations growing out of such studies, it is usually conceded that the tracing of cell-lineage gives a basis for accurate description of the details of embryological development. Such accuracy in itself seems to furnish sufficient present justification for studies in cell-lineage, for no one can predict what interpretations may in the future grow out of any recorded facts of to-day.

A study of *Lepas fascicularis* was begun by me in June 1894. Late in that year there appeared an elaborate and important paper by T. T. Groom on the development of several Cirripedia. As stated in a preliminary note (Bigelow, '96), my independent studies of *Lepas fascicularis* partly confirmed Groom's results in the case of other species of this genus, but evidence in hand at the time of the publication of Groom's paper indicated that, so far as accurate description of cleavage and the formation of germ-layers is concerned, his account did not agree with the development as observed in *L. fascicularis*. The studies already begun by me were, therefore, continued and extended to *Lepas anatifera* and other species which Groom had described. The account given in this paper is based primarily upon studies of *L. anatifera*, and *L. fascicularis*.

I take this opportunity to express my great indebtedness to my former teacher, Prof. E. G. Conklin of the University of Pennsylvania, under whose guidance the general outlines of the work were developed.

The completion of the observational work was carried out during the year 1898-99 in the Zoölogical Laboratory of the Museum of Comparative Zoölogy at Harvard College. To all the instructors of the department I am greatly indebted for stimulating interest, but especially do I owe acknowledgment to Dr. W. E. Castle, who continuously followed my work and gave me the benefit of his advice and criticism, and to

Prof. E. L. Mark, who has carefully examined and criticised all my results and given me many helpful suggestions during the arrangement of the results for publication.

During several summers the work has been carried on in the Marine Biological Laboratory and in the United States Fish Commission Station at Wood's Hole, Mass. I wish to express my appreciation of the assistance, in the line of facilities for work, which was extended to me by the officials of these two laboratories, particularly by their respective directors, Prof. C. O. Whitman and Prof. H. C. Bumpus.

## II. Historical.

The history of the development of our knowledge of the Cirripedia has been so often written that for the purpose of this paper it is sufficient to give a mere outline. The now classical monograph of Darwin ('51, '54) reviewed so exhaustively the knowledge obtained by earlier observers, and added such a mass of original information on structure, metamorphosis, relationships, and natural history, that in these respects the Cirripedia have since ranked among well known groups of invertebrate animals. Since Darwin's time much of the investigation on the animals of the group has been concerned with embryological development, to which very little of Darwin's work was devoted. In the "Challenger" Reports Hoek ('83, '84) made important additions to our knowledge of the anatomy and relationships of many cirripedes, and gave a good historical sketch of the group. Gerstäcker's historical review in Bronn's Klassen u. Ordnungen is exhaustive.

The papers of Van Beneden ('70), Willemoes-Suhm ('76), Hoek ('76), Lang ('78), Nassonow ('85, '87), Nussbaum ('90), and Groom ('94) deal in more or less detail with embryonic development, and these papers include the most important existing contributions to our knowledge of cirripede embryology. Müller ('64), Filippi ('65), Münster und Buchholz ('69) and Bovallius ('75) have made contributions regarding certain points in the early development.

Our knowledge of the early development of species of *Balanus* is due principally to the studies of Münster und Buchholz ('69), Hoek ('76), Lang ('78), Nassonow ('85, '87), and Groom ('94).

The early development of species of *Lepas* is known through the investigations of Willemoes-Suhm ('76), Groom ('94), and Bigelow ('96).

The only recorded observations on the early development of *Lepas fascicularis* earlier than those of the present writer are the published

notes of Willemoes-Suhm ('76), who died during the voyage of the "Challenger" before his studies were completed. His paper gives a very complete account of the history of the above mentioned cirripede from the Nauplius to the sessile adult, but only a short and fragmentary description of embryonic development. In some of the later embryonic stages the observations are quite correct, but the few descriptions and figures of cleavage stages are very inaccurate.

The embryology of *Pollicipes* has been studied by Nussbaum ('90), but his account is somewhat fragmentary.

Among the Rhizocephalan Cirripedia the only description of a complete series of embryonic stages is Van Beneden's ('70) account of *Sacculina*.

Further, one or more of the investigators already mentioned has studied the early development of species of the following genera of Cirripedia: — *Conchoderma*, *Scalpellum*, *Tetraclita*, *Dichelaspis*, *Chthamalus*. However, much of this embryological work has been fragmentary, and often superficial.

The last, and by far the most important, paper on the early embryology of the Cirripedia was published by Groom in 1894. This contains a good résumé of the previous work on the subject, reviewing the contributions of the various investigators mentioned in the preceding paragraphs. Groom studied the embryology of five species, namely, *Balanus perforatus*, *Lepas anatifera*, *L. pectinata*, *Chthamalus stellatus*, and *Conchoderma virgata*. His observations on the later stages of embryonic development and on the larval stages were exhaustive. The study of the cleavage was undertaken secondarily, and was not investigated as accurately as were the later stages.

The accounts of the early embryology of cirripides which were given by observers before Groom do not as a rule contain records of detailed observation, which alone could be used comparatively in a paper from the standpoint of cell-lineage. Groom reviewed well the general accounts of previous investigators, and brought their results into line with his own observations. In reviewing the literature I must necessarily deal primarily with Groom's account, because he is the only investigator who has attempted detailed description of the early stages of cirripede development.

### III. Materials and Methods.

The material upon which this paper is based was collected at Wood's Hole, Mass., in the summers of 1894, 1895, 1898, and 1899. Prof. Harold Heath of Stanford University, Cal., has collected and preserved

for me the eggs of *Lepas hillii*, *Pollicipes polymerus* and *Sacculina*, which have been used for comparative study.

In Vineyard Sound and Buzzard's Bay, groups of *Lepas fascicularis*, *L. anatifera* and *L. pectinata* have been found at various times between June and September. Any of these forms may appear at times when the prolonged south-east winds have carried the drifting material of the Gulf Stream in the direction of the Elizabeth Islands. So many elements of chance are involved in getting the animals that it has been found difficult to collect complete developmental series, and the work has been often delayed.

A very large majority of the animals of all species carry eggs in advanced stages of development when they arrive in the waters near Wood's Hole. This has been found especially true of the numerous specimens of *L. fascicularis*, hundreds of which have been found carrying eggs ready to hatch, but only a few dozen with eggs in early cleavage stages. In two different summers a few animals of this species have been found early in June with eggs in stages of maturation, but when large numbers of animals arrived in July, few cleavage stages could be found and in many cases Nauplii were escaping from the brood-lamellæ.

Much drifting timber carrying *L. anatifera* was obtained about the middle of August, 1898. The adult animals all carried eggs which were in advanced stages of development and were hatching rapidly. Many animals which were about half the adult size were laying eggs. The timbers were anchored in the harbor, and for several weeks it was possible to obtain an abundance of material in maturation and cleavage stages. The stages of living and preserved material thus secured for study represented the important phases of every mitotic division in the early development.

As is well known, the development from egg to Nauplius takes place in the mantle chamber. The eggs, each enclosed in a vitelline membrane, lie in the cavities of the egg-plates, or ovigerous lamellæ, which lie between the body and the mantle. In studying living ova it is easy to tear the lamellæ and thus free large numbers of eggs, but in preserving material it is more convenient to fix the lamellæ in large pieces.

Maturation and cleavage were studied first in the living eggs. It was found impossible to keep eggs developing normally under artificial conditions outside the mantle cavity longer than from five to ten hours. Other workers on Cirripedia have had the same experience. It was rarely possible to follow a single egg through the maturation phases to the close of the second cleavage, and fresh material, which had under-

gone the early cleavage while in the brood-lamellæ, was necessarily used for the study of later cleavages.

Many of the fixing reagents ordinarily employed in embryological work have been tried, but only solutions containing picric acid have proven entirely satisfactory. Kleinenberg's stronger fluid and a saturated solution of picric acid in 35% alcohol both gave excellent fixation, but a saturated solution of picric acid in 5% acetic acid gave results which were far superior to those obtained by any other fixing solution. This fluid penetrated rapidly, and eggs thus prepared were very transparent when stained and mounted entire. This transparency was a very important feature in the study of all cleavage stages. The picro-acetic mixture also gave the best results for material which was to be sectioned. It should be remarked that solutions with less acetic acid lack penetrating power.

Strong solutions of mercuric chloride in distilled water, in sea water, in alcohol, or combined with picric acid, gave some good results in the study of maturation and early cleavage stages by means of sections, but material thus fixed proved too opaque for preparations of entire eggs. Material fixed in the mercuric chloride solutions was especially valuable in determining the distribution of the yolk, which readily stained differentially after such fixation. In the study of all stages of development use was made both of sections and of entire eggs viewed as transparent objects. The method of preparing the latter will be described first. Small pieces of egg-lamellæ which had been fixed in the picro-acetic mixture were stained from one to three hours in a concentrated solution of borax-carmin in 35% alcohol (Grenacher's formula). They were then washed in alcohol and rapidly decolorized in 70% alcohol containing 0.3% hydrochloric acid. The decolorizing was watched with a compound microscope, and quickly checked when nuclei and cell-boundaries began to appear. The piece of egg-lamella was then dehydrated and, within two or three hours after staining, cleared.

All the ordinary clearing oils were tried, but no other one gave results comparable in excellence with those obtained by the use of clove oil. This oil renders the egg-lamellæ brittle, so that the eggs can easily be isolated by the use of needles. In practice the stained pieces of egg-lamellæ were placed in a drop of clove oil on a glass slide. Then, using a dissecting microscope, the lamellæ were cut with fine needles and the eggs set free, but they were still surrounded by the vitelline membrane. All attempts at removing this membrane proved unsuccessful. After the greater part of the clove oil had been drained away, the eggs were mounted in xylol-balsam.



Eggs prepared by the above method were so transparent that even in later stages the outlines of cells on either side of the embryo could be clearly seen by appropriate focussing. It was, therefore, easy to study and draw optical sections in any plane. The refractive index of clove oil<sup>1</sup> is such that the vitelline membrane becomes almost invisible.

By carefully moving the cover glass it is possible to roll eggs into any desired position, and for this purpose the balsam was for months kept semi-fluid by occasionally applying a drop of xylol to the edge of the cover glass.

It was found practicable, and in some cases profitable, after studying an egg in balsam, to remove the cover glass, dissolve the surrounding balsam with xylol, lift the egg by means of a capillary tube, transfer it to paraffine, imbed by the watch-glass method and section it. When imbedded near the surface of the block of paraffine, the long axis of the egg can be distinguished by the use of a lens, and hence sections can be cut longitudinally or transversely as desired. This method of sectioning single eggs was employed only for the purpose of gaining an idea of the appearance of sections of particular stages in known planes. As a rule, pieces of the egg-lamellæ rather than single eggs were imbedded and sectioned, the sections being stained on the slide. Since the eggs have no definite arrangement in the lamellæ, sections in all planes were thus obtained. By comparison with sections of single ova in which the orientation had been definitely established, it was possible to choose with certainty the sections representing any desired plane in any stage of development.

For staining sections on the slide Delafield's hæmatoxylin diluted with four or five times its volume of distilled water gave the best results. In the later cleavage stages and in embryonic stages orange G or eosin were used after the hæmatoxylin. By this means the entoblastic yolk-cells were sharply differentiated.

In the study of preparations of the entire eggs a sub-stage condenser with iris diaphragm was absolutely necessary. A  $\frac{1}{2}$  inch homogeneous immersion objective with long working distance was of great service.

Most of the preparations upon which this paper is based are yet in good condition, and are therefore available as evidence in support of the following account of the development of *Lepas*.

<sup>1</sup> Since this paper was written I have found that oil of cassia for clearing gives results even superior to those obtained by the use of clove oil. It has also proved to be an excellent mounting medium, but probably the preparations will not retain stains permanently.

The methods employed have been given at length, because it is believed that the results obtained, which differ widely from those of earlier workers, are due largely to the successful making of transparent preparations of entire eggs. In examining the figures given by previous workers it is evident that none of them had the advantage of such preparations, and consequently none of them were able to follow accurately the history of the nuclei, which is very important for the determination of cell-lineage.

#### IV. Maturation and Fertilization. The Unsegmented Ovum.

In agreement with the observations of Weismann und Ischikawa ('88), eggs taken from the oviducts were found to contain the first maturation spindle. Owing to mutual pressure, there is great distortion of the eggs in the oviducts, but when artificially liberated into sea water they quickly assume a spherical form. The separation of the first polar cell takes place at about the time when the eggs leave the oviducts. Soon after this the formation of the vitelline membrane begins, so that it occupies a position between the first polar cell and the egg (Plate 11, Fig. 95, *mb.vt.*). This is followed by the development of a second polar cell (Plate 2, Fig. 17), which lies within the vitelline membrane (Plate 11, Fig. 95, *cl.pol.*<sup>2</sup>). From the time of assuming the spherical shape, soon after leaving the oviduct, the eggs retain this form, except when pressure of surrounding eggs in the egg-lamellæ distorts them. The egg represented in Figure 17 is an example of the influence of pressure in the egg-lamellæ; such a form at this stage has not been seen among eggs kept isolated in watch glasses. It should be noted here that the uniform distribution of yolk serves to distinguish such eggs, which are pressed into an elongated shape, from later stages in which the eggs are normally ellipsoidal even when isolated, but in which the yolk is collected at the vegetative pole.

Eggs which are isolated soon after oviposition retain the spherical condition and the uniform distribution of the yolk until about the time when the second polar cell is formed. Then the egg begins to elongate in the direction of the chief axis, and the protoplasmic materials begin to concentrate at the animal pole, where the polar cells are located; at the same time the yolk is removed to the lower half of the egg, being concentrated around the vegetative pole. This movement of protoplasm and yolk, towards animal and vegetative poles respectively, continues

and finally results in a telolecithal arrangement of the materials of the egg.

Eggs taken from the egg-lamellæ at all phases of the maturation have been carefully compared with the corresponding stages of isolated eggs which were kept in watch glasses. The distortions in form produced by pressure apparently do not disturb the normal course of cytological changes in the egg.

Figures 1-6 represent a series of camera sketches made from a living egg at intervals within a period of three hours. In Figure 1 the egg is represented just at the completion of the separation of the second polar cell. The egg is approximately spherical and closely surrounded by the vitelline membrane (*mb.vt.*). The yolk with its oil globules is in general uniformly distributed, but already some of the globules have been seen to move towards the vegetative pole. Figure 2 shows the well-marked beginning of elongation; the yolk is collecting at the vegetative pole and a mass of protoplasm, concentrating into the animal half of the egg, is dark and granular. Figure 3 represents a stage some minutes later. A circular depression has appeared around the egg at the equator constricting the egg into nearly equal lobes. The upper, protoplasmic lobe is dark and granular, especially near its centre, whereas the lower or yolk-lobe is relatively clear and transparent, as represented in Figure 18 (Plate 2). The constriction now moves toward the vegetative pole of the egg, where the yolk is collecting (Fig. 4). Gradually the constricting furrow disappears (Fig. 5), and the egg becomes ellipsoidal, as shown in Figure 6. At the animal pole the egg continues to be bluntly rounded, while at the vegetative pole it becomes more pointed. The vitelline membrane, having taken on this shape, retains it throughout the development, and appears to be quite rigid from this stage onward. At the close of the elongation the upper, animal portion of the egg is largely composed of dark granular protoplasm containing some small granules of yolk, but no oil globules (Plate 2, Figs. 19, 20). The lower vegetative part of the egg is more transparent and contains the mass of yolk granules. The oil globules are concentrated at the pointed end of the egg and for a time are arranged in strict radial symmetry with respect to the long (chief) axis of the egg. Protoplasmic strands extend throughout the vegetative half of the egg.

The elongation of the egg and the separation of yolk and protoplasm, which result in the telolecithal condition and the establishment of visible polarity, are entirely distinct from the first cleavage processes, with which Groom ('94) has confused them (see review of the literature on first

cleavage). They belong more properly to the maturation phases, and have many characteristics known for ova of other groups of animals. The polar axis thus established in the cirripede ovum has the same relation to polar cells, maturation spindles, and first segmentation spindle, as is found ordinarily in telolecithal ova.

The phenomena occurring during the elongation and distribution of the materials of the cirripede egg, especially the formation of a constriction which marks off a yolk-lobe at the vegetative pole, are apparently similar to conditions which obtain in some molluscan eggs; for example, in the gasteropods *Nassa* (Bobretzky, '76) and *Ilyanassa* (Crampton, '96). In these cases the formation of the yolk-lobe closely resembles that process in *Lepas*, but its later history is widely different. At one stage of the maturation, the eggs of *Nassa* and *Ilyanassa* have a form similar to that of the egg of *Lepas* as represented in Figure 3, a constriction marking off a yolk-lobe. Whereas in the cirripede the constriction disappears before the first cleavage, in the gasteropods the first cleavage plane forms so that in the unequal division a smaller cell (*ab*) is separated from a larger one (*cd*), which still retains the yolk-lobe. After cleavage the yolk-lobe gradually disappears and the cell *cd* becomes spheroidal in form. In *Lepas*, as in *Nassa* and *Ilyanassa*, the materials composing the yolk-lobe are after the first cleavage contained in the cell *cd*.

In my attempts to determine the precise time of penetration of the spermatozoön I have failed, as have all earlier investigators; but we may infer that it enters before the formation of the vitelline membrane, probably about the time when the first polar cell is separated. In sections similar to that represented in Plate 2, Figure 17 (formation of second polar cell) I have noted a darkly staining body near the vegetative pole of the egg. I am not certain of having identified the male pronucleus in a stage earlier than one corresponding in external form to Figures 3 and 18, in which, however, the pronuclei were widely separated, as shown in Figure 19. A further comparison of Figures 18 and 19 shows that there is not a constant relation between the relative positions of the pronuclei and the telolecithal distribution of the yolk and protoplasm. In external outline and in the presence of the constriction marking off the yolk-lobe, the egg represented in Figure 18, corresponding to Figure 3, is earlier than that shown in Figure 19, which corresponds to Figure 6. But in Figure 18 the size and contact of the pronuclei indicate an older stage than that of Figure 19.

After the disappearance of the yolk-lobe the pronuclei are usually

found in contact, as shown in Plate 2, Figure 20, which suggests that there is retardation in the approach of the pronuclei in cases similar to Figure 19. All my observations point to the conclusion that the pronuclei usually come into contact during the time when the yolk-lobe is disappearing, and the egg is assuming the ellipsoidal form, that is, in stages corresponding to Figures 4-6.

*Review of Literature on Maturation and Fertilization.*

A general review of the literature on these phases of cirripede development is given by Groom ('94), consequently reference will not be made in this connection to writings unless they have direct bearing upon observations recorded in this paper.

The formation of polar bodies and vitelline membrane have been observed and described by Weismann und Ischikawa ('88), Nussbaum ('89), Solger ('90), Groom ('94), and others. My observations on the formation of these structures are merely confirmatory of these earlier writers, and have been recorded simply to complete my account of associated phenomena.

The contractions of the egg during elongation and the segregation of protoplasm and yolk have been observed by Groom and others; but the process has, apparently, not been followed continuously, and has been confused with the first cleavage, as will be shown in the review of literature bearing on that stage.

Groom ('94, p. 133) states that in the unfertilized ovum of *Lepas anatifera* no difference can be distinguished between the two poles, and suggests that the ovum may become oriented only upon fertilization. Opposed to such conclusion is the fact that in eggs taken from the oviducts the first maturation spindle marks the chief axis of the egg, which thus seems to be determined long before fertilization. Nussbaum ('90) correctly observed that the axes of the embryo are established with the formation of the polar bodies.

Groom ('94, p. 136) states that "the axis of the spindle of the segmentation-nucleus is not at right angles to that of the second directive spindle." In the account of the first cleavage it will be shown that, in opposition to this view, the first cleavage spindle is formed in a plane perpendicular to the chief axis of the egg, with which the second maturation spindle coincides at the moment when the polar cell is separated. There is, therefore, in *Lepas* complete agreement with the usual condition in the eggs of other animals.

With regard to the male pronucleus Groom ('94, p. 134) states: "Sections made of ova of *Lepas anatifera* before or shortly after the formation of the first polar body show the first directive spindle or a small round nucleus with several chromatin elements." Having failed to find the male pronucleus, he concluded that it "must be exceedingly small and easily overlooked, otherwise it would be necessary to conclude that the fusion of the two pronuclei takes place immediately after the first polar body is formed (in which case it would be very rarely detected in ova which had given off the first polar body); but this seems improbable, though traces of a male pronucleus were never found in sections at any later phase even in ova where the second polar body was being or had just been given off."

Some of these observations by Groom are in accord with my statement that the male pronucleus has not been certainly identified in sections corresponding to a stage earlier than that represented in my Figure 3, although the spermatozoon is probably present at a stage earlier than that represented in Figure 1, in which the second polar cell has just been separated. Groom's supposition that the pronuclei fuse soon after the formation of the first polar cell is opposed by the evidence afforded by my Figures 17-21. It will be shown later that Groom probably saw the male pronucleus in these later stages, but misinterpreted it as one of the daughter nuclei resulting from the first division of the egg.

Groom says (p. 135), "The nucleus, which, during the period at which the ovum was undergoing contraction [yolk-lobe stages], was small and situated peripherally and anteriorly [at animal pole], and was invisible without special preparation, now becomes larger, and appears as a definite clear spot." He further states (p. 137) that, "the clear spot appearing with the separation of the protoplasm is almost certainly the segmentation-nucleus." I have seen this "clear spot," and sections show that it is the female pronucleus, or sometimes the two pronuclei so approximated that viewed through the opaque substance of the living egg the appearance is that of one transparent area. Groom's statements regarding these stages were apparently based upon studies of living eggs, which are so opaque as to render observation difficult and uncertain.

In a stage which Groom interpreted as that of the first cleavage, he found "two nuclei in the newly-formed [first] blastomere"; these were regarded as the daughter nuclei of the first segmentation nucleus (pp. 137, 142, 145). In the review of literature on first cleavage it will be pointed out that Groom apparently has mistaken for the first segmentation of the ovum a maturation phase, such as that represented in my

Figures 3 and 18; the two nuclei which he describes being evidently the pronuclei and not daughter nuclei sprung from the first segmentation nucleus. The figures in the present paper show that a segmentation nucleus does not exist during the separation of yolk and protoplasm. Two pronuclei are in the egg, but they do not appear to fuse completely until the nuclear membranes fade away at the beginning of division. My figures of the first cleavage show, as opposed to Groom's description, that the nuclei resulting from the first division are not at first both located in the upper half of the egg, where the protoplasm is more concentrated.

Nussbaum ('90) observed the two nuclei in *Pollicipes* as the waves of constriction passed over the egg during the separation of yolk and protoplasm, and interpreted them as pronuclei. He figured and described the pronuclei as approaching along a line nearly coinciding with the long axis of the egg; and he assumed that the plane of the first cleavage is perpendicular to the contact surface of the pronuclei. My Figures 18-20 confirm his observations on *Pollicipes*, for it is certain that there are two pronuclei in the protoplasmic mass at the animal pole of the egg in *L. anatifera* and *L. fascicularis* as the separation of yolk and protoplasm progresses. I have studied sections of *Pollicipes* which show similar conditions. Nussbaum's interpretation of these nuclei as pronuclei is certainly correct, as is likewise his description of their approach and contact.

#### V. General Sketch of Cleavage and Germ-Layers.

The cleavage of *Lepas* is total, unequal, and regular. Stages of 2, 4, 8, 16, 32 and 62 cells are normally formed. Cells of a given generation may anticipate their sister cells in division, but no second division of such cells takes place before all other cells have completed corresponding cleavages and reached the same generation.

The first cleavage plane is nearly parallel to the long axis of the ellipsoidal egg, which divides into a small anterior cell (micromere) and a large posterior yolk-bearing cell (macromere). The plane of the second cleavage is perpendicular to that of the first, a second micromere being cut off from the yolk-bearing macromere, while the first micromere divides into two of equal size. The plane of the third cleavage is essentially perpendicular to both the preceding ones. A third micromere is separated at this cleavage from the yolk-macromere, which is now purely mes-entoblastic. Thus by the first, second, and third cleavages three

micromeres are separated from the yolk-bearing macromere. These three cells contain all the ectoblast, and by their repeated division form the blastoderm. Certain cells of the blastoderm, which are derived from the first two micromeres, give rise to a portion of the mesoblast, hence these two micromeres are not purely ectoblastic. The third contains only ectoblast. In the fourth cleavage a mesoblast cell is separated from the yolk-macromere, which now represents entoblast alone.

The sixteen-cell stage, therefore, is composed of fourteen derivatives of the three micromeres, one mesoblast cell, and one entoblast cell (yolk-macromere). The entoblastic yolk-macromere is nearly enveloped by the fourteen smaller cells composing the blastoderm, only a small part of the entoblast cell being exposed at the blastopore. The single mesoblast cell lies at the posterior edge of the blastopore, and were its history not known would certainly be regarded as a cell of the blastoderm. At the fifth cleavage each of the sixteen cells divides, the two resulting mesoblastic cells still remaining at the surface. At the sixth cleavage all the cells except the two entoblast cells divide, thus producing a sixty-two-cell stage. During the sixth cleavage the two mesoblastic cells, before dividing, sink beneath the blastoderm, as this closes over the entoblast and obliterates the blastopore. At the same time four cells of the blastoderm, lying at the anterior and lateral edges of the blastopore, divide parallel to the surface. The four deep cells thus formed beneath the blastoderm constitute a part of the mesoblast. The mesoblast, then, is derived in part from one cell which is separated from the entoblast in the fourth cleavage (sixteen-cell stage) and in part from four other cells which are detached from the blastoderm during the sixth cleavage.

Gastrulation is of the epibolic type, and is the result of the extension of the blastoderm over the entoblastic yolk-macromere. During the sixth cleavage, which leads to the formation of a sixty-two-cell stage, the blastoderm usually closes over the blastopore, which marks the ventral and posterior part of the future embryo.

In the general features of the late development of the embryo the results of this investigation confirm those of some earlier workers.

## VI. Nomenclature of Cleavage.

For convenience in describing the cell-lineage of *Lepas* and in making comparisons with the development of other forms, it is desirable that some system of cell-nomenclature should be applied.

The common systems, which have been developed with special refer-



ence to the conditions in the developing eggs of annelids and mollusks, are dominated by the conception of cells cleaving in sets of fours or quartets. The system of Blochmann ('81) and its successors have, with few exceptions, been applied to eggs in which a quartet of macromeres (in a morphological sense) is formed by the first two cleavages, and by later cleavages these give rise to successive quartets of micromeres. In all the annelids and mollusks in which the cell-lineage has been determined with certainty, the cells of the four quadrants (*a*, *b*, *c*, *d*) formed by the first two cleavages are equivalent, in that each cell contains a portion of the two primary germ-layers, ectoblast and entoblast. The mesoblast is not so distributed with reference to the quadrants. It will be shown in this paper that the four-cell stage of *Lepas* is not a quartet of equivalent cells so far as the two primary germ-layers are concerned. Whereas in the annelidan and molluskan eggs each cell of the four-cell stage contains both ectoblast and entoblast, in *Lepas* three of these cells (*a*, *b*, *c*) contain ectoblast but no entoblast; and the fourth cell (*d*) contains both ectoblast and *all* the entoblast. In the annelids and mollusks the cells of the first quartet of micromeres (eight-cell stage) contain the ectoblast which is first separated from the entoblastic macromeres; but in *Lepas* one of the cells of the two-cell stage is the first ectoblast to be separated from entoblast.

Enough has been said, in anticipation of the account of the cleavage, to make it evident that the well-known quartet systems of nomenclature would not have their usual significance as indexes of homologies, if applied to the cleavage of *Lepas*, for the cells of the four-cell stage in annelids and mollusks are apparently not comparable with the cells of the same stage of *Lepas*, which would be given the same designations. However, a quartet system has been employed for the purposes of this paper, for the reason that it is convenient and familiar. The above statements will show that the system has not been used here with a view to indicating by it homologies with which it has become associated in its application to the spiral cleavage of annelids and mollusks. As far as regards the cirripede egg, the known facts do not seem to me to warrant the interpretation that cleavage occurs in cells grouped as quartets in the sense in which the term is applied to spiral cleavage; and while the notation of a quartet system has been adapted to the purposes of this paper, the term "quartet" has not been applied in description as designating groups of cells in the cleaving egg of *Lepas*.<sup>1</sup>

<sup>1</sup> See Addendum by E. L. M. and W. E. C. (p. 136) following the General Summary.

The system devised by Kofoid ('94) — which Castle applied to the bilateral cleavage of tunicates, where the conditions of cleavage resemble those of *Lepas* — has with some necessary modifications been followed. The cells of the four-cell stage are designated *a*, *b*, *c* and *d* in the usual order, *a* being the left anterior cell. An exponent indicates the number of the generation, starting with the ovum as the first, e. g.  $a^3$ ,  $b^3$ , etc. A second exponent is used to distinguish a cell from other cells of the same generation and derivation, e. g.  $a^{4.1}$ ,  $a^{4.2}$ ,  $a^{4.3}$ , etc. In assigning the second exponent I have followed in part suggestions made by Kofoid ('94) and put into practice by Castle ('96). In cases of equatorial division the *odd* numbers have been applied to the cells nearer the *vegetative* pole, and the even to those nearer the animal pole. Thus of the cells in the four-cell stage  $a^3$  divides, forming  $a^{4.1}$  which is nearer the vegetative, and  $a^{4.2}$  which is nearer the animal pole, while its sister cell,  $b^3$ , forms  $b^{4.1}$  and  $b^{4.2}$  (see Plate 4, Figs. 34–38). In later stages, where cells do not divide equatorially, but parallel to the sagittal plane, the *odd* exponent has been applied to the cell lying *nearer* that plane. In cases where a cell lies in the sagittal plane and undergoes division in the same plane, the daughter cell on the *right* side of that plane is designated by the *odd* exponent. Whenever cells divide transversely to the chief axis of the embryo, the *anterior* cell is designated by the *odd* exponent.

In determining the designation of cells, the rules given by Kofoid are here applied to *Lepas*. The designation of any derivative of cells *a*, *b*, *c*, *d* being given, the designation of mother cell or daughter cells can be quickly determined. The first exponent indicating the generation of the mother cell will, of course, be one less than that of the daughter cell. The second exponent of the mother cell will be one-half of that of the daughter cell, if that be an even number, and one-half the sum of the second exponent plus one, if that be an odd number. Thus  $a^{4.1}$  and  $a^{4.2}$  are daughter cells of  $a^{3.1}$ . Likewise, to determine the first exponent of the daughter cells, add one to the first exponent of the mother cell; to determine the second exponent, multiply the second exponent of the mother cell by two and the product is the designation to be applied to the cell bearing the even number as exponent, while that product less one designates the sister cell. Thus  $a^{5.6}$  dividing forms  $a^{6.12}$  and  $a^{6.11}$ .

A summary of the important points in the cell-lineage of *Lepas* is given in a table in connection with the general summary.

## VII. Cleavage.

### 1. INTRODUCTORY.

The following description of the cleavage of the egg of *Lepas* applies particularly to *L. anatifera*, of which I obtained abundant material of all stages in 1898, being thus able to study the early development in considerable detail. An extensive series of the eggs of *L. fascicularis* was later obtained and its development has been carefully compared with that of *L. anatifera*. There is such close parallelism in the development of the two species that the following account will apply in all important respects to *L. fascicularis* as well as to *L. anatifera*. Figures 95-126 (Plates 11, 12) of *L. fascicularis* when compared with those of *L. anatifera* show how close is the similarity between the two species. At the close of this chapter (p. 117) there are some notes on the early development of *L. fascicularis* which supplement and correct a preliminary account of this species published by me in 1896.

The principal stages in the development of *L. pectinata* and *L. hillii* have also been examined, but their development does not appear to differ in any important respects from that of *L. anatifera* and *L. fascicularis*.

### 2. FIRST CLEAVAGE. TWO CELLS.

The first cleavage of the egg of all *Lepadidæ* and *Balanidæ* whose development has been heretofore described results in the formation of two unlike cells. The smaller cell, rich in protoplasm, is situated at the rounded end of the vitelline membrane; the other, laden with yolk, at its pointed end (Plate 1, Fig. 16). In previous accounts the first cleavage plane has usually been described as being formed perpendicularly to the long axis (chief axis) of the egg. The first cleavage plane has, accordingly, been characterized as equatorial, and the long axis of the two-cell stage has been regarded as identical with the long axis (chief axis) of the unsegmented egg.

In the following account<sup>1</sup> it will be shown that the first cleavage furrow appears approximately in the long axis (chief axis) of the egg; and that, therefore, the first cleavage is meridional, not equatorial as was hitherto supposed. It will be shown, further, that the position of the cleavage plane in the two-cell stage is due to a rotation of the dividing

<sup>1</sup> Some notes on the first cleavage of *L. anatifera* have already been published (Bigelow, '99).

egg as a whole through an arc of  $90^\circ$  within the vitelline membrane. The long axis of the two-cell stage is, therefore, at right angles to the chief axis, which has rotated  $90^\circ$  from its original position of coincidence with the long axis of the vitelline membrane. The chief axis, which is the longer axis of the unsegmented egg, becomes the shorter axis of the two-cell stage. An examination of Figures 1-16, which represent a series of camera lucida drawings made at intervals during cleavage, will make clear the changes in form and position which the egg of *Lepas* undergoes in the course of the first cleavage.

In a preceding chapter it has been shown that, after the formation of the second polar cell and at about the time of the union of the pronuclei, the yolk becomes partially separated from the protoplasm and becomes aggregated at the vegetative pole of the egg (Figs. 2-6, 18-20). Shortly afterwards it is shifted to one side of the polar area (Figs. 7, 8); this is the first indication that the egg is rapidly approaching cleavage. Soon a wide shallow groove appears, passing obliquely around the ovum from the animal pole (Fig. 8). The furrow rapidly deepens and the forming cells become spheroidal, causing the ovum to elongate perpendicularly to the plane of cleavage (Figs. 9, 10). The ovum *as a whole* at the same time gradually rotates within the vitelline membrane (Figs. 10-15); consequently the plane of cleavage rotates until, at the completion of cleavage, the furrow is usually transverse to the long axis of the vitelline membrane, still unchanged in form; that is, the cleavage furrow occupies a plane almost at right angles to that in which it at first appeared relative to the vitelline membrane (compare Figs. 8 and 15). These facts explain the conflict between the conclusions of earlier observers and the generally accepted idea that the first cleavage is meridional in the ova of nearly all animals.

The figures show that the second polar cell continues to lie in the cleavage furrow, and consequently has retained a fixed position with reference to the egg during its rotation within the vitelline membrane.

In some ova the rotation is through less than a quadrant, so that at the close of the first cleavage the plane of division is more or less oblique to the long axis of the vitelline membrane. In examining living ova taken at random, many oblique cleavage furrows are noticed, but continuous observation usually shows that the obliquity is the result of preparation for the second cleavage. Accordingly, it may be stated as a general rule that at the close of the first cleavage of the ova of *Lepas* the cleavage plane is transverse to the long axis of the vitelline membrane, and that only in comparatively few cases is it markedly oblique.

In those eggs in which it is oblique at the close of the first cleavage, the vitelline membrane appears relatively broader, and the divided ovum is easily adjusted to an oblique position within the membrane.

Fifteen or twenty minutes usually elapse between the first external appearances of division and the complete separation of the cells. From the cases which I followed continuously it appears that the cleavage begins within two to three hours after the formation of the second polar cell.

During this cleavage the ova are seen to undergo a series of marked contractions, as shown in Figures 11 and 14. Immediately following each contraction the cleavage furrow deepens and the ovum rotates through several degrees. These phenomena are probably due to the action of the astral fibres, which, as will be shown later, are a well-marked feature of the cleaving ovum. The external appearances would lead one to think that the internal contractions occur spasmodically rather than continuously. Similar appearances were many times noted also in the later cleavages.

Additional evidence in support of this observation concerning rotation of the dividing egg has been obtained from living eggs of *L. fascicularis* and a species of *Balanus*. In *L. fascicularis* (Plate 11, Figs. 95-97) the first polar cell has been observed to remain attached to the vitelline membrane at its blunter pole until after the close of the first cleavage, when the second polar cell, attached to the egg, has moved  $90^\circ$  from the blunt pole of the vitelline membrane. This observation is conclusive confirmation of my earlier observations on *L. anatifera*.

While no observations have as yet been made on the living ova of species of Cirripedia other than those already mentioned, the study of preserved material of other species indicates that in these the first cleavage takes place as in *L. anatifera* and in *L. fascicularis*. In *L. hillii*, *L. pectinata*, *Pollicipes*, and *Balanus* the chief axis coincides with the long axis of the unsegmented ovum and of the vitelline membrane. After the first cleavage, I find the polar cell in the cleavage furrow, which approximately coincides with a transverse plane of the vitelline membrane.

So far as known similar relations exist between the ovum and the vitelline membrane before and after cleavage in the ova of all Eucirripedia; therefore, it is very probable that cleavage takes place in the entire group as in *L. anatifera*. Van Beneden's ('70) figures of *Sacculina* suggest that the same may also be true for the ova of Rhizocephalan Cirripedia.

The internal phenomena connected with the cleavage could not be

accurately interpreted from observations on the opaque living egg, but sections of ova killed at various stages in the cleavage show some interesting conditions. About the time when the pronuclei come into contact, two clear areas are often seen near the pronuclei, as shown in Figure 20 (Plate 2), but frequently in a plane more nearly transverse than that in which they are shown in the figure cited. In the same positions well-defined asters later make their appearance, and the first cleavage spindle begins to form with its axis oblique to that of the vitelline membrane (Fig. 21). In many cases the spindle begins to form in a plane almost perpendicular to the long axis of the ovum. This is true particularly in *L. fascicularis* (compare Plate 11, Fig. 98).

In the metaphase of the mitosis the spindle is usually oblique to the long axis of the ovum (Fig. 22); sometimes it is almost transverse (Fig. 98), but never parallel to the long axis. In *L. fascicularis* it is most frequently perpendicular to the chief axis, as shown in Figure 98. In *L. anatifera* the spindle is usually almost as long as the transverse axis of the ovum. The astral radiations are very distinct, and appear to be continuous with the general protoplasmic reticulum of the cell (Fig. 22). In the stage of the living ovum corresponding to this the yolk has taken an eccentric position at the vegetative pole (Fig. 7). The relation seen to exist between the yolk and the aster nearest the vegetative pole (Fig. 22) suggests that the movement of the yolk to the eccentric position has some relation to the formation of the aster, for it is during the development of that structure that the yolk moves to the eccentric position.

In the next stage figured, an early anaphase (Plate 3, Fig. 23), the spindle is still oblique and the cleavage furrow has not begun to form. The chromosomes have separated along a plane which is usually inclined to the plane in which the cleavage furrow later appears. This stage corresponds to a stage of the living ovum which is slightly later than that represented in Figure 7.

Figure 24 represents a stage in the anaphase after the cleavage furrow has become well developed, and the dividing ovum has begun to rotate. This is the condition in stages of the living egg corresponding to those shown in Figures 10-13. The central part of the spindle is almost perpendicular to the plane of cleavage, but there is a distinct bend in the spindle near either end. These bends may be regarded as evidence of torsion. Comparing Figures 23 and 24, it appears that during division there has been some shifting of the egg substance with reference to the spindle, which is at first somewhat oblique to the plane

in which the cleavage furrow will appear; but later, when the furrow begins to form, the spindle becomes perpendicular to the plane of cleavage. In *L. fascicularis* the spindle is usually from the very beginning of cleavage perpendicular to the chief axis, in which the cleavage furrow later appears. I have noticed the same conditions in the eggs of a species of *Balanus*. In living eggs of *Lepas* I have observed movements of the egg substances which lend support to the evidence afforded by sections. Figures 8-11 represent conditions between the stages corresponding to Figures 23 and 24, and they show that the egg undergoes great changes in form before rotation begins. It is probable that the turning of the spindle takes place at the time of contractions of the egg such as those represented in Figures 9-11.

The astrospheres are well-marked features of the anaphase (Fig. 24), and are distinctly visible as clearer regions in the living egg.

In a late anaphase the spindle has become straight again and is perpendicular to the cleavage plane (Fig. 26). The rotation of the ovum is now completed. In this stage the cells are still connected in the centre by a mass of cell-substance, surrounding the spindle (Fig. 26).

Finally, in the telophase the chromosomes swell into vesicles, and then fuse together to form the nuclei of the two daughter cells in a manner well known for other ova (Figs. 25-27). The cell plate is next completed, and then the separation of the cells ( $ab^2$ ,  $cd^2$ ) is accomplished. Remnants of the spindle may persist for some time, and a well-marked "Zwischenkörper" is often seen.

Figure 25 represents the condition in the comparatively rare cases in which the cleavage plane remains oblique in an early telophase.

In observing the living egg it was noted that at the close of the anaphase the protoplasm of the yolk-cell ( $cd^2$ ) is centrally located and that the yolk remains in its original position in the vicinity of the pointed end of the vitelline membrane (Figs. 15, 26). The chief axis of the egg now coincides with the transverse axis of the oval vitelline membrane, the animal pole being marked by the second polar cell, which lies in the cleavage furrow. The formative and nutritive materials of the yolk-cell are not as yet arranged with reference to the chief axis, as they naturally would be if they kept their original relations to the chief axis during the rotation of the dividing ovum. It has been observed that in the living egg the yolk and the central mass of protoplasm move to their respective poles in from twenty to fifty minutes after the complete separation of the cells (Figs. 15, 16). It will be seen later that this can have nothing to do with the processes of the second cleavage,

which occur two to three hours later. Sections of ova which were fixed at intervals during the first hour after the close of the first cleavage show that the above mentioned movement of protoplasm and yolk occurs at about the time when the spindle and asters have disappeared (Fig. 27). These facts suggest that the spindle and asters may have in some way inhibited the movement of the yolk in its return to its original position at the vegetative pole of the chief axis, out of which it appears to have been forced during the rotation of the dividing egg. The relative positions of spindle, protoplasmic mass and yolk, as shown in Figures 22-27, seem to lend support to this suggestion. The spindle and astral radiations appear to be arranged so as to hold the cell-substances in the same relative positions which they occupied before the cleavage (Figs. 7, 22); with the disappearance of the spindle and asters the mass of protoplasm apparently became free to move toward the animal pole, while the yolk was moved to the vegetative pole (Plate 1, Fig. 16; Plate 3, Fig. 27). It seems that the formative and nutritive materials after having been displaced return to their respective poles of the egg as soon as the displacing and inhibiting cause is removed. In this case the tendency to return to the original polar relations seems to be related to the phenomenon of cell-polarity, the causes of which are thus far hidden.

Throughout cleavage the mass of protoplasm in the yolk-cell remains at the animal pole of the egg, which is marked by the second polar cell, and the successive blastomeres formed by the unequal division of the yolk-cell are cut off as near the animal pole as is consistent with the position of previously formed cells.

Conklin ('97) has pointed out for the egg of the gasteropod *Crepidula* a tendency of the protoplasmic mass in the macromeres to remain near the animal pole, while successive ectomeres are cut off as near that pole as the position of previously formed cells will allow. The condition in the egg of *Lepas* furnishes a parallel case, and the return of the protoplasmic mass to the polar position after displacement in the first cleavage indicates a strong tendency towards adherence to the original polarity of the unsegmented ovum.

The rotation of the dividing ovum appears to be dependent upon the cleavage processes, and capable of an explanation along mechanical lines. The cleavage furrow arises in an almost longitudinal position, passing through the animal pole (Plate 1, Fig. 8). As the furrow deepens, the forming cells tend to become spheroidal and hence to lengthen the axis of the ovum perpendicular to the plane of cleavage



(Figs. 9-11). If no firm envelope confined the ovum, interfering with change in its form, the long axis of the two-cell stage would be perpendicular to the plane in which the cleavage begins; but the vitelline membrane evidently does interfere with extension in a direction perpendicular to that plane. Therefore, as the cleavage progresses and the resulting cells become more and more spheroidal (Figs. 10-13), a rotation of the ovum becomes necessary, for evidently the long axis of the two-cell stage must approximately coincide with the long axis of the vitelline membrane. An examination of the figures makes it appear that, as the forming blastomeres become more spheroidal and consequently increase the length of the axis of the ovum perpendicular to the plane of cleavage, pressure is obliquely applied to the vitelline membrane with the result that the ovum *as a whole* rotates, and gradually the dividing ovum adjusts itself to the form of the vitelline membrane. The cleavage plane becomes transverse or oblique, depending upon the amount of rotation necessary to meet adjustment. With a relatively wide vitelline membrane the rotation is less than  $90^\circ$ , for the divided ovum can then become adjusted to an oblique axis of the membrane, and the cleavage plane consequently remains oblique.

A rotation of the ovum as a result of cleavage has also been shown in the case of the rotifer *Callidina*, described by Zelinka ('91). Like that of *Lepas*, the ovum of *Callidina* is ellipsoidal and surrounded by a rigid membrane. The polar body is situated at one end of the ovum, and the cleavage plane passes through this point. Zelinka figures an oblique spindle, but no sections showing the relations in the various stages of mitosis. According to Zelinka the rotation of the ovum occurs after division, but the extent of the cleavage plane at the time of rotation was not determined by study of sections. It seems probable that, as in the cirripede ovum, the rotation may be found to take place during the division.

Jennings ('96, p. 20), commenting upon the rotation in *Callidina*, writes:—"It thus appears that in *Callidina* the direction of division itself is determined neither by the principle of Berthold [surface tension] nor that of Hertwig [spindle in long axis of protoplasmic mass], but that the later arrangement of the cells might be held to be due to the action of Berthold's principle." The conditions in *Lepas* appear to be similar to those in *Callidina*, and Jennings' conclusion is applicable in the case of the cirripede.

In the eggs of some nematodes there are conditions at the time of fertilization very similar to those existing in *Lepas*. The contiguous

surfaces of the pronuclei are in a plane which is perpendicular, or slightly oblique, to the long axis of the ellipsoidal egg, and the spindle often begins to form with its long axis in the same transverse plane. Several investigators, among whom may be cited Auerbach ('74, p. 212, Taf. 4) and Ziegler ('95, pp. 379-387), have observed that there occurs a turning of the pronuclei around each other so that their contiguous surfaces and the spindle axis come to coincide with the chief axis of the egg. This turning of the pronuclei and spindle appears to be brought about by streaming movements of the substances of the egg. In addition to these observations on the nuclei during their rotation, there is evidence in the two-cell stage of the nematode that the egg as a whole has not rotated, for the polar cell remains in the long axis of that stage  $90^\circ$  from the equatorial cleavage plane.

As a result of the turning of the pronuclei and the consequent longitudinal position of the spindle, the nematode egg divides in such a plane that the two-cell stage does not require readjustment in order to accommodate its long axis to that of the surrounding egg envelope. Thus the turning of the pronuclei and spindle in the nematode eggs affects the orientation of the two-cell stage as completely as does the rotation of the dividing egg *as a whole* in the case of *Lepas*. My observation that in *L. anatifera* the spindle often appears to begin its formation in a transverse plane and then becomes oblique, suggests that there is a tendency towards coincidence of the spindle axis with the long axis of the egg. If such a tendency really exists, it is inhibited by some unknown conditions, possibly the yolk-mass influencing the streaming of the protoplasm, and as a result the cleavage plane is formed in such a position that the two-cell stage must become readjusted to the vitelline membrane.

#### *Summary of the First Cleavage.*

It has been shown that in *L. anatifera*, *L. fascicularis*, and a species of *Balanus*, the cleavage plane lies at the beginning of cleavage approximately in the long axis of the unsegmented ovum as well as that of the vitelline membrane, and passes through the animal pole. During the division a rotation of the ovum *as a whole* through an arc of  $90^\circ$  takes place, so that at the close of the division the plane of cleavage coincides with the transverse axis of the vitelline membrane.

The evidence afforded by preserved material and published figures makes it probable that a rotation of the dividing ovum occurs in all

Cirripedia which have ellipsoidal eggs surrounded by a rigid vitelline membrane.

The rotation appears to be due to the mechanical relations existing between the dividing ovum and the vitelline membrane.

The first cleavage is a typical case of unequal cell division; this is widely at variance with the account given by Groom (see the following review of the literature).

### 3. REVIEW OF THE LITERATURE ON THE FIRST CLEAVAGE.

According to the accounts or figures of Fillippi ('65), Münter und Buchholz ('69), Hoek ('76), Lang ('78), Nassonow ('87), and Groom ('94), the first cleavage plane in all the species of Lepadidæ and Balanidæ, which have been studied by them, is generally transverse to the chief axis; but it has been sometimes described as occasionally more or less oblique owing to variation. These investigators noticed that the long axis (chief axis) of the unsegmented ovum coincides with the long axis of the vitelline membrane, and that in the two-cell stage the plane of separation is transverse to that axis. These positions of the egg with reference to the vitelline membrane before and after cleavage led to the view that the first cleavage plane is formed at right angles to the chief axis of the egg, i. e., that cleavage is equatorial. Had the position of the polar cell during and after cleavage been carefully observed, this view would not have gained acceptance. Of the above named authors Groom and Nassonow have figured the polar cell in the two-cell stage, and they represent it as situated in the original position near the rounded end of the vitelline membrane, 90° from the cleavage plane.

Nussbaum ('87, '90) observed in some ova of *Pollicipes* cleavage planes in various degrees of obliquity with reference to the vitelline membrane, from nearly longitudinal to transverse. He is the only author who has figured or described a polar cell as lying in the cleavage furrow of the two-cell stage of a cirripede egg. Nussbaum explained these varying positions of the cleavage plane and polar cell with reference to the long axis of the vitelline membrane by assuming that the ovum divides almost longitudinally, and that after division the egg turns within the vitelline membrane. The various positions of the first cleavage plane, which were observed by Nussbaum in different eggs, were assumed to represent phases in the turning of the egg as it rotated from the position in which the forming cleavage plane is nearly longitudinal to the final position, in which it is transverse. Nussbaum sug-

gested that the turn of the egg might be explained on the principle of least resistance, since the long axis of the divided egg can only be adjusted to the long axis of the vitelline membrane. He failed to study sections of stages in the first division and to follow continuously the cleavage of a living ovum. Groom ('94) expressed doubt concerning Nussbaum's identification of the body in the cleavage furrow as the polar cell, for it had not been followed continuously from its formation. Nussbaum's figures of three different ova with cleavage planes respectively in almost longitudinal, in oblique, and in transverse positions do not give conclusive evidence in support of his assumption that the egg rotates after cleavage. Groom has remarked that, if a rotation occurs, an ovum with oblique cleavage plane should show a correspondingly situated polar cell, and Nussbaum's figure of such a stage does not show this. So far as the evidence offered by Nussbaum is concerned, one might well accept Groom's view, that the various positions of the first cleavage plane in different ova indicate merely variation of the position in which it forms.

Although Nussbaum failed to support his assumption with conclusive evidence, he was certainly in the main correct, as the evidence offered in this paper proves. Studies of the preserved material have convinced me that the relations in *Pollicipes* agrees with those in *Lepas*. Nussbaum's assumption that the rotation takes place after division does not agree with the facts in the case of *Lepas*. I have shown that the rotation takes place not after, but during division, and have suggested that the forces concerned in cleavage, reacting upon the rigid vitelline membrane, are apparently the cause of the rotation of the dividing ovum.

Groom's account of the first cleavage is so involved with his description of the separation of the protoplasm from the yolk during maturation that no sharp line is drawn by him between the two processes. I quote from his paper ('94, pp. 135-136) the following description:—

“The polar bodies become pale and disintegrated, and the external one often gets washed away. The protoplasm is at last mainly collected at the anterior pole of the egg, and the yolk at the other (Figs. 6, 7). . . . The surface separating the protoplasmic half from the yolk commonly intersects the ovum in a perfect circle, and marks off what will form the first blastomere. . . . Very generally the line of separation of the protoplasm and yolk is almost accurately transverse, . . . I have frequently seen cases when the wall was accurately transverse, and the polar body situated apically (Figs. 6, 7). Lastly I have been able to watch the gradual formation of the protoplasmic half in a single ovum; the line of junction in these cases was transverse from the first.”

It is evident that this account refers to the processes which I have described in the chapter on maturation of the ovum. They are phenomena concerned with the establishment of visible polarity in the egg, and not with the cleavage process, as Groom's account leads us to infer. The surface marking the boundary of yolk and protoplasm, as shown in Groom's Figures 6 and 7 (in this paper Figs. 3 and 18), does not "mark off what will be the first blastomere." Groom evidently mistook the constriction which I have described in the account of maturation (Fig. 3) for the forming cleavage plane; but I have shown the cleavage plane to be almost perpendicular to this transverse constriction, which merely marks off the yolk-lobe (see Figs. 3 and 18). Groom's misinterpretation explains the cases described by him, in which the cleavage plane appeared transverse and the polar cell apical in position; see his Figures 6 and 7, which evidently correspond to my Figures 3 and 18. Groom has interpreted his Figures 6, 7 and 8 (*L. anatifera*), and 45, 46 and 47 (*L. pectinata*) as representing successive stages in the formation of the first cleavage plane. As a matter of fact there intervene between the last two stages of each of these series all the stages which are shown in this paper by Figures 4-15. The identification by Groom of the transverse constricting furrow of the maturation period as the forming cleavage furrow has probably led to his erroneous interpretation of the position of the polar cell with reference to the first cleavage plane. It was natural that Groom, considering the three figures mentioned above (Figs. 6, 7, 8) as a continuous series, should expect to find the polar cell at the place of its formation, and should overlook it in the first cleavage furrow. The best of observers could easily have been misled, unless an opportunity came for following a single ovum uninterruptedly through the maturation and first cleavage stage. The polar cell lies deep in the cleavage furrow, and is easily overlooked in the living ovum, unless one's attention has been attracted to it in prepared ova, where it is clearly shown in the majority of cases. The rare cases observed by Groom of ova in which the polar cell retained its original position in undoubted two-cell stages are explained by my observation that the polar cell sometimes, but very rarely, fails to rotate with the ovum. That the polar cell is not soon lost, as Groom believed, is evident from many of my figures of later stages. In preparations it is as often seen in later stages of cleavage as in the unsegmented ovum.

Groom's Figure 101 (*L. anatifera*), showing a longitudinal position of the spindle, is certainly from a section taken in a plane oblique to the chief axis so as to show the spindle in the long axis of the sec-

tion. A spindle parallel with the chief axis would be in harmony with Groom's view that the first cleavage furrow is perpendicular to that axis. Numerous transparent preparations of entire eggs have convinced me that such is never the case.

In the review of literature on maturation and fertilization I have already referred to Groom's mistake in identifying the pronuclei as the daughter-nuclei of the segmentation nucleus. He speaks (p. 145) of two nuclei seen in "the first blastomere" (cell  $ab^2$  of this paper). One of the two nuclei which he regards as the daughter-nuclei of the segmentation nucleus remains as the nucleus of "the first blastomere," the other passes into the "yolk hemisphere" (yolk-cell  $cd^2$  in this account) just before the cell-plate is formed. This is certainly erroneous, and is apparently the result of his interpretation of the transverse furrow accompanying maturation as the cleavage furrow. In Groom's Figure 8 two distinct nuclei are represented in the "protoplasmic" part of the egg, which he considered "the first blastomere." It is evident from my figures that the daughter-nuclei of the segmentation nucleus could not normally get into such a position; but the pronuclei are often seen on one side of the constriction during maturation phases (see my Figure 18). I interpret Groom's Figure 8 as representing the pre-cleavage stage corresponding to my Figures 3 and 18, and the lower half of the egg as the yolk-lobe, not the yolk-cell  $cd^2$ . I have already stated that, unless eggs are kept under continuous observation, it is easy to confuse this stage with the two-cell stage, when only living eggs are examined. My series of figures shows that no such interpretation as that above quoted fits the facts. There are two nuclei (pronuclei) in the protoplasmic hemisphere during the later maturation phases (Figs. 18, 20); but in the "first blastomere" (cell  $ab^2$  in my Figs. 26, 27) there are never two, one of which is destined to pass into the yolk. Groom's description of the "yolk" (cell  $cd^2$ ) as at first without a nucleus, but receiving one from the "first formed blastomere" (first micromere  $ab^2$ ), is erroneous. Neither cell can be said to receive a nucleus from the other, for the division of the segmentation nucleus, and the formation of the first cleavage plane is such as ordinarily takes place in unequal cell division.

The last statement applies also to all the later cleavages. The micromeres rich in protoplasm, which are later cut off from the yolk-macromere, cannot be said to give rise to a nucleus which migrates into the yolk before complete separation of the "protoplasmic" cell.

## 4. SECOND CLEAVAGE. FOUR CELLS.

The first cleavage results in the division of the ovum into two cells of unequal size; the smaller cell (first micromere  $ab^2$ ), which is anterior in position, is largely protoplasmic, whereas the larger, posterior cell ( $cd^2$ ) contains the yolk, and will be designated as "yolk-cell." For convenience in description this cell is regarded in the following account of cleavage as a macromere; it retains its individuality during three successive unequal cleavages, giving rise to three "protoplasmic" micromeres, the yolk after each cleavage remaining in the larger daughter-cell, which in each stage will be designated as "yolk-cell." The addition of the exponent indicating the cell generation will prevent the confusion which would arise from the use of the term "yolk-cell" alone, when applied to the cell  $d^3$ ,  $d^{4.1}$  or  $d^{5.1}$ , which are the yolk-bearing derivatives of the cell  $cd^2$  of the two-cell stage. The micromeres are numbered in the order of their separation from the yolk-cell,  $ab^2$  being the first and  $c^3$  the second.

The nearly synchronous successive divisions of the first two cells ( $ab^2$ ,  $cd^2$ ), and afterwards of their derivatives, result in "resting" stages of the egg, which normally consist of 2, 4, 8, 16 and 32 cells, and it becomes easy to classify the successive cleavages of the egg as second, third, fourth and fifth. It will be noticed, however, that in the second and following cleavages the yolk-bearing cell tends to divide after the other cells, and that its division becomes more retarded at each successive generation. This seems to be correlated with the fact that at each division the protoplasm in the yolk-cell is diminished in proportion to the amount of yolk. In the fourth and fifth cleavages the yolk-cell usually completes its division just as the other cells prepare for the next cleavage. However, it is not until after the fifth cleavage (thirty-two cells) that it lags a full generation behind the other cells. The cleavages can, therefore, be classified naturally according to the resting stages, each stage containing twice as many cells as the preceding.

The second cleavage may take place in the cells  $ab^2$  and  $cd^2$  simultaneously (Fig. 28), but either cell may complete the cleavage slightly in advance of the other. In the majority of cases division of the anterior cell ( $ab^2$ ) precedes (Fig. 99), but usually the differences in the phases of mitosis in the two cells are very slight.

In both cells the mitotic spindles for the second cleavage are formed perpendicularly both to the first cleavage spindle (compare Figs. 26 and 28) and to the chief axis of the egg. In the first micromere ( $ab^2$ ) the spindle is centrally situated; the cleavage plane is formed at right angles

to the first cleavage plane, and passes through the animal pole of the egg (Figs. 29, 30).

The spindle in the yolk-cell  $cd^2$  is eccentric in position, lying nearer the animal pole of the egg, and near the centre of the protoplasmic mass; it is nearly perpendicular to the chief axis (Fig. 29). As cleavage progresses the spindle becomes inclined so that one end dips into the yolk-mass, which lies at the vegetative pole of the yolk-cell (Figs. 31 and 99). From the point of view of a miniature observer occupying the chief axis of the ovum with his head directed toward the animal pole, the left end of the spindle is the one that is nearer the animal pole, that is, the spindle is læotropically oblique. Usually the spindle makes an angle of about  $30^\circ$  or  $40^\circ$  with the chief axis.

The yolk-cell  $cd^2$  cleaves unequally, and the cleavage plane may be considered a modified meridional one. The cleavage planes of the "protoplasmic" cell  $ab^2$  and of the yolk-cell meet in a line which passes through the animal pole, but does not coincide with the chief axis; it makes with this axis an angle of about  $45^\circ$ . To our imaginary observer the resulting smaller cell ( $c^3$ ) lies to the left of and above the larger or yolk-cell  $d^3$  (Fig. 31), and also this cell lies above the anterior cell  $b^3$ . The cell  $c^3$  is the second micromere which is separated from the yolk.

At the close of the second cleavage a general tendency towards a læotropic arrangement of the cells is noticed (Figs. 32-34, 100-102). This arrangement in the case of the posterior cells ( $c^3$ ,  $d^3$ ) is apparently the result of the oblique position of the spindle in the yolk-cell  $cd^2$ . Whenever the anterior cell  $ab^2$  (first micromere) divides in advance of the yolk-cell  $cd^2$ , there is no suggestion of a læotropic arrangement either in its spindle or in the position of the resulting cells ( $a^3$ ,  $b^3$ , Fig. 99); but after cleavage of the yolk-cell, the right anterior cell  $b^3$  is depressed by the higher lying cell  $c^3$ . This change can be seen in the living ovum as the cleavage of the yolk-cell  $cd^2$  progresses.

Soon after the completion of the second cleavage the four cells tend to become rounded, and adjustments of position occur. Figures 32-35 and 102, 103 represent the arrangements which are usually seen, and in all of them a definite plan can be recognized. The axis of the future embryo can now be described as passing through the nuclei of the anterior cell,  $b^3$ , and of the yolk-cell,  $d^3$  (Fig. 31). The anterior cell,  $b^3$ , always comes to lie nearer the vegetative pole than the cells  $a^3$  and  $c^3$ , and it is usually more or less covered on the animal side by one or both of these cells (Figs. 34, 35). After examining the eight-cell stage, in which the bilateral symmetry is distinctly marked, it will be seen that



the arrangement of the cells in the four-cell stage and of the spindles for the next cleavage are such that the daughter cells invariably assume definite and constant positions in the eight-cell stage.

*Summary of the Second Cleavage.*

Both cells of the two-cell stage divide nearly or quite simultaneously. The second cleavage plane is meridional and perpendicular to that of the first cleavage. The first micromere ( $ab^2$ ) divides equally, whereas the yolk-cell  $cd^2$  divides unequally, giving rise to the second micromere,  $c^3$ .

After the second cleavage the four cells ( $a^3, b^3, c^3, d^3$ ) become adjusted in a læotropic arrangement.

In the four-cell stage a plane passing through the second polar cell and the nuclei of cells  $b^3$  and  $d^3$  is apparently near the sagittal plane of the future embryo. In this stage, then, there is a suggestion of bilateral arrangement of the cells.

The yolk-cell undergoes ordinary unequal cleavage (see the following review of the literature).

5. REVIEW OF LITERATURE ON SECOND AND SUCCEEDING CLEAVAGES.

In this connection it is necessary to give a general review of the literature bearing on all early cleavages after the first, because no previous worker has recognized definite stages into which the cleavages of the cirripede ovum can be grouped. It is therefore impossible to make any comparison of my account with that of others, except in a general way.

The division of the "protoplasmic" cell ( $ab^2$ ) of the two-cell stage of the cirripede egg has been correctly described by most authors. The plane of cleavage has been generally described as perpendicular to the first cleavage plane, but Nussbaum ('90) has recognized that in *Pollicipes* it intersects the first cleavage plane at the polar cell and is, therefore, meridional.

No investigator of the early development of Cirripedia, except Groom, has shown that the yolk-cell,  $cd^2$ , of the two-cell stage divides and adds new cells to the blastoderm. All other observers, Buchholz ('69), Hoek ('76), Lang ('78), Nassonow ('87), and Nussbaum ('90), have described the yolk-cell  $cd^2$  as remaining undivided while the other cell ( $ab^2$ ) repeatedly divides and its products grow around the yolk-cell, forming the blastoderm. After completion of the blastoderm, and closing of the blastopore, the yolk-cell  $cd^2$  was said to divide, separating the mesoblast from the entoblast. According to this view the cell  $ab^2$ , which forms

the blastoderm, contains only ectoblastic material. An exception is to be noted in the case of Nussbaum, who saw the mesoblast apparently proliferating from the edge of the blastoderm. The cell  $ab^2$  according to his interpretation, then, contains all the ectoblast and the mesoblast.

The erroneous interpretations of the earlier observers are largely explained by the fact that their observations were almost exclusively confined to living eggs, in which the nuclear conditions are hidden. Without sections or transparent preparations divisions of the yolk-cell might be easily overlooked. Lang ('78) and Nassonow ('87) figured for *Balanus*, and Nussbaum ('90) for *Pollicipes*, distinct protoplasmic radiations in the yolk-cell, but failed to see their significance as indicating division. I am convinced that the structures seen were asters or archoplasmic radiations. Korschelt und Heider ('90) made the suggestion, based on Nassonow's figures, that the yolk-cell  $cd^2$  divides and contributes cells to the blastoderm.

Groom ('94) described the yolk-cell  $cd^2$  in the case of all cirripedes whose development he observed, as a macromere giving rise in succession to a number of "blastomeres," which are added to the blastoderm. He proved conclusively that the "protoplasmic" cell  $ab^2$  (his "first blastomere," my "first micromere") does not give rise to all of the ectoblast, as supposed by all previous observers. According to his account several cells (estimated at nine or ten) are cut off from the yolk-cell after the first cleavage, and with the derivatives of the "first blastomere" form the blastoderm.

Several years ago, without knowledge of Groom's results, owing to the inaccessibility of the literature, I ('96) found that in *Lepas fascicularis* the yolk-macromere divides several times, practically synchronously with the divisions of the other cells, thus contributing to the formation of stages of 2, 4, 8, 16 and 32 cells. This confirmed Groom's results in general; but as to the order, method, and number of the divisions I was forced to dissent from his account.

According to Groom's description there is great variation in the number, order, and position of cleavages both in the yolk-cell and in the other cells of the cleaving egg. He concluded that the cleavage of the cirripede egg is decidedly irregular. He writes (p. 140), "there is no constancy in the mode of growth of the blastoderm over the yolk;" and mentions (pp. 139-140) many of the variations which occur.

Many of these supposed variations are certainly misinterpretations due to errors in orientation, and others are apparently based upon abnormal eggs. Mention may be made of several cases. Groom states

that the "second blastomere" (cell  $c^3$ , second micromere, in my figures) may be formed on either side of the yolk-cell  $d^3$ , and illustrates such conditions by his Figures 10 and 12 (*L. anatifera*). There is nothing in either his text or figures to prove that these are not entirely similar eggs viewed from almost opposite poles. They were certainly drawn from different points of view, and the apparently different positions occupied by the "second blastomere" are thus easily explained. Likewise, the "third blastomere" ( $d^{4.2}$ , third micromere, in this paper) is said to arise on either the right or left of the second. Groom's Figures 15 and 16 (*L. anatifera*), which illustrate this, are certainly views of two similar eggs, and apparently the cell considered the "second blastomere" is not the same in both cases. The position of the "third blastomere" shown as "emerging from the yolk," in one figure on the right and in the other on the left, I interpret as being near the animal pole of the egg. A number of other cases of such results based upon uncertain orientation of the egg might be drawn from Groom's paper; but enough has been said to show that his evidence is far from convincing, that there is much variation even in the earliest stages, and that the assumed variability of the later stages rests upon a very uncertain basis. In opposition to this view of the cleavage of the cirripede egg as variable and irregular, I shall give evidence supporting my interpretation of the cleavage of *Lepas* as normally regular and constant.

In this connection I wish to consider Groom's account of the method in which the yolk-cell divides. The discussion will apply to the second or any later cleavage by which blastoderm cells are cut off from the yolk-cell, for the method of division is the same in all.

The following quotations from Groom's paper give his interpretation of the method by which new cells are formed from the yolk-cell. On page 197 he writes: "As the first blastomere becomes cut off from the yolk the nucleus divides and one daughter-nucleus passes into the yolk half, and soon emerges accompanied by protoplasm to form a second blastomere and generally situated close to the first. As this becomes cut off from the yolk it gives off into the yolk a nucleus, which behaving similarly to the daughter-nucleus of the germinal vesicle, forms new protoplasm and emerges as a third blastomere. At each successive stage the yolk is in communication with one merocyte or newly-forming blastomere, and this, before becoming shut off as a blastomere, gives off a single nucleus into the yolk." A similar statement on page 145 of Groom's paper contains some other points to which it will be necessary to refer. One daughter-nucleus of the segmentation nucleus is said to

“pass into the yolk hemisphere, where it transforms yolk material into protoplasm; the second merocyte, formed partly in this way and partly from previously existing protoplasm, issues as the second blastomere, while the first becomes simultaneously cut off from the yolk . . . the nucleus of the third merocyte is derived from that of the second; the latter becomes spindle-shaped, and gives off a nucleus, which, accompanied by little or by no appreciable quantity of protoplasm, passes into the yolk. . . . The third merocyte, in similar manner, while emerging as a blastomere, divides and gives off a nucleus to the yolk, which in a similar manner gives rise to new merocytes and blastomeres.”

It is evident, as indeed Groom distinctly states in another place, that he regards the yolk as non-nucleated and receiving nuclei from the successively formed blastomeres. In the discussion of the first cleavage I have pointed out that a nucleus from “the first blastomere” (the cell  $ab^2$  in this paper) does not pass into the yolk-cell just before the separation of the two cells. This also applies to all succeeding cleavages. The yolk-cell does not derive its nucleus from successively formed “protoplasmic” cells (“blastomeres”) — such a description is inaccurate and misleading. In no case can either “blastomere” or the yolk-cell be said to derive its nucleus from the other, for the micromeres are merely the result of ordinary unequal division, which differs from the division of cell  $ab^2$  in the inequality of the products, but not in the method by which it is brought about.

The term “merocyte” conveys the idea that the protoplasm is more or less sharply distinct from the yolk, as in the case of eggs which undergo superficial cleavage. This is evidently the idea intended to be expressed in the above quotations from Groom. Neither living eggs nor stained sections support such an interpretation. A considerable part of the yolk-cell  $cd^2$  is protoplasmic, the yolk and protoplasm being so mingled that there is no justification for the use of the term “merocyte.” I cannot agree with Groom’s statement that throughout the main portion of its mass the yolk-cell contains little protoplasm. Protoplasmic processes extend even among the oil droplets which lie near the periphery at the vegetative pole of the egg (Fig. 27). I cannot confirm the statement (p. 198) that there is little protoplasm left in the yolk-cell immediately after the separation of a new blastomere, and that the nucleus rapidly transforms yolk into protoplasm to form the new blastomere. The amount of yolk is not very much diminished before the sixth cleavage. This is in accord with the facts known in the case of the development of other animals, for rapid transforma-

tion of yolk during cleavage has rarely been described. The mass of protoplasm in the yolk-cell after the first cleavage is certainly nearly equal in volume to the next cell (second micromere  $c^3$ ) which will be cut off (see Fig. 27). The same is true for the later cleavages. All these facts, together with those relating to the nucleus which were mentioned in the preceding paragraph, are opposed to the idea of an "emergence of merocytes from the yolk," and support the interpretation which I have given, viz., that all divisions of the yolk-cell are cases of unequal total cleavage. There is nothing to warrant the phrase "emergence of merocytes."

In concluding this general discussion of the method of cleavage of the yolk-cell, I wish to emphasize the statement that there appears to be no reason for regarding that cell in any of the cleavage stages as essentially different in its nature or in its method of division from such well-known examples of yolk-macromeres as are found in gasteropod eggs. So far as I have found, the division of such macromeres is described as differing essentially from that of other cells more rich in protoplasm only in the inequality of the products. Furthermore, I can see no essential difference between the process of cleavage in the yolk-cell of *L. anatifera*, where there is much yolk, and in that of *L. fascicularis*, in which there is relatively little yolk, and in which the division is clearly of the ordinary unequal type.

According to Groom's account ('94, p. 137) a forming or "emerging blastomere" is characterized by a radial arrangement of granules around a clear central space situated near the periphery of the yolk-cell. Groom's Figures 50, 86 and 88 represent this condition. He speaks of the nucleus of the forming blastomere as the centre of the radiation (see his Fig. 14). The clear area seen in a living egg at this stage is certainly not the nucleus, but the astrosphere, and the radiations represent an aster. Groom's description of the development of these structures (p. 137) is good. During the division well-marked protoplasmic movements give visible evidence of the differential distribution of the cell-substances. The nucleus itself is not easily seen in the living egg at any stage, and certainly is not vesicular at the time when the astrosphere is clearly defined. Figures 25, 26, and 30 represent sections of eggs in which, when living, the centres of the radiations presented much the appearance shown in Groom's Figures 10-15. The centres of the radiations are seen to be the astrospheres, and the nuclei are represented by the chromatin vesicles, which are certainly invisible in the living egg.

Groom correctly described the radial arrangement of the protoplasm as persisting for some time after cleavage. In my Figure 27 there is represented a radial arrangement of granules which is a persistence of the condition shown in Figure 26 as occurring at the close of the first cleavage. The astrospheres have disappeared, and the nuclei lie near the centres of the persisting radiations. This radial arrangement disappears as soon as the second cleavage spindle forms (Fig. 28), but the new radiations then formed may in turn persist after the cleavage until the formation of the spindles for the third cleavage (Fig. 30).

Groom ('94) states that two or more blastomeres may arise simultaneously from the yolk-cell! "Similar cells [blastomeres from the yolk-cell] are seen to arise in quite different positions at later stages, sometimes two or more at a time," (p. 138). Again, on page 140 he writes: "In the early as in the later stages the merocyte before emerging from the yolk may not uncommonly be seen to give rise by division to a second merocyte." Such conditions are represented in Groom's Figures 17a (*L. anatifera*), and also in his Figures 53 and 57 (*Balanus*). Certainly none of these figures really represents two blastomeres arising at once. The two sets of radiations (asters) which Groom wrongly interpreted as two "emerging merocytes" probably represent cases in which the spindle was in such a position that both asters were visible at the surface. Usually, however, only one aster is to be seen in the living egg, the other being closely connected with the yolk. Sometimes the spindle is long, so that the two asters are visible on opposite sides of the egg. I have frequently seen the two sets of radiations in the living egg, and sections show that the interpretation which I have just given is the correct one.

Sometimes multipolar spindles, which are probably the result of abnormal conditions, are seen in sections of the yolk-cell, and these may possibly result in a multiple cleavage.

Rarely the cell  $c^3$  (Groom's "second blastomere") may be formed near the posterior end of the yolk-cell, as shown by Groom in his Figure 13.

Many other deviations from the regular course of cleavage have been seen, but they are comparatively rare, and are to be regarded as abnormalities. Certainly they should not be interpreted as showing great variability in the cleavage, as was done by Groom. I have noticed that such cases are much more common when the animals have been kept for some time in aquaria, but are rarely seen in eggs taken from animals which were recently removed from the open sea. I have attributed

these abnormalities to the action of chemical impurities and to lack of oxygen. The respiratory movements of the animals are more sluggish when they have been kept several hours in aquaria, and hence the eggs in the mantle chamber may fail to get a sufficient amount of oxygen. It is well known that such abnormal conditions may affect great modifications in otherwise regular cleavage.

#### *Orientation of the Embryo.*

It has already been stated that in the four-cell stage a line drawn through the nuclei of the cells  $b^3$  and  $d^3$  coincides with the longitudinal (antero-posterior) axis of the future embryo, the cell  $d^3$  being posterior. This relation is shown in the orientation on the plate of Figure 31, from which it also appears that the first cleavage plane is oblique to the same axis. The chief axis of the egg coincides with the dorso-ventral axis of the future embryo, the second polar cell at the animal pole being dorsal. The spherules of yolk are at the opposite pole of the yolk-bearing cell, thus marking the vegetative pole and the ventral side of the embryo. The blastopore later appears on this surface near the posterior end of the egg.

The anterior end of the embryo lies, as several investigators have noted, at the rounded end of the vitelline membrane. In the four-cell and later stages the long axis of the vitelline membrane and that of the future embryo apparently coincide, but in the two-cell stage the long axis of the future embryo is oblique to that of the vitelline membrane. The long axis of the embryo is brought into coincidence with that of the vitelline membrane when the cells adjust themselves after the completion of the second cleavage (compare Figs. 31 and 32).

The animal and vegetative poles, which are marked respectively by the second polar cell and the mass of yolk spherules, have a constant relation to the blastomeres and to the planes of cleavage, and I have made use of them as a basis for orientation. Previous investigators of the cleavage of cirripede ova have recognized no definite and constant points of orientation. In 1896 I pointed them out in the cleaving ovum of *L. fascicularis*; since then I have found that the polar cell has exactly the same relations to the embryonic cells in all the stages of cleavage in four species of *Lepas* and in *Pollicipes polymerus*.

## 6. THIRD CLEAVAGE. EIGHT CELLS.

The third cleavage is essentially equatorial. The spindle figures arrange themselves approximately parallel with the chief axis, and therefore nearly perpendicular to the spindles of the preceding cleavages. The spindle in the median anterior cell ( $b^3$ ) is somewhat exceptional, in that it is more or less inclined toward the horizontal plane (Plate 4, Fig. 36). The spindle in the yolk-cell  $d^3$  is generally more nearly parallel to the chief axis. The cells  $a^3$ ,  $b^3$  and  $c^3$  often complete their division in advance of the yolk cell (Plate 11, Fig. 103). Sometimes the spindle in the yolk-cell is just forming as the other cells divide, but the yolk-cell completes the cleavage while the other cells remain in the "resting" condition. Stages with five, six, or seven cells are seen when examining living ova, but after preparation of such ova the nuclei of some cells are found to be retarded in the third division. Such variations in the rhythm of cleavage are not uncommon in the synchronously cleaving ova of other animals. The normal "resting" stage following the third cleavage in *Lepas* is composed of eight cells as invariably as if the cleavage were perfectly synchronous in all of the cells.

The positions of the cells which result from the third cleavage are shown in Figures 37-40 (Plates 4, 5), and 104-106 (Plate 11). The three "protoplasmic" cells ( $a^3$ ,  $b^3$ ,  $c^3$ ) have divided equally, the yolk-cell unequally. The cell ( $d^{4.2}$ ) which is cut off from the yolk-cell lies in the median plane near the animal pole (Fig. 37). This is the *third* micromere. The cells resulting from the division of  $a^3$  occupy the left side, and are symmetrical with those derived from  $c^3$ , which occupy the right side of the egg (Fig. 37). The cell  $b^3$  has given rise to two cells lying in the median plane, one ( $b^{4.1}$ ) near the yolk-cell at the vegetative pole, the other ( $b^{4.2}$ ) at the anterior end of the egg (Figs. 38, 40).

The seven "protoplasmic" cells have now begun to form the blastoderm (Plate 8, Fig. 66), which will later enclose the yolk-entoblast. A very small space, which is the cleavage cavity (*cav. sq.*, Fig. 66), is often seen in sections, but it soon becomes filled with yolk, by the ingrowth of the yolk-cell.

The bilaterality in the arrangement of cells was indicated in the stage with four cells; it is well marked in the stage with eight. The characteristic arrangement of the cells, as shown in Figures 37-40, is visible in the great majority of living or prepared ova, if they are properly



oriented. The bilateral arrangement of cells when the egg is viewed from the animal pole and the position of the yolk near the vegetative pole (Figs. 38, 66) are features which aid in quickly identifying the individual cells when the egg is rolled into proper positions.

During the third cleavage the polar cell is usually crowded beneath the blastoderm, and comes to occupy in the cleavage cavity the position indicated in Figure 66 — a condition which has been described as occurring in the eggs of several other Entomostraca. Sometimes at the close of this cleavage it is found lodged between cells. Occasionally it becomes shifted in the earlier stages so that it no longer lies deep in the cleavage furrow; in such an event it is not forced beneath the blastoderm during the third cleavage, but may be found on the surface in later stages. I have noticed it on the outside of the embryo in stages as late as those of about five hundred cells. In such cases it is sometimes far from its normal position at the anterior dorsal side (animal pole) of the embryo. In its usual position beneath the blastoderm the polar cell is quite definitely situated until very late stages. In the eight-cell stage it is almost equidistant from the two poles of the chief axis of the egg; but it usually lies much nearer the animal pole after the fourth cleavage, and is a very useful "landmark" for orientation of the later stages. In good transparent preparations of entire eggs of any cleavage stage the polar cell is clearly visible, and it is often seen lying beneath the blastoderm in stages with over five hundred cells.

The yolk-cell of the eight-cell stage ( $d^{4.1}$ , Plate 5, Fig. 40; Plate 8, Fig. 66) contains only future mesoblast and entoblast, and will be referred to as mes-entoblast. The third micromere ( $d^{4.2}$ ), separated from the yolk-cell in the third cleavage, is purely ectoblastic, and is the last cell containing ectoblast which is given off from the yolk-macromere. The ectoblast is, therefore, separated from the yolk-laden entoblast in the first three cleavages, being contained in the derivatives of the three micromeres,  $ab^2$ ,  $c^3$  and  $d^{4.2}$ , which are separated from the yolk-bearing macromere in the first, second and third cleavages respectively. A study of the cell-lineage through the later stages of cleavage shows that the cells  $ab^2$  and  $c^3$  are not purely ectoblastic, but contain a portion of the future mesoblast; they may, therefore, be called mes-ectoblasts. Of their descendants in the eight-cell stage, the cells at the animal pole ( $a^{4.2}$ ,  $b^{4.2}$ ,  $c^{4.2}$ ) are purely ectoblastic, while the lower cells around the vegetative pole ( $a^{4.1}$ ,  $b^{4.1}$ ,  $c^{4.1}$ ) contain future "secondary mesoblast" (ectoblastic mesoblast).

*Summary of the Third Cleavage.*

The spindles for the third cleavage are essentially perpendicular to those of the first two cleavages, the cleavage being practically equatorial. The three cells  $a^3$ ,  $b^3$  and  $c^3$  divide equally and synchronously. The yolk-cell  $d^3$ , which is often slightly retarded, divides unequally, the smaller, more protoplasmic, product ( $d^{4.2}$ ) of this division, being the *third* and last micromere containing ectoblast which is separated from the yolk-macromere.

The yolk-cell ( $d^{4.1}$ ) is now mes-entoblastic, and bilaterality in cleavage is well marked.

The arrangement of the cells of this stage is definite and constant.

The second polar cell is crowded into the cleavage cavity during the third cleavage.

## 7. FOURTH CLEAVAGE. SIXTEEN CELLS.

The mitotic spindles for the fourth cleavage, shown in Figures 39, 40 (Plate 5), and 104-106 (Plate 11), have a well-marked bilateral arrangement. The cell  $b^{4.2}$ , at the anterior end of the egg, and also the cell  $d^{4.2}$  have their spindles perpendicular to the sagittal plane of the future embryo, and their cleavage planes coincide with that plane. In the yolk-cell  $d^{4.1}$  the mitotic spindle approaches parallelism with the chief axis, as in the third cleavage. In all the other cells the spindles are parallel with the long axis of the egg.

The seven "protoplasmic" cells divide as a rule equally and quite synchronously. Division of the yolk-cell  $d^{4.1}$  is delayed more than in the preceding cleavage, but is completed while the fourteen "protoplasmic" cells are in the "resting" phase following division (Plate 5, Fig. 41; Plate 8, Fig. 67; Plate 11, Fig. 108). The stage with all cells in the "resting" phase is composed of sixteen cells (Figs. 42, 43). The yolk-cell, as in the preceding divisions, has divided unequally, and the smaller, "protoplasmic" cell ( $d^{5.2}$ ) thus formed lies in the median plane on the dorsal side of the embryo (animal pole) and immediately posterior to the cells  $d^{5.4}$  and  $d^{5.3}$ , which have resulted from the division of  $d^{4.2}$ , the third micromere (Figs. 42, 44, 45, 68). This cell ( $d^{5.2}$ ), formed by division of the yolk-cell  $d^{4.1}$  in the fourth cleavage, is the *primary mesoblast*, as will appear from the subsequent history of its descendants, which sink beneath the blastoderm in a later stage. The yolk-cell  $d^{5.1}$  is now purely *entoblastic*. The cells  $a^{5.2}$ ,  $b^{5.2}$ , and  $c^{5.2}$ , which touch the yolk-cell on the anterior and lateral boundaries of its uncov-

ered ventral portion (Fig. 43) are mes-ectoblasts, and the remaining eleven dorsally-lying cells contain only ectoblast.

Figures 42-46 (Plate 5), and 107-113 (Plates 11, 12), show the positions of the cells in the sixteen-cell stage, regarding which it will be sufficient to call attention to their bilateral arrangement. All the cells of the eight-cell stage, with the exception of the cell  $b^{4.1}$ , which lies at the vegetative pole (Fig. 40), divide so that their daughter cells both lie either on the right or on the left of the median plane of the embryo. The exceptional cell,  $b^{4.1}$ , divides in a plane parallel to the plane of the preceding cleavage, and, consequently, the daughter cells ( $b^{5.1}$  and  $b^{5.2}$ ) are not separated by a plane coinciding with the median plane of the embryo (see Figs. 40 and 43).

The regular and definite arrangement of the cells represented in the figures of the sixteen-cell stage is quite noticeable. This first suggested to me that the arrangement had arisen from an equally definite one in the earlier stages. Figures of a similar stage accompany the accounts of other investigators, who seem to have observed a constant arrangement of the cells in this stage.

At the sixteen-cell stage the "protoplasmic" cells have become extended far over the yolk-cell (compare Plate 5, Fig. 40 with Fig. 45, and Plate 8, Fig. 66 with Fig. 68). This extension is due in part to the addition of a new cell (the primary mesoblast) from the yolk-cell, but more especially to the spreading of the blastoderm, which is caused by division of the derivatives of the three micromeres ( $ab^2$ ,  $c^3$ ,  $d^{4.2}$ ).

The blastopore is marked by that portion of the entoblast cell ( $d^{5.1}$ ), which is still exposed to the exterior (Figs. 45, 46, 68), and it is widely open. Eggs with a relatively small amount of yolk have the blastopore more nearly closed; but, as will be shown later, the number and order of cleavages are constant whether an egg contains a large or a small amount of yolk.

#### *Summary of the Fourth Cleavage.*

A sixteen-cell stage is regularly formed with cells of particular origins occupying definite and constant positions in relation to other cells.

The derivatives of the three micromeres ( $ab^2$ ,  $c^3$ ,  $d^{4.2}$ ) divide synchronously. The yolk-cell  $d^{4.1}$  (mes-entoblast) is delayed in cleavage.

The primary mesoblast ( $d^{5.2}$ ) is separated from the yolk-cell  $d^{5.1}$ , which is now entoblast.

The blastoderm is greatly extended during the fourth cleavage.

## 8. FIFTH CLEAVAGE. THIRTY-TWO CELLS.

All of the sixteen cells of the previous stage are involved in the fifth cleavage, but the primary mesoblast cell ( $d^{5.2}$ ) and the yolk-entoblast ( $d^{5.1}$ ) are greatly retarded in division (Plate 5, Figs. 44-46). The fourteen cells of the blastoderm divide about synchronously, but occasionally some of the anterior cells slightly precede in the cleavage (Plate 5, Figs. 44, 45; Plate 6, Fig. 47; Plate 12, Figs. 112, 113). The nuclear spindles for this cleavage are arranged perpendicularly to those of the preceding cleavage, with the exception of those in the three mes-ectoblast cells ( $a^{5.2}$ ,  $b^{5.2}$ ,  $c^{5.2}$ ), which touch the yolk-cell at the blastopore (Fig. 46). The spindles in the cells  $a^{5.2}$  and  $c^{5.2}$  are always somewhat oblique to those of the preceding cleavage (compare Figs. 40, 45, 46). They appear to be arranged more or less at right angles to the lines along which the greatest pressure would be exerted by the contiguous cells of the blastoderm (see Figs. 45, 46), and the arrangement therefore seems to be in accord with the principle that spindles tend to become arranged in the line of least resistance.

The spindle in the median cell  $b^{5.2}$  is sometimes placed almost longitudinally (Figure 113), in which case the resulting cells ( $b^{6.3}$ ,  $b^{6.4}$ , Fig. 46) are arranged as in Figures 48, 52 and 116. Sometimes the spindle in  $b^{5.2}$  is almost transverse (Fig. 112) and the resulting arrangement of the daughter cells is shown in Figure 51. Many intermediate oblique positions of spindle and cleavage plane have been noted. This, too, is apparently a case of adjustment to least resistance. In the next stage these two cells ( $b^{6.3}$ ,  $b^{6.4}$ ) become so shifted in position that they lie one to the right and the other to the left of the sagittal plane, but usually one is more or less in front of its companion. In the sixty-two-cell stage their derivatives always form the anterior boundary of the blastopore, although in the thirty-two-cell stage one of the cells ( $b^{6.3}$ ) may not be in immediate contact with the yolk-entoblast, a condition shown in Figures 48 and 52.

In Figure 70 (Plate 8) it is noticeable that the cleavage planes which separate the mes-ectoblasts  $a^{6.3}$ , and  $c^{6.3}$  from their sister cells ( $a^{6.4}$ ,  $c^{6.4}$ ) are markedly oblique, so that the latter overlap the former. Attention is here called to the tendency of cells around the blastopore to divide in this manner, for in the succeeding stage there is a similar oblique division of  $a^{6.3}$  and  $c^{6.3}$ , and the inner derivatives are overgrown by the outer overlapping cells.

About the time that the fourteen blastoderm cells have completed their division, the primary mesoblast cell ( $d^{5.2}$ ) prepares to divide, its spindle being transverse to the long axis of the egg (Plate 5, Fig. 48). The cleavage plane coincides with the sagittal plane of the embryo, and the resulting cells form the posterior boundary of the blastopore (Fig. 52). The constant and definite position of these two mesoblast cells, their retarded division, which gives them distinctive nuclear phases, their tendency to stain less intensely than other cells, the definiteness of the position and cleavage direction of the surrounding cells—all these features make it possible to identify positively the derivatives of the primary mesoblast cell ( $d^{5.2}$ ) in this and the following stages.

The yolk-cell (entoblast,  $d^{5.1}$ ) is the last cell to undergo the fifth cleavage; it commonly divides about the time that the blastoderm cells prepare for the next (sixth) cleavage; but at times the cleavage of the entoblast is so delayed as to be nearly simultaneous with the sixth cleavage of the blastoderm cells. The nuclear spindle is usually almost perpendicular to the sagittal plane (Figs. 52, 116, 117). A cleavage plane, dividing the yolk nearly equally makes its appearance at this stage, but it becomes more clearly visible about the time that the next division takes place in the blastoderm cells, and it may therefore be described later, in connection with the figures which illustrate the account of the sixth cleavage.

The blastoderm has been greatly extended since the last stage, owing to the multiplication of its cells by division, and to the accompanying increase of surface produced by the flattening of the cells. The blastopore has become less extensive as the yolk-cell (entoblast) has become more completely covered (Plate 6, Figs. 51, 54; Plate 8, Fig. 69). It is filled by the protoplasmic portion of the yolk-entoblast, and is bounded posteriorly by the two primary mesoblast cells ( $a^{6.3}$ ,  $d^{6.4}$ ), anteriorly and laterally by the four mes-ectoblast cells ( $a^{6.3}$ ,  $b^{6.3}$ ,  $b^{6.4}$ ,  $c^{6.3}$ ). With the exception of these four cells, which are in contact with the yolk-entoblast at the blastopore, all other cells of the blastoderm are purely ectoblastic.

Figures 47–55 (Plate 6), 69, 70 (Plate 8), and 114–117 (Plate 12), show the details of cell arrangement in the thirty-two-cell stage. There is slight variability in the adjustment of the cells to one another, but examination of the figures shows that the relative positions of the cells are the same in all cases. In good transparent preparations I have seen hundreds of eggs in the thirty-two-cell stage conforming to the conditions shown in the figures, very few in which the arrangement of

the cells could not have been harmonized with the general plan indicated by the direction of the spindles of the fifth cleavage as represented in Figures 44-47.

*Summary of Fifth Cleavage.*

The blastoderm cells of the sixteen-cell stage divide synchronously. The primary mesoblast ( $d^{5.2}$ ) and yolk-entoblast ( $d^{5.1}$ ) are greatly delayed in cleavage.

The blastoderm has extended far over the yolk-entoblast.

Regular arrangement of cells of definite origin is as characteristic of this as of preceding stages.

9. SIXTH CLEAVAGE. SIXTY-TWO CELLS. CLOSING OF THE BLASTOPORE.  
THE GERM-LAYERS.

The twenty-eight cells of the blastoderm of the thirty-two-cell stage are the first ones to undergo the sixth cleavage. Cases are often seen in which all of the blastoderm cells have spindles arranged approximately perpendicular to those of the preceding cleavage. About the time that the resulting fifty-six cells pass into the "resting" phase the two daughter cells of the primary mesoblast ( $d^{6.3}$ ,  $d^{6.4}$ ) are found to be in division. The two entoblast nuclei ( $d^{6.1}$ ,  $d^{6.2}$ ) remain undivided until a much later stage. The sixth cleavage, therefore, results in the formation of a sixty-two-cell stage.

A preliminary description of the sixty-two-cell stage resulting from the sixth cleavage will aid in the discussion of the details of that cleavage. Figure 56 (Plate 7) represents an optical sagittal section of an egg with closed blastopore. All of the twenty-eight blastoderm cells of the preceding stage have divided. The two yolk-entoblasts ( $d^{6.1}$ ,  $d^{6.2}$ ) have not divided. The two mesoblast cells ( $d^{6.3}$ ,  $d^{6.4}$ ) are in the sixth cleavage. Two cells ( $b^{7.5}$  and  $c^{7.5}$ ) are represented between these mesoblasts and the blastoderm in the region of the closed blastopore. These two cells contribute to the mesoblast of the embryo, and for purposes of description they may be called the "secondary mesoblasts," to distinguish them from the mesoblasts,  $d^{6.3}$  and  $d^{6.4}$ , which are derived from the primary mesoblast  $d^{5.2}$  (Plate 5, Figs. 44, 45), which was separated from the yolk-entoblast in the fourth cleavage. Referring to Figures 72 and 73 (Plate 8), which represent transverse sections, it will be seen that there are two pairs of "secondary mesoblasts" ( $ms'bl'$ ), an anterior pair,  $b^{7.5}$  and  $b^{7.7}$  (compare Plate 7, Fig. 62), and a posterior pair,  $a^{7.5}$  and  $c^{7.5}$ . The series of sections represented by Figures 74-77 (Plate 9) shows con-

clusively that there are, besides the four "secondary mesoblasts," two entoblasts and two dividing primary mesoblasts in the egg of this stage. The cells of the anterior pair of "secondary mesoblasts" ( $b^{7.5}$ ,  $b^{7.7}$ ) are always hemispherical in form (Fig. 73), while those of the posterior pair are flattened between the primary mesoblast cells ( $d^{6.3}$ ,  $d^{6.4}$ ) and the blastoderm (Fig. 72). It also appears from the figures that the two derivatives of the primary mesoblast ( $d^{6.2}$ ), the two pairs of "secondary mesoblasts," and the two entoblasts, are arranged according to a plan of bilateral symmetry. The division plane in the yolk (Fig. 73) is the cleavage plane formed between the entoblast cells during the fifth cleavage. With this brief description of the sixty-two-cell stage we may now turn to a more detailed consideration of the sixth cleavage, which formed the stage.

The large number of small cells and the absence of "landmarks" makes rapid and certain identification of individual cells of the blastoderm on the dorsal surface impossible in the sixty-two-cell and later stages. By carefully comparing drawings of stages in which the cells of the blastoderm are in early and late stages of mitosis, it is often possible to identify all the individual blastoderm cells in the sixty-two-cell stage. But since it is impossible to follow the blastoderm cells to their fate in organs of the Nauplius, I have not attempted to give in this account the lineage of all cells after the thirty-two-cell stage. After that stage the most important cells concerned with the germ-layers are near the blastopore. These are followed easily and with certainty.

During the fourth and fifth cleavages the blastoderm was greatly extended by the flattening of its cells and by the increase of surface associated with cell-division. This is repeated during the sixth cleavage, and the result is that the blastoderm in the majority of cases is completed, the yolk-entoblast cells being no longer exposed to the exterior at the blastopore (see Plate 7, Fig. 56, and Plate 8, Fig. 71).

In most cases a very small opening between the blastoderm cells represents the remnant of the blastopore. In fact the cells bounding the blastopore rarely come so closely together in this stage as to completely obliterate the opening (see Plate 7, Figs. 57, 60, 62; Plate 8, Fig. 71; Plate 2, Fig. 76). This persistence of the blastopore has been of great service in determining the origin of the "secondary mesoblasts" and in the orientation of succeeding stages.

Along with the growth of the blastoderm over the blastopore during

the sixth cleavage, the two primary mesoblast cells ( $d^{6.3}$ ,  $d^{6.4}$ ) are crowded into the yolk beneath the blastoderm, pushing the two entoblast nuclei deeper into the yolk (Plate 7, Fig. 59). The primary mesoblast cells thus come to lie beneath the blastoderm at the posterior end of the embryo. As in the two preceding stages, they are easily identified by their distinguishing features, and furthermore the divisions of all surrounding cells are accounted for, so that there can be no doubt of the lineage of the primary mesoblast cells. In series of eggs in various phases of the sixth cleavage the primary mesoblast cells have been seen in their successive positions, from that of the thirty-two-cell stage to that of the sixty-two-cell stage. At a time when some ectoblastic cells are undivided and the blastoderm is not completed, the two primary mesoblast cells are seen filling the blastopore and in part exposed to the exterior, but as the blastopore becomes closed they sink into the yolk, and the blastoderm closes over them.

The primary mesoblast cells ( $d^{6.3}$ ,  $d^{6.4}$ ), before the sixth cleavage takes place in them, may be symmetrically placed with reference to the sagittal plane (Plate 7, Fig. 64; Plate 8, Fig. 72; Plate 12, Fig. 120); but more often one ( $d^{6.3}$ ) is found in a position dorsal or anterior to the other (Figs. 56, 59, 60, 71). In the majority of eggs the two cells appear to have undergone torsion as the blastoderm closed around and over them. In the thirty-two-cell stage they are usually symmetrically placed side by side, but even in this stage there may be some shifting, as shown in Figure 52 (Plate 6). Figures 62 and 63 (Plate 7) show a very common condition, in which they have been so turned that the cleavage plane between them no longer coincides with the sagittal plane. In all such cases they appear to retain their original positions with reference to the right and left sides of the embryo. The various positions occupied by these cells may be the result of shiftings in adjustment to least resistance at the time when the overgrowing blastoderm crowds them inwards.

The spindles concerned with the sixth cleavage of the two derivatives ( $d^{6.3}$ ,  $d^{6.4}$ ) of the primary mesoblast cell are more often about perpendicular to the long axis of the egg (Plate 7, Fig. 56), but sometimes almost parallel to that axis; all intermediate conditions are seen. In Figures 65 (Plate 7) and 121 (Plate 12) the two cells are represented as having completed the sixth cleavage, so that there exists a stage with sixty-two cells. Immediately after division the four resulting cells ( $d^{7.5-8}$ ) are rounded, as shown in Figure 65, but soon afterwards



they become flattened and massed together at the extreme posterior end of the egg (Fig. 121).

The amount of yolk in the entoblast cells is in some eggs so great that the blastoderm cannot completely close over the blastopore during the sixth cleavage. Eggs are sometimes seen in which all the blastoderm cells have undergone the sixth cleavage and the two primary mesoblasts, still in division, are seen lying in the blastopore, and projecting far into the yolk (Plate 7, Figs. 60, 61). The anterior pair of "secondary mesoblasts" ( $b^{7.5}$ ,  $b^{7.7}$ ) are seen in their usual place beneath the blastoderm immediately in front of the anterior edge of the blastopore; but the posterior pair ( $a^{7.5}$ ,  $c^{7.5}$ ), which originates from cells lying at the sides of the blastopore, are seen at the surface at the side of the primary mesoblasts (Fig. 60). As these primary mesoblast cells complete the sixth cleavage they move farther into the yolk. Their positions with reference to the surrounding blastoderm cells (Fig. 61) suggests that the change of form during cleavage results in a movement of the dividing cells into the yolk, in which direction there is, apparently, the least resistance. The posterior pair of "secondary mesoblasts" ( $a^{7.5}$ ,  $c^{7.5}$ ) sink below the level of the surface as the blastoderm closes over the blastopore. In many cases this closing is evidently brought about by the next (seventh) cleavage of the blastoderm cells. Certainly the blastopore is always closed and both the primary and "secondary mesoblasts" are completely covered by the blastoderm after the seventh cleavage.

The origin of the two pairs of the "secondary mesoblasts" now remains to be described. Careful study of the cleavage in numerous eggs gives evidence that these are the result of the sixth cleavage in the four blastoderm cells,  $a^{6.3}$ ,  $b^{6.3}$ ,  $b^{6.4}$ ,  $c^{6.3}$ , which form the lateral and anterior boundaries of the blastopore in the thirty-two-cell stage (Plate 6, Figs. 51, 52). These four blastoderm cells have their spindles for the sixth cleavage arranged more or less perpendicular to the surface, as shown in Figures 58 and 59 (Plate 7). The anterior pair of "secondary mesoblasts" ( $b^{7.5}$ ,  $b^{7.7}$ ) lies in front of the anterior edge of the blastopore, as is shown in Figure 57, which represents a section through an egg with incompletely closed blastopore. This is exactly the position of the cells  $b^{6.3}$  and  $b^{6.4}$  in the thirty-two-cell stage (Fig. 51). In Figures 58 and 59 (Plate 7) these cells are shown with spindles (sixth cleavage) somewhat inclined from a perpendicular to the surface. Their relation to the blastopore leaves no doubt that they are the cells  $b^{6.3}$  and  $b^{6.4}$  of the thirty-two-cell stage.

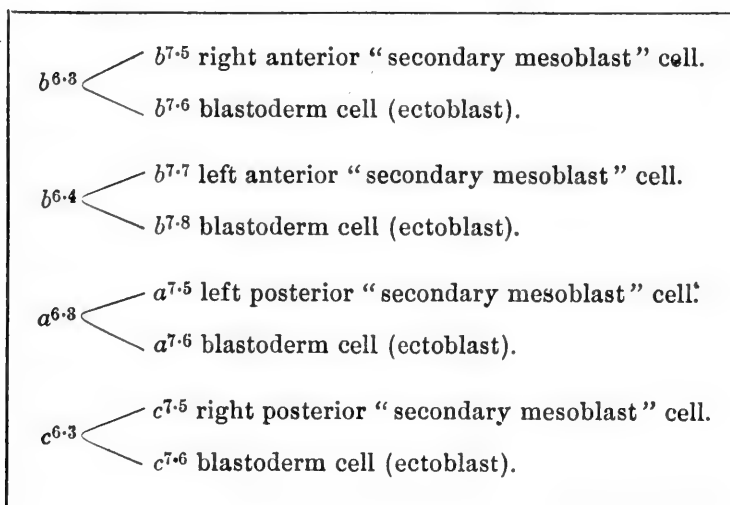
It has been stated in the account of the preceding cleavage that the cell  $b^{6.3}$  does not always touch the anterior edge of the blastopore (see Plate 6, Figs. 48 and 52), for the reason that the cleavage plane between  $b^{6.3}$  and  $b^{6.4}$  may vary in position from perpendicular to the long axis of the egg to coincidence with the sagittal plane of the embryo. In any event it seems certain that these two cells always form the anterior pair of "secondary mesoblasts." In cases like that represented in Figures 48 and 52, the cells become shifted during the sixth cleavage, so that the plane between them approaches coincidence with the sagittal plane of the embryo—the common position of these cells in the thirty-two-cell stage.

The position of the posterior pair of "secondary mesoblasts" with reference to the anterior pair and also to the blastopore leads to the unavoidable conclusion that they are cut off from the cells  $a^{6.3}$  and  $c^{6.3}$ , which are at the sides of blastopore in the thirty-two-cell stage (Figs. 51, 52). These cells are represented in Figures 58 and 59 (Plate 7) as dividing. From their position later, I infer that as division progresses the extension of the blastoderm causes these cells to approach the median plane, where they meet and complete the closing of the blastopore. At the same time the primary mesoblasts  $d^{6.3}$ ,  $d^{6.4}$  are overgrown by the blastoderm, and the cells  $a^{6.3}$  and  $c^{6.3}$  complete their division into the outer cells ( $a^{7.6}$ ,  $c^{7.6}$ ), which remain in the blastoderm, and the inner cells ( $a^{7.5}$ ,  $c^{7.5}$ ), which constitute the posterior pair of "secondary mesoblasts," lie between the blastoderm and the primary mesoblasts (see Plate 7, Fig. 62; Plate 8, Fig. 72).

Cases like those illustrated by Figures 60 and 61 (Plate 7) give additional evidence in support of the above interpretation of the origin of the "secondary mesoblasts." In the egg represented in Figure 60 a remnant of the blastopore is present and at its anterior edge are the two blastoderm cells  $b^{7.6}$ ,  $b^{7.8}$ . Immediately beneath them are the derivatives  $b^{7.5}$  and  $b^{7.7}$ , the anterior pair of "secondary mesoblasts." In the egg represented in Figure 71 (Plate 8) the primary mesoblasts ( $d^{6.3}$ ,  $d^{6.4}$ ) have sunk beneath the blastoderm. The same relations exist between blastopore and anterior "secondary mesoblasts." Similarly in Figure 62 the posterior "secondary mesoblasts" lie beneath the cells  $a^{7.6}$  and  $c^{7.6}$ , which bound the sides of the blastopore. These cells are contiguous to  $b^{7.6}$  and  $b^{7.8}$ . The same relations hold in Figure 60 and in Figures 58 and 59 (Plate 7), which represent the divisions forming the "secondary mesoblasts." Comparison of the arrangement of the cells around the blastopore in the thirty-two-cell stage (Plate 6, Figs. 51, 52) with

the cell arrangement and spindles as shown in Figure 58, 60 and 62 gives evidence entirely in favor of the explanation given of the cell-lineage of the "secondary mesoblasts." They are certainly derived from the ectoblastic cells of the blastoderm, and the evidence completely supports the interpretation that they are derived directly from the cells bounding the blastopore laterally and anteriorly in the thirty-two-cell stage.

The cell-lineage of the "secondary mesoblasts" is, then, as shown in the following table (see also complete table of the cell-lineage on page 135).



It will be noticed that "secondary mesoblast" originates from the quadrants *a*, *b*, and *c*. One cell each is contributed by *a* and *c* but two cells come from *b*. Tracing the lineage to the three micromeres which are separated from the yolk-macromere in the first three cleavages, it is found that only the first ( $ab^2$ ) and the second ( $c^3$ ) contain "secondary mesoblast"; the third ( $a^{4.2}$ ) is purely ectoblastic.

After the sixty-two-cell stage the derivatives of the "secondary mesoblasts" have not been distinguished from those cells which were derived from the primary mesoblast. The cells of the two origins become mingled together and there appear to be in *Lepas* no distinguishing characteristics. Hereafter the term mesoblast (*ms'bl.* in the figures) will be used in the description as including the mesoblast cells of the two origins.

The entoblast nuclei ( $d^{6.1}$ ,  $6.2$ ) are always near the primary mesoblast cells, but, as shown in the figures, they occupy no constant position in relation to particular cells. They stain more intensely than the nuclei

of the mesoblast cells, and in good transparent preparations of the entire egg are easily recognizable. The cleavage plane separating the yolk-entoblast cells may occupy various positions at this stage. If the primary mesoblasts are symmetrically placed with reference to the median plane (Plate 7, Fig. 64), the cleavage plane in the yolk coincides approximately with the sagittal plane of the embryo; but when one of the primary mesoblasts is anterior or dorsal to its sister cell, the plane of separation between the entoblasts is inclined towards the horizontal, or, if vertical, is oblique to the long axis, as in Figure 63. In all cases it appears to extend from near the plane separating the right and left primary mesoblasts towards the antero-dorsal side of the embryo (Figs. 63, 64, 65, 73). This relation suggests that the horizontal and oblique positions are secondary and due to movement of the yolk when the primary mesoblast cells are forced beneath the blastoderm and adjusted to unsymmetrical positions. The fact that when the primary mesoblasts retain their original symmetrical relation, the cleavage plane in the yolk is found apparently coinciding with the sagittal plane, lends support to this view.

It may be of interest to notice that the cleavages involved in the segregation of the germ-layers are always the same, no matter whether the blastoderm is completed in the sixth or seventh cleavages. The cleavages separating from the yolk-cell the micromeres which form the blastoderm are not variable in number, but definite (three); and there is no variation in regard to the number of micromeres which produce the variable numbers of blastoderm cells required to cover the yolk. This conclusion is opposed to that of Groom ('94, p. 141). (See review of literature on late cleavage.) This relation is exactly what has been found in the case of the eggs of gasteropods and annelids, in which it has been shown (Conklin, '97, pp. 61-63) that the number of micromeres (ectoblasts) separated from the macromeres (mes-entoblast) is constant for all species which have been studied, although the macromeres in some cases are very large and require a large number of ectoblastic cells to complete the blastoderm; in such cases — precisely as in *Lepas anatifera* and *L. fascicularis* — there is more subdivision of the micromeres before the blastoderm is completed. It appears that the same relation exists in the case of the other species of *Lepas*.

#### *Summary of Sixth Cleavage.*

All derivatives of the three micromeres ( $ab^2$ ,  $c^3$  and  $d^{4.2}$ ) and of the two primary mesoblasts ( $d^{6.3}$ ,  $d^{6.4}$ ) undergo division. The two entoblast

cells remain undivided. The "resting" stage following the sixth cleavage normally consists of sixty-two cells.

By the extension of the blastoderm during the sixth cleavage the blastopore is usually closed. As to the method of closing the blastopore, this account completely disagrees with Groom ('94; see also review of literature on the closing of the blastopore).

During this cleavage the two primary mesoblasts sink beneath the blastoderm as it closes over the blastopore.

Four blastoderm cells, derived from cells  $a^3$ ,  $b^3$  and  $c^3$  (the first and the second micromeres,  $ab^2$  and  $c^3$ ), are divided parallel with the surface, thus cutting off four cells which lie in the yolk beneath the blastoderm. These are designated "secondary mesoblasts."

The mesoblast is, then, derived from each of the four quadrants of the four-cell stage. In the cells  $a^3$ ,  $b^3$  and  $c^3$  there is mesoblast in connection with ectoblast (ectoblastic mesoblast), whereas in the  $d$  quadrant the mesoblast arises directly from entoblast, and may be designated entoblastic mesoblast. The origin of the mesoblast in *Cirripedia* has not heretofore been traced accurately (see review of the literature on the germ-layers).

All cells sharing in the formation of the lip of the blastopore in the thirty-two-cell stage, as represented in Figure 51, contribute to the mesoblast.

The blastoderm is composed of derivatives of *three*, and only three, micromeres ( $ab^2$ ,  $c^3$ ,  $d^{4.2}$ ), even when the size of the yolk-mass does not permit of the blastopore being closed until the following cleavage.

#### 10. SEVENTH CLEAVAGE. THE MESOBLAST.

The sixty-two-cell stage has been described as embracing fifty-two ectoblastic cells composing the blastoderm, which has usually grown over the blastopore; eight mesoblast cells, of which four have been designated as "secondary"; and two entoblast cells, resulting from the division of the yolk-macromere. All these, excepting the two entoblast cells, divide more or less synchronously and form a stage which may be estimated to consist of about one hundred and twenty-two cells. The planes of cleavage appear in most cases to be perpendicular to those of the sixth cleavage. For convenience in description this may be designated the seventh cleavage.

Figures 78-80 (Plate 9) represent a series of parasagittal sections through an egg of the 122-cell stage, but some of the cells have not completed the seventh cleavage. Figures 81-86 represent a series of

transverse sections of the same stage, of which 81 is the most posterior. In the blastoderm at this stage there is nothing worthy of note except the indentation which marks the former position of the blastopore. The cells in this region are rarely as closely arranged as in the other parts of the blastoderm.

The mesoblast cells are crowded together, and it is impossible to distinguish in all cases between those derived from the primary mesoblast and those from the "secondary mesoblast." As used in the description of later stages, the term mesoblast includes both the primary and "secondary mesoblast."

The possibility of origin of mesoblast cells from the blastoderm after the sixth cleavage has been kept in mind during the observations, but there is no evidence of such an origin. The cleavage spindles in all parts of the embryo have been seen, but not one perpendicular to the surface has been detected. Moreover, the mesoblast cells have been repeatedly counted in sections and their nuclei have also been counted in transparent preparations of the entire egg, and there have never been seen more cells than could be accounted for by the division of the eight mesoblast cells described in the sixty-two-cell stage.

It should be mentioned that by rapid decolorization of specimens stained in borax carmine it has often been found possible to draw the color from the nuclei of the blastoderm cells and stop the reaction while the mesoblast nuclei were still brilliantly stained. With such preparations it is easy to count the nuclei of the mesoblast cells in the entire egg. This method has been employed in all the stages with mesoblast.

The entoblast nuclei are stained brightly by this carmine method, and are easily identified in transparent preparations of entire eggs, as well as in sections. In all stages between that of thirty-two cells and that with about one hundred and twenty cells there is no evidence of division of these nuclei. In these stages only two "resting" nuclei are to be found in the yolk, as shown in Figures 78-80 and 81-86 (Plate 9). Usually in the 120-cell stage the two nuclei are enlarged, while the chromosomes are distinct. Evidently the nuclei are preparing for division, but the spindles are rarely seen until after the blastoderm cells have divided again. In the resulting stage, with about two hundred and fifty cells, four entoblast nuclei are often seen. It does not seem possible that there can have been an overlooked division of these nuclei. Moreover, the origin of the mesoblast cells has been determined to be independent of the two entoblast cells, which are seen in this and in the preceding stage.

*Summary of the Seventh Cleavage.*

All cells, except the two entoblasts, divide.

Derivatives of the two kinds of mesoblast have not been distinguished after the cells are crowded together at the posterior end.

There is no evidence that mesoblast originates otherwise than as described in the preceding account of the sixth cleavage. The entoblast nuclei have been traced from the sixteen-cell stage and there has been but one division. Hence, contrary to the assumption of earlier investigators, the entoblast nuclei cannot contribute to the mesoblast (see the following review of the literature).

11. REVIEW OF LITERATURE ON LATE STAGES OF CLEAVAGE, ON CLOSING OF THE BLASTOPORE, AND ON DIFFERENTIATION OF THE GERM-LAYERS.

*a. Late Cleavage.* — Groom ('94) did not follow the later cleavages in detail, because his results showed so great variation in the early stages. He describes the later growth of the blastoderm over the yolk as "taking place in precisely the same manner as in the earlier stages, i. e., by the emergence of merocytes from the yolk and the division of blastoderm cells. . . . The variation is so great that the process may be said to be irregular. . . . I am unable to say how many merocytes take part in the formation of the blastoderm; but in all probability the number is variable, but not large. As the ovum is often half covered when four or five have emerged, some such number as nine or ten may not be far from the mark" (Groom, '94, pp. 140, 141).

The supposed variation in early stages of cleavage has already been discussed in the reviews of the literature on those stages. The later cleavage and growth of the blastoderm have been shown in this paper to be very regular, and the variations upon which Groom has placed much stress are comparatively rare. These variations can usually be ascribed with strong probability to unfavorable conditions in the environment of the developing egg. The number of "protoplasmic" cells (micromeres) formed from the yolk-cell has been shown to be not variable (nine or ten), as Groom supposed, but constant, viz. *four*, of which the first *three* — containing all the ectoblast and "secondary mesoblast" — are separated from the yolk by the first three cleavages, while the fourth cleavage differentiates the primary mesoblast from the yolk-entoblast. Groom's statement (p. 198) that epiblastic cells continue to be

formed at the expense of the yolk-cell until the blastopore closes, is completely disproved by the facts of cell-lineage.

*b. Closing of Blastopore.* — Groom did not see the closing of the blastopore in *L. anatifera*, but he ('94, p. 141) described it for other species as follows: "The end of the yolk projects out at one point as a small rounded elevation. . . . A merocyte appears in the centre of this, and fills the gap between the surrounding cells, and finally emerges from the yolk as the blastomere."

This description is far from being in harmony with the facts in the case of *L. anatifera*. The closing of the blastopore has been shown in this paper to be due to the repeated divisions of the ectoblastic derivatives of the three micromeres ( $ab^2$ ,  $c^3$ ,  $d^{4-2}$ ) which are separated from the yolk-macromere in the first three cleavages. The "merocyte" which Groom saw in the blastopore (see his Fig. 127) is represented by the protoplasmic mass concentrated around the nucleus of the entoblast cell, which is situated as shown in my Figure 54 (Plate 6). I have shown by tracing the cell-lineage that this cell divides (Fig. 52, fifth cleavage), usually before the closing of the blastopore, sometimes during the sixth cleavage of the ectoblastic cells, and that the resulting entoblast nuclei are later found deeper in the yolk. Nussbaum observed in *Pollicipes* a division of the yolk before the blastopore closed. Groom ('94, p. 147) states that this may rarely occur, a condition which is completely at variance with his account of the closing of the blastopore.

The evidence presented in the present account of the cell-lineage leads to the conclusion that no cell is cut off directly from the yolk to fill the blastopore. It has been shown that at the time of closing there are two nuclei in the yolk, not as Groom stated, a single one. Hence Groom's conclusion, that the "merocyte" which fills that blastopore "before becoming shut off as a blastomere, gives off a single nucleus into the yolk" ('94, p. 198), cannot be accepted. The evidence is completely opposed to such a view. It appears that in Groom's account of the closing of the blastopore, his view of "emerging merocytes" has led, as in the early stages, to an erroneous interpretation.

*c. Differentiation of the Germ-Layers.* — Groom's account of the "meso-hypoblast" agrees in general with the descriptions of all the earlier authors, who regarded this as represented by the yolk-cell, or cells, after the closing of the blastopore. Groom ('94, p. 146) writes: "The closing of the blastopore is almost immediately followed by the division of the yolk into two pyramids or segments; the formation of the mesoblast immediately commences by the successive cutting off and



sub-division of nucleated segments from the two yolk segments." According to Groom these yolk-segments after separation of the mesoblast divide and form endoderm cells.

In opposition to this it has been shown in the present paper that the mesoblast clearly does not originate directly from the yolk-cells after the closing of the blastopore; but from certain cells which have been designated in this account as primary and secondary mesoblasts. The origin of all these cells has been definitely traced. Moreover, evidence has been presented to show that the two yolk-entoblasts do not begin to divide after the thirty-two-cell stage until at least one hundred and twenty cells are present, of which more than a dozen are mesoblastic. Since the entoblast cells do not divide during these stages, they cannot be the direct progenitors of any of the mesoblast cells. All the evidence given seems conclusive and opposed to Groom's interpretation.

The figures of Groom fail to establish his conclusions regarding the origin of mesoblasts from yolk-entoblasts, for in no case are nuclear spindles, the only unimpeachable evidence of such origin, shown. His interpretation of the origin of mesoblast cells seems to be based upon their position. In numerous preparations I have seen all the conditions which Groom figures, but I have found no evidence opposed to my interpretation of the origin of the mesoblast. Groom did not have transparent preparations of entire eggs, and his account of the mesoblast is based entirely upon sections. His figures represent isolated sections, when in many cases only complete series of sections would be convincing. His erroneous conclusion, that the mesoblast is cut off in a series of divisions occurring in a pair of yolk-cells ("meso-hypoblast"), may have resulted from certain conditions which I have frequently noted. Sometimes in stained sections the cell-boundaries of the mesoblast cells are invisible, they appearing to be continuous with the yolk. Under such conditions the mitotic spindles of the mesoblast cells might easily be mistaken for division of the yolk-cells to form new mesoblast cells. I have seen many such cases which exactly simulated some of Groom's figures, but after removal of the cover glass and restaining, the cell-boundaries of the mesoblast cells and the nuclei of the yolk-entoblasts appeared as usual.

Nussbaum ('90) described the mesoblast in *Pollicipes* as formed by the division of blastoderm cells surrounding the blastopore before it closes. The mesoblast was said to grow inwards and anteriorly over the yolk. The account of the origin of mesoblast given in the present paper makes it probable that Nussbaum's description is in a general way correct. Had

not the details of the cell-lineage been traced in *Lepas*, I should be led to describe in similar general terms the origin of the mesoblast. I infer from Nussbaum's description that in *Pollicipes* the blastopore does not become closed as early as in *Lepas*. It seems probable that in *Pollicipes* the primary and secondary mesoblast cells may undergo some divisions before they are forced beneath the overgrowing blastoderm. Such a process would have the appearance of the production of mesoblast from the blastoderm cells at the edge of the blastopore.

In stages preceding gastrulation Nussbaum saw two large cells at the posterior pole, but he lacked material for following out their history. It seems probable that he saw the two primary mesoblasts which I have seen in the thirty-two-cell stage of *Lepas*.

## 12. DETERMINATE CLEAVAGE.

The small size and large number of cells make it impossible to determine the lineage of the individual cells of the embryo beyond the sixty-two-cell stage, and they cannot therefore be traced directly to particular organs of the Nauplius. However, the great regularity and constancy of preceding stages renders it extremely probable that the cells are destined for definite organs. Cells of definite origin have been traced to definite positions in the later cleavage stages. Careful observation has given no evidence of changes in position of cells taking place after the completed segregation of the germ-layers. Indeed the beginning of irregularity is scarcely to be expected in such late and well differentiated stages of development. The regions of the embryo from which particular organs arise have been definitely traced to groups of cells of known lineage. There seems to be no reasonable doubt that the cells of the late cleavage stages are destined to enter into the formation of particular organs. The cleavage of *Lepas* is, then, an example of what Conklin ('98) has termed "determinate cleavage."

The conclusions in the preceding paragraph on "determinate cleavage" are widely at variance with those of all previous writers on cirripede development. The early development of the ova of cirripedes has always been regarded as irregular and indeterminate. Great variations have been said to occur.

Groom ('94, p. 199) summarizes his study of the cleavage of various Cirripedia as follows: — "In describing the details of division of the cells of the blastoderm and yolk-endoderm much variation has been shown to occur, so much indeed that the process may be termed irregu-

lar. Such differences show well the morphological insignificance of the details of cell division in the present case, for the Nauplii vary proportionately much less; every one of the numerous, simple, or compound bristles or spines of the Nauplius has its definite character and position, which are maintained with surprising constancy throughout, although they must have been produced by epiblast cells having very different modes of origin and arrangement."

In the preceding account of the various stages of cleavage this supposed great variation in development has been discussed. It has been shown that the development is extremely regular, and that there is not the slightest foundation for views such as those above quoted.

In a preliminary paper on *L. fascicularis* (Bigelow, '96) the results were summarized as follows:—"In all important respects the cleavage of *L. fascicularis* is as regular as is ordinarily found in other Metazoa. All previous observers have failed to recognize any definite order in the cleavage of cirripede ova. It has always been described as exceedingly variable, irregular and *sui generis*. There is undoubtedly some irregularity and variation in the cleavage of the ova of those cirripedes where a great amount of yolk is present. However, as will be pointed out in a future paper, the cleavage of these forms, when interpreted by the cleavage of *L. fascicularis*, is seen to follow a much more regular order than has been supposed."

Later studies have completely supported this interpretation, and even the irregularity of development which I formerly believed to exist in the case of those cirripedes whose ova have much yolk, appears not to exist in the course of normal development. More extended study has shown that *L. anatifera*, one of the forms which I at first interpreted as somewhat variable in its development, is extremely regular. Studies now in progress on other genera support the conclusion which I have drawn from *L. fascicularis* and *L. anatifera*, namely, that the evidence derived from a study of cell-lineage indicates that *the development of Lepas is as regular as the well known cases among gasteropods and annelids.*

### 13. NOTES ON CLEAVAGE AND GERM-LAYERS IN *L. FASCICULARIS*.

The early development of *Lepas fascicularis* is so closely like that already described in the case of *L. anatifera* that extensive special description is unnecessary, but some remarks are needed in order to correct and supplement a preliminary note on this species which I published in 1896.

Figures 95–121 (Plates **11**, **12**) show how close is the resemblance to the cleavage of *L. anatifera*. Except in size and some unimportant details, the various stages of the two species are indistinguishable, and the description of the figures of *L. anatifera* may be applied to those of *L. fascicularis*.

A renewed study of the few old preparations, supplemented by many new ones, shows that I ('96) was wrong in the conclusion that the ectoblast is detached from the yolk-macromere by means of four successive divisions ('96, ectomeres *A*, *B*, *C*, and *D*). The supposed fourth ectomere ('96, Figs. 6 and 7 *D*) is the primary mesoblast cell. In origin and position it corresponds exactly with the mesoblast cell ( $d^{5.2}$ ) seen in the sixteen-cell stage of *L. anatifera*. I now interpret the spindle seen in the yolk during the fifth cleavage ('96, Fig. 7), which was then supposed to represent the separation of the mesoblast and the entoblast, as a rare case of precocious division of the entoblast. Study of the complete series, with all mitotic phases represented, shows that in *L. fascicularis*, as in *L. anatifera*, the first, second, and third cleavages form micromeres containing the ectoblast and "secondary mesoblast," while the fourth cleavage separates mesoblast and entoblast from each other.

With regard to the planes of cleavage and orientation, I find no important disagreement with *L. anatifera*. The descriptions of the first and second cleavages in the preliminary note were similar to those of *L. anatifera* given in this paper. The rotation during the first cleavage was not then known. The equatorial nature of the third cleavage was not clearly shown by the figure of a four-cell stage with inclined spindles in the preliminary note; Figures 100–103 (Plate **11**) in this paper better represent the four-cell stage and the third cleavage. The figure of the eight-cell stage ('96, Fig. 6) was drawn from an egg which is now known to have been incorrectly oriented. Eggs which give exactly such camera tracings will, when properly oriented by moving the cover glass, always show the same arrangement of cells as that seen in Figures 104–106 in this paper.

Figure 6 of the preliminary paper represented a separation of mesoblast and entoblast (fourth cleavage), and not as was incorrectly assumed, the formation of a "fourth ectomere." Figures 108–110 are the corresponding figures in this paper.

The primary mesoblast cell, shown in Figure 8 of the preliminary paper as filling the blastopore, represented the delayed fifth cleavage, which was in progress. The single entoblast nucleus was not yet undergoing the fifth cleavage. The inferred connection between the spindle

in the yolk-cell, in the sixteen-cell stage, and the separation of a mesoblast cell is now known to have been an erroneous interpretation. The series of stages is now so complete as to leave no doubt that the mesoblast cell is separated from the yolk-entoblast in the fourth and not in the fifth cleavage.

In the sixty-two-cell stage the origin and position of cells is certainly the same as in *L. anatifera*. The "secondary mesoblasts" were observed and figured during my earlier studies, but were interpreted as derivatives of the primary mesoblast, which seemed to divide more rapidly than did the other cells. It now appears from a study of all phases of the sixth cleavage that there are eight mesoblast cells in the sixty-two-cell stage, only four of which are derived directly from the ectoblast. Up to this stage the divisions of the primary mesoblast are the same as have been described in detail in the case of *L. anatifera*. In living eggs recently studied, and also in preparations of favorably preserved material, I have observed the cell-wall between the two entoblast nuclei of this stage, and it follows that — contrary to my former supposition — there is no exception to the rule that every nuclear division during the cleavage is associated with total cell division.

#### VIII. Extension of the Mesoblast and Entoblast. Later Development of the Germ-Layers.

The mesoblast in the 122-cell stage consists of a mass of cells at the posterior end of the embryo, near the former position of the blastopore (Plate 9, Figs. 78-86). The arrangement of the cells leaves no doubt about the position of the blastopore, but orientation of the succeeding stage is more difficult and uncertain. During the next division the embryo begins to elongate posteriorly. A comparison of the blastoderm cells on the ventral surface of the 122-cell and 250-cell (estimated numbers) stages leads to the suggestion that the elongation is due to flattening of the ventral blastoderm cells, while those on the dorsal surface remain columnar in form. At any rate, this elongation appears to be confined mostly to the ventral region of the blastoderm, anterior to the former position of the blastopore. The result is that the cells which closed the blastopore and the adjoining mesoblast cells are moved from the ventral surface towards the extreme posterior end, where for a time the mesoblast consists of a conical mass of cells (compare Plate 9, Fig. 80 with Plate 10, Fig. 87). The rapid division of the mesoblast cells produces a plate, which grows forward on the dorsal side of the embryo

(Fig. 87). That this plate of mesoblast is on the side of the embryo opposite that on which the blastopore was situated, is supported to some extent by the facts above mentioned concerning the posterior growth of the blastoderm. Further evidence of this is found in the columnar shape of the cells, which is characteristic for those on the dorsal side; moreover many embryos long retain a slight depression marking the place of the blastopore, and the blastoderm (ectoblast) cells in this region are often delayed in division in late stages, as well as in the earlier stages, as may be seen when the position of the blastopore is definitely known. It should also be mentioned that the second polar cell, which lies dorsally (animal pole) in the yolk at the anterior end, is often visible near the anterior extension of the mesoblast both in sections and in transparent preparations of entire embryos corresponding to Figures 87 and 88 (Plate 10). These facts all seem to favor the conclusion that the forward growing band of mesoblast (Figs. 87, 88) is on the side opposite that occupied by the blastopore in earlier stages, and consequently opposite that on which the mesoblast extends farthest forward at the time of the closing of the blastopore (Plate 8, Fig. 71; Plate 9, Fig. 80).

Examination of Figures 88, 89 and 90 (Plate 10), representing longitudinal and transverse sections, will give some idea of the direction and extent of growth in the mesoblast. A solid, conical mass of cells lies at the extreme posterior end and extends anteriorly as a broad band on the dorsal side (Fig. 88); this grows laterally towards the ventral side (Fig. 90). The mesoblast at first consists of a single layer of cells, which divide rapidly; the layer becomes many cells in thickness on the dorsal side, but gradually thinner towards the ventral edges of the band (Figs. 90, 92). At the same time that the extension of the mesoblast has been in progress, the entoblast cells have been dividing. Their cell-boundaries are often well defined, and the nuclei do not migrate far from the positions where they are formed by division (Figs. 91, 92).

The blastoderm has remained a single cell in thickness, as shown in the Figures 87-94.

As shown in the preceding chapter, Groom's (94) view of the origin of the mesoblast is erroneous, but the account which I have given of the extension of the mesoblast is, in essentials, entirely confirmatory of Groom's description of the same process. Groom has given many good figures of entire eggs, showing the appearance of the entoblast yolk-cells in living eggs of *Lepas* and *Balanus*. All my observations on these

stages agree essentially with his account. His figures showing the extension of the mesoblast closely correspond with those which I have given and described, not with an idea of contributing new facts, but in order to connect these stages with my account of the early development.

Groom interpreted the anterior growth of the mesoblast as taking place on the dorsal side, and I shall later give confirmation of this opinion, which rests on an orientation that I have used thus far without adequate proof.

### IX. Formation of the Appendages of the Nauplius, and Development of the Organs.

With regard to these phases of the development, my observations are quite in harmony with the account by Groom ('94, pp. 151-154). A few figures have been placed in this paper in order to show relations to the early stages, but since there is such close agreement with Groom, it is unnecessary to give a detailed description and numerous figures.

Groom's important observation, that the appendages first appear on the side which has the band of mesoblast, and that this is dorsal, is supported by my Figures 91-94 (Plate 10) and 122-126 (Plate 12). All earlier writers on cirripede development had considered the mesoblast band as ventral (see review of literature in Groom's paper).

Figures 91 and 122 represent the first indication of the segmentation of the embryo. Two transverse furrows (1, 2) appear on the dorsal side, and extend around towards, but do not reach, the ventral surface. The limit of extension of the transverse furrows corresponds closely with that of the underlying mesoblast. The body is divided by the two furrows into three regions, corresponding to the three segments of the Nauplius.

Soon after the appearance of the transverse furrows there appears a median longitudinal furrow on the same side (dorsal) of the embryo. This is shown in transverse section in Figure 92 and in dorsal view in Figure 125. This furrow intersects the two transverse furrows, but does not extend to the extreme end of the embryo. Two new transverse furrows now appear (3, 4, Figs. 93, 123-125), superficially dividing the anterior and posterior segments of the Nauplius. Earlier writers have published many drawings of these stages, and it seems unnecessary to insert similar ones in this paper.

The transverse furrows and the median longitudinal one deepen rapidly, and cut off the three pairs of appendages, as has been correctly described by Groom and earlier workers. The extension of the floor of

the longitudinal furrow laterally and ventrally is shown in Figure 94, which also shows the ectoblast and mesoblast composing the appendages. The deepening of the furrows progresses and the appendages are folded off commencing at their dorsal distal ends until finally their attachment is to the ventral side of the embryo, as determined by the position of the mouth and labrum (Figs. 124, 126). It will be seen that my account confirms Groom in that the mesoblast band and the furrows are dorsal, and that the appendages are folded off from dorsal to ventral, the free ends of the appendages remaining directed dorsally until about the time of hatching. Investigators before Groom gave good descriptions and figures of the formation of appendages, but considered that the mesoblastic band and the furrows were ventral instead of dorsal.

Many of my preparations and unpublished figures of later stages confirm Groom's account regarding the formation of the stomodæum and proctodæum, and the development of the mesenteron from the yolk-entoblast cells.

It is to be noted that many of Groom's minor observations on later stages were confirmatory of earlier writers, whose work he has reviewed, and it has, therefore, for my purposes been sufficient to refer directly to Groom's paper. For the details of late development of organs of the Nauplius, reference must be made to Groom and earlier workers, for this paper is concerned, primarily, with cleavage and germ-layer formation.

The fate of the germ-layers, which were identified in the sixty-two-cell stage, may be summarized as follows: — The ectoblast forms the outer covering of the body and appendages, the stomodæum, proctodæum, and the nervous system. The yolk-entoblast forms the mesenteron. The mesoblast forms the muscles and connective tissues of the appendages, and of the body of the Nauplius.

So far it has not been possible to distinguish between the fate of the primary and secondary mesoblasts. It can only be stated that at least a part of the muscular and mesenchymatous tissues of the Nauplius come from the ecto-mesoblast ("secondary mesoblast"). In other genera of Cirripedia an attempt is now being made at tracing the two kinds of mesoblast farther than has been possible in *Lepas*.

#### X. General Considerations on Cleavage and Cell-Lineage.

Korschelt und Heider ('90-91) have classed the cleavage of the cirripede ovum with their type II of crustacean cleavage — a type beginning with total cleavage, but soon changing to superficial. This classification



was evidently based upon Nassonow's figures of *Balanus*; but is shown to be erroneous by subsequent investigations. It is controverted in the case of *Balanus*, by the account of Groom, as well as by unpublished observations of my own; and in the case of *Lepas* it is clearly inapplicable. In both these genera cleavage is total and unequal.

Knipowitsch ('92) described the cleavage of the Ascothoracidan genus *Laura* as superficial from the very beginning of development. His figures do not warrant such a conclusion, for cell-boundaries appear to form after every nuclear division. The few figures of segmentating eggs in Knipowitsch's paper resemble the figures which other authors have drawn from the eggs of parasitic copepods; for example, Pedaschenko's ('93) figures of *Lernæa*. The latter is evidently a case of total, but very unequal, cleavage, and the cleavage of *Laura* is apparently to be interpreted in the same way.

Van Beneden's ('70) figures illustrating his account of the development of *Sacculina* indicate to my mind that the cleavage of *Rhizocephalan Cirripedia* is also of the unequal total type. Even the fact that in late stages the four yolk-macromeres appear to fuse does not support the interpretation that the cleavage is in later stages superficial. In no stage of the development is there nuclear division which is not associated with total cell division, and we are led to the conclusion that the cleavage of *Sacculina* cannot be correctly characterized as superficial in any stage.

Regarding the type of cleavage of cirripede ova, the conclusion is that, so far as present knowledge extends, the eggs undergo unequal total cleavage, and with respect to the cleavage processes there is no close resemblance to the superficial cleavage of the higher Crustacea; rather is the resemblance to that of the yolk-laden eggs of gasteropods.

In the order of the cleavages involved in the establishment of the germ-layers there are in *Lepas* some interesting resemblances to the annelids and mollusks. As is well known, studies of the cell-lineage of annelids, gasteropods, lamellibranchs, and chitons have shown that in all of these forms the ectoblast is separated from the mes-entoblast by three successive cleavages, while a fourth cleavage separates the primary mesoblast from the entoblast. Moreover, it has been shown in the cases of some gasteropods and lamellibranch mollusks, that the mesoblast is derived from both primary germ-layers; in addition to the primary mesoblast (*entoblastic* mesoblast) there are mesoblast cells which come from the ectoblast (*ectoblastic* mesoblast). This has been designated "secondary mesoblast" or "larval mesenchyme" (Lillie, '95, p. 24; Conklin, '97, p. 150).

So far it has not been shown conclusively that the mesoblast of annelids has a like double origin, but the studies of Wilson ('98) make it appear probable that in the annelid egg there is mesoblast of ectoblastic origin, which is comparable to the "secondary mesoblast" or "larval mesenchyme" of mollusks.<sup>1</sup>

It must be understood that, in offering the following suggestions of some resemblances between the cleavage of *Lepas* and the forms above mentioned, it is not here claimed that any cell homologies exist. Our knowledge of this subject is not as yet sufficiently extensive to warrant any decision for or against such a conclusion.

The fact that in *Lepas* the ectoblast is separated from the mes-entoblast by three successive cleavages, while the fourth separates the primary mesoblast from the entoblast is, at least, an interesting coincidence. The double origin of mesoblast is another point of resemblance, for in *Lepas*, as in gasteropods, lamellibranchs and probably annelids also, the ectoblast is a second source of mesoblastic cells.

In one important respect there seems to be a wide difference between the cleavage of *Lepas* and that of annelids and mollusks; for in these latter groups there are three quartets of ectoblastic micromeres formed by as many successive cleavages of four macromeres, whereas in *Lepas* there are not three quartets of cells but three cells formed in the same order of cleavage. In the annelids and mollusks the first segregation of ectoblast from entoblast is represented by the upper four cells (first quartet of micromeres) of the eight-cell stage, formed by the third cleavage, whereas in *Lepas* the first segregated ectoblast is one of the two cells formed by the first cleavage. Stated in other terms, in annelids and mollusks, unlike *Lepas*, the first and second cleavages are not directly concerned with the segregation of ectoblast from entoblast, but they divide the egg into a quartet of macromeres, each containing entoblast, from which in succession three quartets of ectoblastic micromeres are separated. In *Lepas* the segregation of ectoblast begins, as it were precociously, without the previous division of the entoblast into a quartet of cells. As a result of this there is in *Lepas* one entoblastic macromere instead of four, as in annelids and mollusks, and single micromeres appear to represent quartets. So far as the order of cleavage involved in the segregation of the primary germ-layers is concerned, the first micromere ( $ab^2$ ) of *Lepas* apparently corresponds to the first quartet of

<sup>1</sup> Since this paragraph was written, several investigators have given support to the suggestion that there is a double origin of the mesoblast in annelids. See Treadwell (: 01, p. 427), Wilson (: 01, p. 891) and Torrey (: 02, p. 576).

ectoblastic micromeres seen in the eight-cell stage of such eggs as have four macromeres resulting from the quartet-forming (first and second) cleavages. The micromeres of *Lepas* are, then, according to this view, to be regarded as equivalent to quartets of micromeres, while the single yolk-macromere equals a quartet of macromeres. It must be recognized that there are great, perhaps irreconcilable, differences between the development of the cirripedes and that of annelids and mollusks, and that consequently, the above comparisons might be extreme, if they were to be used as evidence of the existence of cell-homologies. At present it is possible simply to compare the order of cleavages involved in segregating the germ-layers.

A similar relation in cleavage occurs within the group of the Cirripedia. Van Beneden ('70) showed that in the Rhizocephalan genus *Sacculina*, the first and second cleavages divide the egg into a quartet of yolk-bearing macromeres, all containing entoblast, from which a quartet of ectoblastic micromeres is separated by the third cleavage in the formation of the eight-cell stage. This is exactly the order of cleavages in the eggs of annelids and mollusks. In *Sacculina*, then, the first segregation of ectoblast occurs two cleavages later than in *Lepas*, in which there is precocious segregation of ectoblast. In *Sacculina* the first and second cleavages divide the egg into four yolk-bearing macromeres, each containing entoblast and ectoblast, and the segregation of the primary germ-layers begins at the third cleavage; but in *Lepas* the segregation begins at the first cleavage without subdivision of the egg into four quadrants. Comparing the four-cell stage of the two genera, the entoblast in *Lepas* is all concentrated into one of the four cells each of which in *Sacculina* contains entoblast. According to this view the first cleavage of *Lepas* corresponds to the third of *Sacculina* so far as the first segregation of ectoblast is concerned. Whether the first micromere of *Lepas* is homologous with the quartet of micromeres in *Sacculina* cannot be determined until the fate of those cells is traced in the latter genus. There is reason for inferring that in *Sacculina* other quartets of ectomeres are cut off from the yolk-macromeres and added to the ectoblast. This must be settled before any further conclusions can be drawn. The final result of the development — the Nauplius — is similar in *Lepas* and in *Sacculina*. A comparison of the cell-lineage of the two genera may be expected to yield some results bearing on the suggestion that possibly the micromeres ( $ab^2$ ,  $c^3$ ,  $d^{4.2}$ ) of *Lepas* may be equivalent to quartets of ectoblastic micromeres in *Sacculina*, and possibly to those in more distantly related forms. These are

merely suggestions which have grown out of comparison of the order of the cleavages involved in segregating the germ-layers.

The segregation of the ectoblast as three micromeres is apparently not peculiar to *Lepas* among Entomostraca. The cleavage of certain parasitic Copepoda has close resemblances to that of *Lepas* as regards number of cleavages involved in the segregation of the germ-layers. In *Lernæa*, according to Pedaschenko ('93), the ectoblast and mesoblast are separated from the yolk-macromere (entoblast) by means of four cleavages. It will appear in the discussion of the germ-layers in the following section of this paper, that in the instance just cited the first three micromeres probably contain all the ectoblast with the "secondary mesoblast," while the fourth is the primary mesoblast; in this case, then, the number and order of cleavages involved in germ-layer segregation would agree with my observations on *Lepas*.

In the figures and accounts of the cleavages of various phyllopod and copepod, in which the germ-layers appear to be established as early as the thirty-two-cell stage, there are found many suggestions that further investigations may show a close resemblance to the cell-lineage of *Lepas*. Some examples of such suggestive papers are those of Grobden ('79, '81) on *Moina* and *Cetochilus*, Urbanowicz ('86) and Häcker ('92, '97) on *Cyclops*, and Pedaschenko ('93) on *Lernæa*; but in none of these genera are the facts as yet sufficiently well known to warrant close comparison with *Lepas*, especially since there is much disagreement between the observations of these investigators. At present this mention of a possible resemblance to the cleavage of *Lepas* can have only the value of a suggestion, which may possibly stimulate comparative study of the cleavage of those Entomostraca in which the early segregation of the germ-layers makes it possible to trace the lineage of the cells to the complete separation of the germ-layers.

The cleavage of *Lepas* has some general resemblances to that of the nematodes. Particularly is there resemblance in the early segregation of the germ-layers; but, as to the order of cleavage involved in this process, there are great and at present irreconcilable differences. The first cleavage in Nematoda begins the separation of the germ-layers. Thus the cell  $ab^2$  contains ectoblast in the nematodes as in the cirri-pede, and  $cd^2$  contains ectoblast and mes-entoblast. The second cleavage in the nematodes completes the segregation of the mes-entoblast from ectoblast, whereas this is accomplished by the third cleavage in *Lepas*. It is obviously impossible to make any comparison of the details of the early development.

In certain respects the cell-lineage of *Lepas* recalls that of some rotifers, as described by Zelinka ('91) and especially by Jennings ('96). In the rotifers, as in *Lepas*, the separation of the primary germ-layers begins with the first cleavage, the cell  $ab^2$  being ectoblastic, and  $cd^2$  containing ectoblast in addition to all the entoblast. Still more remarkable is the resemblance in that the entoblast is derived from the cell  $d^{5.1}$  both in *Asplanchna* and in *Lepas*. This cell is purely entoblastic in *Lepas*, and probably so in *Asplanchna*; its two minute derivatives  $d^{6.2}$  and  $d^{7.2}$  are regarded by Jennings as belonging to this germ-layer. The macromere  $d^3$  in this rotifer, as in *Lepas*, gives rise to  $d^{4.2}$  in the third cleavage and  $d^{5.2}$  in the fourth. In both  $d^{4.2}$  is purely ectoblastic. In *Lepas*  $d^{5.2}$  is the primary mesoblast, but in *Asplanchna* it is ectoblast. However, the exact origin of the mesoblast in the rotifers is unknown. It is evident that the number and order of cleavages which are involved in the segregation of the entoblast from the ectoblast are the same in the rotifer as in the cirripede.

#### XI. Comparisons of the Germ-Layers of *Lepas* with those of other Crustacea.

The account here given of the development of *Lepas* agrees with the published descriptions of the development of the majority of Crustacea, in that the blastopore is posterior and ventral, and apparently near the position of the future anal aperture. This similarity in the relation of the blastopore appears at first to be without significance, if one compares the embryo of *Lepas*, which has the mesoblastic band on its dorsal side, with crustacean embryos containing much yolk and having the mesoblastic plate ventral in position, as it is in decapods. However, the facts appear to allow of the following interpretations: In crustacean eggs which are heavily laden with yolk, the embryonic disk is at first confined to the ventral surface, but gradually extends dorsally over the yolk-mass. The mesoblast is formed while the embryonic disk is ventral. In *Lepas*, and some other Crustacea in which there is a relatively small amount of yolk, the embryonic disk is not confined to the ventral surface, but from the close of cleavage it is extensive enough to surround the yolk completely. In consequence of this the mesoblast, which in higher Crustacea forms bands on either side of the median ventral line, in *Lepas* extends along the dorsal line. If one imagines an ordinary decapod egg deprived of the greater part of its yolk until, at the close of cleavage, the edges of the embryonic disk meet on the dor-

sal surface, the conditions in *Lepas* would be closely imitated. The mesoblast bands would in such a case come to lie more and more dorsally, in proportion as the loss of yolk allowed the embryonic disk to cover the whole surface. In *Lepas* these bands in their position near the median-dorsal line, where the distal ends of the appendages later appear, may be considered as representing the outer edge of the embryonic disk of eggs having so much yolk that the disk is spread out over the ventral surface only, not being folded completely around the yolk as in the case of *Lepas*. It appears, then, that, though the mesoblast of *Lepas* is dorsal and that of yolk-laden eggs of higher Crustacea ventral, the two may be regarded as having homologous positions. In comparing *Lepas* with most other Crustacea the blastopore may be considered as having the same relative position, and the germ-layers may be compared with reference to their method of formation at the blastopore and their extension from that region.

Groom ('94, p. 199), who regarded the mesoblast and entoblast as originating from a single yolk-cell after the blastopore is closed, was necessarily led to the conclusion that "with respect to the origin of the mesoblast and hypoblast of the Nauplius, the cirripedes occupy an isolated position among Crustacea." This statement is based upon his view that the yolk-cells after the closing of the blastopore constitute the mes-entoblast. This view is at variance with the conditions in other Crustacea, for the mesoblast commonly originates from the blastoderm and not from yolk-cells lying beneath that structure. In this paper it has been shown that, in general terms, the mesoblast in *Lepas* originates from the blastoderm, and that, consequently, Groom's view is incorrect.

The accounts of most earlier workers on cirripede embryology lead to conclusions practically the same as Groom's. In opposition to such conclusions it will be pointed out in the following discussion that in the formation of the germ-layers there are many fundamental resemblances between *Lepas* and other Crustacea.

Among all Crustacea whose embryology is at present known, the closest resemblance to the development of Cirripedia appears to be found among the Phyllopoda and Copepoda, especially the latter. In the preceding chapter reference has been made to similarity of cleavage in these three groups of Entomostraca, but here the comparison between the germ-layers is to be emphasized.

Urbanowicz ('86) has studied the germ-layers of the copepod *Cyclops* and has found only one entoblast cell, over which the ectoblast grows

closing the blastopore. Ectoblastic cells around the blastopore give rise to mesenchyme ("secondary mesoblast"), which forms most of the mesoblastic structures of the Nauplius. The mesoblast proper probably originates from the entoblast, as does the primary mesoblast of *Lepas*. It is evident that there is in *Cyclops*, according to Urbanowicz, a condition closely resembling that of *Lepas*.

In close agreement with Urbanowicz's account of *Cyclops* and my own of *Lepas*, is Pedaschenko's ('93) description of the formation of the germ-layers of the parasitic copepod *Lernæa*. In this genus the mesoblast and ectoblast are separated from the yolk-entoblast in the first four divisions, as in *Lepas*. The four micromeres thus produced subdivide and form the blastoderm, which grows over the entoblast. At the margin of the growing blastoderm (blastopore) some cells (apparently ectoblastic) divide parallel to the surface and form migrating mesenchyme cells. These apparently correspond to the "secondary mesoblast" of *Lepas*. On the ventral side four of the cells sink beneath the ectoblast and constitute the primitive mesoblast cells. The lineage of these cells has not been definitely traced, but from their position I infer that they are probably the direct descendants of the fourth micromere, in which case the primary mesoblast originates directly from the entoblast, as in *Lepas*.

Häcker's ('92, '97) studies of *Cyclops* led to results widely different from those of Urbanowicz. According to Häcker, a cell lying in the blastopore divides into a genital cell and a primitive mesoderm cell. The cells surrounding the blastopore divide, giving rise to the primitive endoderm cells; this is in line with Grobben's account of *Cetochilus*, to which reference will be made later, and opposed to Urbanowicz, who found mesenchyme cells originating from cells bounding the blastopore.

Grobben's ('81) views of the formation of the germ-layers in the copepod *Cetochilus* do not agree with the account of *Cyclops* given by Urbanowicz, and only in part is there agreement with Häcker's account of *Cyclops*. His description of the thirty-two-cell stage of *Cetochilus* forms the best starting-point for purposes of comparison. In this stage, viewed from the vegetative pole, there is noticed a distinct bilateral symmetry in arrangement of the cells. A "central entoderm" cell and one small "anterior entoderm" cell lie in the median plane. Four cells placed symmetrically on either side of the "central entoderm" cell will by the next division form "entoderm" and ectoderm. The cell in the median line and posterior to the "central entoderm" cell forms in later division four cells, of which the two nearer the "central

entoderm" are said to be the primitive mesoblast cells, and the two posterior products ectodermal.

It appears that the "central entoderm" cell of Grobбен is probably the single entoblast cell to which Urbanowicz refers. The blastoderm cells lying laterally and anterior to the entoderm cell in Cyclops are said by Urbanowicz to give rise to mesenchyme, while Grobбен in *Cetochilus* and Häcker in Cyclops find entoderm originating from cells in corresponding positions. It is probable that this contradiction arose from failure to follow the germ-layers into the ultimate organs. The figures of *Cetochilus* by Grobбен and those of Cyclops by Häcker do not give conclusive proof regarding the fate of the cells which they consider endoderm. I have not seen the original figures by Urbanowicz. The differences between these authors will probably be adjusted when the later history of the mesoblast and entoblast is more accurately traced.

The cell posterior to the "central endoderm" cell in the thirty-two-cell stage of *Cetochilus* is said by Grobбен to form the mesoblast and also to contain some ectoblast. This latter point must still be regarded as problematical, for Grobбен's figures do not give convincing proof. It is possible that the cell in question may be wholly mesoblastic, instead of only partly so. However, the important point is that this cell appears to originate in connection with the "central endoderm" cell. Accordingly mesoblast in *Cetochilus* originates from entoblast; a condition certainly existing in the case of the barnacle *Lepas*, and the studies of Urbanowicz make it appear probable that such is also the case in Cyclops.

Grobбен's ('79) account of the development of the phyllopod *Moina* agrees with Urbanowicz's account of Cyclops and my own account of *Lepas* as to the formation of ectoblastic mesoblast from blastoderm cells bounding the blastopore laterally and anteriorly. But in a position corresponding to that of the entoblast cell of *Lepas* and Cyclops there is in *Moina* a "primitive genital cell," and the entoblast is said to be developed from a cell lying immediately posterior to it. It should be mentioned here that Samassa ('93), while agreeing essentially with Grobбен's description of cleavage stages, failed to find evidence of such early differentiation. With respect to this result it must be considered improbable that the visible peculiarities of the cells in the region of the blastopore in cleavage stages are without significance. It seems more probable that the peculiar features of certain cells do represent early differentiations, as Grobбен claimed. The results of Samassa and



others render doubtful the early differentiation of a genital cell in *Moina*; but Häcker ('92, '97) has contributed some important cytological evidence favorable to Grobben's conclusions.

To summarize the comparison of *Lepas* with the Copepoda and Phyllopoda, it has been pointed out that —

1. In *Lepas*, in *Moina* (Grobben), in *Cyclops* (Urbanowicz), and probably in the parasitic copepod *Lernæa* (Pedaschenko) mesoblast originates from ectoblastic cells of the blastoderm around the blastopore. In *Cetochilus* (Grobben) and in *Cyclops* (Häcker) there is a disagreement with *Lepas*, in that the *entoblast* cells are said to originate from cells whose origin and position is similar to those which in the above mentioned forms produce mesoblast.

2. In *Lepas*, *Cyclops* (Urbanowicz) and *Lernæa* a single entoblast cell, in *Cetochilus* (Grobben) the "central entoblast" cell, at first lies in the blastopore and it, or its derivatives, are overgrown by the blastoderm.

3. In *Lepas*, *Cyclops* (Urbanowicz), *Cetochilus* (Grobben) and *Lernæa* (?) (Pedaschenko) some mesoblast originates directly from the entoblast cell which lies in the blastopore, that is to say, the yolk-macromere is mes-entoblastic. In all of these except *Cetochilus* (Grobben) mesoblast also originates from ectoblastic cells around the blastopore.

The foregoing comparisons of the germ-layer formation in *Lepas* and other Entomostraca in which early differentiation takes place, brings out many points of resemblance. But in some cases there are differences apparently irreconcilable. One can scarcely believe that such contradictory statements as have been summarized in the preceding paragraphs are based upon observations all equally reliable. Renewed investigation of the uncertain points is much needed. The numerous resemblances even from the beginning of development, make it very desirable that the cell-lineage should in these cases be carefully studied so as to give a basis for accurate comparisons. Until such data are accessible it is unsafe to draw conclusions respecting homologies of cells or even of the germ-layers.

In many Crustacea there is at the blastopore an immigration of many cells into the cleavage cavity. In some of these cases the cavity is up to that time filled with yolk. The cell-mass thus formed by immigration into the cleavage cavity is mes-entoblastic, and the mesoblast and entoblast are at first indistinguishable, or at any rate investigators have failed to find distinguishing marks. As examples of

such conditions may be cited *Daphnia*, according to Lebedinsky ('91); *Moina* and *Daphnia*, according to Samassa ('93); and many higher Crustacea.

Such an origin of mesoblast and entoblast is not necessarily opposed to the account which I have given of the germ-layer formation of *Lepas*, for differentiation, though not observable, may yet occur in the cases mentioned. Were there not in *Lepas* peculiarities by which the cells can be distinguished at an early stage, the immigrating mass of cells, composed of entoblast, and of primary and secondary mesoblast, would be correctly described as mes-entoblast, out of which the two layers become later visibly differentiated. If the entoblast cells of *Lepas* were completely separated from the yolk-mass, as is the case in many other Crustacea, it would perhaps be impossible, in the absence of the easily recognized yolk-laden entoblast, to trace the lineage of the mesoblast independently of the entoblast, and in such conditions it would be necessary to consider the immigrating mass of cells as mes-entoblastic. It is probable that some such conditions obtain in some of the Crustacea in which a mes-entoblastic immigration is said to occur. At any rate, germ-layer formation in such cases agrees in essentials with that observed in *Lepas*. Grobben's ('79) study of *Moina* suggests that in this genus, at least, the immigrating mass of mes-entoblast may be not entirely undifferentiated as Samassa ('93) supposed.

There is some evidence that the comparison between *Lepas* and certain higher Crustacea may be carried still farther than the suggestions offered in the preceding paragraph. In *Astacus*, according to Reichenbach ('86), the mesoblast originates at the anterior margin of the blastopore, where the ectoblast joins the entoblast. Reichenbach distinguished in the invagination both yolk-absorbing cells (vitellophags), which enter into the yolk-pyramids, and also the cells forming the entoderm plate. All these cells are said to enter into the mesenteron and liver lobes, and hence the invagination is entoblastic. However, McMurrich ('95, pp. 135, 136) reviews the evidence and suggests that the yolk-pyramids give rise to some mesoblast. If this proves true, the invagination is to be regarded as mes-entoblastic; but, in addition to mesoblast so formed from entoblast, other mesoblast cells certainly originate from the blastoderm in front of the invagination. It follows that there are, as regards origin, two kinds of mesoblast — ectoblastic and entoblastic.

In other accounts of development of the higher Crustacea there are suggestions of such a double origin of mesoblast, but there is as yet

lack of a definiteness of statement sufficient to afford basis for comparisons of any value.

Comparing the development of *Astacus* with that of *Lepas*, the ectoblastic mesoblast at the anterior edge of the blastopore appears to be equivalent to the "secondary mesoblast" of *Lepas*. If the suggestion, that the invagination is mes-entoblastic, proves true, it may be possible to regard the mes-entoblastic cell  $d^{4.1}$  of *Lepas* as representing the invaginated cells of the higher Crustacea; the primary mesoblast and entoblast of *Lepas* would then be comparable with the germ-layers derived from the invagination in the higher forms. In such a case there would be further agreement with *Lepas* in that the mesoblast originates from both ectoblast and entoblast.

#### *Summary.*

1. *Lepas* resembles most other Crustacea (*a*) in respect to position of the blastopore, which is ventral and posterior, (*b*) in extension of the entoblast and mesoblast from the blastopore as a starting-point, (*c*) in the mode of formation of the organs of the larva.

2. In *Lepas*, as in most other Crustacea, the mesoblast and entoblast originate in the region of the blastopore from cells which, speaking in general terms, at first lie in the blastoderm and later migrate into the cleavage cavity.

3. Among the migrating mes-entoblastic cells one can distinguish in *Lepas* the individual cells of entoblast and of two varieties of mesoblast. Representatives, if not precise homologues, of these kinds of cells are probably present both in other Entomostraca and in the higher Crustacea.

## XII. General Summary with Table of Cell-Lineage of *Lepas*.

The results which are of special interest in relation to the development of Cirripedia have already been summarized in connection with the accounts of the several stages of development. Only results of more general interest are again summarized here.

The cleavage of *Lepas* is throughout total and unequal.

Stages with 2, 4, 8, 16, 32, and 62 "resting" cells are regularly formed.

In the eight-cell stage and thereafter there is a well-marked bilateral arrangement of the cells.

In the first three cleavages three "protoplasmic" micromeres are

separated from the yolk-bearing macromere, and the fourth cleavage separates the primary mesoblast from the yolk-entoblast. Thus, in the sixteen-cell stage the entoblast is completely separated from the other germ-layers.

Mesoblast originates both from entoblast (fourth cleavage) and from ectoblast (sixth cleavage). The mesoblast derived from ectoblast ("secondary mesoblast") forms a large part at least of the mesenchyme of the Nauplius. The fate of the primary mesoblast (entoblastic mesoblast) has not been distinguished from that of the "secondary mesoblast" (ectoblastic mesoblast).

The blastoderm grows over the yolk-bearing entoblast, usually closing the blastopore after the sixth cleavage. In cases where the yolk-mass is very large, the closing of the blastopore may not occur until the succeeding cleavage. But in all cases the blastoderm is formed from derivatives of *three* and only three micromeres ( $ab^2$ ,  $c^3$ ,  $d^{4.2}$ ), which are cut off in the first three cleavages.

The yolk-macromere of the sixteen-cell stage has been traced to the mesenteron. All the evidence supports entirely the interpretation that after the fourth cleavage the yolk-macromere is purely entoblastic.

The irregularity and variability which authors have ascribed to the cleavage of cirripedes do not normally exist in the case of *Lepas*. The origin, relative position, and fate of all cells of all cleavage stages have been shown to be constant, definite, and "determinate" so far as the formation of germ-layers is concerned. In later stages specific areas of cells, known to be of definite origin, enter into the formation of particular organs. It is therefore probable that the cells in cleavage stages bear a definite and constant relation to future organs.

The chief points in the cell-lineage and their relation to the formation of the germ-layers are summarized in the accompanying table.

Describing the formation of the germ-layers of *Lepas* in general terms, there is no conflict with most existing accounts of the development of other Crustacea; in the absence of complete records of the cell-lineage in other Crustacea, it is not possible to compare the details with certainty (see *Summary*, p. 133).

TABLE OF THE CELL-LINEAGE OF LEPAS.

1 cell.	2 cells.	4 cells.	8 cells.	16 cells.	32 cells.	62 cells.		
Fertilized Ovum	$ab^2$ (1)	$a^3$	$a^{4.2}$ ( <i>ec'bl.</i> )	$a^{5.2}$	$a^{6.4}$ ( <i>ec'bl.</i> )	$a^{7.6}$ ( <i>ec'bl.</i> ) $a^{7.5}$ ( <i>ms'bl.'</i> ) $b^{7.8}$ ( <i>ec'bl.</i> ) $b^{7.7}$ ( <i>ms'bl.'</i> ) $b^{7.6}$ ( <i>ec'bl.</i> ) $b^{7.5}$ ( <i>ms'bl.'</i> )		
			$a^{4.1}$				$a^{5.1}$ ( <i>ec'bl.</i> )	$a^{6.3}$
		$b^3$	$b^{4.2}$ ( <i>ec'bl.</i> )	$b^{5.2}$	$b^{6.4}$		$b^{6.3}$	
			$b^{4.1}$					$b^{5.1}$ ( <i>ec'bl.</i> )
		$cd^2$ ( $y^2$ )	$c^3$ (2)	$c^{4.2}$ ( <i>ec'bl.</i> )	$c^{5.2}$		$c^{6.4}$ ( <i>ec'bl.</i> )	$c^{7.6}$ ( <i>ec'bl.</i> ) $c^{7.5}$ ( <i>ms'bl.'</i> )
				$c^{4.1}$				
	$d^3$ ( $y^3$ )		$d^{4.2}$ ( <i>ec'bl.</i> ) (3)	$d^{5.2}$ ( <i>ms'bl.</i> )	$d^{5.1}$ ( <i>en'bl.</i> ) ( $y^5$ )			
			$d^{4.1}$ ( $y^4$ )					

$y^2, y^3, y^4, y^5$  designate the yolk-bearing macromere; (1), (2), (3), the three micromeres containing ectoblast; *ec'bl.*, ectoblast; *en'bl.*, entoblast; *ms'bl.*, primary mesoblast, *ms'bl.'*, "secondary mesoblast."

## ADDENDUM.

BY E. L. MARK AND W. E. CASTLE.

To avoid any misunderstanding we wish to state that the opinions expressed by Dr. Bigelow regarding "quartet" cleavage are not wholly shared by us. *Lepas* seems to us a good example of modified "quartet" cleavage, and for that reason we think the quartet nomenclature has more than mere convenience in its favor. To be sure, the quadrants in *Lepas* are not symmetrical, but perfect symmetry is rarely met with in quartet cleavage. So far as we recall, complete symmetry of the quadrants is found only in platodes. The condition there realized may be considered primitive, all four quadrants sharing equally in the production of ectoblast, mesoblast, and endoblast (see Wilson, '98). One modification of this primitive symmetry is found in annelids and mollusks, another in rotifers and cirripedes.

In the first-named groups the *mesoblast* is segregated, more or less completely, in quadrant *d*, while the endoblast remains distributed among all four quadrants. In the rotifers (see Jennings, '96) the *endoblast* is segregated in quadrant *d*, precisely as in *Lepas*, yet the cleavage progresses in perfect quadrant symmetry through at least the first eight cell-generations, even though, to realize this symmetry, so-called "mechanical laws of cleavage" are repeatedly transgressed. The origin of the mesoblast in rotifers remains uncertain, but in *Lepas*, as Dr. Bigelow clearly shows, the mesoblast arises *from all four quadrants*. An examination of his table of cell-lineage (p. 135) shows other unmistakable evidences of quadrant symmetry in *Lepas*.

1. The first-formed definitive ectomeres — which are also the first cells to be differentiated for a particular germ-layer — arise symmetrically and synchronously from all four quadrants. They are the four dorsal cells of the eight-cell stage, namely,  $a^{4.2}$ ,  $b^{4.2}$ ,  $c^{4.2}$ , and  $d^{4.2}$ . They correspond with what in polyclads, annelids, and mollusks have been called the "first quartet of micromeres," which in these forms, as in *Lepas*, are always the first ectomeres to be differentiated.

2. At the sixteen-cell stage, in *Lepas*, the mesoblast is included in corresponding blastomeres ( $a^{5.2}$ ,  $b^{5.2}$ ,  $c^{5.2}$ ,  $d^{5.2}$ ) in all four quadrants.

The only essential difference among the quadrants in the mode of separation of the mesoblast is this: In quadrant *d*, cell  $d^{5.2}$  is *purely* mesoblastic; but the corresponding cells in each of the other quadrants contain mesoblast associated as yet with ectoblast, and the two are not separated until the second later generation, that is, in the sixty-four-cell stage. The earlier separation of the mesoblast in quadrant *d*, as compared with the other quadrants, may be due to the relatively *greater bulk* of the mesoblast in quadrant *d*. The mesoblast is really *partially segregated* in quadrant *d*,—since that quadrant contains a greater portion of mesoblast than any of the three remaining quadrants,—while the endoblast is *completely* segregated in that quadrant. The segregation of the mesoblast in quadrant *d* finds a parallel repeatedly in mollusks and annelids; that of the endoblast in the same quadrant is paralleled in rotifers.

Notwithstanding these coenogenetic modifications, the primitive quadrant-symmetry finds frequent expression in the cleavage of *Lepas*, a fact to which the quadrant nomenclature clearly directs attention.

It is true that in *Lepas* radial symmetry is replaced by bilateral symmetry considerably earlier than is the case in most annelids and mollusks, and much earlier than in rotifers, but the difference is one of degree rather than of kind. Cleavage in *Lepas*, as truly as in the other forms mentioned, is at first radial, and only gradually becomes bilateral.

BIBLIOGRAPHY.<sup>1</sup>

Auerbach, L.

'74. Organologische Studien. Breslau. 262 pp., 4 Taf.

Beneden, E. van.

'70. Recherches sur l'embryogénie des Crustacés. III. Développement de l'œuf et de l'embryon des Sacculines (*Sacculini carcini*, Thomps.). Bull. Acad. Roy. Belgique, sér. 2, Tom. 29, pp. 99-112, 1 pl.

Bigelow, M. A.

'96. On the early Development of *Lepas fascicularis*. (A preliminary note.) Anat. Anz., Bd. 12, pp. 263-269, 9 figs.

Bigelow, M. A.

'99. Notes on the First Cleavage of *Lepas*. Zool. Bull., Vol. 2, pp. 173-177, 7 figs.

Blochmann, F.

'81. Über die Entwicklung der *Neritina fluviatilis* Müll. Zeit. f. wiss. Zool., Bd. 36, pp. 125-174, Taf. 6-8.

Bobretzky, N.

'76. Studien über die embryonale Entwicklung der Gastropoden. Arch. f. mikr. Anat., Bd. 13, pp. 95-169, Taf. 8-13.

Bovallius, C.

'75. Embryologiska Studier. I. Om *Balanidernas* Utveckling. Stockholm. 44 pp., 5 pls.

Castle, W. E.

'96. The Early Embryology of *Ciona intestinalis*. Bull. Mus. Comp. Zool., Harvard Coll., Vol. 27, pp. 201-280, 13 pls.

Conklin, E. G.

'97. The Embryology of *Crepidula*, a Contribution to the Cell Lineage and early Development of some Marine Gasteropods. Jour. Morph., Vol. 13, pp. 1-226, pls. 1-9.

<sup>1</sup> No attempt has been made to cite a complete bibliography on cirripede embryology. Groom ('94) has given a tolerably complete list of the literature on the structure and development of the Cirripedia.



Conklin, E. G.

- '98. Cleavage and Differentiation. Biol. Lect., Wood's Holl, 1896-97, pp. 17-43.

Crampton, H. E.

- '96. Experimental Studies on Gasteropod Development. Arch. f. Entwickelungsmech. d. Organismen, Bd. 3, pp. 1-19, Taf. 1-4.

Darwin, C.

- '51. A Monograph on the Sub-class Cirripedia. Lepadidæ. Ray Society, London. xi + 400 pp., 10 pls.

Darwin, C.

- '54. A Monograph on the Sub-class Cirripedia. (Balanidæ, Verrucidæ, etc.). Ray Society, London. viii + 684 pp., 30 pls.

Filippi, F.

- '65. Ueber die Entwicklung von *Dichelaspis Darwinii*. Untersuchungen zur Naturlehre (Moleschott), Bd. 9, pp. 113-120, 2 Taf.

Grobben, C.

- '79. Die Entwicklungsgeschichte der *Moina rectirostris*, u. s. w. Arb. Zool. Inst. Wien, Tom. 2, pp. 203-268, Taf. 11-17.

Grobben, C.

- '81. Die Entwicklungsgeschichte von *Cetochilus septentrionalis*. Arb. Zool. Inst. Wien, Tom. 3, pp. 243-282, Taf. 19-22.

Groom, T. T.

- '92. On the Early Development of Cirripedia. (Abstract.) Proc. Roy. Soc. London, Vol. 52, pp. 158-162.

Groom, T. T.

- '94. On the Early Development of Cirripedia. Phil. Trans. Roy. Soc. London, Vol. 185, B, pp. 119-232, pls. 14-28.

Häcker, V.

- '92. Die Kerntheilungsvorgänge bei der Mesoderm- und Entodermbildung von *Cyclops*. Arch. f. mikr. Anat., Bd. 39, pp. 556-581, Taf. 24, 25.

Häcker, V.

- '97. Die Keimbahn von *Cyclops*, u. s. w. Arch. f. mikr. Anat., Bd. 49, pp. 35-91, Taf. 4, 5.

Hoek, P. P. C.

- '76. Zur Entwicklungsgeschichte der Entomostraken. (I. Embryologie von *Balanus*.) Nederl. Arch. f. Zool., Bd. 3, Heft 1, pp. 47-82, Taf. 3, 4.

Hoek, P. P. C.

- '83. Report on the Cirripedia collected by H. M. S. Challenger. (Historical and Systematic.) Vol. 8, Part 25, Zoöl. Series, 169 pp., 13 pls.

Hoek, P. P. C.

- '84. Report on the Cirripedia collected by H. M. S. Challenger. (Anatomical.) Vol. 10, Part 28, Zoöl. Series, 47 pp., 6 pls.

**Jennings, H. S.**

- '96. The Early Development of *Asplanchna Herrickii* de Guerne. A Contribution to Developmental Mechanics. Bull. Mus. Comp. Zoöl., Harvard Coll., Vol. 30, pp. 1-116, 10 pls.

**Knipowitsch, N.**

- '92. Beiträge zur Kenntniss der Gruppe Ascothoracida. Trav. de la Soc. Nat. St. Petersburg, Tom. 23, pp. 82-155, 3 Taf. (Russian with abstract in German.)

**Kofoid, C. A.**

- '94. On some Laws of Cleavage in *Limax*. A Preliminary Notice. Proc. Am. Acad. Arts and Sci., Vol. 29, pp. 180-203, 2 pls.

**Kofoid, C. A.**

- '95. On the Early Development of *Limax*. Bull. Mus. Comp. Zoöl., Harvard Coll., Vol. 27, pp. 35-118, 8 pls.

**Korschelt, E., und Heider, K.**

- '90-91. Lehrbuch der vergleichenden Entwicklungsgeschichte der wirbellosen Thiere. Jena. xii + 908 pp.

**Lang, A.**

- '78. Die Dotterfurchung von *Balanus*. Jena. Zeit. f. Naturw., Bd. 12, pp. 671-674, Taf. 20, 21.

**Lebedinsky, J.**

- '91. Die Entwicklung der *Daphnia* aus dem Sommereie. Zool. Anz., Jahrg. 14, pp. 149-152.

**Lillie, F. R.**

- '95. The Embryology of the Unionidæ. A Study in Cell-Lineage. Jour. Morph., Vol. 10, pp. 1-100, pls. 1-6.

**McMurrich, J. P.**

- '95. Embryology of the Isopod Crustacea. Jour. Morph., Vol. 11, pp. 63-154, pls. 5-9.

**Müller, F.**

- '64. Für Darwin. Leipzig. 91 pp., 67 figs.

**Münter, J., und Buchholz, R.**

- '69. Über *Balanus improvisus* Darw., var. *Gryphicus* Münt., Beitrag zur carcinologischen Fauna Deutschlands. Mitth. aus dem Naturw. Verein von Neu-Vorpommern und Rügen. Bd. 1, pp. 1-40, Taf. 1, 2.  
*Review by Gerstäcker in Arch. f. Naturg. Jahrg. 1871, Bd. 2, pp. 364, 365.*

**Nassonow, [W.] N.**

- '85. Zur embryonalen Entwicklung von *Balanus*. Zool. Anz., Jahrg. 8, pp. 44-47.

**Nassonow, [W.] N.**

- '87. On the Ontogeny of the Crustaceans *Balanus* and *Artemia*. Izvyest. imp. Obshch. Ljubit. Estestv. Antrop. i Ethnog. Moscow. Tom. 52, pp. 1-14, 35 figs. (Russian.)

**Nussbaum, M.**

- '87. Vorläufige Bericht über die Ergebnisse einer mit Unterstützung der Königlichen Akademie ausgeführte Reise nach Californien. Sitzungsber. d. k. preuss. Akad. der Wiss. zu Berlin, pp. 1051-1055.

**Nussbaum, M.**

- '89. Bildung und Anzahl der Richtungskörper bei Cirripeden. Zool. Anz., Jahrg. 12, p. 122.

**Nussbaum, M.**

- '90. Anatomische Studien an Californischen Cirripeden. Bonn. 97 pp., 12 Taf.

**Pedaschenko, D.**

- '93. Sur la segmentation de l'œuf et la formation des feuilletts embryonnaires chez la *Lernæa branchialis* L. Rev. des. Sc. Nat. St. Petersburg, Tom. 4, pp. 186-199, 11 figs. (Russian with abstract in French.)

**Reichenbach, H.**

- '86. Studien zur Entwicklungsgeschichte des Flusskrebsses. Abhandl. Senckenberg. Naturf. Gesellsch. Frankfurt. Bd. 14, pp. 1-137, Taf. 1-14.

**Samassa, P.**

- '93. Die Keimblätterbildung bei den Cladoceren. I. *Moina rectirostris* Baird. [II. *Daphnella* und *Daphnia*.] Arch. f. mikr. Anat., Bd. 41, pp. 339-366, Taf. 20-22; pp. 650-688, Taf. 36-39.

**Solger, B.**

- '90. Die Richtungskörperchen von *Balanus*. Zool. Anz., Jahrg. 13, pp. 607-609.

**Torrey, J. C.**

- :02. The Cell-Lineage of the Mesoblast-Bands and Mesenchyme in *Thalassema*. Science, n. s., Vol. 15, No. 380, pp. 576, 577.

**Treadwell, A. L.**

- :01. The Cytogeny of *Podarke obscura* (Verrill). Jour. Morph., Vol. 17, No. 3, pp. 399-486, pls. 36-40.

**Urbanowicz, F.**

- '84. Zur Entwicklungsgeschichte der Cyclopiden. (Vorl. Mitth.) Zool. Anz., Jahrg. 7, pp. 615-619.

**Urbanowicz, F.**

- '86. Contributions to the Embryology of Copepods. Kosmos, Lemberg, Jahrg. 10, pp. 239-259, 300-314. (Polish.)

**Urbanowicz, F.**

- '86<sup>a</sup>. Contributions à l'embryologie des Copépodes. Arch. Slav. Biol., Tom. 1, fasc. 3, pp. 663-667; et Mém. Univers. Varsovie. (Abstract of preceding paper.)

**Van Beneden, E.** See **BENEDEN, E. VAN.****Weismann [A.] und Ischikawa [C.]**

- '88. Weitere Untersuchungen zum Zahlengesetz der Richtungskörper. Zool. Jahrb., Abth. f. Anat. u. Ontog., Bd. 3, pp. 575-610, Taf. 25-28.

**Willemoes-Suhm, R. von.**

- '76. On the Development of *Lepas fascicularis* and the "Archizoëa" of Cirripedia. Phil. Trans. Roy. Soc. London, Vol. 166, pt. 1, pp. 131-154, pls. 10-15.

**Wilson, E. B.**

- '98. Considerations on Cell-Lineage and Ancestral Reminiscence, etc. Annals N. Y. Acad. Sci., Vol. 11, pp. 1-27, 7 figs.

**Wilson, E. B.**

- :01. Studien über den Körperbau der Anneliden, V. By Eduard Meyer. (Review.) Science, n. s., Vol. 14, No. 362, pp. 389-91.

**Zelinka, C.**

- '91. Studien über Räderthiere. III. Zur Entwicklungsgeschichte der Räderthiere nebst Bemerkungen über ihre Anatomie und Biologie. Zeit. f. wiss. Zool., Bd. 53, pp. 1-159, Taf. 1-6.  
Also in: Arbeiten a. d. Zool. Inst. Graz. Bd. 4, pp. 323-481, Taf. 1-6.

**Ziegler, H. E.**

- '95. Untersuchungen über die ersten Entwicklungsvorgänge der Nematoden. Zugleich ein Beitrag zur Zellenlehre. Zeit. f. wiss. Zool., Bd. 60, pp. 351-410, Taf. 17-19.

## EXPLANATION OF PLATES.

The figures of Plates 1-10 were drawn from the eggs of *Lepas anatifera*, and those of Plates 11 and 12 from *L. fascicularis*.

An Abbé camera lucida was in every case used in sketching the eggs. The figures of Plate 1, and Figures 57, 63-65, 74-77 were drawn at a magnification of about 220 diameters; all others in Plates 1-10 at about 365 diameters. The figures of Plates 11 and 12 are magnified about 210 diameters.

All figures, except those of transverse sections, are so arranged that the *posterior* end of the embryo, or the more pointed end of the vitelline membrane, is directed toward the bottom of the Plate; in transverse sections the ventral side is toward the bottom.

Double-headed arrows are used in some of the figures to connect two cells of common origin.

The vitelline membrane has not been represented, except in Figures 1-17 and 94-97.

Figures 1-30 and 95-99 are oriented by the axis of the vitelline membrane; all others by the axis of the embryo.

The small circles without stippling indicate the positions of the oil spherules in the yolk. Nuclei are distinguished by wavy lines, or by stippling, to represent chromosomes.

In Plates 2 and 3 a pale yellowish buff tint has been used to represent the more finely granular and more "protoplasmic" portion of the egg and blastomeres.

Plates 1, 4, 11, and 12 have been printed without tint. To aid in quickly distinguishing between the derivatives of quadrants *a*, *b*, and *c*, all the blastomeres of quadrant *b* in Figures 38-59, 61 are printed in *stipple without tint*, and in Figures 60 and 65 (Plate 7) the same method of designation has been employed to indicate the cells ( $b^{7.5}$ - $b^{7.8}$ ) of this quadrant concerned in the formation of the secondary mesoblast.

In Plates 5-10 the pale yellowish buff tint has been employed to indicate the blastomeres derived from quadrant *d*, the *primary mesoblast* ( $d^{5.2}$  and its descendants) being distinguished from the other derivatives by receiving a *stippling in addition to the tint*. In Plates 8-10 the tint has been restricted to  $d^{4.1}$  (entoblast) and its derivatives.

## ABBREVIATIONS.

For explanation of the letters and exponents designating blastomeres, see explanation of the nomenclature of cleavage (pp. 74-76).

<i>ast'cæl.</i>	Astrocæl.	<i>ec'bl.</i>	Ectoblast.
<i>app.</i>	Appendage.	<i>en'bl.</i>	Entoblast.
<i>at</i> <sup>1</sup> .	First antenna.	<i>lbr.</i>	Labrum.
<i>at</i> <sup>2</sup> .	Second antenna.	<i>mb.vt.</i>	Vitelline membrane.
<i>bl'po.</i>	Blastopore.	<i>md.</i>	Mandible.
<i>bl'drm.</i>	Blastoderm.	<i>ms'bl.</i>	Mesoblast of double origin.
<i>cav.sg.</i>	Cleavage cavity.	<i>ms'bl'.</i>	"Secondary mesoblast" (ectoblastic mesoblast).
<i>cl.pol</i> <sup>1</sup> .	First polar cell.	<i>pr'nl.</i> ♂	Male pronucleus.
<i>cl.pol</i> <sup>2</sup> .	Second polar cell.	<i>pr'nl.</i> ♀	Female pronucleus.
<i>d.</i>	Dorsal.		

The Roman numerals I. II. (Figs. 28, 30) indicate the position of the first and second cleavage planes, respectively; the Arabic numerals 1-4 (Figs. 91, 93, 122-126), the sequence in which the transverse furrows marking off the Nauplius appendages make their appearance.

Plate 1.	Figs. 1-16.
Plate 2.	Figs. 17-22.
Plate 3.	Figs. 23-30.
Plate 4.	Figs. 31-38.
Plate 5.	Figs. 39-46.
Plate 6.	Figs. 47-55.

Plate 7.	Figs. 56-65.
Plate 8.	Figs. 66-73.
Plate 9.	Figs. 74-86.
Plate 10.	Figs. 87-94.
Plate 11.	Figs. 95-110.
Plate 12.	Figs. 111-126.



PLATE 1.

Figures in this plate are all from living eggs, and represent stages between oviposition and the close of the first cleavage. The small circles represent the oil spherules which are embedded in the yolk.

Fig. 1. Egg about thirty minutes after oviposition. Vitelline membrane and second polar cell have appeared. Yolk uniformly distributed in the egg.

Figs. 2-5. Egg elongating. Protoplasm concentrating in upper half of the egg. Yolk becomes aggregated at the vegetative pole. Development of yolk-lobe.

Fig. 6. Yolk-lobe has disappeared. Yolk radially symmetrical with reference to chief axis of egg. Vitelline membrane has assumed its definitive form.

Fig. 7. Yolk moves to eccentric position with reference to the chief axis.

Figs. 8-15. First cleavage. Time thirty minutes. Drawings made at intervals of about four minutes. Rotation of the dividing egg within the vitelline membrane.

Fig. 16. One hour after close of first cleavage (Fig. 15). Yolk has returned somewhat toward the vegetative pole.

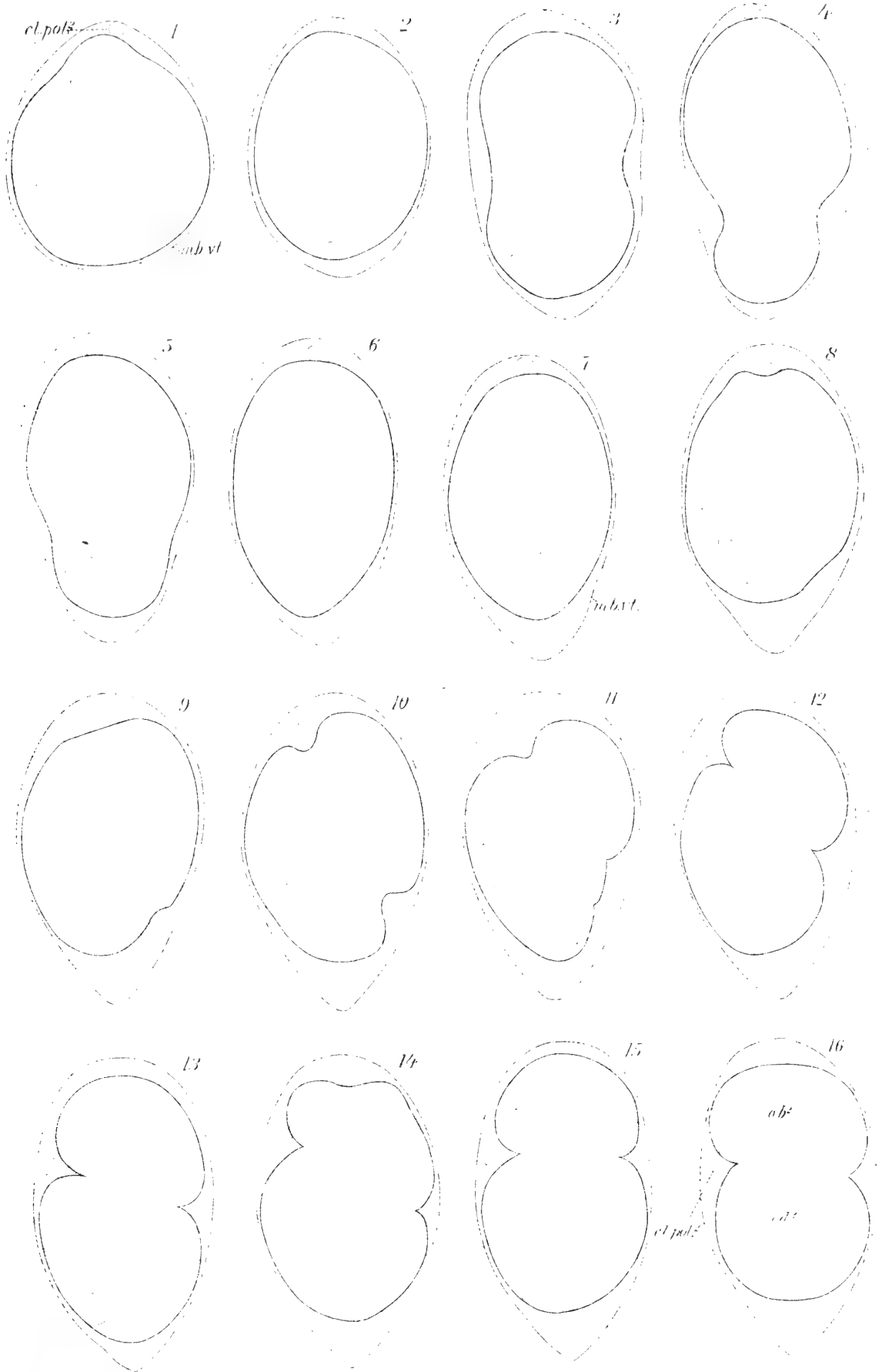


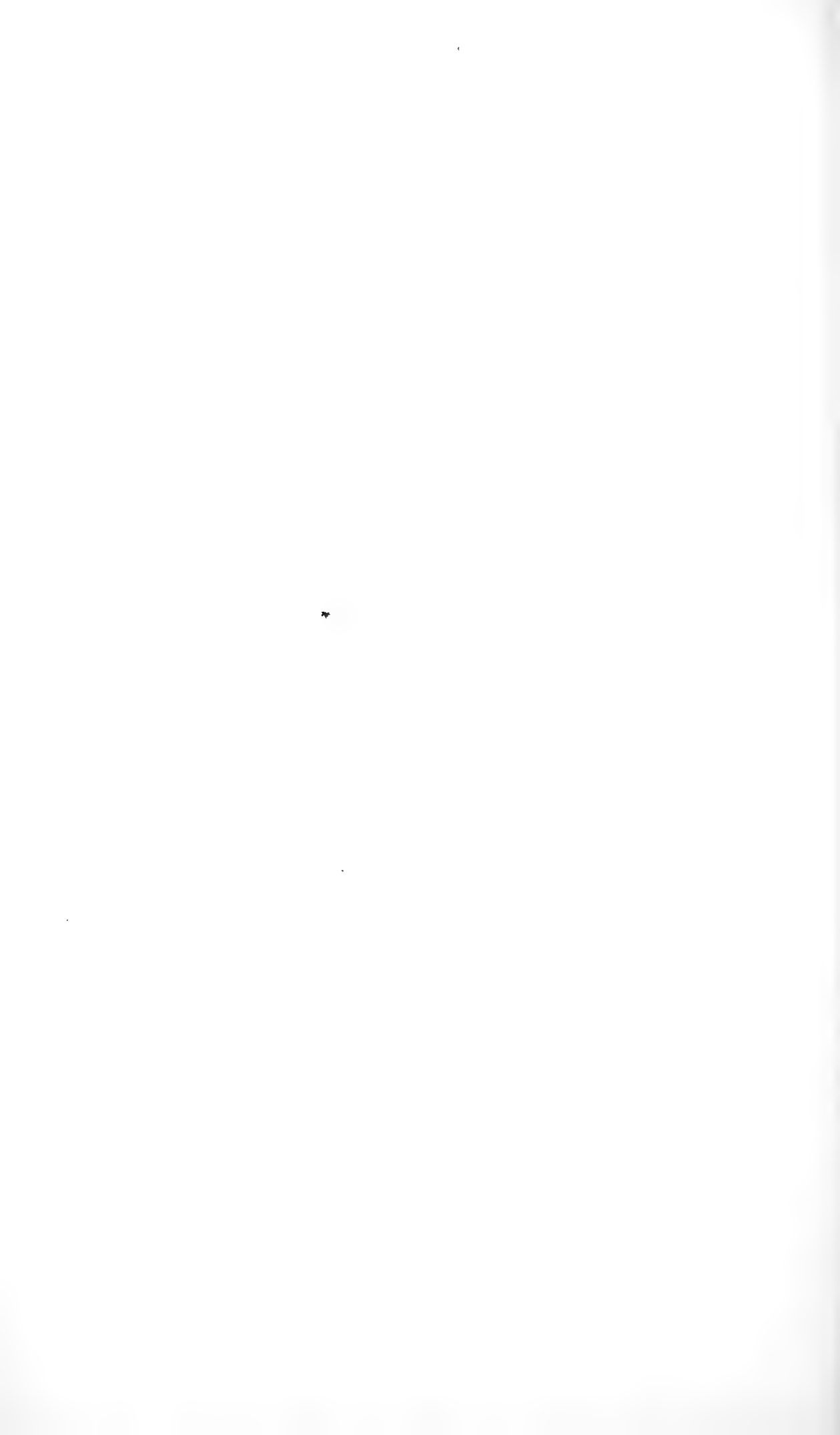


PLATE 2.

Sections of eggs representing stages shown in Plate 1.  
The vitelline membrane is represented in Figure 17 only.

- Fig. 17. Formation of second polar cell. Yolk uniformly distributed in the egg, which is somewhat distorted into a form more than normally elongated, owing to pressure in the egg-lamella.
- Fig. 18. Same stage as that represented in Plate 1, Figure 4. Male and female pronuclei in contact. Yolk collecting at the vegetative pole. The pronuclei in this stage, which is characterized by the presence of a yolk-lobe, are often separated as in Figure 19.
- Fig. 19. Same stage as that shown in Figure 6. Pronuclei approaching; they are usually in contact in this stage, as in Figure 20.
- Fig. 20. From an egg fixed in mercuric chloride, showing the distribution and relative amount of the yolk. Early appearance of the asters (?). Pronuclei in contact. Same stage as that shown in Figure 6.
- Fig. 21. Formation of first cleavage spindle. Yolk becomes eccentric, as shown in Figure 7.
- Fig. 22. Beginning of metaphase of first cleavage.





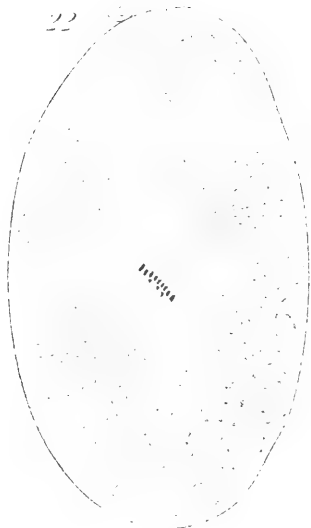
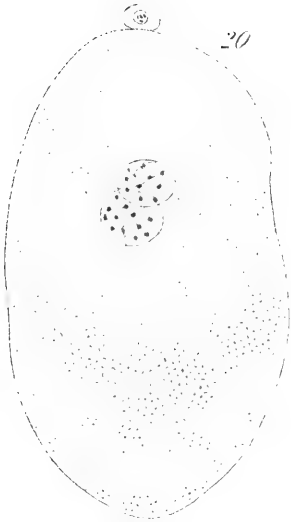
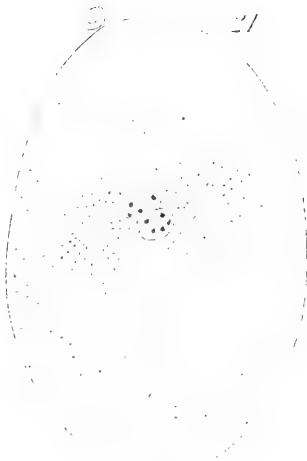
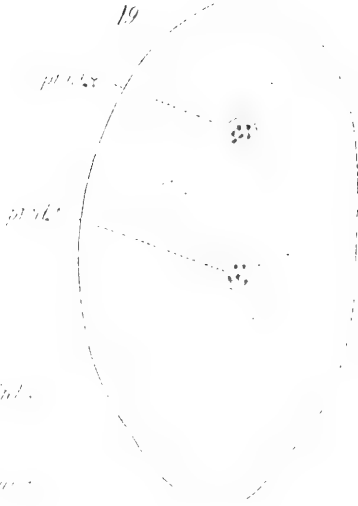
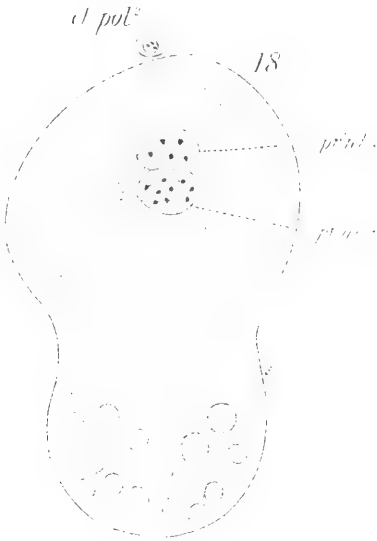
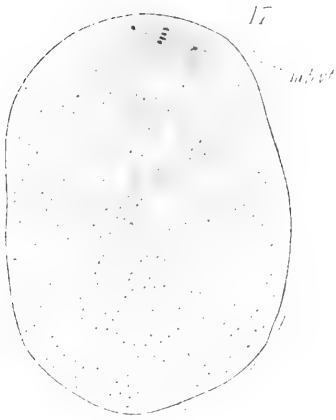




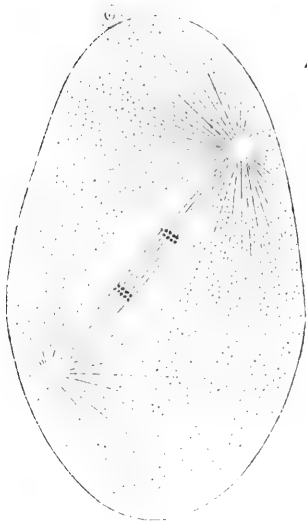


PLATE 3.

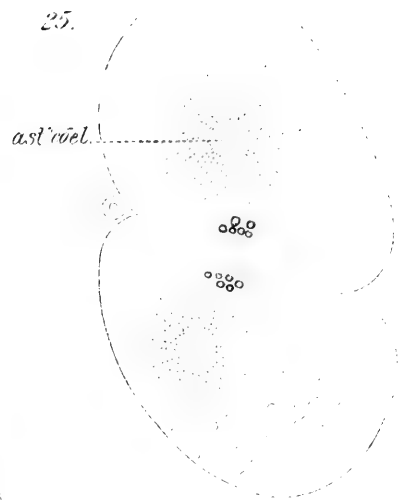
All Figures drawn from sections.

- Fig. 23. Early anaphase of first cleavage.
- Fig. 24. Late anaphase. Dividing egg in rotation. Second polar cell in cleavage furrow.
- Fig. 25. Telophase of egg, which has not yet rotated through a complete quadrant.
- Fig. 26. Rotation completed. Cleavage plane developing. Spindle disappearing. Chromosomes vesicular.
- Fig. 27. Two-cell stage. Vesicular chromosomes unite to form the nuclei. Yolk has approached the vegetative pole, as in Figure 16.
- Fig. 28. Second cleavage at beginning of metaphase, viewed from animal pole.
- Fig. 29. Equatorial-plate stage of second cleavage; same egg as Figure 28. Lateral view.
- Fig. 30. Second cleavage in late anaphase, viewed from animal pole. *I, I*, indicate first cleavage plane, *II, II*, second cleavage plane. The long arrow falls in the projection of the sagittal plane of the embryo.





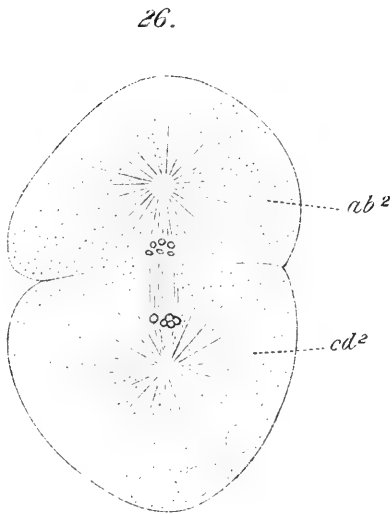
23.



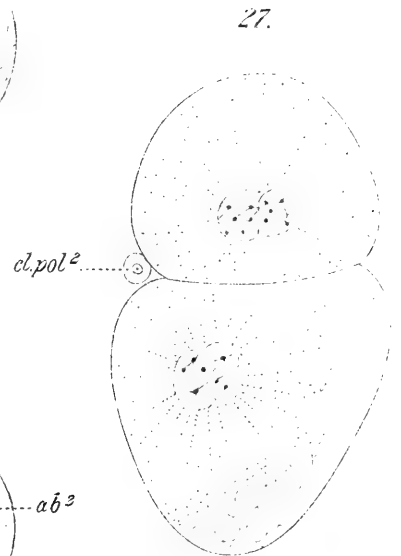
25.



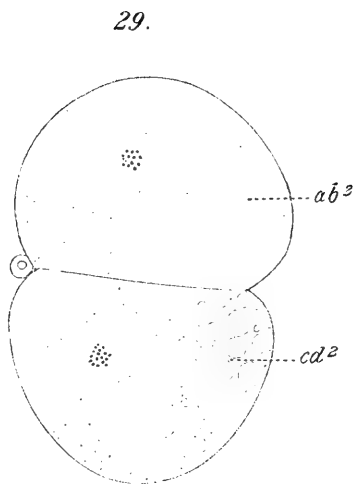
24.



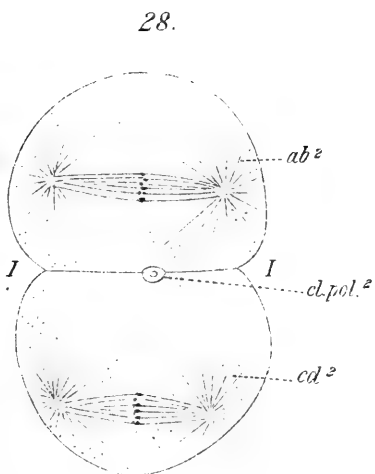
26.



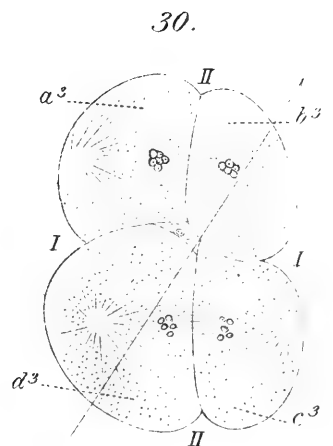
27.



29.



28.



30.



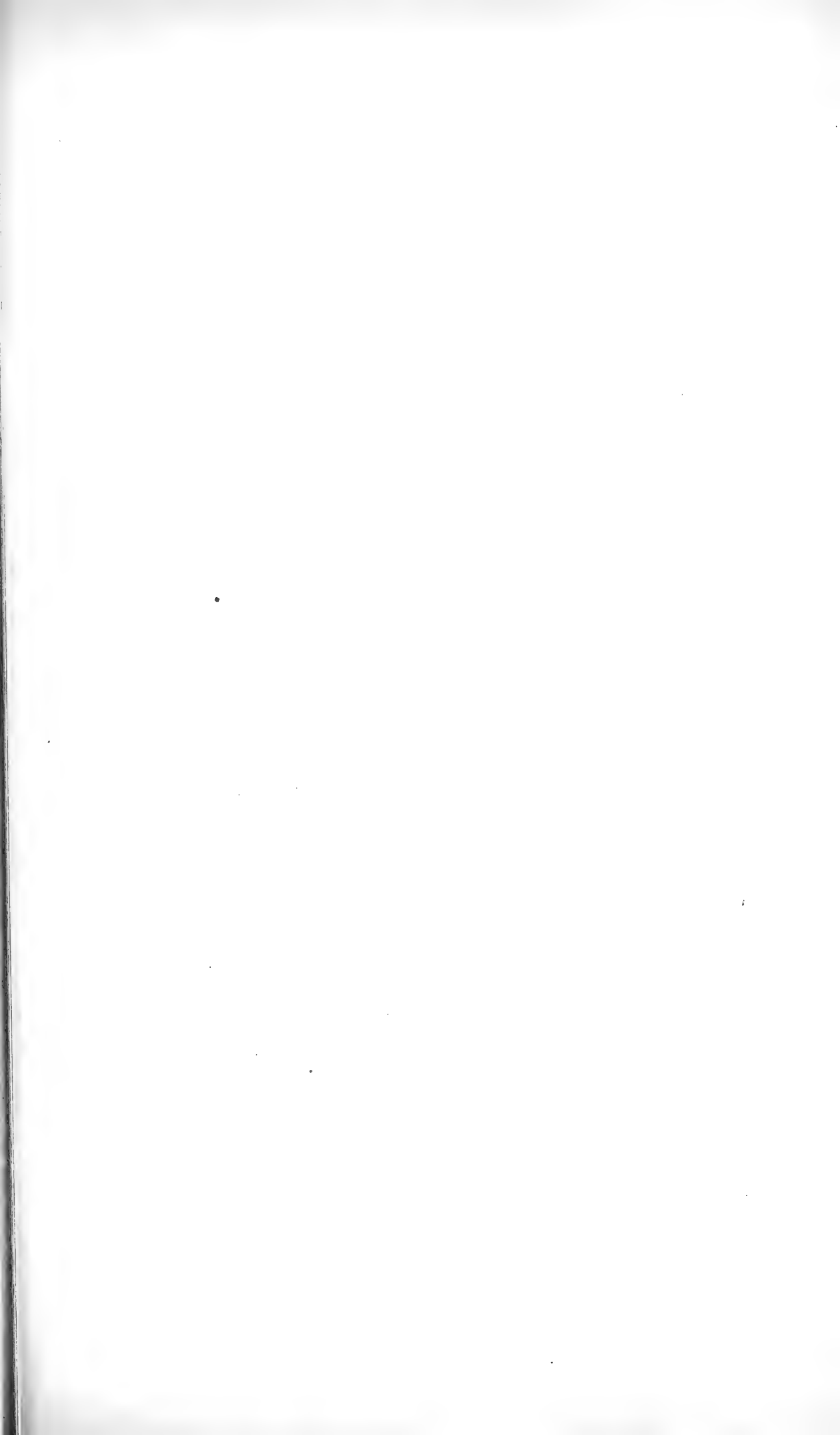
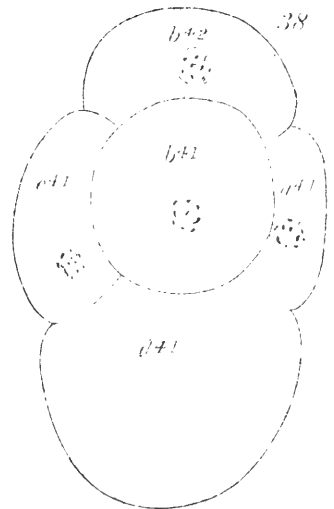
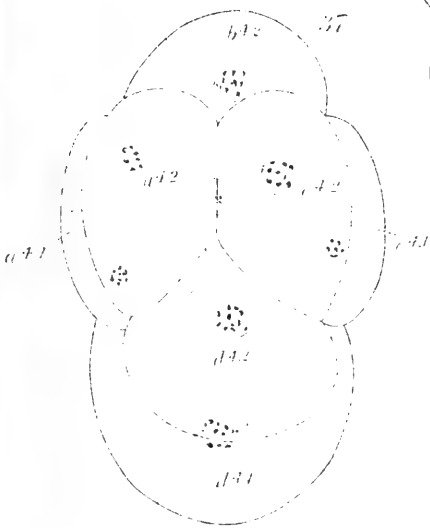
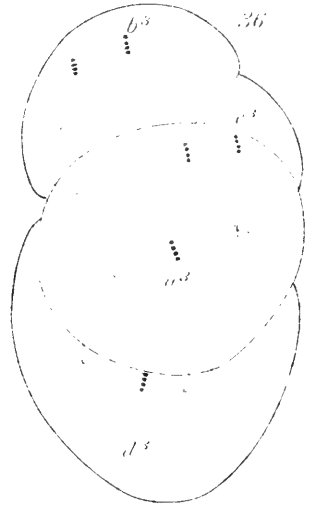
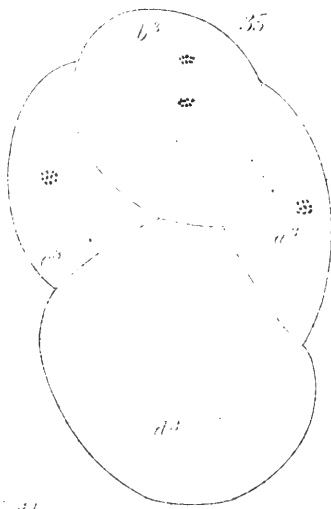
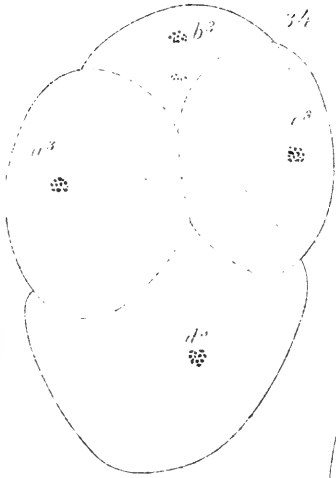
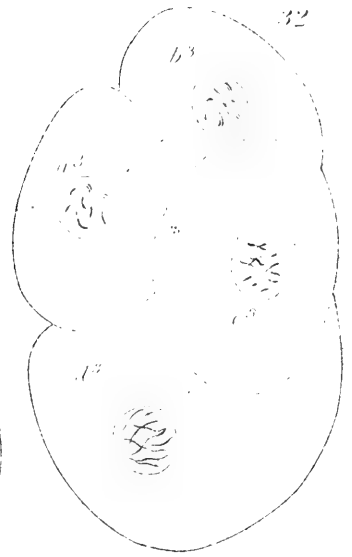
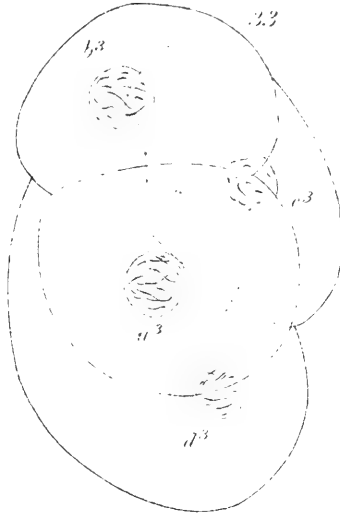
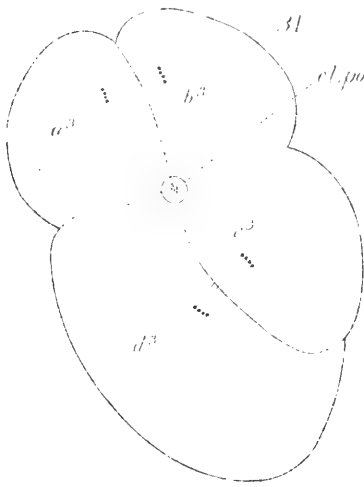


PLATE 4.

Figures drawn from transparent preparations of entire eggs. Vegetative pole at the *left* in lateral views.

- Fig. 31. Egg viewed from animal pole. Late anaphase of second cleavage.  
Fig. 32. Four-cell stage. Nuclei in "resting" phase. Egg viewed from animal pole.  
Fig. 33. Same egg viewed laterally. Yolk at vegetative pole of cell  $d^3$ .  
Fig. 34. Four-cell stage during third cleavage. Viewed from animal pole.  
Fig. 35. Same egg from vegetative pole. Oil spherules of the yolk near the surface.  
Fig. 36. Same egg in lateral view.  
Fig. 37. Eight-cell stage from animal pole. All nuclei are in "resting" phase. Second polar cell covered in by the meeting of  $a^{4.2}$  and  $c^{4.2}$ .  
Fig. 38. Same egg from vegetative pole. Oil spherules near lower surface of yolk-cell. Cells of quadrant  $b$  ( $b^{4.1}$ ,  $b^{4.2}$ ) stippled.





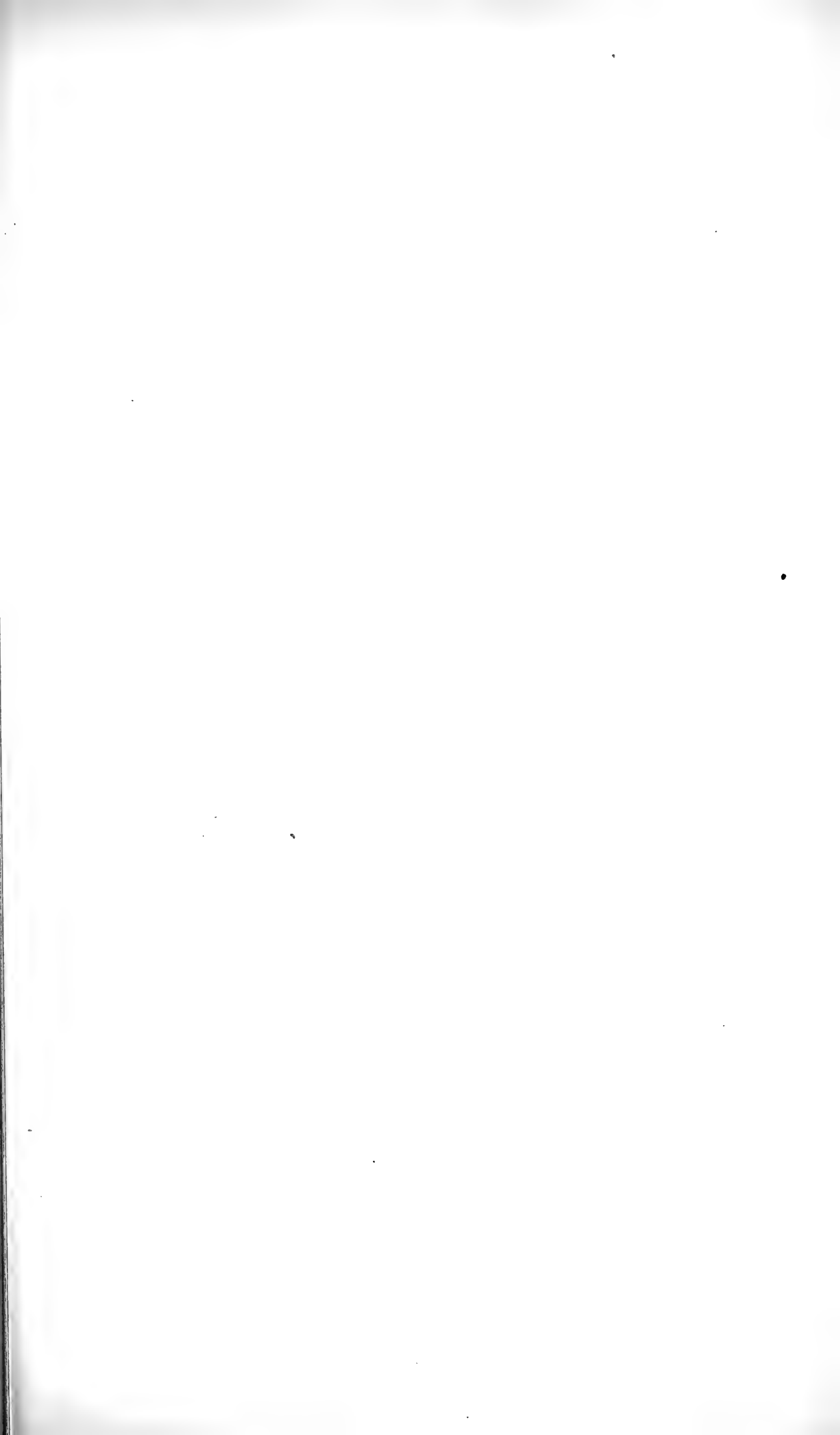


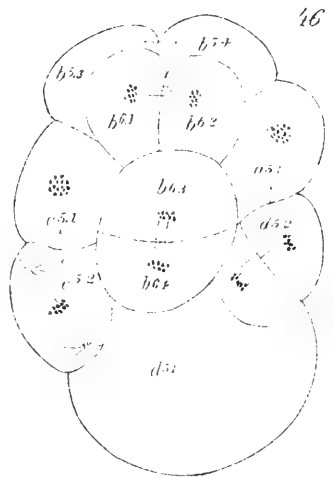
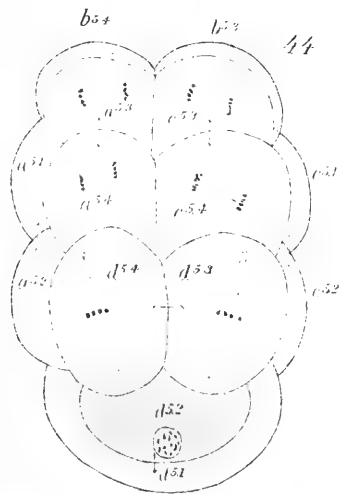
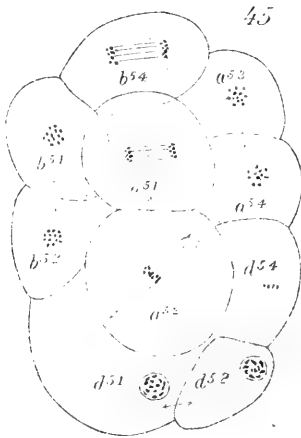
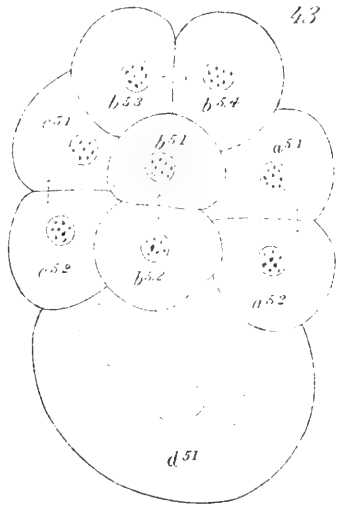
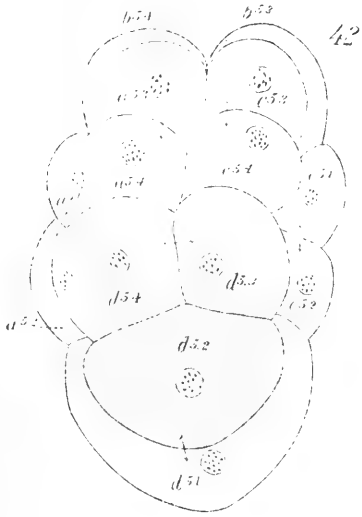
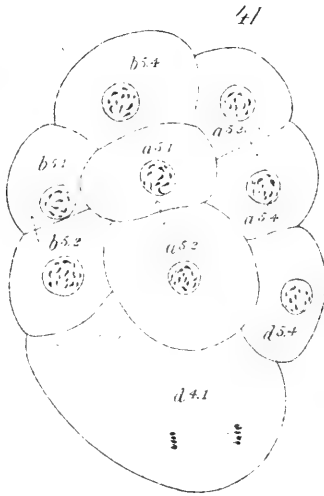
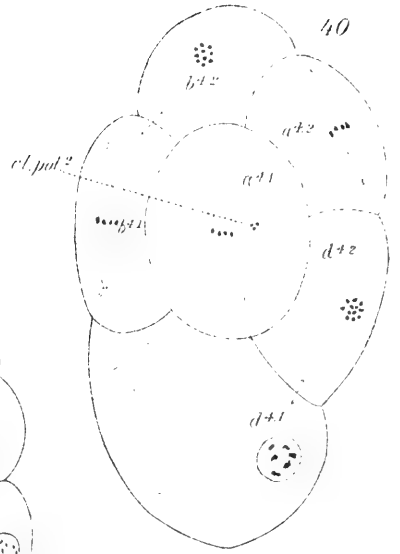
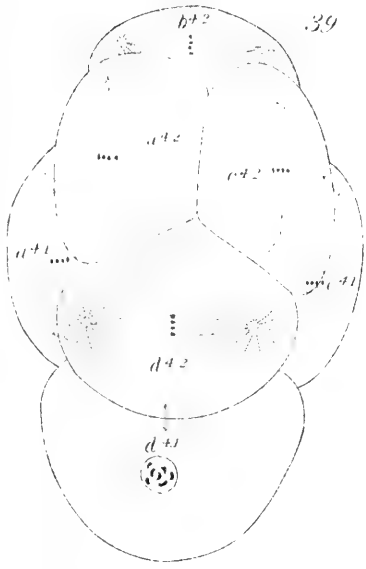
PLATE 5.

Figures from transparent preparations of entire eggs. Vegetative pole at the *left* in figures which represent lateral views.

- Fig. 39. Eight-cell stage from animal pole. The seven "protoplasmic" cells are in the fourth cleavage; the nucleus of yolk-cell ( $d^{4.1}$ ) is preparing for division.
- Fig. 40. Same egg in lateral view. Yolk at vegetative pole of cell  $d^{4.1}$ .
- Fig. 41. Fifteen "protoplasmic" cells; the yolk-cell ( $d^{4.1}$ , mes-entoblast) dividing. Lateral view.
- Fig. 42. Sixteen-cell stage from animal pole. Nuclei of all cells are in "resting" phase. Primary mesoblast ( $d^{5.2}$ ) separated from entoblast ( $d^{5.1}$ ).
- Fig. 43. Same egg viewed from vegetative pole. Oil spherules near lower surface of the yolk-cell.
- Fig. 44. Sixteen-cell stage from animal pole. All cells, except yolk-cell (entoblast  $d^{5.1}$ ) and the primary mesoblast cell ( $d^{5.2}$ ), are undergoing the fifth cleavage.
- Fig. 45. Same egg in lateral view.
- Fig. 46. Same stage from vegetative pole. The three mes-ectoblasts (compare Fig. 43,  $a^{5.2}$ ,  $b^{5.2}$ ,  $c^{5.2}$ ) contiguous to yolk-cell.

NOTE. — Cell  $a^{5.2}$  is represented as divided, and its derivatives should have been labelled  $a^{6.3}$ ,  $a^{6.4}$ .







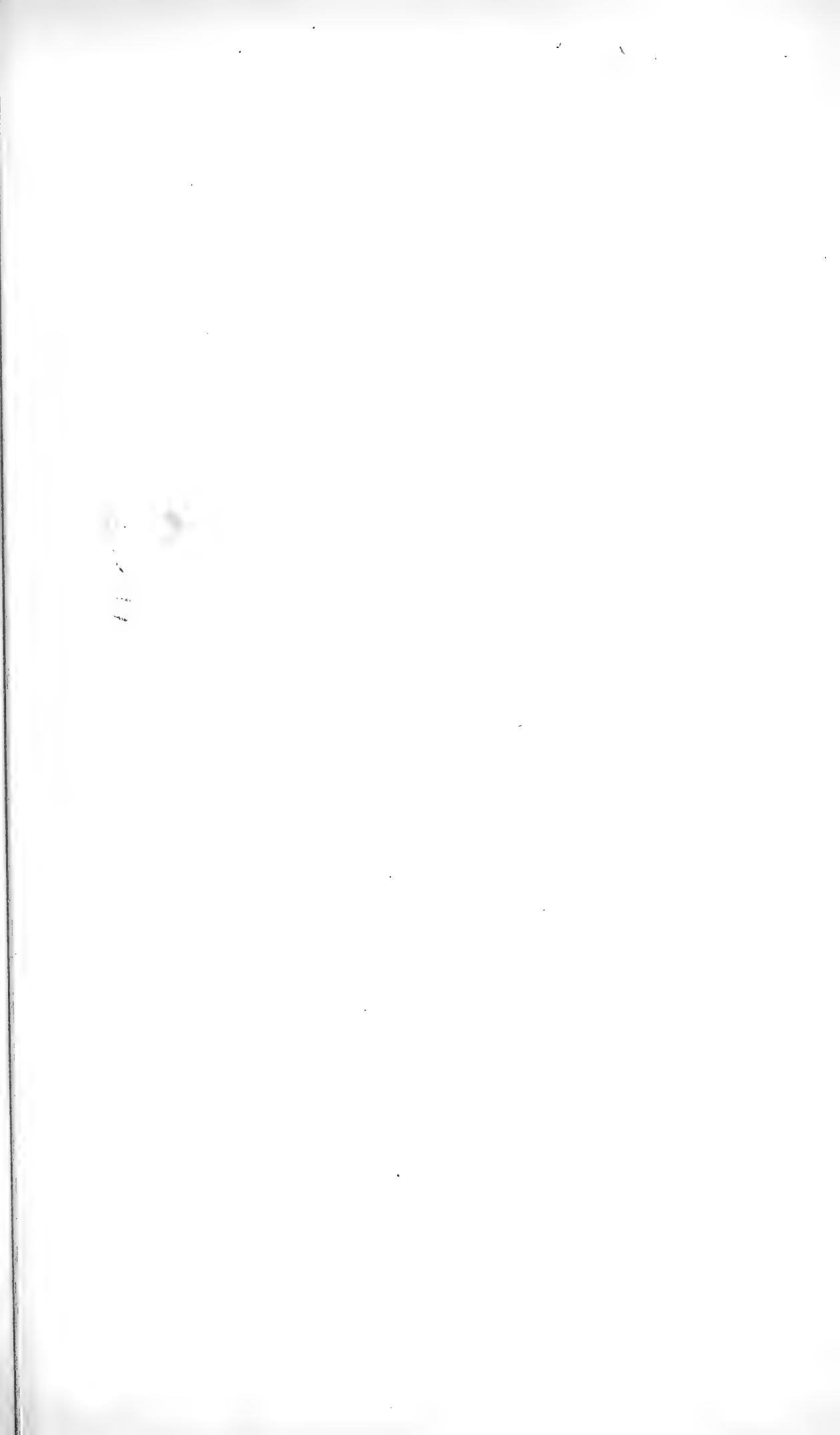


PLATE 6.

Figures from transparent preparations of entire eggs. Vegetative pole at the *right* in figures representing lateral views.

- Fig. 47. Sixteen-cell stage with all cells of the blastoderm in fifth cleavage. Primary mesoblast ( $d^{5-2}$ ) and entoblast ( $d^{5-1}$ ) with enlarging nuclei. Lateral view.
- Figs. 48 and 51. Eggs with thirty cells, but the primary mesoblast cell ( $d^{5-2}$ ) has not yet completed the fifth cleavage. Nucleus of entoblast cell ( $d^{5-1}$ ) still in "resting" phase, but chromosomes preparing for fifth cleavage. Entoblast (blastopore) bounded anteriorly and laterally by mes-ectoblasts ( $a^{6-3}$ ,  $b^{6-3}$ ,  $b^{6-4}$ ,  $c^{6-3}$ ). Viewed from vegetative pole.
- Figs. 49, 50 and 53. Same stage seen in lateral view. In Figure 53 more of the dorsal than of the ventral side is seen. Comparison shows that the cells have essentially the same positions in the three eggs.
- Fig. 52. Egg with thirty-two cells, reckoning the dividing yolk-entoblast as two cells. Derivatives ( $d^{6-3}$ ,  $d^{6-4}$ ) of the primary mesoblast at the posterior edge of entoblast (blastopore). Viewed from vegetative pole.
- Fig. 54. Optical section in sagittal plane of egg similar to one represented in Figure 50. Cleavage cavity occupied by the yolk-entoblast, which is uncovered at the blastopore only.
- Fig. 55. View from animal pole of egg represented in lateral view in Figure 53.

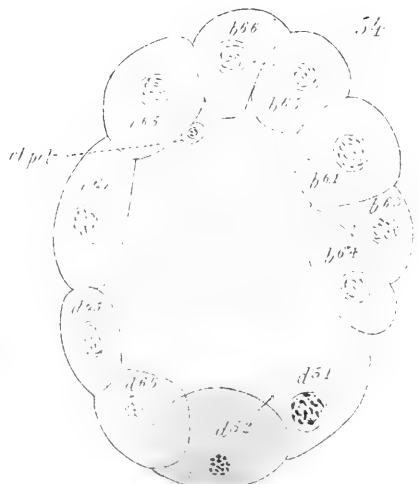
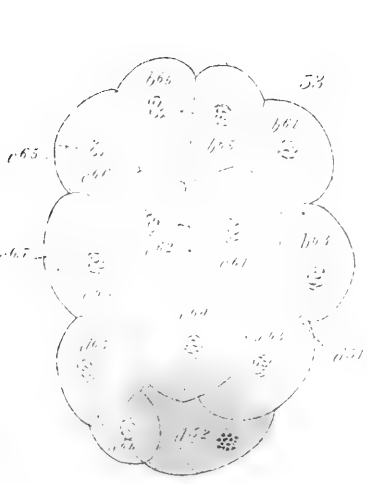
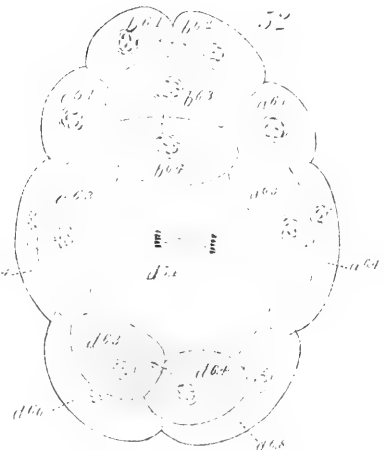
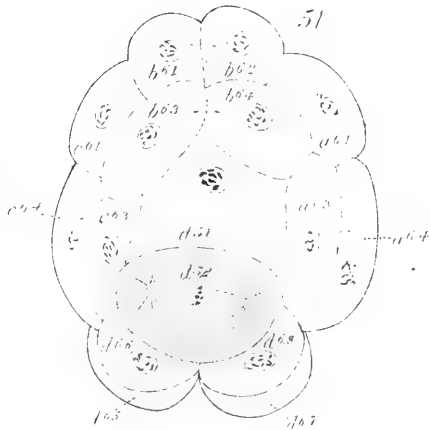
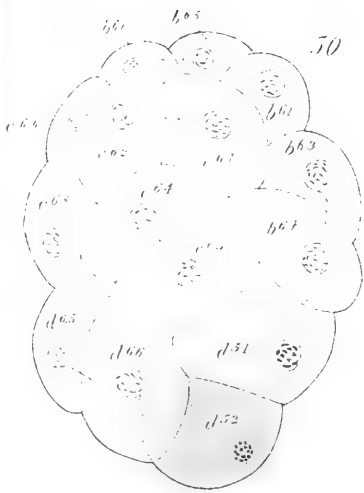
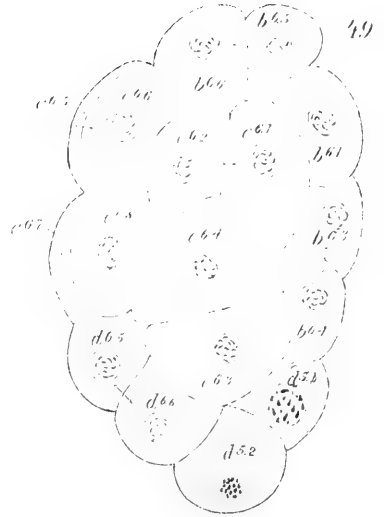
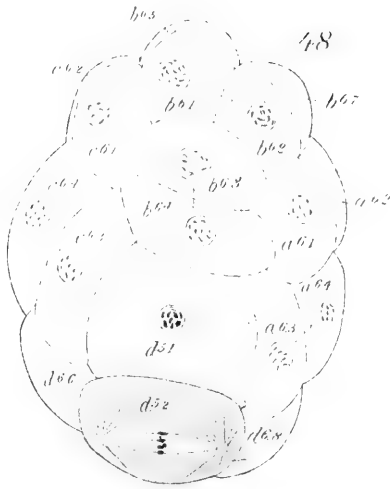
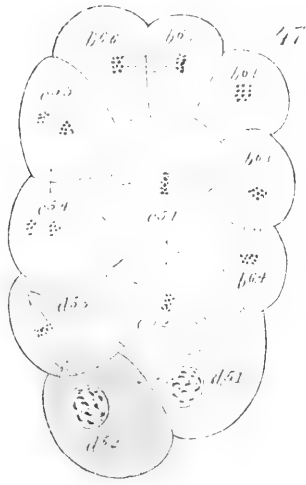




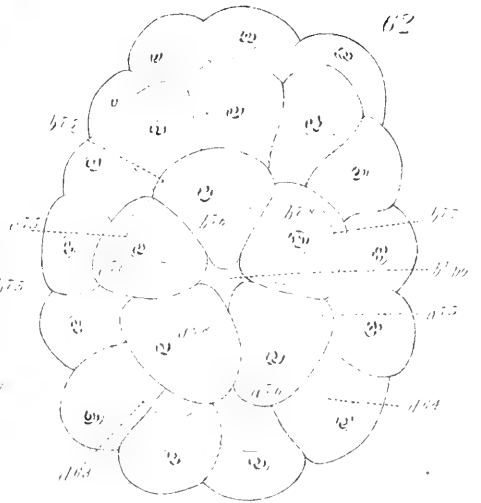
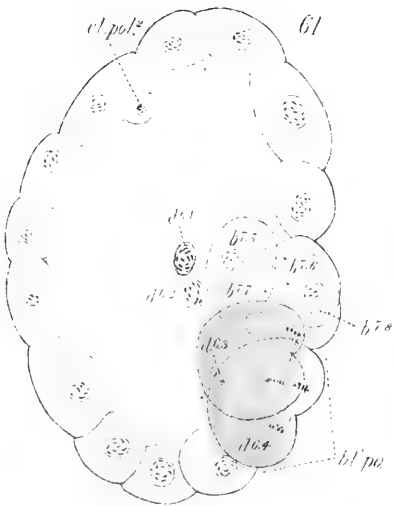
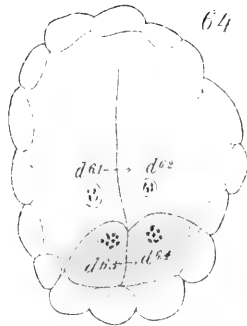
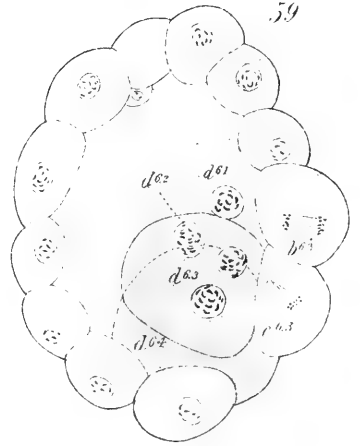
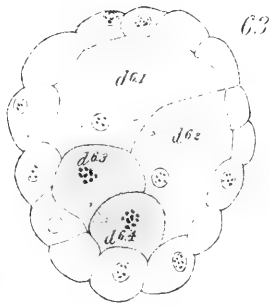
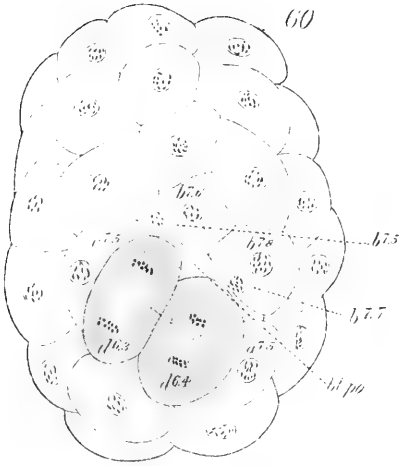
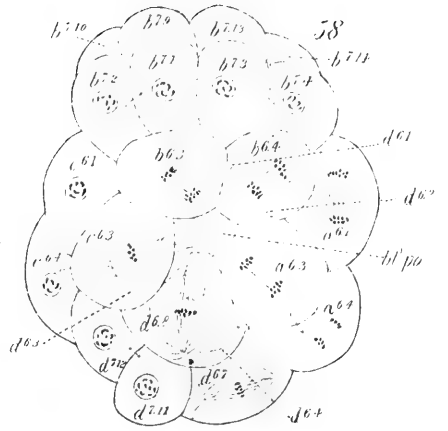
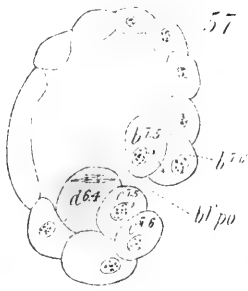
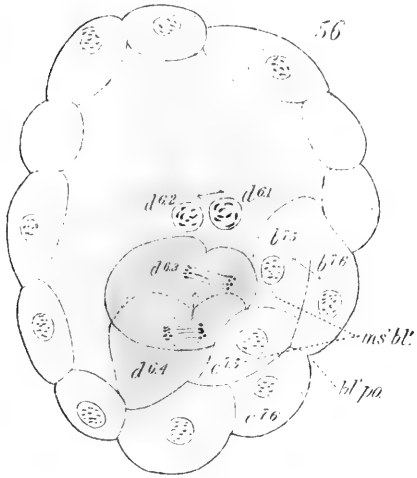


PLATE 7.

Figures drawn from transparent preparations of entire eggs. Vegetative pole and blastopore at the *right* side in figures seen in lateral view.

- Fig. 56. Optical section in sagittal plane. Sixty-two cells, counting the dividing primary mesoblasts ( $d^{6.3}$ ,  $d^{6.4}$ ) as four cells.
- Fig. 57. Same stage. Actual section. Blastopore not completely closed.
- Fig. 58. View from vegetative pole. The mes-ectoblasts ( $a^{6.3}$ ,  $b^{6.3}$ ,  $b^{6.4}$ ,  $c^{6.3}$ ) in sixth cleavage, which results in forming the "secondary mesoblasts." Blastopore slightly open.
- Fig. 59. Same egg in optical section in parasagittal plane. The primary mesoblasts ( $d^{6.3}$ ,  $d^{6.4}$ ) not yet in sixth cleavage. Two entoblastic nuclei ( $d^{6.1}$ ,  $d^{6.2}$ ). Mes-ectoblast cells  $b^{6.3}$  and  $c^{6.3}$  dividing parallel to the surface of blastoderm, to form "secondary mesoblasts."
- Fig. 60. View from vegetative pole of egg in which the primary mesoblasts ( $d^{6.3}$ ,  $d^{6.4}$ ) have not been overgrown by the blastoderm during the sixth cleavage. These cells nearly fill the blastopore; the posterior pair of "secondary mesoblasts" ( $a^{7.5}$ ,  $c^{7.5}$ ) lie at the sides of the primary mesoblasts.
- Fig. 61. Optical section near sagittal plane of same egg, showing anterior pair of "secondary mesoblasts" ( $b^{7.5}$  and  $b^{7.7}$ ) and two entoblast nuclei.
- Fig. 62. View from vegetative pole of egg with fifty-six blastoderm cells, four "secondary mesoblasts" ( $a^{7.5}$ ,  $b^{7.7}$ ,  $b^{7.5}$ ,  $c^{7.5}$ , represented by broken lines), two dividing primary mesoblasts ( $d^{6.3}$ ,  $d^{6.4}$ , outlines shown by fine continuous line), and two entoblast nuclei (seen at deeper level but not figured).
- Figs. 63, 64. Optical sections in horizontal plane of different eggs, viewed from vegetative pole. Same stage as Figure 56. Figure 63 represents a common condition in which mesoblasts and entoblasts are not separated by the sagittal plane.
- Fig. 65. Optical section in sagittal plane of egg with sixty-two cells. The primary mesoblasts have completed the sixth cleavage, forming  $d^{7.5-8}$ .





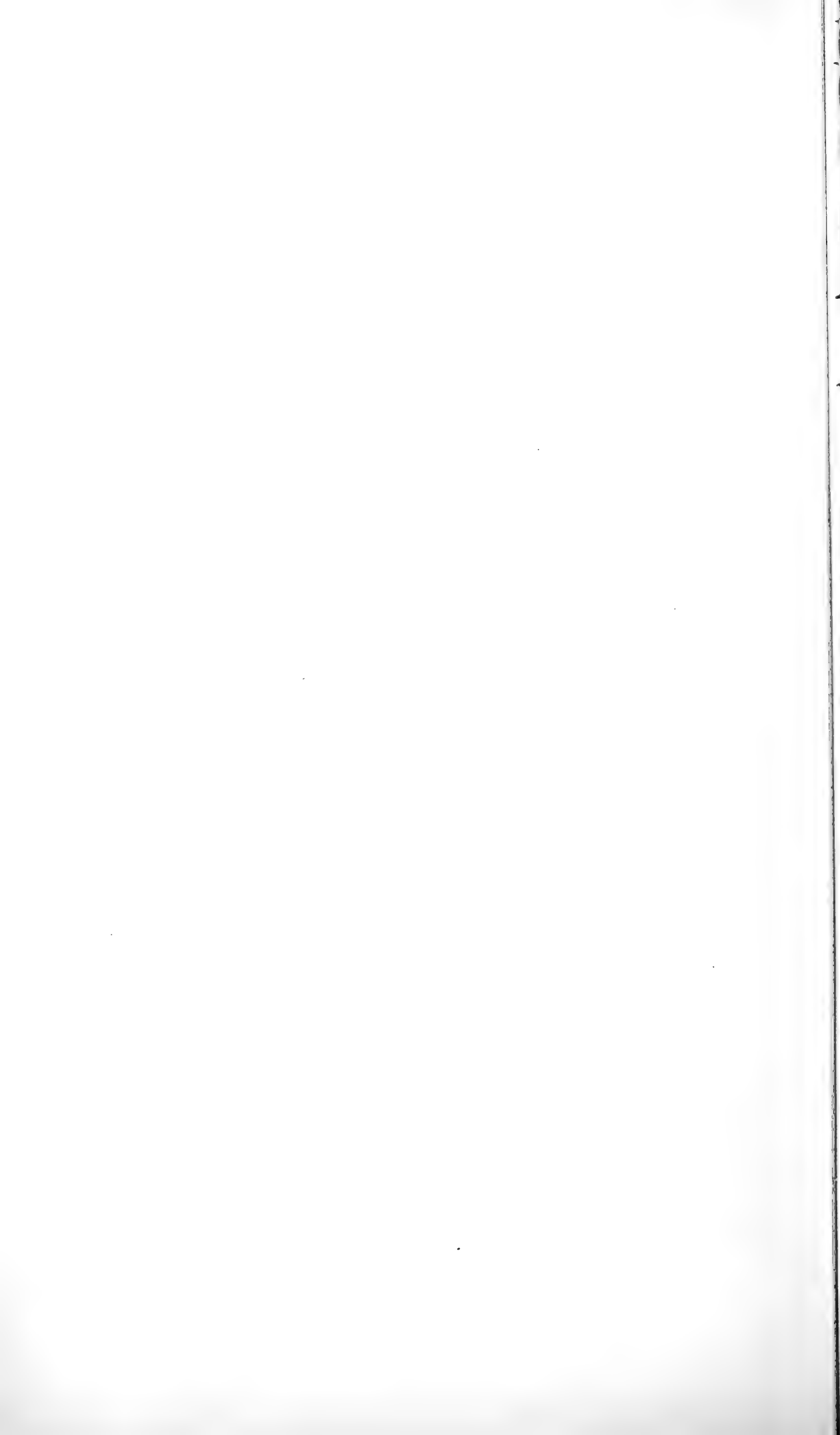




PLATE 8.

All figures drawn from sections ten micra thick. Vegetative (ventral) pole and blastopore at the *left* in views of sagittal sections.

- Fig. 66. Parasagittal section of eight-cell stage, a little to the left of the sagittal plane, and corresponding to the stage shown in Figure 40 (Plate 5).
- Fig. 67. Section, in same plane, of stage with fifteen blastoderm cells; the yolk-cell still in the stage of fourth cleavage. This stage corresponds to that of Figure 41.
- Fig. 68. Parasagittal section of sixteen-cell stage, corresponding to that shown in Figure 45.
- Fig. 69. Sagittal section of egg with twenty-eight cells in blastoderm; primary mesoblast cell ( $d^{5.2}$ ) in division; entoblast nucleus preparing to divide. Compare with Figures 49, 50 (Plate 6).
- Fig. 70. Horizontal section of same stage, seen from vegetative pole.
- Fig. 71. Sagittal section of sixty-two-cell stage, counting two dividing primary mesoblasts ( $d^{6.3}$ ,  $d^{6.4}$ ) as four cells. Same age as Figure 56 (Plate 7).
- Fig. 72. Transverse section of egg in similar stage cut through the primary mesoblasts and the posterior pair of "secondary mesoblasts" ( $a^{7.5}$ ,  $c^{7.5}$ ).
- Fig. 73. Section immediately anterior to the one represented in the preceding figure. The anterior "secondary mesoblasts" ( $b^{7.5}$ ,  $b^{7.7}$ ) and the two entoblast cells ( $d^{6.1}$ ,  $d^{6.2}$ ) are represented.

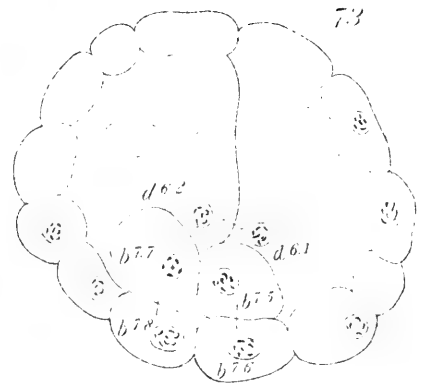
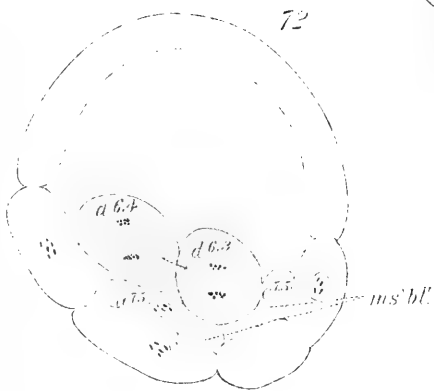
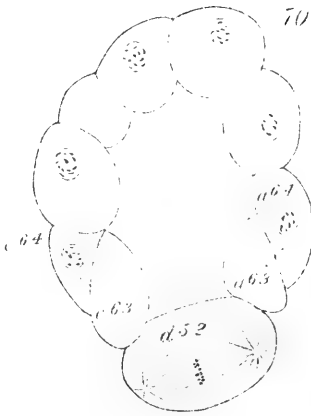
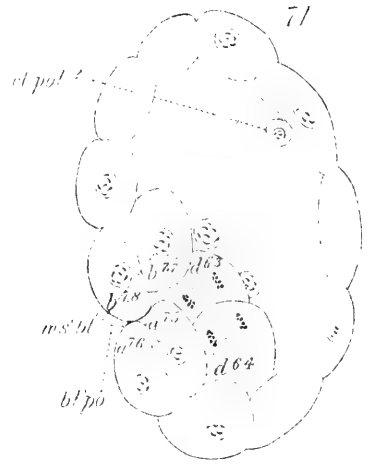
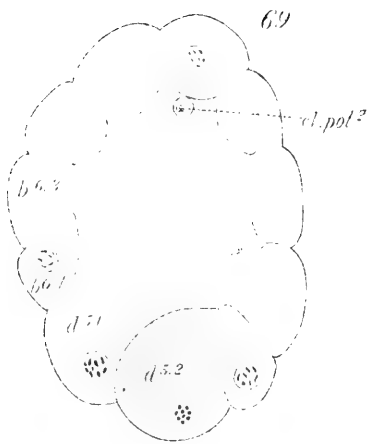
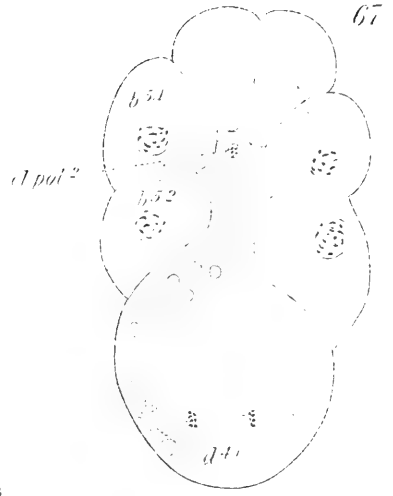
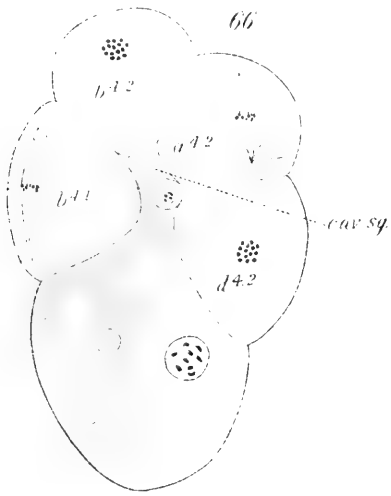






PLATE 9.

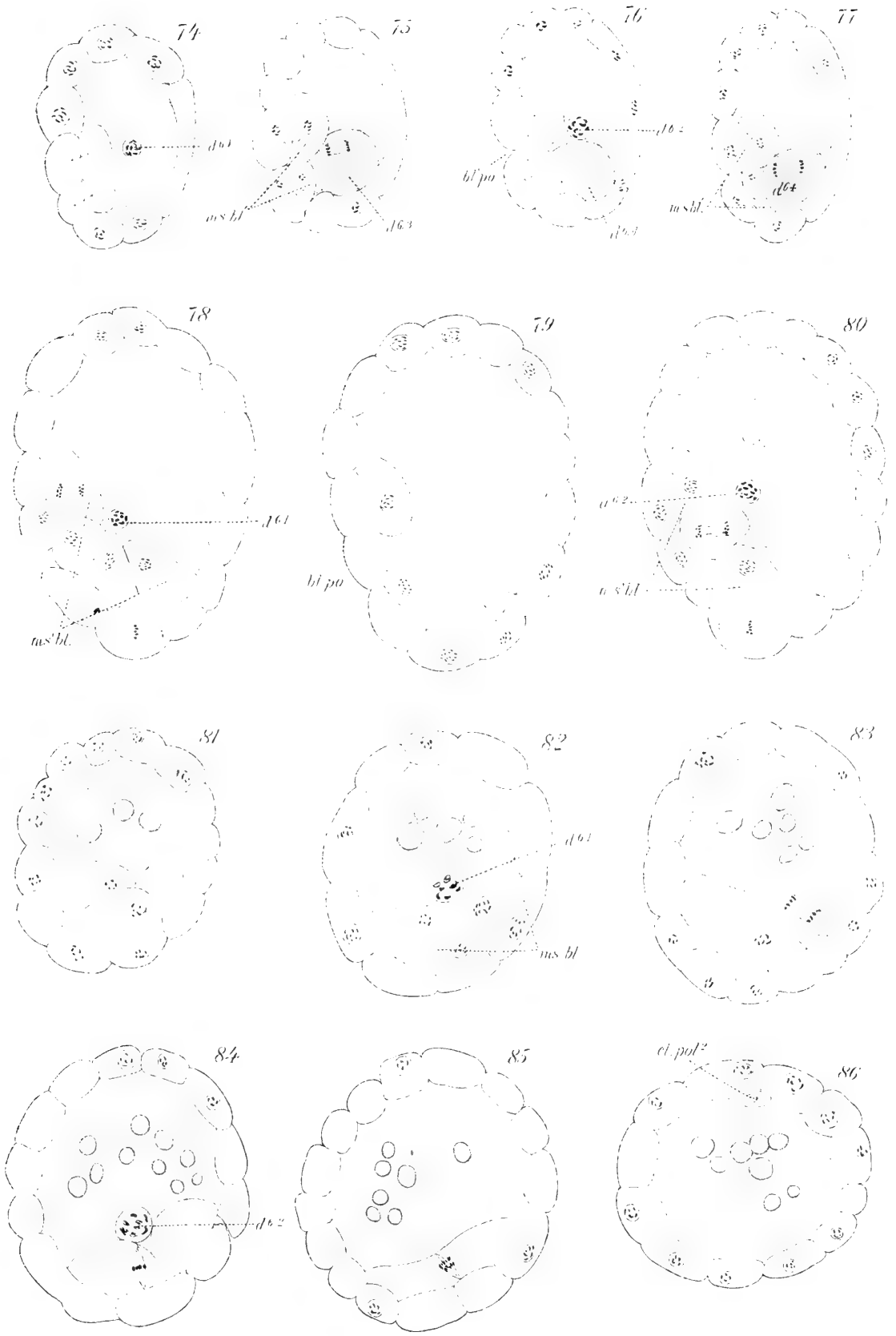
Figures from three sets of consecutive serial sections. Vegetative (ventral) pole and blastopore are at the *left* in Figures 74-80 and at the *lower* side in Figures 81-86. Blastoderm one cell in thickness.

Figs. 74-77. Series of consecutive sections parallel to sagittal plane from an egg in sixty-two-cell stage, counting two dividing primary mesoblasts as four cells. The first and sixth sections of this series contained only blastoderm cells and have not been figured.

Figs. 78-80. Series of consecutive sections parallel to sagittal plane through egg in a stage with about one hundred and twenty cells. The first and last sections of the series are not figured.

Figs. 81-86. Series of consecutive transverse sections (viewed from their posterior faces) from an egg in same stage as that of last series. Figure 81 shows the most posterior of the sections represented. The first and last sections of the series, containing only blastoderm cells, and three anterior to and similar to Figure 86 have not been figured.







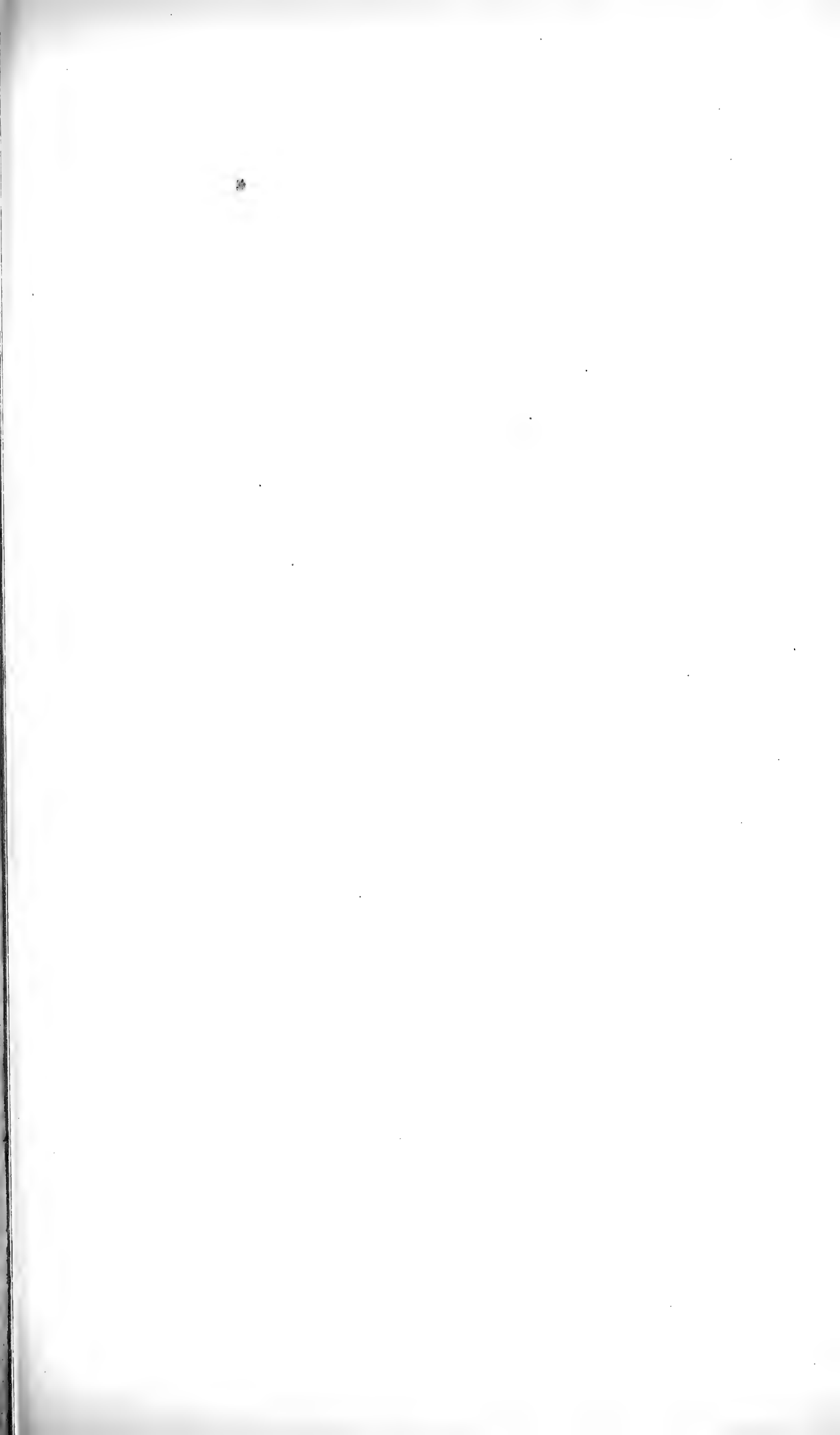


PLATE 10.

Figures from sections. Ventral side (blastopore) at the *left* in figures of sagittal sections, and at the *lower* side in figures of transverse sections. Blastoderm one cell in thickness.

Fig. 87. Sagittal section of a stage with two hundred and fifty cells (estimated). The mesoblast band (*ms'bl.*) is extending anteriorly along the *dorsal* side.

Fig. 88. Sagittal section of a later succeeding stage. Egg has elongated posteriorly. Continued extension of the mesoblast.

Figs. 89, 90. Transverse sections through an egg similar to the one represented in Figure 88 and made at the levels indicated in that figure by the numbers 89 and 90. Mesoblast dorsal in Figure 90.

Fig. 91. Sagittal section of later stage. Two transverse dorsal furrows (1, 2) mark off the three metameres. Compare with Figure 122.

Fig. 92. Transverse section of egg in same stage as that of Figure 91, showing the median dorsal longitudinal furrow. The mesoblast has greatly thickened and extended ventrally on either side of the entoblast. Compare with Figure 90.

Fig. 93. Sagittal section of still later stage. Two new transverse furrows (3, 4) partially subdivide the first and third metameres of the previous stage. Compare with Figures 123-125.

Fig. 94. Transverse section of stage similar to that shown in Figure 93. Longitudinal furrow extending laterally and ventrally folding off the appendages, in which process the transverse furrows 1-4 share.

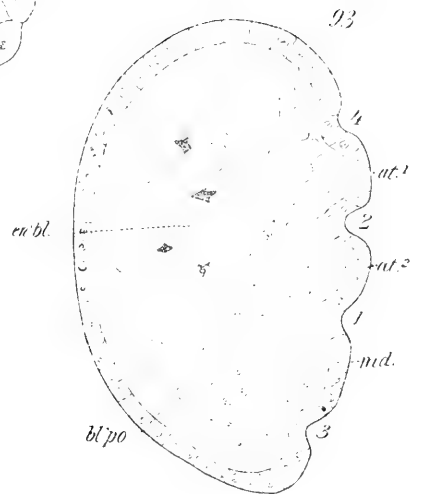
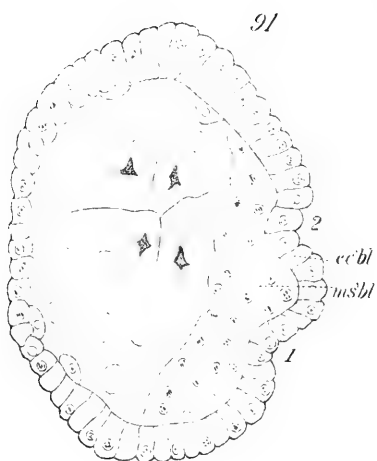
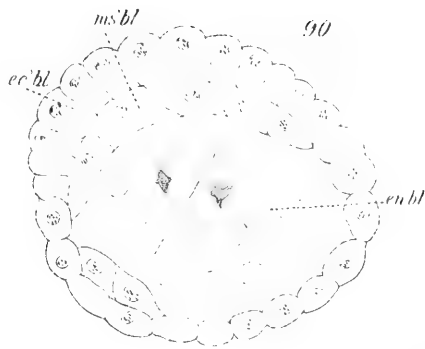
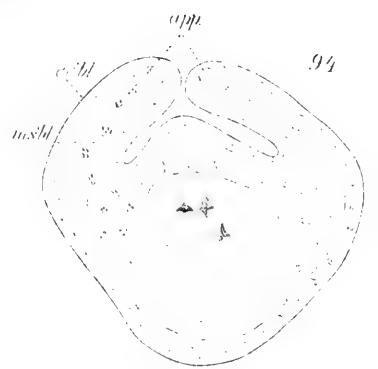
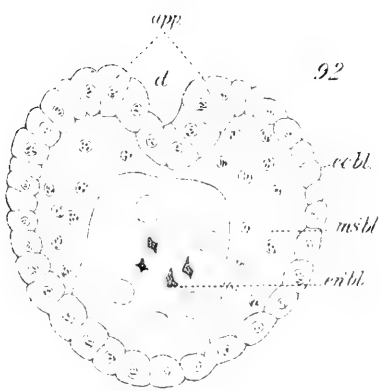
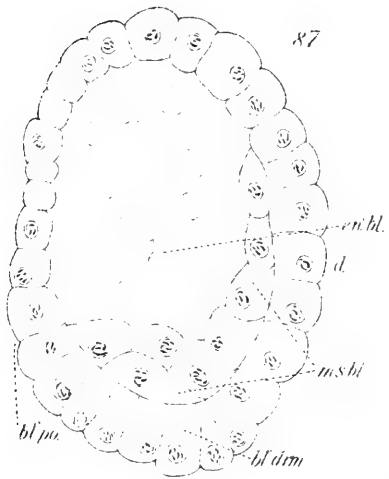






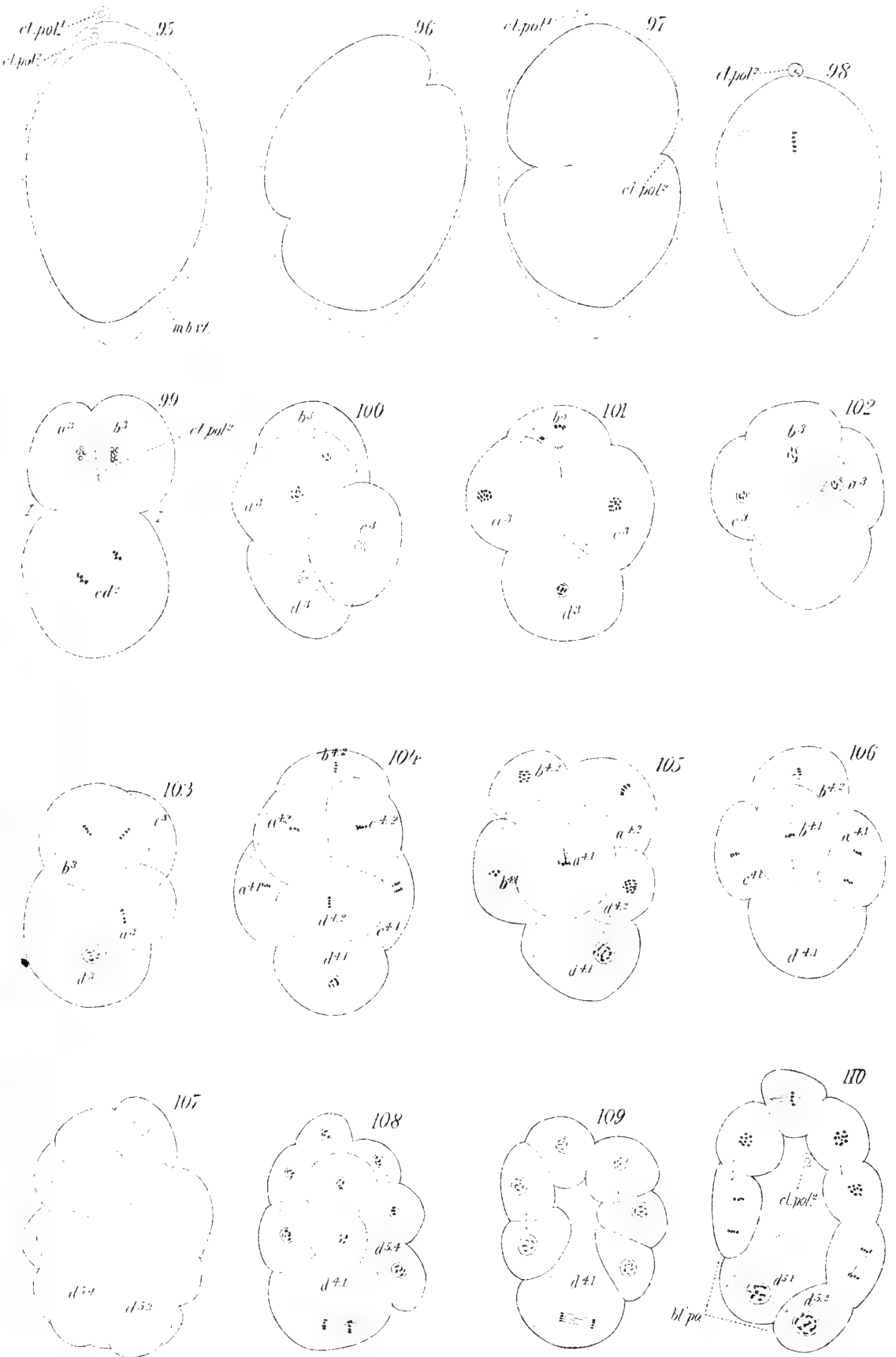
PLATE 11.

*Lepas fascicularis*.

The figures in parenthesis following the descriptions refer to corresponding stages of *L. anatifera*.

- Fig. 95-97. Outlines of a living egg, showing its rotation within the vitelline membrane during the first cleavage. (Figs. 6-16.)
- Figs. 98-110. Drawn from transparent preparations of entire eggs.
- Fig. 98. First cleavage, spindle arranged transversely to chief axis of egg. (Figs. 21-23.)
- Fig. 99. Second cleavage. View from animal pole. (Fig. 31.)
- Figs. 100, 101. Four-cell stage from animal pole. (Figs. 32, 34.)
- Fig. 102. Same from vegetative pole. (Fig. 35.)
- Fig. 103. Same seen from the *left* side. "Protoplasmic" cells already in third cleavage. (Fig. 36.)
- Fig. 104. Eight cells. View from animal pole. Seven "protoplasmic" cells in fourth cleavage. Yolk-cell ( $d^{4.1}$ ) retarded in division. (Fig. 39.)
- Fig. 105. Same stage from *left* side. (Fig. 40.)
- Fig. 106. Same stage viewed from vegetative pole.
- Fig. 107. The divisions shown in Figure 104 as beginning are now completed. View from animal pole. (Compare with Figs. 41, 42.)
- Fig. 108. Same stage viewed from *left* side. Yolk-cell ( $d^{4.1}$  mes-entoblast) in fourth cleavage. (Fig. 41.)
- Fig. 109. Optical sagittal section of egg in same stage viewed from *left* side. (Fig. 67.)
- Fig. 110. Optical sagittal section of sixteen-cell stage. Left lateral view. (Fig. 68.)







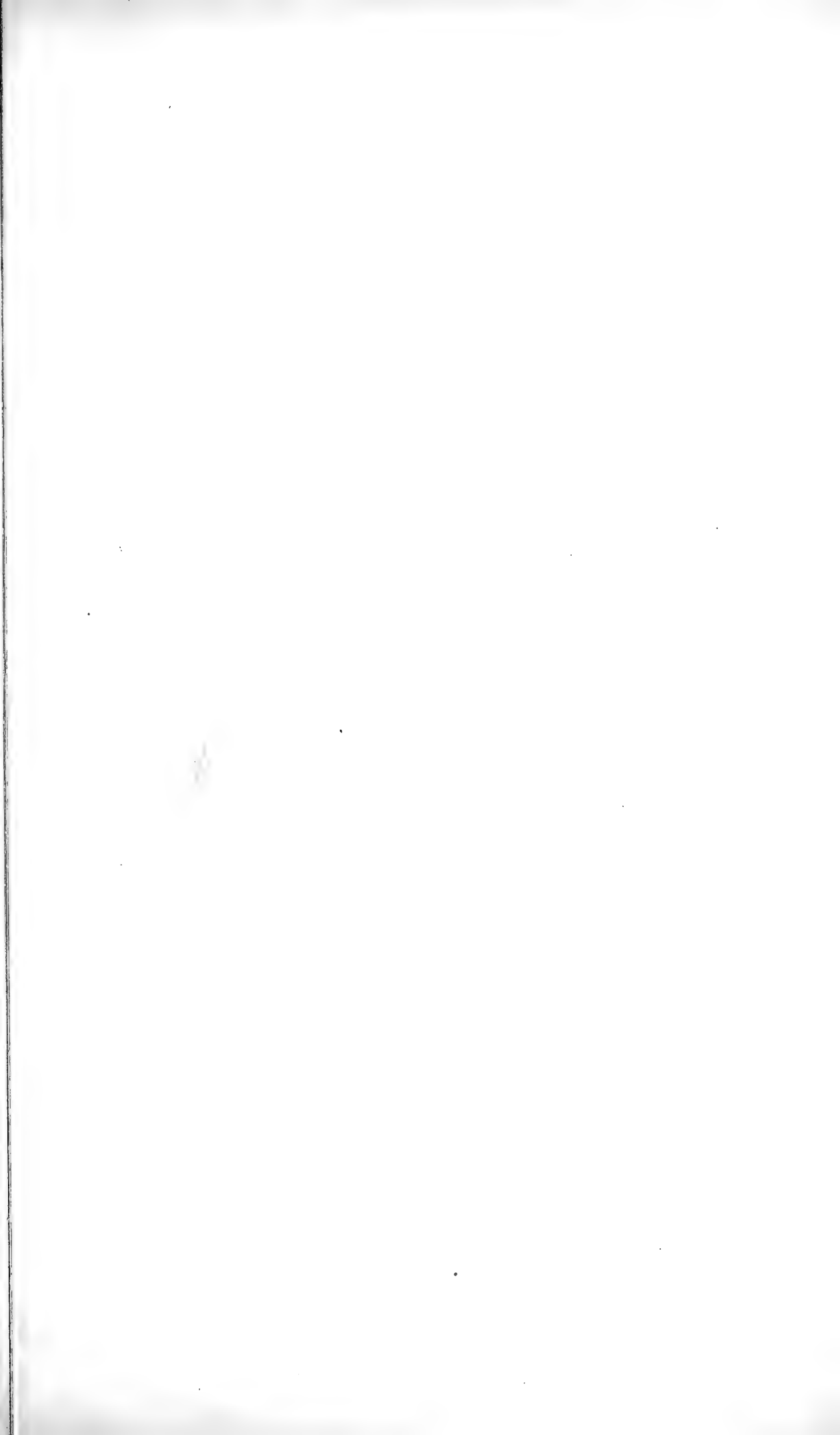
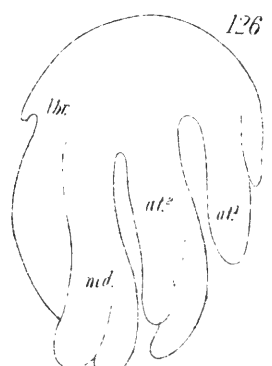
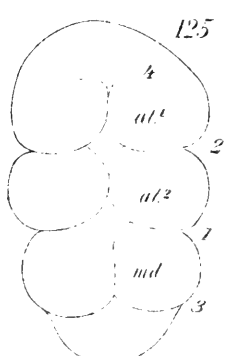
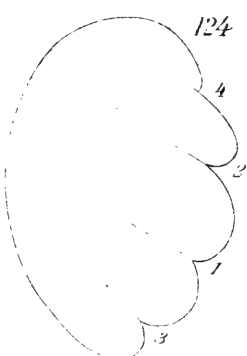
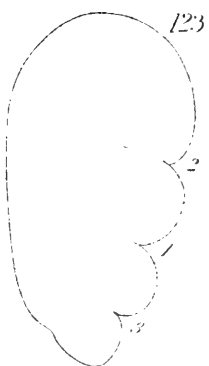
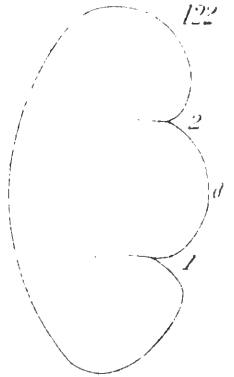
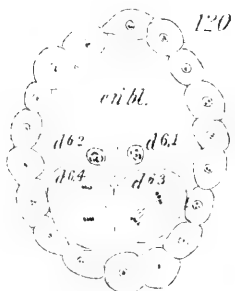
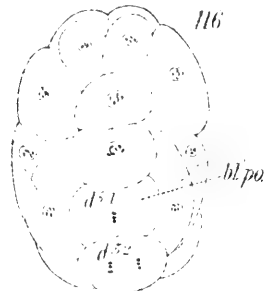
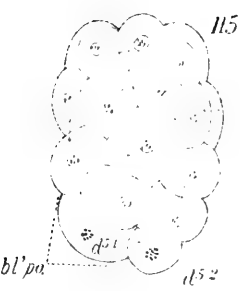
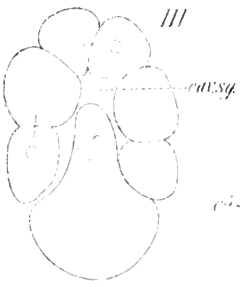


PLATE 12.

*Lepas fascicularis*.

The figures in parenthesis following the descriptions refer to corresponding stages of *L. anatifera*.

- Fig. 111. Horizontal section of sixteen-cell stage. (Compare with Fig. 43.)  
Fig. 112. Sixteen-cell stage viewed from vegetative pole. Fifth cleavage. (Fig. 46.)  
Fig. 113. Same stage, seen from *left* side. (Fig. 45.)  
Fig. 114. Thirty-two-cell stage viewed from animal pole. (Fig. 55.)  
Fig. 115. Same stage seen from *left* side. (Fig. 53.)  
Fig. 116. Same stage viewed from the vegetative pole. Primary mesoblast ( $d^{5\cdot2}$ ) and entoblast ( $d^{5\cdot1}$ ) in fifth cleavage. (Fig. 48.)  
Fig. 117. Egg in same stage, looking upon the posterior pole.  
Fig. 118. Sixty-two-cell stage seen from *left* side.  
Fig. 119. Same stage. Sagittal optical section seen from *left* side. Primary mesoblasts still in sixth cleavage. (Fig. 56.)  
Fig. 120. Same stage. Horizontal optical section seen from animal pole. (Fig. 64.)  
Fig. 121. Sixty-two cells. Primary mesoblasts have completed sixth cleavage, being now four in number ( $d^{7\cdot5}$ - $d^{7\cdot8}$ ). Two entoblasts.  
Fig. 122. Profile of late stage. Formation of dorsal transverse furrows (1, 2), which mark off the three metameres. Seen from *left* side. (Fig. 91.)  
Fig. 123. Somewhat later stage seen from *left* side. Appearance of a third furrow superficially subdividing the posterior (mandibular) metamere.  
Fig. 124. Still later stage seen from *left* side. Another furrow subdivides the anterior (first antennary) metamere. (Fig. 93.)  
Fig. 125. Dorsal view of same stage showing the longitudinal and transverse furrows, which, growing ventrally, fold off the appendages.  
Fig. 126. Nauplius after development of paired appendages and beginning of the labrum. Seen from the *left* side, ventral being up.





Professor Mark for the encouraging interest he has shown in my investigations, for helpful suggestions, and for invaluable training in precision of method.

In the course of my histological studies on the developing feather I have naturally examined the literature of the subject, and believe that a more elaborate analysis and description of the various stages in the development of the complex structure of the feather, especially of those elements producing color, is highly desirable. This work therefore deals mainly with the histological side of the subject of color in the definitive feather with some contributions to the general knowledge of the development of the feather.

## II. Methods and Material.

My principal material has been obtained from the remiges of *Sterna hirundo* Linn. During the summer of 1899 while occupying a table in the laboratory of the United States Fish Commission Station at Wood's Hole, Mass., I obtained two young birds of *S. hirundo* with feather germs ("pin feathers"), some of which had begun to expose fully cornified portions at their ruptured distal ends.

Immediately after killing the birds, the wings and strips of skin bearing feathers were placed either in Kleinenberg's picro-sulphuric mixture, or saturated aqueous solution of corrosive sublimate.

In the summer of 1900 I put up some more material of *S. hirundo*, this time using Kleinenberg's picro-sulphuric fluid and the fixing mixtures of both Hermann and Flemming. I found that better penetration was secured when the feather was simply pulled from the feather follicle and dropped into the fluid, without the superfluous tissue of the follicle and the connective tissue below the inferior umbilicus. One soon learns to perform this operation easily and without injury to the tissues, in spite of the fact that the latter are very delicate at the proximal end of the feather germ.

I have found Kleinenberg's picro-sulphuric mixture and Hermann's fluid the most satisfactory fixing agents; the latter gives by far the best preservation. Kleinenberg's picro-sulphuric is especially advantageous for the study of developing pigment cells, in that it leaves no stain after proper washing, whereas osmic-acid fluids produce a blackening of the cytoplasm that is very objectionable in the study of early stages of the pigment cell.

*The Development of Color in the Definitive Feather.* By R. M.  
STRONG.

TABLE OF CONTENTS.

	PAGE		PAGE
I. Introduction . . . . .	147	IV. The production of color in the feather . . . . .	161
II. Methods and material . . . . .	148	V. The pigmentation of the feather . . . . .	163
III. The development of the feather . . . . .	151	A. The chemical nature of feather pigments . . . . .	163
A. The feather germ . . . . .	151	B. The origin of pigment . . . . .	164
B. The differentiation of the feather . . . . .	156	C. The distribution of pig- ment in feathers . . . . .	168
1. The barbules . . . . .	156	VI. Change of color without molt . . . . .	172
2. The barbicels . . . . .	157	VII. Summary . . . . .	176
3. The barb . . . . .	158	Bibliography . . . . .	179
4. The rhachis . . . . .	160		
5. The residual cells . . . . .	160		
6. Cornification and with- drawal of the feather . . . . .	161		

I. Introduction.

The more or less striking variations in color exhibited by many species of birds at different seasons of the year have been a fruitful theme for discussions and speculation among ornithologists. Numerous cases of change of color not apparently connected with the ordinary process of molt have been reported from time to time. A theory of change of color without molt was the subject of a rather warm controversy about the middle of the nineteenth century, and there has been something of a revival of the discussion in the last few years.

It has seemed to me that a solution of the problem could not be attained without a thorough consideration of the causes of color and its development.

The present work was begun in the fall of 1899 under the direction of Professor E. L. Mark in the Zoölogical Laboratory at Harvard University. I wish here to acknowledge my great indebtedness to



*The Development of Color in the Definitive Feather.* By R. M. STRONG.

TABLE OF CONTENTS.

	PAGE		PAGE
I. Introduction . . . . .	147	IV. The production of color in the feather . . . . .	161
II. Methods and material . . . . .	148	V. The pigmentation of the feather . . . . .	163
III. The development of the feather . . . . .	151	A. The chemical nature of feather pigments . . . . .	163
A. The feather germ . . . . .	151	B. The origin of pigment . . . . .	164
B. The differentiation of the feather . . . . .	156	C. The distribution of pigment in feathers . . . . .	168
1. The barbules . . . . .	156	VI. Change of color without molt . . . . .	172
2. The barbicels . . . . .	157	VII. Summary . . . . .	176
3. The barb . . . . .	158	Bibliography . . . . .	179
4. The rhachis . . . . .	160		
5. The residual cells . . . . .	160		
6. Cornification and withdrawal of the feather . . . . .	161		

I. Introduction.

The more or less striking variations in color exhibited by many species of birds at different seasons of the year have been a fruitful theme for discussions and speculation among ornithologists. Numerous cases of change of color not apparently connected with the ordinary process of molt have been reported from time to time. A theory of change of color without molt was the subject of a rather warm controversy about the middle of the nineteenth century, and there has been something of a revival of the discussion in the last few years.

It has seemed to me that a solution of the problem could not be attained without a thorough consideration of the causes of color and its development.

The present work was begun in the fall of 1899 under the direction of Professor E. L. Mark in the Zoölogical Laboratory at Harvard University. I wish here to acknowledge my great indebtedness to

Professor Mark for the encouraging interest he has shown in my investigations, for helpful suggestions, and for invaluable training in precision of method.

In the course of my histological studies on the developing feather I have naturally examined the literature of the subject, and believe that a more elaborate analysis and description of the various stages in the development of the complex structure of the feather, especially of those elements producing color, is highly desirable. This work therefore deals mainly with the histological side of the subject of color in the definitive feather with some contributions to the general knowledge of the development of the feather.

## II. Methods and Material.

My principal material has been obtained from the remiges of *Sterna hirundo* Linn. During the summer of 1899 while occupying a table in the laboratory of the United States Fish Commission Station at Wood's Hole, Mass., I obtained two young birds of *S. hirundo* with feather germs ("pin feathers"), some of which had begun to expose fully cornified portions at their ruptured distal ends.

Immediately after killing the birds, the wings and strips of skin bearing feathers were placed either in Kleinenberg's picro-sulphuric mixture, or saturated aqueous solution of corrosive sublimate.

In the summer of 1900 I put up some more material of *S. hirundo*, this time using Kleinenberg's picro-sulphuric fluid and the fixing mixtures of both Hermann and Flemming. I found that better penetration was secured when the feather was simply pulled from the feather follicle and dropped into the fluid, without the superfluous tissue of the follicle and the connective tissue below the inferior umbilicus. One soon learns to perform this operation easily and without injury to the tissues, in spite of the fact that the latter are very delicate at the proximal end of the feather germ.

I have found Kleinenberg's picro-sulphuric mixture and Hermann's fluid the most satisfactory fixing agents; the latter gives by far the best preservation. Kleinenberg's picro-sulphuric is especially advantageous for the study of developing pigment cells, in that it leaves no stain after proper washing, whereas osmic-acid fluids produce a blackening of the cytoplasm that is very objectionable in the study of early stages of the pigment cell.

Material was kept in the picro-sulphuric solution for about five hours and then transferred to 70% alcohol followed by 90%. It usually took one to two weeks with several changes of alcohol to remove all traces of picric acid. A fixation of three hours was found sufficient for Hermann's fluid and the usual methods of washing and hardening followed.

Dehydration was accomplished by immersion in absolute alcohol for at least twenty-four hours.

For clearing and infiltration with paraffin, I have found the chloroform method especially satisfactory; it was the only successful medium for cornified portions of the feather when anything like complete series were desired. I have found it particularly good in preparing material for sections of dry feathers. I have often secured almost perfectly complete series with it, whereas with xylol, or cedar oil, only occasionally would a section remain in the paraffin ribbon.

Feather germs were left in melted paraffin two to five days and were then imbedded in hard paraffin (135° F.).<sup>1</sup> Dry feathers were, in ordinary cases, dropped into chloroform for a few hours and then transferred to melted paraffin for about twelve hours.

Serial sections were cut with a Minot-Zimmermann microtome  $3\frac{1}{2}$  to 10 micra thick, mostly  $3\frac{1}{2}$  or  $6\frac{2}{3}$  micra. Also a few sections at the proximal end of the feather germ were cut 2 micra thick by means of the Minot microtome having Zimmermann's improved feeding attachment. I found it necessary to have the temperature as low as 60° F., and each section was cut with a very slow motion of the object carrier. For almost all purposes, however, sections  $3\frac{1}{2}$  micra thick are thin enough.

Sections of the cornified portions of the feather germ are very elastic and tend to curl and spring from the paraffin ribbon, especially when the sections are as much as ten micra thick, but with the methods described above fairly complete series were obtained.

Mayer's albumen fixative was used successfully for affixing sections to the slide; but with osmic-acid material it was found necessary to spread, in addition, a thin film of celloidin over the sections, immediately after the immersion in alcohol which followed the removal of paraffin with xylol. This celloidin film held the sections securely in position and did not interfere with subsequent work.

A number of stains were tried, but by far the most satisfactory were (1) for material fixed in picro-sulphuric a double stain, viz.

<sup>1</sup> A mixture of hard paraffin with about 5% of resin was suggested by Professor G. H. Parker and was used with some success for dry feathers.

Kleinenberg's 70% alcohol haematoxylin followed by eosin, and (2) for osmic material, the iron haematoxylin as used by Heidenhain.<sup>1</sup>

Slides bearing sections of picro-sulphuric material were placed in the haematoxylin solution for three or four minutes only; it was found advisable in some cases to dilute the stain with an equal amount of 70% alcohol. The superfluous haematoxylin was removed with 70% alcohol and then the slide was simply dipped into a jar containing 70% alcohol with a few drops of a sat. solution of eosin in 70% alcohol. Cornifying tissues are stained by the eosin bright red, which stands out in beautiful contrast with the light blue of other tissues. By this method pigment cells and their granules are finely demonstrated. I found, however, with material fixed in the picro-sulphuric mixture a slight tendency to shrinkage, which made it inferior to Hermann's fluid for general histological purposes.

Material fixed with Hermann's fluid for three hours only was blackened superficially; this was corrected by Weigert's decolorizer. The iron-haematoxylin stain was used in the usual way.

Feather germs were sectioned transversely, longitudinally, and obliquely, and were mounted in Canada balsam. Glycerine was used in most cases for mounting sections of dry feathers.

Teased preparations were also found very instructive, material fixed in Hermann's fluid being especially favorable for such treatment. For this purpose a feather germ was first split longitudinally into strips and the epidermal portions removed from the pulp. These strips, after being stained *in toto* in haematoxylin followed by eosin, were teased on the slide in balsam or xylol. Fully cornified portions were unstained by the haematoxylin and eosin, but they retained a light brown stain from the fixing fluid. Elements in process of cornification took an eosin stain, which was deepest in the more advanced stages, though not appearing in the completely cornified elements. Stages preceding cornification took the haematoxylin, as did also nuclei in cornifying portions of the feather.

Dry feathers have also been studied *in toto*, and control observations have been made on them to guard against the possibility of overlooking a pigment that might be dissolved by the histological reagents used. This matter will be brought up later in a discussion of the chemical characteristics of feather pigments.

Besides *Sterna hirundo*, feather germs from *Passerina ciris* Linn.,

<sup>1</sup> Picrocarminate of lithium has been used for differentiating cornifying tissues, but I have found it inferior to the stains mentioned above.

*Passerina cyanea* Linn., *Munia atricapilla* Hume, and the common dove have been studied; and dry feathers from the following birds have also been used: *Cyanocitta cristata* Linn., *Sialia sialis* Linn., *Pitta sordida* Sharpe, *Pitta moluccensis* Swinh., *Cotinga cayana* Bp., and *Megascops asio* Linn.

I wish here to express my thanks to Messrs. Outram Bangs and J. D. Sornborger for aid in procuring material.

### III. The Development of the Feather.

#### A. THE FEATHER GERM.

Of the many accounts of the structure and development of the feather, by far the most accurate and thorough is that of Davies ('89), who also gave an extended review of the literature up to the time of his writing. He studied the feather with particular reference to its homologies with other integumentary structures, but did not consider the question of color.

According to Davies the definitive feather is always preceded by a down feather, — though in some cases the latter is represented by only a rudimentary structure, — and it has the same follicle and the same dermal papilla or pulp as the down feather. The epidermal fundament of the future definitive feather has the same cell layers as the down feather, except that the epitrichial layer is absent. In a longitudinal section of the feather germ, it is easily seen that the cylinder-cell layer, the intermediate cells, and the layer of cornifying cells are continuous with corresponding layers in the epidermis of the skin.

A description of the development of color in the feather can be better appreciated if it is preceded by an account of the various steps in the differentiation of the barbs and barbules. The formation of the latter, especially, is complicated, and must be explained before giving a description of the process of pigmentation.

Davies gave a good description of the differentiation of the various parts of the feather, but his account of the formation of the barbs and barbules, especially of the latter, is incomplete. Moreover, his preparations had evident defects in preservation, which led him into some errors in his description of the conditions connected with the differentiation of the feather fundament, which I hope to correct.

Since the portions of the feather germ near the inferior umbilicus constantly present conditions which are younger than those of portions

more distal in position, a single feather presents at successive levels conditions which are identical with those of a given region of a feather in successive stages of its growth. The conditions shown in Figures 12-23 were taken from sections marked in the diagram, Figure 1, by the numbers 12-23, which are successively more and more distal in position. They correspond to successively older stages in the development of a feather germ. I begin my account of the conditions presented by the remiges of *Sterna hirundo* with a description of the conditions nearer the inferior umbilicus (12, Fig. 1).

In Figure 12 (Plate 2) is shown a portion of a cross-section just above the umbilicus. A peripheral portion of the pulp (*drm.*) is shown at the bottom of the figure. It consists of closely packed connective-tissue cells, whose long axes are cut at right angles. Blood vessels are especially numerous at the periphery of the pulp.

Between the pulp and the epidermis lies the so-called basal membrane. This is seen most favorably in preparations where decolorization was not carried very far. I have also recognized this structure in picrosulphuric material, but far less clearly. Studer ('73) described as structureless a membrane lying between the dermis and epidermis of the feather, but later ('78, p. 425) noticed that it was cellular. Davies ('89) noted Studer's observations of a basal membrane in his review of Studer's work, but, in his own account, does not mention the basal membrane as a separate structure. He treats of it as a part of the connective-tissue pulp, without, however, discussing the subject.

That this structure is cellular in *Sterna hirundo*, is evident from the presence of the nuclei which are inclosed in it (Plate 2, Fig. 14, nl.). There can be no doubt, moreover, that it is of dermal origin, for the nuclei have the characteristic smaller size of dermal nuclei; besides, a sharper line of demarcation exists between the membrane and the cylinder-cell layer than between it and the dermal cells. The nuclei are not abundant, but where they do occur they leave no doubt as to the cellular nature of the structure.

Proceeding distally along the fundament of the feather, the basal membrane becomes thinner and therefore less conspicuous (Figs. 15-21).

The epidermis of the feather germ, including the feather sheath, comprises four fairly well marked layers: The deepest layer, that next the pulp, consists of a single row of spindle-shaped cells (*cl. cyl.*) elongated in the direction of the radii of the cylindrical germ, and called cylinder cells. Except for their blunt deep ends and their weaker stain-

ing properties, these cells are in no way distinguishable from the adjacent cells in the deeper portion of the intermediate cell layer at this level.

In his description of the cylinder-cell layer, Davies ('89, p. 574) remarked that the typical cylindrical form is seldom seen in cells of this layer. On the contrary, as will be seen in Figures 12-14 (Plate 2) and 21-24 (Plates 4, 5), I have found the cylindrical form a very common characteristic of these cells in *Sterna*; however, it must be admitted that in the region from 15 to 20, Figure 1, the cylindrical form is lost (Plate 3, Fig. 15; Plate 4, Fig. 20).

The intermediate cells (*cl. i'm.*) occupy about one third of the thickness of the epidermis. They are undergoing active proliferation, which, as far as I have observed, is always accomplished by mitotic division. Their nuclei, like those of the cylinder cells, are elongated in the direction of the long axes of the cells.

Outside the intermediate cells comes the layer of inner-sheath cells (*cl. tu. i.*), which occupies about one half the thickness of the epidermis. The deeper cells of this layer are easily distinguishable from the intermediate cells by their larger and more spherical nuclei, their more sharply defined cell boundaries, and their more or less polygonal form. The more superficial inner-sheath cells are flattened, with their long axes at right angles to those of the intermediate cells. Those most superficial are cornifying to form the sheath, which at this point has not attained to the full thickness shown in Figure 14. It is also not separable from the follicular sheath at the level of this section.

The sheath (*tu.*) consists of flattened cornified cells more or less fused together. Its finer structure has been described by Lwoff ('84). All layers appear thicker and the cells more elongated than they would in a section strictly perpendicular to the epidermal walls (cf. 12, Fig. 1). At the level of the section from which Figure 13 was made some changes are to be noticed. The intermediate-cell layer is now easily distinguishable from the cylinder-cell layer and the inner-sheath cells. Though it was possible to demonstrate cell boundaries at the stage shown in Figure 12, this could not be done for the intermediate cells at this later stage. The nuclei are larger and more spherical. They are also more numerous. The whole thickness of the epidermis is much reduced from that of the first stage described.

A very short distance above this level we have, as seen in Figure 14, the first evidence of the differentiation of ridges, in the form of extensions of the basal membrane. The intermediate cells are in great confusion and their nuclei are still larger than they appeared in Figure 13.

The cylinder cells are less elongated and their nuclei are also larger. Their boundaries are not easily determined.

At the stage shown in Figure 16 (Plate 3), the cylinder cells and the intermediate cells are completely divided into ridges by the extensions of the basal membrane. These ridges are destined to give rise to the barbs and their barbules.

Davies left undecided the question whether the formation of ridges was brought about by the cylinder-cell layer invading the mass of intermediate cells and dividing it up into ridges, or whether the intermediate cells grouped themselves into ridges and thus made room for the cylinder-cell layer to enter between successive ridges; but he considered the latter view the more probable.

I, too, believe that the initiative in the process of ridge formation is taken by the intermediate cells (*cl. i'm.*), and for the following reasons: (1) they are evidently changing position, as may be seen in Plate 2, Figures 12-14; (2) a tendency to group themselves is manifested in the formation of lateral plates, which are represented in cross-section by rows of cells (Plate 3, Fig. 16, *ser. cl.*).

Maurer ('95) has pointed out that there must be a very great pressure upon the central pulp by the growing epidermal region with its increasing need of space, and that this seems to result in the formation of numerous small elevations and depressions (Plate 2, Fig. 12, *crs''*.) varying in size with the resistance at different points. I agree with him in considering this a factor also in the formation of ridges (Plate 2, Fig. 14, *crs.*), especially in producing extensions of the basal membrane into the epidermis of the feather germ.

As was observed by Davies, the ridges do not arise simultaneously at any given level, but are first seen on the sides of the feather germ. The distal portion of a ridge is formed before the proximal part, where it joins the shaft or rhachis; the differentiation of the barb and its barbules therefore begins at the distal tip of the ridge and gradually approaches the proximal insertion on the rhachis. In a single cross-section, there will be ridges cut at various distances from their point of union with the shaft. The sections of the ridges most distant from the rhachis, *i. e.* of those on the ventral side of the feather germ, pass through the distal ends of ridges which will appear successively nearer to the shaft in sections taken at more proximal points in the germ. These relations may be more easily understood by reference to Figure 4 where ridges (*crs.*) in various stages of differentiation are represented by rows of pigment cells.



The common condition of asymmetry in the vane, with the barbs on one side of the rachis longer than those of the other side, causes the point where the distal ends of the ridges meet to be more or less at one side of the median plane of the feather-germ (Plate 9, Fig. 41, *dst'*). A conspicuous out-curving of the two sides of the feather fundament at this point is seen in a wing-feather from the dove (Plate 9, Fig. 42, *dst*).

The cylinder-cell layer, which forms a continuous sheet of cells covering the ridge completely on the pulp side and between adjacent ridges, takes no direct part in the formation of barb or barbule. These are formed exclusively from the "intermediate cells," which constitute the greater portion of the ridge. These intermediate cells become differentiated into three parallel structures, an axial plate, longer in a radial than in a tangential direction, and two lateral plates. A large portion of the cells forming the axial plate are ultimately metamorphosed, or fused together, to form the barb; the cells which compose the lateral plates of the ridge, and which are separated from the furrows by the cylinder-cells, are to be connected into barbules, whose attachment to the barb will be near the inner or pulp margin of the axial plate. In each ridge one lateral plate will form the distal barbules and the other the proximal barbules of a single barb.

Davies ('89, Taf. 24, Fig. 19) described and figured clefts or spaces, which he found occurring between the plates of barbule cells and the cells forming the axial plate. He called these spaces "Längsfurchen," a term which seems inappropriate for a fissure-like space, and especially so in this case, because he uses the same word for the spaces that he found between successive ridges. The latter could with some reason be called furrows, but the spaces between the barbule rows and the axial plate are nothing but artificial clefts. I have never found them except in preparations that had experienced shrinkage in fixation. In osmic material these clefts are altogether wanting, as are also the wide V-shaped furrows which he described and figured as occurring between ridges (Davies, '89, pp. 574-5; Figs. 17-19).

The growth of the cells comprising the feather fundament and the proliferation of cells at its basal, or proximal, end brings about a longitudinal growth of the feather germ, the sheath preventing lateral expansion.

Davies described this extension of the feather germ as due exclusively to cell proliferation at the base, ignoring the growth of the cells as a factor. This is partly explained by his conception that there were

clefts (Längsfurchen) between the lateral plates and the axial plates. He described these clefts as being filled ultimately by the growth of the cells of the barbule fundamentals. They would thus provide room for the expansion.

## B. The Differentiation of the Feather.

### 1. THE BARBULES.

Each barbule is composed of a single series of "intermediate cells" placed end to end, thus forming a *column* of cells (Plate 7, Fig. 38, *col. cl.*), which comes to lie nearly parallel to the feather germ, with its own axis forming a feeble spiral. The columns of cells are so closely arranged as to be in contact with each other by their edges. Accordingly, in cross-sections of the germ many columns are cut cross-wise, each being represented by a single cell. These cells form, in any given series, a *row* (Plate 3, Figs. 16, 18, *ser. cl.*); those nearest the pulp in the row are also nearest the cells destined to form the barb. They are cut nearer the base, or attached end, of the prospective barbules than cells which lie farther from the pulp in the row. Those at the extreme periphery, next to the inner-sheath cells, are the ones which are destined to form the tips of the barbules. A single row of these cells in a cross-section (Figs. 16-21, *ser. cl.*) therefore shows conditions of development for various portions of different barbules.

By a comparison of the stages shown in Figures 16-21 and 24, it may be seen that the deeper cells in a row undergo a great metamorphosis in shape and size to form the broad flattened portion of the future barbule (Plate 5, Figs. 25 and 26). The more superficial, and therefore more distal, barbule cells become elongated to form the attenuated portion of the barbule. They appear, consequently, much smaller in cross-section than the proximal cells.

In the broad flattened cells the nuclei come to occupy a ventral position (Plate 5, Figs. 23, 27). The boundaries between contiguous proximal cells of a single barbule run obliquely forward from the dorsal margin to a point near the ventral margin just proximal to the nuclei, where they turn slightly backwards towards the proximal end of the barbule (Plate 5, Figs. 26 and 27). In the region of transition from the broad flattened form to the slender distal portion (Fig. 27), the outline of these inter-cell boundaries changes to a form presenting a convexity in an opposite direction, *i. e.* towards the proximal end of the barbules; the sides of the convexity being likewise more symmetrical.

The broad cells of the proximal barbules (*brb. prx.*, Plate 5, Fig. 23) undergo a special metamorphosis, in which their dorsal margins are bent over and inwards towards the axial plate to form the well-known recurved margin (Fig. 25, *marg.*) to which the hooklets of the distal barbules are ultimately to secure attachment.

It should be noticed here that the barbule fundamentals are not cut exactly at right angles by cross-sections, but somewhat obliquely, especially in their broad proximal portions.

At a very early stage in the differentiation of the barbules, the barbule columns lie in the plane of a radius of the feather germ (Plate 3, Fig. 16, *ser. cl.*). They also make an angle of over  $60^\circ$  with the long axis of the feather germ. With the growth of the cells composing the barbule fundamentals, this angle becomes smaller and smaller, while the distal, attenuated portion comes to lie nearly parallel with the axis of the feather germ.

The surface made by the barbule fundamentals collectively undergoes a bending, which is clearly seen to increase steadily from the stage shown in Figure 16 to that of Figure 20, *ser. cl.* This, I think, is brought about partly by the great increase in the size of the ridges near their attachment to the rhachis, at the expense of their distal ends, which lie farther away from the rhachis. It results from the fact that the barbules will be largest at the proximal ends of the barbs and will gradually decrease in size towards the distal ends of the latter. A cross-section at a point where the ridges are first differentiated does not show so great a contrast in size between sections of ridges near the shaft and those on the ventral side. This increase in size must be accompanied by lateral displacement, which would account for the gradual increase in the curvature of the rows of cells representing the barbules.

## 2. *The Barbicels.*

The barbicels arise as one or two processes of single barbule cells at a comparatively late stage in the development of the barbule. The barbicel appears first as a thick blunt projection of the cell (Plate 5, Fig. 27, *brbc.*); its final form is not attained until the end of cornification.

The cells of the distal halves of the distal barbules are, except for a few of the most proximal, each provided with two distinct barbicels, — one ventral and one dorsal (Plate 5, Figs. 26, 27, *brbc.*). Of these the ventral is the longer. Towards the middle of the barbule the ventral barbicels are of considerable size, and they are more or less recurved at their distal ends to form the so-called "hooklets" or "hamuli" (*haml.*).

The two most proximal of the ventral barbicels (Plate 5, Fig. 27) are smaller and without hooks.

The barbicels of the proximal barbules (Fig. 25, *brbc.*) are rudimentary except for the two most proximal on the ventral side, which are similar in form and size to the corresponding barbicels of the distal barbules. They may be absent altogether from both sets of barbules, as is frequently the case in the more distal portions of body coverts.

In a cross-section of the feather germ at the level of 21, Figure 1, the barbicels appear as loose irregular fragments. I have found teased preparations most favorable for studying their origin.

### 3. *The Barb.*

Between the two rows of barbule cells for each ridge, as seen in cross-section, there is a group of cells which I have called the axial plate (*la. ax.*, Plate 3, Fig. 16). The cells of this plate never acquire a regular arrangement like those of the lateral rows. At the same time it is to be noticed that the rows of barbule cells do not extend quite to the apex of the ridge, the apex being occupied by a group of cells (Plate 4, Fig. 20, *fnl. brb.*) which is continuous with the axial plate. Differentiation begins at a rather late stage.

The cells in the deeper portions of the axial plate, near the cylinder-cell layer, become large and conspicuous and have a more or less polygonal form (Plate 4, Fig. 21, *med.*). They are destined to form the medulla of the future barb.

The number of cells entering into the formation of the medulla at any given place depends on the size of the barb at that region. Around these medullary cells, as around an axis, other cells become applied and flattened, so that, in cross-section, they appear spindle-shaped. These form the cortex of the barb. In a region where the barb is large, *i. e.*, near its proximal end, almost all of the axial-plate cells enter into its formation.

With this differentiation the ridge experiences an extension in the direction of a radius of the feather germ, and the diameter of the central pulp decreases correspondingly. Before this differentiation began, the region corresponding to the prospective barb occupied a comparatively small area in the cross-section (Plate 4, Fig. 19); but after the differentiation, it occupies a large portion of the ridge (Plate 5, Fig. 23). The barbules are thereby pushed farther and farther away from the pulp.

The structure of the medulla and cortex was early studied by

Schwann ('39), who gave a very good general description of them. Since then they have been considered by various writers on the structure of the feather. I have nothing to add to the more recent accounts, except to call attention to the ventral ridge (*crs'*) of the cortex of the barb, which is shown in transverse section for several birds (Plate 1, Figs. 7, 8, 9; Plate 5, Fig. 24), and also to the structure of the dorsal thickened portion of the cortex (Plate 5, Fig. 23, *ctx. d.*; Fig. 24, *ctx.*). I find the ventral ridge, or keel, a frequent and important feature of the ventral cortex. It furnishes a convenient "ear mark" for the orientation of barb sections; its apex in transverse sections always points towards the shaft. During the process of cornification, it becomes much reduced from the conspicuous size which it has in stages corresponding with that shown in Figure 23, but it still retains the same characteristic want of symmetry (Fig. 24, *crs'*).

The dorsal portion of the cortex is made up of cells which fuse at a comparatively late date in the feathers I have studied.

Haecker ('90) described thick-walled medullary cells which he found in the barbs of certain birds, designating them by the term "Schirmzellen." I have examined sections of the barbs from two of the species of birds which he studied (*Cotinga cayana* and *Pitta moluccensis*), and also from *Pitta sordida*, and have identified his so-called "Schirmzellen" (Plate 2, Figs. 10 and 11, *cl. med.*).<sup>1</sup> I regret not having been able to get material for the study of their development; but there seems little reason to doubt that they are modified medullary cells, as Haecker himself leaves one to infer.

They were observed and figured by Krukenberg ('82) in *Irene puella*; he called them thickened medullary cells ("Markzellen"). Gadow ('82) saw them in *Pitta moluccensis*, but his figures and descriptions are incorrect. He described them as prismatic columns with minute parallel ridges on their surfaces; but neither Haecker nor I have found any ridges. Gadow seems to have depended solely on observations from the exterior, having apparently worked without the aid of sections.

The "Schirmzellen," as described by Haecker, occur mostly on the dorsal side of the barb immediately underneath the cortex; but they are also represented by two or three typical thick-walled cells on the ventral side in *Pitta moluccensis*.

<sup>1</sup> As this paper goes to press and since the printing of the plates, an article appears by Haecker und Georg Meyer (: 01) in which the Schirmzellen are recognized as modified medullary cells and are re-named "Kästchenzellen," a much more appropriate term.

Haecker also mentioned an outer epitrichium covering the cortex. I have not been able to satisfy myself that such a layer actually exists. There are appearances suggesting an epitrichium, but these I regard as purely optical effects.

Haecker's figures of transverse sections of barbs are, with few exceptions, the only ones that I have found approaching accuracy in detail, and even his are sometimes confusing. I have therefore prepared figures showing in detail cross-sections of barbs from different birds, though several of them have been figured before. The figures given by Jeffries ('83) for transverse sections of barbs are almost worthless, but their crudity is probably largely explained by the lack of a suitable technique.

The cortex in a cross-section of a barb from *Megascops asio*, which appeared in an otherwise beautiful plate published by Chadbourne ('97), is wholly erroneous.

#### 4. *The Rhachis.*

The shaft, or rhachis, arises on the dorsal side of the feather germ and represents two or more combined ridges (Plate 1, Fig. 2; Plate 9, Fig. 42, *rch.*); its structure is, in general, like that of a barb with a central medulla of polygonal cells and an outer thickened cortex. It also bears barbules like those of the barb, between the points of insertion of the latter, on its sides. The development of the rhachis was carefully studied by Davies, to whose account I have nothing to add.

#### 5. *The Residual Cells.*

As has already been stated, not all the cells of the ridge are employed in the formation of the barbules and barb. With the growth of the ridges, the layer of cylinder cells is pushed closely against the corresponding layer of the neighboring ridges, and these cells (Plate 3, Fig. 16, *cl. cyl.*) still continue to be so crowded in the layer that their nuclei appear almost to touch each other; but with the great longitudinal extension of the germ, due to the growth of the barbs and barbules, in which the lateral cylinder cells do not share, the cylinder cells become more and more spread out (Plate 4, Fig. 19, *cl. cyl.*, Figs. 20-21). The inner-sheath cells also experience a contraction during the growth of the feather. In Figure 23, Plate 5, the elements of the feather proper have been shaded. Residual cells are scattered through the more superficial spaces not occupied by the barbules. Their nuclei are shrivelled. The deeper cells, including the cylinder cells, retain their regular form and size until a later stage.

6. *Cornification and Withdrawal of the Feather.*

With cornification, the barb cortex differentiates from the surrounding tissue and the outlines of individual cells become less and less evident, until, finally, in the fully cornified barb there is little or no evidence of its former cellular nature. The nuclei of the barbule cells shrink, and the last seen of them is a small glistening mass of shrivelled chromatic substance, which finally disappears along with all traces of cell boundaries. Nevertheless the former position of the nucleus can frequently be distinguished, through the different refractive properties of this region. The barbule thus becomes a horny, almost homogeneous body with no evidence of its original cellular structure, except such as is furnished by the position of the barbicels, the nuclear region, and the presence of pigment patches, to be discussed later.

Toward the end of the process of cornification the feather elements withdraw or shrink away from the non-differentiated cells, which themselves become more or less shrivelled and cornified (Fig. 24, Plate 5). After the completion of cornification, the feather begins to break forth from the distal end of the feather sheath, a process that begins and continues some time before the formation of the calamus takes place. The barbules, on escaping from the confining sheath, swing about by their own elasticity from the position shown in Plate 1, Figure 6, to that seen in Figure 3.

The process by which the pulp atrophies, having been well described by Davies, will not be discussed here. In the completed feather, as is well known, all that remains of the dermal pulp is the series of dry horny caps found in the quill and a small functional papilla, which projects slightly up into the quill through the inferior umbilicus. At the time of molt, this papilla is destined to become active again in the formation of a new feather.

The cornification of the feather elements has been described by Waldeyer ('82) and Lwoff ('84).

## IV. THE PRODUCTION OF COLOR IN THE FEATHER.

The researches of Altum ('54, '54<sup>a</sup>), Bogdanow ('58), Brücke ('61), Gadow ('82), Krukenberg ('84), and Haecker ('90) have shown that the colors of birds may in general be divided into two classes, (1) those due simply to the presence of a pigment, and (2) the so-called structural colors. Under simple pigment colors they have placed red, yellow, orange, black, and brown; whereas white, gray, blue, the so-called metal-

lic colors, iridescent phenomena, and lustre are called structural colors. According to Haecker, green is a structural color except for the single case of turacoverdin, a pigment described by Krukenberg ('82).

The production of structural colors has been variously explained as due to either (1) light-interference phenomena or (2) diffraction or dispersion of light-rays. Except for white, however, a dark granular pigment (melanin) has always been found associated with such effects.

Peculiar modifications in structure are associated with blue colors. Altum ('54<sup>a</sup>) observed that feathers giving bright blues have the barbs isolated, i. e., not connected with each other by barbules.

Haecker ('90) considered as necessary for the production of blue: (1) a thickened unpigmented cortex, (2) a deposit of brown pigment in the medullary cells of the barb, and (3) the occurrence of more or less polygonal, porous-walled "Schirmzellen."

I have examined blue feathers from the indigo bird (*Passerina cyanea*), the blue-bird (*Sialia sialis*), *Pitta sordida*, *Pitta moluccensis*, *Cotinga cayana*, and the blue-jay (*Cyanocitta cristata*). The brilliant blue feathers furnished by *Pitta* and *Cotinga* have the barbules rudimentary or of insignificant size where the color is most intense. The lateral diameter of the barb is also greater than in the more proximal and less brilliant portion. Such feathers never appear blue except when seen from above. Their ventral surface gives a dull brown color. The "Schirmzellen" are conspicuously developed (Plate 2, Figs. 10-11, *cf. med.*).

The cavities of the ordinary medullary cells have a thick peripheral layer of dark brown pigment. In *Cotinga* I found no ordinary medullary cells, but the ventral cortex was thickened and appeared black from a rich supply of pigment.

Blue feathers from the blue-jay, blue-bird, and indigo bird show no "Schirmzellen," but there is a pigmentation of the central medullary cells (Plate 1, Figs. 7-8, *med.*) similar to that observed in the *Pittas* (Plate 2, Fig. 11).

The distal portions of blue feathers from the blue-bird which I examined gave a much more brilliant blue than the proximal portions. The transition from bright to dull blue was abrupt. With the aid of a microscope, it could be seen that a light blue color of uniform intensity was given by the barbs in both proximal and distal portions. Where the feather appeared bright blue, *the barbules were absent*. A similar relation between brightness of color and the absence of barbules has been noticed by other writers for other birds.



A variation from the conditions described by Haecker for the production of blue is found in the blue feathers of the indigo bird. I have never seen any pigment in the medullary cells, but heavily pigmented barbules occur and they are not reduced in size (Plate 5, Fig. 29).

A section of a barb from the dark brown tertiaries of the "homer" pigeon shows little, if any, more pigment than is found in gray feathers of *Sterna* (cf. Plate 1, Fig. 9, and Plate 5, Fig. 24). The distal as well as the proximal barbules are liberally supplied with brown pigment, however; whereas in *Sterna*, only the more proximal portions of the distal barbules have an appreciable amount of pigment. The wing feathers of the *juvenal* plumage vary from plain gray to brownish gray. When the latter color occurs, there is a noticeable pigmentation of the proximal barbules.

## V. The Pigmentation of the Feather.

### A. THE CHEMICAL NATURE OF FEATHER PIGMENTS.

The researches of Bogdanow ('56, '57) and Krukenberg ('81-'84) have shown that the pigments of birds' feathers may be divided into two groups: (1) those soluble in alcohol and ether, — yellow, orange, and red pigments (also a single green pigment, turacoverdin); and (2) those soluble in acids and alkalies, — the dark brown to black pigments.

Krukenberg ('84) designated the first group under the general term of *lipochromes* or fat pigments. The second group is included among the widely distributed dark brown animal pigments known as *melanins*.

The solubility of the lipochromes in alcohol and ether renders the study of their origin in the feather by ordinary histological technique impracticable. I have found, for instance, that yellow feather germs from the canary and from the nonpareil (*Passerina ciris*), though retaining their color after fixation, lose it in all except the cornified portions during the process of hardening in alcohol. Various writers who have alluded to the origin of pigment in feathers have described a melanin pigment, but they usually fail to recognize that the melanins are not the only pigments present in feathers.

The dissolving action of chemical re-agents on the melanins of different animals has been described differently by various authors, but, in general, a great resistance to acids and alkalies has been found. Alcohol, ether, chloroform, xylol, etc., seem to have no action whatever

on them. I have had material in alcohol for months without any apparent effect on melanin granules. It is not inconceivable that histological re-agents may produce chemical changes in the developing melanin granules, but I have had no positive evidence of any such alterations.

Especially to be noticed is the red pigment turacin, which was described by Church ('69, '93) as containing 7.1% of copper. Feathers containing this pigment are said to give a red color to water in which they may be placed. At the same time, there is more or less of a tendency for such feathers to exchange their normal red color for blue; but the red returns when the feather is dried. Church found turacin easily soluble in water, especially if the latter was slightly alkaline.

### B. THE ORIGIN OF PIGMENT.

The many writers on the origin of pigment in epidermal structures may be divided into two groups: (1) those believing in an exogenous formation of pigment, and (2) those who argue for an endogenous or autochthonous development of pigment in the epidermis.

The theories ascribing an exogenous origin to pigment all involve a more or less direct relation of pigment to the blood. Most prominent is that which derives the melanins from the haematin of the red blood corpuscles. Certain writers have argued that pigment originates in internal organs, from which it is transported to the integument either in solution in the blood plasma or as a colorless mother substance in the blood-cells. Closely allied to this is the excretion- (or waste-) product theory advocated by Eisig ('87) and others for invertebrates. Finally, there is the leucocyte theory, which makes leucocytes the bearers of pigment from the blood to the epidermis.

The writers who have argued for an endogenous formation of pigment in the epidermis believe that pigment results from the metabolic activity of either the nucleus or the cytoplasm of epithelial cells.

Among those who have advocated an exogenous origin of the pigment of epidermal structures are Langhans ('70), Gussenbauer ('75), Kerbert ('76), Riehl ('84), Aeby ('85), Quinke ('85), Ehrmann ('83, '91, '92), Kölliker ('87), Karg ('88), Phillipson ('90), Kaposi ('91), and Bloch ('97).

The following have supported the endogenous origin: Demiéville ('80), Krukenberg ('84), Mertsching ('89), Jarisch ('91, '92), Rabl ('94), Post ('94), Rosenstadt ('97), Loeb ('98), and Prowazek ('00).

Pigment may be present either, (1) in the dermis only, (2) in the

epidermis only, or (3) in both. Most writers who advocate origin from the blood have described pigment as being formed in the dermis, either in ordinary connective-tissue cells, or in special cells differentiated for the purpose, which in the case of epidermal pigmentation wandered from the dermis into the epidermis or sent amoeboid processes up between the cells of the cylinder-cell layer.

I have found the remiges of the tern (*Sterna hirundo*) especially favorable material for studying the formation of epidermal pigments. Their pigment cells attain a large size, are comparatively regular in contour, and very abundant.

The first signs of pigment formation appear in certain of the "intermediate cells" of the fundament of the feather immediately before the differentiation of the ridges. The pigment arises in the form of grayish or light yellowish corpuscles, of exceedingly small size, arranged along delicate protoplasmic strands, which radiate from the nucleus and sometimes anastomose more or less with one another. These corpuscles increase rapidly in size and are soon large enough to be recognized with a  $\frac{1}{12}$  inch oil immersion lens as definite rod-shaped granules (Plate 6, Figs. 30, 31). At the same time they become deeper in color and more and more numerous until finally they form a complete ball, Plate 3, Fig. 16; Plate 6, Fig. 35, *cl. pig.*), which was often taken by the earlier writers to be a homogeneous mass.

In the course of development these rods are easily seen to be radially distributed about the nucleus, an arrangement which has been described for the pigment cells and chromatophores of other animals.

The nuclei of these pigment cells are entirely destitute of the pigment granules, a condition which Solger ('89, '90, '91) also noted in the pigment cells of fishes and mammals.

Kromayer ('97), too, observed in the developing chromatophores of frog skin that the first appearance of pigment granules was along protoplasmic strands; the granules were at first light in color, but gradually grew darker.

Post ('94, pp. 491, 492) found that melanin pigment granules have characteristic variations in shape and size for different animals. "Die Pigmenttheilchen in den Oberhautgebilden verschiedener Thierarten sind ebenfalls sehr verschieden, z. B. bei der Katze lang und ziemlich dick, beim Hunde wetzsteinförmig in der Mitte verdickt, beim Meer-schweinchen und Kaninchen kurz und dick, beim Rinde ziemlich lang und schlank. Auch das Pigment der Taubenfedern besteht aus Stäbchen von mässiger Grösse." I have also found variations in size for the birds

I have studied, but pigment rods when fully formed, i. e., at the stage indicated in Figure 36 (Plate 6) are of uniform size for each species. The peculiar rod-like appearance and also the size are indicated in Figure 36 (Plate 6), which was drawn with a magnification of 1500 diameters. I have found the pigment rods of *Sterna* invariably as near to 2 micra long as I could measure, and about one-third of a micron in diameter. The shape does not seem to vary noticeably in different species.

In the following species the rods are of practically the same size as in *Sterna*: *Passerina ciris*, *P. cyanea*, and the "homer" pigeon. In the common dove (reddish-brown feather) the length is only 0.9  $\mu$ .

I find myself in entire agreement with Post ('94) as to the origin of melanin in feathers. At no time have I found pigment in the pulp. The pigment cells, moreover, have always been separated from the pulp by the cylinder-cell layer and the basal membrane, so that there could be no question of misinterpretation as to the place of the pigment granules. Rabl ('94) has made the same observation on the down feathers of the chick.

I have examined many preparations, at stages both preceding and accompanying the formation of pigment cells, for evidence that leucocytes enter the epidermis. Although leucocytes are to be found in the blood capillaries close to the basal membrane, I have not seen a single case suggesting actual invasion of the epithelium by them or by any other form of cell. It may be objected that because my preparations did not catch wandering cells at the moment of their entering the epithelium, I have not sufficient ground for denying that they ever penetrate. Even granting the force of this contention, we still should have a right to expect transition stages in the form of the nuclei from that of typical leucocytes to that of pigment cells, but such intermediate stages I have never been able to find. Furthermore, if there were an immigration of prospective pigment cells, or melanoblasts, from the pulp, it is reasonable to suppose that at the earlier stages of the development of pigment the cell would be comparatively near to the cylinder-cell layer; but there is no evidence that such is at any time the condition. In order to have something more definite than a general impression on this point, I have noted the distances of pigment cells from the pulp at various stages in their development, and for this purpose have divided the cells into four groups. The following table gives the results of these measurements. Group *A* includes the youngest stages, those represented in Figures 30-32 (Plate 6); *B*, those shown in Figure 33; *C*, those in Figure 34; and *D*, those in Figure 35. The table gives

the number of cells of each group found at the indicated distances from the basement membrane.

	10 $\mu$	15 $\mu$	20 $\mu$	25 $\mu$	30 $\mu$	35 $\mu$	40 $\mu$	45 $\mu$	Total
<i>A</i>	3	4	11	3	8	8	6	2	45
<i>B</i>	2	0	4	2	9	6	3		26
<i>C</i>	2	4	9	8	14	13	3	1	54
<i>D</i>	1	5	12	9	22	12	5		66
	8	13	36	22	53	39	17	3	191

The measurements given in this table show that there is no noticeable correlation between the position of pigment cells and their stages of development. Moreover in stages later than those of Group *D*, the pigment cells come to occupy a position very close to the pulp, seeming in some cases to migrate towards rather than away from it.

It would be absurd to deny all physiological relation whatever of the melanins to the blood, since the whole feather germ is of course dependent on the blood for nourishment.

I have observed that the nuclei of pigment cells lose stainable chromatin, as described by Jarisch ('92), and it is only reasonable to suppose that the nucleus must share to some extent in the profound changes that take place in the pigment cell. The first visible pigment elements appear, however, in the cytoplasm, and it seems probable that the pigment rods are formed from cytoplasmic material.

Against the hypothesis that pigment is an excretion product, may be urged the striking variations in amount of pigmentation for different animals, where there is no reason to believe that corresponding differences in excretion occur. Albinos lack entirely melanin pigmentation in integumentary structures, yet no one would deny that they have normal excretory processes. Then, too, such a theory requires, as Krukenberg ('84) has said, a marvellous selective power on the part of the pigment cells, and it is more difficult to conceive of this than it is to imagine that certain cells manufacture from a common nourishing material the pigment granules that are to be supplied to neighboring cells.

## C. THE DISTRIBUTION OF PIGMENT IN FEATHERS.

When the pigment cells or chromatophores have reached the stage represented in Figure 35 (Plate 6), they send out processes (Plate 3, Fig. 18, *prc.*) which take a sinuous course among the cells of the axial plates and at length approach the cells of the future barbules which are to be pigmented and in some way distribute pigment to them. The form of these processes varies in the feather germs of different species. In *Sterna hirundo* they are especially regular and well defined. These pigment-cell processes usually branch one or more times, and they are frequently swollen or beaded at the points of branching (see Plate 7, Figure 38, *cl. pig.*).

I have studied many preparations to ascertain whether the cell wall of the pigment cells grows out in the form of a process the existence of which can be shown by any other evidence than these rays of pigment granules. I have also endeavored to see whether there is a flow of pigment granules inside the process. In preparations fixed in Hermann's fluid and stained in iron haematoxylin there are frequently appearances suggesting the existence of regions in the processes which are not completely filled with pigment. In Figure 18 *prc'*. (Plate 3), I have shown such a condition, the process seeming to lack pigment granules for a short distance near its proximal end. This supposition is further strengthened by the presence of a loose arrangement of the pigment rods at each end of the region apparently free from pigment, as though there were here a transition to the closely packed condition. Ordinarily the pigment process appears as a sinuous limb of the cell which contains pigment rods packed together so closely as to be indistinguishable from one another and gives no evidence of possessing an enclosing membrane.

Post ('94, p. 497) gave the following mechanical explanation for the production of these ramifications of feather pigment-cells. "Bis diese Zellen [Barbule cells] zu verhornen beginnen, bleibt jenes vorrätliche Pigment in den verzweigten Zellen aufgespeichert und wird erst allmählich dorthin übergeführt, ein Vorgang, der durch mechanische Mittel wie den Wachstumsdruck der umgebenden Zellen, die wechselnde Blutfülle der Pulpa, Zugwirkung der Musculatur des Federbalges hinreichend erklärt werden kann."

In the case of the dove, the pigment-cell processes are so irregular in form that it is easy to see how Post was led to such a conclusion. In *Sterna* and *Cyanea*, however, we have processes whose contour does not

suggest a simple mechanical cause (Plate 3, Figs. 17, 18, and Plate 7, Fig. 38). They are more uniform in diameter than those of any dove which I have observed, and they frequently branch in a manner that is very characteristic of chromatophores, whose processes are unquestionably the result of cell outgrowths.

The transfer of the pigment granules contained in the processes of the pigment cells to the barbule cells is even more difficult to explain. According to Post it does not take place until after cornification has begun.

Riehl ('84) thought that in the case of the pigmentation of hair, the cornifying cortex cells of the hair might take up the pigment granules brought to them by the pigment-cell processes in much the same way that an amœba engulfs particles of foreign substance. Against this hypothesis Mertsching ('89) objected that the hair cells are motionless and show no amœboid movements. I have found that the form of the barbule cells when they receive pigment is conspicuously uniform and constant (Figs. 17, 18, and 19, *ser. cl.*), with no suggestion of amœboid movements.

Another explanation was suggested by Post ('94, p. 494), — that the barbule cells of the feather fundamēt might receive pigment by a process of osmosis, which would sweep the pigment rods in through pores in the cell walls. “Auf diesen Befunden darf man schliessen, dass die grossen Pigmentzellen ihr Pigment allmählich in jene Nebenstrahlenzellen überführen, und dass diese letzteren erst auf einer gewissen Stufe im Verhornungsprozesse das Pigment aufnehmen. Dieser Vorgang dürfte am einfachsten erklärt werden durch die Annahme, dass die Oberfläche der verhornenden Zellen poröse werde. Die Pigmentstäbchen werden vermöge des osmotischen Austausches in die Zellen eingeschwemmt und in den Maschen des Protoplasmas festgehalten.”

In *Sterna*, the pigment-cell processes come in contact with the barbule cells (Figs. 17, 18, 19, and 36) on their dorsal margins; at such points pigment rods are found in the cytoplasm of the barbule cells, mostly dorsal to the nucleus, where they remain permanently. The barbule cells of other birds, so far as I have observed, are supplied with melanin in a similar way, but they may have their cytoplasm packed with pigment on all sides of the nucleus. The pigment-cell processes may branch so as to supply a group of barbule cells, as is shown in Figure 38 (Plate 7) for the Indigo bird, *Passerina cyanea*.

A question naturally arises as to the factors which determine the direction taken by the pigment-cell processes and cause them to go to the

particular cells which are to be permanently pigmented. It seems not impossible that a condition of chemotaxis exists between the cells which are to receive pigment and the pigment-cell processes.

A unique theory has been advanced by Kromayer ('97) for the chromatophores of the frog's epidermis. He considers the chromatophore to be something more than a simple cell; it has a cell at its centre, but it includes parts of numerous other epithelial cells lying near it. It may be that in the case of the feather we have an actual connection between the pigment-producing cell and the cells which receive pigment. These united cells might, for the time being, be considered an organ in the sense of Kromayer's hypothesis. However, the short duration of such a condition for any particular cell makes such an explanation improbable, even if connection actually occurs.

The pigmentation of the different cells in a barbule is accomplished by a distribution of pigment rods, accompanying the growth of the pigment cell processes, such that the more peripheral barbule cells receive pigment later than those nearer the pulp. In the case of *Sterna* the pigment found in the barb is the last to be distributed.

As we have already seen, the barb develops much later than its barbules, and with its differentiation the undifferentiated epithelial cells near the basal membrane are shoved farther and farther inwards and away from the barbule fundaments, as can be seen in transverse sections (Plate 4, Figs. 19, 20, and 21). This separation breaks the continuity of the pigment-cell process, and the main mass of the cell becomes widely separated from the pigmented barbule cells. The pigment seen in the dorsal cortex of the barb in *Sterna* (Plate 5, Fig. 24, *ctx.*) seems to come from the more proximal portion of the pigment-cell process, which is now some distance away from its original position.

I have tried to determine whether all of the pigment borne in the processes is taken up by cells of the feather germ, but though this is probable, I am unable to state it positively. Neither can I deny that there is a free formation of pigment in barbule cells independently of that supplied by the pigment cells, as was supposed by Klee ('86). However, I have not been able to discover any evidence of such a condition, and the fact that there is a copious supply of pigment by the pigment cells makes Klee's supposition improbable.

It is interesting to note that the amount of melanin produced is not always correlated with the darkness of the feather, even in the case of simple pigment colors. If a preparation such as is shown in Figure 4 be examined under low magnification, we see, in the case of *Sterna*, a



field of numerous dark bodies a short distance above the inferior umbilicus; these are developing pigment cells. They soon become more conspicuous and pass abruptly into regularly arranged massive black rows, corresponding to the differentiating ridges. The whole inner surface from this point to the distal end appears almost continuously black, except for very narrow spaces between the ridges and the sparsely pigmented region in the ventral side of the feather germ. If, however, we take a similar preparation from a *dark brown* feather of a dove, we find, instead of dense rows of pigment cells, a comparatively sparse and inconspicuous distribution of the latter along the ridges. A cross-section of a stage when the barbs are differentiated shows that the pigment cell has given up all of its pigment to the feather fundament and that nothing remains of it except the nucleus (Plate 9, Fig. 42).

In the nonpareil (*Passerina ciris*) there are enormous pigment cells which also give up all of their pigment contents to the barbules (cf. Fig. 40, Plate 8 and Fig. 41, Plate 9). Here is seen a heavy pigmentation of long barbules, which requires a large supply of pigment. Likewise, in the indigo bird (*Passerina cyanea*) all of the pigment formed is used by the feather.

The persistence of a surplus of pigment in the main body of the pigment cell, which I have described for *Sterna*, seems to have been observed by Haecker ('90) in the feather germ of *Scolopax major*. I have found the distal portions of barbs, with their barbules, which are developed on the ventral side of the feather germ to be unpigmented. Pigment cells occur in this region, however, making an almost complete circle of pigment cells about the pulp, as seen in cross-section. By this arrangement the series of pigment cells (Plate 1, Fig. 4, *crs.*) belonging to each ridge is continued to the distal end of the ridge on the ventral side of the feather germ. The pigment cells in the distal portions of the ridges, where the feather is not to be pigmented, are smaller, however, and less numerous; and they do not branch nor give up any of their pigment.

This development of pigment in excess of what is used by the feather fundament I am inclined to consider as of some phylogenetic importance, for it may indicate ancestors whose feathers were much more heavily pigmented.

I have examined white feathers from the dove, and, like Post, have found no pigment.

In the barbules of the completed feather, the rods of melanin are

arranged parallel with the axis of the barbule (Plate 5, Figs. 26, 27), a condition for which I have no explanation.

The variations in pattern exhibited by a single feather, in the form of bars, spots, etc., are easily correlated with variations in the distribution of pigment in the corresponding regions of the feather germ.

That the distribution of lipochrome pigments to the feather fundamen-  
tation takes place at about the same stages in the development of the feather as that of the melanins, seems certain. The germs of yellow feathers from the canary and the nonpareil show a yellow color which corresponds in position to the dark color of feather germs pigmented with melanin.

## VI. Change of Color without Molt.

The changes in color claimed by many writers to occur without molt may be grouped under two heads: (1) the destructive, and (2) the constructive. Under destructive changes are included the results of abrasion and physical disintegration. Constructive changes include supposed regeneration and rearrangement of pigment.

For a review of the general literature of change of color without molt, the reader is referred to Allen ('96). More recently Meerwarth ('98) has claimed that change of color without molt occurs in the tail-feathers of certain Brazilian Raptores. He describes variations in color pattern that he has observed in material consisting mostly of skins. His paper gives no satisfying evidence that the changes alleged may not have taken place through irregular molting. Furthermore, he does not offer any explanation of the process of change.

Descriptions of repigmentation have been mostly pure speculation. Within a few years the following remarkable explanation of the pigmentation of the feather has been given by Keeler ('93): "Pigment is a definite chemical substance which travels through the various branches of the feather, advancing farthest and most rapidly along the lines of least resistance and accumulating in masses where the resistance is greatest. Now the pigment cells must reach the various parts of the feather by way of the shaft, and we should *a priori* expect to find that the resistance would be least down the shaft. It might spread out a very short distance on the barbs, but the main tendency would be towards the tip. This would produce a streaked feather as the most primitive form."

Still more recently Birtwell (:00), in arguing for change of color with-

out molt in *Passerina cyanea*, described a process of rearrangement of melanin granules as follows: "The rhachis appeared, centrally, to be cellular in construction with an enveloping sheath thickly supplied with the black pigment matter, the granules arranged in an order suggestive of a streaming movement towards the tip of the feather. The streaming movement of the color granules is now especially prominent in an actively changing feather, and it readily appears that the rhachis gives up a part of its matter to the barbs, which in turn supply it to the barbules. A positive change of pigment is manifested macroscopically, for a fall feather held to the light or crushed remains yellowish in its yellow-colored parts, while a spring feather, appearing entirely blue, so treated, shows darkly, due to the addition of black pigment."

This idea of a streaming movement was probably suggested by the regular longitudinal arrangement of pigment rods in the cortex.

An anomalous case is that of the pigment turacin which was described by both Church and Krukenberg as leaving the feather when the latter is placed in water. Krukenberg mentioned a regeneration following the drying of the feather.

Fatio ('66) attempted to prove that pigment may dissolve and spread in the feather. He placed a feather so that the proximal portion of the calamus was immersed in a carmine solution and observed an ascent of the latter in the feather structure as far as the first few barbs. He also noticed that when a feather is immersed in ether, the latter may penetrate to the medulla of the barbs.

Chadbourne ('97) argues for a so-called vital connection of the feather with the organism, "The mature feather (*i. e.*, one which has reached full functional development) is far from being 'dead and dry,' a foreign body no longer connected with the vital processes of the rest of the organism, as has sometimes been asserted; for during *its* life it receives a constantly renewed supply of fluid from the parts around it. In strong contrast to this is the really dead feather, in which the fluid matter is deficient, as, for example, the majority of cast-off feathers. Some of the evidence in support of these facts may be of vital interest:—(a) The fatty or oil-like droplets on the surface of the feather can be shown by micro-chemical tests (staining, etc.) to be some of them identical with the oil from the so-called 'oil-gland;' while others are totally unlike that secretion; and these latter are alone found extruding from the pores on the surface of the rami, radii, and shaft. The pores, some with drops of varying size issuing from them, show best at the distal ends of the segments of the downy rays. (b) In the living bird the imported

fluid can be colored, its progress noted, and the feather stained *intra vitam*. Soon after death this becomes no longer possible. To see the stain the microscope is usually necessary. Call this 'osmosis,' 'capilarity,' or what you please, it is none the less a vital process in that it ceases soon after death, and must be studied in the fresh feather. (c) The broken tips of the rays forming the vanes are, when fresh, capped by a mass of the fluid, which has escaped, leaving the part immediately below the stump pale from the loss of the fluid pigmented matter. (d) In museum skins this fluid matter gradually dries and by its consequent increase in density, and that of the feather tissue, the colors darken: while the freshness and gloss of life disappear. (e) The evanescent tints of some species,—notably the fading of the rosy 'blush' of some of the Terns, soon after life is extinct, is due to the drying up or escape of this fluid, while the lost tint was due to the physical effect of structure, the shrivelling and change of form would act on the light rays and the former colors would be lost in consequence. Comparisons of specimens of *Sterna paradisea*, *S. dougalli*, and other Terns in my collection, showed that examples having the 'blush' most marked are those in which the feathers are least dry."

Chadbourne ('97<sup>a</sup>) has described the case of a canary<sup>1</sup> which was supposed to have changed under the influence of being fed with red pepper to the reddish yellow color which, as is well known, may be produced at the time of molting. It was clearly demonstrated by Sauer-mann ('89), however, that in the birds experimented on by him the color is not altered unless the special feeding is carried on while the feathers are in process of development. This I have found to be also the testimony of bird fanciers.

Though it is probable that the oil supplied by the uropygeal gland is a factor in the production of color effects, especially in giving gloss or lustre, it is unreasonable to suppose that the feather itself produces or gives forth any of the oil found upon it. Although the feather structure is slightly permeable by liquids, as Fatio observed, it does not follow that the pigment imbedded or diffused in its horny substance is able to flow about.

There is no satisfactory evidence of the occurrence of repigmentation.

<sup>1</sup> Dr. Chadbourne has explained to me that there was a misunderstanding in the case of the canaries he mentioned. They were not kept by him, but were in the possession of the janitor of the Harvard Medical School, who tells me that the changes mentioned by Dr. Chadbourne were produced only by feeding at the time when the feathers were developing.

The number of supposed cases was greatly reduced when it was discovered that more than one molt may take place in a year, and the recent researches of Chapman ('96), Dwight (:00, :00<sup>a</sup>), and Stone ('96 and :00), which I can corroborate from my own observations on caged birds, have shown that partial molts may take place at various times during the year. Changes due to such partial molts seem sufficient to account for all forms of color change hitherto attributed to a process of repigmentation.

I have found no good record of actual solution by natural causes of pigments contained in the feather except in the case of the pigment turacin. In the great majority of cases, artificial solution is accomplished by chemical reagents with great difficulty. Even if pigments were dissolved in the feather, it is inconceivable that they should be redistributed to form the exceedingly constant and often complex patterns characteristic of bird feathers.

Pigmentation takes place, as has been shown, at a very early stage in the differentiation of the feather, when the cells composing its fundament are in an active condition and in intimate relation with sources of nutrition. In the case of melanin pigments, there are branched pigment cells which supply pigment in the form of rod-shaped granules directly to the feather fundament. The contention for a flow of pigment from the barbs into the barbules, etc. (Keeler), is at once made absurd by the fact that the barbules are pigmented before the barbs are differentiated.

Variations in color patterns are easily correlated with variations in the distribution of pigment in the early stages of the feather's development. When completed, the feather is composed of cells which have been entirely metamorphosed into a firm horny substance and its pigment is imbedded in that lifeless matter. The cells composing a barbule are fused into a solid, more or less homogeneous structure. The pigment of one portion of the barbule is as effectually isolated from that of another as is the coloring of various parts of a piece of agate. Likewise in the barb and rachis, pigment is definitely and permanently located either in the solid cortex or in effectually separated cells of the medulla; and there are no pores large enough to admit the passage of melanin granules. The characteristic longitudinal arrangement of melanin granules, which one finds at the close of cornification of the feather, is permanent.

The case cited by Krukenberg of a regeneration of the pigment turacin was unfortunately not described. It seems to me probable that the

reappearance of the normal color after drying was not due to any true regeneration, but to the fact that upon drying a physical change had taken place in the pigment and that it had not been dissolved.

When the feather is completed, the dermal pulp possesses no functional connection with it; the barbs and barbules are then practically isolated from the vital processes of the organism and have no further power of growth.

The arguments against change of color without molt through repigmentation or regeneration of pigment may be summed up as follows:

1. Most feather pigments are too resistant to chemical reagents to warrant belief in their solution and redistribution.

2. Pigmentation of the feather has been observed to take place only in the younger stages of the feather germ.

3. At the end of cornification melanin granules have a definite arrangement, which is permanent.

4. When cornification has ensued, the various elements of the feather are hard, more or less solid, structures and their pigment contents are effectually isolated from one another.

5. There is no satisfactory evidence of the occurrence of repigmentation, and all the histological conditions render such an event highly improbable.

## VII. Summary.

1. The intermediate cells at the base of the feather germ multiply by mitosis, not all of them being derived from the cylinder-cell layer directly.

2. The barbules are formed each from a single column of cells placed end to end. These columns are arranged parallel to each other and form the two *lateral* plates in each ridge of the feather fundament. The lateral plates correspond respectively to distal and proximal sets of barbules. The final form of the barbule results from a change in the shape of its component cells.

3. Each of the cells composing the distal half of a distal barbule may send out one or two processes, the barbicels.

4. The barbs are differentiated from cells making up the *axial* plate, and appear later (Figs. 20, 21) than the barbules. On the ventral cortex of the barb is often found an asymmetrical ridge, which has its apex pointing towards the rhachis, as may be seen in a cross-section of the feather germ. The epitrichium described by Haecker as covering the cortex, I consider to be only an optical effect.

5. A basal membrane composed of flattened dermal cells separates the

epidermis of the feather germ from the pulp. This was seen by Studer, but apparently overlooked by Davies.

6. The cylinder-cell layer comprises cells having the characteristic cylindrical form, except in the region where there is an extensive growth of the intermediate cells which go to form the barbules.

7. The initiative in the differentiation of "ridges" is taken by the intermediate cells, not by the cylinder-cell layer, nor by the dermis.

8. The condition of asymmetry with reference to the rhachis in the vane of the completed feather is represented in a cross-section of the feather germ by an unequal number of ridges on the two sides of the rhachis.

9. The "Längsfurchen" described by Davies as occurring between successive ridges, and also within the ridges themselves, are artificial clefts due to imperfect fixation.

10. The longitudinal extension of the feather germ is accomplished by proliferation of cells at its base and also by the growth of the cells composing the feather fundament.

11. The columns of cells composing barbules experience bendings in two directions, resulting in a slightly spiral course. (1) By the growth of its component cells the barbule column increases greatly in length. Lateral extension in the feather germ being prevented by the confining sheath, its more distal portions are bent inwards until they come to lie nearly parallel with the long axis of the feather germ. (2) During the development of the feather the ridges become larger near their attachment to the rhachis. At a given level, as may be seen in cross-sections, this results in a crowding or lateral displacement of ridges towards the ventral side of the feather germ. The lateral plates (composed of barbule columns) are bent so that they present a concave face towards the rhachis. This condition is represented in a cross-section by the curving of the *rows* of barbule cells.

12. While a deposit of melanin pigment in the more central of the medullary cells of the barb is usually associated with the production of blue, as described by Haecker, the pigment may occur in the barbules and not in the barbs. This is the case in the indigo bunting (*Passerina cyanea*).

13. The melanins are supplied to the feather by branching pigment cells, which distribute their pigment rods to certain cells of the feather fundament during, or immediately preceding, early stages of cornification.

14. The granules of melanin found in feathers are formed in the cyto-

plasm of so-called pigment cells. These are differentiated exclusively from epidermal cells which lie in the intermediate cell layer of the epidermis of the feather near the apices of the epidermal ridges.

15. Before cornification has ceased, all the pigment which the feather is ever to receive has been supplied to the cells composing its fundament.

16. Changes in the color of plumage may take place either (1) by a molt, during which the new feathers may have the same pigmentation as their predecessors or a different one; (2) by a loss of certain portions of the feather; or (3) by physical disintegration in the cortex of the feather as the result of exposure. There is no satisfactory evidence of a process of repigmentation, and the histological conditions of the feather render such a process highly improbable.

I wish to express my sincere gratitude to Professors Mark and G. H. Parker for helpful criticism and revision of the manuscript.



BIBLIOGRAPHY.

**Aeby, C.**

- '85. Die Herkunft des Pigmentes im Epithel. *Centrallbl. f. d. med. Wiss.*, Jahrg. 23 (1885), No. 16, pp. 273-275.

**Allen, J. A.**

- '96. Alleged Changes of Color in the Feathers of Birds without Molting. *Bull. Amer. Mus. Nat. Hist.*, Vol. 8, Art. 3, pp. 13-44.

**Altum, B.**

- '54. Ueber die Farben der Vogelfedern im Allgemeinen, über das Schillern insbesondere. *Naumannia. Arch. f. d. Ornith.*, Jahrg. 1854, pp. 293-304.

**Altum, B.**

- '54<sup>a</sup>. Ueber den Bau der Federn als Grund ihre Färbung. *Journ. f. Ornith.*, Jahrg. 2, pp. xix-xxxv.

**Birtwell, F. J.**

- '00. The Occurrence of Aptosochromatism in *Passerina cyanea*. *Science*, n. s., Vol. 11, No. 269, pp. 292-299.

**Bloch, A.**

- '97. Le pigment du système pileux et son origine. *Bull. Soc. d'Anthrop.* Paris, sér. 4, Tome 8, No. 6, pp. 573-587.

**Bogdanow, A.**

- '56. Note sur le pigment des plumes d'oiseaux. *Bull. Soc. Nat. Moscou.* Tome 29, No. 2, pp. 459-462.

**Bogdanow, A.**

- '57. Note sur le pigment rouge des plumes du *Calurus auriceps*, Gould. *Rev. et Mag. d. Zool.*, sér. 2, Tome 9, pp. 511-514. See also *Compt. Rend. (Paris)*, Tome 45, pp. 688-690.

**Bogdanow, A.**

- '58. Études sur les causes de la coloration des Oiseaux. *Rev. et Mag. d. Zool.*, sér. 2, Tome 10, pp. 180-181.

**Brücke, E.**

- '61. Ueber den Metallglanz. *Sitzungsb. Akad. Wiss. Wien.*, math.-naturw. Cl., Bd. 43, Abth. 2, pp. 177-192.

**Chadbourne, A. P.**

- '97. The Spring Plumage of the Bobolink, with Remarks on 'Color-Change' and 'Moulting.' *The Auk*, Vol. 14, No. 2, pp. 137-149, Pl. 1 a.

**Chapman, F. M.**

- '96. On the Changes of Plumage in the Snowflake (*Plectrophenax nivalis*). *Bull. Amer. Mus. Nat. Hist.*, Vol. 8, Art. II., pp. 9-12, 2 text figures.

**Church, A. H.**

- '69. Researches on Turacine, an Animal Pigment containing Copper. *Chem. News, Amer. Reprint*, Vol. 5, No. 2, p. 61.

**Church, A. H.**

- '93. Turacin: A Remarkable Animal Pigment containing Copper. *Nature*, Vol. 48, pp. 209-211.

**Davies, H. R.**

- '89. Die Entwicklung der Feder und ihre Beziehungen zu andern Integumentgebilden. *Morph. Jahrb.*, Bd. 15, pp. 560-645, Taf. 23-26.

**Demiéville, P.**

- '80. Ueber die Pigmentflecke der Haut. *Arch. f. path. Anat. u. Physiol.*, Bd. 81, Heft 2, pp. 333-354, Taf. 9.

**Dwight, J., Jr.**

- :00. The Plumages and Moults of the Indigo Bunting (*Passerina cyanea*). *Science*, n. s., Vol. 11, pp. 627-630.

**Dwight, J., Jr.**

- :00<sup>a</sup>. The Sequence of Plumages and Moults of the Passerine Birds of New York. *Ann. New York Acad. Sc.*, Vol. 13, No. 1, pp. 73-360, Pl. 1-7.

**Ehrmann, S.**

- '85. Untersuchungen über die Physiologie und Pathologie des Hautpigmentes. *Arch. f. Derm. u. Syph.*, Jahrg. 12, pp. 507-532, Taf. 22-25.

**Ehrmann, S.**

- '91. Ueber Hautentfärbung durch sekundär syphilitische Exantheme. *Arch. f. Derm. u. Syph.*, Jahrg. 23, Ergänzungsheft 2, pp. 75-102, Taf. 5.

**Ehrmann, S.**

- '92. Zur Kenntniss von der Entwicklung und Wanderung des Pigments bei den Amphibien. *Arch. f. Derm. u. Syph.*, Jahrg. 24, pp. 195-222, Taf. 8.

**Eisig, H.**

- '87. Monographie der Capitelliden, u. s. w. Fauna u. Flora des Golfes von Neapel. Bd. XVI, xxvi + 906 pp., 37 Taf., 20 Holzschn.

**Fatio, V.**

- '66. Des diverses modifications dans les Formes et la Coloration des Plumes. *Mém. Soc. Phys. et Hist. Nat. Genève*, Tome 18, Part 2, pp. 249-308, 3 pls.

Gadow, H.

- '82. On the Colour of Feathers as affected by their Structure. Proc. Zool. Soc., London, pp. 409-421, Pls. 27, 28. 3 text figures.

Gussenbauer, C.

- '75. Ueber die Pigmentbildung in melanotischen Sarcomen und einfachen Melanomen der Haut. Arch. f. path. Anat. u. Physiol., Bd. 63, pp. 322-355, Taf. 8.

Haecker, V.

- '90. Ueber die Farben der Vogelfedern. Arch. f. mikr. Anat., Bd. 35, Heft 1, pp. 68-87, Taf. 4.

Haecker, V., und G. Meyer.

- :01. Die blaue Farbe der Vogelfedern. Zool. Jahrb., Abth. f. Syst., Geog., u. Biol. d. Thiere, Bd. 15, Heft 2, pp. 267-294, Taf. 14.

Jarisch, [A.]

- '91. Ueber die Anatomie und Entwicklung des Oberhautpigmentes beim Frosche. Arch. f. Derm. u. Syph., Jahrg. 23, pp. 559-590, Taf. 10.

Jarisch, [A.]

- '91a. Zur Anatomie und Herkunft des Oberhaut-und Haarpigmentes beim Menschen und den Säugethieren. Arch. f. Derm. u. Syph., Jahrg. 23, Ergänzungsheft 2, pp. 35-55, Taf. 1.

Jarisch, [A.]

- '92. Ueber die Bildung des Pigmentes in den Oberhautzellen. Arch. f. Derm. u. Syph., Jahrg. 24, pp. 223-234, Taf. 9.

Kaposi, M.

- '91. Ueber Pathogenese der Pigmentirungen und Entfärbungen der Haut. Arch. f. Derm. u. Syph., Jahrg. 23, pp. 191-205.

Karg.

- '88. Studien über transplantierte Haut. Arch. f. Anat. u. Physiologie, Jahrg. 1888, Anat. Abth., pp. 369-406, Taf. 20-22.

Keeler, C. A.

- '93. Evolution of the Colors of North American Land Birds. Calif. Acad. Sci., Occasional Papers, [No.] 3, xii + 361 pp., 19 pls.

Kerbert, C.

- '76. Ueber die Haut der Reptilien und anderer Wirbelthiere. Arch. f. mikr. Anat., Bd. 13, pp. 205-262, Taf. 18-20.

Klee, R.

- '86. Bau und Entwicklung der Feder. Hallersche Zeitschr. f. Naturwiss., Bd. 59, Heft 2, pp. 110-156, Taf. 3/4.

Kolliker, A.

- '87. Ueber die Entstehung des Pigmentes in den Oberhautgebilden. Zeitschr. f. wiss. Zool., Bd. 45, Heft 4, pp. 713-720, Taf. 37-38.

**Kromayer, E.**

- '97. Einige epitheliale Gebilde in neuer Auffassung. Beiträge zur Pigmentfrage. *Derm. Zeitschr.*, Bd. 4, Heft 3, pp. 335-400, Taf. 1-4, 13 Textfiguren.

**Krukenberg, C. F. W.**

- '81. Die Farbstoffe der Federn. Erste Mittheilung. Vergleichend-physiol. Studien. (Heidelberg.) - Reihe I., Abth. 5, pp. 72-99, Taf. 3.

**Krukenberg, C. F. W.**

- '82. Die Farbstoffe der Federn. Zweite Mittheilung. *Vergl.-physiol. Studien.* (Heidelberg.) Reihe II., Abth. 1, pp. 151-171.

**Krukenberg, C. F. W.**

- '82<sup>a</sup>. Die Farbstoffe der Federn. Vierte Mittheilung. *Vergl.-physiol. Studien.* (Heidelberg.) Reihe II., Abth. 3, pp. 128-137. Taf. 9.

**Krukenberg, C. F. W.**

- '84. Grundzüge einer vergleichenden Physiologie der Farbstoffe und der Farben. *Vergl.-physiol. Vorträge.* Bd. 1 [Theil] 3, pp. 83-184. Heidelberg.

**Langhans, T.**

- '70. Beobachtungen über Resorption der Extravasate und Pigmentbildung in denselben. *Arch. f. path. Anat. u. Physiol.*, Bd. 49, pp. 66-116, Taf. 3, 4.

**Loeb, L.**

- '97. Ueber Transplantation von weisser Haut auf einen Defekt in schwarzer Haut und umgekehrt am Ohr des Meerschweinchens. *Arch. f. Entwick.-Mech.*, Bd. 6, Heft 1, pp. 1-44, Taf. 1-3, 2 Textfiguren.

**Loeb, L.**

- '98. Ueber Regeneration des Epithels. *Arch. f. Entwick.-Mech.*, Bd. 6, Heft 3, pp. 297-364, Taf. 15-22, 9 Textfiguren.

**Lwoff, W.**

- '84. Beiträge zur Histologie des Haares, der Borste, des Stachels und der Feder. *Bull. Soc. imp. Moscou*, Tome 59, Part 1, pp. 141-174, Taf. 5-8.

**Maurer, F.**

- '95. Die Epidermis und ihre Abkömmlinge. Leipzig. ix + 352 pp., 9 Taf., 28 Textfiguren.

**Meerwarth, H.**

- '98. Beobachtungen über Verfärbung (ohne Mauser) der Schwanzfedern brasilianischer Raubvögel, nebst einem Beitrag zur Phylogenese der Raubvögelzeichnung. *Zool. Jahrb., Abth. f. Syst., Geog., u. Biol. d. Thiere*, Bd. 11, Heft 2, pp. 65-88, Taf. 8-10.

**Mertsching.**

- '89. Histologische Studien über Keratohyalin und Pigment. *Arch. f. path. Anat. u. Physiol.*, Bd. 116, Heft 3, pp. 484-516, Taf. 9.

**Meves, W.**

- '55. Ueber die Farbenveränderung der Vögel durch und ohne Mauser. Jour. f. Ornith., Bd. 3, pp. 230-238, Taf. 2, 3. *Transl from Oefversigt af k. Vetenskaps Akadem. Förhandl*, 1854, Nr. 8 (Stockholm).

**Phillipson, A.**

- '90. Ueber Hautpigment. Fortschr. d. Med., Jahrg. 8, pp. 216-221.

**Post, H.**

- '94. Ueber normale und pathologische Pigmentirung der Oberhautgebilde. Arch. f. path. Anat. u. Physiol., Bd. 135, Heft 3, pp. 479-513, Taf. 13.

**Prowazek, S.**

- :00. Beitrag zur Pigmentfrage. Zool. Anz., Bd. 23, No. 623, pp. 477-480.

**Quincke, H.**

- '84. Beiträge zur Lehre vom Icterus. Arch. f. path. Anat. u. Physiol., Bd. 95, Heft 1, pp. 125-139.

**Rabl, H.**

- '94. Ueber die Entwicklung des Pigmentes in der Dunenfeder des Hühnchens. Centralbl. f. Physiol., Bd. 8, p. 256.

**Rabl, H.**

- :00. Ueber Bau und Entwicklung der Chromatophoren der Cephalopoden, nebst allgemeinen Bemerkungen über die Haut dieser Thiere. Sitzungsber. Akad. Wiss. Wien, math.-naturw. Cl., Bd. 109, Abth. 3, Heft 7, pp. 341-404, 4 Taf.

*Abstract in* Centralbl. f. Physiol., Bd. 14, No. 24, p. 615, 1901.

**Riehl, G.**

- '84. Zur Kenntniss des Pigmentes im menschlichen Haar. Arch. f. Derm. u. Syph., Bd. 11, pp. 33-39, Taf. 5.

**Rosenstadt, B.**

- '97. Studien über die Abstammung und die Bildung des Hautpigments. Arch. f. mikr. Anat., Bd. 50, Heft 2, pp. 350-384.

**Sauermann, C.**

- '89. Ueber die Wirkung organischer Farbstoffe auf das Gefieder der Vögel bei stomachaler Darreichung. Arch. f. Anat. u. Physiol. Jahrg. 1889, Physiol. Abth., pp. 543-549.

**Schwann, T.**

- '39. Mikroskopische Untersuchungen, u. s. w. Berlin. xviii + 270 pp., 4 Tab.

**Solger, B.**

- '89. Zur Structur der Pigmentzelle. Zool. Anz., Jahrg. 12, No. 324, pp. 671-673, 1 Textfigur.

**Solger, B.**

- '90. Nachtrag zu dem Artikel: "Zur Structur der Pigmentzelle." Zool. Anz., Jahrg. 13, No. 328, pp. 93-94.

Solger, B.

- '91. Zur Kenntnis der Pigmentzellen. Anat. Anz., Jahrg. 6, No. 6, pp. 162-165, 2 Abbildungen.

Stone, W.

- '96. The Molting of Birds with Special Reference to the Plumages of the Smaller Land Birds of Eastern North America. Proc. Acad. Nat. Sci. Phila., 1896, pp. 108-167, Pls. 4-5, 2 text figures.

Stone, W.

- '00. Report on the Birds and Mammals collected by the McIlhenny Expedition to Pt. Barrow, Alaska. Proc. Acad. Nat. Sci. Phila., 1900, pp. 4-49.

Studer, T.

- '73. Die Entwicklung der Federn. Inaug.-Dissert. [Philos.] Facult. Bern. Bern. 29 p., 2 Taf.

Studer, T.

- '78. Beiträge zur Entwicklungsgeschichte der Feder. Zeitschr. f. wiss. Zool., Bd. 30, pp. 421-436, Taf. 25, 26.

Waldeyer, W.

- '82. Untersuchungen über die Histogenese der Horngebilde, insbesondere der Haare und Federn. Beiträge z. Anat. u. Embry. als Festgabe J. Henle. Bonn. pp. 141-163, Taf. 9, B.

## EXPLANATION OF PLATES.

Figures 12-21 and 23 are from sections of a feather germ (secondary) of *Sterna hirundo* which was fixed with Hermann's fluid and stained in iron haematoxylin. They represent corresponding regions, indicated in Figure 2 by an asterisk (\*), — but taken at different levels. The levels of the sections are indicated in Figure 1 by the horizontal lines 12, 13, 14, etc. Figures 3, 35, 36, and 37 are also from material fixed in Hermann's fluid and stained with iron haematoxylin. Figures 22, 24, 38, 39, 40, 41, 42 were made from material fixed with Kleinenberg's picrosulphuric mixture and stained in Kleinenberg's haematoxylin followed by eosin. All drawings were made with the aid of a camera lucida.

## ABBREVIATIONS.

<i>bar.</i>	Barb.	<i>dst.</i>	Distal.
<i>baric.</i>	Barbicel.	<i>eth.</i>	Epithelium.
<i>barbu.</i>	Barbule.	<i>fund.</i>	Fundament.
<i>cal.</i>	Calamus.	<i>gran. pig.</i>	Pigment granule.
<i>cl. cyl.</i>	Cylinder-cell layer.	<i>haml.</i>	Hamuli or hooklets.
<i>cl. int.</i>	Intermediate cells.	<i>la. ar.</i>	Axial plate.
<i>cl. med.</i>	Medullary cells.	<i>mac pig.</i>	Pigment patches.
<i>cl. pig.</i>	Pigment cells.	<i>margin.</i>	Recurved margin of proximal barbule.
<i>cl. sheath.</i>	Inner sheath cells.	<i>mb. ba.</i>	Basal membrane.
<i>col. cl.</i>	Column of cells forming a single barbule.	<i>med.</i>	Medulla.
<i>epi. sup.</i>	Red blood corpuscles.	<i>nl.</i>	Nucleus.
<i>ers.</i>	Ridge of epithelium marked off by <i>mb. ba.</i>	<i>nl.</i>	Nucleolus.
<i>ers.</i>	Ventral ridge of barb.	<i>proc.</i>	Process of pigment cell.
<i>ers.</i>	Irregular ridges of epithelium.	<i>prox.</i>	Proximal.
<i>ext.</i>	Cortex.	<i>rch.</i>	Rhachis.
<i>cyt. pl.</i>	Cytoplasm.	<i>ser. cl.</i>	Row of barbule cells seen in transverse section.
<i>d.</i>	Dorsal.	<i>tu.</i>	Feather sheath.
<i>derm.</i>	Derma.	<i>umb. inf.</i>	Inferior umbilicus.
		<i>v.</i>	Ventral.

PLATE 1.

All Figures except 7-9 are of *Sterna hirundo*.

- Fig. 1. Diagrammatic longitudinal section.  $\times 15$ . Figures 12-21 and 23 were drawn from sections taken at the points indicated by the dotted lines 12, 13, 14, etc.
- Fig. 2. Semi-diagrammatic cross-section, indicating by an asterisk (\*) the region chosen for illustration in Figures 12-21 and 23.
- Fig. 3. A portion of a barb and its barbules seen from the dorsal side.  $\times 117$ .
- Fig. 4. A "primary" feather having been split dorso-ventrally and the pulp removed, the inner or pulp, surface of the proximal portion of one half of the feather fundament is here shown.  $\times 16$ .
- Fig. 5. External view of definitive feather germ. The dotted line 23 corresponds in position to the line 23 in Fig. 1.
- Fig. 6. Diagram, to show position of barbules with reference to the barb, while still enclosed in the feather sheath.
- Fig. 7. Transverse section of barb from blue body-covert of *Sialia sialis*.  $\times 495$ . *crs'*. Ventral ridge of cortex of barb.
- Fig. 8. Transverse section of barb from blue wing-covert of *Cyanocitta cristata*.  $\times 495$ .
- Fig. 9. Transverse section of barb from brown wing-covert of the "homer" pigeon.  $\times 495$ .



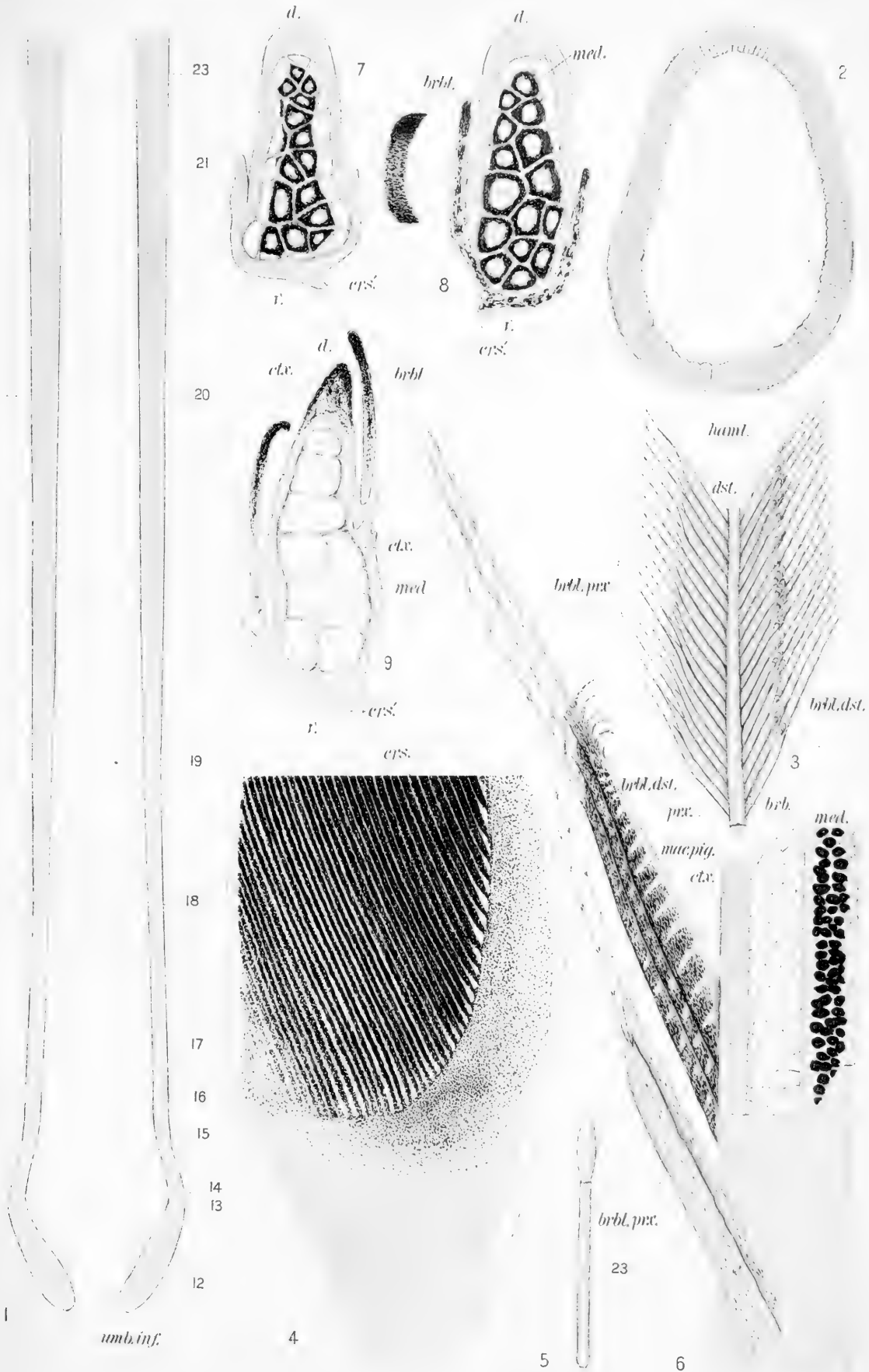


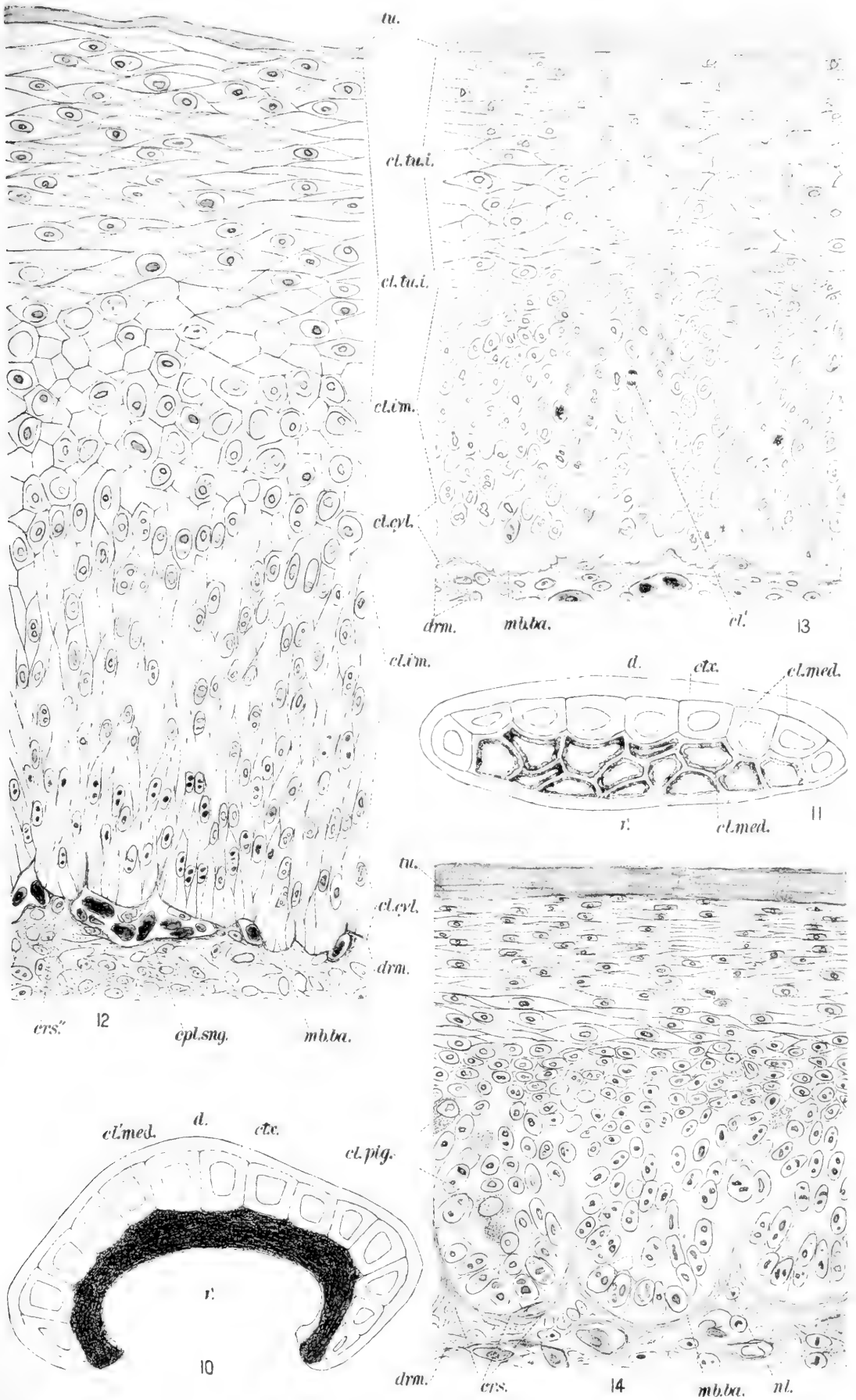




PLATE 2.

All Figures magnified 495 diameters.

- Fig. 10. Transverse section of barb from blue feather of *Cotinga cayana*.  
Fig. 11. Transverse section of barb from blue wing-feather of *Pitta moluccensis*.  
Figures 12-14 are portions of transverse sections of wing-feathers from *Sterna hirundo*.  
Fig. 12. Section at level of 12 in Fig. 1. The position of the part of the section here shown is indicated in Figure 2 by the asterisk (\*). *crs''*. Small ridge in epithelium preceding formation of barb ridges.  
Fig. 13. Section at the level 13, in Figure 1. *cl'*. Dividing cell.  
Fig. 14. Section at the level 14 in Figure 1.





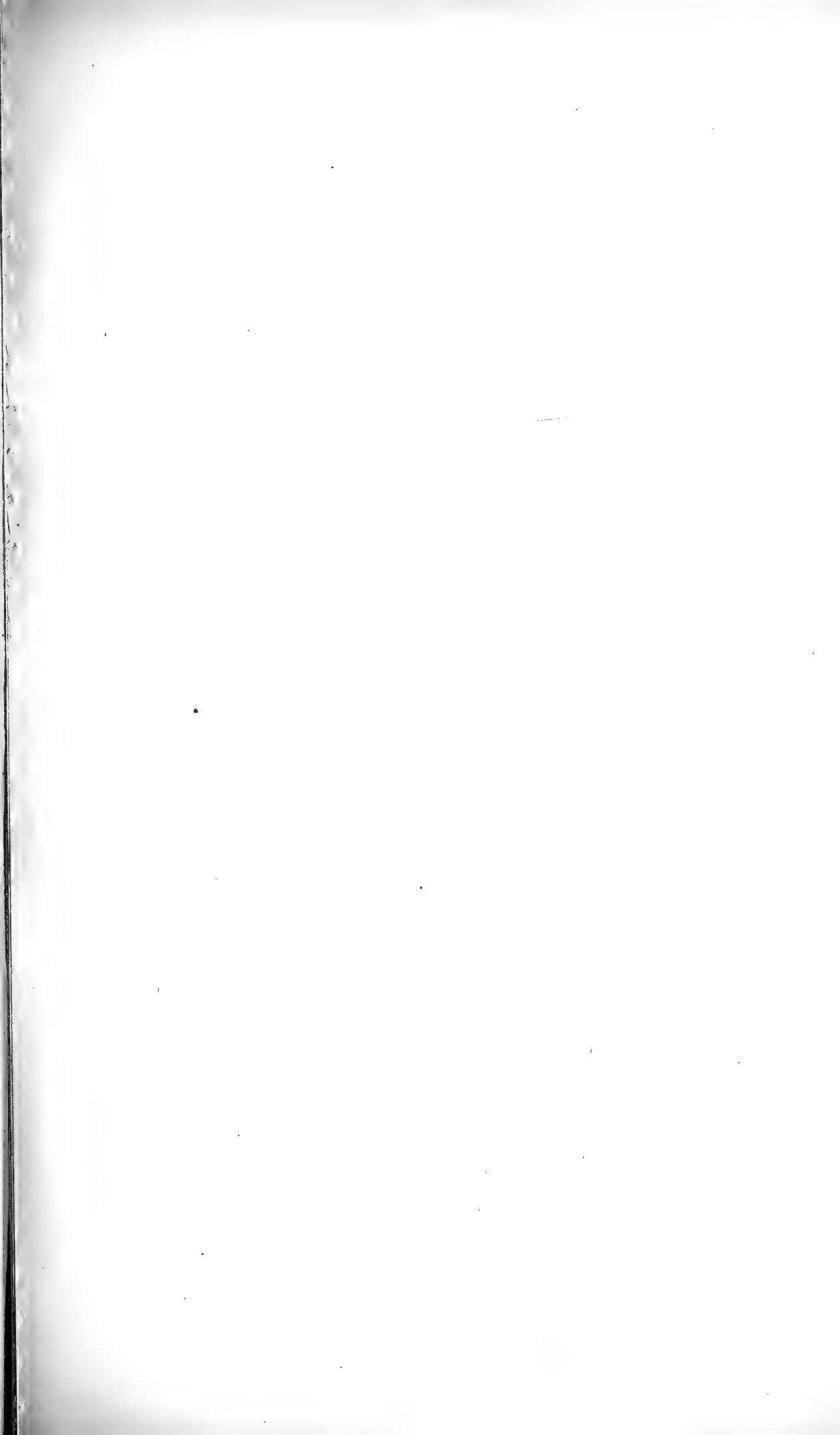
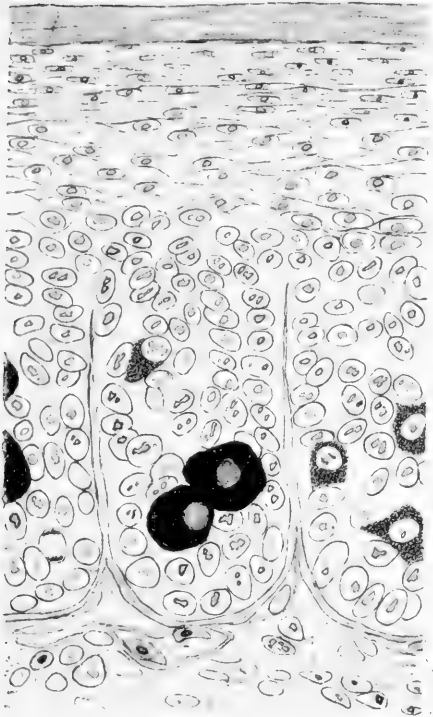


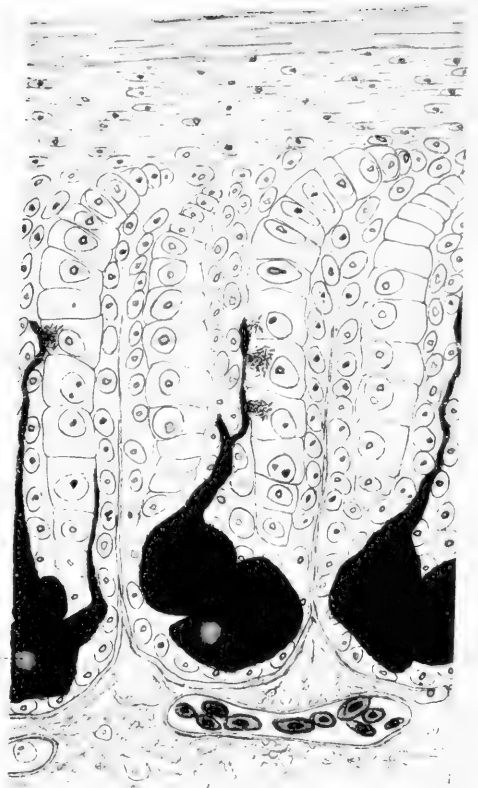
PLATE 3.

- Figs. 15-18. Transverse sections of feather germs of *Sterna hirundo*.  $\times 495$ .
- Fig. 15. Section at level 15 in Figure 1.
- Fig. 16. Section at level 16, Figure 1.
- Fig. 17. Section at level 17, Figure 1.
- Fig. 18. Section at level 18, Figure 1. *prc.* A pigment-cell process apparently not entirely filled with pigment granules.

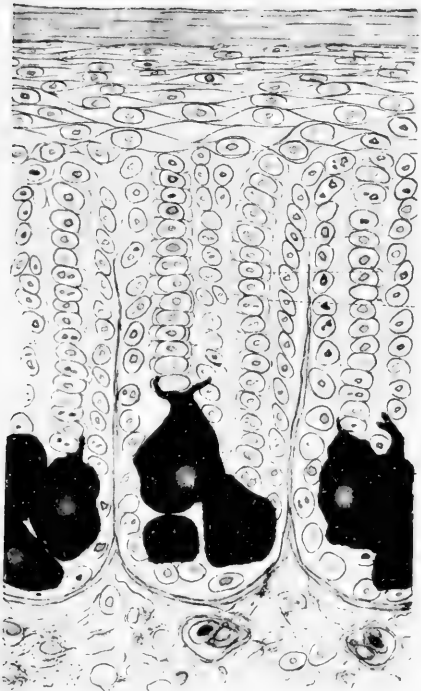




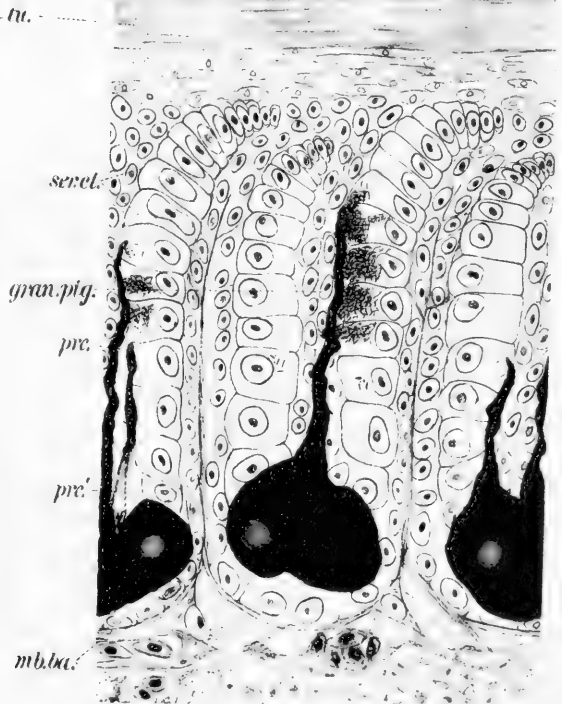
15



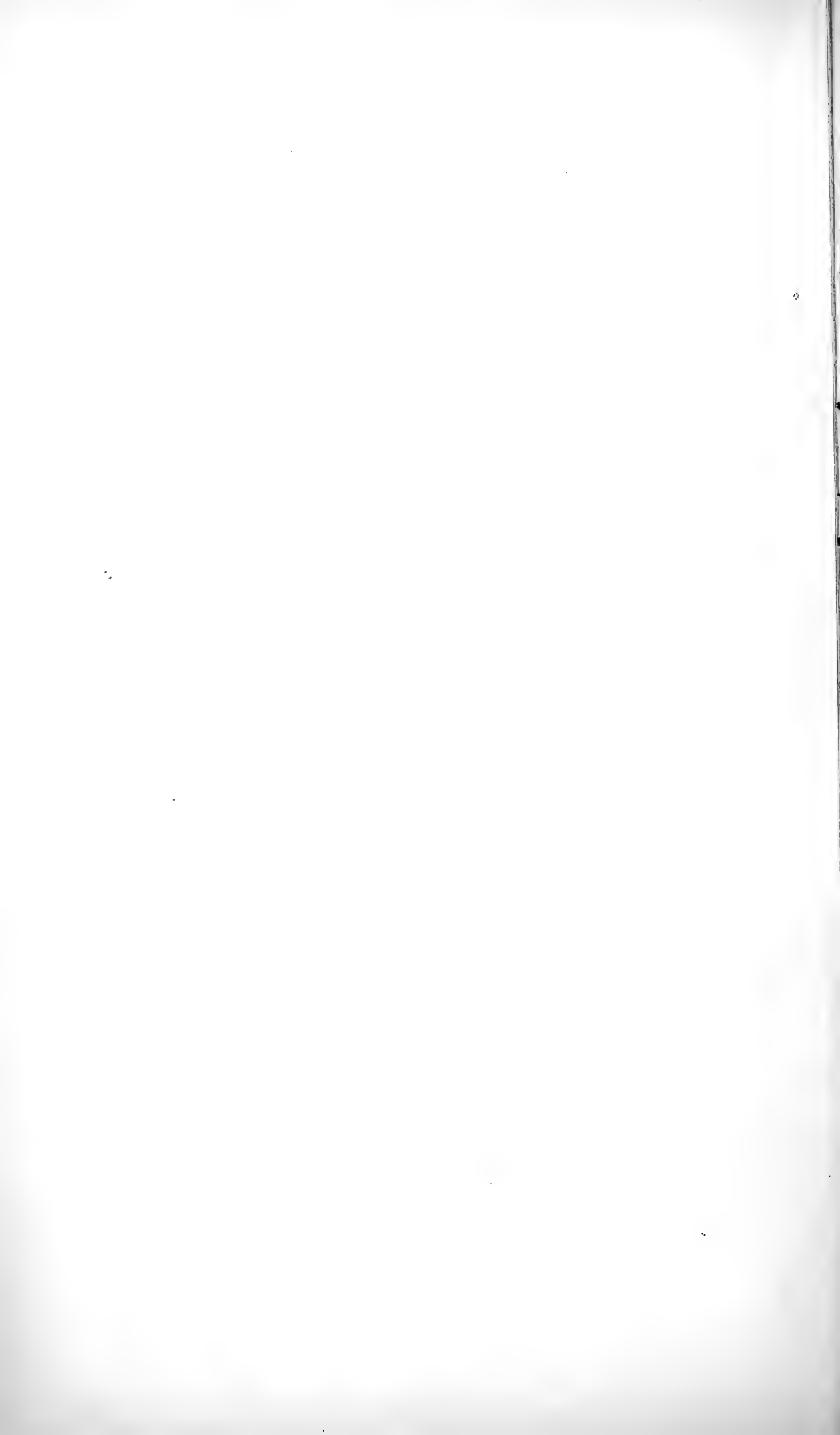
17



16



18



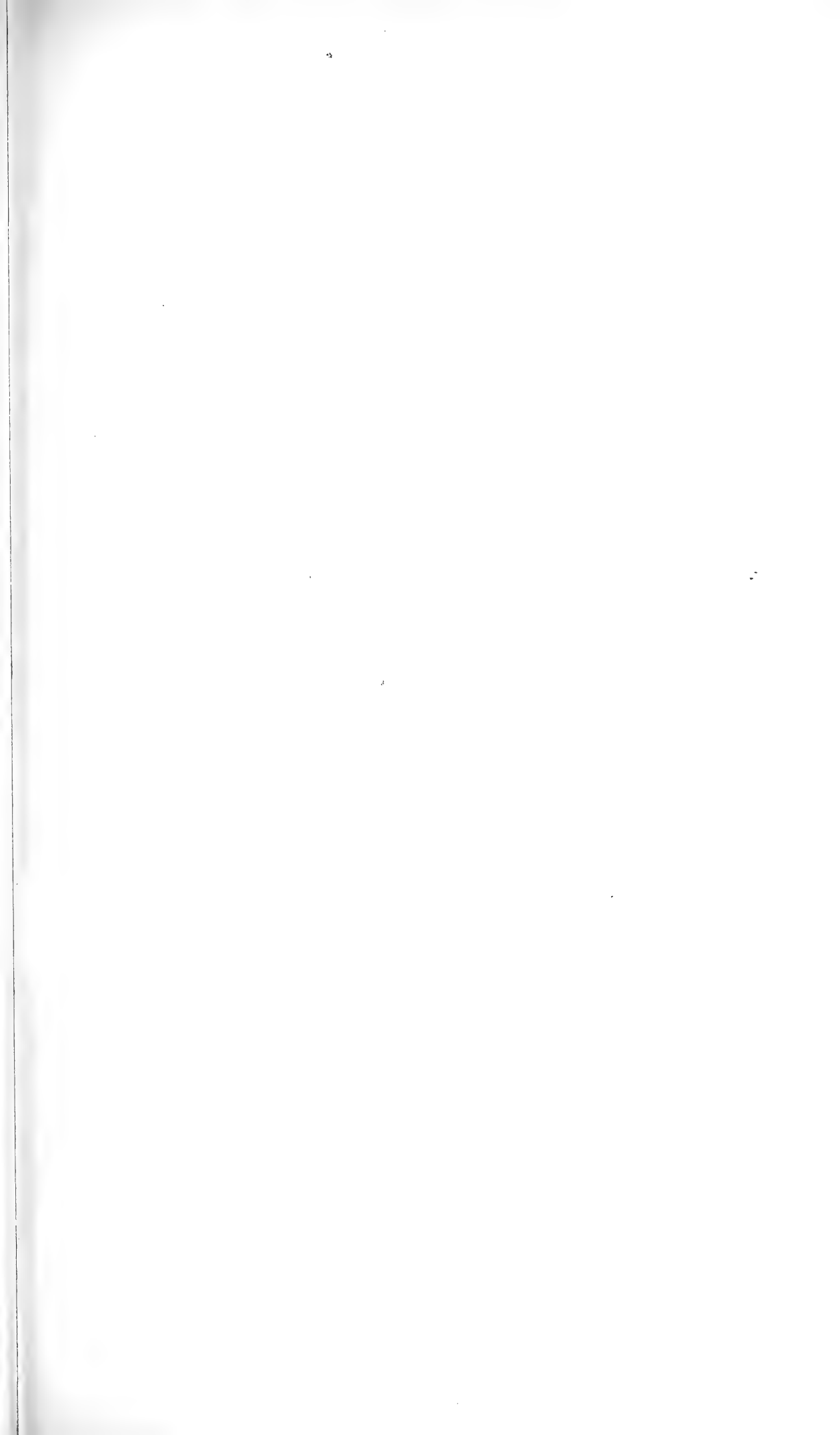
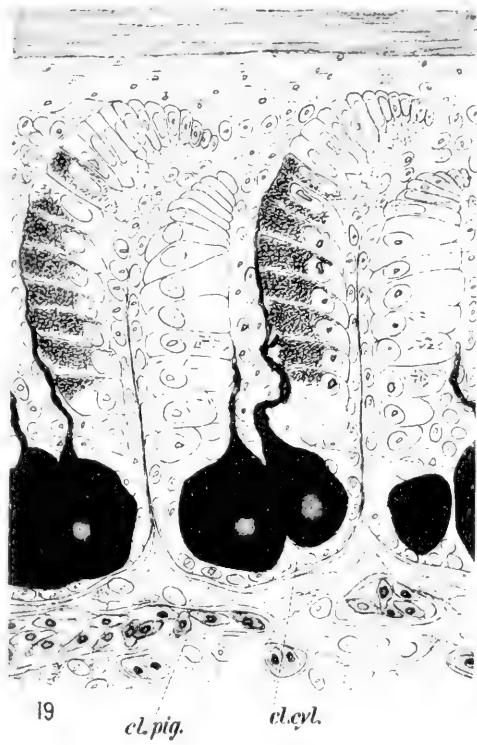


PLATE 4.

- Figs. 19-21. Transverse sections of feather germ of *Sterna hirundo*. × 495.  
Fig. 19. Section at level 19, Figure 1.  
Fig. 20. Section at level 20, Figure 1.  
Fig. 21. Section at level 21, Fig. 1. *cl. pig.* Unused pigment.  
Fig. 22. Section of feather germ of body covert of *Passerina cyanea*, showing pigmentation of blue portion of feather and also the withdrawal of the feather elements from the surrounding tissue. × 495.



19

*cl. pig.*

*cl. cyl.*

*tu.*

*ser. cl.*

*cl. cyl.*

*cl.*

*med.*

*cl. pig.*

21

*cl.*

*cl. cyl.*



20

*cl.*

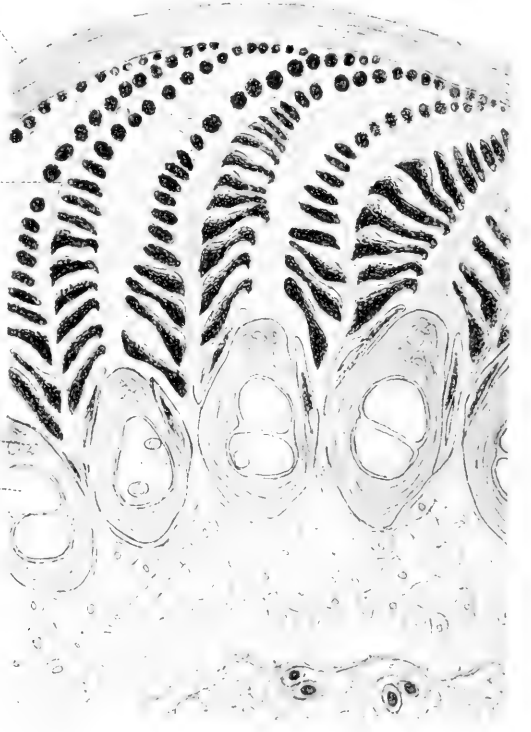
*tu.*

*ser. cl.*

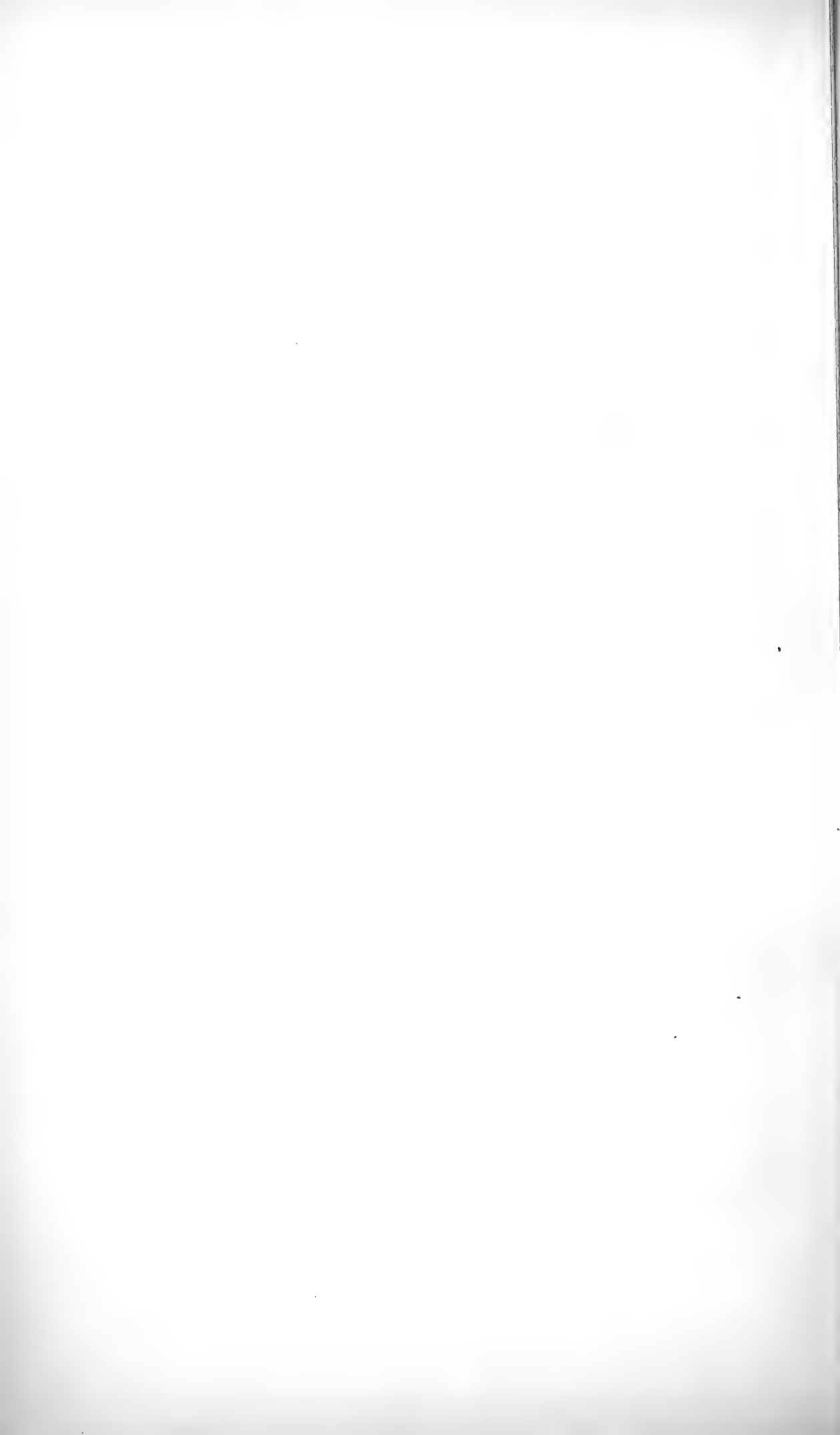
*ind. brb.*

*ctx.*

*med.*



22



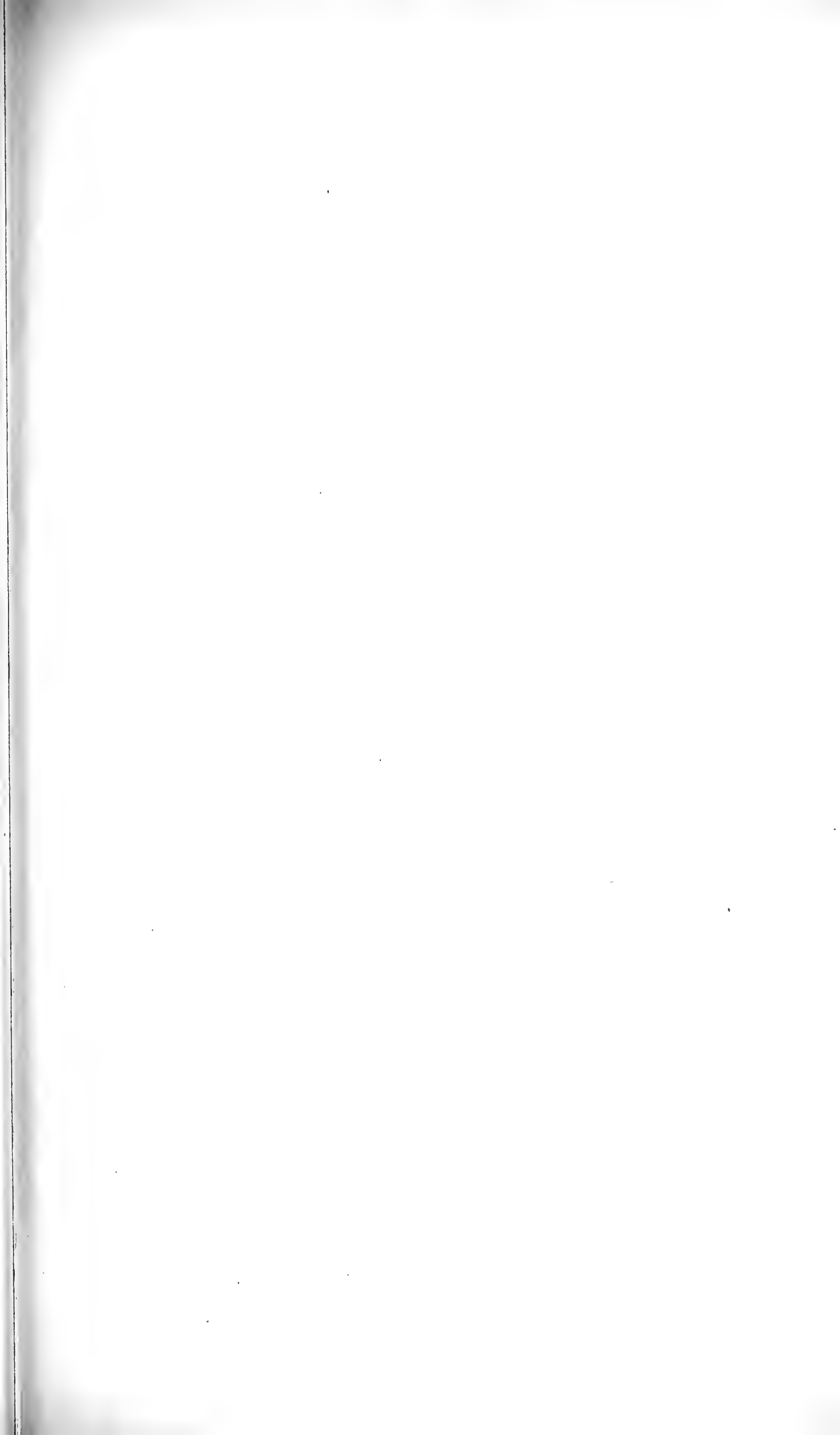


PLATE 5.

All Figures are from feathers of *Sterna hirundo* except Fig. 29.

Fig. 23. Transverse section of feather germ at level 23 in Fig. 1.  $\times 495$ .

Note, — By an oversight the proximal and distal barbules are lettered *brb.* instead of *brbl.*

Fig. 24. Transverse section of wing-covert, showing withdrawal of barbs from the surrounding tissue preceding the unfolding of the feather.  $\times 495$ .

Fig. 25. A proximal barbule from wing-feather.  $\times 117$ .

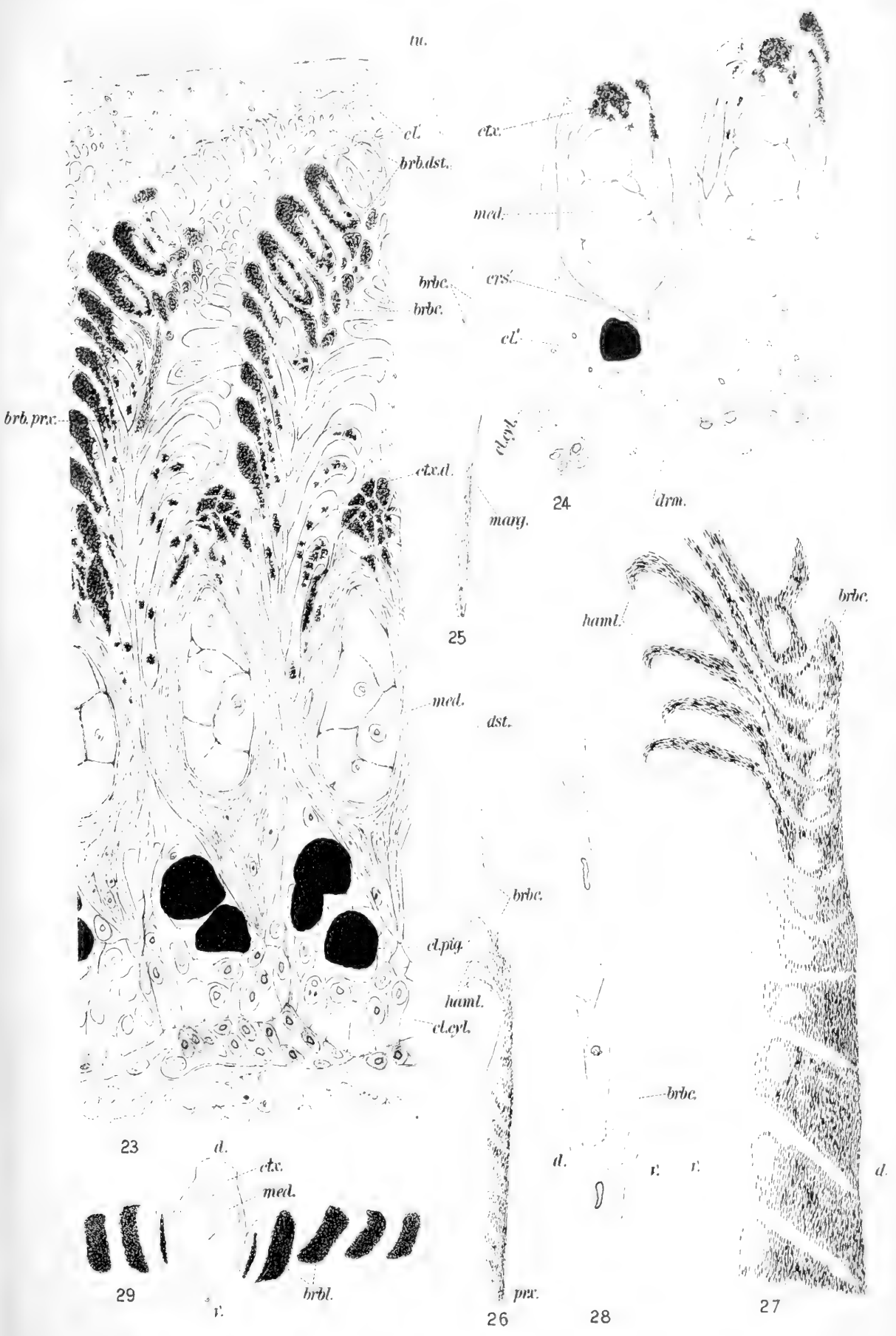
Fig. 26. A distal barbule from wing-feather.  $\times 117$ .

Fig. 27. Middle portion of a barbule from wing-feather showing distribution of pigment, the form of the cells composing the barbule, and the formation of barbicels. Cornification is not yet complete.  $\times 495$ .

Fig. 28. Distal portion of barbule shown in Figure 27.  $\times 495$ .

Fig. 29. Transverse section of barb from blue portion of a body-covert of *Passerina cyanea* with portions of barbules on either side.  $\times 495$ .







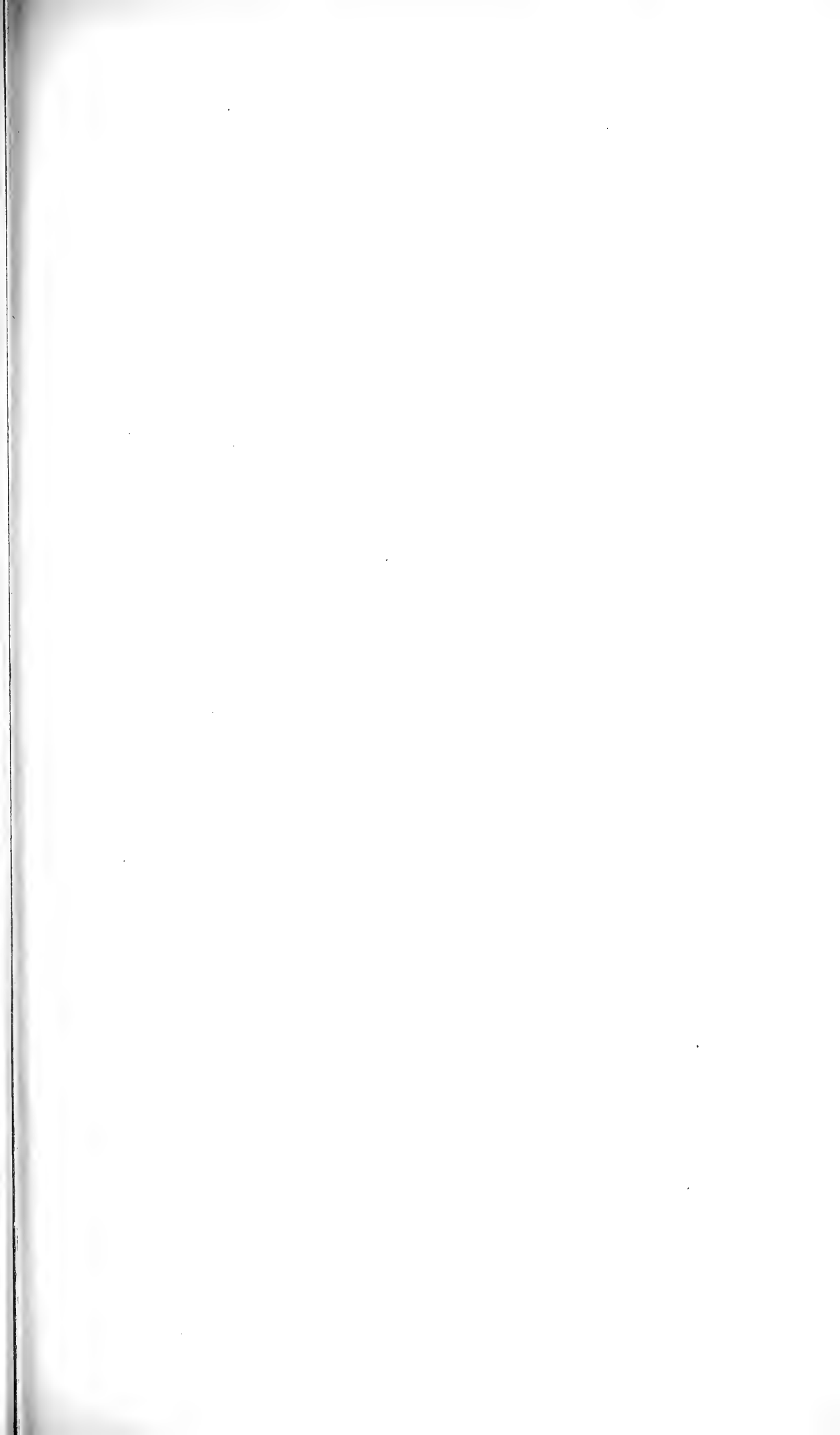
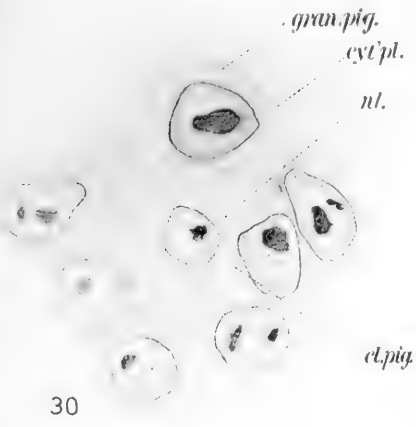


PLATE 6.

All Figures are from feather germs of *Sterna hirundo*.

- Fig. 30. Transverse section showing first appearance of pigment granules in the cytoplasm of the pigment cell.  $\times 1500$ .
- Figs. 31-34. Successive stages in development of pigment cells. Figures 31 and 32 represent about the same stage.  $\times 1500$ .
- Fig. 35. Pulp edge, or apex, of a ridge of the feather fundament, showing three pigment cells with granules crowded into an opaque mass and with processes beginning to be formed.  $\times 1500$ .
- Fig. 36. A somewhat later stage, showing pigment granules or rods entering barbule cells (compare Plate 3, Fig. 17).  $\times 1500$ .

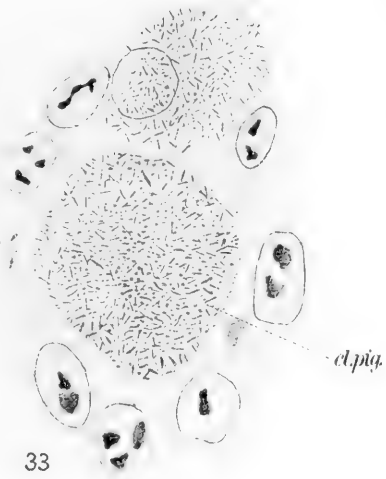


30

31



32



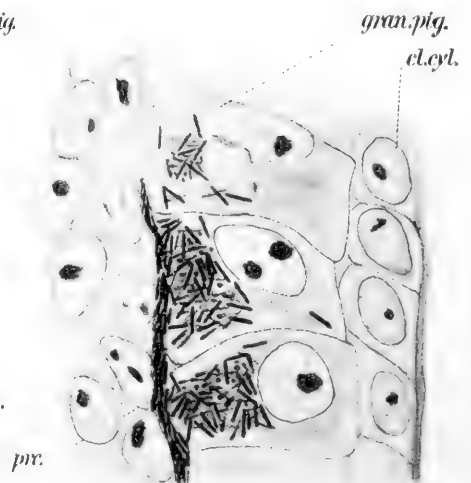
33



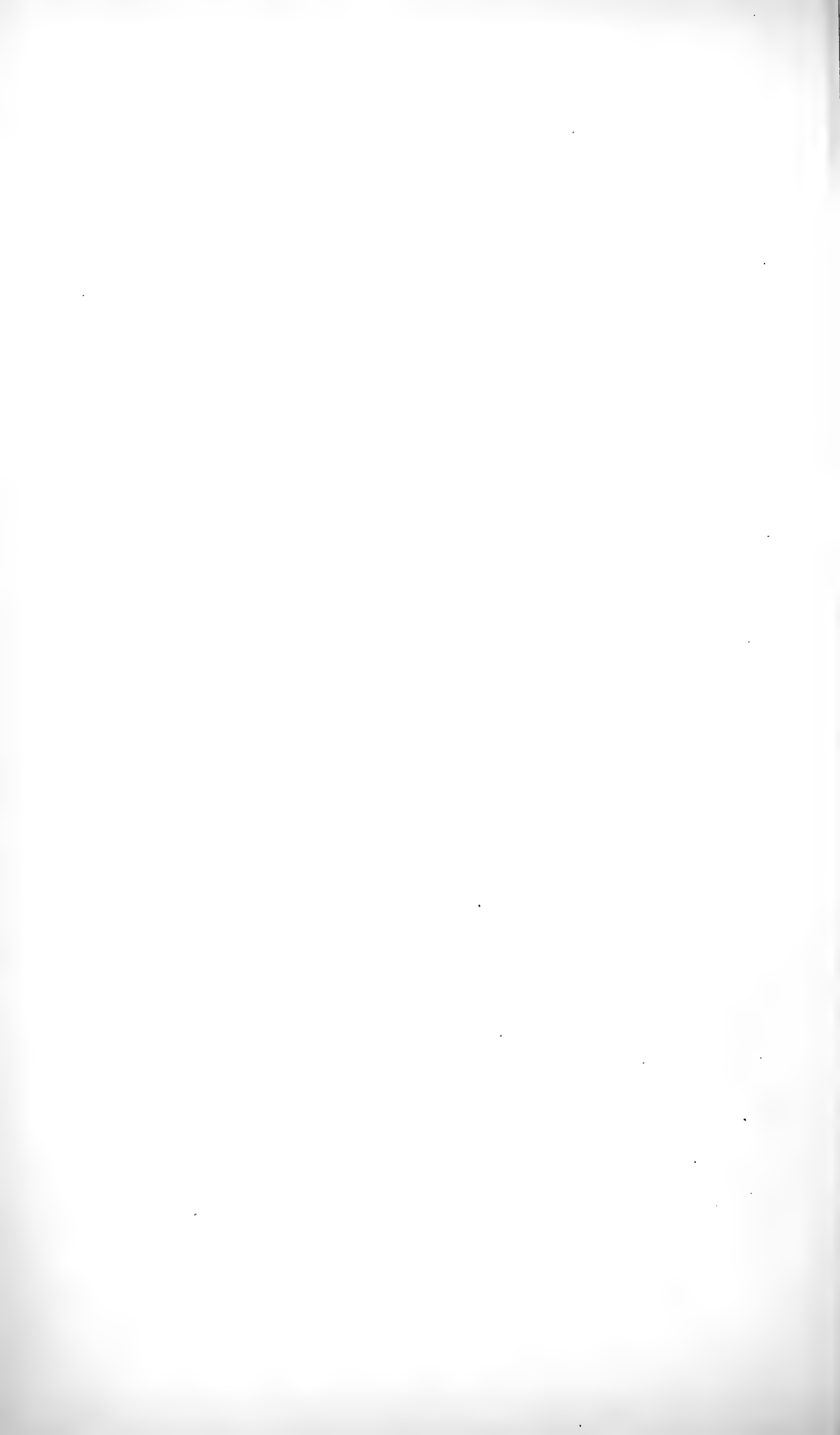
34



35



36



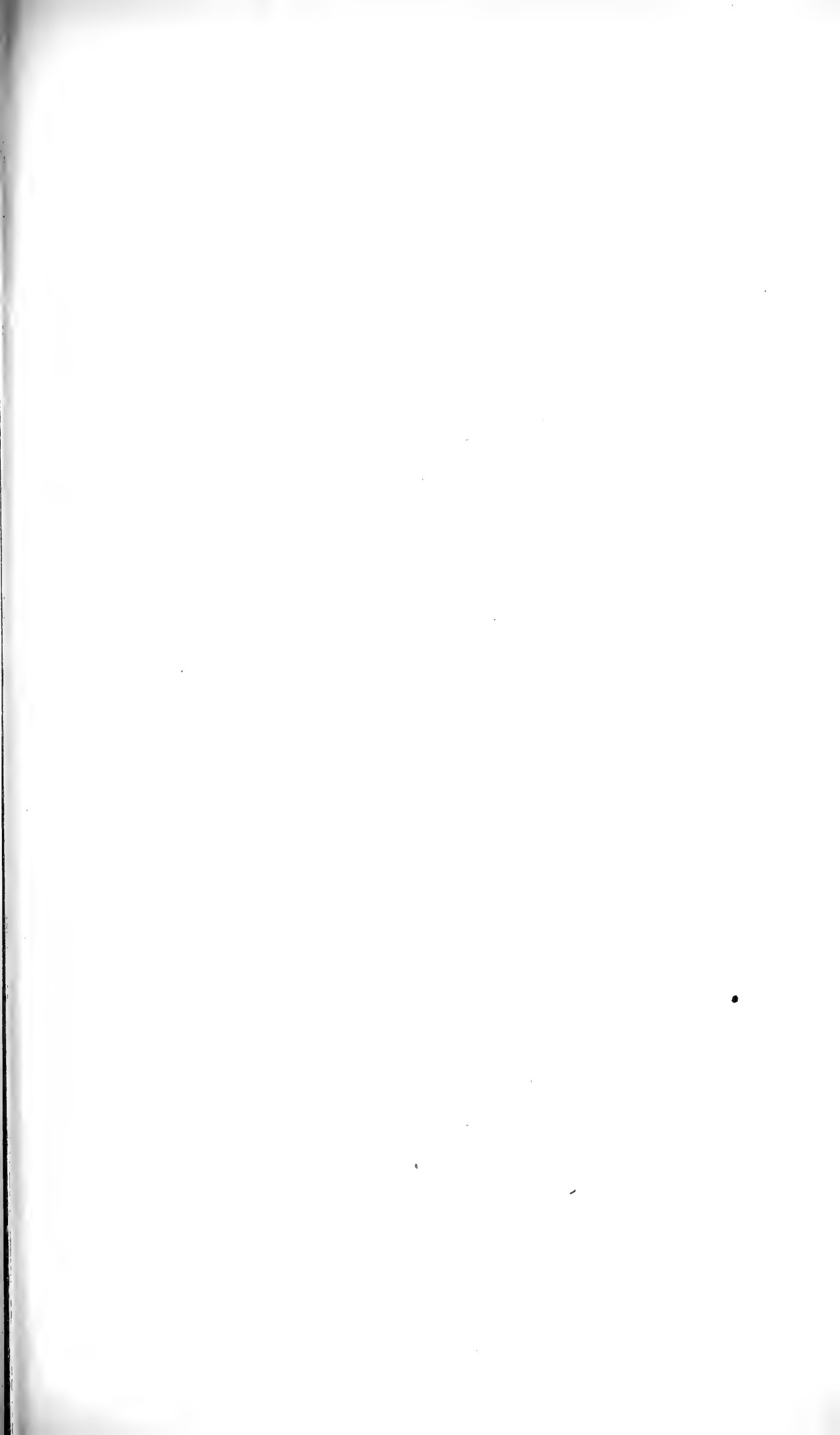


PLATE 7.

Photomicrographs.

- Fig. 37. Portion of transverse section of feather germ from *Sterna hirundo*.  $\times 300$ .  
Fig. 38. Portion of longitudinal section of blue-feather germ from *Passerina cyanea*.  $\times 480$ .



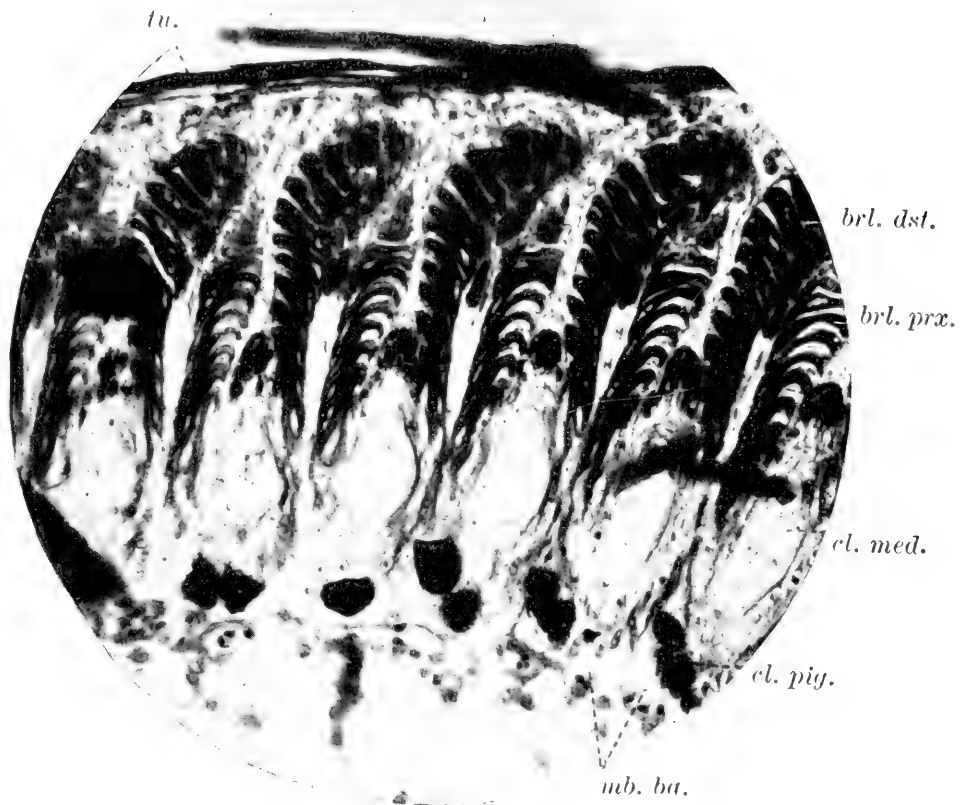


Fig. 37.

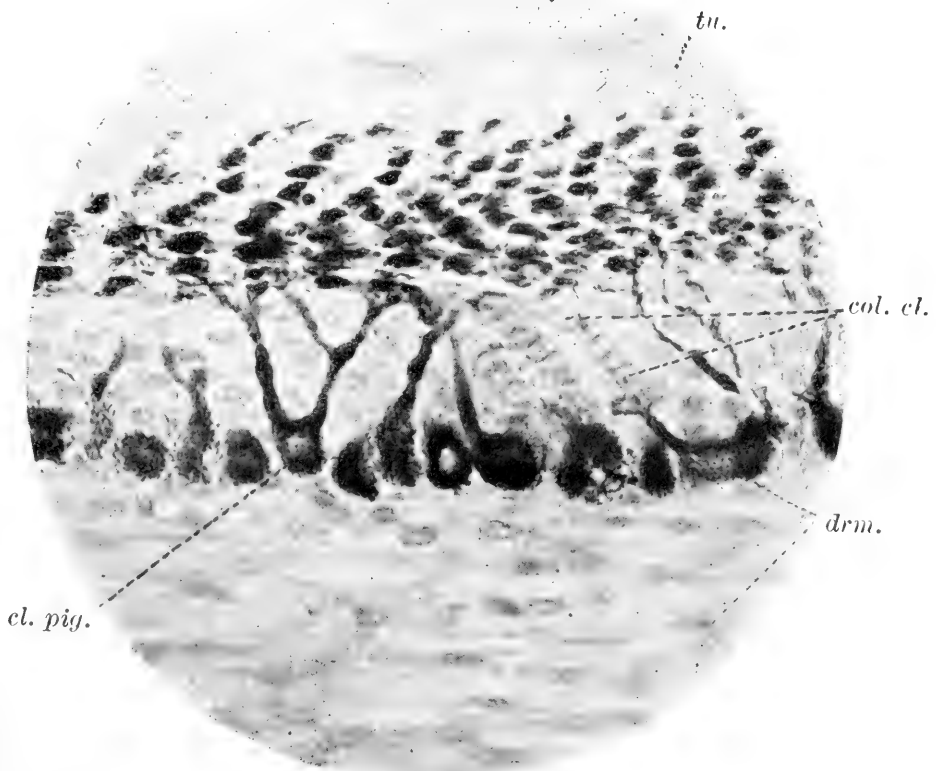


Fig. 38.



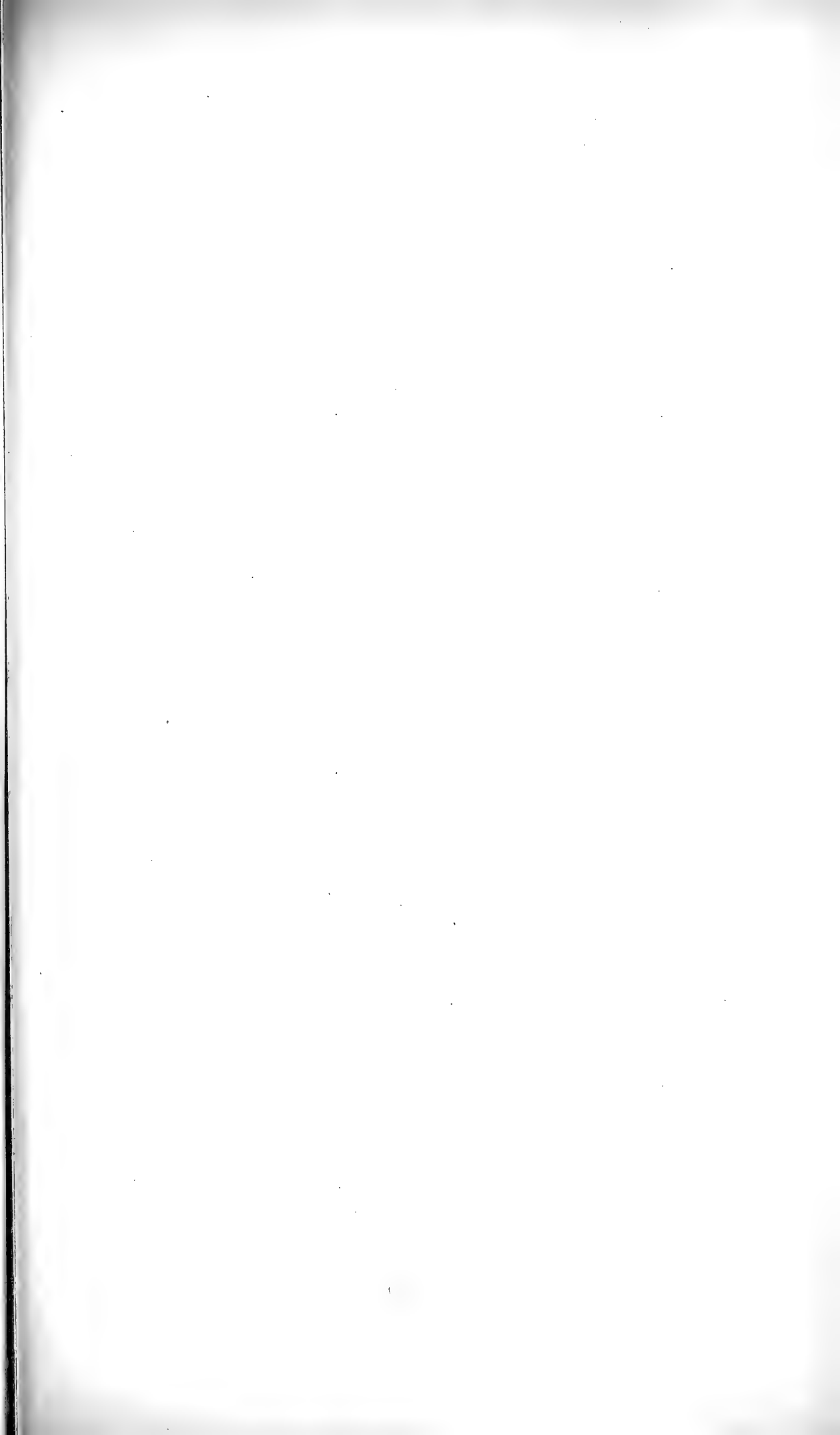


PLATE 8.

Photomicrographs.

- Fig. 39. Transverse section of blue-feather germ from *Passerina cyanea*. × 250.  
Fig. 40. Transverse section of green-feather germ from *Passerina ciris*, showing process of pigmentation of the barbules. × 157.

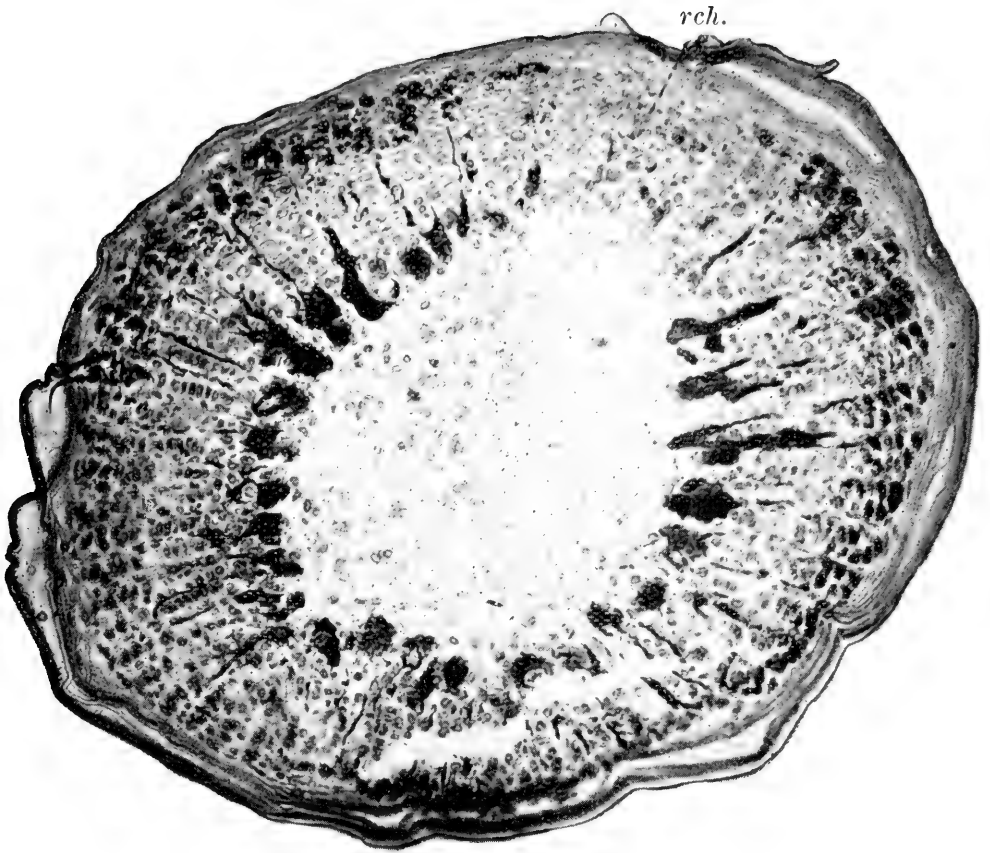


Fig. 39.

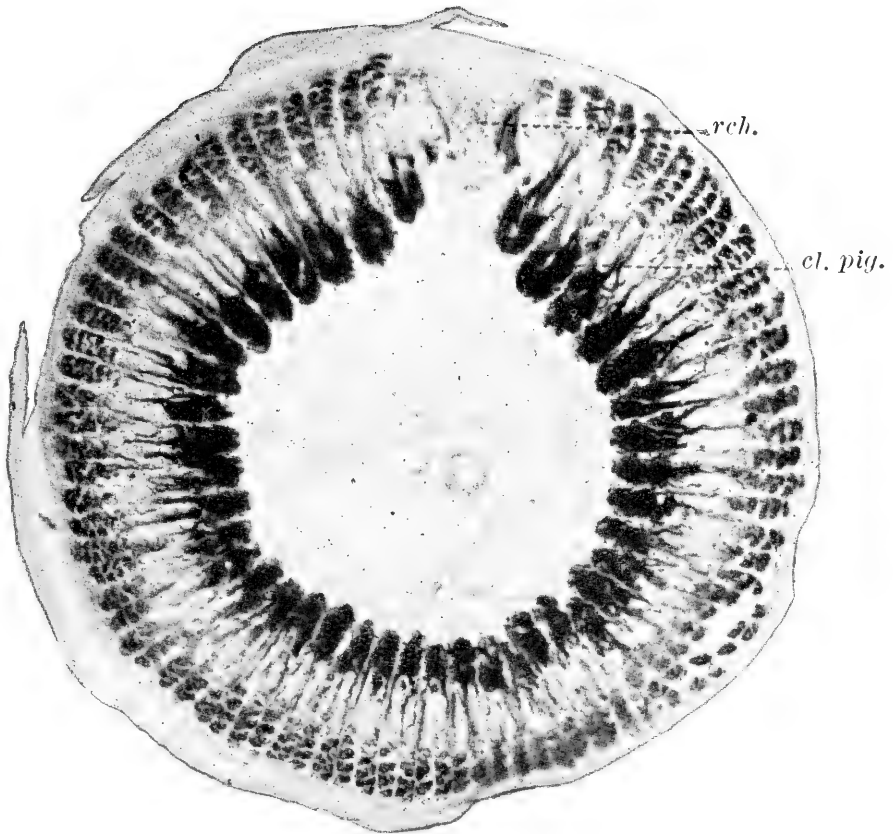
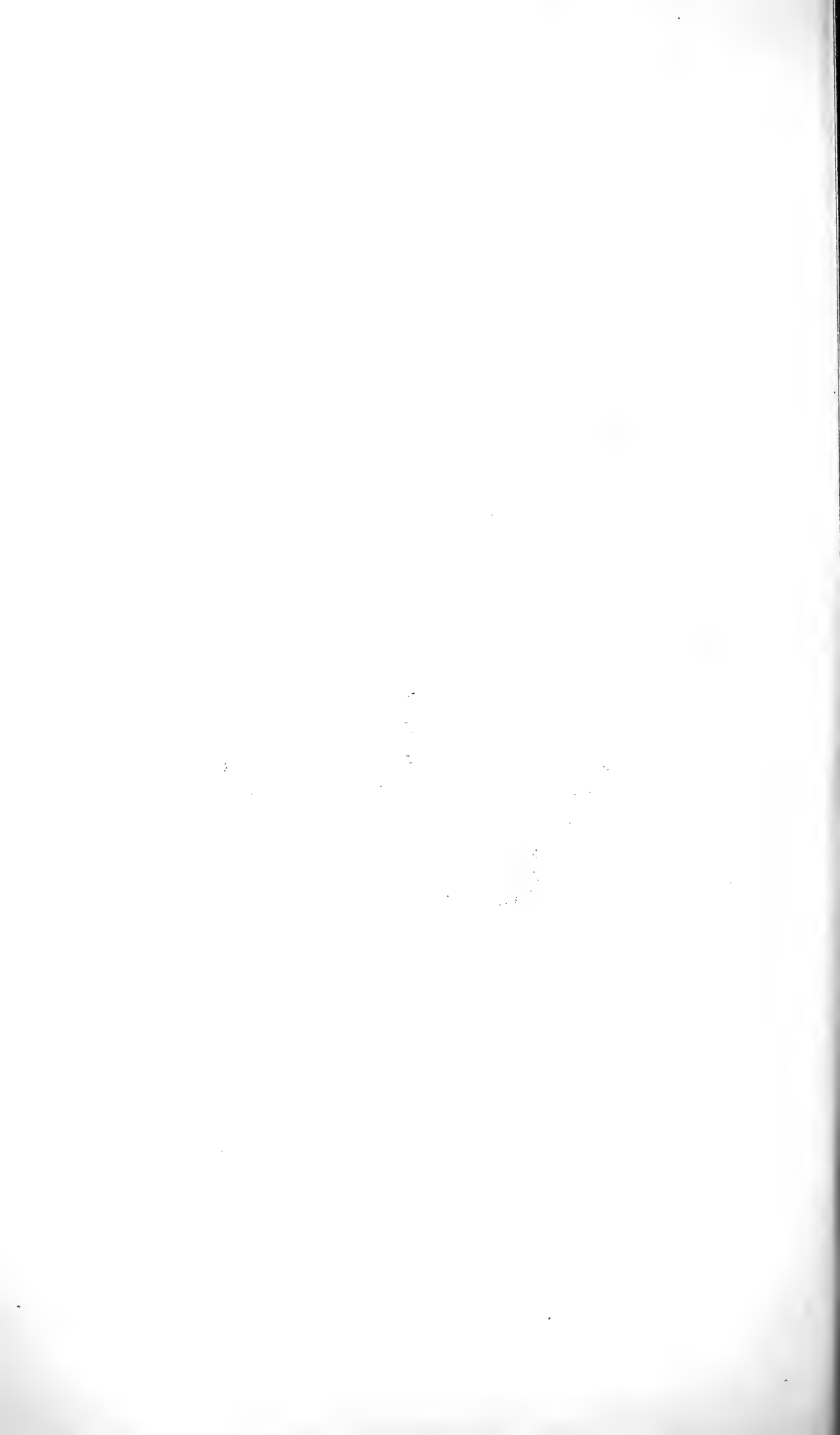


Fig. 40.



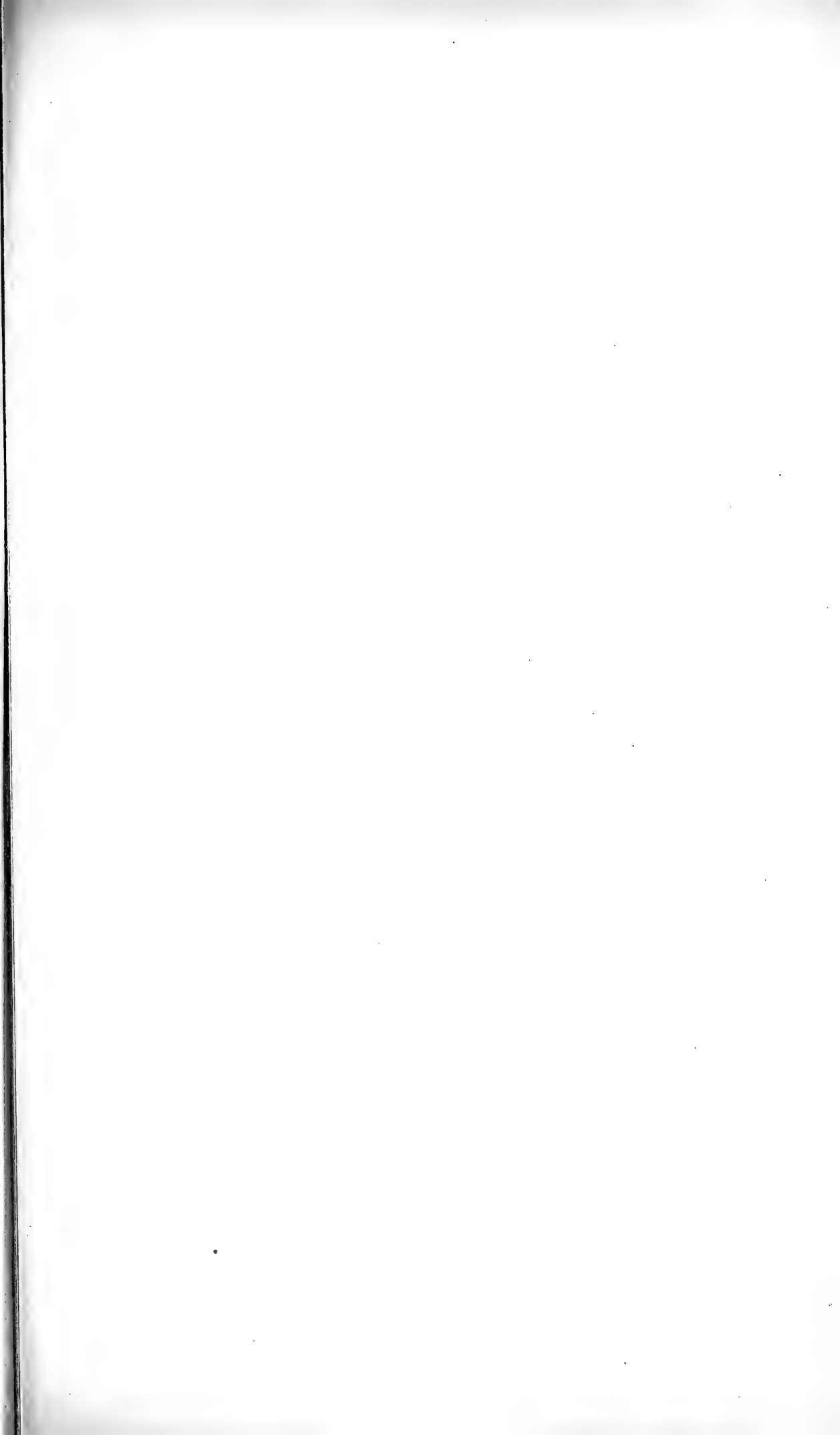


PLATE 9.

Photomicrographs.

- Fig. 41. Transverse section of green-feather germ from *Passerina ciris*, showing pigmentation completed and cornification nearly so.  $\times 157$ .
- Fig. 42. Transverse section of wing-feather from the "homer" pigeon, showing differentiation and cornification completed.  $\times 69$ .



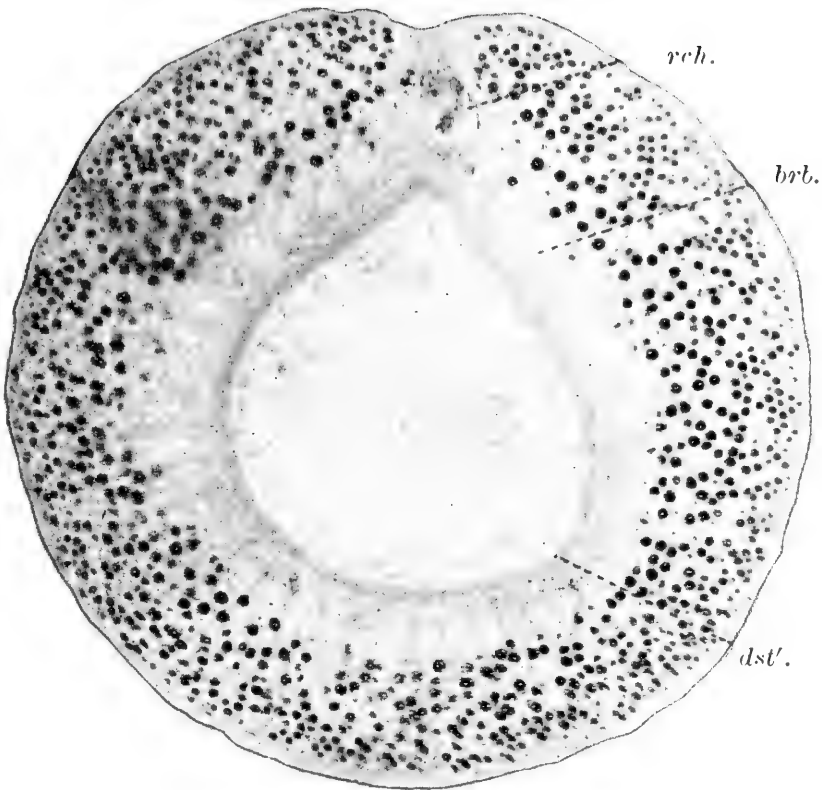


Fig. 41.

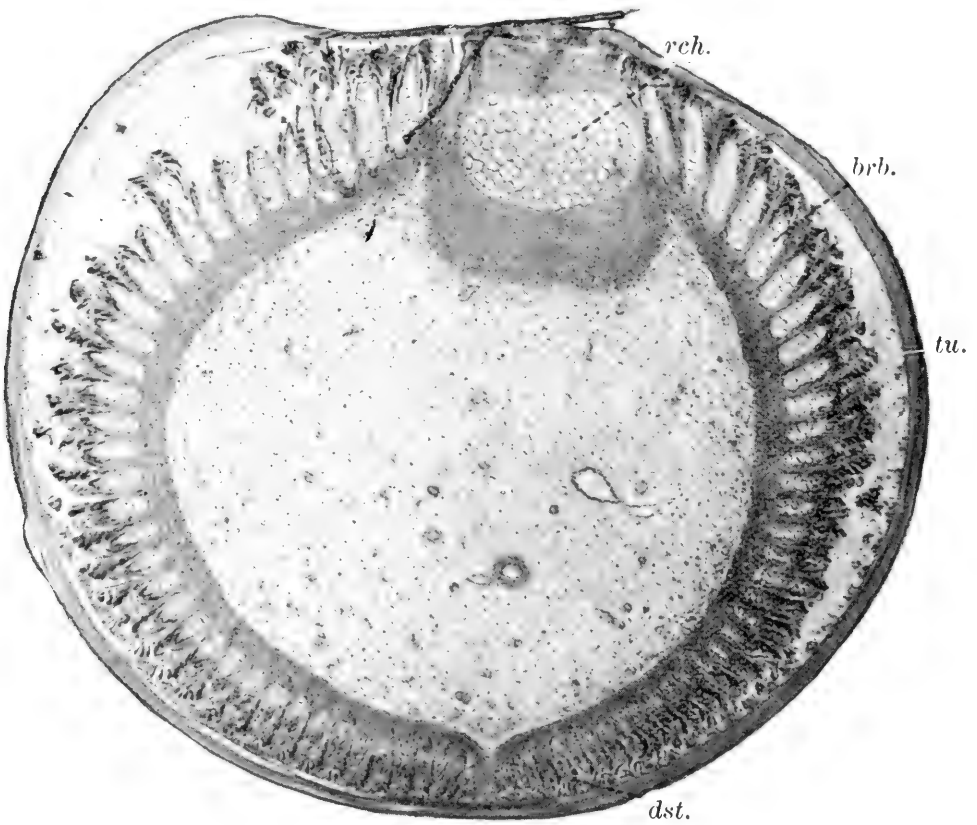


Fig. 42.







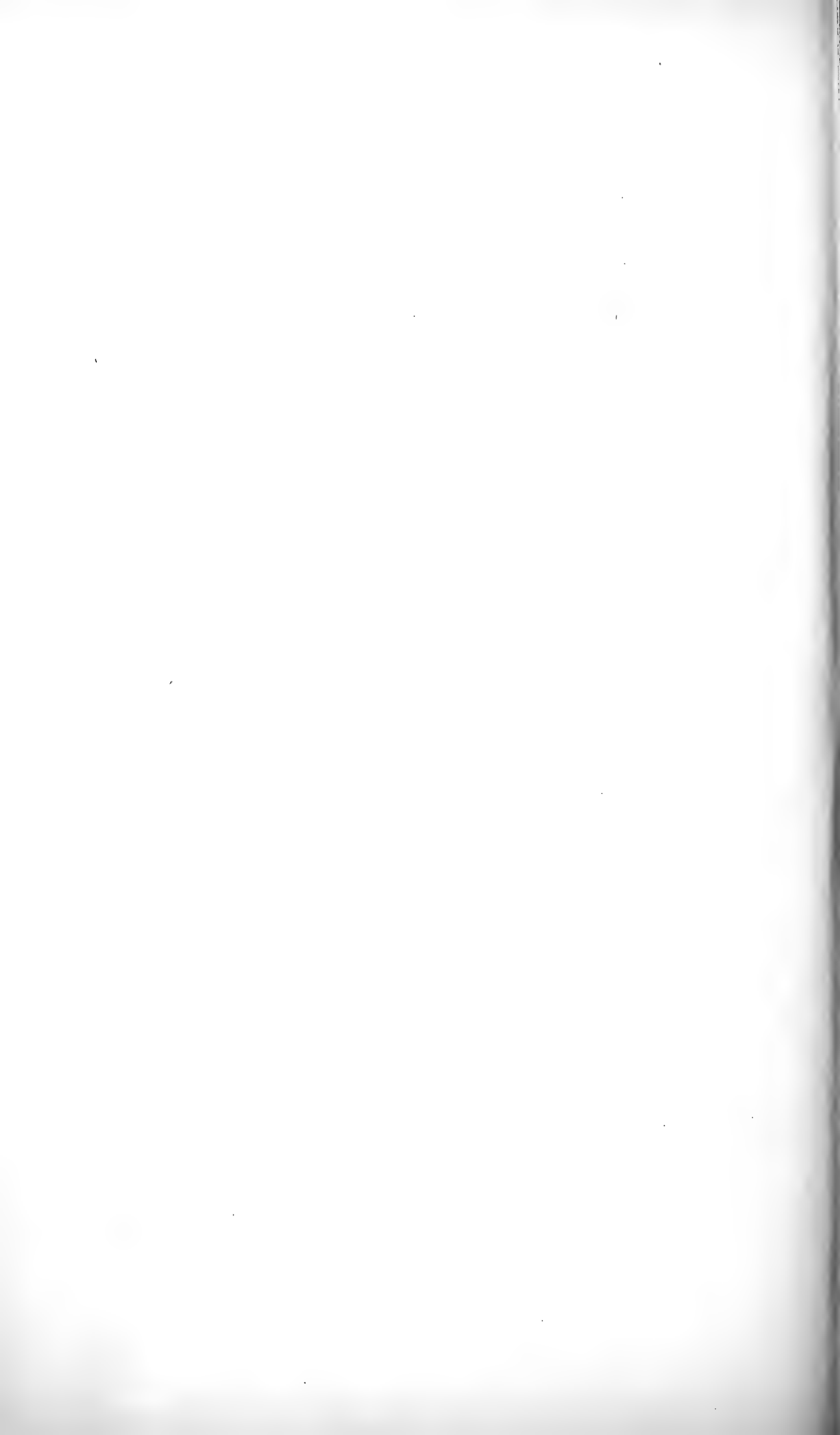
Bulletin of the Museum of Comparative Zoölogy  
AT HARVARD COLLEGE.  
VOL. XL. No. 4.

---

THE HEREDITY OF SEX.

BY W. E. CASTLE.

CAMBRIDGE, MASS., U. S. A.:  
PRINTED FOR THE MUSEUM.  
JANUARY, 1903.



*The Heredity of Sex.* By W. E. CASTLE.

CONTENTS.

	PAGE		PAGE
I. Introduction . . . . .	189	(b) Special cases . . . . .	201
II. Sex an attribute of each gamete, and hereditary . . . . .	190	A. <i>Rhodites rosae</i> . . . . .	201
III. Principles of heredity applicable to sex . . . . .	191	B. <i>Hydatina senta</i> . . . . .	202
1. Mendel's law . . . . .	191	C. <i>Artemia salina</i> . . . . .	203
(a) The principle of dominance . . . . .	191	D. Exceptional parthenogenesis in <i>Bombyx mori</i> , etc. . . . .	205
(b) The principle of segregation . . . . .	192	V. Abnormal sex proportions among hybrids . . . . .	205
2. Mosaic inheritance . . . . .	192	1. Relative infertility of certain combinations of gametes . . . . .	206
IV. Application of the principles stated . . . . .	193	2. Coupling of certain sex and somatic characters in the germ-cells . . . . .	208
1. Dioecious and hermaphrodite organisms . . . . .	193	VI. Summary . . . . .	214
2. Parthenogenetic organisms . . . . .	198	Bibliography . . . . .	216
(a) General application . . . . .	198		

I. Introduction.

A NEW theory of sex is advanced in this paper, yet a theory which in its elements is not new. It is an attempt to correlate three ideas, the correctness of which, separately considered, is generally recognized: (1) the idea of Darwin ('76), that in animals and plants of either sex the characters of the opposite sex are latent; (2) the idea of Mendel ('66), that in the formation of the gametes of hybrids a segregation of the parental characters takes place, and when in fertilization different segregated characters meet, one will dominate, the other become latent or recessive; (3) the idea of Weismann ('93) that in the maturation of egg and spermatozoön, a segregation of ancestral characters takes place, and that this segregation is attended by a visible reduction in the number of chromosomes in the germinal nuclei.

## II. Sex an Attribute of each Gamete, and Hereditary.

The last forty years have seen the rise, culmination, and at least incipient decline of a plausible but fundamentally erroneous idea about sex, — the idea that it is subject to control through the environment of the developing organism. The latest manifestation of this idea is found in Schenk's (:02, :02<sup>a</sup>) theory of sex-control in man through regulation of the nutrition of the mother. One or the other, or both, of two fallacies are involved in all such theories of sex-control. (1) It is known that in animals which reproduce sometimes by parthenogenesis, sometimes by fertilized eggs, *good nutrition* favors the former process, poor nutrition the latter. But in the former process, when it proceeds without interruption, the offspring are all of the female sex, whereas the first effect of poor nutrition is the production of males, and this is followed by the production of fertilized eggs. The conclusion is drawn that *good nutrition* favors the production of females *among animals generally*, and that poor nutrition results *in general* in the production of males. As a matter of fact the primary effect of good nutrition, in the case described, is *not female production, but parthenogenesis*, and the effect of poor nutrition is, *not primarily male production, but reproduction by fertilized eggs*, in which process the production of males is necessarily involved. The determination of parthenogenesis instead of sexual reproduction is one thing, determination of sex in animals not parthenogenetic is quite another thing. (2) The other fallacy mentioned relates solely to the case of animals not parthenogenetic. Its true nature has been repeatedly pointed out, but apparently none too often, for Schenk seems to rest his theory upon it. Feeding experiments, especially with Lepidoptera, often lead to the production of an excess of males when the nutrition is scanty, simply because the female requires a greater amount of food to complete her development. Excess of males because of a greater mortality among female individuals is wrongly interpreted as a production of male individuals by a scanty diet.

On the other hand, evidence has been steadily accumulating in recent years to show that sex is inherent in the germ, and is not subject to control in the slightest degree by environment. A masterly summary of this evidence has been made in the case of animals by Cuénot ('99), and in the case of plants by Strasburger (:00).

If it be true that sex is inherent in the germ, and is independent of environment, it must be contained in one or the other or both of the



sexual gametes, and the appropriate subject for investigation is the law or laws of its inheritance, rather than the visionary external causes of sex.

That sex is borne by the egg is shown clearly by the case of parthenogenetic animals, which without the intervention of a male produce young of both sexes. That the spermatozoön also bears sex is manifest in the case of animals like the honey-bee, for the egg of the bee, if unfertilized, invariably develops into a male, but if fertilized, into a female. We have, therefore, specific reasons, in addition to the general ground of the equivalency of egg and spermatozoön, for supposing that sex is a character possessed by every egg and spermatozoön.

In the following pages I have attempted to formulate certain of the laws of sex-heredity, an attempt which is greatly aided by recent developments in our knowledge of heredity in general.

### III. Principles of Heredity Applicable to Sex.

#### 1. MENDEL'S LAW.

Perhaps the greatest discovery ever made in the study of heredity is what is commonly known as Mendel's Law. Bateson and Saunders (: 02) in a recent paper suggest that sex may be inherited in accordance with that law. In the light of this suggestion certain phenomena of sex are in this paper examined, and found to have their almost perfect parallels in recognized Mendelian phenomena. In consequence we get a new point of view from which to study the phenomena of sex, and many of its long-time mysteries find ready explanation. The basic principles of Mendel's law are two, the principle of dominance and the principle of segregation.

(a) *The Principle of Dominance.* When there unite in fertilization two gametes, one of which bears one of a pair of alternative characters, while the other gamete bears the other character, it often happens that the zygote formed manifests only *one* of the two characters. This character may be called the *dominant* one. The other character becomes latent, or *recessive*, and is first seen in the next generation of offspring. For example, when white mice are crossed with wild gray mice, all the offspring are gray, that character being dominant, white recessive. White mice are never obtained in the first hybrid generation, but upon breeding of the primary hybrids *inter se*, both white and gray offspring are obtained approximately in the ratio, 1:3.

(b) *The Principle of Segregation.* The appearance of white mice, as just described, in the second hybrid generation, follows from the principle of segregation. The primitive germ-cells of the primary hybrid contain both parental characters, *D* (dominant) and *R* (recessive), but in the maturation of the germ-cells the two are separated, so that the ripe germ-cell (or gamete) contains either *D* or *R*, but not both. This is demonstrably true in both sexes. Accordingly there are ova, *D* and *R*, and spermatozoa, *D* and *R*. If dominants and recessives are produced by each parent in equal abundance, and they unite at random, the sorts of zygotes resulting and their relative frequencies of occurrence will be expressed by the product, —

$$\frac{D + R \text{ (ova)} \\ D + R \text{ (spermatozoa)}}{DD + 2 D (R)^* + RR \text{ (zygotes)}}.$$

One individual in four will be a pure dominant, *DD* (gray in the case of mice); likewise one in four will be a pure recessive, *RR* (white in mice); while two in four will be hybrids, *D (R)*, like their parents, the primary hybrids, though indistinguishable in appearance from the pure dominant, *DD*.

## 2. MOSAIC INHERITANCE.

An important exception to the two principles just stated needs to be noted. In cases otherwise conforming to Mendel's law, there sometimes occur exceptional hybrid individuals in which the normal dominance of one character is not realized, but the two alternative characters coexist in a patchwork or mosaic arrangement. Such a condition is illustrated in the case of piebald, or spotted, mice.

Segregation of characters does not commonly occur in the formation of the gametes produced by mosaic individuals. The gametes, as well as the parents, are mosaic, *DR*. For when two mosaic individuals are mated, they commonly produce only mosaic offspring; and when a mosaic is mated with a pure recessive, *RR*, no recessive offspring are as a rule produced. These facts show clearly that the ordinary mosaic individual forms no pure recessive gametes; in other words, that *segregation does*

\* The parenthesis is used to indicate that the recessive character, though present, is not visible. Whenever the recessive character alone is present in an individual [as in (*RR*)], it will of course be visible; but whenever the recessive character is present together with the dominant [as in the two individuals *D (R)*], the recessive character will not be visible.

*not occur* at the formation of its gametes. Nevertheless a mosaic individual does occasionally occur which produces a certain proportion of segregated (that is, *pure*) gametes. Exceptionally a spotted mouse when paired with a recessive mate produces pure recessive (white) offspring as well as hybrid (dark) offspring. The peculiarity is inherent in the parent and is manifested with uniformity by certain individuals, but not at all by others.

#### IV. Application of the Principles Stated.

##### I. DIOECIOUS AND HERMAPHRODITE ORGANISMS.

Sex in dioecious animals and plants is inherited in accordance with Mendel's law; that is, in accordance with the principles of dominance and segregation. The ordinary dioecious individual is a sex-hybrid or "heterozygote" (Bateson), in which the characters of both sexes are present, one dominant, the other recessive. In the male, the female character is recessive, and conversely in the female, the male character; but each sex transmits the characters of both.

The existence of each sex (in a latent condition) in the other is shown by the occurrence in each sex of rudimentary organs peculiar to the other. This evidence is supported by numerous observations brought forward by Darwin ('76) to show that an animal in its old age, or when its genital organs become diseased, often manifests characters of plumage or of voice, or even instincts, which are characteristic of the opposite sex.

But perhaps the strongest evidence of the latency of each sex in the other is afforded by the transmission through one sex of the characters of the other. Thus, as Darwin states, when the domestic cock is crossed with the hen pheasant, the male offspring have the secondary sexual characters of the *male pheasant*; these, manifestly, must have been inherited through the *female* pheasant.

Again, in many animals which reproduce by parthenogenesis, the female bears (without fertilization) both male and female offspring, showing that she really possesses *both* sex-characters.

Experimental evidence of the latency of one sex in the other in plants has been produced by Bordage ('98). He cut back the apex of young male plants of *Carica papaya*, just before the appearance of the first male flowers. Lateral branches, two on each plant, then arose immediately below the cut, and these produced female flowers and fruit.

A somewhat similar case is described by Strasburger (:00), in which a smut, *Ustilago violacea*, when present as a parasite in the female plant of *Melandryum album*, causes the female organ of the latter, the pistil, to remain undeveloped, while the anthers, normally mere rudiments, grow to a large size and actually form pollen-mother cells, which the fungus then attacks and destroys. In this case it is the *male* character which, though normally recessive, is made to appear upon destruction of the genital fundament of the opposite sex; in the case of *Carica papaya*, it is the *female* character which behaves in a similar way.

The objection may be offered that certain of the examples cited really belong in the category of imperfect hermaphroditism, or at any rate of *potential* hermaphroditism. This I freely grant; I would even go farther and say that *all* animals and plants are *potential* hermaphrodites, for *they contain the characters of both sexes*, but ordinarily the characters of one sex only are developed, those of the other sex being latent or else imperfectly developed.

In true hermaphrodites, however, the characters of both sexes exist fully developed side by side, as do the gray and the white coat-colors in spotted mice. The true hermaphrodite, then, is a sex-mosaic; to the heredity of sex, in its case, we may expect to find applicable the general principles of mosaic inheritance.

The difference between a hermaphrodite and a dioecious animal is *precisely* parallel to that which exists between a spotted and a normal hybrid mouse. In the hermaphrodite, as in the spotted mouse, two characters ordinarily alternative exist as co-ordinates, side by side; in dioecious animals, as in ordinary hybrid mice, the same two characters exist in their more usual relationship of dominant and recessive. The only difference between the two classes of cases is this. In coat-color among mice gray is *invariably* dominant over, or balanced with white, but *never recessive* toward it. But in dioecious animals the male character is sometimes dominant over the female, sometimes balanced with it, and *sometimes recessive* toward it. This condition, though not paralleled in the illustration chosen (coat-color of mice), is not without a parallel among other Mendelian cases. For, Tschermak (:00) finds that in certain crosses among peas, one character may be, with reference to another, sometimes dominant, sometimes recessive.

We have seen that spotted (hybrid) mice commonly produce gametes which are, like themselves, mosaic, *DR*, whereas ordinary (gray) hybrids, in which white is recessive, produce "pure" gametes, either *D* or *R*, in accordance with the principle of segregation. Similarly the *sex*-mosaic,

the normal hermaphrodite, probably produces mosaic gametes, ♂ ♀, for when in fertilization these unite in pairs, they invariably form hermaphrodite individuals, ♂ ♀. If segregation occurred in the production of the gametes, we should expect the occurrence also of its counterpart, dominance, in fertilization. Since in hermaphrodites the latter does not occur, it is probable that the former does not occur either.

But in *dioecious* species sexual dominance almost invariably occurs; it is probable, therefore, that in such species segregation of sex-characters takes place in the formation of the gametes. If so, and if, as in color heredity among mice, all possible combinations of gametes are formed in fertilization, and in the frequencies demanded by the law of chance, the sex of the offspring should be indicated by the product, —

$$\begin{array}{r} \text{♂} + \text{♀} \quad (\text{ova}) \\ \text{♂} + \text{♀} \quad (\text{spermatozoa}) \\ \hline \text{♂♂} + 2 \text{♂♀} + \text{♀♀} \quad (\text{zygotes}). \end{array}$$

According to this, half the offspring, it will be observed, must be *purely* of one sex or the other; that is, must contain and transmit *the characters of one sex only*. But we have no reason to think that such sexually "pure" individuals exist. On the contrary, when, as in the case of the honey-bee, the individual apparently transmits uniformly the character of one sex, that sex is invariably the *opposite* to its own. It is highly probable, therefore, that an egg bearing the character of one sex can unite in fertilization only with a spermatozoön bearing the character of the opposite sex. Our present knowledge of the process of fertilization indicates that in it a union is accomplished between elements *strictly equivalent* to those which were separated in the formation of the gametes. But there exist, as we have seen, strong reasons for believing that in the formation of the gametes, *opposite* sex-characters are separated. Consequently, on *a priori* grounds, we should expect only opposite sex-characters to unite in fertilization.

But, some one may object, if a ripe egg of one sex can be fertilized only by a spermatozoön of the opposite sex, it follows that half the eggs produced are infertile toward half the spermatozoa. This, however, is not so serious an objection as it may at first thought seem to be. It does not involve impotency of half the eggs and spermatozoa, nor of any portion of them. All the eggs of one sex will be fertile toward all the spermatozoa of the opposite sex; the remaining eggs will be fertile toward the remaining spermatozoa. The infertility which exists is only

a relative one, and relative infertility much greater than this is a well-established fact in other cases. Thus, the writer (Castle, '96) showed some years ago that more than 90% of the eggs produced by the hermaphrodite tunicate, *Ciona intestinalis*, are wholly infertile toward sperm produced by the same individual; yet toward the sperm of another individual the fertility is almost perfect. This instance is only one of many which might be cited as indications that successful fertilization depends upon *unlikeness* between the gametes uniting. In the case of the tunicate, which is hermaphrodite, sexual unlikeness between gametes probably does not occur, hence it is some other unlikeness which brings egg and sperm together, and it is not surprising to find a degree of gametic differentiation between the eggs and sperm of the same individual which is insufficient, in most cases, for successful fertilization.

On the hypothesis advanced, the zygote must, in all cases, bear both the male and the female characters. In the zygote of a hermaphrodite species, these two characters will exist in the balanced relationship in which they were received from the parents, a relationship which has not been disturbed by segregation, and which accordingly is stable. But in a dioecious species the male and female characters meet anew in a struggle for supremacy at each fertilization. Sometimes one, sometimes the other, dominates in the zygote, the vanquished character becoming recessive. Exceptionally, as in the occasional or the mixed hermaphrodite of a dioecious species, the fight is indecisive, and neither combatant is supreme.

In parthenogenetic species, the female character appears to be *uniformly* the stronger of the two, so that it dominates in *every* contest, for the fertilized egg in such species develops *invariably into a female*. In dioecious species, on the other hand, neither character, apparently, has any uniform advantage over the other. Males and females are produced in approximately equal numbers. In hybridization the contest between gametes may often be an unequal one, and it will not be surprising to find the gametes of one species uniformly dominant over those of another *in sex* as well as in somatic characters. This is a matter to which further attention will presently be given.

But, it may be objected, the hypothesis presented is improbable because in parthenogenetic animals like the honey-bee, each sex uniformly transmits the opposite. May it not be so in dioecious animals also? (See Wedekind, :02.) This suggestion is negatived by the following considerations: (1) Most parthenogenetic animals, like *Daphnia*,

for example, produce both male and female offspring *from unfertilized eggs!* (2) The eggs of *Dinophilus*, laid by the same mother, are of two distinct sizes, one about three times as large as the other. From the larger sort develop females, from the smaller, males (see Korschelt, '87). (3) Similar morphological differences, though less obvious ones, exist between the male and female eggs of the gypsy-moth, *Ocneria dispar*, according to Joseph ('71) and Cuénot ('99), and of the silk-moth, *Bombyx mori*, according to Brocadello as quoted by Cuénot. This case is supported by the observations of von Siebold ('56) and others, which show that eggs of the two species mentioned occasionally develop *without fertilization*, and that in such cases normal individuals of *both sexes are produced*.

On the other hand, dimorphic spermatozoa exist in the case of *Paludina* and some other animals, but there is no adequate reason at present for supposing that this dimorphism is related to sex. The consensus of opinion on the part of those who have studied these cases is that the more usual form of spermatozoön alone is functional, the other being pathological. Nevertheless, the subject is one meriting further investigation.

The occasional occurrence of cases of true hermaphroditism, in species normally dioecious, may be cited as evidence in favor of the hypothesis of sex presented in this paper. Each dioecious individual, we have supposed, is a potential hermaphrodite, but has the characters of one sex recessive. The true hermaphrodite (rare in dioecious species) is an animal in which *neither* sex is recessive, but the characters of both sexes are developed together. Unilateral and mixed hermaphrodites are an exceptional form of sex-mosaic: they may in some cases be animals in whose development fusion of the pronuclei has not occurred, one side or region of the body containing only nuclei derived from the male, the other from the female gamete. A similar result might follow, if, even after fusion of the pronuclei in the egg, segregation of sex-characters should occur in cleavage, instead of the normal equatorial divisions. Or, thirdly, a mosaic sex-character may exceptionally be possessed by the gametes themselves, comparable with the mosaic character as to color possessed by the gametes of spotted mice.

Gynandromorphic individuals, not rare among arthropods, clearly result from imperfect dominance of the characters of one sex over those of the other. It is significant that such individuals are especially common among hybrids, which represent abnormal combinations of gametes untried and uncertain as to their relative strength. One of the most

interesting and instructive recorded cases of this sort was reported by von Siebold ('64). A hive of bees possessed by a certain Herr Eugster of Constance contained a queen of pure Italian race, which had been mated with a drone of the common German race. During a period of four years this hive produced hundreds of hermaphroditic bees, and it is important to observe, *always from fertilized eggs*. For the drones produced in this hive were of pure Italian race, like the mother; whereas the hermaphrodites showed the characters of both parents, though more often with a predominance of maternal characters.

The peculiarity, apparently, lay not solely in the gametes of the mother, for in that case the hermaphrodites should have been of pure Italian race, but rather in the *combination* of the (male) gametes of the Italian queen with the (female) gametes of the German drone. The dominance, normal among bees, of the female character (borne by the spermatozoön) was not realized in these hybrid hermaphrodites.

Siebold obtained some two hundred of the hybrid bees and dissected many of them. They included about all conceivable sorts and degrees of hermaphroditism. There were true unilateral and antero-posterior hermaphrodites, as well as others with intermediate or mixed characters, as in size of eyes, number of joints in antennæ, etc. Internal organs were usually not closely correlated with external in character, but animals male posteriorly possessed both testes and male copulatory organs, yet sometimes had an imperfect sting (a female character), or a certain number of egg tubes fused with the testis, or even an ovary in place of a testis.

The hermaphrodite character clearly resulted in the case of these bees from imperfect realization of the normal dominance of the female sex character.

## 2. PARTHENOGENETIC ORGANISMS.

### (a) *General Application.*

A study of sex-heredity in parthenogenetic animals shows (1) that in such animals the female character uniformly dominates over the male whenever the two are present together, precisely as in the case of hybrid mice gray coat-color dominates over white; (2) that when a segregation of sex-characters occurs in the formation of the gametes, it does so at the second maturation division of the egg (in all but one or two exceptional cases), and probably at the corresponding stage in spermatogenesis.

In a few species of animals parthenogenesis is the only known method of reproduction, males never having been observed. But in a far greater



number of cases, sexual reproduction (by fertilized eggs) occurs in the same species with parthenogenesis, the two processes either alternating with each other, or occurring under different external conditions. Favorable conditions in such cases result in parthenogenesis; unfavorable conditions of any sort may result in sexual reproduction.

1. With a single exception to be discussed presently, we know that in uninterrupted parthenogenetic reproduction, as it occurs, for example, in the Daphnidæ and Rotifera at certain seasons of the year, the parthenogenetic egg forms *only one* polar cell, and the animal developing from such an egg is *invariably female*, or more correctly ♀ (♂), the male character being recessive. In other words, the daughter produced by parthenogenesis is exactly like her mother. No segregation of sex-characters has taken place in her development. That the male character is still present in the agamic female is known from the fact that such a female retains the capacity to produce males under appropriate external conditions.

2. At the return to sexual reproduction, the parthenogenetic mother produces eggs which form a *second* polar cell, and from such eggs (if unfertilized) *only males develop*. It is clear, then, that in the second maturation division the female character has been eliminated from the egg, for were it still present there, it must from its nature dominate.

In the honey-bee, all the eggs without exception form two polar bodies, and the unfertilized egg invariably develops into a male. Accordingly a queen-bee which has not copulated can produce *only male offspring*. But one which has copulated produces both male and female offspring, the former, however, only from unfertilized eggs, the latter always from fertilized eggs.

In parthenogenetic Rotifera and Crustacea, under optimum external conditions, the egg develops straightway after the formation of a single polar cell, usually while still within the body of the mother, and without awaiting the occurrence of a second maturation division. No segregation of sex-characters has yet occurred within the egg, which develops, without the necessity of fertilization, into an agamic female like the mother. If, however, external conditions are unfavorable, the egg will not proceed to develop until it has undergone a second maturation division. The egg is then capable of development either with or without fertilization. If it is not fertilized, as must necessarily be the case unless the mother has copulated, development takes place at once within the body of the mother, and a male is produced. But if the egg is fertilized, it takes up yolk and acquires a resistant shell, which ordinarily prevents

its development until the following season; that is, it becomes a "winter egg." From such eggs there hatch invariably agamic females.

These facts support the view already advanced, that in parthenogenetic animals a segregation of sex-characters takes place at the formation of the second polar cell. The female character passes into the second polar cell, leaving only the male character in the egg. Hence, if the egg which has formed two polar cells develops without fertilization, it must develop into a male. But if such an egg is fertilized, it invariably forms a parthenogenetic female, ♀ (♂), that is, an individual in which the male character is recessive. Accordingly the functional spermatozoon must in such cases invariably bear the *female* character, and this is as invariably dominant over the male character when the two meet in fertilization.

But we are now confronted with a serious difficulty. The egg, which has formed two polar cells, we have supposed, is purely male, yet the animal which develops from it by parthenogenesis produces only gametes purely female.

The studies of Petrunkevitch (:01) on the honey-bee give us a clue to the solution of this difficulty. The genital gland of the male bee probably develops, not from any part of the mature egg, but from the second polar cell, after the union of that body with one of the two products of division of the first polar cell. But the second polar cell contains, according to our hypothesis, *only the female character*; the same is probably true of *one* of the products of division of the first polar cell, perhaps of that one which fuses with the second polar cell. If so, the genital gland of the male bee will contain *only* the female character, and in the spermatogenesis of the bee, no segregation of sex-characters will be found to occur. On the other hand, if the *male* character is borne by that derivative of the first polar cell which fuses with the second polar cell, the body formed by their union will contain *both* the male and female characters, and will be homologous with the cleavage nucleus of a fertilized egg. In that case we shall expect to find the occurrence of a normal process of spermatogenesis with segregation of sex-characters. If this is so, there doubtless are produced *male* as well as female spermatozoa in the honey-bee, but the latter sort alone can be functional because the fecundable egg, as we have seen, invariably bears the *male* character.

In support of the important observation of Petrunkevitch may be cited the earlier observation of Henking ('93). He finds that, as a rule, in insects generally no polar cells are formed at maturation, but merely polar nuclei which remain imbedded in the cytoplasm of the egg. The

first of these polar nuclei commonly divides about at the time of formation of the second polar nucleus. There are thus formed three polar nuclei (or cells), which all lie imbedded in the cytoplasm of the egg. There regularly takes place a fusion of the *inner* derivative of the first polar cell with the second polar cell, exactly as observed by Petrunkevitch in the case of the honey-bee. Further development of this body was not observed in most of the cases studied by Henking, though he mentions certain apparently abortive "attempts" at division by this body. The outer product of division of the first polar cell was observed regularly to undergo disintegration without further change, except in a few cases, such as that of the parthenogenetic gall-wasp, *Rhodites rosae*, in which all three polar nuclei fuse into a single body. Henking seems to regard ultimate disintegration as the normal fate of all the polar nuclei, whether or not conjugation has occurred among them. This is precisely what the observations of Petrunkevitch would lead us to expect in the case of all *fertilized* eggs, as well as of parthenogenetic eggs which form but one polar cell. We have no reason to suppose that Henking ever studied the development of a male parthenogenetic egg, in which sort alone (in addition possibly to *Rhodites*) we should expect to find the genital gland of the embryo developing out of the conjugated polar nuclei.

If, contrary to the opinion of Petrunkevitch, it shall be found that in the male honey-bee the testis develops, not from polar cells, but from a blastomere, we may well look for evidence of segregation of the testis fundamental early in cleavage. For, if our assumption be correct, that in parthenogenetic animals the female character is uniformly dominant over the male, it will be impossible for the male character to find expression in the soma of the individual, until the female character has been eliminated from it.

#### (b) *Special Cases.*

The explanations offered of sex-heredity in the honey-bee and rotifer are applicable to all cases known to the writer of normally parthenogenetic animals, except two. These are the gall-wasp *Rhodites rosae*, and the rotifer *Hydatina senta*.

##### A. RHODITES ROSAE

In *Rhodites* males are very rare, and parthenogenesis is the normal method of reproduction. According to Henking, the unfertilized egg in this species undergoes *two* maturation divisions, yet the offspring devel-

oping from such eggs must be almost invariably female, because males, as already stated, are extremely rare. Yet for the very reason that males *are* occasionally produced, we are forced to the conclusion that the male character is present, recessive, in the ordinary female of *Rhodites*. If so, the egg does not eliminate the character of that sex at the formation of the second polar cell, but retains the characters of *both* sexes, and so has a formula, ♂ ♀, a supposition for which we have warrant in the mosaic gametes of spotted mice. In further support of this idea may be mentioned the observation of Henking, that in the maturation of the egg of *Rhodites* *no reduction division occurs*; the nucleus of the ovarian egg, the three polar nuclei, and the nucleus of the mature egg, all alike contain nine chromosomes each. It is probable, therefore, that normally the second maturation division in *Rhodites* is qualitatively like the first, an equation division, in which no segregation of sex characters takes place. But the occasional production of a *male* *Rhodites* indicates that the egg still retains a capacity to eliminate the dominant female character in maturation, and so to become male, as do the eggs of other parthenogenetic animals under appropriate conditions.

#### B. HYDATINA SENTA.

*Hydatina senta* differs from other parthenogenetic animals in the following respects. Its female summer eggs, instead of forming *one* polar cell, form *none*. Its male summer eggs and fecundable (winter) eggs (doubtless at the outset one and the same sort), instead of forming *two* polar cells, form *one*. It is evident that one of the normal maturation divisions has in this species been omitted. Clearly it is not the normal second division, for the single one which occurs is a segregation (or reduction) division. Manifestly, then, the maturation division which is suppressed in *Hydatina* is the normal first maturation division of fecundable eggs, the sole maturation division of eggs not fecundable.

Corroborative evidence of the correctness of this interpretation comes from an unexpected source, the mammals. Sobotta ('99) finds that in the egg of the mouse there occurs usually only a single maturation division. This is the homologue of the *second* maturation division of other animals. When two maturation divisions occur in the same egg, the second is always of the *same type* as the single maturation division of other eggs, and it occurs in a like stage of maturity of the Graafian follicle. The single maturation division of one type of egg, and the second maturation division of the other type, are apparently alike reduction divisions, for the mitotic spindle, according to Sobotta's figures,

bears in these cases about half as many chromosomes as it does in the case of the first maturation division of eggs of the less usual type.

In the mouse, then, and perhaps in other mammals also, the first, or equational, maturation division is usually, but not always, omitted; in *Hydatina*, however, it appears to be *regularly* omitted.

#### C. ARTEMIA SALINA.

Weismann und Ischikawa ('83) observed the formation of only one polar cell in the parthenogenetic eggs of about a dozen different species of Crustacea as well as in two species of Rotifera. Presumably their observations were made exclusively on the commoner form of parthenogenetic egg, the "female summer egg." In the fertilized eggs of three of the same species of Crustacea (namely, *Daphnia longispina*, *Moina rectirostris*, and *M. paradoxa*) the same authors found that *two* polar cells are regularly formed. In the case of the remaining species, including *Artemia salina*, no fertilized eggs were examined.

Maturation of the eggs of *Artemia salina* has since been studied by Brauer ('94) and Petrunkevitch (:01). Both agree that the ovarian egg contains regularly 84 chromosomes, and Petrunkevitch finds that the chromosomes are clearly *double!* Both observers likewise are in substantial agreement as to the method and result of the first maturation division. The first polar cell and the egg contain each 84 *double* (Petrunkevitch) chromosomes. No reduction division has occurred. But from this point on, the two observers differ in their accounts of what happens. Petrunkevitch stoutly maintains that *no second maturation division occurs*; this is in accord with the observations of Brauer as to a *large majority* of the eggs studied by him, but in a certain number of eggs he observed the occurrence of *a second maturation division*. However, a second polar cell was in no case extruded. Two nuclei were formed, one peripheral, the other central in position, and these later came together and fused, *exactly as* male and female pronuclei do in the fertilized eggs of other species, thus forming a cleavage nucleus. Each of the two nuclei was found to contain 84 *small* chromosomes, indicating that at the second maturation division a separation had taken place between the two parts of the originally double chromosomes; in other words, that the second maturation division is a reduction division. Moreover, these small or part chromosomes were observed to remain *distinct* even after the union of the two nuclei, the cleavage cells containing 168 small chromosomes, whereas in eggs

which had formed only one polar cell, the cleavage cells contained 84 *double* chromosomes.

As the eggs of the second type were rare and sometimes showed multipolar spindles, Brauer is uncertain whether they were really capable of normal development or not. Petrunkevitch is certain that they must have been purely pathological, for he never observed evidence of any such second method of maturation in his own preparations, though this was the especial object of his search, and he worked with material from the same locality, Trieste, that had furnished Brauer's material, and in addition with material from a second locality, Odessa, where *male Artemias* not infrequently occur.

But a moment's reflection will show that the apparently discordant results of Brauer and Petrunkevitch are readily reconcilable. *Brauer's second type of maturation may have been observed in the rare male (or fecundable) eggs.*

But why, then, it may be asked, did not Petrunkevitch encounter this second type of egg, the especial object of his search, for he examined material from Odessa, where males *frequently* occur. Probably because he, as he explicitly states, worked *exclusively with winter eggs* ("Dauereier"), whereas Brauer worked both with summer eggs ("Subitaneier") and with winter eggs. Though Brauer makes no statement concerning the matter, I confidently hazard the conjecture that the second type of maturation was observed by him only among the summer eggs, for in no species, so far as I know, in which parthenogenesis occurs, has the development of a male animal from a winter egg ever been observed. In parthenogenetic Crustacea, Rotifera, and Platodes alike, there invariably hatches from the winter egg a parthenogenetic female. Should Petrunkevitch study the parthenogenetic *summer eggs*, instead of the *winter eggs*, produced by *Artemias* of the Odessa race, I venture to predict that his search for the second type of maturation will be abundantly rewarded, at least to this extent, that he will find the occurrence of two maturation divisions in the *male summer eggs*.

It is doubtful whether the other process observed by Brauer, a fusion of the nucleus of the second polar cell with the egg nucleus, takes place in the development of the male *Artemia*. More probably the result of this process would be the same as that of fertilization, or of an entire suppression of the second maturation division; namely, the production of a female in which the male character is recessive. This view is quite in harmony with Brauer's own interpretation of his observations.

D. EXCEPTIONAL PARTHENOGENESIS IN *BOMBYX MORI*, ETC.

Occasional parthenogenesis is known to occur in certain Lepidoptera, when the mother is forcibly prevented from copulating. The cases which have been most carefully studied are those of the silk moth, *Bombyx mori*, and the gypsy moth, *Ocneria dispar*. The unfertilized as well as the fertilized eggs of these species are known, through the investigations of Platner ('88) and Henking ('92), to undergo *two* maturation divisions. But only an occasional unfertilized egg develops to the larval stage, — only one in several hundred, or even one in thousands. A still smaller proportion attain the condition of imagos. These few, however, are of *both sexes*, and are capable of reproduction when bred to ordinary individuals (von Siebold, '56).

But it is entirely possible that in the very exceptional egg which develops normally, a second maturation division has for some reason failed to take place, or after it has taken place, a reunion has occurred of the second polar nucleus with the egg nucleus, as sometimes in the egg of *Artemia*, according to Brauer. Such a reunion would bring together again the sex-characters segregated in maturation, and would produce the physiological and morphological equivalent of the cleavage nucleus of a fertilized egg. A similar result would follow the complete suppression of a second maturation division.

The occurrence of individuals of both sexes among the parthenogenetic offspring of the silk moth and gypsy moth shows that in these species, as in other normally dioecious animals, there is no uniform dominance of one sex over the other, such as we find occurring among normally parthenogenetic animals, where the female character regularly dominates.

## V. Abnormal Sex Proportions among Hybrids.

Bateson and Saunders (:02, p. 139) consider it as “on the whole *against* the hypothesis that sex depends chiefly on gametic differentiation that the statistical distribution of sex among first crosses shows great departure from the normal proportions.” The writer does not share this opinion, for on the hypothesis of sex advanced in this paper departures of the sort indicated are capable of ready explanation.

It should be stated, however, that the known cases of this sort are comparatively rare, whereas the statement of Bateson and Saunders might lead one to expect their frequent occurrence. The writer knows of but two cases about which our information is full enough to warrant statistical examination.

1. RELATIVE INFERTILITY OF CERTAIN COMBINATIONS OF GAMETES.

Tutt ('98) reports that in crosses between two nearly related species of Lepidoptera, *Tephrosia bistorta* and *T. crepuscularia*, it has been found that when *bistorta* is the male parent, the hybrid offspring show a normal distribution as to sex, a slight excess of males. See crosses [1] and [2] in Table I. But in the reciprocal cross, with *crepuscularia* (or its dark aberration, *delamerensis*) as the male parent, the offspring are practically all males. See Table I., crosses [3] and [4].

TABLE I.

*Sex-proportions among two generations of hybrid offspring of Tephrosia bistorta (B) × T. crepuscularia (C) or the dark aberration of the latter, delamerensis (D).*  
 [Statistics of Tutt ('98).]

Parent species.	C ♀	B ♂	D ♀	C ♂	B ♀	D ♂
Hybrid Gen. I.	[1] ♂ 92 ♀ 75		[2] ♂ 59 ♀ 62		[3] ♂ 40 ♀ 0	
Hybrid Gen. II.	[5] ♂ 19 ♀ 16		[6] ♂ 38 ♀ 11		[7] ♂ 37 ♀ 7	
				[4] ♂ 118 ♀ 1		

Hybrid female offspring of *bistorta* ♂ × *delamerensis* ♀ (cross [2], Table I.) when crossed with *crepuscularia* ♂ gave (cross [6], Table I.) a large excess of males, as we should expect on the Mendelian hypothesis that the hybrid furnishes in equal numbers gametes having the pure character of either parent race. For we should expect the combination of pure *delamerensis* with *crepuscularia* gametes, which would occur in half the total cases, to yield offspring having the normal sex-proportion, a slight excess of males (compare cross [1], Table I.); but pure *bistorta* ova fertilized by *crepuscularia* sperm should yield only male offspring (compare cross [3], Table I.). Accordingly the result to be expected is 3 + ♂ : 1 ♀ ; the observed result is 38 ♂ : 11 ♀ .

To explain the peculiar sex-distribution observed in these crosses, we may make two simple hypotheses, which, I believe, are warranted by the facts observed. (1) *The sex-character borne by a bistorta (B) gamete*



dominates in all unions with a *crepuscularia* (C) or a *delamerensis* (D) gamete. Tutt states that the species *bistorta* "predominates" in crosses with *crepuscularia*. It would not be surprising, accordingly, to find that the *sex-character* borne by the "predominant" gamete likewise dominates in the zygote. (2) *Of the four possible combinations of gametes, one is sterile*; namely, the combination, ovum B ♀ + sperm C (or D) ♂. The three fertile combinations are, —

ovum            B ♂ + sperm C (or D) ♀,  
 "            C (or D) ♀ + "            B ♂,  
 "            "            ♂ + "            B ♀.

A sufficient justification of this hypothesis is that it explains satisfactorily the results observed. Those results are, indeed, peculiar, but there is no reason to question their accuracy, for they represent the combined and harmonious observations of two independent and competent experimenters. Calculating the sex-proportion in the various crosses on the basis of the two hypotheses stated, we obtain the results shown in Table II. For convenience in comparison, the observed ratios are placed opposite the calculated ones.

TABLE II.

*Sex-proportions among hybrid offspring of Tephrosia. (Compare Table I.)*

Cross (Table I.)	Calculated Ratio.		Observed Ratio.	
	♂	♀	♂	♀
[1] + [2]	1	1	1+	1
[3] + [4]	1	0	158	1
[5]	4	3	4-	3
[6]	2	1	3+	1
[7]	4	3	5+	1

The calculation has been made on the basis of a normal equality between the sexes. As a matter of fact, males are normally slightly in excess of females, so that it is not surprising to find the calculated number of males a little too low in nearly all cases. Not improbably the normal excess of males results from greater mortality among female larvæ; and since the mortality is especially high among hybrid broods,

the normal disparity between the sexes is naturally accentuated. Nevertheless, the differences between calculated and observed ratios are small in all the crosses except [6] and [7]. Even in these two cases calculated and observed results are *qualitatively* harmonious. Both indicate a large excess of males; but the observed excess is larger than the expected one, especially in cross [7].

## 2. COUPLING OF CERTAIN SEX AND SOMATIC CHARACTERS IN THE GERM-CELLS.

In certain other crosses among Lepidoptera, males and females occur in their normal proportions, approximate equality, but there is a tendency for the offspring which resemble one parent to be predominantly of one sex, those which resemble the other parent being predominantly of the other sex. In the following crosses between a species and its melanistic aberration, Standfuss ('96) notes the predominance of males among the offspring having the aberrant form, while females predominate among those which have the species form.

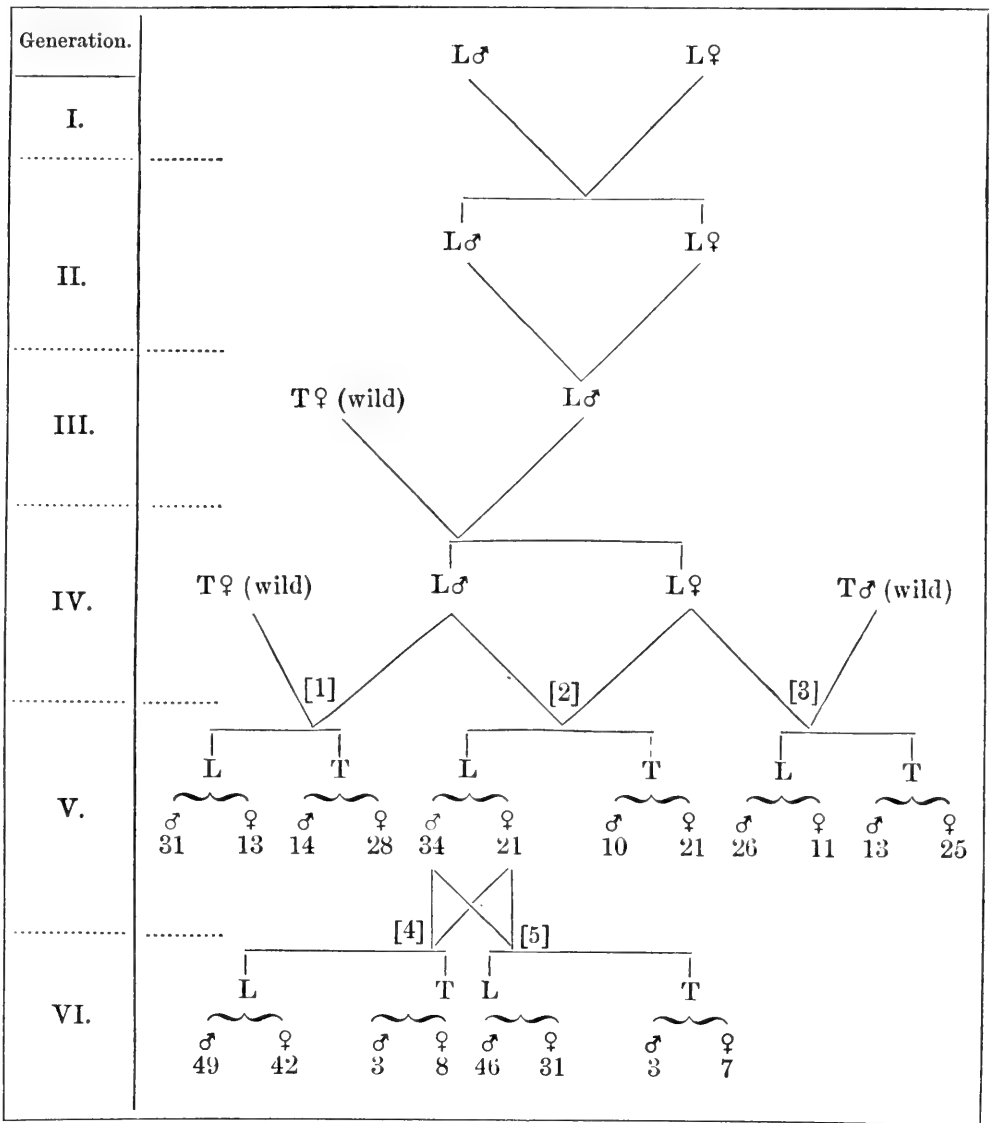
	Offspring like aberration.		Offspring like species.	
	♂	♀	♂	♀
<i>Psilura monacha</i> × <i>ab. zatima</i> . . . . .	18	5	2	20
<i>Aglia tau b</i> × <i>ab. lugens</i> . . . . .	186	118	43	89
<i>Grammesia trigrammica</i> × <i>ab. bilinea</i> . . . . .	14	14	13	20
<i>Angerona prunaria</i> × <i>ab. sordiatata</i> . . . . .	24	18	3	10
<i>Boarmia repandata</i> × <i>ab. conversaria</i> . . . . .	4	2	10	18

In these cases, there is clearly an imperfect correlation between the male sex-character and the aberrant form-character. Is such correlation consistent with the doctrine of gametic differentiation? It is; correlation, or "coupling," between members of different pairs of characters is a recognized Mendelian phenomenon. Thus, Correns (:00) has shown that in crossing *Mathiola incana* with *M. glabra*, those hybrid plants which have villous leaves always bear pink flowers, and those which have glabrous leaves bear white flowers. Leaf character and flower color are in this case perfectly correlated, or "coupled," so that they cannot be separated in heredity. Similarly, though less perfectly, in the butterfly crosses

already cited, the male character is coupled with the aberrant form, and those gametes of the hybrid which bear the aberrant character bear also the male sex-character in a majority of cases. This can, I believe, be

TABLE III.

*Sex-distribution among offspring of Aglia tau (T) crossed with its dark aberration lugens (L). [Statistics of Standfuss ('96).]*



conclusively shown from the statistics of Standfuss. The cross on which he made the most extensive observations is that between *Aglia tau* and its aberration *lugens*. The various matings obtained and their outcome, so far as recorded, are shown in Table III.

Inspection of this table indicates that lugens is dominant over tau, for when the two forms are crossed, in Generation III., the offspring are apparently *all* of the lugens form, at least Standfuss does not mention the occurrence of any taus. The resulting fourth generation hybrids, L in the table, but really L (T), when bred *inter se*, or when crossed with normal tau, produce, as we should expect, both lugens and tau forms. See Table III., crosses [1], [2], [3]. Likewise the fifth generation lugens, obtained by intercrossing lugens of the fourth generation (cross [2]), produce when bred *inter se* both lugens and tau forms. See Table III., crosses [4], [5]. We have, then, convincing evidence that tau may be recessive (or latent) in lugens, but lugens is in no case shown to be latent in tau. Accordingly we have here a case of simple dominance of lugens over tau. The numerical proportions of lugens and tau in the crosses between those two forms are close to those demanded by the Mendelian principles of dominance and segregation. See Table IV., Generations III., IV. [1], and IV. [3]. But when hybrid lugens individuals are bred *inter se* ([2], [4], and [5]), considerable discrepancies occur between calculated and observed results. These discrepancies, I believe, arise from coupling—in the gametes produced by the hybrids—of the male character with the lugens character, and of the female character with the tau character. This explanation accounts at the same time for the peculiar sex-distribution between lugens and tau forms observed in all the crosses.

Suppose that *in the germ-cells of every hybrid individual*, D (R), the segregation of characters occurs in such a way that *the male sex-character passes into the same gamete as the dominant (lugens) form-character*. Then there will be produced only gametes D ♂ and R ♀. I do not say that this is invariably so; indeed, it clearly is not so for any of the crosses in all cases. It occurs only in a certain number of cases in each cross, but this number is large enough materially to affect the result. The calculation, however, will be simplified if, for the time being, we suppose the segregation to occur in all possible cases among the gametes of hybrids. See Table IV.

In Generation IV., crosses [1] and [3], a hybrid *lugens*, D (R), is mated with a recessive wild *tau*, R. The two crosses are reciprocals, but the outcome is substantially the same in both, so that evidently whatever peculiarity is possessed by hybrid ova belongs also to hybrid spermatozoa. Suppose, as suggested, that it be coupling of the male character with the lugens character. Then we shall have gametes D ♂ and R ♀ furnished by the hybrid parent, and gametes R ♂ and R ♀

furnished by the recessive parent. If gametes of opposite sex always unite in fertilization, and the sex-character borne by the hybrid gamete always dominates, the resulting zygotes will be D (R) ♂ and R ♀. See Table IV. But if dominance attaches to the gametes of one parent as often as to those of the other, the result will be D(R) ♂ + D(R) ♀ + R ♂ + R ♀. Manifestly neither of these results agrees closely with the one observed, which lies between the two. It seems probable, then, that if coupling does occur, it occurs not in all possible cases, but only in a part of them.

TABLE IV.

*Sex-distribution among offspring of Aglia tau (R) crossed with its aberration lugens (D). Compare Table III.*

Generation and Cross.	Nature of Cross.	Total Offspring.	Calculated ratio, D : R, without coupling.	Total R.		Sex of Offspring.		Calculated distribution, coupling in all cases.				Calculated distribution coupling in $\frac{1}{3}$ of cases.							
				Calculated	Observed.	♂	♀	D or D (R)		R		D or D (R)		R					
								♂	♀	♂	♀	♂	♀	♂	♀				
				III.	D × R	?	all D	0	0?										
IV., [1]	D (R) × R	86	1 : 1	43	42	45	41	45			41	30	13	15	28	<i>31</i>	<i>13</i>	<i>14</i>	<i>28</i>
IV., [2]	D (R) × D (R)	86	3 : 1	21.5	31	44	42	44	42			40	28	5	14	<i>34</i>	<i>21</i>	<i>10</i>	<i>21</i>
IV., [3]	D (R) × R	75	1 : 1	37.5	38	39	36	39			36	26	12	13	24	<i>26</i>	<i>11</i>	<i>13</i>	<i>25</i>
V., [4]	D (R) × D (R)	102	3 : 1	25.5	11	52	50	52	50			46	33	6	17	<i>49</i>	<i>42</i>	<i>3</i>	<i>8</i>
V., [5]	"	87	3 : 1	21.7	10	49	38	49	38			44	25	5	13	<i>46</i>	<i>31</i>	<i>3</i>	<i>7</i>

NOTE. Numerals in italics indicating the observed distribution are, for convenience in comparison, inserted immediately below the calculated numbers.

Suppose that it occurs in only one-third of them; then the gametes of the hybrid will be 2 D ♂ + D ♀ + R ♂ + 2 R ♀. If such gametes meet others all of which are R, as in a cross with a recessive individual, and if *sexual dominance is possessed in all cases by the gamete of the hybrid parent*, we get the following distribution of zygotes, 2 D (R) ♂ + D (R) ♀ + R ♂ + 2 R ♀, which, as we have seen, is close to that observed. Compare Table IV., Generation IV. [1] and [3]. On the other hand, the assumption that sexual dominance is possessed as often by the gamete of one parent as the other would lead to the result normal

in the case of other crosses of a hybrid with a recessive form, namely,  $D(R) \text{♂} + D(R) \text{♀} + R \text{♂} + R \text{♀}$ , which is not the result obtained in this case.

Hence to explain the exceptional results before us we must assume two exceptional occurrences, (1) a partial coupling, among the gametes of the hybrids, of the male sex-character with the dominant (lucens) form-character, (2) possession of sexual dominance by the gametes of the hybrid parent, when that parent is crossed with a recessive. But when two hybrids are intercrossed, as in Generation IV. [2] and Generation V. [4] and [5], we should not expect to find sexual dominance possessed uniformly by the gametes of either parent, since both are hybrids. If, on the other hand, coupling occurs among *all* the gametes of both hybrid parents, only hybrid offspring will be produced and in the normal sex-proportion, approximately an equality. See Table IV. For each parent will produce only gametes  $D \text{♂}$  and  $R \text{♀}$ , and when opposite sex-characters meet, the zygote formed must always be  $DR$ . The result will be the same whether sexual dominance is possessed exclusively by the gametes of one parent, or is shared equally by those of both. The fact that in all of the three matings indicated a certain number of recessive offspring occurs, shows conclusively that coupling between the male character and the lucens character does *not* occur in all possible cases. In Generation IV. [2], the total number of recessive offspring is even greater than it should be if *no* coupling occurred, and I am at a loss for an explanation of the discrepancy, unless one parent furnished considerably more than the theoretical number (one-half) of recessive gametes. But in the two similar crosses of Generation V., the total number of recessive offspring, on the supposition that no coupling occurs, is less than half the theoretical. In all three cases the *sex-proportion* among the offspring, both dominants and recessives, approximates that which would result from chance combinations of gametes of two hybrid parents on the suppositions: (1) that there occurs a *coupling* of the male character with the lucens character and of the female with the tau character in approximately one-third of all cases, and (2) that when coupled gametes meet uncoupled ones in fertilization, the sex of the former always dominates in the zygote. On these two hypotheses, each hybrid parent will furnish gametes in the proportions  $2 D \text{♂} + D \text{♀} + R \text{♂} + 2 R \text{♀}$ , of which one of the two  $D \text{♂}$ s and one of the two  $R \text{♀}$ s will be *coupled*. If all possible matings occur and the coupled gametes are sexually dominant over uncoupled ones, the distribution of the offspring will be  $8 D \text{♂} : 6 D \text{♀} : R \text{♂} : 3 R \text{♀}$ . On this basis

are calculated the numbers inserted in the last four columns of Table IV., regard being had for the observed ratio of males to females in each cross. Thus the males in each cross between hybrid parents are distributed between D and R in the ratio, 8 : 1 ; and the females in the ratio, 6 : 3.

To sum up, an examination of Table IV. shows in three of the six crosses considerable discrepancies between the calculated Mendelian ratios of D to R and those actually observed. In two of the three crosses mentioned, the discrepancies are satisfactorily accounted for on the assumption that coupling occurs in about one out of three cases among the gametes produced by hybrids, on the one hand between the male sex-character and the aberrant form-character, and on the other hand between the female sex-character and the species form-character. The same assumption explains satisfactorily the peculiar sexual distribution of dominant and recessive forms in all five broods, if we suppose further that coupled gametes are sexually dominant over uncoupled ones, and the gametes of hybrids over those of recessive individuals.

The principles of coupling involved in this case may serve to explain other apparent exceptions to Mendel's law. We have seen how deviations from the expected ratios of dominants to recessives may result from partial coupling of each with a different sex-character. *Complete* coupling of this sort must necessarily result in the production of a *stable* or *self-perpetuating* hybrid form. In case the hybrid form is indistinguishable from a pure dominant, its real nature may be unsuspected, until a cross with a third form may serve to break the coupling and bring to light a series of new combinations. How many of our supposedly pure species may be sexually coupled hybrids? May it not be that many aberrant variations (mutations, de Vries) result from resolution of these couplings?

Furthermore, the principle of coupling affords an explanation of the inheritance of sexual dimorphism in general. There is one set of form-characters coupled with the male sex-character, another with the female. Dominance in the zygote of one sex-character necessitates dominance also of the form-characters which are coupled with it, while the other sex-character and the form-characters coupled with it together become recessive.

The author desires to thank Professor E. L. Mark for valuable assistance in the revision of his manuscript and proofs.

## VI. Summary.

1. Sex is an attribute of every gamete, whether egg or spermatozoön, and is not subject to control through environment. It is inherited in accordance either with Mendel's law of heredity or with the principle of mosaic heredity.

2. Mendel's law includes two principles, (1) the principle of dominance in heredity of one of two alternative characters over the other, and (2) the principle of segregation of those characters at the formation of the gametes.

3. Mosaic inheritance is an important exception to both these principles. In this process alternative characters coexist without dominance of either, and pass together (without segregation) into the gametes.

4. The Mendelian principles of dominance and segregation apply to the heredity of sex among dioecious animals and plants, but among hermaphroditic animals and plants mosaic inheritance of sex takes place.

5. Latency of one sex in the other, among dioecious animals and plants, is shown by evidence both anatomical and experimental.

6. Segregation of sex, among the gametes of dioecious animals and plants, is accompanied by morphological differences between the male and female eggs in *Dinophilus* and certain *Lepidoptera*, and possibly also by dimorphism among the spermatozoa of *Paludina*.

7. Among dioecious animals, a gamete of one sex can unite, in fertilization, only with one of the opposite sex; consequently no individuals are produced from fertilized eggs, which are *purely* of one sex or the other.

8. Dominance, in dioecious species, is possessed sometimes by the male character, sometimes by the female.

9. In parthenogenetic species, the female character invariably dominates, when the characters of both sexes are present together. Accordingly in such species: (a) All fertilized eggs are female. (b) Unfertilized eggs which are produced without segregation of the sex-characters are female. (c) Males develop only from unfertilized eggs *from which the female character has been eliminated*.

10. The female character, eliminated from the male parthenogenetic egg, passes into the testis; accordingly the spermatozoa bear the *female* character, though the individual producing them is in soma purely male.



11. Possibly the testis, in males of parthenogenetic species, contains the male character as well as the female. If so, these are doubtless segregated in spermatogenesis, but only the female spermatozoa can be functional, because only male fecundable eggs are produced by such species.

12. The segregation of sex-characters takes place in most parthenogenetic animals, and doubtless in dioecious animals also, at the second maturation division (the "reduction division") of the egg, and probably at a corresponding stage in spermatogenesis. For (1) eggs which develop without fertilization and without undergoing a second maturation division contain both the male and the female characters, the former recessive, the latter dominant; but (2) in normally parthenogenetic species, eggs which, after undergoing a second maturation division, develop without fertilization, are always male (except in *Rhodites*). In such species the female character regularly passes into the second polar cell, the male character remaining in the egg. In dioecious animals, on the other hand, *either* sex character may remain in the egg after maturation.

13. In *Hydatina senta* there is no maturation division homologous with the first maturation division of the eggs of other animals. A single maturation division occurs in the male (or fecundable) eggs, but this is clearly homologous with the second maturation division of other parthenogenetic animals, for in it a segregation of sex-characters takes place. In the female parthenogenetic egg, no maturation division occurs.

14. The parthenogenetic egg of *Rhodites rosae* undergoes two maturation divisions, but apparently without the occurrence of segregation in either of them. If segregation does occur in one of the two maturation divisions, the character retained in the egg must be regularly the female, because the offspring are uniformly of that sex. In that case, the genital gland of *Rhodites* probably develops, as does the testis of the honey-bee according to Petrunkevitch, from the fused polar cells.

15. Abnormal sex-proportions among hybrids are capable of explanation, in some cases, on the ground that certain combinations of gametes are infertile.

16. Sexual dimorphism, in a species, is the result of coupling, in the zygote and in the gametes, of certain form-characters with one or the other sex-character. A similar explanation accounts satisfactorily for abnormal sex-distribution of the offspring, in the case of certain crosses, between the two parent forms.

## BIBLIOGRAPHY.

Bateson, W., and Saunders, E. R.

'02. Experimental Studies in the Physiology of Heredity. Reports to the Evolution Committee of the Royal Society. Report I, 160 pp. London.

Bordage, E.

'98. Variation sexuelle consécutive a une mutilation chez le Papayer commun. Compt. Rendu. Soc. de Biol., sér. 10, tom. 5, pp. 708-710.

Brauer, A.

'94. Zur Kenntniss der Reifung des parthenogenetisch sich entwickelnden Eies von *Artemia salina*. Arch. f. mikr. Anat., Bd. 43, Heft 1, 19. Febr., pp. 162-222, Taf. 8-11.

Castle, W. E.

'96. The Early Embryology of *Ciona intestinalis*, Flemming (L.). Bull. Mus. Comp. Zoöl., Vol. 27, no. 7, pp. 201-280, 13 pl.

Correns, C.

'00. Ueber Levkojenbastarde. Zur Kenntniss der Grenzen der Mendel'schen Regeln. Bot. Centralbl., Bd. 84, pp. 97-113.

Cuénot, L.

'99. Sur la détermination du sexe chez les animaux. Bull. Sci. France et Belg., tom. 32, pp. 462-535.

Darwin, C.

'76. The Variation of Animals and Plants under Domestication. Second Edition, revised. N. Y., D. Appleton and Co., 2 Vol., xiv + 473 and x + 495 pp.

Henking, H.

'92. Untersuchungen über die ersten Entwicklungsvorgänge in den Eiern der Insekten. III. Specielles und Allgemeines. Zeit. f. wiss. Zool., Bd. 54, pp. 1-274, Taf. 1-12.

Joseph, G.

'71. Ueber die Zeit der Geschlechtsdifferenzirung in den Eiern einiger Liparidinen. 48. Jahresber. d. Schles. Gesell. für vaterl. Cultur (1870), pp. 143-146.

**Korschelt, E.**

- '87. Die Gattung *Dinophilus* und der bei ihr auftretende Geschlechtsdimorphismus. Zool. Jahrb., Bd. 2, pp. 955-967, 1 fig.

**Mendel, G.**

- '66. Versuche über Pflanzen-Hybriden. Verh. naturf. Vereines in Brünn, Bd. 4, Abhandl., pp. 3-47.

**Petrunkewitsch, A.**

- :01. Die Richtungskörper und ihr Schicksal im befruchteten und unbefruchteten Bienenei. Zool. Jahrb., Abth. f. Anat. u. Ontog., Bd. 14, Heft 4, 22. Juli, pp. 573-608, Taf. 43-46.

**Petrunkewitsch, A.**

- :02. Die Reifung der parthenogenetischen Eier von *Artemia salina*. Anat. Anz., Bd. 21, No. 9, 27. Mai, pp. 256-263, 4 fig.

**Platner, G.**

- '88. Die erste Entwicklung befruchteter und parthenogenetischer Eier von *Liparis dispar*. Biol. Centralbl., Bd. 8, No. 17, 1. Nov., pp. 521-524.

**Schenk, L.**

- :02. Meine Methode der Geschlechtsbestimmung. Verh. V. Internat. Zool.-Congresses zu Berlin, 12-16 Aug. 1901, pp. 363-374.

**Schenk, L.**

- :02<sup>a</sup>. Zusammengefasste Antworten zur Diskussion über seinen Vortrag. Verh. V. Internat. Zool.-Congresses zu Berlin, 12-16 Aug. 1901, pp. 379-402.

**Siebold, C. T. von**

- '56. Wahre Parthenogenesis bei Schmetterlingen und Bienen. Ein Beitrag zur Fortpflanzungsgeschichte der Thiere. Leipzig, vi + 144 pp., 1 Taf.

**Siebold, C. T. von**

- '64. Ueber Zwitterbienen. Zeit. f. wiss. Zool., Bd. 14, Heft 1, pp. 73-80.

**Sobotta, J.**

- '99. Ueber die Bedeutung der mitotischen Figuren in den Eierstockseiern der Säugetiere. Festschr. phys.-med. Gesell. Würzburg, 1899, pp. 185-192, 1 Taf.

**Standfuss, M.**

- '96. Handbuch der paläarktischen Gross-Schmetterlinge für Forscher und Sammler. Jena, G. Fischer. xii + 392 pp., 8 Taf.

**Strasburger, E.**

- :00. Versuche mit diöcischen Pflanzen in Rücksicht auf Geschlechtsverteilung. Biol. Centralbl., Bd. 20, No. 20-24, pp. 657-665, 689-698, 721-731, 753-785.

**Tschermak, E.**

:00. Ueber Künstliche Kreuzung bei *Pisum sativum*. *Zeit. f. landwirths. Versuchswesen in Oester.*, Bd. 3, pp. 465-555.

**Tutt, J. W.**

'98. Some Results of Recent Experiments in Hybridising *Tephrosia bistortata* and *Tephrosia crepuscularia*. *Trans. Ent. Soc. Lond. for the Year 1898*, pt. 1, Apr. 20, pp. 17-42.

**Wedekind, W.**

:02. Die Parthenogenese und das Sexualgesetz. *Verh. V. Internat. Zool.-Congresses zu Berlin*, 12-16 Aug. 1901, pp. 403-409.

**Weismann, A.**

'93. *The Germ-plasm, A Theory of Heredity*. Translated by W. N. Parker. xxii + 477 pp., 24 fig. New York.

**Weismann, A., und Ischikawa, C.**

'88. Weitere Untersuchungen zum Zahlengesetz der Richtungskörper. *Zool. Jahrb., Abth. f. Anat. u. Ontog.*, Bd. 3, Heft 3, 30. Nov., pp. 575-610, Taf. 25-28.

Bulletin of the Museum of Comparative Zoölogy

AT HARVARD COLLEGE.

VOL. XL. No. 5.

---

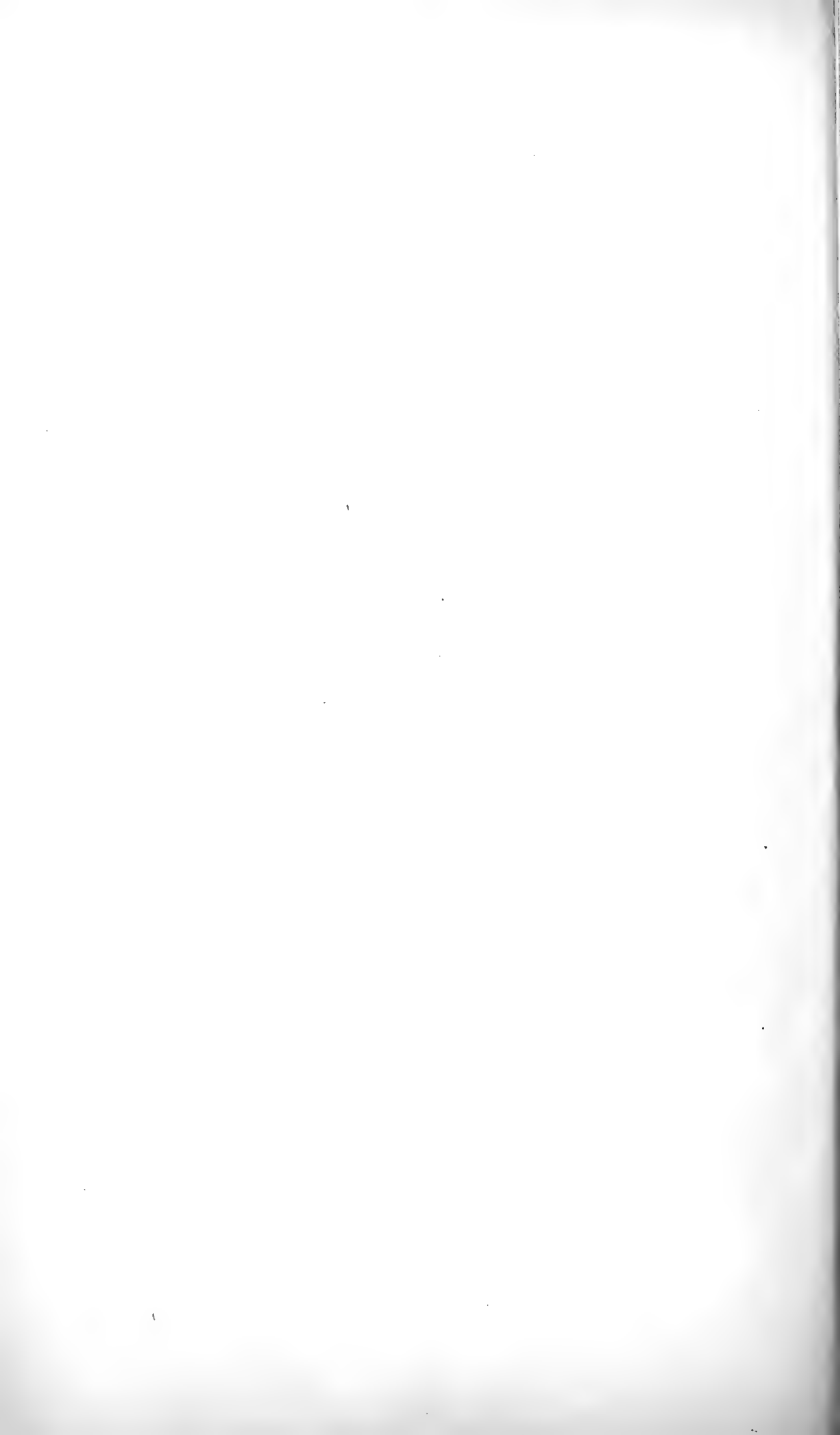
THE OPTIC CHIASMA IN TELEOSTS AND ITS BEARING  
ON THE ASYMMETRY OF THE HETEROSTOMATA  
(FLATFISHES).

By G. H. PARKER.

WITH ONE PLATE.

CAMBRIDGE, MASS., U. S. A. :  
PRINTED FOR THE MUSEUM.

JANUARY, 1903.



*The Optic Chiasma in Teleosts and its Bearing on the Asymmetry  
 of the Heterosomata (Flatfishes).*

By G. H. PARKER.

TABLE OF CONTENTS.

	PAGE		PAGE
I. Introduction . . . . .	221	chiasmata of the Hetero-	
II. Positions of the nerves in the chiasmata of symmetrical teleosts . . . . .	222	somata . . . . .	224
III. Positions of the nerves in the Bibliography . . . . .		IV. The asymmetry of the Hetero-	
		somata . . . . .	233
		V. Summary . . . . .	238
			239

I. Introduction.

THE optic chiasma in the great majority of teleosts is formed by a crossing of the optic nerves without an intermingling of their fibres; hence these vertebrates are peculiar in that the two optic nerves can be readily dissected apart even at the chiasma. Since the organs connected by these nerves — the eyes and the optic lobes — are, as a rule, symmetrically disposed, it would seem a matter of indifference whether an optic nerve in its course from the eye to the optic lobe should pass in the chiasma dorsally or ventrally to the other optic nerve. Apparently very little attention has been given to this relation, for a search through the papers on the cranial nerves of fishes has yielded only a few scattered observations and general statements unsupported by much evidence. Stannius ('49, p. 12) declared that for the most part the nerve from the left side of the brain, that is, the right nerve,<sup>1</sup> is dorsal at

<sup>1</sup> There has been some confusion in the use of the terms *right* and *left* as applied to the optic nerves. Some authors, particularly the older ones, designate the nerve right or left depending upon the side of the brain from which it arises; others use these terms in accordance with the eye to which the nerve is attached. In this paper the nerves are termed right or left depending upon their attachment to the right or to the left eye.

the chiasma, but he further remarked that this relation is not constant, and that individual differences occur. Owen ('66, p. 300) observed that the nerves cross each other without interchange of fibres, and that sometimes the nerve of the right eye is dorsal, as in the hake, and sometimes that of the left, as in the halibut. He added in a note that both conditions had been seen in different individuals of the cod. Gegenbaur ('98, p. 796), in his recent comparative anatomy, reiterates the chief statement made by Stannius; namely, that the right nerve is usually dorsal, but he cites no examples supporting this opinion. C. J. Herrick ('99, p. 394), in his work on *Menidia*, remarks that in this fish the left nerve is dorsal, as "is typical for teleostomes," and in this statement I understand him to mean the nerve connected with the left eye, an interpretation already put on this passage by Cole and Johnstone (:01, p. 116). Finally Greeff (:00, p. 25), in the new edition of the *Graefe-Saemisch Handbuch der Augenheilkunde*, reaffirms the statement originally made by Stannius that the right nerve is dorsal. Thus there is a difference of opinion as to which nerve usually is dorsal, — a condition of affairs that can be cleared up only by reinvestigation.

Much of the material upon which the following studies were made, was either from the collections of the Museum of Comparative Zoölogy or from those of the United States Fish Commission. To the officers of both these institutions I express my grateful thanks. The materials obtained from each of the two sources are indicated by foot-notes in connection with the Tables; material not otherwise designated was obtained by myself.

## II. Positions of the Nerves in the Chiasmata of Symmetrical Teleosts.

To ascertain whether the right nerves or the left nerves are more usually dorsal at the chiasmata of symmetrical teleosts, I examined a hundred specimens each of ten common species. The results of this examination are given in Table I., in which the columns opposite the name of the fish show the number of instances of right nerves dorsal and of left nerves dorsal in a total of one hundred cases. These two conditions, as Owen ('66, p. 300) long ago observed, are well shown in the cod (Figs. 1 and 2).

This table shows that in six of the ten fishes examined (*Fundulus*, *Rhombus*, *Stenotomus*, *Tautoga*, *Prionotus*, and *Melanogrammus*) the left nerve was dorsal about as frequently as the right, the greatest dif-



ference being never more than ten per cent, and that in the remaining four (*Menidia*, *Pomatomus*, *Tautogolabrus*, and *Gadus*) this difference does not exceed in any instance twenty per cent. The differences, moreover, are not all in favor of one side; in four species the excess is in left nerves dorsal, and in six in right nerves. Summing all together, it appears that in a total of one thousand the right nerve was dorsal 514 times, the left 486. Since in each of the ten species both conditions are so abundantly represented and are often so nearly equal, one is justified in concluding that neither nerve is characteristically dorsal,

TABLE I.

	Left optic nerve dorsal.	Right optic nerve dorsal.
<sup>1</sup> <i>Fundulus majalis</i> (Walbaum). Woods Hole, Mass. . . . .	51	49
<sup>1</sup> <i>Menidia notata</i> (Mitchill). Martha's Vineyard, Mass. . . . .	61	39
<i>Rhombus triacanthus</i> (Peck). Boston Markets . . . . .	53	47
<i>Pomatomus saltatrix</i> (Linnaeus). Boston Markets . . . . .	43	57
<sup>1</sup> <i>Stenotomus chrysops</i> (Linnaeus). Woods Hole, Mass. . . . .	49	51
<sup>1</sup> <i>Tautogolabrus adspersus</i> (Walbaum). Woods Hole, Mass. . . . .	43	57
<sup>1</sup> <i>Tautoga onitis</i> (Linnaeus). Martha's Vineyard, Mass. . . . .	45	55
<sup>1</sup> <i>Prionotus carolinus</i> (Linnaeus). Woods Hole, Mass. . . . .	53	47
<i>Gadus morrhua</i> Linnaeus. Boston Markets . . . . .	40	60
<i>Melanogrammus aeglefinus</i> (Linnaeus). Boston Markets . . . . .	48	52
Total	486	514

though there is a slight difference in favor of the right. This difference is so slight, however, that it is probable that a larger number of observations would give a still closer agreement in numbers, a state indicative of the unimportance from a physiological standpoint of the dorsal or the ventral position of a nerve at the chiasma.<sup>2</sup>

Since both types of nerve crossing were abundantly represented in

<sup>1</sup> Material supplied from the Biological Laboratory of the United States Fish Commission, Woods Hole, Mass.

<sup>2</sup> A condition of approximate equality, essentially like that just pointed out, has been observed by F. H. Herrick ('96, p. 143) in the right or left occurrence of the crushing claw of the common lobster and by Yerkes (:01, p. 424) in the enlarged claw of the male fiddler crab.

each of the ten species examined, these species may be said to be dimorphic in this respect, and one might naturally ask whether this dimorphism is correlated with other characters such as sex, race, etc. To the question, Is the dimorphism of the chiasma correlated with sex? a conclusive answer can be given, for two of the ten species examined. In *Fundulus* of the 51 specimens with left nerves dorsal 29 were females and 22 males, and of the 49 with right nerves dorsal, 29 were females, and 20 males. Of the 43 specimens of *Tautogolabrus* with the left nerves dorsal 26 were females, and 17 males; and of the 57 with right nerves dorsal, 26 were females, and 31 were males. These figures show clearly that there is no close correspondence between the crossing of the optic nerves and sex.

Whether or not the two types of nerve crossing represent racial differences,<sup>1</sup> cannot at present be decided. In *Fundulus*, *Menidia*, *Tautogolabrus*, *Tautoga*, and *Prionotus* the whole material came in each instance from a very restricted area, presumably from a single colony, and yet both conditions were abundantly present. But evidence of this kind is obviously very inconclusive, and a satisfactory answer to this question can probably be obtained only by experiments in breeding.

It thus appears that symmetrical teleosts are from the standpoint of their optic chiasmata dimorphic, and that their optic nerves cross without either nerves being preponderantly dorsal, a condition of approximate equality not previously recognized.

### III. Positions of the Nerves in the Chiasmata of the Heterosomata.

From the symmetrical teleosts one naturally turns to the flatfishes as a group whose lack of symmetry, particularly in the positions of the eyes, invites study. In the older classifications these fishes constituted one family, the *Pleuronectidae*; in more recent taxonomic works, such as that by Jordan and Evermann ('96-00), the group is raised to a suborder, *Heterosomata*, and divided into two families, the *Pleuronectidae*, or flounders, and the *Soleidae*, or soles. This separation agrees well with the facts to be given in the subsequent part of this paper and will,

<sup>1</sup> For a good instance of this kind among the Crustacea, we are indebted to F. H. Herrick ('95, p. 143), who states that "in *Alpheus saulcyi*, where the large crushing chela can be recognized even before the animal is hatched, the members of a brood are either right-handed or left-handed; that is, have the crushing claw on the same side of the body."

therefore, be adopted here. I shall begin with a consideration of the soles.

The *Soleidae*, according to Jordan and Evermann ('96-00, p. 2692), may be divided into three subfamilies: the Achirinae, or American soles; the Soleinae, or European soles; and the Cynoglossinae, or tongue fishes. The Achirinae and Soleinae have their eyes on the right side, that is, they are dextral; the Cynoglossinae are sinistral. I have had the opportunity of studying representatives of all three subfamilies, and the positions of their optic nerves at the chiasmata are given in Table II.

TABLE II.

FAMILY SOLEIDAE (SOLES).	Sinistral individuals.		Dextral individuals.	
	Left nerve dorsal.	Right nerve dorsal.	Left nerve dorsal.	Right nerve dorsal.
Subfamily Achirinae (American Soles). Species dextral.				
<sup>1</sup> <i>Achirus lineatus</i> (Linnaeus). Tampa Bay, Fla.			6	8
<sup>1</sup> <i>Achirus fasciatus</i> Lacépède. Wareham River, Mass. . . . .			3	3
Subfamily Soleinae (European Soles). Species dextral.				
<sup>2</sup> <i>Solea solea</i> (Linnaeus). Mersey River, Eng.			1	0
“ “ “ Plymouth, Eng.			14	14
Subfamily Cynoglossinae (Tongue Fishes). Species sinistral.				
<sup>2</sup> <i>Symphurus plagusia</i> (Bloch et Schneider). Rio Janeiro.	0	1		
<sup>1</sup> <i>Symphurus plagiusa</i> (Linnaeus). Tampa Bay, Fla.	13	4		

Of the American soles two species were examined, *Achirus lineatus* and *A. fasciatus*. All specimens were dextral, as is typical for this subfamily, and in both species individuals with the left nerve dorsal, and others with the right nerve dorsal were found. The numbers given in the Table indicate an approximate equality in the occurrence of these

<sup>1</sup> Material supplied by the United States Commission of Fish and Fisheries.  
<sup>2</sup> Material from the collections of the Museum of Comparative Zoölogy.

two types of chiasmata. The American soles may, therefore, be said to be dimorphic in the same sense that symmetrical teleosts are.

The only representative of the European soles that was studied was the common sole, *Solea solea* (Linn.), or, as it is often called, *S. vulgaris* Quens. All the specimens at hand were dextral. As the Table shows, about half had the right nerve dorsal and half the left one dorsal. Cunningham ('90, p. 68) states that in this species the left nerve is dorsal, but he makes no mention of the number of specimens examined. Doubtless his information was based on the inspection of too few individuals.

Of the tongue fishes, which are typically sinistral, observations were made on two species, but only in *Symphurus plagiusa* was the material sufficient to yield significant results. Here, as in the American and the European soles, both types of crossing were observed, but specimens with the left nerve dorsal were much more numerous than those with the right nerve dorsal.

One may conclude from these facts that the species of Soleidae, both dextral and sinistral, are characterized, like the symmetrical teleosts, by dimorphism in the structure of their optic chiasmata.

The dimorphism of the Soleidae, since it is accompanied by asymmetry, gives rise to rather unusual conditions in the optic nerves, and these conditions are characteristic for each of the two types of nerve crossing. Thus, in a dextral species the individuals with the left nerve (that is, the nerve connected with the migrating eye) *dorsal* have in a measure begun to uncross the optic nerves, since the migration of the left eye tends to draw the nerve connected with it into a course more nearly parallel with the right nerve (*cf.* Fig. 8); whereas individuals with the left nerve *ventral* have emphasized the crossing of the nerves by having the left nerve drawn around the right one by the migration of the left eye. Thus, though the Soleidae are like symmetrical teleosts in having two types of optic nerve crossings, their chiasmata are more or less pronounced, according as the nerve connected with the migrating eye is ventral or dorsal.

The Pleuronectidae, or flounders, are divisible into some six sub-families, three of which are abundantly represented in American waters; these are the Hippoglossinae or halibuts, of which some species are dextral and some sinistral, the Pleuronectinae, or flounders proper, which with very few exceptions are dextral, and the Psettininae, or turbot, which are as a rule sinistral. I have had the opportunity of examining in all twenty-eight species of Pleuronectidae. Of these, three were

represented each by both dextral and sinistral individuals and their consideration will be reserved till later. The conditions found in the remaining twenty-five, each of which was represented by specimens either exclusively dextral or sinistral, are recorded in Table III.

TABLE III.

FAMILY PLEURONECTIDAE (FLOUNDERS).	Sinistral individuals.		Dextral individuals.	
	Left nerve dorsal.	Right nerve dorsal.	Left nerve dorsal.	Right nerve dorsal.
Subfamily Hippoglossinae (Halibuts). Species dextral or sinistral.				
<sup>1</sup> <i>Atheresthes stomias</i> (Jordan and Gilbert). San Francisco Markets . . . . .			1	0
<sup>1</sup> <i>Eopsetta jordani</i> (Lockington). San Francisco Markets . . . . .			11	0
<sup>2</sup> <i>Hippoglossoides platessoides</i> (Fabricius). Salem, Mass. . . . .			1	0
<sup>1</sup> <i>Psetticthys melanostictus</i> Girard. San Francisco Markets . . . . .			23	0
<sup>2</sup> <i>Paralichthys brasiliensis</i> (Ranzani). Callao, Peru . . . . .	0	1		
<sup>1</sup> <i>Paralichthys dentatus</i> (Linnaeus). Woods Hole, Mass. . . . .	0	17		
<sup>1</sup> <i>Paralichthys albiguttus</i> Jordan and Gilbert. Anclote, Fla. . . . .	0	11		
Subfamily Pleuronectinae (Flounders). Species dextral.				
<sup>2</sup> <i>Hypsopsetta guttulata</i> (Girard). San Diego, Cal.			1	0
<sup>1</sup> <i>Parophrys vetulus</i> Girard. San Francisco Markets . . . . .			11	0
<sup>1</sup> <i>Isopsetta isolepis</i> (Lockington). San Francisco Markets . . . . .			1	0
<sup>2</sup> <i>Oncopterus darwini</i> Steindachner. East Patagonia . . . . .			1	0
<i>Limanda ferruginea</i> (Storer). Massachusetts Bay.			51	0
<sup>1</sup> <i>Pseudopleuronectes americanus</i> (Walbaum). Martha's Vineyard, Mass. . . . .			100	0
<sup>2</sup> <i>Pleuronectes platessa</i> Linnaeus. Triest, Austria.			1	0
<sup>2</sup> <i>Liopsetta putnami</i> (Gill). Salem, Mass. . . . .			1	0
<sup>1</sup> <i>Glyptocephalus zachirus</i> Lockington. San Francisco Markets . . . . .			6	0

TABLE III. (continued).

FAMILY PLEURONECTIDAE (FLOUNDERS).	Sinistral individuals.		Dextral individuals.	
	Left nerve dorsal.	Right nerve dorsal.	Left nerve dorsal.	Right nerve dorsal.
Subfamily Psettinae (Turbot). Species sinistral.				
Lophopsetta maculata (Mitchill). Massachusetts Bay . . . . .	0	68		
<sup>1</sup> Platophrys spinosus (Poey). Tampa Bay, Fla. . . . .	0	5		
<sup>1</sup> Platophrys pavo Bleeker. Kingsmill Isl. . . . .	0	1		
<sup>1</sup> Syacium papillosum (Linnaeus). Tampa Bay, Fla. . . . .	0	34		
<sup>2</sup> Syacium micrurum Ranzani. Rio Janeiro . . . . .	0	1		
<sup>2</sup> Azevia panamensis (Steindachner). West Panama . . . . .	0	1		
<sup>1</sup> Citharichthys sordidus (Girard). San Francisco Markets . . . . .	0	11		
<sup>2</sup> Citharichthys spilopterus Günther. Rio Janeiro. . . . .	0	1		
<sup>1</sup> Etropus rimosus Goode and Bean. Tampa Bay, Fla. . . . .	0	10		

An inspection of Table III. will show at once that the conditions of the optic chiasmata in the Pleuronectidae are radically different from those in the Soleidae and the symmetrical teleosts. In the Hippoglossinae the first four species in the table are dextral, and in every one of their thirty-six representatives the left nerve was dorsal. The three remaining species are sinistral, and in all of their representatives the right nerve was dorsal. In like manner the nine species of Pleuronectinae, all typically dextral, invariably had the left nerve dorsal, and the nine species of Psettinae, all sinistral, regularly had the right nerve dorsal. Summarizing the whole table, it may be stated that in all the dextral Pleuronectidae examined the left nerve was dorsal and in all sinistral ones the right nerve was dorsal. These results agree perfectly with the observations of those few investigators who have recorded the positions of the optic nerves in flounders. Thus in the two dextral species, *Pleuronectes platessa*, studied by Cole and Johnstone (: 01, p. 116), and *Pseudopleuronectes americanus*, studied by Williams (: 02, p. 34), the left nerves are said to be dorsal; and in the sinistral species, *Lophopsetta maculata*, the right nerve is reported by Williams (: 02, p. 34) to

<sup>1</sup> Material supplied by the United States Commission of Fish and Fisheries.

<sup>2</sup> Material from the collections of the Museum of Comparative Zoölogy.

be dorsal. It is thus evident that the Pleuronectidae, unlike all other fishes, do not have a dimorphic condition of the chiasma, but a monomorphic one, in that dextral species, have the left nerve dorsal (Fig. 4) and sinistral species the right nerve dorsal (Fig. 3). This monomorphic condition sets the Pleuronectidae in strong contrast not only with the symmetrical teleosts, but also with the Soleidae, and justifies the recent tendencies in the taxonomy of fishes to separate these two groups.

So far as the species of Pleuronectidae thus far examined are concerned the generalization reached in the preceding paragraph may be put in a still simpler way. In the sinistral species the right eye is the one that migrates and its nerve, as we have seen, is always dorsal; in the dextral species the left eye migrates and its nerve is likewise dorsal. Hence in all Pleuronectidae thus far considered the nerve of the *migrating* eye is dorsal. This conclusion was reached by Williams (:02, p. 34) for the two species studied by him, and, as the preceding account shows, it probably applies generally to such species of the Pleuronectidae as are exclusively dextral or sinistral.

There is a certain mechanical advantage in the dorsal position of the nerve of the migrating eye. Since this eye moves through the dorsal part of the head, its nerve is in a more advantageous position to move with the eye if dorsal at the chiasma than if ventral. With the nerve dorsal the effect of the migration, as already pointed out, would be to bring the two optic nerves into more nearly parallel positions, that is, to make the chiasma less emphasized than in a symmetrical fish, as Cole and Johnstone (:01, p. 117) have already observed it to be in *Pleuronectes platessa*. Were the nerve ventral, the effect of the migration would be to wrap it around its fellow so as to accentuate the chiasma. While this latter condition is not impossible, for, as we have seen, it exists in many of the Soleidae, it is certainly less advantageous mechanically than the other. One may, therefore, say that the monomorphic condition of the Pleuronectidae is of such a kind as to give a mechanical advantage to the migrating eye.

The crossing of the optic nerves in young Pleuronectidae is established in the eggs long before the young fishes hatch and is, I believe, as uniformly monomorphic there as in the adults. It is well known to all who have had any experience in rearing young flounders that their period of greatest mortality is during the migration of the eyes. It might be supposed that those which die at this stage are flounders whose migrating eyes had ventral nerves; that, in other words, the flounders hatched from eggs included animals with the nerve of the migrating eye

ventral as well as those with that nerve dorsal, and that, when metamorphosis sets in, only those whose migrating eyes had dorsal nerves survived. Unfortunately there is no evidence in favor of this view and much against it. Williams, whose paper (:02) I have already quoted, informs me that in the two species of Pleuronectidae studied by him all the symmetrical young had the same type of optic nerve crossing that the metamorphosed individuals had. I have myself determined the positions of the nerves in the chiasmata of ten newly hatched but unmetamorphosed *Pseudopleuronectes americanus*, and in all, the left nerve was dorsal, as was characteristic of the adult. I therefore believe that the young Pleuronectidae are hatched with the type of optic nerve crossing characteristic of the adult, and that this may be looked upon as an adaptation preparatory to the migration of the eye.

Writers in the past, and even recent writers, such as Cunningham ('90, p. 51); and Williams ('02, p. 1), often refer to the newly hatched Pleuronectidae as "perfectly symmetrical" and with "eyes and all other parts of the head . . . as symmetrical as in any other fish." But the way in which the optic nerves cross sets this question in a somewhat different light. The soles, so far as their optic chiasmata are concerned, doubtless are hatched in a condition like ordinary fishes, but those Pleuronectidae that turn in one direction only come from the egg with a monomorphic type of nerve crossing that conforms in a mechanically advantageous way to the ultimate direction of their turning. It is doubtful whether the term symmetrical should be applied to the conditions of the optic chiasmata of ordinary teleosts, but if it is so applied, the young Pleuronectidae are not in that sense symmetrical, for of the two kinds of chiasmata found in each species of ordinary teleosts only one occurs in each species of Pleuronectidae, and this condition is established some time before hatching.

It might be inferred from what has gone before that the factors that determine which eye in the Pleuronectidae will migrate are to be sought for, not, as is usually done, in the environment when the young fish undergoes its metamorphosis, but in the egg at the time when the optic chiasma is established, or even earlier. But this assumption would imply that the manner of the crossing of the optic nerves and the migration of the eye are mutually dependent phenomena. That they are not invariably so can be shown by the following observations.

A few species of Pleuronectidae are represented by both sinistral and dextral individuals. Thus *Pleuronectes platessa*, a dextral species, may, according to Duncker ('96, p. 83) be occasionally represented by a



sinistral specimen, and *Pleuronectes flesus*, also dextral, has been reported by the same authority (:00, p. 339) as represented in different localities by from five to thirty-six per cent of sinistral individuals. In American waters three such species are known: the halibut of the Atlantic and Pacific coasts, and the bastard halibut and starry flounder of the California coast. The halibut is typically a dextral species and, like *Pleuronectes platessa*, is only rarely represented by sinistral individuals. The bastard halibut, according to Jordan and Evermann ('96-00, p. 2625), is almost as frequently dextral as sinistral, and the starry flounder, a dextral species, is said by the same authorities

TABLE IV.

FAMILY PLEURONECTIDAE.	Sinistral individuals.		Dextral individuals.	
	Left nerve dorsal.	Right nerve dorsal.	Left nerve dorsal.	Right nerve dorsal.
Subfamily Hippoglossinae.				
Halibut, <i>Hippoglossus hippoglossus</i> (Linnaeus). Grand Banks . . . . .	<i>1</i> <sup>1</sup>	0	12	0
<sup>2</sup> Bastard halibut, <i>Paralichthys californicus</i> (Ayes). San Francisco Markets . . . . .	0	11	0	15
Subfamily Pleuronectinae.				
<sup>2</sup> Starry flounder, <i>Platichthys stellatus</i> (Pallas). San Francisco Markets . . . . .	50	0	50	0

('96-00, p. 2607) to be frequently sinistral. If now the determinations as to which optic nerve shall be dorsal at the chiasma and as to which eye shall subsequently migrate are dependent phenomena, it follows that in those species in which the left eye migrates in some individuals and the right one in others, there should be found two corresponding types of nerve crossings. In ascertaining whether such is the case or not, I examined specimens of the three American species mentioned; the results of this examination are given in Table IV.

<sup>1</sup> Atypical individuals are indicated by italic numerals.

<sup>2</sup> Material supplied in part by the United States Commission of Fish and Fisheries.

Of the halibut, *Hippoglossus hippoglossus*, thirteen specimens were examined, twelve dextral and one sinistral, and in all the left optic nerve was dorsal, thus confirming the statement of Owen ('66, p. 300) for this species. Of the bastard halibut, *Paralichthys californicus*, twenty-six were examined, eleven sinistral and fifteen dextral, and in all the right nerve was dorsal. Of the starry flounder, *Platichthys stellatus*, one hundred were examined, fifty sinistral and fifty dextral, and in all the left nerve was dorsal. It therefore appears that each of these three species has a monomorphic chiasma irrespective of the fact that it may be composed in part of sinistral and in part of dextral individuals, and, therefore, the conclusion is that, at least in these species, the manner of the crossing of the optic nerves is independent of the type of migration shown by the eye.

The three species mentioned seem at first sight to be exceptions to what has been said of the Pleuronectidae in general, but such is not wholly true. Each species, as in the other Pleuronectidae examined, has a monomorphic chiasma, and the nerve that is dorsal in each instance is the one that would reasonably be expected to be. Thus, in the halibut the species is essentially dextral, for sinistral individuals are extremely rare,<sup>1</sup> and in conformity with this the left nerve is always dorsal. The bastard flounder belongs to a genus all other American members of which are sinistral; it is therefore natural to find that in this species, though it contains both dextral and sinistral individuals, the rule for a sinistral form holds, the right nerve being always dorsal. The starry flounder is a member of the Pleuronectiinae, a subfamily in which this species is almost the only American exception to complete dextrality, and as usual the rule for dextral species prevails, all left nerves being dorsal. These species, therefore, conform perfectly to the rule for other Pleuronectidae that prescribes a monomorphic chiasma, and though in them the dorsal nerve is not always connected with the migrating eye, it is always connected with that eye which in the greater number or nearest of kin is the one to migrate. Thus these species are not so exceptional as they at first appear.

Of the two conditions presented by each of the three species mentioned one may be said to be typical and the other atypical. The typical condition is represented by the dextral halibuts and starry flounders and by the sinistral bastard halibuts; the atypical condition by the

<sup>1</sup> The sinistral halibut examined by me was the only individual obtained during the winter of 1900-01 by one of the largest halibut establishments in Boston. It was certainly a single individual in many thousands.

sinistral halibuts and starry flounders and by the dextral bastard flounders. These two conditions are distinguished not only by differences in the external symmetry of the fishes, but still more so by the optic chiasmata. Thus, in a sinistral species, like *Paralichthys californicus*, the typical individuals, having their right nerves dorsal, will have their optic chiasmata somewhat uncrossed (Fig. 5), as already explained in dealing with the soles (p. 226), and the atypical individuals, having their right nerves also dorsal, will have their optic crossings emphasized (Fig. 6). Converse conditions occur, of course, in dextral species, such as *Platichthys stellatus* (Figs. 7 and 8).

It might at first sight seem that the relations here pointed out are like those already noticed in the Soleidae, but such is not precisely the case. When it is kept in mind that there are two types of chiasmata and that these may be combined with eyes either on the right or on the left side of the head, it is clear that there must be four possible combinations. The conditions in any species of sole can be thought of as a combination of one of two types of nerve crossing with eyes always on the same side of the head. The conditions in the three species of Pleuronectidae may be described as a combination of one type of nerve crossing with the eyes either on the right or the left side of the head. It thus follows that the two combinations in any one species of sole cannot duplicate those in any one species of the Pleuronectidae in which both dextral and sinistral individuals occur.

#### IV. The Asymmetry of the Heterosomata.

The older naturalists assumed generally that the asymmetry of the flatfishes was simply a question of the migration of the eye. It is now being recognized that the problem is a much more complex one. Thus Cole and Johnstone (:01, p. 8) have pointed out that the lack of symmetry of the mouth is quite independent of that of the eyes, though both are probably adaptations to side swimming. The different colorations of the two sides of the body, as well as the unsymmetrical form of the skull, seem to be independent of the migration of the eye. This is proved in part by the observations of Bumpus ('98, p. 197), who noticed that many specimens of *Pseudopleuronectes americanus* were marked with dark splotches on their light sides, though otherwise normal, and also by those of Holt ('94) on a sole in which the typical coloration and form of skull were present, though the eye had not migrated. The

independence of the type of chiasma and the kind of migration of the eye, in some species at least, has been pointed out in this paper. It thus appears that the asymmetry of a flatfish is made up of numerous more or less independent elements, which in the typical individual are brought together by a combination of events, but which may from time to time show evidence of their independence by appearing in unusual ways. What the factors are that control these elements in the asymmetry of the fish is unknown, but how they may be discovered has been indicated by Agassiz ('79, p. 12), who initiated experiments on the unmetamorphosed fishes to ascertain the influence of light from below, experiments which when carried out still further by Cunningham and MacMunn ('94, p. 791) showed that this factor is of importance in determining pigmentation.

Although it must be admitted that in the halibut, bastard halibut, and starry flounder the evidence of the independence of the factor or factors determining the crossing of the optic nerves and those controlling the migrations of the eyes is as complete as it well can be under the circumstances, it does not follow that in other species these factors are so unrelated, nor that they have always been independent in the three species named. The fact that in every species of Pleuronectidae that turns in only one direction (Table III.) the nerve of the migrating eye is always dorsal shows that there has been at least in the past a very intimate relation between the process of chiasma formation and that of eye migration. It seems beyond a doubt that in the ancestral Pleuronectidae the process of forming a chiasma was narrowed down to the production of that type which was mechanically most advantageous for the migrating eye, and thus a stock arose in which a particular type of chiasma was associated with a particular type of asymmetry. From this standpoint the occurrence of reversed specimens, as in the three species already mentioned (Table IV.), cannot be regarded a primitive trait, as implied by Thilo (: 02, p. 306), but must be looked upon as a new departure, for all these species show in their optic chiasmata the stamp of an ancestral condition uniform for each one.

Although phylogenetic questions, like taxonomic, are seldom well answered on the basis of single characters, single characters are often very important in the investigation of these questions. From this standpoint the crossing of the optic nerves has a significant bearing on the general questions of the origin and the present classification of the flatfishes. The flatfishes have undoubtedly descended from symmetrical fishes, and, as Johannes Müller ('46) long ago pointed out,

their nearest present relatives are probably the Gadidae. The Gadidae, however, have a body very differently formed from that of any living flatfish, and if they were ancestral to the present flatfishes, there must have been intermediate members whose bodies were flattened sidewise and were probably symmetrical. A fish of such proportions is seen in the modern *Zeus faber*. Without going the length that Thilo (:02) does and assuming that this fish really represents the forerunners of the flatfishes, it seems certain that the ancestors of these fishes must have had much the proportions of *Zeus*. From fishes of such form the unsymmetrical flatfishes have doubtless been derived. Their symmetrical ancestors, like all other symmetrical teleosts, probably had dimorphic chiasmata. That this feature was handed on to the flatfishes is evident from the fact that it still characterizes the whole family of soles. I am aware that the soles are usually regarded as degraded Pleuronectidae, and they certainly are in many respects degenerate; but, from the standpoint of their chiasmata, they certainly present the most primitive conditions seen in any flatfish, and I believe, therefore, that they are degenerate descendants of the original stock of flatfishes that had not yet passed beyond the stage of dimorphic chiasmata. From this stock was differentiated the Pleuronectidae by a process whereby, amongst other things, a monomorphic chiasma was produced. This type of chiasma was differentiated in two lines so as to meet the requirements, (1) of a sinistral type of symmetry, as in the Psettinæ, or turbot, and (2) of a dextral type, as in the Pleuronectinæ, or flounders proper. In the tribes thus established species here and there varied in their symmetry as in the starry flounder, etc., but in such instances the character of the chiasma indicates at once whether the species belongs to a stock originally sinistral or dextral. Such changes as these must be looked upon as the most recent realized by the flatfishes.

It would be a matter of great satisfaction if the ancestry of the flatfishes could be traced through their fossil remains. Unfortunately the scantiness of such material renders this impossible, though the occurrence of a *Rhombus* in the upper eocene and of a *Solea* in the miocene points to the antiquity of these fishes among teleosts.

Throughout the whole of the preceding discussion on the Pleuronectidae, it has been assumed that the dorsal position of the nerve connected with the migrating eye is a real advantage to the animals possessing it. In fact, the explanation of the prevalence of the monomorphic condition in the Pleuronectidae rests upon this assumption. It is by no means easy to show that this assumption is, as I believe it to be,

perfectly sound, for there are not a few species, like the starry flounder, the bastard halibut, etc., in which the ventral position of the nerve of the migrating eye occurs in many adults. The death rate of these individuals, as compared with that of individuals having the nerve of the migrating eye dorsal, would, however, be significant. Duncker (: 00, p. 339) has determined this for *Pleuronectes flesus*. In a large collection of material from Plymouth, England, including the dextral and the sinistral individuals in natural proportion, it was found that among the smaller, and presumably *younger*, individuals the sinistral specimens were relatively more abundant than among the larger ones, the proportion being about one hundred to eighty-five. As Duncker correctly concludes, the death rate of the sinistral individuals must therefore be higher than that of the dextral ones. As this is a dextral species, it follows that individuals in which the nerve of the migrating eye is ventral are more open to early death than those in which this nerve is dorsal, and that therefore there is good reason to suppose that the dorsal position of the nerve of the migrating eye is a real advantage in the Pleuronectidae.

Numerous attempts have been made to explain the phylogenetic process by which the asymmetry of the flatfish has been established. Most of these deal with the migration of the eye, and Cunningham ('90, p. 51; '92, p. 193) has set forth in a clear way the two chief lines of argument. One of these is based upon Darwinian principles, and the other, which is on the whole favored by Cunningham, involves Lamarckian methods. This second explanation is somewhat elaborated by Cunningham, in that he has ascribed the migration of the eye chiefly to the action of the oblique eye muscles. In any fish that was flattened sidewise and had taken up with side swimming, the oblique muscles of the eye that faces downward would be continually brought into play to lift the eye to a position of greater service, and if the effect of this action could be inherited, the migration of the eye might thus be accounted for. It would be hazardous in the present state of our knowledge to assert that such changes cannot be inherited, though this does not prove that they are. Granting that they are handed on from generation to generation, it is, in my opinion, conceivable that operations such as those described by Cunningham may have brought about the migration of the eye. But with the monomorphic chiasma the question seems to me wholly different. The Pleuronectidae have descended from a stock with two types of optic chiasmata essentially like those of the present symmetrical teleosts, and of these two types, that one has been retained which in each group is mechanically advantageous for the migration

of the eye. The selection and preservation of this type seems to me entirely inexplicable from the standpoint of Lamarckian factors, for the optic nerves are in no way open to muscle influence as the eye is; the whole change is, in my opinion, at once suggestive of a process of elimination. Hence I regard the origin of the monomorphic chiasmata of the Pleuronectidae as an operation in which the Lamarckian factors have played no part, but which may be entirely explained through natural selection. Although natural selection seems to be the only way of accounting for the origin of the monomorphic chiasmata of the Pleuronectidae, I do not wish to be understood to imply that the whole asymmetry of the flatfishes has been thus produced. I can see no reason why continued muscle action may not in the end modify the position of an eye or why some direct influence of the environment, such as light, may not have much to do with pigmentation; nor am I convinced that such changes may not be inherited.

It seems to me entirely possible from our present knowledge that the asymmetry of a flatfish may be in part the result of the action of Lamarckian factors and in part the outcome of natural selection, for these two operations are not at all incompatible and may perfectly well work together. But what I wish particularly to point out in this connection is that in the origin of the monomorphic chiasmata of the Pleuronectidae natural selection seems to be the only available means.

From another standpoint the flatfishes are biologically interesting. Their asymmetry is of a very pronounced type, and its particular phase sometimes characterizes a whole tribe, as the dextral Pleuronectinae and the sinistral Psettinæ. Notwithstanding this evidence of general stability, species may occur almost anywhere among modern forms in which a complete reversal of symmetry of external characters at least may exist. This is well shown in *Pleuronectes flesus*, *Platichthys stellatus*, etc., and indicates that this group of animals is open to discontinuous variation of a profound and fundamental kind. Flatfishes are not peculiar in this respect, for discontinuous variation, as Bateson ('94) has pointed out, has long been recognized in other groups. Thus in the gasteropods reversed (sinistral) shells of the common *Buccinum* and of the European garden snail have long been known. Reversed specimens of this kind may establish themselves as a special race, as in the case of *Fusus antiquus* of Vigo Bay, Spain. Sometimes whole species are characterized by reversal, as among the Pupæ, or even whole genera, as in *Clausilia* and *Physa*. Not only do the gasteropods show these differences, but some lamellibranchs, like *Chama*, are also reversed.

Among arthropods the presence of enlarged chelae on one or other side, as already mentioned, may involve discontinuity. The same is true of the sexual asymmetry of the Cyprinodonts as worked out by Garman ('95), and it is probable that the condition in the human being known as *situs transversus viscerum* is of like nature. Thus many other animals show in the reversal of asymmetrical conditions evidence of discontinuous variation not unlike that of the flatfishes; but the flatfishes differ from many of these in the relatively high degree of stability that their asymmetry possesses, — a condition in part explainable, in my opinion, as the result of the association of a special form of asymmetry with certain advantageous internal conditions, like a particular type of optic nerve crossing.

### V. Summary.

1. In each of ten species of symmetrical teleosts the optic chiasmata were dimorphic, in that in some instances the right optic nerve was dorsal, in others the left.

2. In a thousand cases the right nerve was dorsal 514 times, the left 486 times.

3. The two types of chiasmata are not correlated with sex.

4. In the Soleidae the chiasmata are also dimorphic, as in symmetrical teleosts.

5. In the Pleuronectidae the chiasmata are monomorphic for each species; in dextral species the left nerve is dorsal, in sinistral species the right nerve is dorsal.

6. All species of Pleuronectidae that turn in only one direction have their dorsal nerves connected with their migrating eyes. In all species that have both dextral and sinistral individuals (Table IV.), the dorsal nerve is connected with that eye which in the greatest number or in the nearest of kin migrates.

7. The unmetamorphosed young of the Pleuronectidae are not symmetrical in the same sense that symmetrical teleosts are, for they have monomorphic chiasmata.

8. The Soleidae are not degraded Pleuronectidae, but degenerate descendants of primitive flatfishes, from which the Pleuronectidae have probably been derived.

9. The monomorphic condition of the optic chiasma of the Pleuronectidae can be explained only on the assumption of natural selection.

10. The flatfishes afford striking examples of discontinuous variation.



## BIBLIOGRAPHY.

**Agassiz, A.**

- '79. On the Young Stages of Bony Fishes. Proceed. Amer. Acad. Arts and Sci., Vol. 14, pp. 1-25, pl. 1-9.

**Bateson, W.**

- '94. Materials for the Study of Variation. London and New York. xvi + 598 pp.

**Bumpus, H. C.**

- '98. A Recent Variety of the Flatfish, and its Bearing upon the Question of Discontinuous Variation. Science, New Series, Vol. 7, pp. 197-198.

**Cole, F. J., and J. Johnstone.**

- :01. Pleuronectes. L. M. B. C. Memoirs on Typical British Marine Plants and Animals, [No.] 8. London. viii + 252 pp., 11 pl.

**Cunningham, J. T.**

- '90. A Treatise on the Common Sole (*Solea vulgaris*). Plymouth. viii + 147 pp., 18 pl.

**Cunningham, J. T.**

- '92. The Evolution of Flatfishes. Natural Science, Vol. 1, pp. 191-199.

**Cunningham, J. T., and MacMunn, C. A.**

- '94. On the Coloration of the Skins of Fishes, especially of Pleuronectidae. Philos. Trans. Roy. Soc., London, Vol. 184, pp. 765-812, pl. 53-55.

**Duncker, G.**

- '96. Variation und Verwandtschaft von *Pleuronectes flesus* L. und *Pl. platessa* L. Wissenschaftliche Meeresuntersuchungen, Neue Folge, Bd. 1, Heft 2, pp. 47-103, Taf. 1-4.

**Duncker, G.**

- :00. Variation und Asymmetrie bei *Pleuronectes flesus* L. Wissenschaftliche Meeresuntersuchungen, Neue Folge, Bd. 3, Abt. Helgoland, Heft 2, pp. 333-406, Taf. 11-14.

**Garman, S.**

- '95. The Cyprinodonts. Mem. Mus. Comp. Zool. Harvard Coll., Vol. 19, pp. 1-179, 12 pl.

**Gegenbaur, C.**

'98. Vergleichende Anatomie der Wirbelthiere. Bd. 1. Leipzig. xiv + 978 pp.

**Greeff, R.**

:00. Die mikroskopische Anatomie des Sehnerven und der Netzhaut. In Graefe-Saemisch Handbuch der gesamten Augenheilkunde. Zweite Auflage. Bd. 1, Kapitel 5. Leipzig.

**Herrick, C. J.**

'99. The Cranial and First Spinal Nerves of Menidia; a Contribution upon the Nerve Components of the Bony Fishes. Jour. Comp. Neurology, Vol. 9, pp. 153-455, pl. 14-20.

**Herrick, F. H.**

'96. The American Lobster. Bull. U. S. Fish Commission for 1895, pp. 1-252, pls. A-J, and 1-54.

**Holt, E. W. L.**

'94. On an adult Specimen of the Common Sole (*Solea vulgaris*, Quensel) with symmetrical Eyes, with a Discussion of its Bearing on Ambicoloration. Proceed. Zool. Soc. London, 1894, pp. 432-446.

**Jordan, D. S., and Evermann, B. W.**

'96-00. The Fishes of North and Middle America. Bull. U. S. Nat. Museum, No. 47, lx + xxx + xxiv + ci + 3312 pp., 392 pl.

**Müller, J.**

'46. Ueber den Bau und die Grenzen der Ganoiden und über das natürliche System der Fische. Berlin. 100 pp., 6 Taf.

**Owen, R.**

'66. On the Anatomy of Vertebrates. Vol. 1. London. xlii + 650 pp.

**Parker, G. H.**

:01. The Crossing of the Optic Nerves in Teleosts. Biol. Bull., Vol. 2, pp. 335-336.

**Stannius, H.**

'49. Das peripherische Nervensystem der Fische. Rostock. iv + 156 pp., 5 Taf.

**Thilo, O.**

:02. Die Umbildung am Knochengerüste der Schollen. Zool. Anzeiger, Bd. 25, pp. 305-320.

**Williams, S. R.**

:01. The Changes in the Facial Cartilaginous Skeleton of the Flatfishes, *Pseudopleuronectes americanus* (a dextral fish) and *Bothus maculatus* (sinistral). Science, New Series, Vol. 13, pp. 378, 379.

**Williams, S. R.**

- :02. Changes accompanying the Migration of the Eye and Observations on the Tractus Opticus and Tectum Opticum in *Pseudopleuronectes americanus*. Bull. Mus. Comp. Zool. Harvard Coll., Vol. 40, No. 1, pp. 1-57, 4 pl.

**Yerkes, R. M.**

- :01. A Study of Variation in the Fiddler Crab *Gelasimus pugilator* Latr. Proceed. Amer. Acad. Arts and Sci., Vol. 36, pp. 417-442.

PARKER. — Optic Chiasma.

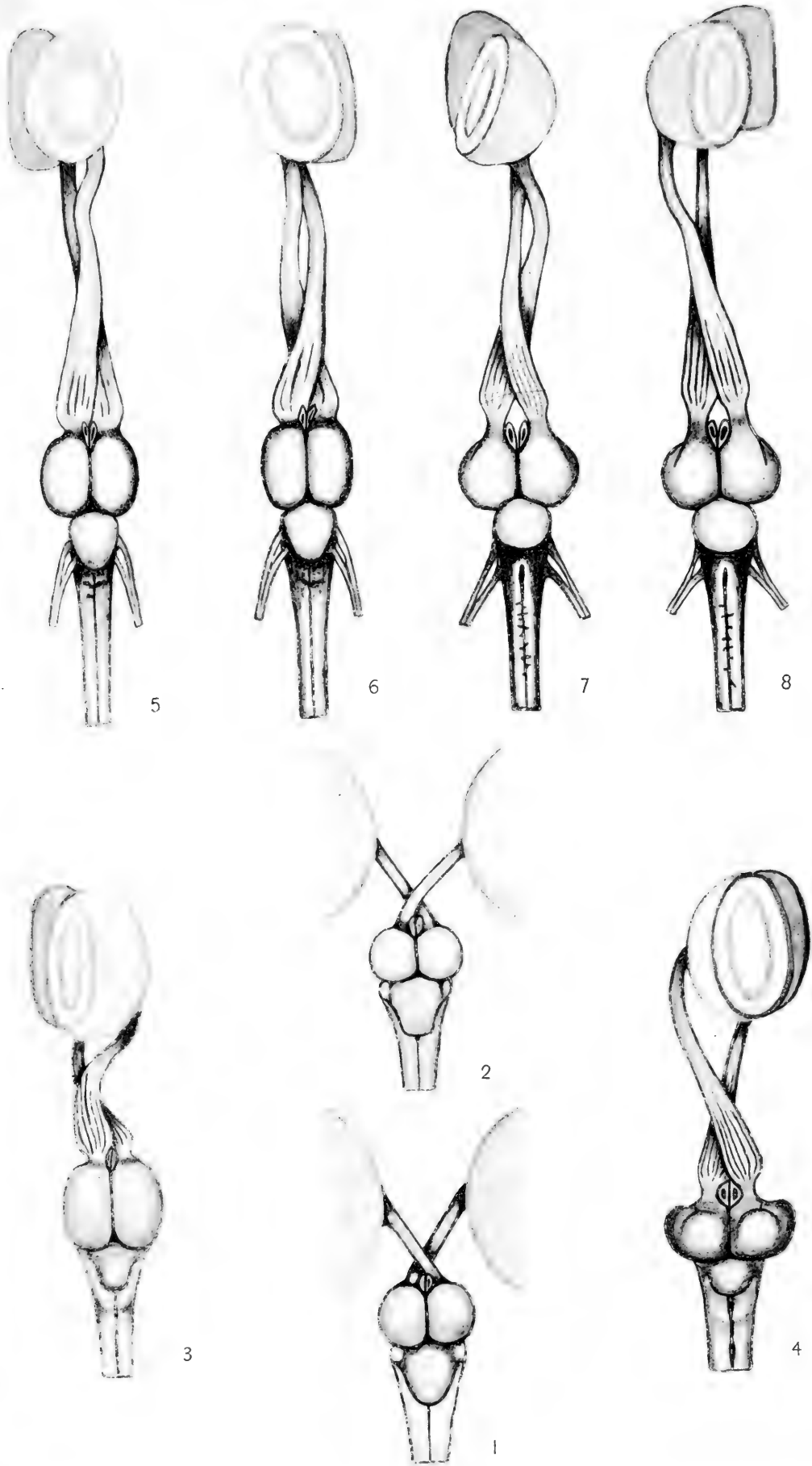
### EXPLANATION OF THE PLATE.

---

All figures represent *dorsal* views of brains of teleosts from which the cerebral hemispheres have been removed, thus exposing the optic nerves, chiasmata, and parts of the tracts. The optic lobes, cerebellum, and medulla are shown in each instance, as well as the outline of the eyeballs.

- Fig. 1. *Gadus morrhua* Linn. Left optic nerve dorsal.  
Fig. 2. *Gadus morrhua* Linn. Right optic nerve dorsal.  
Fig. 3. *Lophopsetta maculata* (Mitchill). Sinistral species. Right optic nerve dorsal.  
Fig. 4. *Pseudopleuronectes americanus* (Walbaum). Dextral species. Left optic nerve dorsal. For the best exposure of the chiasma the brain is viewed from an antero dorsal position; hence the optic lobes are somewhat foreshortened.  
Fig. 5. *Paralichthys californicus* (Ayres). Sinistral species. Sinistral individual. Right optic nerve dorsal.  
Fig. 6. *Paralichthys californicus* (Ayres). Sinistral species. Dextral individual. Right optic nerve dorsal.  
Fig. 7. *Platichthys stellatus* (Pallas). Dextral species. Sinistral individual. Left optic nerve dorsal.  
Fig. 8. *Platichthys stellatus* (Pallas). Dextral species. Dextral individual. Left optic nerve dorsal.

PARKER.—OPTIC CHIASMA.





Bulletin of the Museum of Comparative Zoölogy

AT HARVARD COLLEGE.

VOL. XL. No. 6.

---

POLYDACTYLISM IN MAN AND THE DOMESTIC ANIMALS,  
WITH ESPECIAL REFERENCE TO DIGITAL  
VARIATIONS IN SWINE.

By C. W. PRENTISS.

WITH TWENTY-TWO PLATES.

CAMBRIDGE, MASS., U. S. A. :  
PRINTED FOR THE MUSEUM.  
APRIL, 1903.





*Polydactylism in Man and the Domestic Animals, with especial  
Reference to Digital Variations in Swine.*

By C. W. PRENTISS.

TABLE OF CONTENTS.

	PAGE		PAGE
Introduction . . . . .	245	connected with meta-	
I. Historical survey . . . . .	246	carpal II. . . . .	284
II. Polydactylism in man . . . . .	251	a. One supernumerary	
A. Literature . . . . .	251	digit . . . . .	284
B. Observations . . . . .	252	b. Two supernumerary	
III. Polydactylism in carnivora . . . . .	255	digits . . . . .	285
A. Literature . . . . .	255	C. Significance of variations	
B. Observations . . . . .	257	observed . . . . .	288
IV. Polydactylism in the fowl . . . . .	259	VI. Polydactylism in ruminants . . . . .	292
V. Polydactylism in swine . . . . .	261	A. Literature . . . . .	292
A. Literature . . . . .	261	B. Observations . . . . .	293
B. Observations . . . . .	263	VII. Polydactylism in the equidae . . . . .	296
1. Manus in which the su-		A. Literature . . . . .	296
pernumerary digits are		B. Observations . . . . .	298
independent of the nor-		VIII. Theories of polydactylism . . . . .	299
mal digits . . . . .	270	1. External influences . . . . .	299
a. One supernumerary		2. Internal influences . . . . .	300
digit . . . . .	270	a. Reversion . . . . .	300
b. Two supernumerary		b. Germinal variation . . . . .	305
digits . . . . .	277	IX. Summary . . . . .	307
2. Manus in which the su-		Bibliography . . . . .	309
pernumerary parts may		Explanation of plates . . . . .	314
be more or less closely			

Introduction.

THE frequent occurrence of extra digits on the extremities of both man and the domestic animals has attracted the attention of many anatomists during the past century. Various theories have been advanced to account for the appearance of these digital abnormalities, and the opinions expressed by different investigators have been remarkably contradictory.

Through the great kindness of Dr. W. McM. Woodworth, Keeper of the Museum of Comparative Zoölogy at Harvard College, a valuable collection of polydactyle specimens was placed at my disposal. The investigation represented by this paper was undertaken with the view to obtaining, from a study of these abnormalities, some clue as to the causes leading to their occurrence.

In order to understand the phenomena of polydactylism, and to make it possible to draw some general conclusions, a comparative study of such abnormal structures is necessary. It has, therefore, been considered worth while to collate from the literature brief descriptions of polydactylism in those forms of which we were unable to obtain suitable material. In reviewing the literature, however, a résumé is given of only those papers which draw important and general conclusions. Works concerned chiefly with descriptions of polydactylism in individual animals are treated of in the separate accounts of digital variations in man and the different domestic animals here referred to.

My research was carried on at the Zoölogical Laboratory of Harvard University, and to Prof. E. L. Mark are due my sincerest thanks for both the laboratory privileges I enjoyed, and his own kind direction and most valuable criticism. To Dr. W. E. Castle I am also indebted for important criticisms and revision of proof.

### I. Historical Survey.

Allusions to polydactylism are to be met with as far back as the time of Pliny. The first investigator who attempted to collect scientific data on the subject was Struthers ('63). He tabulated digital abnormalities in man, and proved that they were strongly inherited.

Darwin ('76) accounts for the fact that supernumerary digits are more numerous on the hands than on the feet by suggesting that the hand is more specialized than the foot, and therefore more likely to vary. For the same reason polydactylism is less common in women, the male showing always greater differentiation, and therefore a greater tendency to variation. Darwin at first assumed polydactylism to be reversion to a more primitive ancestral condition; but this assumption was later withdrawn.

Gegenbaur ('80) criticises the theory which regards polydactylism as atavistic. His arguments are: (1) that other parts of the manus or pes show no correlated modifications; (2) that man normally possesses five digits, the typical number for vertebrates, and that the supernumerary

digits are produced by duplication or intercalation. He regards all cases of polydactylism in the pig as due to the splitting of one of the functional digits, and holds therefore that they are monstrosities. Polydactylism in the horse, he admits, may be atavistic, as (1) the reversion is to a closely related ancestor; (2) in *Hipparion*, a three-toed fossil horse, the second digit is better developed than the fourth, and in polydactyle horses the second digit is the one which most usually appears; (3) the rudiments of the extra digits may be present in the embryo. Atavism Gegenbaur divides into two types: (1) Palaeogenetic, or cases where the fundament of an organ is always present in the embryo, and may develop, or may degenerate (centrale of man); (2) Neogenetic, or cases where the organ is absent even in the embryo, (phalanges of digits II and V in the horse).

Bardeleben ('85, '85<sup>a</sup>, '86) answers Gegenbaur's objections to reversionary polydactylism in man, by advocating the *prae-pollex* theory. He maintains that the cartilaginous elements found on the radial side of the hand and the tibial side of the foot are rudiments of a "*prae-pollex*" and "*prae-hallux*," respectively, and not sesamoids, as had been previously maintained. Also that the pisiform of the carpus and the *tuberositas calcanei* of the tarsus represent the rudiments of "*post-minimi*." The manus and pes of primitive mammals were therefore in his opinion heptadactyle, and polydactylism in man and other mammals is simply reversion to this ancestral seven-toed condition.

Boas ('85, '90) considers polydactylism in the horse and ox as due to reversion. The extra digits formed do not represent simply the persistence of an embryonic condition, for in the polydactyle ox phalanges are formed in the extra digits, and these elements are normally absent in the embryo.

Albrecht ('86) points out that in man the greater number of polydactyle cases consist in the duplication of a single digit. This he assumes to be reversion to the bifid fin-rays of the elasmobranchs. He distinguishes this type of polydactylism (false hyperdactyly) from that found in animals where the number of digits is less than five (true hyperdactyly). Albrecht is supported in his view by Kollman ('88).

Gegenbaur ('88) states that the discovery of the so-called "*prae-pollex*" is not new, but was originally made by Cuvier, and he opposes the "*prae-pollex*" theory of Bardeleben on the following grounds: (1) these doubtful rudiments never form true fingers, and their development is secondary to that of the other digital bones; (2) polydactylism in man cannot be explained by it, for supernumerary digits occur on the ulnar as well

as on the radial side of the carpus, and they may also be interpolated between the other digits; (3) when the "prae-pollex" is present, no correlated changes have been observed in the carpus and other parts of the manus; (4) its inheritability is no proof of reversion to a palinogenetic digit, for all monstrosities are inherited. Bardeleben's theory is therefore an "unbegründete Behauptung," and polydactylism in man is due to doubling of the normal digits.

Zander ('91) describes in some detail a case of hexadactylism in man, concluding that the abnormality was produced by the splitting or duplication of the fundament of the normal thumb. He discusses at some length the different theories which have been advanced to account for polydactylism. Reversion and the assumption of Bardeleben he rejects on the following grounds: (1) the rudiments of the prae-pollex are of secondary formation, and therefore are sesamoids, not digital vestiges; (2) Kükenthal ('89-93) has shown that the sixth digit found in *Delphinus leucas* is produced by the splitting of the fifth digit in the embryo; (3) the most primitive fossil reptiles, the Ichthyopterygia, possessed, according to Baur ('87), only five digits, and therefore the hexadactyle condition must have been brought about later, either by duplication of the primary digits, or by neomorphic development on the ulnar side of the extremity; (4) no case has been observed where the "rudiments" of Bardeleben have developed into supernumerary digits. On the contrary, the extra fingers of man are usually attached distally, where no rudiments exist. Polydactylism in man, therefore, cannot be atavistic, but is due to duplication of normal digits. This duplication is caused *in utero* by the pressure of amniotic threads.

This explanation was first proposed by Ahlfeld ('85-86), who observed at the birth of an infant with a divided thumb that an amniotic thread was still present in the fissure of the duplicated digit. This theory accounts most satisfactorily for the different stages of division to be met with in cases of polydactylism and polymelia; for, the earlier the amnion presses upon an extremity of the embryo, the more complete and far-reaching will be the duplication produced.

Marsh ('92), in treating of polydactylism in the horse, gives little weight to the fact that the unguis phalanges of the supernumerary digits never revert to the partially cleft condition peculiar to the fossil horse. But he concludes (p. 351) that "All the examples of polydactylism in the horse which the writer has had opportunity to examine critically are best explained by atavism, and many of them admit of no other explanation. Taken together with their great frequency they clearly indi-

cate the descent of the horse from comparatively recent polydactyle ancestry."

Blanc ('93) recognizes three distinct classes of polydactylism: (1) Atavistic, or cases where ancestral digits reappear; (2) Teratological, or cases in which either normal digits or atavistic supernumerary ones are duplicated; (3) Heterogenic, or cases belonging to neither (1) nor (2).

(1) *Atavistic polydactylism.* Bardeleben's theory is accepted without reservation. Atavism is regarded by Blanc not as the neo-generation of an ancestral digit, but merely as the development of rudiments normally present in the embryo. From an examination of digital abnormalities in mono-, di-, tetra-, and penta-dactylous animals he deduces the following general principles: (a) the more simple the extremity, the more varied and the more divergent from the normal are the forms of polydactyly. (b) In all species the thoracic limb presents ancestral digits more frequently than the pelvic does; this leads to the conclusion that the manus has become simplified later than the pes. (c) In man the post-minimus appears more frequently than the prae-pollex or prae-hallux; the reverse is true for other animals.

(2) *Teratological Polydactylism.* The proximate cause of these abnormalities Blanc regards as obscure, but he favors Albrecht's ('86) view of reversion to the pterygian fin rays of selachians; the single digit of the higher animals represents two of these rays fused.

(3) *Heterogenic polydactylism.* This consists usually of the intercalation of extra digits, and the producing cause is unknown.

If Albrecht's view is accepted, Blanc proposes the following classification of polydactylism:

1. *Atavistic polydactylism.*

- a. Reversion to the pentadactyle or mammalian type.
- b. Reversion to the heptadactyle or reptilian type.
- c. Reversion to forms possessing a double series of phalanges or to the selachian type.

2. *Heterogenic polydactylism.*

The supernumerary digits are monstrosities.

Bateson ('94) studied polydactylism in the cat especially, but cites and figures a large number of digital variations in the other domestic animals and in man. His conclusions are: (1) Polydactylism occurs much more frequently in certain species than in others. (2) Particular forms of digital variation are peculiar to particular animals. (3) The abnormality usually occurs symmetrically placed on both sides of the body, and often on both fore and hind extremities. (4) There is a tendency for

the abnormal digits to form systems of minor symmetry. (5) Polydactylism is due to variation, and not to reversion.

Wilson ('96) gives an account of five cases in man where polydactylism was transmitted through several generations, and concludes that the abnormalities are generally constant in position, but variable in degree. In reviewing the different theories advanced to account for polydactylism he rejects that of reversion and Bardeleben's prae-pollex theory on grounds similar to those put forward by Gegenbaur ('80, '88) and Zander ('91), and holds that germinal variation is the proximate cause.

If we summarize the conclusions of the various investigators whose work we have briefly reviewed, it appears that three explanations have been proposed to account for the occurrence of digital variation: (1) Reversion, or Atavism. (2) External stimuli (pressure of amnion *in utero*). (3) Internal stimuli (germinal variation). A discussion of these theories will be more in place after we have examined for ourselves the types of polydactylism occurring in the different domestic animals. In proceeding with this examination we must keep these three theories clearly in mind. If we are warranted in rejecting Bardeleben's prae-pollex theory, the possession of six digits by any domestic animal must be accounted for on grounds other than reversionary. And only in animals normally possessing fewer than five digits may we look for atavism to restore, either partially or completely, the typical number of digits; even in these cases the supernumerary parts may be produced by the duplication of one or more of the normal digits. Throughout the following pages, therefore, we shall endeavor to determine as definitely as possible the respective parts which these supposed causes play in producing polydactylous abnormalities.

The special point which we have to determine is whether the extra digits which appear in polydactylism are of palingenetic or neogenetic origin, — whether they are returns to old structures, or represent new variations. The term reversion has been loosely used to designate the general phenomenon of heredity. To avoid confusion I shall limit its meaning to the abnormal inheritance of *palingenetic* characters, while heredity will be used in the broader sense. Beginning with the typical pentadactyle extremity characteristic of man and the Carnivora, we shall take up in turn those forms in which the number of functional digits has been reduced (fowl, swine, Ruminantia, and Equidae).

## II. Polydactylism in Man.

### A. LITERATURE.

On account of its importance to the medical profession, polydactylism has been more often observed in man than in other vertebrates, numerous cases having been described. Unfortunately the majority of the descriptions are confined to the external appearance of the abnormalities, and to the structure of the skeletal parts; the anatomy of the muscles, and still more important, that of the nerves, has seldom been thoroughly worked out. Besides the many instances cited by Bateson ('94), the observations of Morand (1773), Förster ('61), Struthers ('63<sup>a</sup>), Ahlfeld ('85-86), Fackenheim ('88), Windle ('91), Zander ('91), and Wilson ('96) are of especial importance. From the descriptions of the above investigators, it appears that the supernumerary digits are more frequently found on the manus than on the pes, and on both the right and left extremities than on one side only. But in those cases where the abnormalities are symmetrically placed, the structural conditions of each extremity may be different from those of the others.

The most of the cases observed fall readily into two classes:

(1) A supernumerary digit occurs on the radial side of the extremity (Fig. A); this digit may be of two or three phalanges, and in the latter case the pollex ( $1^b$ ) is often composed of three elements instead of two. In most cases where an extra digit is present on the radial side of the manus, the abnormality is evidently due to a duplication of the pollex, and it is not possible to say that either of the digits is the normal thumb. These conditions hold good for the foot as well as the hand.

(2) A supernumerary digit occurs on the ulnar side of the extremity (Plate 1, Fig. 3). This digit may be (*a*) complete, of three phalanges, and having its metacarpal articulating with the unciform (in the manus), or (*b*) incomplete, of two or three phalanges which articulate with the ulnar side or distal end of metacarpal v (minimus); in some cases the extra digit may be merely attached to the minimus loosely by a peduncle of the skin. Here again the digital variation usually occurs simultaneously on both hands, or both feet, or even on hands and feet; the conditions on the right and left sides, however, may be different. It is often impossible to tell whether the fifth or sixth digit is the true minimus. In the well known case originally described by Morand (1773) the muscular attachments peculiar to the minimus were transferred to

the sixth, or supernumerary, digit in the *right* hand, leading us to suppose this to be the true minimus. But in the *left* hand the sixth digit was rudimentary, and the fifth must therefore be taken as the normal minimus. These abnormalities, which occur on the ulnar side of the extremity, may therefore be best explained as due to duplication of the minimus; either one of the two digits produced may develop into an

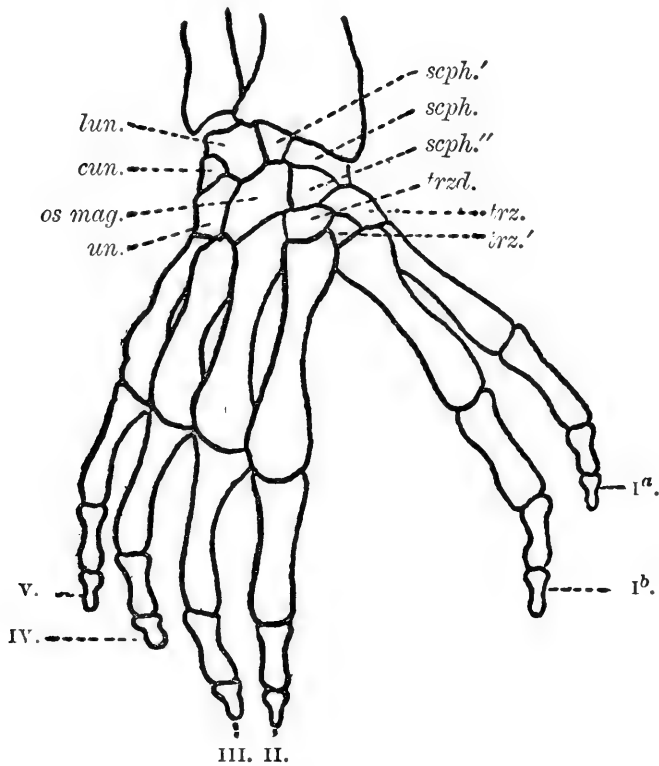


FIG. A. — Bones of right hand of man, showing duplicated thumb.  $I^a$ ,  $I^b$ , pollices; *cun.*, cuneiform; *lun.*, lunar; *os mag.*, os magnum; *trz.*, trapezium; *trz'*, accessory trapezium; *trzd.*, trapezoid; *scph.*, scaphoid; *scph'*, *scph''*, accessory scaphoids; *un.*, unciform. (After Bateson.)

apparently normal fifth digit. To this class belong the greater number of digital abnormalities in man.

There are a few cases of polydactylism in man where one extra digit has been interpolated. Bateson regards these cases as of doubtful origin.

#### B. OBSERVATIONS.

Through the kindness of Prof. W. F. Whitney, Curator of the Warren Museum at the Harvard Medical School, I was permitted to study the skeletal parts of twelve polydactyle extremities in man, and to obtain



skiagraphs of the more important abnormalities. In every case examined the extra digit appeared on the ulnar side of the manus or pes.

The polydactyle extremities were from late foetal stages ; the carpals and tarsals, therefore, show little or no calcification, and only the diaphyses of the digital elements are ossified. The specimens were on exhibition in the cases of the museum, and so could not be dissected.

Number 912 (Plate 1, Figs. 3-6) is an interesting case. This foetus shows an extra digit on each hand and foot. In the right manus (Fig. 4) there are only five metacarpals, but the fifth shows evidence of duplication. It is abnormally large at its distal extremity, and from the ulnar side of this end projects a bony process. This process is directed somewhat proximad, and with it articulates the supernumerary digit ( $v^b$ ), which is little more than half the length of  $v^a$ , and consists of but two phalanges. The other digits of this manus are apparently normal in all respects.

The structural conditions of the right foot (Fig. 6) are very similar to those of the right manus. The fifth metatarsal is short, and nearly as broad as long ; a small protuberance on its ulnar side marks the point of articulation for the extra digit. The supernumerary digit shows only two ossification centres, but the incompletely calcified condition exhibited by the normal digits leads one to suppose that three phalanges might have been developed eventually. The supernumerary digit ( $v^b$ ) is somewhat smaller than  $v^a$ , which may be interpreted as the normal fifth digit.

The left manus (Fig. 3) presents a different skeletal structure. The first four digits are normal as before, but the supernumerary one ( $v^a$ ) is apparently located on the radial side of the normal fifth digit ( $v^b$ ). The two are entirely independent of each other, and are of nearly the same size. From the appearance of the phalanges it is difficult to say which is the normal digit ; however, the metacarpal of  $v^a$  is ossified at its distal end only, thus indicating that it is the interpolated digit.

The digits of the left pes (Fig. 5) resemble in their structure those of the corresponding manus. There are six distinct digits, and all of the metatarsal bones are well developed. The four external (ulnar) digits are similar in structure, each being composed of a metatarsal and two phalanges ; the ossification centre of the middle phalanx has not yet appeared. The phalanges of digit  $v^b$  are smaller, and its metatarsal bone is shorter than the corresponding skeletal elements of the other digits. We may therefore consider it as the extra digit, and from the

conditions found in the hands and the right foot, it seems reasonable to assume that the fifth digit has been duplicated.

These four cases of polydactylism are probably all abnormalities produced by the splitting of the fundament of the fifth digit; each instance differs slightly from the others, but the manus and pes of the right side are of somewhat similar skeletal structure, and the same is true of the left appendages. In the appendages of the right side the fifth digit is incompletely duplicated. In those of the left side the division is complete; in the manus the metacarpus of the more internal of the two digits ( $v^a$ ) is amorphous, while in the pes digits  $v^a$  and  $v^b$  are both distinct and perfectly developed.

We are not warranted in assuming that either  $v^a$  or  $v^b$  is the extra digit. In the right hand  $v^a$  is better developed, in the left hand  $v^b$ , while in the feet it is difficult to distinguish any difference between the two.

Number 5809 is a foetus which, like 912, exhibits a hexadactyle condition in all four appendages. Both feet are identical in skeletal structure with the pes shown in Figure 6 (Plate 1); the fifth metatarsal is a massive bone, as broad as long, and with it articulate two digits of nearly equal size, each consisting of two phalanges.

The right manus (Plate 2, Fig. 8) resembles the left manus of number 912 (Plate 1, Fig. 3); the digits  $v^a$  and  $v^b$  are distinct, but the metacarpal of  $v^a$  is amorphous. The left manus (Fig. 7) exhibits a peculiar condition. Metacarpal  $v$  is abnormally large, especially at its distal end; with it articulate the two digits  $v^a$  and  $v^b$ .  $v^a$  is apparently normal in form, size, and the number of its phalanges.  $v^b$ , however, is small, and directed proximad. Its three phalanges are small and the distal one is double.

There are, thus, three instances in which digit  $v$  is incompletely duplicated, and a single case in which there is complete splitting of this digit. Here, too, we are unable to say with certainty that either  $v^a$  or  $v^b$  is the extra digit.

In a third foetus, number 913 of the Warren Museum, only the left manus and right pes were preserved. The manus (Plate 2, Fig. 9) has a small supernumerary digit ( $v^b$ ) on the ulnar side of metacarpal  $v$ , but not articulating with it. This digit is composed of three skeletal elements, of which the two distal from their form may be interpreted as representing the first and third phalanges. The proximal element is a small nodule of bone, and may be the rudiment of a metacarpal. Metacarpal  $v$  is apparently normal, as is the digit  $v^a$ .

The right pes of the same foetus (Plate 2, Fig. 10) has six distinct

digits. Digits  $v^a$  and  $v^b$  show ossification centres of only one phalanx, while in II, III, and IV, two or three may be seen. This may indicate that the development of digits  $v^a$  and  $v^b$  had been retarded.  $v^b$  is slightly smaller than  $v^a$ , but otherwise their skeletal structure is identical.

Figures 1 and 2 (Plate 1) show a pair of feet from a fourth foetus (number 6730), in both of which six distinct digits are present. The right pes (Fig. 1) is noteworthy because of the condition of metatarsals  $v^a$  and  $v^b$ ; these are nearly connected at their proximal ends, which project further proximad than any of the other metatarsals. This is another ground for assuming that  $v^a$  and  $v^b$  originated from the same fundament. In the left foot (Fig. 2) these digits are considerably smaller than the others and the proximal ends of their metatarsals also project further proximad, i. e., toward the tarsus; in both appendages the first phalanx of digits  $v^a$  and  $v^b$  is the only one showing a centre of ossification.

To sum up our observations on these twelve cases of polydactylism, we find: (1) the abnormalities in every instance affect the ulnar (fibular) side of the extremity and probably only the fifth digit; (2) in five cases metacarpal (metatarsal)  $v$  bears two digits; these may be equally well developed, or the one on the ulnar side may be more or less rudimentary; (3) in seven cases  $v^a$  and  $v^b$  are distinct from each other, although showing evidence of a common origin; either one of these digits may be completely formed, or rudimentary, and it cannot be said that one of them is the normal, and the other the abnormal, digit.

There is no evidence of reversive modifications in the polydactyle extremities an account of which has been given here. Even if we admit that the primitive ancestor of the mammalia was hexadactyle, there are still obstacles in the way of accounting for these abnormalities by reversion. A discussion of these points will be taken up in the theoretical portion of this paper.

### III. Polydactylism in Carnivora.

#### A. LITERATURE.

Hereditary digital variations in the extremities of the cat were observed by Poulton ('83, '86); the anatomy of the skeletal parts has been studied by Bateson ('94); and Howe (:02) has given a detailed account of the general anatomy of a single case. Such abnormalities are comparatively rare in the dog, and of the few cases which have been observed I know of none which have been carefully described. Blanc

(93) figures a single case in which the hallux was developed and duplicated.

In both the cat and dog the normal manus is composed of five digits, but the pollex is much reduced in size. In the pes only four functional digits are present, the hallux being represented by merely a rudiment of metacarpal I. These animals are therefore tetradactyle in the pes, and it is there only that we may look for evidence of reversion, unless we assume the existence of a hexadactyle ancestor.

Most of the digital abnormalities in Carnivora occur on the *radial* side of the manus or pes; digits II-V remain practically normal in all cases. This is an important fact when the polydactyle conditions in other animals are considered, for it shows that the digits which vary are in most cases those which have been either reduced or modified in the course of phylogenetic development.

In the pes of the cat the digital abnormalities fall into three classes:

- (1) Five digits, each possessing three phalanges (Fig. B).
- (2) Six digits, five of them possessing three phalanges each, the sixth, which resembles a normal pollex (Fig. C), exhibiting only two.
- (3) Six digits, each having three phalanges. This is the condition of most frequent occurrence; the digits in this case are usually so formed that the pes is bilaterally symmetrical. Bateson lays considerable stress upon this symmetrical condition, which is brought about in the following manner. The distal phalanges of the normal extremities are retractile, and are always drawn back to the ulnar side of the second phalanx (that is, in the right extremity to the right, and in the left to the left). For this retraction the second phalanx of each digit is hollowed out on the ulnar side. The supernumerary digits, however, do not conform to this plan, but their unguis phalanges are drawn back to the other (radial) side of the manus or pes; consequently the second phalanx is hollowed out on the radial side to correspond. This change in the symmetry of the phalanges may extend also to the second digit (II).

In the manus of the cat we find the same three types of polydactylism and in addition a fourth type, in which there are seven digits present. Digits II-V are always normal; on the radial side of II are three extra digits, the most radial of which is amorphous (Bateson, '94, Fig. 86, p. 319). Torrey (:02) describes a similar case in which seven digits appeared, but the most radial was resorbed soon after birth. In the case described by Howe (:02) three complete extra digits were developed, which he considers similar in structure to digits III, IV, and V. To this class belong the majority of polydactyle cats. When six meta-

carpals are present in the polydactyle manus, the trapezium is almost invariably duplicated, and the length of the scapholunar is correspondingly increased; and the same is true respectively of the cuneiform and navicular in the abnormal pes.

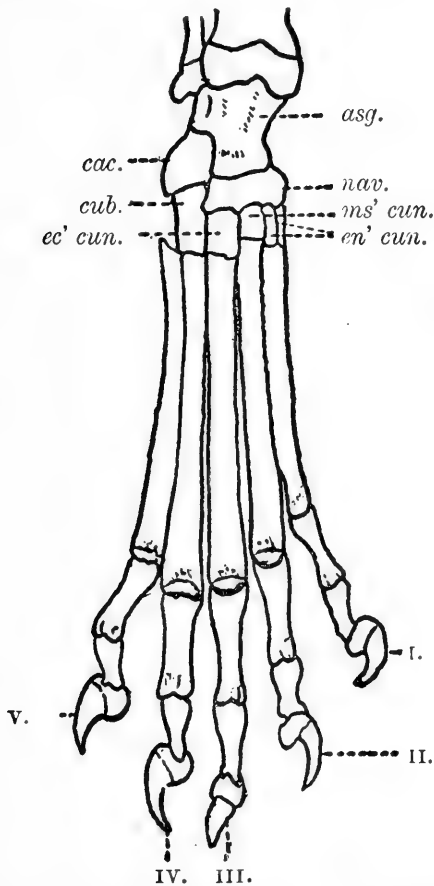


FIG. B. — Right pes of cat, showing hallux abnormally developed. I, hallux; *asg.*, astragalus; *cac.*, calcaneum; *cub.*, cuboid; *ec'cun.*, ecto-cuneiform; *en'cun.*, ento-cuneiform; *ms'cun.*, meso-cuneiform; *nav.*, navicular. (After Bateson.)

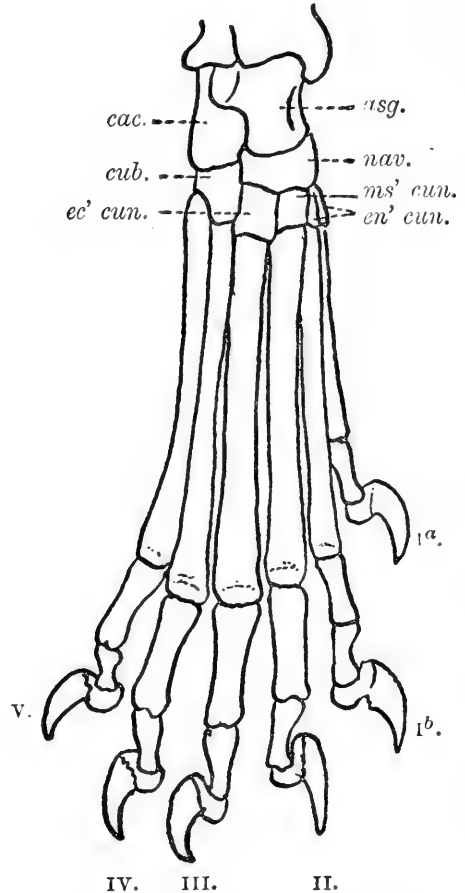


FIG. C. — Right pes of cat, showing duplicated hallux. I<sup>a</sup>, I<sup>b</sup>, duplications of hallux; *asg.*, astragalus; *cac.*, calcaneum; *cub.*, cuboid; *ec'cun.*, ecto-cuneiform; *en'cun.*, ento-cuneiform; *ms'cun.*, meso-cuneiform; *nav.*, navicular. (After Bateson.)

### B. OBSERVATIONS.

Although a number of cases of polydactylism in the cat have come under my observation, it was not thought necessary to devote especial study to them, the careful work done by Bateson making that unnecessary. Polydactylism in the dog, however, has never been adequately described. On account of the difficulty of obtaining suitable material, my own work on these abnormalities is far from being complete.

Digital variations are extremely rare in the manus of the dog. The pes, however, is quite often affected, and in the larger breeds (St. Bernard, mastiff, and collie) the hallux is frequently present. All of the digital variations which have come under my observation were of the pes. As we have seen, this consists of four digits, the hallux being normally represented by only the proximal end of its metatarsal bone. The four functional digits remain unmodified in all cases of polydactylism, and the supernumerary digits occur on the radial side of digit II, as variations of the hallux. We may distinguish three classes of these abnormalities: (1) Hallux, or "dew-claw," present and formed of two phalanges articulating with the distal end of a rudimentary metatarsal. This digit does not articulate with the proximal rudiment of metatarsal I, but is merely held in place by the skin. Six cases were observed in the shepherd dog, and five cases in the St. Bernard.

(2) Hallux (Fig. *D*) presenting two well developed phalanges, of which the proximal articulates with the rudimentary metatarsal bone; this element is much longer than the normal phalanx. Three cases were observed in the mastiff, and one case in the Scotch collie.

(3) Hallux present as in (1), and more or less completely duplicated, exhibiting two phalanges and the distal rudiment of a metatarsal. This is the common condition in the pes of the St. Bernard dog. The duplication of the hallux may give rise to the rudiment of only a single ungual phalanx, or there may be complete duplication, with the formation of two similar digits (Fig. *E*.  $1^a$ ,  $1^b$ ). In some cases the two ungual phalanges of  $1^a$  and  $1^b$  bear but a single large claw, which, however, usually shows evidence of duplication.

The cases of polydactylism which we have observed in Carnivora may all be accounted for as modifications of the pollex and hallux. Except for the change in symmetry of the phalanges of the extremities of the cat, the rest of the manus or pes is unmodified. The conditions found in the *manus* of Carnivora are thus similar to the digital variations which occur in the hand of man. In each case a functional, but reduced, digit is affected. In man, however, it is the minimus which is normally reduced, whereas in Carnivora it is the pollex.

In the *pes* of Carnivora the conditions are somewhat different. Only a vestige of the hallux is normally present; in cases of polydactylism, this is developed and duplicated to a greater or less degree. It would seem, however, that the same underlying cause which produces polydactylism in the manus (variation of a reduced but functional digit), brings about also the digital abnormalities in the pes (variation of a

vestigial digit). Whether this underlying cause is reversion, will be discussed later.

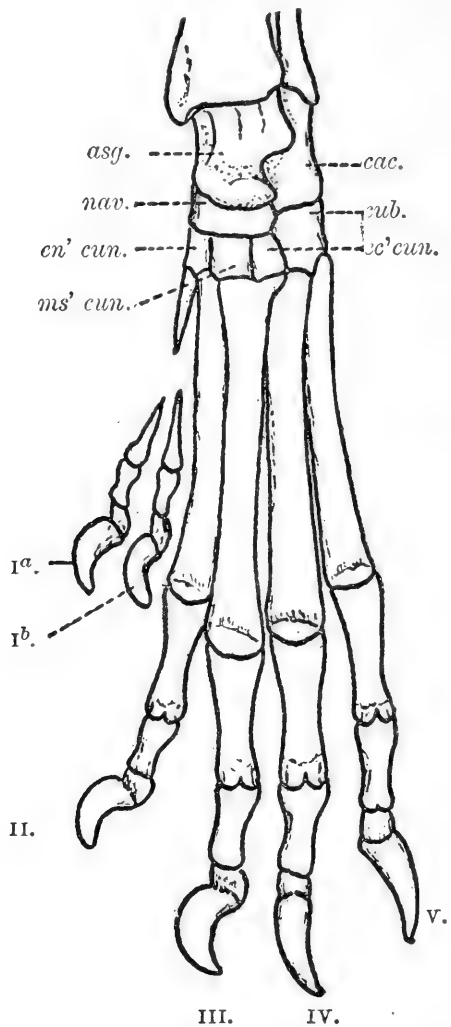
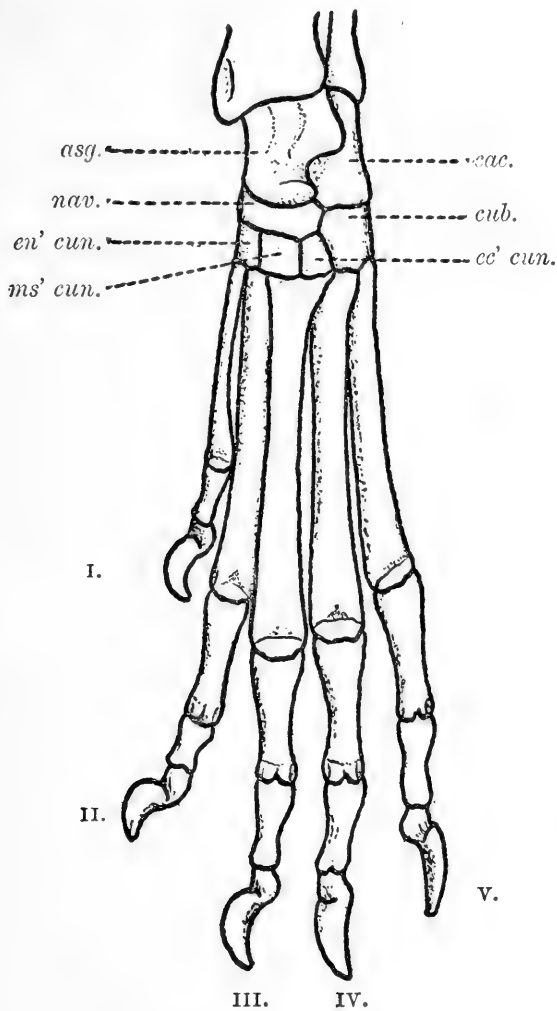


FIG. D. — Left pes of dog, showing hallux fully developed. I, hallux; *asg.*, astragalus; *cac.*, calcaneum; *cub.*, cuboid; *ec'cun.*, ecto-cuneiform; *en'cun.*, ento-cuneiform; *ms'cun.*, meso-cuneiform; *nav.*, navicular.

FIG. E. — Left pes of dog, showing duplicated hallux. I, rudimentary metatarsal of hallux; *I<sup>a</sup>*, *I<sup>b</sup>*, accessory digits; *asg.*, astragalus; *cac.*, calcaneum; *cub.*, cuboid; *ec'cun.*, ecto-cuneiform; *en'cun.*, ento-cuneiform; *ms'cun.*, meso-cuneiform; *nav.*, navicular.

#### IV. Polydactylism in the Fowl.

Although the domestic hen is tetradactyle, the fifth digit was lost so early in phylogeny that it never appears in polydactyle abnormalities. As the hallux of the pes is reduced, however, polydactylism is entirely limited to this digit; the condition is thus directly comparable to that

found in the pes of the dog and cat. The skeletal parts of the polydactyle pes have been described by Cowper ('89), Howes ('92), Bateson ('94), and Anthony ('99). The last-named writer also examined the pedal musculature of the Dorking.

Polydactylism, generally rare in birds, is quite common among the Gallinaceae, especially the domestic fowl. It has become a fixed characteristic of the Dorking breed, and also occurs quite constantly in the Houdan variety. In the normal fowl, as is well known, the hallux, or first digit, is articulated at the side of the tarso-metatarsal, by a distinct rudimentary metatarsal element. Digits II-IV have their metatarsals fused together; V is entirely wanting. In nearly all cases of polydactylism in the fowl a supernumerary digit (sometimes two) occurs on the tibial side of the hallux. The abnormalities may be grouped into three classes:

(1) Pes of five digits, metatarsal I bearing a normal hallux, and tibial to this a digit of three phalanges (Cowper, '89, p. 249). This is the most common condition.

(2) Pes of five digits; the supernumerary digit is borne upon the proximal phalanx of the hallux instead of articulating with its metacarpal. This condition is quite frequent.

(3) Pes of five digits; the hallux being completely divided into two digits of two or three phalanges each (Howes, '92, Fig. 5).

Single cases have been described in which two extra digits occur. Of these, one possesses three phalanges, is placed at the tibial side of the hallux, and has an independent articulation with the tarso-metatarsus; the other exhibits only two phalanges and is formed by the more or less complete duplication of the hallux.

Bateson and Saunders (:02) by crossing the polydactylous Dorking fowl with white and brown Leghorn varieties, found that in the resulting offspring the polydactylous character is dominant, though not completely so, over the normal pes of the Leghorn. In addition, *the supernumerary digits of the crossbreeds varied greatly from their structure in the normal Dorking*. They are described as follows (p. 97):

"When present the two hind toes may consist, as in the normal Dorking, of a short toe, like the hallux of a 4-toed bird, with a long many-jointed digit proximal to it pointing upwards. The two, however, may often be *both* short, pointing downwards, never both long. This condition ranges through many stages of bigemination down to mere bifidity of the nail. A form very rarely seen is an *elongation* of the hallux without any extra toe being present.<sup>1</sup>

<sup>1</sup> "[A chick has lately occurred with a 'long' hallux bigeminus of this sort—probably a hitherto unrecorded form.] March, 1902."



"In such a hallux there is increase in the number of phalangeal joints. This of course corresponds to the three-jointed pollex in man. . . . In the highest form of the reduplication the short toe is itself represented by two digits, making six in all. Of this, also, there are many grades.

"Lastly, any of these conditions may be seen on one foot only, while the other foot shows one of the other states or is normally four-toed. Generally speaking, however, there is a fairly close symmetrical agreement between the two feet."

Thus we see that a single cross between the Dorking and Leghorn varieties produces *all* of the polydactylous abnormalities which investigators have so far observed in the fowl.

The conditions presented are interesting and noteworthy from their structural similarity to the digital variations found in man and the Carnivora. For here, too, we find that the abnormalities are mainly confined to a reduced or modified digit, which becomes partially or completely doubled.

Howes ('92) and Anthony ('99) regard these abnormalities as due to the splitting of the hallux, not as reversions to a five or six-toed ancestor. Bateson and Saunders (:02, p. 137) evidently agree with them, for besides their allusions to "the reduplication" of the hallux, they class the abnormalities as "*new characters*" — "a palpable sport" (p. 137).

The significance of their experiments and the bearing of "Mendel's law" upon polydactylism will be discussed later with other theoretical considerations.

## V. Polydactylism in Swine.

### A. LITERATURE.

Although polydactylism is quite common in the pig, and many cases have been recorded, few careful descriptions have been given, and those deal only with the skeletal parts. As a consequence, very conflicting statements are made by different authors concerning the causes productive of the conditions, some maintaining that polydactylism in the pig is atavistic, others that it is due to duplication of the whole foot, and still others that it is to be accounted for only by haphazard variation. Geoffroy St. Hilaire ('32-37), Gurlt ('77), Gegenbaur ('80), Bateson ('94), and Werner ('97) have observed instances of digital variation in swine. Otto ('41), Ercolani ('81), and Blanc ('93) have given good descriptions of the skeletal parts of a few cases.

Ercolani obtained data as to the skeletal structure in twenty-five

cases. Of these, there was only one instance where the supernumerary digits occurred on the posterior extremity. In four cases the abnormality was found on both fore feet; and in all the specimens which he himself examined, or which were described by other observers, the extra digits occurred on the radial, or thumb, side of the manus. The abnormalities as figured by Ercolani (Tav. 1, Fig. 1-6) consist in the presence of from one to three supernumerary digits. He found also that the trapezium of the carpus was well developed in most cases, and occasionally duplicated. In two cases, however, it was entirely absent, and Ercolani therefore concludes that its presence in connection with the supernumerary digits is no proof that polydactylism is atavistic; for the trapezium is present also in most normal swine. Its absence is a deformity by defect and may occur in the normal manus.

Blanc ('93) considers most of the cases of polydactylism in swine as due to reversion. He figures four types: (1) Manus with an extra digit of two phalanges, representing the developed pollex (Fig. 7, p. 70). (2) An extra digit of three phalanges, which he regards as the pollex strongly developed; digit II is also abnormally large (Fig. 8). (3) Manus resembling (2), but with a small digit of two phalanges and a rudimentary metacarpal occurring on the radial side of digit I (Fig. 9). (4) Manus of six completely formed digits, the two supernumerary being large and of nearly equal size (Fig. 10). Blanc considers types (3) and (4) as reversions to the hexadactyle ancestor of mammals. Two other cases are figured to illustrate the duplication of digits I and II.

Gegenbaur ('80) examined two cases of polydactylism in the manus of the pig. In one specimen the carpals had been entirely removed, in the other they were partly cut away. From this fragmentary material he draws his conclusion, — that all cases of polydactylism in swine are monstrosities and not due to atavism. The conclusions of Blanc and Gegenbaur are thus completely contradictory.

If we reject the prae-pollex theory as untenable, the hexadactyle cases regarded by Blanc as reversions must be accounted for in some other way. On the other hand, Gegenbaur bases his arguments on the slender evidence of two mutilated specimens; there is need therefore of further investigation into the structural conditions peculiar to polydactyle swine, before his refutation of reversion can be accepted. In proceeding with our description of digital abnormalities in the pig we shall keep especially in mind their bearing on this question.

## B. OBSERVATIONS.

The thirty-six specimens of polydactylism in the pig which are to be described were collected at The North Pork Packing establishment, Somerville, near Boston, Mass., by Mr. Charles Bullard. In certain cases the manus was severed from the arm at the inter-carpal joint, and consequently the upper row of carpals was lost. These bones, however, are fortunately not so important for study as those of the lower row, which were saved in all but one case.

In preparing the specimens for study they were first dissected merely enough to allow a spreading of the digits, and were then skiagraphed. I am indebted to the Director of the Jefferson Physical Laboratory of Harvard University, and to Professor Sabine for kindly allowing me the use of electrical apparatus for this purpose. After obtaining skiagraphs of the more important abnormal types, the muscles and nerves were dissected. Finally the bones of the carpus and metacarpus were studied and separately compared, first with the corresponding parts of the normal manus, and next with those of the fossil swine figured by Kowalevsky ('73) and by Scott ('95). By the latter means it was possible to ascertain whether or not the manus of the polydactyle pig reverts to that of more primitive fossil forms in characters other than the presence of extra digits.

Before passing to a description of the various abnormal specimens which have been studied, it may be well to examine the normal manus of the pig, and compare its skeletal elements with those of its fossil ancestors.

The pollex, or digit I, is normally absent in all living artiodactyles, and the remaining digits are arranged in two pairs (Plate 3, Fig. 11). Of these, III and IV are large, functional, and of equal length; II and V are only two thirds as long, and do not ordinarily reach the ground, II being usually the smaller. Each digit consists of a metacarpal and three phalanges. The metacarpals of digits III and IV are large and their proximal extremities interlocked; IV articulates with the ulnar side of III and is partially over-lapped proximally by the large process of the latter. In the same way a radial process from digit III overlaps metacarpal II, and, as we shall see, is a distinguishing mark in the manus of the modern pig. The phalangeal region of the manus is bilaterally symmetrical, the unguis phalanx and hoof being concave on the side facing the median plane of the manus, and convex on the side turned away

from it. The hoofs of digits III and IV are united posteriorly by means of a horny pad.

The carpus (Fig. *F*) consists of two rows of four bones each; in the proximal row occur in succession, passing from the radial to the ulnar side, the scaphoid, lunar, cuneiform, and pisiform. In the distal row, which chiefly concerns us, the trapezium is most radial in position; next

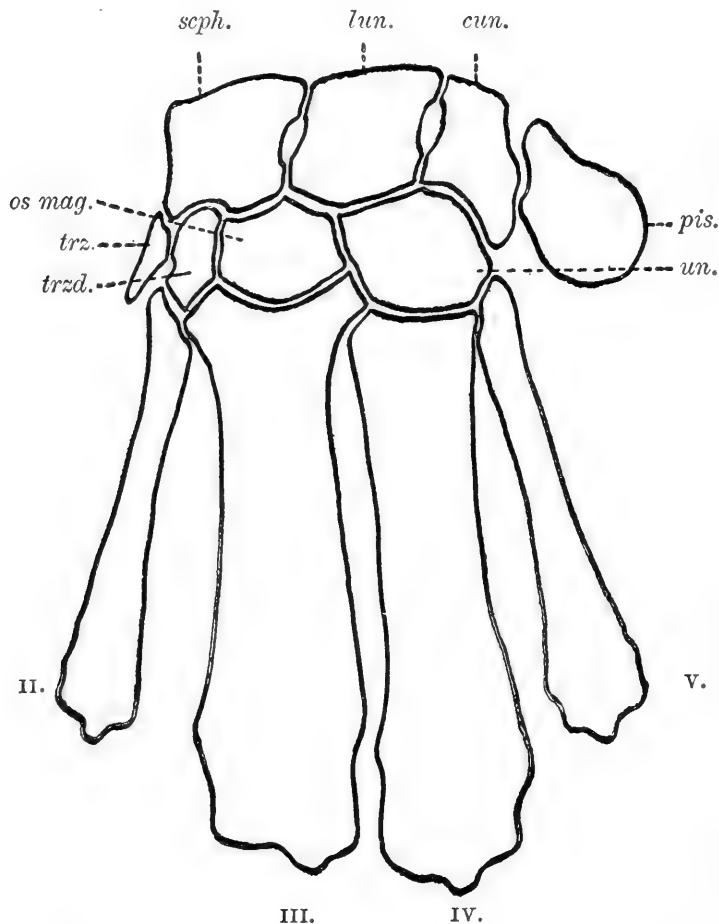


FIG. *F*. — Left normal manus of pig, showing carpals and metacarpals. II-V, metacarpals; *cun.*, cuneiform; *lun.*, lunar; *os mag.*, os magnum; *pis.*, pisiform; *scph.*, scaphoid; *trz.* trapezium; *trzd.*, trapezoid; *un.*, unciform.  $\frac{2}{3}$  natural size.

come in order the trapezoid, os magnum, and unciform. The trapezium (Fig. *F*, *trz.*) is rudimentary; it articulates with the postero-lateral surface of the trapezoid and ends distally in a free, pointed process, which projects distad of the proximal extremity of metacarpal II. The trapezoid (*trzd.*) is functional but small. It articulates proximally with the scaphoid, distally with metacarpals II and III. Its distal extremity is

wedge-shaped and divided into two facets of nearly equal size, the radial for articulation with metacarpal II, the ulnar for the large process of metacarpal III. The os magnum articulates distally with the third metacarpal only; the unciform has distally a small facet for the ulnar process of metacarpal III, a large one for metacarpal IV, and a small facet laterally placed for metacarpal v.

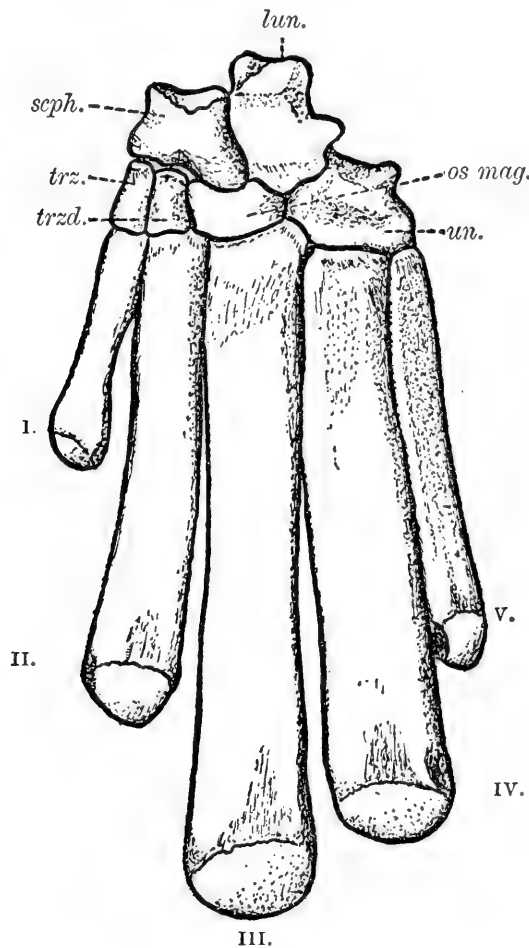


FIG. G. — Left manus of *Ancodus brachyrhynchus*, showing carpals and metacarpals. I-V, first to fifth metacarpals; *lun.*, lunar; *os mag.*, os magnum; *scph.*, scaphoid; *trz.*, trapezium; *trzd.*, trapezoid; *un.*, unciform.  $\frac{2}{3}$  natural size. (After Scott.)

If we compare the carpus and metacarpus of the pig with those of fossil swine (*Palaeochoerus* and *Hyopotamus* or *Ancodus*) figured by Kowalevsky ('73) and Scott ('95), we find some remarkable differences.

In *Hyopotamus* (*Ancodus* of Kowalevsky) the trapezium (Fig G.) is nearly as large as the trapezoid, and articulates superiorly with the scaphoid, inferiorly with the metacarpal of digit I. The trapezoid has

only a single facet on its distal end and articulates with metacarpal II. The pollex is present and is represented in the figure by metacarpal I. Digits II and V are relatively large, especially at their proximal extremities; II is better developed than V, and occupies the whole distal surface of the trapezoid. It also articulates by a small facet with the os magnum.

The third metacarpal is longer than any of the others and proximally there is no radial process for articulation with the trapezoid. In general we may say that the digits of the fossil swine are confined chiefly to their own carpal bones, while in the pig of the present day the third metacarpal has developed a radial process which articulates with the trapezoid and has partially crowded out digit II. In the same way metacarpal IV has encroached upon the distal articular surface of the unciform, and pushed the fifth digit to one side; the third and fourth digits thus come to occupy most of the carpo-metacarpal articulation in the modern pig, a condition of evident advantage, as it strengthens the joint between the carpus and the functional digits.

If complete reversion occurs in the skeletal parts of the pig's manus, we should expect to find (1) an extra digit of two phalanges articulating with the trapezium, and (2) metacarpals II and III articulating with their proper carpal bones (trapezoid and os magnum respectively); (3) metacarpal III should be longer than IV, and without a radial process, and (4) digits II and V should be relatively larger than in the normal manus.

The normal musculature of the manus is quite complex. We need mention here only those muscles which in the polydactyle manus present variations from the normal. Anteriorly we have (1) the radial or great extensor of the metacarpus (Fig. H, *ext. mt'carp. mag.*). This is a large muscle and is inserted by a strong tendon into the proximal end of metacarpal III; (2) the ulnar or oblique extensor of the metacarpus (Fig. H, *ext. mt'carp. ob.*), a small muscle, the tendon of which crosses that of the magnum obliquely, and is inserted into the proximal end of metacarpal II; (3) the extensor communis digitorum internus (*ext. com. dg. i.*), a large muscle inserted by means of three tendons. The main tendon bifurcates, the radial portion being inserted in the third phalanx of digit II; the remaining portion of the tendon runs some distance and again bifurcates, the two branches becoming attached to the unguis phalanges of the third and fourth digits; (4) the extensor proprius internus (*ext. prp. i.*), a much smaller muscle than the preceding, is inserted by two tendons, the larger going to the radial side of the third digit, the smaller to the unguis phalanx of II; (5) extensor proprius

pollicis et indicis (*ext. prp.*) is a rudimentary muscle in the pig; it arises with the extensor metacarpi obliquus, and its threadlike tendon is lost in that of the extensor communis digitorum internus.

Of the posterior muscles we may mention (1) the flexor perforatus, or superficial flexor of the digits (Fig. I, *flx. perf.*); this is composed of two

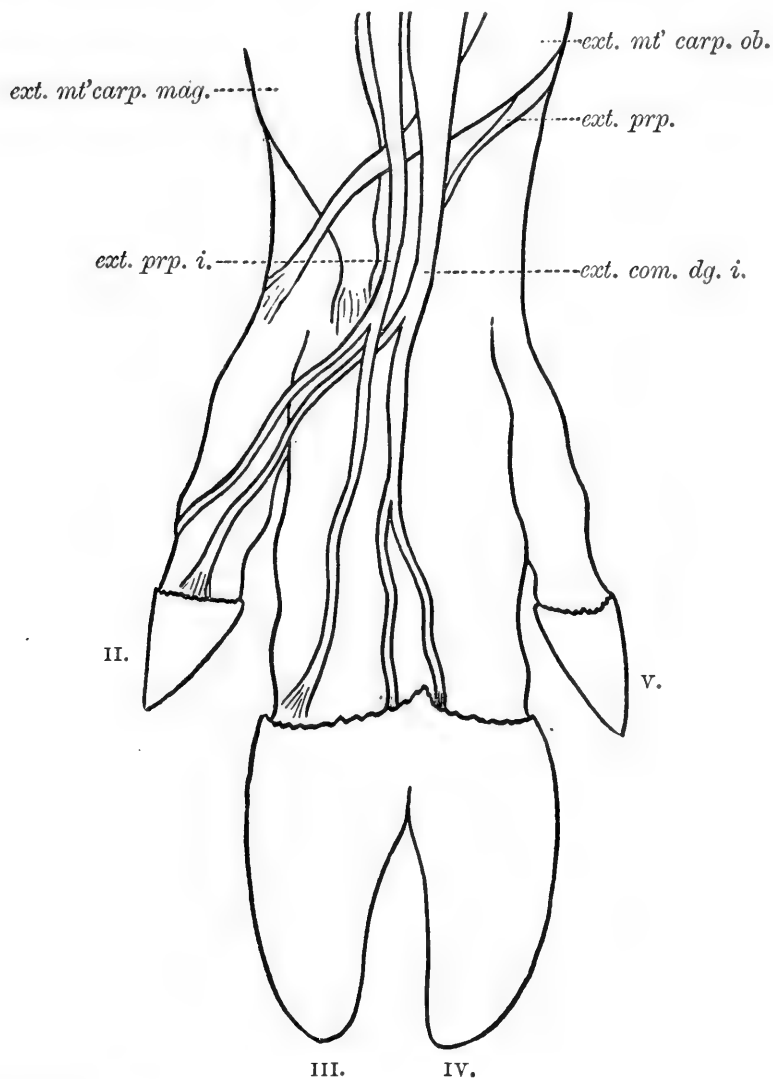


FIG. H. — Left normal manus of pig, showing extensor muscles. *ext. com. dg. i.*, extensor communis digitorum internus; *ext. mt' carp. mag.*, extensor metacarpi magnus; *ext. mt' carp. ob.*, extensor metacarpi obliquus; *ext. prp.*, extensor proprius pollicis et indicis; *ext. prp. i.*, extensor proprius internus.  $\frac{2}{3}$  natural size.

distinct parts, the tendons of which are inserted into the second phalanges of digits III and IV. These tendons form two sheaths for the large tendons of the flexor perforans muscle (*flx. perf.*'), the deep flexor of the

digits. This divides into four tendons, two large and two small; the two large ones, after passing through the sheaths formed by the perforatus, are inserted into the unguis phalanges of digits three and four; the two smaller tendons are attached similarly to the second and fifth digits.

As regards the innervation of the normal manus, we need concern ourselves with the condition of the median nerve only, by which the digits

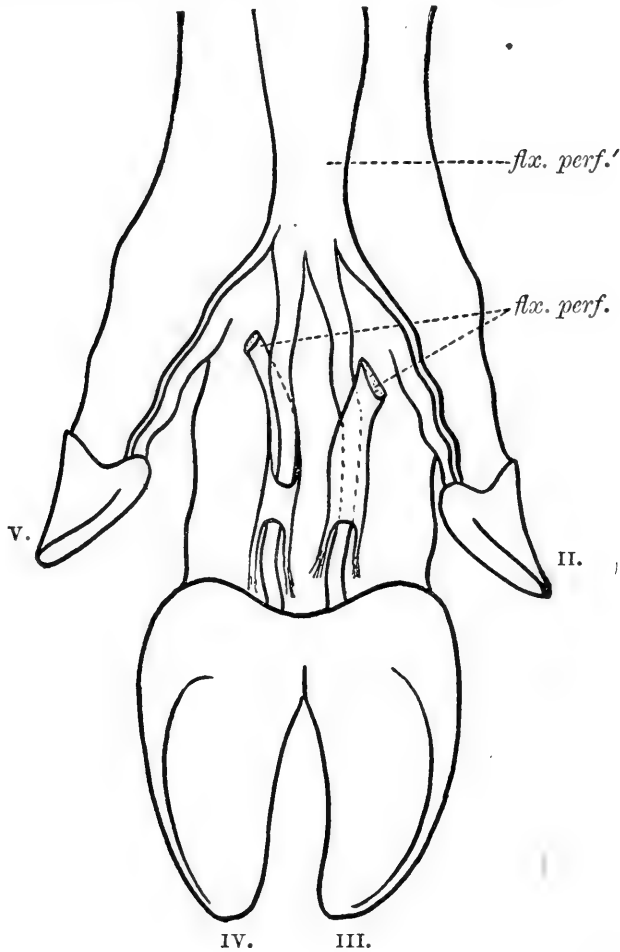


FIG. I. — Left normal manus of pig, showing flexor muscles. *flx. perf.*, tendons of flexor perforatus; *flx. perf'*, flexor perforans.  $\frac{2}{3}$  natural size.

are chiefly supplied. The trunk of the median nerve (Fig. *J*, *n.m.*) passes between the two flexor muscles at the carpal joint; nearly at a level with the proximal ends of metacarpals II and V it gives off two lateral branches (2, 5) to supply these digits. The main nerve, continuing distally, soon separates into two large branches (3, 4), which pass together along the region between digits III and IV, to which they are distributed. The lateral branches (2, 5) before passing to their



respective digits divide, the larger of the resulting branches innervating the lateral portions of the third and fourth digits.

In pentadactyle animals (Carnivora and Primates) the median nerve gives off a fifth branch radial to 2 of the pig's manus, which divides and supplies the thumb and index. No remains of such a nerve branch could be detected in dissections of the normal manus of the pig.

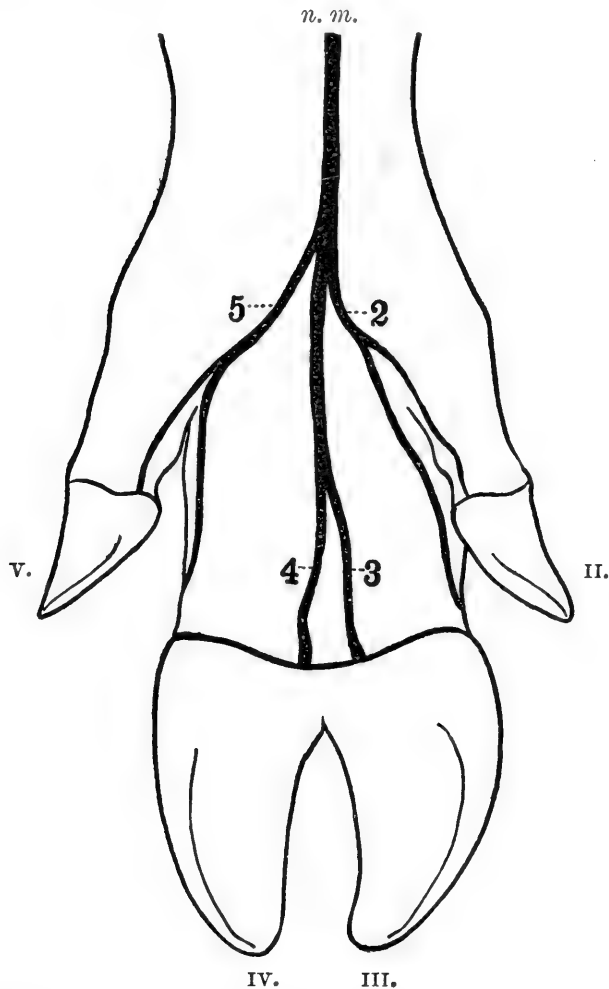


FIG. J. — Posterior view of the left normal manus of pig, showing innervation. *n. m.*, median nerve; 2-5, four branches of the median nerve supplying the corresponding digits.  $\frac{2}{3}$  natural size.

If the polydactyle manus of swine is due to reversion, we might expect to find reversionary modifications in the muscles and nerves, as well as in the skeletal parts.

The extensor of the thumb and index might be fully developed and its tendon inserted into the phalanges of digits I and II, as in penta-

dactyle animals; the oblique extensor of the metacarpus might be found inserted into metacarpal I, and the flexor perforans muscle might send a tendon to digit I. The pollex, if thus supplied with muscles, should be innervated by a branch from the radial side of the median nerve. In examining the following cases of polydactylism in the manus of the pig, we shall see whether these theoretical conditions are ever fulfilled.

Of the thirty-six instances of polydactylism which were studied, all were of the manus; in every case, also, the supernumerary digit occurred on the radial side of the extremity. Digit II is abnormal in some cases. The abnormalities might be divided into numerous types according to the number and condition of the extra digits; but as these types grade into one another, we shall attempt to distinguish but two classes: (1) cases in which the supernumerary parts are distinct from, and independent of, the normal digits; (2) cases where they are more or less closely connected with digit II. We shall see that even these are artificial groups, and that intermediate conditions link together the two. In the following descriptions, we shall begin with the simplest forms, and pass in succession to the more complex types of polydactylism.

1. *Manus in which the Supernumerary Digits are Independent of the Normal Digits.*

a. ONE SUPERNUMERARY DIGIT.

The simplest example of this condition is represented by a single case (Plate 4, Fig. 12). Externally the extra digit (I) is inconspicuous, but originally bore a small claw-like hoof. It is composed of two rudimentary phalanges and a spheroidal element, which apparently represents the distal end of a metacarpal. This does not articulate with the second metacarpal, but is merely held in place by fibrous tissue and the skin.

In the carpus the trapezium is abnormally long; it articulates with the trapezoid laterally, and has a facet proximally for the scaphoid; in other respects the bones of the manus are normal. The muscles and nerves are unmodified.

Figure 13 (Plate 5) shows a manus in which the pollex is fully developed. Of this type, four cases were examined. The pollex (I) is smaller than digit II and consists of the metacarpal and two phalanges. The metacarpal bone articulates with the trapezium, which is abnormally large and has three facets: a distal for metacarpal I, a lateral for the trapezoid, and a proximal for the scaphoid. The relations of the bones of this digit to those of the rest of the manus are thus identical with the conditions found in fossil swine and in other pentadactyle animals.

On examining the other skeletal elements of the manus, in order to determine whether they show reversible modifications, one is at once struck by the form of the trapezoid (Fig. *K*, *trzd.*). Although of normal size, there is a remarkable change at its distal end; instead of projecting as a wedge between metacarpals II and III (see normal manus, Fig. *F*, *trzd.*, p. 264), and presenting two distal facets nearly equal in size,

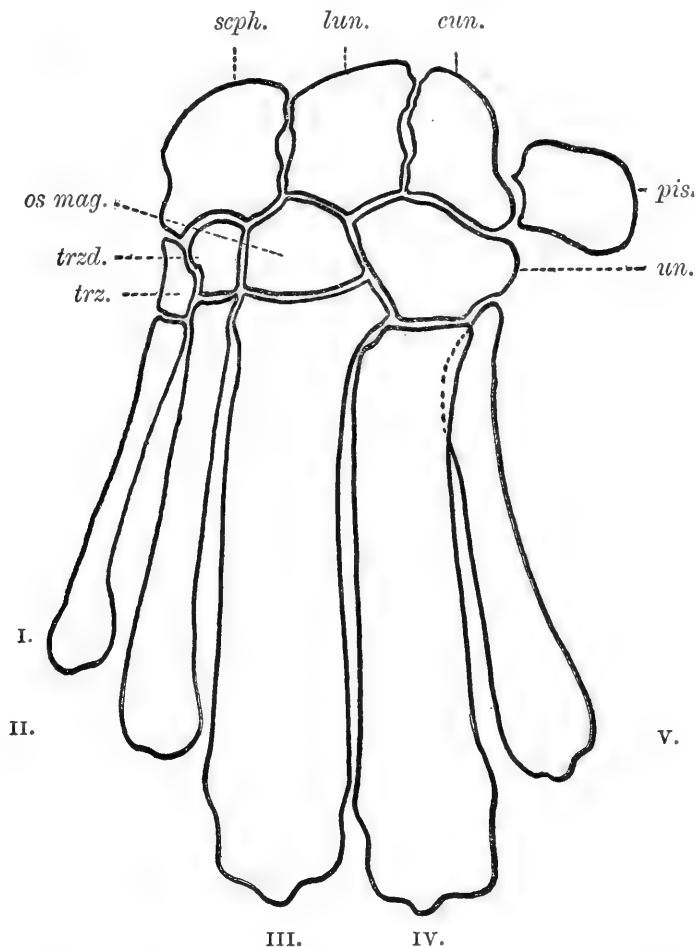


FIG. *K*.—Anterior view of left polydactyle manus of the pig, showing carpals and metacarpals. I–V, first to fifth metacarpals; *cun.*, cuneiform; *lun.*, lunar; *os mag.*, os magnum; *pis.*, pisiform; *scph.*, scaphoid; *trz.*, trapezium; *trzd.*, trapezoid; *un.*, unciform.  $\frac{2}{3}$  natural size.

there is only one articular surface, which is slightly convex and occupied entirely by metacarpal II. The trapezoid barely touches metacarpal III; its form and relations to the other skeletal parts thus approach those of the trapezoid of fossil swine (Fig. *G*, p. 265).

In correspondence with these carpal variations, the metacarpals show some changes. The metacarpal of digit II is slightly larger than nor-

mal, and its proximal end is relatively large. In digit III the radial process of the metacarpal bone, a special character of the manus in recent swine, is greatly reduced, and as a result scarcely touches the trapezoid, while metacarpal II comes in contact posteriorly with the os magnum. The trochlear ridges of the metacarpals are retained, and the phalanges show no modifications in form.

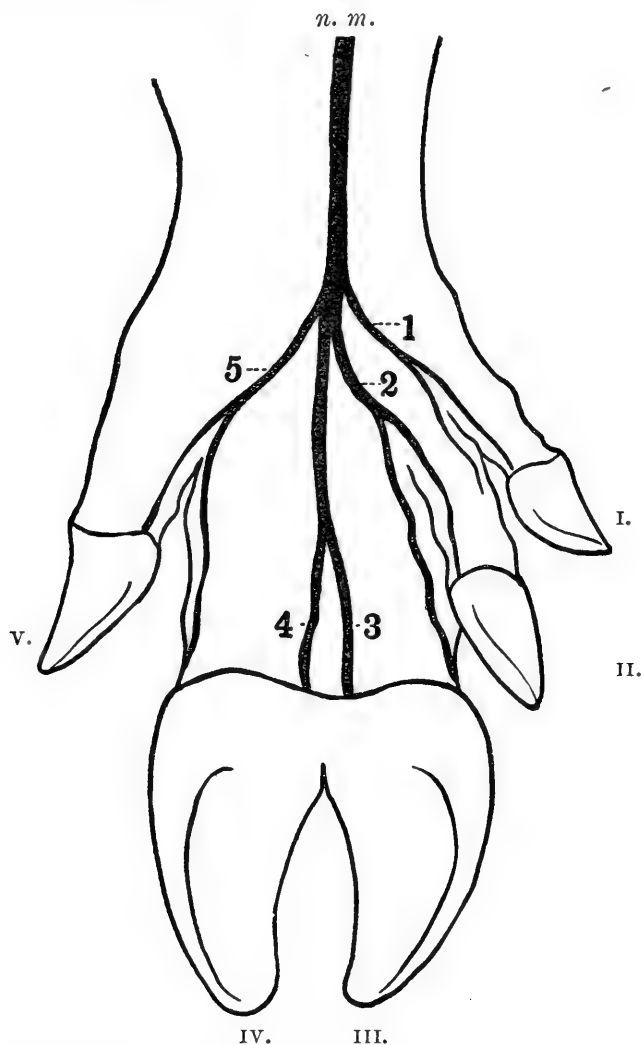


FIG. L. — Posterior view of left polydactyle manus of the pig, showing innervation. *n. m.*, median nerve; 1, branch of median nerve supplying the supernumerary digit (I).  $\frac{2}{3}$  natural size.

The muscles are not much modified, for the extra digit is small and functionless. In two instances, however, the tendon of the extensor metacarpi obliquus muscle is inserted into the proximal end of digit I. This is an interesting condition, as in normal five-toed animals this muscle is likewise always inserted into the metacarpal of the pollex.

The innervation of the extra digit is also noteworthy. The median nerve (Fig. *L*, *n.m.*) gives off on the radial side of its normal divisions a small additional branch (1). This divides like the other branches, sending one division to digit II and the other to the pollex.

Closely resembling the cases just described, are two instances of polydactylism in which the trapezium is fused to the supernumerary metacarpal. The extra digit is very small, and the metacarpal articulates well up on the radial side of the trapezoid. This condition favors the

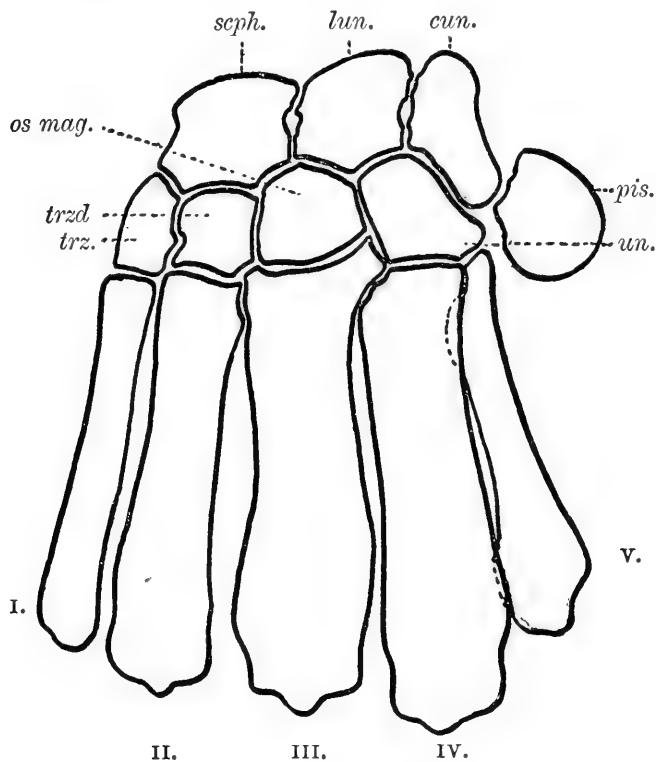


FIG. *M*. — Anterior view of left polydactyle manus of the pig, showing carpals and metacarpals. I-V, first to fifth metacarpals; *cun.*, cuneiform; *lun.*, lunar; *os mag.*, os magnum; *pis.*, pisiform; *scph.*, scaphoid; *trz.*, trapezium; *trzd.*, trapezoid; *un.*, unciform.  $\frac{2}{3}$  natural size.

theory that the trapezium of the manus of the pig may represent the carpal element plus the rudiment of digit I.

Taking now a step further in our series, we come to a condition in which the extra digit is still larger and consists of three phalanges (Plate 6, Fig. 14). The four cases of this type studied showed practically the same anatomical conditions. Digit II is relatively larger. Digit I articulates with the trapezium, which is large and has facets for the trapezoid, scaphoid, and metacarpal I (Fig. *M*, *trz.*). The trapezoid

has become enlarged to correspond with the increased size of its digit (II); it articulates chiefly with metacarpal II, its facet for III being small. The radial process of metacarpal III is considerably reduced. In another case (Plate 7, Fig. 15) the trapezium was fused to the proximal end of metacarpal I.

In Figure 16 (Plate 8) is shown a manus which exhibits an extremely interesting structure. The extra digit is identical in its structure with that of the manus figured in Plate 6, but the second digit is very strongly developed, and is in fact more massive than either III or IV.

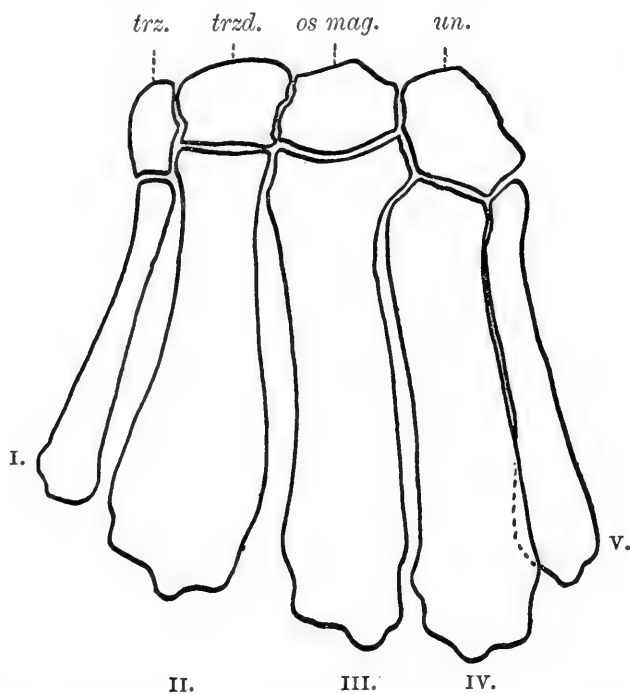


FIG. N. — Anterior view of left polydactyle manus of the pig, showing lower row of carpals and metacarpals. I-V, metacarpals; *os mag.*, os magnum; *trz.*, trapezium; *trzd.*, trapezoid; *un.*, unciform.  $\frac{3}{4}$  natural size.

Its hoof is large, convex on its radial, and flat on its ulnar surface; it is entirely independent of the hoof of digit III. The third phalanx of digit II is also convex on its radial side; that of digit III is indifferent, and its hoof is flat on either side. The other digits are apparently normal. Of the carpals, the trapezium (Fig. N, *trz.*) is large and articulates with the scaphoid, trapezoid, and metacarpal I. The trapezoid (*trzd.*) is nearly as large as the os magnum (*os mag.*), and its single distal facet articulates with only metacarpal II.

Of the metacarpals, I is small but well formed; II is larger than III at its distal end and shows evidence there of pathological hypertrophy.

Metacarpal III has scarcely any radial enlargement at its proximal end and does not articulate with the trapezoid.

Turning now to the musculature of these cases in which the super-numerary digit is composed of three phalanges, we find that in every

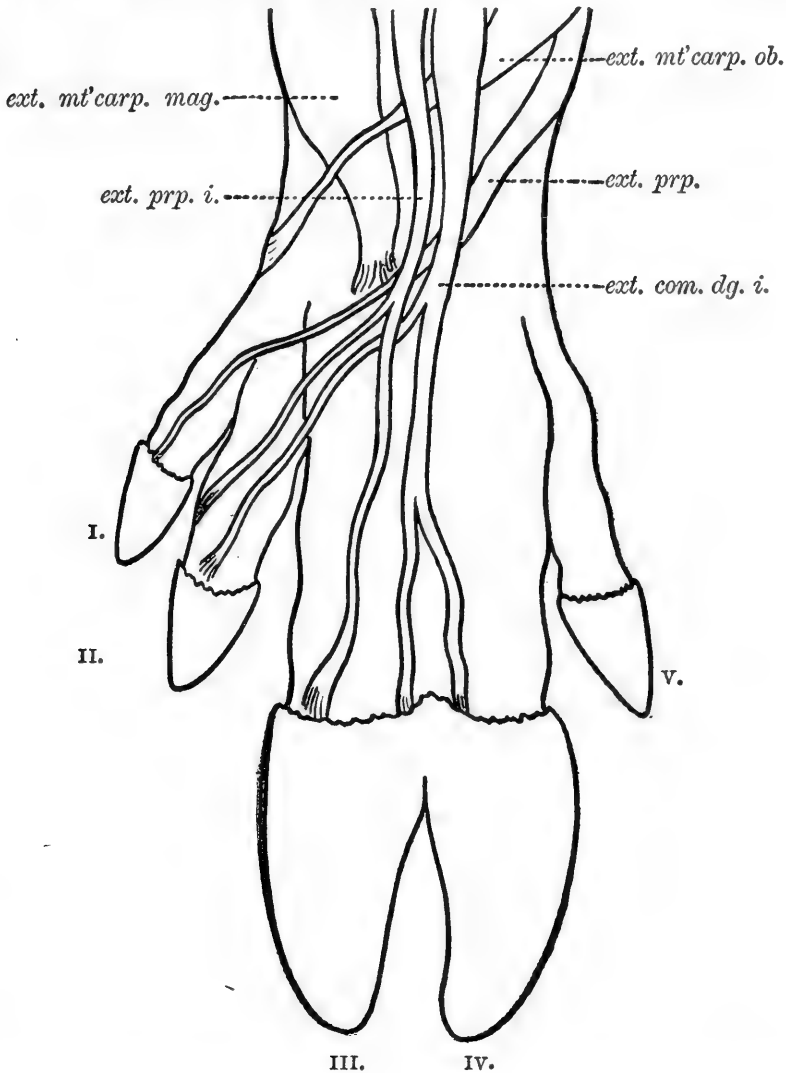


FIG. O. — Anterior view of left polydactyle manus of the pig, showing extensor muscles. *ext. com. dg. i.*, extensor communis digitorum internus; *ext. m'carp. mag.*, extensor metacarpi magnus; *ext. m'carp. ob.*, extensor metacarpi obliquus; *ext. prp.*, extensor proprius pollicis et indicis; *ext. prp. i.*, extensor proprius internus.  $\frac{2}{3}$  natural size.

case the extensor metacarpi obliquus (Fig. O, *ext. m'carp. ob.*) has shifted its insertion from the second to the first metacarpal; the extensor proprius pollicis et indicis (Fig. O, *ext. prp.*), which normally is extremely rudimentary, is in two cases inserted into the distal phalanges of digit I.

The flexors exhibit a very interesting condition; in all cases the deep flexor, or perforans (Fig. *P*, *flx. perf.*'), sends a small tendon to the extra digit; this apparently is not formed by the division of the tendon which supplies digit II, but is given off from the main tendon independently and more proximally. It may represent the radial portion of the flexor perforans. In the three cases where the second digit is abnormally

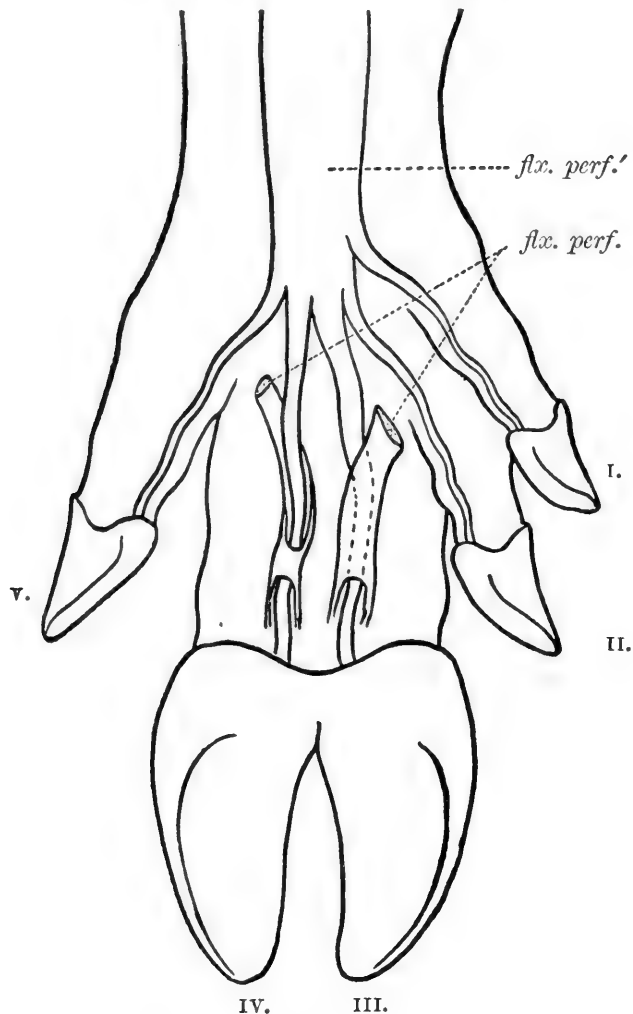


FIG. *P*. — Posterior view of left polydactyle manus, showing flexor muscles. *flx. perf.*, flexor perforatus; *flx. perf.*', flexor perforans.  $\frac{2}{3}$  natural size.

large, the tendon of the perforans supplying this digit is much stronger than usual. The superficial flexor, or perforatus, is normal in most cases, but in one instance has three insertions, an extra tendon going to the second digit.

The innervation of these cases is identical with that shown in Fig. *L*.



A still greater development of digit I was exhibited in two of the cases studied. Such a manus is shown in Figure 17 (Plate 9). The three phalanges and metacarpal of digit I are larger than those of digit II; the digit is borne on the trapezium, which is also large and articulates with the scaphoid and trapezoid. The other skeletal elements of the manus are normal in structure. The musculature and innervation of these two cases were identical with those shown in Figures *O*, *P*, and *L*.

The cases thus far described possess but one extra digit. Continuing the examination of the polydactyle series, it is found that this digit may be partially or completely doubled.

#### b. TWO SUPERNUMERARY DIGITS.

Ten cases were studied. From the intermediate conditions found, it seems probable that these forms of polydactylism are further modifications of those instances which have but a single extra digit. Figure 18 (Plate 10) shows the skeletal structure of one of the simplest of these conditions. The anatomy of the manus resembles in general that seen in Figure 17 (Plate 9). Metacarpal I is large and articulates with the trapezium, but instead of a single set of phalanges two series of bones are present. One of these series (Plate 11, Fig. 19, *1<sup>b</sup>*) may be small, pollex-like and composed of two phalanges, or both sets may be of nearly equal size and each consist of three elements (Plate 10, Fig. 18, *1<sup>a</sup>*, *1<sup>b</sup>*). Of four cases examined, three showed the latter condition. The trapezium and scaphoid are abnormally large in all cases. The musculature is like that of the pentadactyle manus (Figs. *O*, *P*), but the tendons which there supply the single extra digit may here bifurcate, and be inserted into the two digits. The nerve branch which supplies the first digit in Figure *L* also divides (Fig. *Q*), so that in these cases there is undoubtedly a duplication of digit I. Eliminating this digit, the rest of the manus, save for the large size of the trapezium, would be entirely normal.

We now pass to a polydactyle condition in which digit I is completely divided. The manus shown in Figure 20 (Plate 12) is interesting as being a stage intermediate between the preceding cases and a complete hexadactyle condition, and as additional evidence that the two extra digits are produced by the duplication of digit I. For in this case, although each is composed of a metacarpal and three phalanges, *1<sup>a</sup>* and *1<sup>b</sup>* are alike in size and form; still more noteworthy is the fact that the two unguis phalanges are enveloped in a single hoof, and that the two metacarpals articulate with the single trapezium. This carpal is large;

the trapezoid, on the contrary, is small and laterally compressed, as is also the proximal end of metacarpal II.

The tendons of the muscles and the nerve of digit I bifurcate (Fig. Q, 1).

This intermediate stage leads up to conditions in which there are two complete and entirely distinct digits. The duplication may extend even

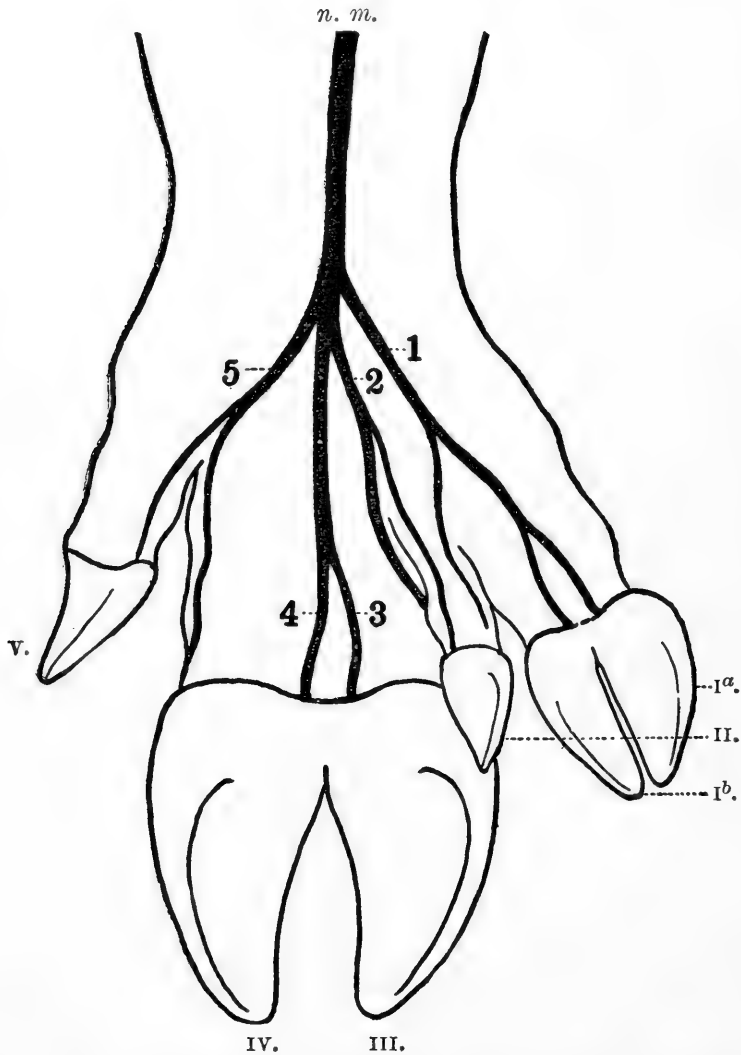


FIG. Q. — Posterior view of left polydactyle manus, showing innervation.  $I^a$ ,  $I^b$ , supernumerary digits; 1, first branch of median nerve, which bifurcates twice, the branches from the second bifurcation going to digits  $I^a$  and  $I^b$ .  $\frac{2}{3}$  natural size.

to the carpus, and the two digits thus formed may be nearly as large as the functional digits (III and IV) of the manus. Six such cases were examined. In the typical condition (Plate 13, Fig. 21) the supernumerary digits ( $I^a$ ,  $I^b$ ) are somewhat smaller than III and IV. Each

bears a large hoof, and the two hoofs are connected posteriorly by a cushion of horny tissue, as are the functional digits. The trapezium, which articulates with both extra digits, is very large, and shows evidence of duplication; the scaphoid also is abnormally large and broad. The

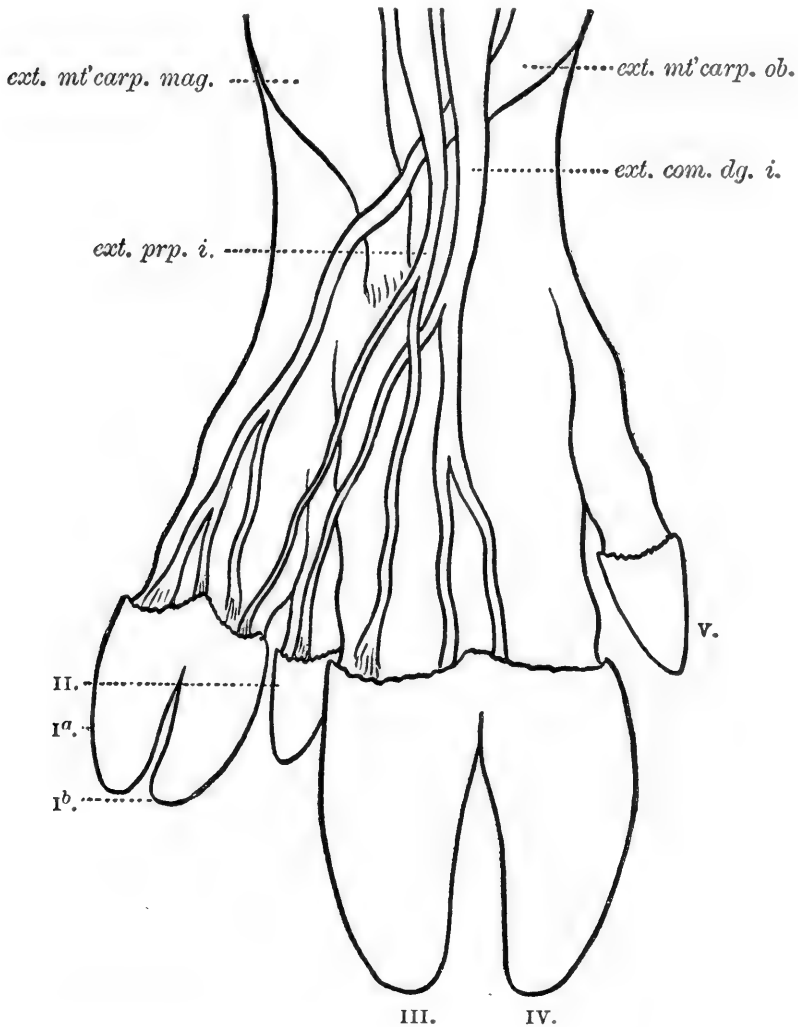


FIG. R.—Anterior view of left polydactyle manus of the pig, showing extensor muscles. *ext. com. dg. i.*, extensor communis digitorum internus; *ext. mt' carp. mag.*, extensor metacarpi magnus; *ext. mt' carp. ob.*, extensor metacarpi obliquus; *ext. prp. i.*, extensor proprius internus; I<sup>a</sup>, I<sup>b</sup>, supernumerary digits.  $\frac{2}{3}$  natural size.

trapezoid is narrow, being flattened by the large trapezium; the proximal end of metacarpal II also suffers in this respect.

When I<sup>a</sup> and I<sup>b</sup> are so large as to be functional, the muscles of the manus show some important modifications. Extensor proprius internus (Fig. R, *ext. prp. i.*) sends a tendon to I<sup>b</sup>; extensor metacarpi obliquus

(*ext. mt'carp. ob.*) is large, and its tendon, instead of being inserted as normally into the proximal end of metacarpal II, continues down to the distal phalanges of the supernumerary digits, into which it is inserted by three slips. In two cases this muscle was strengthened by a strong slip from the great extensor of the metacarpus. This is an interesting case

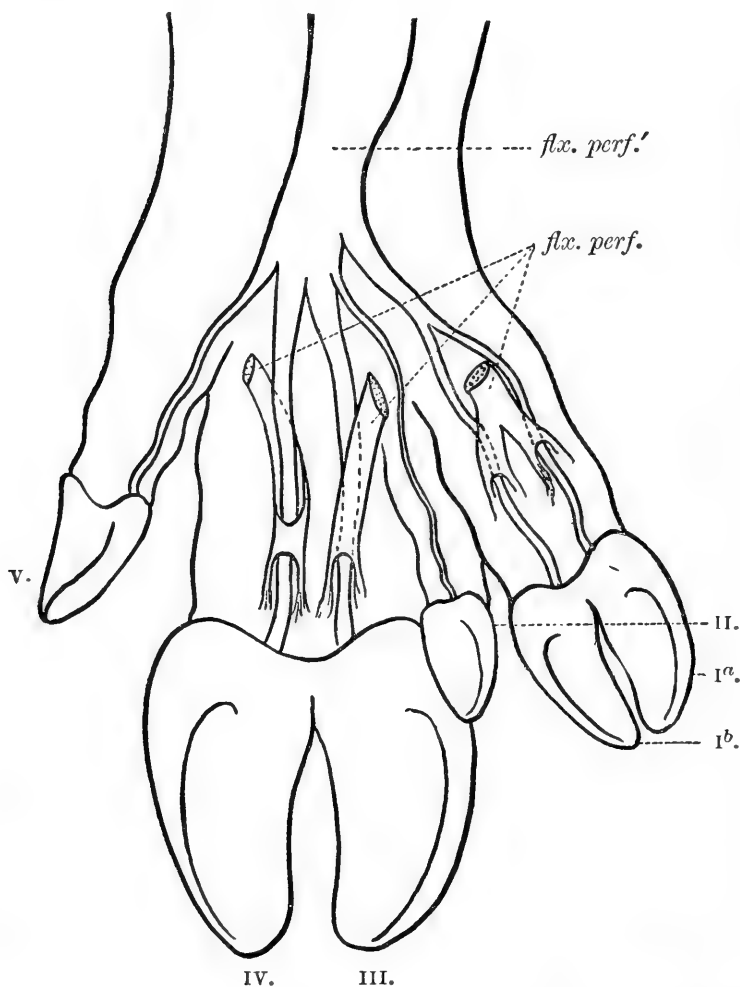


FIG. S.—Posterior view of left polydactyle manus of the pig, showing flexor muscles. *flex. perf.*, flexor perforatus tendons; *flex. perf.*, flexor perforans; *I<sup>a</sup>*, *I<sup>b</sup>*, supernumerary digits.  $\frac{2}{3}$  natural size.

of adaptation, and shows what a strong influence the functional capacity of the digits has on the development and structure of their muscles.

Of the flexor muscles, the perforans (Fig. S, *flex. perf.*) gives off a large tendon to the extra digits; this divides, and a branch is inserted into each ungual phalanx. The flexor perforatus (*flex. perf.*) also sends a large tendon to the extra digits, which bifurcates in the region of the

second phalanges and forms a sheath for each division of the perforans tendon. The innervation is shown in Figure *Q*.

With the increase in size of the extra digits of the polydactyle series, goes a corresponding decrease in the size of digit II. It is apparently reduced, and partially, sometimes completely, atrophied on account of the abnormal development of the supernumerary parts. In a case figured by Bateson ('94) the middle portion of metacarpal II is gone. In two front feet, from a single animal, I found that the left manus was like that shown in Figure 20, the trapezoid and proximal end of metacarpal II being reduced; in the right manus, however, metacarpal II was completely atrophied, but the three phalanges persisted and were of nearly normal size. The trapezoid remained as a small flattened bone, articulating chiefly with metacarpal III. The reduction is carried a step further in another case, in which the three phalanges of digit II are present, but exceedingly small, and the hoof reduced to a claw-like vestige (Plate 14, Fig. 22, II).

The nerve branch which normally supplies the second digit innervates this vestige (Fig. *T*, 2), making it reasonably certain that we have to do with the rudiment of digit II.

Figure 23 (Plate 15) represents the skeletal parts of a manus in which the second digit has apparently atrophied completely. Three specimens were examined which exhibited this condition. Such cases have been described as duplications of digit II, but a careful study of the manus shows that this is not the case. If we compare Figure 23 with Figure 22, the resemblance between the skeletal parts of the extra digits is striking. In each case they both articulate with the trapezium, and digit I<sup>b</sup> has taken nearly complete possession of the distal facet of the trapezoid, which is normally occupied by digit II. The trapezoid itself is narrow and smaller than the trapezium; the scaphoid in Figure 23 is divided into two elements, a condition which is found *only when two large functional digits are added to the normal number*. Other important facts are that digits I<sup>a</sup> and I<sup>b</sup> are of nearly equal size, symmetrical with reference to each other, and bear hoofs which are connected posteriorly by a pad of horn.

The musculature and nerves also afford good evidence in favor of this interpretation. The tendons which are normally inserted into the second digit are wanting here. The second branch of the median nerve (Fig. *U*, 2), which normally supplies digit II, still sends a large branch to the radial side of digit III and may thus be identified. But dissections failed to disclose the small nerve which usually supplies the second

digit. We can only conclude, then, that digit II, together with its accessories, has atrophied. This manus is therefore only pseudo-pentadactylous, and belongs in reality to the hexadactyle abnormalities. This conclusion is made possible only through the completeness of the polydactyle series which I have studied, and emphasizes the futility of at-

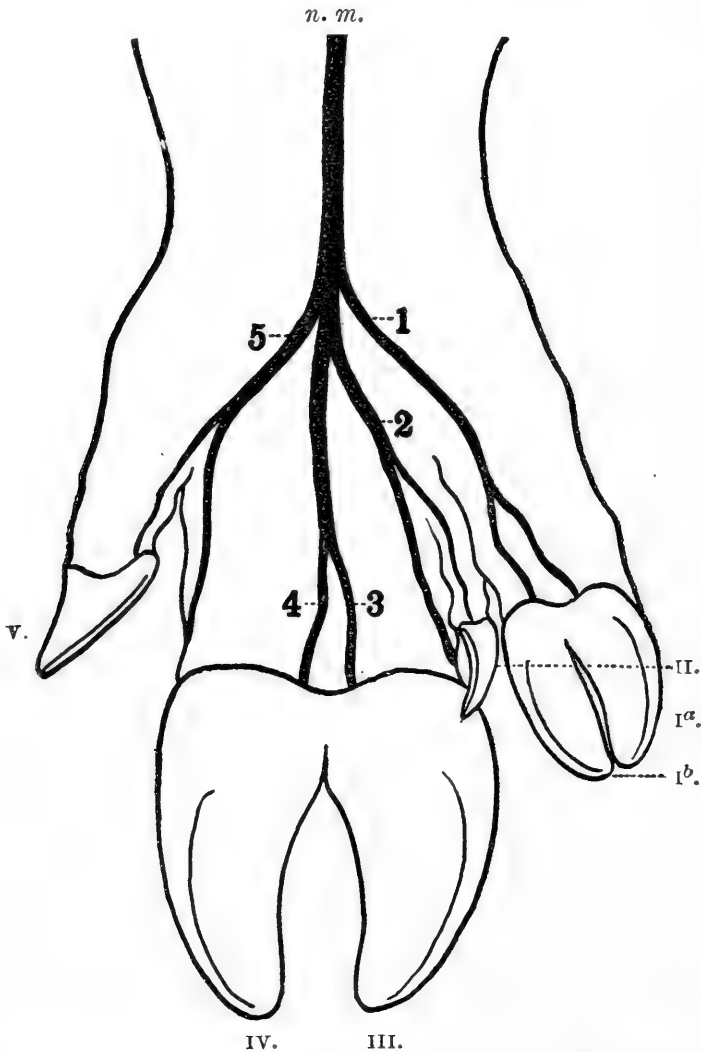


FIG. 7. — Posterior view of left polydactyle manus of the pig, showing innervation. I<sup>a</sup>, I<sup>b</sup>, supernumerary digits; 1, first branch of the median nerve, which bifurcates to the extra digits; 2, second branch, a division of which innervates the rudimentary digit II.  $\frac{2}{3}$  natural size.

tempting to obtain general results from single cases of polydactylism. Except for the intermediate stages at my disposal, the true significance of the structural conditions shown in Figure 23 could only have been guessed at.

Conditions are rare where more than two supernumerary digits occur in the polydactyle manus. Such a condition, however, is shown in Figure 24 (Plate 16). Digits  $1^a$  and  $1^b$  are well formed and each consists of three phalanges, but between them, and articulating with the

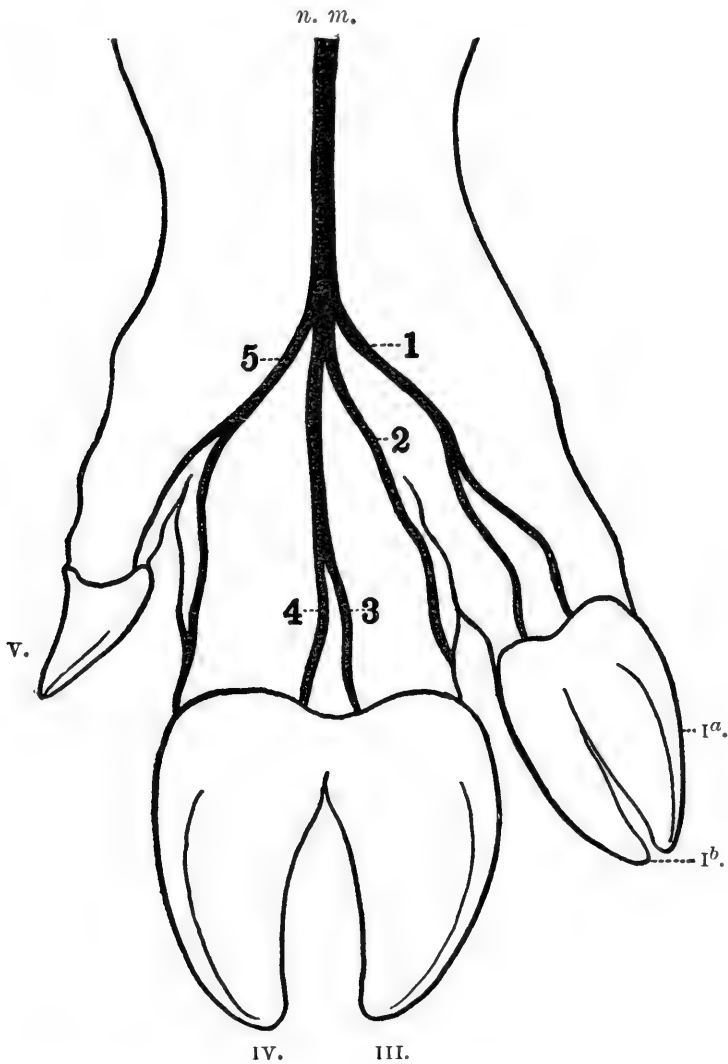


FIG. U. — Posterior view of left polydactyle manus of the pig. *n. m.*, median nerve; 1, first branch of median nerve, supplying digits  $1^a$ , and  $1^b$ ; 2, second branch, innervating digit III; its small radial division is wanting.  $\frac{2}{3}$  natural size.

proximal end of the second phalanx of  $1^b$ , is an elongated bone, which, from its position and form, may represent a first phalanx fused to a portion of a metacarpal. In the carpus we find the trapezium represented by two elements (*trz.*, *trz.*'), and the scaphoid is also duplicated.

The other skeletal elements of this manus are normal. The musculature and innervation are identical with the conditions shown in Figures Q, R, and S.

2. *Manus in which the Supernumerary Parts may be more or less closely connected with Metacarpal II.*

a. ONE SUPERNUMERARY DIGIT.

This condition was observed in five cases. From a typical example (Plate 17, Fig. 25) it might be inferred that all these cases were to be interpreted as mere duplications of digit II. The extra digit (I) possesses three phalanges and is of the same size as II. Both are borne on the same metacarpal, which is large and has two articular condyles at its distal end. The digits, however, are not symmetrical with each other, as we should expect if they had resulted from duplication of digit II; in both, the hoofs and ungual phalanges are concave on the ulnar, convex on the radial side. In the carpus *the trapezium is larger than normal*, and articulates above with the scaphoid, and below with the radial portion of the proximal facet of metacarpal II. This condition is represented by only a single case. In four other specimens the skeletal parts exhibited very interesting conditions which serve to connect this class of abnormalities with the first part of the series we are describing. In Figure 26 (Plate 18) it is seen that the extra digit (I) is much larger than the second (II), but, as in the preceding case, both are borne on a single large metacarpal. They are not symmetrical with each other, and on examining carefully the metacarpal, a dark irregular line will be seen, running nearly the whole length of the bone and dividing it into two unequal portions. This line of separation, so clearly brought out in the skiagraph, is not, of course, a surface marking but represents a complete bony septum. The two components into which the metacarpal is thus divided, correspond in size with the digits which they respectively bear.

The structure of the carpals furnishes important evidence as to whether the extra digit is formed by the splitting of II. If this were the case, the trapezoid should show signs of duplication, while the trapezium should remain normal. On the contrary the trapezium is large and *fused to the trapezoid*. Comparing Figure 26 with Figure 17 (Plate 9), the similarity of the skeletal structures is striking, and we can but conclude that the manus shown in Figure 26 differs from that shown in Figure 17 only in the fusion of its trapezium and trapezoid,



and of its first and second metacarpals. This view is borne out by another manus, in which the trapezium is fused to the proximal end of the compound metacarpal, and also by a case figured by Ercolani ('81, Tav. I, Fig. 2). In this instance digit II is of normal size, and its metacarpal is fused with metacarpal I along its proximal half only. This element (I) is large and bears three large phalanges. The compound bone formed by the fusion of metacarpals I and II *articulates above with the trapezoid, which is normal, and also with the trapezium, which is abnormally large.* If metacarpals I and II of the manus shown in Figure 17 were fused at their proximal ends, we should have a condition identical with that figured by Ercolani.

The evidence of the skeletal parts is in the main confirmed by the arrangement of the muscles and nerves. The condition of the muscles is similar to that of cases where the extra digit is distinct (Figs. O, P, pp. 275, 276). In the five cases dissected, digit II retained its own peculiar muscles. In one case all the muscles were normal; and in one instance the most radial tendon of the flexor perforans (Fig. P, *flx. perf.*'), which is normally inserted into digit II, bifurcates and is attached to digit I as well. In all cases the supernumerary digit was innervated by a *special branch* given off independently from the radial side of the trunk of the median nerve, as in pentadactyle animals (Fig. L, 1, p. 272). There is little ground, therefore, for regarding these cases of polydactylism as due to duplication of digit II; on the contrary, there is direct evidence against this view. (1) Digit I varies in size, while digit II always remains normal; (2) they are not symmetrical with each other; (3) the divisions of the metacarpal bone are unequal; (4) the trapezoid is not duplicated nor increased in size; (5) there is no general duplication of muscle tendons; (6) the extra digit is innervated by an independent branch of the median nerve.

In favor of the assumption that the extra digit represents the pollex independently developed and later fused to metacarpal II, is the fact that the trapezium is of abnormal size, and always articulates with the radial portion of the proximal facet of the compound metacarpal; also the striking resemblance of the skeletal, muscular, and nervous structures to those of the cases in which the extra digit does arise independently.

#### b. TWO SUPERNUMERARY DIGITS.

Three cases were observed representing two types. Of the simplest condition there was but one case. In this manus digit I<sup>a</sup> (Plate 19, Fig. 27) consists of two small phalanges and the distal end of a meta-

carpal bone; digits  $1^b$  and II are of nearly equal size, each composed of three phalanges and borne on a single large metacarpal.  $1^a$  and  $1^b$  are enclosed in the same hoof, which shows evidence of duplication.

The phalanges of digit II are of normal size and form; the carpals are practically normal, but the trapezium articulates with the proximal

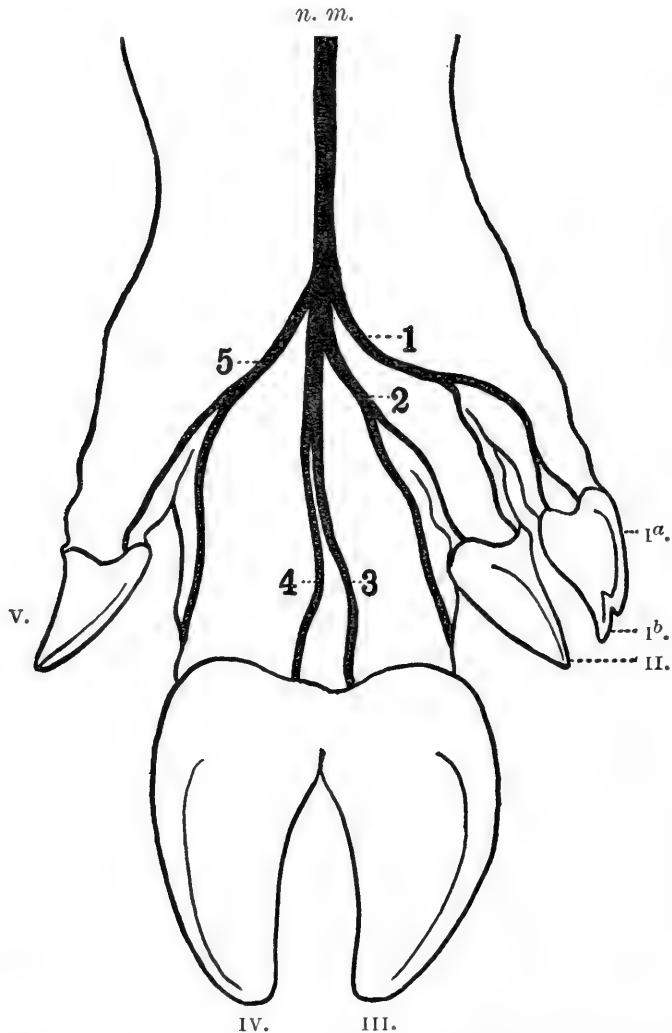


FIG. V.—Posterior view of left polydactyle manus, showing innervation.  $1^a$ ,  $1^b$ , supernumerary digits; *n. m.*, median nerve; 1, first branch of median nerve supplying digits  $1^a$  and  $1^b$ .  $\frac{2}{3}$  natural size.

end of the compound metacarpal, and ends in a free distal process. The musculature of digit II is normal. The extensor proprius pollicis et indicis divides and is inserted into the distal phalanges of both  $1^a$  and  $1^b$ . The flexor perforans gives off an independent tendon to digit  $1^b$ . The innervation of the manus (Fig. V) is identical with that of cases in which the two extra digits are entirely distinct from II (Fig. Q).

This abnormality may be accounted for in two ways: Either (1) digit  $1^a$  represents the developed pollex, and  $1^b$  is formed by the duplication of digit II, or (2) digits  $1^a$  and  $1^b$  are duplications of the pollex, and the metacarpal of  $1^b$  is secondarily fused to that of digit II. The first hypothesis is supported by the similarity in structure of digits  $1^b$  and II, their symmetry with reference to each other, and the differences existing between  $1^a$  and  $1^b$ . The second view, however, is supported (1) by the fact that the extra digits are enclosed in the same hoof, and therefore probably developed together, (2) by the fact that the trapezium articulates with the compound metacarpal, and (3) by the structure of the muscles and nerves.

To another type belong two cases in which digit  $1^a$  is completely developed and articulates with the carpus (Plate 20, Fig. 28). Digits  $1^b$  and II are borne on a single large metacarpal, but  $1^b$  is much the larger. The phalanges of II are of normal size and unsymmetrical with those of  $1^b$ . The ungual phalanges of both  $1^a$  and  $1^b$  are enclosed in separate hoofs, and are symmetrical with each other, although differing somewhat in size. The trapezium is large, and articulates with metacarpal  $1^a$  and with a portion of the compound metacarpal. The musculature and innervation of this manus are similar to those of the foregoing case.

Our view that these abnormalities are due to duplication of the pollex and the subsequent fusion of the metacarpal of  $1^b$  to that of II, is favored by the structure of a manus figured by Otto ('41, Tab. 26, Fig. 12). In this case there are two extra digits of three phalanges;  $1^a$  is borne on a distinct metacarpal, which articulates with the trapezium, and  $1^b$  on a metacarpal which is almost completely fused to metacarpal II. Digit II is of normal size. The phalanges of  $1^a$  and  $1^b$  form a single series of three bones, each of which is incompletely divided into two; the ungual phalanx evidently bore a single hoof. The trapezium articulates with metacarpal  $1^a$  and with two-thirds of the proximal surface of the compound metacarpal. The trapezoid is smaller and articulates with the remaining third of the proximal facet of the large metacarpal bone. In this manus, therefore, the digits  $1^a$  and  $1^b$  evidently developed together, and the fusion of metacarpal  $1^b$  to that of II was of subsequent occurrence. This being the fact, it is very probable that the foregoing cases which we have examined were produced in a similar manner.

Having now briefly described the types of digital variation in the manus of the pig, we shall next attempt to determine their significance.

## C. SIGNIFICANCE OF THE VARIATIONS OBSERVED.

The objections to explaining polydactylism in the pig by the theory of reversion are based on anatomical, embryological, and palaeontological evidence. They have been well summed up by Gegenbaur ('80): (1) the accessory pollex is composed of three phalanges, whereas, if due to reversion, it should consist of only two; (2) the other parts of the manus show no modifications toward ancestral conditions; (3) no fundament of the pollex is present at any stage in the embryo pig, nor is it present as a rudiment in any artiodactyle, living or extinct. Gegenbaur, accordingly, concludes that the extra digit is not produced by the development of a vestige, but can be formed only from the duplication of one of the normal digits. Are these objections and Gegenbaur's theory supported by the cases which we have examined?

First, as to the number of phalanges in digit I: in five of our cases there was present a pollex of two phalanges. In the remaining twenty-nine cases, however, there were three elements in each of the extra digits. Gegenbaur is thus right in the main, but there are a few instances which contradict his sweeping statement.

As regards the modification of the other parts of the polydactyle manus, Gegenbaur is again correct in his general statement. But we have seen that in a limited number of cases there are found the identical conditions which he maintains never exist. The trapezium, trapezoid, and third metacarpal of the polydactyle manus resemble in structure the same elements in the manus of certain fossil swine (*Ancodus*, *Palaeochoerus*). But the trochlear ridge is found at the distal articular face of the metacarpals in all polydactyle conditions, although it is partly or completely wanting in fossil forms. Other peculiarities of the phalanges of fossil forms are not reverted to.

The musculature also shows some interesting changes. Extensor metacarpi obliquus is in many cases inserted into the metacarpal of the extra digit (1) rather than into metacarpal II. But we know that in the polydactyle manus of man tendons may shift from normal to abnormal digits, although reversion plays no part in producing these abnormalities. The development (1) of the extensor proprius pollicis et indicis (which is rudimentary in the normal manus) and (2) of an independent tendon from the radial side of the flexor perforans are the best evidences presented by the musculature that the extra digit is produced from a vestige. But no great weight can be placed on the structure of the muscles, as their modifications appear to be chiefly adaptive. They are

most highly developed when the extra digits are functional, and often to an abnormal degree.

Much greater stress can be laid on the innervation of the polydactyle manus, for the structural conditions are singularly uniform throughout this polydactyle series. In all cases the supernumerary parts are innervated by an independent nerve arising from the radial side of the median trunk, and at about the position where the nerve of the pollex is normally given off in pentadactyle animals. When two extra digits are present in the manus, this branch bifurcates and supplies both. Thus modifications exist in the skeletal, muscular, and nervous organs of the polydactyle manus; they point towards the *vestigial origin of the extra digits, but there is little evidence of reversion in other parts of the manus.*

Gegenbaur's third objection, that the pollex is absent in the embryo and in all adult Artiodactyla, is well taken. For if these are facts, reversion would have to produce a digit of which there is no fundament in the embryo, and reproduce an organ characteristic of only extremely remote ancestors. But Scott ('95) has shown in his work on the American Anthracotheridae, that *Ancodus brachyrhynchus* has the pollex well developed. We do not, therefore, have to go back further than the Suinae to find a pentadactyle form. As to the absence of the fundament of the pollex in the pig embryo, I have confirmed Rosenberg's ('73) results by examining the carpus of a large number of embryos in various stages of development. For this material I am indebted to Prof. E. L. Mark. There was absolutely no evidence of a pollex-fundament other than the trapezium. This element is generally regarded as being simply the carpal element of digit I, for it develops as a single cartilage. We know, however, that the scaphoid and unciform bones develop in the same way, yet that each represents *two* carpals fused. A careful study of the trapezium in the embryo, in the normal adult and in the polydactyle pig, furnishes some evidence in support of the view that the so-called trapezium represents a rudiment of the pollex as well as a carpal element. (1) In the earliest stages of its development, the cartilage which is to form the trapezium has the pointed distal end characteristic of its adult condition, *and projects distad to the proximal limit of the metacarpus.* (2) In the normal adult carpus the trapezium has always the form of an elongated cone. Its distal end is free, and pointed, instead of truncated, as we should expect if we had to do with only a carpal element. Furthermore, its free end projects farther distad than the other carpal bones and *into the region of the metacarpus.* (3) In the polydactyle manus one case was described in which only the distal

end of metacarpal I was developed; yet the so-called trapezium is abnormally long and projects well down by the side of metacarpal II. In three cases where the pollex is developed in a rudimentary condition the *trapezium is fused to metacarpal I*.

In other animals, such as the horse and ox, where there are well-authenticated cases of vestigial polydactylism, the extra digits usually represent the development of rudiments normally present in the embryo. In the case of polydactyle swine, where the extra digits constantly make their appearance in the region of digital reduction, it is but natural to conclude that a rudiment of this digit, even though extremely vestigial, is present in the embryonic manus.

In cases where two (rarely three) extra digits are found in the polydactyle manus, there are no modifications in the other parts. Moreover, it is out of the question to consider digit 1<sup>a</sup> as representing a prae-pollex and 1<sup>b</sup> a pollex. Granting that the prae-pollex existed, there are still insurmountable difficulties in the way of this interpretation. Both extra digits develop on a single carpal element, the trapezium. They are supplied by bifurcations of the same muscle tendon, innervated by the divisions of the same nerve-branch, and may even be enclosed distally in the same hoof. In addition, they are usually of the same size and symmetrical with each other. Thus their structure, and the fact that conditions exist intermediate between a single undivided digit and two completely separate ones, make it almost certain that the two extra digits arise from the duplication of the pollex.

Having found good evidence in favor of the vestigial origin of the extra digits, and that Gegenbaur's objections do not hold for all cases, let us examine the evidence in favor of his theory that all cases of polydactylism in the pig are due to duplication of the second digit.

On examining the structure of two digits which are known to be duplications of a single one, we find that they are of nearly the same size, symmetrical with each other, often enclosed in the same hoof, and borne always on a single duplicated carpal element. They are supplied also by duplications of the same muscle tendons, and innervated by the bifurcations of the same nerve-branch.

In the polydactyle cases which we have examined these are not the characteristic conditions. As we have seen, digits I and II always differ greatly in size, often in number of phalanges, and are not bilaterally symmetrical. Digit I is never borne on the trapezoid, but on its own proper carpal, the trapezium; when the trapezium is apparently absent, it is really fused to metacarpal I, or to the trapezoid. The mus-

cular attachments and the innervation of the extra digit are entirely distinct from those supplying and innervating digit II. We can only conclude, therefore, that in these cases the supernumerary digit is not a duplication of digit II. If it were such a duplication, why should not the fifth digit be affected as often as the second? On the contrary, *in every polydactyle manus so far observed the supernumerary digit is found on the radial side of digit II.*

There is no doubt that abnormalities due to the duplication of a functional digit may occur in the manus of the pig as in other mammals; but in the majority of cases the origin of the extra digit must be vestigial. By variation and duplication of this vestige in its development, two or more supernumerary digits may be formed. Whether or not the development of this digital vestige is due to reversion, we will discuss in the theoretical portion of this paper.

Summing up the facts obtained as to polydactylism in the pig, it is found that —

1. Polydactylism is confined almost entirely to the manus. (This fact is interesting, as the condition restores that found in fossil swine. In the pes of *Ancodus* the hallux is entirely gone, although in the manus the pollex is well developed. If we regard the extra digit as due to duplication of digit II we should expect this duplication to occur as often in the pes as in the manus; but if the extra digit is vestigial in its origin, the early and complete reduction of the hallux in fossil swine is good reason for its never being developed in the pig of the present day.)

2. The supernumerary digits in every case occur on the radial side of the second normal digit.

3. In nineteen of the thirty-six cases examined, a single supernumerary digit is present; in five instances this digit is composed of two phalanges; in nine cases, of three; and in five instances its metacarpal is fused to that of digit II.

4. In the remaining seventeen specimens thirteen are hexadactyle, although in three cases the metacarpal of one supernumerary digit (*1<sup>b</sup>*) is fused to that of digit II; in three instances two supernumerary digits are present, but digit II is entirely wanting; and in one specimen there are evidences of three extra digits.

5. In more than a third of the cases examined, the skeletal, muscular, and nervous organs of the manus give some evidence that the extra digit is vestigial.

6. The trapezium (so-called) may represent this carpal element plus the rudiment of digit I.

7. The extra digits articulate with the trapezium in nearly every case; they therefore represent the development of a vestigial pollex, but may vary extremely from the normal pollex structure.

8. There may be cases where the extra digit is formed by the duplication of digit II, but there is strong evidence against this being the general rule.

9. Two supernumerary digits may be formed by the duplication of the vestigial pollex; there are no grounds for considering one of them a "prae-pollex."

## VI. Polydactylism in Ruminants.

### A. LITERATURE.

Observations have been made on polydactylism in ruminants and descriptions given by Geoffroy St. Hilaire ('32-37), Goodman ('68), Chauveau et Arloing ('79), Boas ('90), Baumüller ('92), Blanc ('93), and Bateson ('94). In the normal manus of ruminants, III and IV are the functional digits, and in all forms save the water chevrotain their metacarpals are fused to form a single "cannon bone." The pollex is always wanting; digits II and V are reduced in varying degrees in the different groups of ruminants. In the camel they are wanting; in the ox metacarpal V remains as a proximal rudiment; the phalanges are completely gone, but a "dew-claw" represents each hoof. The sheep has the two distal phalanges and hoofs of II and V persistent, while in the Cervidae these digits are represented by three well-developed phalanges and the distal ends of the metacarpal bones; the hoofs of digits II and V are functional when the deer is running or travelling over soft ground. In the water chevrotain there are four complete digits, each formed of a distinct metacarpal and three phalanges.

I know of no instance of polydactylism in the camel, and there are few descriptions of such abnormalities in sheep. Geoffroy St. Hilaire ('32-37) describes the manus of a lamb in which digits I, II, and V were developed; digits I and II were borne on the same metacarpal and probably represent a duplicated condition of digit II. The best description of polydactylism in the sheep is that of Chauveau et Arloing ('79). The manus of a lamb is figured, in which both the second and fifth digits are developed, each being composed of a distinct metacarpal element and three phalanges nearly as large as those of the functional digits. This condition is certainly due to the development of vestiges, and has been attributed to reversion.



Baumüller ('92) figures the manus of a roebuck (*Cervus caprea*) which was composed of five digits. The abnormality was found on both fore feet. Baumüller regards the extra digit as a pollex, and attributes its presence to reversion.

Bateson ('94) remarks with reference to polydactylism in the sheep and ox, that the extra digits are in all cases formed by duplication or variation. As to the development of digits II and V he asserts that "there is no such case."

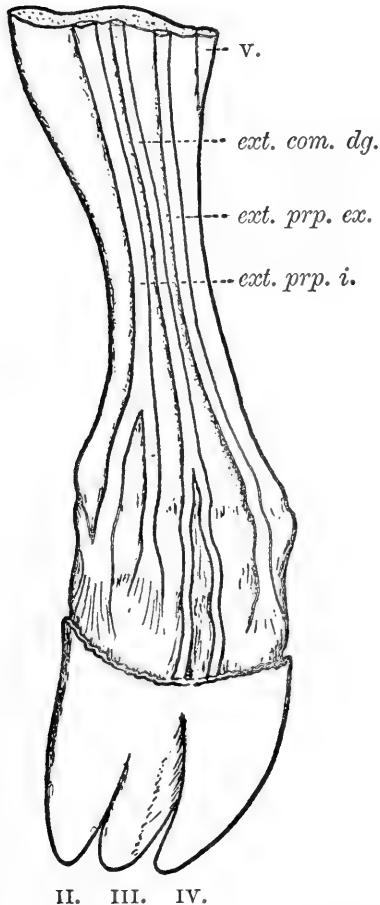
In the ox, a number of cases of polydactylism have been observed and described. They may be divided into two groups: (1) manus or pes of three digits, all of nearly equal size, and borne on a single metacarpal bone (Bateson, '94, Figs. 114, 115, p. 375). In these cases the presence of both accessory hoofs (rudiments of II and V) in their normal positions makes it certain that the vestiges of digits II or V have not developed, but that either III or IV has become duplicated. Four cases are described by Bateson, and it is stated by Goodman ('68) that the abnormality was common and frequently inherited in a herd of English cattle. (2) Manus of four digits, II and V both being developed; the accessory hoofs are located at the distal extremities of the extra digits; each supernumerary digit is composed of a distinct metacarpal element, and digit II has in addition two small phalanges. Boas ('90) describes two cases, and considers them good instances of reversionary polydactylism.

#### B. OBSERVATIONS.

Two cases of polydactylism in the manus of the ox have come under my observation. Both specimens had been disarticulated at the carpo-metacarpal joint, and the carpal bones were thus unfortunately lost; they were right and left fore feet and probably belonged to one animal. Both are abnormally wide at the distal end of the cannon bone; in each the hoof of the radial side is very broad and incompletely divided into two parts (Fig. *W*, p. 294, and Plate 21, Fig. 29). The accessory hoof of the ulnar side of the manus is normal in position, but that of the radial side is absent in both cases.

In the left manus (Fig. 29) the skeletal parts are well formed. The metacarpus is of normal length, and is distinctly divided into three elements, each of which bears an articular head for a corresponding digit. These three elements represent three metacarpal bones, and we may designate them as II, III, and IV. III is larger than either of the others; its distal articular surface is unsymmetrical, as the trochlear ridge

has shifted toward the ulnar side. The supernumerary metacarpal (II) is the smallest of the three; it is fused to III throughout its whole length, and can be traced to the proximal extremity of the metacarpus, where it takes part in forming the articular facet for the carpals. The



II. III. IV.  
 FIG. W. — Anterior view of the left polydactyle manus of a calf, showing the extensor muscles. II, supernumerary digit; v, metacarpal of digit five; *ext. com. dg.*, extensor communis digitorum; *ext. prp. ex.*, extensor proprius externus; *ext. prp. i.*, extensor proprius internus.  $\frac{1}{2}$  natural size.

distal epiphysis extends beyond those of the normal metacarpals, has a flattened instead of a convex articular surface, and no trochlear ridge. The fifth metacarpal (Fig. W, v) is, as normally, a rudimentary stylet articulating at the ulnar side of the proximal extremity of iv.

All three digits are composed of three phalanges. Digit iv is apparently normal; digit III is more massive, and the symmetry of its phalanges and hoof is affected by the presence of the abnormal digit. Instead of being optical images of those of digit iv, these bones are indifferent in their conformation, curving neither to the right nor to the left. The hoof in which the unguis phalanx is enclosed is common also to digit II. The extra digit (II) is shorter and not so massive as the normal ones; its unguis phalanx is flattened laterally, and more pointed than the normal phalanges; the sesamoids are absent.

Dissection of the musculature of this manus shows that the flexors are entirely normal; the extensors, however, exhibit an important modification. The tendon of the extensor proprius internus (Fig. W, *ext. prp. i.*) divides, and the more radial of the two slips thus formed is inserted into the second and unguis phalanges of the supernumerary digit. Before its insertion this tendon is joined by a division of the suspensory ligament. The anatomical relations of this tendon thus resemble the normal condition in four-toed animals. If the supernumerary digit is a duplication of digit III, we should expect to find the extensor communis digitorum (*ext. com. dg.*) and the flexor tendons bifurcated; but they are unmodified.

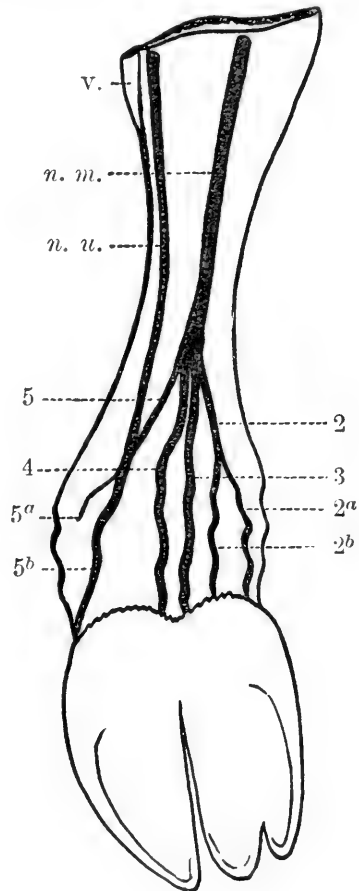
The nerves of this manus also show important modifications. The normal manus, like that of swine, is innervated by four branches of the median nerve; the most radial and most ulnar branches (compare Fig. X, 2, 5) give off small twigs to the rudiments of digits II and v. Branch 5 is joined by the ulnar nerve immediately before it divides to form 5 *a* and 5 *b*. In the polydactyle manus (Fig. X, 2, 5) the modification is in connection with the small fasciculus (2<sup>a</sup>), which normally innervates the radial accessory hoof (rudiment of digit II). This is no longer a mere filament ending at the distal end of the metacarpus, but a moderate-sized branch, which continues to the hoof and ungual phalanx of the supernumerary digit. The condition of this nerve branch, together with the fact that the accessory hoof of this side is absent, affords most convincing proof that this abnormality is not a monstrosity, or a duplication of digit III, but is due to the development of digit II.

The second case, a right manus, confirms by its structure the conclusion which we have drawn from the first.

The line of demarkation between the second and third metacarpals is even more distinct (Plate 22, Fig. 30); the first and second phalanges of digit II are fused together and are abnormally short.

Rosenberg ('73) states that metacarpals II and v are present in the embryo of the sheep and ox, but later partially degenerate and fuse to the cannon bone, a small portion of v remaining distinct in the ox. In the Cervidae the distal ends of the metacarpals persist in the adult. It is not surprising therefore that we find these digital rudiments occasionally developed in the adult ruminant.

Polydactylism in ruminants is thus of two types: (1) vestigial, due to the development of either digit II or v (or both); (2) teratological, produced by the duplication of one of the functional digits (III or IV).



IV. III. II.

FIG. X. — Posterior view of left polydactyle manus of the calf, showing innervation. II, extra digit; v, metacarpal of fifth digit; n. m., median nerve; n. u., ulnar nerve; 2-5, four branches of median nerve; 2<sup>a</sup>, division of second branch which supplies the extra digit (II); 5<sup>a</sup>, division of fifth branch which innervates the accessory hoof (digit v).  $\frac{1}{2}$  natural size.

## VII. Polydactylism in the Equidae.

## A. LITERATURE.

The anatomy and diseases of the horse have been studied almost as thoroughly as those of man, and consequently we find that polydactylism in the Equidae has received considerable attention. Aside from the classical allusion of Suetonius ('86) to the horse of Julius Caesar "which had feet that were almost human, the hoofs being cleft like toes," the first account of polydactylism is that of Winter (1703), who describes two cases. Geoffroy St. Hilaire ('32-37) records a foetus which was polydactyle in the fore feet, the left foot bearing three nearly equal digits, and the right two. Numerous instances have since been noted, the more important descriptions being those of Arloing ('67), Wood-Mason ('71), Marsh ('79, '92), Ercolani ('81), Boas ('85), Pütz ('89), and Ewart ('94). Blanc ('93), and Bateson ('94) review the general subject.

The normal functional digit of the Equidae is III of the typical mammalian manus; it consists of a long metacarpal bone and three phalanges. The ungual phalanx is completely enclosed in a massive hoof. Two splints, representing the metacarpals of digits II and IV, articulate at each side of the cannon bone posteriorly and with the carpus. The trapezium is a small pea-shaped rudiment lying posterior to the trapezoid and often wanting. The os magnum is very large, and with it, chiefly, the cannon bone articulates.

The polydactyle cases cited by various investigators fall into two groups, the first of which may be subdivided into three:

(1) *Supernumerary digits representing the development of digital vestiges.*

a. *Three metacarpals, the extra digits being borne on II and IV.* The condition of an extra digit borne on metacarpal II may occur on all four feet (Marsh, '92) or be limited to the manus (Arloing, '67). The extra digits are always smaller than III and do not function in locomotion; this condition is of quite frequent occurrence. A single case is cited by Wood-Mason ('71), in which an extra digit of three phalanges occurs on metacarpal IV; the radial splint bone (II) was also somewhat better developed than in a normal manus. Cases of three digits (both II and IV being developed) are cited by Geoffroy St. Hilaire ('32-37) and Marsh ('92), but no good anatomical descriptions are given.

*b. Four metacarpals*; digit I is represented by a splint radial to digit II, which is fully developed and composed of three phalanges (Fig. Y).

In these cases there are four large bones present in the distal row of carpals. Digit II is large, and its metacarpal is fused throughout most of its length to that of digit III. Four cases are cited by Marsh ('92), and one is carefully described by Bateson ('94).

A different interpretation from that here assumed may be brought forward in explanation of these cases. The digit designated as II in Figure Y may be regarded as a duplication of digit III, and the so-called trapezoid of the carpus may represent a duplication of the os magnum. Then the bone designated as trapezium must be the true trapezoid, and its splint bone the second, not the first, metacarpal. Only by a careful examination of the skeletal, muscular, and nervous structures can we determine which interpretation is correct; whether digit II is of vestigial origin, or due to a duplication of digit III. The fact that in phylogeny the pollex disappeared long before the fifth digit is a strong argument against the former interpretation. For by that interpretation we should here have the pollex reappearing, and the second digit almost as large as the third, while the fourth digit is unmodified and the fifth is entirely absent.

*c. Five metacarpals; one supernumerary digit, borne on metacarpal II.* One case is described by Pütz ('89) in which the trapezoid bears digit II; this consists of a well-developed metacarpal bone and three phalanges. Radial to this is a large trapezium, articulating with the scaphoid and trapezoid and bearing a splint six cm. long; metacarpal IV is normal, and on its ulnar side is another metacarpal element supposed to represent digit v. The supernumerary elements in this case can only be explained as of vestigial origin.

(2) *Two digits borne on metacarpal III.*

These are clear cases of duplication, and have been described in the manus only. The doubling may extend to the metacarpal bone, but is

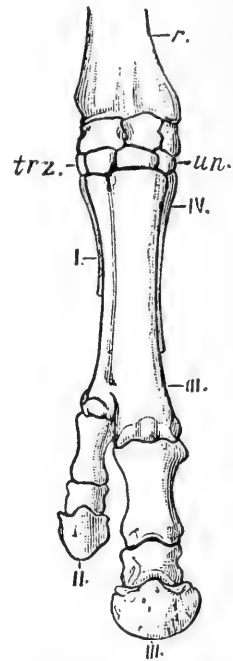


FIG. Y. — Anterior view of left polydactyle manus of horse. I, metacarpal of first supernumerary digit (pollex); II, second supernumerary digit; III, functional digit; IV, metacarpal (splint) of fourth digit; r, radius; trz., trapezium; un., unciform. (After Marsh.)

usually limited to the phalanges. Such conditions have been described by Struthers ('63), Arloing ('67), and Boas ('85).

### B. OBSERVATIONS.

Through the kindness of Dr. Frothingham, of the Harvard Veterinary School, an abnormal manus of a polydactyle colt came under my observation. The specimen came from Texas. Externally the hoof was almost

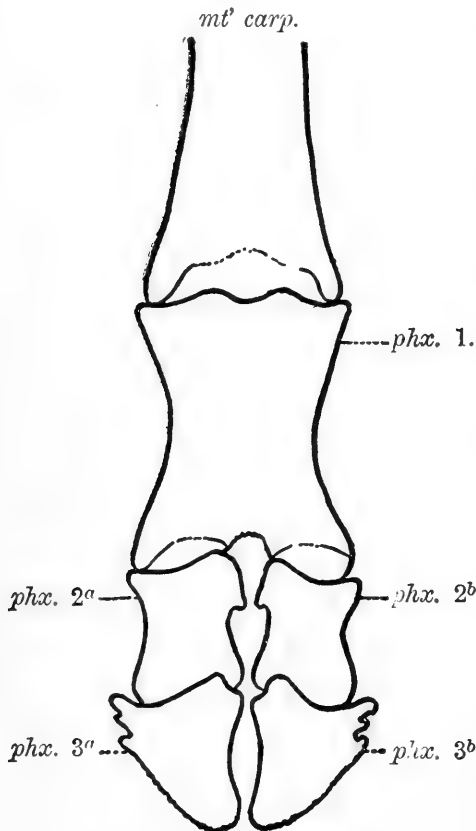


FIG. Z. — Anterior view of left polydactyle manus of the horse, showing duplication of digit III. *mt' carp.*, distal end of third metacarpal bone; *phx. 1*, first phalanx of third digit; *phx. 2<sup>a</sup>, 2<sup>b</sup>*, duplications of second phalanx; *phx. 3<sup>a</sup>, 3<sup>b</sup>*, duplications of ungual phalanx.  $\frac{1}{2}$  natural size.

completely divided into two; each portion was several inches long, and curved away from the other. On examining the skeletal parts (Fig. Z), they were found to be normal down to the distal end of the first phalanx, which was bifurcated and bore two articular surfaces. Each of these carried two phalanges, which resembled the median and ungual phalanges of the artiodactyle digit. The two series were mirrored images of each other; each os pedis was slightly concave on the surface facing the median plane of the digit, and convex on the opposite side, so that the two fitted together would give a phalanx of nearly normal form. A navicular of about half the length of the normal bone articulated with the posterior face of each os pedis, thus resembling the condition of ruminants.

This specimen had been dried before it was examined, and the innervation could not be studied, but examination of the chief muscle tendons showed that the extensor pedis and flexor perforans were duplicated at their distal ends. This case is therefore simply an example of duplication of digit III.

It has long been known that the "splint bones" of the equine manus represent rudimentary metacarpals, but until recently the presence of phalangeal vestiges in the manus of the embryo has been denied.

Rosenberg ('73) searched for such vestiges, but without success. Ewart ('94), in tracing out the skeletal development of the limbs of the horse, found cartilaginous nodules articulating in an imperfect manner with the distal epiphyses of metacarpals II and IV. The vestige attached to digit II was the larger, and in some instances showed evidence of division into two or three parts, which Ewart takes to be the fundamentals of as many phalanges.

This is an interesting and important discovery, since, if digit II is better developed than IV in the normal embryo, we have a good explanation for the fact that in polydactyle horses it is the second digit which is of most frequent occurrence. Dissection of the manus of a foetus 35 cm. long enabled me to confirm Ewart's work. There is thus conclusive evidence that in the horse extra digits are frequently of vestigial origin. The digital abnormalities of the Equidae can therefore be divided into two distinct classes:

(1) Vestigial cases, in which the extra digits are developed from rudiments normally present in the manus of equine embryos and extinct ancestors.

(2) Teratological cases, which are malformations usually due to the partial or complete duplication of the functional digit (III).

### VIII. Theories of Polydactylism.

The occurrence of polydactylism has been attributed to two proximate causes: (1) External influences, (2) Internal influences.

#### 1. EXTERNAL INFLUENCES.

The supporters of this theory (Ahlfeld, '85-86, and Zander, '91) would explain all cases of digital variation as due to the pressure of amniotic threads *in utero*. This view accounts satisfactorily for the variation in degree of digital duplications, but utterly fails to explain their fixed position with reference to certain digits, and cannot apply to the development of digital vestiges. Pressure from an amniotic thread would naturally affect *any* finger or toe, whereas we know that polydactylism in mammals is practically limited to the first or fifth digit, is often bilaterally symmetrical in its occurrence, and may affect both manus and pes in the same individual. The abnormalities are also strongly inherited, and the amniotic theory, if correct, would necessitate admitting the inheritance of acquired characters. Although the duplication of organs has been artificially produced by Dareste ('91) and others, it

has yet to be proved that such modifications are inherited. Certain cases of digital duplication are undoubtedly caused by the pressure of amniotic threads. Such abnormalities are true malformations, and usually affect a normal, unreduced digit. An assured case is that of a duplicated thumb described by Ahlfeld, in which a fold of the amnion was found at birth still adherent between the duplications of the pollex. It is possible that certain cases where a single functional digit is duplicated are produced in a similar manner. Such examples of polydactylism, however, are the exceptions rather than the rule, for in both mammals and birds we have seen that the typical, unmodified, functional digits vary but rarely. Under this class might come the cases of partial or complete duplication of digits II-IV in birds and man; of digits II-V in carnivores; of digits III and IV in artiodactyles, and of digit III in the horse. Some cases of the duplication of digits I and V in man and of digits II and V in swine may also be included in the above category; but it may be that all the symmetrically placed, hereditary digital abnormalities are produced by some internal influence emanating from the germ itself.

## 2. INTERNAL INFLUENCES.

One of the most important facts brought out by the comparative study of polydactylism is its limitation chiefly to the *variation of digits which normally are either modified, rudimentary, or vestigial*. It is natural to conclude that all such variations are due to one and the same cause. But on comparing the different types we find that it is only in the horse, ruminants, swine, and the pes of carnivores that extra digits arise as *vestigial* developments; whereas, in man, the fowl, and the manus of the cat they are formed as *duplications of functional digits*.

### a. Reversion.

The theory of reversion, first proposed by Darwin to account for polydactylism in man, has been supported, and extended to all mammalian forms, by Bardeleben ('85), Albrecht ('86), Kollman ('88), Cowper ('89), and Blanc ('93). Boas ('85, '90) limits reversionary polydactylism to the horse and ox. Marsh ('92) asserts that the digital variations in the Equidae can be accounted for in no other way. Gegenbaur ('80, '88), while strongly opposed to the theory in general, admits that it may be applicable to polydactylism in the horse.

Reversion, as generally understood, is but heredity carried to an extreme in point of time. It is the inheritance by an individual of



qualities peculiar to a distant ancestor,—qualities which were once characteristic of the species, but have been lost in the evolution of varieties. Consequently, the best-authenticated instances of reversion are those in which individuals of a certain variety or breed return to the characters of the original species. Well-known examples are the reversion of domestic varieties to the character of the wild rock-pigeon; the recurrence of shoulder-stripes and a dun coloration in the horse and mule; the appearance of longitudinal stripes on the backs of young domestic swine when allowed to return to the feral state,—a coloration peculiar to the sucklings of the wild ancestors of the hog, but normally wanting in the young of the domestic pig. In these cases, which we know are reversionary, it may be observed (1) that the phenomenon is simply the return of individuals of a variety to the original characteristics of the species; (2) that the variation in such reversions relates merely to the degree of completeness with which the atavistic qualities are transmitted; monstrous conditions, or malformations, are never thus produced.

In animals in which the typical number of functional digits is normally reduced (pes of Carnivora, swine, ruminants, and Equidae), the supernumerary digits in the majority of cases are developed independently of the normal digits, but in connection with embryonic vestiges or rudiments. Is not reversion, then, the factor which is operative here, causing the development of degenerate digits, and thus tending to restore the original pentadactyle condition? The objection is raised, however, that there is *too great a distance in point of time and relationship between the polydactyle animal and the pentadactyle ancestor to which it is supposed to revert*. According to the old idea of heredity this might seem true, but in the light of Mendel's law (recently fully confirmed) it is no longer a serious objection. As pointed out by Bateson and Saunders (:02) and Castle (:03), the important facts discovered by Mendel are that a single parental character may be segregated in the *germ-cells* of the offspring, and that *one* of a pair of parental characters may regularly dominate over the other; further that each of the offspring, though exhibiting the dominant character only, produces ripe germ-cells half of which bear the dominant character of one parent, the other half, the recessive character of the other parent. Thus, if the polydactylous Dorking is crossed with the normal Leghorn, nearly all of the hybrids will be polydactylous — not quite all, however, for the extra toe in this case is not completely dominant. But continued breeding shows that the sperm and ova of the crossbreds will bear either the dominant polydactylous

character, *D*, or the normal recessive character, *R*, and that equal numbers of *D*'s and *R*'s will be produced. Offspring of the crossbreds will therefore show these characters in the following ratios:— 1 *D* : 2 *DR* : 1 *R*. But the character *D* being dominant, not only the 1 *D*'s but the 2 *DR*'s will be polydactylous and therefore only one-fourth of the chicks will have normal toes. Bateson's experiments show that this is really the case.

To us the significance of Mendel's law lies in the fact that a certain character may be transmitted pure from generation to generation of germ-cells in a latent condition; that is, the character may not appear in the structure of the animal, though present in its germ-cells.

The occurrence in a latent condition of characters which when active are dominant may thus explain the constant outcropping of these characters, such, for example, as the continual appearance of "rogues," in apparently pure races of plants and in animals which have been selectively bred for generations. The appearance of reversionary polydactylism may be explained in this way.

Although we know that in the horse, ruminants, swine, and the pes of carnivores the extra digits may be of vestigial origin, yet Gegenbaur has objected that there is no other evidence of reversion, either in the polydactyle extremity or in the general appearance of polydactyle animals.

We have shown that in polydactyle swine the abnormality is confined to the manus, and that in most, if not all, cases the extra digits represent the development of the normally vestigial pollex. In a third of the cases a well-formed digit of two or three phalanges is found, and when these conditions are compared with those of the manus of the earliest fossil swine, it appears that the two are similar; for a pollex is found in the manus of the fossil pig, while in the pes the hallux is entirely wanting. In addition to the development of the pollex, other modifications were found in the structure of the polydactyle manus, which seemed to reproduce a primitive, ancestral condition. We have also seen that in most cases of polydactylism in the ox and horse the extra digits represent the development of digital parts normally rudimentary,— a development which might be regarded as due to reversion, for other parts of the polydactyle member show correlated variations, and related fossil ancestors also have the same digits normally developed and functional. Moreover, according to recent discoveries in heredity, single segregated characters may be inherited, without general modification of the germ-plasm. This has been proved by Bateson and Saunders (:02), Castle (:03, :03<sup>a</sup>) and others in agreement with Mendel's law.

The least answerable of the arguments against the general occurrence of reversionary polydactylism is the fact that more than five digits are found in certain cases of polydactylism (man and cat), and that in other cases the extra digits, though of vestigial origin, are exceedingly variable, and often duplicated (swine and pes of Carnivora). Some factor other than reversion must enter here, unless we assume with Albrecht ('86) that the tendency to digital duplication is reversion to the bifid fin-rays of elasmobranch fishes, or with Bardeleben ('86) that the sixth and seventh digits represent reversions to a hypothetical six-toed or seven-toed ancestor. Albrecht's assumption seems absurd, for we know that such duplications are of common occurrence in the development of other structures to which his explanation of reversion cannot apply. Likewise, it has been clearly shown by various investigators that Bardeleben's "prae-pollex" theory is a mere assumption unsupported by the evidences of anatomy, embryology, or palaeontology. For (1) the "prae-pollex" rudiments never develop into digits and are not located in the region where the supernumerary digits appear in man (Förster, '61; Gegenbaur, '88; Zander, '91). (2) They are not the vestigial remains of a degenerating digit, but secondary developments, or neomorphs (Tornier, '89; Carlsson, '90; Wiedersheim, '02). (3) The most primitive reptilian fossils (the Ichthyopterygia) possess only five digits (Baur, '87). The "prae-pollex" theory is thus rightly rejected by such eminent anatomists as Gegenbaur and Wiedersheim. With it, as a consequence, must go the assumption that polydactylism in pentadactyle extremities is a reversion to a heptadactyle type.

In comparing the skeletal parts of the polydactylous manus shown in Figure 13 (Plate 5) and in Figure *K* with the normal and fossil conditions (Figs. *F* and *G*), no one can doubt that reversion is the true cause of such abnormalities. The same conclusion holds true for a fully formed hallux in the dog and for the cases of vestigial polydactylism in the horse and ruminants. It seems probable, however, from the variations which we have described in swine, that the character of digits produced by reversion is not firmly fixed in the germ, and that on crossing with normal animals, the abnormal character, since it is dominant in Mendel's sense of the word, is transmitted to the offspring, but in different degrees of variation and duplication. Experimental breeding may settle this question, but at present we can only argue from analogy with other forms. Thus, Bateson found that the extra digits of the fowl varied greatly on crossbreeding. But in the case of the fowl the extra digits are sports, not palingenetic structures.

We have suggested the possibility that a factor in the production of polydactylism in man, the cat, and the fowl may be reversion, *not* to a hypothetical heptadactyle ancestor, but to the unmodified minimus, pollex or hallux of a not distantly related pentadactyle form. The re-acquired structures might prove to be in their germinal characters, like those of many neomorphs, so unstable as to lead to variations in the next generation, such as polydactylous duplications.

We have evidence to show that in man, the cat, and the fowl it is *not a definite number of extra digits, but a tendency to digital variation and duplication* which is inherited. In man the minimus may be duplicated on all extremities, but to a different degree in each case, and the variations may increase in succeeding generations. Thus, Fackenheim ('88) cites the case of normal parents whose daughter had a rudimentary sixth finger on the ulnar side of each hand. Of her two sons, one had six fully developed digits on each hand, the other six digits *on all four extremities!* In another family the first parent observed had six toes on each foot. Of eight children three were normal, three had six toes (in one case correlated with hare-lip), and two had six fingers; all the extra digits were of symmetrical occurrence. In the three succeeding generations extra digits appeared *now on the feet, now on the hands*, and in two cases *on all four extremities*. In two cases also, *seven toes* were present on one or both feet.

In a family of cats observed by Poulton ('86) the abnormality appeared in the third generation (number of extra digits not stated). In the fourth generation six toes appeared on all four extremities. In the fifth generation there *were many individuals with seven* toes on all paws, and evidences of further duplication in the existence of doubled claws. All gradations occurred between the extreme and normal form. This condition prevailed up to the ninth generation, although in every case the male parent was normal.

Torrey (:02) describes a similar case in which the offspring of a female cat with six toes on the manus and five on the pes showed all gradations between the normal and a seven-toed condition. Often in these cats the pollex was *abnormally long and composed of three phalanges* instead of two. In all cases digits II-V were apparently normal in structure.

Bateson's breeding experiments show the same to be the case in the polydactylous fowl. On crossing with normal birds all degrees of variation are exhibited by the hallux, from simple elongation to complete duplications and reduplications.

These observations bring out the important fact that often *no extra*

*digit is produced*, but simply a *variation in the structure of the pollex, hallux, and minimus*. It would seem, therefore, that it is this tendency of the modified digits to vary which is inherited.

We know that such digital variations occur also in the offspring of normal individuals, and that they are inherited. Bateson cites the occurrence of such a case in cattle and the formation of a three-toed race thereby. The duplication of appendages is common in the lower animals, and variation is of frequent occurrence in all neomorphic organs. Well-known examples are the duplicated claws of arthropods and the doubled horns of sheep. Polydactylism according to Fackenheim ('88) is often correlated with abnormality by defect.

None of these variations can be attributed to reversion. The law of Mendel, as Bateson and Saunders (:02, p. 150) have pointed out, "applies only to the manner of transmission of a character already existing. It makes no suggestion as to the manner in which such a character came into existence." Bateson regards the polydactyle fowl as "a palpable sport;" the usual digital abnormalities of the fowl, the cat, and of man undoubtedly belong to the same class of polydactylous abnormalities. It is possible that reversion may be the *primal* cause in producing certain of these digital variations, but the present evidence does not warrant a positive statement to that effect.

#### *b. Germinal Variation.*

This has been regarded as the chief factor in polydactylism by Förster ('61), Darwin ('76), Gegenbaur ('80), Howes ('92), Weismann ('93), Bateson ('94), Wilson ('96), and many others. Weismann's view ('93, p. 329) is, that excessive nutrition in the cells of the embryo may cause the duplication of a group of determinants which are to form a particular digit; the doubled condition of the determinants might then be inherited, and thus the inheritance of these digital abnormalities accounted for. This, however, does not explain the changes in position which digital variations in man may undergo in the course of hereditary transmission (that is, from fingers to toes). Wilson ('96) attempts to clear up this point by assuming that there may be variation in those determinants which affect the nutrition of the digital fundament, and that it is the tendency of these determinants to vary which is transmitted, rather than the doubled condition of the digital determinants themselves.

There is some direct evidence that germinal variation is due to an excess of nutrition. It has been observed by Ercolani ('81) and Boas ('85, '90) that certain polydactyle conditions in the ox and horse

occurred along with the atrophy, partial or complete, of the functional digits, which apparently caused the subsequent development of the normally rudimentary ones. In these instances it would seem that the nutriment which is normally appropriated by the functional digits is transferred to, and utilized by, the digital rudiments, thus enabling them to continue their development. We are familiar with the same phenomenon in plants, where, if the terminal bud is removed, lateral buds, which would otherwise have remained dormant, are stimulated to development by the extra supply of nutriment which they receive. Again, polydactylism very often accompanies acephalic conditions, and other abnormalities due to defect of some organ, as recorded by Fackenheim and others. Here the same law is applicable; on account of the abnormal absence of certain organic fundamentals, the remaining ones receive more than their usual amount of nutrition; as a result, an increased development of normally reduced or otherwise modified digits may be brought about. But these cases of polydactylism may also be explained as due to external influences acting *in utero*. Fackenheim has shown that in a certain family polydactylism did not appear as a correlative of inherited abnormality by defect, until one of its members married into another family in which digital abnormalities were of frequent occurrence. Then only did offspring appear afflicted with both polydactylism and defective teeth. From such cases the evidence that excess of nutriment causes germinal variation loses much of its weight.

Any explanation of the phenomena of germinal variation must necessarily be theoretical, as long as our practical knowledge of the germ-plasm is so limited. We know, however, that all neomorphs are prone to variation. In polydactylism all the digital abnormalities produced by internal causes vary greatly, and the tendency to variation is inherited. By Mendel's law the inheritance of these variations is explained, and the puzzling point which Wilson ('96) attempted to clear up by his theory of nutritive variation, is made plain,—the fact that in man an individual having a polydactyle manus may produce offspring with abnormal pes or with all extremities abnormal. In this case we may assume that the variation first appeared on all extremities as a duplication of the minimum, due to the doubling of the determinants of these digits. On marrying with a normal individual the abnormal character would be dominant, but not completely so (Bateson found this to be the case with the polydactyle fowl). Of the *DR* offspring produced, some would be abnormal like the *D* parent, but in others the usually dominant character might be recessive; their extremities might be entirely normal, or only

the hands polydactyle. In either case, however, they would be capable of producing other *DR* offspring, if married to normal individuals, and these offspring might themselves be normal or polydactyle; should they marry with recessive individuals like themselves, pure *D*'s would be produced as well as *RD*'s, and such individuals again would be polydactyle on both hands and feet. Wilson's theory of nutritive variation is thus rendered unnecessary, as Mendel's law explains how all cases of polydactylism, not due to external causes, may be the result of inheritance.

All such inherited types of polydactylism are thus ancestral. But only those forms in which the extra digits develop directly from rudiments and vestiges may be attributed to palingenetic reversion. In those cases in which digital rudiments and vestiges are duplicated, reversion and germinal variation may occur together; but the duplications of functional digits are probably caused by germinal variation alone. As to the cause of these germinal variations, or sports, we know little or nothing.

#### IX. Summary.

1. Polydactylism consists in an excess in the number of digits possessed by the individual over the number peculiar to the species.

2. The supernumerary digits generally occur symmetrically placed on the right and left extremities, either in the manus, in the pes, or in both; they are found most frequently in the manus.

3. The extra digits are formed most frequently in connection with the fifth and first digit in man; with the first digit in the fowl, Carnivora, and swine; with the second digit in ruminants and the Equidae. In general, *polydactylism may be said to affect digits which are normally much reduced or modified.*

4. Cases of polydactylism in which more than five digits occur cannot be attributed to reversion alone (a heptadactyle ancestor is hypothetical, the so-called prae-pollex and post-minimus are rudiments of secondary development, and they have never been known to produce functional digits).

5. Palingenetic polydactylism is limited to those forms in which — the number of functional digits being normally reduced to fewer than five — the digital rudiments develop and reproduce, more or less completely, the structure of homologous digits typical of some ancestral form. The evidences of comparative anatomy, embryology, and palaeontology show this to be the case in the horse, ruminants, and swine; possibly in the pes of Carnivora.

6. This eventual dominance of a digital character, which has been

transmitted in a recessive condition through many generations, is in strict accordance with Mendel's law of heredity.

7. Neogenetic and palingenetic forms of polydactylism are, like other new characters, extremely variable ; as they are hereditary, we may conclude that duplications of both functional and vestigial digits are due to variations in the gametes.

8. The polydactyle abnormalities of man and the domestic animals may be classified as follows :

I. *Teratological polydactylism* includes those cases of digital duplication and malformation which are produced by external influences ; it occurs rarely in all animals, often in correlation with other monstrosities.

II. *Neogenetic polydactylism* includes those digital variations, or sports, which are produced by some internal cause, presumably germinal variation.

*a.* Duplication of *unmodified* functional digits occurs occasionally in all animals and is transmissible.

*b.* Variation of *modified* but functional digits is the ordinary form of polydactylism in man, the cat, and the fowl (pes), and it also is transmissible.

III. *Palingenetic polydactylism* includes those cases in which digital rudiments, or vestiges, develop into extra digits.

*a.* The extra digits reproduce more or less completely the structure of the homologous functional digits of related fossil ancestors ; this condition is found in the horse, ruminants, swine, and the pes of the dog.

*b.* The extra digits arise as variations or duplications of rudiments, or vestiges ; they are neogenetic in so far as they do not reproduce ancestral conditions. Examples are the hallux and pollex having three phalanges and the various duplications of these digits found in the manus of swine and the pes of Carnivora.



## BIBLIOGRAPHY.

Ahlfeld, F.

- '85-86. Die Verwachsungen des Amnion mit der Oberfläche der Frucht. Berichte u. Arbeit. geburtshilflich-gynäkolog. Klinik zu Marburg, Bd. 3, pp. 158-165.

Albrecht, [P.]

- '86. Ueber den morphologischen Werth überzähliger Finger und Zehen. Centralbl. f. Chirurg., Jahrg. 1886, Beilage zu Nr. 24, pp. 105-107.

Anthony, R.

- '99. Étude sur la Polydactylie chez les Gallinacés. (Poulet domestique.) Journ. d. l'Anat. et Physiol., tom. 35, pp. 711-750, 25 fig.

Arloing, S.

- '67. Contribution à l'étude de l'organisation du pied chez le cheval. Ann. des Sci. Nat., sér. 5, tom. 8, pp. 55-81, 2 pl.

Bardeleben, K.

- '85. Zur Morphologie des Hand- und Fuss skelets. Sitzungsber. d. Jena. Gesell. f. Med. u. Naturw. für das Jahr 1885, pp. 84-88.

Bardeleben, K.

- '85<sup>a</sup>. Ueber neue Bestandteile der Hand- und Fusswurzel der Säugethiere, so wie die normale Anlage von Rudimenten "überzähliger" Finger und Zehen beim Menschen. Sitzungsber. d. Jena. Gesell. f. Med. u. Naturw. für das Jahr 1885, pp. 149-164.

Bardeleben, K.

- '86. Hand und Fuss. Tagebl. d. 59. Versamml. deutscher Naturf. u. Aerzte zu Berlin, Jahrg. 1886, pp. 96-102.

Bateson, W.

- '94. Materials for the Study of Variation; treated with especial Regard to Discontinuity in the Origin of Species. xv + 598 pp., 209 fig. London and New York.

Bateson, W., and Saunders, E. R.

- :02. Experimental Studies in the Physiology of Heredity. Reports to the Evolution Committee of the Royal Society. Report I, 160 pp. London.

Baumüller, B.

- '92. Polydactylie beim Reh. Abh. naturhist. Gesell. zu Nürnberg., Bd. 9, pp. 51-71, 1 Taf.

Baur, G.

- '87. On the Morphology and Origin of the Ichthyopterygia. Amer. Naturalist, Vol. 21, pp. 837-840.

Blanc, L.

- '93. Étude sur la Polydactylie chez les Mammifères. Ann. Soc. Linn. Lyon, tom. 40, pp. 53-88, 29 fig.

Boas, J. E. V.

- '85. Bemerkungen über die Polydactylie des Pferdes. Morph. Jahrb., Bd. 10, pp. 182-184.

Boas, J. E. V.

- '90. Ein Fall von vollständiger Ausbildung des 2. und 5. Metacarpale beim Rind. Morph. Jahrb., Bd. 16, pp. 530-533, 2 fig.

Carlsson, A.

- '90. Von den weichen Theilen des sogenannten Präpollex und Prähallux. Eine vorläufige Mittheilung. Verh. d. Biol. Vereins in Stockholm, Bd. 2, No. 8, pp. 117-124.

Castle, W. E.

- :03. Mendel's Law of Heredity. Proceed. Amer. Acad. Arts and Sci., Vol. 38, No. 18, pp. 533-548.

Castle, W. E.

- :03<sup>a</sup>. The Heredity of Sex. Bull. Mus. Comp. Zool., Harvard Coll., Vol. 40, No. 4, pp. 187-218.

Chauveau, A., et Arloing, S.

- '79. Traité d'anatomie comparé des animaux domestiques. 3<sup>me</sup> ed., Paris. 1036 pp., 406 fig.

Cowper, J.

- '89. On Hexadactylism. With especial Reference to the Signification of its Occurrence in a Variety of Gallus domesticus. Journ. Anat. and Physiol., Vol. 23, pp. 242-249, 2 fig.

Dareste, C.

- '91. Recherches sur la production artificielle des monstruosités: ou, Essais de tératogénie expérimentale, 2<sup>e</sup> éd. xvi + 590 pp., 16 pl.

Darwin, C.

- '76. The Variation of Animals and Plants under Domestication. 2d ed., revised. New York. 2 vols. xiv + 473; x + 495 pp.

Ercolani, G.

- '81. Della polidactilia e della polimelia nell' uomo e nei vertebrati. Mem. Accad. Sci. Istit. Bologna, ser. 4, tom. 3, pp. 727-824, tav. 1-4.

**Ewart, J. C.**

- '94. The Development of the Skeleton of the Limbs of the Horse, with Observations on Polydactyly. *Journ. Anat. and Physiol.*, Vol. 28, pp. 236-256, 342-369, 25 fig. and pl. 12.

**Fackenheim, J.**

- '88. Ueber einen Fall von hereditärer Polydactylie mit gleichzeitig erblicher Zahnanomalie. *Jena. Zeitschr.*, Bd. 22, pp. 343-385, 7 Abbildungen.

**Förster, A.**

- '61. Die Missbildungen des Menschen. *Jena.* iv + 171 pp., 26 Taf.

**Gegenbaur, C.**

- '80. Kritische Bemerkungen über Polydactylie als Atavismus. *Morph. Jahrb.*, Bd. 6, pp. 584-596.

**Gegenbaur, C.**

- '88. Ueber Polydactylie. *Morph. Jahrb.*, Bd. 14, pp. 394-406.

**Geoffroy-St. Hilaire, I.**

- '32-37. Histoire générale et particulière des Anomalies de l'organisation chez l'homme et les animaux, etc. 3 tom. Paris. xv + 746; 571; 618 + xx pp., avec Atlas, 20 pl.

**Goodman, N.**

- '68. On a Three-toed Cow. *Journ. Anat. and Physiol.*, Vol. 2, pp. 109-113.

**Gurlt, E. F.**

- '77. Thierische Missgeburten. Ein Beitrag zur pathologischen Anatomie und Entwicklungsgeschichte. Berlin. 97 pp., 20 Taf.

**Howe, F., Jr.**

- :02. A Case of Abnormality in Cats' Paws. *Amer. Nat.*, Vol. 36, pp. 511-526, 18 fig.

**Howes, G. B.**

- '92. On the Pedal Skeleton of the Dorking Fowl, with Remarks on Hexadactylism and Phalangeal Variation in the Amniota. *Journ. Anat. and Physiol.*, Vol. 26, pp. 395-403, 5 fig.

**Kollman, J.**

- '88. Handskelett und Hyperdactylie. *Verh. Anat. Gesell.* 2te Versam. in Würzburg, 1888, pp. 25-40, 1 Taf.

**Kowalevsky, W.**

- '73. On the Osteology of the Hyopotamidae. *Phil. Trans. London*, Vol. 163, Pt. 1, pp. 19-94, pl. 35-40.

**Kükenthal, W.**

- '89-93. Vergleichend-anatomische und entwicklungsgeschichtliche Untersuchungen an Walthieren. *Denkschr. med.-naturw. Gesell. zu Jena*, Bd. 3, 8 + 448 pp., 25 Taf. u. 124 Abbild.

**Marsh, O. C.**

'79. Polydactyle Horses Recent and Extinct. Amer. Journ. Sci. and Arts, ser. 3, Vol. 17, pp. 499-505, 4 fig., 1 pl.

**Marsh, O. C.**

'92. Recent Polydactyle Horses. Amer. Journ. Sci. and Arts, ser. 3, Vol. 43, pp. 339-355, 21 fig., 1 pl.

**Mendel, G.**

'66. Versuche über Pflanzen-Hybriden. Verh. naturf. Vereines in Brünn, Bd. 4, Abhandl., pp. 3-47.

**Morand, [S. F.]**

1773. Recherches sur quelques conformations monstrueuses des doigts dans l'homme. Mém. Acad. Roy. Sci., Paris, pour l'année 1770, pp. 137-150, pl. 4-12.

**Otto, A. W.**

'41. Monstrorum sexcentorum descriptio anatomica. xx + 335 pp., 30 tab. Vratislaviense.

**Poulton, E. B.**

'83. Observations on Heredity in Cats with an Abnormal Number of Toes. Nature, Vol. 29, pp. 20-21, 8 fig.

**Poulton, E. B.**

'86. Observations on Heredity in Cats with an Abnormal Number of Toes. Nature, Vol. 35, pp. 38-41, 8 fig.

**Pütz, H.**

'89. Eine überzählige Zehe bei einem Pferde. Deutsch. Zeitschr. f. Thiermedizin, Bd. 15, pp. 224-232, Taf. 5.

**Rosenberg, A.**

'73. Ueber die Entwicklung des Extremitäten-Skeletes bei einigen durch Reductionen ihrer Gliedmassen characterisirten Wirbelthieren. Zeitschr. f. wiss. Zool., Bd. 23, pp. 116-166, Taf. 5-7.

**Scott, W. B.**

'95. The Structure and Relationships of Ancondus. Journ. Acad. Nat. Sci., Philadelphia, ser. 2, Vol. 9, Pt. 4, pp. 461-497, pl. 23, 24.

**Struthers, J.**

'63. On the Solid-hoofed Pig; and on a Case in which the Fore Foot of the Horse presented Two Toes. Edinb. New Phil. Journ., New Ser., Vol. 17, pp. 273-280, 2 fig.

**Struthers, J.**

'63<sup>a</sup>. On Variation in the Number of Fingers and Toes, and in the Number of Phalanges, in Man. Edinb. New Phil. Journ., New Ser. Vol. 18, pp. 83-111, pl. 2.

Suetonius (Caius Suetonius Tranquillus).

- '86. *De vita Caesarum*. (C. von Roth) Lipsiac. civ + 357 pp.  
[Original appeared about the year 120 A.D.]

Tornier, G.

- '89. Gibt-es ein Prähallux-rudiment? *Sitzungsber. Gesell. naturf. Freunde zu Berlin*, Jahrg. 1889, pp. 175-182, 1 Fig.

Torrey, H. B.

- :02. Prepotency in Polydactylous Cats. *Science*, N. S., Vol. 16, pp. 554-555.

Verrier, E.

- '85. Des anomalies symétrique des doigts et du rôle que l'on pourrait attribuer à l'atavisme dans ces anomalies. *Compt. Rend. Acad. Sci.*, Paris, tom. 100, pp. 865-867.

Weismann, A.

- '93. *The Germ-Plasm. A Theory of Heredity*. Translated by W. N. Parker. xxii + 477 pp., 24 fig., New York.

Werner, T.

- '97. Polydactylie beim Schwein. *Sitzungsber. Gesell. naturf. Freunde zu Berlin*, Jahrg. 1897, pp. 47-48.

Wiedersheim, R.

- :02. *Der Bau des Menschen als Zeugniß für seine Vergangenheit*. 3te Aufl., Freiburg, i. B. 243 pp., 132 fig.

Wilson, G.

- '96. Hereditary Polydactylism. *Journ. Anat. and Physiol.*, Vol. 30, pp. 437-449, 2 fig.

Windle, B. C. A.

- '91. The Occurrence of an Additional Phalanx in the Human Pollex. *Journ. Anat. and Physiol.*, Vol. 26, pp. 100-116, pl. 2.

Winter, G. S.

1703. *Tractatio nova et auctior de re equaria*. Nürnberg, 14 + 223 pp., 34 tab.

Wood-Mason, J.

- '71. [A case of Polydactylism in a Horse.] *Proceed. Asiat. Soc. Bengal*, 1871, pp. 18, 19, pl. 1.

Zander, R.

- '91. Ist die Polydactylie als theromorphe Varietät oder als Missbildung anzusehen? *Arch. f. path. Anat.*, Bd. 125, pp. 453-487.

## EXPLANATION OF PLATES.

THE figures are all reproduced from natural size skiagraphs of the polydactyle specimens; in every plate the distal ends of the extremities are down, but right and left are reversed. Right extremities therefore appear as left in the figures, and *vice versa*.

## ABBREVIATIONS.

<i>asg.</i> . . . .	Astragalus.	<i>flx. perf.'</i> . . .	Flexor perforans.
<i>cac.</i> . . . .	Calcaneum.	<i>lun.</i> . . . .	Lunar.
<i>cub.</i> . . . .	Cuboid.	<i>ms'cun.</i> . . . .	Mesocuneiform.
<i>cun.</i> . . . .	Cuneiform.	<i>mt'carp.</i> . . . .	Metacarpal.
<i>ec'cun.</i> . . . .	Ectocuneiform.	<i>mt'tar.</i> . . . .	Metatarsal.
<i>en'cun.</i> . . . .	Entocuneiform.	<i>nav.</i> . . . .	Navicular.
<i>ext. com. dg. i.</i> . .	Extensor communis digitorum internus.	<i>n. m.</i> . . . .	Median nerve.
<i>ext. mt'carp. mag.</i>	Extensor metacarpi magnus.	<i>n. uln.</i> . . . .	Ulnar nerve.
<i>ext. mt'carp. ob.</i>	Extensor metacarpi obliquus.	<i>os. mag.</i> . . . .	Os magnum.
<i>ext. prp.</i> . . . .	Ext. proprius pollicis et indicis.	<i>phlx.</i> . . . .	Phalanx.
<i>ext. prp. ex.</i> . . .	Extensor proprius ex- ternus.	<i>pis.</i> . . . .	Pisiform.
<i>ext. prp. i.</i> . . .	Extensor proprius in- ternus.	<i>scph.</i> . . . .	Scaphoid.
<i>flx. perf.</i> . . . .	Flexor perforatus.	<i>trz.</i> . . . .	Trapezium.
		<i>trzd.</i> . . . .	Trapezoid.
		<i>un.</i> . . . .	Unciform.
		<b>I-V</b> . . . .	First to fifth digits.
		<b>1-5</b> . . . .	First to fifth branches of the median nerve.

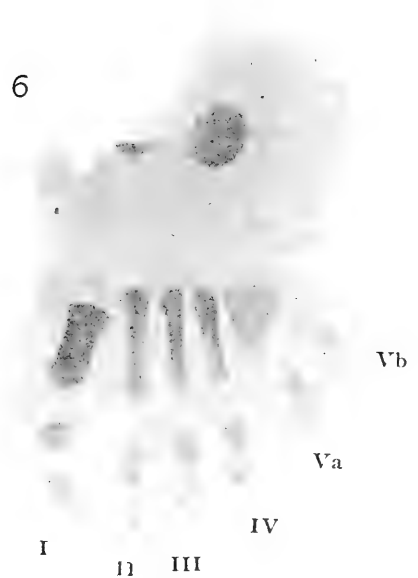
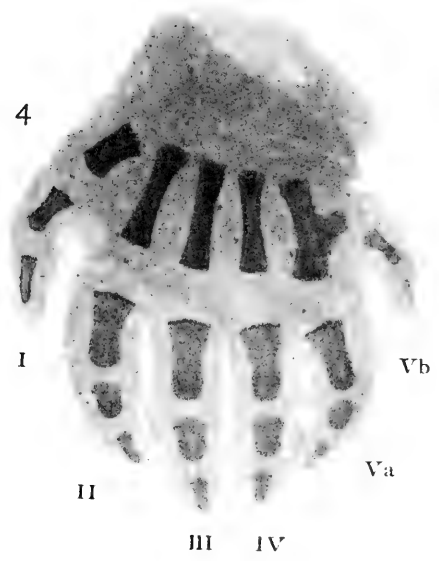
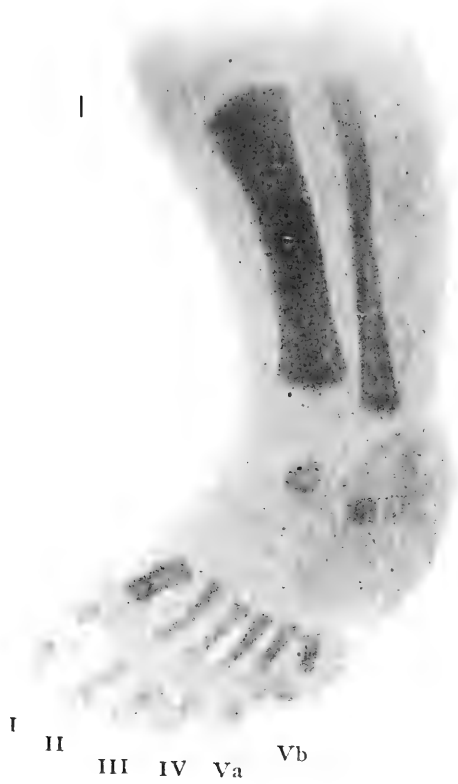


PLATE 1.

All figures are skiagraphs of human appendages.

- FIG. 1. Right foot of foetus, No. 6730.
- FIG. 2. Left foot of foetus, No. 6730.
- FIG. 3. Left hand of foetus, No. 912.
- FIG. 4. Right hand of foetus, No. 912.
- FIG. 5. Left foot of foetus, No. 912.
- FIG. 6. Right foot of foetus, No. 912.







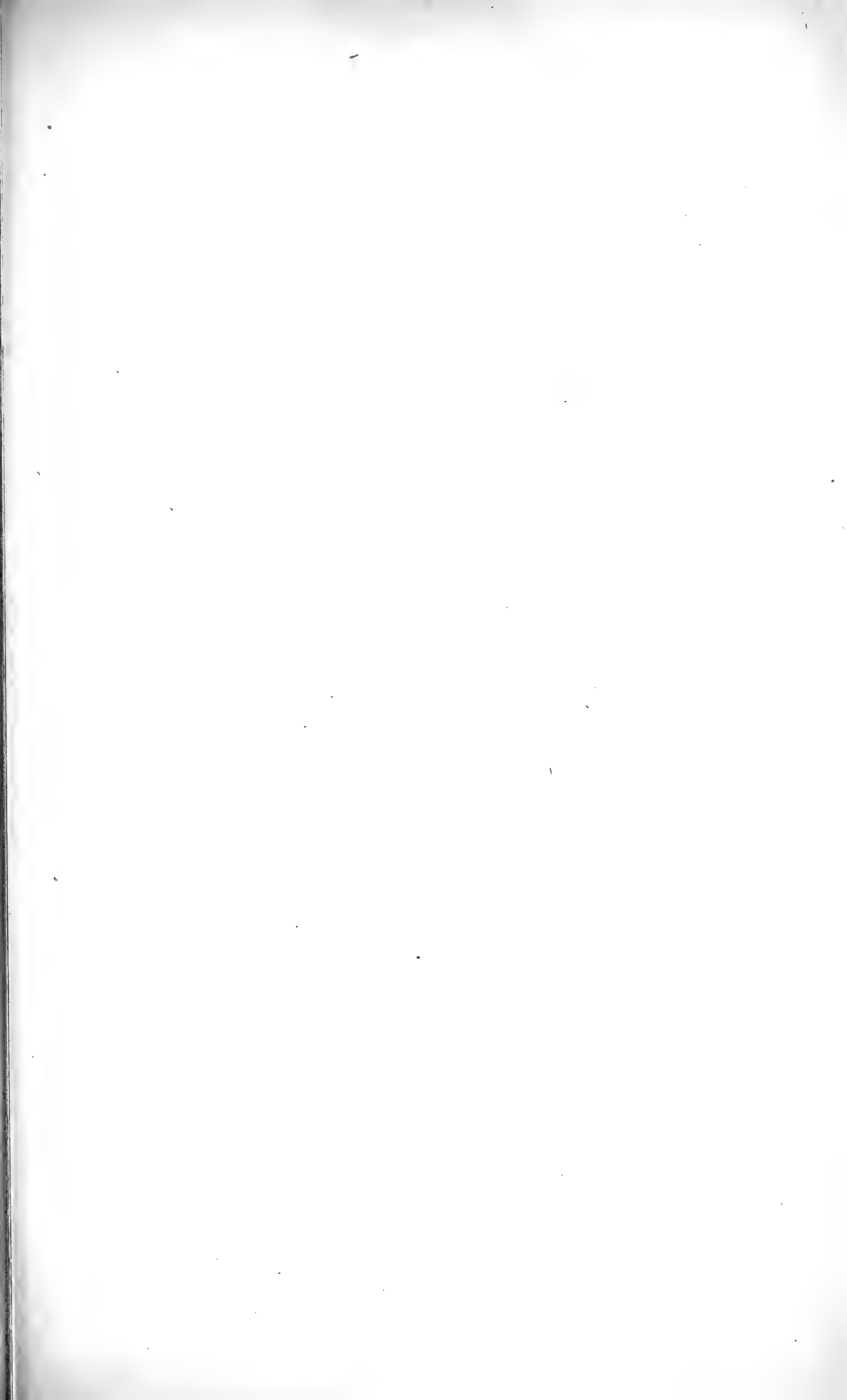


PLATE 2.

All figures are from skiagraphs of human foetal appendages.

- FIG. 7. Left hand of foetus, No. 5809.  
FIG. 8. Right hand of foetus, No. 5809. NOTE. — The metacarpal mentioned in the text (p. 254) has failed of reproduction in the printing of this plate.  
FIG. 9. Right hand of foetus, No. 913.  
FIG. 10. Left foot of foetus, No. 913.

7

Vb

Va

IV III II

I

8

I

II

III

IV

Va

Vb

9

Vb

Va

IV

III

I

II

10

Vb

Va

IV

III

II

I



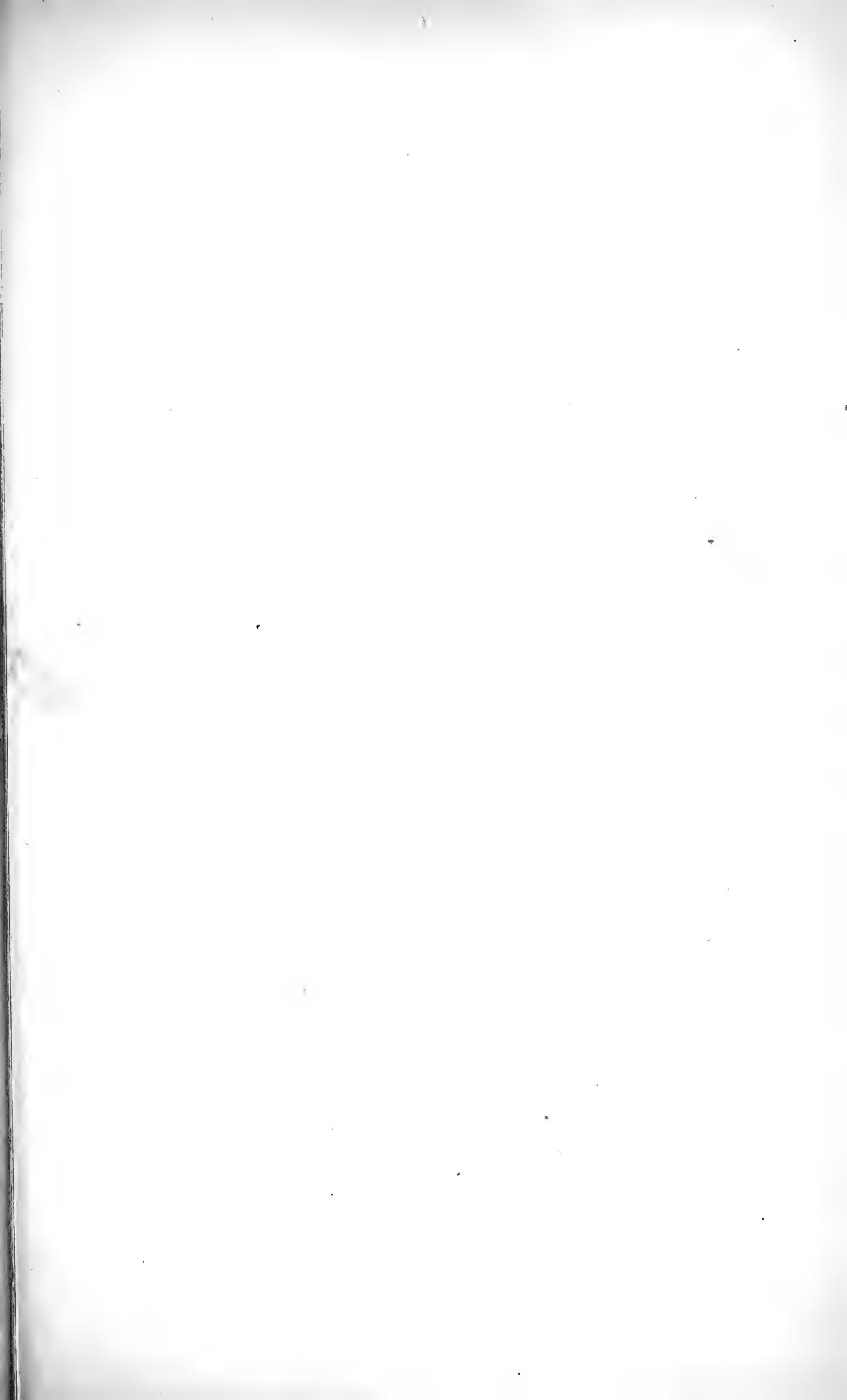


PLATE 3.

FIG. 11. Normal left manus of the pig, anterior view, showing skeletal structure of the digits.



II.



II

V

IV

III



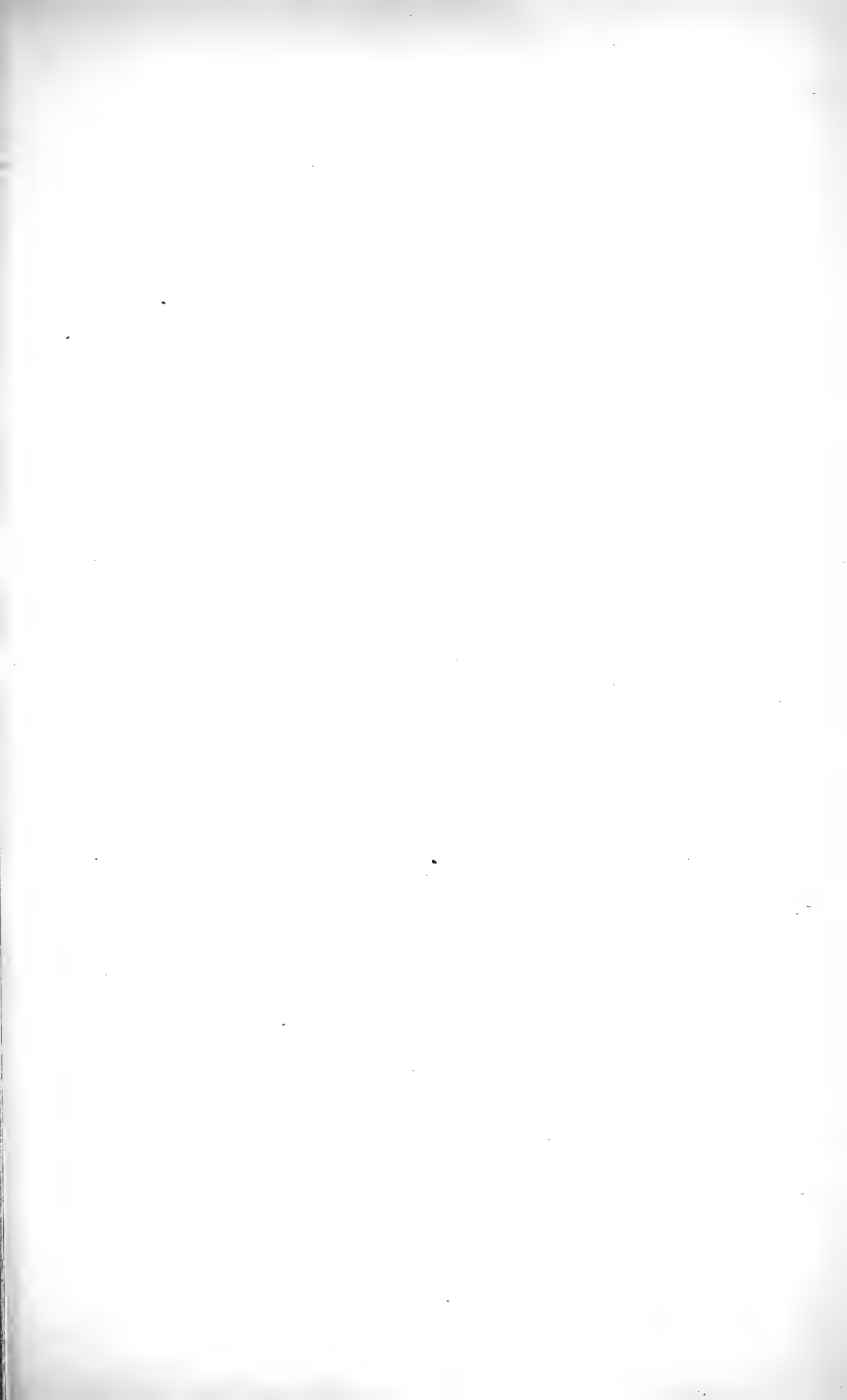
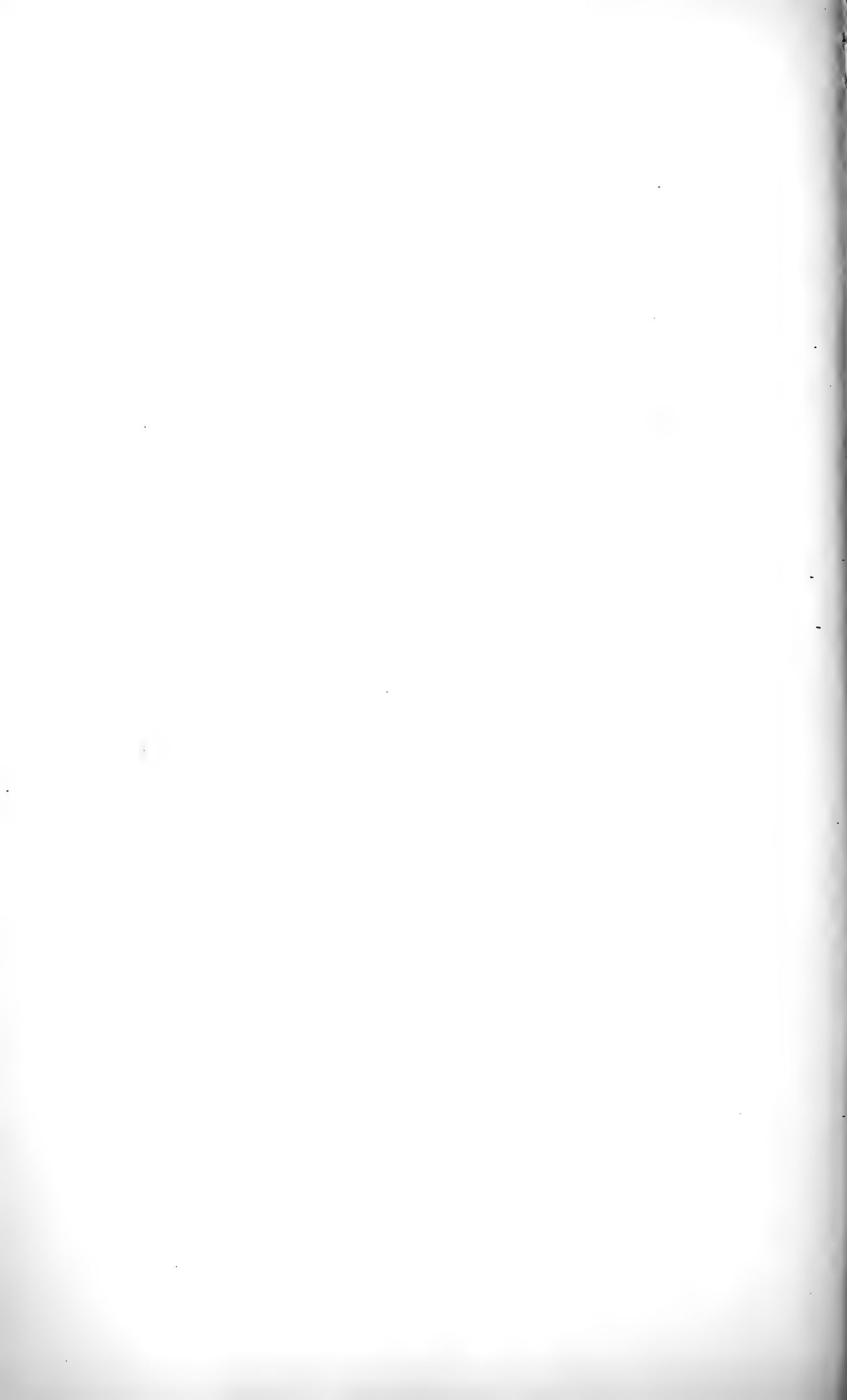


PLATE 4.

FIG. 12. Anterior view of left polydactyle manus of the pig, showing a small supernumerary digit (1) and the lower row of carpals.





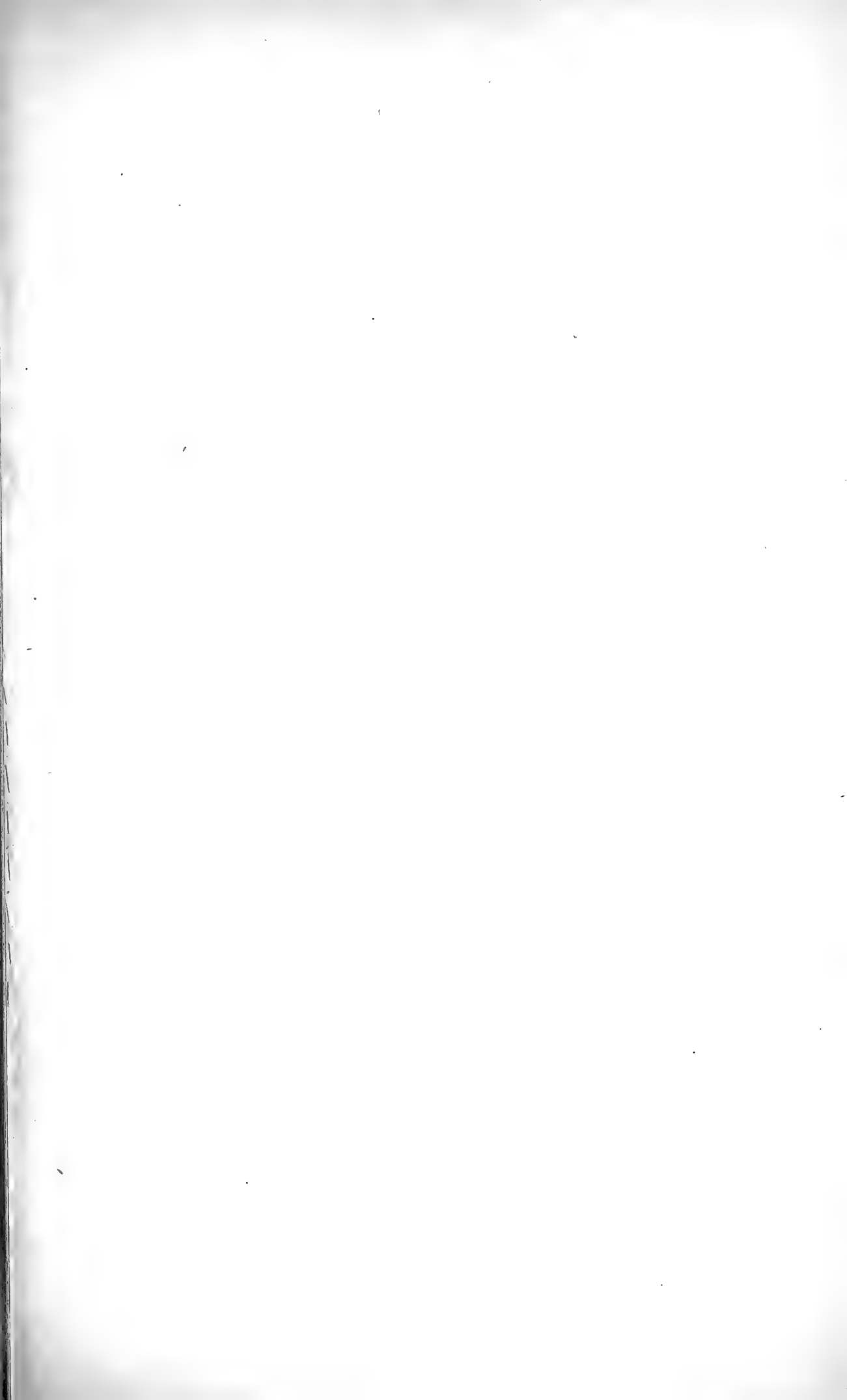


PLATE 5.

FIG. 13. Anterior view of the left polydactyle manus of the pig, showing a fully developed pollex (1) and the bones of the carpus.









PLATE 6.

FIG. 14. Anterior view of left polydactyle manus of the pig with one supernumerary digit (I), and digit II abnormally large.

14.

*trad.*

*trz.*



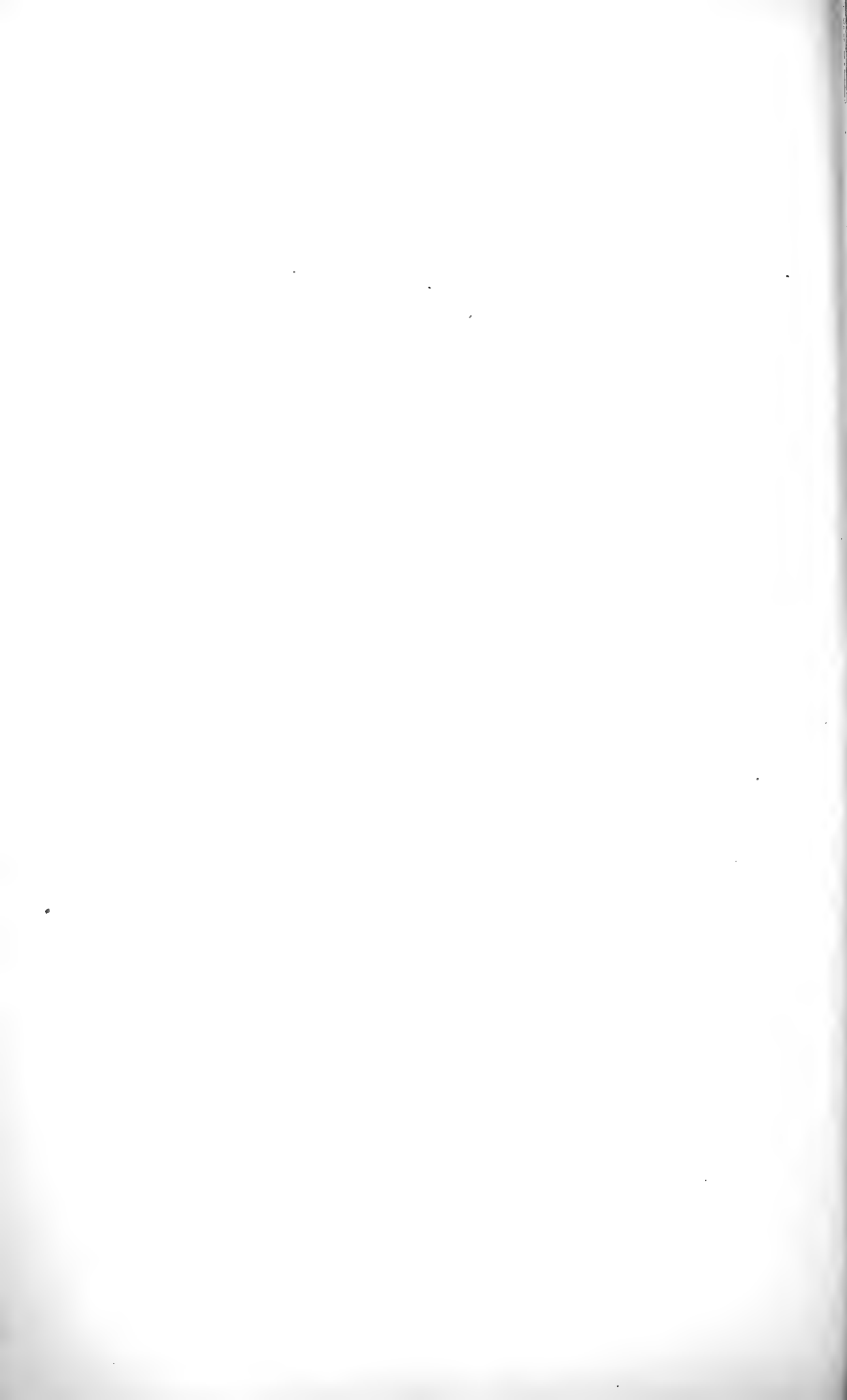
V

I

IV

III

II



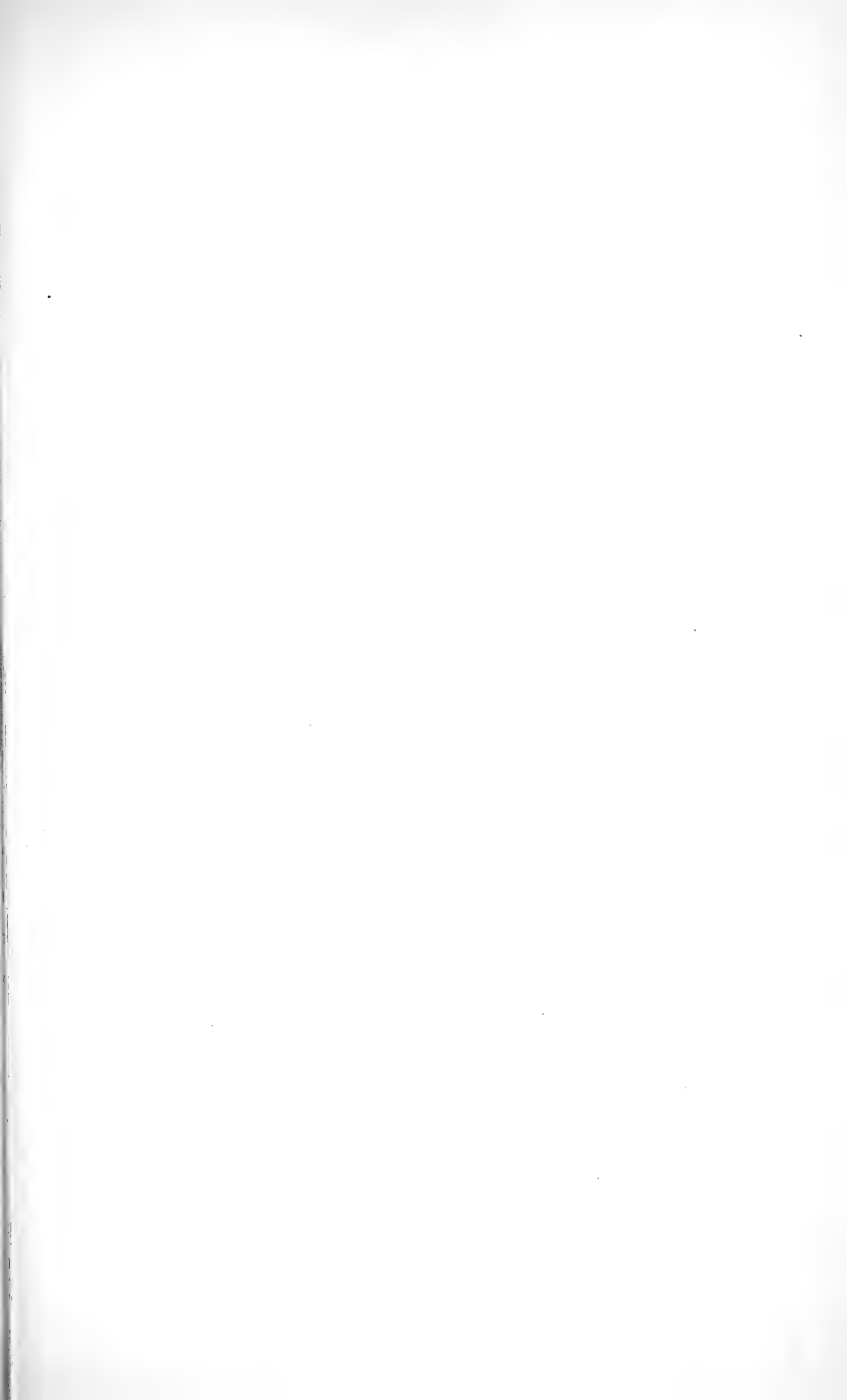
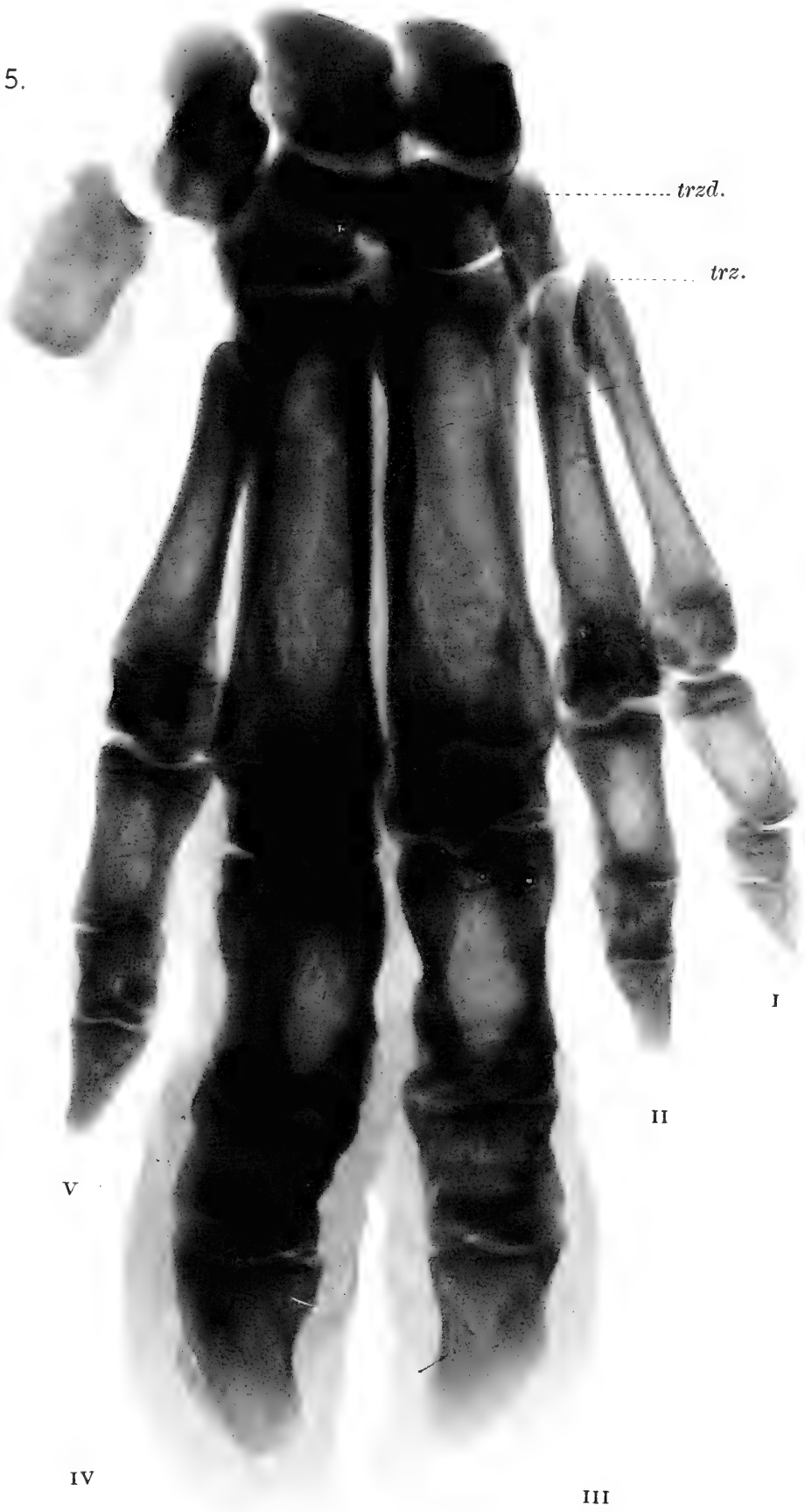


PLATE 7.

FIG. 15. Anterior view of the left polydactyle manus of the pig, showing a supernumerary digit (1), to the proximal end of which the trapezium is fused.



15.





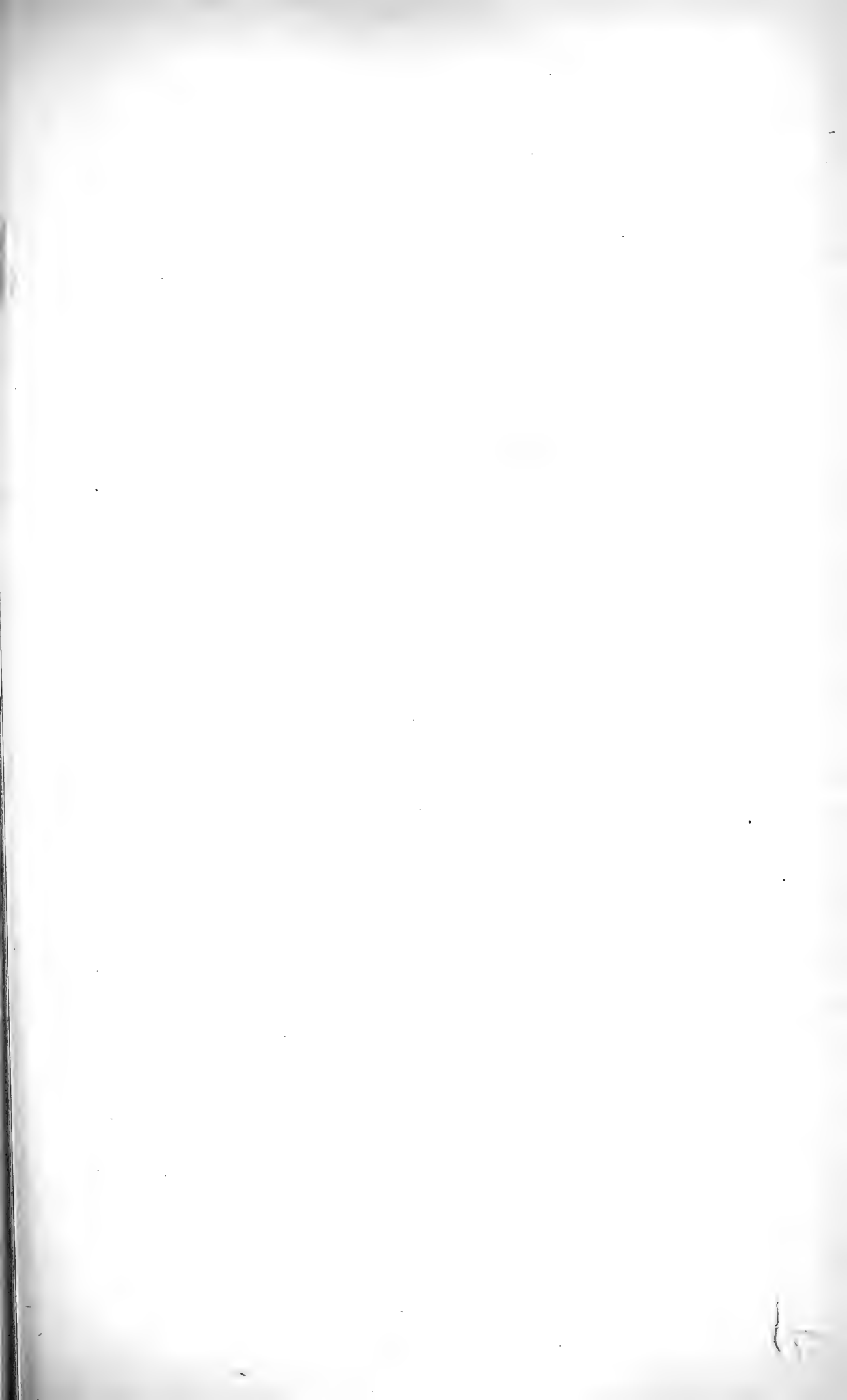


PLATE 8.

FIG. 16. Anterior view of the left manus of a polydactyle pig, showing the lower row of carpals, a supernumerary digit (I), and digit (II) abnormally developed.

16.

*trzd.*

*trz.*







PLATE 9.

FIG. 17. Anterior view of the left manus of a polydactyle pig, showing the lower row of carpals and a large supernumerary digit (1).



*trzd.*

*trz.*

17.



V

II

I

III

IV



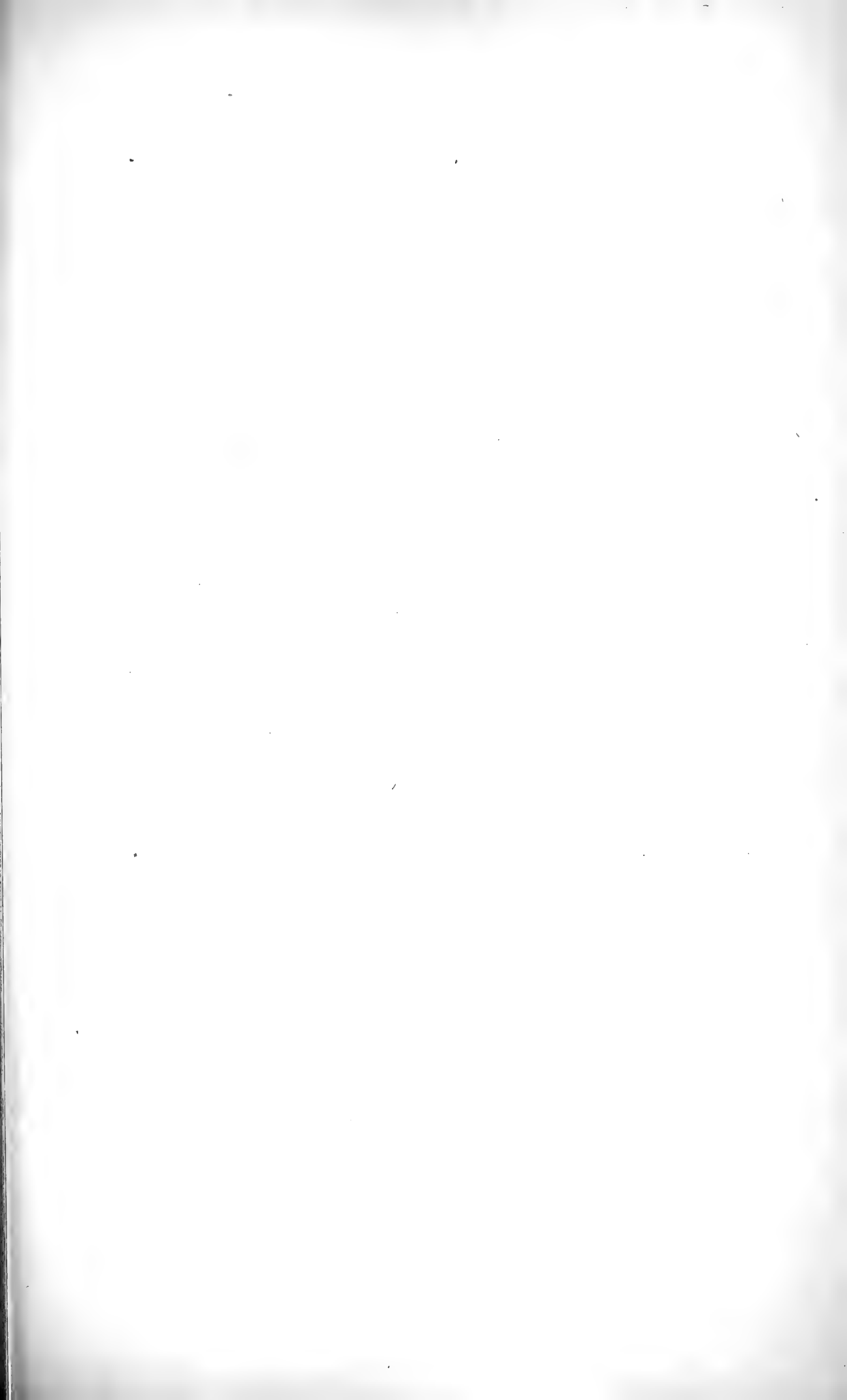


PLATE 10.

FIG. 18. Anterior view of the right manus of a polydactyle pig, showing the lower row of carpals and two supernumerary digits borne on metacarpal 1.



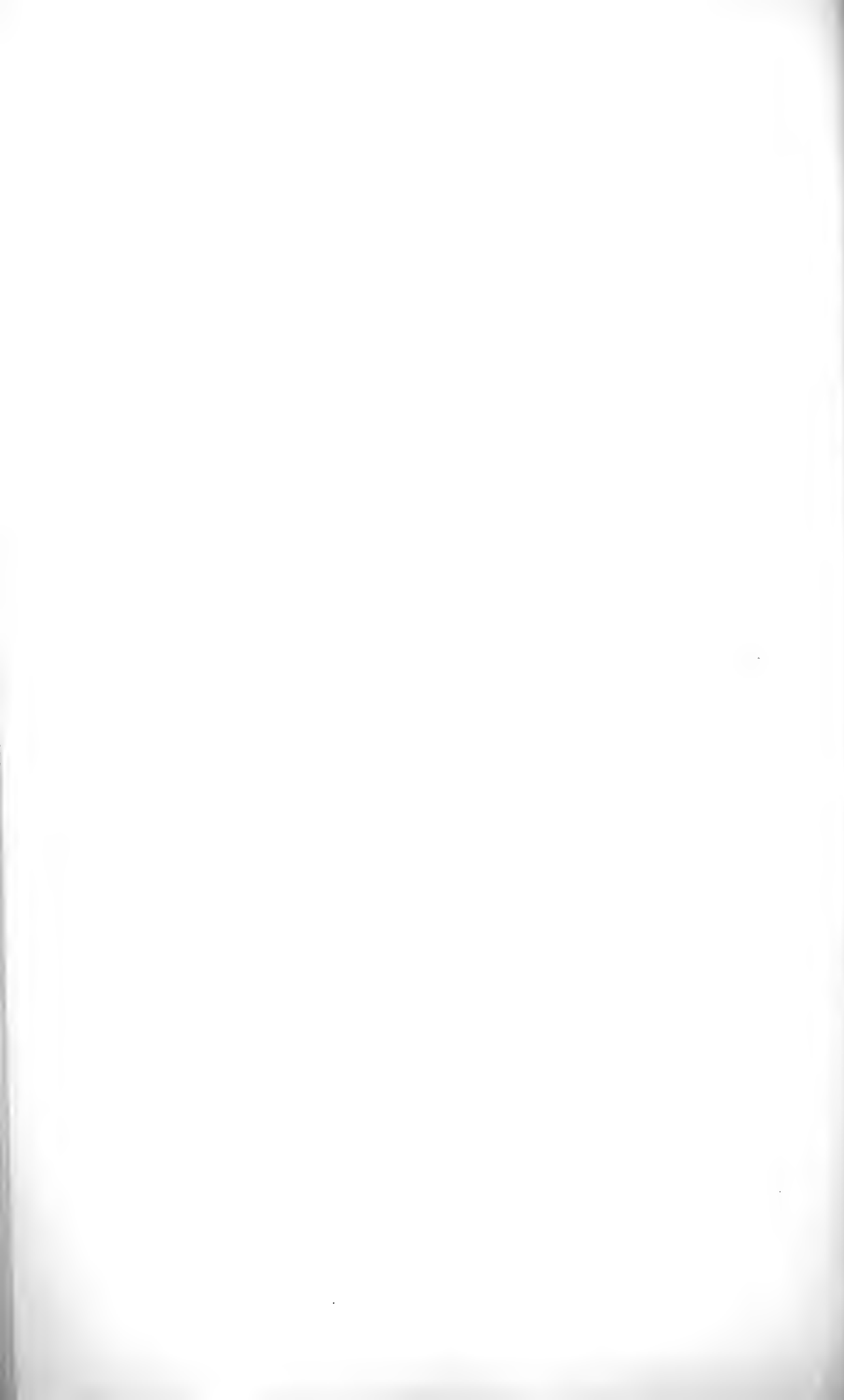
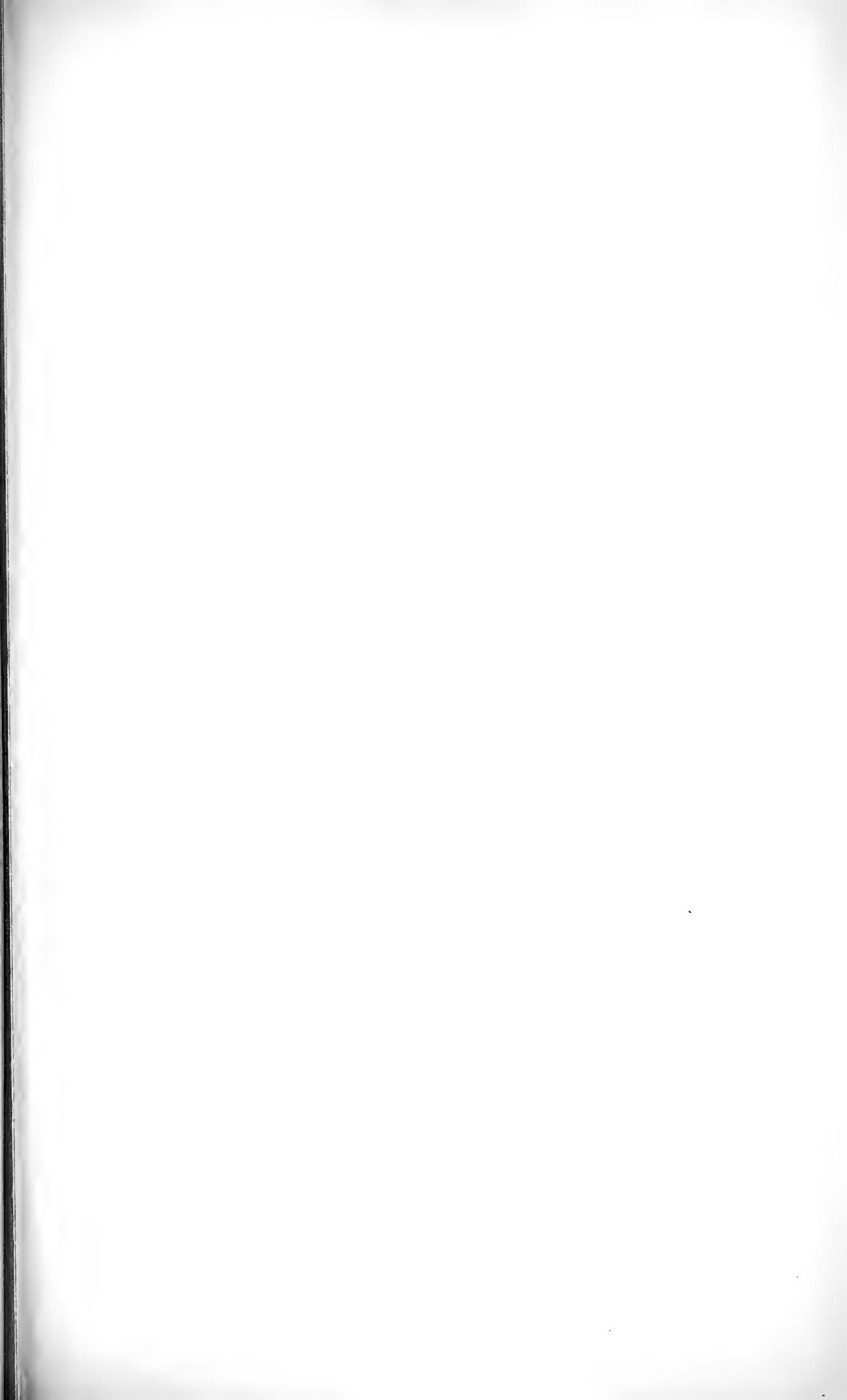




PLATE 11.

FIG. 19. Anterior view of the left polydactyle manus of a polydactyle pig, showing the lower row of carpals, and two extra digits borne on metacarpal 1.

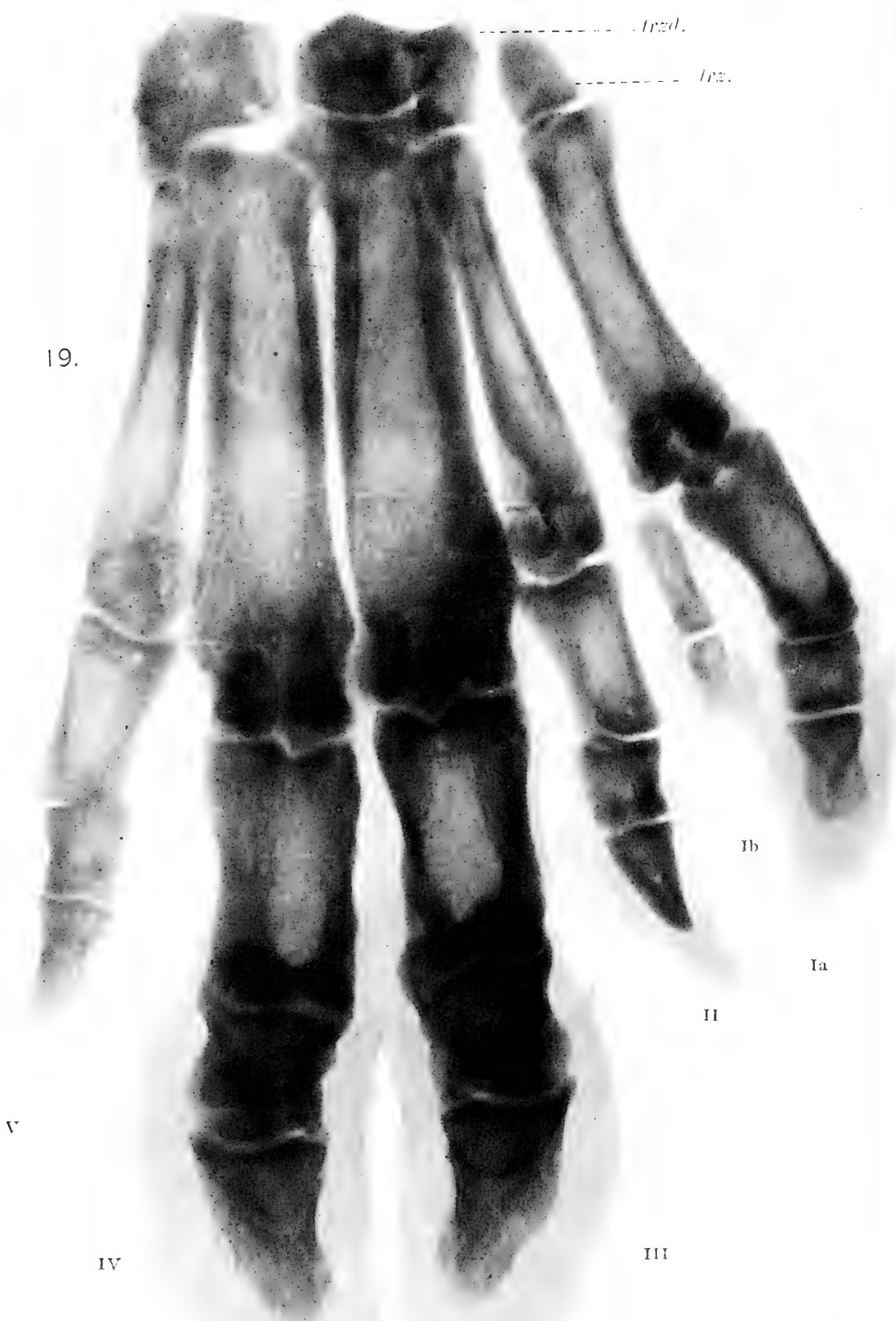




19.

*Arzd.*

*Arz.*



Ib

Ia

II

V

IV

III

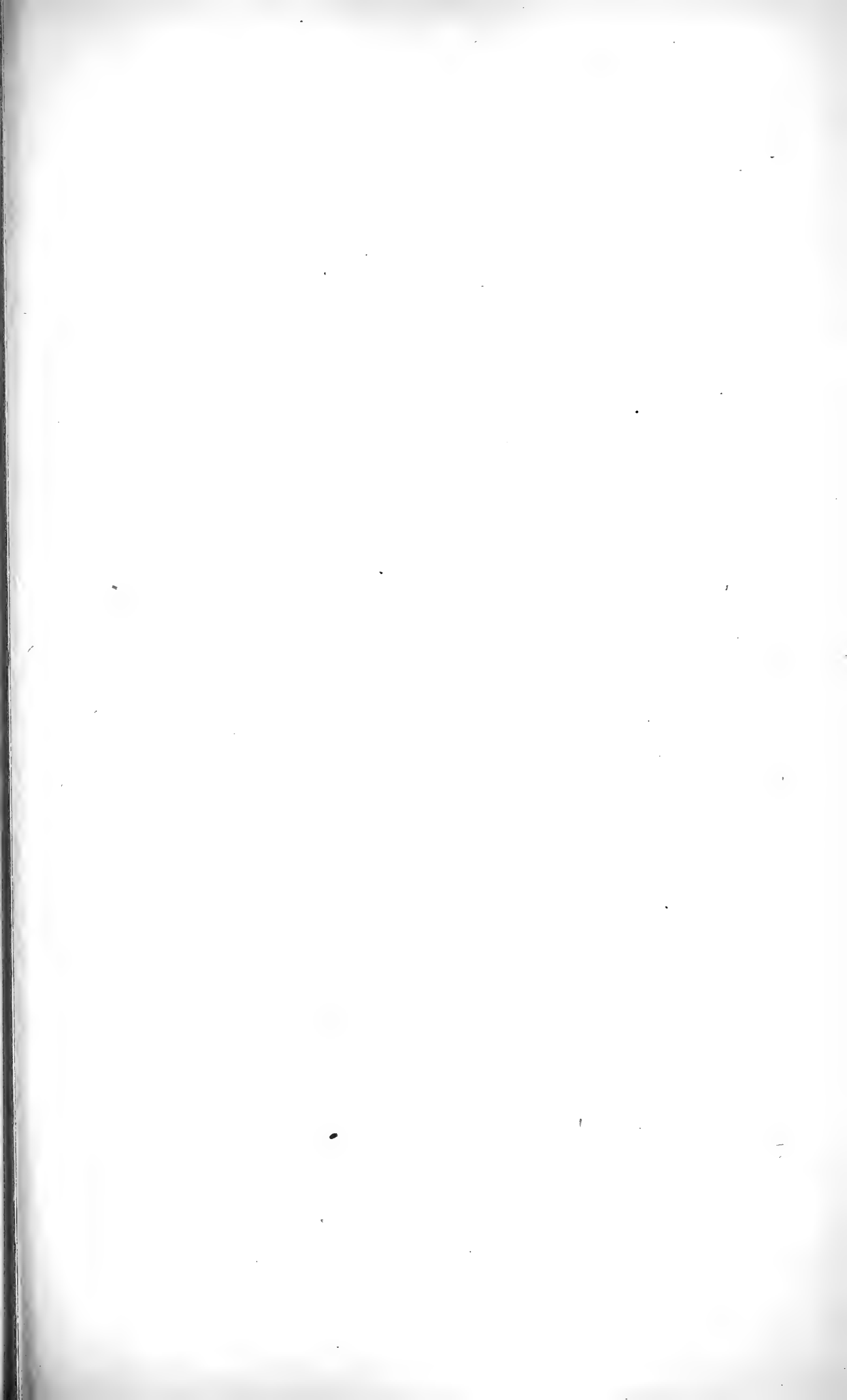
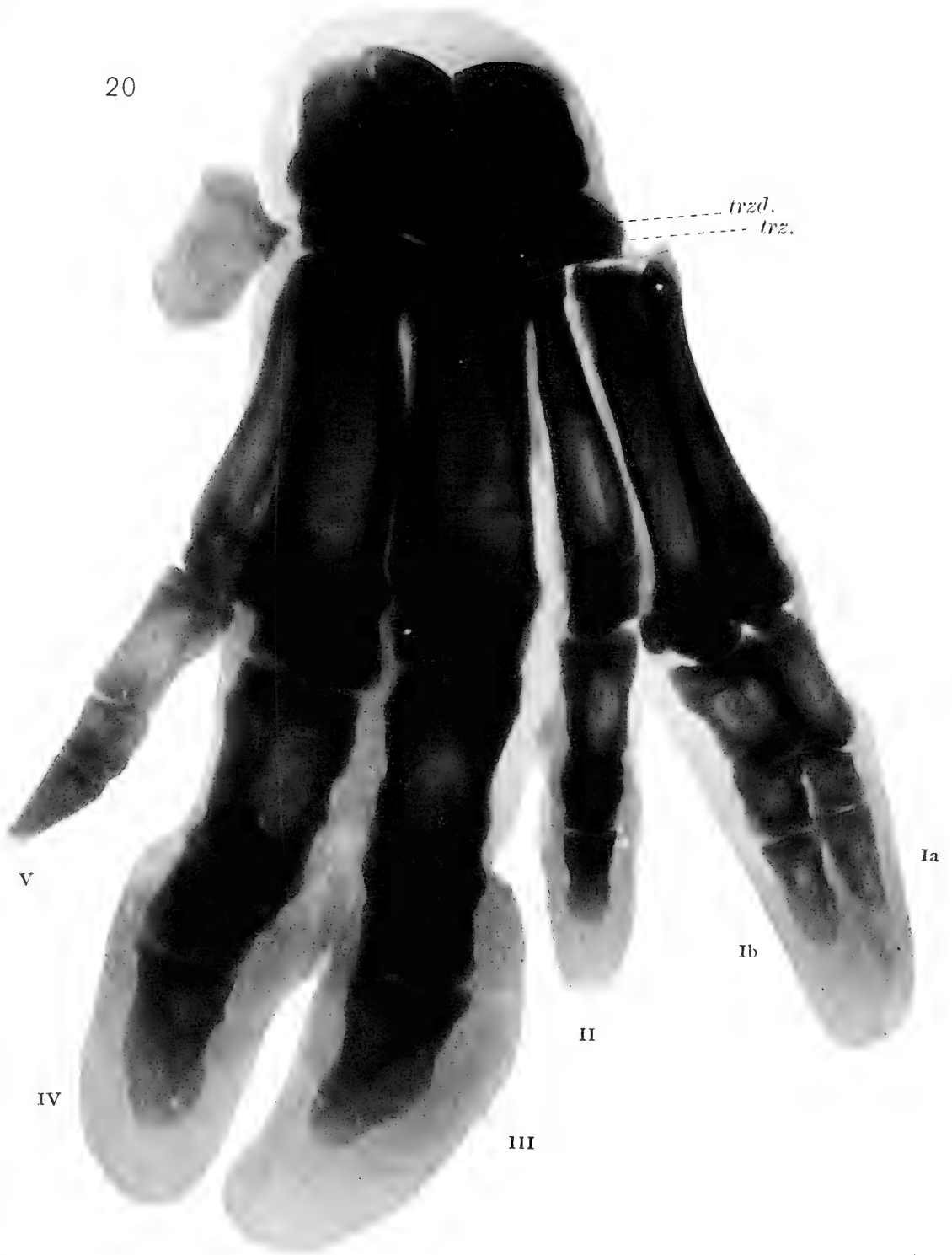
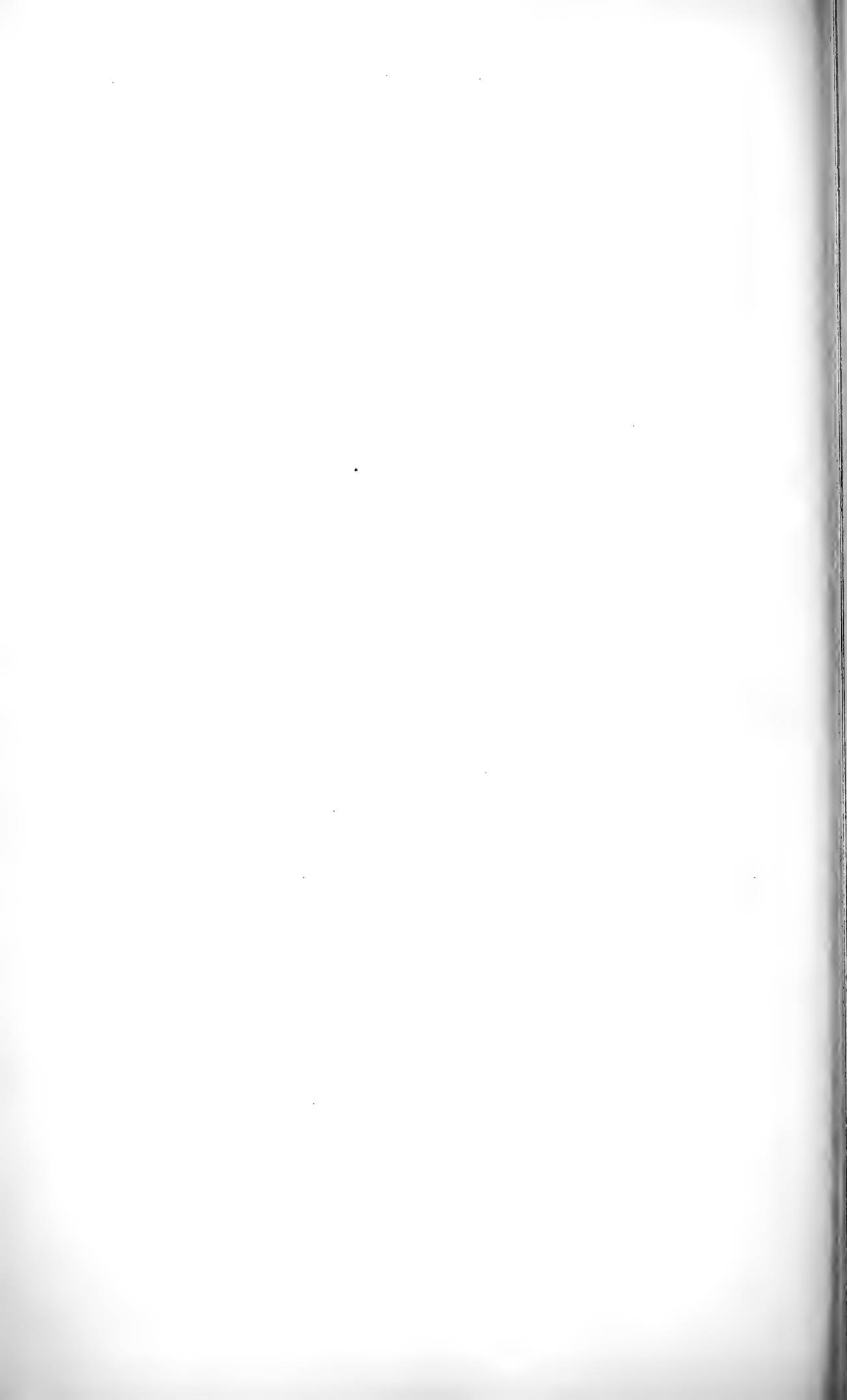


PLATE 12.

FIG. 20. Anterior view of the left manus of a polydactyle pig, showing two complete supernumerary digits enclosed distally in a single hoof.

20





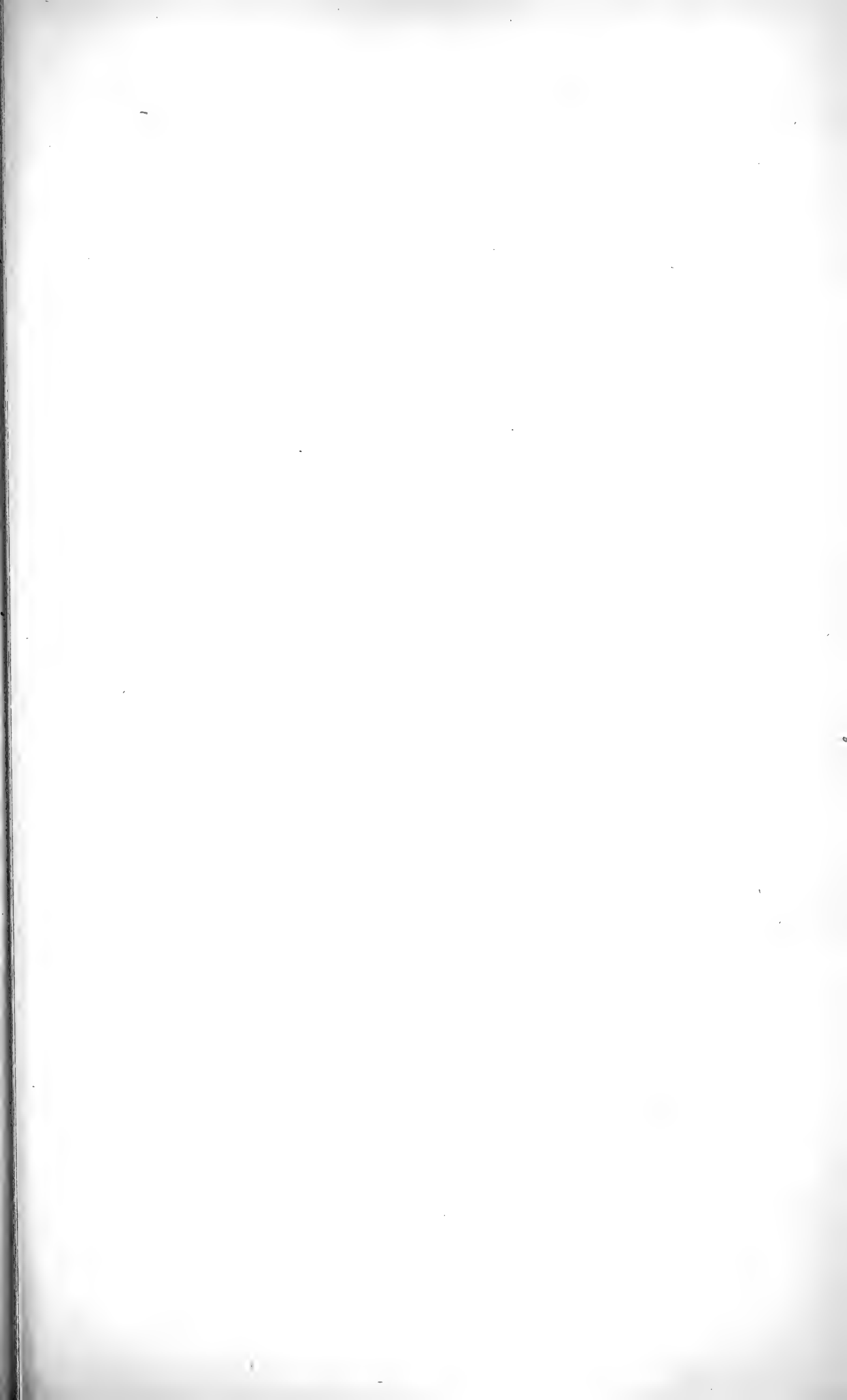
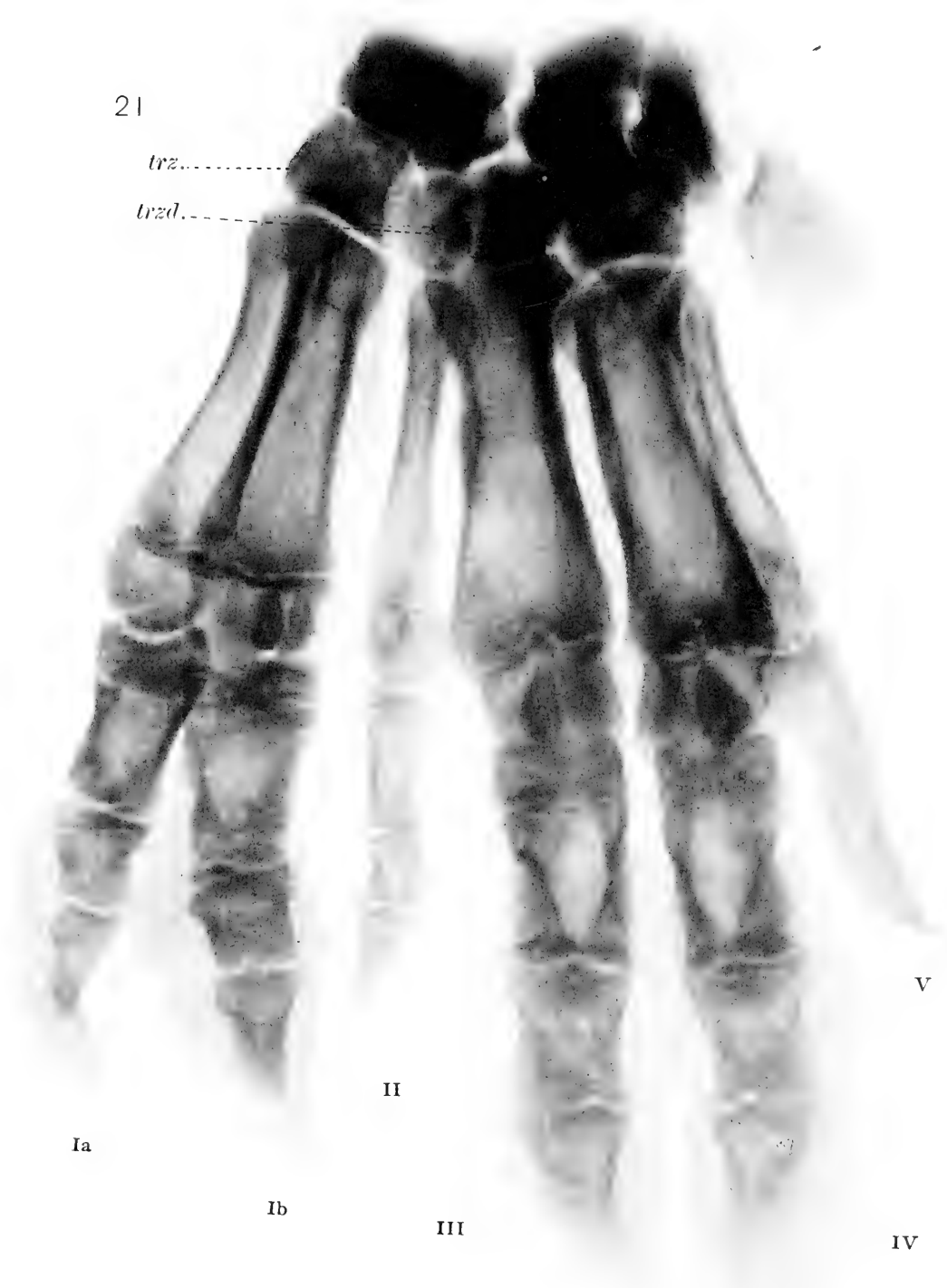
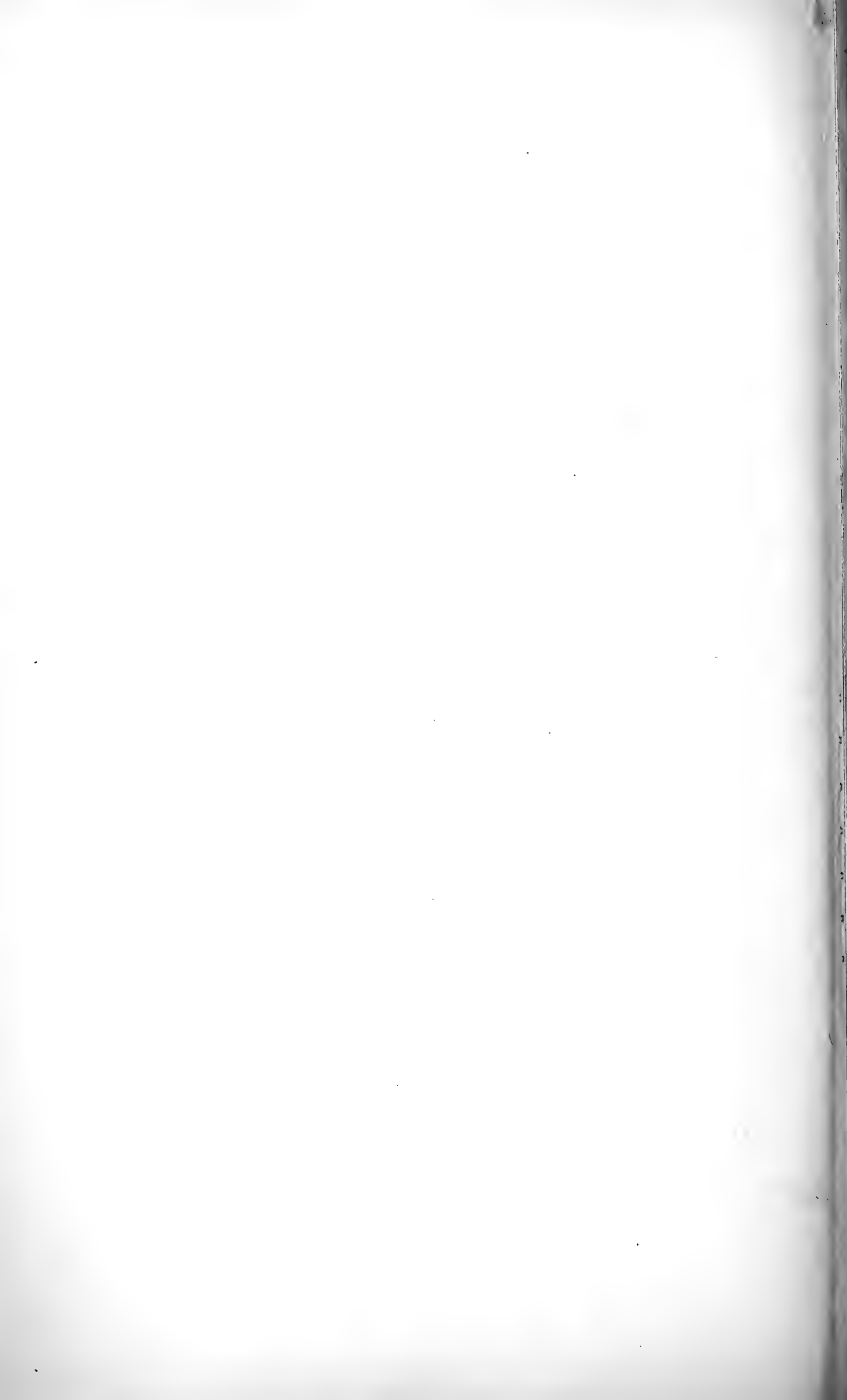


PLATE 13.

FIG. 21. Anterior view of the right manus of a polydactyle pig, showing two complete supernumerary digits.







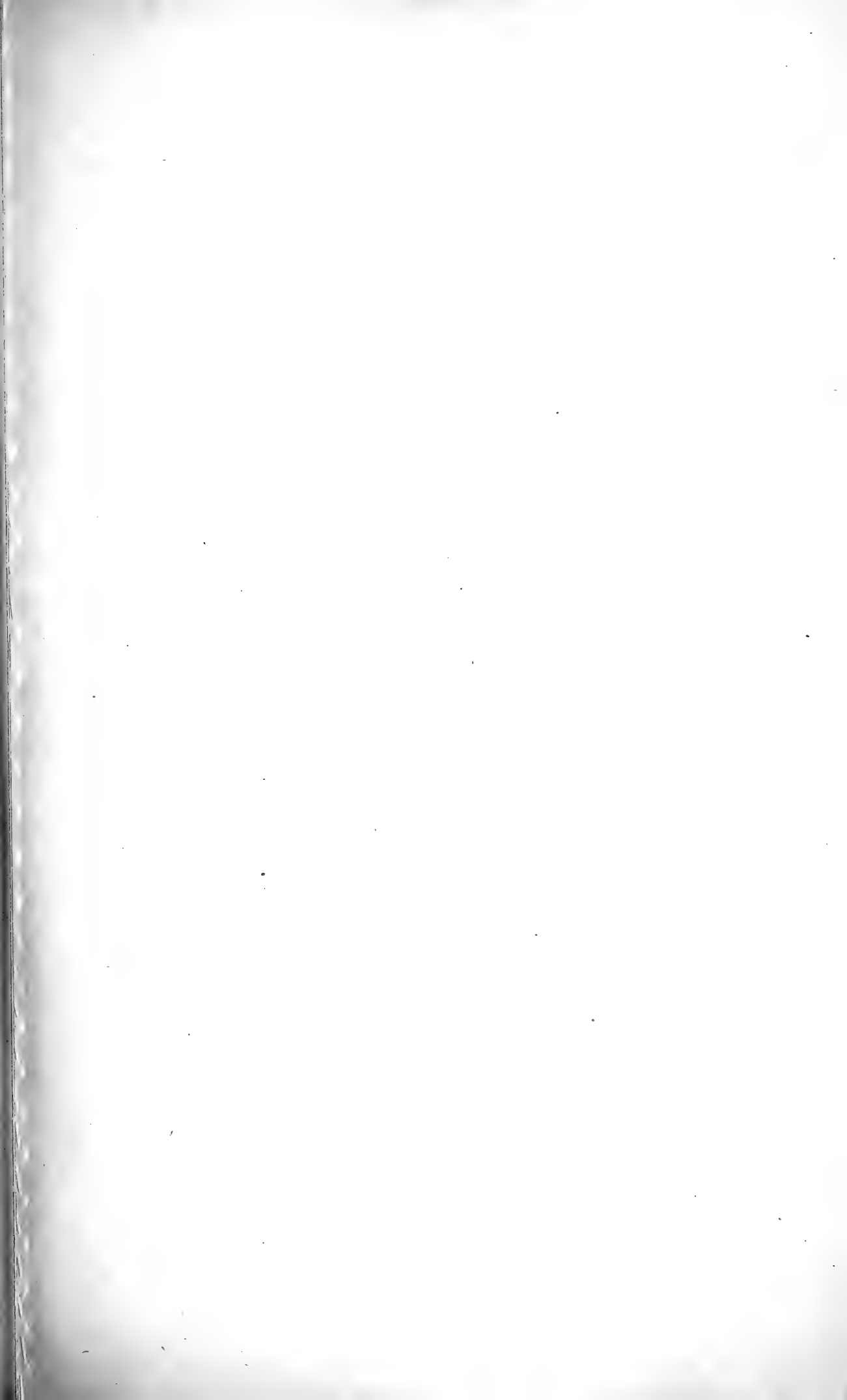
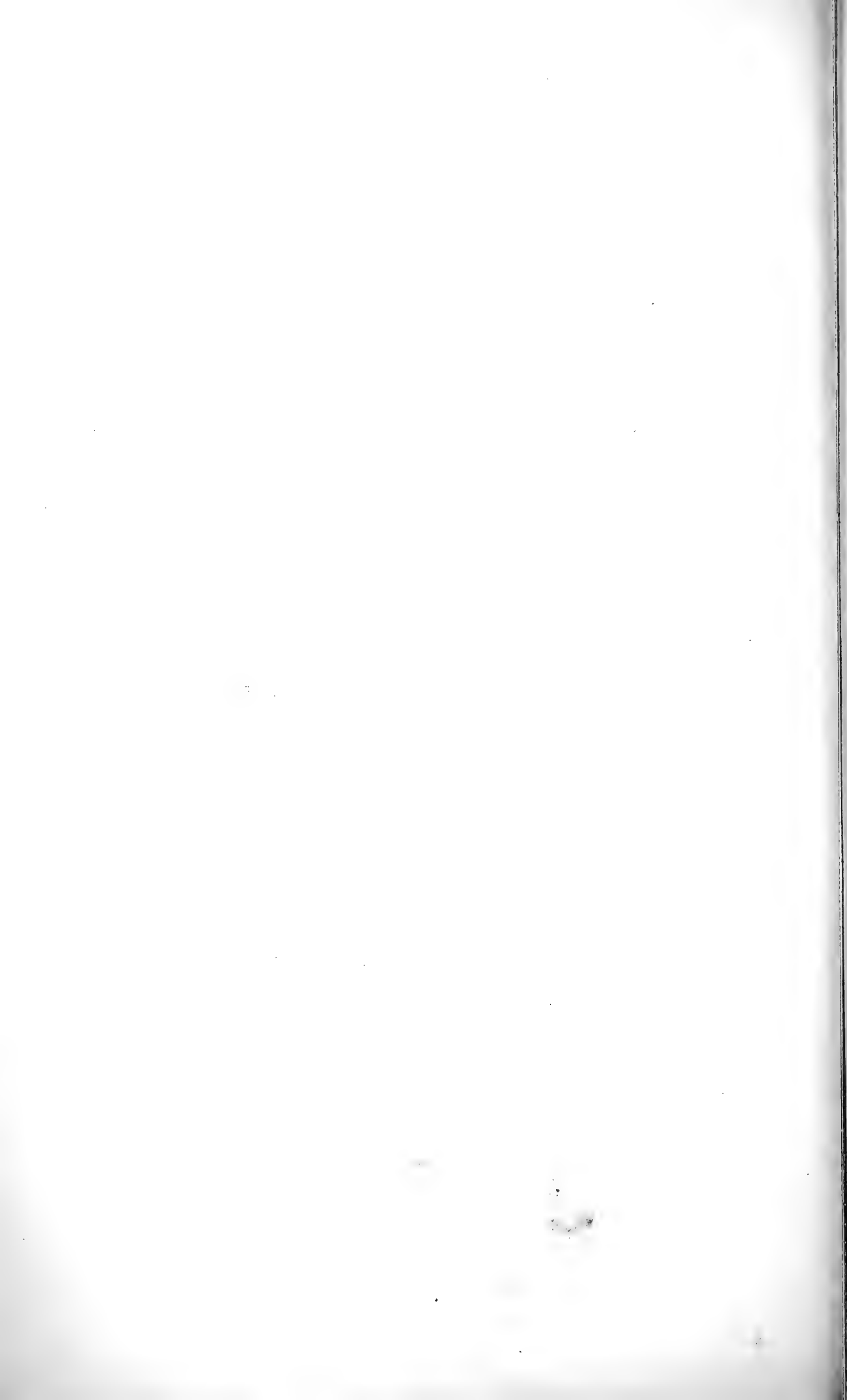


PLATE 14.

FIG. 22. Anterior view of the left polydactyle manus of a polydactyle pig, showing the lower row of carpal bones, two supernumerary digits, and the rudimentary phalanges of digit II.

22.





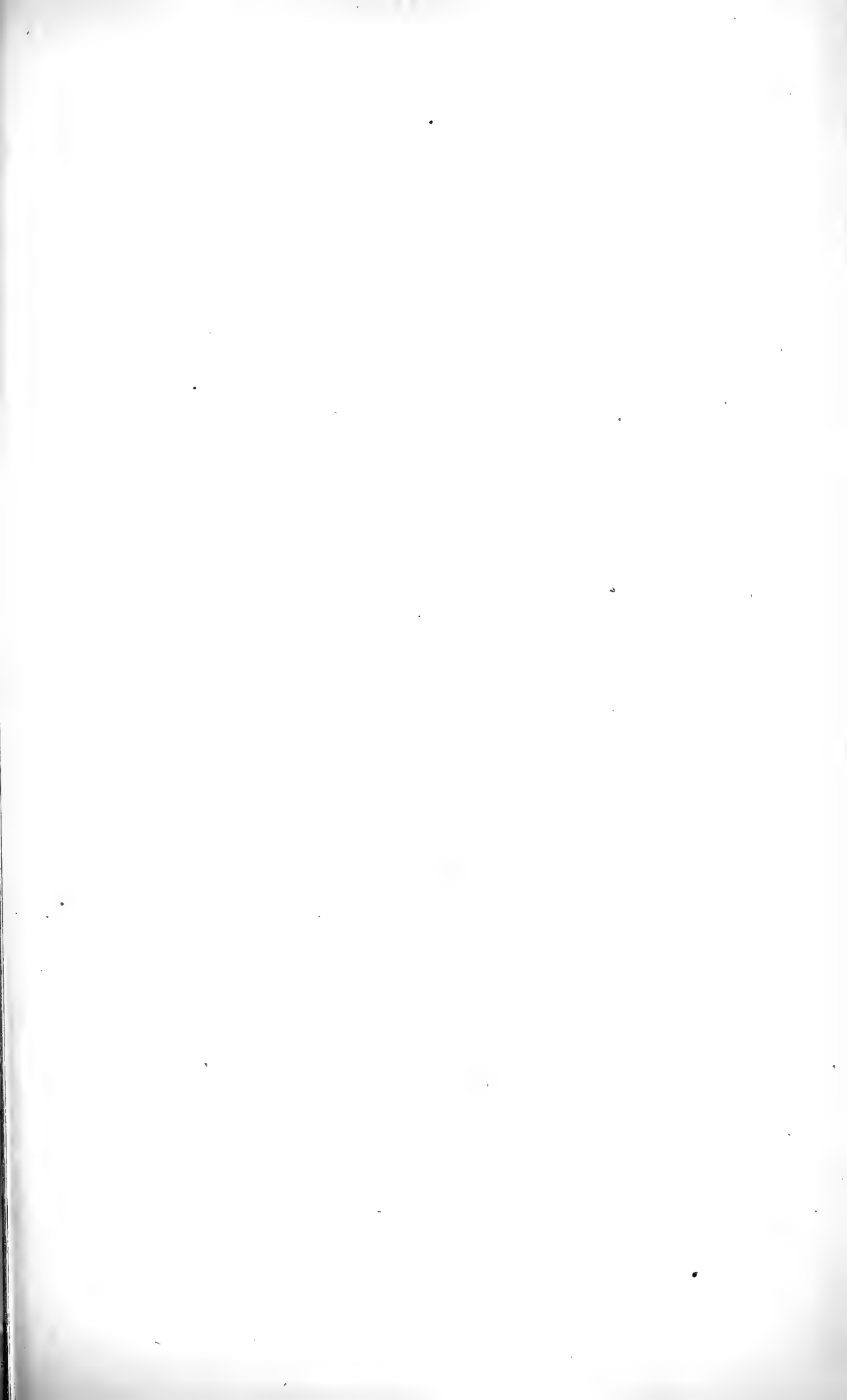


PLATE 15.

FIG. 23. Anterior view of the left manus of a polydactyle pig in which two large supernumerary digits are present, but digit II is absent.



23.

*scph.*

*scph.*

*trzd.*

*trz.*



V

IV

III

Ib

Ia



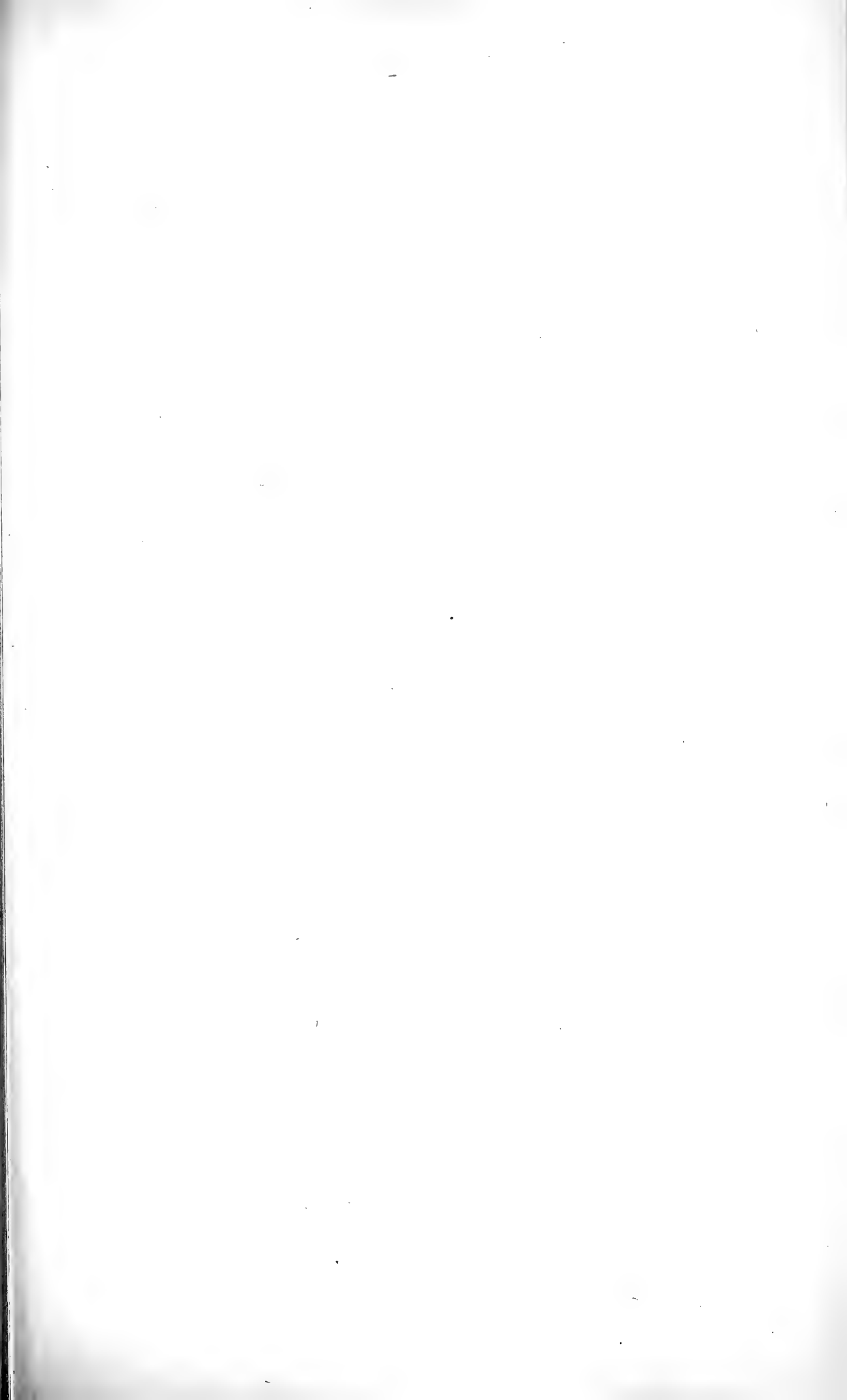


PLATE 16.

FIG. 24. Anterior view of the left manus of a polydactyle pig, showing two fully formed supernumerary digits, and the rudiments of a third.

24

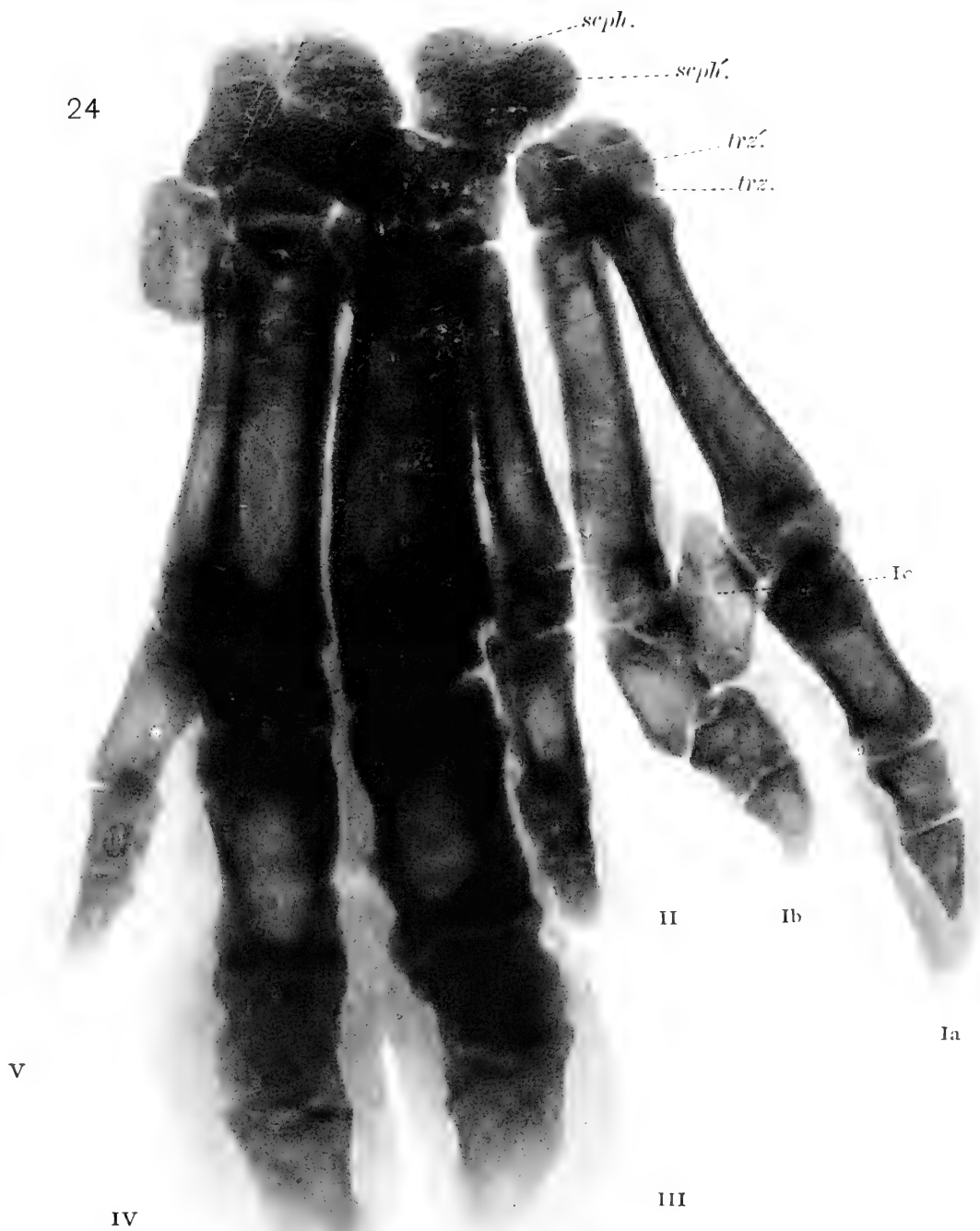






PLATE 17.

FIG. 25. Anterior view of the right manus of a polydactyle pig, showing an extra digit borne on metacarpal 11, and the lower row of carpals.



25.

*trzd.* -----

*trz.* -----



I

II

III

IV

V



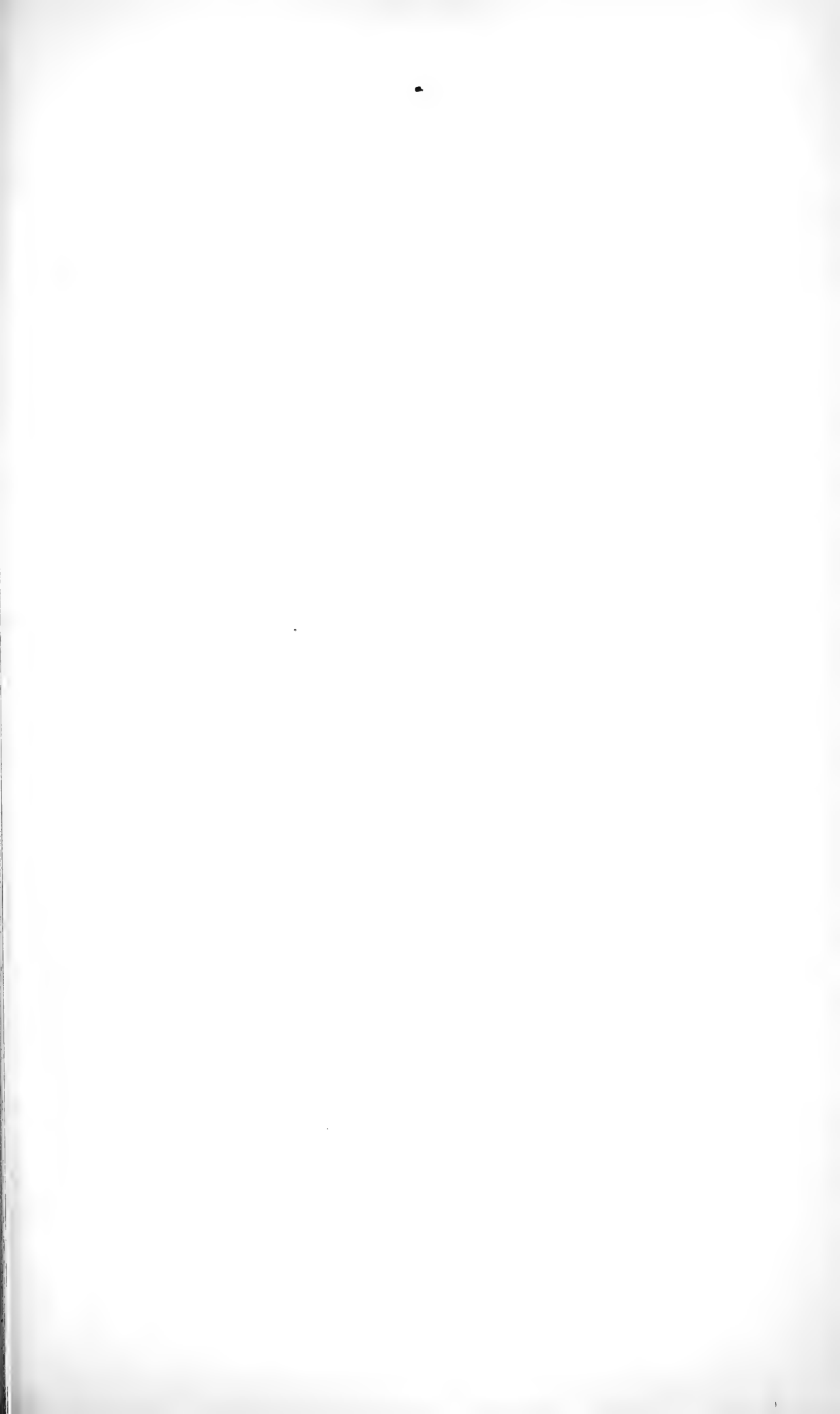


PLATE 18.

FIG. 26. Anterior view of the left manus of a polydactyle pig, showing a large supernumerary digit, the metacarpal of which is fused to that of digit II.

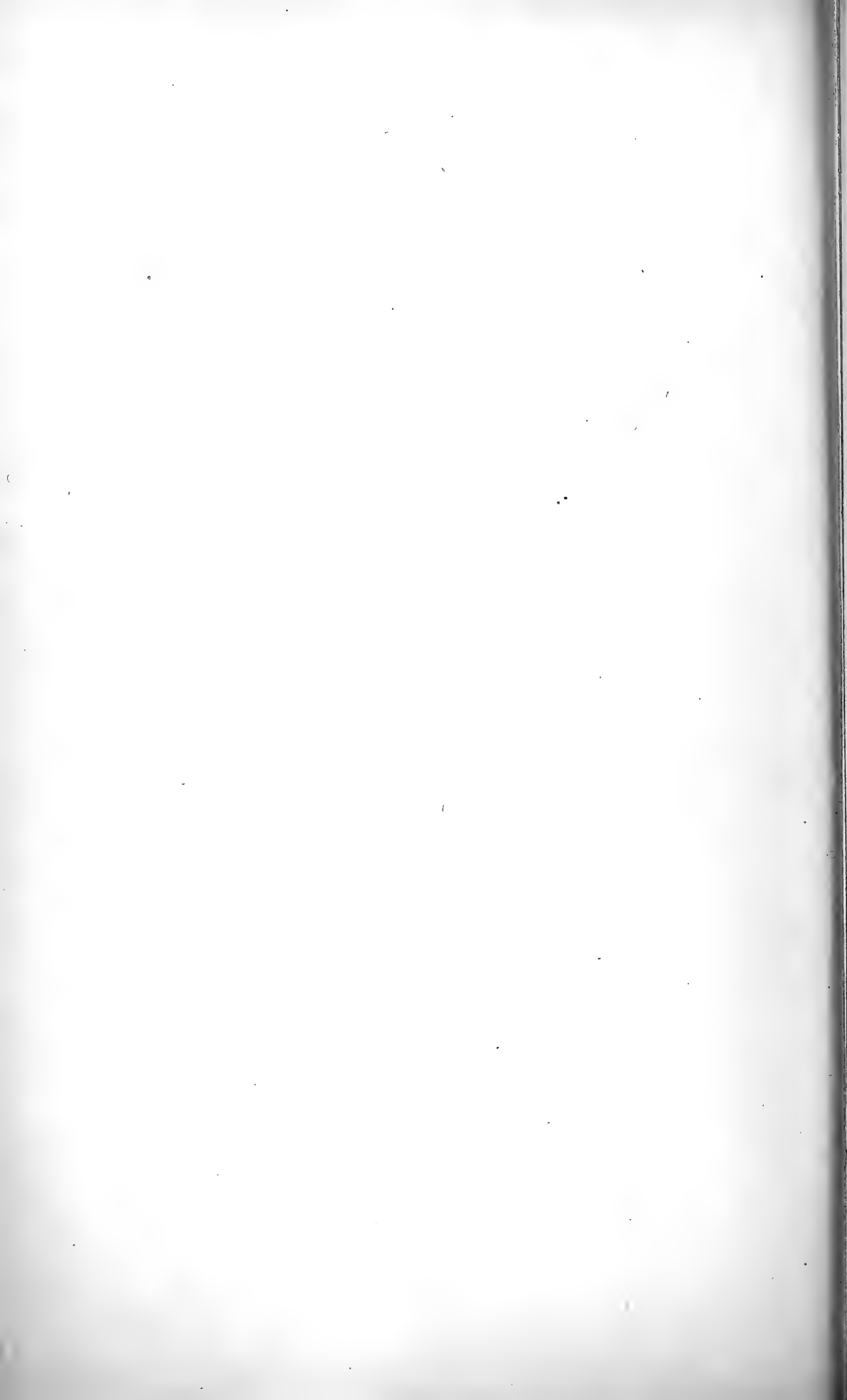
26.



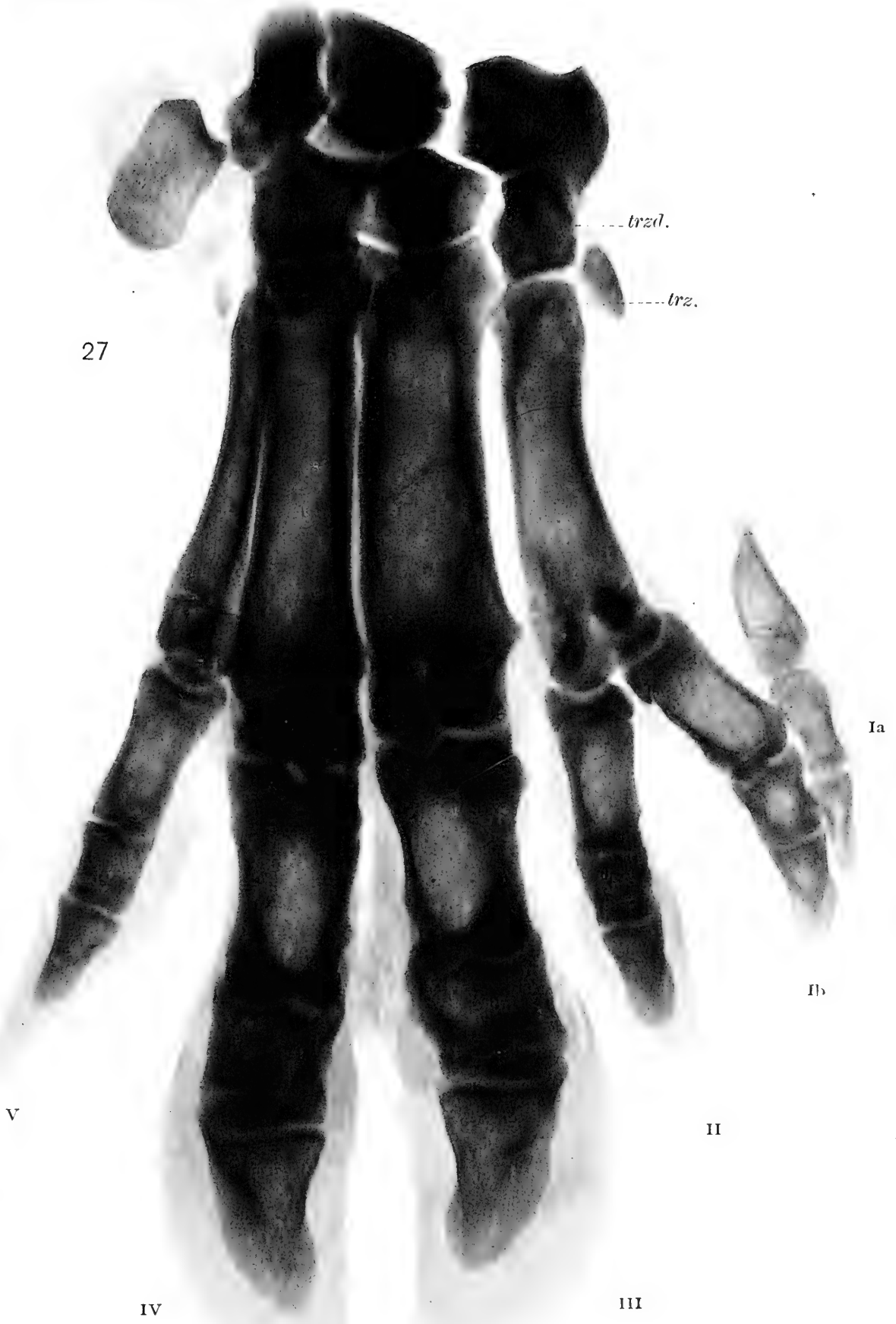


PLATE 19.

FIG. 27. Anterior view of the left manus of a polydactyle pig, showing two extra digits, one of which is borne on metacarpal II.









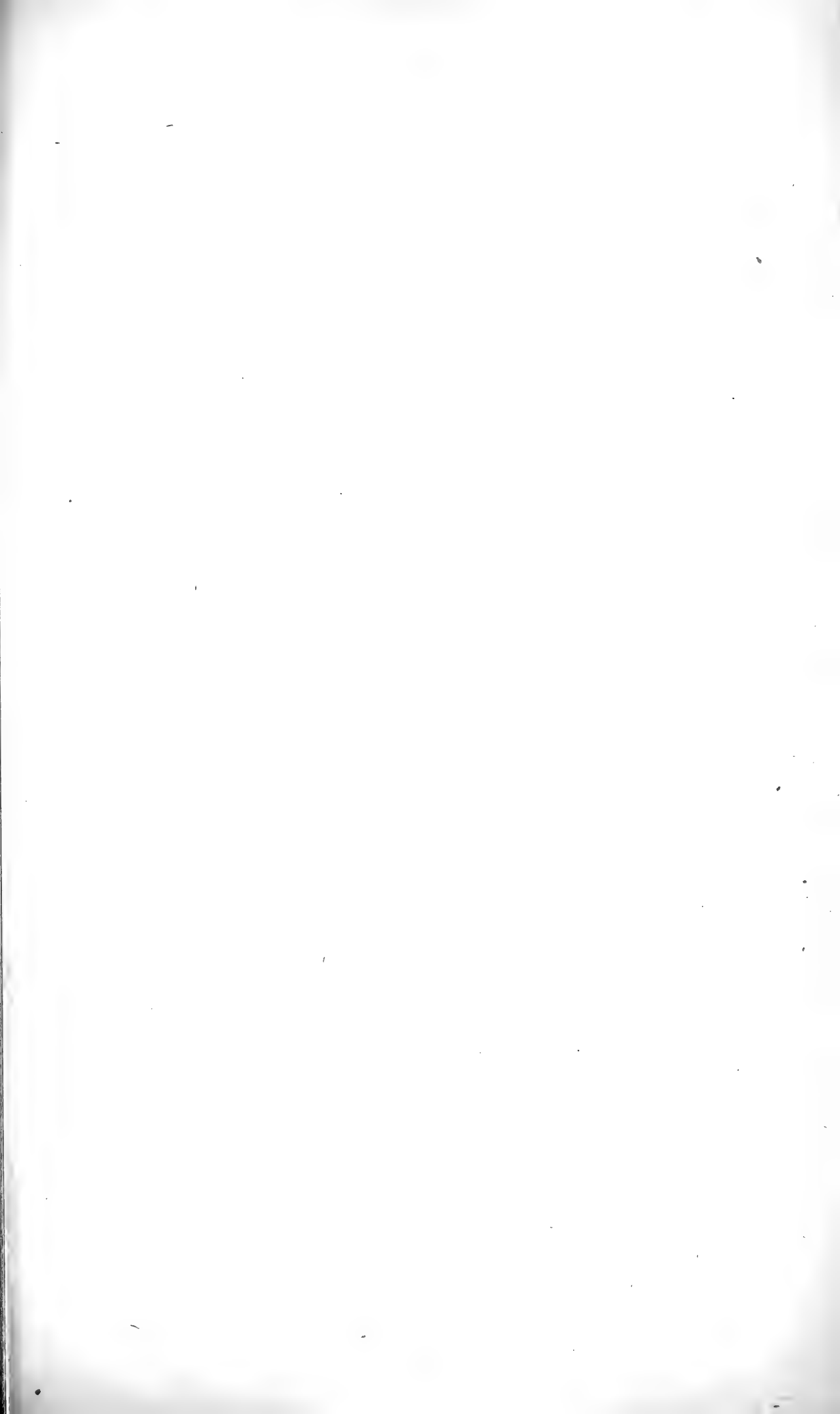


PLATE 20.

FIG. 28. Anterior view of the left manus of a polydactyle pig, showing two extra digits, one of which ( $1^b$ ) is borne on the same metacarpal with II.

28.





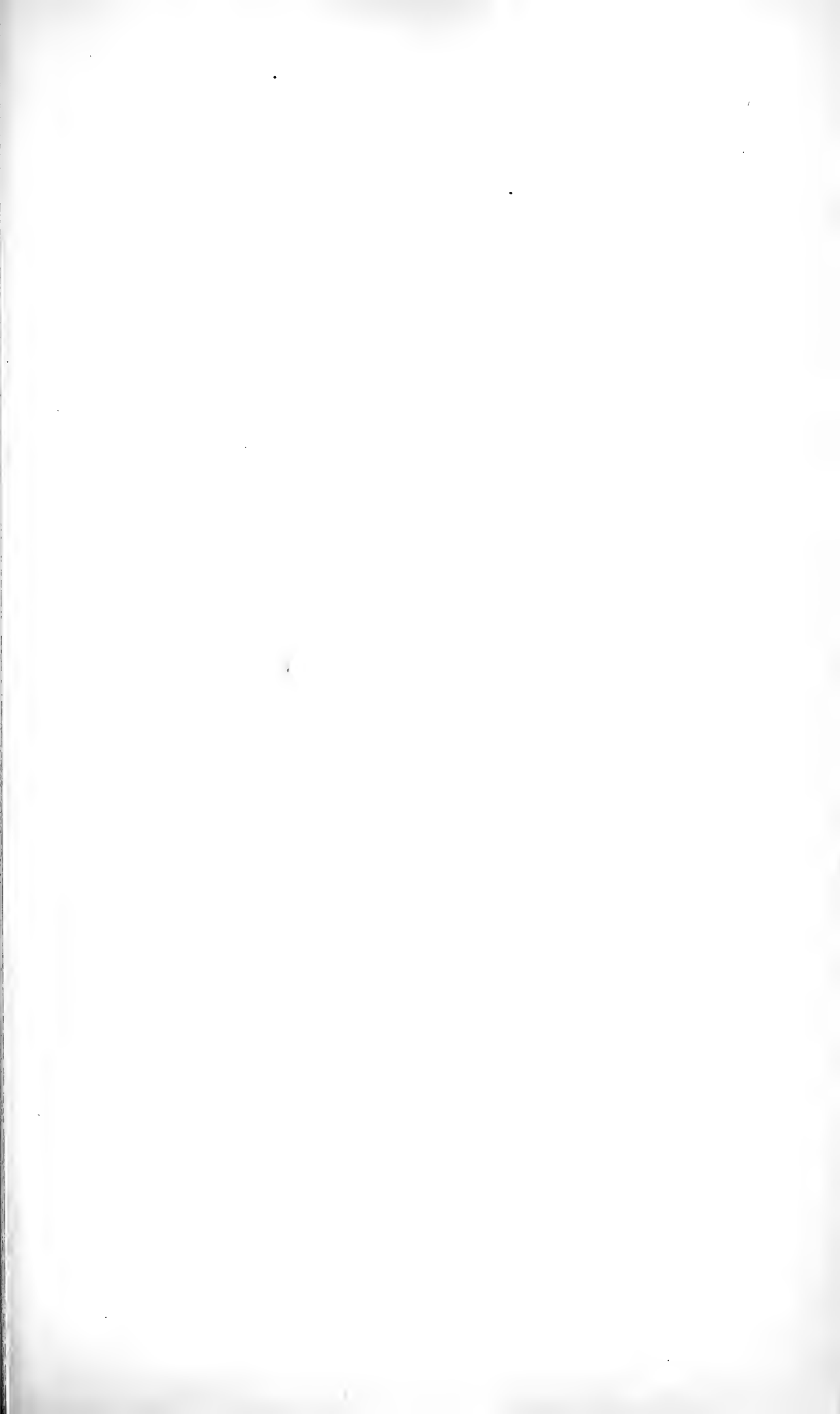
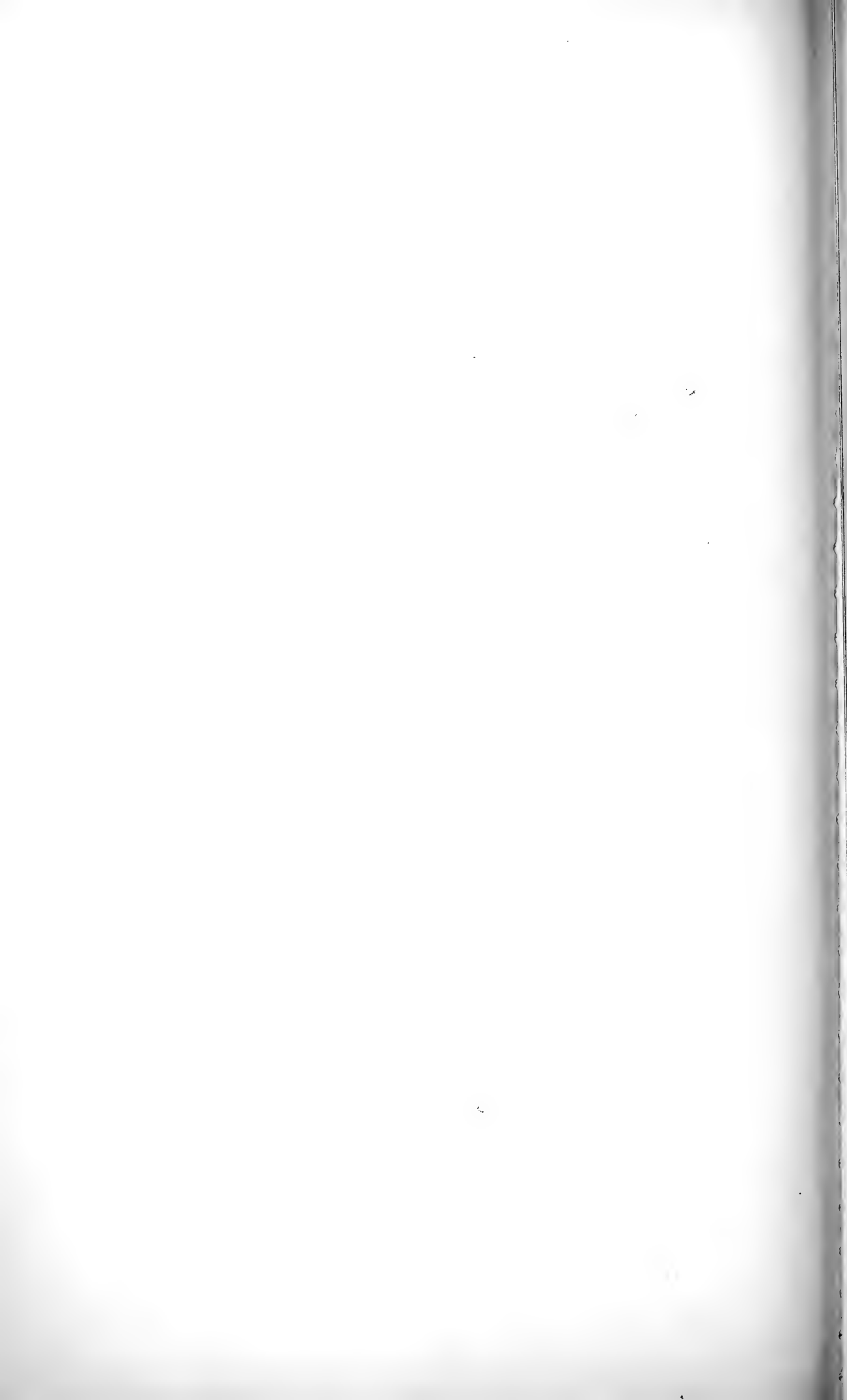


PLATE 21.

FIG. 29. Anterior view of the left manus of a polydactyle calf, showing only the distal extremity of the metacarpus, and a supernumerary digit (11).







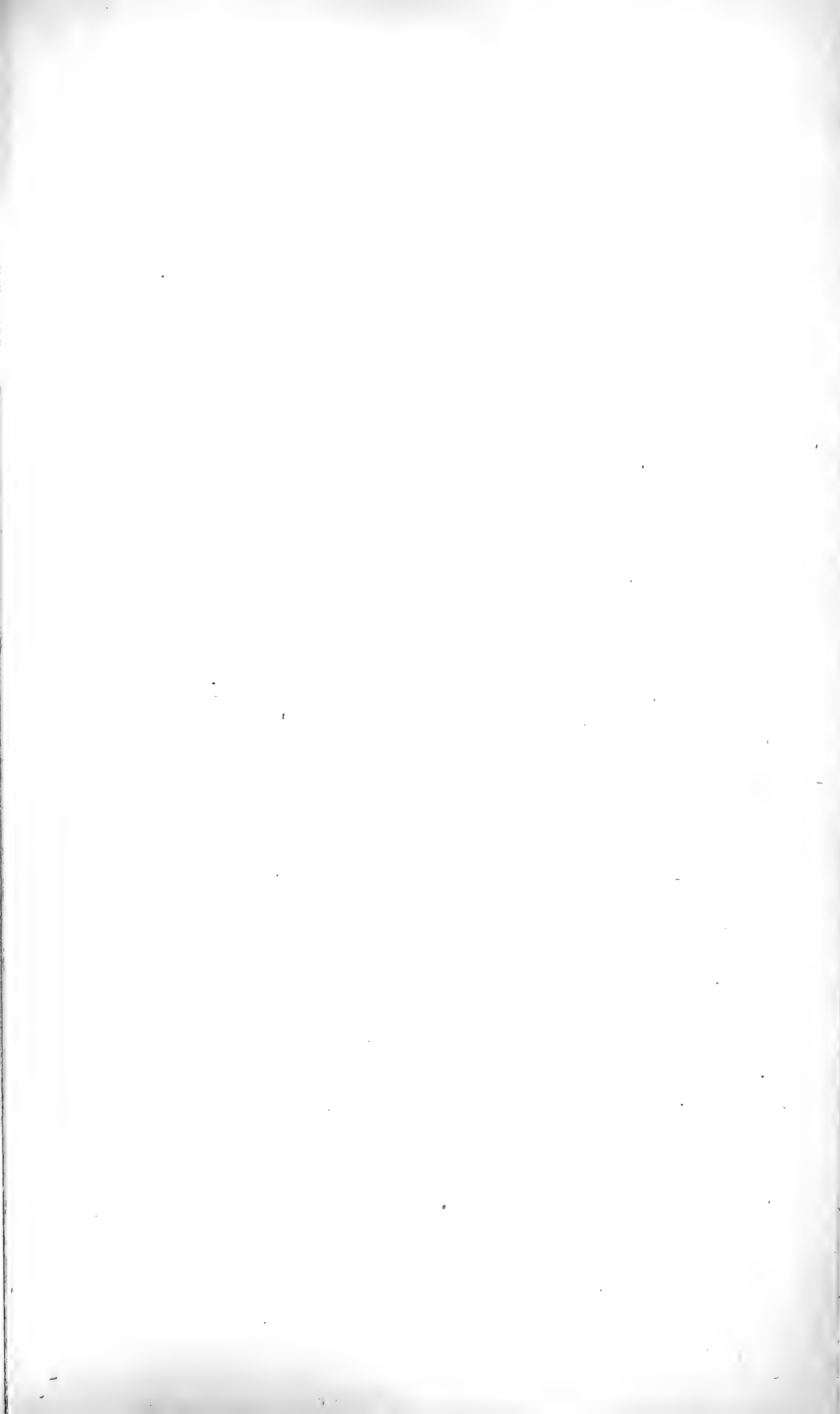


PLATE 22.

FIG. 30. Anterior view of right manus of same calf as Fig. 29, showing one extra digit (11).

30.

II

III

IV





Bulletin of the Museum of Comparative Zoölogy  
AT HARVARD COLLEGE.  
VOL. XL. No. 7.

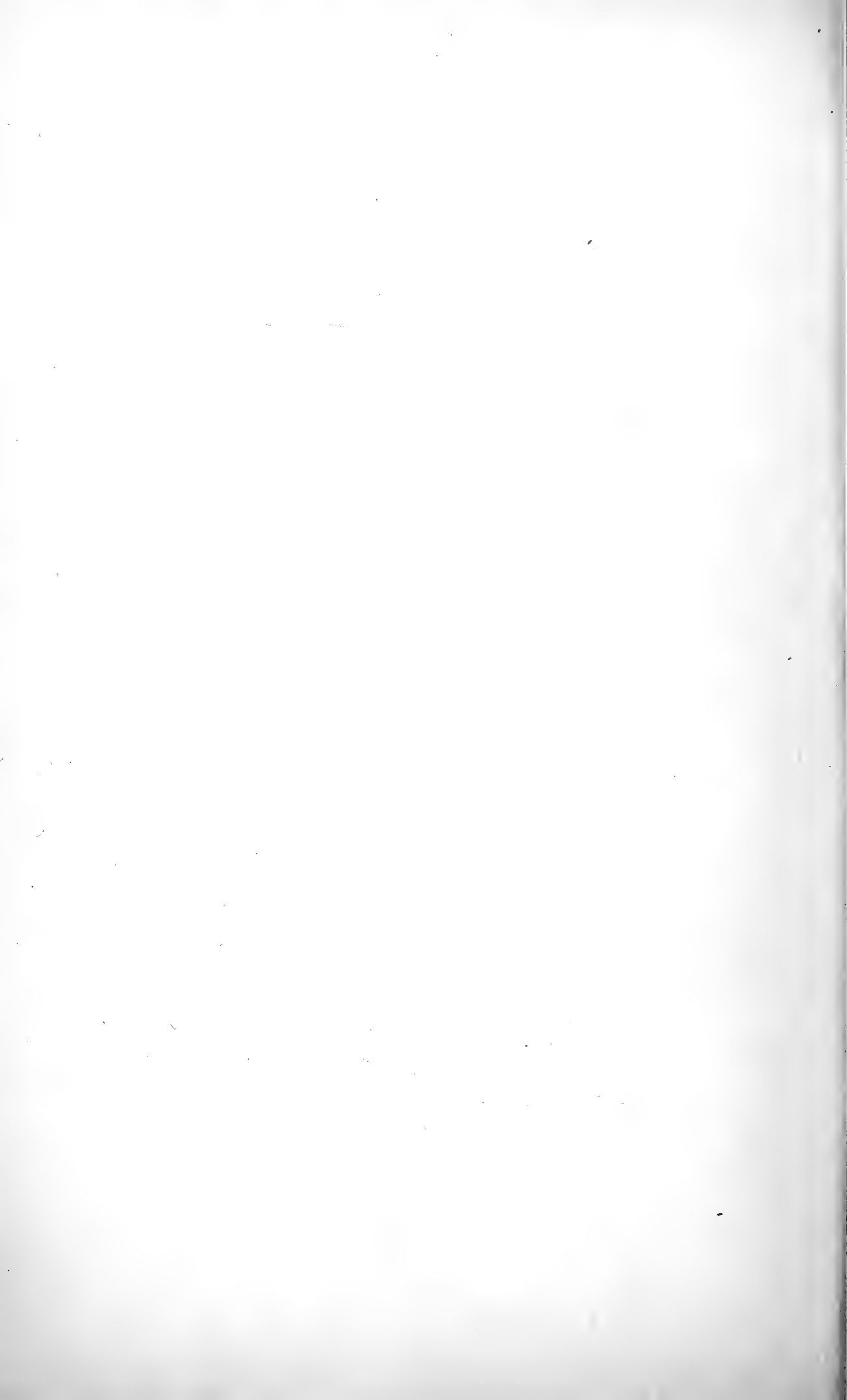
---

THE CHANGES WHICH OCCUR IN THE MUSCLES OF A  
BEETLE, THYMALUS MARGINICOLLIS CHEVR.,  
DURING METAMORPHOSIS.

BY ROBERT S. BREED.

WITH SEVEN PLATES.

CAMBRIDGE, MASS., U. S. A. :  
PRINTED FOR THE MUSEUM.  
OCTOBER, 1903.





*The Changes which occur in the Muscles of a Beetle, Thymalus  
 marginicollis Chev., during Metamorphosis.*

By ROBERT S. BREED.

TABLE OF CONTENTS.

	PAGE		PAGE
Introduction . . . . .	317	a. Muscles that pass unal-	
Part I.—Anatomy . . . . .	318	tered from the larva to	
A. Historical Survey . . . . .	318	the imago . . . . .	349
B. Observations . . . . .	319	b. Metamorphosis of larval	
1. Material . . . . .	319	muscles into	
2. Methods . . . . .	321	(1). Muscles of the wing	
3. Anatomical changes of the		type . . . . .	349
muscles . . . . .	321	a. Larval period . . . . .	349
a. Metathorax . . . . .	322	β. Pupal period . . . . .	353
(1). Dorsal antero-posterior		γ. Imaginal period . . . . .	355
muscles . . . . .	323	(2). Muscles of the leg type	356
(2). Lateral dorso-ventral		a. Larval period . . . . .	357
muscles . . . . .	324	β. Pupal period . . . . .	357
(3). Ventral antero-poste-		γ. Imaginal period . . . . .	358
rior muscles . . . . .	336	(3). Metamorphosis of the	
b. Mesothorax . . . . .	337	intestinal muscles . . . . .	358
c. Prothorax . . . . .	338	c. Histolysis of the larval	
d. Head . . . . .	338	muscles . . . . .	361
e. Abdomen . . . . .	338	d. Histogenesis of the imag-	
f. Appendages . . . . .	339	inal muscles . . . . .	363
4. Discussion of results . . . . .	339	3. Observations on other Cole-	
Part II.—Histology . . . . .	340	optera . . . . .	364
A. Historical survey . . . . .	340	C. Discussion of results . . . . .	366
B. Observations . . . . .	347	Summary . . . . .	371
1. Methods . . . . .	347	Bibliography . . . . .	375
2. Histological changes of the		Explanation of plates . . . . .	380
muscles . . . . .	348		

Introduction.

While there have been numerous researches on the changes which occur during the metamorphosis of insects, many points remain not clearly understood, and others are in dispute. The present investigation

has been undertaken with the purpose of aiding, if possible, in the explanation of some of these alterations, and thus to untangle the confusion in regard to them. A detailed study has been made on Coleopterous material, since beetles were found to present a fairly simple metamorphosis of the muscular system.

These changes naturally fall into two groups; the anatomical and the histological. Previous papers on this subject have ignored almost completely the anatomical side of the question. This one-sided method has been responsible for much of the confusion which has arisen.

In connection with this neglect of the study of the anatomy of the muscles, most authors have assumed that all of the muscles of any one insect undergo similar changes during pupal life. Yet, it is conceivable that any one of, or any combination of, the following conditions may be found in a single holometabolic insect:

a. The larval muscles may not be changed, but pass unaltered into the imago.

b. The larval muscles may undergo a more or less complete metamorphosis into the imaginal muscles.

c. The larval muscles may degenerate entirely, and the imaginal muscles form anew in the pupa.

As the results of this research show that a combination of these three methods is found in Coleoptera, and as the remaining orders of metabolic insects are probably fundamentally like Coleoptera, it is not strange that contradictions have arisen. It is possible that two investigators, even though working on the same species, have, in studying different muscles, studied different conditions.

This investigation was undertaken at the suggestion of Dr. E. L. Mark. During the three years that I have been engaged in the work, he has constantly aided me by his advice and criticism. To him, my heartiest thanks are due. I also wish to express my thanks to Mr. Samuel Henshaw, of the Museum of Comparative Zoölogy, for his many kindnesses.

## Part I. — Anatomy.

### A. HISTORICAL SURVEY.

The dissections of the muscular system of insects are not very numerous, and, as the homologies of the muscles are difficult to determine, the comparative myology of insects is not in a very satisfactory condition. Those investigations which have been published are, with few exceptions,

based on dissections in which only imaginal forms have been used. The few exceptional cases in which larval forms have been used happen to be dissections of larvae from orders of insects other than Coleoptera. The best attempt that has been made as yet to establish the homologies of the imaginal forms is that of Petri ('99), who has studied the muscular systems of Trichoptera, Diptera, and Hymenoptera. On account of this unsatisfactory state of the comparative myology, no attempt will be made to homologize the muscles of Coleoptera with those of other orders. Consequently, only those papers that deal with Coleoptera will be mentioned. A very good review of the whole ground is given by Petri ('99).

Of the three papers that deal with the imaginal muscular system of Coleoptera, the monumental work of Straus-Dürckheim ('28), on *Melolontha vulgaris*, is the first and most important. The nomenclature used by him is, however, unsatisfactory, as it is not generally applicable. The next paper in importance for us is that of Luks ('83), who gives good figures and a short description of the thoracic musculature of *Dytiscus marginalis* Linn. He finds the musculature much the same as in *Melolontha*, with the exception of the coxal muscles of the metathorax. Owing to the firm fusion of the coxae to the metasternum, the functions of the coxal muscles have changed. These muscles serve either as indirect wing muscles, or as flexors or extensors of the trochanter. The Latin nomenclature used by him is founded principally on the functions of the muscles. It is the best nomenclature available, and is therefore used as far as practicable in this paper. When the homologies shall have been made clear, probably a modification of the nomenclature of Amans ('85), founded on the attachments and positions of the muscles, will be used for all orders of insects. In his paper, Amans gives a short description of the wing muscles of beetles.

#### OBSERVATIONS.

##### 1. *Material.*

The principal material used has been *Thymalus marginicollis* Chevr., one of the Trogositidae. *Marginicollis* (Chevr. 1842) is used as the specific name of this species by the authority of Lèveille ('88), who, in his catalogue of the Temnochildes (=Trogositidae), substitutes this name for *fulgidus* (Erich. 1844), the name in most common use. Inasmuch as *marginicollis* is figured in the original description, and has priority, it certainly ought to be used. This species lives in *Polyporus betulinus*, the common shelf fungus growing on white birch (*Betula populifolia*

Ait. ; Dr. Roland Thaxter tells me that it is also sometimes found on *B. papyifera* Marshall). This species of *Thymalus* is entirely North American, so far as recorded, being found within, and limited to, the regions occupied by these species of white birch. The localities recorded are Canada, Maine, New Hampshire, Vermont, Massachusetts, New York, Pennsylvania, New Jersey, Michigan, Wisconsin, and Iowa.

The only account of its life history is that of Beutenmueller ('90), who gives little more than an accurate description of the larva and pupa. My specimens agree with his in every particular, excepting in regard to the size of the larva. He states that the larvae are 6 mm. by 3 mm., whereas my specimens of full grown larvae are not as broad, being only 2-2.5 mm. broad by 6-7 mm. long. Material has been obtained in the spring from three localities about Cambridge; viz., Middlesex Fells, Arlington Heights, and Belmont. The eggs are deposited in the fall and hatch in the spring. Young larvae, 2-5 mm. long, were found in the fungi as early as the 17th of April, 1901, and the 4th of April, 1902.

The larvae grow rapidly, bore through the fungus in various directions, and finally excavate a chamber at the end of the burrow, in which to pupate. These chambers are usually made in the upper portion of the fungus. A drawing of a resting larva, taken from one of the chambers is shown in Figure 6 (Plate 2). Peculiar hooked hairs are found on the under side of the abdomen, as shown in the drawing. These hairs are found on all of the older larvae, but not on the younger ones (2-4 mm. long), nor on the pupae. Inasmuch as the points of the hooks are turned forward, it seems as if these hairs would seriously impede the forward locomotion of the larvae. However, this would probably not be a great hinderance to the larvae, since they move but a few inches during the month or more of their existence. No use for these hairs can be suggested until further knowledge of the habits of the larvae is obtained.

The first pupa from the larvae obtained April 17, 1901, appeared May 9th. These larvae, kept in a laboratory where the temperature was from 15°-22° C., had all pupated by the 13th of May. A drawing of one of the pupae is shown in Figure 8 (Plate 3). These pupae took from 8-10 days to mature, the first imago appearing May 19th. There is considerable variation in the date of the appearance of the imagines of this species, as larvae were obtained out of doors on May 29th. These did not begin to pupate till June 4th. The first of the beetles appeared in the imaginal state June 11th, while several did not appear until a few days later. It is probable that the beetles appear normally about the first of

June. As long as they were under observation, i.e., till the first part of July, they showed no signs of leaving the protected places about the fungus from which they hatched. Inasmuch as the *Polyporus* which serves the larvae as a food plant is an annual, there is probably but one brood during the year, the eggs not being deposited until fall.

*Thymalus* is a particularly good form for histological study, inasmuch as material seems to be plentiful wherever there is a food supply. It is of convenient size and has a relatively thin cuticula at every stage.

## 2. *Methods.*

Since *Thymalus* is a small beetle, it has been necessary in studying the anatomy of the musculature to resort to reconstructions from sections in place of dissections. Material killed in hot water, or by some method which gave no distortion, was used, and serial sections cut  $16\frac{2}{3} \mu$  in thickness. To obtain a plane for reconstruction, a "definition apparatus" made by Zimmermann has been used. By means of this apparatus, the lateral faces of the paraffin block were cut exactly perpendicular to each other and to the proposed plane of sectioning. Two adjacent lateral surfaces were then painted with a mixture of soft paraffin and lampblack, melting at about  $51^{\circ}$  C., after which each face was again trimmed in the "definition apparatus" so that only a very thin layer of paint was left.

The sections were cut on a Minot microtome in a plane perpendicular to that of the painted surfaces. In mounting the sections, much of the lampblack washes away, but, with ordinary care in the staining and other processes, enough adheres to the albumen affixative to give a very definite line at the outer edge of the lampblack area. A magnification of 120 diameters was used in all of the reconstructions, as this made the thickness of each section equivalent to 2 mm. The drawings made from the reconstructions have been reduced to  $\frac{1}{16}$  of their original size in the process of reproduction, so that the ultimate magnification in the plates is about 67.5 diameters.

Whole and partial preparations have been used in checking the results of reconstruction.

## 3. *Anatomical Changes of the Muscles.*

Early in my study of the histological alterations of the muscles in Coleoptera, it was found that all of the muscles do not undergo the same changes. Some remain unchanged from larva to imago, many metamorphose, and a few degenerate. Whether or not there were any newly

formed in the pupa, it was impossible to say without a systematic search. To settle this question, and also to find out precisely which muscles remain unchanged, which metamorphose and which degenerate, a detailed study of the musculature of the metathorax was made. This is for Coleoptera, the most important somite as far as the muscular system is concerned. After completing the study of the metathorax, it was found to be unnecessary to investigate the anatomical changes of the muscles of the other somites except in a general way.

In connection with this study of *Thymalus*, a dissection of *Colymbetes sculptilis* Harr., one of the Dytiscidae, was made in order to permit a closer comparison with the dissection of *Dytiscus marginalis* by Luks. The anatomy of the imaginal musculature of *Synchroa punctata* Newm. (Melandryidae) and of *Bruchus obtectus* Say (Bruchidae) has also been studied. The two latter species have been studied from serial sections, both being too small to be dissected successfully. This gives five beetles, of as many different families, for comparison, to which may be added the dissection of *Melolontha* by Straus-Dürkheim. Several points of difference in various muscles were found among these beetles, which are noted at the end of the description of the muscle in question. Where nothing is stated to the contrary, it may be understood that the conditions in the other forms agree essentially with those in *Thymalus*.

#### a. METATHORAX.

The muscles of the larval metathorax, or of any larval somite, may be naturally separated into three groups; the dorsal antero-posterior, the ventral antero-posterior, and the lateral dorso-ventral.

The function of most of the muscles of the larval metathorax is to aid in locomotion. Some of the lateral dorso-ventral muscles are attached to the legs and serve as flexors or extensors. The antero-posterior muscles of both groups serve to bend the body in one direction or another. All of the muscles are employed in a not very successful creeping movement, similar to the creeping movements of certain Annelids, such as the earthworm. That is, the longitudinal muscles oppose the dorso-ventral muscles through the medium of the body fluid.

In the imago the muscles may, or may not, retain their larval function. Most of the leg muscles retain their former function, but many of the others, including all of those which form the imaginal wing muscles, change their function during pupal life. From this, it is readily seen that many of the names of these muscles, given from their function in

the imago, are misnomers when applied to the muscle in its larval state. Even though such misnomers may cause confusion, they are retained in this paper because no better nomenclature is available at present.

In the detailed description of the muscles, the order followed is: (1) dorsal antero-posterior, (2) lateral dorso-ventral, and (3) ventral antero-posterior. By this arrangement, the wing muscles of the imago, both direct and indirect, are spoken of first.

(1) *The dorsal antero-posterior group of muscles* is shown in Figure 1 (Plate 1), which is a view of the left side of the *larval* metathorax seen from above (dorsal), anterior being up on the plate. Figure 2 is a similar view of the *pupal* metathorax. In the upper portions of Figure 9 (Plate 4) and Figure 11 (Plate 5) is shown the same group of muscles in the *imago* as they would appear when seen from the left side of the thorax, after cutting away the lateral wall of the metathorax.

*Musculus metanoti* of Luks.

(*Abaisseur de l'aile* of Straus-Dürkheim; *dorsal* of Amans.)

The *musculus metanoti* is one of the most important of the indirect wing muscles, since it functions as the principal depressor of the wing in the imago. In the *larva* (Plate 1, Figure 1, *mt'nt.*) it exists as three distinct muscles, extending from the anterior to the posterior boundary of the metathorax. At this stage the three muscles do not even lie parallel to one another. It is their subsequent history only which shows that they constitute one imaginal muscle. Just before pupation, in a larva which is no longer feeding, these three muscles show histological evidences of metamorphosis, which will be described later. There is very little change anatomically, till pupation, when there is a quite rapid shifting of the attachments of the three muscles, caused by the unequal growth of the hypodermis. In the *pupa* (Figure 2, *mt'nt.*) they still extend throughout the entire length of the somite, but have changed their relative positions so that now they lie parallel to one another. In the older pupa they grow in size until they touch each other, and in the young *imago* (Plate 4, Figure 9; Plate 5, Figure 11, *mt'nt.*) they become so united as to be almost indistinguishable. Each of the three original muscles has divided lengthwise into from three to nine fibres, so that the entire adult muscle is composed of about fifteen fibres.

During pupal life there is formed an ingrowth of the hypodermis along the dorsal portion of the suture between the meso- and metathorax, and from this is formed the mesophragma of the imago (Plate 4, Figure 9,

*ms'phg.*). Since the infolding hypodermis of the pupa carries with it the attachments of the anterior end of this muscle, the musculus metanoti is attached in the imago to the posterior face of the mesophragma. The metaphragma (*mt'phg.*) is formed by a similar infolding at the posterior margin of the somite, and consequently the posterior end of the muscle is attached to the anterior face of this ingrowth.

*Musculus lateralis metanoti* of Luks.

(*Prétracteur de l'aile* of Straus-Dürckheim; *latéro-dorsal* of Amans.)

This muscle is present in the *larva* (Plate 1, Figure 1, *l. mt'nt.*) as two, or occasionally three, fibres. When three fibres are present, the two more lateral are always closely approximated, as in the case figured; this, then, is a simple doubling of the more usual single fibre. These fibres do not stretch through the full length of the metathorax, but extend from a suture (Plate 1, Figure 2, *sut. a.*) — which probably represents the posterior boundary of the prescutum — posteriorly and laterally to the posterior edge of the somite. In the *pupa* (Figure 2, *l. mt'nt.*, drawn from an animal which had but two fibres in the larva) these two or three fibres become approximated, and in the old pupa fuse to form a single muscle. In the *imago* (Plate 4, Figure 9, *l. mt'nt.*) the attachments of this muscle are, anteriorly, to the anterior portion of the scutum, and, posteriorly, to the postscutellum and metaphragma.

The muscles which degenerate (Plate 1, Figure 1, *a, β, γ, δ, ε, ζ, η*) are, in general, those of the deeper layer, and all of them except *a* extend the full length of the somite. In the young *pupa* (Figure 2, *a, β, γ, δ, ε, ζ, η*) they are still present, showing, however, even anatomical evidences of degeneration. They are very irregular in outline, and do not extend in a straight course from origin to insertion, because they are greatly relaxed. No traces of them can be found in old pupae and imagines.

(2) *The lateral dorso-ventral group of muscles* of the larva is by far the most important of the three groups, since from it are developed nearly all of the muscles of the metathorax of the imago. This group is shown in lateral aspect for the larva in Figures 3 and 4 (Plate 1); for the pupa in Figure 5 (Plate 2) and Figure 7 (Plate 3), and for the imago in Figure 9 (Plate 4) and Figure 11 (Plate 5). Figures 4, 5, and 9 show the more superficial lateral layer of muscles in their respective stages. The group embraces no less than twenty-seven muscles on each side of the metathorax: viz.:



*Musculus lateralis metathoracis anterior* of Luks.

(Élévateur de l'aile of Straus-Dürkheim; sternali-dorsaux of Amans.)

In the *larva* (Plate 1, Figure 3, *l. mt' thx. a.*) this muscle is composed of two fibres, extending vertically downwards from the antero-dorso-lateral portion of the metathorax to their attachment near the anterior edge of the metathoracic leg. It serves as an extensor of the leg. Even in the young *pupa* (Plate 3, Figure 7, *l. mt' thx. a.*), these two fibres become so fused that they cannot be distinguished from each other, except in cross sections of the muscle. In common with the corresponding attachments of all of the dorso-ventral muscles, the ventral attachment of this muscle becomes shifted posteriorly by the very considerable posterior growth of the ventral portion of the metathorax. The muscle, therefore, changes in its general direction, becoming directed obliquely downward and backward. In the *imago* (Plate 5, Figure 11, *l. mt' thx. a.*) this muscle forms the anterior portion of the musculus lateralis metathoracis, which serves for the elevation of the wings. At its dorsal end, it attaches to the anterior lateral part of the scutum. Ventrally, it attaches near the median line of the metasternum; but, contrary to the condition found by Straus-Dürkheim in *Melolontha* and by Luks in *Dytiscus*, no fibres attach to the lateral faces of the median lamina of the metafurca (*mt' fur. 4*).

*Musculus lateralis metathoracis posterior* of Luks.

(Synonymy as with the anterior muscle.)

This muscle is found in the *larva* (Plate 1, Figure 3, *l. mt' thx. p.*) as a single fibre immediately posterior to musculus lateralis metathoracis anterior, with which it is nearly parallel. This relation is continued in all stages of the *pupa* (Plate 3, Figure 7, *l. mt' thx. p.*) and in the *imago* (Plate 5, Figure 11, *l. mt' thx. p.*). The muscle attaches in the imago, dorsally, to the lateral portion of the scutum and, ventrally, near the median line of the metasternum. In the adult *Thymalus*, the anterior and posterior muscles are separated farther from each other than in the larva; but in the other beetles examined, as well as in *Dytiscus* (Luks), they may be so fused that they cannot be readily distinguished from each other.

*Flexor coxae metathoracis secundus* of Luks.

(Second fléchisseur de la hanche of Straus-Dürkheim.)

While this muscle acts as a flexor of the posterior coxa, it also acts in the imago as an elevator of the wing. It is, therefore, described here

among the wing muscles. In the *larva* (Plate 1, Figure 3, *flx. cox. mt'thx. 2*) it is composed of three fibres, extending from the dorso-lateral portion of the metathorax vertically downward, and attaching to the posterior side of the leg. It serves in this stage exclusively as a flexor of the coxa, since no wings are present. The three fibres become closely approximated during *pupal* life (Plate 3, Figure 7, *flx. cox. mt'thx. 2*). The dorsal attachment in the *imago* (Plate 5, Figure 11, *flx. cox. mt'thx. 2*) is to the posterior part of the scutum, from which it extends downward and backward to attach to the ventral surface of the middle of the coxa.

*Extensor alae magnus metathoracis* of Luks.

(*Extensor antérieur de l'aile* of Straus-Dürckheim; *préaxillaire* of Amans.)

The great extensor of the wings is composed in the *larva* (Plate 1, Figure 4, *ext. al. mag. mt'thx.*) of either three or four fibres, there being individual variations. These fibres, which are very short, are found in the lateral ventral portion of the metathorax, immediately above the base of the larval leg, and extend nearly vertically. They probably have some connection with the leg movements. These fibres elongate very rapidly in the *pupa* (Plate 2, Figure 5, *ext. al. mag. mt'thx.*) and fuse completely at their dorsal ends. During this growth, the dorsal end shifts its position very noticeably, so that its attachment comes to lie in the antero-lateral portion of the somite. By the time the *imaginal* state (Plate 4, Figure 9, *ext. al. mag. mt'thx.*) is attained, the muscle has increased still more in size, and its fibres are so fused as to show but two parts, which are separated at the ventral end only. It extends from what is known as the large cupule — a tendon formed during pupal life — backward and downward to the middle of the lateral expanse of the metasternum. The posterior portion of the muscle at its ventral end attaches to a chitinous ingrowth from the metasternum.

This muscle in *Colymbetes* is also very plainly divided into anterior and posterior portions, the division being much plainer than Luks has shown for *Dytiscus*. The division into two parts is not as apparent in *Synchroa* and *Bruchus* as in *Thymalus*.

*Extensor alae parvus metathoracis* of Luks.

(*Troisième fléchisseur de la hanche et extenseur postérieur de l'aile* of Straus-Dürckheim; *postaxillaire* of Amans.)

Besides acting as an extensor of the wing in the *imago*, this muscle is also the *third flexor of the metathoracic coxa*. It is composed in the *larva*

(Plate 1, Figure 3, *ext. al. pa. mt'thx.*) of two fibres, which extend from the posterior lateral surface of the metathorax ventrally, and a little toward the median plane to attach to the posterior edge of the leg, very close to the attachment of the second flexor of the coxa. At this stage its only function is that of flexor of the coxa. In the *pupa* (Plate 2, Figure 5, *ext. al. pa. mt'thx.*) a fusion of the two fibres takes place, and a very considerable shifting of position. The attachments of this muscle in the *imago* (Plate 4, Figure 9, *ext. al. pa. mt'thx.*) are, dorsally, to the small cupule, which is placed immediately posterior to the large cupule, and, ventrally, to the ventral surface of the coxa just lateral to the insertion of the second flexor of the coxa.

*Relaxator extensoris alae* of Luks.

(*Releveur de la grande cupule* of Straus-Dürckheim ;  *dorso-préaxillaire* of Amans.)

There is some doubt as to the larval condition of this muscle and the few muscles next described ; this is due principally to their small size. During pupal life, this muscle and the relaxator alae metathoracis are so closely united as to be indistinguishable. In fact, there is little more than a mass of tissue containing remains of larval muscle and having about the position indicated in Figure 5 (Plate 2) by *rlx. ext. al.* and *rlx. al. mt'thx.* Out of this mass are differentiated the two muscles mentioned above. In the *imago* the relaxator extensoris alae (Plate 4, Figure 9, *rlx. ext. al.*) is inserted on the edge of the large cupule to which the extensor alae magnus metathoracis is attached. Its origin lies almost directly dorsal to this point on the wing-bearing apophysis.

*Relaxator alae metathoracis* of Luks.

(*Relaxateur de l'aile* of Straus-Dürckheim ; *muscles du tampon* of Amans.)

The attachments of this muscle in the *imago* (Plate 4, Figure 9, *rlx. al. mt'thx.*) are as follows. Its origin is on a small cupule placed near the dorsal attachment of the musculus lateralis metathoracis anterior (Plate 5, Figure 11, *l. mt'thx. a.*), from which it extends laterally, and somewhat ventrally, to attach on the base of the wing.

As to the larval condition of the two muscles last described (*rlx. ext. al.*, *rlx. al. mt'thx.*), it seems probable that they are derived from three fibres. It is possible, and even probable, that the two fibres so marked (Plate 1, Figure 4, *rlx. ext. al. ?*) give rise to the relaxator extensoris alae of the imago, and that the other fibre (Plate 1, Figure 4, *rlx. al.*

*mt'thx.?*) gives rise to the relaxator alae metathoracis. If this be so, then the two muscles probably remain distinct throughout pupal life. Certainly the positions of these larval fibres correspond very closely with the positions of the two muscles in the imago, and the identification seems the more probable when one takes into account the shifting in positions of the extensor alae magnus metathoracis and other muscles which attach near by. There is no doubt but that both of the muscles under discussion are metamorphosed larval muscles, not muscles newly formed in the pupa.

*Flexor alae metathoracis primus et secundus.*

(*Fléchisseur de l'aile* of Straus-Dürckheim; *entopleuro-dorsal* of Amans.)

*Larva* (Plate 1, Figure 4, *flx. al. mt'thx. 1, 2*). These flexors are found in the larva as single fibres, running nearly parallel with each other. They extend almost vertically from the dorso-lateral portion of the somite to the ventro-lateral portion. The positions in the *pupa* (Plate 2, Figure 5, *flx. al. mt'thx. 1, 2*) are changed but slightly. In the *imago* (Plate 4, Figure 9, *flx. al. mt'thx. 1, 2*), they extend from the posterior portion of the base of the wing, ventrally and posteriorly, to attach to the dorsal edge of the episternum.

*Flexor alae metathoracis tertius.*

(Synonymy as in *primus* and *secundus*.)

The facts concerning this muscle are much the same as those concerning the relaxator extensoris alae and the relaxator alae metathoracis. In the *larva* (Plate 1, Figure 3, *flx. al. mt'thx. 3?*) there are usually three fibres, sometimes two as shown in the figure. These fibres lie parallel and close together, extending from the antero-lateral portion of the metathorax to the antero-ventro-lateral portion, and show all the evidences of metamorphosis in older larva. In the young pupa it is very difficult to trace their development, but it is probable that they form the mass of tissue shown in Figure 5, *flx. al. mt'thx. 3* (Plate 2). From this mass of tissue is developed the third flexor of the wing in the *imago* (Plate 4, Figure 9, *flx. al. mt'thx. 3*). This muscle in its adult condition is composed of three parts, which attach by a common tendon on the anterior part of the base of the wing.

These flexors are so different from those described by Straus-Dürckheim for *Melolontha* that their homologies are somewhat uncertain. The third flexor in *Thymalus* is probably homologous with the three flexors

of Melolontha, though possibly the three flexors of Thymalus are respectively homologous with the three of Melolontha.

Luks states that he is unable to find more than one flexor of the wing in Dytiscus. As a matter of fact, the muscle which he has described as the flexor of the wing is the fourth flexor of the posterior coxa. This may be seen in his own figure (Tafel 23, Figur 12, *fa.*), where this muscle is shown attaching to the lateral edge of the posterior coxa, and occupying a position exactly similar to that of the fourth flexor of the coxa as shown by Straus-Dürckheim and myself (Plate 4, Figure 9, *flx. cox. mt'thx. 4*). This conclusion is corroborated by the dissection of Colymbetes, where not only the fourth flexor of the coxa, but also the three flexors of the wing are found occupying their usual positions. Inasmuch as the muscles of Colymbetes are almost exactly identical with those of Dytiscus, it is certain that Luks overlooked the flexors entirely.

The conditions in Synchrona and Bruchus are much like those in Thymalus, except that in both of these beetles the second and third flexors are fused into a single muscle. The third flexor is divided in both cases into three parts, which attach on the base of the wing by a common tendon.

The muscles described thus far are all muscles of flight, acting either directly or indirectly on the wing. Those now following have very little, if any, action on flight.

*Musculus mesofurcae dorsalis.*

(Abaisseur du diaphragme of Straus-Dürckheim; *musculus furcae dorsalis* of Luks.)

In the *larva* (Plate 1, Figure 3, *ms'fur. d.*), this is one of the muscles which extend dorso-ventrally along the suture between the meso- and metathorax. It attaches laterally, and extends to a ventro-lateral position. The position of this muscle changes very little during *pupal* life (Plate 3, Figure 7, *ms'fur. d.*), but there are ingrowths of hypodermis at both dorsal and ventral attachments. The dorsal ingrowth forms in the *imago* the inferior process of the mesophragma (*prc. if. ms'phg.*), to the tip of which this muscle (Plate 5, Figure 11, *ms'fur. d.*) attaches. The ventral attachment is to the ventral ingrowth which forms the mesofurca (*ms'fur.*) in the *imago*.

*Musculus lateralis processus inferioris mesophragmatis.*

In the *larva*, this muscle (Plate 1, Figures 3, *l. prc. if. ms'phg.*) is a simple fibre, whose dorsal end attaches to the suture between the meso-

and metathorax in a dorso-lateral position, and whose ventral attachment is on the antero-ventro-lateral surface of the metathorax. In the *pupa* this fibre (Plate 3, Figure 7, *l. prc. if. ms'phg.*) shortens very considerably, but no more than would be expected from the growth of the extensor alae magnus metathoracis during the same period. The dorsal attachment of the extensor is just ventral to the ventral end of this muscle, so that dorsal growth of the former, necessarily means a shortening of the latter. The attachments of this muscle in the *imago* (Plate 5, Figure 11, *l. prc. if. ms'phg.*) are, medianly, to the inferior process of the mesophragma, and, laterally, just posterior to the metathoracic stigma.

This muscle was not found by Straus-Dürckheim in *Melolontha*, nor by Luks in *Dytiscus*, nor was I able to find it in *Colymbetes*. It may be present in some of these beetles, however, as it might easily be overlooked in the dissections, on account of its small size. It is present in both *Synchroa* and *Bruchus*, occupying the same position as in *Thymalus*.

*Musculus lateralis mesofurcae.*

In the *larva* (Plate 1, Figure 4, *l. ms'fur.*) this muscle is found as two nearly parallel fibres which extend from the antero-ventro-lateral portion of the metathorax, anteriorly and ventrally, to the suture between the meso- and metathorax near the ventral attachment of the musculus mesofurcae dorsalis. The two fibres fuse so as to be indistinguishable in the *pupa* (Plate 3, Figure 7, *l. ms'fur.*), maintaining, however, a closely similar position. The attachments in the *imago* (Plate 5, Figure 11, *l. ms'fur.*) are, medianly, to the tip of the mesofurca (*ms'fur.*), and, laterally, just posterior and ventral to the metathoracic stigma (*stg. mt'thx.*).

This muscle is not mentioned by either Straus-Dürckheim or Luks. It also did not show in my dissection of *Colymbetes*, nor could it be found in the sections of *Bruchus*. It is present in *Synchroa*, however, extending from the mesofurca to the lateral wall of the metathorax as in *Thymalus*.

*Depressor tergi.*

(*Abaisseur du tergum* of Straus-Dürckheim.)

In the *larva* the depressor tergi (Plate 1, Figure 3, *dep. trg.*) is a single fibre, extending dorso-ventrally along the suture between the metathorax and the first abdominal somite. In the young *pupa* (Plate 3, Figure 7, *dep. trg.*) there is a very evident bend both in this muscle and

in flexor processus postero-lateralis metafurcae, the muscle next to be described. This bend is caused by the presence of a large trachea, a branch from the trunk arising at the first abdominal stigma. The trachea lies in such a position that the muscles are bent around it when their ventral attachments shift posteriorly. In older pupae the relations of these parts become readjusted so that there is no bend in the muscles. The metafurca commences to form very early in the pupa, and by its ingrowth carries in the ventral attachments of this muscle, together with that of several other muscles. On account of the ingrowth, this muscle is shortened in later pupal life until, in the *imago* (Plate 5, Figure 11, *dep. trg.*), it has about one third of its original length. The attachments are, dorsally, to the suture between metathorax and abdomen, the same as in the larva, and, ventrally, to the tip of the posterior lateral horn of the metafurca (*mt'fur. 2*).

The depressor of the tergum is frequently fused with the muscle next to be described, this being the case in *Bruchus* and *Colymbetes*. This condition is probably found in *Dytiscus*, though Luks does not figure either of the muscles.

*Flexor processus postero-lateralis metafurcae.*

(Fléchisseur latéral de l'apophyse épisternale postérieure of Straus-Dürckheim.)

This muscle in the *larva* (Plate 1, Figure 3, *flx. prec. p-l. mt'fur.*) has a position exactly parallel with that of the muscle last described, but is shorter, lying more laterally. During *pupal* life (Plate 3, Figure 7, *flx. prec. p-l. mt'fur.*) there is an ingrowth of the hypodermis at both dorsal and ventral attachments, so that in the *imago* (Plate 5, Figure 11, *flx. prec. p-l. mt'fur.*) this muscle lies in a horizontal position instead of a vertical one as formerly. This change in position is in such a direction that the former ventral end lies mediad. The process formed ventrally is the metafurca, this muscle being attached to its posterior lateral horn (*mt'fur. 2*). The lateral attachment is to the inferior process of the metaphragma (*prec. inf. mt'phg.*).

The flexor of the posterior lateral horn of the metafurca was found by Straus-Dürckheim, but not by Luks. It is certain that it is present in *Dytiscus*, however, since it is present in *Colymbetes*, extending from the posterior lateral horn of the metafurca to the inferior part of the metaphragma, there being no inferior process. In *Colymbetes*, as also in *Bruchus*, the depressor tergi and this muscle are fused, the development

of their attachments being such that they lie parallel and close together. The conditions in *Synchroa* and *Melolontha* agree with those in *Thymalus*.

*Musculus episternalis.*

(*Muscle expirateur dans le métathorax* of Straus-Dürckheim; *Expirationsmuskel* of Luks.)

This is a muscle of which no trace can be found in the larva or young pupa. Therefore it is probably a muscle of new formation in the pupa. In the *imago* (Plate 4, Figure 9, *e'stn.*) it is found just beneath the episternum. Its origin is near the dorsal edge of the episternum, from which it extends obliquely downward and mediad to attach to the ventral edge of the episternum. It was described and figured by Straus-Dürckheim ('28), who ascribed to it the function of an expiratory muscle. In his own words (p. 164), "It is only by conjecture that I regard this muscle as acting in respiration, not being able to ascribe to it any other function." Also (p. 165), "This muscle, being placed between two pieces of the case which forms the thorax, does not appear to act either in flight or in the movements of the legs, and, as it compresses the thoracic cavity, and so necessarily compresses the trachea, I believe it ought to be regarded as an expiratory muscle." Luks adopts these views without comment.

That this is not the function in *Thymalus*, is shown by a cross section of the thorax in the region of this muscle (Plate 6, Figure 13). Here the elytron (*ely.*) is shown hooked into a fold (*pli.*) on the episternum by means of a ridge (*loph.*) on the inflexed edge of the elytron. The elytron after being hooked into the fold is held firmly in place by the interlocking of the teeth along the inner surface of the elytron with those on the outer surface of the metathorax at the place indicated by a star (★) and by the teeth on the inner side of the fold (*pli.*). This fold extends antero-posteriorly along the episternum as far as the muscle reaches. The contraction of the muscle releases the elytra by bringing the cuticula into the position shown by the dotted lines. This muscle is aided in its action by a pull on the bases of the elytra by their extensor muscles. The contraction of this muscle would be necessary in replacing the elytra, as it would depress the fold for the reception of the ridge.

The episternal muscle is present in all of the beetles examined, as also in *Melolontha* and *Dytiscus*. Yet the elytra of some of these species do not lock into a fold when closed, so that in such cases the muscle is probably functionless.



The remaining muscles of the lateral dorso-ventral group are all leg muscles, either flexors or extensors. The homologies with the muscles of *Dytiscus* are not all entirely certain, because the leg muscles of *Dytiscus* are so different from those of *Melolontha* and *Thymalus*, that the homologies are not always evident.

*Flexor coxae metathoracis primus.*

(*Premier fléchisseur de la hanche* of Straus-Dürckheim; *extensor trochanteris metathoracis* of Luks.)

This muscle is found in the *larva* (Plate 1, Figure 4, *flx. cox. mt'thx. 1*) as one fibre, whose origin is on the ventral portion of the suture between the metathorax and the abdomen, and whose insertion is on the outside surface of the leg on a portion which later forms the coxa of the adult. In the *pupa* (Plate 3, Figure 7, *flx. cox. mt'thx. 1*) its position is changed greatly by the formation of the metafurca, and the shifting of the leg posteriorly. The origin of this muscle in the *imago* (Plate 5, Figure 11, *flx. cox. mt'thx. 1*) is on the posterior part of the median lamina of the metafurca (*mt'fur. 4*), and its insertion, on the anterior ventral edge of the coxa about one third of the distance from the trochanter to the lateral edge of the coxa.

For an account of *Flexor coxae metathoracis secundus*, see page 325, and for an account of *Flexor coxae metathoracis tertius*, see page 326.

*Flexor coxae metathoracis quattuor.*

(*Quatrième fléchisseur de la hanche* of Straus-Dürckheim; *flexor alae metathoracis* of Luks.)

This is the second muscle of the imaginal metathorax which has not been found in the larva. It is found in younger pupae than is the first muscle (*musculus episternalis*), but it is probably a muscle of new formation in the *pupa* (Plate 2, Figure 5, *flx. cox. mt'thx. 4*). In the *imago* (Plate 4, Figure 9, *flx. cox. mt'thx. 4*) it takes its origin near the middle of the dorsal side of the episternum, and, extending caudad and a little ventrad, is inserted on the extreme anterior lateral edge of the coxa. This is the muscle which Luks has incorrectly described for *Dytiscus* as the flexor of the wing.

*Flexor coxae metathoracis quintus.*

(*Cinquième fléchisseur de la hanche* of Straus-Dürckheim; *musculus furcae dorsalis* of Luks.)

The fifth metathoracic flexor of the coxa is found in the *larva* (Plate 1, Figure 4, *flx. cox. mt'thx. 5*) as a single fibre, extending from the latero-

ventral portion of the suture between the metathorax and abdomen to the postero-lateral portion of the metathorax. In the *pupa* (Plate 3, Figure 7, *flx. cox. mt'thx. 5*) this muscle has changed its position considerably, extending more nearly laterad from the newly forming metafurca. Its origin in the *imago* (Plate 5, Figure 11, *flx. cox. mt'thx. 5*) is on the anterior portion of the median lamina of the metafurca (*mt'fur. 4*). From this it extends laterad and a little caudad, attaching by a long tendon to the suture between the metasternum and coxa, a little dorsal to the insertion of the muscle last described.

*Extensor coxae metathoracis primus.*

(*Premier extenseur de la hanche* of Straus-Dürckheim; *extensor trochanteris metathoracis* of Luks.)

This extensor is composed of a single fibre in the *larva* (Plate 1, Figure 4, *ext. cox. mt'thx. 1*), whose origin is on the ventral portion of the suture between the metathorax and abdomen; its insertion is on the postero-lateral surface of the upper part of the larval leg. In the *pupa* (Plate 3, Figure 7, *ext. cox. mt'thx. 1*) its position has changed to some extent, as a result of the changes in position of both its attachments. Its origin in the *imago* (Plate 5, Figure 11, *ext. cox. mt'thx. 1*) is on the posterior face of the lateral wing of the metafurca (*mt'fur. 3*), from which it extends ventrad and caudad to its insertion on the posterior median surface of the coxa.

*Extensor coxae metathoracis secundus.*

(*Second extenseur de la hanche* of Straus-Dürckheim; *extensor trochanteris metathoracis* of Luks.)

This muscle properly belongs to the first abdominal somite, but since it acts as an extensor of the coxa in some beetles, it is spoken of here among the muscles of the metathoracic leg. In the *larva* this muscle forms part of the ventral antero-posterior group of muscles of the first abdominal somite. During *pupal* life (Plate 3, Figure 7, *ext. cox. mt'thx. 2*) there is a great change in this group of muscles. Some degenerate, while the remainder metamorphose, to form this so-called extensor of the coxa, which in the *imago* (Plate 5, Figure 11, *ext. cox. mt'thx. 2*) is divided into two parts. The origin of these muscles is on the posterior side of the posterior lateral horn of the metafurca (*mt'fur. 2*) and their insertion, on the boundary between the first and second abdominal somites, very close to the median face of the metacoxa.

At first sight it seems impossible that larval muscles, extending antero-posteriad the full length of the first abdominal somite, should be transformed into extensors of the coxa of the imago. In *Thymalus*, indeed, these muscles have no such function in the imago, but in forms in which the ventral plate of the first abdominal somite becomes completely eliminated, it does not seem improbable that such a shifting of position takes place. In *Thymalus* their function is that of ventral protractors of the second abdominal somite.

*Extensor coxae metathoracis tertius* of Luks.

(*Troisième extenseur de la hanche* of Straus-Dürckheim.)

The third extensor of the coxa is present in the *larva* (Plate 1, Figure 4, *ext. cox. mt'thx. 3*) as two fibres extending dorso-ventrally from the dorso-lateral part of the metathorax to the ventro-lateral part. In the *pupa* (Plate 2, Figure 5, *ext. cox. mt'thx. 3*) the ventral attachment is shifted posteriorly, so that the muscle extends obliquely from an antero-dorsal to a postero-ventral position. The origin of this muscle in the *imago* (Plate 4, Figure 9, *ext. cox. mt'thx. 3*) is on the lateral edge of the scutum and the insertion, on the dorso-median edge of the coxa.

*Extensor trochanteris metathoracis* of Luks.

(*Extenseur du trochanter* of Straus-Dürckheim.)

The extensor of the trochanter in the imago is divided into two parts, — the long and the short heads. In the reconstruction only the pupal and imaginal conditions of the long head have been determined. In the *pupa* a muscle (Plate 3, Figure 7, *ext. trehn. mt'thx.*) is found which shows histologically that it is a metamorphosed larval fibre; this forms the long head of the extensor trochanteris in the *imago* (Plate 3, Figure 7, *ext. trehn. mt'thx.*). Its origin is on the posterior face of the lateral wing of the metafurca (*mt'fur. 3*), very close to the origin of the first extensor of the coxa. Its insertion is on an apodeme which projects from the median side of the trochanter. The short head of this muscle attaches to the same apodeme, and would show in the same figures as the long head, if it had been reconstructed.

The *flexor trochanteris metathoracis* would likewise have been visible in Figure 7 (Plate 3) and Figure 11 (Plate 5), if it had been reconstructed.

The remainder of the imaginal leg muscles are metamorphosed larval muscles. The details of their changes have not been studied out.

This ends the description of the changes of the lateral dorso-ventral

group of muscles, with the exception of three larval muscles which degenerate during pupal life. Two of these muscles (Plate 1, Figure 3,  $\lambda$ ,  $\mu$ ) extend dorso-ventrally along the suture between the meso- and metathorax. They do not disappear for some time, and are shown in the figure of the *pupa* (Plate 3, Figure 7,  $\lambda$ ; Plate 2, Figure 5,  $\mu$ ). The third of these degenerating muscles (Plate 1, Figures 3, 4,  $\nu$ ) extends the full length of the metathorax. It lies in the lateral part of the somite extending obliquely from antero-dorsal to postero-ventral. This muscle is one of the first to disappear, and so is not shown in the figure of the pupa.

(3) *The ventral antero-posterior group* consists in the larva of eight muscles, five of which fuse to form the single representative of this group in the imago. This muscle is shown in the reconstruction drawings only in the pupa (Plate 3, Figure 7, *rtr. ms'thx. if.*) and in the imago (Plate 5, Figure 11, *rtr. ms'thx. if.*); in both the view is from the left side of the insect. Cross sections of this group (*rtr. ms'thx. if.*,  $\theta$ ,  $\iota$ ,  $\kappa$ ) are shown in Figure 10 (Plate 4) for the larva, and in Figure 12 (Plate 5) for the young pupa.

*Retractor mesothoracis inferior* of Luks.

(*Prétracteur de l'apophyse épisternali postérieure* of Straus-Dürckheim.)

The five larval muscles (Plate 4, Figure 10, *rtr. ms'thx. if.*), all of which extend the full length of the somite, become in the *pupa* (Plate 5, Figure 7, *rtr. ms'thx. if.*) closely approximated to form a single muscle. This, by the ingrowth of the meso- and metafurcae, comes to have in the *imago* the position shown in Figure 11, *rtr. ms'thx. if.* (Plate 5). Here its origin is seen to be on the anterior lateral horn of the metafurca (*mt'fur. 1*) and its insertion on the mesofurca (*ms'fur.*).

The three remaining larval muscles of this group ( $\theta$ ,  $\iota$ ,  $\kappa$ ), degenerate during pupal life (Figure 10, larva; Figure 12, pupa). These muscles extend the full length of the somite, form the deeper layer of this group, and present in general the same characteristics as the degenerating muscles of the dorsal group.

Summing up the changes which take place in the muscles of the metathorax during pupal life, we find:

a. That not a single larval muscle persists unaltered from larva to imago.

b. That the great majority of the larval muscles metamorphose into adult muscles, and

c. That thirteen of the larval muscles degenerate, these being in general dorso-ventral intersegmental muscles and the inner layer of the antero-posterior muscles. Two of the imaginal muscles (musculus episternalis and flexor coxae metathoracis quattuor) are muscles of new formation in the pupa.

#### b. MESOTHORAX.

In the mesothorax the muscles are arranged similarly to those of the metathorax. For the dorsal group of antero-posterior muscles, the figures of the similar group of the metathorax (Plate 1, Figures 1, 2) would serve with only minor changes. It is very interesting to find that the serial homology is practically complete even to the changes which take place during pupal life. The three muscles which in the metathorax metamorphose into musculus metanoti have counterparts in this somite which metamorphose into *musculus mesonoti*. The same relations hold true between musculus lateralis metanoti and *musculus lateralis mesonoti* (*retracteur de l'aile* of Straus-Dürckheim). The remaining mesothoracic muscles of this group degenerate during pupal life, as do their counterparts of the metathorax.

The close similarity of the muscles of the lateral dorso-ventral groups in the two somites is likewise remarkable. A careful comparison between these muscles in a series of frontal sections of a resting larva showed only the following slight anatomical differences. The muscle in the mesothorax corresponding to the third extensor coxae metathoracis (Plate 1, Figure 4, *ext. cox. mt' thx. 3*) was composed of three fibres instead of two, and the muscle corresponding to the oblique muscle  $\nu$  (Figure 4) was divided dorsally into two parts. The changes of the mesothoracic muscles of this group do not correspond exactly to the changes of their counterparts in the metathorax. A greater number of muscles degenerate in the mesothorax than in the metathorax. The additional muscles of this somite which have been noticed to degenerate are the musculus lateralis mesothoracis and the second flexor of the coxa. It is evident from the muscles which are present in the imago that a few others degenerate also, but their identity has not been established. These additional degenerating muscles are such as would function in the imago as muscles of flight, if the elytra were used as organs of flight.

In the ventral antero-posterior group, only seven muscles are found in the larva; three of these degenerate, while the remaining four metamorphose to form the *retractor prothoracis inferior*. The only difference between the metathorax and the mesothorax in this case is, that in the latter there are only four metamorphosing muscles, whereas, in the

former, there are five. The outline of the retractor of the prothorax is shown by the dotted lines in Figure 11, *rtr. prothx. if.* (Plate 5). This shows the imaginal position of the muscle, its origin being on the mesofurca and its insertion on the antefurca.

c. PROTHORAX.

The serial homology between the muscles of this somite and those of meso- and metathorax is not so marked as between those just compared. Yet, in general, muscles in similar positions undergo similar changes. The great majority of the larval muscles of the prothorax metamorphose into imaginal muscles, but a number degenerate. None of the larval muscles pass unchanged into the adult.

d. HEAD.

The muscles of the head of the larva are probably all metamorphosed into imaginal muscles, for there is no evidence that muscles degenerate, nor do any of the muscles remain unchanged. One point in regard to the adductor of the mandible may be of interest. In the larva this muscle is composed of about fifty fibres, whereas in the imago the same muscle has from two to three hundred fibres of smaller calibre, which have been formed by the longitudinal splitting of the larval fibres.

e. ABDOMEN.

The abdomen is the only region of the body where any muscle remains unaltered from the larva to the imago. The abdominal muscles which have this fate occupy in general positions homologous with those of the muscles of the thoracic region which undergo degeneration. They are the inner muscles of the dorso-ventral intersegmental muscles and the inner layer of the antero-posterior muscles. Most of the remaining larval muscles in the abdomen metamorphose into imaginal muscles; there are a few, however, which degenerate. The latter are found in the somites in which the greatest changes in external form take place during pupal life, i. e., the first and last abdominal somites. No muscles newly formed in the pupa have been observed, though some may be present. Such are quite probably to be found in connection with the sexual organs, — ovipositors, etc.

Two of the metamorphosed muscles of the first abdominal somite are shown at *ab*, in Figure 9 (Plate 4). The metamorphosis of extensor coxae metathoracis secundus from muscles of the first abdominal somite has already been described (page 334).

*f. APPENDAGES.*

The imaginal appendicular muscles of *Thymalus* are apparently all metamorphosed larval muscles. No evidence of the degeneration of larval muscles nor of the new formation of imaginal muscles in the pupa has been observed. The changes of these muscles in some beetles are quite different from those of *Thymalus*. This is especially true of the forms with legless grubs. In these, the imaginal leg muscles are of new formation in the pupa.

4. *Discussion of Results.*

Summing up the anatomical changes which the muscles of *Thymalus* undergo during pupal life, we find that :

1. The only larval muscles which remain unchanged in both position and histological structure are found in the abdominal region, this being the region of least change in external form during pupal life. This persistence of the larval muscles might have been inferred from the fact that the pupa retains throughout life the power to roll itself about by means of the movements of the abdominal somites on each other.

2. However, only about half of the larval muscles of the abdomen remain unchanged, those of the more peripheral layers undergoing a metamorphosis into imaginal muscles. Most of the muscles of the larval thorax and all of the muscles of the head and appendages metamorphose into imaginal muscles.

3. The larval muscles which degenerate are found in the thorax and the first and last abdominal somites. They occupy in nearly every case positions similar to the positions of the muscles of the abdomen which persist unaltered by the metamorphosis. Exceptions to this statement have been noted in the mesothorax, where there is a degeneration of dorso-ventral muscles other than intersegmental ones.

4. Probably two new metathoracic muscles are formed during pupal life, one being a flexor of the metathoracic coxa and the other, the muscle which operates the fold of the episternum into which the elytra catch when closed.

The most radical changes in the musculature are found in the thoracic region. This is to be expected as the imaginal thorax differs greatly from the larval in both form and function. The least radical changes are found in those somites of the abdomen whose larval condition most resembles the imaginal. The serial homology between the degenerating muscles of the thoracic region and the persistent larval muscles of the

abdominal region is a curious fact of which no explanation can be offered.

The direct descent of most of the imaginal muscles from larval muscles, which has here been shown, will help in solving some of the difficult problems of the comparative myology of insects, — a subject about which little is known. Hitherto the only basis of comparison between the muscles of metabolic and ametabolic insects, or between the muscles of different metabolic insects, has been the origin and insertion of the muscles in the imago. No attention has been paid to the larval musculature, since this has been generally supposed to have no connection with the imaginal. But, as this paper shows, there is a close connection between the larval and imaginal musculature in Coleoptera, and a similar connection will probably be found to exist in most of the metabolic insects. With this relation as a basis for comparisons, the simpler conditions — the larval — may be used in establishing the homologies instead of the more complex, — the imaginal. And this, not only for comparison between different metabolic insects, but also between metabolic and ametabolic insects.

A word ought, perhaps, to be added to meet the possible criticism, that in some of the muscles there are such radical differences between the conditions in the stages figured that the identity of the various muscles in successive stages is doubtful. In answer to this, it may be stated that not only the stages figured, but also several intermediate stages, have been studied. The dorso-ventral metathoracic muscles have been identified with the help of camera sketches in four individuals in stages of development intermediate between the stages used in making the reconstructions. Numerous other animals have been used in which a part of these muscles have been identified. The antero-posterior muscles are much simpler, and have been identified in as many as twenty cases.

## Part II. — Histology.

### A. HISTORICAL SURVEY.

This review of researches on the histological changes of the muscles during the metamorphoses of insects has been arranged in four parts corresponding to the four principal groups of holometabolic insects. Such an arrangement is used rather than a simple chronological one, because so little comparative work has been done that the mutual relations of the changes of the various groups are not entirely understood. The studies



on Coleoptera will be spoken of first, and in greater detail than those on the other groups, as they are of more interest in connection with this paper. None of the researches on Coleoptera had, as a main object, the study of the muscular changes, and most of the investigators speak of them only incidentally.

*Coleoptera.* The first paper in chronological order is that of Rengel ('96), who describes the changes which occur in the midintestine of *Tenebrio* during metamorphosis, including a description of the changes of the intestinal muscles. The muscle layer of the larval intestine degenerates into a structureless protoplasmic zone in the late larva and early pupa. In this protoplasmic zone the individual muscle fibres can no longer be distinguished, though the nuclei of the larval fibres remain unaltered. No phagocytes ("Körnchenkugeln" of Weismann, '64) are present, this degeneration being entirely chemical. The intestinal muscles of the imago develop in this protoplasmic zone, but the exact method of their formation is somewhat in doubt. Apparently, part or all of the nuclei of the larval muscles remain and form the new muscles out of the material in which they are embedded.

De Bruyne ('97), speaking of phagocytosis in the development of invertebrates, treats of the changes in the hypodermal muscles of *Tenebrio* during metamorphosis. He finds a degeneration of the larval muscles, which begins with a chemical alteration of the muscle substance. The muscles soon break into fragments, which later are engulfed in leucocytes acting as phagocytes, thereby forming "Körnchenkugeln." These muscle fragments undergo fatty degeneration in the phagocytes, each becoming surrounded by a vacuole. The vacuoles with their contents fuse with one another until each phagocyte contains a few large vacuoles with correspondingly large fat globules inside. These fat globules are then dispersed to the growing tissues, leaving the large vacuoles in the cytoplasm of the phagocyte. This is the beginning of degeneration for many of the phagocytes.

Krüger ('98), describing the development of the wings in beetles (*Tenebrio*, Lema), states that he finds two larval muscles at the base of the wing (the flexor alae metathoracis, judging from his figures) which metamorphose into wing muscles of the imago. He concludes from this that the wing muscles of the adult are metamorphosed larval muscles. He also finds in the blood what he calls "Weismannsche Körnchenzellen."

In an article on the anatomy and metamorphosis of the intestinal canal of *Anobium*, Karawaiew ('99) states that there is no phagocytosis

of the muscles of the larva. The changes of the muscles are similar to those in *Lasius*, as described by himself ('98).

Deegener (:00) describes the metamorphosis of the intestine in *Hydrophilus*. His observations on the changes of the intestinal musculature differ in many fundamental points from those of Rengel on *Tenebrio*. He finds typical phagocytosis, such as Kowalevsky ('87) and Van Rees ('88) found in *Muscidae*. The phagocytes make their appearance in the old larvae, engulfing both sarcoytes (muscle fragments) and muscle nuclei. They then do not become scattered through the body, but degenerate—in larger part at least—in the lumen of the pupal intestine. Spindle cells whose origin is uncertain, but which cannot have been derived from the nuclei of the larval muscle, appear in the old larvae. In the muscle layer of the pupa, the changes are difficult to follow on account of the close intermingling of diverse elements. The spindle cells give rise to the imaginal musculature, but he does not describe the process clearly, nor give figures.

In the midintestinal region, there are so few phagocytes that they are not sufficient to entirely account for the disintegration of the muscles, so that, in this case, there must be chemical degeneration as well. The source of the imaginal musculature in this region is doubtful, as no spindle cells could be distinguished. Deegener thinks, however, that spindle cells are present in the closely intermingled elements of the muscle layer, and that the imaginal muscles are derived from them.

Berlese (:00, :01, :02<sup>a</sup>) speaks of the histolysis and histogenesis of the hypodermal muscles in *Aphodius* and other *Coleoptera*. He states that the larval muscles are dissolved, but that the nuclei resist dissolution. These nuclei emigrate from the degenerating larval muscles, acquiring cytoplasm and a cell membrane, and thus become "sarcocytes." By division, the "sarcocytes" form spindle-shaped "myocytes," which give rise to the imaginal muscles by fusing in rows to form muscle fibres. The "myocytes" at one stage closely resemble leucocytes, so that there is a possibility of confusing them; but Berlese, reasoning from his similar studies on *Muscidae*, feels confident that their origin is, as has just been stated, from the nuclei of the degenerating larval fibres.

Needham (:00) states that in *Mononychus vulpeculis* the fat cells of the abdominal region, after getting rid of their surplus food supply, become associated with the new muscle rudiments, and that their nuclei become nuclei of the developing muscle fibres.

*Diptera*. The most important of the investigations concerning the postembryonic development of insects have been made on *Diptera*.

After the classical researches of Weismann ('62, '64, '66), the more important of the earlier authors are Künckel d'Herculis ('72, '75), Ganin ('76), and Viallanes ('81, '82). Later authors have shown that the results of these papers on the histological changes of the muscles during pupal life are not of great importance, so that they need not be mentioned in detail here. The higher (cyclorrhaphic) and the lower (orthorrhaphic) Diptera seem to present, together with other differences, two distinct types of muscle degeneration, and so the papers on each group are here reviewed separately.

a. *Cyclorrhapha*. Van Rees ('84, '88) and Kowalevsky ('85, '87) both find in *Calliphora* that the larval muscles undergo phagocytosis. The leucocytes penetrate the muscle fibres, which they break up into fragments; these, together with the muscle nuclei, are engulfed by the leucocytes and digested. The leucocytes with their inclusions are the "Körnchenkugeln" of Weismann ('64). Van Rees finds that three pairs of muscles in the dorsal part of the mesothorax are exempt from this fate, and that they metamorphose to form the indirect wing muscles of the adult.

Lowne ('90-95) confirms the two preceding authors in regard to the phagocytosis of the larval muscles, but denies the metamorphosis of the three pairs of muscles of the mesothorax described by Van Rees. He states that all of the imaginal muscles are newly formed in the pupa, being produced from mesoderm cells which are derived from the imaginal disks.

De Bruyne ('97) practically agrees with Van Rees and Kowalevsky, except that he finds that the leucocytes are not the active agents in breaking up the muscle substance into fragments, the muscle being frequently broken up before the arrival of the leucocytes. He also finds that some of the nuclei of the larval muscles are not immediately destroyed. These, collecting a portion of the sarcoplasm of the fibre about themselves, act as myoblastic phagocytes, engulfing and digesting the muscle fragments. He calls this "autophagocytosis," to distinguish it from ordinary or leucocytic phagocytosis.

The results of the studies of Noetzel ('98) accord with those of De Bruyne in regard to the breaking up of the muscle before the arrival of the leucocytes.

Berlese ('99, :00, :00<sup>a</sup>, :01, :02, :02<sup>a</sup>) differs from the above authors in many essential points. He states that there is no phagocytosis, the ingestion of the sarcolytes and muscle nuclei by the leucocytes being for the purpose of distributing those elements to all parts of the body. The

muscle nuclei are never digested by the leucocytes, but divide and form cells — the “sarcocytes” — which give rise to “myocytes.” The “myocytes” then fuse with each other, either developing into imaginal muscles or undergoing fatty degeneration to form the imaginal fat-body.

Vaney (:00), who studied *Gastrophilus*, describes the larval muscles as undergoing, during pupal life, a phagocytosis accompanied by the formation of “Körnchenkugeln.”

*b. Orthorrhapha.* Hurst ('90) states that all of the imaginal muscles are present in the young pupa of *Culex*.

Miall and Hammond ('92, :00) find in *Chironomus* cells which resemble “Körnchenkugeln,” but these do not result from the phagocytosis of the larval muscles. The larval muscles of the head and thorax seem to waste away gradually and uniformly while undergoing for a long time no external change of form. Some of the larval muscles remain in the adult.

Kellogg (:01) finds in *Holorusia*, with a generalized larval form, that there is no phagocytosis. The larval muscles of the thorax undergo a “selbständige Degeneration” (Karawaiew, '98), while many new muscles are added in the head and thorax during pupal life. In *Blepharocera*, with a highly specialized larval form, he finds active phagocytosis, but apparently without the formation of “Körnchenkugeln.”

*Lepidoptera.* In a paper on the changes of the muscles in *Tinea*, Korotneff ('92) states that all of the imaginal muscles are to be regarded as metamorphosed larval muscles. The resorption of the muscles takes place as follows: the nuclei and sarcoplasm of each fibre accumulate on one side, and finally become separated from the fibrillar substance by a longitudinal splitting. The imaginal muscles originate from this detached strand, which is composed of the undifferentiated sarcoplasm containing the nuclei, whereas the strand which is composed of contractile fibrillar substance undergoes a chemical degeneration in which the leucocytes take no part.

De Bruyne ('97), in his study of *Bombyx*, finds that the initial cause of the muscular destruction lies in the muscles themselves. There is both autophagocytosis and leucocytic phagocytosis of the muscles, the latter taking place only at a late stage in the destruction of the muscles.

Berlese (:00, :01, :02<sup>a</sup>) obtains in *Lepidoptera* results similar to those which he found in beetles.

Pérez (:00) states that he finds typical phagocytosis, and denies the truth of Korotneff's observations. The results of these papers on *Lepidoptera* are apparently irreconcilable.

*Hymenoptera.* The first, and one of the most important, of the researches on Hymenoptera is that of Karawaiew ('97, '98,) on *Lasius*. He finds that there are two kinds of nuclei in the muscle fibres of the old larva, one larger than the other. During metamorphosis the larger nuclei degenerate, while the small ones, which are imaginal myoblasts, divide amitotically and after the fibrillar substance of the larval muscle has been dissolved, form the imaginal muscles. The imaginal muscles are, therefore, metamorphosed larval muscles, except in the case of the appendicular muscles, which are of new formation in the pupa.

Terre ('99, :00, :00<sup>a</sup>) confirms most of Karawaiew's results. He adds, among other new observations, that the two kinds of nuclei are present in the muscles of larvae which had but just escaped from the egg.

Anglas ('99, '99<sup>a</sup>, :00, :01, :01<sup>a</sup>, :02) and Pérez ('99, :00) dispute the observations of the two authors last cited, stating that there is an invasion of the larval muscles by leucocytes. Pérez speaks of this invasion as the beginning of an active phagocytosis which destroys the muscles. However, according to the statements of Anglas, the substance of the muscles is digested by the secretions of the leucocytes without any ingestion of solid particles. This is not true intracellular digestion or phagocytosis, but, rather, an extracellular digestion, for which he proposes the term "lyocytosis." There are no "Körnchenkugeln" formed, a statement in which all of the authors concur. Anglas finds that this lyocytosis totally destroys certain muscles (those of the pharynx, of the anterior part of the thorax, of the posterior part of the abdomen, the rectal sphincter, and the transverse muscles); while in the thoracic and intestinal muscles the nuclei of the larval muscles survive and give rise by fragmentation to small nuclei. These in turn form the imaginal muscles in the midst of the mass left from the destruction of the remainder of the fibre. The abdominal muscles do not undergo so deep-seated a metamorphosis, inasmuch as the leucocytes never invade their substance. The imaginal muscles in this case likewise are derived from nuclei which arise by the direct division of the larval nuclei. There are some muscles of new formation in the pupa which are derived from indifferent mesoderm cells.

The results of Berlese's (:01, :02<sup>a</sup>) observations agree more with those of Karawaiew and Terre than with those of Anglas and Pérez. According to Berlese, the imaginal myoblasts of Karawaiew are the same as his "sarcocytes," and are derived from the larval muscle nuclei by direct division. These may remain in the place where they are formed and give rise to "myocytes," which then develop into the imaginal muscles

(the metamorphosing muscles of Anglas), or they may emigrate and form muscles elsewhere in the body (the degenerating muscles and the muscles of new formation of Anglas).

No very important generalizations can be made from this review. The subject has reached a stage where it is evident that the muscular changes differ in the various groups of insects, and that not all of the muscles of the same insect undergo the same changes. Yet the importance and significance of these differences are not known. Comparative researches are therefore needed. Two of the investigators have already attempted such researches, but both attempts are unfortunate. De Bruyne's results, both his observations and his interpretations of the phenomena observed, have already been shown by Berlese to be untrustworthy. Berlese has given us an elaborate memoir full of interesting observations, and as accurate as could be expected when the phenomena observed are so complicated. His interpretations of these phenomena are not so fortunate, however. Judging from my observations on Coleoptera, as well as from personal observations on all of the groups of insects which he has studied, and from the numerous authors whose interpretations of phenomena he has contradicted, his fundamental idea of the formation of "sarcocytes" from the larval muscle nuclei, and the development of imaginal "myocytes" from the "sarcocytes" is not true in many cases, if at all. The reasons for this statement, as far as Coleoptera are concerned, will be given in detail in discussing the results of the present paper, while the results of my comparative studies on other insects I hope to publish in the not far distant future. The fundamental correctness of the interpretations of the present paper, as contrasted with those of Berlese, is indicated by the fact that they are in complete accord with the statements of three (Rengel, Krüger, Karawaiew) of the seven authors who have previously mentioned these changes, while the results of Berlese are not in accord with those of any of the other investigators.

Some confusion has arisen from the careless use of the word "Körnchenkugeln," for which there is no really satisfactory English equivalent. Some authors have used it to signify any leucocyte containing solid bodies of whatever nature, or, worse yet, some have used it in cases where it does not appear that the cells in question are even leucocytes. The "Körnchenkugeln" which Weismann found and so called are leucocytes containing fragments of muscle, either pieces of the contractile substance or occasionally muscle nuclei. As this is the generally accepted use of the word, carelessness in its use ought not to be permitted. With

such a meaning of the word, the presence of "Körnchenkugeln" in an animal implies, as a necessary corollary, the breaking up of muscles into fragments somewhere in the body, and the ingestion of these fragments by the leucocytes. This corollary is probably not generally true in any of the insects except the higher Diptera, and statements as to the presence of typical "Körnchenkugeln" in other groups of insects must be taken with reserve, unless some evidence is offered that they are "Körnchenkugeln" and not leucocytes containing bodies derived from some other source than degenerating muscles. According to this definition, "Körnchenkugeln" is not equivalent to "phagocyte," since it includes only a particular class of phagocytes, or, if Berlese's idea of the function of the cells be correct, they ought not to be called phagocytes at all.

Another cause of confusion is found in statements that muscles *degenerate* when, from later observations, it is evident that *metamorphose* or some equivalent word is intended. In the present paper, whenever it is stated that a muscle degenerates, the meaning is that no part of its substance retains its morphological integrity to function as part of a muscle or as any other tissue. By metamorphosis of muscles is signified that some part, or all, of the muscle substance persists, with more or less change in structure, and functions in the adult either as muscular tissue or — if Berlese's idea in regard to the development of the imaginal fat body in Muscidae be correct — sometimes as fat tissue.

## B. OBSERVATIONS.

### 1. *Methods.*

Serial sections of either the entire insect, or of a large part of its body, were used, in order that any particular muscle might be identified. Nearly all of the usually recommended fixing fluids were tried. The best results were obtained by killing in hot (70° C.) water and fixing in a cold, saturated solution of corrosive sublimate in 35% alcohol, or in cold picro-sulphuric acid. It is necessary to cut the animal open, in order to allow the fixing fluids to penetrate. Objects were left in the fixing fluids for several hours, even as long as twenty-four hours in many cases. Hermann's platino-aceto-osmic and Flemming's chromo-aceto-osmic mixtures are good for special purposes, but, on account of their lack of penetrating power, they are not as good for general results.

The serial sections were cut  $6\frac{2}{3}$  or  $10\mu$  in thickness and stained on the slide. Borax carmine, safranin, haemalum, and several haematoxylin stains, including iron haematoxylin, were tried, but none gave as good results as a saturated aqueous solution of thionin. This is very selective and does not stain the cytoplasm of the growing tissues as deeply as most of the other stains. My thionin preparations have not faded much, though some of them are three years old. The preparations in which the stain has a greenish tinge fade more quickly than those in which it is of a deep blue. All of the preparations used in making drawings were stained in thionin. Haemalum and safranin are also very satisfactory stains.

## 2. *Histological Changes of the Muscles.*

The hypodermal muscles of insects exhibit three varieties which, though fundamentally alike, present quite different appearances under ordinary magnifications. Weismann ('62) has designated these types as the larval, the leg, and the wing muscles, from their principal distributions.

The muscles of the larval type include in Coleoptera not only all of the muscles of the larva, but also some of those of the pupae and imagines. Those found in the pupa and imago exist in the abdominal region only, and are muscles of the larva which have persisted unaltered during the metamorphosis. All of these muscles are composed of a few relatively large fibres with a well-marked sarcolemma, and usually with the nuclei at the periphery of the fibres.

The muscles of the second, or leg, type are formed during pupal life, and are found not only in the legs but also in other parts of the body. In the imaginal form of *Thymalus* all of the skeletal muscles are of this type, except the few metathoracic muscles mentioned below, and the persistent larval muscles of the abdominal region noted above. These muscles are composed of numerous small fibres frequently arranged in a penniform or bipenniform manner and attached by a common tendon. The nuclei are found at the surface of the fibres in *Thymalus*, but in many other insects, including many Coleopterous forms, they are arranged in rows along the axis of the fibres.

The muscles of the third, or wing, type are frequently spoken of as the fibrillar muscles, since they separate very readily into their primitive fibrillae. They are composed of very large fibres with nuclei scattered throughout their substance. Numerous tracheoles penetrate the fibres of these muscles. The following muscles are of this type in the



imagines of Coleoptera (compare Aubert, '53): musculus metanoti, musculus lateralis metanoti, musculus lateralis metathoracis, flexor coxae metathoracis (secundus), extensor alae magnus metathoracis, and extensor alae parvus metathoracis.

a. MUSCLES THAT PASS UNALTERED FROM THE LARVA TO THE IMAGO.

The larval muscle fibres of *Thymalus* have the structure of this type of cross-striated muscle. Cross and longitudinal sections are shown in Figures 16, 22 (Plate 6) and Figure 33 (Plate 7). A granular sarcoplasm containing the nuclei is found unevenly distributed just beneath a well-marked sarcolemma. Occasionally the nuclei are embedded deep in the fibres, but these exceptions are practically limited to a certain few muscles; as, for instance, the adductor mandibularis, where the fibres are larger than usual and frequently have their nuclei embedded in the contractile substance. The cross striations are well marked (Figure 33), and may show all of the usual bands (Z, E, N, J, Q, H of Rollett, '85). The muscle columns are flattened and of irregular shapes, so that the Cohnheim's areas seen in cross sections (Figures 16, 22) make a peculiar pattern.

The trachae supplying the larval muscles break up into fine intracellular tracheoles at the surface of the fibres. Whether these tracheoles penetrate the sarcolemma or not, is difficult to determine with the methods used. From cross sections (Figures 16, 22, *trl.*) it appears as if they penetrated the sarcolemma (*sar'lem*), but remained in the superficial layers of the sarcoplasm (*sar'pl.*).

The muscle fibres of the abdomen, whose anatomical positions have been described on page 338, preserve the structure just described in all of the stages of the pupa and the imago.

b. METAMORPHOSIS OF LARVAL MUSCLES INTO

(1) *Muscles of the Wing Type.*

a. *Period of the resting Larva or Period of Destructive Changes.* In the feeding larva the muscles which metamorphose into imaginal muscles of the wing type show the same structure as the larval muscles described above. When the larva ceases feeding, and the wings have been evaginated from their hypodermal pockets, these muscles undergo several rapid changes. Perhaps the most striking of these changes take place in the contractile substance. This, in the course of a few days, divides lengthwise into from four to ten strands, the

division being completed at a stage when the wings have grown so large that they begin to be crumpled and folded. Figure 14 (Plate 6) and Figure 34 (Plate 7) show, respectively, cross and longitudinal sections in which this division has been partially accomplished. Figure 14 shows the cross section of six angular strands, the larger of which again divide to form the usual eight or nine fibres of this muscle in the imago (Figure 15). The rounding of these more or less angular strands into the cylindrical form of a muscle fibre takes place in the very young pupa.

At an early stage in the division of the fibre, the sarcolemma is broken up and soon disappears.

The changes in the finer structure of the muscle substance during the time in which the fibres undergo this division are very noticeable. These changes are illustrated by a series of drawings magnified 1,600 diameters, in which both cross and longitudinal sections are shown at three different stages of the resting larva. Stage one (Figures 23, 26, Plate 6) represents the condition before any change has taken place. Cohnheim's areas (*aa. Cohn.*) are very plainly shown in the cross section, while the longitudinal section shows both longitudinal fibrillation and cross striations.

Stage two (Figures 24, 27) is from a resting larva several days before pupation. The figures are drawn from muscles which correspond in their stages of development with those shown in Figures 14 (Plate 6) and 34 (Plate 7). In the figures at the higher magnification (Figures 24, 27) it is seen that the muscle columns have partially separated into their primitive fibrillae, Cohnheim's areas appearing in only a few places. The cross striation has disappeared entirely, whereas the longitudinal fibrillation shows nearly as plainly as before. The sarcoplasm between the fibrillae has meanwhile increased in amount and now begins to take a stain with thionin, a characteristic of the cytoplasm of all actively growing tissues. This is a strong reason for believing that the sarcoplasm is itself in an active metabolic condition, and therefore the agent which is causing the solution of the fibrillae.

Figures 25 and 28, which represent stage three, are drawn from a series of sections of a larva which would have pupated in a few hours. These figures show only a finely granular sarcoplasm, in which there is no trace of the fibrillae of the previous stage, not even a suggestion of longitudinal fibrillation remaining. The muscle as a whole appears still more deeply stained than before, since none of the non-staining fibrillae remain.

The course of events in the destructive changes of the contractile substance is quite evident from these three stages. The muscle columns break up into their primitive fibrillae, and these then undergo dissolution. The sarcoplasm increases in amount during this process, but not enough to balance the loss in volume caused by the dissolution of the fibrillae, so that each fibre shrinks in actual volume. This is shown by a determination of the volume of the largest fibre of *musculus metanoti* (Plate 1, Figure 1, *mt'nt.*) in each of the three stages described. Of course there is a chance for error in this determination, in that the muscle fibres vary in size in different individuals; but the ratios of the volumes in the three stages will at least give an indication of the amount of shrinkage. The ratios of the volumes are in the case determined very nearly,  $\frac{\text{stage i : ii : iii}}{\text{volume 4 : 3 : 2}}$ . From this it seems probable that not all of the material derived from the dissolution of the fibrillae is transformed immediately into sarcoplasm, but that some of it remains for a time in solution. It is suggested above that the agent which causes this dissolution is the sarcoplasm. There is no evidence of the action of leucocytes, either phagocytic or lyocytic, since they come into the neighborhood of the muscles only occasionally; nor is there reason for supposing action on the part of other outside agents.

During the whole period of these destructive changes the muscle nuclei undergo frequent amitotic divisions. The larval nuclei (Plate 7, Figure 34, *nl.*) before division are comparatively large, with usually a single definite nucleolus. Figure 34 shows a nucleus dividing amitotically (*nl.*<sup>1</sup>) and three pairs of smaller nuclei (*nl.*<sup>2</sup>), the resultants of such divisions. At pupation very few of the nuclei presenting the characteristics of *nl.* are found, whereas very much elongated nuclei (Plate 6, Figure 25, *nl.*<sup>3</sup> shows one that is comparatively short) are found associated with strings of nuclei which have arisen from the division of such elongated ones. Many of these nuclei no longer lie at the periphery of a fibre, nor even at the periphery of one of the strands which have arisen from the division of a fibre, but are deeply embedded in the muscle substance (Figures 14, 27, 28).

The sarcoplasm found at the surface of the larval fibres becomes lost at an early stage, intermingling with the increasing amount of sarcoplasm between the fibrillae.

The only tissues, other than the muscular, which need to be considered in this connection are the tracheae and the embryonic tracheal cells. The tracheal endings on the muscles before any change takes place have

been described. Immediately on the division of the muscle into strands, the cells of these finer tracheoles begin very rapid mitotic division. Cells in various stages of division (*cl. mit.*) are to be found in nearly every section of a muscle in a stage similar to Figure 14 (Plate 6) and Figure 34 (Plate 7). Most of the new cells so formed become either actually or apparently detached from the tracheoles, and penetrate into the fissures between the muscle strands (*cl. tr.*). Some, however, remain connected with the tracheae and show tracheoles, running through their cytoplasm (Figure 14, *cl. tr.*<sup>1</sup>). Especially in longitudinal sections (Figure 34, *cl. tr.*) they show long processes, which frequently connect with each other. These processes cause the cells to be of irregular forms, the spindle form being, however, the most frequent. The cytoplasm stains so deeply in thionin that the limits of the nuclei are in many cases difficult to determine.

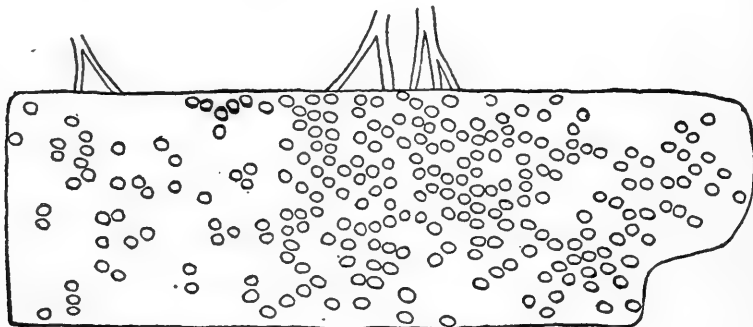


FIG. A.

Other considerations than those mentioned above point to the origin of these cells from the cells of the walls of the tracheae. Figure A is a projection of the nuclei of the tracheal cells (represented by the small oval outlines) on an optical longitudinal section of the largest of the fibres of *musculus metanoti* (Plate 1, Figure 1, *mt'nt.*) to show the positions and numbers of these cells. The particular fibre chosen for this reconstruction was in an early stage of its metamorphosis, the reconstruction being made from a series of cross sections similar to Figure 14 (Plate 6). From the textfigure it is seen that near the places where the tracheae join the fibre, tracheal cells are much more numerous than elsewhere, and that they are distributed in just such positions as would be expected if they were being formed from the intracellular tracheoles which arise from the tracheae. This uneven distribution of the tracheal cells can scarcely be explained by assuming an origin of these cells from nuclei of the muscle fibre or from leucocytes. Mitosis is found in the cells of

the walls of the tracheae, the tracheal cells, and in the cells of the hypodermis, the latter being, of course, the tissue from which the tracheae were derived. Few of the other tissues show mitosis, amitosis being the method of division in both leucocytes and muscle nuclei. Moreover, there is little chance of confusing the tracheal cells with leucocytes, as the latter are readily distinguishable by their more rounded form and finely vacuolated cytoplasm, which does not stain as deeply as the cytoplasm of the tracheal cells. The sudden appearance of the tracheal cells in all parts of the body at once, precludes any possibility of a local place of origin, such as the base of the wing, etc. Finally their fate, i. e., development into tracheae, indicates their origin from tracheae.

The question might be raised, whether or not these cells are the active agents in the splitting of the muscle into strands. This can scarcely be so, because the earlier the stages in the changes of these muscles, the fewer are these cells in the spaces between the strands. Moreover, in the earliest stages there are numerous fissures in which there are no tracheal cells.

The relationships of these tracheal cells to the mesenchyme, mesoderm, embryonic cells, myocytes, etc., which other investigators have found in connection with the postembryonic development of insects, cannot be entirely settled. The tracheal cells are doubtless the same as the spindle cells of Deegener. It is also probable that they are the same as the so-called myocytes of Berlese; at least, the same as those that he has described for Coleoptera. That entirely different kinds of cells have been described under these various terms, is almost certain. For myself, I am disposed to think that there are present during the metamorphoses of holometabolic insects, two distinct kinds of embryonic cells, which resemble each other in form and structure, but which have different origins and fates. One kind might properly be called mesenchymal; these are cells which arise singly from the tracheae or hypodermis and rise to tracheae, leucocytes, and other related tissues. Such cells are to be expected in most cases. The other kind may be called mesodermal. Their origin is not established as yet, but probably they are derived from cells of the embryonic mesoderm which persist until pupal life. They give rise to muscles and possibly other tissues in the pupa and are found principally in those insects in which muscles are newly formed during pupal life. There are many facts to support such a view, but it cannot be definitely proved with the material at hand.

*β. Pupal or Reconstructive Period.* The time of pupation agrees closely with the change from destructive to reconstructive changes in

the wing muscles, destructive changes taking place for only a short time after pupation. As we have seen, the so-called wing muscles are at the time of pupation composed of a few cylindrical strands or fibres of undifferentiated sarcoplasm which contain many nuclei undergoing rapid amitotic division. For some time in the pupa no very evident changes occur. Many of the elongated muscle nuclei and numerous chains of nuclei (Plate 6, Figure 30) are present. The tracheal cells are still increasing rapidly by mitosis, and in a two- to three-day pupa have become numerous, occupying most of the space between the strands (Figure 19, *cl. tr.*).

At a stage when pupal life is nearly half over, the fibrillae of the adult muscles begin to show. Figures 29 and 30, represent the appearance of the muscles at this period. The cross section (Figure 29) shows scattered through it the cross sections of newly formed fibrillae of various sizes. The longitudinal section (Figure 30), taken from another muscle of the same series of sections, shows longitudinal fibrillation. Sections of stages a little younger than this, e. g., the stage shown in Figure 19, reveal only the faintest hint of these structures under high magnifications.

During the last half of pupal life, a number of important changes take place, the most noteworthy being growth in size. In some muscles the area of cross section doubles or even quadruples during this period (compare Figure 19 with Figure 21, the latter showing three fibres of the former, the magnification being in each case 800 diameters). This increase in area of cross section is accompanied by a lengthening of the muscles, sometimes to even twice their former length, so that their volume increases many fold. A rough estimate of the changes in volume during metamorphosis of any metathoracic muscle can be made from the series of anatomical drawings given on Plates 1-5, as these are all drawn to the same scale.

The tracheal cells in a stage a few days before the emergence of the imago (Figure 21, *cl. tr.*) arrive at a condition in which there are no more cell divisions. In cross sections of the muscles at this stage the tracheal cells are not as numerous as in the earlier stages (Figure 19). This does not mean that they are fewer in number in the whole muscle, however, as the volume of the muscle has increased without a corresponding increase in the number of tracheal cells. Nearly every tracheal cell in Figure 21 shows its future plainly. Some (*cl. tr.*<sup>1</sup>) have formed tracheoles through their cytoplasm and show connections with tracheae. Most of the others are connected with tracheae, but their connections are severed by the plane of the section (*cl. tr.*<sup>2</sup>). There are a few, however,

which (*cl. tr.*) do not show their tracheal nature in the least, these forming a direct transition to the tracheal cells of the previous stages (*cl. tr.*, Figures 14, 19, etc.). The processes of these cells are embedded in the muscle substance, and even some of the cells (*cl. tr.*<sup>3</sup>) may be entirely embedded in the muscle. All through the substance of the muscle are found the processes (*prc.*) of these cells detached from the cell body by the plane of the section. Some of these processes are solid, but most of them are already tubular tracheoles, which show prominently in the sections because their walls stain deeply. They may be seen better in the more enlarged representation (Figure 32, *prc.*). This penetration of the wing muscles by the tracheoles has long been known, but their development has never before been described. A similar development of the intracellular tracheoles in other parts of the body has been noted in several cases.

It is probable that some of these tracheal cells become leucocytes at about this period. Certainly the large vacuolated leucocytes which have persisted from the larva, such as are shown in Figure 51, *leu'cyt.* (Plate 7), disappear in old pupae, and their places are taken by smaller, less vacuolated leucocytes which resemble the tracheal cells. These new leucocytes grow in size, and soon are characteristically vacuolated (Figure 36, *leu'cyt.*).

The finer structure of the muscle substance at a stage corresponding to Figure 21 (Plate 6) is shown in Figure 32. The fibrillae are much more numerous than before (Figure 29), and show more plainly in cross section, while the amount of stainable sarcoplasm between them is relatively less, so that the muscle as a whole stains fainter than before. In longitudinal sections the fibrillation is plain, but no cross striation is visible. In none of my sections of pupae does the cross striation show in these muscles, but it appears in a series of sections of an imago a few hours old (Figure 31), so that possibly this striation is formed during the last stages of pupal life.

In the stage shown in the longitudinal section the muscle nuclei (Plate 7, Figure 35, *nl.*<sup>1</sup>) are still dividing amitotically, but in the somewhat older stage, shown in cross section only (Figure 21, Plate 6), amitosis is rare. The nuclei in this older stage are numerous and are scattered throughout the substance of the muscle. They are short oval in form, the elongated nuclei of the preceding stages having disappeared entirely.

*γ. Imaginal Period.* The structure of the wing muscles of insects has been described so well by various authors that it need not be repeated

here (see Heidenhain, '98, for a bibliography of papers on cross-striated muscle). Cross and longitudinal sections of these muscles in *Thymalus* are given in Figures 15 and 36, respectively. The changes since the old pupa are few. Cross striation is readily distinguishable, showing the J and Q bands. The fibrillae show clearly in both cross and longitudinal sections, and are nearly all of one size. In *Thymalus* they are about  $1\ \mu$  in diameter, which is smaller than in many other insects. No sarcolemma could be demonstrated, though it has been described for this type of muscle (see Cajal, '88, p. 268).

The tracheoles (*trl.*) are fully developed and are often to be seen in the muscle substance. It is, however, much more difficult to distinguish them than it was earlier, since they have thinner walls and these do not stain as deeply as in the earlier stage.

(2) *Muscles of the Leg Type.*

The figures already described as showing the structure of the larval muscles (Plate 6, Figures 16, 22, and Plate 7, Figure 33) will serve as a starting point for the description of this type also; for, as already stated, both the wing and the leg muscles are at first alike. In some of the larval muscles which are destined to metamorphose into muscles of the leg type, changes begin at the same time that they do in those of the wing type, i. e., at about the time the larva ceases feeding; but in others of the leg type metamorphosis does not begin until later. The muscles which are to undergo the greatest changes in position at the time of pupation begin to show alterations first. The others start their changes during the resting larval period, though some of them are not greatly changed even at the time of pupation. On account of this variation in the time of the beginning of the metamorphosis in different muscles, it is of great importance to be able to identify these muscles at every stage of development. The details of their metamorphosis are, however, apparently the same in all instances, there being in no case which has been observed transitional conditions between these metamorphosing muscles and the muscles which pass unaltered from the larva to the imago.

These muscles may be somewhat artificially divided into three groups, according to the period in which they begin their metamorphoses. Those of Group I. begin their metamorphosis at the same time as the muscles of the wing type. This group includes, among other muscles, the adductor of the mandible, and the following metathoracic muscles: the third flexor of the wing, the relaxator of the wing, and the relaxator



of the extensor of the wing. Group II. includes those muscles which begin their metamorphosis soon after the muscles of Group I. have begun theirs, but which retain their cross striation until the time of pupation. Examples of metathoracic muscles of this group are : the first and second flexors of the wing and the third extensor of the coxa. The remaining group (III.) includes the muscles which show little evidence of metamorphosis even at the time of pupation. Among these may be mentioned the dorsal muscle of the mesofurca, the lateral muscle of the inferior process of the mesophragma, the lateral muscle of the mesofurca, the depressor of the tergum, and the flexor of the postero-lateral process of the metafurca. It will be noticed that the examples of Group III. include all of the intersegmental muscles which lie between the meso- and metathorax, and also all of those between the metathorax and the first abdominal somite. Why these muscles should all belong to the group which is the most retarded in beginning its metamorphosis, is not evident.

*a. Larval Period.* In the muscles of this type the larval existence does not include the entire period of destructive changes, these extending into the pupal stage. In the destructive alterations, the differences between those larval muscles which metamorphose into muscles of the wing type and those which assume the leg type are not great; these differences alone need be mentioned. Figure 49 (Plate 7) shows a cross section of the second flexor of the wing drawn from an older larva than the one from which Figure 14 (Plate 6), of the wing-muscle series, was drawn. These muscles are at nearly the same stage of development and will serve to illustrate the differences in the metamorphoses of the two types. These differences are chiefly, that the muscles of the leg type divide into a greater number of smaller longitudinal strands (19-22 in the particular muscle figured), and that the fibrillae of most of the leg-type muscles do not disappear as quickly as those of the wing type.

*β. Pupal Period.* Eventually the substance of these muscles reaches a structureless condition, the same as is shown in Figures 25, 28 (Plate 6) for the wing muscles, though this stage in some cases is not attained until the middle of pupal life. In fact, the structureless condition has not been observed in all of the muscles of Group III. mentioned above. It is even possible that in some cases the fibrillae of the larval muscles of this group may persist as fibrillae in the imaginal muscles. If so, these muscles would form a transition, so far as the contractile elements are concerned, to those which remain entirely unchanged from the larva to the imago. The structureless period is certainly of shorter

duration in some muscles than others, and is not found in all of the muscles at the same instant.

During the period of these destructive changes in the contractile muscle substance, the angular strands become more rounded and separated, precisely as in the wing muscles during the same period. However, the nuclei, with rare exceptions, remain at the periphery of the strands. The tracheal cells are never formed as numerous as is shown for the wing muscles in Figure 19, and, in fact, are fewer at all stages than in the wing muscles at the corresponding stages.

The reconstructive changes begin in the pupa, at varying times for the different muscles, the same as has been shown concerning the beginning of the destructive changes. It is difficult to determine much about the reconstruction of the fibrillae of these muscles, because the fibrillae are so small. In fact, it is not certain that they have been recognized. In cross sections of these muscles from old pupae there appear irregular polygonal areas of small size (less than  $1\ \mu$  in diameter), which, however, are presumably Cohnheim's areas, rather than the cross sections of separate fibrillae. These become more evident in later stages, and show plainly in the imaginal muscles (Figure 18). Longitudinal fibrillation appears at the same time that the polygonal areas begin to show, whereas cross striation is not seen until the day before the emergence of the imago. A longitudinal section of a stage corresponding to that shown in Figure 18 is given in Figure 17. This presents the usual appearance of the cross-striated muscles of the legs of insects.

*γ. Imaginal Period.* The same muscle that is shown in cross section in its larval state in Figure 49 (Plate 7) is represented in its imaginal state in Figure 50. A comparison between the two figures will reveal how simple the changes between the two stages really are. In the imaginal muscle, there is evident a superficial layer of sarcoplasm with the nuclei embedded in it. A sarcolemma is present about each fibre, having been formed during the late pupal stages. The tracheal cells have developed into tracheae, which, however, do not penetrate the muscle substance as in the case of the indirect wing muscles. Most of the muscles of the leg type increase somewhat in size during metamorphosis, but this increase is small compared with the growth of the majority of the wing muscles.

### (3) *Metamorphosis of the Intestinal Muscles.*

The intestinal muscles undergo changes precisely similar to those described for the leg type of muscles. My observations are in almost exact accord with those of Rengel ('96), so far as he has described the

changes in the muscles of the intestine. I have studied especially the region of the proventriculus, where the muscle layers are well developed. No differences were discovered between the changes of the muscles of this region and those of the remainder of the intestine. Two general figures are given. Figure 51 (Plate 7) is a portion of the wall of the proventriculus in a larva about to pupate, and Figure 52 is a similar figure from an old pupa. The muscle fibres are found in two layers: a circular layer inside (*mu. crc.*), and a longitudinal layer outside (*mu. lg.*). Their structure is similar to that of the other larval muscle fibres, except that the nuclei are more frequently found at the centre of the fibres and that Cohnheim's areas are arranged similarly to those shown in Figure 20 (Plate 6); this particular figure, however, is not from one of the larval fibres. The principal difference between the destructive changes in these muscles and in those of the leg type is, that they are still slower in being completed than the latter. The larval fibres rarely, if ever, divide lengthwise to form new fibres, those in the larva being apparently as numerous as those in the imago. The tracheal cells are slower in making their appearance, and only a few are found in this region at the time of pupation (see Figure 51, which does not show any of them); whereas, even before this time, they are numerous in the regions of the other metamorphosing muscles. Compare Figure 14 (Plate 6) and Figure 49 (Plate 7), which are from younger pupae than Figure 51. The intestinal muscles show cross striation much longer than any of the other metamorphosing muscles, as the striation does not disappear until the pupa has undergone nearly half of its development. Longitudinal fibrillation disappears almost as quickly, and thus a structureless stage, shown in Figure 52 (*mu. crc.*), is reached.

During all the time in which the destruction of the contractile elements is taking place, the muscle nuclei show no apparent changes. No cases of amitosis have been seen, though they are common in the other metamorphosing muscles; nor is there any evidence of degeneration and phagocytosis such as Deegener (:00) states that he finds. It seems as if Deegener's statement, that there is phagocytosis of these muscles, such as Kowalevsky ('87) and Van Rees ('88) found in Muscidae, must be strongly questioned. For, in the first place, both Rengel and I have failed to find evidence of it in Coleoptera. Secondly, it is evident on reading Deegener's paper that this statement is based more on inference than actual observation. No satisfactory figure nor description is given of the phenomena which take place when the leucocytes attack the muscles. Apparently the only ground for the statement is that he

has found what he calls "Körnchenkugeln." Judging from his figures of them, they do not look much like the "Körnchenkugeln" of the Muscidae, nor does their migration into the lumen of the intestine agree with what has been found in Diptera. Moreover, he states that these phagocytes are not numerous enough in the region of the midintestine to account for the degeneration of the muscles of this region, and consequently infers that there is chemical degeneration as well as phagocytosis. Such different methods of degeneration in similar muscles of the same animal is improbable. But the principal reason for believing that there is no phagocytosis of these muscles in Thymalus and other Coleoptera lies in the exact similarity of all their changes to those occurring in the muscles of the leg type. In these muscles it can be stated with certainty, not only that there is no phagocytosis, but also that the larval muscles metamorphose into the imaginal muscles instead of degenerating.

The typical "Körnchenkugeln" which Deegener finds, but which Rengel could not find, are met with in Thymalus. That is to say, there are to be found leucocytes containing bodies many of which would answer the description given by Deegener, but these leucocytes are not such "Körnchenkugeln" as Weismann found. This is evident from some of the appearances reproduced in Figures 40-48 (Plate 7). These all represent leucocytes found in old pupae magnified 1600 diameters. Figures 43 and 46 look like leucocytes containing degenerating nuclei, and there is a possibility that such may be the true explanation of some of them; none of them, however, are nuclei from the intestinal muscles. Figures 40, 42, and 47 show inclusions which certainly are not degenerating nuclei, and since there are found transitional stages (Figure 48) to the first mentioned conditions, it is probable that all of the inclusions are of the same kind. The most probable interpretation of them is that they are intracellular parasites. This view is strengthened by the presence of apparently similar bodies in the intestinal epithelium of resting larvae. Also, bodies similar to the deeply stained portions of Figure 40 are found very numerous in the body cavity and lumen of the intestine of old pupae and young imagines. The true nature and relationship of these bodies cannot be stated with certainty as yet, but whatever they may be, very few, if any of them, can be called "Körnchenkugeln."

Concerning the formation of the intestinal muscles of the imago, my observations, again, are in harmony with those of Rengel, and disagree with those of Deegener. The reconstruction of the intestinal muscles

from the structureless muscle substance containing the larval nuclei is the same as the reconstruction of the leg muscles. That is, longitudinal fibrillation appears first, then cross striation, the latter appearing about the time of the emergence of the imago. At the same time Cohnheim's areas become plainly distinguishable, and have the pattern shown in Figure 20 (Plate 6), which is drawn from the cross section of a single fibre of the foreintestine of the imago. The muscle substance, when structureless, stains deeply with thionin, but after the fibrillae are formed, it stains scarcely at all. The nuclei remain as they were, while a new sarcolemma is formed about each fibre in the old pupa. The tracheal cells of this region give rise to the new tracheae and possibly, as stated before, to imaginal leucocytes.

Deegener, who speaks of these tracheal cells as spindle cells (page 146, *et seq.*), derives the intestinal musculature of the imago from them. He gives no conclusive proof of this derivation in any case, however. In the region of the midintestine he was unable to distinguish these spindle cells with certainty, so that his conclusion that the muscles of this region are formed from these cells is pure assumption. He is forced to make such an assumption by his conclusion, — which has already been shown to be incorrect, — that there is a phagocytosis and total destruction of the larval muscles. There is no reason for supposing that these cells form the intestinal muscles of the imago any more than that they form the muscles of the remainder of the body, and this, as has been shown, is not true.

#### c. HISTOLYSIS OF THE LARVAL MUSCLES.

The muscles which undergo histolysis in the pupa present great individual variation as to the time when degeneration begins. There are also variations in the details of the degeneration, which are of such a nature that they form a partial transition to metamorphosing muscles. However, no instance of a muscle which sometimes degenerates and sometimes metamorphoses into a rudimentary imaginal muscle has been found, though it does not seem improbable that such may be present in some of the beetles.

The group of muscles of the metathorax designated in Figure 1 (Plate 1) by the Greek letters  $\beta$ ,  $\gamma$ ,  $\delta$ ,  $\epsilon$ ,  $\zeta$ ,  $\eta$  belong to a class of degenerating muscles which are very distinct from the metamorphosing muscles. This group will serve as a type in describing the degeneration and the differences between these and the other degenerating muscles noted later. The substance of these degenerating muscles never stains with thionin.

For this reason, they stand in sharp contrast with the nearby metamorphosing muscles. No other evidence of degeneration manifests itself until the pupal stage is reached. Then there begins a gradual atrophy of the muscles, during which the substance of the muscle becomes somewhat broken, as is shown in Figure 39 (Plate 7). This figure, drawn from a cross section, is of muscles  $\zeta$ ,  $\eta$  (Plate 1, Figure 2), and Figure 37 (Plate 7) is a longitudinal section of one of the similar group of mesothoracic muscles, both taken from pupae a few days old. The size of the area of cross section has diminished nearly one half at this stage; this, however, does not mean a proportional shrinkage in volume, because the length of the fibres increases at pupation. Cross sections at this stage show Cohnheim's areas, but only where viewed with a higher magnification than that used in making Figure 39. Longitudinal sections (Figure 37) show fibrillation distinctly and cross striation faintly. The nuclei are apparently unchanged, retaining the nucleoli found in the nuclei of the larval muscles. In longitudinal sections they commonly project from the surface of the fibres, as shown in the figure. Sarcolemma can usually be distinguished even at this stage. Tracheal cells are sometimes found in the fissures of the muscle substance (Figure 39, *cl. tr.*), though this is not common. There can be little question of the identity of these cells with the tracheal cells of the remainder of the body, or of the fact that they are not leucocytes. There is no evidence of phagocytosis at any stage.

From this period of the young pupa, until the old pupa, there is a gradual atrophy of the muscle substance of each fibre, until only a slender strand is left. This strand has in connection with it all the nuclei of the original fibre, these nuclei showing little evidence of degeneration until practically all of the remainder of the fibre has entered into solution. They then undergo a typical chromatolysis, as shown in Figure 38, *nl.* Inside the nuclear membrane, the chromatin grains collect into masses of various sizes which at first stain deeply. These masses seem to persist for a short time after the dissolution of the nuclear membrane, for there may be found such chromatin masses (*chr.*) around which no nuclear membrane can be distinguished. No trace of these muscles can be found in pupae shortly before the emergence of the imago. The possibility that leucocytes may engulf some of these degenerating nuclei ought to be mentioned. Such an engulfment of loose débris would agree with the well-known habits of leucocytes, and it might be contended that such appearances as are represented in Figures 41, 44, and 45 (Plate 7) are due to this cause. No direct evidence can be

given for or against this view, but it seems to me that more probable explanations of the source of these leucocytes can be given.

Transitional conditions between degenerating and metamorphosing muscles have been noticed, especially in the *musculus lateralis mesothoracis* and other mesothoracic muscles whose counterparts in the metathorax metamorphose into imaginal muscles. Until a few days before pupation, there are few differences between the changes of these mesothoracic muscles and those of their counterparts in the metathorax. That is, the changes of the mesothoracic muscles differ from those of the type of degenerating muscles just described in the following particulars: they begin their changes in the early resting larva, instead of at the time of pupation; they split into a definite number of longitudinal strands; their nuclei divide amitotically, though not as abundantly as in most of the metamorphosing muscles; the muscle substance stains with thionin; and the tracheal cells are present in considerable numbers. All these features so resemble those of the metamorphosing muscles that for a long time I supposed that these muscles likewise metamorphosed. It was only by tracing the history of each muscle individually that I was able to establish their final and total disappearance. Their final disintegration takes place in the old pupa at the same time, and in the same manner, as that of the other degenerating muscles. The fate of the tracheal cells connected with them is not certain, but eventually they must become free in the blood plasma, where they presumably form tracheae or leucocytes.

The probable explanation of the similarity of these degenerating muscles to the metamorphosing muscles is, that in some ancestral form not far removed, the former also metamorphose to become imaginal muscles. That such a condition (i. e. a *metamorphosis* of the *l. m'thx.* and the other degenerating mesothoracic muscles) will be found in some of the hemimetabolic insects, is very probable. A similar relation between the fibrillar wing muscles of certain beetles is almost certain. In *Thymalus* these fibrillar muscles are metamorphosed larval muscles, but in the imagines of certain wingless beetles they are not found (Aubert, '53). It is probable, therefore, that investigation would show their presence in the larvae of these forms and that they degenerate in the pupa.

#### d. HISTOGENESIS OF THE IMAGINAL MUSCLES.

Nothing has been determined with certainty about the origin of the two metathoracic muscles of *Thymalus* which were absent in the larva. They probably are derived in the same manner as the muscles of new

formation in the pupa of other beetles; that is, from cells resembling the tracheal cells, but probably having a different origin.

### 3. *Observations on other Coleoptera.*

*Bruchus obtectus* Say, the common bean weevil, was chosen for comparison with *Thymalus* chiefly because of the different conditions which might be expected in the leg muscles. *Thymalus* is a form with an unmodified larva possessing six well-developed legs. *Bruchus*, on the other hand, has a more highly specialized larva, which has legs when it hatches from the egg, but at the first moult loses all except the merest rudiments of them. During the remainder of larval life, these rudiments are barely visible. The legs of the first larval form are scarcely larger than the hairs which are found on other parts of the body. They do not show all the joints of the adult leg, but only the femur and tibia, the latter possessing an enlargement at the distal end which represents the tarsus. In whole preparations, no muscles can be distinguished in these legs, and it is probable that they are functionless as locomotor organs. (For descriptions and figures of the larval stages of this insect, see Chittenden, '99.)

Sections of half-grown larvae — the youngest used in sectioning — show rudiments of legs, at the bases of which are found masses of cells. These masses are principally composed of the small spindle-shaped cells which later give rise to the muscles of the imaginal legs. These cells have a somewhat oval nucleus surrounded by a small amount of cytoplasm. A few tracheae aerate this mass, while an occasional leucocyte is also found. The origin of the spindle cells has not been traced, but they are presumably the embryonic mesoderm cells which would have formed the muscles of the legs, had muscles been functionally developed in the legs of the larva.

At the time of pupation, three kinds of cells are found in these masses. There are (1) the leucocytes, which are readily distinguished. They are several times larger than the other cells, have a more rounded form, an abundant cytoplasm, and a spherical nucleus, in which the chromatin network lies chiefly at the periphery. The remaining cells are spindle-shaped and apparently all alike; but later stages of development indicate that they are of two kinds, which probably have different origins. These are (2) the mesoderm cells mentioned above and (3) mesenchymatous tracheal cells. The mesoderm cells probably have an embryonic origin, and they develop into muscles. No direct proof of the origin of the tracheal cells can be given, because in their young stages it has been



impossible to distinguish them from the mesoderm cells. But from analogy with the remainder of the body, it is very likely that they have not persisted from embryonic life, but are developed during the period of the resting larva from the tracheae which supply the masses of tissue at the bases of the legs. They develop into the tracheae of the legs of the imago.

In young pupae in which the legs have grown to some size, in the places where new muscles are to be formed, there may be found groups of cells already transforming into muscle fibres. Between these forming fibres are to be seen free cells, many of which are dividing mitotically. These may now be recognized as tracheal cells, which are precisely like the cells found associated with the metamorphosing muscles of the remainder of the body. The muscle nuclei in the earliest stages in which they can be recognized as such are seen to be undergoing frequent amitotic divisions. From this time on the amitotic is their only method of division: a thing which is characteristic of the nuclei of all of the muscles which have been studied. The muscle fibres increase rapidly in size, and it very soon becomes impossible to distinguish them from the metamorphosing muscles of the leg type, which meanwhile have completed their destructive changes, and are starting on their reconstruction. The tracheal cells remain as free cells between these fibres until a late stage of the pupa, when they form tracheae in a manner similar to that already described for *Thymalus*.

The question whether each muscle fibre is developed from a single cell or not, is almost impossible to settle in this case. There cannot be much fusion, however, as the fibres of the completed muscles are almost, if not quite, as numerous as the cells from which they are developed.

The metamorphosing, degenerating, and persistent larval muscles of *Bruchus obtectus* show conditions exactly comparable with those of *Thymalus*. The fibrillae of the indirect wing muscles are larger in *Bruchus*, and their development in the structureless sarcoplasm of these muscles in the pupa is much more obvious than in *Thymalus*. No leucocytes with inclusions have been found at any stage, though a careful search has been made for them.

Sections of larvae and pupae of *Synchroa punctata* Newm., a Melandryid oak-bark borer, and *Cyllene pictus* Drury, the common Cerambycid hickory borer, have also been examined. The muscular changes of these forms are essentially like those already described. A sharp look-out has been maintained for "Körnchenkugeln," or similar bodies, but none have been seen in these forms.

## C. DISCUSSION OF RESULTS.

An attempt will now be made to harmonize the results of the various investigators of the muscular changes of Coleoptera. The researches of those who have studied the remaining groups of holometabolic insects, though treated of first, will not be considered in detail, because the relation of the changes in Coleoptera to those in the other groups are not yet perfectly clear. It is sufficient to state that the results of this paper are not fundamentally at variance with those obtained by many of these investigators.

Concerning the state of affairs in Diptera, the following facts are evident from the papers on the subject. In the orthorrhaphic Diptera there is a persistence of many of the larval muscles. The degeneration of those muscles which disappear during pupal life does not seem to be different from that found in Coleoptera. In the cyclorrhaphic forms no investigator has found a persistence of larval muscles. Degeneration seems to be the common fate of the larval muscles, a degeneration which takes place by a method different from that found either in Orthorrhapha or in other insects. Muscles newly formed in the pupa are very common in Diptera, especially in the higher forms. A true metamorphosis of larval muscles into imaginal muscles has been noted by Van Rees ('88) only. I can confirm from my own observations the metamorphosis of the three pairs of muscles which Van Rees has noted. Contrary to his statement, however, these do not form all of the indirect wing muscles, but only *musculus mesonoti*, each of the three larval muscles dividing into two fibres, and thus giving rise to the six fibres composing the imaginal mesonotal muscles of each side of the body. A similar development of *musculus mesonoti* from three pairs of larval muscle fundaments is found in *Culex* sp. and *Chironomus* sp. The metamorphosis of the undoubtedly homologous three pairs of larval muscles in both meso- and metathorax of *Thymalus* has already been noted (pages 337 and 323, respectively).

The results of the investigators who have studied Lepidopterous material are so greatly at variance with one another that little can be stated definitely. The probabilities seem to favor the authors who state that there is a metamorphosis of many of the larval muscles. Pérez (:00) states, and probably correctly, that many of the larval abdominal muscles pass into the adult with no changes except a proliferation of their nuclei.

It is my belief that not one of the investigators of Hymenopterous

forms has interpreted entirely correctly the phenomena which he has seen. I affirm this the more confidently because in the controversy which has arisen among these authors neither side has satisfactorily explained the observations of the other. They all agree in describing phenomena which are so like those of which I have here given an account for Coleoptera, that it does not seem possible that there should be any fundamental differences between the two groups. It is evident, chiefly from the completed paper of Anglas (:01), that there is in Hymenoptera a metamorphosis of most of the larval muscles, a degeneration of the remaining ones, and a new formation in the pupa of some imaginal muscles. There are no persistent larval muscles such as exist in Coleoptera, Lepidoptera, and orthorrhaphic Diptera, the abdominal muscles undergoing a less complete metamorphosis than the metamorphosing muscles of the remainder of the body.

The settlement of the whole controversy between the five authors (Karawaiew, Terre, Anglas, Pérez, Berlese) depends on the interpretation of the nature of certain cells found in the regions of the metamorphosing and degenerating muscles, these cells being apparently exactly comparable to the cells in Coleoptera which have been spoken of in the present paper as tracheal cells. None of the five authors mentioned above has considered the possibility of the tracheal nature of these cells. Nevertheless, none of their observations preclude such an origin. Karawaiew, Terre, and Berlese contend that these cells are not leucocytes, but are developed from the nuclei of the larval muscles; whereas Anglas and Pérez contend that they are not developed from the nuclei of the larval muscles, but are leucocytes. Is it not possible that both sides are correct in their negative conclusions and incorrect in their positive affirmations? May not these cells be developed from the tracheoles of the larval muscles, instead of from either of the tissues mentioned? None of these investigators has described the origin of the tracheae of the imaginal muscles. Yet these tracheae are so exceedingly abundant in the region of the wing muscles, that their origin cannot be so inconspicuous as to have been overlooked entirely, nor ought it to have been neglected, as it has been. It is to be hoped that some of these authors will at least consider the possibility of the explanation which I have suggested, since, if correct, it will straighten out what otherwise is an apparently hopeless controversy.

We will now consider the researches on Coleoptera. A review of the disagreements of Rengel ('96) and Deegener (:00) has already been given in considering the changes of the intestinal musculature. It is

rarely possible to confirm the results of another investigator's work more completely than Rengel's results have been confirmed by my own investigation.

The results of De Bruyne's ('97) investigation of *Tenebrio* may be entirely disregarded, because there can be little doubt but that he has mistaken the fundamental nature of the changes with which he was dealing. Misled by the similarity in appearance of cross sections of metamorphosing muscles (such as my Figure 15, Plate 6) to cross sections of the degenerating muscles of Muscidae (see figures given by Kowalevsky, '87, Van Rees, '88, and others), he has concluded that the muscles in *Tenebrio* likewise degenerate. As a matter of fact, there can be no doubt but that he was dealing with metamorphosing muscles which retained their individuality throughout pupal life, as is indicated by Krüger's ('98) results on the same insect, as well as by the present study of Coleopterous forms. The probability is that his leucocytes, which he found engulfing fragments of muscle, are the same as the tracheal cells of the present paper, and that his "Körnchenkugeln" are the same as the detached fat cells described by Krüger ('98, p. 16).

Krüger ('98) was venturesome in generalizing from such meagre data, but his conclusion is entirely confirmed by the present research. All of the imaginal wing muscles are metamorphosed larval muscles, though some of the other metathoracic muscles nearby are not. However, it is questionable if the cells which Krüger ('98, p. 17) describes as "Weismannsche Körnchenzellen" are such in reality. He has given us no evidence to support the view that the inclusions in these cells are muscle fragments. Other, just as probable, explanations of the nature of these cells might be given.

Karawaiew's statement ('99, p. 202), that he finds no phagocytosis of the muscles of *Anobium*, agrees with what has been found in *Thymalus*.

It was impossible to explain the disagreement of Berlese's results with the results of the present research, until a copy of his last paper (:02<sup>a</sup>) was received. His idea, that there is, in the metamorphosis of the muscles of all the metabolic insects: first, an emigration of nuclei from the larval muscles; secondly, a formation of "sarcocytes" from these; thirdly, a transformation of these "sarcocytes" into "myocytes;" and, finally, a production of new muscles from these, meets a fatal objection, as far as Coleoptera are concerned, when the anatomical changes of these muscles are considered. The first half of my paper is taken up with tracing individual larval muscles in their metamorphosis into

imaginal muscles. At no stage do these metamorphosing muscles lose their identity, so that a dissolution of these muscles and a survival of their nuclei only, is impossible.

Berlese's mistake may be easily explained, however. He has neglected entirely the study of the anatomical changes; these would have immediately revealed the falsity of his view. Moreover, he is unfortunate in his choice of the adductor of the mandible, as a muscle in which to study these changes. This muscle is composed of numerous fibres (50 in the larva, 250 in the imago of *Thymalus*), so that it is impossible to follow any particular one of them in its development. When the destructive changes in the metamorphosis of this muscle are completed, there remains simply a confused mass of these fibres still retaining their nuclei, with numerous spindle-shaped cells scattered between the fibres, precisely as Berlese describes and figures (:02<sup>a</sup>, p. 65, Fig. 253). His mistake arises from his imagining that spindle cells are derived from the muscle nuclei, a mistake very easily made. In some of the beetles which I have examined, the difference between these cells and the muscle nuclei is not obvious at first sight. In *Thymalus*, however, there can be no doubt of a difference between them at all stages. As already shown, the spindle cells develop *from* tracheae and *into* tracheae, while the muscle nuclei persist as they are in the undifferentiated sarcoplasm and form the imaginal muscles. The conditions which Berlese shows in his second figure (Fig. 254) are different from anything observed in *Thymalus*. That all the cells pictured in this figure are of the same nature, is open to question. It has also been shown that there is no need of supposing a derivation of complete cells from nuclei alone, as Berlese has done. This assumption itself is enough to shake one's confidence in his views.

He also lays great stress on the simplicity of his idea, and the fact that he has been able to make it apply in every case which he has studied. But there may be a fault in too great simplicity, as well as in too great complexity. The reasonableness of the ideas of the present paper, as contrasted with those of Berlese, may best be shown by tracing what may have been the phylogenetic development of these muscular changes.

It is fair to assume that in primitive insects the muscles were the same in number, function, and position, when the larva escaped from the egg, as they were when the imaginal form was attained, since there doubtless was little difference between the two stages except in size. Now, in the development of such primitive insects into hemimetabolic forms, and the development of these into holometabolic forms, it has

come about that the imaginal form is exceedingly different from the larval. This has necessitated great changes in the muscular system. It is easy to see that in this evolution many muscles must have reached a stage where, if they were to be useful in the imago, they must be stronger, or their attachments must be shifted, or they must be changed in some other manner, which would necessitate a greater or less metamorphosis. In this metamorphosis nothing could be more probable than that there should be, first, a proliferation of the nuclei, second, a longitudinal splitting of the original fibre into as many new fibres as were needed, and, if an extensive metamorphosis was required, a destruction of the original fibrillae and the formation of new fibrillae by the undifferentiated sarcoplasm remaining. Such is the metamorphosis which has been described in the present paper for Coleoptera, and I can conceive of nothing simpler or more probable.

The presence of degenerating muscles is quite as easily explained. In the development of holometabolic insects, it must have happened many times that a muscle which was useful in the larva became functionless in the imago. It is evident that the ultimate fate of such a muscle would be degeneration at the end of larval life. The method of degeneration might be different in different cases, but no one can deny successfully that such muscles would exist, though Berlese has attempted to do so. The converse of this might also be expected, that is, muscles which are useful in the imago but functionless in the larva. Such muscles would tend naturally to be retarded in their development until they came to be muscles newly formed in the pupa; but in their final development they would arise from the cells which had previously formed them. How it could come about that these muscles of new formation in the pupa should be developed from cells furnished by the degenerating muscles of *other parts of the body*, as Berlese states, is something which I cannot understand.

From what has been said, it is evident that there is little doubt as to the incorrectness of Berlese's main idea in other groups of insects, as well as in Coleoptera.

Needham's (:00) statement that the nuclei of fat cells become associated with the developing muscles, does not seem probable. The development of such highly specialized cells into a tissue of such an entirely different nature, is an exceedingly rare phenomenon. Nothing that would indicate such a development has been seen in the present study.

### Summary.

During the metamorphosis of the larvae of Coleoptera into the imagines, some of the larval muscles remain unaltered during the metamorphosis, a few degenerate, while many metamorphose into imaginal muscles. Imaginal muscles are formed in the pupa from cells of an embryonic nature, but they are few in number.

#### I. ANATOMICAL.

1. The muscles which remain *unaltered* by the metamorphosis are all found in the abdominal region. They compose the inner layer of the antero-posterior muscles, and the inner muscles of the dorso-ventral intersegmental muscles. Exceptions to this statement are found in the first and last abdominal somites, where muscles occupying these positions are found to degenerate. This is explained by the greater changes of external form which these somites undergo.

2. The typical *degenerating* muscles are found in the thorax and the abdominal somites just mentioned. They occupy positions in these somites serially homologous to the positions of the persistent larval muscles of the abdomen. There are some cases of the degeneration of dorso-ventral muscles other than intersegmental muscles. These were noticed especially in mesothoracic muscles whose counterparts in the metathorax metamorphose into imaginal muscles. Their histological changes show transitional stages between metamorphosing and degenerating muscles. The muscles which show these conditions are such as would be functional in the adult, if the elytra were used as organs of flight, as presumably was the case in the ancestors of beetles.

3. Imaginal muscles of *new formation* in the pupa are not very common, only two somewhat questionable cases having been observed in *Thymalus*. In *Bruchus* and other forms with legless larvae, the leg muscles belong to this class.

4. The *metamorphosing* larval muscles are by far the most numerous, and include all of the remaining larval muscles. In general, these are the muscles of the head, the peripheral layers of the hypodermal muscles, and the intestinal muscles. There is a metamorphosis of larval muscles into imaginal muscles of both the wing and the leg types.

#### II. HISTOLOGICAL.

1. The fibres of the larval muscles which pass *unaltered* from the larva to the imago, present the usual structure of this type of muscle

fibre. Each muscle is composed of a few fibres whose nuclei are placed at the surface of the fibre in an abundant sarcoplasm. They show a well-marked sarcolemma and evident cross and longitudinal striations. The intracellular tracheoles which supply the muscles apparently penetrate the sarcolemma and ramify in the superficial layer of the sarcoplasm.

2. The larval muscles which metamorphose into muscles of the *wing* type begin their metamorphosis at an early stage of the resting larva. The metamorphosis consists of (1) a longitudinal division of the original fibre into from four to ten fibres, (2) the destruction of the fibrillae of the larval muscles, and the formation of the larger separate fibrillae of the imaginal muscles in the remaining structureless sarcoplasm, and (3) a great increase in the number of the nuclei, which become redistributed throughout the substance of the muscle. All of the muscles of this type increase in size during these changes. At an early stage in the metamorphosis, mesenchymatous cells derived from the intracellular tracheoles make their appearance between the newly divided fibres. These cells increase rapidly by mitotic division, and, in a late stage of the pupa, form the abundant new tracheoles which supply these muscles in the imago. Possibly some of these mesenchymatous cells become imaginal leucocytes.

3. The metamorphosis of the larval muscles into muscles of the *leg* type does not differ essentially from that of muscles of the wing type. The principal difference is that the muscles of the leg type divide into smaller fibres, and a greater number of them, fifteen to twenty fibres being frequently formed by this division. The nuclei divide frequently by amitosis, and in the redistribution may take either of two positions in the new fibres. They may come to lie at the periphery, as in *Thymalus*, or in a row along the axis of each fibre, as in *Bruchus*. There is in different muscles a great variation in the time of the beginning of this metamorphosis. Some begin their changes as early as those which metamorphose into imaginal muscles of the wing type; others begin their changes at various periods during the resting larva; while a few show scarcely any evidence of metamorphosis, even at the time of pupation. It is barely possible that in the muscles last mentioned some of the fibrillae of the larval muscles may persist as fibrillae of the imaginal muscles. This cannot be commonly the case, however. In the region of the leg muscles the mesenchymatous tracheal cells are not as numerous as in the wing muscles, and the tracheae developed from them do not penetrate the substance of the muscle fibres.

4. The metamorphosis of the *intestinal* muscles is later in starting than that of any of the other muscles. Not until well along in pupal



life are the fibrillae of the larval muscles entirely dissolved. There seems to be no increase in the number of muscle fibres by longitudinal division, and the nuclei were not observed to divide amitotically, as in the other metamorphosing muscles. The usual tracheal cells are found accompanying these muscles.

5. The *degeneration* of the larval muscles is entirely chemical, there being no evidence of phagocytosis. In the early pupa, there commences a gradual atrophy of the muscle substance, during which the muscle is partially divided into longitudinal strands. The nuclei show no evidence of degeneration until practically all other parts of the muscle have disappeared. They then undergo a typical chromatolysis. This happens in the late pupa. Occasionally, tracheal cells are found in the fissures formed by the breaking up of these muscles.

In those cases which presented transitional conditions between degeneration and metamorphosis, the muscles underwent changes exactly similar to those of the metamorphosing muscles, until the stage was reached where the reconstructive changes begin. Then the degenerating muscles seemed to lack the stimulus to start this reconstruction, and, therefore, continued to atrophy, and finally disappeared at the same time and in the same manner as the more typically degenerating muscles.

6. The histological changes of the muscles of *new formation* in the pupa were observed principally in the leg muscles of *Bruchus*. These muscles are formed from spindle-shaped mesoderm cells found in the larva at the bases of imaginal folds which represent the legs. These cells probably are derived from the embryonic mesoderm. In the young pupa these mesoderm cells form the muscle fibres, each cell possibly giving rise to a single fibre. In the youngest stage in which the muscle fibres can be distinguished with certainty, it is evident that there are two kinds of cells in this mass: one, the mesoderm cells which form the muscle fibres; the other, tracheal cells which form the tracheae of the leg. The latter are presumably derived from the same source as the tracheal cells of the rest of the body, that is, from the intracellular tracheoles of the resting larva. These cells may be distinguished as mesenchyme.

### III. ADDITIONAL.

1. Incidentally some other points have been noted. The *musculus episternalis* of the metathorax, whose function former authors had suggested to be that of an expiratory muscle, was discovered not to have this function. In the imaginal form of *Thymalus*, the pair of episternal

muscles lie in such positions that their contraction depresses the folds on the metaepisterni into which ridges on the elytra catch when these are closed. This depression of the folds releases the elytra, or, if these are open, it allows them to be closed.

2. Phagocytosis of the muscles of Coleoptera does not exist. No "Körnchenkugeln" have been found, though leucocytes containing what are evidently foreign bodies have been found in Thymalus. These inclusions are possibly to be explained as intracellular parasites.

## BIBLIOGRAPHY.

Amans, P. C.

- '85. Comparaisons des organes du vol dans la série animale. *Ann. Sci. Nat., Zool., Sér. 6, Tome 19, pp. 9-222, pl. 1-8.*

Anglas, J.

- '99. Sur l'histolyse et l'histogénèse des muscles des Hyménoptères pendant la métamorphose. *Comp. Rend. et Mém. Soc. Biol., Paris, Sér. 11, Tome 51, pp. 931-933.*

Also in *Bull. Soc. Entomol. France, Année 1899, pp. 348-350.*

Anglas, J.

- '99<sup>a</sup>. Sur l'histogénèse des muscles imaginaires des Hyménoptères. *Comp. Rend. et Mém. Soc. Biol., Paris, Sér. 11, Tome 51, pp. 947-949.*

Anglas, J.

- :00. Sur la signification des termes "phagocytose" et "lyocytose." *Comp. Rend. et Mém. Soc. Biol., Paris, Sér. 11, Tome 52, pp. 219-221.*

Anglas, J.

- :01. Observations sur les métamorphoses internes de la Guêpe et de l'Abeille. *Bull. Sci. France et Belgique, Tome 34, pp. 363-473, pl. 19-23, 8 fig.*

Anglas, J.

- :01<sup>a</sup>. Quelques caractères essentiels de l'histolyse pendant la métamorphose. *Bull. Soc. Entomol. France, Année 1901, pp. 301-304.*

Anglas, J.

- :02. Nouvelles observations sur les métamorphoses internes. *Arch. d'Anat. Micr., Tome 5, pp. 78-121, pl. 4, 1 fig.*

Aubert, H.

- '53 Ueber die eigenthümliche Structur der Thoraxmuskeln der Insecten. *Zeit. f. wiss. Zool., Bd. 4, pp. 388-399, Taf. 15.*

Berlese, A.

- '99. Osservazioni su fenomeni che avvengono durante la ninfosi degli insetti metabolici. Parte I. Tessuto adiposo. *Rivista Patolog. vegetale, Anno 8, pp. 1-155, tav. 1-6, 42 fig.*

**Berlese, A.**

:00. Intorno alle modificazioni de alcuni tessuti durante la ninfosi della *Calliphora erythrocephala*. Bull. Soc. Entomol. Ital., Anno 32, pp. 253-288, 7 fig.

**Berlese, A.**

:00<sup>a</sup>. Considerazioni sulla Fagocitosi negli insetti metabolici. Zool. Anz., Bd. 23, pp. 441-449.

**Berlese, A.**

:01. Vorgänge, welche während der Nymphosis der metabolischen Insecten vorkommen. Zool. Anz., Bd. 24, pp. 515-521.

**Berlese, A.**

:02. Osservazioni su fenomeni che avvengono durante la ninfosi degli insetti metabolici. Parte I. Tessuto adiposo, Memoria seconda. Rivista Patolog. vegetale, Anno 9, pp. 177-344, tav. 7-10, 53 fig.

**Berlese, A.**

:02<sup>a</sup>. Osservazioni su fenomeni che avvengono durante la ninfosi degli insetti metabolici. Parte II. Tessuto muscolare. Rivista Patolog. vegetale, Anno 10, pp. 1-120, tav. 11-14, 4 fig.

**Beutenmueller, W.**

'90. Description of the larva of *Thymalus fulgidus*. Entomol. Amer., Vol. 6, p. 57.

**Bruyne, C. de.**

'97. Sur l'intervention de la phagocytose dans le développement des invertébrés. Arch. de Biol., Tome 15, pp. 181-300, pl. 7-11.

Also in Mém. cour. et Mém. savants étrangers Acad. roy. de Belgique, Tome 56, pp. 1-114, pl. 1-5, 1898.

**Cajal, R. y.**

'88. Observations sur la texture des fibres musculaires des pattes et des ailes des insectes. Internat. Monat. f. Anat. u. Physiol., Bd. 5, pp. 205-232, 253-276, Taf. 19-22.

**Chittenden, F. H.**

'99. Insects injurious to beans and peas. Yearbook U. S. Dept. Agri. for 1898, pp. 233-260, 17 fig. in text.

**De Bruyne, C. See BRUYNE, C. DE.****Deegener, P.**

:00. Entwicklung der Mundwerkzeuge und des Darmkanals von *Hydrophilus*. Zeit. f. wiss. Zool., Bd. 68, pp. 113-168, Taf. 8-10.

**Ganin, M.**

'76. (The postembryonic development of insects.) (Russian.) Arbeit. d. V. Versammlung russ. Naturf. u. Ärzte in Warschau.

Reviewed in Zeit. f. wiss. Zool., Bd. 28, 1877, pp. 386-389.

**Hammond, A. R.**

See Miall, L. C., and Hammond, A. R.

**Heidenhain, M.**

'98. Struktur der kontraktiven Materie. 1. Struktur der quergestreiften Muskelsubstanz. *Anat. Hefte, Ergeb. d. Anat. u. Entwickl.*, Bd. 8, pp. 3-111, 19 Textfig.

**Hurst, C. H.**

'90. The pupal stage of *Culex*. An inaugural dissertation for the degree of Ph. D. in the Univ. of Leipzig. 26 pp., 1 pl., Manchester.

**Karawaiew, W.**

'97. Vorläufige Mittheilung über die innere Metamorphose bei Ameisen. *Zool. Anz.*, Bd. 20, pp. 415-422.

**Karawaiew, W.**

'98. Die nachembryonale Entwicklung von *Lasius flavus*. *Zeit. f. wiss. Zool.*, Bd. 64, pp. 385-478, Taf. 9-12, 15 Textfig.

**Karawaiew, W.**

'99. Ueber Anatomie und Metamorphose des Darmkanals der Larve von *Anobium paniceum*. *Biol. Centralbl.*, Bd. 19, pp. 122-130, 161-171, 196-202, 19 Textfig.

**Kellogg, V. L.**

:01. Phagocytosis in the postembryonic development of the Diptera. *Amer. Nat.*, Vol. 35, pp. 363-368, 2 fig. in text.

**Korotneff, A.**

'92. Histolyse und Histogenese des Muskelgewebes bei der Metamorphose der Insekten. *Biol. Centralbl.*, Bd. 12, pp. 261-265, 5 Textfig.

**Kowalevsky, A.**

'85. Beiträge zur nachembryonalen Entwicklung der Musciden. *Zool. Anz.*, Jahrg. 8, pp. 98-103, 123-128, 153-157.

**Kowalevsky, A.**

'87. Beiträge zur Kenntniss der nachembryonalen Entwicklung der Musciden. *Zeit. f. wiss. Zool.*, Bd. 45, pp. 542-594, Taf. 26-30.

**Krüger, E.**

'98. Ueber die Entwicklung der Flügel der Insekten mit besonderer Berücksichtigung der Deckflügel der Käfer. Inaugural-Dissertation, Univ. Göttingen. 60 pp., 19 Textfig. Göttingen.

**Künckel d'Herculis, J.**

'72. Sur le développement des fibres musculaires striées chez les insectes. *Comp. Rend. Acad. Sci., Paris*, Tome 75, pp. 359-362.

**Künckel d'Herculis, J.**

'75. Recherches sur l'organisation et le développement des Volucelles. vi+208 pp., 26 pl., Paris.

Léveillé, A.

- '88. Catalogue de la famille des Temnochildes. Ann. Soc. Entomol. France, Sér. 6, Tome 8, pp. 429-448.

Lowne, B. T.

- '90-95. The Anatomy, Physiology, Morphology, and Development of the Blow-fly (*Calliphora erythrocephala*). Vol. 1, ix+350 pp., 21 pl., 47 fig. in text; Vol. 2, viii+428 pp., 30 pl., 60 fig. in text. London.

Luks, C.

- '83. Ueber die Brustmuskulatur der Insecten. Jena. Zeit., Bd. 16, pp. 529-552, Taf. 22-23.

Miall, L. C., and Hammond, A. R.

- '92. The Development of the Head of the Imago of *Chironomus*. Trans. Linn. Soc. London, Ser. 2, Vol. 5, pp. 265-279, pl. 28-31.

Miall, L. C., and Hammond, A. R.

- :00. The Structure and Life-history of the Harlequin Fly (*Chironomus*). vi+196 pp., 1 pl., 129 fig. in text. Oxford.

Needham, J. G.

- :00. Some general Features of the Metamorphosis of the Flag Weevil, *Mononychus vulpeculus* Fabr. Biol. Bull., Vol. 1, pp. 179-191, 10 fig. in text.

Noetzel, W.

- '98. Zur Kenntniss der Histolyse. Arch. f. path. Anat. u. Physiol., Bd. 151, pp. 7-22.

Pérez, C.

- '99. Sur la métamorphose des insectes. Bull. Soc. Entomol. France, Année 1899, pp. 393-402.

Pérez, C.

- :00. Sur l'histolyse musculaire chez les insectes. Comp. Rend. et Mém. Soc. Biol. Paris, Sér. 11, Tome 52, pp. 7-8.

Petri, L.

- '99. I muscoli delle ali nei ditteri e negli imenotteri. Bull. Soc. Entomol. Ital., Anno 31, pp. 3-45, tav. 1-3, 9 fig.

Rengel, C.

- '96. Über die Veränderungen des Darmepithels bei *Tenebrio molitor* während der Metamorphose. Zeit. f. wiss. Zool., Bd. 62, pp. 1-60, Taf. 1.

Rollett, A.

- '85. Untersuchungen über den Bau der quergestreiften Muskelfasern. Denkschr. Kaiser. Akad. Wissen. Wien, Bd. 49, pp. 81-132, 4 Taf.

Straus-Dürckheim, H.

- '28. Considérations générales sur l'anatomie comparée des animaux articulés. xix + 434 + 36 pp., 9 pl. Paris.

**Terre, L.**

'99. Contribution à l'étude de l'histolyse et de l'histogénèse des tissus musculaire chez l'Abeille. *Comp. Rend. et Mém. Soc. Biol. Paris, Sér. 11, Tome 51*, pp. 896-898.

Also in *Bull. Soc. Entomol. France, Année 1899*, pp. 351-352.

**Terre, L.**

:00. Sur l'histolyse musculaire des Hyménoptères. *Comp. Rend. et Mém. Soc. Biol. Paris, Sér. 11, Tome 52*, pp. 91-93.

Also in *Bull. Soc. Entomol. France, Année 1900*, pp. 23-25.

**Terre, L.**

:00<sup>a</sup>. Métamorphose et phagocytose. *Comp. Rend. et Mém. Soc. Biol. Paris, Sér. 11, Tome 52*, pp. 158-159.

**Van Rees, J.**

'84. Over intra-cellulaire spijsverteering en over de beteekenis der witte bloedlichaampjes. *Maandblad voor Natuurwetenschappen, Jaarg. 11*, 28 pp.

**Van Rees, J.**

'88. Beiträge zur Kenntniss der inneren Metamorphose von *Musca vomitoria*. *Zool. Jahrb., Abth. f. Anat. u. Ontog., Bd. 3*, pp. 1-134, Taf. 1-2, 15 Textfig.

**Vaney, C.**

:00. Contributions à l'étude des phénomènes de métamorphose chez les Diptères. *Comp. Rend. Acad. Sci., Paris, Tome 131*, pp. 753-761.

**Viallanes, H.**

'81. Sur l'histolyse des muscles de la larve durant le développement postembryonnaire des Diptères. *Comp. Rend. Acad. Sci., Paris, Tome 92*, pp. 416-418.

**Viallanes, H.**

'82. Recherches sur l'histologie des insectes et sur les phénomènes histologiques qui accompagnent le développement post-embryonnaire de ces animaux. *Ann. Sci. Nat., Zool., Sér. 6, Tome 14*, pp. 1-348, pl. 1-18.

**Weismann, A.**

'62. Ueber die zwei Typen contractilen Gewebes und ihre Vertheilung in der grossen Gruppen des Thierreichs, sowie über die histologische Bedeutung ihrer Formelemente. *Zeit. f. ration. Med., Bd. 15*, pp. 60-103, Taf. 4-8.

**Weismann, A.**

'64. Die nachembryonale Entwicklung der Musciden nach Beobachtungen an *Musca vomitoria* und *Sarcophaga carnaria*. *Zeit. f. wiss. Zool., Bd. 14*, pp. 187-336, Taf. 21-27.

**Weismann, A.**

'66. Die Metamorphose der *Corethra plumicornis*. *Zeit. f. wiss. Zool., Bd. 16*, pp. 45-132, Taf. 3-7.

## EXPLANATION OF PLATES.

All figures were drawn with the aid of the camera lucida from preparations of *Thymalus marginicollis* Chevr. The magnifications are given with the descriptions of the several figures.

In Plates 1-5, Figures 1-5, 7, 9, and 11 are drawn from reconstructions of serial sections. They form two series of figures illustrating the anatomical changes of the dorsal antero-posterior (Figs. 1, 2) and lateral dorso-ventral (Figs. 3-5, 7, 9, 11) groups of metathoracic muscles during metamorphosis. These figures are all magnified 67.5 diameters.

## ABBREVIATIONS.

<i>aa. Cohn</i> . . . . .	Cohnheim's areas.
<i>al.</i> . . . . .	Wing.
<i>cd. n.</i> . . . . .	Nerve cord.
<i>chr.</i> . . . . .	Chromatin masses left after the disintegration of nuclei.
<i>cl. mit.</i> . . . . .	Tracheal cells in stages of mitotic division.
<i>cl. tr.</i> . . . . .	Tracheal cell.
<i>cl. tr.<sup>1</sup></i> . . . . .	Tracheal cells showing connections with tracheae.
<i>cl. tr.<sup>2</sup></i> . . . . .	Tracheal cells whose connections with the tracheae have been severed, but which show tracheoles through their cytoplasm.
<i>cl. tr.<sup>3</sup></i> . . . . .	Tracheal cell entirely embedded in the muscle.
<i>cp. adp.</i> . . . . .	Fat body.
<i>cr.</i> . . . . .	Heart.
<i>cta.</i> . . . . .	Cuticula.
<i>dep. trg.</i> . . . . .	Depressor tergi.
<i>ely.</i> . . . . .	Elytron.
<i>e'stn.</i> . . . . .	Musculus episternalis.
<i>e'th.</i> . . . . .	Epithelial lining of the foreintestine.
<i>ext. al. mag. mt'thx.</i> . . . . .	Extensor alae magnus metathoracis.
<i>ext. al. pa. mt'thx.</i> . . . . .	Extensor alae parvus metathoracis.
<i>ext. cox. mt'thx. (1-3)</i> . . . . .	Extensor coxae metathoracis (primus, secundus, tertius).
<i>ext. trchn. mt'thx.</i> . . . . .	Extensor trochanteris metathoracis.
<i>flx. al. mt'thx. (1-5)</i> . . . . .	Flexor alae metathoracis (primus, secundus, tertius).
<i>flx. cox. mt'thx. (1-5)</i> . . . . .	Flexor coxae metathoracis (primus, secundus, tertius, quatuor, quintus).



<i>flx. prc. p-l. mt'fur.</i>	Flexor processus postero-lateralis metafurcae.
<i>flx. trchn. mt'thx.</i>	Flexor trochanteris metathoracis.
<i>hy'drm.</i>	Hypodermis.
<i>in.</i>	Intestine.
<i>leu'cyt.</i>	Leucocyte.
<i>l. ms'fur.</i>	Musculus lateralis mesofurcae.
<i>l. mt'nt.</i>	Musculus lateralis metanoti.
<i>l. mt'thx. a.</i>	Musculus lateralis metathoracis anterior.
<i>l. mt'thx. p.</i>	Musculus lateralis metathoracis posterior.
<i>loph.</i>	Cross section of ridge on elytron.
<i>l. prc. if. ms'phg.</i>	Musculus lateralis processus inferioris mesophragmatis.
<i>ms'fur.</i>	Mesofurca.
<i>ms'fur. d.</i>	Musculus mesofurcae dorsalis.
<i>ms'phg.</i>	Mesophragma.
<i>mt'fur.</i>	Metafurca.
<i>mt'nt.</i>	Musculus metanoti.
<i>mt'phg.</i>	Metaphragma.
<i>mu. crc.</i>	Circular layer of intestinal muscles.
<i>mu. lg.</i>	Longitudinal layer of intestinal muscles.
<i>n.</i>	Cross section of the main branch of the sympathetic nervous system.
<i>nl.</i>	Nucleus of larval muscle fibre before division.
<i>nl.<sup>1</sup></i>	Nucleus of muscle fibre undergoing amitotic division.
<i>nl.<sup>2</sup></i>	Pairs of nuclei resulting from amitotic division.
<i>nl.<sup>3</sup></i>	Elongated nucleus common in metamorphosing muscles.
<i>nl.<sup>4</sup></i>	Nucleus of degenerating muscle undergoing chromatolysis.
<i>nl.<sup>5</sup></i>	Nucleus of leucocyte.
<i>pli.</i>	Cross section of fold on episternum.
<i>prc.</i>	Processes of tracheal cells detached from cell body by the plane of the section.
<i>prc. ms'phg. if.</i>	Processus mesophragmatis inferior.
<i>prc. mt'phg. if.</i>	Processus metaphragmatis inferior.
<i>rlx. al. mt'thx.</i>	Relaxator alae metathoracis.
<i>rlx. ext. al.</i>	Relaxator extensoris alae.
<i>rtr. ms'thx. if.</i>	Retractor mesothoracis inferior.
<i>rtr. prothx. if.</i>	Retractor prothoracis inferior.
<i>sar'lem.</i>	Sarcolemma.
<i>sar'pl.</i>	Sarcoplasm.
<i>stg. ab. 1</i>	Stigma of the first abdominal somite.
<i>stg. mt'thx.</i>	Metathoracic stigma.
<i>sut. a.</i>	Suture of the larval metathorax, probably equivalent to the suture between prescutum and scutum.
<i>sut. p.</i>	Suture probably equivalent to the suture between the scutum and scutellum.
<i>tr.</i>	Trachea.
<i>trl.</i>	Intracellular tracheole.
$\alpha, \beta, \gamma, \delta, \epsilon$ , etc.	Larval muscles which degenerate during pupal life.
<i>1</i>	Anterior lateral horn of the metafurca.

- 2 . . . . . Posterior lateral horn of the metafurca.
- 3 . . . . . Lateral wing of the metafurca.
- 4 . . . . . Median lamina of the metafurca.

The \* is used in Figure 13 to indicate the place where teeth on the inner surface of the elytron interlock with teeth on the outer surface of the thorax, thereby holding the elytron in position.

The table given below shows in a comprehensive manner the relative development of all of the animals used in making drawings. Where figures are bracketed together, all of the figures embraced in the bracket were drawn from the same animal. In all, twenty-three specimens were used in making the fifty-three figures.

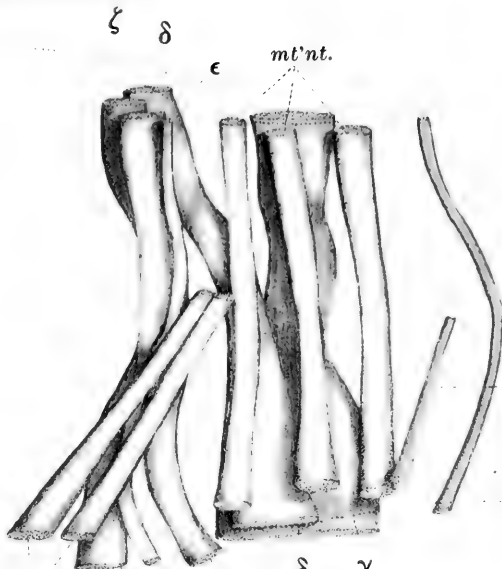
Feeding Larva.	Resting Larva		Pupa.			Imago.
	Young.	Old.	Young.		Old.	
Fig. 1	Fig. 6		Fig. 2	Fig. 8	{ Fig. 21 Fig. 32	{ Fig. 9 Fig. 11
{ Fig. 3 Fig. 4	Fig. 14	{ Fig. 25 Fig. 28 Fig. 51	{ Fig. 5 Fig. 7 Fig. 12	{ Fig. 35 Fig. 38 Fig. 43 Fig. 45 Fig. 48		
Fig. 10	Textfig. 1					
{ Fig. 16 Fig. 22			{ Fig. 19 Fig. 39		{ Fig. 29-30 Fig. 41-42	{ Fig. 17 Fig. 18
{ Fig. 26 Fig. 33	{ Fig. 24 Fig. 27 Fig. 34				{ Fig. 44 Fig. 46-47	
Fig. 23	Fig. 49		Fig. 37		{ Fig. 52	



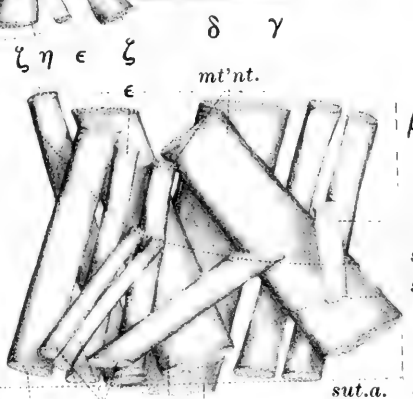
PLATE 1.

All of the figures magnified 67.5 diameters.

- Fig. 1. Dorsal view of the dorsal antero-posterior muscles of the left side of the metathorax of a *feeding larva*. Anterior is up on the plate.
- Fig. 2. *Young pupal* stage of the muscles shown in Fig. 1. Similar view.
- Fig. 3. Deeper layer of the lateral dorso-ventral muscles of the left side of the metathorax of a *feeding larva* seen in lateral aspect. Anterior at the left.
- Fig. 4. Superficial layer of the group of muscles whose deeper layer is shown in Fig. 3.



β  
2  
a



β  
1  
a  
sut.a.  
sut.p.

3.  
l.pr.c.if.  
ms'phg.

l.mt'thx.a.

sut.a.

flx.cox.mt'thx.2 η

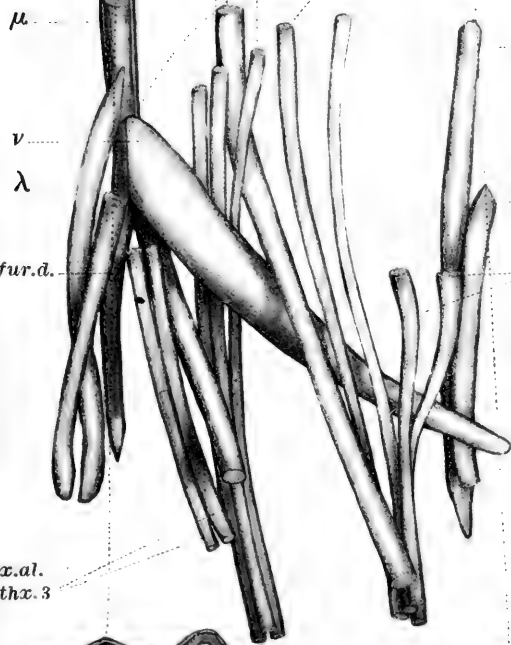
l.mt'nt. δ γ

sut.a. sut.p.

4.

sut.p.

ext.cox.mt'thx.3



μ

ν

λ

dep.trg.

rlx.ext.al.?

flx.prc.p-l.  
mt'fur.

rlx.al.  
mt'thx.?

ext.al.pa.  
mt'thx.

flx.al.mt'thx.1,2

ms'fur.d.

l.ms'fur.

flx.cox.  
mt'thx.5

flx.al.  
mt'thx.3

ext.al.mag.  
mt'thx.

ext.cox.  
mt'thx.1

flx.cox.  
mt'thx.1



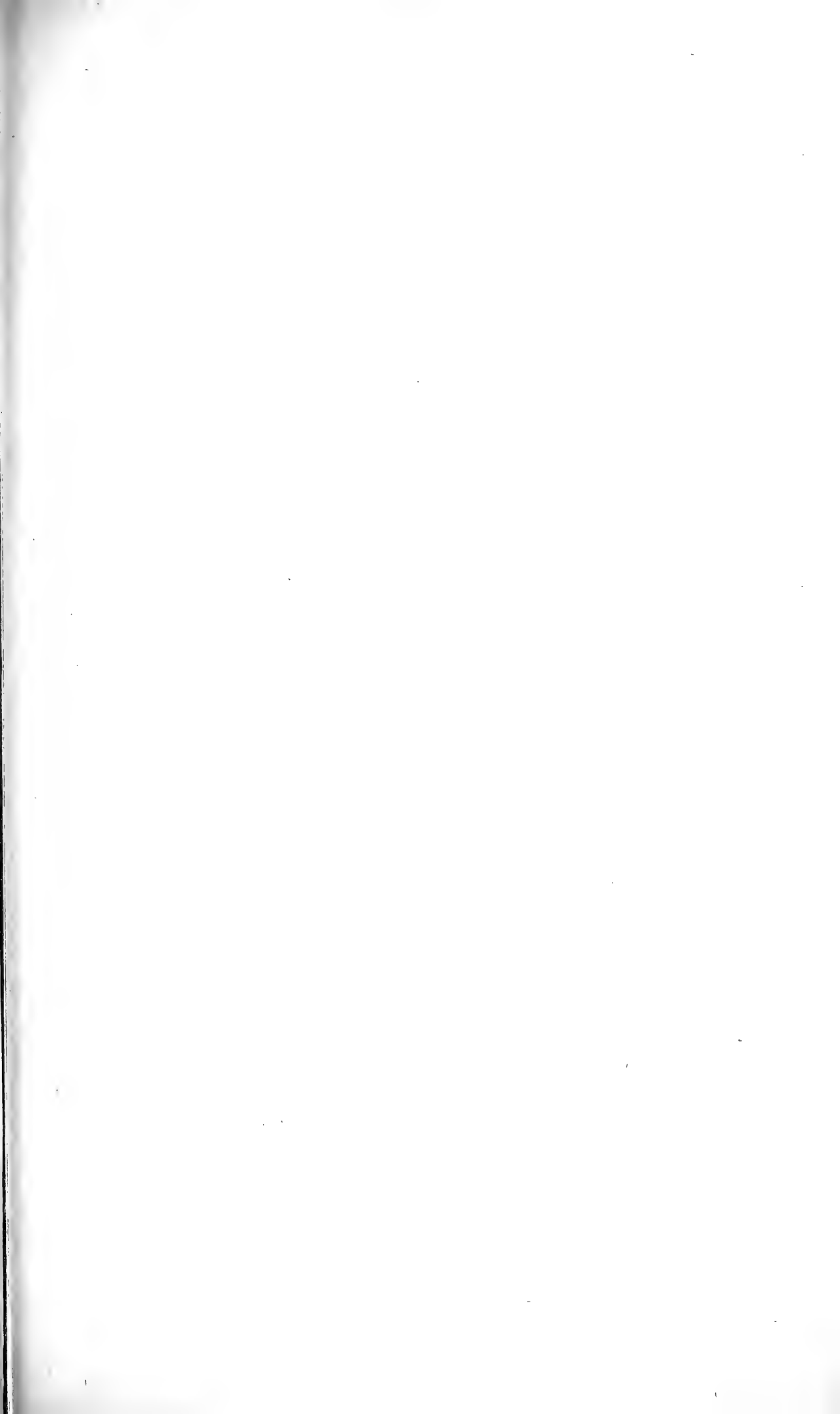


PLATE 2.

- Fig. 5. Superficial layer of the metathoracic lateral dorso-ventral muscles of the left side of a *young pupa* as they would appear with the lateral wall of the metathorax removed. Anterior at the left.  $\times 67.5$ .
- Fig. 6. Side view of the resting *larva* of *Thymalus*.  $\times 13$ .



*flx.al.mt'thx.12*

*ext.cox.mt'thx.3*

*rlx.ext.al.  
c.al. mt'thx.*

*x.al.mt'thx.3*

$\mu$

*stg.mt'thx.*

*ext.al.mag.mt'thx.*

*stg.ab.1*

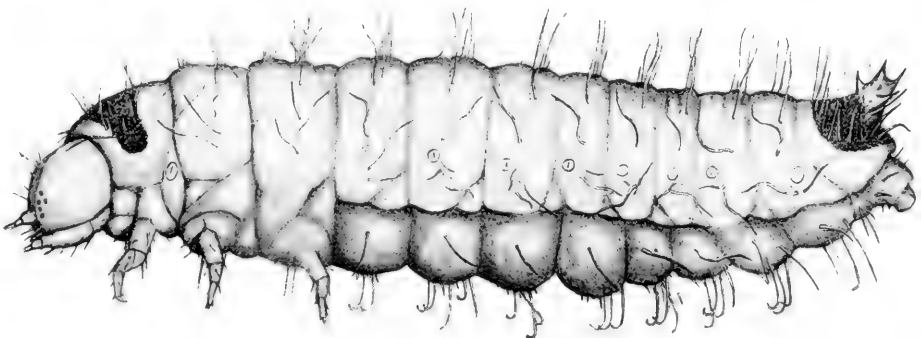
5.

*ms'fur.*

*flx.cox.mt'thx.4*

*ext.al.pa.mt'thx.*

6.





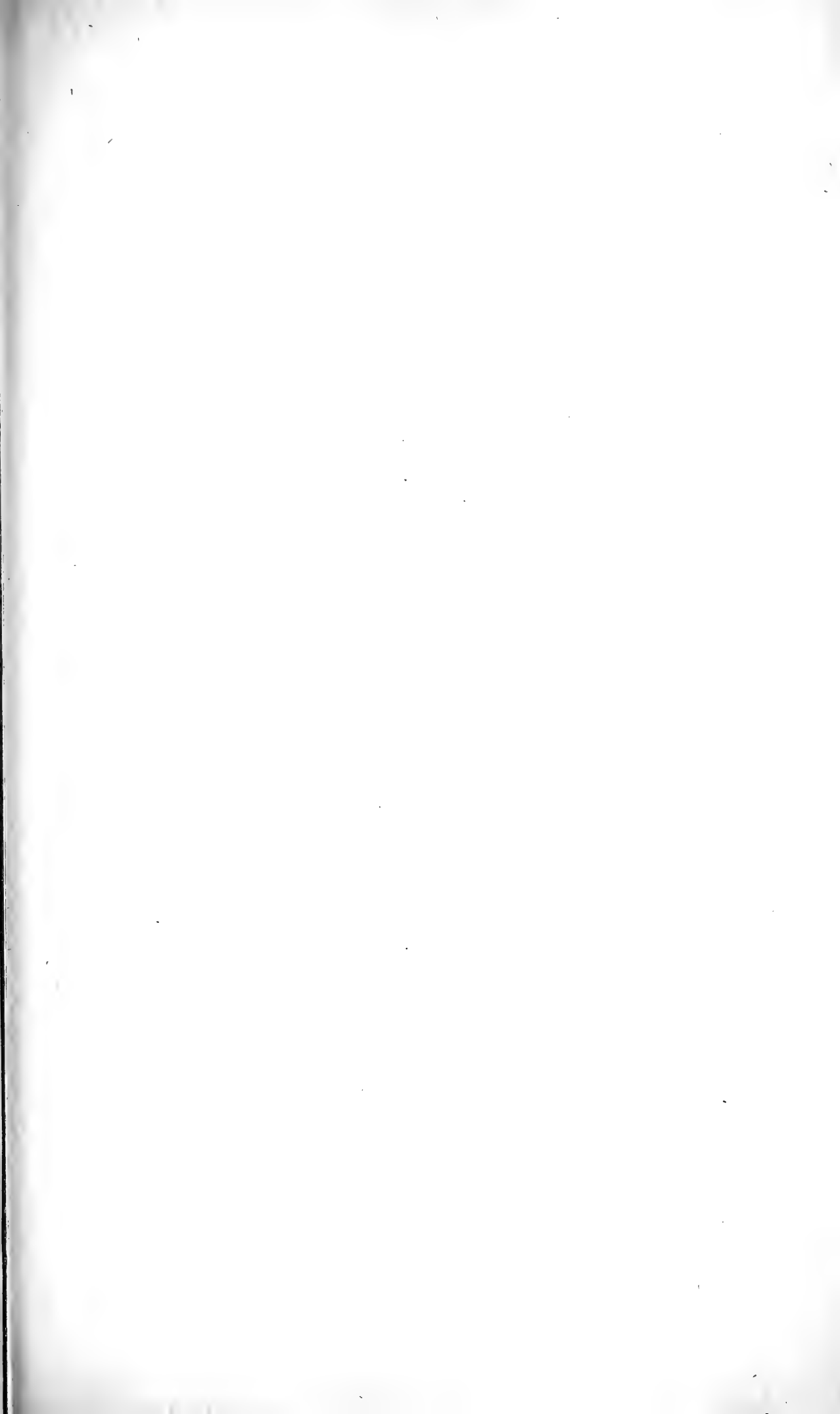


PLATE 3.

- Fig. 7. *Young pupa*. Deeper layer of the group of muscles whose superficial layer is shown in Fig. 5.  $\times 67.5$ .
- Fig. 8. Side view of the *pupa* of *Thymalus*.  $\times 13$ .

*l.mt'thx. p.*    *flx.cox.mt'thx. 2*    *dep.trg.*

*l.mt'thx. a.*

*rc.if. ms'phg.*

λ

*ms'fur.d.*

*l.ms'fur.*

*flx.prc.p-l.*  
*mt'fur.*

*stg.ab.1*

7.

*ms'fur.*

*rtr.ms'thx.if.*

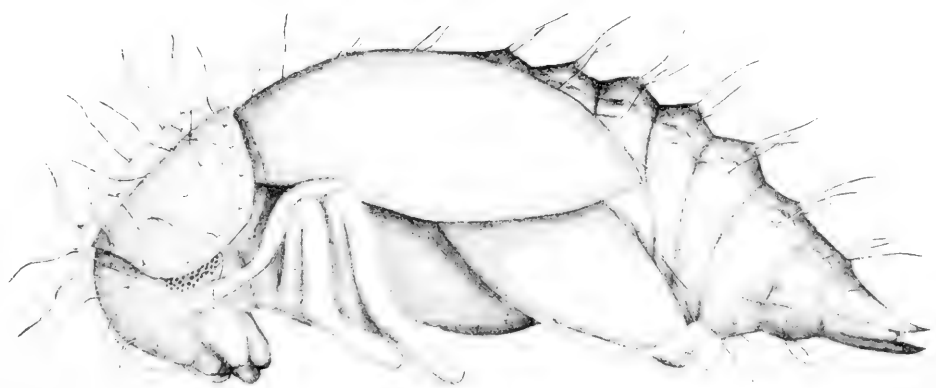
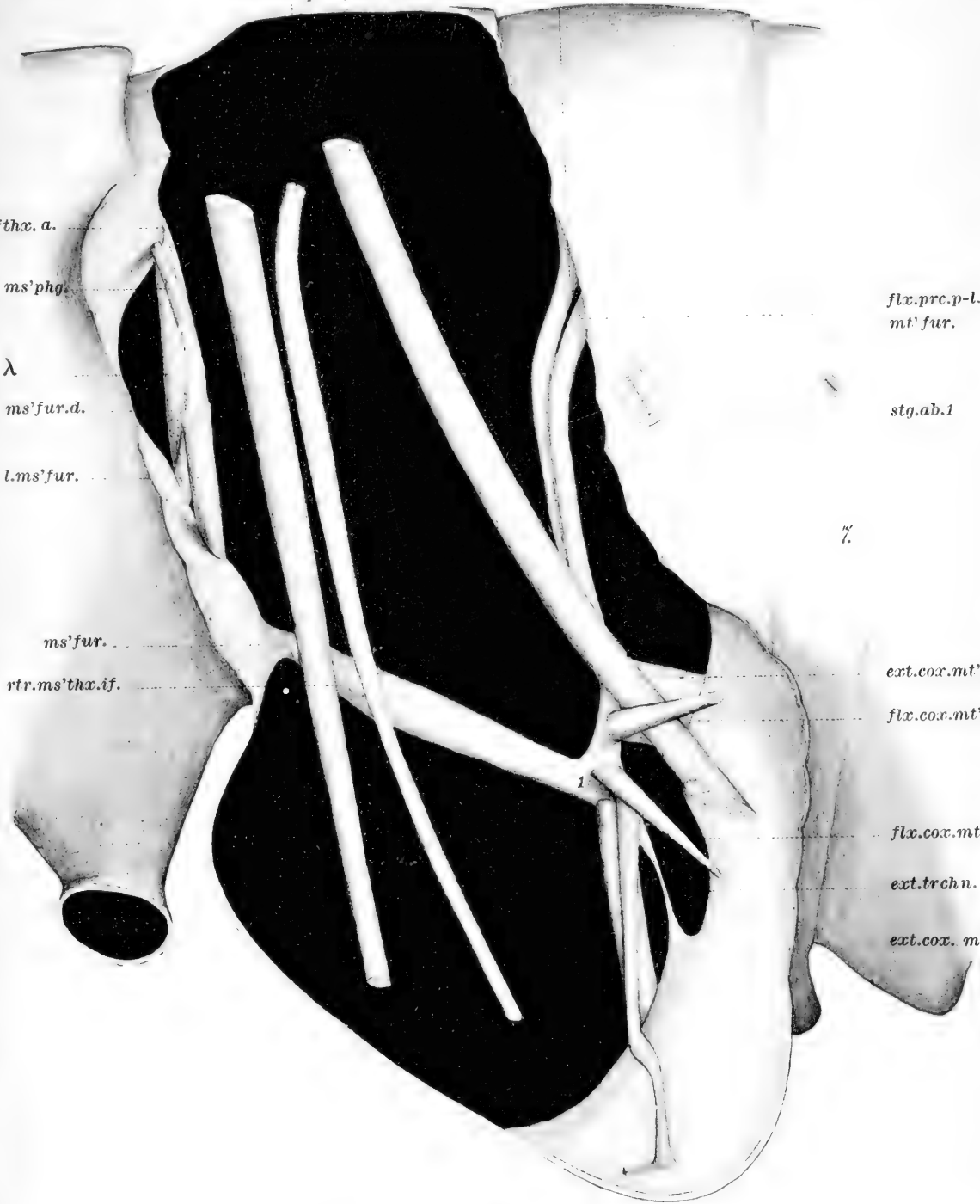
*ext.cox.mt'thx. 2*

*flx.cox.mt'thx. 5*

*flx.cox.mt'thx. 1*

*ext.trchn.*

*ext.cox. mt'thx. 1.*



8



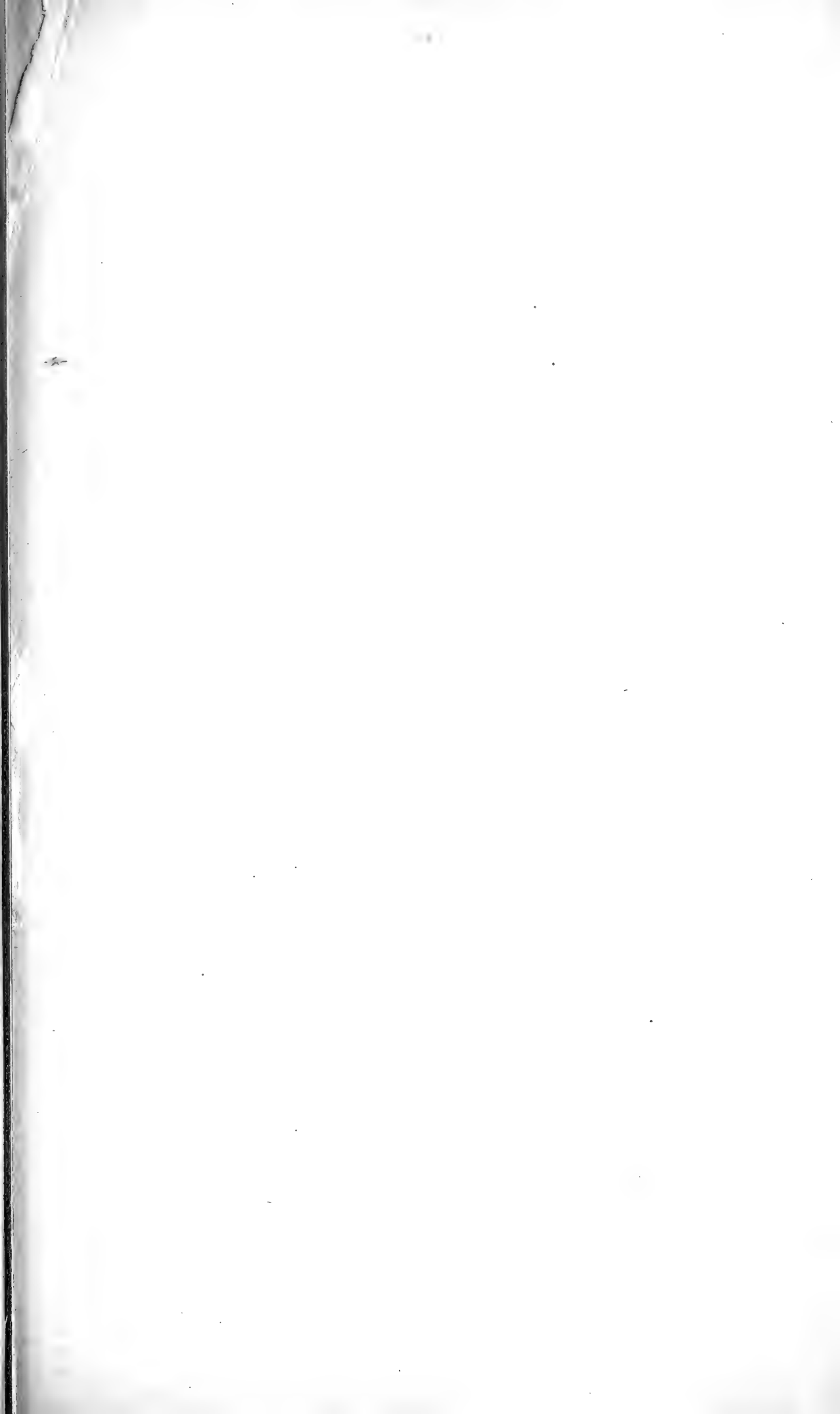


PLATE 4.

Both figures magnified 67.5 diameters.

- Fig. 9. Superficial layer of the metathoracic muscles of the left side of an *imago* as they would appear with the lateral wall of the metathorax removed. Anterior at the left.
- Fig. 10. Portion of a cross section of the metathorax of a *larva* showing the cross section of the ventral antero-posterior muscles. Dorsal up on the plate.



flex.al.mt'thr.1 flex.coz.mt'thr.2

rlx.ext.al. V K

flex.coz.mt'thr.2 flex.al.mt'thr.1,2

ext.coz.mt'thr.3 l.mt'nt. mt'nt. mt'phg.

l.mt'thr. p.

pre.mt'phg.if.

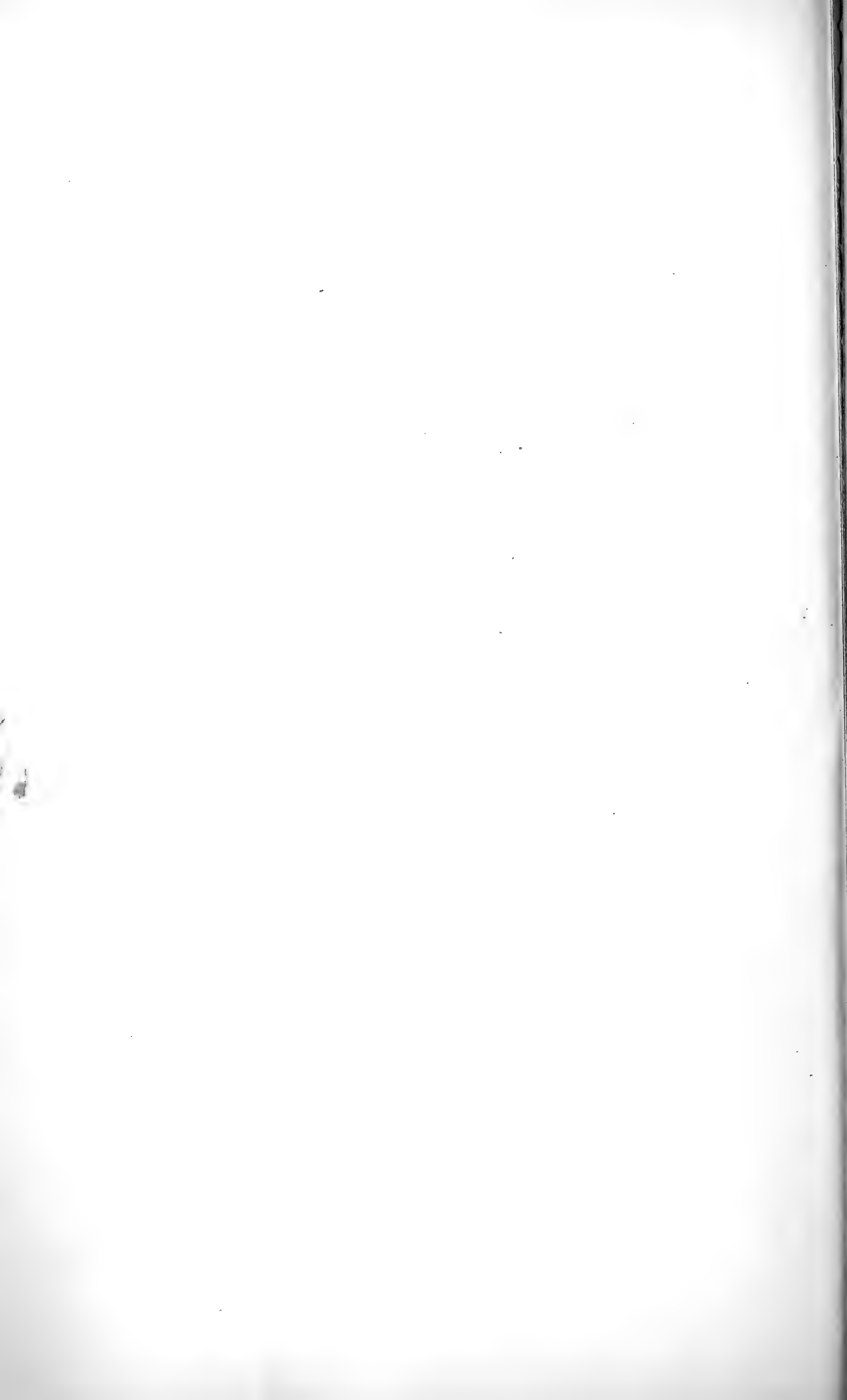


RSB del

ext.al.pa. mt'thr.

ab.

e'stn. flex.coz.mt'thr.4



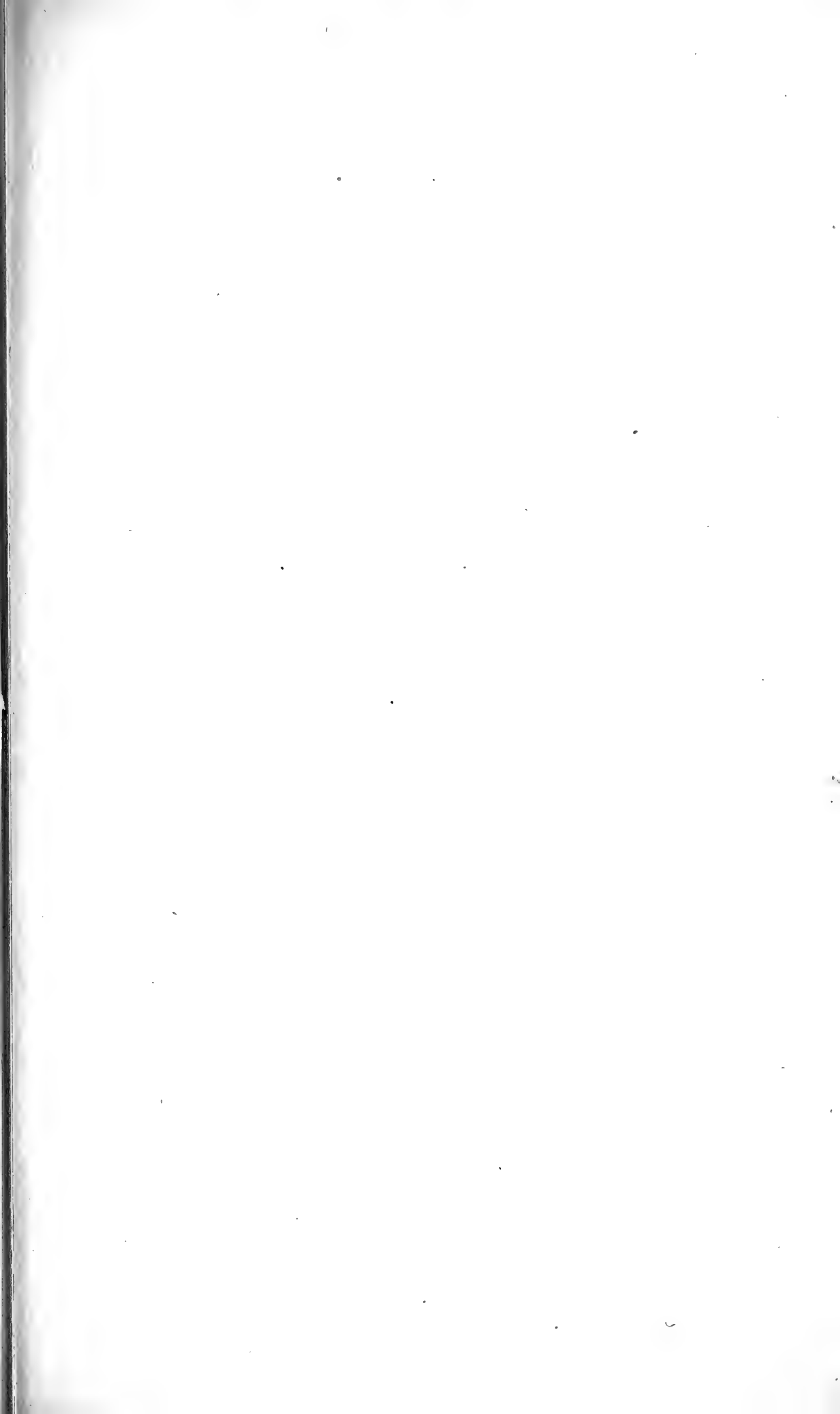
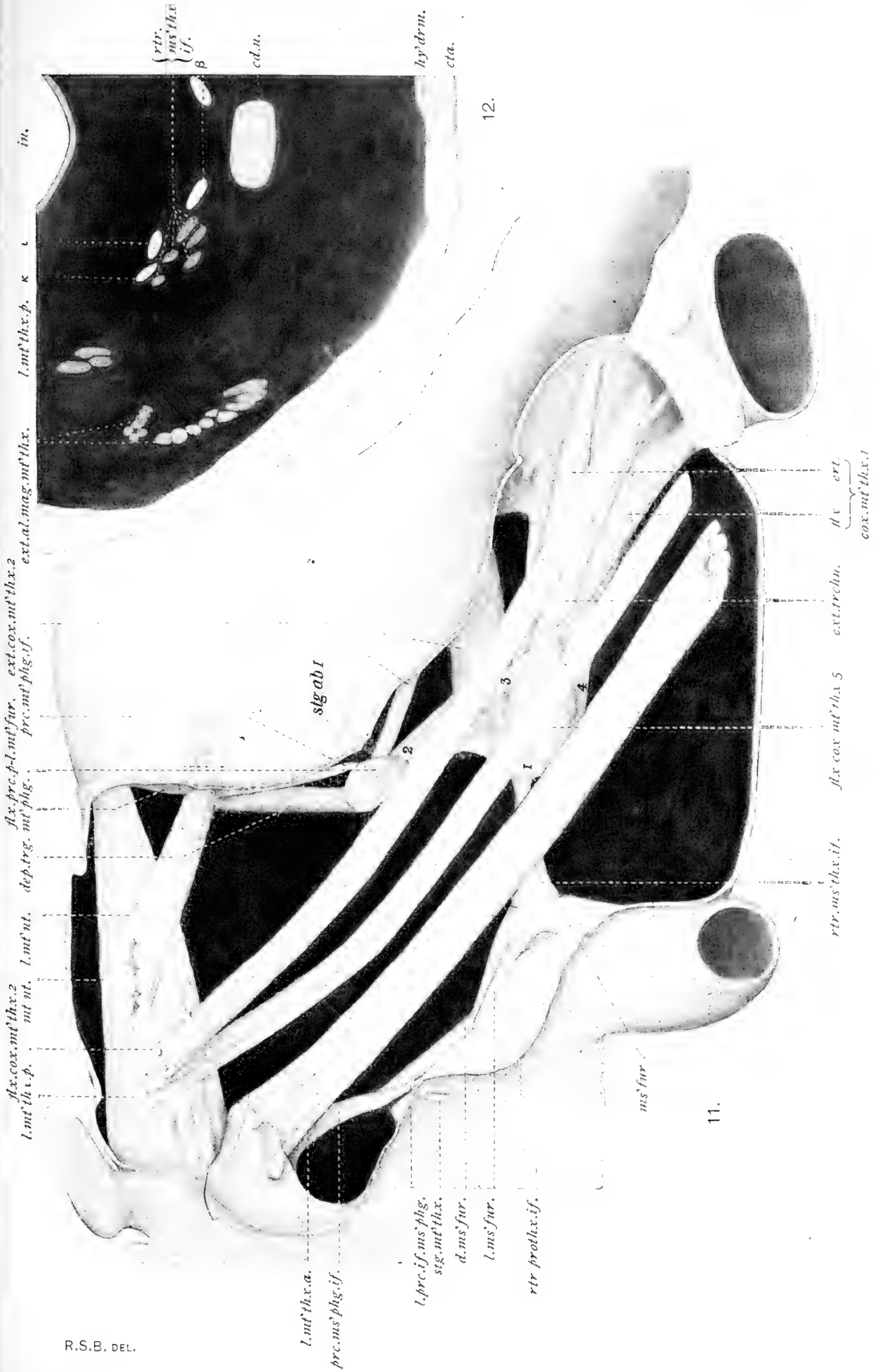


PLATE 5.

Both figures magnified 67.5 diameters.

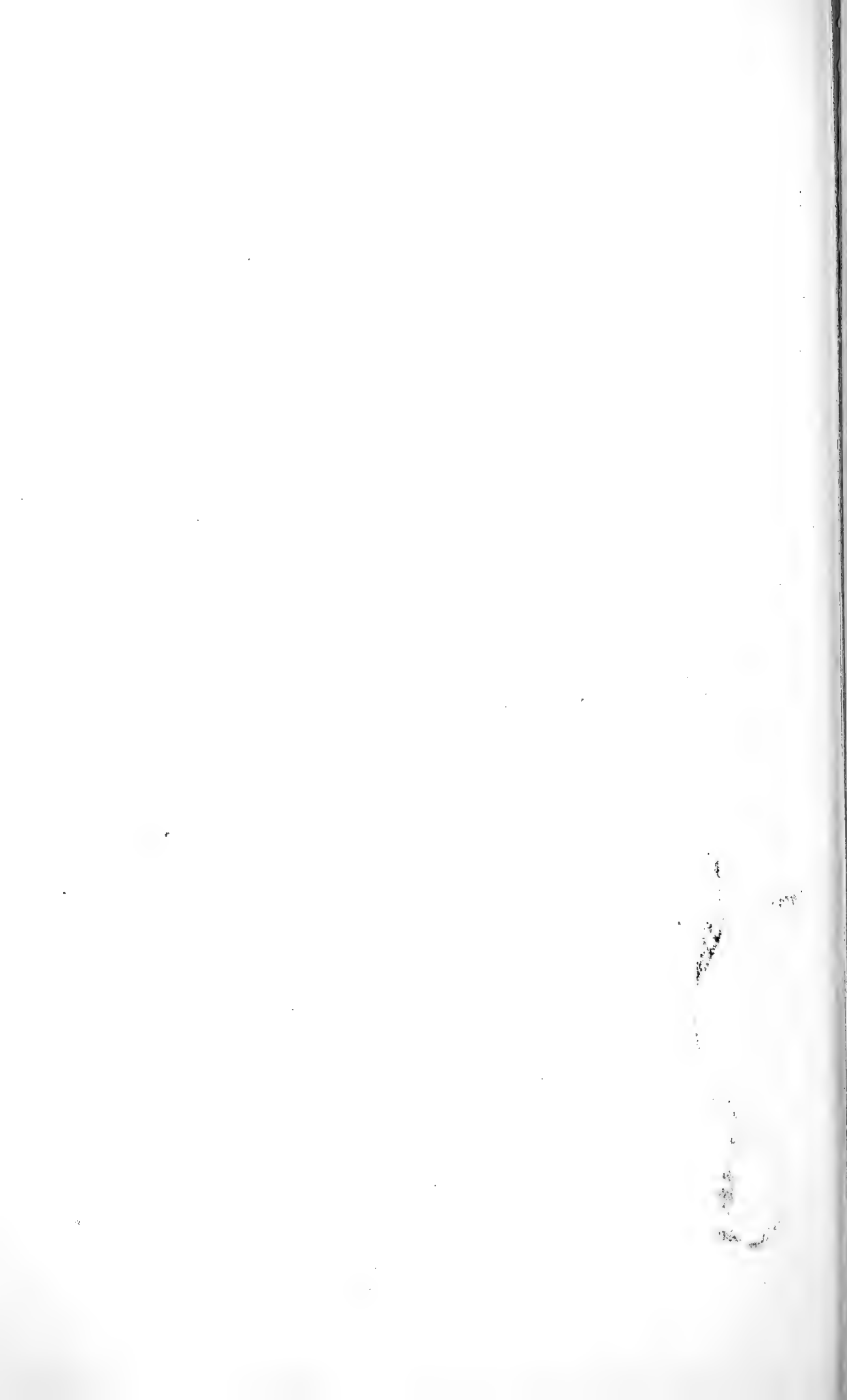
- Fig. 11. *Imago*. Deeper layer of the muscles whose superficial layer is shown in Fig. 9.
- Fig. 12. Portion of a cross section of the metathorax of a *pupa* showing the cross section of the ventral antero-posterior muscles. Dorsal up on the plate. Compare with Fig. 10.



R.S.B. DEL.

12.

11.



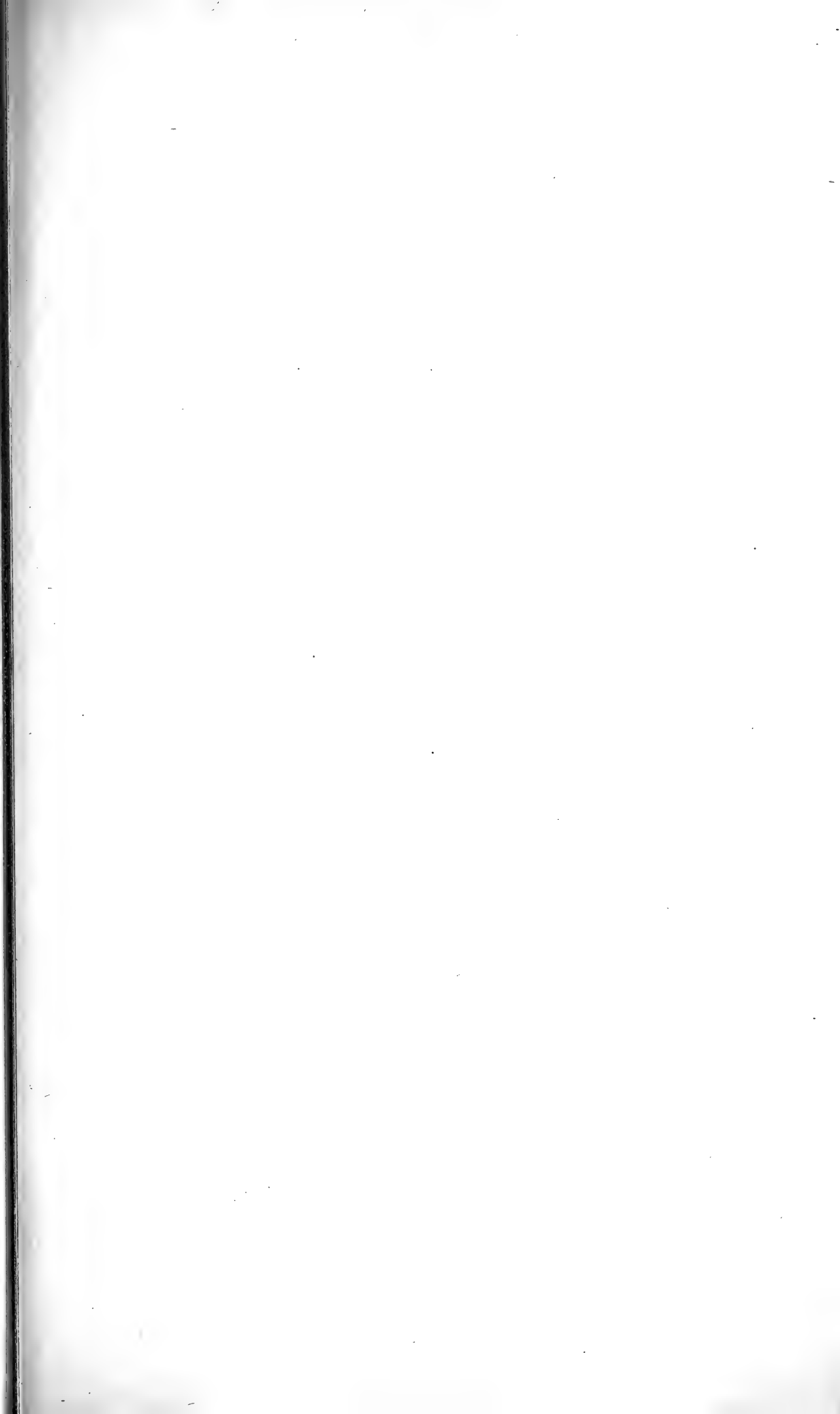


PLATE 6.

- Fig. 13. Posterior face of lateral (right) portion of cross section of the metathorax of an *imago* showing the parts affected by the contraction of musculus episternalis (*e'stn.*).  $\times 150$ .
- Fig. 14. Cross section of the largest fibre of musculus metanoti. Drawn from a *resting larva* about midway in its development.  $\times 800$ .
- Fig. 15. Cross section of that portion of musculus metanoti which has been derived from the largest fibre of this muscle in the larva. Drawn from an *imago*. Compare Fig. 14.  $\times 800$ .
- Fig. 16. Cross section of a functional larval muscle fibre. *Feeding larva*.  $\times 800$ .
- Fig. 17. Longitudinal section of a fibre of retractor mesothoracis inferior. Drawn from an *imago*.  $\times 1600$ .
- Fig. 18. Cross section of a fibre of flexor alae metathoracis secundus drawn from the same series of sections.  $\times 1600$ .
- Fig. 19. Cross section of flexor coxae metathoracis secundus. Drawn from a *young pupa*.  $\times 800$ .
- Fig. 20. Cross section of a circular muscle fibre of the foreintestine of an *imago*.  $\times 1600$ .
- Fig. 21. Cross section of three fibres of flexor coxae metathoracis secundus. Taken from an *old pupa*. Compare Fig. 19.  $\times 800$ .
- Fig. 22. Cross section of a functional larval muscle fibre. *Feeding larva*.  $\times 800$ .
- Figs. 23–32. Of these figures, Figs. 23–25, 30 and 31 form a series of longitudinal sections, and Figs. 26–29 and 32 a series of cross sections, of small portions of muscle fibres of the *wing* type. These drawings illustrate the changes in the finer structure of these muscles during their metamorphosis. All of the figures are magnified 1600 diameters.
- Fig. 23. *Feeding larva*. Longitudinal section of part of a functional fibre.
- Fig. 24. *Resting larva*. Longitudinal section of part of musculus metanoti.
- Fig. 25. *Resting larva* a few hours before pupation. Longitudinal section of part of musculus lateralis metathoracis anterior.
- Fig. 26. *Feeding larva*. Cross section of part of a functional fibre.
- Fig. 27. *Resting larva*. Cross section of part of flexor coxae metathoracis secundus.
- Fig. 28. *Resting larva* a few hours before pupation. Cross section of part of musculus metanoti.
- Fig. 29. *Midway pupa*. Cross section of part of musculus lateralis metathoracis posterior.
- Fig. 30. *Midway pupa*. Longitudinal section of part of musculus metanoti.
- Fig. 31. *Young imago*. Longitudinal section of part of musculus metanoti.
- Fig. 32. *Old pupa*. Cross section of part of extensor alae metathoracis.

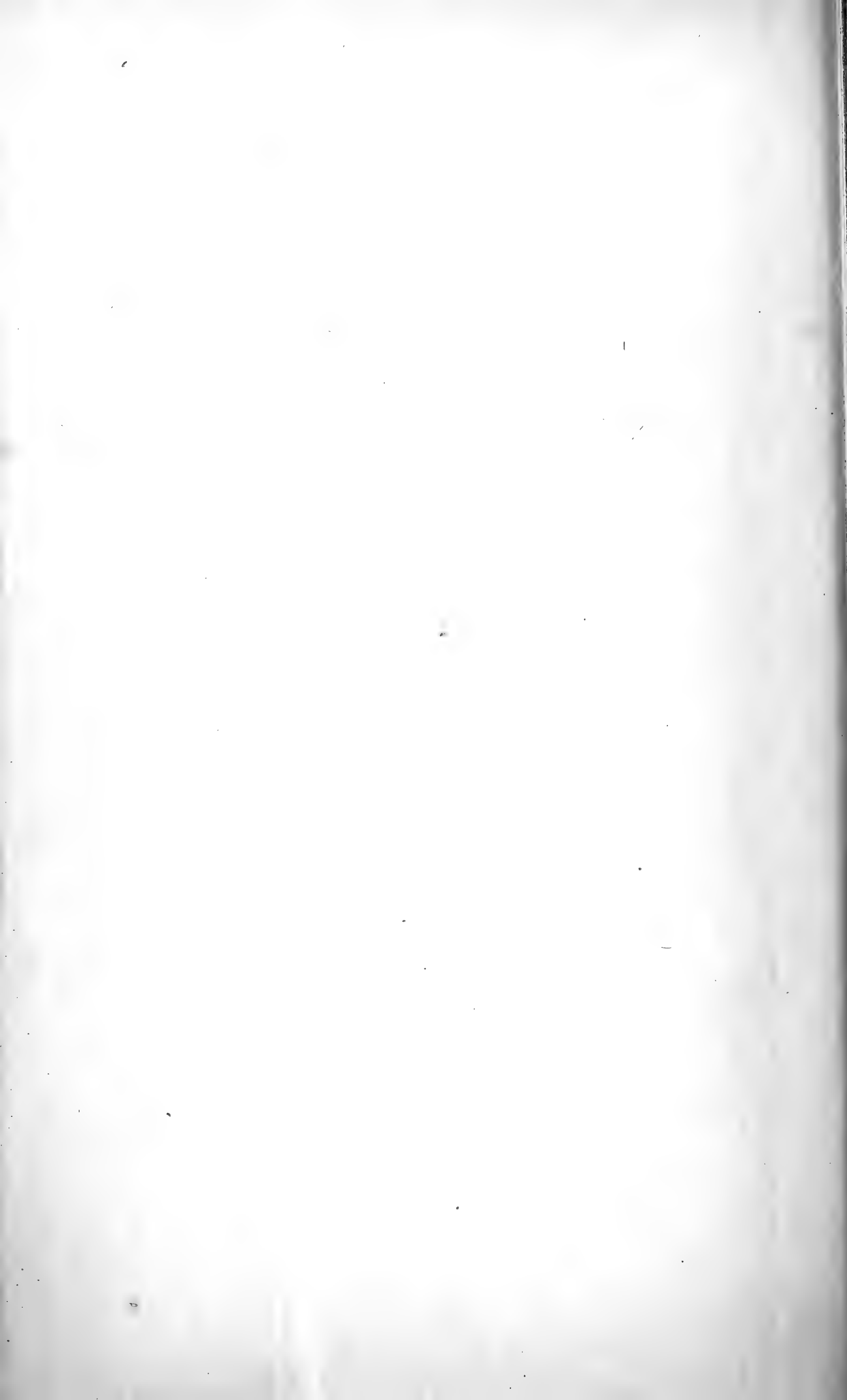


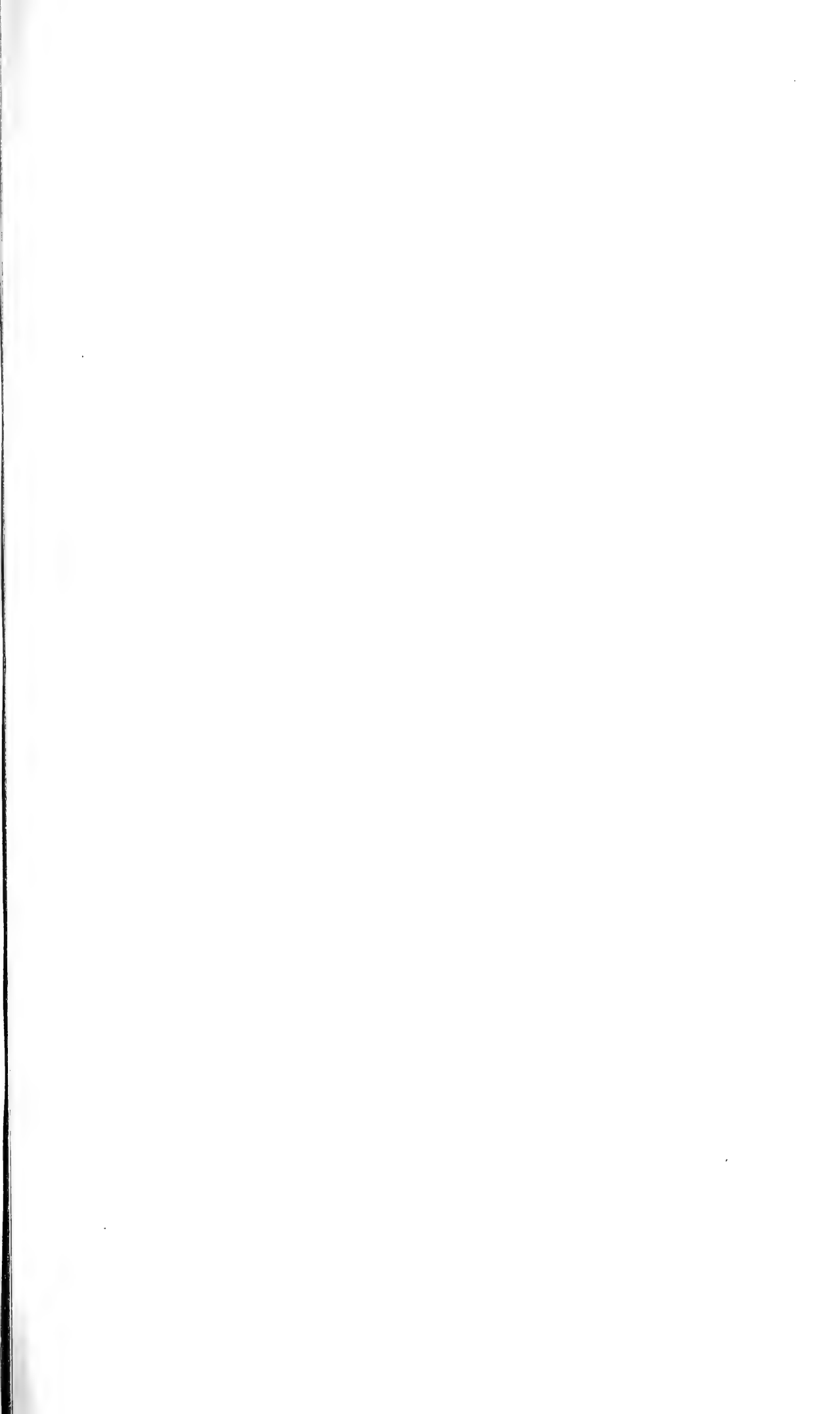




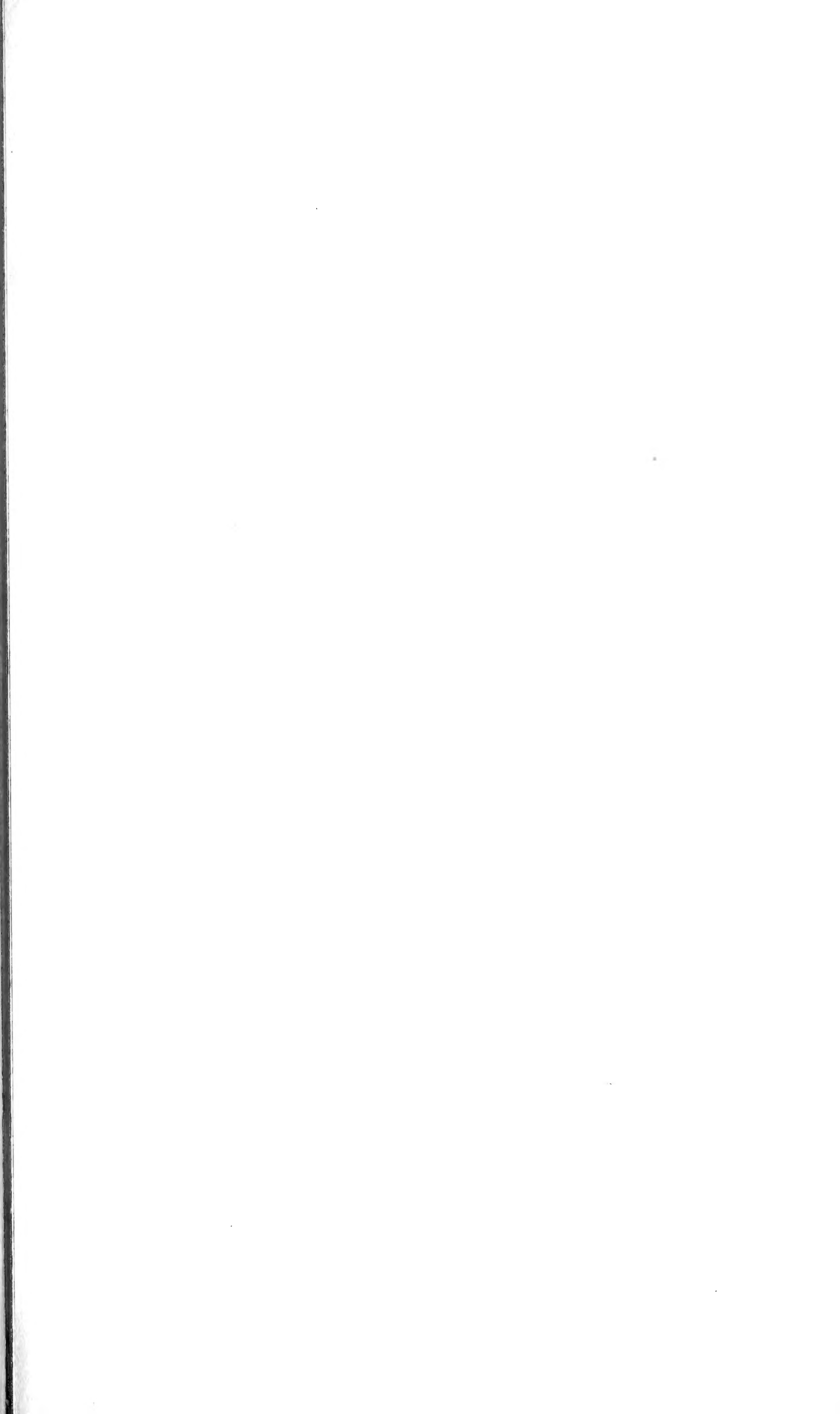
PLATE 7.

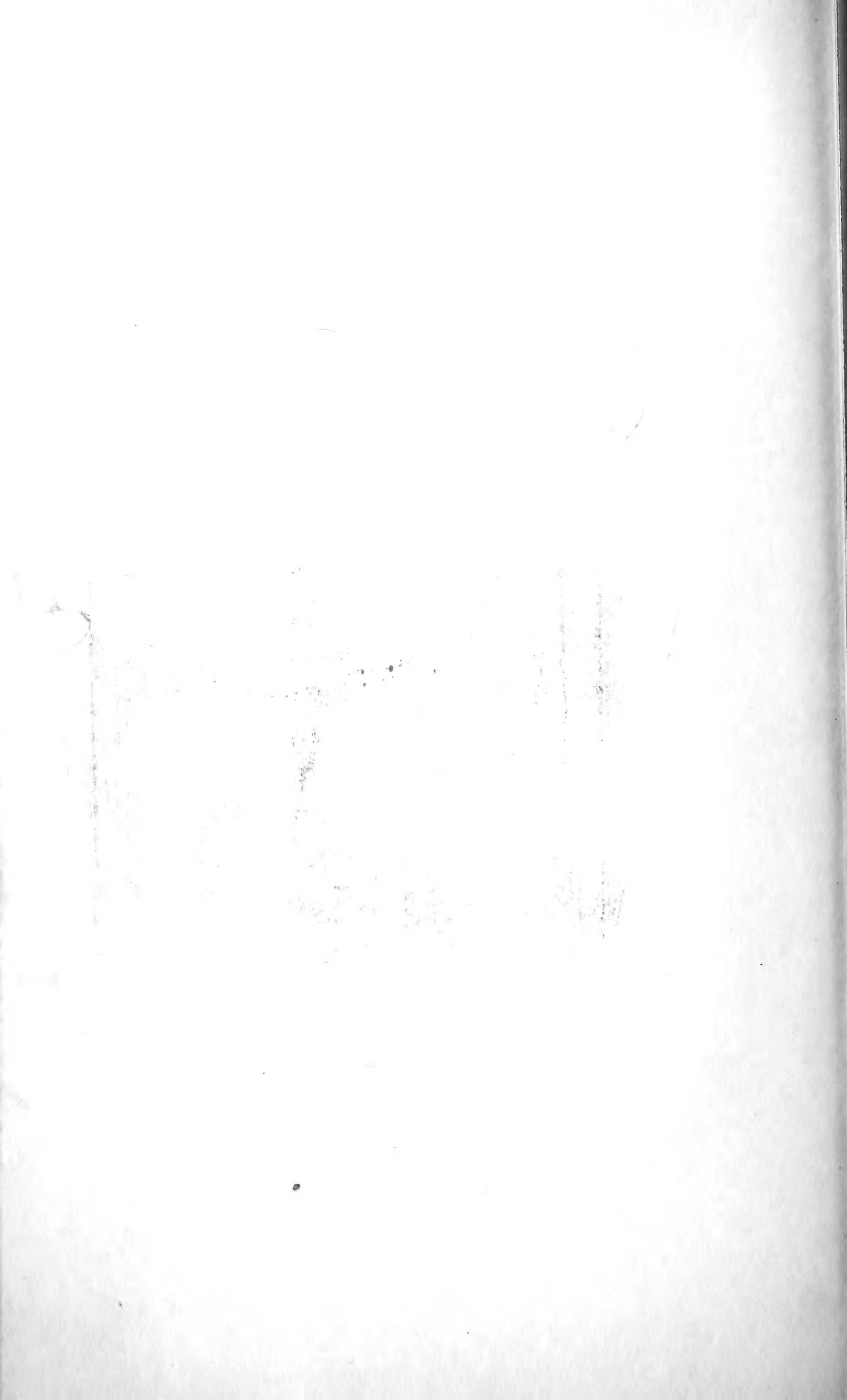
- Fig. 33. Longitudinal section of a functional muscle fibre. *Feeding larva*.  $\times 800$ .
- Fig. 34. Longitudinal section of the largest of the fibres of musculus metanoti. Taken from a resting larva.  $\times 800$ .
- Fig. 35. Longitudinal section of a portion of musculus metanoti. Taken from an *old pupa*.  $\times 800$ .
- Fig. 36. Longitudinal section of a part of flexor coxae metathoracis secundus. Drawn from an *imago*.  $\times 800$ .
- Fig. 37. Longitudinal section of one of the degenerating larval muscles of the dorsal antero-posterior group in the mesothorax. Drawn from a *young pupa*.  $\times 800$ .
- Fig. 38. Remains of the degenerating larval muscles  $\epsilon$ ,  $\eta$  (see Fig. 1). Drawn from an *old pupa*.  $\times 800$ .
- Fig. 39. Cross section of the degenerating larval muscles  $\epsilon$ ,  $\eta$ . Drawn from a *young pupa*.  $\times 800$ .
- Figs. 40-48. Leucocytes containing foreign bodies, all of them being taken from *old pupae*.  $\times 1600$ .
- Fig. 49. Cross section of flexor alae metathoracis secundus. Drawn from a *resting larva*.  $\times 800$ .
- Fig. 50. Cross section of the same muscle in the *imago*.  $\times 800$ .
- Fig. 51. Cross section of a part of the wall of the proventriculus of a *larva* about to pupate.  $\times 1200$ .
- Fig. 52. Dorsal part of a cross section of the proventriculus of an *old pupa*. Ventral is uppermost on the plate.  $\times 1200$ .













QL  
l  
H3  
v.39-40

Harvard University. Museum  
of Comparative Zoology  
Bulletin

Biological  
& Medical  
Serials

PLEASE DO NOT REMOVE  
CARDS OR SLIPS FROM THIS POCKET

---

UNIVERSITY OF TORONTO LIBRARY

---

STORAGE

