

SBM 1035

ISSN 0968-0470

Bulletin of The Natural History Museum

712

102 1007

1007 1007

1007 1007

1007 1007

Zoology Series



THE
NATURAL
HISTORY
MUSEUM

VOLUME 63 NUMBER 1 26 JUNE 1997

The *Bulletin of The Natural History Museum* (formerly: *Bulletin of the British Museum (Natural History)*), instituted in 1949, is issued in four scientific series, Botany, Entomology, Geology (incorporating Mineralogy) and Zoology.

The Zoology Series is edited in the Museum's Department of Zoology
Keeper of Zoology Dr C.R. Curds
Editor of Bulletin: Dr N.R. Merrett
Assistant Editor: Dr B.T. Clarke

Papers in the *Bulletin* are primarily the results of research carried out on the unique and ever-growing collections of the Museum, both by the scientific staff and by specialists from elsewhere who make use of the Museum's resources. Many of the papers are works of reference that will remain indispensable for years to come. All papers submitted for publication are subjected to external peer review for acceptance.

A volume contains about 160 pages, made up by two numbers, published in the Spring and Autumn. Subscriptions may be placed for one or more of the series on an annual basis. Individual numbers and back numbers can be purchased and a Bulletin catalogue, by series, is available. Orders and enquiries should be sent to:

Intercept Ltd.
P.O. Box 716
Andover
Hampshire SP10 1YG
Telephone: (01264) 334748
Fax: (01264) 334058

Claims for non-receipt of issues of the Bulletin will be met free of charge if received by the Publisher within 6 months for the UK, and 9 months for the rest of the world.

World List abbreviation: *Bull. nat. Hist. Mus. Lond.* (Zool.)

© The Natural History Museum, 1997

ISSN 0968-0470

Zoology Series
Vol. 63, No. 1, pp. 1-92

The Natural History Museum
Cromwell Road
London SW7 5BD

Issued 26 June 1997

Typeset by Ann Buchan (Typesetters), Middlesex
Printed in Great Britain by Henry Ling Ltd., at the Dorset Press, Dorchester, Dorset

A new species of *Microgale* (Insectivora, Tenrecidae), with comments on the status of four other taxa of shrew tenrecs

PAULINA D. JENKINS *✉*

Department of Zoology, The Natural History Museum, Cromwell Road, London SW7 5BD.

CHRISTOPHER J. RAXWORTHY

Division of Herpetology, University of Michigan, Museum of Zoology, Ann Arbor, Michigan 48109, USA.

RONALD A. NUSSBAUM

Division of Herpetology, University of Michigan, Museum of Zoology, Ann Arbor, Michigan 48109, USA.

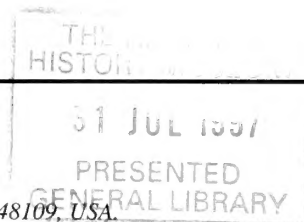

SYNOPSIS. A new species of *Microgale* is described from rainforest localities in Madagascar. Evidence is presented that *M. drouhardi* is a distinct species, with *M. melanorrhachis* as a synonym, and similarly that *M. pulla* is a synonym of *M. parvula*.

INTRODUCTION

The Family Tenrecidae is currently divided into four subfamilies, three of which, the Geogalinae, Oryzoricinae and Tenrecinae are endemic to Madagascar, while the fourth, the Potamogalinae, occurs only in Africa (see Hutterer, 1993). Within this highly diverse family, the most diverse of all are the shrew tenrecs belonging to the Oryzoricine genus *Microgale* Thomas, 1882, which at various times has been subdivided into four genera or sub-genera, comprising as many as 22 species. Despite the revision by MacPhee (1987) based on specimens available at that time in museum collections, in which only ten species were considered valid, the species composition of *Microgale* remains unclear. Subsequent to this revision, the number of specimens of *Microgale* available has probably doubled as a result of several recent expeditions to different localities in Madagascar. These expeditions have attempted to provide an inventory of the small mammal fauna, for taxonomic and biogeographic purposes and for the development of conservation strategies. These intensive surveys suggested that some of the species synonymised in MacPhee's revision, are in fact distinct (Nicoll & Rathbun, 1990; Raxworthy & Nussbaum, 1994; Stephenson, 1995; Jenkins *et al.*, 1996; Goodman *et al.*, 1996) and revealed the presence of several undescribed species of *Microgale* (Jenkins, 1988, 1992, 1993; Jenkins *et al.*, 1996). Specimens from five widely separated localities, distinctive in external appearance, are believed to be conspecific and to represent an additional undescribed species, the description of which is given below.

During the course of these surveys, good samples of adult and juvenile specimens of *Microgale* were collected from a wide range of localities, allowing re-evaluation of the specific status of four taxa, *M. drouhardi* Grandidier, 1934, *M. parvula* Grandidier, 1934, *M. melanorrhachis* Morrison-Scott, 1948 and *M. pulla* Jenkins, 1988. The first three species were originally described from juvenile specimens, a problematic situation in this genus, where the deciduous and permanent dentitions may differ considerably, so causing confusion over the correct specific attribution of juveniles and adults (see MacPhee, 1987). *Microgale drouhardi*, *M. parvula* and *M. pulla* were also known only from their respective type localities, and *M. parvula* and *M. pulla* only from their holotypes. Both *M. drouhardi*

and *M. melanorrhachis* are of uncertain status and were considered to be synonyms of *M. cowani* Thomas, 1882 by MacPhee (1987) but evidence is presented below to show that *M. drouhardi* is a distinct species with which *M. melanorrhachis* is synonymous. Likewise, it is demonstrated that *M. pulla* is a synonym of *M. parvula*.

MATERIALS AND METHODS

In each of the surveys listed above, small mammals were collected in pitfall traps, usually operating for five to ten days at each site. For detailed information on collection methods see Raxworthy & Nussbaum (1994; 1996) and Goodman *et al.* (1996).

Measurements, in millimetres, were recorded using dial calipers and a microscope measuring stage. External measurements include head and body length (HB) from the tip of the nose to the distalmost point of the body (at base of tail); tail length (TL) measured from the base of the tail to the end of the distalmost vertebra, excluding terminal hairs; hind foot length (HF) from the heel to the distal part of the longest toe, excluding the claw; ear length (EL) measured from the notch at the base of the ear to the distalmost edge of the pinna; weight (WT) measured with Pesola spring scales, animals weighing less than 10 gm within 0.2 gm and 10–100 gm within 0.5 gm. Cranial measurements were taken as follows: condyloincisive length (CIL) cranial length from first upper incisor to occipital condyle; upper toothrow length (UTL) from anterior of first upper incisor to posterior of third upper molar, parallel to the long axis of the skull; breadth of braincase (BB) the greatest distance measured across the squamosals; height of braincase (BH) greatest height in the midline from basioccipital to parietal.

The dental nomenclature follows that of Mills (1966), Swindler (1976), Butler & Greenwood (1979) and MacPhee (1987). Dental notations are given in parentheses in the text; premaxillary and maxillary teeth are denoted by upper case, mandibular teeth by lower case, as follows: incisor (I/i), canine (C/c), premolar (P/p), molar (M/m); a prefix 'd' indicates deciduous teeth, thus (dI) refers to a deciduous upper incisor.

Age classes are defined as follows:

Infant: individuals in which the deciduous antemolar dentition and the molars are not fully erupted; premaxillary, parietal and basioccipital sutures unfused.

Juvenile: individuals in which the molars are fully erupted and the deciduous antemolar dentition is erupted and in the process of replacement by the permanent teeth; cranial sutures are in the process of fusing. The eruption sequence of the permanent teeth has been subdivided into four stages by MacPhee (1987).

Adult: individuals with a fully erupted permanent dentition; cranial sutures generally fused although their position is usually clearly marked.

Abbreviations used for institutions include, BMNH – The Natural History Museum, London [formerly British Museum (Natural History)]; FMNH – Field Museum of Natural History, Chicago; MCZ – Museum of Comparative Zoology, Harvard; UMMZ – University of Michigan, Museum of Zoology, Michigan; USNM – National Museum of Natural History, Washington [formerly United States National Museum].

Abbreviations used for protected sites in Madagascar: PN – Parc National; RNI – Réserve Naturelle Intégral; RS – Réserve Spécial. Other abbreviations used are: RAN – UMMZ field tag series; gm – grams; km – kilometres; m – metres; mm – millimetres.

RESULTS

Microgale fotsifotsy sp. nov.

Figs 1–5

HOLOTYPE. UMMZ 168468 (RAN 38784) adult male, fixed in formalin, preserved in alcohol, skull extracted. Collected by Christopher Raxworthy [CR] 13 January 1992.

TYPE LOCALITY. Camp 2, Antomboka River Fitsahana, Parc National de la Montagne d'Ambre, Antsiranana Fivondronana, Antsiranana Province 12°29'S 49°10'E, altitude 650m, rain forest.

PARATYPES. Camp 2, Antomboka River Fitsahana, Parc National de la Montagne d'Ambre, Antsiranana Fivondronana, Antsiranana Province 12°29'S 49°10'E, altitude 650–670m, rain forest: UMMZ 171056 (RAN 38596), juvenile; BMNH 1996.278 (RAN 38648), adult female; UMMZ 171057 (RAN 38710), juvenile; UMMZ 168470 (RAN 38740), juvenile; UMMZ 168466 (RAN 38752), juvenile; UMMZ 171058 (RAN 38753), adult male; UMMZ 168467 (RAN 38754), adult male; UMMZ 168469 (RAN 38791), adult male; UMMZ 171059 (RAN 38821), adult male. Collected by CR 2–17 January 1992. All specimens fixed in formalin, preserved in alcohol, skulls extracted.

Camp 1, Antomboka River, Parc National de la Montagne d'Ambre 12°32'S 49°10'E, altitude 1150m, rain forest: UMMZ 171055 (RAN 38192), adult female, collected by CR 23 November 1991. Fixed in formalin, preserved in alcohol, skull extracted.

Parc National de la Montagne d'Ambre, 5.5 km SW of Joffreville [Ambohitra], 12°31'S 49°10'E, altitude 1000m, disturbed rain forest: FMNH 154590 adult male; FMNH 154591 juvenile male; FMNH 154592 juvenile male; FMNH 154593 juvenile male; FMNH 154594 juvenile; FMNH 154595 juvenile male; FMNH 154596 juvenile male. Collected by Steven Goodman 28 March–1 April 1994. All skins and skulls.

REFERRED MATERIAL. RS d'Ambatovaky, Soanierana-Ivongo Fivondronana, Toamasina Province 16°51'S 49°08'E, 600m, in rain forest: BMNH 91.247.

RNI de Zahamena, Ambatondrazaka Fivondronana 17°40'S–17°42'S 48°46'E, 850–1180m: UMMZ 171060–171065; BMNH 96.279.

Maitso, RNI d'Andringitra, 22°10'S 46°50'E, 1400 m, in disturbed forest, 20 yards [18.3 m] from stream; found drowned in puddle on top of shelter 5 feet [1.5 m] above the ground: BMNH 95.257. 40 km S of Ambalavao, along Volotsangana River, RNI d'Andringitra, 22°13'S 46°58'E, altitude 1210 m, in montane forest: FMNH 151646–151647.

Marosohy Forest, 16 km WNW of Ranomafana-Sud, Fivondronana Tolagnaro [Tölanaro Fivondronana], Toliara Province, 24°34'S 46°48'E, 650m, in rain forest: USNM 578787; USNM 578887.



Fig. 1 Dorso-lateral view of *Microgale fotsifotsy* to show external features.

Table 1 Dimensions of adult *Microgale fotsifotsy* presented as range, mean \pm standard deviation and number of specimens in parentheses.

	Combined	PN Montagne d' Ambre 650–1150m	RNI Zahamena 850–1180m	RNI d' Andringitra 1200–1400m	Marosohy forest 650m
Head and body length	63.9–81.0 69.0 \pm 5.11 (17)	63.9–70.0 66.2 \pm 2.17 (8)	66.7–69.2 68.2 \pm 1.02 (4)	70.1–81.0 76.7 \pm 5.8 (3)	64, 77 (2)
Tail length	71.4–94.0 79.8 \pm 6.16 (16)	71.4–82.7 77.3 \pm 4.31 (7)	75.0–84.0 79.5 \pm 3.21 (4)	85–94 89.3 \pm 4.51 (3)	71, 79 (2)
Hind foot length	14–18 15.7 \pm 1.03 (17)	14–16 15 \pm 0.71 (8)	16–17 16.5 \pm 0.50 (4)	15–18 16.3 \pm 1.25 (3)	15, 16 (2)
Ear length	11–16 14.1 \pm 2.03 (16)	11–15 12.6 \pm 1.22 (8)	15–16 15.7 \pm 0.47 (3)	16–17 16.7 \pm 0.47 (3)	12, 16 (2)
Ratio of tail length to head and body length	1.0–1.3 1.2 \pm 0.08 (16)	1.1–1.2 1.2 \pm 0.05 (7)	1.1–1.3 1.2 \pm 0.07 (4)	1.1–1.3 1.2 \pm 0.09 (3)	1.0, 1.1 (2)
Condylolincisive length	19.8–21.6 20.6 \pm 0.55 (16)	19.8–20.9 20.3 \pm 0.32 (8)	20.7–21.6 21.1 \pm 0.38 (4)	20.7–21.2 21.0 \pm 0.29 (3)	19.8 (1)
Upper toothrow length	9.5–10.6 10.0 \pm 0.37 (16)	9.5–10.0 9.7 \pm 0.16 (8)	10.2–10.5 10.4 \pm 0.13 (4)	10.0–10.6 10.3 \pm 0.3 (3)	9.5 (1)
Maxillary breadth from M3–M3	5.8–6.6 6.1 \pm 0.26 (16)	5.8–6.3 6.0 \pm 0.17 (8)	6.0–6.5 6.3 \pm 0.21 (4)	6.1–6.6 6.3 \pm 0.21 (3)	5.8 (1)
Braincase breadth	8.6–9.7 9.1 \pm 0.38 (16)	8.6–9.0 8.8 \pm 0.15 (8)	9.2–9.6 9.5 \pm 0.15 (4)	9.5–9.7 9.6 \pm 0.12 (3)	9.1 (1)
Ratio of tail length to condylolincisive length	3.6–4.4 3.9 \pm 0.25 (15)	3.6–4.1 3.8 \pm 0.20 (7)	3.6–3.9 3.8 \pm 0.13 (4)	4.0–4.4 4.2 \pm 0.21 (3)	4.0 (1)

DIAGNOSIS. Digits of fore and hind feet and tail tip light coloured, contrasting with darker coloration of head, body and tail. Ears pale and conspicuous. Third upper and lower incisors (I3 and i3) small, I3 slightly greater in crown height than distostyle of second upper incisor (I2), i3 subequal in height to posterior accessory cusp of second lower incisor (i2); i2 greater in breadth than first lower incisor (i1); upper and lower canines greater in crown height than second upper and lower premolars (P3 and p3)

DESCRIPTION. Small to medium in size, tail longer than head and body (see Figs 1–2 and Table 1). Pinnae prominent and conspicuous, pale in colour, reaching beyond eye if pressed forward along head. Dorsal pelage soft in texture and grizzled yellowish brown and grey; hairs with silvery grey bases, bright buff distally, usually with dark brown tips; guard hairs slender, dark brown to black, some with pale tips. Ventral pelage light grey with buff or reddish wash; individual hairs with light silvery grey bases and light cream tips. Tail more or less bicolored, grey brown above, light grey buff below; with contrastingly light coloured tip, usually with thin pencil of white hairs. Tail scale hairs moderately dense, approximately three scales in length. Fore and hind feet brown with contrasting light coloured digits, often with light lateral line along outer side of foot. Fifth digit of hind foot elongated and scarcely shorter than second digit; cheiridia on the hind feet elongated. Skull small to medium in size (see Table 1). Rostrum moderately broad; interorbital region moderately short; maxillary process of zygoma at right angles to long axis of cranium; braincase broad and short (see Fig. 3). Dentition illustrated in Figs 3–4. First upper incisor (I1) robust, slightly proodont, distostyle prominent, lingual cingulum present, buccal cingulum with accessory cusp; second upper incisor (I2) with small anterior accessory cusp, distostyle and prominent

anterolingual cusp; I3 small, slightly greater than the distostyle of I2 in crown height, trace of distostyle evident in unworn teeth. Upper canine (C) much greater than second upper premolar (P3) in crown height, with indistinct anterior accessory cusp, distostyle and lingual cingulum present. First upper premolar (P2) with small anterior accessory cusp and distostyle; mesostyle of P3 small but distinct, anterior ectostyle distinct and distostyle present; mesostyle of third upper premolar (P4) large and distinct, anterior ectostyle broad and distinct but posterior ectostyle and distostyle distinct or indistinct; talon large and bicuspid in some specimens. Talon of first and second upper molars (M1 and M2) large and bicuspid; third upper molar (M3) subequal to or broader than M2. Diastemata present between I1 and I2 and between I3 and C, C and P3. Lower first incisor (i1) procumbent, with distinct hypoconulid; lower second incisor (i2) spatulate, subequal in crown height but broader than i1 and much larger than very reduced third lower incisor (i3); i3 subequal in height to posterior accessory cusp of i2. Lower canine (c) procumbent, anterolingual cingulum present but anterior accessory cusp lacking. First lower premolar (p2) smaller than c and anteroflexed, anterior cusp very small or absent in some individuals. Protoconid of second lower premolar (p3) lower in crown height than that of third lower premolar (p4) and paraconid present; p4 and first and second lower molars (m1 and m2) lack distinctive features, except for anterior and posterior buccal cingula in most specimens. Talonid of third lower molar (m3) incomplete and reduced to a hypoconulid, hypoconid indistinct or absent, entoconid and entoconid ridge absent and entoconid basin indistinct or absent. Diastemata generally absent, although present in some individuals between c and p2.

Deciduous Dentition Deciduous anterior teeth smaller than permanent anterior teeth, in particular first upper and lower deciduous

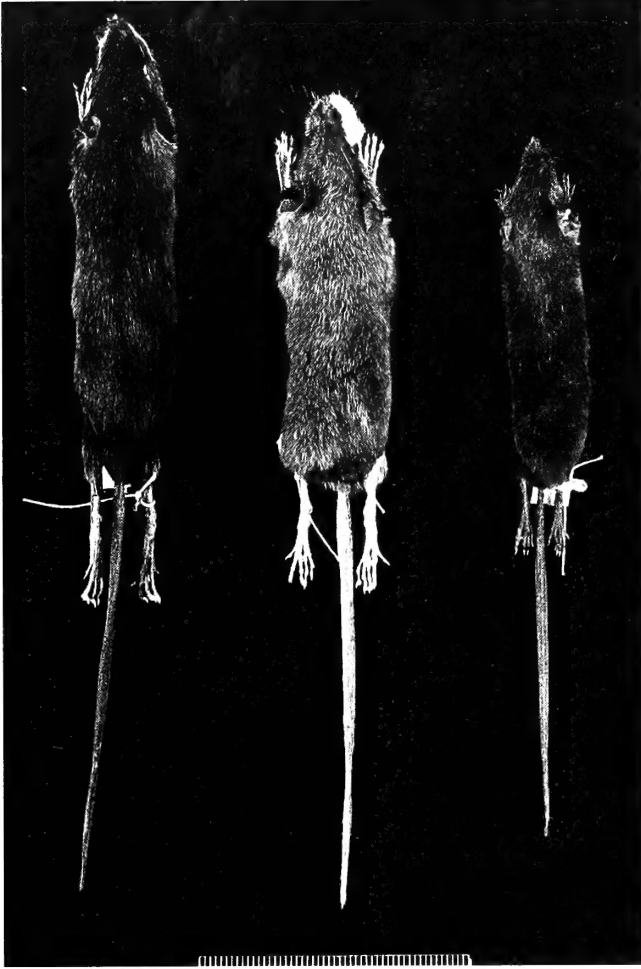

Fig. 2 Dorsal view of skins from left to right of *Microgale drouhardi* (FMNH 154565), *M. fotsifotsy* (FMNH 154590) and *M. parvula* (FMNH 151620).

incisors (dI1 and dI1) respectively considerably smaller than I1 and i1 (see Figs 4 and 5). Principal cusp of dI1 slender, distostyle present, no anterior accessory cusp; morphology of deciduous second upper incisor (dI2) similar to I2 but smaller; deciduous third upper incisor (dI3) very small, less than height of distostyle of dI2. Deciduous upper canine (dC) subequal in height to deciduous second upper premolar (dP3), distostyle distinct, anterior accessory cusp present. Trace of anterior cuspid on deciduous first upper premolar (dP2); deciduous second upper premolar (dP3) with distinct mesostyle and distostyle present. Deciduous first lower incisor (dI1) subequal in height to second deciduous lower incisor (dI2) but considerably smaller in occlusal area; dI2 similar in morphology to i2, with or without a small lingual cusp. Deciduous third incisor (dI3) shed in all specimens examined. Deciduous lower canine (dC) and first lower premolar (dP2) similar in morphology to respective permanent counterparts but smaller, with trace of anterolingual cuspid; deciduous second lower premolar (dP3) taller than dC (unlike permanent dentition), metaconid present or indicated.

Eruption sequence partially determined: i3 to I3, I1 to i1, P2/p2, I2/i2, P4/p4; P3/p3 and C/c last teeth to erupt but sequence remains to be determined.

INTRASPECIFIC VARIATION. The known populations of this undescribed species are geographically widely separated and this is reflected in the moderately high degree of intraspecific variation. There is slight variation in pelage coloration: specimens from PN de la Montagne d'Ambre are generally paler than those from RS d'Ambatovaky, RNI de Zahamena and RNI d'Andringitra which also often have a reddish buff wash; specimens from RNI de Zahamena often show a reddish buff wash ventrally, while those from RNI d'Andringitra have a buff wash. Specimens from the RNI d'Andringitra and RNI de Zahamena populations are larger on average than either of the other populations (see Table 1), particularly in cranial dimensions. The two specimens from Marosohy, although geographically closer to the RNI d'Andringitra specimens in southeastern Madagascar are, however more similar to the PN de la Montagne d'Ambre specimens in size, as is the single juvenile specimen from RS d'Ambatovaky. There is some evidence of correlation between size and altitude; specimens from localities at lower

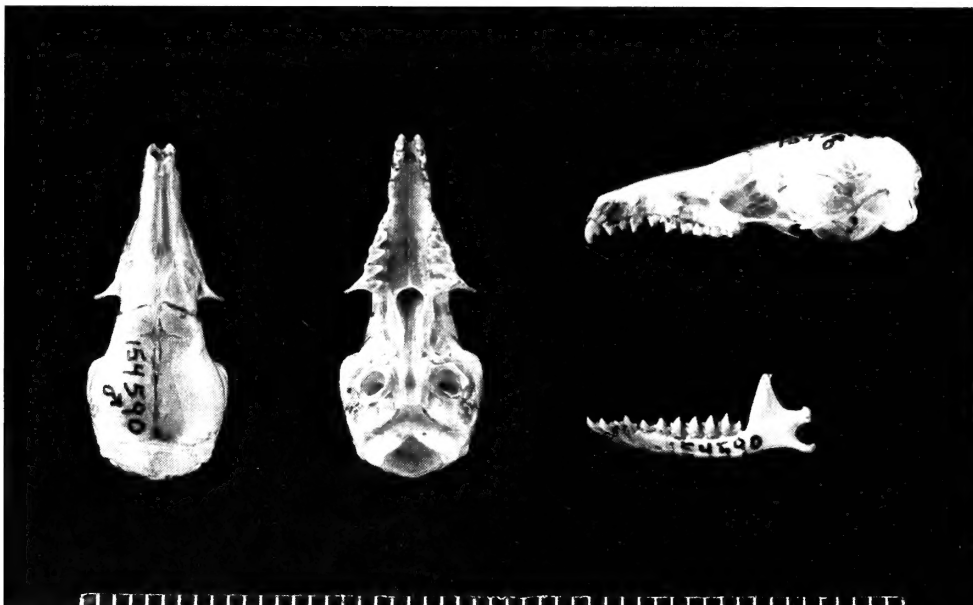

Fig. 3 Cranium of *Microgale fotsifotsy* (FMNH 154590) from left to right, dorsal, ventral, and lateral view of cranium and mandible.

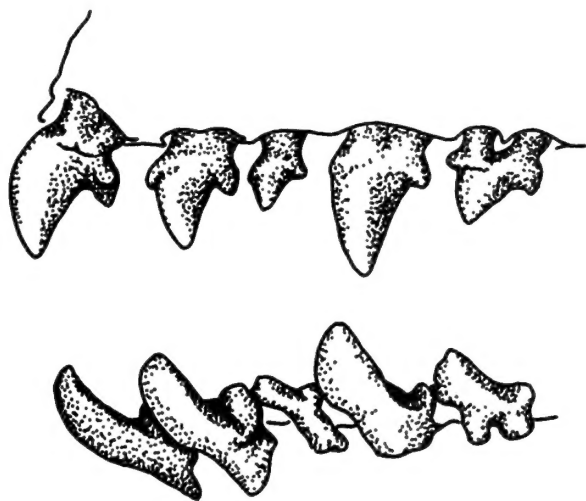

Fig. 4 Buccal view of left permanent anterior dentition of *Microgale fotsifotsy* (UMMZ 168468) I1–P2 above, i1–p2 below. Scale = 1 mm.

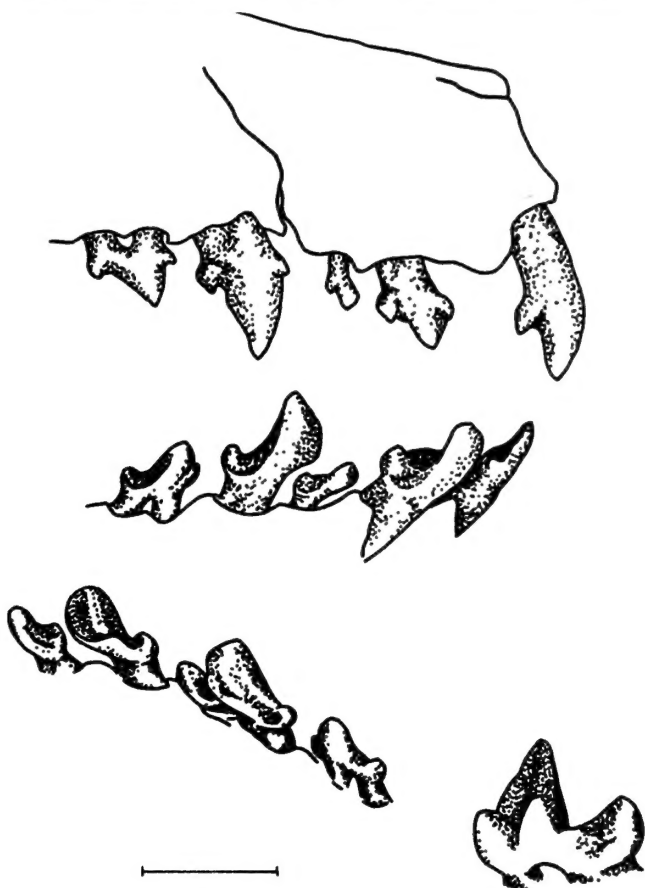

Fig. 5 Deciduous right anterior dentition of *Microgale fotsifotsy* (FMNH 154529) buccal view of di1–dP2 above; buccal view middle, lingual view below of di1, di2, i3, dp2. Below right lingual view of right m3. Scale = 1 mm.

Table 2 Altitudinal size variation in adult *Microgale fotsifotsy*.

	Altitude 650m–670m	Altitude 850m–1400m
Condylolincisive length	19.8–20.4 20.1±0.25 (7)	20.0–21.6 20.8±0.49 (9)
Upper tooththrow length	9.5–9.9 9.7±0.15 (7)	9.7–10.6 10.2±0.28 (9)
Braincase breadth	8.5–9.1 8.9±0.16 (7)	9.0–9.7 9.5±0.23 (8)
Ratio of tail length to condylolincisive length	3.5–4.0 3.8±0.17 (6)	3.6–4.4 4.0±0.24 (9)

altitudes averaging smaller than their counterparts from higher altitudes (see Table 2).

ETYMOLOGY. *Fotsifotsy* is Malagasy for pale or whitish. The name is used here as ‘the pale one’ in reference to the light coloured fore and hind feet and tail tip, as well as the dorsal pelage which is paler than in most other species of *Microgale*.

COMPARISONS WITH OTHER SPECIES. *Microgale fotsifotsy* differs from other species of *Microgale* in a number of external and craniodental features. The combination of light body coloration and conspicuously pale coloured feet and tail tip, and the large, pale ears are unique to this species (see Figs 1 and 2). The early stages of the eruption sequence apparently differs from that ascribed to *M. cowani* and *M. pusilla* Major, 1896b by MacPhee (1987) and to *M. soricoides* Jenkins, 1993. In the sequence common to the three latter species, I3 and i3 erupt in the first stage, followed in sequence by P2, p2, p4, and I1 and i1 at the end of the second stage. In the specimens available of *M. fotsifotsy*, the sequence progresses from i3 to I3, to I1 to i1, to p2 then P2, so that, unusually the first upper and lower permanent incisors replace the deciduous teeth before any of the permanent premolars have erupted. *Microgale fotsifotsy* resembles *M. longicaudata* Thomas, 1882 in having elongated cheiridia and fifth digits on the hindfeet and with a tail longer than head and body length; the tail is, however, considerably longer in *M. longicaudata* than in *M. fotsifotsy* (ratio of TL to HB 1.03–1.3, mean 1.2 ± 0.08 , $n = 16$ in *M. fotsifotsy*; 1.7–2.4, mean 2.1 ± 0.22 , $n = 11$ in *M. longicaudata*). Despite some similarities to *M. longicaudata* in external proportions, the crania of the two species differ markedly. That of *M. fotsifotsy* is larger and the braincase is relatively broader, shorter and shallower than that of *M. longicaudata* in which the skull is slightly concave in profile.

Despite the differences in size and external appearance, the skull of *M. fotsifotsy* is more similar in overall proportions to *M. soricoides* than to any other species. The skull of *M. fotsifotsy* is much smaller and more delicate than that of *M. soricoides*. The rostrum is much more slender and elongated but the maxillary processes of the zygoma are flared at right angles to the long axis of the cranium in both species, and the braincase is similarly short and broad, although the occipital is proportionately much smaller in *M. soricoides*. There are also more features common to the dentitions of these two species than to others. In both *M. fotsifotsy* and *M. soricoides*, I1 is robust and somewhat similar in its proportions, but that of *M. fotsifotsy* is less pro-odont, and a larger cuspid is present on the buccal cingulum. In both species, I2 is very similar in shape and proportions but I3 is less reduced than in *M. soricoides*, in which P2 is also very reduced, unlike *M. fotsifotsy*. These two species also differ considerably in the anterior ectostyle of P3 which is distinct in *M. fotsifotsy* but very

reduced in *M. soricoides*. In the mandibular dentition of *M. soricoides*, both *i*3 and *p*2 are very reduced and the latter is unusual in having a single root; both of these teeth in *M. fotsifotsy* are reduced but less markedly so and *p*2 has two roots. The lower canine is similar in both species but *p*3 is more caniniform in *M. soricoides*. The third lower molar shows a similar degree of reduction of the talonid in both species.

The dentition of the new species is distinctive and does not readily group with any of the species clusters described by MacPhee (1987) but, as outlined above, does show some similarity to *M. soricoides*, which may represent a separate cluster. The degree of development of accessory cusps on I1–C is similar to that of members of the *cowani* cluster but less marked than in the *longicaudata* cluster, also the presence of interproximal gaps between the upper incisors occurs in *M. fotsifotsy* and the *cowani* cluster. In contrast, *M. fotsifotsy* is more similar to the *longicaudata* cluster in that the buccal aspects of P3 and P4 are similar in shape, the lower canine lacks a paraconid and the crown of *p*2 appears anteroflexed as in *c*, due to the shorter convex anterior slope and longer concave posterior slope. The relative proportions of the anterior teeth of *M. fotsifotsy* differ from either the *cowani* or the *longicaudata* cluster, they are similar to, but less extreme than those in *M. soricoides*, as shown in Table 3.

Table 3 Relative proportions of the anterior teeth of *Microgale fotsifotsy* in comparison with *M. cowani* cluster, *M. longicaudata* and *M. soricoides*.

<i>cowani</i> cluster	I1 > I2 > I3 < C > P2 <	P3	C ≅ P3
<i>longicaudata</i>	I1 > I2 > I3 < C > P2 >	P3	C > P3
<i>fotsifotsy</i>	I1 > I2 » I3 < C » P2 < or ≅	P3	C > P3
<i>soricoides</i>	I1 » I2 » I3 « C » P2 «	P3	C > P3
<i>cowani</i> cluster	i1 ≅ i2 > i3 < c ≅	or < p2 < p3	c < p3
<i>longicaudata</i>	i1 < i2 > i3 < c >	p2 < p3	c ≅ p3
<i>fotsifotsy</i>	i1 ≅ i2 » i3 < c >	p2 < p3	c ≥ p3
<i>soricoides</i>	i1 » i2 » i3 « c »	p2 « p3	c ≅ p3

Microgale drouhardi G. Grandidier, 1934

Microgale melanorrhachis Morrison-Scott, 1948

Microgale cowani Thomas: MacPhee, 1987, in part.

HOLOTYPE. MCZ 45034 (specimen A in original description) juvenile female, body in alcohol, skull extracted, collected by Monsieur Drouhard.

TYPELOCALITY. environs of Diego-Suarez [Antsiranana, c. 12°16'S 49°18'E—see MacPhee, 1987].

PARATYPES. MCZ 46007–46011 (specimens B–F in original description), MCZ 46012 (juvenile mentioned in original description), all in alcohol. All from the same locality as the holotype.

REFERRED MATERIAL. environs of Diego-Suarez [Antsiranana, c. 12°16'S 49°18'E]: MCZ 46013–46019.

PN de la Montagne d'Ambre, 5.5 km SW of Joffreville [Ambohitra], 12°31'S 49°10'E, 1000m, in relatively undisturbed rain forest: FMNH 154489; FMNH 154491; FMNH 154493–154494; FMNH 154499; FMNH 154514–154515; FMNH 154517; FMNH 154561–154564; FMNH 154567–154571.

Camp 1, Antomboka River, PN de la Montagne d'Ambre, Antsiranana Fivondronana, Antsiranana Province, 12°32'S 49°10'E, 1150–1250m, rain forest: UMMZ 171000–171015; BMNH 1996.280; BMNH 1996.281.

5km S of Joffreville [Ambohitra], Mont[agne] d'Ambre, Diego

Suarez [Antsiranana] Province, [c 12°32'S 49°10'E], rain forest: USNM 341692; 6km S of Joffreville [Ambohitra], Mont[agne] d'Ambre, Diego Suarez [Antsiranana] Province, [c 12°32'S 49°10'E], rain forest: USNM 341693.

Bekoloso, RS de Manongarivo, Ambanja Fivondronana, 14°03'S 48°18'E, 1150m, rain forest: UMMZ 171016–171019.

Matsabory, RNI de Tsaratanana, Ambanja Fivondronana, 14°09'S 48°58'E, 2350m, rain forest: UMMZ 171020.

RS d'Ambatovaky, Soanierana-Ivongo Fivondronana, Toamasina Province 16°51'S 49°08'E–49°16'E, 360–600m: BMNH 91.220; BMNH 91.221–91.226.

RNI de Zahamena, Ambatondrazaka Fivondronana 17°41'S–17°42'S 48°46'E, 850–920m: UMMZ 171021–171027.

RNI de Zahamena, Vavatenina Fivondronana 17°44'S 48°59'E, 420–560m: UMMZ 171028–171039.

PN de Mantady, Moramanga Fivondronana, Toamasina Province, 18°51'S 48°27'E, 1100m, rain forest: UMMZ 168471–168474.

Didy, E of Lake Alaotra [Toamasina Province, c 18°02'S 48°32'E – see Carleton & Schmidt, 1990]: USNM 328686.

Périnet [= Andasibe], near Moramanga, eastern Madagascar, 19°00'S 48°30'E, 3000 feet [915m]: BMNH 48.88 (holotype of *Microgale melanorrhachis*).

43 km S of Ambalavao, junction of Sahanivoraky and Sahavatoxy Rivers, RNI d'Andringitra, 22°13'S 47°00'E, 810m: FMNH 151627; FMNH 151756. 45 km S of Ambalavao, E bank of Iantara River, along Ambalamanenjana–Ambatamboay Trail, edge of RNI d'Andringitra, 22°13'S 47°01'E, 720m: FMNH 151626.

6 miles E of Ivohibe, 22°30' 47°00'E, 5000 feet [1525m], [high rain forest]: BMNH 48.87.

TAXONOMIC NOTES. The original description of *M. drouhardi* was based on several specimens, consisting of whole bodies preserved in alcohol, with the exception of the holotype, which is a body with the skull extracted. Grandidier (1934) believed that all but one of these specimens were adult but MacPhee (1987) demonstrated that the holotype is immature with the dentition partially deciduous (Stage 2, see MacPhee, 1987: 13). As MacPhee emphasised, repeated misidentifications and faulty taxonomic judgements have occurred in this genus because of the problems of distinguishing between deciduous and permanent dentitions. However, two of the specimens mentioned in the type description are adult and, more critically, another specimen (MCZ 46017) prepared as a skull and skeleton, is adult and, although not mentioned in the original description, was evidently available to Grandidier. Grandidier deposited his private collection, including the original series of *M. drouhardi*, in the Museum of Comparative Zoology, Harvard. In effect, this material became unavailable to subsequent authors, such as Morrison-Scott (1948) and Heim de Balsac (1972), who were unaware at which institution in the the United States these specimens were held. MacPhee was apparently the first author to re-examine this material, he concluded that, although at the extreme of the size range, the morphology of the teeth was such that the specimens were inseparable from *M. cowani* and that *M. drouhardi* should be treated as a synonym.

The type locality of 'the environs of Diego-Suarez [Antsiranana]' is unfortunately vague and, as pointed out by MacPhee (1987) and Nicoll & Rathbun (1990), includes ecologically diverse habitats of dry forest on limestone at Tendrombohitra' Antsingy, Ankarana, Analamera and Cap d'Ambre, grassland and dry forest on the lower slopes of the basaltic Montagne d'Ambre, with rain forest at higher altitudes of Montagne d'Ambre. Since most species of *Microgale* are recorded from rain forest (*M. pusilla* Major, 1896b and *M. principula* Thomas, 1918 contained in owl pellets of indeterminate

Table 4 Variation between populations of adult *Microgale drouhardi*. Dimensions given as range, mean±standard deviation and number of specimens in parentheses.

	PN Montagne d'Ambre 1000–1250m	Bekolosy 1150m	RS d'Ambatovaky 360–600m	RNI Zahamena 420–1180m	Didy	PN Mantady 1100–1150m
Head and body length	64–83 75.8±5.39 (16)	73.0, 73.3 (2)	62.5–74.4 68.8±4.00 (7)	63.0–76.8 69.7±3.78 (17)	80.1 (1)	69.8–75.4 72.5±1.98 (4)
Tail length	67–83 74.7±4.85 (16)	70.5, 72.4 (2)	52.9–62.3 56.7±3.24 (7)	52.7–62.1 58.3±2.83 (16)	–	63.7–71.0 67.7±2.66 (4)
Hind foot length	16–19 17.6±0.77 (17)	17 (2)	13–15 14.1±0.64 (7)	14–15 14.6±0.49 (17)	–	16–18 17.0±0.71 (4)
Ratio of tail length to head and body length	0.8–1.2 1.0±0.10 (16)	1.0 (2)	0.8–0.9 0.8±0.05 (7)	0.8–0.9 0.9±0.05 (15)	–	0.9–1.0 0.9±0.04 (4)
Condylolincisive length	22.5–23.9 23.3±0.45 (18)	22.0, 22.5 (2)	21.0–21.6 21.3±0.22 (7)	20.5–22.3 21.4±0.45 (17)	22.3 (1)	22.4, 22.5 (2)
Upper toothrow length	10.6–11.5 11.1±0.21 (19)	10.3, 10.7 (2)	9.8–10.3 10.1±0.16 (7)	9.7–10.4 10.0±0.23 (17)	10.2 (1)	9.9–10.5 10.2±0.26 (4)
Maxillary breadth from M3–M3	6.0–6.7 6.4±0.14 (19)	6.2 (2)	6.1–6.3 6.2±0.09 (7)	5.9–6.4 6.1±0.17 (17)	6.2 (1)	6.3–6.9 6.6±0.11 (4)
Braincase breadth	9.0–9.7 9.4±0.18 (19)	9.5, 9.8 (2)	8.5–9.1 8.8±0.20 (7)	8.5–9.2 8.9±0.20 (17)	9.2 (1)	8.9–9.5 9.3±0.26 (3)
Ratio of tail length tp condylolincisive length	3.0–3.6 3.2±0.21 (15)	3.1, 3.3 (2)	2.4–2.9 2.7±0.17 (7)	2.6–2.9 2.7±0.12 (15)	–	3.0 (2)

age, and *M. brevicaudata* Grandidier, 1899 are exceptions [for discussion of these apparently anomalous drier habitats see MacPhee, 1987]) it is conjectured here that rain forest is also the most likely source habitat for the type series of *M. drouhardi*. Additionally the large size of these specimens suggests that they may have originated from a high altitude locality (see section on variation), which is most compatible with Montagne d'Ambre rather than any of the other localities listed above.

In the original description, Grandidier described the dorsal pelage as uniformly dark with the venter barely lighter in colour. The young specimen mentioned in the type description (evidently an infant) is described as having a black line along the mid-dorsum, which according to Grandidier, disappears in adults. Re-examination of the type series (by CR) shows that due to the discoloring and deleterious effect of long-term storage in alcohol, these specimens are no longer dark in colour but are now a dull reddish brown. Furthermore, a dark dorsal stripe is discernable, which is obvious in some specimens, where it is most evident on the head and anterior part of the body, but faint and difficult to see in others. Shared features such as the presence of a dorsal stripe, size and relative proportions of the body and cranium, and morphology of the deciduous and permanent dentitions, between the type series of *M. drouhardi* and specimens recently collected (particularly from Montagne d'Ambre), lead to the conclusion that they are conspecific.

Microgale melanorrhachis Morrison-Scott, 1948 was originally distinguished by the presence of its dark mid-dorsal stripe. The description was based on the skin and skull of the juvenile holotype (believed to be adult by the author) from Perinet [Andasibe], plus a damaged skin from another locality (Ivohibe). Following the original description, an additional specimen was recorded by Eisenberg & Gould (1970) from Didy, east of Lake Alaotra and references to

the species were included in the literature (Heim de Balsac, 1972; Genest & Petter, 1975). MacPhee (1987), however, observed that a proportion of *M. cowani* also exhibited a variable tendency to a mid-dorsal stripe, and he synonymised *M. melanorrhachis* with *M. cowani* on the basis of its dentition. Subsequent authors disregarded MacPhee's opinion and continued to treat *M. melanorrhachis* as a distinct species (Nicoll & Langrand, 1989; Nicoll & Rathbun, 1990; Raxworthy & Nussbaum, 1994; Stephenson, 1995). The conclusion drawn from the current study comparing recently collected large series of adult and juvenile specimens from the localities listed above with the type series of *M. drouhardi* and *M. melanorrhachis*, is that they are conspecific.

DESCRIPTION. Medium sized (see Table 4), tail slightly shorter or subequal to head and body length. Dorsal pelage dark brown, brown or rufous brown with well demarcated, distinctly darker brown mid-dorsal stripe, extending from crown of head to base of tail (see Fig. 2); hairs of dorsal pelage have light grey bases, red distally with brown tips; hairs of mid-dorsal stripe dark brown for most of their length, with grey bases, lacking red band; guard hairs also dark brown with grey bases. Ventral pelage silvery buff, buff or rufous buff, individual hairs having grey bases and buff or reddish buff tips; transition between dorsal and ventral coloration moderately distinct. Tail bicolored, dark brown above, buff or reddish buff below; tail scales readily visible, scale hairs short, each overlapping c 2 scales on basal third of tail. Hind feet dark brown on outer dorso-lateral and ventral surface, reddish buff or buff on inner dorso-lateral surface.

Skull medium in size (see Table 4 and Fig. 6), with moderately elongated and shallow but broad rostrum, nasals extend beyond zygomatic plate into interorbital region; frontals slightly dorso-laterally inflated; braincase moderately broad, short and shallow;

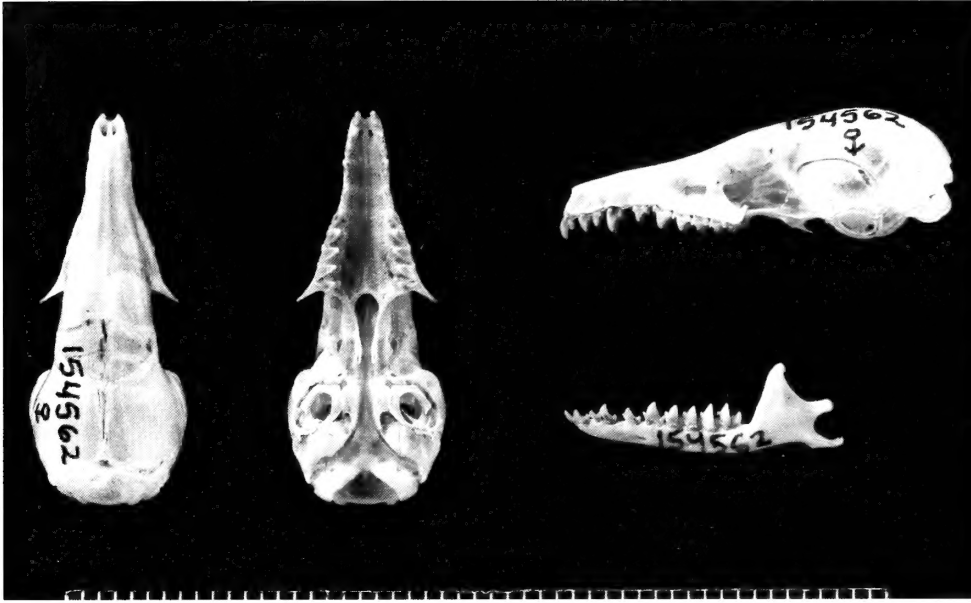

Fig. 6 Cranium of *Microgale drouhardi* (FMNH 154562) from left to right, dorsal, ventral, and lateral view of cranium and mandible.

parietal-supraoccipital junction rounded or subangular. Short diastemata present between anterior teeth from I1 to P3 and usually present on either side of p2; I3 often distinctively caniniform, usually anteroflexed, anterior accessory cusp usually absent or very reduced and distostyle may be reduced (see Fig. 7). Upper canine long and slender, notably greater in crown height than other teeth in upper dentition (including P3), root usually evident externally a swelling in rostrum. Talonid of m3 slightly reduced, talonid basin narrow and entoconid lacking (see Fig. 8).

VARIATION. There is a moderately high degree of variation in pelage coloration between populations. Specimens from PN de la Montagne d' Ambre are usually dark brown, with or without a rufous

wash; those from Bekolosy, PN de Mantady, Didy and Andasibe, also RS d' Analamazaotra (see Stephenson, 1995) are bright rufous or rufous brown dorsally, with a buff or rufous wash ventrally; specimens from RS d' Ambatovaky are dull rufous brown dorsally, grey ventrally; those from RNI de Zahamena are light rufous brown dorsally, with a rufous wash ventrally; while specimens from RNI

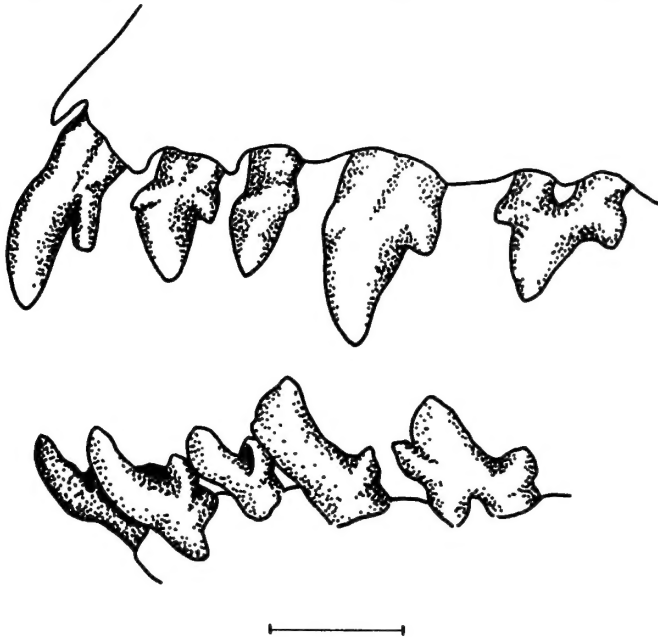

Fig. 7 Buccal view of left permanent anterior dentition of *Microgale drouhardi* (FMNH 154514) I1-P2 above, i1-p2 below. Scale = 1 mm.

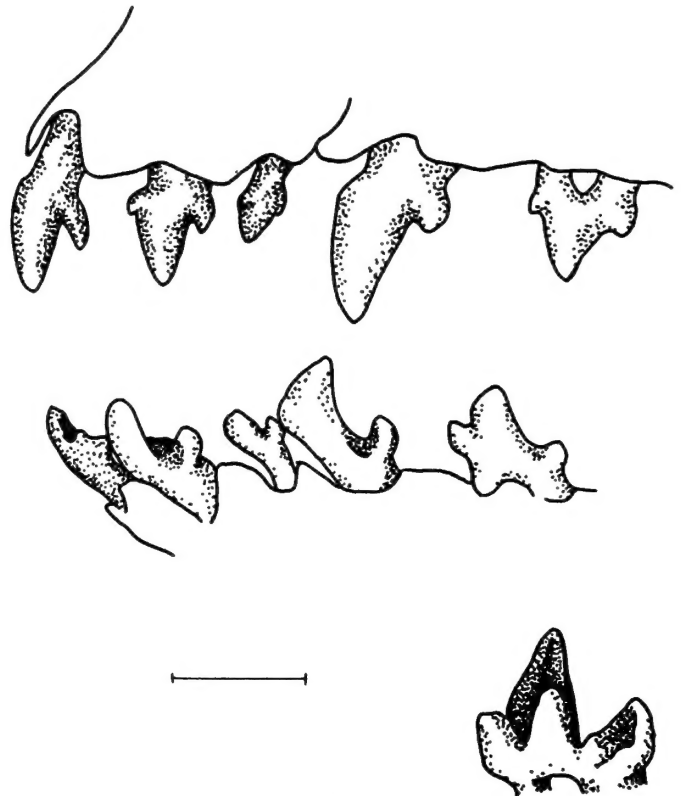

Fig. 8 Deciduous left anterior dentition of *Microgale drouhardi* (UMMZ 168480): buccal view of dI1-dP2 above, buccal view of di1-dp2 below. Below right lingual view of right m3. Scale = 1 mm.

Table 5 Altitudinal size variation in adult *Microgale drouhardi*.

	Altitude 360m–920m	Altitude 1000m–1250m
Condyloincisive length	20.5–22.3 21.4±0.47 2 (15)	21.1–23.9 23.0±0.78 (23)
Upper tooththrow length	9.7–10.5 10.1±0.23 (22)	9.9–11.4 10.8±0.47 (25)
Braincase breadth	8.5–9.3 8.9±0.20 (22)	8.6–9.8 9.4±0.31 (23)
Ratio of tail length to condyloincisive length	2.5–2.9 2.7±0.14 (20)	2.7–3.6 3.1±0.21 (20)

d'Andringitra (all juveniles) have a grey brown dorsum, grizzled with yellowish buff. Although always present and distinctly demarcated, there is some variation in the width and length of the dorsal stripe. The intensity of the rufous buff coloration of the venter, undersurface of the tail and lateral surfaces of the hind feet also shows within-population variability. The pelage of juveniles from all localities is indistinguishable in coloration and degree of striping from that of adults, which refutes the view of Grandidier (1934) that striping is a juvenile characteristic and confirms MacPhee's observation that striping occurs also in dental adults.

This species exhibits an exceptional degree of inter-population size variation (see Table 4). Specimens from RS d'Ambatovaky and RNI de Zahamena are notably smaller than those from PN de la Montagne d'Ambre and Bekolosy, although the extremes shown by these populations are bridged by specimens from PN de Mantady, (and RS d'Analamazaotra, see Stephenson, 1995) which are intermediate in size. Such a high degree of size variation is much greater than encountered in any other species of *Microgale* so far investigated. There is no apparent correlation between size and geographical location, although there is some evidence of a link with altitude. Specimens from lower altitudes are smaller, those from higher altitudes average larger (see Table 5).

COMPARISONS. *Microgale drouhardi* is most similar in size and dentition to *M. cowani* and *M. taiva* Major, 1896b. *Microgale taiva* is another taxon regarded as a synonym of *M. cowani* by MacPhee (1987), however recently collected specimens suggest that the two species are distinct and the descriptions of both have been amplified (see Jenkins *et al.*, 1996). *Microgale drouhardi* is readily distinguished from both species by the presence of the sharply demarcated, dark, mid-dorsal stripe; also in life, *M. drouhardi* has a much paler

Table 6 Comparison of adult *Microgale drouhardi*, *M. cowani* and *M. taiva*. Dimensions presented as range, mean±standard deviation and number of specimens in parentheses.

	<i>M. drouhardi</i>	<i>M. cowani</i>	<i>M. taiva</i>
Ratio of tail length to condyloincisive length	2.4–3.6 3.0±0.27 (33)	2.5–3.1 2.9±0.19 (14)	3.5–4.2 3.9±0.19 (14)
Condyloincisive length	20.5–23.9 22.4±1.02 (39)	21.4–23.7 22.5±0.52 (16)	22.1–23.5 22.8±0.44 (14)
Ratio of anterior dentition(I–P3) to upper tooththrow length	41.6–50.9 48.8±1.87 (41)	52.8–56.4 54.0±1.00 (16)	49.1–52.8 50.7±0.88 (14)
Braincase breadth	8.5–9.8 9.2±0.36 (40)	9.8–10.4 10.1±0.19 (18)	9.6–10.3 9.9±0.22 (14)

venter than *M. cowani* and *M. taiva*. *Microgale cowani* is distinguished from *M. drouhardi* by the more elongated rostrum with longer diastemata between the teeth of the anterior dentition, by the broader, deeper braincase and by the presence of all elements of the talonid of m3 (see Table 6). *Microgale taiva* has a relatively broader, deeper braincase than that of *M. drouhardi*, the tail is relatively longer, and the ratio of the anterior teeth (from I1 to P3) to the upper tooththrow is greater on average (see Table 6).

Microgale parvula Grandidier, 1934

Microgale pulla Jenkins, 1988

HOLOTYPE. MCZ 45465, juvenile male, body in alcohol, skull extracted, collected by Monsieur Drouhard.

TYPE LOCALITY. environs of Diego-Suarez [Antsiranana, c. 12°16'S 49°18'E – see MacPhee, 1987]

REFERRED MATERIAL. Camp 1, Antomboka River, PN de la Montagne d'Ambre, Antsiranana Fivondronana, Antsiranana Province, 12°32'S 49°10'E, 1125–1225m, rain forest: UMMZ 171043–171044.

Bekolosy, RS de Manongarivo, Ambanja Fivondronana, Antsiranana Province, 14°03'S 48°18'E: BMNH 96.282.

RNI de Marojejy, Andapa Fivondronana, 14°26'S 49°46'E, 650–900m: UMMZ 171045–171051.

Forêt d'Anandrivola, c 10 km southwest of Maintimbato Village, c 40 km southwest of Maroantsetra, northeast Madagascar, 15°46'S 49°35'E, 450–625 m: BMNH 87.132 (holotype of *M. pulla*).

RNI de Zahamena, Ambatondrazaka Fivondronana 17°40'S 48°46'E, 1180–1270m: UMMZ 171052–171053.

RS d'Ambohitantly, Ankazobe Fivondronana 18°11'S 47°17'E: UMMZ 171054.

PN de Mantady, Moramanga Fivondronana, Toamasina Province, 18°51'S 48°28'E, 1100m: UMMZ 171040–171042; BMNH 96.283.

38 km S of Ambalavao, along Volotsangana River, RNI d'Andringitra, 22°11'S 46°58'E, 1625 m: FMNH 151623; FMNH 151723; FMNH 151793–151794; FMNH 151801; FMNH 151805–151806. 40 km S of Ambalavao, along Volotsangana River, RNI d'Andringitra, 22°13'S 46°58'E, 1210 m: FMNH 151722; FMNH 151764; FMNH 151766. 43km S of Ambalavao, junction of Sahanivoraky and Sahavatoy Rivers, RNI d'Andringitra, 22°13'S 47°00'E, 810 m: FMNH 151622. 45 km S of Ambalavao, east bank of Iantara River, along Ambalaman-enjana–Ambatamboay Trail, edge of RNI d'Andringitra, 22°13'S 47°01'E 720 m: FMNH 151621.

Ampamakiesiny Pass, Tôlanaro Fivondronana, Toliara Province, 24°32'S 46°51'E, 750–850m. UMMZ 167258; UMMZ 167261–167263.

Marosohy Forest, 16 km WNW of Ranomafana-Sud, Fivondronana Tolagnaro [Tôlanaro Fivondronana], Toliara Province, 24°34'S 46°48'E, 700–800m: USNM 578784–578785; Marosohy Forest, near Tsitongatona River, 15 km WNW of Ranomafana-Sud, Fivondronana Tolagnaro [Tôlanaro Fivondronana], Toliara Province, 24°34'S 46°48'E, 580m: USNM 578786.

Nahampoana, Vohimena Mountains; Tôlanaro Fivondronana, 24°58'S 46°58'E, 120m: UMMZ 167233.

Manantantly, Vohimena Mountains, Tôlanaro Fivondronana, 24°59'S 46°58'E, 100–300m: UMMZ 167222–167223; UMMZ 167228–167229; UMMZ 167231.

TAXONOMIC NOTES. *Microgale parvula* was described originally from a single specimen, erroneously considered to be adult by the

Table 7 Comparison of adult *Microgale parvula* and *M. pusilla*. Dimensions presented as range, mean±standard deviation and number of specimens in parentheses.

	<i>M. parvula</i>	<i>M. pusilla</i>
Head and body length	49.6–64 56.1±3.8 (19)	52 (1)
Tail length	46.5–66 54.8±5.9 (19)	72 (1)
Hind foot length	9–11 10.0±0.64 (19)	12 (1)
Ratio of tail length to head and body length	0.8–1.1 1.0±0.08 (18)	1.4 (1)
Condylolncisive length	15.5–17.1 16.4±0.36 (17)	15.6–16.8 16.4±0.4 (6)
Upper tooththrow length	6.9–7.8 7.4±0.21 (18)	7.2–7.9 7.6±0.19 (9)
Maxillary breadth from M3–M3	4.3–4.6 4.5±0.08 (19)	4.9–5.2 5.0±0.11 (9)
Braincase breadth	6.4–6.9 6.7±0.15 (18)	6.8–7.3 7.0±0.16 (6)
Braincase height	3.6–4.3 4.0±0.17 (18)	4.7–5.4 5.0±0.24 (6)
Ratio of tail length to condylolncisive length	2.9–4.0 3.4±0.33 (17)	4.4 (1)

author but later demonstrated to have a deciduous dentition by MacPhee (1987). Perhaps because its very small size presents collection difficulties, no further specimens were recorded in the literature nor represented in the major museum collections accessed by MacPhee (1987). The dentition of this specimen was illustrated by MacPhee (1987), who also corrected the measurements given in

the original description. He was in no doubt about the validity of this distinctively small species, which he grouped in the *cowani* cluster on the basis of phenetic characters. The origin of the holotype of *M. parvula* is the same as for *M. drouhardi* and similar arguments may be applied, suggesting that it was most probably collected from Montagne d'Ambre and from rain forest. It was assumed that the species might be confined to northern Madagascar. *Microgale pulla* Jenkins, 1988 was described from another single, although adult specimen, from further south. MacPhee (personal communication) advised that this specimen might simply represent the adult of *M. parvula* and this possibility was mentioned in the original description of *M. pulla*, although the data available at that time suggested otherwise. Recent collections from different localities extending from Montagne d'Ambre in the extreme north to the eastern forest as far south as Manantantely, included adult and juvenile specimens positively ascribable to the same taxon, directly associating the adult *pulla* with the juvenile *parvula*. *Microgale pulla* was synonymised with *M. parvula* (see Jenkins *et al.*, 1996).

DESCRIPTION. Very small (see Table 7 and Fig. 2), tail subequal in length to that of head and body. Dorsal pelage dark brown, ventral pelage dark grey brown, tail and feet uniform dark grey brown. Individual hairs of dorsal pelage with grey bases, orange red distally with brown tips, guard hairs flattened, with grey bases and brown tips. Hairs of ventral pelage with grey bases and brown or reddish buff tips. Tail scales visible beneath moderately dense scale hairs, 2.5–3 scales in length. Skull very small, delicate and elongated in appearance (see Fig. 9); rostrum slender, moderately short; braincase shallow and long, frontals and occipital large relative to parietals, occipital condyles postero-dorsally orientated. Diastemata present between I1 and I2 and on either side of C and P2; anterior and posterior accessory cusps present on I2, I3 and P2. Diastema between c and p2. Talonid of m3 with well developed hypoconulid but reduced hypoconid, entoconid and entoconid ridge, and narrow, shallow talonid basin. See Fig. 10 for illustrations of permanent and deciduous dentitions.

VARIATION. There is no obvious intraspecific variation in pelage coloration or size between the populations studied, nor any evidence

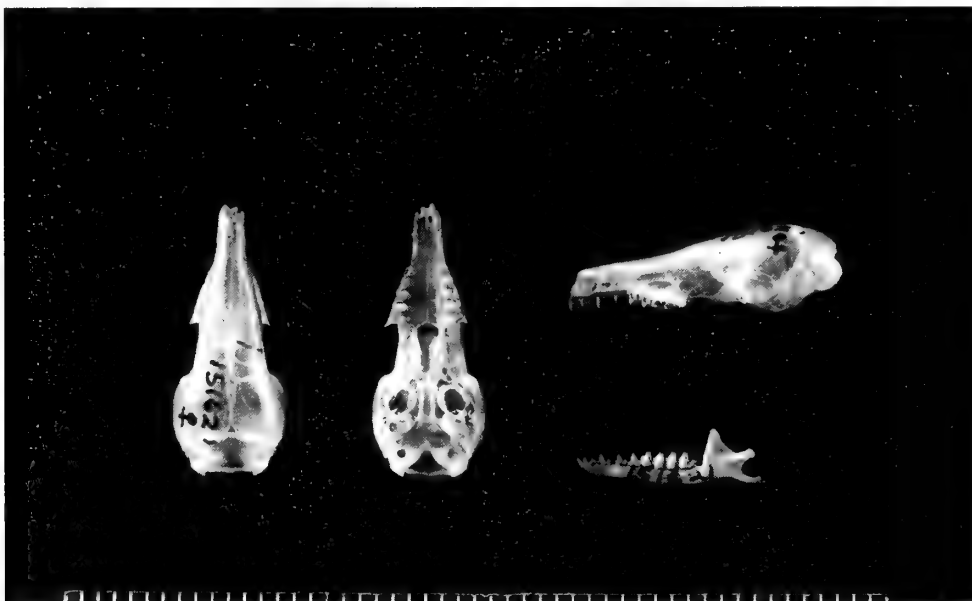

Fig. 9 Cranium of *Microgale parvula* (FMNH 151621) from left to right, dorsal, ventral, and lateral view of cranium and mandible.

of altitudinal variation. Variation may, however, be present but obscured by the small sample size from individual localities.

COMPARISONS. *Microgale pusilla* Major, 1896b is the only species with which *M. parvula* is likely to be confused because of similarities in size. The two species differ in coloration: *M. parvula* is dark grey brown dorsally, grading into grey ventrally, with a dark grey tail which is only slightly paler ventrally; in contrast, *M. pusilla* is reddish buffy brown dorsally, with a moderately abrupt transition to the buffy grey brown venter and with the tail darker grey brown above than below. Although the skull of both species is of a similar length (see Table 6), the skull proportions differ considerably and, in particular the braincase of *M. parvula* is shallower than that of *M. pusilla* and the occipital condyles are more postero-dorsally aligned (see Fig. 9 and Jenkins, 1988: Fig. 1). The major dental difference between the two species is that p2 has a single root in *M. pusilla* but is double rooted in *M. parvula*.

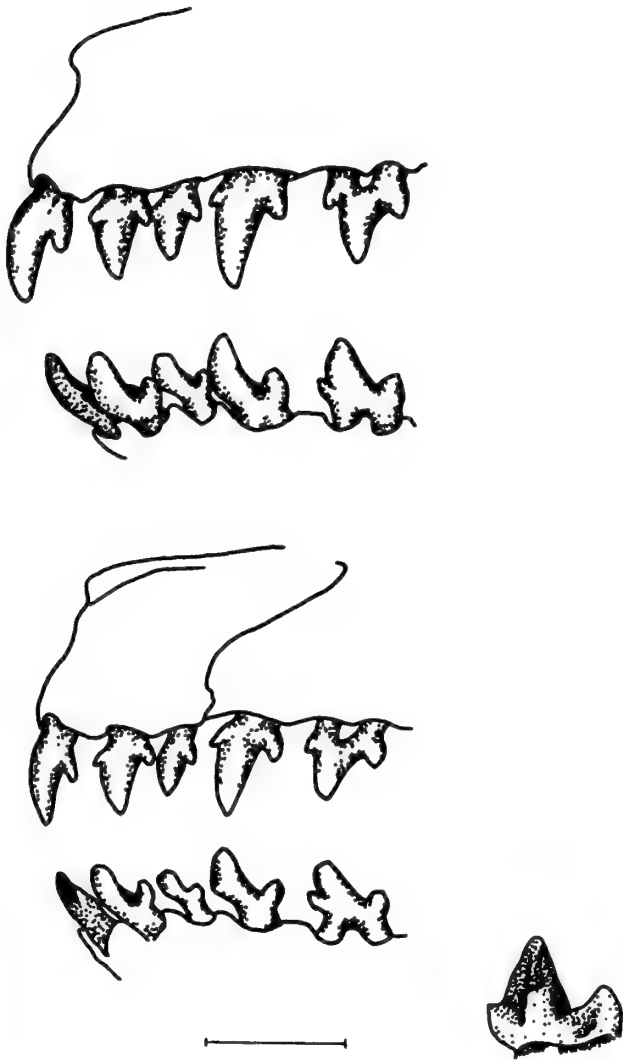

Fig. 10 Top: left permanent anterior dentition of *Microgale parvula* (FMNH 151623) buccal view of I1–P2 above, buccal view of i1–p2 below. Below: deciduous left anterior dentition of *Microgale parvula*, buccal view of dI1–dP2 (FMNH 151806) above, buccal view of di1–dp2 (FMNH 151622) below. Lower right: lingual view of right m3 (FMNH 151622). Scale = 1 mm.

DISCUSSION

Purely on a phenetic basis, MacPhee (1987) grouped the species of *Microgale* into six species 'clusters', as follows:

cowani cluster: *M. cowani*, *M. thomasi*, *M. parvula*. Species considered by MacPhee to be synonyms of *M. cowani*, but subsequently removed from synonymy, namely *M. taiva* (see Jenkins *et al.*, 1996) and *M. drouhardi* (this paper) continue to be assigned to this group.

gracilis cluster: *M. gracilis*

longicaudata cluster: *M. longicaudata*, *M. principula*

pusilla cluster: *M. pusilla*

brevicaudata cluster: *M. brevicaudata*

dobsoni cluster: *M. dobsoni*, *M. talazaci*

Of those species described after MacPhee's revision, *Microgale dryas* Jenkins (1992) was considered to group with members of both the *cowani* and *gracilis* clusters, while the unusual dentition of *M. soricoides* Jenkins, 1993, was believed to be sufficiently distinct to merit a separate cluster. Because of its greater resemblance in craniodental morphology and proportions to *M. soricoides* rather than any other species, *M. fotsifotsy* is placed in the *soricoides* cluster.

Surprisingly, although *Microgale fotsifotsy* represents a new species, the distribution of this shrew tenrec extends through almost the entire length of the rain forest belt (from latitude 12°–24°S) in Madagascar. It has been collected from six different regions: Montagne d'Ambre, Marojejy, Ambatovaky, Zahamena, Andringitra and Marosohy Forest, near RNI Andohahela (Anosy Mountains). The elevational range for this species is 600–1400m, suggesting that it is primarily restricted to mid-altitude rain forest. Because trapping in lower elevations at Ambatovoky, Zahamena and the Anosy Mountains (as well as other sites) did not yield further examples of *M. fotsifotsy*, we conclude that this species is absent from forest below 600m altitude.

The habits of this species remain largely unknown; most captures so far have been made with pitfall traps in primary rain forest, demonstrating that it is active on the forest floor. One specimen, however, was found on top of a shelter 1.5m above the ground, suggesting that it may also be partly arboreal. This view is supported by morphological features such as the relatively long tail and elongated hind foot with a long fifth digit, adaptations which are associated with arboreality in Soricidae (Hutterer, 1985) and occur in a more extreme form in another species of shrew tenrec, *M. longicaudata*, (see Thomas, 1918) a species for which there is some behavioural evidence of arboreal adaptation (CR personal observation; Goodman, personal communication).

Microgale drouhardi and *M. parvula* are also widely distributed in the rain forest regions of Madagascar. Both occur as far north as Montagne d'Ambre (latitude 12°S) and as far south as Andringitra (22°S) for *M. drouhardi*, and Manantantely, Vohimena Mountains (25°S) for *M. parvula*. *Microgale drouhardi* has one of the largest elevational ranges known for the genus, from 360–2350m. The only other species with a similar elevational range is *M. talazaci* Major, 1896a which occurs from 100m (Raxworthy, unpublished) to about 2300m (Albignac, 1970). *Microgale drouhardi*, *M. talazaci* (and *M. cowani*, Goodman personal communication) appear to be the most montane *Microgale* known. The elevational range of *M. parvula* is also large, between 100–1550m altitude. None of these species of *Microgale* are specialists of a single elevational zone, having been collected from low, mid and even montane evergreen forest. *Microgale drouhardi* occurs

sympatrically in parts of its range with several other species similar in size and external morphology, notably *M. cowani* and *M. taiva*. Obvious ecological differences have yet to be determined between these species, except that *M. drouhardi* is known from higher elevations. The only *Microgale* species similar in size to *M. parvula* is *M. pusilla*, and based on MacPhee's (1987) distribution summary, they are broadly sympatric over much of the eastern rain forest belt (latitude 18°–21°S), although there is as yet no evidence of microsympatry.

The broad elevational and latitudinal distributions of these rain forest species of *Microgale* are surprising in as much as *M. parvula* was previously only known by the holotype and *M. fotsifotsy* was unknown. Conventional small mammal traps are inefficient at trapping the smaller shrew-sized mammals, which fail to trigger the trap mechanism. This may explain why *M. fotsifotsy*, and more particularly, the very small, light weight, *M. parvula* were previously unrecorded or rarely recorded. *Microgale drouhardi*, although more commonly collected, is only represented by small series in museum collections and, following the revision of MacPhee (1987) has been considered as a synonym of *M. cowani*. One of the main reasons for this situation is that most *Microgale* material was collected in the last century (see MacPhee, 1987), with modern specimens being rare in museums. The pitfall trapping method that we used in this study has proved to be extremely productive at sampling *Microgale* populations.

ACKNOWLEDGEMENTS. We are greatly indebted to Jean Baptiste Ramanamanjato, Achille Raselimanana, Angelien and Angeluc Razafimanantsoa, for their assistance with this study. This research was made possible through the cooperation of the Malagasy Ministère de l'Enseignement Supérieur, the Ministère de la Production Animale et des Eaux et Forêt, and the Ministère de la Recherche Scientifique et Technique pour le Développement.

We particularly thank Steven Goodman, Field Museum of Natural History, Chicago for allowing us to examine recently collected material from RNI d'Andringitra and PN de la Montagne d'Ambre, which included specimens of the undescribed species, and also for bringing additional specimens of this undescribed species in the collection of the USNM to our attention. For their kind assistance and for the loan of specimens in their care, we are grateful to William Stanley and John Phelps, Division of Mammalogy, Field Museum of Natural History; Phillip Myers and Jim Birch, Division of Mammalogy and Gregory Schneider, Division of Herpetology, University of Michigan, Museum of Zoology; Michael Carleton, Marc Frank and Helen Kafka, Division of Mammalogy, National Museum of Natural History, Washington, D.C. For two specimens we thank respectively, Tanya Barden and members of the 1993 Cambridge University expedition, Louise Ashmore, Juliet O'Keefe, Matthew Thomas and Oliver Tunstall Pedoe. Maria Rutzmoser, Museum of Comparative Zoology, Harvard, kindly provided information on the holotypes of *M. parvula* and *M. drouhardi*.

For their highly valued constructive comments and criticism of the manuscript, we are indebted to Steven Goodman, Ross MacPhee (Department of Mammalogy, American Museum of Natural History) and Darrell Siebert (Department of Zoology, The Natural History Museum).

Photographs were prepared by Phillip Hurst, Photographic Unit, The Natural History Museum.

This research was supported in part by grants from the National Science Foundation (DEB 90-24505 and DEB 93-22600) and the National Geographic Society (5396-94). Logistic support was provided by the World Wide Fund for Nature and Conservation International.

REFERENCES

- Albignac, P.** 1970. Mammifères et Oiseaux du Massif du Tsaratanana (Madagascar Nord). *Mémoires ORSTOM* 37: 223–229.
- Butler, P. M., & M. Greenwood.** 1979. Soricidae (Mammalia) from the Olduvai Gorge, Tanzania. *Zoological Journal of the Linnean Society*, 67: 329–379.
- Carleton, M. & D. F. Schmidt.** 1990. Systematic studies of Madagascar's endemic rodents (Muroidea: Nesomyinae); an annotated gazetteer of collecting localities of known forms. *American Museum Novitates*, (2987): 1–36.
- Eisenberg, J.F. & E. Gould.** 1970. The tenrecs: a study in mammalian behavior and evolution. *Smithsonian Contributions to Zoology*, (27): 1–138.
- Genest, H., & F. Petter.** 1975. Part 1.1. Family Tenrecidae, pp. 1–7. In Meester, J. and H. W. Setzer, eds., *The mammals of Africa: an identification manual*. Smithsonian Institution Press, Washington, D.C.
- Goodman, S. M., C. J. Raxworthy & P. D. Jenkins** 1996. Insectivore ecology in the Réserve Naturelle Intégrale d'Andringitra, Madagascar pp. 218–230. In S.M. Goodman, ed., A floral and faunal inventory of the eastern side of the Réserve Naturelle Intégrale d'Andringitra, Madagascar: with reference to elevational variation. *Fieldiana: Zoology* (85).
- Grandidier, G.** 1899. Description d'une nouvelle espèce d'insectivore provenant de Madagascar. *Bulletin Muséum National d'Histoire Naturelle*, 5: 349.
- 1934. Deux nouveaux mammifères insectivores de Madagascar. *Bulletin Muséum National d'Histoire Naturelle*, sér. 2, 6: 474–477.
- Heim de Balsac, H.** 1972. Insectivores, pp. 629–660. In: Battistini, R., and G. Richard-Vindard, eds., *Biogeography and ecology in Madagascar*. W. Junk, the Hague.
- Hutterer, R.** 1985. Anatomical adaptations of shrews. *Mammal Review*, 15: 43–55.
- 1993. Order Insectivora, pp. 69–130. In: Wilson, D. E. and D. M. Reeder. *Mammal species of the world: a taxonomic and geographic reference*. Smithsonian Institution Press, Washington, D.C.
- Jenkins, P. D.** 1988. A new species of *Microgale* (Insectivora: Tenrecidae) from northeastern Madagascar. *American Museum Novitates*, (2910): 1–7.
- 1992. Description of a new species of *Microgale* (Insectivora: Tenrecidae) from eastern Madagascar. *Bulletin of the British Museum Natural History (Zoology)*, 58: 53–59.
- 1993. A new species of *Microgale* (Insectivora: Tenrecidae) from Eastern Madagascar, with an unusual dentition. *American Museum Novitates* (3067): 1–11.
- S. M. Goodman & C. J. Raxworthy 1996. The shrew tenrecs (*Microgale*) of the Réserve Naturelle Intégrale d'Andringitra, Madagascar pp. 191–217. In S.M. Goodman, ed., A floral and faunal inventory of the eastern side of the Réserve Naturelle Intégrale d'Andringitra, Madagascar: with reference to elevational variation. *Fieldiana: Zoology* (85).
- MacPhee, R. D. E.** 1987. The shrew tenrecs of Madagascar: systematic revision and Holocene distribution of *Microgale* (Tenrecidae: Insectivora). *American Museum Novitates*, (2889): 1–45.
- Major, C. I. Forsyth.** 1896a. Diagnoses of new mammals from Madagascar. *Annals and Magazine of Natural History*, (6) 18: 318–325.
- 1896b. Descriptions of four additional new mammals from Madagascar. *Annals and Magazine of Natural History*, (6) 18: 461–463.
- Mills, J. R. E.** 1966. The functional occlusion of the teeth of Insectivora. *Journal of the Linnean Society (Zoology)*, 47: 1–125.
- Morrison-Scott, T. C. S.** 1948. The insectivorous genera *Microgale* and *Nesogale* (Madagascar). *Proceedings of the Zoological Society of London*, 118: 817–822.
- Nicoll, M. E., & O. Langrand.** 1989. *Madagascar: Revue de la conservation et des Aires Protégées*. World Wide Fund for Nature, Gland, Switzerland, XVII + 374 pp.
- & G. B. Rathbun. 1990. *African Insectivora and Elephant-shrews: An action plan for their conservation*. IUCN/SSC Insectivore, Tree-shrew and Elephant-shrew Specialist Group, Gland, Switzerland, iv+53 pp.
- Raxworthy, C. J. & R.A. Nussbaum.** 1994. A rainforest survey of amphibians, reptiles and small mammals at Montagne d'Ambre, Madagascar. *Biological Conservation*, 69: 65–73.
- & — 1996. Amphibians and Reptiles of the Réserve Naturelle Intégrale d'Andringitra, Madagascar pp. 158–170. In S.M. Goodman, ed., A floral and faunal inventory of the eastern side of the Réserve Naturelle Intégrale d'Andringitra, Madagascar: with reference to elevational variation. *Fieldiana: Zoology* (85).
- Stephenson, P. J.** (1995). Taxonomy of shrew-tenrecs (*Microgale* spp.) from eastern and central Madagascar. *Journal of Zoology*, 235: 339–350.
- Swindler, D. R.** 1976. *Dentition Of Living Primates*. Academic Press, London, 308 Pp.
- Thomas, [M. R.] Oldfield.** 1882. Description of a new genus and two new species of Insectivora from Madagascar. *Journal of the Linnean Society (Zoology)*, 16: 319–322.
- 1918. On the arrangement of the small Tenrecidae hitherto referred to *Oryzomys* and *Microgale*. *Annals and Magazine of Natural History* (9) 1: 302–307

Notes on the anatomy and relationships of *Sundasalanx* Roberts (Teleostei, Clupeidae), with descriptions of four new species from Borneo

DARRELL J. SIEBERT

Department of Zoology, Natural History Museum, Cromwell Road, London, U.K. SW7 5BD

CONTENTS

Introduction	13
Materials and Methods	14
Notes on the Anatomy of <i>Sundasalanx</i>	14
Colour Pattern	14
Soft Anatomy	15
Gut	15
Gonads	16
Gas Bladder and Associated Structures	16
Laterosensory Canals	17
Osteology	17
Caudal Skeleton	17
Pelvic Girdle	17
Vertebral Column	18
Intermusculars	18
Dorsal- and Anal-fin Supports	18
Jaws	18
Gill Arches	18
Dentition	19
Suspensorium	19
Lower Hyoid Arch	19
Opercular Series	19
Infraorbital Series	19
Skull Roofing Bones	19
Relationships	19
Distinctiveness of <i>Sundasalanx praecox</i>	20
Descriptions of New Species	20
<i>Sundasalanx malleti</i> , sp. nov.	20
<i>Sundasalanx mesops</i> , sp. nov.	23
<i>Sundasalanx megalops</i> , sp. nov.	23
<i>Sundasalanx platyrhynchus</i> , sp. nov.	23
Discussion	24
Acknowledgements	25
References	25

SYNOPSIS. *Sundasalanx* has a prootic bulla and a *recessus lateralis*. Thus it is a clupeiform. The degree of caudal skeleton consolidation found in *Sundasalanx* suggests relationship to the clupeid genus *Jenkinsia*. *Sundasalanx* is unusual among known miniature clupeiforms. Its somatic development is equivalent to that of late stage unmetamorphosed larvae of other clupeiforms; *Sundasalanx* is highly progenetic. Among fishes perhaps only *Schindleria* attains a comparable degree of progenesis. *Sundasalanx* is widely distributed over Southeast Asia, with considerable species diversity. Descriptions are provided for four new Bornean species: *S. malleti* Siebert and Crimmen; *S. mesops* Siebert and Crimmen; *S. megalops* Siebert and Crimmen; and *S. platyrhynchus* Siebert and Crimmen.

INTRODUCTION

Roberts (1981) described two new species of minute transparent fishes, one from Khlong Falamee, Isthmus of Kra, southern Thai-

land, and the other from the Kapuas River, Kalimantan Barat, Indonesia, as *Sundasalanx praecox* and *Sundasalanx microps*, respectively. *Sundasalanx* is now known also from peninsular Malaysia (Roberts, 1984; Kreutzman, 1993), Thailand north of the peninsula (Roberts, 1984), and eastern Borneo north of the Kapuas River basin

(L. Parenti, pers. comm.). Four new species of *Sundasalanx* are described below, three from the Barito River, Central Borneo, Indonesia and one from the Kapuas river, West Borneo, Indonesia. The new species of *Sundasalanx* appear to be larger than *S. praecox* and *S. microps* but are very small fishes nevertheless, with observed standard lengths not exceeding 30 mm.

Roberts (1981) considered *Sundasalanx* to be so unlike other known fishes he erected a new family for it. While recognising its unusual nature Roberts nevertheless felt it is allied with Salangidae (icefishes), hence the name *Sundasalanx*, and its familial derivative, Sundasalangidae. The following list of features was presented as evidence in support of this conclusion: 1) jaw suspensorium consisting of a single cartilaginous element; 2) 4th hypobranchial element present; 3) pedunculate pectoral fins; 4) scaleless body; 5) absence of symplectic; 6) absence of circumorbital bones; 7) myotomal muscles not meeting at the ventral midline of the body; and 8) distal two-thirds of maxilla curved beneath the head so that its ventral edge is directed medially. Others have regarded *Sundasalanx* simply as a salangid, arguing that if its relationship is with salangids then recognition of a Sundasalangidae would render Salangidae paraphyletic (Fink, 1984; Begle, 1991), if co-ordinate ranking is maintained in classification. Johnson & Patterson (1996) recently have proposed a classification of the Salmoniformes in which salangids are nested within the Osmeridae. In their classification salangids are given lower rank. They plus *Mallotus* make up the tribe Salangini.

All of the features enumerated above as suggestive of a relationship with salangids, except possibly the curve of the posterior portion of the maxilla to beneath the head, are simply aspects of a physiognomy that is paedomorphic to an extreme. They are in fact features suggestive of a larval stage of development and are a consequence of a truncated ontogeny. As such they might not each constitute independent evidence of relationship as each might be the result of the same process or event that altered the development of *Sundasalanx*. Furthermore, they amount to statements of absence, which renders them ineffectual as evidence of relationship in the absence of corroboration from other characters. Different evidence, and a new radical hypothesis of relationship for *Sundasalanx* are presented below.

MATERIALS AND METHODS

Comparative morphometry is presented with reference either to Standard length (SL) or Head length (HL), each measured as recommended in Hubbs & Lagler (1947). Head width (HW) was taken as the width of the widest part of the head. Eye diameter was measured from camera lucida tracings of heads. Counterstained (C&S) materials were prepared following Dingerkus & Uhler (1977). Since ossification in *Sundasalanx* is slight some materials were cleared and then stained with alizarin only. Some very lightly ossified elements were only apparent in material prepared this way. Whether very lightly ossified elements were obscured by the blue counterstain or dissolved by the acidic alcian blue solution during the counterstaining process was not determined. Institutional abbreviations follow Leviton *et al.* (1985).

Anatomical notes are based on observations of cleared and stained specimens: 17 *Sundasalanx malleti* sp. nov., from the Barito River; 10 *Sundasalanx mesops* sp. nov., from the Barito River, 3 *Sundasalanx platyrhynchus* sp. nov., from the Kapuas River; 2 paratypes of *Sundasalanx microps* Roberts, from the Kapuas River, 1 paratype of *S. praecox* Roberts, from peninsular Thailand; and 1 paratype of *S. megalops* sp. nov., from the Barito River.

MATERIAL EXAMINED. Materials of the new species are listed below in the descriptions of new species.

Sundasalanx microps, paratypes, CAS 44220, 5 of 9 alc., 2 of 7 C&S, Indonesia, Kalimantan Barat, Kapuas R. basin, Kapuas R. mainstream at Kampong Nibung, ca 100 km northeast of Selimbau, 5-6 Jul 1976, T.Roberts.

Sundasalanx praecox, paratypes, BMNH 1981.5.19:80-84, 4 alc. ex., 1 C&S, Thailand, Isthmus of Kra, Khlong Falamee, a tributary of Tale Sap, ca. 2 km W of Pak Payoon, 20 Jun 1970, T.Roberts.

NOTES ON THE ANATOMY OF SUNDASALANX ROBERTS, 1981

Small size and light ossification make *Sundasalanx* difficult subjects to study. Observations and interpretations that augment, or differ from, those of Roberts (1981, 1984) and Kottelat (1991) are presented below. Although the relationships of *Sundasalanx* are discussed later, comparisons are made here to clupeomorph, clupeiform, or clupeid anatomy as an aid in interpreting *Sundasalanx*. This is based on the conclusion that *Sundasalanx* is a clupeid, not a salangoid.

Sundasalanx does not look like other juvenile or adult clupeids. Rather, their physiognomy is very much like that of a late stage pre-metamorphosis larva. Although there is a large literature concerning the identification of larval clupeomorphs (McGowan & Berry, 1984) surprisingly little has been written about their internal anatomy (O'Connell, 1981). An exception is the gas bladder-inner ear-lateral line system, of which detailed anatomical descriptions are available for a number of clupeiforms (Allen *et al.*, 1976; Blaxter & Hunter, 1982; O'Connell, 1981; Shardo, 1996).

Sundasalanx is distinctive. The peculiar structures Roberts (1981) termed parapelvic cartilages (or bones; Fig. 1) are unknown elsewhere among teleosts. *Sundasalanx* also possesses a highly derived caudal skeleton (described below; Fig. 7A). A number of other features listed by Roberts, mostly paedomorphic and not unique to *Sundasalanx*, contribute to the generic diagnosis (Roberts, 1981). The absence of hypobranchials 1-3 but with presence of hypobranchial 4, a cartilage bar uniting the shoulder girdle across the ventral midline and a rayless pectoral fin supported by a single cartilaginous plate rather than by separate radials are particularly striking among the list.

Colour Pattern

Previous descriptions of *Sundasalanx* have been based on single

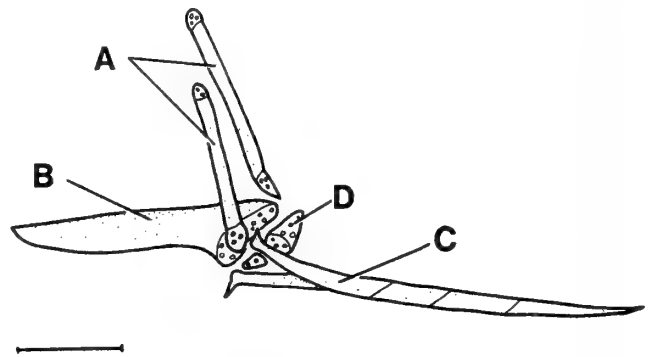

Fig. 1 Pelvic girdle of *Sundasalanx malleti* (anterior to left); A = parapelvic bones, B = basipterygium, C = 1st pelvic fin-ray, D = radial, scale bar = 0.5 mm.

samples, albeit relatively large ones. Roberts (1984) suggested a more detailed investigation of the colour pattern of different populations of *Sundasalanx* was needed since every population seemed to exhibit its own distinctive pattern, and implied that the observed variation might be intra- rather than interspecific. Preserved materials studied here indicate that *Sundasalanx* species share a basic colour pattern, but some species differ in certain aspects and it varies with size and between sexes. Sex and size are the two factors that appear to influence colour pattern most. Larger specimens have more strongly developed colour patterns and males have more vivid patterns than females or juveniles.

In life *Sundasalanx* is transparent except for the silvery cover around the eyeballs, which decomposes to reveal black pigment around the eye if specimens are conserved in formalin. Close examination, however, of preserved specimens reveals an extensive colour pattern (Figs 2, 11, 13–15). A small black spot is present behind the eye in the prootic region (best seen in Fig. 14), associated with the posterodorsal surface of what is herein identified as a prootic bulla. This spot was observed in all species examined except *S. praecox*, studied materials of which were largely depigmented. Pigment deposition on the dorsal surface of the prootic bulla during development has been observed in other clupeoids (Hoss & Blaxter, 1982), and is possibly a general feature of the group. Absence of prootic bulla pigmentation in *S. praecox* is likely an artefact of preservation.

A dark prepectoral mark, consisting of 1–5 melanophores, is present just anterior to the pectoral fin in most individuals examined (present in all large individuals; seen best in Figs 11, 13) of all species except *S. praecox*. The extent of the mark appears to vary interspecifically with the mark in Barito River species consistently larger than that of species examined from elsewhere. In species with a smaller mark it consists of one or two melanophores on the dorsolateral surface of the connective tissue sheath surrounding the *sternohyoideus* just anterior to the origin of the muscle on the cleithrum. Species with a larger mark possess up to three more melanophores on the rear wall of the gill chamber, dorsal to those on the *sternohyoideus*.

Elements of a mid-ventral line of melanophores are present in all species (Fig. 2). A midventral gular streak, dividing the *sternohyoideus* muscle mass into right and left sides, is present in all species. A midventral line of melanophores from behind the compartment in which the heart lies to the caudal fin, as described for southern peninsular Malaysia materials by Roberts (1984), is present in all species except *S. praecox*. In the region of the body cavity the melanophores are associated with the ventral finfold or its remnants. In the region of the anal fin, ventral midline pigmentation consists of melanophores located between each anal-fin pterygiophore, one per interpterygiophore space (best seen in Fig. 15); behind the anal fin the line is continued as a midventral series of melanophores situated between the ventral ends of myotomes of the caudal peduncle myotomes.

A line of melanophores is present on each side of the body at the ventral edge of myotomes in the region of the body cavity in all species examined (Figs 11, 13–15). The line begins immediately behind the shoulder girdle and ends at the anus, with the frequency of melanophores usually greater than one per myotome, but less than two per myotome. The line is continuous except in the region immediately dorsal to the pelvic fins, from which melanophores are absent.

In all species examined, a dark spot consisting of a single melanophore is located just anterior to the insertion of the pelvic fins (Figs 2, 11, 13–15), below the course of the myotomal line. An additional spot is located near the anterior end of the basipterygium of *S.*

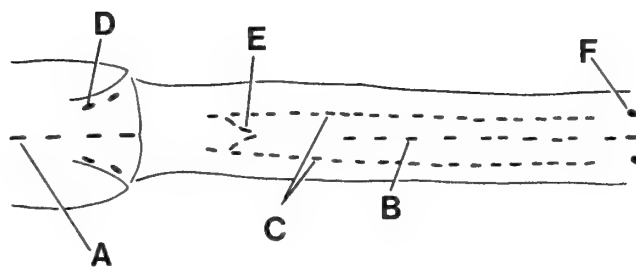

Fig. 2 Schematic representation of the melanophore pattern of *Sundasalanx* in ventral view (anterior to left); A = gular streak of midventral line, B = midventral line of the ventral fin fold, C = myotomal line, D = melanophores of cleithral mark associated with the *sternohyoideus*, E = cardiac compartment melanophores (present only in males of *S. microps*, *S. mesops*, *S. megalops*, and *S. platyrhynchus*), F = basipterygium melanophore (present in all species examined).

praecox. Males of *S. malleti* with mature, or maturing, testes show additional pigmentation of the pelvic-fin girdle, with a ring of melanophores encircling the basipterygium.

The lower caudal-fin lobe is marked by a broad swath of melanophores in all species except possibly *S. praecox*. This lower caudal-fin lobe swath is especially intense in materials identifiable as male (Fig. 14). A few scattered melanophores were observed on the upper caudal-fin lobe of a few individuals.

The posterior half of the compartment in which the heart lies is marked with melanophores (Fig. 2) in males of *S. microps*, *S. mesops*, *S. megalops*, and *S. platyrhynchus*, even in quite small individuals. Examination of larger specimens in which it is obvious that maturation of the testes has begun shows the mark is present only in males; specimens with maturing or mature ovaries lack the mark, as do all of the smallest specimens. The juxtaposition of the anterior end of the myotomal lines to the pigmentation of the cardiac compartment creates a very distinctive M-shaped ventral mark just posterior to the pectoral girdle in males of those species with cardiac compartment pigmentation (Fig. 2).

Soft anatomy

Gut

The gut of *Sundasalanx* is straight, with three sections clearly distinguishable under gross microscopical examination of cleared and stained specimens (Fig. 3). Length of gut measures approximately 62% of SL in the largest cleared and stained specimen examined (24 mm SL). The first section, approximately 20% of total gut length, is characterised by longitudinal folds, continuous throughout its length. No obvious distinction between oesophagus and stomach is apparent, although the posterior part of this section is somewhat greater in diameter than the anterior part. The pneumatic duct exits from the dorsal side of the posterior half of the stomachal

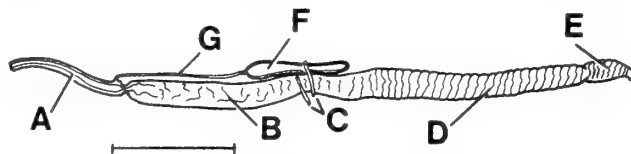

Fig. 3 Gut and gas bladder of *Sundasalanx malleti* (anterior to left); A = anterior section of gut (oesophagus/stomach), B = middle section of gut (anterior part of intestine), C = parapelvic bones, D = middle section of gut (posterior part of intestine), E = posterior section of gut, F = gas bladder, G = pneumatic duct, scale bar = 3 mm.

region. The second section, consisting of the intestine, is separated from the oesophagus–stomach by an obvious sphincter, and measures approximately 73% of total gut length. The anterior third of the intestine is marked by irregular folds, which are more vertically oriented and regular in the region of the air bladder and parapelvic bones. Posterior to the air bladder the folds are regular, nearly vertical, and wavy. They appear to encircle the gut so that the posterior half of the intestine looks very much like the external appearance of an earthworm. The end of the intestine is conical and projects slightly into the third section. The third section of the gut is short, less than 10% of total gut length and is slightly greater in diameter than the intestine. It also is characterised by wavy, vertical folds, but these are more numerous (distinctly closer together) and more wavy than those of the intestine.

Gonads

The gonads lie dorsal to the gut and when mature occupy nearly the entire length of the body cavity, as described for *S. praecox* (Roberts, 1981). Testes exhibit the vertical striations characteristic of at least some other clupeomorphs (Roberts, 1981; Whitehead & Teugels, 1985). Judging from enlargement of posterior sections of testes in some individuals, maturation of testes proceeds from posterior to anterior. Ovaries contain eggs of distinct size classes, egg size presumably being an indication of degree of egg maturation. One female contained 18 very large eggs, nine in each ovary arranged in a single file. These eggs were slightly wider than the width of two myotomes (nearly 1 mm in diameter) and occupied nearly the entire length of the ovaries. Smaller eggs of two distinct size classes were interspersed among the larger eggs (Fig. 4). Among clupeomorphs the presence of distinct size classes of eggs in ovaries is considered indicative of repeat spawning within a single breeding season. *Sundasalanx* may thus have considerable fecundity even though relatively few mature ova are present (can fit) within an ovary. Roberts (1981) reported egg size in *S. praecox* of only 0.20–0.25 mm in diameter. *Sundasalanx praecox* may have smaller ova than other *Sundasalanx* species, but among clupeiforms that are repeat spawners final enlargement of the egg does not occur until shortly before spawning (Blaxter & Hunter, 1982). Thus the difference in egg size between Barito River species of *Sundasalanx* observed here and *S. praecox* may be due to the stage of egg development at which materials were preserved.

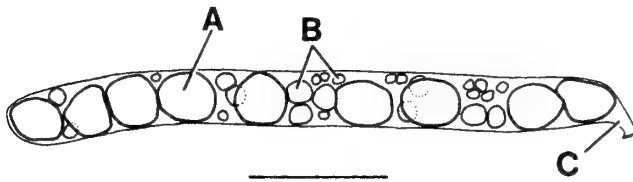

Fig. 4 Outline drawing of the left ovary of *Sundasalanx mesops* (anterior to left); A = large ovum, B = smaller size classes of ova, C = duct to genital opening, scale bar = 2 mm.

Gas Bladder and Associated Structures

The gas bladder is located above the gut in the region of the pelvic fins, and is somewhat constricted by the parapelvic bones (Fig. 3). The pneumatic duct appears to enter the anterior end of the gas bladder, an entry position unusual among clupeomorphs (Whitehead and Blaxter, 1989). The gas bladder was deflated in most specimens but in a few the anterior portion was partially filled with gas. Nocturnal, facultative filling of the gas bladder by swallowing air is well known among larval clupeomorphs. Thus no special significance is attached to the observation that in some *Sundasalanx* specimens the gas bladder is partially filled with air whereas in most

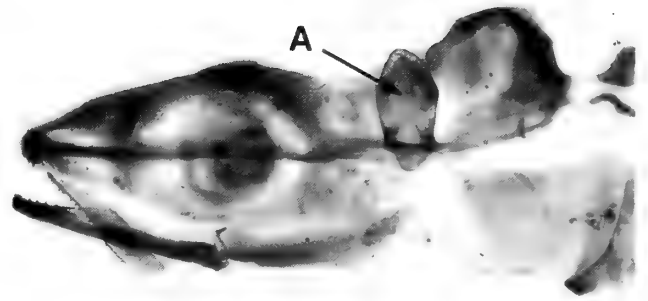

Fig. 5 Photograph of the head of a skeletal preparation of *Sundasalanx malleti* (BMNH 1996.7.18.15) showing the relative position, size, and shape of the prootic bulla (A).

it is deflated. A duct leading from the gas bladder to the region of the anus, usually present in clupeomorphs, was not observed.

A very large, vertically oriented, spindle-shaped bulla is present in the prootic (Fig. 5). It is approximately 40% of head depth in height, protrudes ventrally into the branchial chamber, and extends dorsally nearly to the dorsal surface of the head. It is capped with melanophores and is among the few structures other than the eyes that can be seen on living *Sundasalanx*. A canal for the precoelomic gas duct is apparent but the duct itself was not detected. Ossification of the prootic bulla is not apparent in counter stained preparation, only in preparations stained solely with alizarin.

Lateral to the prootic bulla lies a cavity, identified as a *recessus lateralis*, on which the supraorbital, temporal, and infraorbital laterosensory canals converge (Fig. 6). A small, circular fenestra on the dorsolateral side of the prootic bulla communicates with the

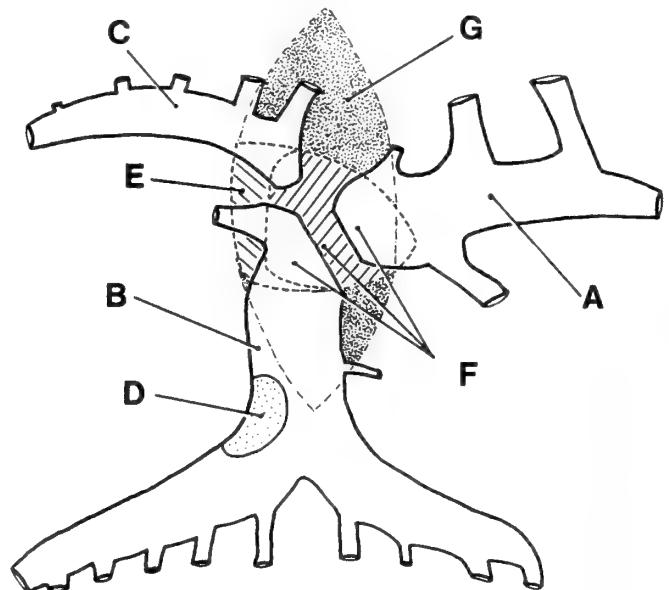

Fig. 6 Schematic representation of the *recessus lateralis* and cephalic laterosensory canals of *Sundasalanx malleti* (anterior to left); A = infraorbital canal, B = temporal canal, C = supraorbital canal, D = infraorbital bone, E = *recessus lateralis* chamber, F = fenestra on the medial wall of the *recessus lateralis*, G = prootic bulla.

recessus lateralis. A large fenestra to the rear of the *recessus lateralis* communicates with the perilymphatic system.

Laterosensory canals

No laterosensory canals were observed other than the infraorbital, supraorbital, and temporal canals which converge on the *recessus lateralis* (Fig. 6). All are short. The supraorbital canal does not extend to even over the eye. The temporal canal does not reach the shoulder girdle or form a supratemporal commissure with its counterpart from the opposite side. The infraorbital canal does not extend to beneath the eye.

Osteology

No part of the skeleton of *Sundasalanx* is heavily ossified. Ossification of dermal elements appears to be exceptionally slight and many, usually present in other teleosts, may be absent. For example, no parietals or dermal ethmoid element were detected.

Caudal skeleton

The caudal skeleton of *Sundasalanx* is highly consolidated, and somewhat reduced (Fig. 7A). Preural centrum 1 and ural centra 1 and 2 are consolidated into a single compound element, to which uroneural 1 is apparently fused. Uroneural 2 is free, and in Barito River *Sundasalanx* greatly expanded. Only a single epural is present. The parhypural and hypural 1 are fused (observed in an ontogenetic series of cleared and stained materials); the compound parhypural-hypural is autogenous; hypural 2 is fused to the compound centrum; hypural 3 is autogenous; hypural 4 is expanded to about the size of

hypural 1; hypural 5 is present. A hypural 6 was not observed. Bases of caudal-fin rays appear unmodified.

Pelvic girdle

The two vertically oriented bones in the pelvic girdle of *Sundasalanx* Roberts (1981) termed parapelvic cartilages are unknown elsewhere among fishes. The anterior bone is stouter, more vertically oriented, with its ventral end closely associated with the basipterygium and first pelvic ray (Fig. 1). The posterior bone is more slender, usually longer than the anterior bone, and is usually inclined forward, often as much as 30° from vertical. It is not as closely associated with the basipterygium as the anterior bone; there is often a considerable gap between the ventral end of the posterior bone and the basipterygium. The greater length and position of the posterior bone relative to the basipterygium results in it extending above the dorsal end of the anterior bone by as much as half its length. The length of the posterior parapelvic bone appears to vary among species. In some specimens of *S. praecox* the posterior bone is nearly twice the length of the anterior bone whereas in specimen of *S. megalops* examined the bones are subequal.

The origin of parapelvic bones is unknown. In some fishes pleural ribs are connected to the pelvic girdle via ligaments and it would not be unreasonable to suggest parapelvic bones might be modified ribs, or ossifications of ligaments associated with the pelvic girdle. Parapelvic bones are similar to pleural ribs in two respects. They are preformed in cartilage (preformation of ribs in cartilage is widespread among clupeoids; Patterson & Johnson, 1995), and they lie internal to body musculature, not in myosepta. However, peculiar

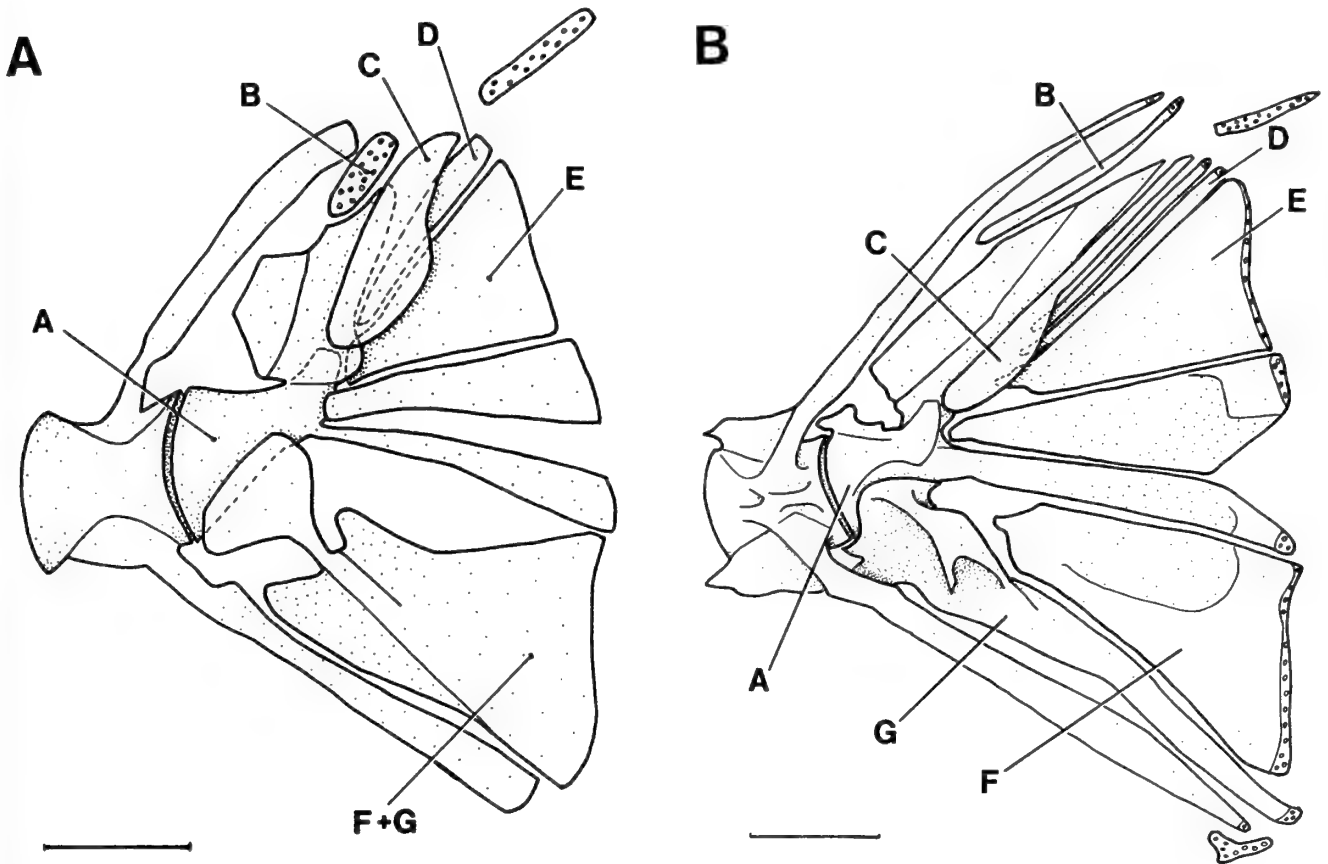

Fig. 7 A) Caudal skeleton of *Sundasalanx malleti* (BMNH 1996.7.18.15), scale = .3 mm; B) Caudal skeleton of *Jenkinsia* (BMNH 1962.7.21.48-50), scale = .45 mm; A = compound centrum (PU1+U1+U2), B = epural, C = uroneural 2, D = hypural 5, E = hypural 4, F = hypural 1, G = parhypural

cartilage chevrons, unique among lower teleosts, are associated with the lateral tips of epicentral intermuscular bones in many clupeoids and the derivation of parapelvic bones from these structures should also be considered.

Vertebral column

Vertebrae of *Sundasalanx* are lightly ossified, with neural arches present on all vertebrae preceding the compound caudal vertebra. Caudal vertebrae appear to ossify first. All neural arches preform in cartilage and the anterior few may not ossify. The first neural arch has a broader base than the others and neural spines do not appear to form on the first 4 or 5 arches. No supraneurals are present. Haemal arches also preform in cartilage. Cartilaginous basiventrals are present on all preural centra, including the first. No ribs are present.

Intermusculars

No intermuscular bones or ligaments (Patterson & Johnson, 1995) are present.

Dorsal- and anal-fin supports.

Middle radials do not develop in dorsal- and anal-fin pterygiophores. Distal radials are clearly present. Proximal elements (=proximal + middle radials) of the last few dorsal pterygiophores appear to fuse.

Jaws

Toothed premaxillary and maxillary bones make up the upper jaw. No supramaxillary bones were detected. Dentary, anguloarticular, and retroarticular bones were identified in the lower jaw.

Gill arches

The primitive complement of structures that make up the median series of hyoid- and gill arch elements of teleosts, not all of which may be present in adult forms, develops from three copulae (copula 1–3; Nelson, 1969). Derivatives of all three copulae are present in *Sundasalanx*. The series includes (Fig. 8): the basihyal (derived from copula 1); basibranchial 1–2 and basibranchial 3 (derivatives of copula 2); and basibranchial 4–5 (derived from copula 3). Gill arches 1 and 2 articulate with basibranchial 1–2, gill arch 3 articulates with basibranchial 3, and gill arches 4 and 5 articulate with basibranchial 4–5. Hypobranchials are not evident in the first three arches. Roberts (1981) suggested they were fused to the median elements but such fusion of lateral endoskeletal elements to median endoskeletal elements is rare (Nelson, 1969). A more likely explanation is that hypobranchials 1–3 never condense from the hypo/ceratobranchial precursors and thus never develop at all. Hypobranchial 4 is present in all species examined, and a curious cartilage nodule, located in the ligament between ceratobranchial 4 and 5, was seen in some specimens of *S. praecox*, *S. malleti*, *S. mesops*, and *S. megalops*, but not in *S. microps* or *S. platyrhynchus*, both from the Kapuas River. Five conventional ceratobranchials are present. Four epibranchials and three pharyngobranchials are present (Fig. 9). Epibranchials 2–4 are short. Epibranchial 1 is large, occupying the space of pharyngobranchial 1 in addition to its own. Epibranchial 4 curves anteromesially to articulate with the lateral posterodorsal corner of pharyngobranchial 4, dorsal to the tooth plate associated with the posteroventral side of pharyngobranchial 4. The efferent arterial canal of epibranchial 4 is completely closed, with no sign of any line of fusion of interbranchial 4. A small levator process projects dorsally from the top of the ring of cartilage that forms this canal. The *levator exturnus* IV, which has its origin on the posterodorsal corner of the skull, inserts on this process. Epibranchial 3 is short, and articulates with the posterolateral end of a large pharyngobranchial 3. The mesioposterior end of pharyngobranchial

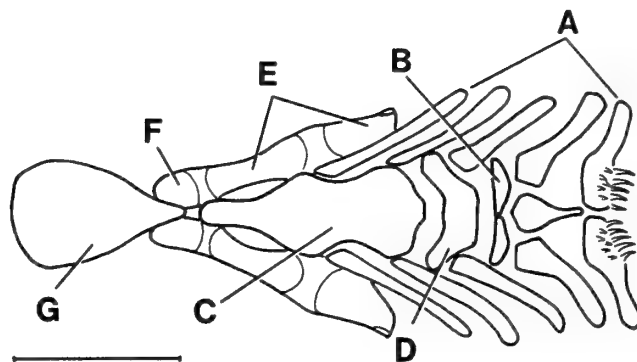

Fig. 8 Lower branchial arches of *Sundasalanx malleti* (anterior to left); A = ceratobranchial 1–5, B = hypobranchial 4, C = basibranchial 1–2, D = basibranchial 3, E = anterior and posterior ceratohyals, F = hypohyal, G = basihyal, scale bar = 1 mm.

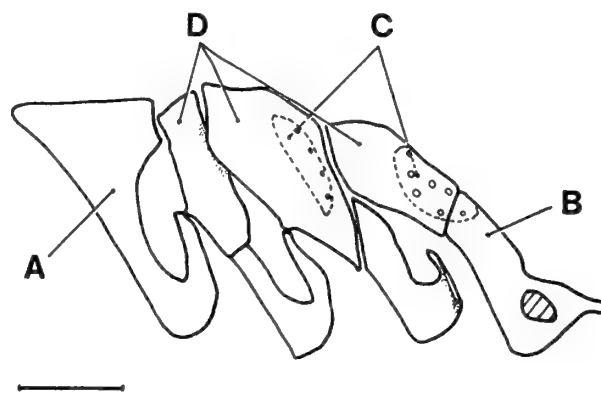

Fig. 9 Dorsal view of left side upper gill arch elements of *Sundasalanx malleti* (anterior to left); A = epibranchial 1, B = epibranchial 4, C = tooth plates (circles indicate tooth positions diagrammatically), D = pharyngobranchial 2–4, scale bar = 0.25 mm.

3 articulates broadly with the anterior end of pharyngobranchial 4. A large tooth plate is associated with the ventral surface of the posterior half of pharyngobranchial 3. The uncinat process of epibranchial 3 is modified to form a canal for efferent artery 3. The artery is completely ringed in *S. praecox*, so that the lateral end of epibranchial 3 looks similar to the lateral end of epibranchial 4. It is almost completely ringed in *S. platyrhynchus*, but only partially encircled in *S. malleti*, *S. mesops*, and *S. megalops*. Epibranchial 2 is also short, but with a long uncinat process that articulates with the lateral edge of pharyngobranchial 3, the point of articulation on pharyngobranchial 3 drawn out to form an 'uncinat' process in *S. malleti*. Pharyngobranchial 2 is much longer than wide, extending from the medial edge of epibranchial 2 in an anteromedial direction to the tip of pharyngobranchial 3. No tooth plate was found to be associated with pharyngobranchial 2. Epibranchial 1 is narrow near the articulation with ceratobranchial 1, broadly spatulate at its medial edge. It possesses a long uncinat process that articulates with the uncinat process of pharyngobranchial 2. A separate pharyngobranchial 1 was not observed. Enlargement of epibranchial 1 may be the result of fusion between it and pharyngobranchial 1, or of failure of condensation of pharyngobranchial 1 from the epi-pharyngobranchial anlagen in a shortened developmental programme.

Very thin perichondral ossification of ceratobranchial 5 was the only ossification detected for endoskeletal gill arch elements. If other elements are ossified their ossification is beyond the limit of

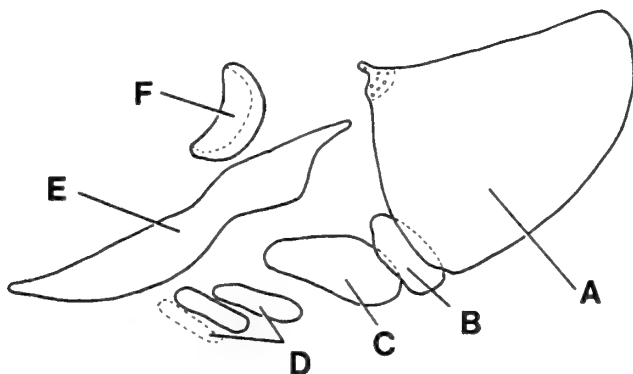

Fig. 10 Schematic illustration of the opercular and branchiostegal series of *Sundasalanx malleti* (anterior to left); A = opercle, B = subopercle, C = interopercle, D = branchiostegals, E = preopercle, F = infraorbital bone.

resolution of the staining procedures used, or the materials prepared as whole mount preparations.

Dentition

Roberts (1981, 1984) reported teeth on the premaxilla and maxilla, and that teeth are embedded directly in cartilage on the lower jaw (Meckel's cartilage), ceratobranchial 5, and pharyngobranchial 4 of *S. praecox* and *S. microps*. Kottelat (1991) reported a pharyngobranchial 4 tooth plate in the species here named *S. platyrhynchus*, rather than teeth embedded directly in cartilage. Materials prepared only as alizarin preparations in this study indicate the conclusion that some teeth in *Sundasalanx* are directly embedded into cartilage is erroneous, and most likely due to examination of specimens prepared by counter-staining for cartilage and bone.

In addition to those structures listed above, all species of *Sundasalanx* examined were found to also have a tooth plate and teeth associated with the underside of the posteromedial part of pharyngobranchial 3. The size of the tooth plate appears to vary among species. *Sundasalanx praecox* was found also to possess teeth on the posterior end of basibranchial 1-2) in the floor of the mouth, and small 'vomarine' tooth patches were found also in the roof of the mouth, one on either side of the anterior tip of the parasphenoid. The largest cleared and stained specimen of *S. malleti* appears to have a tooth plate (toothless) associated with the posterior end of the basihyal.

Suspensorium

The suspensorium is weakly ossified and not well differentiated. Independent quadrate, metapterygoid, symplectic, or hyomandibula ossifications were not detected in any species of *Sundasalanx*. The posterior articulation of the suspensorium with the skull is broad. An independent cartilaginous palatine was observed in all examined species except *S. praecox*, the smallest species, in which a thin strut of cartilage communicates between the palatine and the hyomandibular complex. An extremely thin, sheet-like ossification under the eye between the palatine and hyomandibular is here identified as the mesopterygoid.

Lower hyoid arch

The basihyal is a large expansive structure that essentially fills the floor of the mouth anterior to the hyoid arch. A cartilaginous hypohyal is present, but apparently without differentiation into upper and lower hypohyoid elements. Ossified anterior and posterior ceratohyals are present, as is an unossified interhyal. Two, three,

or four branchiostegals, subequal in size, were found to be associated with the ventrolateral side of the posterior ceratohyal. The number of branchiostegals present is not constant in any species of *Sundasalanx* examined. The anteriormost branchiostegal is positioned at the anterior edge of the posterior ceratohyal, partially overlapping the gap between the posterior- and anterior ceratohyal. Succeeding branchiostegals are positioned posteriorly along the ceratohyal and there is a distinct gap between the branchiostegal series and the interopercle, which is associated with the posterolateral side of the posterior ceratohyal near the articulation of the interhyal. The interopercle is distinctly larger than any member of the branchiostegal series (Fig. 10).

Opercular series

An opercle, subopercle, interopercle, and preopercle were found in all species examined (Fig. 10). All elements are very lightly ossified and are easily overlooked, especially the preopercle. The opercle, subopercle and interopercle form an overlapping series, with the ventroanterior corner of the opercle lying external to the posterior edge of the subopercle and the anterior edge of the subopercle lying external to the posterior edge of the interopercle. The interopercle is associated with the posterolateral side of the posterior ceratohyal, near the interhyal. The preopercle is an elongate element. Its anterior end lies lateral to the undifferentiated quadrate. More posteriorly it lies lateral to the ventral portion of the cartilaginous structure that is the undifferentiated hyomandibula. Its posterior portion occupies the space between the infraorbital and the opercle. No lateral sensory canal was observed to be associated with the preopercle.

Infraorbital series

A single infraorbital element was detected. It is an extremely thin ossification located in the interior of the bend of where the infraorbital laterosensory canal turns in an anterior direction. The infraorbital canal emerges from the *recessus lateralis* well behind the eye. Consequently the sole infraorbital is positioned well posterior to the eye.

Skull Roofing Bones

The only roofing bone identified is an ossification associated with the supraorbital laterosensory canal and *recessus lateralis*. The bone is very weakly ossified and difficult to detect. The pair, one on each side, are here identified as frontals, because of the association between the supraorbital laterosensory canal, the *recessus lateralis* and the frontal in clupeiforms. Parietals, and dermal ethmoid elements were not detected.

RELATIONSHIPS

In the discussion that follows, the informal term salangid refers to icefishes (=Salangidae of Roberts, 1984). This does not imply criticism of the rank ascribed to them by Johnson and Patterson (1996). Features identified as suggesting a relationship between *Sundasalanx* and salangids (Roberts 1981, 1984; listed previously [p. 5]) are all paedomorphic, with the possible exception of the orientation of the posterior part of the maxilla. If maxilla orientation in other larval clupeoids is found to be like that *Sundasalanx* then this feature also is paedomorphic. The features are plesiomorphic too, being features found in larvae of lower teleosts, and in larvae of some euteleosts. Such a list, no matter how long, is nothing more than an appeal to sympleysiomorphy as evidence for the hypothesis of relationship. However, as Roberts (1984) indicated the question

remains as to whether the apomorphic condition of neoteny in *Sundasalanx* and salangids is a synapomorphy or a homoplasy. Derived, non-paedomorphic, features unique to both *Sundasalanx* and salangids can corroborate a *Sundasalanx*–salangid relationship, thereby establishing neoteny as synapomorphic for *Sundasalanx* and salangids.

The recent re-examination of lower euteleostean relationships by Johnson & Patterson (1996) provides a context for the search for non-paedomorphic features that might confirm a *Sundasalanx*–salangid relationship. The relevant groups and characters (numbered sequentially) are: euteleosts – 1) supraneurals develop caudally, 2) uroneural 1 with a membranous outgrowth (stegural), 3) caudal median cartilages present; salmoniforms – 4) epicentrals with cartilage rods distally, 5) epicentral and epineural intramuscular bones lacking proximal forks; salmonoids + osmeroids – 6) derm- and supraethmoid separate, 7) posttemporal fossa open, 8) a single supramaxilla, 9) upper pharyngeal tooth plate 4 absent, 10) anterior epineurals not fused to neural arches; 11) epipleurals absent, 12) distal parts of posterior neural and haemal arches forming a keel, 13) uroneural 2 anterodorsal to uroneural 1, 14) scales without radii, 15) nuptial tubercles present, 16) diadromy; osmeroids – 17) orbitosphenoid absent, 18) basisphenoid absent, 19) articular reduced, 20) gill rakers toothless, 21) preural centrum 1 and ural centrum 1 fused, 22) cleithrum with a narrow columnar process toward coracoid, 23) no postcleithrum; osmerids – 24) short hyomandibular crest, 25) opercular with anterodorsal notch, 26) levator process present on epibranchial 4, 27) uroneural 1 fused to preural centrum 1, 28) caudal scutes absent, 29) extrascapular fragmented into several ossicles, 30) posterior dorsal pterygiophores fused, 31) adipose cartilage present, 32) egg with adhesive membrane; osmerines – 33) otic bulla (=saccular recess) somewhat inflated, 34) keel formed by posterior neural and haemal spines absent; salangins – 35) ethmoid endoskeleton long and unossified, 36) 1st pectoral radial unmodified, 37) 4th pectoral radial multifid distally, 38) males with modified anal fin endoskeleton; and Icefishes (=salangids) – 39) anterior margin of metapterygoid above quadrate, 40) antorbital bone absent, 41) 1 supraneural present, 42) 4th pectoral radial articulates with glenoid, 43) dermal plate absent from basibranchials.

At least 19 of these characters are 'absence characters', or 'reversals' to a more primitive condition, leaving just 24 as 'presence characters'. As with Roberts' list, resemblance between *Sundasalanx* and salangids due to the first class characters requires confirmation from congruence with the second class of characters. Character 32, egg with adhesive membrane, was not checked in this study. Of the remaining 24 characters from the second class of characters *Sundasalanx* can be shown to have only four, fusion of preural centrum 1 with ural centrum 1 (21), levator process on epibranchial 4 present (26), uroneural 1 fused to preural centrum 1 (27), and posterior dorsal pterygiophores fused (30). *Sundasalanx* simply lacks the rest, either because they are primitively absent or because *Sundasalanx* is so underdeveloped they never appear in its ontogeny. All of the four that are present in *Sundasalanx* are also present among clupecocephalan, or even elopococephalan, fishes. The evidence for a close relationship among *Sundasalanx* and icefishes should be regarded as non-existent.

Sundasalanx is highly paedomorphic and as obvious from comparison to the above lists establishing its relationship presents certain difficulties. It is not, however, wholly paedomorphic and the non-paedomorphic features of *Sundasalanx* suggest a relationship not with salangids, nor any other euteleostean, but with clupeciforms, and further to dussumieriine clupecids.

Prootic bullae are found only among clupecocephal fishes and the *recessus lateralis* is found only among clupeciforms (Greenwood *et*

al, 1966; Grande, 1985). *Sundasalanx* is thus a clupeciform. Establishing the relationships of *Sundasalanx* within Clupeciformes is less easy. Many external and internal features used to elucidate relationships within the order (Grande, 1985) are absent; all scute and scale characters widely used in the identification of clupeciforms are absent from *Sundasalanx*, which is completely scaleless and lacks ribs and supraneurals. However, *Sundasalanx* exhibits a derived, highly consolidated, caudal skeleton. Derived features are: 1) fusion of preural centrum 1 (PU1), ural centrum 1 (U1), ural centrum 2 (U2), and the first uroneural into a single element; 2) reduction of the number of epurals to 1; 3) reduction of the number of hypurals to 5; 4) fusion of the parhypural and hypural 1; 5) an expanded hypural 4; and 6) absence of the extensions of the middle caudal fin rays characteristic of clupeciforms. Among clupeciforms only the spratelloidin dussumieriine genus *Jenkinsia*, a marine, Caribbean endemic, approaches the degree of caudal skeleton consolidation found in *Sundasalanx* (Fig. 7B). The pertinent modifications are (Grande, 1985): 1) fusion of PU1, U1, and U2 into a single element; 2) reduction of the number of epurals to one; and 3) expansion of hypural 4 to a size equal to that of hypural 1. Fusion of PU1 with U1 is also known in some pelionulines, some engraulids and *Clupeonella*, but these lack the other derived caudal skeleton features of spratelloidins (Grande, 1985). *Sundasalanx* is thus a spratelloidin, and possibly the sister-group of *Jenkinsia*.

DISTINCTIVENESS OF SUNDASALANX PRAECOX

The discovery of materials seemingly intermediate in eye size between *S. praecox* and *S. microps* led Roberts (1984) to suggest that distinction between them at the species level needed further consideration, with the implication that there might be only one widespread species of *Sundasalanx*. *Sundasalanx praecox* and *S. microps* were re-examined for this study. I conclude that Roberts' (1981) original assessment of the specific status of *S. praecox* is correct. It is different from other species of *Sundasalanx* in so many details that it stands out as the most distinctive of all the described species. No other known species of *Sundasalanx* possesses any palatal or basibranchial teeth. It has far fewer vertebrae, many more upper jaw teeth, larger pharyngeal tooth plates with many more teeth, larger and more numerous gill rakers, a relatively longer posterior parapelvic bone than any species known from Kalimantan, and lacks a midventral line of melanophores associated with the ventral fin-fold.

DESCRIPTIONS OF NEW SPECIES

Sundasalanx malleti Siebert and Crimmen, sp. nov.

(Fig. 11)

HOLOTYPE. MZB 6096, 26.4 mm SL, Indonesia, Kalimantan Tengah, Barito River basin, Sungai Barito at Muara Laung, dip nets and seines, 20–22 Feb 1991, D. Siebert, A. Tjakrawidjaja, O. Crimmen, and A. Effendi.

PARATYPES. MZB 6097 (20), collection data as for holotype. BMNH 1996.7.18.147–311 (164), collection data as for holotype. USNM 320689 (5), collection data as for holotype.

REFERRED MATERIAL. BMNH 1996.7.18.315–324 (10), C&S, Indonesia, Kalimantan Tengah, Barito River drainage, sand bars of

Table 1 Selected mensural characters of *Sundasalanx malleti*, *S. mesops*, *S. megalops*, and *S. platyrhynchus*; the mean \pm standard deviation is followed by the sample minimum – maximum; sample size is reported in parentheses if different from that reported under each species' name.

	<i>S. malleti</i> n = 10		<i>S. mesops</i> n = 30		<i>S. megalops</i> n = 2		<i>S. platyrhynchus</i> n = 20	
Eye (% SL)	4.2 \pm 0.3	3.8– 4.7	5.2 \pm 0.3	4.5– 5.7	5.9– 6.0	5.1 \pm 0.4	4.2– 5.7	(18)
Eye (% HL)	21.3 \pm 1.1	19.9–23.2	25.5 \pm 1.3	21.4–27.5	27.5–29.0	23.8 \pm 1.2	21.7–25.9	(16)
Snt (% SL)	4.3 \pm 0.4	3.5– 4.8 (9)	3.8 \pm 0.4	3.1– 4.8	3.5– 4.9	4.0 \pm 0.7	2.9– 5.2	
Snt (% HL)	21.2 \pm 1.7	18.4–23.9 (9)	18.6 \pm 1.7	15.6–22.9	17.3–22.6	18.1 \pm 1.9	15.3–21.4	(19)
Snt:eye	1.0 \pm 0.1	0.8– 1.2 (9)	0.7 \pm 0.1	0.6– 1.0	0.6– 0.8	0.8 \pm 0.1	0.6– 1.0	(18)
Head d. (% SL)	8.2 \pm 0.8	6.3– 9.0	7.9 \pm 0.5	7.3– 9.1	9.4– 9.6	8.3 \pm 0.7	7.2– 9.5	
Head l. (% SL)	20.0 \pm 0.8	18.8–21.1	20.7 \pm 0.7	18.7–21.8	20.4–21.6	21.4 \pm 1.2	19.6–23.2	(18)
Head w. (& SL)	9.7 \pm 0.7	8.6–10.6 (9)	10.5 \pm 0.4	9.8–11.2	9.4 (1)	10.9 \pm 0.5	10.2–12.0	(21)

Table 2 Number of vertebrae of species of *Sundasalanx*; counts for *S. praecox* and *S. microps* are from Roberts (1981). Analysis of variance with a *post hoc* test of location reveals *S. praecox* to be significantly different from *S. microps*, *S. platyrhynchus*, *S. malleti*, and *S. mesops* at $p < 0.001$.

	Vertebrae								
	37	38	39	40	41	42	43	44	
<i>S. praecox</i>	2	7							
<i>S. microps</i>					2	4	1		
<i>S. platyrhynchus</i>					1		2		
<i>S. malleti</i>				2	5	3	4	2	
<i>S. mesops</i>				2	8				
<i>S. megalops</i>					1				

Table 3 Dorsal- and anal-fin branched ray counts for species of *Sundasalanx*. *Sundasalanx praecox*, *S. microps*, *S. platyrhynchus*, *S. malleti*, and *S. mesops* were tested for difference in number of dorsal- and anal-fin branched rays with one-way analysis of variance, with Tukey's *post hoc* HSD test to locate differences of means. *Sundasalanx platyrhynchus* differs from *S. mesops* in number of branched dorsal-fin rays at $p < 0.01$; for branched anal-fin rays *S. microps* and *S. platyrhynchus* test as significantly different from *S. praecox*, *S. malleti*, and *S. mesops* with $p < 0.01$.

	D-fin rays					A-fin rays				
	8	9	10	11	12	13	14	15	16	17
<i>S. praecox</i>		4	1			1	2	2		
<i>S. microps</i>		2	5					2	3	2
<i>S. platyrhynchus</i>		3	15	4	1		4	3	12	4
<i>S. malleti</i>		4	16	23	3		9	16	13	5
<i>S. mesops</i>		2	28	8			3	23	9	2
<i>S. megalops</i>				2				1	1	

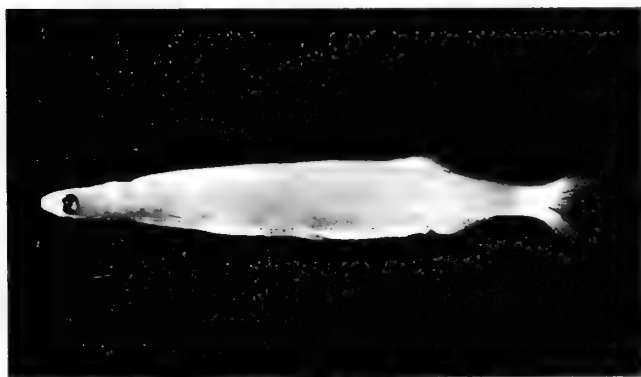

Fig. 11 Holotype of *Sundasalanx malleti*, female. MZB 6096, 26.4 mm SL.

Sungai Murung around Project Barito Ulu basecamp on Sungai Murung, seine, 12 Feb 1991, D. Siebert, O Crimmen, and A. Tjakrawidjaja.

DIAGNOSIS. A photograph of *S. malleti* is presented as Fig. 11; selected morphometrics are summarised in Table 1 and vertebral and fin-ray counts are summarised in Table 2 and Table 3. It is a species of *Sundasalanx* with a relatively small eye (3.8–4.7% SL, 19.7–23.2% HL); snout long (18.4–23.9% HL); and with snout:eye ratio usually greater than 1 (0.8–1.2). Prepectoral blotch extensive; maturing or mature males (large individuals) with basipterygium ringed by melanophores; no melanophores on posterior wall of cardiac compartment; lower caudal-fin lobe with a broad swath of melanophores. Vertebral number 40–44 (median=42); dorsal-fin rays 8–11 (median=10); anal-fin rays 13–17 (median=14). Premaxilla with 4–5 teeth, maxilla with 15–17 teeth; dentary with 10–12 teeth; 5th ceratobranchial tooth plate large, with 5–6 teeth in principal posterior row, 2 or 3 rows of smaller teeth anterior to principal row; 3rd pharyngobranchial tooth plate large, longer than wide, subequal to or larger than 4th pharyngobranchial tooth plate; 4th pharyngobranchial tooth plate large, nearly 1/2 size of 4th pharyngobranchial, with principal row of larger teeth along posterior edge.

Sundasalanx malleti is easily distinguished from its Barito River

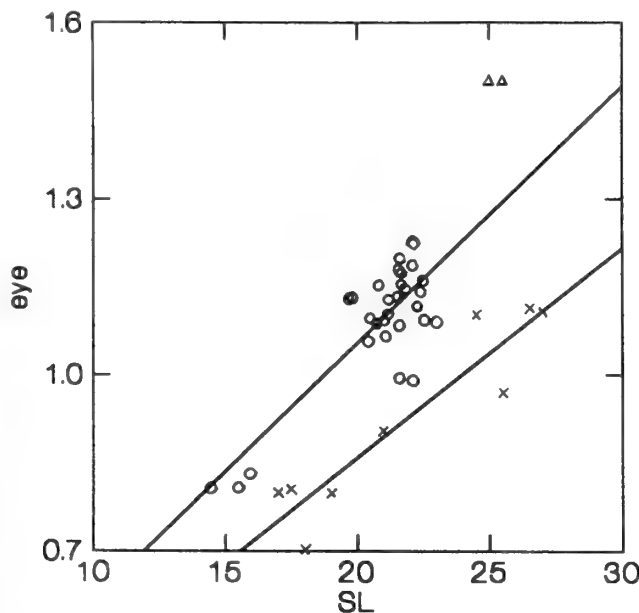

Fig. 12 Scatter plot of Eye versus Standard length for Barito River species of *Sundasalanx*, with linear smoothing function superimposed on points for *S. malleti* and *S. mesops*; Δ = *S. megalops*, O = *S. mesops*, x = *S. malleti*.

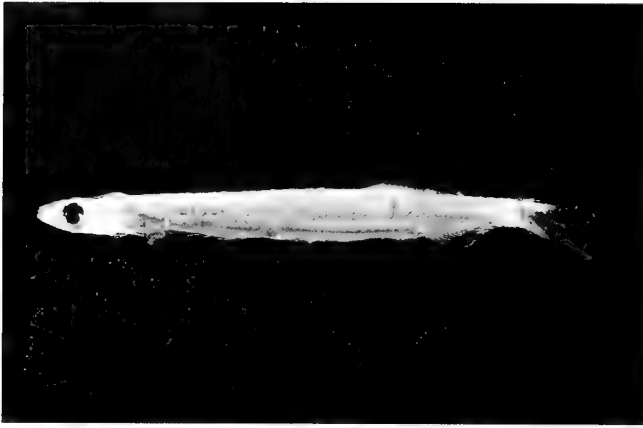

Fig. 13 Holotype of *Sundasalanx mesops*, female, MZB 6098, 20.7 mm SL.

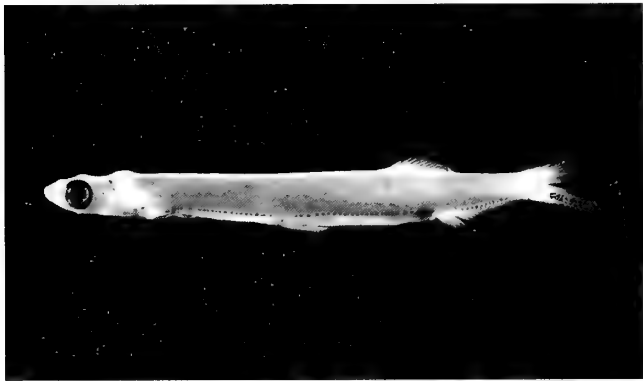

Fig. 14 Holotype of *Sundasalanx megalops*, MZB 6100, male, 25.5 mm SL. The melanophore cap of the prootic bulla is clearly visible, the myotomal pigment line is clearly interrupted above the pelvic fins, melanophores associated with anal fin pterygiophores are clearly visible, and the vivid swath of melanophores on the lower caudal fin lobe characteristic of males is clearly evident. The wavy striations of the posterior half of the intestine are discernible posterior to the pelvic fins.

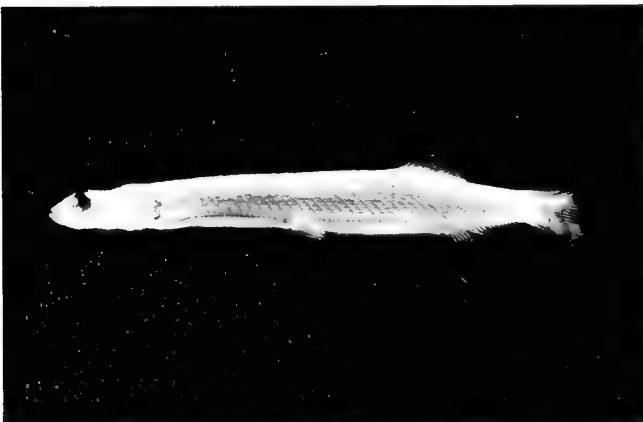

Fig. 15 Holotype of *Sundasalanx platyrhynchus*, MZB 5944, 19.2 mm SL.

congeners and *S. platyrhynchus* by size of eye, snout length, and colour pattern. Other Barito River *Sundasalanx* have discernibly larger eyes (Figs 11–15; Table 1), have a snout:eye ratio < 1, lack a ring of melanophores around the basipterygium in maturing males,

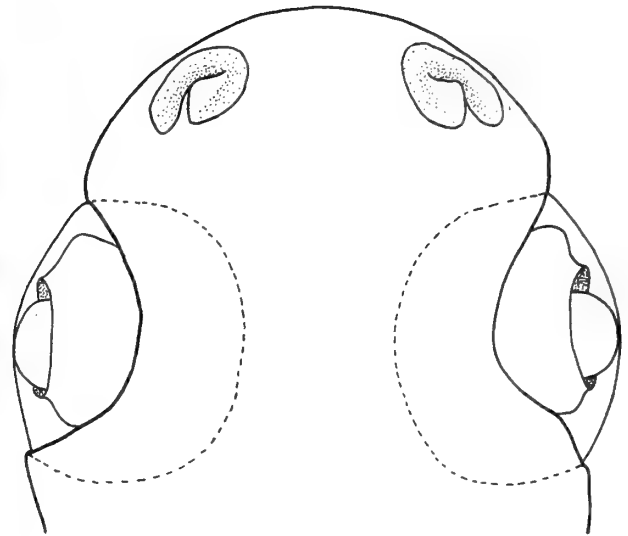

Fig. 16 Dorsal view of the head of *Sundasalanx platyrhynchus*.

and possess melanophores on the posterior wall of the cardiac compartment in males. Table 4 summarises diagnostic features of all described species of *Sundasalanx*.

SEXUAL DIMORPHISM. *Sundasalanx malleti* is sexually dimorphic for colour pattern. Unbleached cleared-and-stained materials that are identifiable as male or as female show a difference between sexes in pigmentation of the basipterygium and lower caudal-fin lobe. Males have a more intense mark on the lower caudal-fin lobe, the result of a greater density of melanophores that make up the lower caudal lobe swath. Males with maturing or mature testes also possess additional pigmentation around the basipterygium that was not observed in any female. Minimally, females, males, and juveniles possess a single melanophore just anterior to the pelvic-fin origin. The basipterygium of males is marked by additional melanophores along its side and across its posterior edge between the pelvic-fin bases so that it is completely encircled with melanophores.

ECOLOGY. *Sundasalanx malleti* was captured in turbid flowing waters over silty, clayey substrates along banks adjacent to mainstream currents and at depths up to 1 m. Children with fly-screen scoop nets, working bankside shallows before dusk for small fishes for the evening meal, captured them in great abundance. The same shallows worked during daylight usually yielded no or few *Sundasalanx*. Thus *S. malleti* probably inhabits deeper waters during daylight hours, moving to shallower areas at dusk, possibly to escape predation. Fishes captured in the same habitat with *S. malleti* were many species of small and juvenile cyprinids and catfishes, *Nemacheilus* sp., *Homaloptera* sp., and chandids.

Remains of insects and crustaceans are observable in guts of cleared and stained specimens.

ETYMOLOGY. This species is named after John Valentine Granville Mallet, former Prime Warden of the Worshipful Company of Fishmongers, whose enthusiasm, encouragement, and support have made possible the continuation of a research programme on freshwater fishes of Southeast Asia.

***Sundasalanx mesops* Siebert and Crimmen, sp.nov.**

(Fig. 13)

HOLOTYPE. MZB 6098, 20.7 mm SL, Indonesia, Kalimantan Tengah, Barito River drainage, Sungai Laung at desa Maruwei, O° 21.986'S, 114° 44.103'E, miscellaneous catches, 15–18 Jul 1992, D. Siebert, A. Tjakrawidjaja and O. Crimmen.

PARATYPES. MZB 6099 (10), collection data as for holotype. BMNH 1996.7.18.2–51 (50), collection data as for holotype.

REFERRED MATERIAL. BMNH 1996.7.18.52–56 (5), Indonesia, Kalimantan Tengah, Barito River drainage, small tributary of Sungai Maruwei approx. 1 km upstream from desa Maruwei, O° 21.986'S, 114° 44.103'E, rotenone, 15 Jul 1992, D. Siebert, A. Tjakrawidjaja and O. Crimmen. BMNH 1996.7.18.57–66 (10), C&S, collection data as for BMNH 1996.7.18.52–56. BMNH 1996.7.18.67–109 (43), collection data as for BMNH 1996.7.18.52–56. BMNH 1996.7.18.110–146 (37), Indonesia, Kalimantan Tengah, Barito River drainage, Sungai Barito approx. 2 km below Muara Laung, beach seine at dusk, 8 Jul 1992, D. Siebert, A. Tjakrawidjaja and O. Crimmen. BMNH 1996.7.18.312 (1), 26.5 mm, Indonesia, Kalimantan Tengah, Sungai Barito drainage, sand bank of Sungai Joloi upstream from Sungai Busang, seine, 7 Feb 1991, D. Siebert, A. Tjakrawidjaja and O. Crimmen. BMNH 1996.7.18.313–314 (2), 26.0–29.5 mm, Indonesia, Kalimantan Tengah, Barito River drainage, sand bars of Sungai Joloi upstream from Sungai Busang, seine, 8 Feb 1991, D. Siebert, O. Crimmen, A. Tjakrawidjaja.

DIAGNOSIS. A photograph of *S. mesops* is presented as Fig. 13; selected morphometrics are summarised in Table 1 and vertebral and fin-ray counts are summarised in Table 2 and Table 3. It is a species of *Sundasalanx* with a relatively large eye (4.5–5.7% SL, 21.4–27.5% HL); and relatively short snout (15.6–22.9% HL). Vertebral number 40–41 (median=41); dorsal-fin rays 8–10 (median=9); and anal-fin rays 13–16 (median=14). Prepectoral mark well developed; posterior wall of cardiac compartment with melanophores; basipterygium without ring of melanophores. Premaxilla with 3–5 teeth; maxilla with 16–18 teeth; dentary with 12–13 teeth in single row; 5th ceratobranchial tooth plate with 3–5 teeth in principal posterior row, teeth anterior to principal row small and few; 3rd pharyngobranchial tooth plate small, with 3 or 4 teeth; 4th pharyngobranchial tooth plate relatively small, about 1/3 size of 4th pharyngobranchial, with principal row of larger teeth along posterior edge.

Sundasalanx mesops is easily distinguished from its Barito River congeners by size of eye, colour pattern, and upper pharyngeal dentition. The eye of *S. malleti* is smaller; the eye of *S. megalops* is larger (Figs 11–14). Colour pattern features that distinguish it from *S. malleti* are listed above in the diagnosis for *S. malleti*. *Sundasalanx malleti* has larger upper pharyngeal tooth plates, with more teeth; *S. megalops* possesses fewer teeth in jaws and smaller upper pharyngeal tooth plates with fewer teeth (see below). *Sundasalanx mesops* can usually be distinguished from *S. platyrhynchus* of the Kapuas River, West Kalimantan by dorsal- and anal-fin ray counts (Table 3).

SEXUAL DIMORPHISM. Cleared and stained materials in which male and female specimens are clearly identifiable reveal *Sundasalanx mesops* is sexually dimorphic for colour pattern. Females differ from males in pigmentation of the cardiac compartment and lower caudal-fin lobe. Males have a more intense mark on the lower caudal-fin lobe; the lower caudal-fin lobe of the female specimen with the largest eggs is not as dark as that of males with only partially mature testes. Males with maturing or mature testes also possess pigmentation of the posterior wall of the cardiac compartment which was not observed in any female.

ECOLOGY. *Sundasalanx mesops* was captured downstream from creek mouths in shallows over sandy or silty substrates during daylight hours. During a spate specimens were also taken from inundated grassy stream banks.

DISTRIBUTION. *Sundasalanx mesops* was taken from several localities throughout the upper Barito River basin, Central Kalimantan, Indonesia, from the widest variety of habitat sizes. On present evidence it has the widest distribution of Barito River *Sundasalanx*.

ETYMOLOGY. The name *mesops*, is a combination of *meso*, Greek for middle, and *ops*, Greek for eye. It is in reference to the size of its eye relative to other Barito River *Sundasalanx* species.

***Sundasalanx megalops* Siebert and Crimmen, sp. nov.**

(Fig. 14)

HOLOTYPE. MZB 6100, 25.5 mm SL, Indonesia, Kalimantan Tengah, Sungai Barito drainage, sand and silt bank at the mouth of Sungai Sapen, a small left hand tributary of Sungai Joloi above Sungai Busang, seine, 6 Feb 1991, D. Siebert and O. Crimmen.

PARATYPE. BMNH 1996.7.18.1; (1), 25.0 mm, C&S, collection data as for holotype.

DIAGNOSIS. A photograph of *S. megalops* is presented as Fig. 14; selected morphometrics are summarised in Table 1 and vertebral and fin-ray counts are summarised in Table 2 and Table 3. It is a species of *Sundasalanx* with a deep head (approximately 9.5% SL); large eye (approximately 6.0 per cent SL, 28% HL); and short snout (snout:eye ratio < 1). Prepectoral mark well developed; posterior wall of cardiac compartment with melanophores; basipterygium without ring of melanophores. Meristics of paratype as follows: vertebral number 41; dorsal-fin rays 10, anal-fin rays 14–15. Premaxilla with 2–3 teeth; maxilla with 12–14 teeth; dentary with 8–10 teeth, arranged in 2 rows in rear portion of dental arcade; ceratobranchial 5 tooth plate with 5–6 teeth in principal posterior row, teeth anterior to principal row small and few; pharyngobranchial 3 tooth plate small, with only 2 or 3 teeth; pharyngobranchial 4 tooth plate small, about 1/3 size of pharyngobranchial 4, with principal row of larger teeth along posterior edge.

Sundasalanx megalops is easily distinguished from its Barito River congeners by size of eye (Figs 11–15; Table 1), snout length, and colour pattern. Its eye is easily recognisable as the largest. Colour pattern features in which it differs from *S. malleti* are listed under *S. malleti*. Distinguishing features for all described *Sundasalanx* are presented in Table 4.

ECOLOGY. *Sundasalanx megalops* was captured at the mouth of a creek over sandy, silty substrate in flowing turbid water approximately 1.5 m deep. Seining sand and mud bars along Sungai Joloi up- and downstream from its point of capture produced specimens of *S. mesops*.

DISTRIBUTION. *Sundasalanx megalops* was captured from a single locality on Sungai Joloi, a large upper basin tributary of the Barito River, Central Kalimantan, Indonesia.

ETYMOLOGY. This species is named *megalops*, a combination of *mega*, Greek for large, and *ops*, Greek for eye.

***Sundasalanx platyrhynchus* Siebert and Crimmen, sp. nov.**

(Fig. 15, 16)

HOLOTYPE. MZB 5944 (ex CMK 6979), 19.2 mm SL, Indonesia, Kalimantan Barat, Kapuas River basin, Kapuas R. mainstream

Table 4 Summary table of diagnostic differences among described species of *Sundasalanx*.

	<i>S. praecox</i>	<i>S. microps</i>	<i>S. platyrhynchus</i>	<i>S. malleti</i>	<i>S. mesops</i>	<i>S. megalops</i>
Ipb 3 tooth plate	large	small; 1–2 teeth	small; 2–3 teeth	large; row of teeth along post. edge	medium; teeth along post. edge	small; 4–5 teeth
Ipb 4 tooth plate	large	small	large	large	large	large
Palatal and Bb 1 teeth	present	absent	absent	absent	absent	absent
Gill rakers on 1st arch	well devel.; 8+1; along whole arch	minute; 2–3+0	minute; 2–3+0	minute; 5+1	minute; 3+0	minute; 2+0
Upper jaw teeth	10–11 + 30	5–9 + 15–19	5–7 + 15–19	4–5 + 15–17	3–5 + 16–18	2–3 + 12–14
Lower jaw teeth	16; 2 rows	15–16; 2 rows	15–18; 2 row post.	10–12	12–13	8–10; 2 rows post
¹ Vertebrae	37–38	41–42	41–42–43	40–42–44	40–41	41
¹ Branched dorsal rays	9–10	9–10	9–10–12	8–10–11	8–9–10	10
¹ Branched anal rays	13–14–15	15–16–17	14–16–17	13–14–17	13–14–16	14–15
Eye size	medium; 4–5% SL	small; approx. 3% SL	medium; 4–6% SL	small; 3–4.5% SL	medium; 4–6% SL	large; approx. 6% SL
Prepectoral spot	absent	present	present	present	present	present
Cardiac chamber pigmentation	absent	present	present	absent	present	present
Mid-ventral line	absent	present	present	present	present	present
Basipterygium pigment ring	absent	absent	absent	present	absent	absent

¹ Median value italicised.

about 7 km SW of Nanga Silat, approx. 0° 19'N 111° 45'E, 29-IV-1990, M.Kottelat *et al.*

PARATYPES. CMK 6979 (12), collection data as for holotype. CMK 7898 (3), c&s, data as for holotype. CMK 6892 (8), Indonesia, Kalimantan Barat, Kapuas River basin, Kapuas R. mainstream at Teluk Ujung Bayur, approx. 0° 50'N 112° 45'E., 27-IV-1990, M.Kottelat *et al.*

DIAGNOSIS. A photograph of *S. platyrhynchus* is presented as Fig. 15; selected morphometrics are summarised in Table 1 and vertebral and fin-ray counts are summarised in Table 2 and Table 3. It is a species of *Sundasalanx* with a large head (HL 19.6–23.3% SL, HW 10.2–12.0% SL), relatively large eye (4.2–5.7% SL, 21.7–25.9% HL), and short snout (15.3–21.4% HL). Prepectoral mark present; posterior wall of cardiac compartment marked with melanophores; basipterygium without ring of melanophores. Vertebral number 41–43 (median=43); dorsal-fin rays 9–12 (median=10); anal-fin rays 14–17 (median=16). Premaxilla with 5–7 teeth; maxilla with 15–19 teeth; dentary with 15–18 teeth, arranged in 2 rows in posterior part of dental arcade; 3rd pharyngobranchial tooth plate small, with only 2 or 3 teeth; 4th pharyngobranchial tooth plate small, about 1/3 size of pharyngobranchial 4, with principal row of larger teeth along posterior edge.

Sundasalanx platyrhynchus is easily distinguished from its Kapuas River congener by size of eye and pharyngeal dentition. The eye of *S. microps* is much smaller (Table 4) and pharyngeal dentition in *S. microps* is much reduced. *Sundasalanx platyrhynchus* can be distinguished from its Barito River congeners by size of eye and vertebral, dorsal- and anal-fin ray counts. *S. malleti* has a smaller eye; *S. megalops* has a larger eye. *S. mesops* has fewer vertebrae and dorsal- and anal-fin rays.

DISTRIBUTION. *Sundasalanx platyrhynchus* is known from the Kapuas River basin, West Kalimantan, Indonesia.

ETYMOLOGY. The name *platyrhynchus* is a combination of *platys*, Greek for broad, and *rhynchus*, Greek for snout.

DISCUSSION

Sundasalanx is very small and much of its anatomy is suggestive of the larvae of lower teleosts generally (as realised by Roberts, 1984). Evolution of a tiny adult size among clupeiforms is not unusual; it is known both in engraulids (Cervigón, 1982; Nelson, 1986; Roberts, 1981; Whitehead *et al.*, 1988) and other clupeids (Poll, 1948; Roberts, 1972; Whitehead, 1988; Whitehead & Teugels, 1985). Among these a good anatomical description is available only for *Sierrathrissa leonensis* (Whitehead and Teugels, 1985). However 'youthful' an impression small size lends to *Sierrathrissa leonensis*, it nevertheless is more or less a miniature adult. The degree of ossification, development of the intestinal tract, development of the air bladder, fin positions, etc. are all indicative of at least a juvenile stage in the life cycle, if not of an adult.

Sundasalanx on the other hand is both tiny and underdeveloped. Its level of skeletal and somatic development (straight gut, small air bladder, myotomes not extending ventrally to cover ventral portion of body cavity, presence of ventral fin-fold, undifferentiated cartilaginous plate supporting a rayless pectoral fin, etc.) is comparable to that of other unmetamorphosed clupeid larvae. Migration of the dorsal fin forward to a position characteristic of adults is considered to mark the transition between larvae and adults in clupeiforms. The positions of the dorsal fin, anus, and anal fin, in absolute terms and relative to each other, of the largest *Sundasalanx* specimens studied are similar to the positions reported for other unmetamorphosed spratelloidins (Leis & Trnski, 1989) and there is no difference in the positions of any of these structures between the smallest and largest specimen for any species studied. *Sundasalanx* appears to have attained the ability to reproduce at a stage of development equivalent to larvae of other clupeids. If this assessment of developmental stage of *Sundasalanx* is correct the size of *Sundasalanx* may be unusual. Transition, or metamorphosis, in other spratelloidins often begins at sizes of less than half that attained by *Sundasalanx*.

Small size, lack of somatic development beyond that of the

larvae of other clupeoids, and obvious acceleration of gonadal maturation suggest *Sundasalanx* are progenetic. Whitehead & Teugels (1985) attributed the small size of *Sierrathrissa leonensis* to progenesis, but *Sundasalanx* exhibits a more extreme condition of the syndrome than *Sierrathrissa leonensis* since *S. leonensis* is, morphologically, a miniature 'adult'. Among fishes perhaps only *Schindleria* (Johnson & Brothers, 1993) matches *Sundasalanx* for degree of progenesis. Both *Sundasalanx* and *Schindleria* (Schindler, 1932; Gosline, 1959) are obvious larval forms that have attained reproductive capabilities. This may be what sets them apart from other small progenetic fishes, like *Sierrathrissa*, with paedomorphic reductive tendencies.

Sundasalanx is of such small size an individual probably only goes through one sexual cycle during its lifetime. Mature or maturing specimens have been taken from the Barito River during February and August, suggesting *Sundasalanx* might breed year around, a reproductive phenomenon observed for other species of tropical Bornean freshwater fishes (Roberts, 1989). Alternatively, it may follow a bimodal breeding pattern tuned to rainfall patterns of the region since February and August are months which correspond to the two periods of low rainfall and low water levels of the annual climatic cycle of Central Kalimantan. Larvae of marine clupeoids can attain the known size of *Sundasalanx* within two months or less if water temperatures are high enough and resources adequate (Blaxter & Hunter, 1982). Conditions permitting, *Sundasalanx* probably is capable of completing its life cycle within a single wet-dry cycle only half a year long, and thus might be capable of completing two generations per annum.

Weitzman & Vari (1988) and Kottelat & Vidthayanon (1993) observed that many miniature freshwater fishes are found in still or slow-flowing waters. Within the Barito River basin *Sundasalanx* was captured adjacent to strong currents and its apparent ability to move in-shore at dusk within a riverine environment suggests it is an exception to this generalisation, as is also one of the other miniature clupeiforms (*Thrattidion noctivagus* Roberts, 1972; Whitehead, 1988). Barito River *Sundasalanx* also appears to be found only in larger habitats. It was never taken in small tributary streams, many of which were sampled.

ACKNOWLEDGEMENTS. The Indonesian Institute of Sciences (LIPI) is gratefully acknowledged for permission to conduct research in Indonesia; Dr. Soetikno Wirjoatmodjo, Dr. Dedy Darnedi, Dr. Arie Budiman, and Mr. Pak Amir, all of the Research and Development Centre for Biology, Bogor, Java, have supported research efforts in the Barito basin and their support is gratefully acknowledged; The Worshipful Company of Fishmongers, the Royal Society, and the Godman Fund are acknowledged for financial support; Project Barito Ulu is acknowledged for logistic support; Dr. Maurice Kottelat kindly made Kapuas River materials available from his private collection. Oliver Crimmen is thanked for his efforts in describing the new species. Colin Patterson, Dave Johnson, Peter Forey, and Lance Grande all made valuable suggestions toward improving the manuscript. Finally my colleague and friend Agus Tjakrawidjaja is warmly acknowledged for his personal attention to research on freshwater fishes in Indonesia.

REFERENCES

- Allan J.M., Blaxter, J.H.S., & Denton, D.J. 1976. The functional anatomy and development of the swimbladder-inner ear-lateral line system in herring and sprat. *Journal of the Marine Biological Association, U.K.*, **56**:471-486.
- Begle, D.P. 1991. Relationships of the osmeroid fishes and the use of reductive characters in phylogenetic analysis. *Systematic Zoology* **40**(1):33-53.
- Blaxter, J.H.S. & Hunter, J.R. 1982. The biology of clupeoid fishes. *Advances in Marine Biology*, **20**:1-223.
- Cervigón, F. 1982. La ictiofauna estuarina del Caño Mánamo y áreas adyacentes. pp. 205-260. In: Novoa R., D. (ed) *Los Recursos Pesqueros del Rio Orinoco y su Explotación*. Corporación Venezolana de Guayana, Caracas.
- Dingerkus, G. & Uhler, L.D. 1977. Enzyme clearing of alcian blue stained whole small vertebrates for demonstration of cartilage. *Stain Technology* **52**:229-232.
- Fink, W.L. 1984. Basal euteleosts: relationships. pp. 202-206. In: Moser, H.G., Richards, W.J., Cohen, D.M., Fahay, M.P., Kendall, A.W., & Richardson, S.L. (eds) *Ontogeny and Systematics of Fishes*. American Society of Ichthyologists and Herpetologists, Special Publication No. 1, Allen Press, Lawrence, Kansas.
- Gosline, W.A. 1959. Four new species, a new genus, and new suborder of Hawaiian fishes. *Pacific Science* **13**:67-77.
- Greenwood, P.H., Rosen, D.E., Weitzman, S.H., & Meyers, G.S. 1966. Phyletic studies of the teleostean fishes, with a provisional classification of living forms. *Bulletin American Museum Natural History* **131**:339-456.
- Grande, L. 1985. Recent and fossil clupeomorph fishes with materials for revision of the subgroups of clupeoids. *Bulletin American Museum Natural History* **181**:231-372.
- Hoss, D.E. & Blaxter, J.H.S. 1982. Development and function of the swimbladder-inner ear-lateral line system in the Atlantic menhaden, *Brevoortia tyrannus* (Latrobe). *Journal of Fish Biology*, **20**:131-142.
- Hubbs, C.L. & Lagler, K.F. 1947. Fishes of the Great Lakes region. *Bulletin of the Cranbrook Institute of Science* **26**:1-186.
- Johnson, G.D. & Brothers, E.B. 1993. *Schindleria*: a paedomorphic goby (Teleostei: Gobioidae). *Bulletin of Marine Science*, **25**:441-471.
- & Patterson, C. 1996. Chapter 12. Relationships of lower euteleostean fishes. pp. 251-332. In: Stiassny, M.L.J., Parenti, L., & Johnson, G.D. (eds) *Interrelationships of Fishes*. Academic Press, San Diego.
- Kottelat, M. 1991. Notes on the taxonomy and distribution of some western Indonesian freshwater fishes, with diagnoses of a new genus and six new species (Pisces: Cyprinidae, Belontiidae, and Chaudhuriidae). *Ichthyological Exploration of Freshwaters* **2**:273-287.
- & Vidthayanon, C. 1993. *Boraras micros*, a new genus and species of minute freshwater fish from Thailand (Teleostei: Cyprinidae). *Ichthyological Exploration of Freshwaters* **4**:161-176.
- Kreutzman, T. 1993. Mystery fish of Macu. *Aquarist & Pondkeeper* **57**:8-9.
- Leis, J.M. & Trnski, T. 1989. *The Larve of Indo-Pacific Shorefishes*. 371 pp. University of Hawaii Press, Honolulu.
- Leviton, A.E., Gibbs, R.H., Heal, E. & Dawson, C.E. 1985. Standards in herpetology and ichthyology: part 1. Standard symbolic codes for institutional resource collections in herpetology and ichthyology. *Copeia* **1985**:802-832.
- McGowan, M.F. & Berry, F.H. 1984. Clupeiformes: Development and Relationships. pp. 108-126. In: Moser, H.G., Richards, W.J., Cohen, D.M., Fahay, M.P., Kendall, A.W., & Richardson, S.L. (eds) *Ontogeny and Systematics of Fishes*. American Society of Ichthyologists and Herpetologists, Special Publication No. 1, Allen Press, Lawrence, KS.
- Nelson, G.J. 1969. Gill arches and the phylogeny of fishes, with notes on the classification of vertebrates. *Bulletin of the American Museum of Natural History* **141**:477-552 + pls. 79-92.
- 1986. Identity of the anchovy *Engraulis clarki* with notes on the species-group of *Anchoa*. *Copeia* **1986**:891-902.
- O'Connell, C.P. 1981. Development of organ systems in the Northern Anchovy, *Engraulis mordax*, and other teleosts. *American Zoologist* **21**:429-446.
- Patterson, C. & Johnson, G.D. 1995. The intermuscular bones and ligaments of teleostean fishes. *Smithsonian Contributions to Zoology* **559**:1-85 pp.
- Poll, M. 1948. Poissons recueillis au Katanga par H. J. Bredo. *Bulletin du Musée royal d'Histoire naturelle de Belgique* **24**:1-24.
- Roberts, T.R. 1972. Osteology and description of *Thrattidion noctivagus*, a minute, new freshwater clupeid fish from Cameroon, with a discussion on pellenulid relationships. *Breviora* **382**:1-25 pp.
- 1981. Sundasalangidae, a new family of minute freshwater salmoniform fishes from Southeast Asia. *Proceedings of the California Academy of Sciences* **42**:295-302.
- 1984. Skeletal anatomy and classification of the neotenic asian salmoniform superfamily Salangoidea (Icefishes or Noodlefishes). *Proceedings of the California Academy of Sciences* **43**:179-220.
- 1989. The freshwater fishes of Western Borneo (Kalimantan Barat, Indonesia). *Memoirs of the California Academy of Sciences* **14**:1-210 pp.
- Schindler, O. 1932. Sexually mature larval Hemiramphidae from the Hawaiian Islands. *Bulletin of the Bernice P. Bishop Museum* **97**:1-28 + 10 pls.
- Shardo, J.D. 1996. Radial polarity of the first neuromast in embryonic American Shad, *Alosa sapidissima* (Teleostei: Clupeomorpha). *Copeia* **1996**:226-228.
- Weitzman, S.H. & Vari, R.P. 1988. Miniaturization in South American freshwater fishes: an overview and discussion. *Proceedings of the Biological Society of Washington* **101**:444-465.
- Whitehead, P.J.P. 1988. FAO species catalogue. Vol. 7. Clupeoid fishes of the world.

- An annotated and illustrated catalogue of the herrings, sardines, pilchards, sprats, anchovies and wolfherrings. Part 1 – Chirocentridae, Clupeidae and Pristigasteridae. *FAO Fisheries Synopsis No. 125* 7:1–303.
- & **Blaxter, J.H.S.** 1989. Swimbladder form in clupeoid fishes. *Zoological Journal of the Linnean Society* 97:299–372.
- , **Nelson, G.J.** & **Wongratana, T.** 1988. FAO species catalogue. Vol. 7. Clupeoid fishes of the world. An annotated and illustrated catalogue of the herrings, sardines, pilchards, sprats, anchovies and wolfherrings. Part 2 – Engraulididae. *FAO Fisheries Synopsis No. 125* 7:305–579.
- & **Teugels, G.G.** 1985. The West African pygmy herring *Sierrathrissa leonensis*: general features, visceral anatomy, and osteology. *American Museum Novitates* 2835:1–44.

Redescription of and lectotype designation for *Balistes macrolepis* Boulenger, 1887, a senior synonym of *Canthidermis longirostris* Tortonese, 1954 and *C. villosus* Fedoryako, 1979 (Teleostei, Tetraodontiformes, Balistidae)

ANTHONY C. GILL

Division of Lower Vertebrates, Department of Zoology, The Natural History Museum, Cromwell Road, London SW7 5BD, United Kingdom

JOHN E. RANDALL

Ichthyology Division, Bishop Museum, P.O. Box 19000A, Honolulu, Hawaii 96817-0916, U.S.A.

SYNOPSIS. *Balistes macrolepis* Boulenger, 1887 is identified as a valid species of *Canthidermis* from an examination of the two stuffed syntype specimens, 444 and 457 mm SL, from Muscat, Oman. The larger of these is designated lectotype. The species is redescribed on the basis of the lectotype, paralectotype and two juvenile (30.5–32.0 mm SL) specimens from the Gulf of Aden, and is shown to be a senior synonym of *C. longirostris* Tortonese, 1954 (described from a 365 mm SL specimen from the Dahlak Islands, southern Red Sea) and *C. villosus* Fedoryako, 1979 (described from eight 55.5–177.3 mm SL juveniles from the Gulf of Aden). *Canthidermis macrolepis* is distinguished from congeners in having fewer body scale rows (35–40 versus 39–58). Juveniles of *C. macrolepis* are readily distinguished from those of congeners by scale morphology (relatively long, branched, fleshy outgrowths present on body and head scales versus fleshy outgrowths short and unbranched or absent) and coloration (pale spots on head and body large and forming a network pattern versus pale spots absent or small and not forming a network pattern).

INTRODUCTION

Boulenger (1887) described *Balistes macrolepis* from two large (stated total length one foot 11 inches), dry specimens from Muscat, Oman. With the exception of two books [Randall (1995) and Debelius (1996)] that give accounts for *B. macrolepis* resulting from the present research, the species has not been referred to subsequently. Boulenger gave the following characters for the species: dorsal-fin rays III + 26; anal-fin rays 23; a groove in front of eye; no enlarged scales behind the gill opening; no spines on the tail; falciform dorsal and anal fins; and a strongly notched caudal fin. The absence of enlarged scales behind the gill opening is unique among Indo-Pacific balistids to the genera *Canthidermis* Swainson, *Xanthichthys* Kaup and *Xenobalistes* Matsuura (Matsuura, 1980, 1981; Smith & Heemstra, 1986). There are two stuffed specimens labelled as *B. macrolepis* in the Natural History Museum, London, which we believe to be the syntypes. One (BMNH 1887.11.11.334; Fig. 1) measures 457 mm SL and is mounted on an exhibition stand, whereas the other (BMNH 1887.11.11.335) measures 444 mm SL. The specimens have a terminal mouth with uneven, notched teeth, a deep groove before the eye, and a relatively well-developed third dorsal spine extending above the dorsal edge of the body, and lack enlarged scales behind the gill opening and longitudinal grooves on the cheek; this combination of characters is unique among balistids to species of the genus *Canthidermis* (Matsuura, 1980).

Recent authors (e.g., Berry & Baldwin, 1966; Matsuura, 1980; Smith & Heemstra, 1986) have recognised only two valid species of *Canthidermis*, the cosmopolitan *C. maculatus* (Bloch) and the Atlantic *C. sufflamen* (Mitchill). However, Fedoryako (1979) recognised five species of *Canthidermis* in the most recent review of the genus:

C. maculatus, *C. sufflamen*, *C. willughbeii* (Lay & Bennett) (from the eastern Pacific), *C. rotundatus* (Proce) (from the Indo-West Pacific), and *C. villosus*, which Fedoryako described as a new species.

Fedoryako (1979) described *C. villosus* from eight pelagic juveniles (55.5–177.3 mm SL) from the Gulf of Aden. He distinguished it from juvenile congeners in having relatively long, branched, fleshy outgrowths on body and head scales (versus fleshy outgrowths short and unbranched or absent), large, pale spots on head and body forming a network pattern (versus pale spots absent or not forming a network pattern), and 36–40 (versus 39–57) transverse rows of scales (= body scale rows). We located two additional juvenile specimens of the species in the Natural History Museum, London, (BMNH 1939.5.24.1849–1850) that had been surface dipnetted in the Gulf of Aden by the 1933–34 John Murray Expedition (Station 25) on the 10th of October, 1933. These specimens had been identified as *Canthidermis* sp. and briefly described in Norman's (1939) report of fishes of the 1933–34 John Murray Expedition. Adult specimens of *C. villosus* have not been described. However, the fin-ray and scale counts of the two adult syntypes of *Balistes macrolepis* agree closely with those of *C. villosus* (Table 1), and we conclude that the two nominal species are conspecific. *Balistes macrolepis* Boulenger, 1887 is therefore a senior synonym of *Canthidermis villosus* Fedoryako, 1979.

The second author searched his photographic library and found four photographs of individuals that we believe to be conspecific with the syntypes of *B. macrolepis*. One photograph taken at Fahl Island off Muscat in the Gulf of Oman by J.P. Hoover shows a nesting pair (Fig. 2). Two others by H. Debelius are of specimens from Oman, one a natural underwater photograph, the other of an

aquarium specimen in the Muscat Aquarium; both photographs were reproduced in Debelius (1993: 298). The final photograph, taken by the second author, is of a ca. 300 mm total length specimen in the Zubayr Islands, southern Red Sea (reproduced in Randall, 1995: fig. 1108). The localities for these photographs and specimens suggest that the species might be restricted to the northwestern Indian Ocean and Red Sea. We searched literature on *Canthidermis* from the area and found two additional references. Tortonese (1954) described *C. longirostris* from the Dahlak Islands, southern Red Sea, and Dor (1984) recorded *C. maculatus* from the Red Sea. However, Dor's record was based on Tortonese's specimen of *C. longirostris*, and followed Berry & Baldwin's (1966) synonymy of the two species; apparently, Fedoryako (1979) overlooked *C. longirostris* in his review of the genus. Examination of Tortonese's description and figure of *C. longirostris* revealed that it is not referable to *C. maculatus*, rather it is a second junior synonym of *B. macrolepis*.

MATERIALS AND METHODS

Pectoral-fin ray counts include the uppermost, rudimentary ray. Other methods of counting and measuring follow Matsuura (1980). Institutional codes follow Leviton *et al.* (1985).

SYSTEMATIC ACCOUNT

Canthidermis macrolepis (Boulenger, 1887)

Figures 1–3; Tables 1–2

Balistes macrolepis Boulenger, 1887: 666 (type locality: Muscat; lectotype: BMNH 1887.11.11.334, 457 mm SL, designated below).

Canthidermis sp. – Norman, 1939: 109 (Gulf of Aden).

Canthidermis longirostris Tortonese, 1954: 77, fig. 1 (type locality: Dahlak Is, Red Sea; holotype: MZGZ 20162, 365 mm SL).

Canthidermis villosus Fedoryako, 1979: 985, fig. 1B (type locality: 12°29'N 44°23'E, Gulf of Aden; holotype: MGY P-15097, 55.5 mm SL). – Fedoryako, 1981: 21, fig. 1c (English translation of original description).

Canthidermis maculatus [*non Balistes maculatus*, Bloch 1786]. – Berry & Baldwin, 1966: 463 (synonymy with *C. longirostris*). – Dor, 1984: 275 (Red Sea; based on holotype of *C. longirostris*). – Debelius, 1993: 298 (colour photographs of specimens from Oman).

Canthidermis macrolepis. – Randall, 1995: 393, fig. 1108 (description, synonymy and distribution based on present study; colour photograph). – Debelius, 1996: 298 (colour photographs of specimens from Oman).

DIAGNOSIS. *Canthidermis macrolepis* is readily distinguished from congeners in having fewer body scale rows (35–40 versus 39–58). As noted by Fedoryako (1979, 1981; see above), juveniles of *Canthidermis macrolepis* are readily distinguished from those of congeners by scale morphology (relatively long, branched, fleshy outgrowths present on body and head scales versus fleshy outgrowths short and unbranched or absent; Fedoryako, *loc. cit.*: fig. 1C *cf.* fig. 1A,B) and coloration (pale spots on head and body large and forming a network pattern versus pale spots absent or small and not forming a network pattern).

DESCRIPTION. (based on data from BMNH specimens; see Tables 1,2 for counts and measurements of individual specimens, and for data from Tortonese's and Fedoryako's respective descriptions of *C. longirostris* and *C. villosus*)

Dorsal-fin rays III + 25–26, all segmented rays branched except for the first 1–2; anal-fin rays 22–23, all rays branched except for the first; pectoral-fin rays 15–16, the upper ray a rudiment, and the second from uppermost unbranched; body scale rows 35–39; head scale rows 25–29; vertebrae 7 + 11 (from radiographs of BMNH 1939.5.24.1849–1850 only); gill rakers 8–10 + 20–22 = 30, the

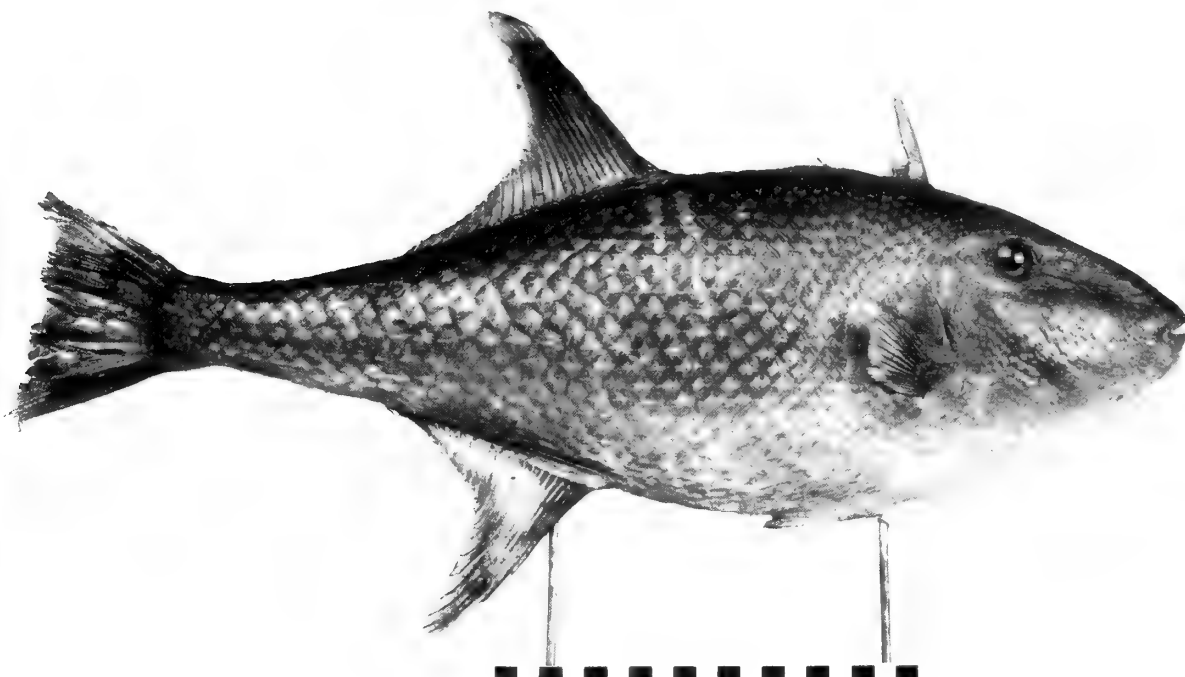

Fig. 1 *Canthidermis macrolepis*, BMNH 1887.11.11.334, lectotype, 457 mm SL, Muscat, Oman (photograph by P. Hurst).



Fig. 2 *Canthidermis macrolepis*, nesting pair in 7 m, Fahl Island, off Muscat, Oman (underwater photograph by J.P. Hoover).

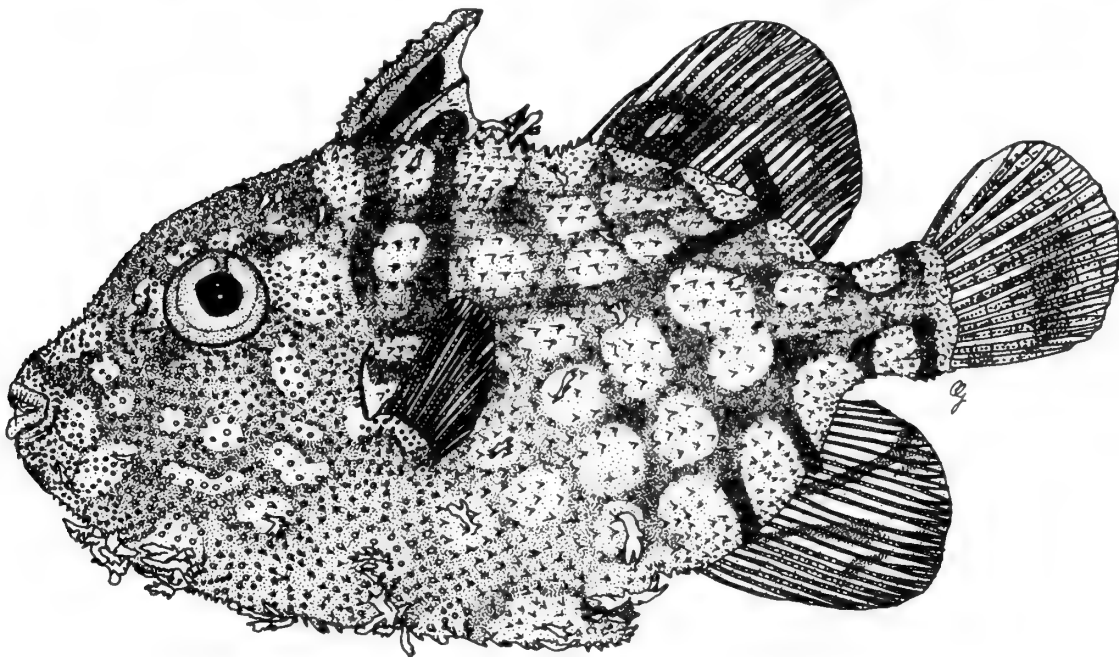

Fig. 3 *Canthidermis macrolepis*, BMNH 1939.5.24.1849–1850, 30.5 mm SL, 1933–34 John Murray Expedition station 25, Gulf of Aden (drawing by A.C. Gill).

upper-lobe rakers markedly smaller than those of lower lobe (from examination of right sides of BMNH 1939.5.24.1849–1850).

Body relatively deep in juveniles (greatest body depth 56.3–57.0% SL; depth of body 46.6–46.9% SL), more elongate in adults (greatest body depth 32.9–35.9% SL; depth of body 27.9–29.3% SL); width of body 22.3–22.5% SL in juveniles, 14.9–15.3% SL in adults; head large in juveniles (head length 39.0–39.7% SL), shorter in adults (26.0–27.5% SL); snout length 19.0–19.1% SL in juveniles, 17.1–17.8% SL in adults, the dorsal profile of snout slightly concave in juveniles and slightly convex in adults; eye round, the

greatest orbit diameter 11.8–12.1% SL in juveniles, 4.6–4.7% SL in adults; interorbital space broad (interorbital width 13.1% SL) and concave in juveniles, convex and narrower (interorbital width 9.4–9.5% SL) in adults; caudal peduncle short and deep in juveniles (least depth 12.5–12.8% SL, length 12.8–13.1% SL), long and slender in adults (least depth 8.3% SL, length 22.8% SL); pelvic flap not capable of large ventral expansion, the free pelvic terminus with two apparent, weakly movable sections.

Mouth small and terminal; teeth incisiform, sharp and notched on the edges, projecting and close set, four on each side of jaws, with an

Table 1 Meristic frequencies for specimens of *Canthidermis macrolepis*. Data for type specimens of *Canthidermis longirostris* and *C. villosus* follow Tortonese (1954) and Fedoryako (1979), respectively.

	D ₂ rays			A rays			P ₁ rays*		Body scale rows*						Head scale rows*				
	24	25	26	22	23	24	15	16	35	36	37	38	39	40	25	26	27	28	29
<i>B. macrolepis</i>																			
Lectotype	-	-	1	-	1	-	-	2	-	-	-	-	2	-	2	-	-	-	-
Paralectotype	-	1	-	damaged			1	1	-	-	2	-	-	-	-	2	-	-	-
<i>C. longirostris</i> holotype	-	-	1	-	-	1	not given		-	-	-	1	-	-	not given				
<i>C. villosus</i> types**	1	2	3	3	5	-	1	7	-	2	-	3	1	2	not given				
Murray specimens	-	2	-	1	1	-	-	4	1	1	2	-	-	-	-	-	2	1	1
Totals	1	5	5	4	7	1	2	14	1	3	4	4	3	2	2	2	2	1	1

* - characters where bilateral counts are included for some specimens. ** - it is apparent from data given for other *Canthidermis* species that Fedoryako (1979) did not include the upper rudiment in his counts of pectoral-fin rays; we have therefore added one to the values recorded by him.

Table 2 Selected morphometric values expressed as percentages of SL for specimens of *Canthidermis macrolepis*.

	Murray specs	<i>C. villosus</i> types						
		Holo.	Paratypes		<i>longirostris</i>	<i>macrolepis</i> types		
			(n=3)	(n=4)		holo.	Paral.	Lecto.
SL	30.5	32.0	55.5	75-95	111-177	365	444	457
Head length	39.0	39.7	37.6	35.0-36.4	33.6-34.0	26.5	27.5	26.0
Snout length	19.0	19.1	19.8	19.8-20.4	19.2-20.6	**	17.8	17.1
Body depth	46.6	46.9	**	**	**	**	27.9	29.3
Greatest body depth	57.0	56.3	53.0	46.2-53.3	41.1-48.3	**	32.9	35.9
Body width	22.3	22.5	**	**	**	**	14.9	15.3
Snout to D ₁ origin	43.6	43.8	42.0	40.3-42.3	35.2-38.9	**	29.7	28.4
Snout to D ₂ origin	65.9	63.4	**	**	**	**	54.5	54.5
Interdorsal space	23.6	20.6	**	**	**	**	26.4	27.6
Snout to A origin	75.7	75.3	73.0	69.5-73.7	66.3-68.1	**	61.0	60.8
D ₂ base length	29.5	30.3	28.8	29.4-29.8	27.9-30.2	**	27.0	26.9
A base length	26.9	27.5	24.2	24.3-24.7	23.9-24.9	**	**	22.3
Gill opening length	7.9	9.4	**	**	**	6.0	4.7	4.8
Eye diameter	12.1	11.8	10.5	8.4-8.8	7.1-8.9	4.9	4.7	4.6
Caudal peduncle length*	12.8	13.1	12.0	12.6-14.1	13.4-17.2	**	**	22.8
Caudal peduncle depth	12.5	12.8	12.1	10.9-12.7	10.3-11.4	9.5	8.3	8.3
First dorsal spine length	22.3	21.8	**	**	**	**	11.0	**
Longest D ₂ ray length	20.0	21.3	24.0	20.2-24.8	20.7-29.5	**	**	22.5
Longest A ray length	18.7	20.3	20.4	20.5-22.7	22.0-25.4	**	**	21.4
Pectoral fin length	15.4	16.3	**	**	**	9.6	10.1	**
Caudal fin length	23.9	23.1	**	**	**	20.4	24.3	**

* - caudal peduncle length values given for the *C. villosus* types are the postdorsal distance values given by Fedoryako (1981; measured from base of last second-dorsal ray base to base of caudal fin). ** - character not given in literature or not available because of specimen damage.

inner three plate-like teeth on each side of upper jaw. Gill opening slightly oblique (sloping in posterodorsal direction), its length 7.9-9.4% SL in juveniles, 4.7-4.8% SL in adults; no patch of modified scales posterior to gill opening. Nostrils small, located just in front of orbital rim between about 9 and 10 o'clock position from centre of eye. A deep groove extending beneath nostrils from midanterior edge of eye along upper third of snout. No longitudinal or diagonal grooves on cheek.

Scales of juveniles rhomboidal, not overlapping, with a large spine projecting posterolaterally from scale centre and well-developed ridges that extend posteroventrally and posterodorsally from base of central spine; ridges usually ending dorsally and ventrally with a smaller spine; scale spines each with a fleshy outgrowth, these small and unbranched on most scales, but large and highly branched on at least some scales. Scales of adults rhomboidal, weakly overlapping, those on body with a spine-like ridge on centre, and about 25-60 small nodules arranged in a diamond-shaped patch immediately behind ridge. Lateral line not apparent.

Origin of spinous dorsal fin about 1 (juveniles) to 2 (adults) eye

diameters posterior to eye; first dorsal-fin spine of juveniles stout, its length 21.8-22.3% SL, with two ridges on its lateral surfaces, these converging near base and tip of fin spine and bearing large, irregular spines; first dorsal-fin spine of adults stout, its length 11.0% SL, with nodules on its anterior surface, these small and arranged in about 12 irregular rows proximally, becoming larger and arranged in 3 prominent rows distally; second spine of juveniles and adults slender, without spinules or nodules, about half to two-thirds length of first spine, acting as trigger to release the first spine when the latter is locked in upright position; third spine of juveniles and adults slender and short, about two-thirds length of second spine, without spinules or nodules, and partly concealed by a deep groove into which the spinous dorsal fin folds; origin of soft dorsal fin about one eye diameter anterior to anal-fin origin in juveniles, and above anus in adults; first soft dorsal-fin ray short, the longest ray in juveniles the sixth or seventh, 20.0-21.3% SL, and in adults the fourth, 22.5% SL; first anal-fin ray short, the longest ray in juveniles the fifth or sixth, 18.7-20.3% SL, and in adults the fourth, 21.4% SL; soft dorsal and anal fins broadly rounded in juveniles, strongly pointed

and falcate in adults; pectoral fins rounded, 15.4–16.3% SL in juveniles, 10.1% SL in adults; caudal fin rounded in juveniles, double emarginate in adults, its length 23.1–24.3% SL; segmented fin rays of juveniles bearing 1–3 rows of small spinules, these largest on basal part of fins; segmented-fin-ray spinules not apparent in adults.

PRESERVED COLORATION OF JUVENILES (based on BMNH 1939.5.24.1849–1850; Fig. 3). Head and body pale brown, paler ventrally; body and caudal peduncle with large (slightly larger than pupil to about twice diameter of eye), pale brown to whitish spots arranged in about six oblique columns; about six spots in anteriormost column (just behind pectoral-fin base), reducing to two spots in posteriormost column (on caudal peduncle); pale spots most conspicuous on caudal peduncle and posterior part of body; interspaces between spots accentuated with dark grey-brown stripes, bars and (particularly at junctions of bars and stripes) spots, these forming a reticulate pattern; dark grey-brown markings most conspicuous below first dorsal fin, on caudal peduncle and adjacent to bases of anal and second dorsal fins; head with pale spots and irregular markings, these generally smaller and less distinct than those on body; fleshy scale outgrowths mostly unpigmented, except for a few scattered dark grey-brown unbranched outgrowths; first dorsal fin pale brown to hyaline, with three large dark grey spots, one behind each fin spine; second dorsal and anal fins pale brown to hyaline, with large pale spots and dark grey reticulate pattern extending on to basal two thirds of fin; caudal fin pale brown to hyaline, dusky basally near dorsal and ventral edges of fin, with a dusky bar through proximal third of fin; pectoral fins pale brown to hyaline.

Fedoryako (1981: 22) gave the following description for preserved juveniles: 'The coloration of preserved specimens up to 100 mm [SL] in size is beige with a coarse reticular pattern. The 2nd dorsal, the anal and caudal fins, have large light spots along the margin and the basal part. In large fish [i.e., 111–177 mm SL] the head and trunk are of a uniform beige, the ventral surface of the head and trunk in front of the pelvic fins is lighter.'

LIVE COLORATION OF ADULTS (see Debelius, 1993, 1996; Randall, 1995). Head and body grey, shading to pale ventrally; dorsal, anal and caudal fins grey, the distal edges of caudal, anal and second dorsal fins dark grey; pectoral fins dark grey.

DISCUSSION

We herein designate the larger syntype of *Balistes macrolepis* (BMNH 1887.11.11.334, 457 mm SL) lectotype of the species.

Species of *Canthidermis* are pelagic, only coming into shallow areas to breed, whereupon demersal eggs are laid in a large pit in sand and/or rubble (Fig. 2). Juveniles are usually found in association with floating debris and vegetation; Fedoryako (1979: 986; 1981: 21) indicated that the type specimens of *C. villosus* were collected near the surface beneath 'floating microphytes.' Presum-

ably, juveniles are camouflaged by their spotted/reticulate coloration and branched, fleshy scale outgrowths. Current evidence suggests that *C. macrolepis* breeds in Oman from at least July to November. J.P. Hoover has photographed adults of the species in shallow areas in Oman during the months of July and September, and J.K.L. Mee (pers. comm.) informed us that adults are commonly caught by hook-and-line fishermen working in shallow areas off Muscat around October to November. Interestingly, although taste tests conducted by Omani fisheries researchers indicate that the species is one of the most flavoursome of Omani fishes, Omani fisherman usually discard their catches believing the species to be poisonous, or at least inedible (J.K.L. Mee, pers. comm.).

ACKNOWLEDGEMENTS. We are grateful to H. Debelius and J.P. Hoover for making photographs of *Canthidermis macrolepis* available to us, and to J.K.L. Mee for helpful discussions. We thank P. Hurst of the Photographic Unit of the Natural History Museum for the photograph of the lectotype reproduced in Fig. 1. P.C. Heemstra kindly loaned comparative materials of *Canthidermis* from various western Indian Ocean localities. We thank A.-M. Woolger and S. Davidson for preparing radiographs of specimens, and O.A. Crimmon for assistance in locating the syntypes of *Balistes macrolepis*. We are grateful to J.B. Hutchins, K. Matsuura and D.J. Siebert for their constructive reviews of the manuscript.

REFERENCES

- Boulenger, G.A.** 1887. An account of the fishes obtained by Surgeon-Major A.S.G. Jayakar at Muscat, east coast of Arabia. *Proceedings of the Zoological Society of London* **1887**(43): 653–667, pl. 54.
- Berry, F.H. & Baldwin, W.J.** 1966. Triggerfishes (Balistidae) of the eastern Pacific. *Proceedings of the California Academy of Sciences* **4**(34)(9): 429–474.
- Debelius, H.** 1993. *Indian Ocean Tropical Fish Guide*. 321 pp. Aquaprint Verlags GmbH, Neu Isenburg.
- 1996. *Fischführer Indischer Ocean*. 321 pp. IKAN-Unterwasserarchiv, Frankfurt.
- Fedoryako, B.I.** 1979. Спинороги родов *Canthidermis* и *Xanthichthys* (Balistidae, Tetraodontiformes [sic]) тихоокеанского и индийского океанов. *Voprosy Ikhtiologii* **19**(6): 983–995. [In Russian]
- 1981. Triggerfishes of the genera *Canthidermis* and *Xanthichthys* (Balistidae, Tetraodontiformes [sic]) from the Pacific and Indian Oceans. *Journal of Ichthyology* **19**(6): 19–30.
- Leviton, A.E., Gibbs Jr, R.H., Heal, E. & Dawson, C.E.** 1985. Standards in herpetology and ichthyology: Part 1. Standard symbolic codes for institutional resource collections in herpetology and ichthyology. *Copeia* **1985**(3): 802–832.
- Matsuura, K.** 1980. A revision of Japanese balistoid fishes. 1. Family Balistidae. *Bulletin of the National Science Museum, Series A (Zoology)* **6**(1):27–69.
- 1981. *Xenobalistes tunidipectoris*, a new genus and species of triggerfish (Tetraodontiformes, Balistidae) from the Marianas Islands. *Bulletin of the National Science Museum, Series A (Zoology)* **7**(4):191–200.
- Norman, J.R.** 1939. *The John Murray Expedition 1933–34. Scientific Reports*. Vol. 7, no. 1. Fishes. 116 pp. British Museum (Natural History), London.
- Randall, J.E.** 1995. *Coastal Fishes of Oman*. 439 pp. Crawford House Publishing Pty Ltd, Bathurst.
- Smith, M.M. & Heemstra, P.C.** 1986. Family no. 263: Balistidae. pp. 876–882. In: Smith, M.M. & Heemstra, P.C. (eds) *Smiths' Sea Fishes*. Springer-Verlag, London.
- Tortonese, E.** 1954. Spedizone subacquea italiana nel Mar Rosso. Ricerche zoologiche. VI. Plettognati. *Rivista di Biologia Coloniale* **14**: 73–86.



A review of the *Diogenes* (Crustacea, Paguridea) hermit crabs collected by Bedford and Lanchester from Singapore, and from the 'Skeat' Expedition to the Malay Peninsula, with a description of a new species and notes on *Diogenes intermedius* De Man, 1892

PATSY A. MCLAUGHLIN /

Shannon Point Marine Center, 1900 Shannon Point Road, Anacortes, WA 98221-4042, U.S.A.

PAUL F. CLARK

Department of Zoology, Natural History Museum, Cromwell Road, London SW7 5BD, England.

CONTENTS

Introduction	33
Material and Methods	34
Systematic Account	34
<i>Diogenes inglei</i> sp. nov.	34
<i>Diogenes rectimanus</i> Miers, 1884	37
<i>Diogenes goniochirus</i> Forest, 1956	38
<i>Diogenes avarus</i> Heller, 1865	39
<i>Diogenes planimanus</i> Henderson, 1893	40
<i>Diogenes platvoeti</i> nom. nov.	42
<i>Diogenes stenops</i> Morgan and Forest, 1991	43
<i>Diogenes mixtus</i> Lanchester, 1902	45
<i>Paguristes hians</i> Henderson, 1888	46
Acknowledgements	48
References	48

SYNOPSIS. Species of the hermit crab genus *Diogenes*, collected by Francis P. Bedford and William F. Lanchester from Singapore, and from the 'Skeat Expedition' to Malay Peninsula near the turn of the century have been reviewed for the first time. Specimens identified as *D. senex* Heller from Lanchester's Singapore collecting trip represent an undescribed species, while those from the 'Skeat' expedition to the Malay Peninsula have proved to represent the taxon recently described as *D. stenops* Morgan and Forest. Similarly, specimens identified by Lanchester as *D. rectimanus* Miers do not represent that taxon, but rather *D. avarus* Heller and *D. goniochirus* Forest. Because of this latter confusion, the holotype of *D. rectimanus* has been redescribed. Lanchester's specimens assigned to *D. planimanus* Henderson include both *D. planimanus* and *D. intermedius* De Man. However, the species name, *D. intermedius* De Man, 1892 is preoccupied and a replacement name is proposed. *Diogenes mixtus* Lanchester also has been redescribed, and *D. desipiens* Lanchester placed in synonymy with *Paguristes hians* Henderson. All of the species have been illustrated.

INTRODUCTION

In a recent review of specimens assigned to *Diogenes senex* Heller, 1865, by McLaughlin and Haig (1995), Heller's (1865) taxon was restricted, by neotype designation, to a species presently known only from the eastern coast of Australia. Among the other specimens of *D. senex sensu lato* examined by McLaughlin and Haig (1995) were three lots from the Natural History Museum (BMNH): one from East Africa (BMNH 1955.3.5.58–60), one from the Suez Canal (BMNH 1927.11.2.226), and one from Singapore (BMNH 1905.10.21.33–36). These authors did not attempt to identify the

species from East Africa. They noted that the specimen from the Suez Canal agreed with those identified by Bouvier (1892) and Nobili (1906) as *D. senex* from Suez and Djibouti that had subsequently been referred to *D. gardineri* Alcock, 1905 by Lewinsohn (1969). While the specimens from Singapore 'were definitely' not *D. senex sensu stricto*, McLaughlin and Haig were unable to determine their identity. All three lots have now been reexamined. The specimens from the Suez Canal have been compared with specimens of *D. gardineri* from its type locality, the Maldive Islands, and the identity of the Museum specimens as that species has been verified. The specimen from East Africa has also proved to be *D. gardineri*. The specimens from Singapore represent an undescribed species.

There is little information accompanying these latter specimens except the locality, Blakang mati, Singapore, and the collectors, Bedford and Lanchester. However, as mentioned by Lanchester (1900a) and Ingle (1991), Bedford and Lanchester collected in the Straits Settlements (Singapore and Malacca) during a seven month period (1899–1900). Francis P. Bedford was an echinoderm specialist, but collected on that occasion with Lanchester (Ingle, 1991). William F. Lanchester is best known in the British carcinological community for his publications on the Brachyura from Singapore and Malacca, the Crustacea of Malaysia from the collections of the Karawak Museum and those of the 'Skeat' Expedition to Malaysia (Lanchester, 1900a, 1900b, 1901; Ingle, 1991). Lanchester's (1900a) report 'On a collection of crustaceans made at Singapore and Malacca. — Part I. Crustacea Brachyura', suggested that a second part, dealing with the other Crustacea, was planned, but apparently was never published. Although the brachyuran crabs from the Singapore collection were acquired by the Natural History Museum in 1900 (reg. 1900.10.22); these particular hermit crabs were not added to the registry until 1905.

The second part of Lanchester's report on the Crustacea from the 'Skeat' Expedition to Malaysia (Lanchester, 1902) did deal with the Anomura, Cirripedia, and Isopoda, and included the descriptions of two new species of *Diogenes*, i.e., *D. desipiens* Lanchester, 1902 and *D. mixtus* Lanchester, 1902, and one lot each of specimens attributed to *Diogenes senex*, *D. rectimanus* Miers, 1884, and *D. planimanus* Henderson, 1893. McLaughlin and Haig (1995) expressed the belief that Lanchester's (1902) *D. senex* might correctly represent a species of the *Troglopagurus* group of *Diogenes* (cf. Forest, 1952).

All of Lanchester's (1902) *Diogenes* species from the 'Skeat' Expedition in the collections of the University Museum of Zoology, Cambridge (UMZC) were examined during the present study and despite a thorough search, the single male specimen upon which Lanchester based his description of *D. desipiens* could not be located. Correspondence between Lanchester and then Superintendent S.F. Harmer, and a list of Crustacea from the expedition identified by Lanchester appear in volume V of the University Museum's 'History of the Collection'. Only *D. desipiens* is absent from that list, which suggests strongly that it was never registered at the Museum (R. Symonds, pers. comm.). Consequently, searches were made of the collections of the BMNH and those of the National University of Singapore. Both failed to locate Lanchester's specimen, and it must be presumed that it is no longer extant.

As indicated above, the BMNH's Singapore specimens attributed to *D. senex* are described herein as a new species of *Diogenes*. Lanchester's (1902) Malay *D. senex* is, as suspected by McLaughlin and Haig (1995), a species of the *Troglopagurus* group of *Diogenes*, i.e., *Diogenes stenops* Morgan and Forest 1991. Lanchester's (1902) description of *D. mixtus* consisted of little more than a comparison with three other species. It is now redescribed from the type materials and one additional specimen from Malaysia. Both Lanchester's (1902) *D. rectimanus* and *D. planimanus* have been compared with type material of their respective taxa. His *D. rectimanus* is represented by two different taxa, *D. avarus* Heller, 1865, and a species subsequently described by Forest (1956) as *D. goniochirus* Forest; his *D. planimanus* includes specimens of both *D. planimanus* and *D. intermedius* De Man, 1892.

Notwithstanding the length of Miers' (1884) description, neither it nor his figures are particularly diagnostic, which may account for Lanchester's (1902) confusion. Consequently, the holotype of *D. rectimanus*, also in the collection of the BMNH, is redescribed. De Man's (1892) original description of *D. intermedius* was based on the comparison of a single specimen (sex not indicated) from Pare Pare, Celebes (Sudawesi, Indonesia), that seemed to differ from the

presumed type specimens of *D. custos* (Fabricius, 1798) and *D. miles* (Fabricius, 1787), but incorrectly attributed to H. Milne Edwards (1837). De Man (1892) was sufficiently uncertain about the singularity of his specimen that he described it simply as *Diogenes* sp. with the notation that should it prove to be a species distinct from *D. custos* it should be called *D. intermedius*. Although he provided a rather detailed description, it essentially indicated the differences between his specimen and *D. custos*, and was not accompanied by any illustrations. Until now, subsequent reports have not been based on material. The nomenclatural status of the species name *Diogenes intermedius* De Man, 1892, is compromised because it is preoccupied by *Diogenes pugilator* var. *intermedius* Bouvier, 1891. This matter is resolved by proposing a replacement name for De Man's taxon.

Although the type specimen of *D. desipiens* has not been located, Lanchester's (1902) description and illustrations have been carefully examined. It is our opinion that *D. desipiens* is not a species of *Diogenes*, but rather of *Paguristes*, and in fact is a junior subjective synonym of *Paguristes hians* Henderson, 1888. A comparison of Henderson's taxon, based on its holotype and supplemental material, with Lanchester's (1902) account, provides justification for our synonymy.

MATERIALS AND METHODS

The new species of *Diogenes* comes from the Bedford and Lanchester collection housed in the BMNH. The syntypes of *Diogenes mixtus*, the Malaysian specimens assigned to *D. senex*, and the specimens identified by Lanchester (1902) as *D. rectimanus* and *D. planimanus* have been borrowed from the University of Cambridge collection. The holotype of *Diogenes rectimanus*, the specimen herein designated lectotype of *D. planimanus*, the holotype of *Paguristes hians*, two paralectotypes of *D. goniochirus*, and the additional specimen of *Diogenes mixtus* from Kuching, Malaysia, are in the BMNH collection. The holotype of *D. intermedius* has been borrowed from the Instituut voor Taxonomische Zoölogie (Zoölogisch Museum), Universiteit van Amsterdam (ZMA). Four paratypes of *D. stenops*, borrowed from the Western Australian Museum (WAM), have been compared to verify our determination of Lanchester's (1902) '*D. senex*'. One measurement, shield length (SL), measured from the midpoint of the anterior margin of the shield to the midpoint of the posterior margin provides an indication of specimen size. Photographs all were taken with Nikon 35 mm cameras equipped with a Medical Nikkor 1:5.6/F=200 or Micro Nikkor Auto 1:3.5/F=55 mm lens.

SYSTEMATIC ACCOUNT

Diogenes inglei sp. nov.

(Figs 1a–e, 2a–d, 10a)

MATERIAL EXAMINED. Holotype. Ovigerous ♀ (SL = 1.46 mm), in 'shell' which actually is fragment of worm tube; Blakang mati, Singapore, 1899, collectors, F. Bedford and W. F. Lanchester, BMNH 1905.10.21.33. Paratypes. 2 ♀, 1 ovigerous ♀ (SL = 1.13–1.52 mm), same locality, date and collectors, BMNH 1905.10.21.34–36.

DIAGNOSIS. Shield surface (Fig. 1a) anteriorly and laterally

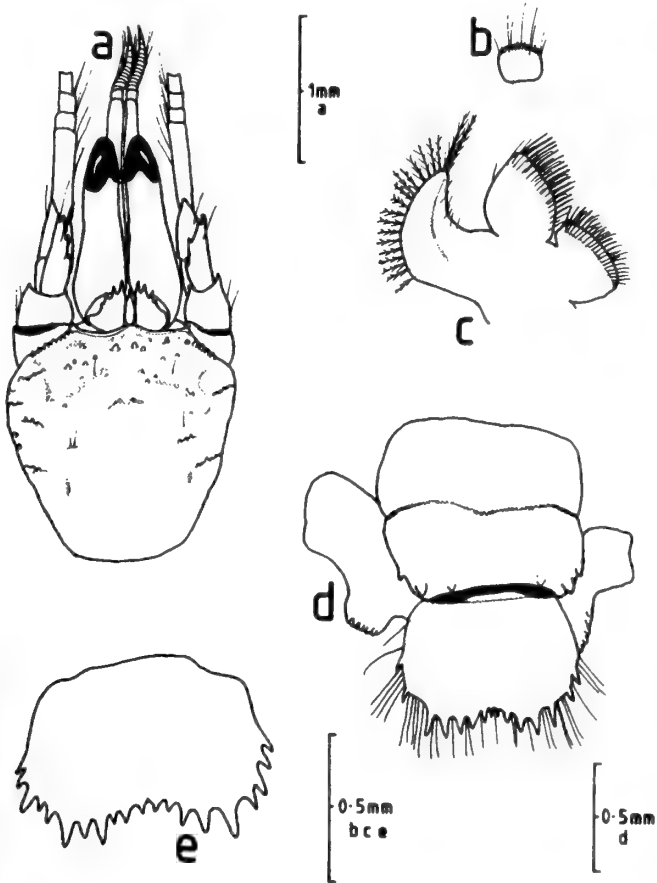

Fig. 1 *Diogenes inglei* sp. nov., holotype ovigerous ♀ SL = 1.46 mm, BMNH 1905.10.21.33; a. shield and cephalic appendages; b. anterior lobe of sternite of 3rd pereopods; c. 1st maxilliped; d. 6th abdominal tergite, protopods of uropods and telson; e. telson.

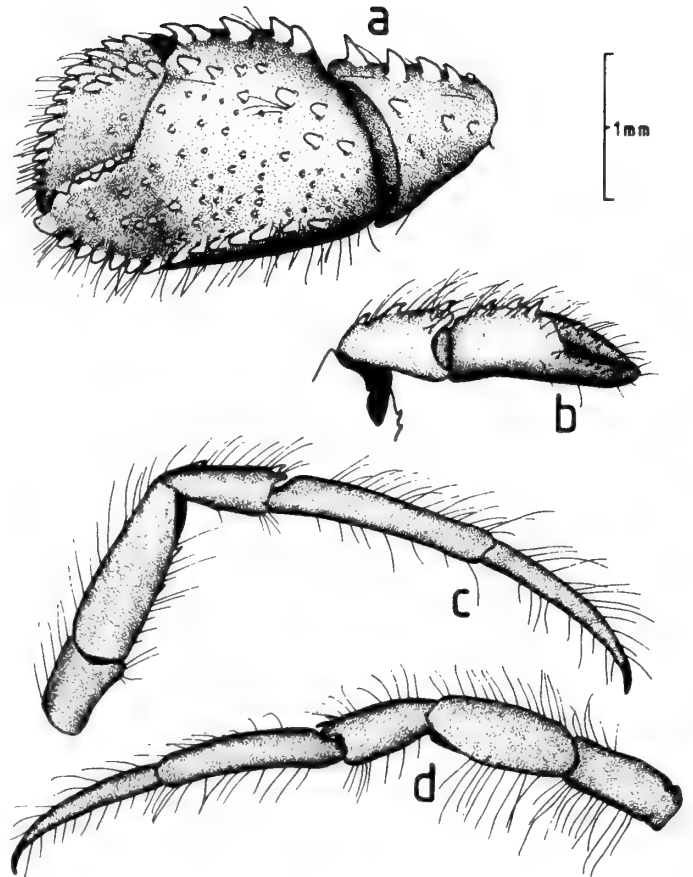

Fig. 2 *Diogenes inglei* sp. nov., holotype ovigerous ♀ SL = 1.46 mm, BMNH 1905.10.21.33; a. left chela; b. right chela; c. right 2nd pereopod; d. left 3rd pereopod.

weakly spinulose. Dorsal margins of branchiostegites with 3–6 small spines or spinules. Ocular peduncles swollen proximally and narrowing distally to tapering corneae; overreached by antennular peduncles. Ocular acicles with 1–3 strong and 1 or more smaller spines. Intercalary rostriform process slender, reaching beyond proximal half of acicle but not to tip of inner-most acicular spines; no ventral spine. Antennal peduncles reaching to or slightly beyond distal margins of corneae. Antennal acicle simple, with bifid terminal spine and 2 widely-spaced spines on mesial margins. Antennal acicles with pair of long pinnate setae on each article. First maxilliped (Fig. 1c) without exopodal flagellum.

Left cheliped (Figs 2a, 10a) with row of prominent spines on upper margins of dactyl, palm and carpus, and lower margins of palm and fixed finger; outer surface of dactyl with short row of spines near upper margin; palm and fixed finger with scattered small spines or tubercles, irregular row of larger spines near upper margin of palm. Right cheliped (Fig. 2b) with row of 3 spines adjacent to upper margin of palm; 3 strong spines on upper margin of carpus. Carpi of ambulatory legs (Figs 2c, d) each with dorsodistal spine and 1 additional spine on dorsal surface proximally on second pereopods. Tergite of sixth abdominal somite with lateral and terminal spines marginally.

Telson (Figs 1d, e) with median cleft practically obsolete; terminal margin with row of several large and few smaller spines, extending onto lateral margins.

DESCRIPTION. Shield (Fig. 1a) longer than broad; anterior margin between rostrum and lateral projections weakly concave; anterolateral margins with marginal or submarginal row of small blunt or acute spinules; anterolateral angle unarmed; posterior margin truncate; dorsal surface with scattered spinules anteriorly and laterally. Rostrum obsolete. Lateral projections obtusely triangular, with prominent marginal or submarginal spine. Dorsal margin of branchiostegite with 3–6 sometimes widely-spaced small spines or minute spinules, 1 spine on anterior margin.

Ocular peduncles moderately long, approximately 0.80 length of shield; swollen proximally and narrowing distally to somewhat reduced and distally tapered corneae, dorsomesial surface with row of long fine setae in proximal half. Ocular acicles almost subtriangular, anterior margin with 1–3 strong and 1 or more smaller spines; separated basally by width of intercalary process. Latter moderately well developed, somewhat depressed, reaching beyond proximal half of ocular acicles, with terminal spinule; no ventral spine.

Antennular peduncles, when fully extended, overreaching corneae by approximately 0.33–0.50 length of ultimate segment. Ultimate segment with 1 or 2 long setae on dorsodistal margin. Penultimate segment with few scattered setae. First segment frequently with small spine on ventrodistal margin.

Antennal peduncles reaching to, or slightly overreaching distal margin of corneae; with supernumerary segmentation. Fifth segment with 3 or 4 pairs of long setae on ventral margin distally. Fourth and third segments with few short setae. Second segment with

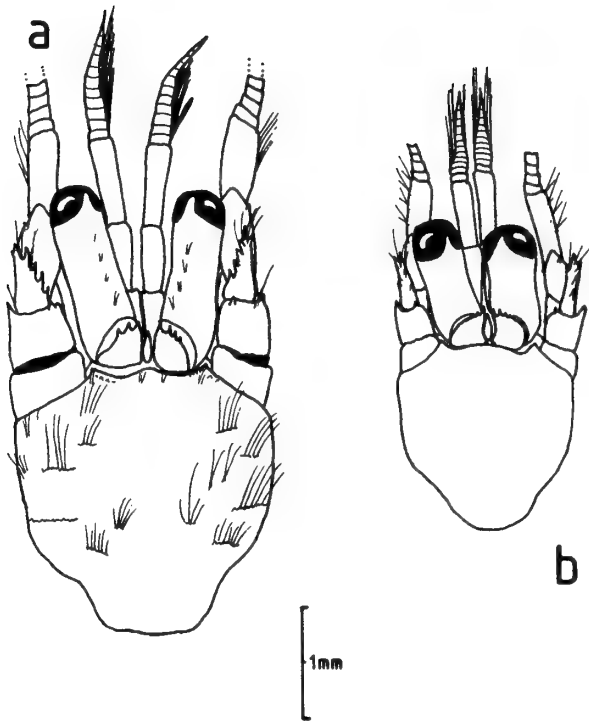

Fig. 3 Shield and cephalic appendages, a. *Diogenes goniochirus* Forest, 1956, ♀ SL = 2.15 mm, UMZC Nov. 30, 1899; b. *Diogenes avarus* Heller, 1865, ♂ SL = 1.53 mm, UMZC Nov. 30, 1899.

dorsolateral distal angle weakly produced and terminating in small spine, dorsomesial distal angle with small spine, laterodistal margin usually with 2 small spines, and 1 or 2 prominent slender spines ventrally. First segment with 1 small spine on lateral margin ventrally. Antennal acicle not reaching to distal apex of fourth peduncular segment, terminating in bifid spine, with 2 widely-spaced spines on mesial margin. Antennal flagella moderately short, approximately as long as ambulatory legs; each article with pair of long pinnate (pappose) setae.

Maxillule with endopod lacking external lobe. First maxilliped (Fig. 1c) lacking flagellum; endopod fused to exopod. Third maxilliped with 2 strong spines on basis, ischium without crista dentata but with 1 very strong curved spine; merus with 1 or 2 spines on ventral margin.

Left cheliped (Figs 2a, 3a) with dactyl approximately 0.33 longer than upper margin of palm; cutting edge with row of calcareous teeth; terminating in small calcareous claw, overlapped by fixed finger; outer surface flattened, with short row of 4 or 5 blunt to extremely slender and acute spines near upper margin and 2 or 3 spinules centrally; upper margin with row of strong, subacute to extremely acute spines, decreasing in size distally and sparsely interspersed with long setae; inner surface with few widely scattered long setae. Fixed finger with outer surface flattened, armed with few scattered small blunt or sharp spines; lower margin armed with row of strong, blunt or acute spines, sparsely interspersed with long setae, and forming weak curve with lower, similarly armed margin of palm; cutting edge with row of calcareous teeth; terminating in prominent calcareous claw. Palm with outer surface convex, armed with scattered blunt or acute spines, with irregular row of stronger spines beginning near midpoint of proximal margin, curving upward, and continuing to near distal articulation with fixed finger; upper margin with 5 or 6 strong subacute or very acute curved spines; inner surface with few scattered tufts of short setae. Carpus

approximately equal to or very slightly longer than palm; upper margin with row of 4 or 5 strong spines, outer face convex and with slightly oblique row of 3 widely-spaced spines; inner surface glabrous. Merus triangular; dorsal margin with row of spinules and tufts of setae, 1 much stronger spine at dorsodistal margin; ventromesial with 3 or 4 small spines in proximal half; ventrolateral margin with 3 or 4 spinules in distal half. Ischium unarmed.

Right cheliped (Fig. 2b) appreciably smaller than left. Dactyl approximately equal to length of palm; upper margin not distinctly delimited, outer surface with few spinules partially obscured by long setae; cutting edge with row of fine corneous teeth, terminating in small corneous claw and overlapped by fixed finger. Palm with row of 3 spines and long setae on or adjacent to upper margin, convex outer face with varying amounts of long setae, usually 1 additional small spine distally near upper margin and second small spine near base of fixed finger, lower margin unarmed; fixed finger with row of very fine spinules in midline; cutting edge with row of corneous teeth, terminating in small corneous claw; inner surfaces of dactyl, fixed finger and palm with long setae, most numerous on dactyl and fixed finger. Carpus with long setae and 3 strong spines on upper margin, outer surface convex, with few long setae and 1 prominent spine at mid-distal margin; inner and lower surfaces with scattered setae. Merus triangular; dorsal margin with 1 or 2 spinules and long setae, 1 more prominent spine at dorsodistal margin; ventromesial margin with 2 or 3 small spines in distal half, ventrolateral margin with 1–3 spinules distally. Ischium unarmed.

Ambulatory legs (Figs 2c, d) with dactyls approximately equaling length of propodi, both dactyls and propodi of second appreciably longer than third, unarmed but with numerous long setae. Carpi with dorsodistal spine and 1 spine on dorsal surface in proximal half (second), unarmed or with tiny proximal spinule (third), dorsal and ventral surfaces with long setae. Meri with long setae on dorsal and ventral surfaces, second with 2 widely-spaced spines, third unarmed. Ischia unarmed, but with long dorsal and ventral setae. Sternite of third pereopods with subquadrate to subrectangular anterior lobe (Fig. 1b), terminal margin with 3–8 small spines and long setae.

Male pleopods unknown. Female with pleopods 2–4 well developed, biramous; pleopod 5 appreciably reduced, with rudimentary exopod. Tergite of sixth abdominal somite with deep transverse median furrow; posterolateral margins each with 2 spines, terminal margin with 1 spine one each side of midline. Protopods of uropods (Fig. 1d) each with row of small tubercles. Telson (Figs 1d, e) with median cleft obsolete or only faintly indicated; terminal margin slightly concave, with row of several large and few smaller spines, extending onto lateral margins.

COLOUR. Unknown.

DISTRIBUTION. At present recognized only from Singapore.

ETYMOLOGY. It is with great pleasure that we dedicate this species to Ray Ingle, formerly of the Crustacea Section, the Natural History Museum, in recognition of his many contributions to our knowledge of decapod crustaceans in general, and of the Paguridea of the northeastern Atlantic and Mediterranean regions in particular.

AFFINITIES. *Diogenes inglei* sp. nov. most closely resembles *D. gardineri* in the general shapes of the left and right chelipeds, and in the armature of the pereopods. *Diogenes inglei* sp. nov. is readily distinguished from Alcock's species by its longer antennal peduncles and flagellum which carries a pair of long pinnate setae ventrally on each article. Differences are also apparent in the armature of the chelipeds. However, variation in cheliped armature is common in species of this genus, and our present knowledge of *D. inglei* sp. nov. is too limited to permit evaluation.

REMARKS. The first maxilliped of *Diogenes* species is not often described or illustrated, but in those few species for which it has been (e.g., Tirmizi and Siddiqui, 1982a), a two-segmented exopodal flagellum is typical. *Diogenes inglei* sp. nov. is the only species of the genus currently known to lack the flagellum; in its place are a pair of short setae (Fig. 1c). Whether this loss is unique to *D. inglei* sp. nov. or simply reflects inadequate examinations of other species remains to be determined. It should be noted, however, that the only hermit crabs routinely lacking a flagellate first maxilliped are parapagurids or coenobitids. *Diogenes inglei* sp. nov. also appears distinctive in having the sixth abdominal segment armed with spines on the posterolateral and posterior margins. This again may simply reflect inadequate observations of other species.

***Diogenes rectimanus* Miers, 1884**

(Fig. 10b)

Diogenes rectimanus Miers, 1884:262, pl. 27, fig. c; Gordan, 1956:318 (in part; lit.).

? *Diogenes rectimanus*: Henderson, 1893:419; Alcock, 1905b:71, pl. 6, figs 8, 8a, pl. 7, fig. 2, 2a; Ajmal Khan and Natarajan, 1984:20, fig. 17; Morgan, 1987b:175; Haig and Ball, 1988:167; Rahayu and Forest, 1995:395.

Non *Diogenes rectimanus*: Lanchester, 1902:366.

MATERIAL EXAMINED. Holotype♂ (SL = 4.30 mm), Prince of Wales Channel, Torres Strait; BMNH 1882.7.

REDESCRIPTION. Shield slightly longer than broad, almost subquadrate; anterior margin between rostrum and lateral projections slightly concave, with 5 or 6 small tuberculate spinules near bases of lateral projections; anterolateral margins sloping; posterior margin truncate; dorsal surface with few transverse spinulose ridges laterally. Rostrum broadly rounded; lateral projections each with rather strong marginal spine. Branchiostegial margins each with 5 or 6 moderately well developed spines.

Ocular peduncles approximately 0.80 length of shield, moderately stout; cornea not dilated; ocular acicles with straight inner margins, broadly rounded anterolaterally, with 3 small, but prominent spines and several additional smaller spinules, not extending entire length of terminal margin. Intercalary rostriform process reaching approximately to distal third of ocular acicles, broad basally, tapering to moderately slender subacute tip.

Antennular peduncles overreaching cornea by almost entire length of ultimate segment. Ultimate segment with few setae dorsally and tuft distally on both ultimate and penultimate segments; basal segment unarmed.

Antennal peduncles overreaching distal margin of cornea by 0.20–0.35 length of ultimate segment. Fifth segment with row of tufts of setae on ventral margin; fourth segment with few scattered setae and small spine on dorsolateral distal margin; third segment with tuft of setae; second segment with small spine at dorsolateral distal angle and very small spine on dorsomesial distal angle, ventrolateral distal angle with small spinule; first segment with row of small spinules on distal margin laterally and similar row of small spinules on lateral margin ventrally. Antennal acicle not reaching to apex of fourth segment, with strong bifid spine and 4 accessory strong spines on mesial margin, few tufts of setae on lateral margin.

Maxillule without external endopodal lobe.

Dactyl of left cheliped (Fig. 3b) approximately 0.35 longer than palm; double row of spines on upper margin, outermost strongest, row of equally strong spines adjacent to upper margin, outer surface with scattered small spinose tubercles and very short setae; cutting edge with multiple series of small calcareous teeth, largest in distal

third; inner surface with row of low protuberances. Palm slightly shorter than carpus; upper surface with irregular triple row of spines, outer surface with slightly concave area just below upper margin with few scattered spinules and tubercles and tufts of short setae, upper outer face with adjacent longitudinal row of moderately strong spines in proximal half, not reaching articulation of palm, remaining outer surface with rather widely-spaced small spines; proximal margin with row of stronger spines continuing to lower margin, lower outer surface of palm spinose, to with short setae; inner surface with few very small tubercles in lower half; lower margin with row of strong, outwardly directed spines, decreasing in size on fixed finger, and adjacent second row of much smaller spines; surface of fixed finger with spinulose tubercles. Carpus with row of moderately blunt spines on upper margin (distal 2 or 3 stronger), outer surface convex, with series of small tuberculate spines, lower margin with strong spine at lower distal angle, inner and lower surfaces with few tubercles. Merus triangular; dorsal surface rounded, with transverse rows of small spines or spinules continuing onto lateral surface dorsally, one such row adjacent to laterodistal margin appreciably longer, mesiodistal margin with row of tuberculate spines, mesial face tuberculate in ventral half, ventromesial margin with row of broad, low bifid spines, ventrolateral margin with row of spines distally becoming spinulose tubercles proximally, ventral surface with numerous low bifid spinules. Ischium with row of small tubercles on laterodistal margin ventrally and proximal margin.

Right cheliped with dactyl approximately 0.35 longer than palm; upper surface with double row of small spines, outer surface with row of slightly larger spines, both surfaces generally concealed by long setae; cutting edge with row of calcareous teeth, terminating in calcareous claw, slightly overlapped by fixed finger. Palm approximately 0.65 length of carpus; upper surface somewhat spinulose, small spines or spinules forming quasi transverse rows; outer face with few small spines or low protuberances and tufts of setae; fixed finger with 2 rows of moderately strong spines on outer surface, cutting edge with quite prominent calcareous teeth; inner surface of palm with tufts of setae, row of widely-spaced tubercles on fixed finger. Carpus with row of spines on upper margin and second adjacent row on upper outer face, outer distal margin with 2 spines, low protuberances on lower outer face, surfaces all with long setae. Merus with short transverse spinulose ridges and tufts of setae on dorsal margin, lateral face with low spinulose protuberances; ventrolateral margin with 2 acute spines distally, low sometimes bifid spinulose protuberances proximally extending onto ventral surface; mesial face generally glabrous, ventromesial margin with row of small spinules distally, double row of stronger spinules proximally. Ischium with 2 spinules on ventromesial margin.

Ambulatory legs similar. Dactyls 0.25–0.35 longer than propodi; dorsal margins of dactyls each with almost double row of long stiff dense setae, lateral faces with faint transverse sulcus in proximal half and row of long setae, ventral margins each with row of long setae proceeding onto lateroventral margin distally, mesial faces also with row of long stiff dense setae ventrally and second row of stiff setae beginning in upper half and progressing ventrally toward claw. Propodi approximately 0.25 longer than carpi, right with dorsal, ventral, mesial and lateral tufts of setae, left with tufts of setae accompanied by row of spinules dorsal surfaces, strongest on third. Carpi each with row of acute spines, somewhat shorter on third. Meri with dorsal and ventral tufts of setae; second with spinulose protuberances ventrally on lateral faces and row of small spinules on ventral margin, ventrolateral distal margin also with row of spinules. Ischia with 2 or 3 spinules (second) or unarmed (third). Sternite of third pereopods with indistinctly bilobed anterior lobe, each pseudo-lobe with tuft of setae.

Telson with small median cleft, terminal margins of both lobes with long spines interspersed with slightly smaller spines, extending down lateral margin of left only.

COLOUR. Not known.

DISTRIBUTION. Known with certainty only from the Torres Strait, Arafura Sea; ? Persian Gulf, Gulf of Aden, India, Sri Lanka, Indonesia, and Northern Australia.

REMARKS. Henderson's (1893) very brief diagnosis of *D. rectimanus* could refer to several species. The fact that he noted that the lower margin of the left chela and fixed finger was straight, and the fingers very short suggests that he may not have been dealing with Miers' (1884) species. Alcock (1905) stated in his diagnosis that the merus of the left cheliped was not spinose. The merus of the left cheliped of the holotype of *D. rectimanus* has a spinulose dorsal margin; both the ventromesial and ventrolateral margins are spinose. However, Alcock's (1905, pl. 6, fig. 8, pl. 7, fig. 2) figures show a very strongly armed merus, and in other respects do bear considerable similarity to the holotype of *D. rectimanus*. None of the other citations of this species are sufficiently detailed to ascertain whether or not the authors were actually dealing with Miers' (1884) taxon. However, as pointed out by Rahayu and Forest (1995), Haig and Ball's (1988) notation on the reduced armature of the lower margin of the palm of the left cheliped, does suggest that they may not have been, despite the close proximity of their specimen to the type locality.

Diogenes goniochirus Forest, 1956

(Figs 3a, 8a, 9a, 11a)

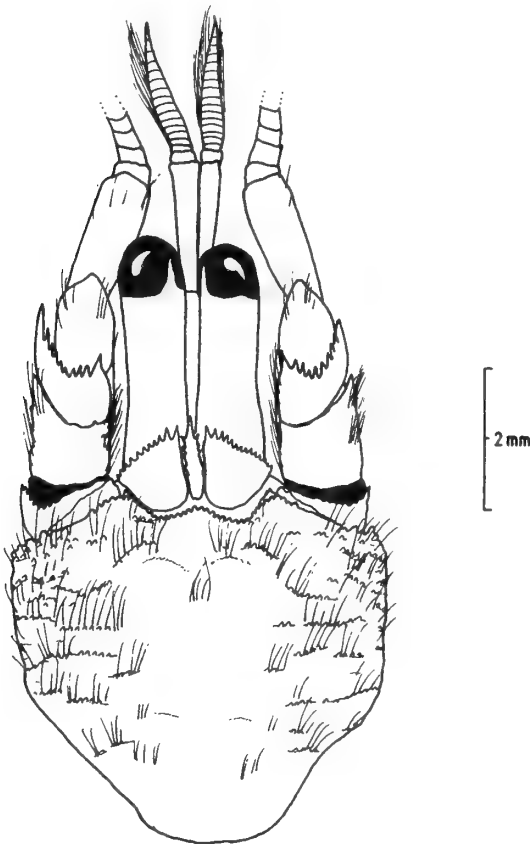

Fig. 4 Shield and cephalic appendages, *Diogenes planimanus* Henderson, 1893, ♀ SL = 4.85 mm, UMZC Nov. 30, 1899.

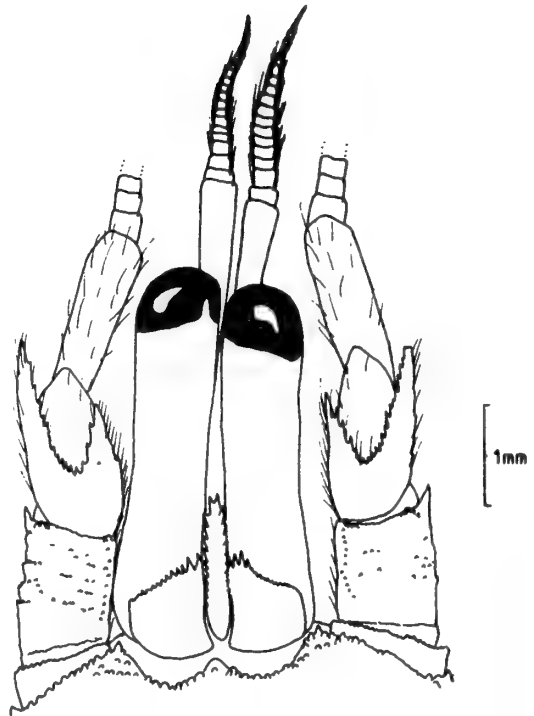

Fig. 5 Anterior portion of shield and cephalic appendages, *Diogenes platvoeti* nom. nov., holotype ♂ SL = 4.81 mm ZMA De201.872.

Diogenes rectimanus: Lanchester, 1902:366 (in part) [**Non** *Diogenes rectimanus* Miers, 1884].

Diogenes goniochirus Forest, 1956:527, figs 5–7; Rahayu and Forest, 1995:395.

MATERIAL EXAMINED. Type material. Paralectotype ♂ (SL = 2.78 mm), ovigerous ♀ (SL = 3.05 mm), Long Hai, Cochinchine, Vietnam, Modest, 1905; BMNH 1995.1663–64.

Lanchester material examined. 1 ♀ (SL = 2.15 mm), 'Loc. —?', 'Skeat' Expedition, Malay Peninsula; UMZC, Nov. 30, 1899.

DIAGNOSIS. Shield (Fig. 3a) as broad or slightly broader than long; anterior margin with only few spinules between broadly rounded rostrum and slightly produced lateral projections; dorsal surface with few transverse, setose and/or spinulose ridges laterally. Dorsal margin of branchiostegite with row of closely-spaced small spines over entire length. Ocular peduncles 0.75–0.80 length of shield; corneae dilated little if at all. Ocular acicles broadly sub-triangular; terminal margins with 3 or 4 spines, extending approximately half length of margins. Intercalary rostriform process subovate, acute, not reaching to tips of acicular spines, no ventral spine. Antennular and antennal peduncles approximately equal in length, both over-reaching ocular peduncles. Antennal acicles not forked, with simple terminal spine, lateral margin with 1 spine distally, mesial margin with row of 4–6 spines. Antennal flagella with long ventral setae.

Left cheliped (Fig. 11a) with ventral and lateral faces of merus spinulose, ventromesial distal margin with row of very small spines; outer face of carpus spinulose, with longitudinal row of small spines centrally, culminating in strong spinose protuberance distally, upper margin with row of spines; lower surface and margin of palm and fixed finger straight or convex, armed with 3 to several rows of blunt or spinulose tubercles, outer surface of palm spinulose but without median crest, row of small spines on upper margin of palm, sometimes more prominent distally, double row of spines on dactyl. Right

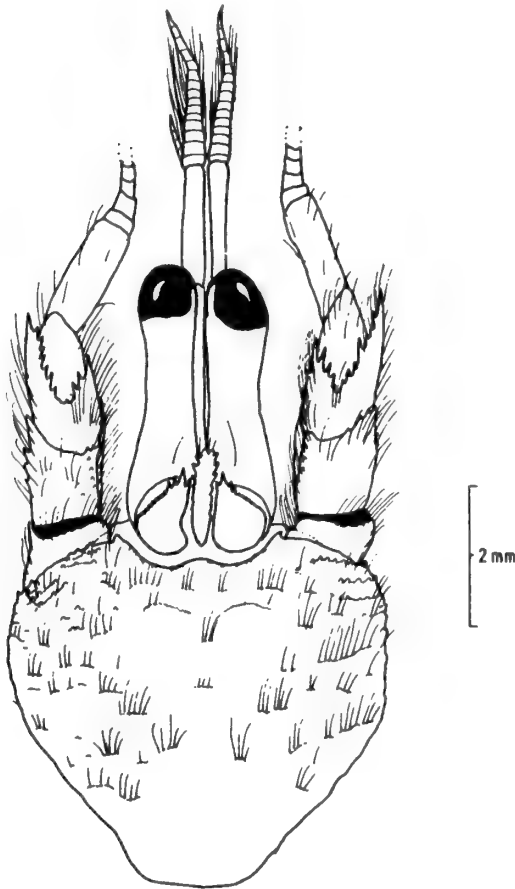

Fig. 6 Shield and cephalic appendages, *Diogenes platvoeti* nom. nov., ♀ SL = 4.67 mm, UMZC Nov. 30, 1899.

cheliped with row of very small spines on upper surfaces of carpus, palm, and dactyl, all practically obscured by rows of long setae. Ambulatory legs with dorsal margins of carpi each with row of closely-spaced small spines; dorsal margins of propodi each with row of very small spinules and long setae (second) or double row of long stiff setae (third); mesial faces of dactyls (Fig. 8a) each with 4 rows of setae, dorsal and ventral rows long and simple, median rows shorter and pinnate, more distinct on third.

Telson with distinct median cleft, lobes slightly asymmetrical; terminal margins with 2–4 moderate to strong and 3–6 smaller spines, sometimes extending onto lateral margins.

COLOUR. Not reported.

DISTRIBUTION. Vietnam; Malaysia; Indonesia.

REMARKS. The Malay specimen of *D. goniochirus* is the largest of 12 specimens identified by Lanchester (1902) as *Diogenes rectimanus*, and the only one he removed from its shell. Lanchester remarked that the small size of the specimens probably accounted for the lack of prominence of the spines on the lower margin of the left chela and more obscure arrangement of granules on this appendage. Judging from the development of the pleopods, this specimen is most probably a mature female. In having a prominent spinose protuberance on the carpus and lack of a crest on the outer surface of the palm of the left cheliped, this specimen agrees well with the paralectotypes of *D. goniochirus* that we examined. The spinose dorsodistal angle of the palm is also apparent, but not as prominent

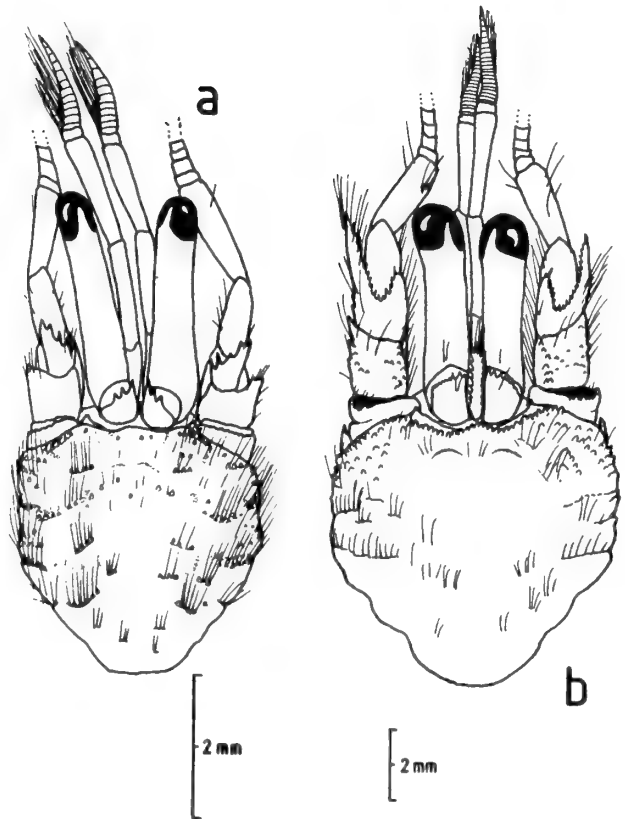

Fig. 7 Shield and cephalic appendages, a. *Diogenes stenops* Morgan and Forest, 1991, ovigerous ♀ SL = 3.11 mm, UMZC Nov. 30, 1899; b. *Diogenes mixtus* Lanchester, 1902, lectotype ♂ SL = 6.88 mm, UMZC I.10050.

as in the paralectotype female. The setation of the mesial faces of the ambulatory legs is a little more distinct, but corresponds well with that of the paralectotypes. The remaining 11 specimens, all of appreciably smaller size but none the less mature, differ markedly from this specimen of *D. goniochirus*, and are assigned to *D. avarus*.

Diogenes avarus Heller, 1865

(Figs 3b, 8b, 9b, c, d, 11b)

Diogenes avarus Heller, 1865:83, pl. 7, fig. 2; Alcock, 1905: 68, pl. 6, figs 6, 6a; Forest, 1956:524, figs 1–4; Lewinsohn, 1969:37, fig. 4; Tirmizi and Siddiqui, 1982a:54, fig. 29; Haig and Ball, 1988:167; Rahayu and Forest, 1995:398, Figs 2b, g, h.

Diogenes rectimanus: Lanchester, 1902:366 (in part) [**Non** *Diogenes rectimanus* Miers, 1884].

? *Diogenes avarus*: Ajmal Khan and Natarajan, 1984:18, fig. 15.

MATERIAL EXAMINED. Lanchester's material. 7♂, 3♀, 1 ovigerous ♀, (SL = 1.04–1.52 mm), 'Loc. — ?', 'Skeat' Expedition, Malay Peninsula, UMZC, Nov. 30, 1899.

DIAGNOSIS. Shield (Fig. 3b) longer than broad, with few short transverse spinulose ridges and long setae on dorsal surface; rostrum obsolete or broadly rounded. Dorsal margins of branchiostegites with 5–8 small spines. Ocular peduncles short and moderately stout; overreached by both antennular and antennal peduncles. Ocular acicles broad, with 1–3 strong spines and several minute spinules on terminal margin, not extending entire length. Intercalary rostriform process slender, reaching beyond proximal half of acicle but not beyond tip of inner-most acicular spines. Antennal peduncles slightly

shorter to nearly equal length of antennular peduncles. Antennal acicle not reaching to distal apex of fourth peduncular segment, with simple or bifid terminal spine, lateral margins usually 1 or 2 spines distally, mesial margins with 3–7 small spines. Antennal flagellum with paired long setae ventrally.

Left cheliped (Fig. 11b) with 1 or more rows of small simple or bifid spines on dorsal margin of merus, ventromesial distal angle with 3 or 4 prominent spines, ventrolateral margin with 2–5 much smaller spines distally; broad upper surface of carpus with 3 rows of small acute or subacute spines, stronger on slightly produced distal angle, outer face angularly convex with tuberculate or spinose protuberance at median distal margin, surface armed with blunt or spinulose tubercles and small spines; lower margin of fixed finger and palm straight, with irregular rows of small tubercles or subacute spines; palm with convex outer surface armed with moderately to closely-spaced tubercles, subacute or acute spines or spinules, and with crest of stronger tubercles or spines proximally near midpoint of proximal margin but not continued to articulation with dactyl, upper margin with irregular usually double row of small spines, strongest on produced upper distal angle; upper surface of dactyl with 3 rows of spines. Right cheliped with noticeable hiatus between dactyl and fixed finger; upper margins of carpus, palm and dactyl each with 1–3 rows of small spines partially obscured by long plumose setae. Ambulatory legs with dorsal margins of carpi each with double row of small spines on dorsal surface of second, usually only single row of smaller spinules on third; propodi with irregular row of small spines or spinules, always on second, frequently on third; mesial faces of dactyls (Fig. 8b) each with 2 rows of rather widely-spaced moderately short setae. Anterior lobe of sternite of third pereopods (Fig. 9b) with roundly rectangular, with tuft of setae on either side of midline.

Telson (Figs 9c,d) with median cleft; terminal margin of left lobe with 3–6 large spines extending onto lateral margin and several very small spinules medianly, right terminal margin with 4–6 small spines.

COLOUR. Carapace rather uniform dark brown. Ocular peduncles uniform light brown, or brown with broad, oblique white band medially; cornea golden. Proximal segment of antennular peduncles dark brown; distal segment with brown chromatophores on white. antennal flagella banded brown and white. Merus and carpus of left cheliped solid light brown, chela white; right cheliped solid light brown. Meri of ambulatory legs white with 2 brown bands; carpi light brown with white band distally; propodi white medially, otherwise dark brown proximally and light brown distally; dactyl dark brown proximally and white distally (after Haig and Ball, 1988).

DISTRIBUTION. Indian Ocean, from Red Sea and east coast of Africa to Mergui Archipelago; Malaysia; Vietnam; Philippine Islands; Indonesia; New Guinea; northeast coast of Australia.

REMARKS. Lanchester's specimens agree well with Forest's (1956) description and with small specimens of this species from northern Australia, particularly in having spinules on the dorsal surfaces of both the carpi and propodi of the ambulatory legs. This is in contrast to the figures of *D. avarus* given by Rahayu and Forest (1995: Fig. 2 g, h) in which the propodi are unarmed, and the third left pereopod has only a few dorsodistal spines on the carpus. However, we observed a similar lack of propodal armature and reduced carpal spination in specimens from Barunda Beach, Lovina Bali. Rahayu and Forest's illustrated specimen was one of their largest males (SL = 3.5 mm), while our specimens from Bali had SL's of 2.84–2.96 mm. The largest of the Lanchester specimens had a SL of only 1.52 mm. It may be that propodal spination is lost with increased animal

size, as the specimens agree in other morphological characters. The identification of *D. avarus* by Ajmal Khan and Natarajan (1894:18, fig. 15) is uncertain.

Diogenes planimanus Henderson, 1893

(Figs 4a, 9c,e, 12a)

Diogenes planimanus Henderson, 1893:416, pl. 39, figs 5, 6; Lanchester, 1902:365 (in part); Nobili, 1903a:15; Dechancé, 1964: 35; Tirmizi and Siddiqui, 1982a:43, figs 21, 22; 1982b:fig. 18.

Diogenes custos var. *planimanus*: Alcock, 1905b:66, pl. 6, fig. 3; Sundara Raj, 1927:133; Kamalaveni, 1950:80; Gordan, 1956:317. ? *Diogenes planimanus*: Ajmal Khan and Natarajan, 1984:16, fig. 13.

MATERIAL EXAMINED. Lectotype (herein designated). ♀ (SL = 5.7 mm) Madras; BMNH 1894:7:21:4. Type locality restricted by lectotype designation to Madras.

Lanchester material examined. 3 ♂, 2 ♀ (SL = 4.72–6.36 mm) Patani; UMZC, Nov. 30, 1899.

DIAGNOSIS. Shield (Fig. 4) nearly as broad as long; anterior

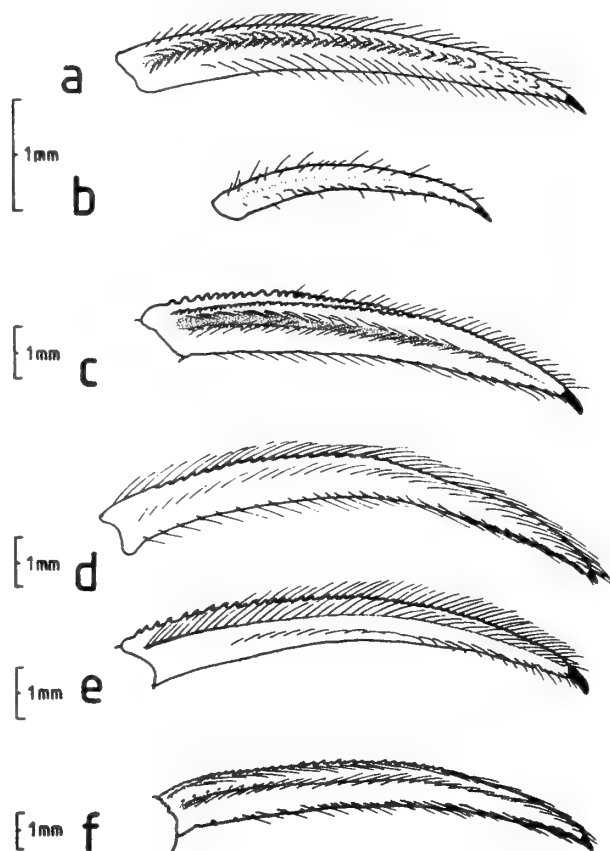

Fig. 8 Dactyl of left 3rd pereopod (mesial view), a. *Diogenes goniochirus* Forest, 1956, ♀ SL = 2.15 mm, UMZC Nov. 30, 1899; b. *Diogenes avarus* Heller, 1865, ♂ SL = 1.53 mm, UMZC Nov. 30, 1899; c. *Diogenes planimanus* Henderson, 1893, ♀ SL = 4.85 mm, UMZC Nov. 30, 1899; d. *Diogenes platvoeti* nom. nov., holotype ♂ SL = 4.81 mm ZMA De201.872; e. *Diogenes platvoeti* nom. nov., ♀ SL = 4.67 mm, UMZC Nov. 30, 1899; f. *Diogenes mixtus* Lanchester, 1902, paralectotype ♂ SL = 5.81 mm, UMZC I.10050.

margin denticulate over entire length. Dorsal margin of branchiostegite denticulate anteriorly and with 3 or 4 distinct spines posteriorly. Ocular peduncles approximately 0.80 shield length, moderately slender. Ocular acicles spinose along entire terminal margin. Intercalary rostriform process slightly overreaching tips of acicular spines; with 2–5 spines on lateral margins in distal two-thirds and terminal spine. Antennular and antennal peduncles approximately equal in length, both overreaching ocular peduncles. Antennal acicle weakly produced mesially, not distinctly forked, anterior margin concave and spinulose or spinose.

Left cheliped (Fig. 12a) with upper margin of dactyl armed with row of closely-spaced spinulose tubercles flanked on either side by row of smaller tubercles; palm with 2 rows of moderately small tuberculate spines on upper margin, proximal margin with row of large blunt or spinulose tubercles; outer surfaces of dactyl, palm and fixed finger all with blunt or acute tubercles, strongest in upper half of palm, lower half of palm flattened, lower margin of palm and fixed finger straight; carpus with double row of spines on upper margin, outer face with irregular row of spines, strongest distally; inner faces of palm and carpus tuberculate. Right cheliped with spinulose upper margin of dactyl partially obscured by long setae; upper margin of palm with irregular row of small spines, outer surface granular or weakly tuberculate; carpus with row of strong spines on dorsal margin and row of smaller spines centrally on outer surface. Ambulatory legs with dorsal margins of dactyls each with double row of small spines, mesial faces (Fig. 8c) each with longitudinal row of small spines partially obscured by row of long setae; propodi, carpi and meri each with double or triple rows of spines or spinulose on dorsal margins, lateral faces of propodi, carpi and meri spinulose or tuberculate, distal margins of carpi also spinulose.

Males with paired gonopores, female with single right gonopore. Telson (Fig. 9e) without distinct median cleft, but with markedly asymmetrical lobes; terminal and lateral margins each with several strong spines interspersed by small spinulose.

COLOUR. Ocular peduncles, antennular and antennal peduncles marked with alternating longitudinal stripes of cream and grey or brownish grey. Rostrum and ocular acicles grey with tinge of red; shield with dark grey-brown patches. Chelipeds and ambulatory legs brown with dark brownish-grey patches (after Tirmizi and Siddiqui, 1982a).

DISTRIBUTION. Indian Ocean, including Bay of Bengal and northern Arabian Sea; Malaysia; southeast coast of Australia.

REMARKS. Only one of the five syntypes is present in the BMNH's collection, *i.e.*, a female, one of four specimens from Madras. The fifth syntype is from Rameswaram. Presumably the remaining syntypes are in the collection of the Indian Museum. Because of the considerable morphological similarities among *D. planimanus*, *D. violaceus* Henderson, 1893, *D. intermedius* De Man, 1892, and *D. custos* (Fabricius, 1798), we are designating the female in the BMNH collection (BMNH 1894:7:21:4) as the lectotype of *D. planimanus*.

Lanchester reported eight specimens of *D. planimanus*, three from 'Loc. —?' from *Murex* shells, and five from Patani from *Natica* shells. The collection now consists of seven specimens: two (one without a shell and one in a *Thais* sp. shell) presumably are those from the unknown locality; five, of which four were still in shells of two species of *Natica*, presumably are those from Patani. The five latter specimens are indeed *D. planimanus*; the other two are not. Of the specimens of *D. planimanus*, only one is complete, although its left second and third pereopods are detached. The left chelipeds are missing on the other four, as are most of the ambulatory legs. Despite

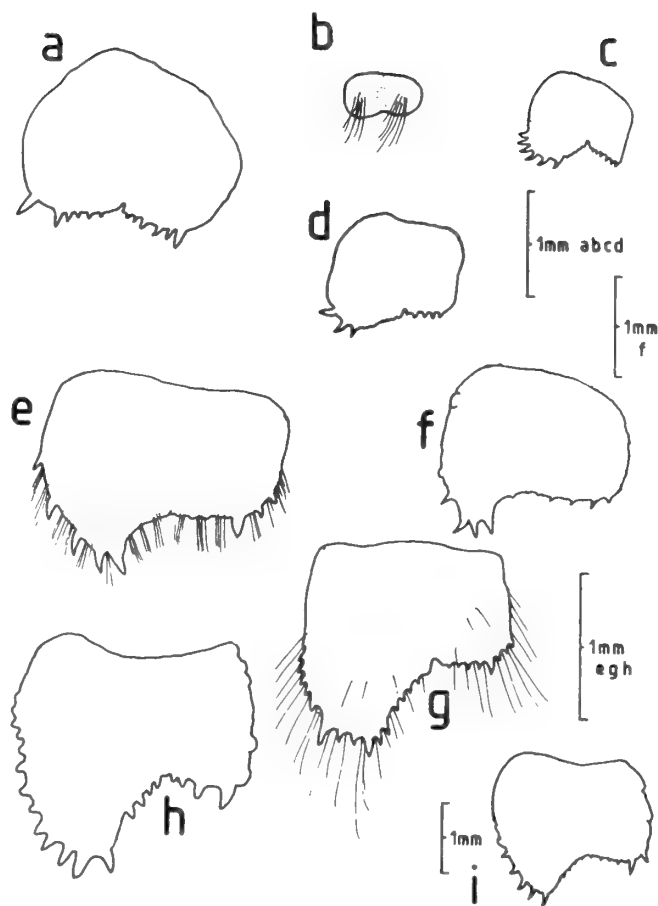

Fig. 9 a. Telson, *Diogenes goniochirus* Forest, 1956, ♀ SL = 2.15 mm, UMZC Nov. 30, 1899; b. anterior lobe of sternite of 3rd pereopod, *Diogenes avarus* Heller, 1865, ♂ SL = 1.53 mm, UMZC Nov. 30, 1899; c. telson, *Diogenes avarus* Heller, 1865, ♂ SL = 1.53 mm, UMZC Nov. 30, 1899; d. telson, *Diogenes avarus* Heller, 1865, ♂ SL = 1.53 mm, UMZC Nov. 30, 1899; e. *Diogenes planimanus* Henderson, 1893, ♀ SL = 4.85 mm, UMZC Nov. 30, 1899; f. telson, *Diogenes platvoeti* nom. nov., holotype ♂ SL = 4.81 mm ZMA De201.872; g. telson, *Diogenes stenops* Morgan and Forest, 1991, ovigerous ♀ SL = 3.11 mm, UMZC Nov. 30, 1899; h. telson, *Diogenes platvoeti* nom. nov., ♀ SL = 4.67 mm, UMZC Nov. 30, 1899; i. *Diogenes mixtus* Lanchester, 1902, lectotype ♂ SL = 6.88 mm, UMZC I.10050.

some variation in the length and armature of the intercalary rostriform process and relative lengths of the ocular, antennular and antennal peduncles these specimens agree well with the lectotype.

Of the two remaining specimens, only one has appendages, although the left cheliped is detached. These specimens are immediately distinguished from *D. planimanus* by the more triangular shape of the shield, longer and more strongly armed intercalary rostriform process, longer antennular peduncles, deeply forked antennal acicles, and ambulatory dactyls that lack a row of spines on the mesial faces.

Dechancé (1964) indicated that *D. planimanus* may have been confounded with *D. custos* over a large portion of the range of the latter. *Diogenes custos*, as described and illustrated by Tirmizi and Siddiqui (1982a), does share some characters with Lanchester's two misidentified specimens, including the longer rostriform process and unarmed mesial faces of the ambulatory dactyls. However, as discussed below, Lanchester's specimens represent *D. intermedius*.

The identity of specimens assigned to *D. planimanus* by Ajmal Khan and Natarajan (1984: 16, fig. 13) is uncertain.

Diogenes platoveti nom. nov.

(Figs 5, 6, 8d, e, 9f, h, 12b)

Diogenes sp. De Man, 1892:352.

Diog. intermedius De Man, 1892:354.

Diogenes intermedius: Alcock, 1905:165 (list); Gordan, 1956:317 (list); Rahayu and Forest, 1995:385 (key), 387.

MATERIAL EXAMINED. Holotype by monotypy. ♂ (SL = 4.81 mm), Pare Pare, Celebes (Sudawesi, Indonesia), 1889, coll. M. Weber, ZMA De.201.872; holotype of *D. intermedius* De Man, 1892. Lanchester's material. 1 ♀ (SL = 4.67 mm), 1 ♂ (SL = 5.86 mm) lodged in shell of *Thais* sp., (Malaysia), collection site unknown, 'Skeat' Expedition; UMZC Nov. 30, 1899.

DIAGNOSIS. Shield (Figs 5, 6) slightly longer than broad, roundly triangular; dorsal surface weakly spinulose and rugose; anterior margin very weakly denticulate between obsolete rostrum and produced lateral projections. Dorsal margin of branchiostegite nearly smooth, with sparse row of setae. Ocular peduncles approximately

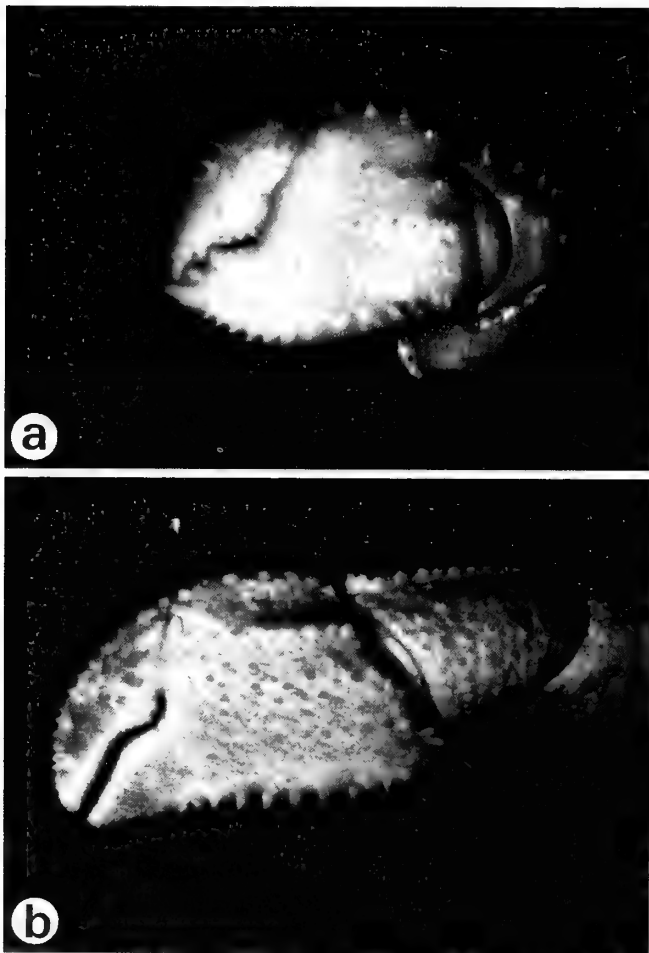

Fig. 10 Left chela (outer face), a. *Diogenesinglei* sp. nov., holotype ovigerous ♀ SL = 1.46 mm, BMNH 1905.10.21.33; b. *Diogenesrectimanus* Miers, 1884, holotype ♂ SL = 4.30 mm, BMNH 1882.7.

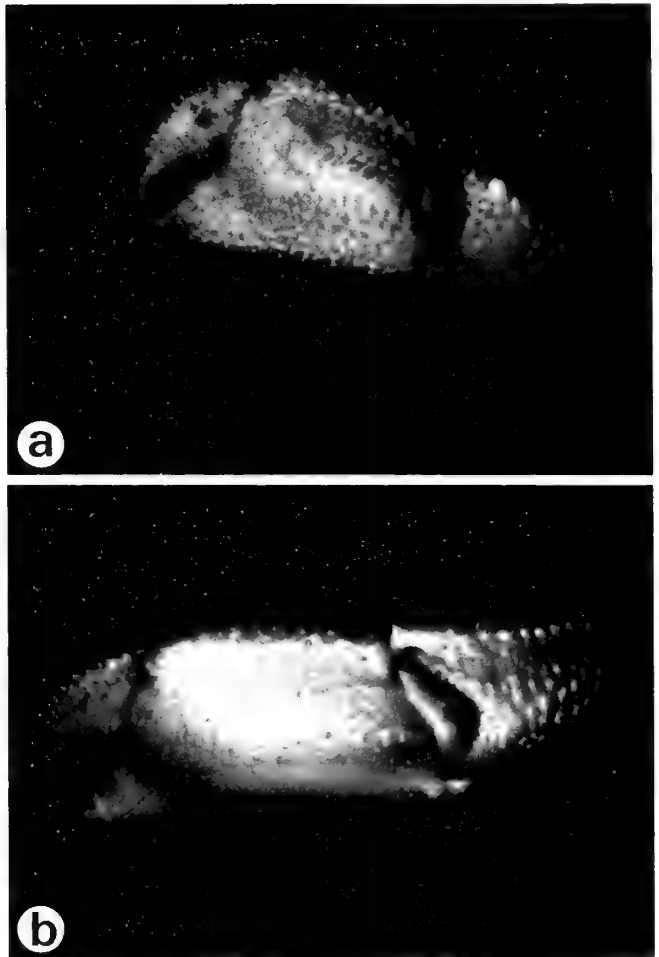

Fig. 11 Left chela (outer face), a. *Diogenesgoniochirus* Forest, 1956, ♀ SL = 2.15 mm, UMZC Nov. 30, 1899; b. *Diogenesavarus* Heller, 1865, ♂ SL = 1.53 mm, UMZC Nov. 30, 1899.

0.90 length of shield, moderately slender. Ocular acicles with 3 or 4 spines mesially and marginal row of very tiny spinules. Intercalary rostriform process approximately 0.3 longer than longest acicular spines; with 3–5 prominent spines, 4 or 5 additional much smaller blunt spinules on lateral margins, and blunt or acute terminal spine. Antennular peduncles overreaching antennal peduncles by 0.60–0.75 length of ultimate segment, and ocular peduncles by entire ultimate segment. Antennal acicle strongly bifurcate, outer projection slightly overreaching distal margin of penultimate segment, inner reaching slightly beyond proximal half; anterior margins of both spinose. Antennal flagellum with irregular long and short setae, at least in proximal half.

Left cheliped (Fig. 12b) with upper margin of dactyl armed with double row of closely-spaced small subacute spines, innermost smallest, with intervening row of long setae; palm with double row of larger subacute spines, proximal margin not distinctly delimited; outer surfaces of dactyl, palm and fixed finger with scattered small subacute or acute spines, largest forming faint arch medianly on palm. Lower margin of palm and fixed finger convex, with generally double row of subacute spines; carpus with numerous small spines on outer surface, strongest in lower half, upper margin with double row of spines; inner faces of palm and carpus tuberculate. Right cheliped with row of long stiff setae between and practically obscured

ing double row of small spines on upper margin of dactyl; upper margin of palm with very short double row of small spines, outer surface of palm, fixed finger and dactyl with widely scattered small spines and tufts of long setae; carpus with row of spines on upper margin, and outer face with scattered spinules and longitudinal row of spines, all partially obscured by long setae. Ambulatory legs with dorsal margins of dactyls each with somewhat irregular row of small spines and long stiff setae, lateral surfaces each with longitudinal sulcus, mesial surfaces (Fig. 8d, e) each with 2 longitudinal rows of quite long setae; propodi each with double row of spines on dorsal surface, carpi and meri each with single row of spines; lateral surfaces of propodi and carpi tuberculate or spinulose, lateral faces of meri nearly smooth; segments all with setose lateral surfaces.

Telson (Figs 9f, h) without median cleft, but with incipient lobes markedly asymmetrical; smaller right lobe with few moderately strong spines on terminal margin, lateral margin with several tubercles or protuberances; elongate, subtriangular left lobe with few spines on oblique terminal margin and series of spines on lateral margin.

COLOUR. Unknown.

DISTRIBUTION. Indonesia; Malaysia.

ETYMOLOGY. This species is named for Dirk Platvoet, Curator of Crustacea, the Instituut voor Taxonomische Zoölogie, Zoölogisch Museum, Universiteit van Amsterdam. The authors of this study hope that honour has been fully satisfied and thank Dirk for his persistence in locating the type of *Diogenes intermedius* De Man.

REMARKS. The species name *Diogenes intermedius* of De Man, 1892 is preoccupied by *Diogenes pugilator* var. *intermedius* Bouvier, 1891 (see page 404). According to ICZN 1985: 39, Article 16, a name proposed with the term 'variety' or 'form' before 1961 does not prevent availability [Art. 45g]. The species of De Man (1892) is, therefore, given the replacement name *Diogenes platvoeti* nom. nov.

Of the two specimens in the Lanchester collection, only the female has chelipeds and ambulatory legs. Both the holotype and the Malaysian specimens are notable in lacking armature on the dorsal margins of the branchiostegites. Lanchester's specimens differ from the holotype in having slightly longer antennular and antennal peduncles. In these specimens the antennal peduncles overreach the distal margin of the corneae by nearly the entire length of the ultimate segment (Fig. 6); the antennal peduncles exceed the corneae by 0.25–0.35 the length of the fifth segment. In the holotype, the corneae are exceeded by only 0.75 the length of the ultimate antennular segment (Fig. 6) and 0.15–0.20 the length of the fifth segment of the antennal peduncles. De Man (1892) distinguished *D. intermedius* [now *D. platvoeti* nom. nov.] from *D. custos* by the more strongly bifurcate antennal acicles of his specimen. The acicles of Lanchester's specimens are similarly more strongly forked (Fig. 6), differing from the holotype (Fig. 5) only in having the outer projection slightly broader and the inner projection slightly shorter. The spination of the lateral margins of the second segment of the antennal peduncle is slightly stronger in Lanchester's material, but the dorsal surface is more spinulose in the holotype. Minor differences between the holotype (Fig. 5) and Malaysian specimens (Fig. 6) have also been observed in the intercalary rostriform process, which in the former is longer and more prominently spinulose in the proximal half.

There is general agreement between Lanchester's intact specimen and De Man's specimen as it pertains to armature of the chelipeds; however, we did find a difference in the specific number of spines present on the inner marginal row of the dactyl and on the upper margin of the palm of the left cheliped. Similarly, the spines on the

outer face of the palm are somewhat stronger in the Malaysian specimen than in the holotype. The row of spines on the dorsal margin of each of the ambulatory dactyls is also stronger in Lanchester's specimens, and the median setal row on the mesial face more complete (Figs 8d, e). The telsons of Lanchester's specimens are also more strongly armed, but the general configuration of the lobes is comparable and the median cleft is absent in both (Figs 9f, h). Tirmizi and Siddiqui (1982a) noted that females of *D. custos* have a gonopore only on the right coxa of the third pereopods. Lanchester's female has paired gonopores, a character which distinguishes it not only from *D. custos*, but also *D. planimanus*.

Diogenes stenops Morgan and Forest, 1991

(Figs 7a, 9g, 13b)

Diogenes senex: Lanchester, 1902:366; **non** *Diogenes senex* Heller, 1865.

Diogenes jousseau mei: Morgan, 1987b:179; **non** *Diogenes jousseau mei* (Bouvier, 1897).

Diogenes stenops Morgan and Forest, 1991:671, figs 9, 10.

MATERIAL EXAMINED. Paratypes: 2♂ (SL = 3.20, 5.40 mm), 1♀ (SL = 4.90), 25 mi south of Cairns, Queensland, 8 November 1965, 27 m, WAM 516–65; 1 ♂ (SL = 2.42 mm), New Year's Island

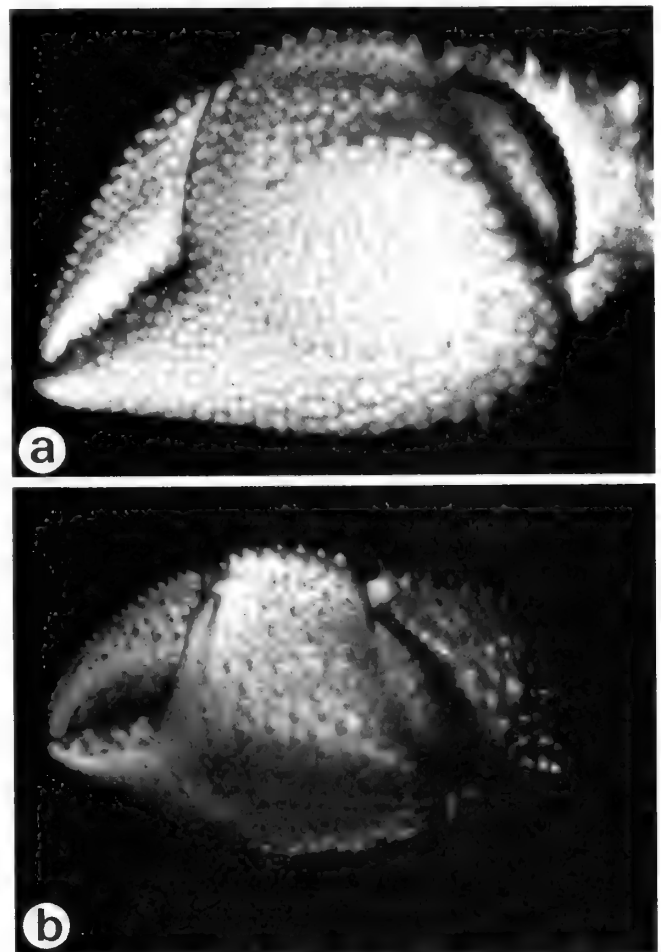

Fig. 12 Left chela (outer face), a. *Diogenes planimanus* Henderson, 1893, ♀ SL = 4.85 mm, UMZC Nov. 30, 1899; b. *Diogenes platvoeti* nom. nov., ♀ SL = 4.67 mm, UMZC Nov. 30, 1899.

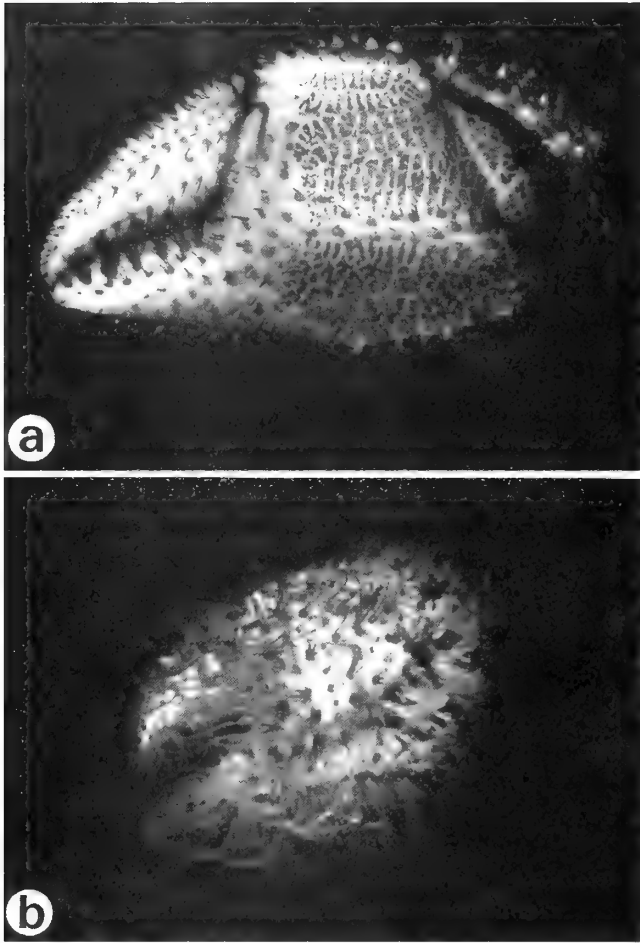

Fig. 13 Left chela (outer face), a. *Diogenes mixtus* Lanchester, 1902, paralectotype ♂ SL = 5.81 mm. UMZC I.10050; b. *Diogenes stenops* Morgan and Forest, 1991, ovigerous ♀ SL = 3.11 mm. UMZC Nov. 30, 1899.

(10° 54', 133° 01'E), October 1962, WAM 403–65. Lanchester collection: 1 ovigerous ♀ (SL = 3.11 mm), Pulau Bidan, Penang; UMZC, Nov. 30, 1899.

DIAGNOSIS. Dorsal surface of shield (Fig. 7a) with tubercles and spines, often in short transverse ridges. Ocular peduncles long and slender, slightly overreached by antennular peduncles. Ocular acicles with 3–5 spines on terminal margins. Intercalary rostriform process very small, not reaching half length of ocular acicles. Antennal peduncles slightly overreaching distal margins of corneae. Antennal acicles with terminal spine and 3 or 4 spines on mesial margin. Antennal flagella with long ventral setae.

Left cheliped (Fig. 13b) with dense plumose setae obscuring armature, particularly on dactyl and palm; dactyl and palm with row of strong spines on upper margin; outer faces of fixed finger and palm with scattered tubercles or small spines, lower margins with spines or spinulose tubercles; carpus with row of 6 or 7 very strong spines on upper margin, distal margin with several spines, 1 or 2 very prominent spines on outer surface near distal midline. Right cheliped with row of small spines on upper margin of dactyl; upper margin of palm with strong distal spine and smaller spines or tubercles proximally, outer face with slight to prominent depression on outer face in upper half and scattered spinulose

tubercles on outer surface of palm and fixed finger; carpus with strong spine at upper distal angle; outer face with strong spine on distal margin in upper half, outer surface and upper margin tuberculate or spinulose. Ambulatory legs with scattered long setae on all segments; dactyls and propodi of second and right third unarmed; carpi each with dorsodistal spine; left third slightly shorter than right or second pereopods, ventral margin of propodus with row of spinules; dactyl and propodus with appreciably more dense tufts of setae, carpus with row of spinules or tubercles ventrolaterally and scattered tubercles on lateral surface, obscured by tufts of setae.

Telson (Fig. 9g) with median cleft distinct, but not deep; posterior lobes markedly asymmetrical, terminal margins with several large and numerous smaller spines, extending onto lateral margins, at least on left.

COLOUR. Shield cream and pale brown with darker patches. Ocular peduncles cream with some brown dorsally and ventrally; cornea black with iridescent yellow speckling. Antennules and antennae cream. Chelipeds cream and dark brown. Second and third pereopods cream with grey-brown mottling, often with irregular brown band proximally on dactyls and at mid-length of propodi, carpi and meri. Setae pale grey, yellow or brown (after Morgan and Forest, 1991).

DISTRIBUTION. Northern Australia from the Northern Territory east to the vicinity of Townsville, Queensland; Penang, Malaysia.

REMARKS. Morgan (1987b) reported *Diogenes jousseaumei* (Bouvier), a species of the *Troglopagurus* group of *Diogenes* from the Port Essington, Northern Territory, Australia, but after examining syntypic material of Bouvier's (1897) species, concluded that his Australian material represented a very similar, but specifically distinct taxon (Morgan and Forest, 1991). In this latter account, Morgan and Forest commented that the previous record of *D. jousseaumei* from Port Curtis, Queensland by Grant and McCulloch (1906) should be regarded with 'some suspicion', and that the records of this species from the Indian region (Alcock, 1905; Southwell, 1906) might require substantiation. Haig and Ball (1988) reported *D. jousseaumei* from the Arafura Sea and Torres Strait, and their colour notes do not agree particularly well with those given by Morgan (1987b) and Morgan and Forest (1991) for *D. stenops*, thus it is possible that both species do occur in the region. Although actual specimens were not in their collection, Rahayu and Forest (1995) included *D. jousseaumei* in their key to *Diogenes* species in Indonesian waters; *D. stenops* was not mentioned from Indonesia, but in an addendum, these authors reported its occurrence in Singapore.

Lanchester's (1902) *D. senex* from Pulau Bidan, Penang, clearly is not conspecific with Heller's (1865) *D. senex sensu stricto*. The markedly reduced intercalary rostriform process and heavy setation of the cheliped unquestionably place it in the *Troglopagurus* group of *Diogenes*. Despite the absence of the right cheliped, Lanchester's specimen compares very well with the four paratypes of *D. stenops* we have examined. However, in the shape of the shield, Lanchester's specimen agrees better with their illustrated holotype (Morgan and Forest, 1991, fig. 9) in having sloping anterolateral margins on the shield. In all four paratypes, these margins are much straighter, giving the shield a subquadrate appearance. The spination of the left third pereopod of the Lanchester specimen corresponds quite well with the smaller two paratypes. Apparently the spines on the ventral margin of the carpus are reduced with increased animal size, as this margin has only a row of minute, easily overlooked spinules in the larger paratypes. The setation, particularly of the left chela, in Lanchester's specimen appears more coarse than any of the Australian paratypes. In the shape and armature of the antennal acicles,

Lanchester's specimen does more closely resemble Morgan and Forest's (1991: fig. 11b) illustration of the syntype of *D. jousseaumei*; however, it falls well within the range of variation in acicular length and armature seen in *D. stenops*. It is quite possible that *D. stenops* and *D. jousseaumei* may coexist geographically while occupying different microhabitats. With the exception of shell occupancy (*Murex* is reported for *D. stenops*), little is known about the ecology of either species.

Another instance of geographic sympatry in species of the *Troglopagurus* group has recently been documented. As previously indicated, *Diogenes stenops* has been recorded from Singapore (Rahayu and Forest, 1995), the type locality of *D. jubatus* Nobili, 1903. Although rarely reported and poorly known, the recent redescription of *D. jubatus* by Lemaitre and Ng (1996) demonstrates clearly the distinctiveness of the two species.

Diogenes mixtus Lanchester, 1902

(Figs 7f, 8f, 9i, 13a)

Diogenes mixtus Lanchester, 1902:367, pl. 34, figs 2, 2a, 2b; Nobili, 1903:16; Alcock, 1905b:165 (list).

MATERIAL EXAMINED. Lectotype (herein selected). ♂ (SL = 6.88 mm), Pulau Bidan, Penang, Malay Peninsula; UMZC I.10050. Paralectotypes. 7♂, 14♀, 1 ovigerous ♀ (SL = 4.15–7.53 mm), Pulau Bidan, Penang, Malay Peninsula; UMZC I.10050.

Additional material. 1♀ (SL = 4.95 mm), Kuching, Malaysia; BMNH 1928.12.1.283.

DIAGNOSIS. Shield (Fig. 7b) with anterior margin weakly denticulate over 0.75 total length; rostrum obtuse, not reaching level of lateral projections. Rostriform process elongate, overreaching ocular acicles by approximately third own length, multidenticulate. Branchiostegites unarmed. Ocular peduncles overreached by both antennular and antennal peduncles; ocular acicles broadly triangular, with 1 or 2 prominent spines mesially, with row of smaller spines extending entire terminal margin. Antennal acicle bifurcate; mesial fork with 0–2 small spines on outer margin and 2–4 smaller spines on inner margin; lateral fork reaching beyond distal margin of fourth peduncular segment, 4 or 5 small spines on inner margin and 0–3 spinules on outer margin.

Left cheliped (Fig. 13a) with outer face of palm armed with double row of blunt spines extending from nearly proximal margin almost to tip of fixed finger, with blunt spines scattered on fixed finger and in somewhat irregular rows on ventral margin, midline of palm with 2 irregular rows and tubercles dorsally; upper margin with 2 rather widely-spaced rows of small spines; dactyl with similar rows of spines; carpus with double row of somewhat blunt spines on upper surface, distal margin of outer face with row of spines curving proximally near ventral margin; merus with acute row of spines on dorsal margin, ventrolateral margin with row of acute spines, ventromesial margin with double row of somewhat blunted spines. Dorsal surface of palm of right cheliped with scattered spines, partially obscured by long setae, dorsomesial margin with row of small spines; upper outer and distal margins of carpus each with irregular row of acute spines. Ambulatory legs generally similar; dactyls (Fig. 8f) longer than propodi, dorsal margins with small spines becoming obsolete in distal half; propodi each with 2 rows of spines on dorsal surface; carpi each with row of spines on dorsal margin.

Telson (Fig. 9i) with terminal margin minutely spinulose on right, strongly spinose on left and approaching lateral angle, continued onto lateral margin over approximately half length.

REDESCRIPTION. Shield (Fig. 7b) longer than broad, subovate to subquadrate; anterior margin with row of closely-spaced small tubercles or blunt spinules over 0.75 to entire width; rostrum obtuse or broadly triangular, weakly produced, not reaching level of lateral projections; lateral projections unarmed or with small to moderately strong terminal blunt or acute spinule. Intercalary rostriform process elongate, overreaching ocular acicles by 0.25–0.50 own length, multidenticulate, with 3–7 lateral spines on each side of terminal simple, bi- or trid spine. Inner pterygostomial plate (cf. Pilgrim, 1973) with strong distal spine. Branchiostegites with upper margin usually with row of closely-spaced small blunt or spinulose tubercles partially obscured by tufts of long setae.

Ocular peduncles, moderately slender, corneae not particularly dilated; overreached by both antennular and antennal peduncles. Ocular acicles broadly triangular, usually with 1 or 2 more prominent spines mesially, with row of smaller spines or spinulose tubercles extending entire terminal margin.

Antennular peduncles overreaching ocular peduncles by 0.25 to nearly entire length of ultimate segment; overreaching antennal peduncles by 0.10–0.50 length of ultimate segment. Ultimate and penultimate segments with scattered setae. Basal segment with row of tiny spinules or tubercles on both distomesial and distolateral margins.

Antennal peduncles with numerous long setae on fifth segment, particularly dorsally and ventrally. Fourth segment with scattered stiff setae. Third segment with spinule at ventrodial angle. Second segment with dorsolateral distal angle produced as acute spine, lateral margin with low protuberances or spinules and long setae; dorsomesial margin with row of small spinules, dorsal surface with scattered spinules. First segment with row of tiny tubercles or spinules on dorsal, dorsolateral and ventrolateral distal margins, ventrodial angle with strong spine. Antennal acicle strongly bifurcate; mesial fork with acute or bifid termination, 0–2 small spines on outer margin and 2–5 smaller spines on inner margin; lateral fork reaching to or beyond distal margin of fourth peduncular segment, terminating in acute simple or bifid spine, 4–14 small spines on inner margin and 0–4 spinules on outer margin, dorsal surface usually with scattered spinules. Antennal flagellum moderately long, usually reaching to or beyond tip of left chela; several proximal articles usually with 1 or 2 short or moderately long stiff setae; setae of articles in distal two-thirds much shorter.

Left cheliped (Fig. 13a) with fingers opening nearly vertically; cusp-like calcareous teeth on cutting edges of both dactyl and fixed finger. Upper margin of dactyl armed with double row of small spines and moderately dense, but relatively short setae; outer surface with scattered small conical tubercles, row of tufts of stiff setae adjacent to cutting edge; inner surface with scattered tufts of setae. Palm with double row of subacute or acute spines on upper margin; outer surface triangularly convex, with widely scattered conical, often rather blunt spines on both lower half of palm and fixed finger, 2 irregular frequently rather widely-separated longitudinal rows of slightly stronger spines in midline of palm and 1 shorter row in upper half, row of blunt or subacute spines on lower margin, becoming double row on fixed finger, lower and inner surfaces of palm tuberculate. Carpus with double row of acute, subacute or blunt spines on upper surface; outer face with numerous spines, strongest in lower half, distal margin with row of small spines, lower margin spinulose or spinose, inner face with weakly tuberculate or spinulose distal margin, longitudinal row of spinulose protuberances or spines and long setae near upper margin. Merus broadly triangular distally; acute row of spines on dorsal margin, diverging distally into mesial, dorsal and lateral rows extending to or nearly to distal margins; dorso- and laterodistal margins with continuous row of moderately

strong, slender spines; ventrolateral margin with row of acute spines, ventromesial margin with irregular double row of subacute or acute spines, ventral surface spinulose or tuberculate. Ischium with spinules or small spines on ventromesial and ventrolateral margins.

Right cheliped with moderately long and slender chela; fingers opening nearly horizontally and terminating in strong calcareous claws. Dorsal surface dactyl with 2 rows of spines and 1 additional row on dorsomesial margin, all partially obscured by long setae. Palm with scattered moderately strong spines, partially obscured by long setae, dorsomesial margin with single or row of small spines, mesial face somewhat spinulose; fixed finger with 2 or 3 rows of small spinules and tufts of long setae on dorsal surface; dorsolateral margin not well defined, but with numerous small spinules. Carpus broadly triangular; dorsomesial margin with row of small spines practically obscured by long dense setae, and adjacent row of stronger spines on dorsal surface, dorsolateral margin with single or irregular double row of spines and tufts of setae, distal margin with several spines; lateral face spinulose; mesial face weakly tuberculate. Merus triangular; dorsal margin with row of spinules or small spines and tufts of long setae, 2 or 3 prominent spines at or near distal margin, often 1 additional strong spine marginally just laterad of midline; dorso- and laterodistal margins usually with small spinules; lateral face frequently with numerous short multifid ridges; ventrolateral margin with row of strong spines or acute spines distally and small, multifid short ridges proximally; ventromesial margin with generally double row of small spinules. Ischium with row of small spines or spinules on ventromesial margin; laterodistal margin with few spinules.

Ambulatory legs generally similar form left to right; dactyls (Fig. 8f) long, approximately 0.20 longer than propodi, slender, curved, slightly twisted; ventral margins each with row of long setae; lateral faces each with longitudinal suture; dorsal margins with small spines becoming obsolete in distal half and long setae; mesial faces each with longitudinal sulcus lined with long setae, row of small spines ventrally decreasing in size and not reaching to distal third and gradually replaced by row of long setae. Propodi each with 2 rows of spines on dorsal surface, strongest mesially and separated by flattened, unarmed or intermittently spined longitudinal space; lateral face with longitudinal row of spinulose tubercles or spines dorsally and usually numerous simple or multidenticulate tubercles, sometimes only weakly developed; ventral surface faintly spinulose, ventrodistal margin usually with row of denticles extending mesially and laterally; mesial face somewhat spinulose ventrally or with irregular longitudinal rows of small tubercles. Carpi each with row of strong spines on dorsal margin; lateral face with 3–5 usually longitudinal rows of spines, spinules, multidenticulate tubercles or low protuberances; laterodistal margin spinose or spinulose; mesial faces each with longitudinal row of small spines adjacent to dorsal margin (second) or unarmed (third). Meri with dorsal surfaces of second pair distally broadened and armed with irregular double or triple rows of small spines or spinulose tubercles, dorsal margin proximally and on third pereopods each with row of spines; ventromesial margins each with nearly double row of spines or spinulose tubercles; row of small spines on ventrolateral margins; lateral faces, particularly of third weakly spinulose or tuberculate. Sternite of third pereopods subrectangular, with tuft of setae on either side laterally. Sternite of fifth pereopods as slender elongate, tuberculate, calcareous rod.

Protopod of right uropod with well developed posterior protuberance nearly equal to size of endopod, and similarly covered with rasp of corneous scales. Telson (Fig. 9i) without median cleft; terminal margin spinulose on right, strongly spinose approaching left lateral angle and continuing onto lateral margin over approximately half length.

COLOUR. Not known.

DISTRIBUTION. Malaysia; ? Singapore.

REMARKS. Nobili (1903) reported numerous specimens of *D. mixtus* collected in Singapore. He distinguished Lanchester's (1902) species from *D. intermedius* De Man, 1892 by the presence, in the former species, of spines on the merus of the second and third pereopods. A check of the collections of the Museo Regionale di Scienze Naturali, Torino, failed to locate Nobili's specimens (Elena Gavetti, pers. comm.); therefore it has not been possible to confirm Nobili's (1903) identification. Although it was not represented in their collection, *D. intermedius* was reported as one of the Indonesian species of *Diogenes* by Rahayu and Forest (1995); no mention was made of *D. mixtus*.

Paguristes hians Henderson, 1888

(Fig. 14)

Paguristes hians Henderson, 1888:79, p. 8, fig. 4; Alcock, 1905:40, pl. 3, fig. 2; Southwell, 1906:216; Estampador, 1937:506; Thompson, 1943:415; Gordan, 1956:322 (in part) (lit.); Edwards and Emberton, 1980:236 (list); Haig and Ball, 1988:173; Hogarth, 1988:1100; Morgan, 1990:21.

Diogenes desipiens Lanchester, 1902:366, pl. 34, figs 1, 1a; Alcock, 1905:165 (list); Gordan, 1956:317 (lit.).

Non *Paguristes hians*: Grant and McCulloch, 1906:33; McCulloch, 1913:346 = *Paguristes monoporos* Morgan, 1987.

MATERIAL EXAMINED. Holotype. ♂ (SL = 4.89 mm); BMNH 1888.33., H.M.S. 'Challenger' station 208, off Manila. Supplemental material. 1 ♂, 2 ovigerous ♀ (SL = 1.67–2.51 mm), Maldive Islands, 14 February, 20 December 1993, collector P. Hogarth.

DIAGNOSIS. Shield (Fig. 14) considerably longer than broad. Rostrum broadly triangular, not produced to level of terminal spinules of obtusely triangular lateral projections. Ocular peduncles long and extremely tenuous, slightly overreaching antennular peduncles and approximately 0.50 longer than antennal peduncles; acicles elongate and nearly rectangular, with large tuberculate terminal spine and smaller accessory spine laterally. Subquadrate calcified lobe with 4 subacute spinules on anterior marginal part of, or articulating with, interocular lobes. Antennal acicle long, reaching nearly to mid-length of ultimate peduncular segment.

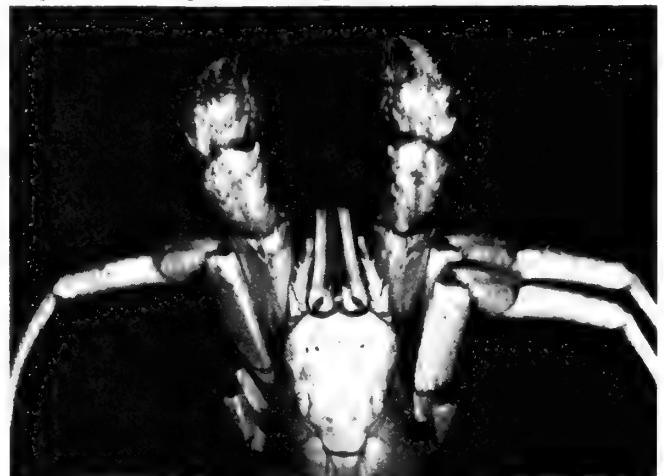

Fig. 14 *Paguristes hians* Henderson, 1888, holotype ♂ SL = 4.89 mm, BMNH 1888.33, a. whole animal; b. enlarged view of shield and cephalic appendages.

Chelipeds (Fig. 14) similar, subequal; dactyls and fixed fingers with distinct hiatus; dorsal surfaces of palms relatively smooth proximally with only few spinules, stronger spines distally; dorsal surfaces of carpi each with irregular row of spinules becoming strong spines at distal margin. Ambulatory legs with dactyls slightly longer than propodi; propodi and carpi of second each with row of spines on dorsal margins, partially obscured by long setae; propodi of third unarmed, carpi each with spine on dorsodistal margin.

Males lacking paired second pleopods; first paired, but consisting of short, broad, uniramous 2-segmented appendages. Telson with posterior lobes nearly symmetrical; terminal margins rounded, armed with 5 or 6 spines.

REDESCRIPTION. Shield (Fig. 14) subtriangular, considerably longer than broad, with numerous small spinules, spinulose tubercles and tufts of plumose setae on dorsal surface, particularly laterally. Rostrum broadly triangular, with very small terminal spinule, not produced to level of terminal spinules of obtusely triangular lateral projections. Branchiostegite with 4 or 5 slender acute spines on dorsodistal margin partially to entirely obscured by long setae.

Ocular peduncles long and slender, slightly overreaching antennular peduncles and approximately 0.50 longer than antennal peduncles, dorsomesial surface with row of long setae; corneae small, not dilated. Ocular acicles elongate and nearly rectangular, dorsally flattened, with large tuberculate terminal spine and smaller accessory spine laterally, with several long plumose setae distally. Subquadrate calcified lobe (with 4 subacute spinules anteriorly in holotype) seemingly articulated with interocular lobes.

Antennular peduncles not reaching to bases of corneae; ultimate and penultimate segments unarmed; basal segment with very strong curved spine on dorsolateral distal margin, smaller spine on ventrodistal margin.

Antennal peduncles with supernumerary segmentation; reaching only to about distal third of ocular peduncles; fifth, fourth and third segments each with strong ventrodistal spine and scattered long setae, most abundant laterally; second segment with dorsolateral distal angle produced, terminating in bifid spine, lateral margin with row of long setae, dorsomesial distal angle with strong spine; first segment unarmed but with long setae laterally. Antennal acicle long, reaching nearly to mid-length of ultimate peduncular segment, broad and dorsally flattened, lateral margins each with 2 or 3 strong spines and row of very long plumose setae, mesial margins each also with 2 or 3 strong spines and row of plumose setae sufficiently long to form a setal net above antennules, terminating in bifid spine. Antennal flagellum short, not reaching beyond proximal margins of chelipeds; each article with 1 or 2 long and 1 or 2 short setae.

Chelipeds (Fig. 14) similar, subequal, right slightly larger (at least in males). Dactyls approximately twice length of palms; dorsomesial margins each with row of spines, dorsal and mesial surfaces with fairly closely-spaced tuberculate spines and tufts of long setae; cutting edges each with 1 or 2 large calcareous teeth proximally and row of smaller calcareous teeth in distal 0.66, terminating in corneous claw; dactyls and fixed fingers ventrally curved and with distinct hiatus. Palms shorter than carpi, dorsomesial margins each with row of 2 to 4 strong conical spines, dorsal surface relatively smooth proximally with few spinules or spinulose tubercles, stronger spines distally tending to form 1 or 2 irregular rows, and on weakly delimited lateroproximal margin; fixed finger with dorsolateral margin not clearly delimited, dorsal and lateral faces with closely-spaced spinulose tubercles and spines; cutting edge with row of calcareous teeth, strongest proximally; ventral surface of palm with few scattered tubercles; all surfaces with tufts of long setae. Carpi

trapezoidal in dorsal view; slightly less than 0.50 length of meri; dorsomesial margins each with row of 4 strong conical spines, first 1–3 with very small spinule basally on mesial side, dorsolateral margins each with irregular row of smaller spines, dorsal surface with irregular row of spinules becoming strong spines at distal margin; ventrolateral distal margins each with 1 or 2 small tubercles; surfaces with long setae. Meri each with longitudinal row of spinules on dorsal margin in proximal 0.65, distally 1 transverse row of prominent spines extending onto lateral and mesial faces dorsally and second similar row on distal margin; ventromesial margin with row of acute spines; ventrolateral margin with row of small spines in distal half and short transverse rows of spinules proximally. Ischia each with row of spinules on ventromesial margin and 1 small spine at ventrolateral distal angle.

Ambulatory legs with dactyls slightly longer than propodi; in dorsal view slightly twisted, in lateral view curved ventrally in distal halves; all surfaces, and particularly dorsal and ventral margins, with rows of long setae. Propodi of second each with row of spines on dorsal margins; carpi with single or double row of spines, all partially to completely obscured by long setae; propodi of third (left third broken at distal margin of ischium in holotype) unarmed but with tufts of long setae on all surfaces, carpi only with spine at dorsodistal margin or with 2 or 3 small spines in distal half, all at least partially obscured by tufts of long setae. Meri of second each with row of very small spinules and tufts of long setae on dorsal margins, ventral margins each with row of spines and tufts of long setae; third with few minute spinules on dorsal margin and tufts of long setae, ventral margin with tufts of long setae. Ischia each with 1 or 2 spinules on dorsal margins, ventral margins each with row of long setae and 1 small spine near distal margin.

Males with paired gonopores; no paired second pleopods; first paired but consisting of short, broad, uniramous 2-segmented appendages positioned directly over coxae of fifth pereopods; unpaired left pleopods 3 to 5 uniramous. Females with single left gonopore; paired first pleopods modified as gonopods; very large brood pouch. Telson with prominent, deep transverse suture; posterior lobes nearly symmetrical, terminal margins rounded, each armed with 4 to 6 spines, some corneous-tipped, and few moderately long setae.

COLOUR. Not reported.

DISTRIBUTION. Oman; Maldives; Red and Arabian Seas; Malaysia; Philippines.

REMARKS. Henderson (1888) described the species from a single male; however, he made no comment on any of the abdominal appendages. Although *Paguristes hians* is a very distinctive species that possesses characters unique among species of *Paguristes*, only the remarks by Haig and Ball (1988) called attention to any of these. These authors appear to have been the first to document that males lacked the paired second pleopods typical of species of *Paguristes*; they also pointed out the presence of a single left gonopore in the female. It may be that these abnormalities were recognized by Grant and McCulloch (1906) and McCulloch (1913) who incorrectly identified atypical *Paguristes* specimens from Mast Head Island, Queensland, Australia, as *P. hians*. Haig (in Haig and Ball, 1988) showed that at least some of the Mast Head Island specimens actually were referable to *P. monoporus* Morgan. As described by Morgan (1987a) this is another rather bizarre species of *Paguristes* in which male first and second pleopods are reduced and restricted to the right side of the abdomen; males possess only a single right gonopore and females have only a single left.

While the characters described above for *P. hians* set this species

apart from all other known *Paguristes* species, they are not the characters that drew our attention to the similarities between this species and Lanchester's (1902) *Diogenes desipiens*. *Paguristes hians* has uniramous unpaired male pleopods, a character commonly associated with species of *Diogenes*. Similarly, *P. hians* has a subquadrate calcified lobe that is, at least positionally, similar to the intercalary rostriform process that distinguishes most *Diogenes* species from other Diogenidae. In the holotype of *P. hians* this structure is armed with 4 marginal spinules. In the three small specimens from the Maldive Islands, this process appears almost identical to that of *D. desipiens* as shown by Lanchester (1902: fig. 1); in one specimen, it appears denticulate under high magnification, as described for *D. desipiens*. Additionally, the distinctive shape, armature, and setation of the ocular and antennal acicles of *P. hians* are virtually identical to those described and illustrated by Lanchester for *D. desipiens*. Lanchester's description of the shield armature, as well as ocular peduncle length and its relationship to the lengths of both the antennular and antennal peduncles agrees extremely well with those of *P. hians*. Furthermore, Lanchester described the chelipeds of his species as being subequal, the right being slightly larger. We know of no *Diogenes* species in which the chelipeds are subequal, but *P. hians* has subequal chelipeds, the right of which is slightly larger in the holotype and male specimen from the Maldive Islands. Lanchester's description of the armature of the chelipeds also agrees quite closely with the type of *P. hians* and the three smaller specimens that we examined. Similarly there is agreement between the length ratios of the dactyls and propodi of the ambulatory legs of the two species. However, disagreement between Lanchester's description of *D. desipiens* and our observations of *P. hians* is found in the armature of these appendages. We observed that the ventral margins of the dactyls of the holotype have a row of slight protuberances; the Maldive Islands specimens each have a row of corneous spinules on these margins. The dorsal margins of the propodi and carpi of the second pereopods each carries a row of spines, and the carpi of the third may have from 1 to 3 spines on the dorsal margins in our specimens. The dorsal margins of the meri of both pairs of pereopods are armed with spines; the ventral margins of the second pereopods also are spinose. But all of the spines are at least partially obscured by tufts of setae. Lanchester described the ambulatory legs as being 'densely hairy on their upper and lower margins, otherwise smooth.' Whether Lanchester simply failed to notice spines amongst the setal tufts on his specimen, or they were actually lacking, is a matter of speculation. Given all of the other similarities between the two taxa, we are inclined to presume the former. Therefore, until specimens having all of the attributes accredited to Lanchester's taxon are found in a species unquestionably referable to *Diogenes*, we consider *D. desipiens* a junior subjective synonym of *Paguristes hians*.

ACKNOWLEDGEMENTS. We express our gratitude to Dr. Raymond Symonds, University Museum of Zoology, Cambridge, for the loan of Lanchester's 'Skeat' Expedition material and providing supplemental information on the collection including *Diogenes desipiens*; Dr. Peter Ng, National University of Singapore for search the Institute reference collections in an unsuccessful attempt to locate the type of *Diogenes desipiens*; Dr. Peter Hogarth, Biology Department, University of York for permitting us to use his specimens of *Paguristes hians* from the Maldive Islands; Dr. Diana Jones, Western Australian Museum for the loan of paratypes of *Diogenes stenops*; Drs L.B. Holthuis and Michel Türkay for information concerning the whereabouts of the Holy Grail, i.e., *Diogenes intermedius*; and Drs F. Schram and Dirk Platvoet, Instituut voor Taxonomische Zoölogie (Zoölogisch Museum), Universiteit van Amsterdam, for the loan of De Man's *Diogenes intermedius*.

The photographs are the work of the late E.J. McGeorge. The assistance of George Holm, Richmond, British Columbia, Canada, and Janet Armbrust, Mt. Vernon, Washington, in the identification of Lanchester's shells is acknowledged. This is a scientific contribution from the Shannon Point Marine Center, Western Washington University.

REFERENCES

- Ajmal Khan, S. & Natarajan, R. 1984. Hermit crabs of Porto Novo coast. *Records of the Zoological Survey of India. Miscellaneous Publication Occasional Paper No. 67*:1-25.
- Alcock, A. 1905. *Anomura. Fasc. I. Pagurides.—Catalogue of the Indian decapod Crustacea in the collections of the Indian Museum 2*:1-197. Calcutta, Indian Museum.
- Bouvier, E.L. 1891. Étude de quelques paguriens recueillis par M. Jules de Guerne sur les côtes de France et de Norvège. *Mémoires de la Société Zoologique de France 4*:393-407.
- 1892. Étude sur les Paguriens recueillis par M. le Dr. Jousseau sur les côtes de la Mer Rouge. *Bulletin de la Société Philomathique de Paris (8) 4*(2):50-55.
- 1897. Sur deux paguriens nouveaux trouvés par M. Coutière dans réclifs madréporiques, à Djibouti. *Bulletin du Muséum d'Histoire naturelle Paris 3*(6):229-233.
- De Man, J.G. 1892. Decapoden des Indischen Archipels. In: M. Weber, *Zoologischs Ergebnisse einer Reise in Niederländisch Ost-Indien*:265-527.
- Dehancé, M. 1964. Sur une collection de Crustacés Pagurides de Madagascar et des Comores. *Cahiers O.R.S.T.O.M., série Océanographie 2*(2):27-45.
- Edwards, A. & Emberton, H. 1980. Crustacea associated with the scleractinian coral, *Sylophora pistillata* (Esper), in the Sudanese Red Sea. *Journal of Experimental Marine Biology and Ecology 42*:225-240.
- Estampador, E.P. 1937. A check list of Philippine crustacean decapods. *The Philippine Journal of Science 62*:465-559.
- Fabricius, J.C. 1787. *Mantissa insectorum sistens eorum species nuper detectas adjectis characteribus genericis, differentiis specificis, emendationibus, observationibus*. 1:xx + 348 pp. Hafniae.
- 1798. *Supplementum Entomologiae Systematicae*. 572 pp. Hafniae.
- Forest, J. 1952. Remarques sur les genres *Diogenes* Dana et *Troglopagurus* Henderson à propos de la description d'un Paguridae nouveau de la côte occidentale d'Afrique, *Diogenes mercatoris* sp. nov. *Bulletin Institut Royal des Sciences Naturelle de Belgique 28*(11):1-15.
- 1956. Les Pagures du Viet-Nam. I. Le genre *Diogenes* Dana. *Bulletin du Muséum national d'Histoire naturelle (2) 28*(6): 524-532.
- Gordan, J. 1956. A bibliography of pagurid crabs, exclusive of Alcock, 1905. *Bulletin of the American Museum of Natural History 108*:253-352.
- Grant, F.E. & McCulloch, A.R. 1906. On a collection of Crustacea from the Port Curtis district, Queensland. *Proceedings of the Linnean Society of New South Wales 1906*:1-53.
- Haig, J. & Ball, E.E. 1988. Hermit crabs from northern Australian and eastern Indonesian waters (Crustacea Decapoda: Anomura: Paguroidea) collected during the 1975 Alpha Helix Expedition. *Records of the Australian Museum (1988) 40*: 151-196.
- Heller, C. 1865. Crustaceen. In: *Reise der Österreichischen Fregatte Novara um die Erde in den Jahren 1857, 1858, 1859 unter den Befehlen des Commodore B. von Wüllerstorff-Urbair. Zoologischer Theil. 2*(3):1-280. Kaiserlich-königlichen Hof- und Staatsdruckerei, Wein.
- Henderson, J.R. 1888. Report on the Anomura collected by H.M.S. Challenger during the years 1873-76. *Scientific Results of the Exploratory Voyage of HMS Challenger, (Zoology) 27*:i-xi, 1-221.
- 1893. A contribution to Indian carcinology. *Transactions of the Linnean Society of London, 1888-94 (2)5, Zoology*: 325-458.
- Hogarth, P.J. 1988. Anomuran Crustacea (Paguridea, Porcellanidae, and Hippidea) from Oman, principally from Dhofar province, southern Oman. *Journal of Natural History 22*: 1095-1110.
- ICNZ. 1985. *International code of Zoological Nomenclature Third Edition adopted by the XX general assembly of the International Union of Biological Sciences*. London: International Trust for Zoological Nomenclature xx + 1-338.
- Ingle, R.W. 1991. Carcinology in The Natural History Museum, London; the brachyuran crab collections and their curation from 1813-1904 (Leach to Calman). *Bulletin of the British Museum of Natural History (Historical Series) 19*:161-224.
- Kamalaveni, S. 1950. On hermit-crabs (family Paguridae) in the collection of the Indian Museum. *Records of the Indian Museum 47*:77-85.
- Lanchester, W.F. 1900a. On a collection of Crustacea made at Singapore and Malacca.—Part I. Crustacea Brachyura. *Proceedings of the Zoological Society of London 1900*:719-770.
- 1900b. On some Malacostracous Crustaceans from Malaysia in the Collection of the Sarawak Museum. *Annals and Magazine of Natural History (7) 6*:249-265.

- 1901. On the Crustacea collected during the 'Skeat Expedition' to the Malay Peninsula with a note on the genus *Actaeopsis*. Part I. *Proceedings of the Zoological Society of London* **1901**:543–574.
- 1902. On the Crustacea collected during the 'Skeat Expedition' to the Malay Peninsula. *Proceedings of the Zoological Society of London* **1902**:363–381.
- Lemaitre, R. & Ng, P.K.L.** (1996). Rediscovery and redescription of the hermit crab *Diogenes jubatus* (Nobili, 1903) (Decapoda: Anomura: Diogenidae), from Singapore. *Raffles Bulletin of Zoology* **44**(2): 323–333.
- Lewinsohn, Ch.** 1969. Die Anomuren des Roten Meeres (Crustacea Decapoda: Paguridea, Galatheidea, Hippidea). *Zoologische Verhandlungen* No. 104:1–213.
- McCulloch, A.R.** 1913. Studies in Australian Crustacea. No. 3. *Records of the Australian Museum* **9**:321–353.
- McLaughlin, P.A. & Haig, J.** 1995. A redescription of *Diogenes senex* Heller, 1865, sensu stricto (Decapoda: Anomura: Paguridae: Diogenidae). *Pakistan Journal of Marine Science* **4**(2):115–126.
- Miers, E.J.** 1884. Crustacea. In: *Report on the zoological collections made in the Indo-Pacific Ocean during the voyage of H.M.S. 'Alert' 1881–2*. 178–322, 513–575. British Museum, London
- Milne Edwards, H.** 1837. *Histoire naturelle des Crustacés, comprenant l'anatomie, la physiologie et la classification de ces animaux*. 2:1–532; atlas, pp. 1–32, pls. 1–42. Paris
- Morgan, G.J.** 1987a. A new and aberrant species of *Paguristes* (Anomura: Diogenidae) from northern Australia. *Records of the Western Australian Museum* **13**(3):379–386.
- 1987b. Hermit crabs (Decapoda, Anomura: Coenobitidae, Diogenidae, Paguridae) of Darwin and Port Essington, northern Australia. *The Beagle, Records of the Northern Territory Museum of Arts and Sciences* **4**(1):165–186.
- 1990. A collection of Thalassinidea, Anomura and Brachyura (Crustacea: Decapoda) from the Kimberley region of northwestern Australia. *Zoologische Verhandlungen* No. 265: 1–90.
- & **Forest, J.** 1991. Seven new species of hermit crabs from northern and western Australia (Decapoda, Anomura, Diogenidae). *Bulletin du Muséum National d'Histoire Naturelle* (4) sec. A, **12**(3–4):649–689.
- Nobili, G.** 1903a. Crostacei di Pondichéry, Mahé, Bombay etc. *Bollettino del Musei di Zoologia ed Anatomia comparata della R. Università di Torino* **18**(452):1–24.
- 1903b. Crostacei di Singapore. *Bollettino del Musei di Zoologia ed Anatomia comparata della R. Università di Torino* **18**(455):1–39.
- 1906. Faune carcinologique de la Mer Rouge. Décapodes et Stomatopodes. *Annales des Sciences Naturelles, Zoologie, Paris* (9)**4**:1–347.
- Pilgrim, R.L.C.** 1973. Axial skeleton and musculature in the thorax of the hermit crab, *Pagurus bernhardus* [Anomura: Paguridae]. *Journal of the Marine Biological Association of the United Kingdom* **53**:363–396.
- Rahayu, D.L. & Forest, J.** 1995. Le genre *Diogenes* (Decapoda, Anomura, Diogenidae) en Indonésie, avec la description de six espèces nouvelles. *Bulletin du Muséum National d'Histoire Naturelle, Paris 4^e sér.*, **16**[1994] section A, n° 2–4:383–415.
- Southwell, T.** 1906. Report on the Anomura collected by Professor Herdman, at Ceylon, in 1902. In: W. A. Herdman, *Report to the government of Ceylon on the pearl oyster fisheries of the Gulf of Manaar, with supplementary reports upon the marine biology of Ceylon, by other naturalists*, Part V: 211–224. Royal Society, London.
- Sundara Raj, B.** 1927. order Decapoda. suborder Anomura (Anomala). Tribe Paguridae. In: The littoral fauna of Krusadai Island in the Gulf of Mannar with a ppendices on the vertebrates and plants. *Bulletin of the Government Museum. New Series. Natural History Section* **1**(1):129–134.
- Thompson, E. F.** 1943. Paguridae and Coenobitidae. In: *The John Murray Expedition 1933–34, Scientific Reports* **7**(5):411–426.
- Tirmizi, N.M. and F.A. Siddiqui.** 1982a. An illustrated key to the identification of northern Arabian Sea pagurids. *Publications of the Institute of Marine Biology, University of Pakistan* **1**:1–31.
- & — 1982b. *The marine fauna of Pakistan: 1 Hermit crabs (Crustacea, Anomura)*: 1–103. University Grants Commission Sector H-9 Islamabad, Pakistan.



A new species of crassispirine gastropod from the Houtman Abrolhos Islands, Western Australia (Gastropoda, Conoidea, Crassispirinae)

ALEXANDER V. SYSOEV

Zoological Museum of Moscow State University, Herzen Street 6, Moscow 103009, Russia

JOHN D. TAYLOR

Department of Zoology, The Natural History Museum, London SW7 5BD, U.K.

SYNOPSIS. A new species of conoidean gastropod, *Burchia spectabilis*, is described from the Houtman Abrolhos Islands, Western Australia. Although the wishbone-type radular teeth are similar to those of *Inquisitor*, the shell is unlike any Indo-Pacific species and most similar to the West American genus *Burchia*.

INTRODUCTION

In this paper we describe a distinctive new species of crassispirine gastropod dredged from around the Houtman Abrolhos Islands, Western Australia. Unfortunately, we have only two specimens of this species, one of which was serial sectioned to determine the anatomy of the foregut which is described in the following paper (Kantor, Medinskaya & Taylor 1997).

SYSTEMATIC DESCRIPTION

Family **TURRIDAE** H. & A. Adams, 1853 (1840)

Subfamily **Crassispirinae** McLean, 1971

Burchia spectabilis Sysoev & Taylor, new species

Figs 1–3

TYPE MATERIAL. Holotype: Western Australian Museum, Perth, WAM 123–9. Paratype: serial sections of the foregut, Natural History Museum, London.

TYPE LOCALITY. Goss Passage, Wallabi Group, Houtman Abrolhos Islands, Western Australia (Glover & Taylor, 1997: station 11), 28°28.64' S, 113°46.45' E, depth 41m, coarse sand and gravel.

DIAGNOSIS. Shell rather large and thick-walled, fusiform, with high and many-whorled spire occupying about half of the shell height. Shell colour pinkish white, with darker reddish-brown siphonal canal and some interspaces between sculptural elements, and blotches of the same colour on the subsutural ramp. Protoconch consists of 1.7 smooth whorls. Initial teleoconch whorls almost flat-sided, then angulate at the periphery. Subsutural fold strong and tuberculate. Subsutural ramp concave and devoid of axial sculpture. Axial sculpture of numerous folds forming low and blunt tubercles below the subsutural ramp. Folds usually branch towards the lower suture. On last teleoconch whorls the folds become irregular. Spiral sculpture of deeply incised and widely spaced grooves becoming closer to each other on the canal. Aperture rather narrow. Siphonal canal short and wide, with distinct notch. Parietal nodule moderately

developed. Anal sinus deep, U-shaped, with the apex in the middle of subsutural ramp. Operculum large and thick, oval, with a terminal nucleus. Radula of wishbone marginal teeth only, teeth rather narrow, with moderately wide accessory limb.

DESCRIPTION OF HOLOTYPE. The shell is rather large, strong, fusiform, with high spire comprising 0.47 of the shell height. The ground shell colour is pinkish-white, with pale brownish spiral band just below the body whorl periphery, reddish-brown siphonal canal and the lower part of the shell base, and some interspaces between sculptural elements, and occasional blotches of the same colour on the subsutural ramp. The periostracum is poorly developed over the entire shell except for the lower part of the shell base and the canal. The protoconch is rather pupiform and consists of 1.7 smooth glossy whorls with shallow suture. The border between protoconch and teleoconch is not clearly defined. The teleoconch consists of 10 whorls separated by rather shallow and slightly wavy sutures. Initial teleoconch whorls are almost flat, then a peripheral angulation appears, which becomes stronger towards the body whorl. The subsutural fold is well developed and tuberculate. The subsutural ramp is rather deeply concave. The whole shell surface is wrinkled by numerous rough growth lines. The axial sculpture consists of numerous folds beginning below the subsutural ramp and forming wide, low and blunt tubercles. Below the tubercles, the folds usually branch into two or three narrower folds separated by narrow interspaces. Sometimes additional folds appear below the row of tubercles and widen towards the lower suture. On the body whorl the folds become even more irregular and of varying width; they may branch or merge along their length. The folds reach the siphonal canal. There are 13 tubercles below the subsutural ramp on the penultimate whorl, and about 18 on the body. The spiral sculpture is represented by incised and widely spaced narrow grooves. There is one such groove below the suture, 4–5 more crowded on the subsutural ramp, and 3 below it on teleoconch whorls. On the body whorl, there are 3 grooves below the subsutural ramp and, after a very wide interspace at the periphery, 3 grooves on the shell base followed by 15 closely spaced ones on the canal. The last quarter of the body whorl is marked by a strong and wide varix, which has no clearly defined borders and looks more like a longitudinal swelling. The aperture is rather narrow, more or less uniform in width, including the short and wide canal with a distinct notch. The columellar part of aperture is almost straight and covered with a

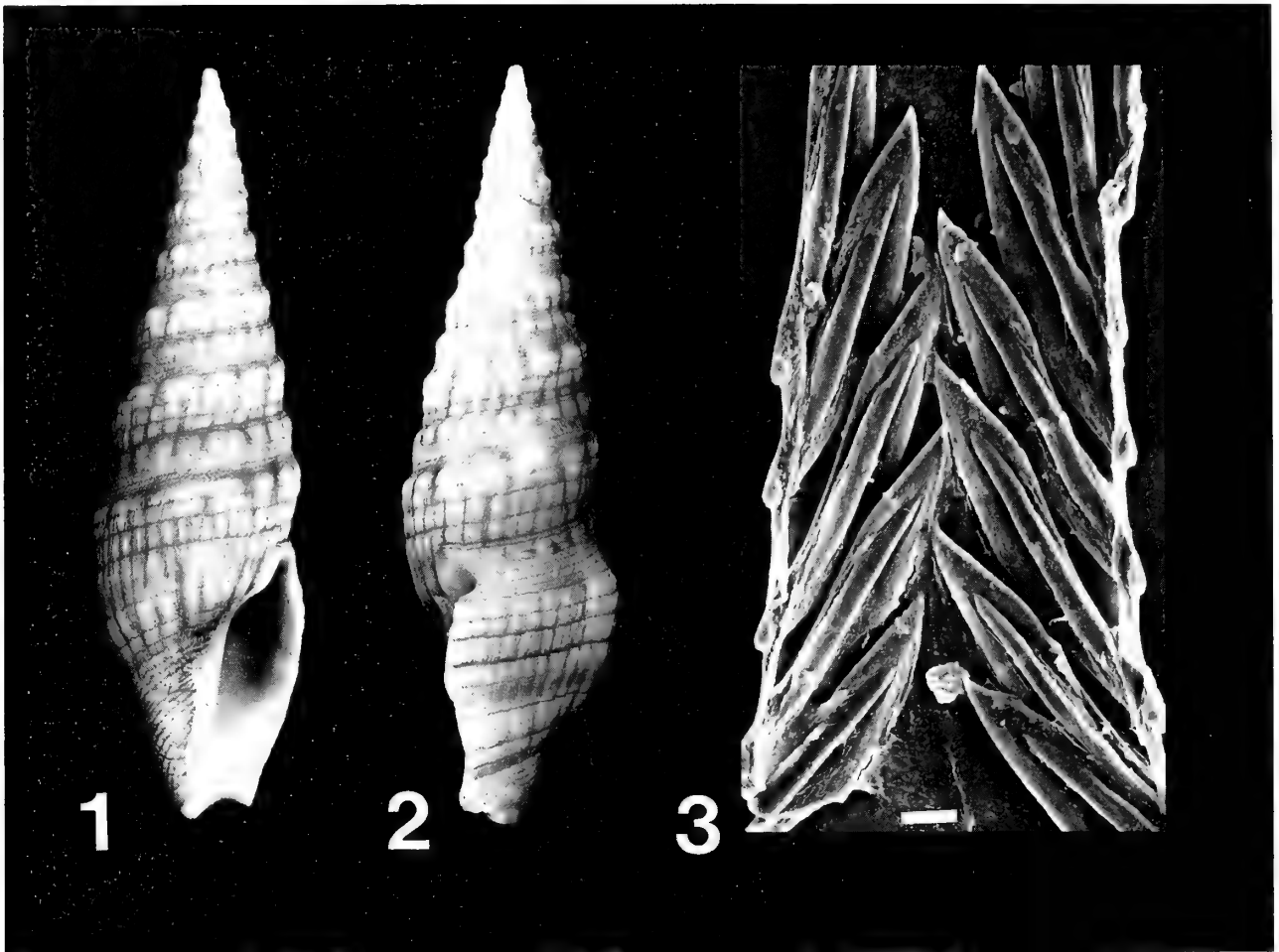

Fig. 1 *Burchia spectabilis* Sysoev & Taylor. Holotype. Shell height 36.9 mm.

Fig. 2 Holotype, lateral view

Fig. 3 *Burchia spectabilis*, holotype, radula teeth. Scale bar = 20µm.

thick, white callus. The parietal nodule is moderately developed. The anal sinus is deep, U-shaped, broadly open, symmetrical, with the apex in the middle of subsutural ramp. The operculum is large and thick, oval, dark-brown, with a terminal nucleus, 7.2×3.2 mm. Shell height is 36.9 mm, body whorl height 19.5 mm, aperture height 14.4 mm, and shell diameter 10.4 mm. Paratype: shell height 12.5 mm.

RADULA. The radula (Fig. 3) consists of two rows of wishbone type marginal teeth only. The teeth are rather narrow, slightly curved and sharply pointed, without barb or cutting edge. The accessory limb is moderately large and attaches to the major limb about just behind the tip.

ANATOMY. The foregut anatomy is described in Kantor *et al.* 1997 (p. 81)

REMARKS. On shell characters, it is difficult to assign this species to any genus of *Crassispirinae* known from Western Australia and the entire Indo-Pacific. Its radular teeth are very similar to those of species of *Inquisitor* Hedley, 1918 (see Taylor & Wells, 1995). In general shell outline the new species resembles some species included by Wells (1994) in the genus *Inquisitor* Hedley, 1918 namely *I. dampierius* (Hedley, 1922) and, to a lesser extent, *I. odhneri* Wells, 1994, but is readily distinguished from them (and from any known

turrid species) by the peculiar character of the sculpture of branching axial folds and widely spaced spiral grooves. However, the two latter species are themselves not very similar to the type-species of *Inquisitor*, *I. sterrhus* (Watson, 1881), and other typical representatives of the genus, which are characterized by a slender shell with a well differentiated and relatively long siphonal canal. Unfortunately, the radular characters of *I. dampierius* and *I. odhneri* are unknown.

On the other hand, the radular and conchological characters of the new species correspond quite well to those of *Burchia* Bartsch, 1944, a Central American subgenus of *Crassispira* Swainson, 1840. The main feature distinguishing species of *Burchia* from the new species, besides the unique sculpture of the latter, is the presence of a thick periostracum. However, the character of periostracum is not usually considered to be of taxonomic importance at the generic level. Therefore, it seems reasonable under these circumstances to place the new species, at least provisionally, into *Burchia*.

ACKNOWLEDGEMENTS. This species was collected during the International Marine Biological Workshop on the Marine Fauna and Flora of the Houtman Abolhos Islands. We are grateful to the organiser Dr Fred Wells of the Western Australian Museum and the crew of the fisheries research vessel 'Flinders' for facilities and logistic support.

REFERENCES

- Glover, E.A. & Taylor, J.D.** 1997 in press. Diversity and distribution of subtidal molluscs from the outer continental shelf, Houtman Abrolhos Islands, Western Australia. In: Wells, F.E. (ed.) *The Marine Fauna and Flora of the Houtman Abrolhos Islands, Western Australia*. The Western Australian Museum, Perth.
- Kantor, Y.I., Medinskaya, A. & Taylor, J.D.** 1997. Foregut anatomy and relationships of the Crassispirinae (Gastropoda: Conoidea). *Bulletin of the Natural History Museum, London (Zoology)* **63**: 55–92.
- Taylor, J.D. & Wells, F.E.** 1994. A revision of the crassispirine gastropods from Hong Kong (Gastropoda: Turridae). pp. 101–116. In: Morton, B. (ed.) *The Malacofauna of Hong Kong and Southern China III*. Proceedings of the Third International Workshop on the Malacofauna of Hong Kong and Southern China, Hong Kong University Press, Hong Kong.
- Wells, F.E.** 1994. A revision of the Recent Australian species of the turrid genera *Inquisitor* and *Ptychobela*. *Molluscan Research* **15**: 71–102.



Foregut anatomy and relationships of the Crassispirinae (Gastropoda, Conoidea)

YURI I. KANTOR AND ALEXANDRA MEDINSKAYA

A.N. Severtzov Institute of Animal Evolutionary Morphology and Ecology, Russian Academy of Sciences, Lenin Avenue 33, Moscow 117071, Russia

JOHN D. TAYLOR

Department of Zoology, The Natural History Museum, Cromwell Road, London SW7 5BD, UK

CONTENTS

Introduction	55
Material and methods	56
Anatomical descriptions	56
Character analysis and relationships within Crassispirinae	84
Discussion	87
Conclusions	91
Acknowledgements	91
References	91

SYNOPSIS. The foregut anatomy of 31 species from the conoidean subfamily Crassispirinae is described. Great variation is found between species in the configuration of the foregut including features such as: the structure of the rhynchodeum, the morphology of the proboscis, the position and number of buccal tube sphincters, the position and structure of the buccal mass, the histology of the salivary glands and venom gland, the length of the oesophagus, the structure of the muscular bulb and the morphology of the radular teeth. Many species have marginal teeth of the wishbone type, but teeth are paddle-shaped in *Funa* and *Vexitomina*, harpoon-shaped in *Cheungbeia* and a hollow awl shape in *Ptychobela*. Many crassispirinae have rather similar shells, but different anatomies. Some species with similar radulae have different anatomies and others with similar anatomy have widely differing radulae. An analysis of relationships, using *Gemmula* as outgroup, shows that the various subgenera of *Crassispira* are not monophyletic and should be raised to generic status. Also, *Epidirona* is polyphyletic with some species belonging in the Turridae, as do some species of *Turridrupa*. Additionally, some species classified in the genera *Guraleus*, *Antiguraleus* and *Paraguraleus*, until recently classified as Mangeliinae, belong in the Crassispirinae.

INTRODUCTION

Gastropods of the superfamily Conoidea are notable for the possession of a large, coiled venom gland, together with the highly modified radular teeth which are used to inject the venom into the prey. Although *Conus* is the most well-known taxon, it represents only a small part of the total diversity of the group which conservative estimates suggest as more than 4000 living species and 340 genera (Taylor, Kantor & Sysoev, 1993). Although most classifications (e.g. Powell, 1966; McLean, 1971) have been based largely on shell and radular characters, Taylor *et al.* (1993) have recently provided anatomical criteria, mainly derived from characters of the foregut, for the definition of suprageneric taxa of conoideans. Although their study involved anatomical investigation by serial sections of more than 72 species of conoideans, this nevertheless represented only a small fraction of the living genera and species. Moreover, amongst the species studied so far, a wide disparity in the configuration of the various organs of the foregut in the Conoidea has been revealed (Taylor *et al.*, 1993), with new arrangements still being discovered (Kantor & Taylor, 1994; Taylor, 1994; Kantor and Sysoev, 1996). These preliminary studies suggested that the subfamily Crassispirinae, one of four subfamilies of Turridae possessing 'wish-

bone' radular teeth, showed a wide variation in radular morphology and foregut anatomy, including the possibility of further evolutionary pathways to the hypodermic feeding system. Moreover, within the Crassispirinae, some species in the genera *Inquisitor*, *Funa* and *Ptychobela* which possess rather similar shells, were shown to have very different foregut and radular morphologies (Kilburn, 1989; Taylor, 1994; Taylor & Wells, 1994). The problem of using shell characters alone to classify conoideans has recently been highlighted in the case of the southern African species *Antiguraleus morgani*, previously classified in the Mangeliinae on the basis of shell morphology, but shown to be a likely crassispirinan on radular characters (Kilburn, 1994). For these reasons we decided to investigate the anatomy of the Crassispirinae in more detail.

Currently, some 48 genera and subgenera have been assigned to the Crassispirinae (Taylor *et al.*, 1993; Taylor & Wells, 1994; Kilburn, 1994) mainly on the evidence of radular characters, but in some cases on shell morphology alone. The subfamily is diverse in the tropical West America (McLean, 1971; Keen, 1971) with over 52 species recorded, and also in the Caribbean (Maes, 1983) and West Africa (Fernandes, Rolán & Otero-Schmitt, 1995). The Indo-Pacific fauna is less well known and there are many undescribed species, but Kilburn (1988; 1994) reports 54 species from Southern Africa, including numerous new genera and species, and many other species

Table 1 List of crassispirine gastropods and the outgroup *Gemmula* which have been sectioned, with details of their collection locations.

Crassispira (*Crassispira*) *incrassata* (Sowerby, 1834). North side of Venado Island, Panama, (8°53'N, 79°36'W). ANSP A9695 T357.

Crassispira (*Crassispira*) *maura* (Sowerby, 1834). Between Tortota and Venado Island, Bay of Panama, Republic of Panama (8°51'45N, 79°35'40W), 9–10 m. ANSP A9613 T357.

Crassispira (*Gibbaspira*) *dysoni* (Reeve, 1846). Isla de Lobos, Gulf of Mexico, Mexico (21°28'N, 97°13'W). ANSP A9423 T357.

Crassispira (*Glossispira*) *harfordiana* *flucki* (Brown & Pilsbry, 1913). Playa Benito, Campeche, Gulf of Mexico, Mexico (19°48'N, 90°36'W). ANSP 356707 A9734 T357.

Crassispira (?*Crassispirella*) *latizonata* (E.A. Smith, 1882). 1 km north of Holotown, St James, Barbados (13°11'N, 59°38'W). ANSP A9866G T357.

Crassispira (*Monilispira*) *pluto* Pilsbry & Lowe, 1932. West San Carlos Bay, Sonora, Mexico (27°57'N, 111°04'W). ANSP A9226 T357.

Crassispira (*Striospira*) *kluthi* Jordan, 1936. Venado Island, Panama (08°53'N, 79°36'W). ANSP 356323 A9698 T357.

Crassispira (*Striospira*) *tepcana* Dall, 1919. San Carlos, Guaymas, Sonora, Mexico, 35 m. ANSP A6670.

Crassispira (*Striospira*) *xanti* Hertlein & Strong, 1951. West side of Viradores sur, Bahía del Cocos, Costa Rica (10°34'45N, 85°43'35W). ANSP 35791A10167 T357.

Crassispira (*Crassiclava*) *turricula* (Sowerby, 1834). Off Nacascola, west side of Bahía Culebra, Bahía Culebra, Costa Rica (10°37'15N, 85°41'20W). ANSP A9753B T357.

Crassispira (*Crassiclava*) *apicata* (Reeve, 1845). Cactus Point, Prickly Pear Island, British Virgin Islands (18°30'55N, 64°22'30W). ANSP 355532 A9461E T357.

Burchia spectabilis Sysoev & Taylor, 1997. Houtman Abrolhos Islands, Western Australia (see Sysoev & Taylor, 1997). BM(NH).

Miraclathurella bicanalifera (Sowerby, 1834). West side of Viradores Sur, Bahía del Cocos, Costa Rica (10°34.30'N, 85°43.40'W). ANSP 357806 A9857A T357.

Hindsiclava andromeda (Dall, 1919). 3 miles southwest of Punta San Antonio, Sonora, Gulf of California, Mexico (27°54'N, 111°08'W). ANSP 358149 A10192G T357.

Hindsiclava militaris (Reeve, 1843) 2 miles east of Punta Doble, Sonora, Gulf of California, Mexico (27°55'N, 111°04'W). ANSP A10186 T357.

West side of Bahía Culebra, off Nacascola, Bahía Culebra, Costa Rica (10°37'15N, 85°41'20W). ANSP 357487 A9753H T357.

Funa jeffreysi (Smith, 1875). South of Cape d'Aguilar, Hong Kong, 20 m. BM(NH).

Funa latisinuata (Smith, 1877). South of Cape d'Aguilar, Hong Kong, 20 m. BM(NH).

Ptychobela suturalis (Gray, 1838). North Lantau Island, Hong Kong, 12 m. BM(NH).

Cheungbeia mindanensis (Smith, 1877). South of Cape d'Aguilar, Hong Kong, 20 m. BM(NH).

Cheungbeia robusta (Hinds, 1839). South of Cape d'Aguilar, Hong Kong, 20 m. BM(NH).

Vexitomina garrardi (Laserson, 1954). 2–3 km E. of Malabar, Sydney, Australia (32°59.27'S, 150°16.48'E). AM.

Inquisitor cf *adenicus* Sysoev, 1996. Off Ras Madrakah, Oman (19°14.8'N, 56°26.8'E), 935 m. NMW.

Inquisitor aemula (Angas, 1877). Outer Lagoon, 10 m, Noumea, New Caledonia. BM(NH).

Inquisitor latifasciata (Sowerby, 1870). Off Cape d'Aguilar, Hong Kong, 25–30 m. BM(NH).

Epidirona gabensis (Hedley, 1922). 2 km East of Long Bay, Sydney, New South Wales, Australia, 66 m. AM.

Antiguraleus morganus (Barnard, 1958). Off Mendu Point 300 m, Transkei, South Africa (32°21.8'S, 29°0.0'E). NM.

Paraguraleus costatus (Hedley, 1922). 28 km east of south head of Little Bay, Sydney, NSW, Australia (33°58'54'S, 151°33'38'E), 183–192 m. AM.

Naudedrillia praetermissa (Smith, 1904). Off Sandy Point, Transkei, South Africa (32°37.4'S, 28°36.9'E), 90 m. NM.

Nquma scalpta Kilburn, 1988. Off Park Rynie, Natal, South Africa (30°23.2'S, 30°50.8'E), 140 m. NM.

Turridrupa bijubata (Reeve, 1843). 30 m, Beacon Island, Houtman Abrolhos Islands, Western Australia. BM(NH).

Haedroleura septangularis (Montagu, 1803). Torre San Giovanni, BR, Italy, 12 m. BM(NH).

Outgroup: subfamily Turrinae:
Gemmula deshayesi (Doumet, 1839). Off Cape d'Aguilar, Hong Kong, 20 m. BM(NH).

Abbreviations: AM, Australian Museum; ANSP, Academy of Natural Sciences, Philadelphia; BM(NH), Natural History Museum, London; NM, Natal Museum; NMW, National Museum of Wales.

are known from around the continental margins of the Indo-W. Pacific Ocean (Wells, 1994; Taylor & Wells, 1994; Sysoev, 1996). The relationships of the Crassispirinae to other conoideans are uncertain and those of the genera within the Crassispirinae are totally unknown; thus it is highly uncertain how the common genera of the East Pacific such as *Crassispira*, *Hindsiclava* etc. are related to some of the common Indo-W. Pacific genera such as *Inquisitor*, and *Funa*.

In order to establish the anatomical range of the Crassispirinae and evaluate characters which might be used to establish relationships both within the group and with other conoideans, we studied by serial sections the foreguts of 35 species. These were collected within the East Pacific, Caribbean, Mediterranean and Indo-Pacific provinces from a wide variety of habitats ranging from intertidal to abyssal depths. Additionally, we used *Gemmula deshayesi* (subfamily Turrinae) as an outgroup. This is the most extensive comparative study yet attempted of the anatomy of any group of Conoidea.

MATERIAL AND METHODS

Details of all the species used in the study are listed in Table 1. For all species longitudinal serial sections were made of the foregut, cut at 8 µm and mostly stained in green Masson's trichrome. Radulae were cleaned with a dilute sodium hypochlorite solution and examined by SEM.

ANATOMICAL DESCRIPTIONS

Abbreviations used in the anatomical figures

asg	acinous salivary gland
asgm	modified acinous salivary gland
bc	buccal cavity
blp	buccal lips
blpi	invertible buccal lips
bm	buccal mass
bs	buccal sac
bt	buccal tube
bts	buccal tube sphincter,
btsa	anterior sphincter of the buccal tube
btsi	intermediate sphincter of the buccal tube
cf	circular fold, surrounding opening of buccal sac
cfbt	circular fold of the buccal tube
con	circumoesophageal nerve ring
ct	connective tissue of the buccal mass wall
ctl	connective tissue layer of the muscular bulb
ebt	sac-like enlargement of the buccal tube
ep	epithelial pad
gre	glandular part of the rhynchodeum
iep	invaginated epithelium of the proboscis tip
ipt	inverted proboscis tip
ire	non-glandular invertible part of the rhynchodeum
lmb	lumen of the muscular bulb
mebt	thickened muscular wall of sac-like enlargement of buccal tube
ngre	non-glandular non-invertible part of the rhynchodeum
oe	oesophagus
oel	oesophageal loop
p	proboscis

pt	proboscis tip
rh/rhc	rhynchocoel
rhs	rhynchostomal sphincter
rs	radular sac
rst	rhynchostome
rtsg	anastomosing tubular salivary gland
rw	rhynchodeal wall
rwg	rhynchodeal wall glandular
sd	salivary duct
se	sac-like enlargement of buccal tube
sg	salivary gland
stag	single tube acinous salivary gland
t	radular tooth.
tsg	simple tubular salivary gland
v	valvule
vg	venom gland
vga	duct of venom gland

In this section we describe and illustrate the foregut anatomy and radulae of each of the species examined. The terminology of the anatomical characters and organs largely follows Taylor *et al.*, (1993). Most of the features are illustrated diagrammatically in Fig. 1, with details of others given in the descriptions of individual species.

Crassispira (Crassispira) incrassata (Sowerby, 1834)

(Figs 2, 4a)

Rhynchodeum and proboscis

The rhynchostomal sphincter is large and located in a slightly posterior position. The epithelium of the posterior rhynchodeal wall

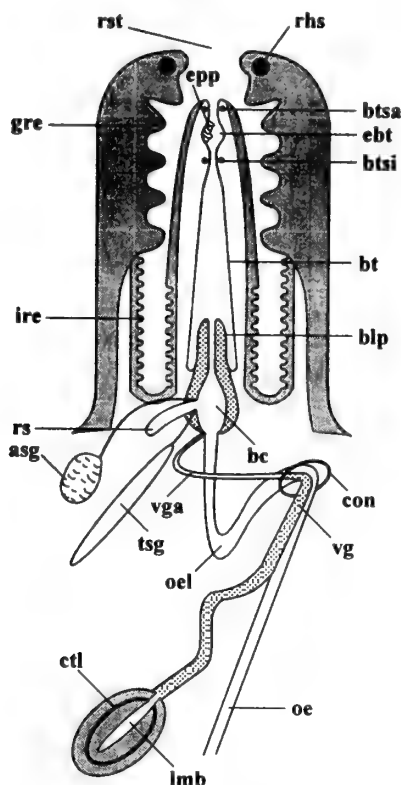

Fig. 1 Composite diagram of the foregut of a hypothetical crassispirine gastropod, showing the location of the major structures discussed in the text. No single species has all these structures.

is continuous with that of the proboscis wall for slightly more than half the length of the rhynchodeum. Extremely large proboscis retractor muscles are attached to the rhynchodeum at the border between the two different epithelia and at the proximal ends to the columellar muscle.

The proboscis is long (more than half of the rhynchodeum), slightly narrowing towards the tip. The proboscis tip is not inverted inside. The muscles of the proboscis wall in the posterior two thirds of the proboscis are significantly thicker than in the anterior section. The proboscis lies coiled within the rhynchocoel (shown uncoiled in drawing to illustrate relative proboscis length). There are two anterior buccal tube sphincters. A sac-like enlargement of the buccal tube is present, with the epithelium lining it taller than that of the rest of the tube. An epithelial pad is also present. There is no intermediate buccal tube sphincter.

The proboscis walls and posterior part of the rhynchodeum are highly folded, suggesting significant elongation of the proboscis during protraction. The proboscis wall is thick, comprising about 10% of proboscis diameter in the posterior half. In the anterior one third of the proboscis, the wall is thinner, but due to the decrease in proboscis diameter the wall comprises about 12% of the total diameter. The wall of the buccal tube is also thick, comprising about 7% of proboscis diameter in its posterior half. Small buccal lips are present.

Buccal mass and oesophagus

The large and very long buccal mass is located entirely within the proboscis, with a thick wall and is curved. The oesophagus is elongated between the buccal mass and nerve ring. The buccal sac is very short.

Glands

The salivary glands are very large and acinous, protruding nearly to the anterior of the rhynchodeum. The histology of the venom gland changes abruptly before passing through the nerve ring. The duct of the venom gland is ciliated, and opens into the buccal cavity at the posterior border with the oesophagus. The muscular bulb is large, with thick walls formed from two equal layers of circular muscle fibres separated by a connective tissue layer, with a third much thinner innermost layer of larger circular fibres.

Odontophore and radula

The odontophore is medium-sized, consisting of a pair of unfused cartilages, formed by single layer of cells. The radula (Fig. 4a) consists of marginal teeth of the robust wishbone type, with a thick, distally-pointed major limb and a shorter, thinner minor limb. The marginal tooth is short, ca. 180µm (0.5% of SL (shell length), 1.2% AL (aperture length)).

Crassispira (Crassispira) maura (Sowerby, 1834)

(Figs 3, 4b)

Rhynchodeum and proboscis

The rhynchodeal sphincter is medium-sized and anteriorly located. The epithelium of the anterior two thirds of the rhynchodeum is glandular, but posteriorly, it changes abruptly to low, cubic non-glandular, epithelium, which is continuous with that of the proboscis wall. The anterior rhynchodeum is narrow with high folds.

The proboscis is short, occupying less than half the length of the rhynchodeum, with the proboscis tip not inverted. The proboscis walls are rather thick, forming about 20% of the proboscis diameter, but the walls of the buccal tube are thin, composing about 4% of the total diameter. The mouth is narrow. The muscles of the proboscis

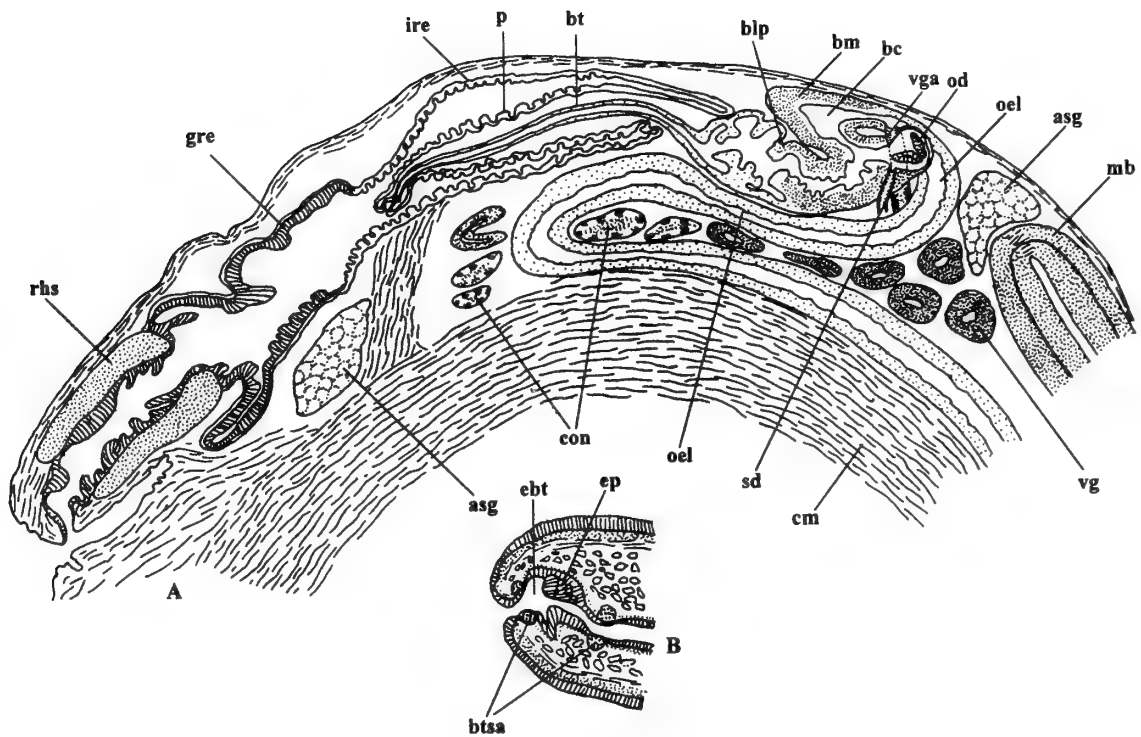

Fig. 2 *Crassispira (Crassispira) incrassata* (Sowerby, 1834). A, semidiagrammatic longitudinal section of the foregut (only one salivary duct is shown); B, longitudinal section of the proboscis tip.

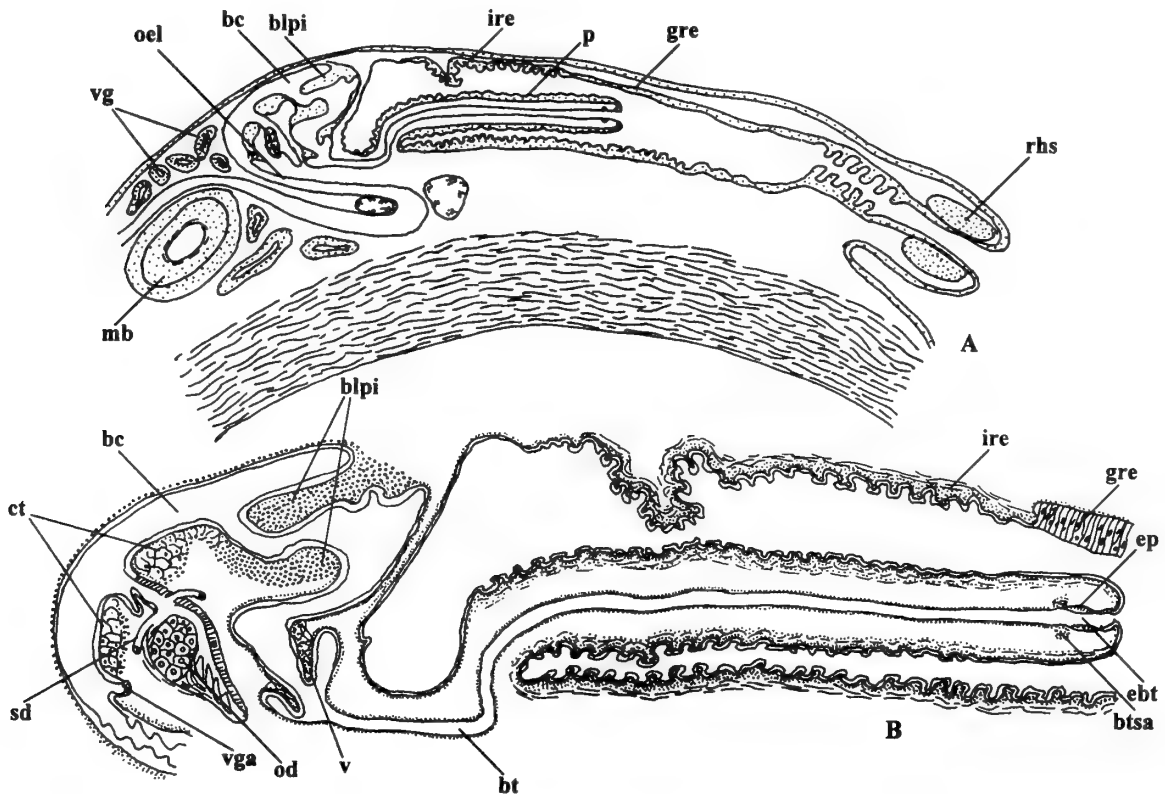

Fig. 3 *Crassispira (Crassispira) maura* (Sowerby, 1934). A, semidiagrammatic longitudinal section of the foregut (salivary glands and ducts not shown); B, longitudinal section of the proboscis and buccal mass.

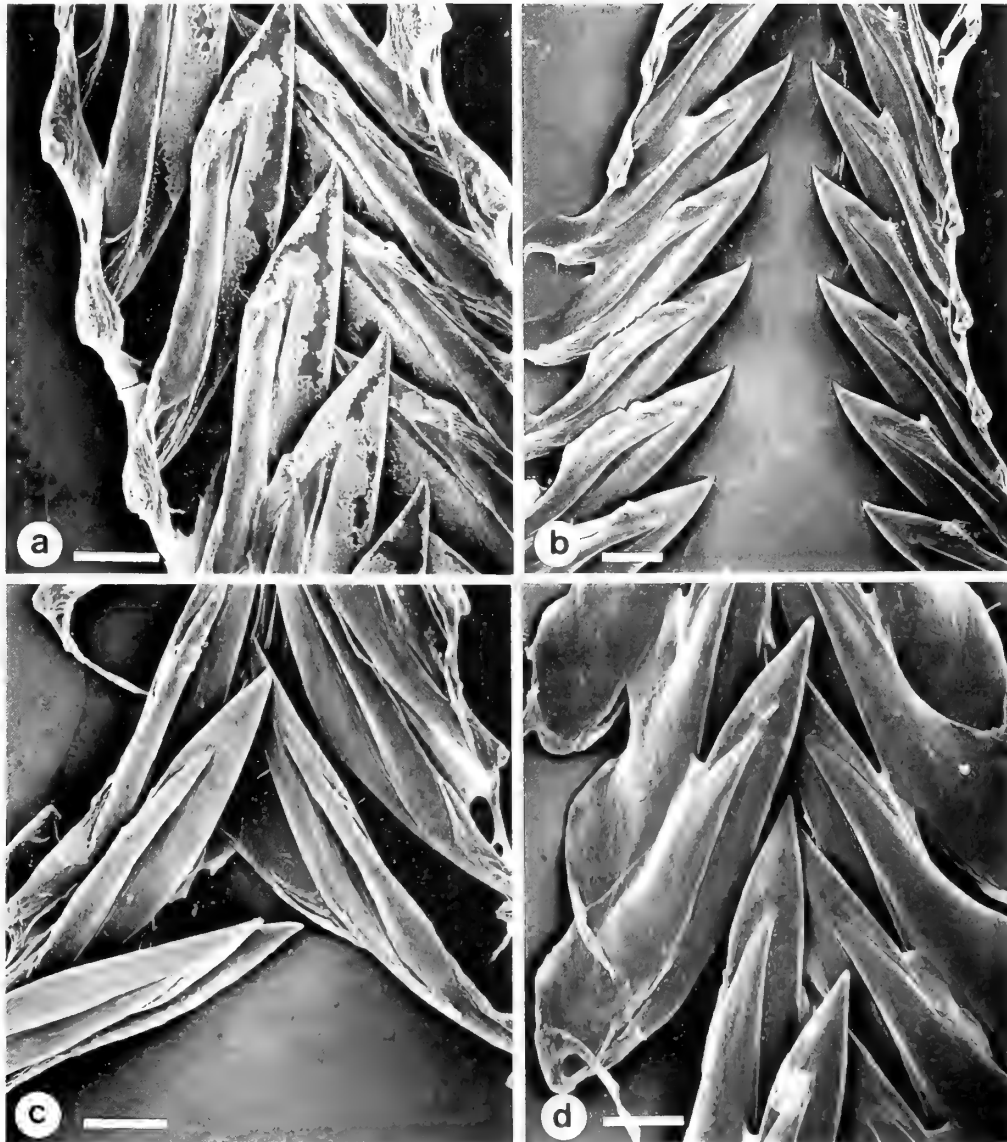

Fig. 4 Radulae of Crassispirinae. a, *Crassispira (Crassispira) incrassata* b, *Crassispira (Crassispira) maura* c, *Crassispira (Gibbaspira) dysoni* d, *C. (Glossispira) harfordiana flucki*. Scale bars = 20µm.

walls are equally developed along its length. There is a small anterior buccal tube sphincter, positioned at the base of the small sac-like enlargement of the buccal tube, which also has an epithelial pad. An intermediate buccal tube sphincter is absent. The buccal tube is very narrow, both inside the proboscis and for some distance behind it, and lined with a very low epithelium. Some distance behind the proboscis, the buccal tube expands greatly and forms two small, poorly-muscularized lips which are directed anteriorly, similar to the 'valvule.' (Sheridan *et al.* 1973). The buccal lips are large and muscular, with the dorsal one inverted inside the buccal cavity.

Buccal mass and oesophagus

The buccal mass is medium-sized and situated to the posterior of the proboscis base. Its dorsal wall is very thin. By contrast, the ventral wall near the entrance of the radular diverticulum is thick, but formed mainly by a layer of loose connective tissue, which is 4–8 times thicker than the muscle layer. The oesophagus is greatly elongated between the buccal mass and nerve ring, forming a long

loop. The buccal sac is of medium length and narrow.

Glands

The salivary glands are very large and acinous, with ducts that are thick and coiled, but become very thin as they approach the buccal mass. The venom gland changes in histology after passing anteriorly through the nerve ring. The duct of the gland is narrow, unciliated, and opens just to the posterior of the buccal cavity. The muscular bulb is large, with most of the wall formed by two subequal layers of longitudinal muscle fibres, divided by a connective tissue layer, with a third innermost, thin layer of circular muscle fibres.

Odontophore and radula

The odontophore is medium-sized with paired, unfused cartilages. The radula consists of only marginal teeth of the wishbone type, with the major limb robust, solid and pointed with a long straight leading edge. The minor limb is smaller and thinner, but tapers towards the base (Fig. 4b). The marginal tooth is short, ca. 130µm (0.3% of SL, 1.0% AL).

Crassispira (Gibbaspira) dysoni (Reeve, 1846)

(Figs 4c, 5)

Rhynchodeum and proboscis

The rhynchostomal sphincter is medium-sized and anteriorly located. The epithelium of the anterior half of the rhynchodeal wall is tall and glandular, while the posterior half is continuous with that of the proboscis wall. The proboscis tip is not inverted. The proboscis is short (about half of the rhynchocoel), not coiled, but slightly folded and narrowing towards the tip. The muscles of the proboscis wall are equally developed along its length.

The anterior buccal tube sphincter is small, whilst the sac-like enlargement of the buccal tube is long, with a long epithelial pad, formed of large cubic cells with large nuclei. At the base of the enlargement, there is an intermediate sphincter, which lies at a distance of three radular tooth lengths from the mouth. The walls of the sac-like enlargement are thicker than the rest of the buccal tube and similar to those of *C. (Crassiclava)* spp. The buccal tube is lined with ciliated epithelium. The proboscis wall is thin, forming about 10% of the proboscis diameter, while the wall of the buccal tube comprises about 7% of proboscis diameter. Buccal lips are absent.

Buccal mass and oesophagus

The buccal mass lies to the posterior of the proboscis, and is small, thin-walled and curved, and comprises less than one fifth of the

proboscis length. The oesophagus is greatly elongated between the buccal mass and nerve ring and forms a long loop. The epithelium bears very long cilia, which occupy nearly the whole lumen. The opening of the radular diverticulum into the buccal cavity is quite narrow and bordered by a rather tall circular muscular fold, similar to that seen in *C. harfordiana*. The salivary ducts open into the radular sac at the base of this fold (Fig. 5).

Glands

The salivary glands are large and acinous, with ducts that are thick, very long and highly coiled. The histology of the venom gland changes after passing anteriorly through the nerve ring. The duct of the gland is narrow, highly coiled and probably ciliated. The gland itself is very long, thick, and occupies a large part of the body haemocoel. The muscular bulb is large, with thick walls formed of two equal layers of circular muscle fibres, divided by a connective tissue layer. The lumen of the bulb is filled with venom granules.

Odontophore and radula

The odontophore is small, consisting of paired, unfused, subradular cartilages, formed by a single layer of cells. The radula consists of marginal teeth (Fig. 4c) which are of the wishbone type, with a large, solid, sharply pointed, major limb and a shorter, slender, secondary limb. The marginal tooth is medium long, ca. 105µm (0.8% of SL, 1.8% AL).

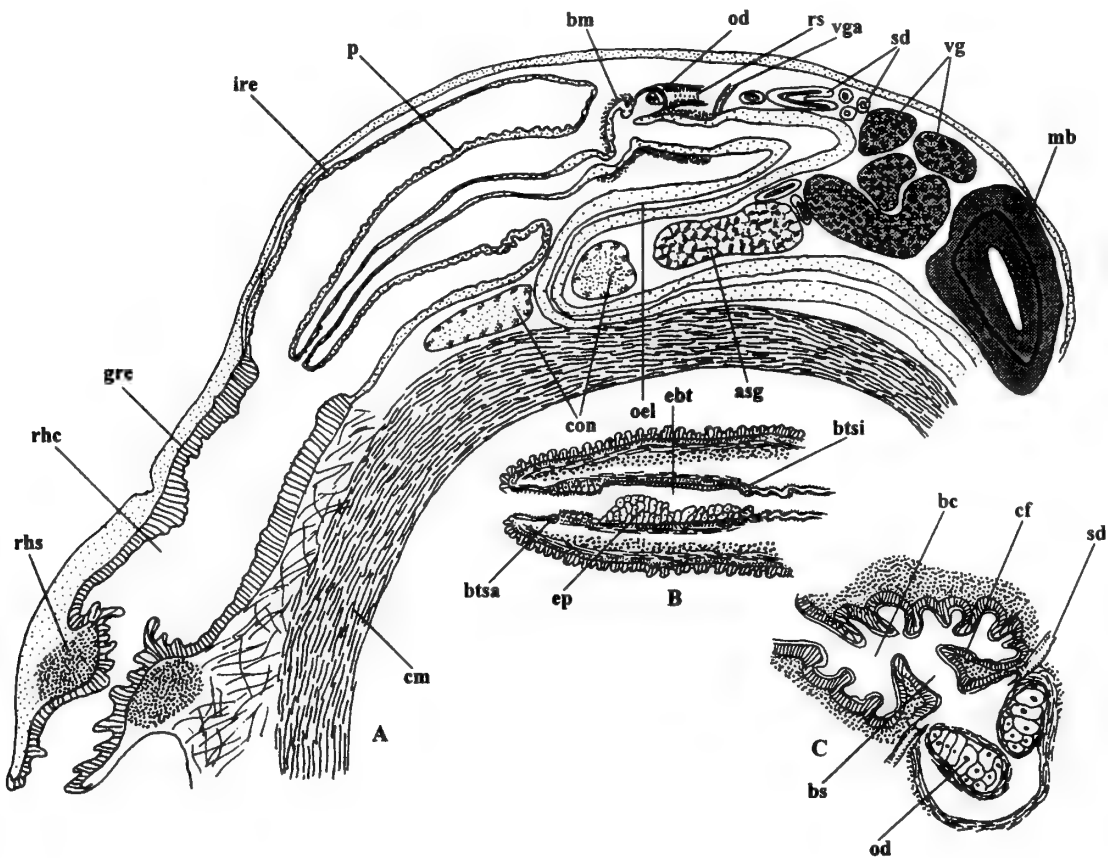

Fig. 5 *Crassispira (Gibbaspira) dysoni* (Reeve, 1846). A, semidiagrammatic longitudinal section of the foregut (salivary ducts not shown); B, longitudinal section of the proboscis tip; C, section of the buccal mass showing the opening of the radular sac.

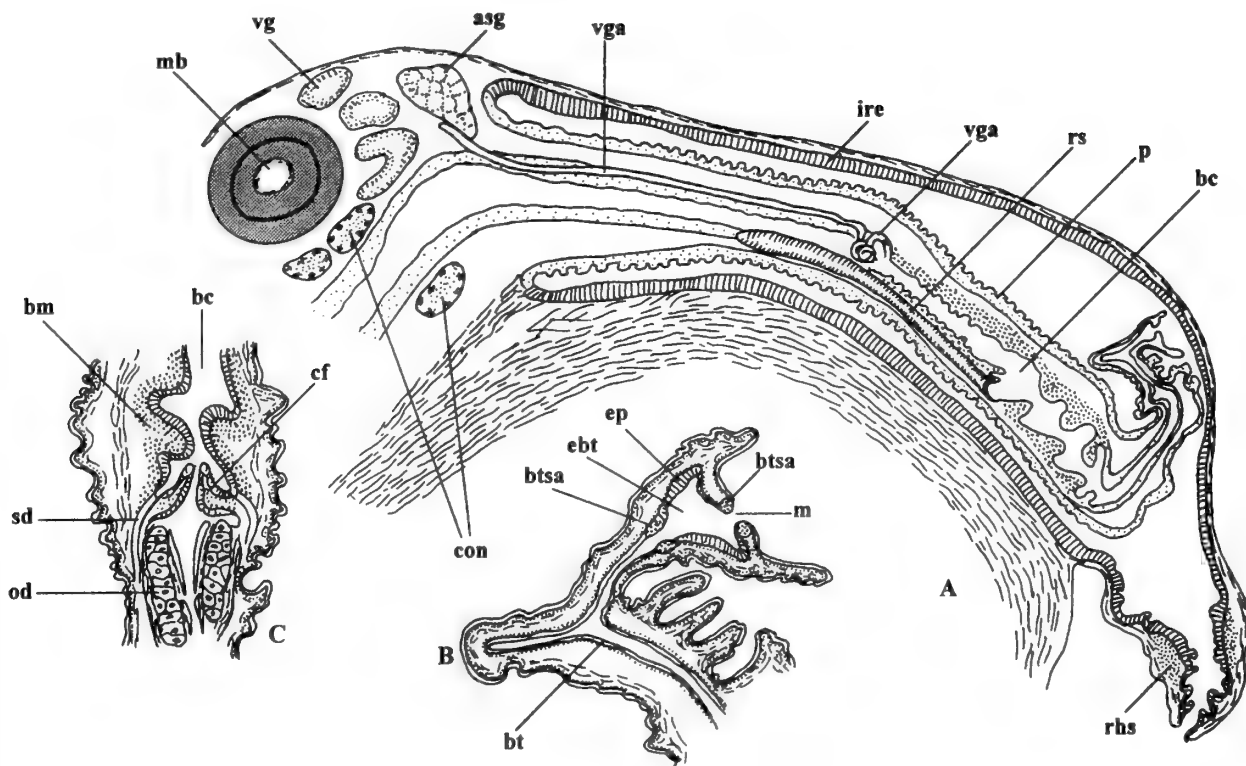

Fig. 6 *Crassispira (Glossispira) harfordiana flucki* (Brown & Pilsbry, 1913). A, semidiagrammatic longitudinal section of the foregut (salivary glands not shown); B, longitudinal section of the proboscis tip; C, section of the buccal mass, showing the opening of the radular sac.

Crassispira (Glossispira) harfordiana flucki (Brown & Pilsbry, 1913)

(Figs 4d, 6, 30e)

Rhynchodeum and proboscis

The rhynchostomal sphincter is small and slightly posteriorly situated. The epithelium of the rhynchodeum wall is glandular and that of the posterior rhynchodeal wall is not continuous with that of the proboscis wall. The proboscis tip is not inverted. The proboscis is very long and highly coiled (longer than the rhynchocoel and shown uncoiled in Fig. 6). The muscles of the proboscis wall are equally developed along its length, except at the very anterior.

The anterior part of the proboscis from the mouth opening to the buccal mass is very thin (about 0.1 mm compared to the proboscis length of about 5–6 mm) and highly folded. The proboscis tip is highly expanded to form a wineglass-shaped structure (Fig. 6, 30e). Closer to the tip, there is a septum with a small, circular sphincter surrounding the narrow opening. The septum delimits the sac-like enlargement of the buccal tube. The epithelium lining this is significantly taller than that of the rest of the tube, forming a low epithelial pad. At the base of the enlargement, there is a second small sphincter. Pieces of one, or possibly more, marginal teeth (fragmented during sectioning) were seen attached to the epithelium. The distance between the two sphincters corresponds to about one tooth length. It is possible, that the enlargement serves as a storage area for detached marginal teeth. There is no intermediate sphincter in the buccal tube.

Buccal cavity and oesophagus

The buccal mass is long (equivalent to about one quarter of proboscis length), with moderately thick walls and no curvature. It is

contained entirely within the proboscis and starts within the distal third of the proboscis length. The walls of the buccal cavity form several annular folds. The buccal lips are small.

The oesophagus is highly elongated between the buccal mass and nerve ring, but because the buccal mass is located anteriorly within the proboscis, there is virtually no loop. A buccal sac is absent. The opening of the radular diverticulum into the buccal cavity is narrow and bordered by a rather tall circular muscular fold. The salivary ducts open into the cavity at the base of this fold (Fig. 6).

Glands

The salivary glands are small, paired and acinous and lie at the proboscis base. The ducts are highly coiled. The histology of the venom gland changes abruptly after passing through the nerve ring. The duct of the venom gland is unciliated, narrow, and highly coiled before opening into the buccal cavity at the border with the oesophagus. The muscular bulb is large, with thick walls formed of two layers of longitudinal muscle fibres, separated by a connective tissue layer, with a much thinner innermost layer of larger circular fibres.

Odontophore and radula

The odontophore is small and composed of a pair of unfused cartilages formed by a single layer of cells. The radula consists of marginal teeth of the wishbone type (Fig. 4d), with a solid, pointed, curved major element and a shorter and narrower secondary element. The marginal tooth is medium long, ca. 195µm (0.7% of SL, 2.7% AL).

Crassispira (Crassispirella) latizonata (E. A. Smith, 1882)

(Fig. 7)

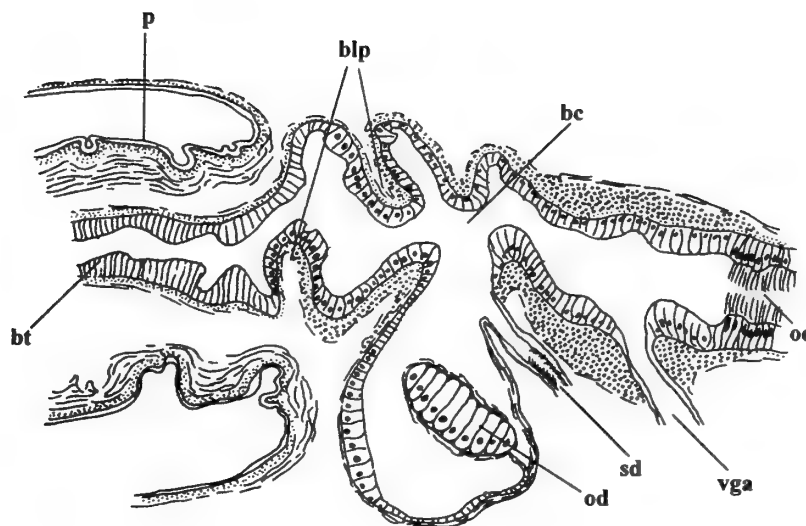

Fig. 7 *Crassispira (Crassispirella) latizonata* (Smith, 1882). Longitudinal section of the posterior part of the proboscis and buccal mass (only one salivary duct is shown).

Rhynchodeum and proboscis

The rhynchostomal sphincter is small and anteriorly located. The epithelium of the anterior half of the rhynchodeal wall is glandular, arranged into high folds, but to the posterior it is continuous with that of the proboscis wall. The dorsal wall of the proboscis tip is inverted inside. The proboscis is medium long (about half of the rhynchocoel) and not coiled. The muscles of the proboscis wall are equally developed along its length.

There is a small, anterior buccal tube sphincter, which lies in front of the well developed, sac-like enlargement of the buccal tube, lined with tall epithelium. There is no epithelial pad. A large, intermediate sphincter of the buccal tube is present, which lies at the base of the distal enlargement at a distance of about 2.5 radular tooth lengths from the mouth opening. The proboscis walls are not thick, composing about 15% of proboscis diameter. The wall of the buccal tube wall is also not thick, forming about 8% of proboscis diameter. Small buccal lips are present.

Buccal cavity and oesophagus

The buccal mass lies posterior to the proboscis base and is large, equivalent to about one quarter of proboscis length. Anterior to the opening of the radular sac, the walls of the buccal cavity are thin, similar to those of the buccal tube, but become thicker to the posterior.

The oesophagus is greatly elongated between the buccal mass and nerve ring and forms a very long loop. A remarkable feature of the oesophagus is that its epithelium bears very long cilia which occupy the whole lumen. The duct of the radular sac is broad and rather long. The buccal sac very short.

Glands

The salivary glands are tubular in histology, coiled and situated near the nerve ring. The salivary ducts are very long, coiled and thick. The histology of the venom gland changes abruptly after passing through the nerve ring. The duct of the venom gland is ciliated, coiled and narrow, with the same diameter as the salivary ducts, and opens into the buccal cavity at the border with the oesophagus. The muscular bulb is large, with thick walls formed of two layers of longitudinal muscle fibres, divided by a connective tissue layer, with a much thinner, innermost layer of circular fibres.

Odontophore and radula

The odontophore is rather large and consists of paired subradular cartilages, formed by single layer of cells. The radula was not examined and there are, unfortunately, no published illustrations.

Crassispira (Monilispira) pluto Pilsbry and Lowe, 1932

(Fig. 11a)

Rhynchodeum and proboscis

The rhynchostomal sphincter is large and anteriorly situated. The epithelium of the anterior seven eighths of the rhynchodeal wall is tall, glandular and arranged into high folds, while that of the posterior one eighth is continuous with the proboscis wall. The proboscis tip is not infolded. The proboscis is very long (ca 1.5 times longer than rhynchocoel), coiled in the anterior part and thick. The muscles of the proboscis wall are more developed at the base.

An anterior buccal tube sphincter is present. The sac-like enlargement of the buccal tube is present, but not well differentiated. Also, there is an epithelial pad with a marginal tooth attached to it. An intermediate sphincter is absent. The proboscis walls are thick, comprising about 20% of proboscis diameter, whilst the buccal tube wall is medium-thick, forming about 15% of the total diameter. The buccal lips are large and muscular.

Buccal mass and oesophagus

The buccal mass lies posterior to the proboscis, is rather long, with thick walls, uncurved and equivalent to about half the proboscis length. The oesophagus is elongated between the buccal mass and nerve ring and forms a long loop. The buccal sac is very short.

Glands

The salivary glands are large and acinous. The histology of the venom gland changes after passing the nerve ring. The duct of the venom gland is narrow and unciliated. The gland itself is long. The muscular bulb was unfortunately missing from the sections.

Odontophore and radula

The odontophore is large, consisting of paired, unfused, subradular cartilages, formed by a single layer of cells. The radula consists of

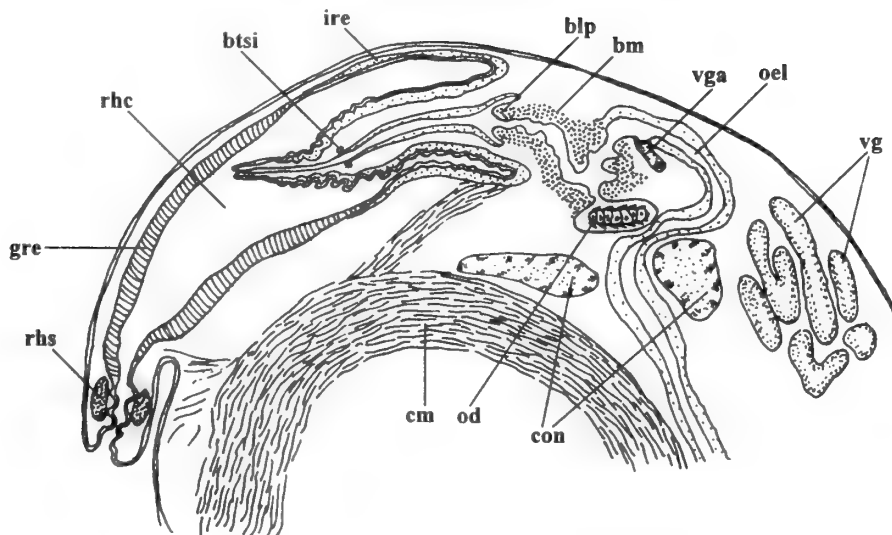

Fig. 8 *Crassispira (Striospira) tepocana* Dall, 1919. Semidiagrammatic longitudinal section of the foregut (salivary ducts and glands not shown).

marginal teeth of the wishbone type (Fig. 11a), with a solid, sharply-pointed major limb and a shorter, slender, secondary limb. The marginal tooth is long, ca. 175 μm (1.1% of SL, 2.9% AL).

Crassispira (Striospira) tepocana Dall, 1919

(Fig. 8)

Rhynchodeum and proboscis

The rhynchostomal sphincter is small and anteriorly located. The epithelium of the anterior two thirds of the rhynchodeal wall is tall and glandular, while that of the posterior one third is continuous with the proboscis wall.

The proboscis is short (about half of the rhynchocoel), coiled and folded in its anterior part, becoming narrow towards the tip. The muscles of the proboscis wall are better developed at the base. The proboscis tip is not infolded. There is no anterior buccal tube sphincter and the sac-like enlargement of the buccal tube is slight. The anterior part of the buccal tube is very narrow. There is a very small intermediate sphincter, which lies at a distance of about three radular tooth lengths from the very narrow mouth opening. The proboscis wall is thick, composing 25% of proboscis diameter at its base, and about 16% in its apical part. The buccal tube wall is medium-thick, making up about 10% of proboscis diameter. The buccal lips are very small.

Buccal mass and oesophagus

The buccal mass is long and curved and lies posterior to the proboscis, equivalent to about two thirds of proboscis length. The oesophagus is elongated between the buccal mass and nerve ring and forms a short loop. The epithelium bears very long cilia, which occupy nearly the whole lumen. The duct of the radular sac is broad and very short, whilst the buccal sac is virtually absent.

Glands

The salivary glands are medium-sized, with the ramified tubular morphology. The histology of the venom gland changes abruptly anterior to the nerve ring. The duct of the venom gland is narrow and unciliated. The gland itself is very long and occupies a large part of the body haemocoel. The muscular bulb is extremely large, with

thick walls formed of two subequal layers of longitudinal muscle fibres, divided by a connective tissue layer, with a much thinner innermost layer of circular muscle.

Odontophore and radula

The odontophore is medium-sized, with paired, unfused subradular cartilages, formed by a single layer of cells. The radula is illustrated by McLean (1971, fig. 66) and consists of marginal teeth of the wishbone type (similar to *C. kluthi*, Fig. 11b), with a large, robust and pointed major limb and a thinner, secondary element which is attached near the tip of the major limb.

Crassispira (Striospira) kluthi Jordan, 1936

(Fig. 11b)

The foregut anatomy of this species is similar to that of *C. tepocana* and only the differences are listed below.

The rhynchostomal sphincter is larger and located further to the posterior. The rhynchodeum is entirely glandular with no change in epithelium along its length. The proboscis is highly coiled. The proboscis walls are very thin in the anterior part and are thinner than in *C. tepocana* (about 15% of the proboscis diameter). The buccal mass lies within the proboscis base. The oesophagus is more greatly elongated and coiled between the buccal mass and nerve ring. The duct of the venom gland is very long and highly coiled. The radular teeth (Fig. 11b) have a large, pointed, major limb and a more slender secondary limb which is attached near the tip of the major limb. The marginal teeth are short, ca. 90 μm (0.5% of SL, 1.4% AL).

Crassispira (Striospira) xanti Hertlein & Strong, 1951

(Fig. 9)

Rhynchodeum and proboscis

The rhynchodeal sphincter is large and anteriorly located. The epithelium of the anterior half of the rhynchodeum is glandular and arranged into high folds; posteriorly, this changes abruptly to a non-glandular epithelium, which is continuous with that of the proboscis wall.

The proboscis is short, about half of the rhynchodeum length, with the tip not infolded. The proboscis walls are thick, composing

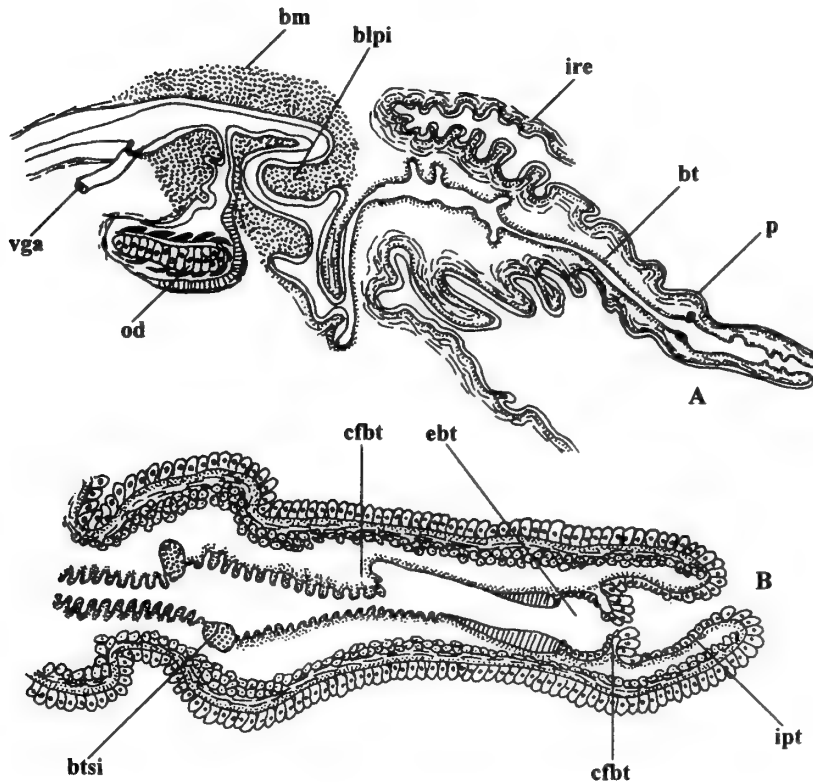

Fig. 9 *Crassispira (Striospira) xanti* Hertlein & Strong, 1951. A, longitudinal section of the proboscis and buccal mass (salivary ducts not shown); B, longitudinal section of the proboscis tip.

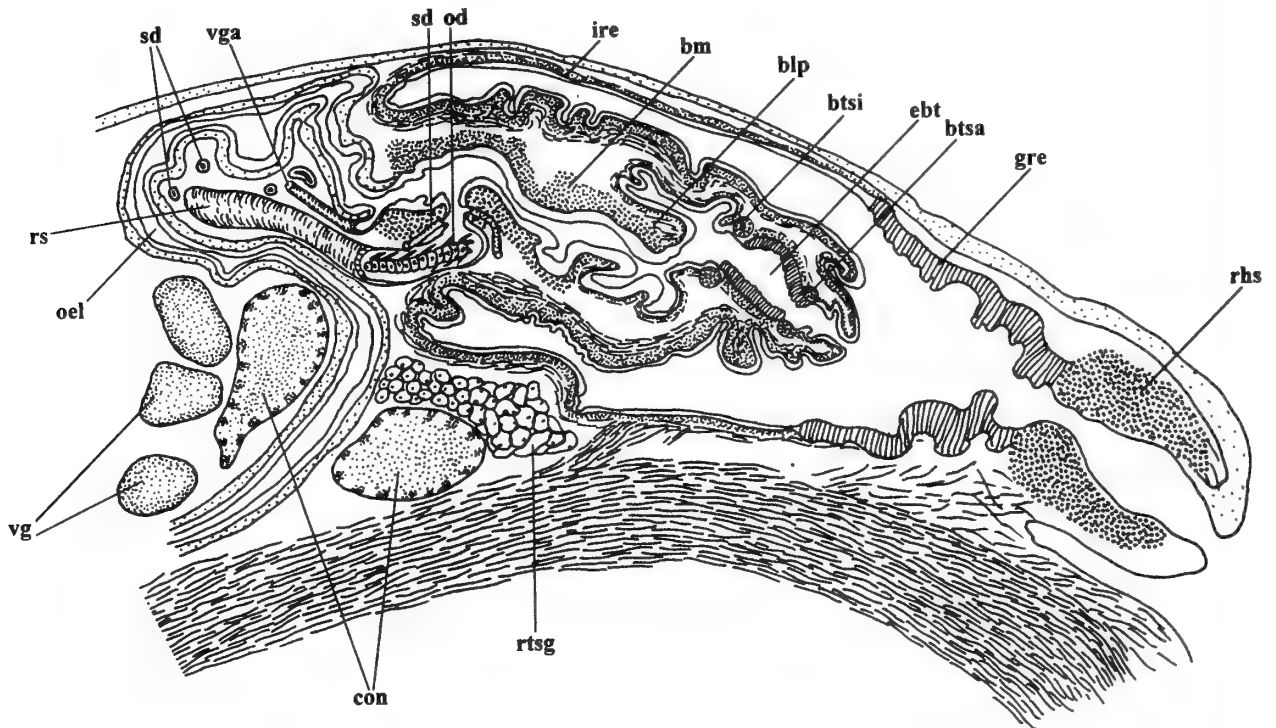

Fig. 10 *Crassispira (Crassiclava) turricula* (Sowerby, 1834). Semidiagrammatic section of the foregut.

about 25% of proboscis diameter, whilst the buccal tube walls are highly folded, but thin, making up about 6% of the total diameter. The mouth is narrow. The proboscis is highly folded, with the base more muscular than the tip. Both the anterior buccal tube sphincter and the epithelial pad are absent. The sac-like enlargement of the buccal tube is long and lined with tall epithelium, but poorly differentiated from the buccal tube. It has two unequal circular folds. The anterior one is larger and directed anteriorly and lined with tall epithelium. To the posterior of the second fold, the wall of the buccal tube forms an invagination, where the base of the radular tooth is situated. The intermediate sphincter of the buccal tube is rather large. The buccal tube is lined with a low, loose epithelium and after leaving the proboscis it expands slightly in diameter and forms two small, poorly-muscularized lips which are directed anteriorly, similar to the 'valvule' seen in *Mangeliinae* (Sheridan *et al.*, 1973). The buccal lips are medium-sized, muscular, with the dorsal one inverted inside the buccal cavity.

Buccal mass and oesophagus

The buccal mass is situated to the posterior of the proboscis, is rather large and muscular, with a narrow lumen, and sharply curved. The oesophagus is greatly elongated between the buccal mass and nerve ring, forming a long loop. The buccal sac is long and narrow.

Glands

The salivary glands are medium-sized and acinous, with long, coiled and rather thick ducts. The venom gland changes in histology after passing through the nerve ring, but its diameter remains nearly the same and there is no defined duct. The gland opens into the oesophagus just posterior to the buccal cavity. The muscular bulb is large, composed of two layers of longitudinal muscle fibres, divided by a connective tissue layer, with an innermost, thin layer of circular muscle fibres.

Odontophore and radula

The odontophore is medium-sized, with paired unfused cartilages formed of one layer of cells. The radula illustrated by McLean (1971, fig. 67) is composed of marginal teeth of the wishbone type, with a robust and pointed major limb and a smaller, shorter, secondary limb.

Crassispira (Crassiclava) turricula (Sowerby, 1834)

(Figs 10, 11c–d)

Rhynchodeum and proboscis

The rhynchostomal sphincter is large and anteriorly situated. The epithelium of the anterior one third of the rhynchodeal wall is glandular, and arranged into high folds; whilst the posterior two thirds is continuous with that of the proboscis wall. The proboscis tip is formed by the invagination of the outer proboscis wall into the buccal tube. This is confirmed by the similar, low, cubic epithelia of the outside of the proboscis and the anterior-most part of the buccal tube. Posteriorly in the buccal tube the cubic epithelium is replaced by one with columnar cells.

The proboscis is of medium length (little more than half of the rhynchocoel), uncoiled, but with telescopically folded walls. The muscles of the proboscis wall are better developed at its base.

An anterior buccal tube sphincter is present. The sac-like enlargement of the buccal tube is well-defined and lined with tall, glandular epithelium. An intermediate sphincter is also present, situated at the base of the sac-like enlargement. The walls of the buccal tube in the area of the enlargement are much thicker and formed by relatively

thicker circular muscle fibres, as if this part of the tube is capable of strong contraction. The proboscis wall is thick, composing about 25% of proboscis diameter, whilst the wall of the buccal tube is medium-thick, representing about 5% of proboscis diameter. Large muscular buccal lips are present.

Buccal mass and oesophagus

The buccal mass lies mainly within the proboscis and is very long, equivalent to about two thirds of the proboscis length. The oesophagus is greatly elongated between the buccal mass and nerve ring and forms a long loop. It is narrow and lined with an epithelium bearing long cilia. The duct of the radular sac is broad and rather long. The buccal sac is short.

Glands

The salivary glands are large, with the ramified tubular morphology. The salivary ducts are very long, coiled, and thick. The histology of the venom gland changes anterior to the nerve ring. The duct of the venom gland is narrow and unciliated. The muscular bulb is extremely large, with thick walls mainly formed of two layers of longitudinal muscle fibres, separated by a connective tissue layer, with a much thinner, innermost layer of circular fibres.

Odontophore and radula

The odontophore is large, consisting of paired, unfused, subradular cartilages, formed by a single layer of cells. The radula (Figs 11c–d) consists of both lateral and marginal teeth. The lateral teeth (use of the term 'lateral' teeth here does not imply homology with the lateral teeth of other neogastropods) are low and arcuate, sharply-curved anteriorly towards the midline of the ribbon. In profile these teeth are cuesta-like, with steep anterior faces and gentle posterior slopes. The marginal teeth are of the robust wishbone form with a large, pointed, major element and a thinner, shorter, minor element. The marginal teeth are ca 200µm long (0.6 %SL; 2.0%AL)

Crassispira (Crassiclava) apicata (Reeve, 1845)

(Fig. 12)

The anatomy of the foregut is similar to the preceding species and only the differences are mentioned.

The anterior part of the rhynchodeum, which is lined with glandular epithelium is shorter than in *C. turricula* and comprises about half the length of the rhynchodeum. The proboscis walls do not form telescopic folds. Also, the proboscis is longer and occupies about two thirds of the rhynchocoel. Only the anterior buccal tube sphincter is present and an epithelial pad is located within the sac-like enlargement of the buccal tube. The enlargement itself is shorter than in *C. turricula*. The proboscis walls are much thinner and comprise only about 6% of its diameter. The salivary glands are very large with the ramified tubular morphology. The radula (from Maes, 1983 figs 31 & 37) consists of both lateral and marginal teeth. The lateral teeth have the arcuate form illustrated for *C. turricula* (Figs 11c–d), whilst the marginal teeth have the wishbone form with a robust major limb and a shorter, thinner, minor limb.

Hindsiclava andromeda (Dall 1919)

(Fig. 13)

Rhynchodeum and proboscis

The rhynchostomal sphincter is of medium size and located slightly to the posterior. The epithelium of the anterior half of the rhynchodeal wall is tall and glandular, whilst the posterior is low and cubic and

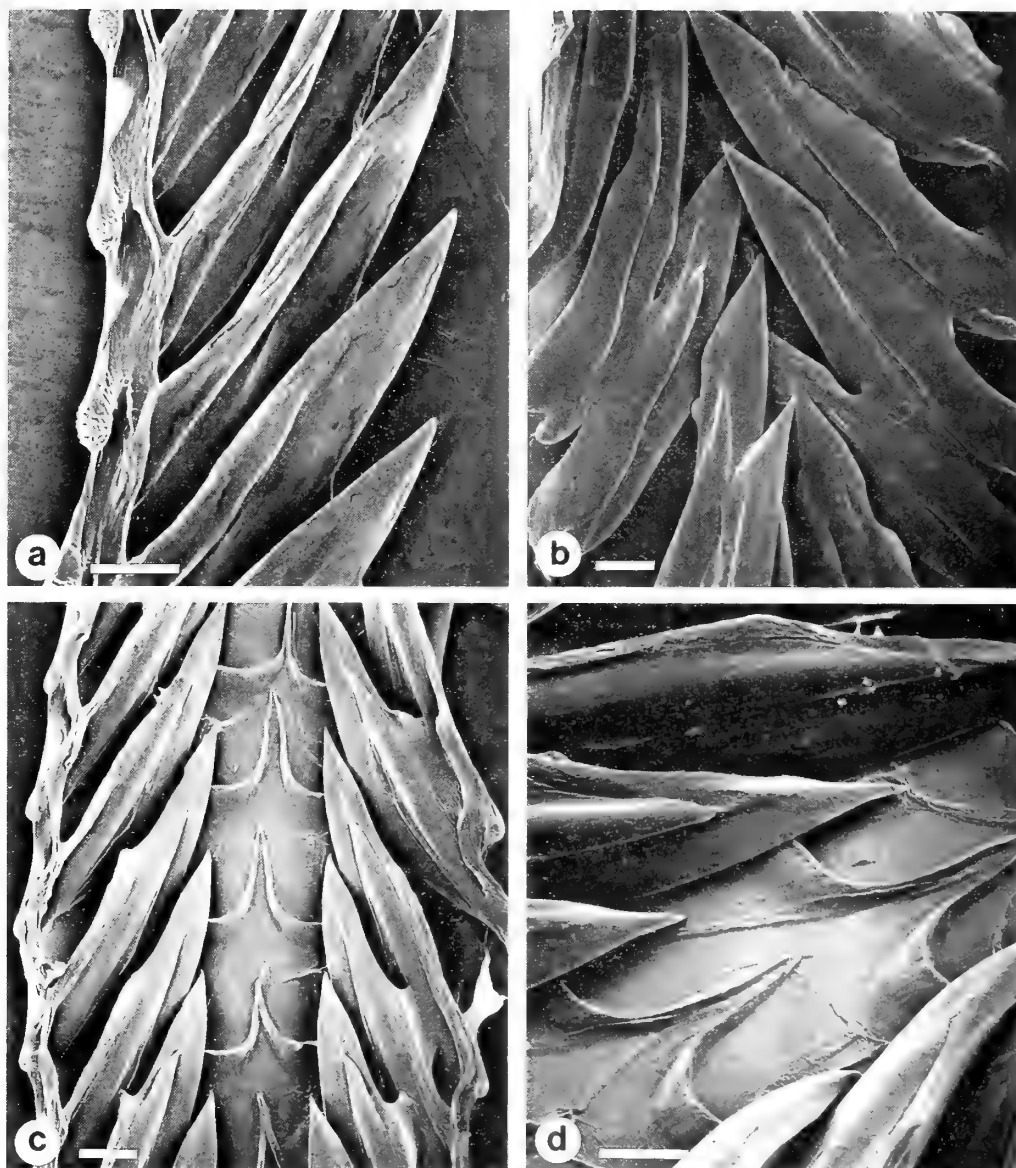

Fig. 11 Radulae of Crassispirinae. a, *Crassispira (Monilispira) pluto*, scale bar = 20 μ m b, *Crassispira (Striospira) kluthi* scale bar = 10 μ m c, *Crassispira (Crassiclava) turricula* scale bar = 30 μ m d, *C. (C.) turricula* scale bar = 20 μ m.

continuous with that of the proboscis wall. The wall of the rhynchodeum in its posterior part is muscular and free and much thicker than to the anterior. This posterior part of the rhynchodeum is able to evert. Powerful retractor muscles are attached at the point where the rhynchodeal epithelium changes; these run along the rhynchodeum and are attached to the buccal mass.

In the retracted position, the proboscis is rudimentary (Fig. 13), being only about twice as long as than the radular tooth length. The mouth opening is very narrow. There is no anterior buccal tube sphincter and the sac-like enlargement of the buccal tube is small. At the base of the enlargement there is an intermediate sphincter, which lies at a distance of about three radular tooth lengths from the mouth and posterior to the proboscis. The buccal tube forms a loop posterior to the proboscis and widens greatly before opening in the buccal mass.

Buccal mass and oesophagus

The buccal mass is medium-sized, and located to the posterior of the

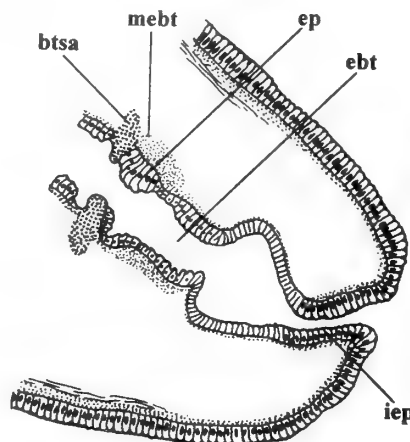

Fig. 12 *Crassispira (Crassiclava) apicata* (Reeve, 1845).

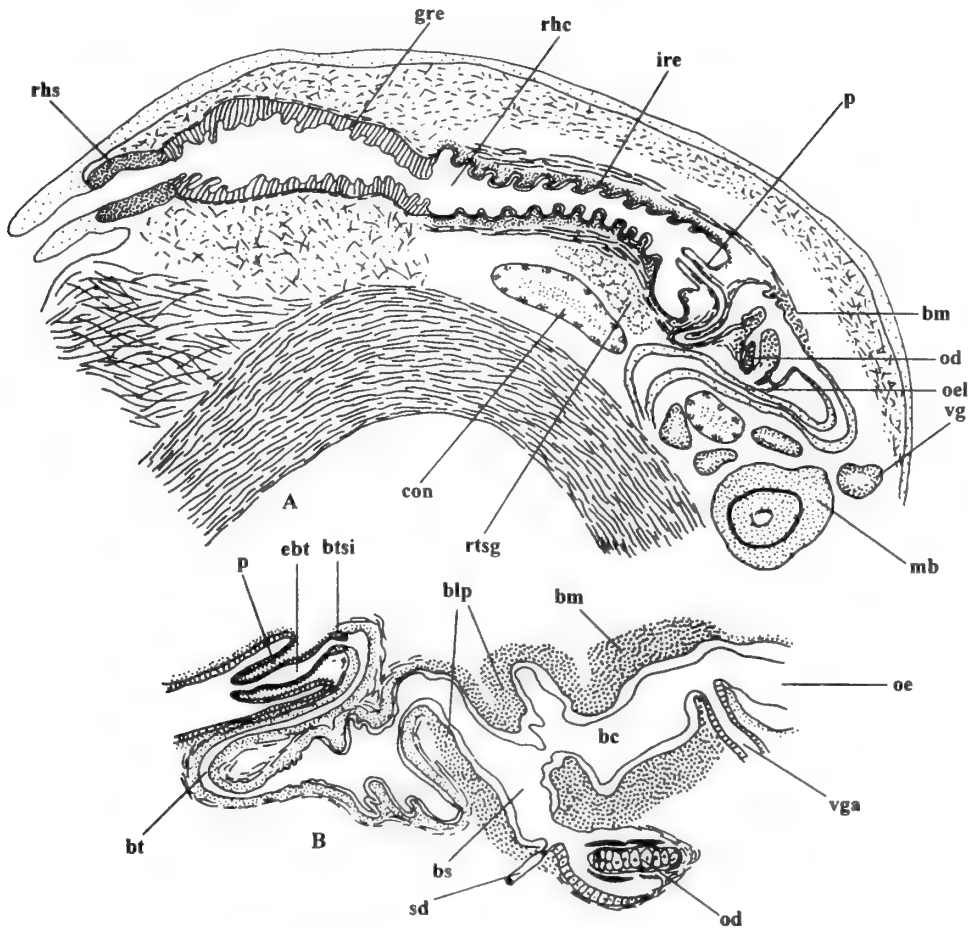

Fig. 13 *Hindsiclava andromeda* (Dall, 1919). A, Semidiagrammatic longitudinal section of the foregut (salivary ducts not shown); B, longitudinal section of the proboscis and buccal mass (only one salivary duct is shown).

proboscis. It has rather muscular walls and is not curved. The buccal lips are asymmetrical, the ventral lip being large, and the dorsal medium-sized. The oesophagus is greatly elongated between the buccal mass and nerve ring and forms a long loop. The opening of the radular diverticulum into the buccal cavity is narrow, and the salivary ducts open at the entrance of radular diverticulum into the buccal mass. A buccal sac is absent.

Glands

The salivary glands are very large with the ramified tubular morphology. The salivary ducts are very long and thick, but only slightly coiled. The histology of the venom gland changes abruptly soon after passing anteriorly through the nerve ring. The duct of the venom gland is narrow, coiled and unciliated. The muscular bulb is large, with a narrow lumen and thick walls mainly formed of two equal layers of longitudinal muscle fibres, divided by a connective tissue layer, with a thin, innermost layer of circular fibres.

Odontophore and radula

The odontophore is small, consisting of a pair of unfused, subradular cartilages, formed by a single layer of cells. Unfortunately, no radular information is available for this species, but it is presumed to be similar to *Hindsiclava militaris* (see below).

Hindsiclava militaris (Reeve, 1843)

(Figs 14 a–b)

Two specimens were sectioned. The species is very similar in general foregut anatomy to *H. andromeda* and differs mainly in the slightly longer proboscis (which occupies from 1/7 to 1/5 of the rhynchodeum). The proboscis is very muscular, with the entire lumen filled with retractor muscles. The anterior buccal tube sphincter is very small, and hardly visible. The proboscis tip is invaginated. This is confirmed by the change of the epithelium in the anterior part of the buccal tube. A short buccal sac is present.

Radula

The radula consists mainly of two rows of marginal teeth. These are wishbone in form but have a very distinctive, hairpin-like morphology (Figs 14 a–b). The major limb is elongate and pointed, slightly concave-upwards in profile with raised edges. The secondary limb is long and slender, attached to the major limb near the tip but detached and distantly separated for most of the length, with separate attachment to the radular membrane. Another feature of the radula is the regular low, transverse ridges which cross the central part of the ribbon (Fig. 14a) The marginal teeth are medium long, ca. 140µm (0.5% of SL, 1.9% AL).

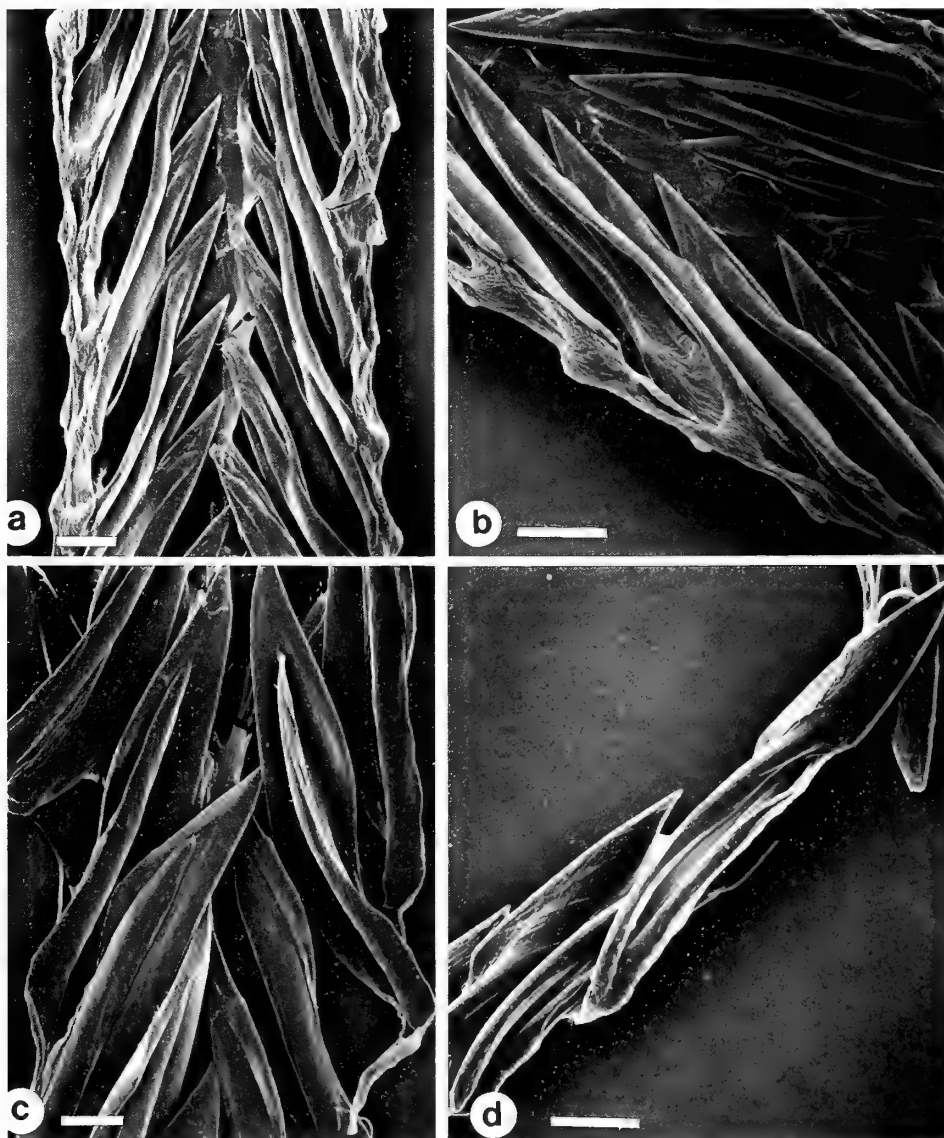

Fig. 14 Radulae of Crassispirinae a, *Hindsiclava militaris* b, *H. militaris* c, *Miraclathurella bicanalifera* d, *Haedropleura septangularis*. Scale bars = 20µm.

***Miraclathurella bicanalifera* (Sowerby, 1834)**

(Fig. 14c)

Rhynchodeum and proboscis

The rhynchodeal sphincter is small and anteriorly located. The epithelium of the anterior part of the rhynchodeal cavity is glandular, whilst that of the posterior rhynchodeum is low, non-glandular, and continuous with that of the proboscis wall. The rhynchostome is rather wide.

The proboscis is as long as the rhynchodeal cavity, highly folded, and very thick at the base, but sharply narrowing towards the tip. The proboscis walls are thick and form about 22% of the proboscis diameter at its base. The wall muscles at the proboscis tip are much thinner. The proboscis is very muscular and its lumen is mostly filled with the retractors. The mouth is narrow. The anterior buccal tube sphincter is absent. The sac-like enlargement of the buccal tube is poorly defined, but lined with taller epithelium with a small epithe-

lial pad. There is a large intermediate sphincter, situated approximately one third of the distance down the proboscis. The buccal tube is very narrow anteriorly, but broad in the posterior part of the proboscis. Its walls are highly folded and compose about 10% of the proboscis diameter. The buccal tube is lined with a very low epithelium, which is replaced with a tall one, continuous with that of the buccal cavity, slightly anterior to the buccal cavity.

Buccal mass and oesophagus

The buccal mass is large, slightly less than half of the proboscis length, and lies within the proboscis. It has rather thick walls with no curvature. The buccal lips are very small and poorly defined. Anterior to them, the walls of the buccal tube form a fold, similar in appearance to the true buccal lips. The oesophagus is elongated between the buccal mass and nerve ring and forms a medium-long loop. A buccal sac is absent. The salivary ducts open in the buccal cavity on both sides of the very broad opening of the radular diverticulum.

Glands

The salivary glands are large, paired and acinous. The venom gland changes in histology after passing anteriorly through the nerve ring. The duct is very narrow, ciliated, coiled, and opens at the border between the buccal mass and oesophagus. The muscular bulb is large, with the wall formed of two equal layers of longitudinal muscle fibres, divided by a connective tissue layer, with an innermost, thin layer of circular muscle.

Odontophore and radula

The odontophore is rather large and protrudes into the buccal cavity. It has paired, unfused cartilages, formed by single layer of cells. The radula (Fig. 14c) consists of marginal teeth of the wishbone type, each tooth with a large major limb with a pointed tip, the middle part of the tooth broad and concavo/convex and narrowing towards the base. The secondary limb is thin at the distal end broadening towards the base. The marginal tooth is 172µm in length (1.1% of SL, 4.2% AL)

Haedropleura septangularis (Montagu, 1803)

(Figs 14d, 15)

The specimen sectioned was rather similar to the illustration in Sheridan *et al.* (1973, fig. 6) and differs only in some details.

Rhynchodeum and proboscis

The rhynchodeal sphincter is small and anteriorly located. The epithelium of the anterior half of rhynchodeum wall is tall, glandular and folded. Posteriorly, it is replaced abruptly with a low, non-glandular, cubic epithelium continuous with that of the proboscis wall.

The whole rhynchocoel is rather short and the thick proboscis, although not long, occupies nearly the entire cavity. The ratio between the proboscis length and its diameter is about 1.3. The proboscis tapers toward the tip, which is slightly invaginated at the mouth opening. The proboscis walls are medium-thick and compose about 16% of the proboscis diameter at its base. The mouth opening is very narrow. The muscles of the proboscis wall are equally developed along the length, and only in the inverted part are they somewhat thinner. The proboscis retractor muscles are very large and occupy the whole inner lumen. A large anterior buccal tube sphincter is present, situated somewhat posterior to the proboscis tip. The distance between the sphincter and the uninverted part of the proboscis tip is equivalent to the length of a single radular tooth. A sac-like enlargement of the distal part of the buccal tube is present, but poorly defined. This is lined with loose, tall, ciliated epithelium, while the remaining part of the tube is lined with extremely low,

inconspicuous, epithelial cells. There is no intermediate sphincter. The buccal tube has thin walls.

Buccal mass and oesophagus

The buccal mass lies to the posterior of the proboscis base, and is rather long, equivalent to about two thirds of the proboscis length. It has thick walls and a narrow inner cavity, which is uncurved. Long, extensible, buccal lips are present (not shown by Sheridan *et al.*, 1973). The oesophagus shows no elongation between the buccal mass and nerve ring.

Glands

The salivary glands are paired, large, tubular and coiled. Their diameter is much larger than illustrated by Sheridan *et al.* (1973) and only 2–3 times smaller than that of the venom gland. The salivary ducts are very short, narrower than the glands and ciliated. There is no change in the histology of the venom gland to the anterior of the nerve ring, and it opens into posterior part of the buccal cavity at the boundary with the oesophagus. The venom gland is very large, highly coiled and occupies most of the body haemocoel. The muscular bulb is very large and elongate; longer and thicker in fact than the proboscis. Its wall is formed of two subequal layers of longitudinal muscle fibres, divided by a connective tissue layer, with a very thin innermost layer of circular fibres.

Odontophore and radula

The odontophore is medium-sized, with paired, unfused, odontophoral cartilages. The radula consists of marginal teeth, which are of the wishbone type (Fig. 14d), but with the major element having a large, spatulate, pointed, distal end and a narrow shaft. The minor element is thinner and attaches distally to the broad blade of the major element and to the radula ribbon at the base. The marginal tooth is long, ca. 145µm (1.7% of SL, 4.0% AL).

Nquma scalpta Kilburn, 1988

(Figs 16, 17a, 30a)

Rhynchodeum and proboscis

The rhynchodeal sphincter is large and anteriorly situated. The epithelium of the anterior two thirds of the ventral rhynchodeum wall and three quarters of the dorsal wall is tall, glandular, folded and formed of large cells. The epithelium of the posterior rhynchodeum is formed of low, non-glandular, cubic cells continuous with that of the proboscis wall.

The proboscis is long, slightly longer than the rhynchocoel and with the tip not infolded. The proboscis walls are medium-thick, comprising about 13% of the proboscis diameter in its central part. The mouth opening is extremely narrow. The muscles of the proboscis wall are equally developed along its posterior part, but are absent near the distal tip of the proboscis. There is no anterior sphincter of the buccal tube. The distal end of the buccal tube possesses a sac-like enlargement which is lined in the anterior part with very tall and narrow columnar cells where there is also an epithelial pad. The base of a marginal radular tooth was seen attached to the pad. Posterior to the pad, the epithelium is very low, similar to that of the remaining part of the buccal tube, but becomes tall and probably glandular just in front of the large intermediate sphincter, which lies close, about two marginal tooth lengths, distant from the proboscis tip. The buccal tube has rather thin walls.

Buccal mass and oesophagus

The buccal mass is long, equivalent to about 2/3 of the proboscis length and lies at the proboscis base, projecting a long way to the

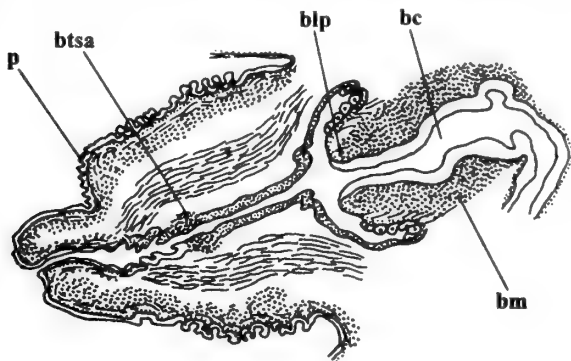

Fig. 15 *Haedropleura septangularis* (Montagu, 1803). Longitudinal section of the proboscis (radular sac not shown).

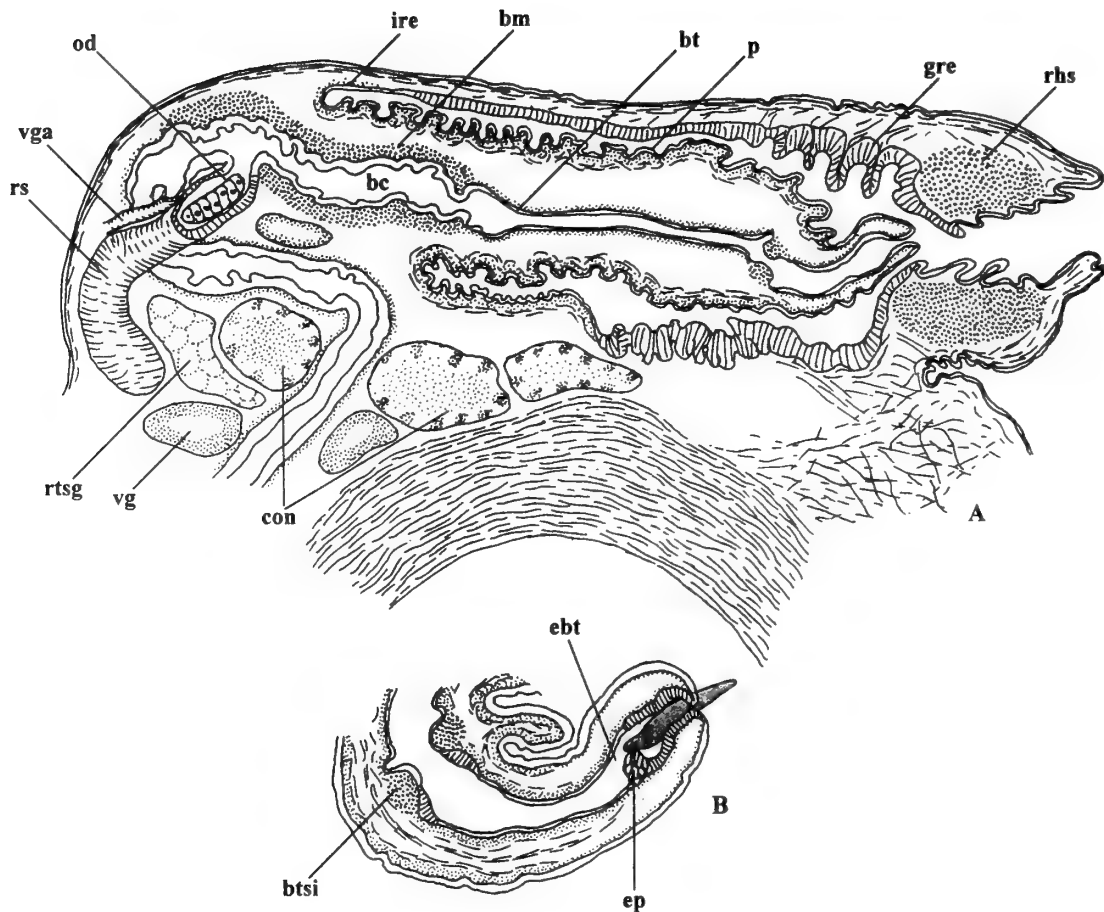

Fig. 16 *Nquma scalpta* Kilburn, 1988. A, Semidiagrammatic longitudinal section of the foregut (salivary ducts not shown); B, longitudinal section of the proboscis tip showing a gripped marginal tooth.

posterior of the rear of the proboscis. It has relatively thin walls and a narrow inner cavity which is uncurved. Extensible buccal lips are absent. The oesophagus is elongated between the buccal mass and nerve ring, forming a rather long loop.

Glands

The salivary glands are large, fused and acinous. The ducts are paired, very long, coiled, thick and leave the gland at the same place. The venom gland changes histology after its anterior passage through the nerve ring. The duct of the gland is narrow, ciliated, long and coiled, and opens into posterior part of the buccal cavity. The wall of the muscular bulb is formed of three layers, the two outermost being divided by a connective tissue layer, with a very thin innermost layer of circular fibres. The two outer layers are formed from longitudinal muscle fibres, the outer being twice as thick as the inner.

Odontophore and radula

The odontophore is small, with paired and unfused, odontophoral cartilages. The buccal sac is short. The radula (Fig. 17a) consist of marginal teeth, with each wishbone tooth formed of two elements. The major element is robust and solid with a distal point. The secondary element is smaller (0.6 of the major element), thinner and terminates before the base of the tooth. The marginal tooth is medium long, ca. 130 μ m (1.3% of SL, 2.7% AL).

Nauvedrillia praetermissa (Smith, 1904)

The foregut anatomy is similar in general pattern to that of *Nquma scalpta* and differs in the position of the buccal mass, which lies totally posterior to the proboscis, and the more developed but nevertheless still short buccal lips. The striking difference is that in *N. praetermissa* the salivary glands are tubular, large and highly coiled, with a rather wide inner lumen. The ducts are very short, of similar diameter to the glands, but ciliated.

A radular tooth was seen in the sac-like enlargement of the buccal tube, attached to the epithelial pad. The radula consists of marginal teeth (Kilburn, 1988, fig. 52), with each tooth comprising two components; a large major element which is an elongate, grooved and twisted blade, with a distal point and a shorter minor element which is attached about halfway along the major element. The marginal tooth is long, ca. 160 μ m (1.3% of SL, 3.5% AL).

Epidirona gabensis (Hedley, 1922)

(Fig. 18a)

Rhynchodeum and proboscis

The rhynchostomal sphincter is large and posteriorly located. The rhynchocoel is very long and narrow. The epithelium of nearly the whole rhynchodeal cavity is tall, glandular, folded and formed of

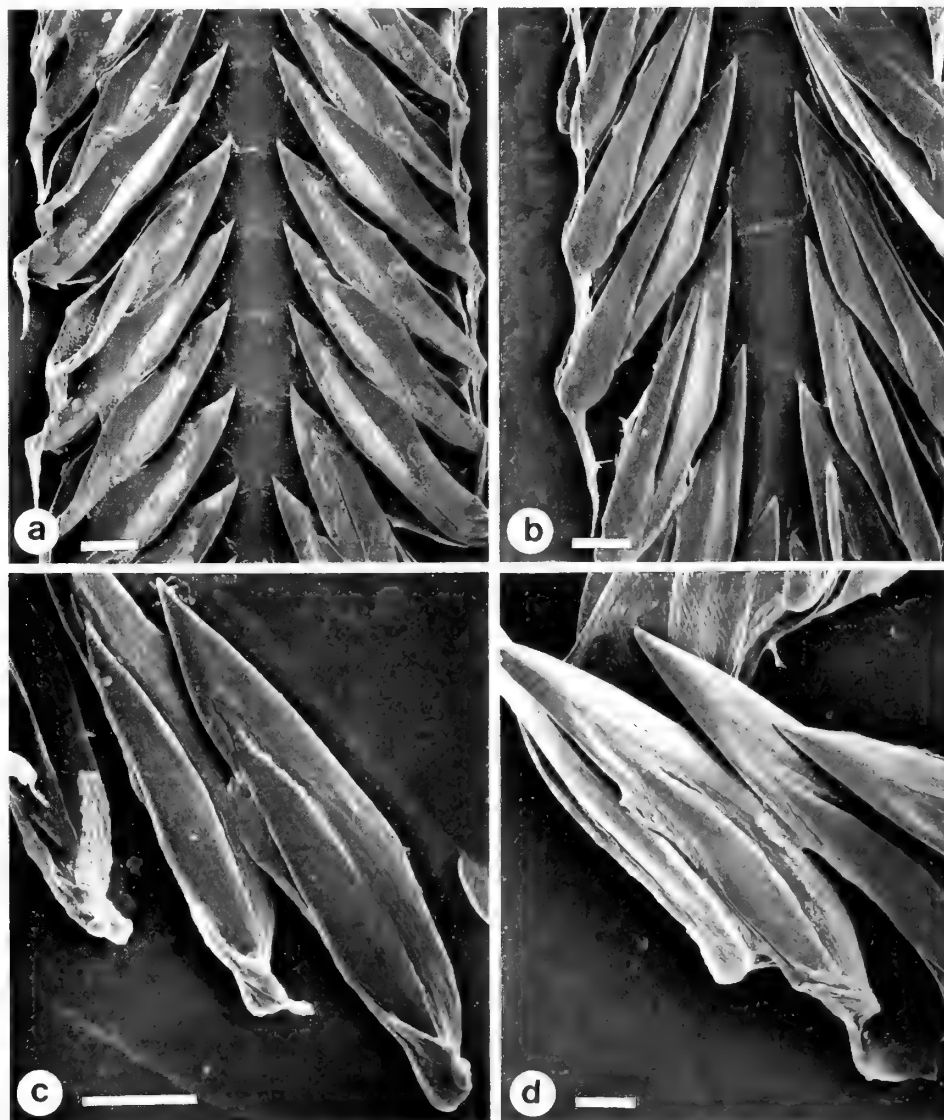

Fig. 17 Radulae of Crassispirinae. a, *Nquma scalpta* scale bar = 20 μ m b, *Inquisitor latifasciata* scale bar = 25 μ m c, *Inquisitor aemula* scale bar = 20 μ m d, *Inquisitor* aff. *adenicus* scale bar = 20 μ m.

large cells. In approximately the posterior one tenth of the rhynchodeum the epithelium is non-glandular and continuous with that of the proboscis wall.

The proboscis is short in comparison with the rhynchocoel (about 1/5 of its length), rather thick and not coiled. The proboscis walls are thick, forming about 25% of the proboscis diameter. The mouth is very narrow. The muscle of the proboscis walls are equally developed along its length. The anterior buccal tube sphincter is very small and lies posterior to the mouth in front of medium-sized sac-like enlargement of the buccal tube. The epithelium, lining the enlargement forms a large pad, to which the base of a marginal tooth was attached. There is a large intermediate sphincter, situated at about three marginal tooth lengths distant from the mouth opening. The buccal tube has rather thin walls, forming about 10% of the proboscis diameter. It is lined with a tall folded epithelium.

Buccal mass and oesophagus

The buccal mass is large in comparison with the proboscis, equiva-

lent to about two thirds of its length. It lies posterior to the proboscis, with a wide lumen and relatively thin walls. Buccal lips are absent. The oesophagus is greatly elongated between the buccal mass and nerve ring, forming a long loop. Anteriorly, it is wide and flattened, but soon becomes very narrow. There is no buccal sac.

Glands

The salivary glands are large, acinous and fused. The venom gland changes in histology abruptly after passing anteriorly through the nerve ring. The duct is very narrow, unciliated, and opens into the buccal cavity at the posterior border with the oesophagus. The muscular bulb is medium sized, of an irregular oval shape, with its wall consisting of a thick outer layer of circular muscle fibres, a connective tissue layer, a thinner layer of circular fibres and a thin innermost layer of longitudinal fibres.

Odontophore and radula

The odontophore is medium-sized, with the odontophoral cartilages

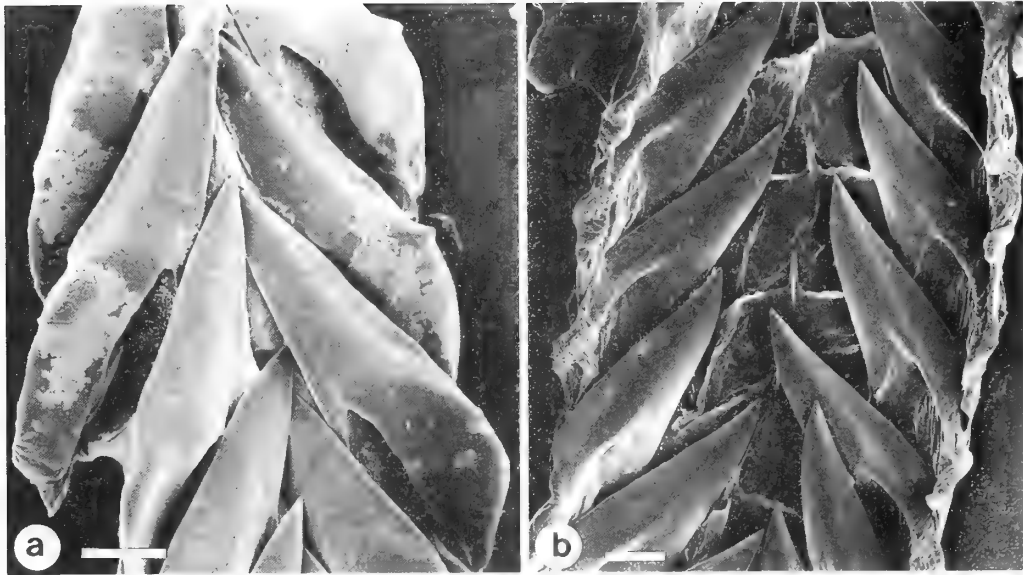

Fig. 18 Radulae of *Epidirona* and *Gemmula* (outgroup). a, *Epidirona gabensis* scale bar = 20µm b, *Gemmula deshayesi* scale bar = 25µm.

paired unfused. The radula is composed of marginal teeth. These teeth (Fig. 18a) are of the wishbone type with the distal half tapering to a sharp point, whilst the proximal part of the tooth bifurcates into two more or less equisized limbs. The marginal teeth are medium long, ca. 120µm (0.5% of SL, 1.8% AL).

Inquisitor latifasciata (Sowerby, 1870)

(Figs 17b, 20)

See also Taylor (1994, plate 1e,7; figs 11–12)

Rhynchodeum and proboscis

The rhynchodeal sphincter is large and anteriorly situated. The epithelium of the anterior two thirds of the rhynchodeal cavity consists of very tall cells, is glandular, and folded. The epithelium of the posterior one third of the rhynchodeum is continuous with that of the proboscis wall, and consists of low, cubic, non-glandular cells. The rhynchostome is narrow.

The proboscis is long in semi-relaxed animals, and lies coiled within the rhynchodeal cavity. In retracted specimens, the proboscis is very short, less than one third of the rhynchocoel and infolded at the tip. The proboscis wall is not thick in retracted specimens, and comprises about 8% of the proboscis diameter. The mouth is narrow in semi-relaxed animals, but is capable of great stretching and is very wide in retracted specimens (Fig. 20). The muscles of the proboscis wall are equally developed along its length. Both anterior and intermediate buccal tube sphincters are absent and there is no sac-like enlargement of the buccal tube. The buccal tube is very thin-walled in the anterior part (in the inverted position of the proboscis tip), but rather thick posteriorly, where it is nearly equal to the proboscis wall in width. The buccal lips are very large and form the muscular tube, which in retracted specimens extends beyond the mouth of the proboscis.

Buccal mass and oesophagus

The buccal mass is muscular, with thick walls and a rather narrow inner cavity which is not curved. In the retracted state, it lies just within the base of the proboscis, but can clearly be protracted to near the distal tip of the proboscis. There are several retractor muscles,

attached to the buccal mass at one end and to the rhynchodeum at the other. The oesophagus is slightly elongated between the buccal mass and nerve ring, forming a short loop.

Glands

The salivary glands are large, paired and acinous. The histology of the venom gland changes abruptly in histology after passing anteriorly through the nerve ring. The duct of the gland is narrow and opens just posterior to the buccal cavity. The muscular bulb wall is formed of two equal layers of longitudinal muscle fibres, divided by a connective tissue layer.

Odontophore and radula

The odontophore is medium sized, with paired, unfused, odontophoral cartilages. The buccal sac is long. The radular comprises marginal teeth only, with each tooth of the wishbone type (Fig. 17b) with a large robust major limb with a distal point and a smaller, slender secondary limb

Inquisitor aemula (Angas, 1877)

(Figs 17c, 21)

Rhynchodeum and proboscis

The rhynchodeal sphincter is medium-sized and anteriorly located. The epithelium of nearly the whole rhynchodeum is glandular and only in a small posterior portion is it low, cubic and non-glandular, like that of the proboscis.

The proboscis is very long, longer than the rhynchodeal cavity and curved when retracted. The proboscis walls are thin, comprising about 10% of the proboscis diameter. The mouth is very narrow, with a low 'rim'. Muscles of the proboscis wall are equally developed along its length. There is no anterior buccal tube sphincter, but there is a large intermediate sphincter, which lies at a distance of about three marginal tooth lengths from the mouth opening. The sac-like enlargement of the buccal tube has a wide lumen, with the epithelium near the mouth opening being columnar and moderately tall, soon becoming low, but forming the epithelial pad, to which a marginal tooth was attached. The buccal tube has moderately thick

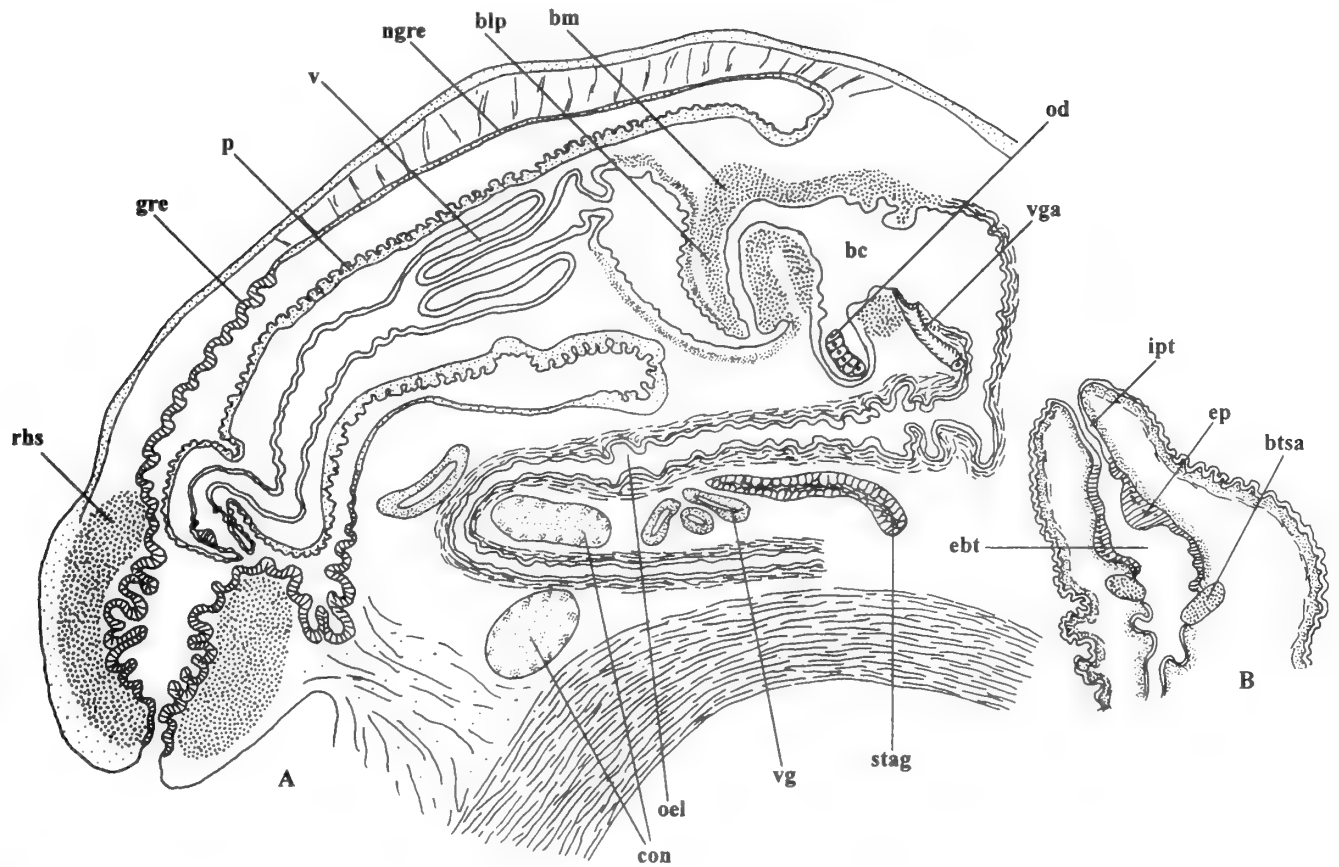

Fig. 19 *Funa jeffreysii* (Smith, 1875). A. Semidiagrammatic longitudinal section of the foregut; B. longitudinal section of the proboscis tip with a gripped marginal tooth.

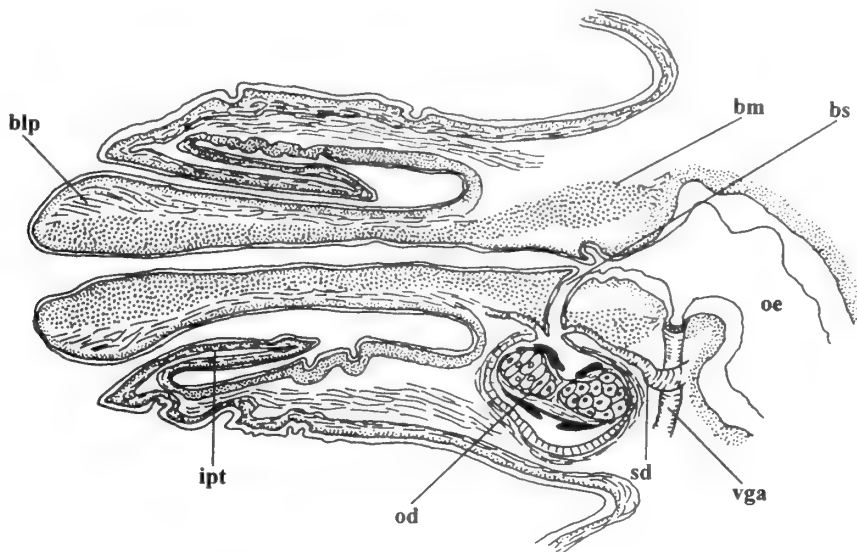

Fig. 20 *Inquisitor latifasciata* (Sowerby, 1870). Longitudinal section of the proboscis and buccal mass in the retracted position.

walls, which are equal in thickness to the proboscis walls. It is wide after the intermediate sphincter, but then greatly reduced in diameter, becoming wider posteriorly (on the drawing the narrowed part of the buccal tube is somewhat shorter, than actual). The buccal lips are small.

Buccal mass and oesophagus

The buccal mass lies within the proboscis and occupies about half the proboscis length. It has rather thin walls and a broad inner cavity, which shows no curvature. The oesophagus is greatly elongated between the buccal mass and nerve ring, forming a long loop.

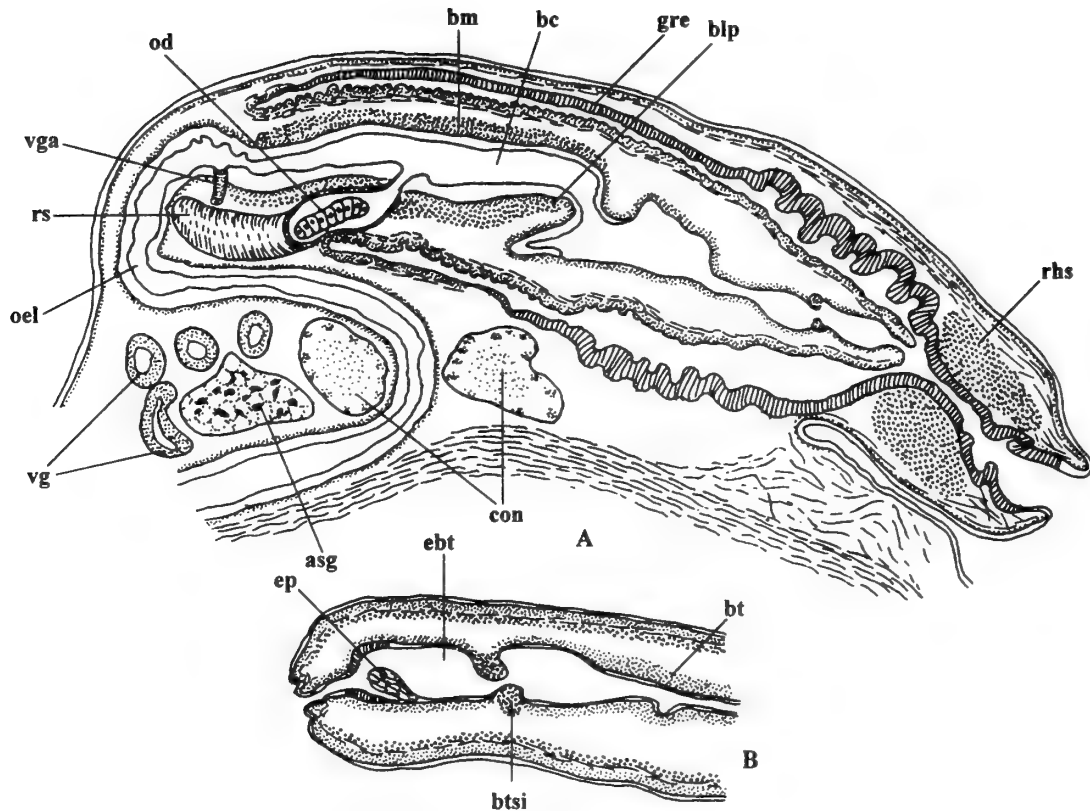

Fig. 21 *Inquisitor aemula* (Angas, 1877). A, semidiagrammatic longitudinal section of the foregut (salivary ducts not shown); B, longitudinal section of the proboscis tip.

Glands

The salivary glands are medium-sized, paired and acinous, with the ducts thick and coiled. The venom gland changes abruptly in histology after passing anteriorly through the nerve ring. The duct of the gland is unciliated, narrow, with thick muscular walls, and opens just posterior to the buccal cavity. The muscular bulb is formed of an outer layer of longitudinal muscle fibres, a connective tissue layer, an inner layer of longitudinal fibres, which is ca. 2.5 times thinner than the outer and finally, a thin, innermost layer of circular muscle fibres. The epithelium lining the inner cavity is rather well developed and non-glandular.

Odontophore and radula

The odontophore is medium-sized, with the odontophoral cartilages paired and unfused. The buccal sac is medium long and very narrow. The radula (Fig. 17c) consists of marginal teeth of the wishbone type, with a robust, solid, pointed, major limb and a smaller thinner, minor limb. The marginal tooth is medium long, ca. 130 μ m (0.6% of SL, 2.3% AL).

Inquisitor aff. *adenicus* Sysoev, 1996

(Fig. 17d)

Rhynchodeum and proboscis

The rhynchodeal sphincter is medium large and anteriorly located. The epithelium of nearly whole the rhynchodeum is glandular and for only about one quarter of the posterior portion is it continuous with that of the proboscis wall.

The proboscis is long, and occupies the entire rhynchocoel in one specimen and about half of it in the other. The proboscis walls are thick, and compose about 25% of proboscis diameter. The mouth is very narrow and lined with probable sensory epithelium. The muscles of the proboscis wall are equally developed along its length. The anterior buccal tube sphincter is very small and hardly visible, but the intermediate buccal tube sphincter is large, and lies at a distance of more than two marginal tooth lengths behind the mouth opening. The sac-like enlargement of the buccal tube is well developed, and lined with tall epithelium, which in one specimen forms a pad with a marginal tooth attached to it. The buccal tube has thin walls, about 3–4% of proboscis diameter, lined with a tall epithelium. The buccal lips are very small.

Buccal mass and odontophore

The buccal mass is short, about one third of proboscis length and lies posterior to the base of the proboscis. It is uncurved, with rather thin walls and a broad inner cavity. Several folds of the walls project into the buccal cavity. The buccal mass lies posterior to the proboscis base. The oesophagus is greatly elongated between the buccal mass and nerve ring, forming a long loop.

Glands

The salivary glands are acinous, with thick, uncoiled ducts. The venom gland changes abruptly in histology after passing through the nerve ring. The duct of the gland is narrow and unciliated, with thick muscular walls, and opens just posterior to the buccal cavity. The muscular bulb is large and long, with its wall formed of two nearly equal layers of circular muscle fibres, divided by a connective tissue

layer. The epithelium, lining the inner cavity is rather well-developed in one specimen, but non-glandular.

Odontophore and radula

The odontophore is medium-sized with paired, unfused odontophoral cartilages. A buccal sac is absent. The radula (Fig. 17d) consists of marginal teeth which are of the wishbone type with a robust major limb and a smaller secondary limb. The marginal tooth is short, ca. 140µm (0.5% of SL, 1.4% AL).

***Funa jeffreysii* (Smith, 1875)**

(Figs 19, 23d)

See also Taylor (1994, plates 1f, 6a; figs 8 & 9)

Rhynchodeum and proboscis

The rhynchodeal sphincter is large and anteriorly located. The epithelium of the anterior one third of the rhynchodeum is highly folded and glandular, formed of large cells. In the posterior of the rhynchodeum there is an abrupt change to a very low and inconspicuous, non-glandular epithelium which is continuous with that of the proboscis wall.

The proboscis is long, as long as the rhynchodeum, with the tip not infolded. The proboscis walls are thin, comprising about 7% of proboscis diameter. The walls of the buccal tube are similarly thin, composing about 5% of total diameter. The mouth is narrow. The muscles of the proboscis walls are equally developed along its length.

There is a medium-sized, anterior buccal tube sphincter, positioned at the base of the sac-like enlargement of the buccal tube. An epithelial pad is present within the sac-like enlargement. There is no intermediate buccal tube sphincter. The buccal tube is lined with a very low epithelium. It expands greatly to form a long circular fold, which appears like poorly-muscularized, anteriorly-directed lips, similar to the 'valvule' (Sheridan *et al.*, 1973) The buccal lips are large and muscular.

Buccal mass and oesophagus

The buccal mass is large and situated partially within the proboscis base. Its walls are moderately thick. The oesophagus is greatly elongated between the buccal mass and nerve ring, forming a long loop. The walls of the oesophageal loop are thick and formed from distinct longitudinal muscle fibres. The buccal sac is not defined.

Glands

The salivary glands are large, consisting of single tubes, surrounded by acinous cells (acinous tubular type). The ducts are thick and coiled. The venom gland changes in histology while passing anteriorly through the nerve ring. The duct of the gland is narrow, unciliated and opens into the posterior buccal cavity. The muscular bulb is medium-sized, its wall formed of two layers of circular muscle fibres (the outer layer being nearly three times thicker than the middle, divided by a connective tissue layer, with a third innermost, thin layer of longitudinal muscle fibres).

Odontophore and radula

The odontophore is medium-sized, with paired, unfused cartilages. The radula consists of marginal teeth (Fig. 23d) which are paddle-shaped with a broad distal blade and a long narrow shaft. The distal tip is pointed, with knife-like edges on either side and a blunt barb. An inconspicuous, thin, secondary limb lies along the margin of the main shaft of the tooth.

Remarks

The unusual feature of this species is that the buccal mass can be protracted way beyond the proboscis tip and out through the rhynchostome (Taylor, 1994, fig. 8). Nevertheless, in the retracted position the buccal mass lies at the proboscis base. It is possible that the presence of the valvule is also connected with the possibility of buccal mass eversion.

***Funa latisinuata* (Smith, 1877)**

(Fig. 23c)

See also Taylor (1994, plate 1g, 6b; fig. 10)

Rhynchodeum and proboscis

The rhynchodeal sphincter is large. The epithelium of the anterior one third of the rhynchodeum is highly folded and glandular whilst the posterior is composed of a low, inconspicuous, non-glandular and continuous with that of the proboscis wall.

The proboscis is long, nearly as long as the rhynchodeum and broad with the tip not infolded. The proboscis and buccal tube walls are thin. The mouth is relatively wide. The muscles of the proboscis wall are equally developed along its length. There is a small anterior buccal tube sphincter, but no sac-like enlargement, no epithelial pad and no intermediate sphincter.

Buccal mass and oesophagus

The buccal mass is large and situated partially within the proboscis base and uncurved. Its walls are moderately thick and muscular. The oesophagus is greatly elongated between the buccal mass and nerve ring forming a long loop. The walls of the oesophageal loop are thick and muscular. There is no buccal sac.

Glands

The salivary glands are large and acinous, but with a modified histology. The ducts are thick and coiled. The venom gland changes in histology while passing anteriorly through the nerve ring. The anterior part has thick muscular walls and opens into the posterior part of the buccal cavity. The muscular bulb is medium-sized, with the wall formed from two equisize layers of circular muscles, divided by a thick connective tissue layer, with a very thin innermost layer of longitudinal muscle fibres.

Odontophore and radula

The odontophore is medium-sized, with paired, unfused cartilages. The radula consists of marginal teeth only (Fig. 23c) which are paddle-shaped, with a flattened, angular, barb-less, distal termination, and a long thin shaft. A thin accessory limb lies along the shaft.

***Ptychobela suturalis* (Gray, 1838)**

(Figs 22, 23a, 30c)

Rhynchodeum and proboscis

The rhynchodeal sphincter is medium-sized and situated rather to the posterior of the rhynchostome. The epithelium of the anterior one third of the rhynchodeal cavity is folded and formed of tall, glandular cells. The low, non-glandular epithelium of the posterior two thirds of the rhynchodeum is continuous with that of the proboscis wall. This indicates that a large part of the rhynchodeal wall takes part in proboscis protraction.

In retracted animals, the proboscis is short with the tip infolded (Taylor 1994, fig. 18). However, in relaxed animals, the proboscis is very long, longer than the rhynchocoel and with the tip not inverted.

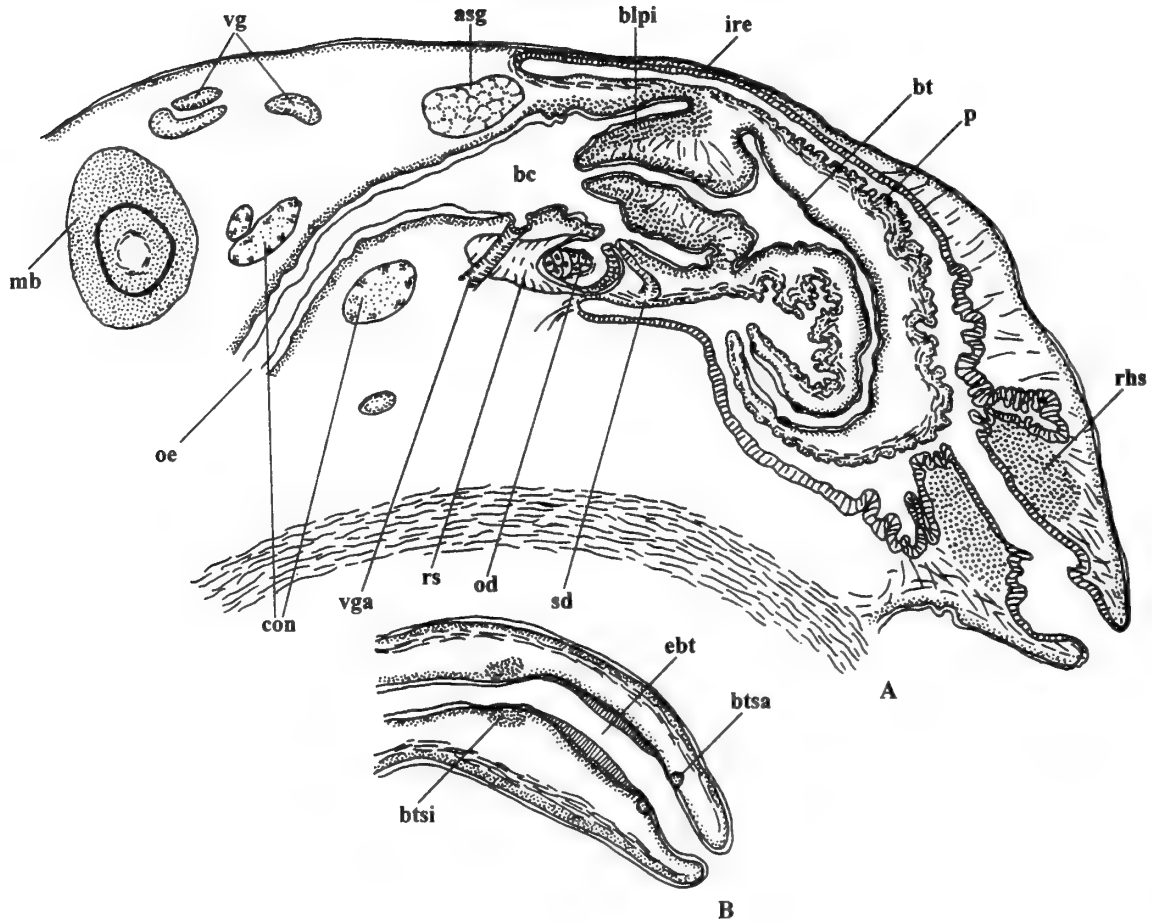

Fig. 22 *Ptychobela suturalis* (Gray, 1838). A, semidiagrammatic longitudinal section of the foregut (only one salivary duct shown) with the proboscis in an everted position and buccal lips inverted inside the buccal cavity; B, longitudinal section of the proboscis tip.

The proboscis walls are medium-thick, and comprise about 15% of the proboscis diameter. The mouth is narrow in relaxed animals, but capable of great expansion. The muscles of the proboscis walls are equally developed along its length.

The buccal tube has a very small anterior sphincter and there is no sac-like enlargement at the distal end. There is a large intermediate sphincter, which lies about two radular tooth lengths behind the proboscis tip. The buccal tube has rather thick walls, only slightly thinner than those of the proboscis. In the anterior half of the proboscis, the buccal tube is narrow, but greatly expanded posteriorly. There are large, extensible buccal lips which can invert into the buccal cavity. In retracted specimens, they form a muscular tube with a flaring aperture, which extends beyond the mouth of the proboscis.

Buccal mass and oesophagus

The buccal mass lies within the base of the proboscis, and is rather long, comprising about a quarter of the proboscis length, with relatively thin walls and a very broad inner cavity, which is not curved. The oesophagus is elongated between the buccal mass and nerve ring, forming the short loop.

Glands

The salivary glands are large, paired and acinous. The venom gland changes in histology after passing anteriorly through the nerve ring. The duct of the gland is narrow, ciliated, and opens into posterior

part of the buccal cavity. The muscular bulb is long, with the wall formed of two equally thick layers of longitudinal muscle fibres, divided by a connective tissue layer and very thin innermost layer of circular fibres.

Odontophore and radula

The odontophore is small with the odontophoral cartilages, paired, and unfused. The buccal sac is very short. The radular teeth (Fig. 23a) are hollow and awl-shaped with a sharp point and broadening towards the base. They are composed of two separate pieces which are fused along one edge and loosely twisted together.

Cheungbeia mindanensis (Smith, 1877)

(Figs 24, 26d, 30d)

See also Taylor (1994, plates 1h, 6d; figs 13–15)

Rhynchodeum and proboscis

The rhynchodeal sphincter is large and anteriorly located and the rhynchostome is relatively wide. The epithelium of the anterior half of the dorsal wall of the rhynchodeal cavity is glandular (dorsal wall is significantly longer than the ventral). In the posterior part of the rhynchodeum the epithelium is non-glandular and continuous with that of the proboscis wall. The proboscis is extremely long and lies coiled within the rhynchocoel. The proboscis walls are highly folded and comprise about 15% of the proboscis diameter. The muscles of

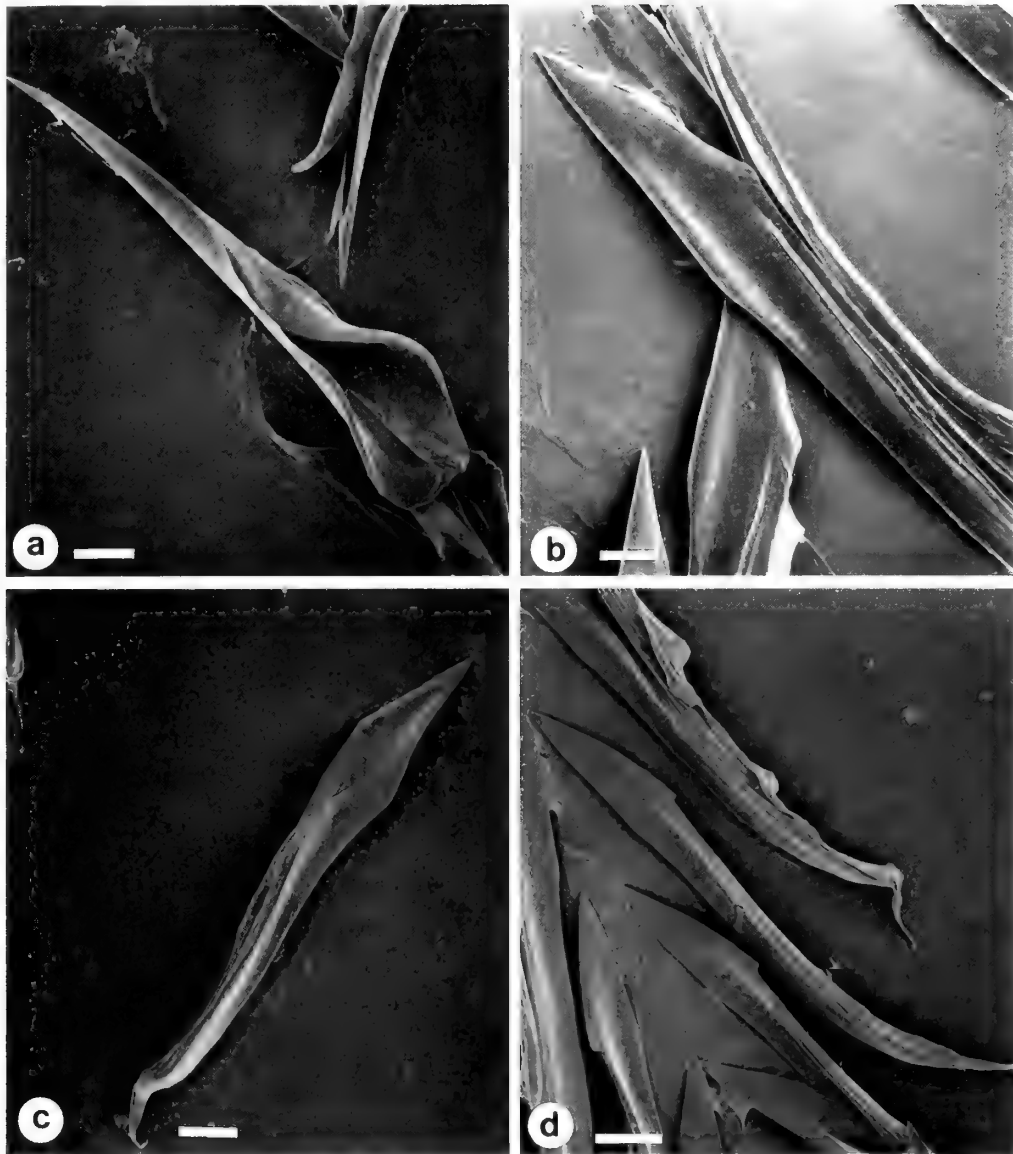

Fig. 23 Radulae of Crassispirinae. a, *Ptychobela suturalis* scale bar = 20µm b, *Vexitomina garrardi* scale bar = 20µm c, *Funa latisinuata* scale bar = 50µm d, *Funa jeffreysii* scale bar = 60µm.

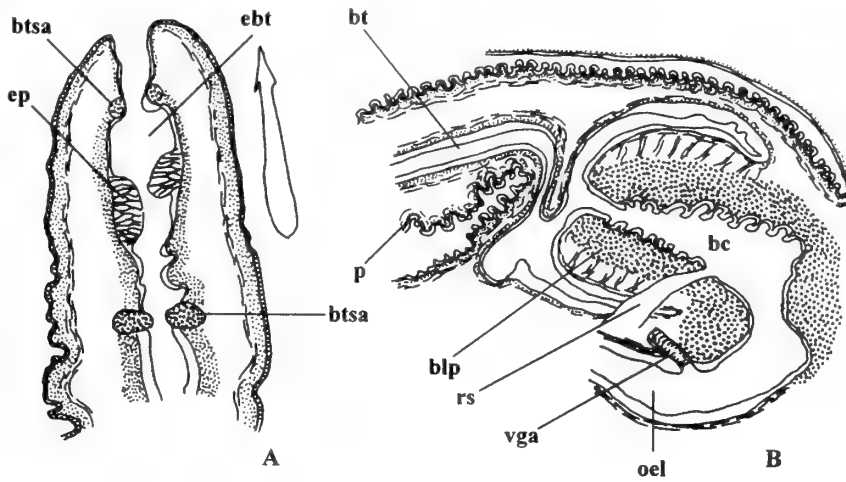

Fig. 24 *Cheungbeia mindanensis* (Smith, 1877) A, longitudinal section of the proboscis tip, the tooth at the same scale shown below; B, longitudinal section of the proboscis base and buccal mass (salivary ducts not shown).

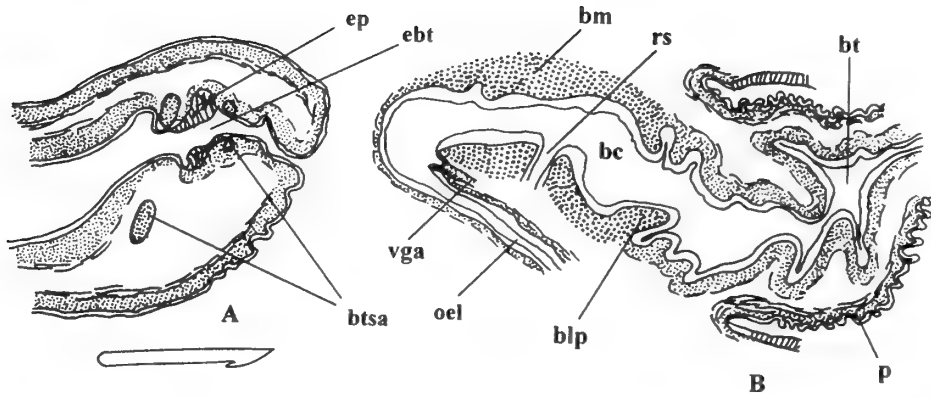

Fig. 25 *Cheungbeia robusta* (Hinds, 1843). A, longitudinal section of the proboscis tip, with a tooth shown at the same scale below; B, longitudinal section of the proboscis base and buccal mass.

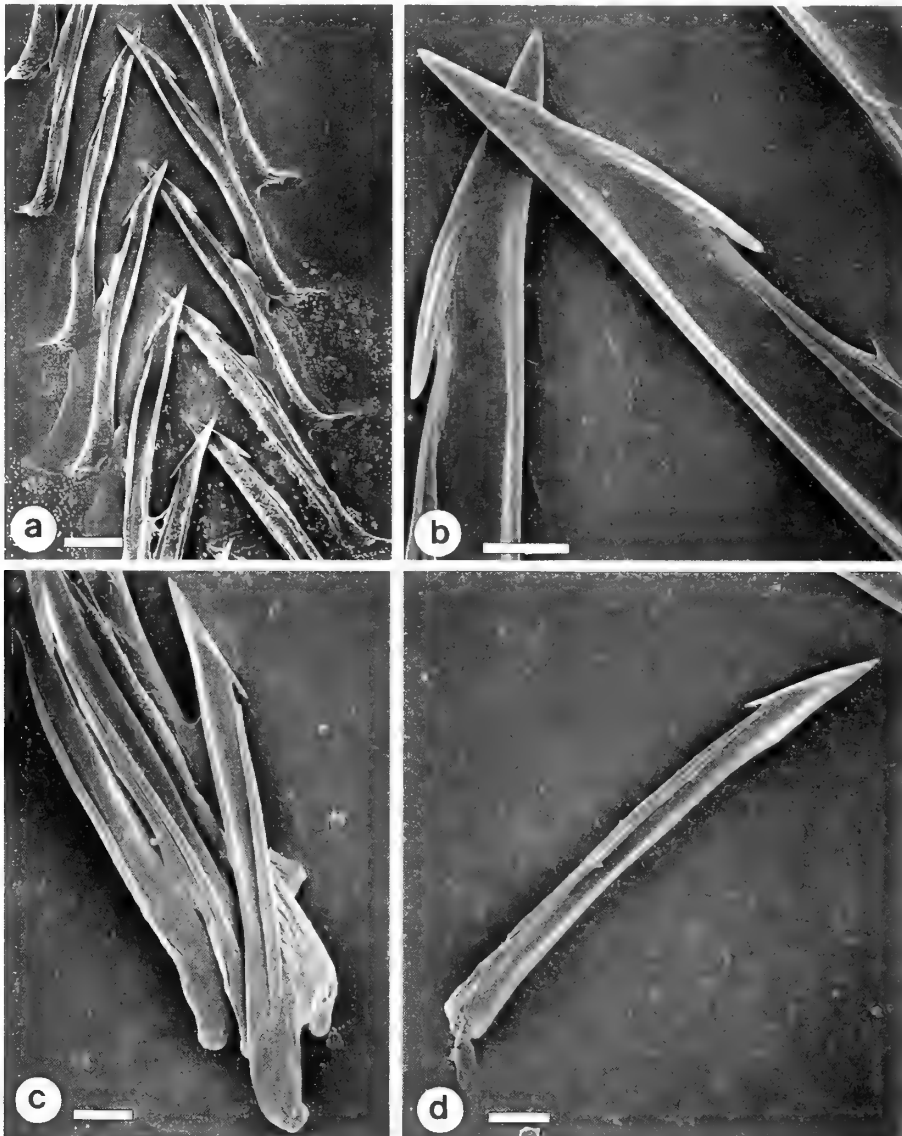

Fig. 26 Radulae of *Cheungbeia*. a–c, *Cheungbeia robusta*, a, portion of radula with two rows of teeth, scale bar = 30 μ m b, detail of tooth tip scale bar = 10 μ m c, single tooth, note secondary limb (arrowed) along edge of major limb scale bar = 20 μ m d, *Cheungbeia mindanensis* single tooth with secondary limb arrowed, scale bar = 25 μ m.

the proboscis wall are equally developed along its length. The mouth is narrow. The proboscis is covered with ciliated epithelium with long cilia, which is replaced by non-ciliated epithelium with a rather thick cuticle at its base.

A small, anterior, buccal tube sphincter lies in front of the sac-like enlargement of the buccal tube, close to mouth opening. The epithelium, lining the enlargement is tall, forming pads on both walls (Fig. 30d). A second larger sphincter lies at the base of the enlargement at the distance slightly longer than one tooth length and therefore should be considered as anterior. The walls of the buccal tube are thin in the anterior part, but become rather thick (about 10% of proboscis diameter) after the second sphincter.

Buccal mass and oesophagus

The buccal mass lies at the proboscis base and is short in comparison to the proboscis. It is thick-walled, with a broad lumen and curved. There are very large, extensible buccal lips. The oesophagus is greatly elongated between buccal mass and nerve ring and forms a long loop. There is no buccal sac. The opening of the radular diverticulum is narrow and relatively long. The salivary ducts open into the buccal cavity on both sides of the opening of the radular diverticulum.

Glands

The salivary glands are medium-sized, paired and acinous. The venom gland changes markedly in histology after passing through the nerve ring. The duct is very narrow, unciliated and opens at the border between the buccal mass and oesophagus. The muscular bulb is medium-sized, with the wall formed from two layers of longitudinal muscle fibres (the outer about twice as thick as the inner), divided by a connective tissue layer, with a thin, innermost layer of circular muscle.

Odontophore and radula

The odontophore is rather large, with paired, unfused cartilages. The radula consist of marginal teeth (Fig. 26d), which are long and harpoon-like in form, but concavo-convex (gutter-shaped) in profile. The distal end of the tooth is sharply pointed with a pronounced barb, whilst the shaft is more or less straight-sided, with just a slight enlargement at the base. A very thin secondary limb lies along the edge of the shaft (Fig. 26d). The marginal tooth is very long, ca. 320µm (1.3% of SL, 4.0% AL).

***Cheungbeia robusta* (Hinds, 1843)**

(Figs 25, 26a–c)

See also Taylor (1994, plates 1i, 6c; figs 16–17)

Rhynchodeum and proboscis

The rhynchodeal sphincter is large and located slightly to the posterior. The epithelium of nearly the whole wall of the rhynchodeal cavity is glandular, whilst only a small posterior portion is non-glandular and continuous with that of the proboscis wall. The rhynchostome is rather wide.

The proboscis is very long, longer than the rhynchocoel and coiled within it. It is relatively wide at the base and narrows towards the tip. The walls of the proboscis are thin and highly folded, forming about 10% of the proboscis diameter. Muscles of the proboscis wall are equally developed along its length. The mouth is narrow. The anterior, buccal tube sphincter is very small and lies close to the mouth opening, in front of the short, only slightly differentiated, sac-like enlargement of the buccal tube. The epithelium lining this enlargement is tall, forming pads on both walls. A

second, larger sphincter lies at the base of the enlargement at slightly more than one radular tooth length from the mouth and therefore should be considered as an anterior sphincter. The buccal tube is narrow anteriorly, but expands greatly posterior to the sac-like enlargement and occupies nearly the whole proboscis lumen. Nevertheless, its walls are thin and form only about 5% of the proboscis diameter at its base.

Buccal mass and oesophagus

The buccal mass is long, thick-walled with broad lumen, curved, and lies at the proboscis base. The boundary between the posterior buccal tube and the buccal mass is not well defined. The buccal lips are very short. The oesophagus is greatly elongated between buccal mass and nerve ring and forms a long loop, which is narrow when leaving the buccal cavity and expands posteriorly. There is no buccal sac. The opening of the radular diverticulum is rather narrow and moderately long. The thick and long salivary ducts open in the buccal cavity on both sides of the opening of the radular diverticulum.

Glands

The salivary glands are medium-sized, paired, and of the modified acinous type. The venom gland changes abruptly in histology after passing through the nerve ring. The duct is very narrow, unciliated and opens at the border between the buccal mass and oesophagus. The muscular bulb is large, with the wall mainly formed of two layers of circular muscle fibres (the outer being about twice the thickness of the inner), divided by a connective tissue layer, with a thin, innermost layer of circular muscle.

Odontophore and radula

The odontophore is small, with paired, unfused cartilages. The radula consist of marginal teeth only (Figs 26a–c) which are harpoon-like and very similar to those of *Cheungbeia mindanensis* (Fig. 26d). These have long shafts which are concavo-convex (gutter shaped) in profile. The distal end of the tooth is sharply pointed with a pronounced barb, whilst the shaft is more or less straight-sided, with just a slight enlargement at the base. A very thin secondary limb lies along the edge of the shaft (Fig. 26c).

***Antiguraleus morganus* (Barnard, 1958)**

(Figs 27, 28a)

Rhynchodeum and proboscis

The rhynchodeal sphincter is medium-sized and anteriorly located. The epithelium of the anterior half of the rhynchodeal cavity is tall, glandular, folded and formed of large cells, while that of the posterior half of the rhynchodeum is non-glandular and continuous with that of the proboscis wall. This posterior part of the rhynchodeum is attached by numerous muscle fibres to the body wall and probably cannot be everted. The rhynchostome is narrow.

The proboscis is very long, more than twice as long as the rhynchodeal cavity, rather thin and coiled. The proboscis walls comprise about 15% of the proboscis diameter. The mouth is very narrow. The muscles of the proboscis wall are equally developed along its length. The anterior buccal tube sphincter is small, and lies in front of a very broad sac-like enlargement of the buccal tube. The epithelium, lining the enlargement is similar to that of the rest of the buccal tube. Additionally, there is large intermediate sphincter, situated approximately half-way along the proboscis. The buccal tube has rather thin walls, forming about 8% of proboscis diameter.

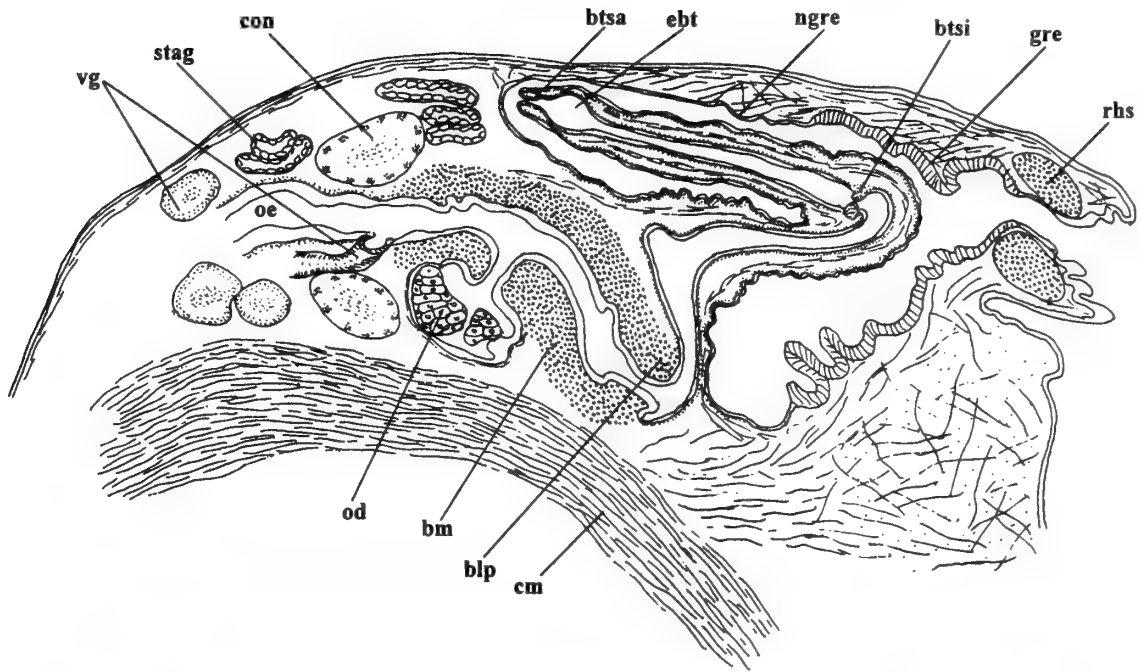

Fig. 27 *Antiguraleus morganus* (Barnard, 1958). Semidiagrammatic longitudinal section of the foregut (salivary glands not to scale).

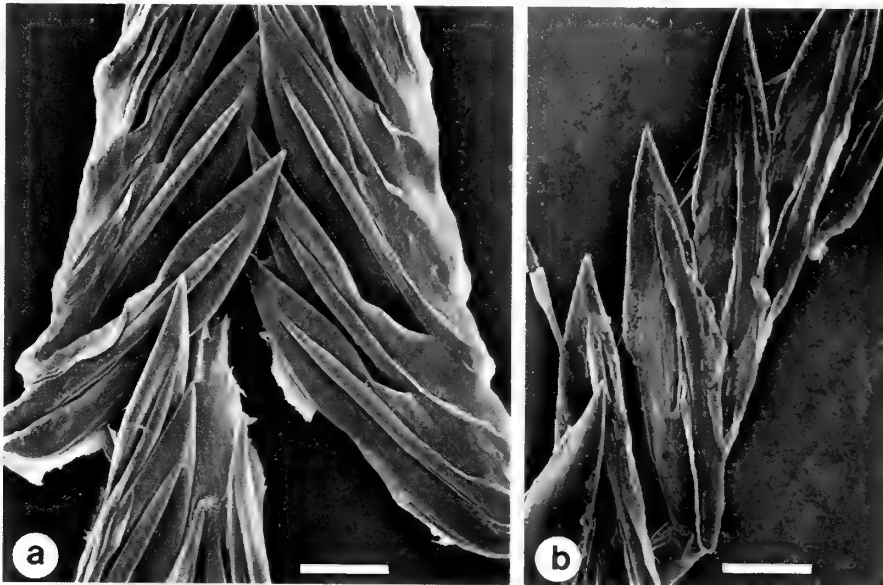

Fig. 28 Radulae of Crassispirinae. a, *Antiguraleus morganus* b, *Paraguraleus costatus*. Scale bars = 20µm.

Buccal mass and oesophagus

The long, buccal mass lies posterior to the proboscis, and is equivalent to nearly half of the proboscis length, with thick walls and a rather broad inner cavity, which is not curved. There are large extensible buccal lips. The oesophagus is not elongated between buccal mass and nerve ring, which is situated closely posterior to the buccal mass. A buccal sac is absent.

Glands

The salivary glands are large, paired, and consist of single, coiled tubes but with the acinous morphology. The venom gland does not change histology after passing anteriorly through the nerve ring. It opens at the border between the buccal mass and oesophagus just in front of the nerve ring. The muscular bulb is small, the wall formed

of two equal layers of longitudinal fibres, divided by a connective tissue layer, with an innermost very thin layer of circular muscle.

Odontophore and radula

The odontophore is medium-sized, with a pair of unfused cartilages formed of one layer of cells. The radula consists of marginal teeth of the wishbone type (Fig. 28a). The major limb of the tooth is elongate with a pointed tip and a constricted waist in the middle of the tooth. Below this constriction, the lower marginal edge of the tooth is extended as a 'soft' buttress to attach to the radular membrane. The minor element is slender and shorter, attached to the distal blade of the major element and broadens slightly at the base, where it attaches to the membrane. The marginal teeth are long, ca. 120µm (1.2% of SL, 3.2% AL).

Guraleus costatus (Hedley, 1922)

(Fig. 28b)

Unfortunately, the specimen was sectioned nearly transversely and an illustration of it comparable with the other species was not possible.

Rhynchodeum and proboscis

The rhynchodeal sphincter is small and anteriorly located. The epithelium of the anterior part of the rhynchodeal cavity is glandular, whilst that of the posterior rhynchodeum is nonglandular and continuous with that of the proboscis wall. The non-glandular posterior part of the rhynchodeum is very thin and attached by numerous muscle fibres to the body wall and probably cannot be everted. The rhynchostome is narrow.

The proboscis is very long and coiled, more than twice as long as the rhynchodeal cavity. It is very thick at the base but narrows towards the tip (diameter of 0.44 mm at the base, but only 0.08 at the tip). The proboscis walls are thin, comprising less than 7% of the proboscis diameter at its base. The mouth is very narrow. A very small, anterior buccal tube sphincter, lies in front of a small, sac-like enlargement of the buccal tube. The epithelium, lining the enlargement is similar to that of the rest of the buccal tube. A single tooth was seen in the enlargement. There is large intermediate sphincter, situated approximately midway down the proboscis. The buccal tube is very narrow anteriorly, but broad in the posterior part of the proboscis. Its walls are very thin and highly folded.

Buccal mass and oesophagus

The buccal mass lies within the base of the proboscis, with thick walls and rather broad inner cavity, and showing no curvature. There are large, extensible, buccal lips, which can be inverted inside the cavity. The oesophagus is slightly elongated between buccal mass and nerve ring and forms a short loop. There is no buccal sac. The

salivary ducts open into the buccal cavity on both sides of the opening of the radular diverticulum.

Glands

The salivary glands are small, paired and acinous. The venom gland changes abruptly in histology after passing through the nerve ring. The duct is very narrow, unciliated and opens at the border between the buccal mass and oesophagus. The muscular bulb is large, the wall is formed of two equal layers of longitudinal fibres, divided by a connective tissue layer, with a thin, innermost layer of circular muscle.

Odontophore and radula

The odontophore is rather large with a pair of unfused cartilages. The radula consists of marginal teeth of the wishbone type (Fig. 28b). Each tooth has a robust and pointed major limb with a straight, blade-like leading edge. The secondary limb is long and slender and attached to the major limb near the distal tip. The marginal teeth are very long, ca. 105µm (1.4% of SL, 4.2% AL).

Burchia spectabilis Sysoev & Taylor, 1997

(Fig. 29)

See Sysoev & Taylor (1997, fig. 3)

Rhynchodeum and proboscis

The rhynchodeal sphincter is very large, and located slightly to the posterior. The anterior one third of the rhynchodeal cavity possesses a very tall, glandular, folded epithelium formed of large cells. The epithelium of the posterior two thirds of the rhynchodeum is continuous with that of the proboscis wall and is low, cubic and non-glandular. This indicates, that the greater part of the rhynchodeal lining is involved in proboscis protraction. The rhynchostome is narrow.

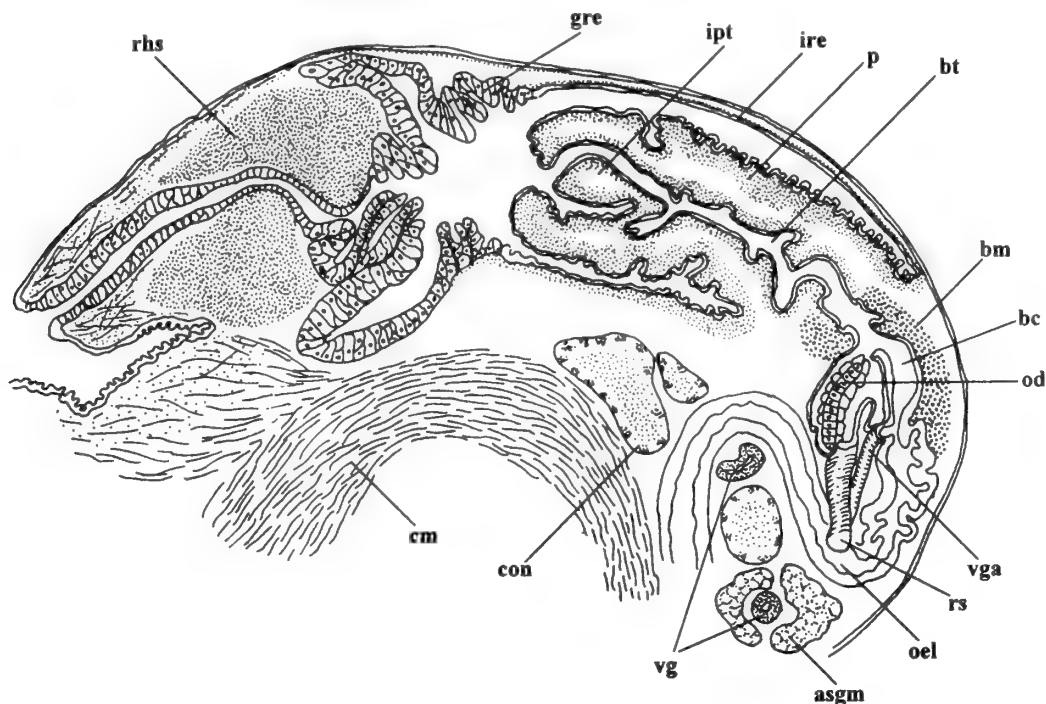

Fig. 29 *Burchia spectabilis* Sysoev & Taylor, 1997. Semidiagrammatic longitudinal section of the foregut (salivary ducts not shown).

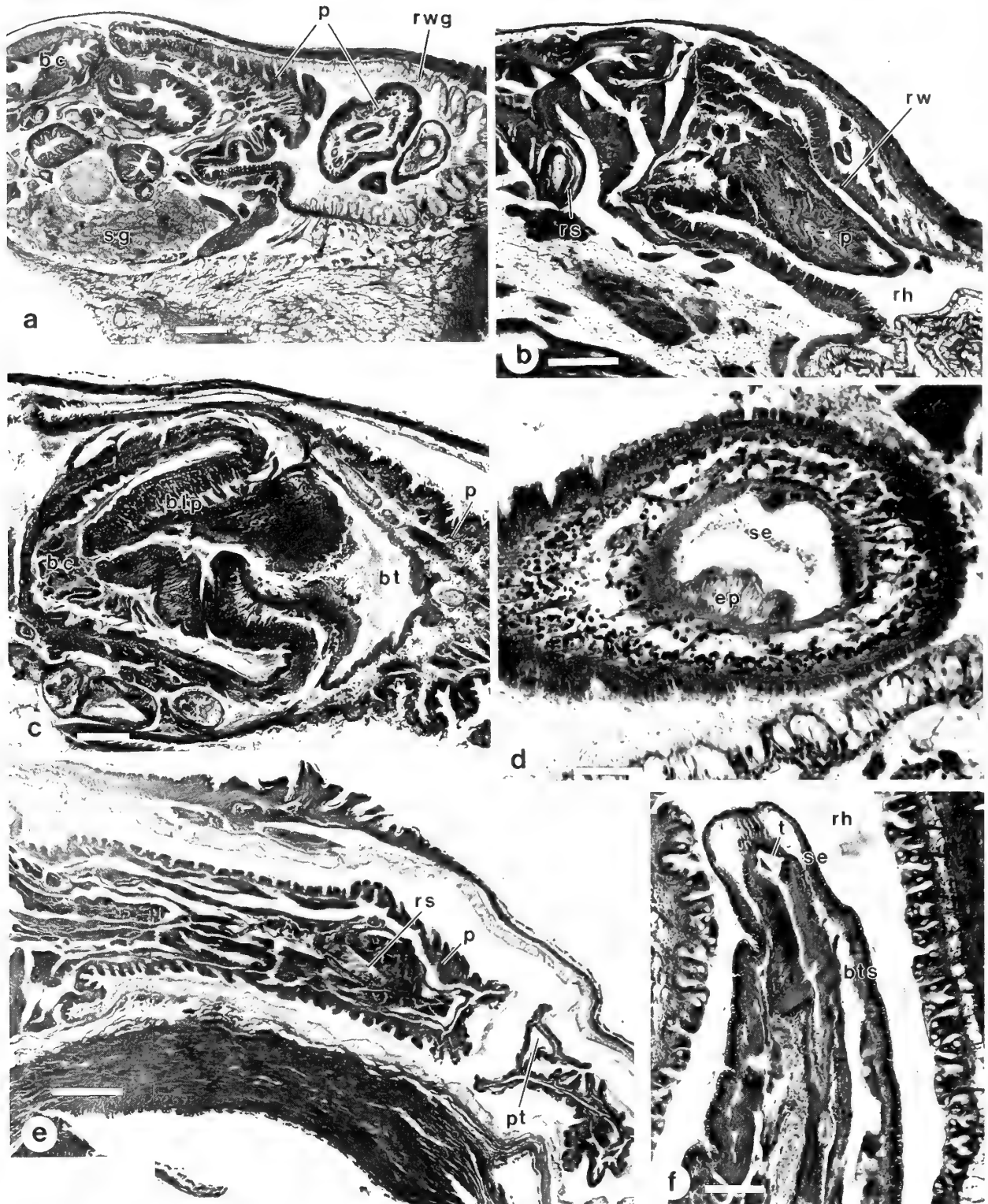

Fig. 30 a, *Nquma scalpta*, longitudinal section of foregut showing proboscis and glandular anterior part rhynchodeal wall. Scale bar = 250µm b, *Vexitomina garrardi* showing proboscis and muscular wall of the posterior rhynchodeum continuous with proboscis wall and also the radular sac located some distance to the posterior of the proboscis base. Scale bar = 250µm c, *Ptychobela suturalis* showing large buccal lips, inverted into the buccal cavity. Scale bar = 250µm d, *Cheungbeia mindanensis*, sac-like enlargement of the buccal tube near the proboscis tip showing the pad of tall epithelial cells. Scale bar = 60µm e, *Crassispira harfordiana flucki*, long proboscis in the rhynchocoel showing the radular sac located in the anterior part of the proboscis and the complex folding of the proboscis tip (see Fig. 6). Scale bar = 250µm f, longitudinal section of the proboscis tip of the outgroup *Gemmula deshayesi* (Turritinae) showing the wishbone tooth held in the sac-like enlargement of the buccal tube and the intermediate sphincter located several tooth lengths from the proboscis tip. Scale bar = 250µm.

The proboscis is long and thick, and occupies about two thirds of the rhynchodeal cavity. The proboscis walls are thick and comprise about 20% of the total diameter. The mouth is narrow in the preserved condition, but appears capable of great enlargement. The ventral side of the anterior part of the proboscis wall is invaginated. The muscles of the proboscis wall are equally developed along its length. Both anterior and intermediate buccal tube sphincters are absent, as is also the distal sac-like enlargement of the buccal tube.

Buccal mass and oesophagus

The buccal mass is situated to the posterior of the base of the proboscis. It is long, equivalent to about half of the proboscis length, with thick walls and a rather narrow inner cavity, which is not curved. Extensible buccal lips are absent. The oesophagus is elongated between the buccal mass and nerve ring, forming a short loop.

Glands

The salivary glands large and acinous. The venom gland shows a change in histology after passing anteriorly through the nerve ring. The duct of the gland is narrow, ciliated and opens into the posterior part of the buccal cavity. The muscular bulb is long with the wall formed of two layers of equal thickness composed of longitudinal fibres, divided by a connective tissue layer.

Odontophore and radula

The odontophore is medium-sized, with paired, unfused, odontophoral cartilages formed of one layer of cells. The radula comprises marginal teeth, which are of the robust, wishbone form, with a long solid, distally pointed major limb and a thinner secondary limb, which attaches near the tip of the major limb. The marginal teeth are short, ca. 165µm (0.5% of SL, 1.4% AL).

***Vexitomina garrardi* (Laseron, 1954)**

(Figs 23b, 30b)

Rhynchodeum and proboscis

The rhynchodeal sphincter is large, long and situated slightly towards the posterior. The epithelium of the anterior two thirds of the rhynchodeum is glandular, forming tall folds, whilst the epithelium of the posterior one third of the rhynchodeum is non-glandular and continuous with that of the proboscis wall. The rhynchostome is wide. The proboscis is short, cone-shaped, and occupies about half the rhynchocoel. The proboscis walls form about 20% of the proboscis diameter. The muscles of the proboscis walls are equally developed along its length. The mouth is very narrow.

The anterior buccal tube sphincter is small, and lies close to the mouth, opening in front of the long sac-like enlargement of the buccal tube. A tall epithelium lines the enlargement. A second, larger sphincter lies at the base of the enlargement, at a distance slightly longer than one tooth length and therefore should be considered as anterior. A tooth was seen in the buccal tube posterior to the latter sphincter. The buccal tube walls are rather thin (about 8% of proboscis diameter) and highly folded. In the posteriormost part the tube forms a very long, but narrow, circular fold.

Buccal mass and oesophagus

The buccal mass is large in comparison with the proboscis, equivalent to about two thirds of its length, with thick, folded walls and a narrow lumen. It lies posterior to the proboscis base. The buccal lips are small. The oesophagus is elongated between the buccal mass and nerve ring and forms a short loop. After leaving the buccal cavity, the

oesophagus is very narrow, but then expands greatly after passage through the nerve ring. The buccal sac is very short.

Glands

The salivary glands are medium-sized, paired, and acinous. The venom gland changes sharply in histology after passing anteriorly through the nerve ring. The duct is very narrow, unciliated and opens at the border between the buccal mass and oesophagus.

The muscular bulb is medium-sized, with the wall formed of two layers of longitudinal muscle fibres (the outer being twice as thick as the inner), divided by a connective tissue layer and innermost thin layer of circular muscle.

Odontophore and radula

The odontophore is medium-sized, with paired, unfused cartilages. The radula consists of marginal teeth (Fig. 23b) which are long, with a blade-like distal portion, which is sharply pointed with a small barb. The shaft is long and tapers gradually towards the base. The teeth are slightly concavo-convex in profile and a very thin splint-like secondary limb lies along the edge of the shaft.

***Turridrupa bijubata* (Reeve, 1843)**

Rhynchodeum and proboscis

The rhynchodeal sphincter is medium-sized and posteriorly located. The anterior half of the rhynchodeum has a highly folded, tall, glandular epithelium whilst the posterior half has a low cubic epithelium similar to that of the proboscis wall. The proboscis is short and occupies about half of the rhynchodeum, the tip is thin, while the base is thicker and muscular. There is a very small anterior buccal tube sphincter, lying at the distal end of a small sac-like enlargement containing a single radular tooth. A larger intermediate sphincter lies at a distance of about 10 tooth lengths from the proboscis tip.

Buccal mass and oesophagus

The buccal mass is long and curved and lies to the posterior of the proboscis. The walls of the buccal mass are long and muscular anterior to the entrance of the radular sac and the buccal lips small and not invertible. The oesophagus is not elongated between the buccal sac and nerve ring.

Glands

The salivary glands are large, paired and acinous, with large ciliated ducts. The venom gland changes abruptly in histology after passing anteriorly through the nerve ring and the duct opens into the oesophagus just posterior to the buccal mass. The muscular bulb is large and comprises two layers of circular muscle separated by a connective tissue layer. The outer layer is about twice as thick as the inner. There is no thin, innermost, muscular layer.

Odontophore and radula

The odontophore is large with two large unfused cartilages. The radula consist of both central and marginal teeth (Kilburn, 1988, fig. 40). The central tooth comprises a square plate with a prominent spine-like cusp. The marginal teeth are of the robust wishbone type with the bifurcating proximal end, similar to *Epidirona gabensis* (Fig. 18a).

Outgroup

This species from the family Turridae, was chosen as the outgroup. The anatomy and radula is described and illustrated in Taylor (1994) and further details are given below.

***Gemmula deshayesii* (Doumet, 1839)**

(Figs 18b, 30f)

Rhynchodeum and proboscis

There is a large rhynchodeal sphincter situated slightly to the posterior. The rhynchodeum has a folded epithelium of tall glandular cells for its entire length.

The proboscis is long, nearly as long as the rhynchodeum. The proboscis walls are medium thick about 15% of total diameter, whilst the walls of the buccal tube are thin forming about 5% of the diameter. The muscles of the proboscis wall are less developed near the tip. There is a small anterior buccal tube sphincter, with a short sac-like enlargement and epithelial pad. A single wishbone radular tooth was held in the enlargement. An large intermediate buccal tube sphincter lies at about five tooth lengths from the mouth.

Buccal mass and oesophagus

The buccal mass is short, muscular and uncurved and lies within the base of the proboscis. The buccal lips are medium long and invertible. The oesophagus is not elongated between the nerve ring and buccal mass.

Glands

Salivary glands are large and acinous with paired ducts. There is no change in the histology of the venom gland to the anterior of the nerve ring. The gland opens into the rear of the buccal cavity by a short ciliated duct. The muscular bulb comprises two subequal layers of circular muscle divided by a connective tissue layer.

Odontophore and radula

There are two medium-sized odontophoral cartilages. The buccal sac is medium long. The radula consist of both central and marginal teeth (Fig. 18b). The central tooth is wide and low with a central spine-like cusp. The marginal teeth are wishbone in form, but of the 'clothes-peg' type with pointed tips and bifurcated proximal ends.

CHARACTER ANALYSIS AND RELATIONSHIPS WITHIN THE CRASSISPIRINAE

Characters and states

On the basis of the analysis of the thin sections described above and previous work (Taylor *et al.*, 1993) we selected 20 characters with potential for determining relationships between the species studied. These characters and their states are listed in Table 2. Many of these are self explanatory or reference is given to figures which illustrate the various states. However, further explanation of some characters is given below.

Character 2. In some species, such as *Inquisitor latifasciata* and *Ptychobela suturalis*, the proboscis tip may be inverted deeply into the buccal tube (Fig. 20).

Character 5. In some species there is an epithelial pad of large cubic cells in the anterior part of the buccal tube (*C. (Gibbaspira) dysoni*, Fig. 5).

Character 7. In many species there is a sac-like enlargement of the anterior part of the buccal tube. This is often lined with an epithelium of tall cells. The function of the sac is to hold single detached radular teeth at the proboscis tip (Fig. 30d).

Character 9. Some taxa possess large buccal lips which are often capable of inversion into the buccal cavity; in others this was not observed.

Character 11. In many species there is a sharp bend within the buccal mass (e.g. Fig. 9), while other species show no curvature.

Table 2 List of characters and states used in the cladistic analysis

-
1. Epithelium of posterior rhynchodeal wall: 0 – glandular; 1 – continuous with proboscis wall for less than ½ of the rhynchodeum length; 2 – continuous with proboscis wall for more than ½ of the rhynchodeum length.
 2. Proboscis tip: 0 – not inverted inside; 1 – inverted inside.
 3. Proboscis tip epithelium: 0 – not invaginated; 1 – invaginated.
 4. Proboscis length: 0 – very long (longer than rhynchodeum); 1 – long (50–100% of rhynchodeum length); 2 – short (less than 50% of rhynchodeum length).
 5. Epithelial pad at tip of buccal tube: 0 – present; 1 – absent.
 6. Anterior buccal tube sphincters (the distance from the sphincter to the mouth opening is less than the radular tooth length): 0 – one; 1 – two; 2 – absent.
 7. Sac-like enlargement of the buccal tube with tall epithelium: 0 – present; 1 – absent.
 8. Intermediate sphincter of the buccal tube (the distance from the sphincter to the mouth opening is more than the tooth length): 0 – absent; 1 – present.
 9. Buccal lips: 0 – large invertible; 1 – large uninvertible; 2 – small; 3 – absent.
 10. Position of the buccal mass: 0 – posterior to the proboscis base; 1 – at the proboscis base; 1 – within the proboscis (up to near tip).
 11. Buccal mass shape: 0 – not curved; 1 – curved.
 12. Elongation of the oesophagus between buccal mass and nerve ring: 0 – absent; 1 – present.
 13. Salivary glands: 0 – acinous; 1 – modified acinous; 2 – acinous tubular; 3 – simple tubular; 4 – anastomosing tubular.
 14. Histology of the venom gland anterior to the nerve ring: 0 – unchanged; 1 – changed.
 15. Position of opening of venom gland into oesophagus: 0 – into rear part of buccal mass; 1 – into oesophagus behind buccal mass.
 16. Number of muscular layers of the muscular bulb: 0–2 layers; 1–3 layers.
 17. Orientation of fibres in outer two layers of muscular bulb: 0 – similar orientation; 1 – opposite orientation.
 18. Radula: central 'tooth': 0 – absent; 1 – central ridges present; 2 – spinose tooth.
 19. Radula: curved lateral 'teeth': 0 – absent; 1 – present.
 20. Radula: marginal teeth: 0 – *Epidirona* type; 1 – *Inquisitor* type; 2 – *Funa* type; 3 – *Haedropleura* type; 4 – *Hindsiclava* type; 5 – *Cheungbeia* type; 6 – *Ptychobela* type.
-

Character 13. During this study we found several distinct morphologies of the salivary glands. Many species possessed the normal acinous type found in most neogastropods. In some species, *Cheungbeia robusta* and *Burchia spectabilis*, the appearance is of modified acinous (State 1). *Funa jeffreysii* and *Antiguraleus morgani* have glands consisting of single tubes surrounded by acinous cells; this we refer to as acinous tubular (state 2). Simple tubular glands are found in *Haedropleura septangularis* and *Naudedrillia*, these are highly coiled in *C. latizonata* (State 3). Finally, in a number of taxa the salivary glands appear to be made up of a mass of anastomosing tubes (State 4).

Character 14. In most Crassispirinae, the venom gland becomes ciliated and duct-like anterior to the nerve ring.

Character 17. The muscle fibres in the outer two layers of the muscular bulb, may either have the same or differing orientations.

Character 18. Although there is no central tooth to the radula in any of Crassispirinae studied, we did observe in two species some low transverse ridges which cross the ribbon (Fig. 14a). We refer to these as transverse ridges. In the outgroup, *Gemmula deshayesii*, a robust central tooth with a spinose central cusp is present (Fig. 18b).

Character 19. In most crassispirines there are no lateral teeth, but amongst the species we examined, two have paired, low, curved structures which are symmetrical on either side of the mid-line (Figs 11c–d). Maes (1983) referred to these structures as 'soft laterals'. It is uncertain whether these structures are homologous with the lateral teeth found in the Drilliidae or other neogastropods.

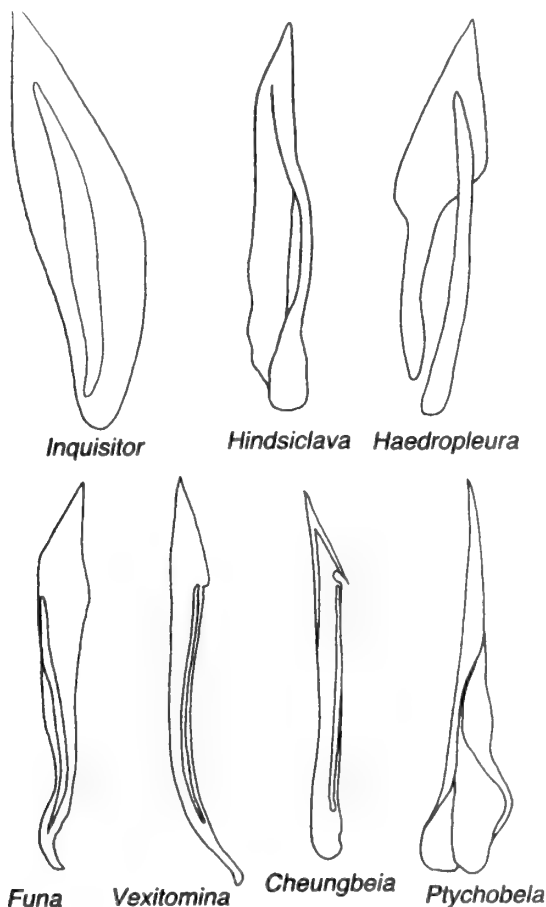

Fig. 31 Summary of major radular types found amongst the Crassispirinae. Not to scale.

They may, as in the Columbelloidea (Guralnick & de Maintenon, 1997), be produced by different secretory cells from ‘true’ teeth. Character 20: several types of marginal teeth are found within the taxa examined. We have divided these into 6 major types, which are summarized in Fig. 31. The *Epidirona* type (State 0) (Fig. 18a) is a wishbone tooth of the clothes-peg type with the tooth bifurcating into two more or less equal limbs. The *Inquisitor* type (State 1) is the most widely distributed and consists of a robust, pointed, major limb with a smaller, slender, secondary limb attached to it. The *Funa/Vexitomina* type (State 2) consists of a long tooth with a broad, pointed blade and a narrow shaft, with a very thin accessory limb attached to the edge of the shaft. In the *Haedropleura* type (State 3), the major limb has a trowel-like distal end and a narrow shaft, with a slender accessory limb. The *Hindsiclava* type (State 4) has a flat, pointed, major limb and a long, slender, detached ‘handle-like’ accessory limb. The *Cheungbeia* type (State 5) is harpoon-like with a pointed, barbed tip and a straight concave shaft, with a thin splint-like secondary limb attached to the edge of the shaft. Finally, the *Ptychobela* type (State 6) is awl-shaped and hollow, composed of two pieces which are fused along one edge and twisted together.

Outgroup

As the outgroup for the Crassispirinae, we chose *Gemmula deshayesi* from Hong Kong, which has the relatively underderived foregut anatomy typical of members of the subfamily Turrrinae. Serial sections of the foregut of this species were already available, as well as a published

Table 3 Distribution of character states for the crassispirine gastropods examined. Details of characters listed in Table 2.

Character	1 1 1 1 1 1 1 1 1 2																			
	1	2	3	4	5	6	7	8	9	0	1	2	3	4	5	6	7	8	9	0
<i>Crassispira incrassata</i>	2	0	2	0	0	1	0	0	2	0	1	1	0	1	0	1	0	1	0	1
<i>Crassispira maura</i>	1	0	2	0	0	0	0	0	0	0	1	1	0	1	0	1	0	0	0	0
<i>Crassispira dysoni</i>	1	0	2	0	0	0	0	0	1	3	0	1	1	0	1	0	0	0	0	0
<i>Crass. harford. flucki</i>	0	0	0	0	0	1	0	0	3	2	0	1	0	1	0	1	0	0	0	0
<i>Crassispira latizonata</i>	2	1	1	0	1	0	0	1	2	0	0	1	3	1	0	1	0	0	0	0
<i>Crassispira pluto</i>	1	0	0	0	0	1	0	1	0	0	1	0	1	0	1	0	?	?	0	0
<i>Crassispira kluthi</i>	0	0	1	0	1	2	1	1	1	1	1	0	1	0	1	0	0	0	0	0
<i>Crassispira tepocana</i>	1	0	2	1	1	2	0	1	1	4	1	0	1	0	0	0	0	0	0	0
<i>Crassispira xanti</i>	1	0	2	1	2	0	1	0	0	1	1	0	1	0	1	0	0	0	0	0
<i>Crassispira turricula</i>	2	0	1	1	0	0	1	1	2	0	1	4	1	0	1	0	0	0	0	1
<i>Crassispira apicata</i>	1	0	1	0	0	0	0	1	2	0	1	4	1	0	1	0	0	0	0	1
<i>Hindsiclava andromeda</i>	2	0	2	1	2	0	1	0	0	1	4	1	0	1	0	?	?	?	?	?
<i>Hindsiclava militaris</i>	2	0	2	1	1	0	0	0	1	0	1	4	1	0	1	0	1	0	1	0
<i>Miraclothurella bicanal.</i>	1	0	1	0	0	2	0	1	2	1	0	1	0	1	0	1	0	0	0	0
<i>Haedropleura septangularis</i>	1	0	1	1	0	0	0	0	1	0	0	0	3	0	0	1	0	0	0	0
<i>Naudedrillia prateris.</i>	1	0	0	0	0	2	0	1	2	0	0	1	3	1	0	1	0	0	0	0
<i>Nquma scalpta</i>	1	0	0	0	0	2	0	1	3	1	0	1	4	1	0	1	0	0	0	0
<i>Epidirona gabensis</i>	0	0	2	0	0	0	0	1	3	0	0	1	0	1	1	1	0	0	0	0
<i>Funa latisinuata</i>	1	0	1	1	1	0	1	0	1	1	0	1	1	1	0	1	0	0	0	2
<i>Funa jeffreysii</i>	1	0	1	1	0	0	0	1	1	1	0	1	2	1	0	1	0	0	0	2
<i>Inquisitor latifasciata</i>	1	1	0	0	1	2	0	1	0	1	1	0	1	1	0	0	0	0	0	1
<i>Inquisitor aff. adenicus</i>	1	0	1	0	0	0	0	1	3	0	0	1	0	1	0	0	0	0	0	0
<i>Inquisitor aemula</i>	0	0	0	0	0	2	0	1	2	2	0	1	0	1	0	1	0	0	0	0
<i>Ptychobela suturalis</i>	2	1	0	0	1	0	0	1	0	2	0	1	0	1	0	1	0	0	0	6
<i>Cheungbeia mindanensis</i>	2	0	0	0	1	0	0	1	0	0	1	0	1	0	1	0	0	0	0	5
<i>Cheungbeia robusta</i>	1	0	0	0	1	0	0	2	0	0	1	1	0	1	0	0	0	0	0	5
<i>Antiguraleus morganus</i>	1	0	0	1	0	0	1	1	0	0	0	2	0	0	1	0	0	0	0	3
<i>Guraleus costatus</i>	1	0	0	1	0	1	1	0	2	0	1	0	1	0	1	0	0	0	0	1
<i>Burchia spectabilis</i>	2	1	1	0	1	2	1	0	3	0	0	1	1	0	0	0	0	0	0	1
<i>Vexitomina garrardi</i>	1	0	2	0	1	1	0	0	3	0	0	1	0	1	0	1	0	0	0	2
<i>Turridrupa bijubata</i>	1	0	2	0	1	0	0	1	3	0	1	0	0	1	1	0	0	2	0	0
<i>Gemmula deshayesi</i>	0	0	1	0	0	0	0	1	3	2	0	0	0	0	0	1	0	2	0	0

description of the anatomy (Taylor, 1994). The characters of the outgroup are recorded with the Crassispirine species in Table 3.

Character distribution

The distribution of the character states amongst the species studied along with those of the outgroup are shown in the data matrix (Table 3). For *Crassispira latizonata* and *Hindsiclava andromeda* we had insufficient material to investigate the radula and there are no published descriptions. In the case of *Crassispira pluto*, the muscular bulb was lost from the sectioned material.

Phylogenetic analysis

This was performed using PAUP version 3.1 and McClade 3.04 for subsequent analysis. Using the data matrix of Table 3 and the heuristic sort option we obtained 24 equally parsimonious trees of 104 steps, with a Consistency Index of 0.33 and Retention Index of 0.54. A consensus tree generated from the 24 trees is shown in Fig. 32a and an example shown in Fig. 32b. Internal nodes of the tree are supported by relatively few characters and there is a high level of homoplasy. *Epidirona gabensis* and *Turridrupa bijubata* are undifferentiated from the outgroup *Gemmula* in all trees. Whilst, *Crassispira dysoni* and *Inquisitor aff. adenicus* which both possess *Inquisitor* type teeth, are undifferentiated in the consensus tree but form a weakly supported branch in most trees. Species classified into different subgenera of *Crassispira* appear in widely separated parts of the tree (Fig. 32b), apart from *Crassispira (Crassispira) s. s.* and *Crassispira (Striospira)* which form a monophyletic clade.

Because we sampled only 24 out of the 46 genera and subgenera and because of the large amount of homoplasy, it would be prema-

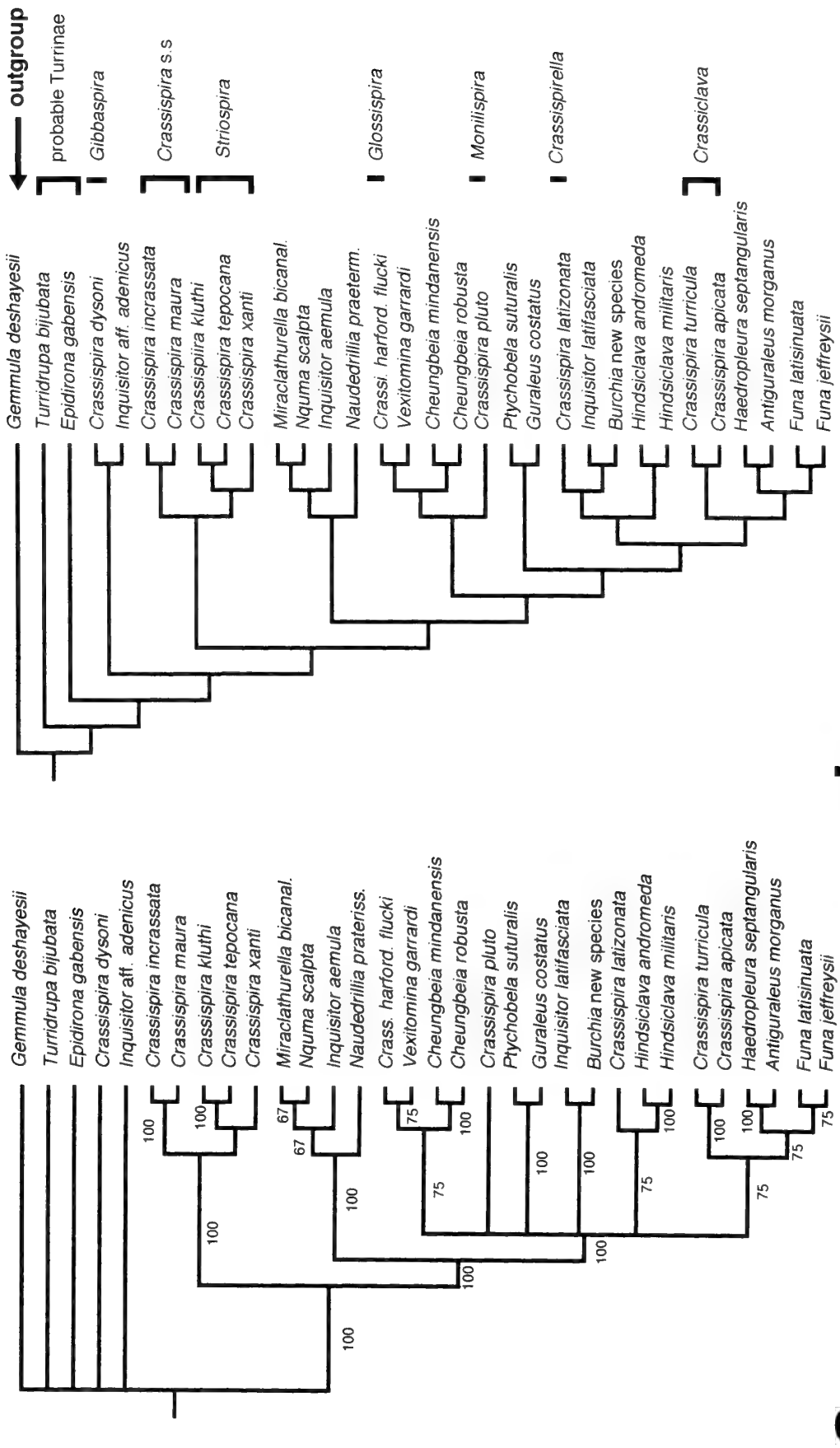

Fig. 32 a. Consensus tree (50% majority rule) of crassispiran relationships with percentage support indicated on branches. b. Single tree. Species classified in different subgenera of *Crassispira* indicated.

ture to use the tree as a basis for classification of the Crassispirinae. However, foregut characters have potential for unravelling relationships amongst the gastropods with rather similar shells.

DISCUSSION

Summary of anatomical variation in Crassispirinae

Considerable variation was found in the configuration of the foregut amongst the species we studied. This variation is reflected in the fact

that we have recognised 13 main types of crassispirine foregut (Figs 33–34), which differ in the presence, position and morphology of the main structures, such as buccal mass, salivary glands, buccal lips and sphincters of the buccal tube.

Several features are characteristic for the vast majority of the crassispirines and these include a glandular lining to the anterior part of the rhynchodeum and the ability of the posterior part of the rhynchodeum to evert during proboscis protraction (except *Crassispira harfordiana flucki* – Fig. 33 C). This is recognised by the continuity of the posterior rhynchodeal and proboscis walls. In nearly all Crassispirinae, the oesophagus is elongated between the

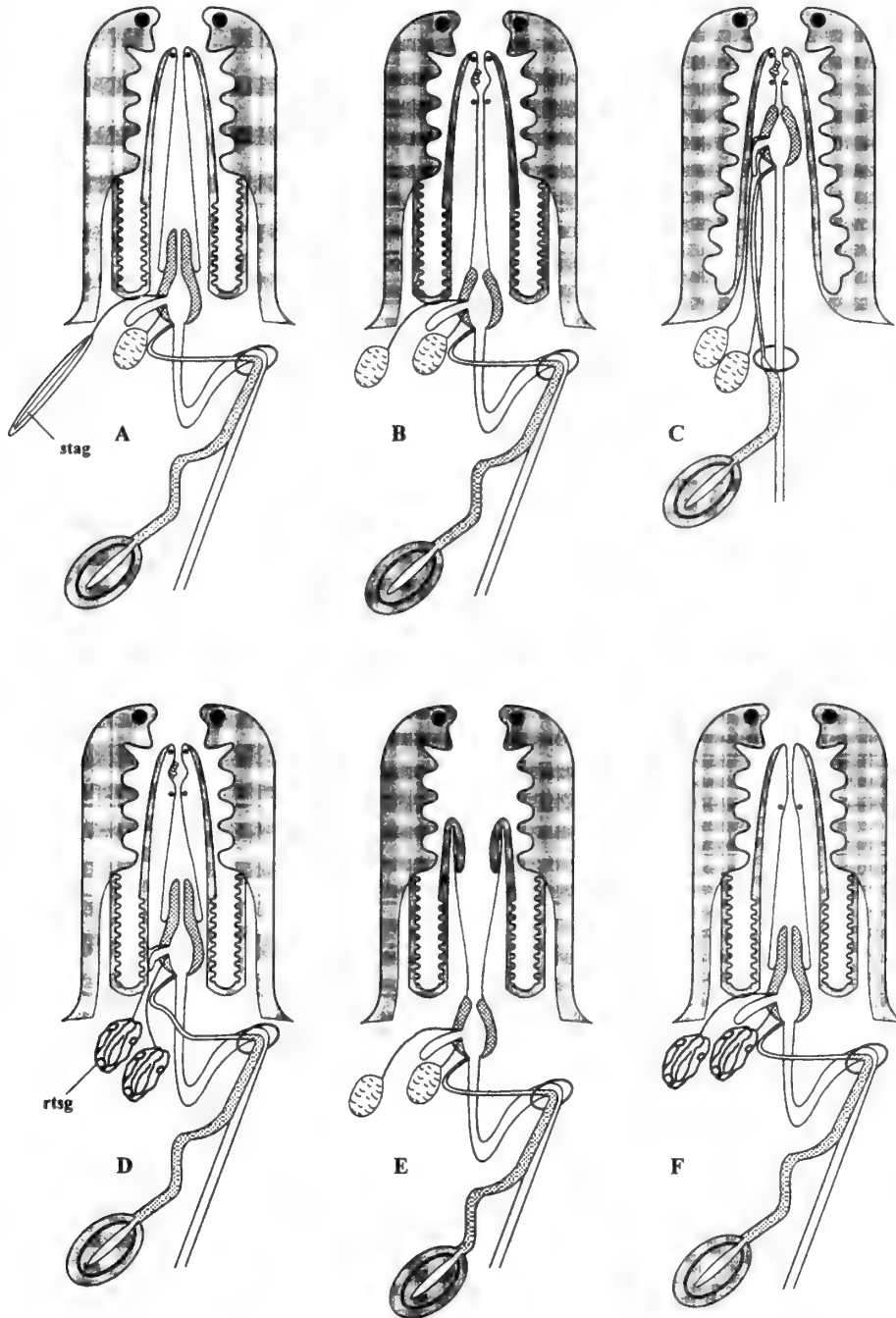

Fig. 33 Diagram summarizing some of the major types of foregut morphology found among the Crassispirinae. Not to scale. A, *Crassispira* (*Crassispira*) spp. – with acinous salivary glands, *Funa* spp. – with single tube acinous gland. B, *Crassispira* (*Gibbaspira*) *dysoni*. C, *Crassispira* (*Glossispira*) *harfordiana flucki*. D, *Crassispira* (*Crassiclava*) spp. E, *Burchia* new species. F, *Crassispira* (*Striospira*) *tepecana*.

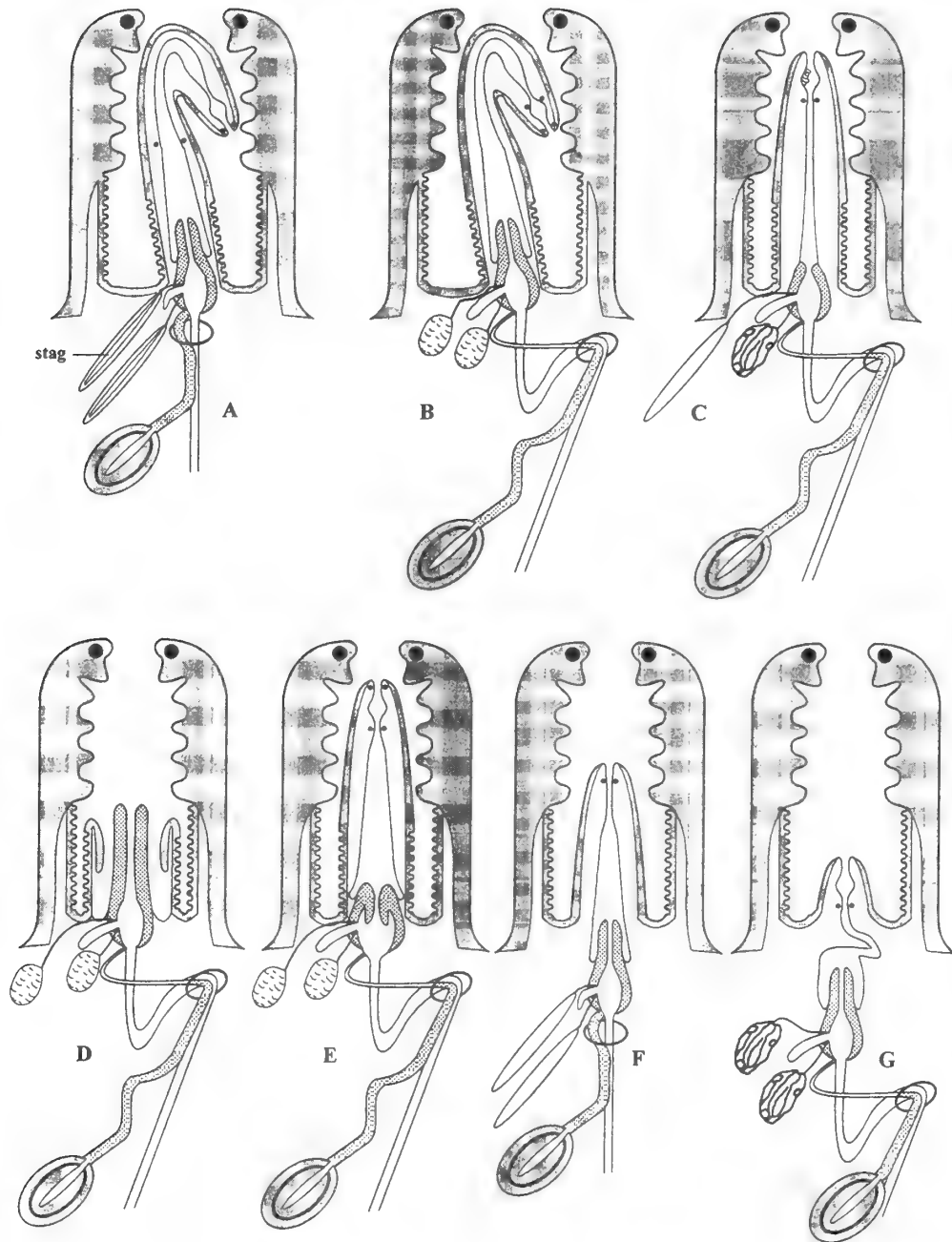

Fig. 34 Diagram summarizing some of the major types of foregut morphology found among the Crassispirinae. Not to scale.

A, *Antiguraleus morganus*. B, *Cheungbeia* spp. C, *Nquma scalpta* (anastomosing tubular salivary glands) and *Naudedrillia praetermissa* (simple tubular salivary glands). D, *Inquisitor latifasciata* and *Ptychobela suturalis* with a retracted proboscis. E, *Ptychobela suturalis* with protracted proboscis. F, *Haedropleura septangularis*. G, *Hindsiclava* spp.

buccal mass and the nerve ring, usually forming a more or less long loop. This character is also associated with the ability to evert the posterior rhynchodeum. Exceptions are *Antiguraleus morganus* (Fig. 34 A) and *Haedropleura septangularis* (Fig. 34 F).

The length of the proboscis in its retracted position is very variable, this is because the posterior part of the rhynchodeum can evert, so that on retraction, the proboscis wall becomes the wall of the rhynchodeum. The most extreme expression of this is found in *Hindsiclava* spp. (Fig. 34 G), where the proboscis, in its retracted position, is extremely short, occupying less than 1/5 of the rhynchocoel length. The anatomy of the posterior part of rhynchodeum suggests

that when protracted the proboscis would be similar in length to that of the other species.

Elongation of the oesophagus is coupled with the anterior elongation of the venom gland. This results in the formation of a usually long, muscular, non-glandular duct, which in nearly all the Crassispirinae studied, opens into the posterior part of the buccal mass at the border with the oesophagus. Exceptions are *Antiguraleus morganus* (Fig. 34 A) and *Haedropleura septangularis* (Fig. 34 F), which are the only species lacking the oesophageal loop. In Turriinae (*Turridrupa*) there is modification of the venom gland in front of the nerve ring, but the oesophageal loop is absent.

In many species, there are large buccal lips, which protrude into the buccal tube (eg. Fig. 33 A – *Funa* spp. 33 D – *Crassispira* (*Crassiclava*) spp.). In several species, for example, *Ptychobela suturalis* (Fig. 34 E) the buccal lips are able to invert inside the buccal cavity. The functional significance of this feature is unknown, but could perhaps be associated with the passage of food items into the buccal cavity.

In four species, the tip of the proboscis is able to invert inside itself (Figs. 33 E, 34 D). In *Burchia spectabilis* (Fig. 33 E), the buccal mass is situated at the base of the proboscis and is not protruded through the mouth, when the proboscis tip is inverted. By contrast, the long buccal lips of *Inquisitor latifasciata* and *Ptychobela suturalis* (Fig. 34 D) are exposed through the mouth when the proboscis tip is inverted. In the latter species, the foregut has a totally different appearance when the proboscis is partially protracted (Fig. 34 E). For one species (*Funa jeffreysii* – Fig. 19), it has been demonstrated that the whole buccal mass can be protruded through the mouth opening (Taylor, 1994, fig. 8). It is highly possible, that in other crassispirines the buccal mass may also be protruded through the mouth and used in prey capture.

Many Conoidea possess one or more sphincters in the anterior part of the buccal tube, these grip the detached, marginal, radular teeth at the proboscis tip (Kantor & Taylor, 1991; Taylor *et al.*, 1993). In Crassispirinae, up to two sphincters were found within the buccal tube (Fig. 33 B – *Crassispira dysoni*, Fig. 33 D – *Crassispira* (*Crassiclava*), and others). Where two sphincters were present, the anterior was usually much smaller than the posterior. The positions of the sphincters also vary. A sphincter(s) was defined as anterior in position, if it lies at a distance of not more than 2.5 marginal tooth lengths from the mouth opening. The more posterior sphincter of the buccal tube is shifted backwards in some species, sometimes occupying a position in the mid-proboscis (Fig. 34 A – *Antiguraleus morgani*). If the sphincter lies at a distance of more than 2.5 marginal tooth lengths from the mouth we classified it as intermediate (e.g. *Crassispira dysoni* – Fig. 33 B; *Crassispira* (*Striospira*) spp. – Fig. 33 F, and others). An intermediate sphincter within the buccal tube has previously been found only in one species of *Splendrilla* (*Drilliidae*) (Sysoev & Kantor, 1989). Its function is obscure, for it cannot be used for gripping teeth at the proboscis tip, but may perhaps be used in transportation of the tooth from the radular sac to the proboscis tip. The anterior buccal tube sphincter is often absent and only the intermediate sphincter present (*Nquma scalpta*, *Naudedrillia praetermissa* – Fig. 34 C; *Inquisitor* spp.; *Crassispira* (*Striospira*) spp. – Fig. 33 F; *Miraclathurella bicanalifera*). Only rarely are both sphincters absent and this indicates that separate marginal teeth are probably not used at the proboscis tip (*Burchia spectabilis* – Fig. 33 E, *Inquisitor latifasciata* – Fig. 33 D).

As in the majority of conoideans, there is in crassispirine species a more or less well-defined, sac-like enlargement of the buccal tube, which is lined with a modified epithelium. The structure is associated with the gripping of single radular teeth at the proboscis tip (Kantor & Taylor, 1991). From our sections of Crassispirinae, it appears that the presence and degree of development of the sac-like enlargement is not correlated with the position of the buccal tube sphincters (either both anterior and intermediate, or only one may be present). In three species, namely, *C. turricula*, *C. apicata* (Figs 12, 33 D) and *C. dysoni* (Figs 5, 33 B), the walls of the enlargement were more muscular than the rest of the buccal tube. No enlargement was found in *Burchia spectabilis* (Fig. 33 E), *Inquisitor latifasciata* (Fig. 34 D), *C. tepocana* and *C. kluthi* (Fig. 33 F). In the two former species, the proboscis tip is able to invert and the separate teeth are not gripped at the proboscis tip, whilst we have no other information about *C. tepocana* and *C. kluthi*.

An unusual character, previously found only in *Splendrilla* (Sysoev & Kantor, 1989), is the presence of an epithelial pad in the anterior portion of the buccal tube. For some species, marginal teeth were seen adhering to this pad, probably for more secure fixation. The epithelial pad was found in several crassispirine species, for example, *Crassispira* (*Crassiclava*) species (Fig. 33 D) and *Crassispira dysoni* (Fig. 33 B).

Salivary glands differ greatly in size and histology. Before this study, only two types of salivary glands were recognised amongst the Conoidea – acinous and simple tubular (Taylor *et al.*, 1993). The structure of the glands was thought to be a character useful at subfamilial level, for instance, differentiating the Mangeliinae and Raphitomininae. However, amongst the crassispirines we were able to recognise four types of salivary gland. Besides the acinous salivary glands (found in majority of species) and simple tubular glands (*Haedropleura septangularis* – Fig. 34 F; *Naudedrillia praetermissa* – Fig. 34 C), we found anastomosing tubular (Figs 33 D, F; 34 C, G) and glands consisting of a simple tube surrounded by acinous cells (*Funa* spp. – Fig. 33 A; *Antiguraleus morgani* – Fig. 34 A). Sometimes, species attributed to the same genus and even subgenus possess different types of glands. For example, in *Crassispira* (*Striospira*) *tepocana*, the glands are anastomosing tubular, while in *C. (S.) kluthi* and *C. (S.) xanthi* they are acinous. Moreover, it should be emphasised, that there were no correlations between the structure of the glands and the foregut anatomy. Sometimes in species possessing the same type of foregut, the glands were of different histology (eg. *Nquma scalpta* and *Naudedrillia praetermissa* – Fig. 34 C; and *Crassispira* (*Crassispira*) spp. and *Funa* spp. – Fig. 33 A).

The Crassispirinae is the only subfamily of the Conoidea, in which a variety of salivary glands has so far been recorded. It is still unclear whether the simple tubular salivary glands can be derived from the acinous type. However, recently, it has been demonstrated (Ball, Taylor & Andrews, in press) that in the embryonic development of *Nucella*, the salivary ducts are formed first, and the salivary gland itself appears later at the tip of the duct. From this, it can be suggested that the simple tubular glands may represent the enlarged ducts, while the gland itself was not developed. Thus, the simple tubular salivary glands may originate from the acinous by paedomorphosis. This may also explain the origin of the anastomosing tubular glands, which could possibly be the result of extensive coiling of the initial duct.

Shell and radular characters

Radula

Radular morphology has been used extensively to recognise and classify suprageneric categories within the Conoidea (e.g. Powell, 1966; McLean, 1971; Kilburn, 1988, Taylor *et al.*, 1993). However, this study has demonstrated that within the Crassispirinae, there is no great congruence between radular and anatomical characters.

Many crassispirine taxa have quite similar radular teeth (e.g. Figs 4, 11) with the wishbone tooth formed by a robust, pointed, major element and a smaller, more slender, secondary element. However, this similarity of radula morphology is not reflected in foregut anatomy and taxa with the same type of teeth often have widely different arrangements of the foregut; for example *Inquisitor latifasciata* (Figs 17b, 20) and *Crassispira harfordiana flucki* (Figs 4d, 6). In other cases, some gastropods possess rather similar and distinctive foregut anatomies, as for example, *Inquisitor latifasciata* and *Ptychobela suturalis*. However, they have very different radular morphologies, with *I. latifasciata* having the rather standard crassispirine wishbone form, but *P. suturalis* has the autapomorphic, awl-shaped, hollow teeth (Fig. 23a).

Although teeth with the wishbone form are found in the subfamilies Turrinae, Clavatulinae and Cochlespirinae, most variation and the most extreme forms are found within taxa classified as Crassispirinae. Although rather a disparate range of radular teeth was found amongst the species we studied, all can probably be derived from the basic wishbone form. Thus, the derivation of the rather extreme forms of wishbone teeth seen in *Hindsiclava* and *Haedropleura* can be envisaged by changes in the relative proportion of the elements. In the large, paddle-shaped teeth of *Funa* and *Vexitomina*, a thin, splint-like secondary limb lies along the shaft of the main tooth. In the most-derived, harpoon-like teeth of *Cheungbeia*, a similar small splint-like secondary limb lies along the edge of the shaft. Finally, the hollow awl-shaped teeth of *Ptychobela* consist of two components and can probably be derived from flattening and fusing of the two wishbone components.

Congruence of shell characters

Shell characters are also a rather poorly correlated with radular morphology or characters of foregut anatomy. A good example of this problem is seen in the genera *Inquisitor*, *Funa*, and *Ptychobela*. These have rather similar shells but the radulae are quite different, *Inquisitor* having the standard crassispirine wishbone form, *Funa* has bladed, paddle-shaped teeth and *Ptychobela* possesses awl-shaped hollow teeth. The allocation of shells to these genera is difficult without radular evidence and many species have been rather arbitrarily assigned to genera (e.g. Wells, 1994).

A striking example of the similarity of shell characters in different families is seen between the pairs of West American species *Crassispira* (*Striospira*) *tepocana* (see Keen, 1971 fig. 1701) and *Strictispira* *ericana* (Keen, 1971 fig. 1727) and *C.* (*Striospira*) *xanti* (Keen, 1971 fig. 1702) with *Strictispira* *stillmani* (Keen, 1971 fig. 1728). These pairs of similar gastropods have quite different anatomies. The *Strictispira* species (family Strictispiridae) lack the venom gland, have the buccal mass located at the proboscis tip and possess very distinctive radula teeth (Kantor & Taylor, 1994).

Parallel evolution of hypodermic feeding mechanism

In two genera, the radular teeth are quite different from the rest of the Crassispirinae, which for the most part consist of variations on the robust wishbone form. In *Cheungbeia* species, the teeth are long, slender and harpoon-like, with distal barbs, whilst in *Ptychobela* the teeth are pointed, awl shaped and hollow. Although most conoidean teeth, including the wishbone types can be used at the proboscis tip for the penetration of prey, the hollow, barbed teeth are regarded as the more efficient. Taylor *et al.* (1993) demonstrated that hollow, barbed teeth had evolved several times within the Conoidea and these two taxa may represent further evolutionary pathways to the hypodermic feeding mechanism. The teeth in *Cheungbeia* and *Ptychobela* although quite different in morphology can both be derived from the crassispiran wishbone form. Although *Cheungbeia* is long and gutter-shaped, a small and very thin accessory limb lies along one side of the shaft (Fig. 26). A similar reduction in the size of the accessory limb is seen in *Funa* and *Vexitomina* which have paddle-shaped teeth, with the thin secondary limb lying along the shaft (Figs 23 b–d). In *Ptychobela*, each tooth is formed from two more or less equal parts which are fused along one edge and loosely enrolled. Neither of these two tooth types can be considered as precursors of the enrolled barbed teeth found in *Conus* (Coninae, *sensu* Taylor *et al.* 1993) because their foregut anatomy is different. Both *Cheungbeia* and *Ptychobela*, for example, have the modified epithelium of the rhynchodeum, the elongated oesophagus, and the

modified venom gland. None of these features is found in *Conus*. Moreover, Conidae have lost the radular membrane and possess a radular caecum for the storage of teeth prior to use.

Comparison between conoidean subfamilies

Three other subfamilies within the Turridae, the Turrinae, Clavatulinae and Cochlespirinae possess the wishbone type of radular teeth and their features should be compared with those of the Crassispirinae.

Members of the Turrinae have wishbone teeth which differ in morphology from those of the other taxa. The proximal half of each tooth is divided like a clothes-peg into two more or less equal units (Fig. 18), with the limbs not detached. This contrasts with the wishbone teeth in the other subfamilies which have the limbs unequal in size and thickness and the secondary limb not in structural continuity with the major limb. Some species of Turrinae also have a quadrate central tooth with a spine-like central cusp. Species of Turrinae also differ in a number of anatomical characters; there is usually no elongation of the oesophagus, no change in the histology of the venom gland anterior of the nerve ring and the rhynchodeum is uniformly glandular along its length (Taylor *et al.*, 1993; Taylor, 1994).

The Clavatulinae have wishbone teeth with a large, bladed, major limb and the secondary limb inserted into a 'V' shaped groove. Additionally, central teeth are usually present. They also have a medio-lateral nucleus to the operculum rather than the terminal position found in the other turrid subfamilies. The buccal mass often lies within the proboscis, but as in Crassispirinae, the oesophagus is often elongated between the nerve ring and buccal mass and the venom gland changes to a ciliated duct anterior to the nerve ring (Kantor, 1990; Taylor *et al.*, 1993).

The Cochlespirinae, represented by *Aforia*, *Antiplanes*, and *Cochlespira*, have similar wishbone teeth to the Crassispirinae, with some species possessing a central tooth, and some having plate-like lateral teeth (Sysoev & Kantor, 1987, 1988; Kantor & Sysoev, 1991). In *Cochlespira* and *Aforia*, the venom gland joins the oesophagus some way to the posterior of the buccal mass, but no details are available for other taxa.

We have found a great variation in the structure of the foregut in the Crassispirinae and some of these features are shared with the Turrinae, Clavatulinae and Cochlespirinae. However, rather few species have been studied from the latter three groups compared with the more extensive survey of the Crassispirinae. A reappraisal of the boundaries and relationships of these four subfamilies is required, but this cannot be attempted before more anatomical details are available from a much wider range of taxa.

Systematic conclusions

ANTIGURALEUS and associated genera

On the basis of his study of southern African species, Kilburn (1994) suggested that two genera, *Anacithara* and *Antiguraleus*, which had previously been referred to the subfamily Mangeliinae (as in Powell, 1966), should be transferred to the Crassispirinae on the basis of radular characters. We studied one of the South African species, *Antiguraleus morgani* and confirm that it has a crassispirine type of radula (Fig. 28a) and also has many foregut characters consistent with other members of the Crassispirinae. Additionally, we also sectioned the eastern Australian species, *Guraleus costatus*, and this also has an operculum, with a radula and foregut anatomy of the

Crassispirinae (Fig. 28b). However, another Australian species that we sectioned, *Antiguraleus howelli* (Laseron), possesses a typical mangeliinae anatomy and Powell (1966, fig. 138) also illustrates a typical mangeliine radula for *Antiguraleus murreus* (Webster, 1906). Our observations suggest that the mostly Australasian species, currently assigned to the *Guraleus* group of genera (*Antiguraleus*, *Paraguraleus*, *Guraleus* and *Neoguraleus*) (Powell, 1966) represent at least two different subfamilies, and the whole complex is in great need of critical revision.

EPIDIRONA

This genus was assigned to the Crassispirinae by Sysoev (In: Taylor *et al.*, 1993) on the evidence of the radula of the type species *Epidirona hedleyi* Iredale, 1931, which has teeth with the wishbone form similar to many other species in the subfamily, with a robust, pointed, major limb and a slender secondary limb (Powell, 1964, plate 229; Powell, 1966, fig. 33). However, our studies show that *Epidirona gabensis* has a radula with the wishbone teeth with the form typical of the subfamily Turrinae, i.e. awl shaped and bifurcating in the proximal half (Fig. 18). Similar teeth were illustrated by Powell (1966, fig. 32) for *Epidirona nodulosa* Laseron, 1954. In our phylogenetic analysis *Epidirona gabensis* was shown to be more similar, despite some anatomical differences, to the outgroup *Gemmula deshayesii*, rather than to the crassispirine species. However, the type species, *Epidirona hedleyi* would seem to be a crassispirine on the evidence of the radula, but we have no anatomical information to confirm this.

Our conclusions are that *Epidirona gabensis* and *E. nodulosa* should be classified within the subfamily Turrinae. *Epidirona hedleyi*, the type species, is likely to be a crassispirine and reference to the illustrations in Powell (1964, plate 230) shows that it differs from the other species on shell characters. A new generic name is necessary for the *Epidirona* species which possess the Turrinae-type of radular teeth, however, anatomical or at least radular studies of the other species is desirable.

TURRIDRUPA

The systematic position of this genus has been uncertain. Powell (1966; 1967) referred it to the Turrinae on shell characters, but his illustration (1967 fig. 300) of the radula of *T. jubata* would seem to be a misinterpretation. Subsequently, Kilburn (1983) transferred *Turridrupa* to the Clavinae (= Drilliidae), but later, on the basis of radular characters (*Turridrupa bijubata* and *cincta*) concluded (1988 p. 235) that *Turridrupa* was 'a primitive crassispirine clade'. Additionally, one of the species, *Turridrupa cerithina*, was again on radular characters, transferred to the genus *Inquisitor*, (Kilburn, 1988, p. 267). Unfortunately, the anatomy is known only for *Turridrupa bijubata* which has a quadrate central tooth and wishbone marginals (Kilburn, 1988 fig. 40) which are of the clothes-peg type similar to those of the Turrinae. Also, our phylogenetic analysis shows that in anatomical characters, *Turridrupa bijubata* is more similar to the outgroup *Gemmula* (Turrinae) and to *Epidirona gabensis* than any of the Crassispirinae. We have not studied *Turridrupa cerithina* which has a different shell morphology from other species and may well be a crassispirinan. In conclusion, we think that *Turridrupa* should be classified in the Turrinae, with *T. cerithina* possibly in the Crassispirinae.

CRASSISPIRA and subgenera

At present, the genus *Crassispira* is usually divided into eight subgenera. Our phylogenetic analysis shows that *Crassispira* (*Crassispira*) and *C. (Striospira)* form a monophyletic clade, but species of the other subgenera appear at widely separated positions on the cladogram (Fig. 33) and have different anatomies from *Crassispira* s.s. Our results suggest that the subgenera of *Crassispira* should be raised to full generic status, with perhaps a case for the retention of *Striospira* as a subgenus.

CONCLUSIONS

This detailed study of the anterior alimentary system of one subfamily of conoideans has revealed an extraordinary diversity of foregut configuration. It is uncertain whether so much variation exists in other conoidean groups, for far fewer species have been studied. However, preliminary evidence suggests that a similar diversity of foreguts exists in the Raphitominae, Clavatulinae and Terebridae (Taylor, 1990; Taylor *et al.*, 1993; Sysoev & Kantor, 1995; Kantor & Sysoev, 1996). The anatomy of *Conus* has usually been taken as being typical of the whole Conoidea, but its foregut is in many ways rather underived (basal buccal mass, unmodified rhynchodeal wall, no oesophageal loop, unmodified anterior venom gland). In fact, *Conus* can be regarded as just one of many possible foregut configurations found within the Conoidea. Virtually all the organs of the foregut can vary in presence or absence, size and position. Thus for example, the proboscis may be very long or very short; the buccal mass may be situated near the tip of the proboscis, at the base or to the posterior; much of the posterior rhynchodeum may be able to evert thus forming an extended proboscis, or there may be several of no sphincters in the buccal tube. Indeed, more extreme conditions exist in the some species of Raphitominae and Terebridae, where the venom gland, radula, salivary glands and proboscis have been lost. This diversity of foregut structure of conoideans likely reflects considerable variation in feeding behaviour and methods of prey capture. Unfortunately, apart from *Conus*, few details are available for other conoidean taxa (Miller, 1989; Taylor *et al.*, 1993).

ACKNOWLEDGEMENTS. We are grateful to Gary Rosenberg, Dick Kilburn, Jim McLean, Philippe Bouchet, Ian Loch, Winston Ponder, Graham Oliver and Marco Oliverio for the generous donation of some of the specimens used in this study. Alexander Sysoev provided discussion and encouragement. Brian Morton gave much logistic support for the collection of specimens in Hong Kong. David Cooper expertly prepared many of the serial sections. Yuri Kantor is grateful to the Royal Society for the air fare enabling him work in London.

REFERENCES

- Ball, A.D., Taylor, J.D. & Andrews, E.B. 1997. Development of the acinous and accessory salivary glands in *Nucella lapillus* (Neogastropoda: Muricoidea). *Journal of Molluscan Studies* **63**: 245–260.
- Fernandes, F., Rolán, E. & Otero-Schmitt, J. 1995. The genus *Crassispira* (Gastropoda, Turridae) in West Africa. *Journal of Conchology* **35**: 283–301.
- Guralnick, R. & de Maintenon, M. 1997. Formation and homology of radular teeth; a case study using columbellid gastropods (Neogastropoda: Columbellidae). *Journal of Molluscan Studies*, **63**: 65–77.
- Kantor, Y.I. 1990. Anatomical basis for the origin and evolution of the toxoglossan mode of feeding. *Malacologia*, **32**: 3–18.

- Kantor, Y.I. & Sysoev, A.V.** 1991. Mollusks of the genus *Antiplanes* (Gastropoda: Turridae) of the northwestern Pacific Ocean. *Nautilus* **105**: 119–146.
- Kantor, Y.I. & Sysoev, A.V.** 1996. New data on the foregut morphology of Raphitominae (Conoidea, Conidae). *Ruthenica* **5**: 155–157.
- Kantor, Y.I. & Taylor, J.D.** 1991. Evolution of the toxoglossan feeding mechanism: new information on the use of the radula. *Journal of Molluscan Studies* **57**: 129–134.
- Kantor, Y.I. & Taylor, J.D.** 1994. The foregut anatomy of *Strictispira paxillus* (Reeve, 1845) (Conoidea: Strictispiridae). *Journal of Molluscan Studies* **60**: 343–346.
- Keen, M.A.** 1971. *Sea shells of tropical West America*. 2nd edition. Stanford University Press, Stanford, California
- Kilburn, R.N.** 1983. Turridae (Mollusca: Gastropoda) of southern Africa and Mozambique. Part 1. Subfamily Turrinae. *Annals of the Natal Museum* **25**: 549–585.
- Kilburn, R.N.** 1988. Turridae (Mollusca: Gastropoda) of southern Africa and Mozambique. Part 4. Subfamilies Drilliinae, Crassispirinae and Strictispirinae. *Annals of the Natal Museum* **29**: 167–320.
- Kilburn, R.N.** 1989. Notes on *Ptychobela* and *Brachytoma*, with the description of a new species from Mozambique (Mollusca: Gastropoda: Turridae). *Annals of the Natal Museum* **30**: 185–196.
- Kilburn, R.N.** 1994. Turridae[s.l.] (Mollusca: Gastropoda) of southern Africa and Mozambique. Part 7. Subfamily Crassispirinae, section 2. *Annals of the Natal Museum* **35**: 177–228.
- McLean, J.H.** 1971. A revised classification of the family Turridae, with the proposal of new subfamilies, genera, and subgenera from the eastern Pacific. *Veliger* **14**: 114–130.
- Maes, V.O.** 1983. Observations on the systematics and biology of a turrid assemblage in the British Virgin Islands. *Bulletin of Marine Science* **33**: 305–3.
- Miller, J.A.** 1989. The toxoglossan proboscis: structure and function. *Journal of Molluscan Studies* **55**: 167–182.
- Powell, A.W.B.** 1964. The family Turridae in the Indo-Pacific. Part 1. The subfamily Turrinae. *Indo-Pacific Mollusca* **1**: 227–346.
- Powell, A.W.B.** 1966. The molluscan families Speightiidae and Turridae. An evaluation of the valid taxa, both Recent and fossil, with lists of characteristic species. *Bulletin of the Auckland Institute and Museum* **5**: 1–184.
- Sheridan, R., van Mol J.J. & Bouillon, J.** 1973. Etude morphologique du tube digestif de quelques Turridae de la région de Roscoff. *Cahiers de Biologie Marine* **14**: 159–188.
- Sysoev, A.V.** 1996. Deep-sea conoidean gastropods collected by the John Murray Expedition, 1933–34. *Bulletin of The Natural History Museum, London (Zoology)* **62**: 1–30.
- Sysoev, A.V. & Kantor, Y.I.** 1987. Deep-sea gastropods of the genus *Aforia* (Turridae) of the Pacific: species composition, systematics, and functional morphology of the digestive system. *Veliger* **30**: 105–126.
- Sysoev, A.V. & Kantor, Y.I.** 1988. Three new deep-sea molluscs of the genus *Aforia* (Gastropoda: Toxoglossa: Turridae). *Apex* **3**: 39–46.
- Sysoev, A.V. & Kantor, Y.I.** 1989. Anatomy of molluscs of genus *Splendrillia* (Gastropoda: Toxoglossa: Turridae) with description of two new bathyal species of the genus from New Zealand. *New Zealand Journal of Zoology* **16**: 205–214.
- Sysoev, A.V. & Kantor, Y.I.** 1995. Two new species of *Phymorhynchus* (Gastropoda, Conoidea, Conidae) from the hydrothermal vents. *Ruthenica* **5**: 17–26.
- Sysoev, A.V. & Taylor, J.D.** 1997. A new species of crassispirine gastropod from the Houtman Abrolhos Islands, Western Australia (Gastropoda, Conoidea, Crassispirinae). *Bulletin of the Natural History Museum London (Zoology)* **63**: 51–53.
- Taylor, J.D.** 1990. The anatomy of the foregut and relationships in the Terebridae. *Malacologia* **32**: 19–34.
- Taylor, J.D.** 1994. Foregut anatomy of the larger species of Turrinae, Clavatulinae and Crassispirinae (Gastropoda: Conoidea) from Hong Kong. pp.185–212. In: Morton B. (ed.) *The Malacofauna of Hong Kong and Southern China III*. Proceedings of the Third International Workshop on the Malacofauna of Hong Kong and Southern China. Hong Kong University Press, Hong Kong.
- Taylor, J.D., Kantor, Y.I. & Sysoev, A.V.** 1983. Foregut anatomy, feeding mechanisms, relationships and classification of the Conoidea (=Toxoglossa) (Gastropoda). *Bulletin of the Natural History Museum London (Zoology)* **59**: 125–170.
- Taylor, J.D. & Wells, F.E.** 1994. A revision of the crassispirine gastropods from Hong Kong (Gastropoda: Turridae). pp.101–116. In: Morton, B. (ed.) *The Malacofauna of Hong Kong and Southern China III*. Proceedings of the Third International Workshop on the Malacofauna of Hong Kong and Southern China, Hong Kong University Press, Hong Kong.
- Wells, F.E.** 1994. A revision of the Recent Australian species of the turrid genera *Inquisitor* and *Ptychobela*. *Molluscan Research* **15**: 71–102.

GUIDE FOR AUTHORS

Policy. The Bulletin of the British Museum (Natural History) Zoology, was established specifically to accommodate manuscripts relevant to the Collections in the Department of Zoology. It provides an outlet for the publication of taxonomic papers which, because of their length, prove difficult to publish elsewhere. Preference is given to original contributions in English whose contents are based on the Collections, or the description of specimens which are being donated to enhance them. Acceptance of manuscripts is at the discretion of the Editor, on the understanding that they have not been submitted or published elsewhere and become the copyright of the Trustees of the Natural History Museum. All submissions will be reviewed by at least two referees.

Manuscripts. Initially three clear, complete copies should be submitted in the style and format of the *Bulletin*. The text must be typed double-spaced throughout, including references, tables and legends to figures, on one side of A4 paper with 2.5 cm margins. All pages should be numbered consecutively, beginning with the title page as p. 1. SI units should be used where appropriate.

Whenever possible a copy of the text, once the paper has been accepted, should also be provided on floppy disc (see below). Discs should only be sent after final acceptance, as papers generally need revision after refereeing. If it is impossible to provide an appropriate disc please ensure that the final typescript is clearly printed.

Authors are requested to ensure that their manuscripts are in final format, because corrections at proof stage may be charged to the author. Additions at proof stage will not normally be allowed. Page proofs only will be sent.

Word-processor discs. Please follow these instructions.

1. Ensure that the disc you send contains only the final version of the paper and is identical to the typescript.
2. Label the disc with the author's name, title of the paper and the word-processor programme used. Indicate whether IBM or Apple Mac (IBM preferred).
3. Supply the file in the word-processor format; if there is a facility to save in ASCII please submit the file in ASCII as well.
4. Specify any unusual non-keyboard characters on the front page of the hard copy.
5. Do not right-justify the text.
6. Do not set a left-hand margin.
7. Make sure you distinguish numerals from letters, e.g. zero (0) from O; one (1) from l (el) and I.
8. Distinguish hyphen, en rule (longer than a hyphen, used without a space at each end to signify 'and' or 'to', e.g. the Harrison-Nelson technique, 91–95%, and increasingly used with a space at each end parenthetically), and em rule (longer than an en rule, used with a space at each end parenthetically) by: hyphen, two hyphens and three hyphens, respectively. Be consistent with rule used parenthetically.
9. Use two carriage returns to indicate beginnings of paragraphs.
10. Be consistent with the presentation of each grade of heading (see **Text** below).

Title. The title page should be arranged with the full title; name(s) of author(s) without academic titles; institutional address(es); suggested running title; address for correspondence.

Synopsis. Each paper should have an abstract not exceeding 200 words. This should summarise the main results and conclusions of

the study, together with such other information to make it suitable for publication in abstracting journals without change. References must not be included in the abstract.

Text. All papers should have an Introduction, Acknowledgements (where applicable) and References; Materials and Methods should be included unless inappropriate. Other major headings are left to the author's discretion and the requirements of the paper, subject to the Editors' approval. Three levels of text headings and sub-headings should be followed. All should be ranged left and be in upper and lower case. Supra-generic systematic headings only should be in capitals; generic and specific names are to be in italics, underlined. Authorities for species names should be cited only in the first instance. Footnotes should be avoided if at all possible.

References. References should be listed alphabetically. Authorities for species names should not be included under References, unless clarification is relevant. The author's name, in bold and lower case except for the initial letter, should immediately be followed by the date after a single space. Where an author is listed more than once, the second and subsequent entries should be denoted by a long dash. These entries should be in date order. Joint authorship papers follow the entries for the first author and an '&' should be used instead of 'and' to connect joint authors. Journal titles should be entered in full. Examples: (i) Journals: England, K.W. 1987. Certain Actinaria (Cnidaria, Anthozoa) from the Red Sea and tropical Indo-Pacific Ocean. *Bulletin of the British Museum (Natural History)*, Zoology 53: 206–292. (ii) Books: Jeon, K.W. 1973. *The Biology of Amoeba*. 628 p. Academic Press, New York & London. (iii) Articles from books: Hartman, W.D. 1981. Form and distribution of silica in sponges. pp. 453–493. In: Simpson, T.L. & Volcani, B.E. (eds) *Silicon and Siliceous Structures in Biological Systems*. Springer-Verlag, New York.

Tables. Each table should be typed on a separate sheet designed to extend across a single or double column width of a Journal page. It should have a brief specific title, be self-explanatory and be supplementary to the text. Limited space in the Journal means that only modest listing of primary data may be accepted. Lengthy material, such as non-essential locality lists, tables of measurements or details of mathematical derivations should be deposited in the Biological Data Collection of the Department of Library Services, The Natural History Museum, and reference should be made to them in the text.

Illustrations. Figures should be designed to go across single (84 mm wide) or double (174 mm wide) column width of the Journal page, type area 235 × 174 mm. Drawings should be in black on white stiff card or tracing film with a line weight and lettering suitable for the same reduction throughout, either 50%, 30% or 25%. After reduction the smallest lettering should be not less than 10 pt (3 mm). All photographs should be prepared to the final size of reproduction, mounted upon stiff card and labelled with press-on lettering. Components of figure-plates should be abutted. All figures should be numbered consecutively as a single series. Legends, brief and precise, must indicate scale and explain symbols and letters.

Reprints. 25 reprints will be provided free of charge per paper. Orders for additional reprints can be submitted to the publisher on the form provided with the proofs. Later orders cannot be accepted.

CONTENTS

- 1 **A new species of *Microgale* (Insectivora: Tenrecidae), with comments on the status of four other taxa of shrew tenrecs**
Paulina D. Jenkins, Christopher J. Raxworthy and Ronald A. Nussbaum
- 13 **Notes on the anatomy and relationships of *Sundasalanx* Roberts (Teleostei, Clupeidae), with descriptions of four new species from Borneo**
Darrell J. Siebert
- 27 **Redescription of and lectotype designation for *Balistes macrolepis* Boulenger, 1887, a senior synonym of *Canthidermis longirostris* Tortonese, 1954 and *C. villosus* Fedoryako, 1979 (Teleostei, Tetraodontiformes, Balistidae)**
Anthony C. Gill and John E. Randall
- 33 **A review of the *Diogenes* (Crustacea, Paguridea) hermit crabs collected by Bedford and Lanchester from Singapore, and from the 'Skeaf' Expedition to the Malay Peninsula, with a description of a new species and notes on *Diogenes intermedius* De Man, 1892**
Patsy A. McLaughlin and Paul F. Clark
- 51 **A new species of crassispirine gastropod from the Houtman Abrolhos Islands, Western Australia (Gastropoda, Conoidea, Crassispirinae)**
Alexander V. Sysoev and John D. Taylor
- 55 **Foregut anatomy and relationships of the Crassispirinae (Gastropoda, Conoidea)**
Yuri I. Kantor, Alexandra Medinskaya and John D. Taylor