



554

con. 1

SCIENTIFIC LIBRARY



UNITED STATES PATENT OFFICE

GOVERNMENT PRINTING OFFICE

11-3623

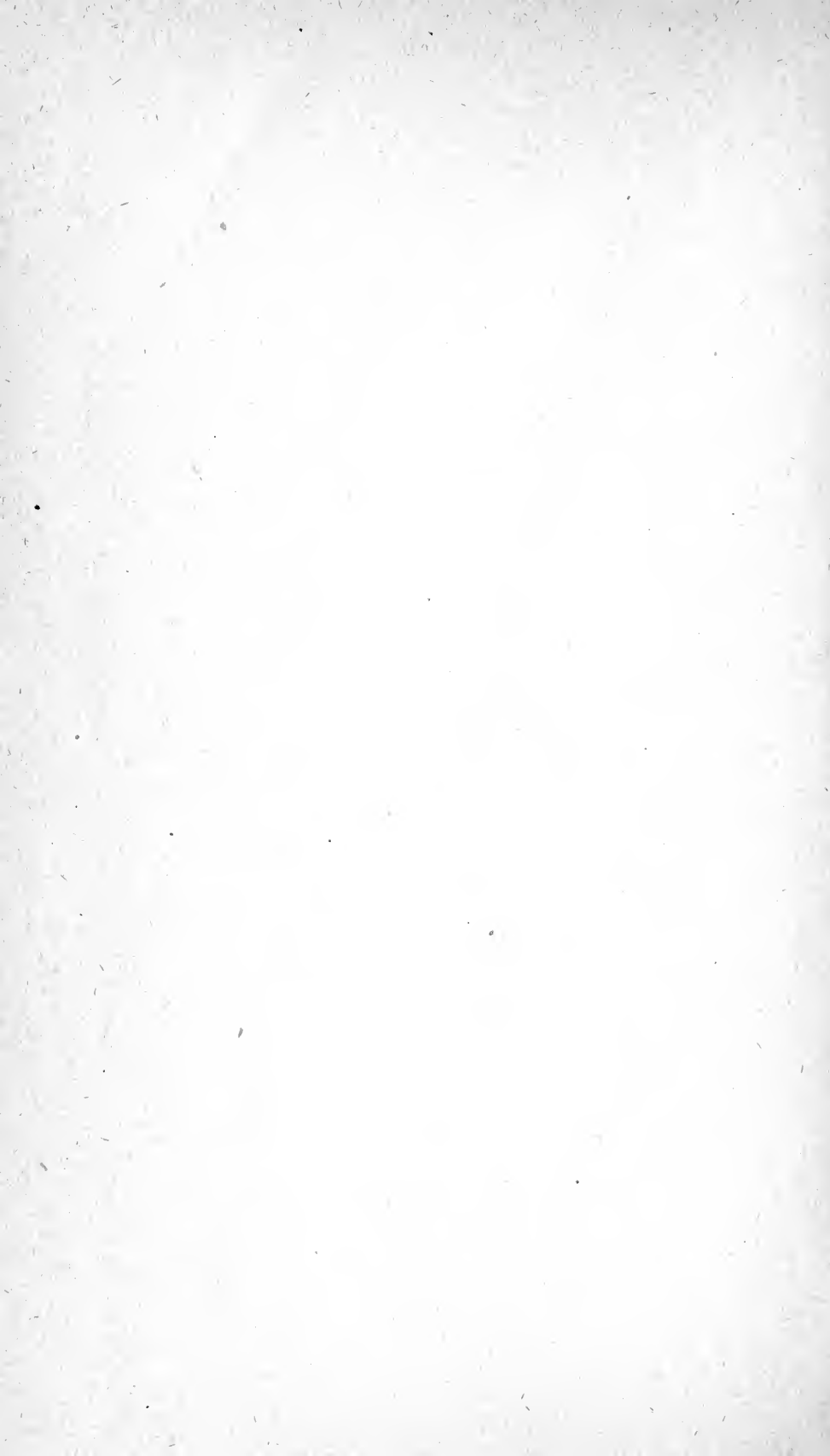



BULLETIN OF THE PHILOSOPHICAL SOCIETY OF WASHINGTON,
VOL. XI, 1888-1891.

Bind this volume in the manner directed by the Committee on Publications, and deliver to Marcus Baker, U. S. Geological Survey, for

(name) *Edward Fargnoli*

(address) *Patent Office Library
Washⁿ D. C.*

(Date) *Apr 26*, 1892.



BULLETIN
OF THE
PHILOSOPHICAL SOCIETY
OF
WASHINGTON.

VOL. XI.

WITH THE CONSTITUTION, RULES,

AND LISTS OF

OFFICERS AND MEMBERS.

WASHINGTON:
PRINTED BY JUDD & DETWEILER.
1892

Q

11

WS

cop. 1

CONTENTS.

	Page.
Constitution	VII
Standing Rules of the Society	VIII
Standing Rules of the General Committee	XII
Standing Rules of the Mathematical Section	XIV
Rules for the Publication of the Bulletin	XV
List of Presidents of the Society	XVI
List of Officers of the Society for 1892	XVII
List of Members	XVIII
Philosophy and Specialties, Annual Presidential Address, 1888, Garrick Mallery	3
On the Observation of Sudden Phenomena, S. P. Langley	41
On Some of the Greater Problems of Physical Geology, C. E. Dutton ..	51
On the Crystallization of Igneous Rocks, J. P. Iddings	65
On the Reduction of Pendulum Observations, E. D. Preston	115
The Relative Abundance of the Chemical Elements, F. W. Clarke ...	131
Assumption and Fact in the Theories of Solar and Stellar Proper Mo- tions, Annual Presidential Address, 1889, J. R. Eastman	143
Hurricanes in the Bay of North America, Everett Hayden	173
The Mineral Composition and Geological Occurrence of Certain Igne- ous Rocks in the Yellowstone National Park, J. P. Iddings	191
The Evolution of Serials Published by Scientific Societies, W J McGee	221
On Certain Peculiar Structural Features in the Foot-Hill Region of the Rocky Mountains near Denver, Colorado, G. H. Eldridge	247
The Progress of Meteoric Astronomy in America, J. R. Eastman	275
Money Fallacies, Annual Presidential Address, 1890, C. E. Dutton ...	359
Constitution and Origin of Spherulites in Acid Eruptive Rocks, Whitman Cross	411
Spherulitic Crystallization, J. P. Iddings	445
Obituary Notices	465
Mohawk Lake Beds, H. W. Turner	385
Minutes of Proceedings of the Society, 1888	499
Minutes of Proceedings of the Society, 1889	528
Minutes of Proceedings of the Society, 1890	549
Minutes of Proceedings of the Society, 1891	563
Minutes of Proceedings of the Mathematical Section, 1888	579
Minutes of Proceedings of the Mathematical Section, 1889	604
Minutes of Proceedings of the Mathematical Section, 1890	606
Minutes of Proceedings of the Mathematical Section, 1891	608
Index	611



THE PHILOSOPHICAL SOCIETY

OF

WASHINGTON.

CONSTITUTION, RULES,

LIST OF

OFFICERS AND MEMBERS FOR 1892,

AND LIST OF

PRESIDENTS OF THE SOCIETY.

CONSTITUTION
OF
THE PHILOSOPHICAL SOCIETY OF WASHINGTON.

ARTICLE I. The name of this Society shall be THE PHILOSOPHICAL SOCIETY OF WASHINGTON.

ARTICLE II. The officers of the Society shall be a President, four Vice-Presidents, a Treasurer, and two Secretaries.

ARTICLE III. There shall be a General Committee, consisting of the ex-Presidents of the Society, the officers of the Society, and nine other members.

ARTICLE IV. The officers of the Society and the nine other members of the General Committee shall be elected annually by ballot; they shall hold office until their successors are elected, and shall have power to fill vacancies.

ARTICLE V. It shall be the duty of the General Committee to make rules for the government of the Society, and to transact all its business.

ARTICLE VI. This constitution shall not be amended except by a three-fourths vote of those present at an annual meeting for the election of officers, and after notice of the proposed change shall have been given in writing at a stated meeting of the Society at least four weeks previously.

STANDING RULES

FOR THE GOVERNMENT OF

THE PHILOSOPHICAL SOCIETY OF WASHINGTON.

1. The Stated Meetings of the Society shall be held at 8 o'clock p. m. on every alternate Saturday; the place of meeting to be designated by the General Committee.

2. Notice of the time and place of meeting shall be sent to each member by one of the Secretaries.

When necessary, Special Meetings may be called by the President.

3. The Annual Meeting for the election of officers shall be the last stated meeting in the month of December.

The order of proceedings (which shall be announced by the Chair) shall be as follows :

First, the reading of the minutes of the last Annual Meeting.

Second, the presentation of the annual reports of the Secretaries, including the announcement of the names of members elected since the last annual meeting.

Third, the presentation of the annual report of the Treasurer.

Fourth, the announcement of the names of members who, having complied with Section 14 of the Standing Rules, are entitled to vote on the election of officers.

Fifth, the election of President.

Sixth, the election of four Vice-Presidents.

Seventh, the election of Treasurer.

Eighth, the election of two Secretaries.

Ninth, the election of nine members of the General Committee.

Tenth, the consideration of Amendments to the Constitution of the Society, if any such shall have been proposed in accordance with Article VI of the Constitution.

Eleventh, the reading of the rough minutes of the meeting.

4. Elections of officers are to be held as follows :

In each case nominations shall be made by means of an informal ballot, the result of which shall be announced by the Secretary ; after which the first formal ballot shall be taken.

In the ballot for Vice-Presidents, Secretaries, and Members of the General Committee, each voter shall write on one ballot as many names as there are officers to be elected, viz., four on the first ballot for Vice-Presidents, two on the first for Secretaries, and nine on the first for Members of the General Committee, and on each subsequent ballot as many names as there are persons yet to be elected ; and those persons who receive a majority of the votes cast shall be declared elected : *Provided*, That the number of persons receiving a majority does not exceed the number of persons to be elected, in which case the vacancies shall be filled by the candidates receiving the highest majorities.

If in any case the informal ballot result in giving a majority for any one, it may be declared formal by a majority vote.

5. The Stated Meetings, with the exception of the annual meeting, shall be devoted to the consideration and discussion of scientific subjects.

The Stated Meeting next preceding the Annual Meeting shall be set apart for the delivery of the President's Annual Address.

6. Sections representing special branches of science may be formed by the General Committee upon the written recommendation of twenty members of the Society.

7. Persons interested in science, who are not residents of the District of Columbia, may be present at any meeting of the Society, except the annual meeting, upon invitation of a member.

8. On request of a member, the President or either of the Secretaries may, at his discretion, issue to any person a card of invitation to attend a specified meeting. Five cards of invitation

to attend a meeting may be issued in blank to the reader of a paper at that meeting.

9. Invitations to attend during three months the meetings of the Society and participate in the discussion of papers, may, by a vote of nine members of the General Committee, be issued to persons nominated by two members.

10. Communications intended for publication under the auspices of the Society shall be submitted in writing to the General Committee for approval.

11. Any paper read before a Section may be repeated, either entire or by abstract, before a general meeting of the Society, if such repetition is recommended by the General Committee of the Society.

12. It is not permitted to report the proceedings of the Society or its Sections for publication, except by authority of the General Committee.

13. New members may be proposed in writing by three members of the Society for election by the General Committee; but no person shall be admitted to the privileges of membership unless he signifies his acceptance thereof in writing, and pays his dues to the Treasurer, within two months after notification of his election.

14. Each member shall pay annually to the Treasurer the sum of five dollars, and no member whose dues are unpaid shall vote at the annual meeting for the election of officers, or be entitled to a copy of the Bulletin.

In the absence of the Treasurer, the Secretary is authorized to receive the dues of members.

The names of those two years in arrears shall be dropped from the list of members.

Notice of resignation of membership shall be given in writing to the General Committee through the President or one of the Secretaries.

15. The fiscal year shall terminate with the Annual Meeting.

16. Any member who is absent from the District of Columbia for more than twelve consecutive months may be excused from payment of dues during the period of his absence, in which case he will not be entitled to receive announcements of meetings or current numbers of the Bulletin.

17. Any member not in arrears may, by the payment of one hundred dollars at any one time, become a life member, and be relieved from all further annual dues and other assessments.

All moneys received in payment of life membership shall be invested as portions of a permanent fund, which shall be directed solely to the furtherance of such special scientific work as may be ordered by the General Committee.

STANDING RULES
OF
THE GENERAL COMMITTEE
OF
THE PHILOSOPHICAL SOCIETY OF WASHINGTON.

With Amendments Adopted April 14, 1888. (Records 1 : 218-220.)

1. The President, Vice-Presidents, and Secretaries of the Society shall hold like offices in the General Committee.

2. The President shall have power to call special meetings of the Committee, and to appoint Sub-Committees.

3. The Sub-Committees shall prepare business for the General Committee, and perform such other duties as may be entrusted to them.

4. There shall be two Standing Sub-Committees: one on Communications for the Stated Meetings of the Society, and another on Publications.

5. The General Committee shall meet at half-past seven o'clock on the evening of each Stated Meeting, and by adjournment at other times.

6. Six members shall constitute a quorum for all purposes, except for the amendment of the Standing Rules of the Committee or of the Society, in which case a majority of the General Committee shall constitute a quorum.

7. The names of proposed new members recommended in conformity with Section 13 of the Standing Rules of the Society may be presented at any meeting of the General Committee, but shall

lie over for at least four weeks before final action. At least fifteen ballots shall be cast to determine an election. Blanks shall not be counted as ballots. Affirmative ballots to the number of four-fifths of those cast shall be necessary to an election. No rejected candidate shall be eligible to membership within twelve months from the date of rejection. The Secretary of the General Committee shall keep a chronological register of the elections and acceptances of members.

8. These Standing Rules, and those for the government of the Society, shall be modified only with the consent of a majority of the members of the General Committee, but by unanimous consent of a quorum any rule except numbers 6 and 7 of the Standing Rules of the General Committee may be temporarily suspended.

STANDING RULES
OF THE
MATHEMATICAL SECTION.

1. The object of this Section is the consideration and discussion of papers relating to pure or applied mathematics.

2. The special officers of the section shall be a Chairman and a Secretary, who shall be elected at the first meeting of the Section in each year, and discharge the duties usually attaching to those offices.

3. To bring a paper regularly before the Section it must be submitted to the Standing Committee on Communications for the stated meetings of the Society, with the statement that it is for the Mathematical Section.

4. Meetings shall be called by the Standing Committee on Communications whenever the extent or importance of the papers submitted and approved appear to justify it.

5. All members of the Philosophical Society who wish to do so may take part in the meetings of this Section.

6. To every member who shall have notified the Secretary of the General Committee of his desire to receive them, announcements of the meetings of the Section shall be sent by mail.

7. The Section shall have power to adopt such rules of procedure as it may find expedient.

RULES RESPECTING PUBLICATIONS
OF
THE PHILOSOPHICAL SOCIETY OF WASHINGTON.

Adopted December 22, 1888.

1. The regular publication of the Society shall have the form of a series of completed papers or memoirs, to which the transactions of the Society shall be added. Publication shall not be made at stated intervals, but whenever directed by the General Committee.

2. Each paper read before the Society and offered for publication shall be at once referred to a special committee of two appointed by the President, which shall submit to the General Committee at its next meeting a written report on the paper, and the General Committee shall decide respecting its publication. The annual address of the retiring President and the annual reports of the Treasurer and Secretaries shall be published in full, without reference. The journal of the Society shall be published in condensed form at the end of the volume.

3. Papers read before a Section of the Society and offered for publication shall be referred to a committee appointed as the Section may direct. The paper, accompanied by a written report, shall be laid before the General Committee, which shall decide respecting publication.

4. Papers approved by the General Committee for publication shall be printed forthwith, and one hundred copies shall be gratuitously furnished to the author.

5. The papers published from time to time shall be paged consecutively, and when sufficient material has accumulated to form a volume of convenient size, a title page, table of contents, and index shall be prepared, and the whole issued as a volume of the Bulletin of the Philosophical Society.

PRESIDENTS OF THE SOCIETY.

JOSEPH HENRY.....	1871-78.
SIMON NEWCOMB.....	1879-'80.
J. J. WOODWARD.....	1881.
W. B. TAYLOR.....	1882.
J. W. POWELL.....	1883.
J. C. WELLING	1884.
ASAPH HALL.....	1885.
J. S. BILLINGS.....	1886.
WM. HARKNESS.....	1887.
GARRICK MALLERY.....	1888.
J. R. EASTMAN	1889.
C. E. DUTTON.....	1890.
T. C. MENDENHALL	1891.
G. K. GILBERT.....	1892.

LIST OF MEMBERS
OF THE
PHILOSOPHICAL SOCIETY OF WASHINGTON;

TOGETHER WITH
YEAR OF ADMISSION TO THE SOCIETY, POST-OFFICE
ADDRESS, AND RESIDENCE.

Corrected to December 31, 1891.

1871. ABBE, PROF. CLEVELAND.
Weather Bureau. 2017 I street.
1875. ABERT, S. T. (Silvanus Thayer),
722 Seventeenth street. 1738 I street.
1881. ADAMS, HENRY,
1603 H street.
1871. ANTISELL, DR. THOMAS,
Patent Office. 1311 Q street.
1890. ATKINSON, W. R. (William Russum),
Geological Survey.
1889. ATWATER, PROF. W. O. (Wilbur Olin),
Wesleyan University, Middletown, Conn.
1879. AVERY, R. S. (Robert Stanton),
320 A street SE.
1881. BAKER, DR. FRANK,
Smithsonian Institution. 1315 Corcoran street.
1876. BAKER, MARCUS,
Geological Survey. 1905 Sixteenth street.
1871. BATES, DR. HENRY H. (Henry Hobart),
Patent Office. The Portland.
1886. BATES, DR. N. L. (Newton Lemuel), U. S. N.,
Navy Department. Mare Island, California.
- (xviii)

1888. BAUER, LOUIS A. (Louis Agricola),
Coast and Geodetic Survey. 2151 L street.
1884. BEAN, DR. T. H. (Tarleton Hoffman),
Smithsonian Institution. 1738 Q street.
1875. BEARDSLEE, CAPT. L. A. (Lester Anthony), U. S. N.,
Navy Department.
1879. BELL, A. GRAHAM (Alexander Graham),
Volta Bureau, 3414 Q street.
1881. BELL, DR. C. A. (Chichester Alexander),
The Richmond, Seventeenth and H streets.
1871. BENÉT, GEN. S. V. (Stephen Vincent), U. S. A.,
1717 I street.
1886. BEYER, DR. H. G. (Henry Gustav), U. S. N.,
Navy Department.
1890. BIGELOW, PROF. FRANK H. (Frank Hagar),
Weather Bureau. 1416 K street.
1871. BILLINGS, DR. J. S. (John Shaw), U. S. A.,
Army Medical Museum. 3027 N street.
1876. BIRNIE, CAPT. ROGERS, U. S. A.,
Ordnance Office, War Dept. 1341 New Hampshire ave.
1883. BODFISH, SUMNER H. (Sumner Homer),
58 B street NE.
1884. BOWLES, NAV. CON'R. F. T. (Francis Tiffany), U. S. N.,
Navy Yard, Norfolk, Va.
1884. BROWN, PROF. S. J. (Stimson Joseph), U. S. N.,
Washburn Observatory, Madison, Wisconsin.
1883. BROWNE, DR. JOHN MILLS, U. S. N.,
Navy Department. The Portland.
1886. BRYAN, DR. J. H. (Joseph Hammond),
806 Seventeenth street. 1644 Connecticut ave.
1883. BURGESS, PROF. E. S. (Edward Sandford),
High School. 1115 O street.
1879. BURNETT, DR. SWAN M. (Swan Moses),
1770 Massachusetts avenue.
1874. BUSEY, DR. SAMUEL C. (Samuel Clagett),
1545 I street. 901 Sixteenth street.
1891. CARR, W. K. (William Kearney),
1008 F Street. 1413 K street.

1871. CASEY, GEN. THOMAS LINCOLN, U. S. A.
War Department. 1419 K street.
1882. CAZIARC, CAPT. LOUIS V. (Louis Vasmar), U. S. A.,
Fort Adams, Newport, R. I.
1883. CHAMBERLIN, PRES. T. C. (Thomas Chrowder),
University of Wisconsin. Madison, Wis.
1888. CHAPMAN, D. C. (Daniel Currier),
Coast and Geodetic Survey. 110 C street SE.
1885. CHATARD, DR. THOS. M. (Thomas Marean),
Geological Survey. The Portland.
1874. CHICKERING, PROF. J. W. (John White),
Deaf Mute College. Kendall Green.
1880. CHRISTIE, ALEX. S. (Alexander Smyth),
Coast and Geodetic Survey.
1877. CLARK, EDWARD,
Architect's Office, Capitol. 417 Fourth street.
1874. CLARKE, PROF. F. W. (Frank Wigglesworth),
Geological Survey. 1612 Riggs place.
1890. COLONNA, B. A. (Benjamin Azariah),
Coast and Geodetic Survey. 138 B street NE.
1880. COMSTOCK, PROF. J. H. (John Henry),
Cornell University. Ithaca, N. Y.
1874. COUES, DR. ELLIOTT,
Smithsonian Institution. 1726 N street.
1873. CRAIG, CAPT. ROBERT, U. S. A.,
War Department. 1822 I street.
1879. CRAIG, DR. THOMAS,
Johns Hopkins University. Baltimore, Md.
1889. CROSS, C. WHITMAN (Charles Whitman),
Geological Survey. 730 Seventeenth street.
1886. CUMMINGS, PROF. GEO. J. (George Jotham),
Howard University.
1884. CURTIS, GEORGE E. (George Edward),
Smithsonian Institution. 1227 M street.
1871. DALL, WM. H. (William Healey),
National Museum. 1119 Twelfth street.
1886. DARTON, N. H. (Nelson Horatio),
Geological Survey.

1880. DAVIS, COMDR. C. H. (Charles Henry), U. S. N.,
Navy Department. 1705 Rhode Island avenue.
1889. DAWSON, REV. J. F. (James Francis),
Georgetown College.
1872. DEAN, DR. R. C. (Richard Crain), U. S. N.,
Navy Department. 1736 I street.
1881. DE CAINDRY, WM. A. (William Augustin),
Commissary General's Office, War Dept. 1909 H street.
1884. DEWEY, FRED. P. (Frederic Perkins),
621 F street. Lanier Heights.
1884. DILLER, J. S. (Joseph Silas),
Geological Survey. 1804 Sixteenth street.
1876. DOOLITTLE, M. H. (Myrick Hascall),
Coast and Geodetic Survey. 1925 I street.
1873. DUNWOODY, MAJ. H. H. C. (Henry Harrison
War Department. [Chase], U. S. A.,
1872. DUTTON, MAJ. C. E. (Clarence Edward), U. S. A.,
San Antonio, Texas.
1890. EAKINS, L. G. (Lincoln Grant),
Geological Survey. 1721 G street.
1884. EARLL, R. EDWARD (Robert Edward),
National Museum. 1441 Chapin street.
1871. EASTMAN, PROF. J. R. (John Robie), U. S. N.,
Naval Observatory. 1905 N street.
1888. EDES, DR. R. T. (Robert Thaxter),
Adams Nervine Asylum, Jamaica Plain, Massachusetts.
1884. EIMBECK, WILLIAM,
Coast and Geodetic Survey. 1014 Fourteenth street.
1887. ELDRIDGE, G. H. (George Homans),
Geological Survey. The Shoreham.
1871. ELDRIDGE, DR. STUART,
Yokohama, Japan.
1883. EMMONS, S. F. (Samuel Franklin),
Geological Survey. 1725 H street.
1873. ENDLICH, DR. F. M. (Frederic Miller),
Ouray, Colorado.
1874. EWING, GEN. HUGH,
"Idleside," Lancaster, Ohio.

1876. FARQUHAR, EDWARD,
Patent Office Library. 2008 F street.
1881. FARQUHAR, HENRY,
Coast and Geodetic Survey. Brookland, D. C.
1889. FASSIG, O. L. (Oliver Lanard),
Weather Bureau. 1424 Eleventh street.
1887. FERNOW, B. E. (Bernhard Eduard),
Department of Agriculture. 1843 R street.
1890. FISCHER, E. G. (Ernst George),
Coast and Geodetic Survey. 436 N. Y. avenue.
1873. FLETCHER, DR. ROBERT,
Army Medical Museum. The Portland.
1882. FLINT, A. S. (Albert Stowell),
Washburn Observatory, Madison, Wisconsin.
1881. FLINT, DR. J. M. (James Milton), U. S. N.,
Navy Department. U. S. S. Miantonomah.
1873. FRISTOE, PROF. E. T. (Edward T.),
Columbian University. 1109 Thirteenth street.
1875. GALLAUDET, PRES. E. M. (Edward Miner),
Deaf Mute College, Kendall Green.
1874. GANNETT, HENRY,
Geological Survey. 1881 Harewood avenue.
1891. GIHON, DR. ALBERT L. (Albert Leary), U. S. N.,
United States Naval Hospital, Brooklyn, New York.
1873. GILBERT, G. K. (Grove Karl),
Geological Survey. 1424 Corcoran street.
1879. GODDING, DR. W. W. (William Whitney),
Government Hospital for the Insane.
1885. GOOCH, PROF. F. A. (Frank Austin),
Yale College, New Haven, Connecticut.
1874. GOODE, DR. G. BROWN (George Brown),
Smithsonian Institution. Lanier Heights.
1875. GOODFELLOW, EDWARD,
Coast and Geodetic Survey. 7 Dupont Circle.
1886. GORDON, PROF. J. C. (Joseph Claybaugh),
Deaf Mute College, Kendall Green.
1880. GORE, PROF. J. HOWARD (James Howard),
Columbian University. 1517 Kingman place.

1878. GRAVES, W. H. (Walter Hayden),
Bureau of Indian Affairs.
1880. GREELY, GEN. A. W. (Adolphus Washington), U. S. A.,
1415 G street. 1914 G street.
1879. GREEN, BERNARD R. (Bernard Richardson),
Building for Library of Congress. 1738 N street.
1875. GREEN, COMDR. F. M. (Francis Mathews), U. S. N.,
Navy Department.
1871. GREENE, PROF. B. F. (Benjamin Franklin), U. S. N.,
West Lebanon, New Hampshire.
1875. GREENE, FRANCIS VINTON,
No. 1, Broadway, New York, N. Y.
1884. GREGORY, DR. JOHN M. (John Milton),
Corner New Hampshire and Oregon avenues.
1879. GUNNELL, DR. F. M. (Francis M.), U. S. N.,
600 20th street.
1889. HAGEN, REV. J. G. (John George),
Georgetown College.
1879. HAINS, LT. COL. P. C. (Peter Conover), U. S. A.,
Portland, Maine.
1871. HALL, PROF. ASAPH, U. S. N.,
Naval Observatory. 2715 N street.
1884. HALL, ASAPH, JR.,
Naval Observatory. 2715 N street.
1885. HALLOCK, DR. WILLIAM,
Smithsonian Institution. 1423 Florida avenue.
1871. HARKNESS, PROF. WILLIAM, U. S. N.,
Naval Observatory. Cosmos Club, 1520 H street.
1891. HARRINGTON, PROF. MARK W. (Mark Walrod),
Weather Bureau.
1890. HARRIS, A. W. (Abram Winegardner),
Department of Agriculture. Brookland, D. C.
1891. HARRIS, R. A. (Rollin Arthur),
Coast and Geodetic Survey. 1740 R street.
1880. HASSLER, DR. F. A. (Ferdinand Augustus),
Santa Ana, Orange County, California.
1886. HAYDEN, EVERETT, U. S. N.,
Hydrographic Office. 1802 Sixteenth street.

1871. JENKINS, RR. ADL. T. A. (Thornton Alexander), U. S. N.,
2115 Pennsylvania avenue.
1890. JENNEY, DR. W. P. (Walter Proctor),
Geological Survey.
1879. JOHNSON, DR. JOSEPH TABER,
1728 K street.
1884. JOHNSON, WILLARD D. (Willard Drake),
U. S. Geological Survey, Berkeley, California.
1884. KAUFFMANN, S. H. (Samuel Hay),
1101 Pennsylvania avenue. 1421 Massachusetts ave.
1887. KEITH, ARTHUR,
Geological Survey. 1707 M street.
1886. KENASTON, PROF. C. A. (Carlos Albert),
Room 4, 26 Court street, Brooklyn, New York.
1884. KERR, MARK B. (Mark Brickell),
402 Front street, San Francisco, California.
1880. KILBOURNE, CAPT. C. E. (Charles Evans), U. S. A.,
Signal Office, War Department. 1922 I street.
1875. KING, DR. A. F. A. (Albert Freeman Africanus),
1315 Massachusetts avenue.
1887. KNIGHT, F. J. (Fred Jay),
Geological Survey. 744 8th street.
1887. KNOWLTON, PROF. F. H. (Frank Hall),
National Museum. Laurel, Maryland.
1874. KNOX, J. J. (John Jay),
19 E. 41st street, New York city.
1882. KUMMELL, C. H. (Charles Hugo),
Coast and Geodetic Survey. 608 Q street.
1887. LANGLEY, MR. S. P. (Samuel Pierpont),
Smithsonian Institution. Metropolitan Club.
1884. LAWRENCE, WILLIAM,
Bellefontaine, Ohio.
1874. LEE, DR. WILLIAM,
2111 Pennsylvania avenue. 1821 I street.
1871. LINCOLN, DR. N. S. (Nathan Smith),
1514 H street.
1890. LINDGREN, WALDEMAR,
Geological Survey. 809 Thirteenth street.

XXVI PHILOSOPHICAL SOCIETY OF WASHINGTON.

1889. LITTLEHALES, G. W. (George Washington),
Hydrographic Office. 928 Twenty-third street.
1880. LOOMIS, E. J. (Eben Jenks),
Nautical Almanac Office. 1443 Stoughton street.
1886. McADIE, A. G. (Alexander George),
Clark University, Worcester, Massachusetts.
1891. McCAMMON, GEN. JOS. K. (Joseph Kay),
1420 F street. 1324 Nineteenth street.
1886. McDONALD, COL. M. (Marshall),
U. S. Fish Commission. 1514 R street.
1883. MCGEE, W J,
Geological Survey. 2410 Fourteenth street.
1879. MCGUIRE, F. B. (Frederick Bauders),
1419 G street. 1333 Connecticut avenue.
1876. McMURTRIE, PROF. WILLIAM,
106 Wall street, New York, N. Y.
1884. MAHER, JAMES A. (James Arran),
Lock Box 35, Johnson City, Tennessee.
1875. MALLERY, COL. GARRICK, U. S. A.,
Bureau of Ethnology. 1323 N street.
1885. MANN, B: PICKMAN (Benjamin Pickman),
Patent Office. 1918 Sunderland place.
1886. MARTIN, ARTEMAS,
Coast and Geodetic Survey. 55 C street SE.
1885. MARVIN, PROF. C. F. (Charles Frederick),
Weather Bureau. 1736 Thirteenth street.
1878. MARVIN, J. B. (Joseph Badger),
Patent Office. 1735 De Sales street.
1884. MATTHEWS, DR. WASHINGTON, U. S. A.,
Fort Wingate, New Mexico.
1885. MENDENHALL, PROF. T. C. (Thomas Corwin),
Coast and Geodetic Survey. 8 B street NE.
1886. MERRIAM, DR. C. HART (Clinton Hart),
Department of Agriculture. 1919 Sixteenth street.
1884. MERRILL, GEORGE P. (George Perkins),
National Museum. 1455 Florida avenue.
1889. MINDELEFF, COSMOS,
Bureau of Ethnology.

1889. MINDELEFF, VICTOR,
Ohio Bank Bldg., 12th and G sts. 1421 Florida ave.
1886. MITCHELL, PROF. HENRY,
18 Hawthorne Street, Roxbury, Massachusetts.
1891. MORTON, GEO. L. (George L——),
Patent Office. 1310 Q street.
1885. MOSER, LIEUT. J. F. (Jefferson Franklin), U. S. N.,
Navy Department.
1884. MURDOCH, JOHN,
Smithsonian Institution. 1429 Stoughton street.
1881. MUSSEY, GEN. R. D. (Reuben Delavan),
470 Louisiana avenue. 2145 K street.
1871. NEWCOMB, PROF. SIMON, U. S. N.,
Navy Department. 1620 P street.
1871. NICHOLSON, W. L. (Walter Lamb),
1114 M street.
1879. NORDHOFF, CHARLES,
Coronado, San Diego County, California.
1884. NORRIS, DR. BASIL, U. S. A.,
Occidental Hotel, San Francisco, California.
1885. NOTT, JUDGE CHARLES C. (Charles Cooper),
Court of Claims. 826 Connecticut avenue.
1884. OGDEN, H. G. (Herbert Gouverneur),
Coast and Geodetic Survey. The Woodmont, Iowa Circle.
1878. OSBORNE, J. W. (John Walter),
216 Delaware avenue NE.
1871. PARKE, GEN. JOHN G. (John Grubb), U. S. A.,
16 Lafayette square.
1877. PAUL, H. M. (Henry Martyn),
Naval Observatory. 2006 F street.
1874. PEALE, DR. A. C. (Albert Charles),
Geological Survey. 1446 Stoughton street.
1873. POE, GEN. O. M. (Orlando Metcalfe), U. S. A.,
34 West Congress street, Detroit, Michigan.
1890. POHLE, DR. JOSEPH,
Catholic University of America, Brookland, D. C.
1884. POINDEXTER, W. M. (William Mundy),
1505 Pennsylvania avenue. 1634 Connecticut avenue.

XXVIII PHILOSOPHICAL SOCIETY OF WASHINGTON.

1882. POPE, DR. B. F. (Benjamin Franklin), U. S. A.,
Whipple Barracks, Arizona Territory.
1874. POWELL, MAJ. J. W. (John Wesley),
Geological Survey. 910 M street.
1880. PRENTISS, DR. D. W. (Daniel Webster),
1101 Fourteenth street.
1888. PRESTON, E. D. (Erasmus Darwin),
Coast and Geodetic Survey.
1879. PRITCHETT, PROF. H. S. (Henry Smith).
Observatory, Washington University, St. Louis, Mo.
1882. RATHBUN, RICHARD,
U. S. Fish Commission. 1622 Massachusetts avenue.
1884. RAY, CAPT. P. H. (Patrick Henry), U. S. A.,
1822 Chicago street, Omaha, Nebraska.
1883. RENSHAWE, JNO. H. (John Henry),
Geological Survey.
1884. RICKSECKER, EUGENE,
P. O. Box 289, Seattle, Washington.
1878. RILEY, PROF. C. V. (Charles Valentine),
Department of Agriculture. Sunbury, Wyoming ave.
1879. RITTER, W. F. MCK. (William Francis McKnight),
P. O. Box 450, Milton, Pennsylvania.
1884. ROBINSON, THOMAS,
U. S. E. Office, Montgomery, Alabama. Vienna, Va.
1872. ROGERS, JOSEPH A. (Joseph Addison),
Naval Observatory.
1882. RUSSELL, ISRAEL C. (Israel Cook),
Geological Survey. 1616 Riggs place.
1883. RUSSELL, THOMAS,
Weather Bureau. 1149 Twenty-first street.
1883. SALMON, DR. D. E. (Daniel Elmer),
Department of Agriculture. 1716 Thirteenth street.
1883. SAMPSON, CAPT. W. T. (William Thomas), U. S. N.,
Navy Department.
1871. SAVILLE, J. H. (James Hamilton),
1419 F street. 825 Vermont avenue.
1871. SCHOTT, C. A. (Charles Anthony),
Coast and Geodetic Survey. 212 First street SE.

1890. SEARLE, REV. G. M. (George Mary),
Catholic University of America, Brookland, D. C.
1875. SHELLABARGER, HON. SAMUEL,
Kellogg Building. 812 Seventeenth street.
1874. SHERMAN, HON. JOHN,
U. S. Senate. 1319 K street.
1881. SHUFELDT, DR. R. W. (Robert Wilson),
Smithsonian Institution. Takoma Park, D. C.
1879. SIGSBEE, COMDR. C. D. (Charles Dwight), U. S. N.,
Naval Academy, Annapolis, Md.
1883. SKINNER, DR. J. O. (John Oscar), U. S. A.,
Surgeon General's Office.
1882. SMILEY, CHAS. W. (Charles Wesley),
P. O. Box 630. 943 Massachusetts avenue.
1891. SMILLIE, THOS. W. (Thomas William),
National Museum. 618 G street SW.
1876. SMITH, CHf. ENG. DAVID, U. S. N.,
Navy Department. 1714 Connecticut avenue.
1880. SMITH, EDWIN,
Coast and Geodetic Survey. Rockville, Maryland.
1887. SMYTH, H. L. (Henry Lloyd),
22 Brinley street, Newport, Rhode Island.
1886. SNELL, MERWIN-MARIE (Merwin-Marie Fitzporter),
Catholic University of America, Brookland, D. C.
1872. SPOFFORD, A. R. (Ainsworth Rand),
Library of Congress. 1621 Massachusetts avenue.
1890. STANLEY-BROWN, JOSEPH,
Geological Survey. 1318 Massachusetts avenue.
1884. STEARNS, R. E. C. (Robert Edwards Carter),
Geological Survey. 1312 12th street.
1891. STOKES, DR. H. N. (Henry Newlin),
Geological Survey. 2416 Fourteenth street.
1874. STONE, PROF. ORMOND,
Leander McCormick Observatory, University of Va.
1881. TAYLOR, F. W. (Frederick William),
Care Smithsonian Institution.
1871. TAYLOR, WM. B. (William Bower),
Smithsonian Institution. 306 C street.

1875. THOMPSON, PROF. A. H. (Almon Harris),
Geological Survey. 1729 Twelfth street.
1884. THOMPSON, GILBERT,
Geological Survey. 1763 P street.
1888. TITTMANN, O. H. (Otto Hilgard),
Coast and Geodetic Survey. 1019 Twentieth street.
1878. TODD, PROF. DAVID P. (David Peck),
Amherst College Observatory, Amherst, Massachusetts.
1873. TONER, DR. J. M. (Joseph Meredith),
615 Louisiana avenue.
1886. TRENHOLM, WM. L. (William Lee),
160 Broadway, New York, N. Y.
1890. TRUE, DR. A. C. (Alfred Charles),
Department of Agriculture. 1604 Seventeenth street.
1882. TRUE, FREDERICK W. (Frederick William),
National Museum. 1101 14th street.
1890. TURNER, H. W. (Henry Ward),
Geological Survey. 1808 H street.
1882. UPTON, WM. W. (William Wirt),
Atlantic Building, 930 F street. 1746 M street.
1880. UPTON, PROF. WINSLOW,
Brown University, Providence, Rhode Island.
1890. VAN HISE, PROF. C. R. (Charles Richard),
U. S. Geological Survey, Madison, Wisconsin.
1883. WALCOTT, C. D. (Charles Doolittle),
National Museum. 1746 Q street.
1881. WALDO, DR. FRANK,
95 Mercer street, Princeton, New Jersey.
1872. WALKER, GEN. F. A. (Francis Amasa),
Massachusetts Institute of Technology, Boston, Mass.
1876. WARD, LESTER F. (Lester Frank),
National Museum. 1464 Rhode Island avenue.
1888. WARDER, PROF. ROBT. B. (Robert Bowne),
Howard University.
1889. WATKINS, J. E. (John Elfreth),
Smithsonian Institution. 1801 Thirteenth street.
1882. WEBSTER, ALBERT L. (Albert Lowry),
107 Drexel Building, corner Wall and Broad sts., N. Y.

1885. WEED, W. H. (Walter Harvey),
Geological Survey. 825 Vermont avenue.
1882. WELLING, DR. JAMES C. (James Clarke),
Columbian University. 1302 Connecticut avenue.
1876. WHITE, DR. C. A. (Charles Abiathar),
National Museum. 312 Maple avenue, Le Droit Park.
1884. WHITE, DR. C. H. (Charles Henry), U. S. N.,
Navy Department.
1887. WHITING, H. L. (Henry Laurens),
Coast and Geodetic Survey.
1885. WILLIS, BAILEY,
Geological Survey. 1006 Twenty-second street.
1887. WILSON, DR. H. C. (Herbert Couper),
Carleton College Observatory, Northfield, Minnesota.
1880. WINLOCK, W. C. (William Crawford),
Smithsonian Institution. 2005 O street.
1891. WINSTON, ISAAC,
Coast and Geodetic Survey. 1325 Corcoran street.
1875. WOOD, JOSEPH,
1003 Pennsylvania avenue, Pittsburgh, Pennsylvania.
1871. WOOD, LT. W. M. (William Maxwell), U. S. N.,
89 State street, Boston, Massachusetts.
1883. WOODWARD, R. S. (Robert Simpson),
Coast and Geodetic Survey. 1804 Columbia road.
1885. WRIGHT, GEO. M. (George Mitchell),
Akron, Ohio.
1887. WÜRDEMANN, DR. H. V. (Harry Vanderbilt),
805 Grand avenue, Milwaukee, Wisconsin.
1874. YARROW, DR. H. C. (Harry Crécy),
814 Seventeenth street.
1884. YEATES, W. S. (William Smith),
National Museum. 805 Eleventh street.
1885. ZIWET, ALEXANDER,
University of Michigan, Ann Arbor, Michigan.

PHILOSOPHY AND SPECIALTIES

BY

GARRICK MALLERY

THE ANNUAL PRESIDENTIAL ADDRESS

DELIVERED

DECEMBER 8, 1888

PRINTED BY
JUDD & DETWEILER,
WASHINGTON, D. C.

PHILOSOPHY AND SPECIALTIES.

BY

GARRICK MALLERY.

ADDRESS AS RETIRING PRESIDENT.

Delivered December 8, 1888.

The time is past when one knight-errant could overcome every antagonist at a tournament of all arms. This was done in intellectual panoply when the chief seats of learning could be successfully challenged to a dispute on any subject and all subjects, or as the pretension was derisively paraphrased, "de omnibus rebus et quibusdam aliis." It was actually done so late as the last quarter of the sixteenth century, when a locally unknown youth posted a notice on the gates of the University of Paris requesting "all learned persons to meet him in public disputation, when he would be ready to answer to what should be propounded to him concerning any science, liberal art, discipline, or faculty, practical or theoretical." After a disputation of nine hours with the most eminent doctors, the foreign stripling was by sound of trumpet declared victor, and presented with prizes of diamonds and gold by the Rector of the great Sorbonne which resounded with wild cheers from the students of the Nations. More graceful applause by jewelled nobles of the third Henry's splendid court followed, and the bright glances of Beauty's flying squadron, commanded by the Medicean Queen-Mother, were doubtless more esteemed by the cadet of Scotland than all his other tributes.

In the days of the Admirable Crichton it was possible for one mind to acquire and hold the total of existing knowl-

edge, and this was because science had not yet risen above the misty horizon. The two most prominent schools depending severally upon revelation and intuition had not yet been supplanted by the new school founded on observation.

Revelation means the withdrawal of a veil that conceals the truth, and that withdrawal was once supposed to be possible only by the graciousness of divinity, not by man's endeavor, which was impious. The very quality of such revelation prohibited discussion upon itself even as an explanation of phenomena. It permitted discussion and reasoning from itself—that is, from its own dogmas—only within the usual bounds of orthodoxy, namely, those which were decided and maintained by the physically, not mentally, strongest battalions. Throughout all the ages, records of which exist, it was fiercely proclaimed in every language, over all known lands and seas, that blind belief was the noblest of human virtues and reason was the most potent of Satan's temptations. Science, on the other hand, demands that the veil hiding truth must be withdrawn by man. One of our favorite living poets has been lauded for his determination of the subject in the beautiful lines:—

Science was Faith once ; Faith were Science now,
Would she but lay her bow and arrows by
And arm her with the weapons of the time.

But this touching plaint is utterly false as a proposition of fact—or, with greater courtesy to Mr. Lowell—it is founded in illusion. The essence and attitude of science, ever since its genesis, have been opposed to the essence and attitude of religious faith and that antagonism must continue. St. Paul pronounced a grand definition of faith that has been a text for eighteen centuries. Last year a sarcastic definition was circulated that "Faith is belief in what you know is not true." Whether the reverent or the cynical definition be adopted, the intrinsic antagonism between faith, however it may be modified, and science, to whatever degree it may be perfected, can never be annulled, not even by their coincidence in all averments, except that one on which agreement

is impossible—that one which requires ascertained fact to be the basis for any averment. The simple expression of historic truth on the subject is—all that once claimed to be science was mythology. An unconscious admission of its atavistic recurrence in its grand division of daimonology may be noticed in the recent adoption of the term theosophy by the votaries of that sciolism. A similar recurrence, perhaps to be classed as a recrudescence, is to be observed in the recent use of the term “Christian Science” with a therapeutic sense.

An opposite scholastic system, which dominated its era, was based on the tenet that intuitions should decide on the nature of things and their perfect and creative type, which was to be ascertained, not from observed data, but from man’s own ideals. Since the examination of a sound mind in a sound body was difficult, the greatest teacher was he who had most enormously tumefied what now in Teutonic fashion is called “inner-consciousness” and could exhibit its morbidity with the most pretentious diagnosis. Subject to this leadership in introspection every man was his own universe. Though specimens of such fossil concepts are still preserved in strongly bound folios they are curiosities not found in the working libraries of science.

The first-mentioned school sought to understand this world by hypnotic communion with another world; the second taught that the best way for an observer to see was to shut his eyes and think about sight.

When, therefore, no attention was paid to facts as such, and all knowledge was either a commentary on revelation or a ratiocination on self, it was not extremely difficult to know everything. To-day the pretender to universal knowledge would be denounced as knowing naught. This judgment is carried to an extreme. Even the exceptional minds whose multiplied facets scintillate brightness in diverse angles, are denied glory as light-bringers on every line successively by higher authorities on each of the lines of light.

And this must needs be so. Besides the search for, finding, and sifting particles of truth, the precious grains must be retorted and analyzed with such care that no one human life will suffice to explore more than a small field. Phenomena are infinite and science must deal with all as observed. In the derivation and formulation of its induced laws no compromise is possible as in politics or in ethics.

Science is limitless, knowing no bonds of time or space. But this infinite is composed of the infinitesimal—atoms, molecules, protoplasms, or whatever name may be invented to console our ignorance—and it is by the study of these minutiae that science exists. So this is the era of specialties. Every freshly discovered fact has not merely its own significance, but by its relations to other facts may solve problems yet most obscure. The original investigator must be not only a specialist, but must be a specialist working in some subdivision of a specialty.

This restriction with differentiation is not confined to original research, but extends to works of compilation and examination within each one of all the specialties. The physical geologist must apply for help to the paleontologist, to the lithologist, the chemist, and to many other specialists. So, in addition to the specialization of the natural sciences, the scientific professions are methodically resolved. In law, besides the boundaries between the *nisi prius* advocate and the jurist and between civil and criminal practice, there are recognized monopolizers of common law, equity, realty, commerce, admiralty, and many other aisles and corridors in the temple of Themis, among which the circulation is in no sense free. So also, after the demarcation between medicine and surgery, there are specialists for age and sex, for brain, eye, ear, throat, lungs, stomach, liver, nerves, skin—in short, for each organ and region of the body. Nor is this mere charlatanry. The whole profession is improved and many human ills are relieved by this division of labor. Similar specialization is found in art. The painter of a good portrait is supposed to be unable to produce a good landscape, and

vice versâ. Though this supposition may be erroneous, its practical effect is so strong that every artist must adopt and adhere to a certain line of production.

But there is no need of examples from without to show the progress of specialization. Nine years ago the Philosophical Society was the only scientific society in Washington, and it embraced all branches of science. Now we are in the midst of a centrifugal storm—an anticyclone, or perhaps a volcanic eruption of societies. To be still more generous in giving choice of metaphors, it seems that each season brings forth a new organism from the parent stem, until danger is apprehended that fissiparous growths may cumber the field to the common injury.

A severe critic might carp at the definition by some of the younger societies of their aims and scope as not being explicitly in the line of specialization. He might suggest that their several preëmpted claims were too broad, but might explain that tendency by the Washington endemic, the characteristic symptom of which is that every department and bureau of the National Government considers every other department and bureau to be properly its subordinate. It is not easy for an anthropologic and a biologic society to set forth their respective claims without mutually overlapping each other's territory, and some debatable ground or free zone must be allowed between them; but the youngest of the societies, the Geographic, like some other young organisms, seems to be rapacious. It divides its functions into "Geography of the Land," "of the Air," "of the Sea," and "of Life." In this grasp would surely be included all geology, biology, and meteorology, and perhaps astronomy, history, biography, and sociology—in fact, all topics relating to this world, down to tariff for revenue or protection and the fisheries imbroglio. Yet this comprehension is not without defense, since proper commercial relations and prosperous food-supplies act markedly upon the changes and activities of populations that modify the earth's surface. The German term for this branch of science is anthrop-geography, and

perhaps it may more properly belong to a society entitled Anthropological than to one entitled Geographical. Candor, however, requires the admission that the several societies referred to, notwithstanding their redundant constitutions, all work on distinct and genuine lines.

It would ill become me personally to speak disparagingly of these offshoots of the Philosophical stem, being one of the three persons who founded the Anthropological, the first of these societies which took independent form, and being also naturally attracted to it as the specialty most closely connected with my own field of work. Yet the motive of my action was "Not that I loved Cæsar less" nor "that I loved Rome more." To pass from one to another of Shakspeare's plays and from the Tiber to the Adriatic, if I shall ever be forced, like Desdemona, to "perceive here a divided duty," I shall at least refuse to elope from home, seduced by travellers' tales about—

The Anthropophagi and men whose heads
Do grow beneath their shoulders.

That there was necessity as well as propriety in securing greater facilities to the special students of Washington than was afforded by the Society which had been entirely adequate to meet the earlier conditions, is demonstrated by the fact that at least four other organizations (apart from the still more specialized societies, such as the Microscopic and the Entomologic) are now in active operation, each holding about the same number of meetings and presenting to good audiences papers not less in number than were and still are recorded of the Philosophical Society. The combined active membership of the five societies is five hundred and fifty, no name being counted more than once, though often appearing on several lists. The names on the consolidated list show that they are there not for honorary or financial considerations, but from genuine interest. A goodly proportion of the members are frequent attendants at the meetings, and the two customary hours of the sessions for one hundred meetings, being about the total of all the

meetings of all the societies during each season, are so entirely occupied by the reading and discussion of original papers that no moment is left for social intercourse, that being provided for by the Cosmos Club, to which the working members of the several societies belong. This exhibit shows an amount of activity in Washington among learned societies without parallel in any other city in the world, notwithstanding the great superiority in population of most of the cities in which such societies flourish.

As this remarkable action of divergence and differentiation has proceeded according to natural methods, without secession, quarrel, or catastrophe, it may seem at first sight to have been wholly beneficial, but it has some results requiring consideration.

Certain practical disadvantages attending differentiation appeal with special force only to the active officers of the several bodies, who pay in full, if not dearly, for their honors. The members generally have an impression that the whole of the work done consists in attendance at the meetings, speaking as occasion arises, and listening—the latter being, when the wrong specialty has the floor, not always the easiest task. But there is much more besides. The preparation, arrangement, publication, and, in general, the business management, without which the meetings would not succeed or continue, constitute a heavy tax on time and strength. The problem is to minimize this incidental work and its attending expense, which certainly is not accomplished by multiplication and complexity of machinery.

The force of inevitable sentiment must be recognized. If all the residents in Washington who are interested in science should belong to one great and powerful body, each could hold it in pride and affection, but the glory and strength shown in that concentration cannot, when in fragments, call forth such enthusiasm or attachment. Indeed, baneful competition by individuals or cliques may be apprehended from the conditions to be expected, if not already existing, and weakness follows disintegration.

But the course of thought most fitting for an occasion like this is not in the line of details of economy, of sentiment, or of local conditions. It should be broad and comprehensive and be applicable not only to Washington but to New York, to London, to Paris—in short, to any place and to all places in which associations are formed by scientific workers for their common benefit.

A not unimportant though minor objection to the exclusive segregation of specialties is the tendency to exaggerate what is nearest, or is most obvious. A body of isolated specialists is in danger of becoming a mutual admiration society with all the attending faults positive and negative. No man is a competent critic of his own profile or voice, and no specialty can judge correctly upon its own features or enunciations, yet will tend to dogmatism on the very points on which its judgment is most fallible. The mere specialist never thoroughly understands his own specialty because, confined within its colored compartment, he cannot examine it from the outside through the white light of generality. While every scientist must work on a specialty he should not imprison himself within it as in a barred cell.

However essential division of labor and specialization, the work of which is by analysis, may be, they are, nevertheless, only means to the ultimate aim of generalization and integration, which constitute wisdom, and their construction is by synthesis.

Within the most circumscribed of specialties there must always be an attempt to reach law through details. The solution of a problem without application of it is like playing a game of solitaire in which time and skill give no substantial result. Mathematics, apart from their gymnastic training, would be useless if their integrals should remain meaningless. Each asserted fact must be tested by varied experiment which often results in failure to establish the assertion. The truth of to-day has sometimes been the paradox of yesterday and may become the falsehood of to-morrow. Admitted facts must be compared with all other facts related to them. Con-

futation must be challenged. Without this process science would be a jumble of inconsistent opinions. While such testing and comparative discussion should exercise its functions in each specialized society it is yet more important that the results as appearing to its members should be carefully examined with the greatest freedom by specialists in other lines, and this examination is not only for further verification and comparison but to extend the area of acquired science. Practically science is only the existing condition of human knowledge, which of necessity is incomplete, though its form, to be science, should not be a broken surface, but a series of steps by which greater heights are gained. For these reasons all specialties should be tried before a court of general jurisdiction—an Amphictyonic Council. After delay, doubtless, the press brings forth scattered judgments of such a universal tribunal; but a hand-to-hand contest is more active and decisive than a protracted war conducted by the discharge of heavy books at long range or by the skirmishing shots of pamphleteers. If scientific association is to do the most good some time and place for trial by battle should be provided, which cannot be done in any or in all of the specialized societies working separately.

The propriety of scientific contest on a common plane is readily illustrated by the yet undetermined controversy between geologists and physicists respecting the age of our earth. As neither side can yet speak without contradiction by the other, neither should speak unless in the hearing of the other with expectation of response. A more popular illustration is in the historic fight between ordnance and engineers—that is, scientific attack by artillery or its equivalent and material defense by fortifications or similar protection. In no systematized war department can either the officer of ordnance or of engineers be confided in except when, after experiment satisfactory to his own corps, his demonstration shall overcome the corps of his complementary antagonist.

Thus by the interrelation and counteraction of specialties

there is mutual correction, ascertainment of truth, and promulgation of law.

The scientific organization most widely known in the United States is the American Association for the Advancement of Science, its prototype being the British Association of corresponding title. It is questionable whether that title is descriptive. The migratory meetings of the Society are certainly of educational value, diffusing information about science and exciting interest in it, but perhaps its constitution, well adapted to the real aims, cannot directly advance science considered as a generality. Its constitution originally provided for sections, which have been multiplied from time to time and have gained increased influence upon the central governing body. But there is no provision for the presentation of scientific papers to and their discussion by the general session. The President's annual address does not fulfill that object. He is probably a specialist, and generally adopts the convenient expedient of working off for the occasion some of his unpublished notes. It is a matter of taste and judgment whether this mode, which in a series of years gives a variety of good specialistic addresses, is more commendable than to present a discourse that aims to be philosophic, leaving specialties to the sections and to the several Vice-Presidents having them in charge. It might well be the ambition of the President to deliver an address which could not bear the blazon of any specialty which he might possess or which might possess him. But, apart from taste, a good reason for his avoiding such specialty is that his paper is not open to discussion and, so far as concerns the Association, might as well have first appeared in the periodicals devoted to science. The other addresses delivered in general meeting are almost always show-pieces professedly popular and given to please the local subscribers to the expenses. As regards interrelation, the meetings of the sections might as well be a thousand miles apart as in the same building.

The Congress of American Physicians and Surgeons recently instituted recognized the disadvantage of leaving

without interconnection the specialties which had grown by natural selection, and inaugurated the excellent plan of reading and discussing papers of general importance in general meeting. This new departure is in the true scientific method.

Ten years ago the general committee of this Society was urged to establish sections in recognition of the specialties growing up within its membership as they were growing up throughout the scientific world. While I refrain from comment upon the controversies on this subject which still continue, it is the historic fact that the request was denied at the golden moment of projection, and in the Standing Rules of 1881 the judicious amendment for the first time appears that "Sections representing special branches of science may be formed by the general committee upon the written recommendation of twenty members of the Society." But this was too late for the exceptional advantage of stimulating the several specialties while preserving autonomy, economy, and concentration. The Anthropological Society had been established February 17, 1879, and the Biological Society December 3, 1880. The children had become too large and too many for the one room provided by their mother and had started independent housekeeping. It may be more respectful to compare them with the colonies from Athens which sailed off to found the cities of Magna Grecia. If that comparison be adopted, the storied ruin of the Violet Crown may teach a lesson that the pure Attic stock in the polity of science can only be preserved by a system of federation.

What might have been accomplished on a large scale by prompt action is shown by what actually was done in a single instance. The Mathematical Section of the Philosophical Society was instituted March 29, 1883, in accordance with the amendment before mentioned.

The older members of the Society will appreciate the advantages attained by the establishment of its Mathematical Section. The formulæ and demonstrations of its mathema-

ticians had occupied every year many hours of the several sessions to the half-concealed ennui of an audience a large proportion of which could not appreciate their value or novelty. Some, indeed, could not comprehend the language used and might have repeated Scaliger's exclamation on hearing the Basques conversing in their vernacular: "They pretend to understand one another, but I don't believe a word of it." It would scarcely be far fetched to liken the attitude of the members generally in those weary hours to guests at an entertainment where they were treated to extremely acid wine, labeled in a long array of gothic gutturals, which they must pretend to relish—both the sour wine and the gutturals—as a proof of high education. On the other hand, the mathematicians recognized this want of true touch and appreciation and mangled their essays accordingly.

Now they are secluded to worship esoterically "the hard-grained muses of the cube and square," and rejoice in their independence. When, presiding during the last year, I have regularly announced the forthcoming meetings of the Mathematical Section to my brethren, I may have internally remarked: "Whither thou goest I certainly will not go." Yet I have not failed to notice that the members of the Mathematical Section are among the best members of the Society, and that some of the most valuable papers presented to the general sessions are mathematical in form and in many details, though as now presented they are of general, and not of merely special, interest. This fact shows clearly what is the proper relation between generalization and specialization in a scientific society.

At this time, with all the loss of papers given to the four new societies, there still remain active in the Philosophical Society many specialists, notably in the fields of geology, astronomy, meteorology, and general physics, who contribute their papers to it exclusively. There are also many members of the special societies who furnish papers that from their subjects might well be and are claimed by the junior rivals, but which from reasons of attachment or judgment

are presented to the Alma Mater; and their leading members, though they do not visit special societies other than their own, regularly attend the meetings of this Society, by which a true representative audience is preserved. The general result has been that the Philosophical Society's sessions during the last year have been as agreeable, as useful, as varied, and as well attended as ever before.

There is a good reason for this which, with its probable consequences, merits careful consideration.

In entering upon this topic it is proper to dwell somewhat more upon the term Philosophy. It once pretended to be pansophy, but is now humble and receptive. It was once used, not as the practical mode of explaining phenomena, but as the converse—not to set forth what was understood, but what was confused and obscure, yet must be treated as fully known in scorn of the maxim "Scire ignorare magna scientia." Not to be certain was infidelity, which was criminal. An honest avowal of intelligent ignorance, now styled agnosticism, was not permitted. The old philosophers abhorred ignorance as they said nature abhorred a vacuum, until the vacuum was actually found, and then of course it was welcomed to a sphere of high utility. Perhaps value may sometime be recognized in the agnostic vacuum to measure the heights and depths of truth's atmosphere. Tennyson used a questionable word "faith," but he had the right thought when he wrote—

There lives more faith in honest doubt,
Believe me, than in half the creeds.

The old philosophers, with rare exceptions, while professing to seek the truth did not do so, but asserted that they possessed it already, and their assumed office was to teach it to others. As before indicated, this philosophy was axiomatic and often connected with theology. Its history is understood. Man did not know, was impatient to know, and, when too lazy or stupid to learn in accordance with his conditions, relied upon some shaman, priest, jossakeed, or spiritualistic medium. The track of some variety of "confi-

dence man" can be traced throughout the centuries, his scath having been more signal when it involved life and liberty than now when his ambition is limited to a swindle in dollars, but now his notoriety is gained by advertising in the public press.

The respective attitudes of science and philosophy to religion (in the popular use of that term, which includes mythology and theology) afford an instructive test for their contradistinction. It has been mentioned before that science and religion were necessarily in antagonism, but the phrase, now trite, in which the word "conflict" is prominent, is both more forcible and more descriptive. That religion should be aggressive is essential. Religionists believe that their doctrines are of supreme importance to all their fellow-beings, and, so believing, their paramount duty is to force those doctrines upon all. The denunciation against the "Scribes and Pharisees" was not that they would "compass sea and land to make one proselyte," but that they did or did not do some other things. Such proselytizing would only be the aggression of philanthropy. But another reason for the activity of religionists may be supposed to originate in a suspicion of insecurity, and that activity strategists would term aggressive-defensive. Any imputation that the belief in question was false would be a most dangerous as well as insulting blow, and such blows should be prevented by attack. Hence the horror and hatred associated perforce with the respectable words sceptic and heretic and the innocent term miscreant—all converted into obloquy—while the word blasphemy, originally but disrespect expressed to any of the orthodoxies, has been distorted to mean the crime of crimes.

Science, too, is aggressive, and also, in practice may be dogmatic, though not without protest. Many of the specialized sciences are in contest with each other, and within each of them there are contending schools. As regards the scientific professions it is only needed for an illustration to whisper the word homeopathy. So, science and religion

being professed and trained combatants, it is to be expected that when the latter applies injurious epithets to the former there shall be a "conflict." This is not the case as regards Philosophy. There cannot be a fight without two parties to it, and Philosophy serenely ignores both attack and defense in this quarrel. The old conditions are reversed. Philosophy was once a part of religion; religion is now a part of Philosophy. Religion is recognized among the forces and phases of human development to be respected as of possibly greater import than any other—it might not be too much to say than all others—by reason of its duration and influence. As religion claims to be true, yet must acknowledge that there are more truths than are connected with itself, while all truths belong to Philosophy, no objection should be made on the side of religion to its inclusion in the scope of Philosophy. Philosophy cheerfully accepts the truths—whether classified in terms of psychology or grouped in the special science of comparative mythology—that exist in all religions and it is tender to the errors found in all religions. It can indeed employ the many oblique lines of human error to demonstrate the directness of truth, and therefore is not harsh to forms of error which may have served their hour in the great economy of nature. All of the sciences and all of the religions are severally but the specialties in the domain of Philosophy, hence there is no more conflict between any of them and Philosophy than there is between the ocean and the tidal streams that empty into it with changing though regulated ripple. Tides during ages produce modifications in Philosophy as in the ocean, but do not cause storms.

That true philosophers have not been excited to combat with the religionists is from no remissness of the latter, who have pelted them with the worst names inventable by their ingenuity, sometimes in ludicrous confusion of terms. But since that is no more than the religionists did to one another such behavior would not greatly trouble a proficient in ecclesiastical history. The Greeks and Romans gave to the

early Christians the title of atheists, which seems to have struck them so favorably as a word of revilement that they ever after used it indiscriminately in their own polemics, sometimes with such adjuncts as to form what the old rhetoric called catachresis but our modern speech calls Irish bull. Athanasius stigmatized the Arians as "polytheists and atheists" and Servetus called Calvin a "trinitarian and an atheist." So recently as 1696 the Parliament at Edinburgh passed an act against "the atheistical opinions of the deists," of course without understanding either term but in an honest attempt to blacken all teachers who did not agree with the Scotch Solons. Archbishop Tillotson was branded as an Arian, a Socinian, a deist, and an atheist. This was promiscuous denunciation raised to the highest power available in Jacobite involution. The latest and mildest accusation against Philosophy is that it is pococurantism and the affectation of serene olympian composure which contemplates the great cycles of Time as the hours of a passing day. In briefer phrase, philosophers are denounced as contemplating and not working.

A distinction which such accusers make between those whom they call workers and those whom they stigmatize as theorists and doctrinaires is found in their declaration that all the greatness of men and the effectiveness of bodies of men have been shown in their "beliefs," meaning religious beliefs. It is broadly asserted that the men who have believed in some particular religion and have acted vigorously on their belief are the only men who have done good in the world. That part of the proposition referring to "good" will generally be affected by prejudices. To illustrate from modern history, it is certain that the Puritans and the Jesuits were vehemently earnest in their beliefs and that they vigorously carried out their beliefs, but as they strove against each other it would not be likely that either should regard the work of the other as beneficial to the world. In our day they would join in condemning the work of the Mormons who believe as intensely and act on their belief as strongly

as any known people. Indeed the Mormons show lines of identity with both the Puritans and the Jesuits, to the former in bibliolatry and in bold independence, to the latter in employing all means to gain proselytes and in business skill, to both in theocratic militancy, but the whole unphilosophic world denies that they do good. The work of the Inquisition, or Holy Office, was logically correct on the principle advocated, which would also justify the massacre on St. Bartholomew's eve. Most historians have united to censure Louis XIV., who refused to commission a nobleman who was reported to be a Jansenist, but who, on learning that the nobleman did not have any religion whatever, straightway ordered him on important duty. The Grand Monarch knew his business as a ruler of men. The Jansenists were perhaps the best people among the Catholics in his kingdom, but they did not believe as he believed and worked on lines which were necessarily opposed to his policy and were therefore not to be trusted to command in his armies, but no danger was to be apprehended from an officer who cared only for his military orders. His action in revoking the edict of Nantes, thereby driving away his most useful subjects, was in a different category. It showed that though a ruler he was not a philosopher, and that he could only see good in those who agreed with him.

The good accomplished by belief, in its high activity, seems, therefore, subject to difference of opinion. It is also to be considered whether the great and effective work, whether good or bad in result, of men and peoples has been done by and through such active belief. It is to be admitted that history is chiefly marked by convulsions and cataclysms which have been closely connected with religious beliefs and their reforms and revolutions, and that these alone are perceived by the unphilosophic observer. But these, together with their resulting wars, famines, and pestilences, correspond to the storms, earthquakes, and deluges of the material world. The secular story of our earth is, however, not mainly composed of, though it has been written in, storms and cat-

aclysms. These storms were but incidents in the grand economy and were factors of little moment compared with the ages of sunshine, of dew, and of gentle rain. So, likewise, the mutual contentions of religions and of the men who believed in them and fought for them, have not directly advanced man's culture, but have been incident to and necessary evils attending its advance. Whatever good has been done by the champions of belief has been done for the most part in their own despite. The crusaders inflicted a heavy blow on the system which they sought to perpetuate, and the Mormons had no intent to provide a mid-continental station to benefit the Gentiles, whom they hated and sought to escape from by an exodus which in heroic faith rivals that of the Children of Israel.

The evolution from savagery to civilization has brought forth many religions, and all of them have inflamed zealots who have represented the fevers to which humanity seems subject. But normal and lasting growth is by health, not by disease, by slow accretion, not by the spasmodic violence of insanity. The disturbances which are relied upon to support the proposition in question were not causes, but sometimes were symptoms, and more frequently were sequences or, in medical language, sequelæ.

When the actions of an individual make obvious his possession by a belief contrary to the reason of the majority, the latter employs one of the designating terms craze, crank, hobby, or fad, selected in proportion to the importance of the contrariety. When large bodies of individuals have been similarly affected and their numbers have gained such success as to become conspicuous, history, which is the verdict of the majority after the fact, decides that their belief was false and their action wrong. Philosophy always should be and often has been able to give the same decision in advance of the recorded result.

As regards the perficient work done by Philosophy, one of the least important of the instances in which its teachings do present good is that they discourage the activity of those

earnest believers in nihilism and socialism who display the energy of their beliefs by dynamite and flame. It happens that in those particular instances the teachings of prevalent religions are now in the same direction with those of Philosophy, but if the numerical relation of the believers should be reversed in any country, religions of nihilism or of communism would there be recognized as orthodox. This rule was established by the political Protestants of the sixteenth century and gave rise to the motto "Cujus regio ejus religio." Its full meaning was that every realm, through its ruler, had the sole right to determine the form of religion that should exist within its boundaries. With the growth of the republican spirit and greater recognition of the rights of majorities the rule mentioned would be made still more operative. Philosophy does not turn upon such relations of numbers. It is not defined by the preponderance of classes in a census nor metamorphosed by revolutions between the fanatics in administration and in opposition.

Theology presented forces and factors in axioms and postulates and permitted the study of logic and mathematics because they do not detect errors in admitted axioms and postulates. Verities by common consent were adopted a priori, which verities, belonging to a low stage of culture, were universal errors not belonging to nature, and therefore only to be explained by the extra-natural, which necessarily was supernatural. It is worthy of remark that all the supernatural instructions, whether Scandinavian, Hebrew, Hindu, Egyptian, American Indian, Grecian, or the multitude of others, about this world's phenomena, have been found to be erroneous when men have learned anything about those phenomena, as, for instance, they have learned in the realms of geology and astronomy. By the law of chances it would seem that among the myriad guesses the truth might once have been hit upon, but from the beginning an "irrepressible conflict" between the natural and the supernatural has been manifest at all points.

The teachers who ignored facts found it convenient to discourse in sophistic terms from the species to the genus, and

from the particular to the general. The crudity of their conceptions was masked by the stucco of mystic and magniloquent words, which the elasticity of languages permitted, grammatic form and euphony being the only limitations. The success of this trick was old when Lucretius wrote—

Omnia enim stolidi magis admirantur, amantque,
Inversis quæ sub verbis latitantia cernunt ;
Veraque constituunt quæ bellè tangere possunt
Aures et lepido quæ sunt fucata sonore.

Which may be translated in lighter vein as—

* Fools love to puzzle with amaze
On thoughts involved in mystic phrase ;
Their ears rejoice in words that tickle
And take for gold the jingling nickel.

This superannuated scholasticism has been generally called metaphysical from the order of Aristotle's works, but is more properly antiphysical. Its combined stupidity and pretense have to some minds inflicted a stigma upon the title Philosophy, which it arrogated.

Modern reaction from the fetichistic worship of this monstrous phantasm may have been too violent. A working hypothesis can be obtained a priori which, properly treated, shall not be fanciful delusion. Deduction need not be pretentious didaction. The old mischievous error was that deduction ascertained truth. Truths are supplied to the reservoir only by induction, but their useful flow with regulation into the best channels is by deduction.

The terms science and knowledge are perhaps convertible in usage as in etymology, but neither of them is synonymous with Philosophy. Professor Mach defines knowledge as "an expression of organic nature," but that is not true unless, by his rather hazy term, he means the final and perfect knowledge which no one now pretends to have acquired, though nature in the abstract doubtless does comprehend it. Claude Bernard is partly right in stating that Philosophy makes a specialty of generalizations. That, however, is measurably true also, as before stated, of each one of

the sciences. Without proper synthesis they do not exist as sciences, but are mere uncouth mosaics. Each special science must have a philosophic side, and the coördination of all those sides constitutes Philosophy in general. In this sense it is not merely the specialty of generalizations, but the generalization of generalizations. Without it the several sciences rest with no common bond, and do not form a synthetic and organic whole. The method of science is to test hypothesis by experimentation and continued observation. From a sufficient number of results a proposition or law is induced, the authority of which increases with the number and weight of those results. It is not a valid objection that generalizations, even obtained a posteriori, have often been erroneous. So much the greater necessity for their trial by a proper tribunal. For the end is to establish from particular facts a general law or principal fact which thereupon explains and shows the relations between the facts which it governs. The collection of and proper deduction from, more strictly the application of, such principal facts or induced laws is the domain of Philosophy.

There is a German saying that three things are necessary to fly a kite—the kite itself, a string, and some one on the ground. One kite will not fly another, but both will tumble. Philosophy provides not only Franklin's conducting cord, but the $\pi\omicron\delta\ \sigma\tau\omega$ of Archimedes.

In recognition of these principles this Society was founded. The title "Philosophical" was adopted, "not to denote the unbounded field of speculative thought which embraces the possible as well as the actual of existence, but to be used to indicate those branches of knowledge that relate to the positive facts and laws of the physical and moral universe." These are the words of that great man, Joseph Henry, who, during all the early years of the Society, as president, guided its proceedings in this direction and so stamped the impress of his character upon it that it nearly reached his ideal.

To sum up the suggestions thus far presented—differen-

tiation is good and necessary, but integration is essential. This is only a modernized form of Bacon's quaint but profound sentence: "Let none expect very great promotion of the sciences, especially in their effective part, unless natural philosophy be drawn out to particular sciences; and again, unless these particular sciences be brought back again to natural philosophy."

There is another broad distinction between general and specialized studies, which, though often neglected, practically transcends in importance those derived from theory and history. This consists in the appropriate and adequate formulation of their respective results. The vocabulary requisite for Philosophy differs from that proper for a specialty. It should be such as may be understood by hearers or readers of good general education. Doubtless the actual operation and formulation of thought in many branches of science, notably chemistry and botany, besides mathematics, require the elaborate technical language and symbols invented for them, and in all lines of study condensation and precision have demanded new terms, which must continue to increase with the rise of new facts and thoughts. But workers with these newly fashioned terminologic tools become too fond of and dependent on them, indeed sometimes are taken captive by them.

A distinguished mathematician contends that if a man cannot reduce his statement on any subject to an algebraic equation his concept cannot be real or clear. It may be true that there is a devotee of algebra who is unable to think except in algebraic symbols, but if he cannot express his thought on a non-mathematical subject in the vernacular it will be of no benefit to others than those within the guild of Euclid. Perhaps no full or grand concept would be conveyed even to them. It might have only the relation that a diagram has to a cyclorama. Surely to present ideas and discoveries in cryptograms (and many cryptograms would be required if individual whim should rule), even if the

keys are considerably furnished, is not the most useful mode of promulgation. This is even worse than volapük, having all the disadvantages of a jargon to be memorized, without the designed universality.

In the use of specialistic and coined terminology not only pedantry may be observed, but the old juggle with words in which pretended novelty is mere mystification. Greek compounds are convenient as brands or labels, but do not make thought less obscure and often leave it more so. Polysyllables and water are bad, but polysyllables and mud are worse. Such obscuration of truth is a serious injury. Tolstoi makes a good profession of faith in saying, "No one can believe the unintelligible. Incomprehensible knowledge is the same as ignorance."

From these views it must be admitted that Philosophy, being broader than any science—than all the sciences together—cannot be limited by the formulation peculiar to any of them, and should not adopt the terminology of any, but use a vocabulary that is generally understood and accepted.

This admission brings up the subject of style in its broadest scope. One of the most noted, by voluminous publication, of American scientists, once sneeringly exclaimed, "Style! bah! that is only the paint." He was perfectly honest in this depreciation, as is shown by his own productions, which, probably not written by any one hand, but constructed by coöperative clerical carpentry, are not read currently, but are only used for reference, as pigeon-holes might be, with an index catalogue. He was wrong in the very conception of style, for all words and sentences are pictures, whether good or bad, and the master-piece as well as the botch comes from the paint as handled by the painter, the canvas of fact being in common. He was still more fundamentally wrong in regarding style as an artificial exterior or varnish overlying the descriptive catalogue which he regards as alone valuable. His sneer shows not only that he would rank the barn-dauber as equal to Raffaele, but that he is unconscious

that words possess color and also substantive form wholly distinct from their alphabetic notation. Word-blindness among English-speaking patients is most frequently diagnosed in those ignorant of the capacities of their vernacular, and more specially ignorant of Latin (a topic which will be dwelt upon in another connection), and then there is hope for the patient through education. But when the knowledge of and about words is present without any real appreciation of their value, then the disease or deformity of word-blindness is incurable.

The notion that the whole duty of science is to bring out facts somehow would commend for its vehicle the slipshod terms and unconnected paragraphs of newspapers, which are never intended to endure and may be printed without expectation of credence even for the day. Such a notion does not accord with the history of scientific advance. Latent facts and concepts have often been in a state ready for crystallization, to use the physical term, or for formulation, in the proper linguistic phrase, yet lay amorphous, though substantially known, waiting for the formative words which should act on them as with an enchanter's spell. The actual sway of words is so momentous that they quickened myth and magic as well as truth. The word, the Logos, has therefore its power in Philosophy as it had for similar reasons in religion. It is the rightly chosen word that first brings the fact into cosmic light. But such words are not found in the slovenly makeshifts of writers who ignore or who despise style.

A further assertion might be ventured that words not only convey thought, but develop thought. Linguistically considered, as in dictionaries, they are but signs for concepts and things, but when existing in an author's fervid brain, in affinity with correlated ideas, one might almost imagine them as charged with psychic electricity which arranges them, apart from the author's consciousness, into organic and sympathetic sense. The imagined battery, thus magnetizing thought to word instead of word to thought, requires,

like other batteries, the expenditure of energy which must do more than shovel out words as counters in a child's game. Treat words as mere counters and they will never be more than counters. Culture them as factors and they may become factors. Now that language has long been visual in script and print its seemingly paradoxical relations to thought can be examined. Even the dictionary definitions prove that old words express new thoughts widely diverse from those first connected with them. This fact is not always due to blunders or to expedients to supplement the paucity of the vocabulary, but may be imaged as an exhibition of independent life in which the word, long since severed from its parent germ, is fertilized by the attraction to it of new thought to bring forth flower and fruit. When language is defined as a vehicle there is too much supposition of a wheelbarrow by which ideas are trundled. Frequent experience of the phenomena of expressed mentation decides that the transport is often less mechanical, and may be likened to the rush of a mettled steed bearing thoughts with the thinker to their goal. It is true that the steed Language sometimes runs away into verbosity, or plunges into the abyss of mysticism, but that is with the careless, stupid, or pompous rider who does not believe in manege. Words, like other forces, are beneficent or dangerous as they are servants or masters. They are certainly not inert except when, treated as corpses, their bones are articulated to serve as dry statements of concrete facts.

The prime requisite of style in philosophic as distinguished from specialistic writing is that it should be clear to all who have sufficient culture for its apprehension, the second that it should be attractive, or perhaps the proper term would be—engaging.

Ben Jonson says: "Whatever loseth the grace and clearness converts into a riddle: the obscurity is marked, but not the value. Our style is like a skein of silk, to be carried and found by the right thread, not ravelled and perplexed: then all is a knot, a heap."

It is not so easy to be clear, and Sheridan's phrase "Easy writing's curs'd hard reading" is enforced by the confession of so great a thinker and writer as Charles Darwin. "I shall always feel respect," says he, "for any one who has written a book, be it what it may, for I had no idea of the trouble which trying to write common English would cost one." Again: "Writing plain English grows with me more and more difficult and never attainable." "No nigger with lash over him could have worked harder at clearness than I have done."

Style is not confined to vocabulary or ornamentation. "Le style c'est l'homme," Renan pronounces with the world's assent. Style, besides being the man, is also his treatment—that is, the spirit and method of presentation, by which the author, putting himself in rapport with the reader, enters into the substance of the thought and translates it from his own mind to many minds. The facts must be distilled before they can become spirited and effective. Style acts not merely to state facts, but to transport the author's full sense of the facts, expressed with method and symmetry—that is, with the intelligence that can be conveyed and the beauty which enravishes to eager acceptance. It is therefore, apart from its matter, the structural work of an architect. Ben Jonson gives another admirable expression in point: "The congruent and harmonious fitting of parts in a sentence hath almost the fastening and force of knitting and connection as in stones well squared, which will rise strong a great way without mortar."

Composition means far more than merely writing out ideas, and unless the ideas are properly composited so as to be understood by other minds it is doubtful if they are clear to the writer. So the effort is as beneficial to the author as to the public. When Böhme was on his death-bed a delegation of his pupils came to him begging to have an obscure passage in his writings explained before it was too late. "My dear children," said the mystic, "when I wrote this I understood its meaning and no doubt the omniscient God

did. He may still remember it, but I have forgotten." The incredible part of this story is that Böhme ever did understand the passage that he had written so obscurely.

That the effort to write intelligibly, forcibly, and elegantly on science can be successful is shown by such recent English writers as Spencer, Tyndall, Huxley, Lubbock, Tylor, Sayce, Galton, Lockyer, and Proctor. I will not attempt to offer a similar list of American writers, but cannot forego the pleasure of mentioning a recent publication as a model for attractive-beauty as well as for sound instruction. It is frequently praised in the phrase "as interesting as a novel," which at once recognizes its literary excellence and implies surprise that science can be entertaining. Its title is *The New Astronomy*.

It is an open question whether a work is more useful which clearly and adequately presents the condition of existing thought and knowledge afterward found erroneous or a work which, correct in its facts and conclusions, is so confused and unintelligible as to require the labors of later commentators to make its truths apparent. The first writers, though mistaken, are at least preserved as milestones to show the march of evolution. Paley may be cited as an example. His *Evidences* will still be read, even after the doctrine of special creations shall have abandoned its hopeless fight. Mr. George now secures and will retain readers by his wealth of illustration and fascinating rhetoric. More accurate closet-thinkers but unattractive or slovenly writers make no positive mark, their rough fragments being only used or abused by antiquarian wreckers of later reputations, as our patent-lawyers, by delving in dusty boxes of waste papers, defeat the perficient inventor and introducer of important originality.

The point involved in the question is more readily examined when the power of style is directed not to the discussion of facts of nature, but to matters of judgment and reason. The contemporary critics of Sir William Blackstone asserted, perhaps with some truth, that on every page of his com-

mentaries there was one false and two doubtful statements of the law of England. Yet such was his perspicuous style and fascinating treatment of the English corpus juris, which before his authorship was but a pile of dry bones, that his vitalizing presentation was at once accepted and has remained the unapproached text-book for subsequent generations of lawyers.

One of our best and most profound writers says that he never reads a book twice, but from a single perusal gets all he wants, preserves sufficient notes, and then closes the volume forever. If he is right it is the fault of the book; which may be useful only as providing more or less information in items, but if the work is good—a book to read and not to read about—the contents are like sound teeth, which are more valuable when left in the mouth than when extracted. A great book should be read often if only for the pleasure it gives. Innocent pleasures are not so many that we can afford to throw one away. How can a man gaze on one gorgeous sunset as a mere phenomenon and be satisfied never to see another? Or how can he travel to the shore of the ocean, verify the statement that there is an ocean, make a note thereof, and close his eyes? But wholly apart from pleasure, there is new substantial gain on each reading of a masterpiece. To dismiss it summarily may imply that you consider yourself at least the author's equal, if not his superior. The old maxim—"Dread the man of one book"—the book being supposed to be a great work—means that its frequent reader has become imbued with its spirit as well as its lore. It would be well to say of many books as Avicenna did of Galen's works—"Sexies legi et iterum vellem legere," and it would be a better employment of time than to be a cormorant of professed novelty.

But if a book is to be read more than once, it must be written more than once. Modern direct inspiration from a foreign source is not a safe reliance. The communications through spiritualistic mediums do not excel in grammar or intelligence. What passes for genius is in fact very hard labor. Even a work of imagination which is said to have

written itself may also read itself, for it will have few other readers. We have heard Darwin's confession, and may go beyond science to learn how to write. Wilkie Collins revised his works seven times before going to press. Blackmore, charming with his quaint and natural expressions, explains that he secures them by often rewriting—"I winnow and harrow and pestle and pepper every particle of sentence." A cursory examination shows that the most popular writers of fiction remold and polish their work many times. Now if this care is necessary to them how much more difficult as well as important is the struggle for clearness and attractiveness in the presentation of scientific facts and philosophic principles. If this struggle is made, it is generally attended with so little success that obscurity and repulsion seem to be sought for—as Hargrave, the commentator on English law, avowed—"Any lawyer who writes so clearly as to be understood is an enemy to his profession." This avowal if made to-day would be a libel on a profession distinguished for literary ability. The once accepted motto "Lady Law must lie alone" is obsolete.

It is not proposed, however, to offer a disquisition on style. But as Wesley once protested, in words rendered more pungent by Elder Knapp, against "the devil having all the best tunes," I desire to enter a vigorous protest against fiction having all the best English.

Three propositions are submitted bearing on the general theme, all of which will be disputed, but probably not all by the same forces, so that for want of union in opposition they may escape demolition.

The first relates to the purist affectation of homage to Anglo-Saxon words. The clear English before mentioned is in no large proportion Anglo-Saxon. It is possible that words of that derivation are best for the topics and the hearers of a Sunday school, and so would the limited terms of the Chinook jargon be for the hearers and topics where it is necessarily used, but it is absolutely impossible to convey modern thought in even so recent a vocabulary as that of

Chaucer. Of late it has been the fashion to decry the study of Latin, indeed newspaperdom has sentenced that classic tongue to death, with more than the penalties of attainder, all phrases, quotations, and derivatives from it being tabooed. That sentence, however, is not a little ridiculous to those who can appreciate the fact that of all writers in English the editors and reporters of newspapers are the most addicted to long Latin words, which they often use with ludicrous impropriety. A decree not to use Latin words without understanding them would be highly beneficial, because it would have the result of stopping nearly all the writing in English of people who object to the study of Latin. There is truth in the assertion that either French or German gives command of a more extensive and valuable literature than the Latin, but as a propædeutic for the specific purpose of writing and understanding English no language can compare with it. Certainly some other language besides English should be studied by the student of English. The most profound aphorism bearing on the subject is that "he who does not understand more than one language understands no language." For broad philologic research several languages, even such as the Klamath or the Dakota, may be more fruitful than either the Latin or the Greek, but Latin, on account of its incorporation, is the language most useful for understanding English. Doubtless there should be an aim to avoid long words when small words suffice, whatever the derivation of either, but the criterion should be that the words should be alive, which the healthy grafts of Latin on the English stock surely are. This criterion permits the use of new vivid terms for new ideas; terms which when they first appear are styled "slang," but which, though taken from the mud of the streets, are often recognized as jewels. A live language grows and evolves novelty and the dictionary comes limping after. And thus it is that vocables from suburban slums may enhance inscriptions on Roman porticoes, and Mark Twain and Gavroche may supplement Cicero and Sir Thomas Malory. The struggle should be to

get the right word, but the scientific or the philosophic writer who deals with modern concepts will seldom find the right word in the Anglo-Saxon vocables for the simple reason that these concepts had not been formulated before the English tongue had become strengthened through its assimilation of Latin and the natural selections of colloquialism, patois, and "slang." Therefore let us be eclectics, not purists, and fear neither Latin nor lingua franca. Let us get the right word for the right use if we must dig for, beg, borrow, or steal it, but be chary of coining it. Coinage belongs to the sovereignty of the people and our private stamps will seldom pass current.

The second suggestion is that poetry should be incorporated, not merely injected, into a scientific production. This does not renew the adjudicated claim of the imagination, "the vision and the faculty divine," to scientific use, but refers to the manner of expression. Never let prose get into your poetry, but put all the poetry you can invoke into your prose. Molière's hero was astonished to learn that he had been talking prose all his life without knowing it, and conversely our best prose writers on the heaviest subjects might find that the poetry in their prose was the secret of their success. But they would admit the fact without surprise, for it is markedly true that most of the great writers of prose have been successful in verse, which has drilled them in the marshaling of vivid phrase and in the harmonies and discords of thought. This conception of poetry does not mean the evanescent, gaudy tints on the bubbles of a scientaster, but the informing and vitalizing light which not only refracts and reflects, but radiates from an original source. Prose, as well as verse, may be profound or acute, intense or picturesque, elevated or simple, abstract or dramatic, severe or sumptuous. Indeed the very form of prose can only be distinguished from that of poetry by the absence of meter and rhyme, rhythm being common to both. The spontaneous characterization of the highest order of prose writings is that they are full of light, fire, spirit, and life, and the term poet

may rightly be applied to their authors in its true etymology—the maker.

My third plea is for the admission of wit and humor into scientific writing. No one—not even Sydney Smith's Scotchman—is willing to confess himself incapable of perceiving humor. Nevertheless nature has not given it to every one, and to those to whom it is denied it is as the absence of a sixth sense, by which want much happiness is lost. This enumeration of humor with the senses is scarcely forced, for man has been styled the "laughing animal," as best distinguishing him from other genera in his zoölogic order. Neither the grin of some simians nor the cachinnation of the hyena, or similar demonstrations by other animals represent human smiles and laughter. Hence the man that cannot laugh may be incomplete in evolution. The deficiency under consideration may be compared with unappreciation of the arts in general, but the most ready comparison may be taken from the histrionic art because on it there is least controversy. Every man who is in the normal possession of his senses appreciates perfect acting. Dr. Johnson suffered from defective vision and hearing and therefore (notwithstanding his famous obituary eulogy) never could reconcile himself to the overwhelming success of his friend David Garrick as an actor. Translate his physical imperfections, while admitting his general judgment, into terms of humor and it may be understood how many good and wise people fail to enjoy it. They also fail to understand humanity, because they are straight-line men, with no curves, so that they cannot fit into those of their fellow-men. With them the dogma is naturally cherished that a witty man is always shallow. Sydney Smith, who knew whereof he spoke, says: "The moment an envious pedant sees anything written with pleasantry he comforts himself that it must be superficial." Many people admire sententious monotony even if it be stupidity and are shocked too much for their delicate nerves at the sudden presentation of an intellectual surprise. Yet, what is more forcible? Is there any mode in which truth

can be more strongly presented than by its humorous opposite? If the dry *reductio ad absurdum* is legitimate, how much better is it when laughter brings an echo. Laughter must be; therefore Philosophy cannot ignore it. We shall not abolish painting and music because individuals are color-blind and note-deaf, or emasculate style to placate sporadic cases of humor-ineptitude. But a yet stronger argument can be made. Schiller and Heine say: "The gods fight against Stupidity in vain." Yes, by direct attack, but the flank fire of ridicule can sometimes excite even stupidity into an exhibition of life, though it be only in retreating panic.

It is not proposed that this Society should usurp the functions of a literary society. Both science and Philosophy are separated from literature by well-established boundaries.

For the moment passing by Philosophy, the distinction between science and literature may be sharply drawn by recognizing that science deals with facts regardless of the vehicle of their expression. Literature, on the contrary, may disregard all facts as such, and deal solely with reflection and sentiment, and in it the form of expression is essential. There is a literature of science and of all the sciences, but few scientific works can be embraced in literature if only because of their defective form.

The favorite though not the single province of literature is esthetics in the true sense of the term, that which is perceived or apprehended by the senses, but limited to what is desirable to be so apprehended, the beautiful, τὸ καλόν. The spirit of literature may rove from this elysian realm but the body cannot abandon it and survive. Specimens of literature may properly be stigmatized as bad—bad in tendency and effect, as in their influence upon morals, religion, politics, and the like, but literature cannot be bad in form, because if its form is not esthetically good it is not literature at all. The assertion has been made that in literature the substance is of little moment, that the form alone is essential; the style and not the thought; the words but

not the theme; the manner in which the things are written and not the things themselves. Nor is this dictum without support. Even the mere utilitarian must admit that the labor for perfection in language, comprising vocabulary and grammatic form, had it been undergone for that alone, has been well repaid in that it has presented to both science and philosophy their vehicle and has established for humanity its imperial distinction over the rest of living beings. An illustration of the value of form is in the continued cult of Homer. There are few important facts in the *Ilias* or the *Odysseia* except those discovered by philologists, and no theories or principles as such are propounded in them, although the anthropologist can sometimes read them between the lines. Only through the crystalline perfectness of their form have they endured through the ages while myriads of once asserted verities have become beacons of error and "vital" principles have died in ignominy.

Some advocates of form versus substance might quote favorite passages of Emerson or Browning which cannot be understood, as is proved by so many diverse interpretations. But while esthetic form is indispensable to constitute literature, comprehensible thought is also indispensable. The smoothest iambics and most stately hexameters which exercise in Latin prosody the scholars of Eton and Harrow, technically styled nonsense verses, are not literature.

Even though a production be intelligible, be printed, and be widely circulated, it is not necessarily literature. A dictionary is surely not a literary work, but a literary tool, and an encyclopedia is not much more. Following in this line of definition would be a bald statement of facts which is really but an expanded encyclopedic article. At the opposite pole, as regards pretension without performance, but also devoid of literary title, are the librettos of grand operas and verses privately printed at the request of admiring friends.

It may seem bold to assert that literature should not meddle with science when every novel lugs into its pages some scientific statement or discussion, and as fast as each new dis-

covery appears it is seized upon by the romancer for his plot as a *deus ex machinâ*. But if this use is more than machinery or incident the novel becomes a dilute treatise and is not proper literary work. It must also be ephemeral. Science advances, leaving its dross and errors to decay in and with such novels which, if they had been founded on the principles of human nature, might have lasted, as some other novels may last, while humanity endures.

From the reasons before adduced, the writer in Philosophy no less than in literature should be an artist in language, strive for the melody of chosen words, for finish of style, for grace, subtlety, or dignity as well as precision of expression, in the well-ordered precession and marriage of form and sense.

Has this Society fulfilled the promise of its title?

It is certainly not a mutual admiration society. No one of its members can arise and say anything marked or tangible on any subject without provoking a discussion which at least brings out supplementary thought and suggestion and often sharp but useful criticism. Papers are not unfrequently presented expressly to elicit such discussion and criticism by which the Society, held as a good representative of the world's audience, may correct error and expression before the *littera imprimata* fixes them in published form too late for emendation.

The communications are generally prepared in writing and with care in style, which care grows with legitimate rivalry. It seems to be recognized that however ready and bright and therefore interesting a talker may be, proper condensation with judicious arrangement and balance cannot attend the best oral discourse formulated at the moment of delivery, though the discourse may be an imposing *tour de force*. The extempore and spontaneous discussions upon the papers by members, and by the author in reply, supply all demand in the direction of vividness and suggestion by the collision of several minds diversely equipped.

As regards the scope of work, the ten published volumes of its Bulletin are decisive. They comprise papers on Mathematics, Astronomy, Physics, Chemistry, Meteorology, Geology, Geography, Biology, Anthropology, Technology, and Philosophy in its general acceptation before defined. These papers were all actually read at the meetings, nearly all by members, when by visitors the fact being noted, and they were all exposed to discussion. The volumes therefore are not deceptive as to the amount of work done, as is the case with some societies that publish writings not by members, but by volunteers who have never been near their place of meeting, and whose published papers were only read by title. The analysis of these volumes shows no falling off in the number of papers presented appropriate even to some specialties for which other societies have been founded, though, as before remarked, the character of such papers is broader than before. While connected by common membership with a congeries of special societies, this Society comprehends their specialties without technicality. In this respect it clearly fulfills its promises.

From long observation I believe that higher philosophic discipline and more perfect philosophic expression are gained by regular attendance on its exercises than could be gained by attendance on all the specialized societies, if such consumption of time were possible.

Speaking in broad and general terms, Science deals with facts, the thoughts being secondary; Literature with thoughts, the facts being secondary; but Philosophy includes equally the facts and the thoughts relative to them. Science supplies food, but neither savor nor digestion. Literature pleases the appetite. Philosophy with appetite digests the food. Again, to Science the language used is subordinate, to Literature the language is paramount, to Philosophy the language is essential but not paramount.

It remains to offer the suggestion that Philosophy should also be regarded from the significance of its etymology—

the love of wisdom. Lessing said that if it were necessary to choose he would prefer to have the love of truth to the possession of truth itself. By that paradox he emphasized his earnest desire for wisdom, not for repletion by facts and cold encyclopedic knowledge.

Knowledge and wisdom, far from being one,
Have oftentimes no connection. Knowledge dwells
In heads replete with thoughts of other men,
Wisdom in minds attentive to their own.
Knowledge, a rude unprofitable mass,
The mere materials with which wisdom builds,
Till smoothed and squared and fitted to its place,
Does but encumber whom it seems to enrich.

The knowledge, whether of good or evil or of both, works no benefit to life and character. The mere possession of truth, not strictly wisdom, may be that of a miser who hoards wealth and does not circulate it to the common good, but the love of wisdom brings wisdom. "Be there a will and wisdom finds a way." "Wisdom crieth aloud, she uttereth her voice in the streets," and it will be regarded. "So teach us to number our days that we may apply our hearts unto wisdom!"

ON THE OBSERVATION OF SUDDEN PHENOMENA.

BY

S. P. LANGLEY.

[Read before the Society, March 2, 1889.]

By a sudden phenomenon is here meant one of that large class where the occurrence is awaited without the observer's previous knowledge of its exact instant, and of which familiar examples may be found in the bursting of a rocket, the appearance of a meteor, or the emergence of a star from behind the moon. A great part of all the phenomena of daily life, as well as of scientific observation, are of this kind, though the importance of a special instance of another class (I refer to the gradual and foreseen approach of a star to a wire) has drawn to this latter such particular attention that we are apt to think only of it when "personal error" is in question.

When in an observatory, we study the means taken to record the precise time of the transit of a star, we find that the precision of modern apparatus has reduced the error which we may expect in almost any part of the mechanism to an extremely minute amount, which may be calculated to the fractional part of the one hundredth of a second. I say "almost," for, as we are all aware, there is one notable exception, at least until photography can be made to intervene. The human brain and nerves, and behind these the inscrutable processes of the will, themselves form an inevitable link in the chain of apparatus of observation, and here an error may and does arise, enormously greater than that of all the rest put together.

We all know that this error varies with the individual and the occasion. It is most constant in the experienced

observer, but even in his case it varies with the daily accidents of the human organism, and even with him it is presumably constant only for the particular observation to which the experience applies. There is not even a presumption, I think, that the personal equation belonging to an experienced transit observer would apply to the same person's notation of the occultation or emergence of a star, and still less, if possible, to any phenomenon outside his ordinary professional experience; for we must, of course, recognize that we carry this fallibility with us in every act of life, and that it is just as present when we attempt to determine the instant at which a race-horse passes the winning post as when we seek to note the particular hundredth of a second at which a star passes the wire.

The very words "personal equation" imply that the errors due to this fallibility can be ascertained and allowed for, and may lead us to think (if we think carelessly) that there is a personal equation always ascertainable; whereas, as we in fact know, it is only possible to apply the correction where long habit has settled the amount of error to be expected with regard to some one special phenomenon.

The number of devices for obtaining and correcting the personal equation, even in the special case of meridian observation, is, as those who have studied the subject know, surprisingly great. I think I have myself examined more than fifty such, and with hardly an exception they all exhibit variations on one idea—the idea, that is, that the error must have been committed *first*; the committing of the error being assumed to be an inevitable necessity, for which subsequent correction is to be made.

I have thought, then, that it might be interesting if I were to ask you to consider with me what may seem at first the somewhat paradoxical suggestion, that means may be found by which any individual, skilled or ignorant, may make, not only meridian observations, but an observation of any sudden visible event of whatever nature, so accurately that we need apply no correction, because the precision may be,

if not absolute, at least such that no correction will in ordinary practice be needed. I may deceive myself in thinking that what I have to suggest involves a novel idea, but I am led to suppose so from the fact that I have met no application of it in a somewhat extended reading on this point.

Let me first remark that while such error as that in question doubtless belongs to all the senses in some degree, we are at this moment considering it in connection with the sense of sight only.

When we see anything in motion (let us suppose for instance a passing train on the railroad) we have the well-known facts that—

First. An instantaneous photograph is made by the optic lens upon the retina, there being a picture formed there, which is perfectly distinct, but which fades out upon the retinal plate in from one-tenth to one-quarter of a second, while the perception of this image is under ordinary circumstances * sensibly instantaneous; (but)—

Second. Nerves convey the distinct impression of every part of this picture to the brain, and it is here, if we have to act on this impression, that a certain time is lost, not only in the carrying of the message along one set of nerves and the bringing back the answer on the other, but in the decision that is being made by that unknown and inner self, which appears to us to exert here a more or less conscious act of will.

In the case of a sudden and startling event, the time elapsed may be almost indefinitely great; and in some cases, probably several entire seconds may pass without the consciousness of the observer. A very imperfectly appreciated interval must occur in all cases, for what we have just said applies to every event of our daily lives, and the professional observation is only a particular instance of it.

Now, I ask your attention to the practical instantaneity

*The writer's observations (Am. Jour. Sc., Nov., 1888) show that appreciable time is required for perception of the retinal impression, with certain excessively faint lights; but these are not here in question.

of the *formation* of this visual picture, which is known to be obtained where the duration of the phenomenon to be observed is much less than the one thousand-millionth of a second, and where we have every reason to believe that the actual formation of the image on the retina under known ordinary conditions requires a time of like order.

We may say, then, that the casting of a picture on the retina is instantaneous. It is its fading out that requires time, and it is while this fading out takes place, and even long after it, that the work of perception, decision, and action is going on behind the retinal curtain in the chambers of the brain. Notice, then, that while to determine *when* a phenomenon occurs may require, under some circumstances, several seconds, and under all ordinary circumstances a notable fraction of a second, to determine *where* it occurs requires (sensibly) no time at all, for one single impression remains on the retina long enough to obtain full recognition and to be reproduced by processes of memory.

I can make my meaning clearer, perhaps, by using the same specific instance as before. Let us suppose that an accident to a passenger on the passing train is the phenomenon, the time of whose occurrence is to be noted, and that this accident is seen from a room in which there are two windows looking on the track. We must have seen the accident, if it be instantaneous, either through the first window or the second. If we had been led to anticipate that we should be called upon to say through which window we saw it, I think we may all admit that there would be no discrepancy on this point between different observers, for in this case we are considering only the element of position, and the element of time does not directly enter at all, so that observers in the same position who had been bidden to note through which window they saw it would all agree on this point.

Now a connection can here obviously be established between the place and the time, from which to infer the latter, if we are granted the knowledge of two facts: the time at

which the carriage could have first come into view from the first window, and the time at which it must have passed out of view behind the second; for if we suppose the speed of the train to have been uniform, we have the means of deciding the fraction of the time when we know the fraction of space. Here, then, as in the case of a common clock or chronograph, or any device where time and space are proportional, we can infer the former from the latter; only let it be observed that we here need no recording apparatus. What we use is the memory of where the event occurred; in other words, we recall the impression on the retinal screen and have no need to bring into use what we may call the time-perception apparatus of the brain which lies behind it; *nor do we in fact need that the object of our observation shall be really in motion, but only that it shall be made to appear to be so.*

This last point is all important, and what I ask your attention to is an experiment heretofore, I think, untried, and which is perhaps a novel application of the fundamental horological idea that time and space must be made proportional, for it seems to me it must be theoretically possible, not only in the case of the clock or the chronograph, but always, to so connect the former with the latter that the essential task of the observer is to say where any visible event apparently occurred, and then let some mechanism outside of himself say when.

That at least is the idea, and if it has, as I hope, been clearly apprehended by you, I will now ask your attention to a working plan for carrying it out. Numerous different devices have been under my consideration. I will take one which is primarily designed for the observation of any celestial phenomenon, though it could very well be adapted to terrestrial ones; and in order to fix our ideas I will suppose that we have an event which we know the approximate time of, but which may burst upon us at some fraction of a second which we want to determine. I will assume (merely to fix our thoughts) that we wish to note the time at which a star emerges from behind the dark body of the moon

with an accuracy which ensures us that we have not made an error so great as one-twentieth of a second.

You see I hold in my hand a peculiar eye-piece, which has been made to observe this or any other terrestrial or celestial phenomenon of sudden occurrence. It can also be used for meridian observation, but its special field seems to lie in noting an event where no correction for personal equation is applicable. This event may be anything celestial or terrestrial, from the entrance of Venus on the disc of the sun to the explosion of a mine; but, for the purpose of illustration merely, let us take it to be the sudden appearance of the star.

On looking into the telescope we see, in the first place, two prominent wires crossing each other at right angles, dividing the field of view into four quadrants. Now, by a simple mechanism, which I shall shortly explain, any object that our telescope is directed on—any fixed star, for example—seems to be revolving in the field, passing successively through the first, second, third, and fourth quadrants. If the star is hidden the mechanism is working just the same, and when the star appears it must evidently first be seen in some particular one of these four quadrants, and experience shows that we shall have no difficulty in telling in which one. The mechanism itself has recorded for us by an electric contact the limiting instant between which it is possible to see the beginning and the end of the cycle during which revolution may be supposed to be made. It is not necessary that this cycle should last just a second; but, supposing it (still for illustration only) to be a second, if it was seen in the first quadrant, it was seen in the first quarter of the second; if it was in the second quadrant, sometime in the second quarter of the second; in the third, in the third quarter; in the fourth, in the final quarter. All that we have to do in this case is to know in which second it occurred; for the quarter of a second we may say is noted for us by the purely automatic action of the optic lens and retina, since

the first image on the retina must be that of the star as seen in some particular one of the four quadrants.

Going a little farther, we will now suppose each of the four quadrants, which in turn correspond to quarter seconds, to be divided into five parts, so that the whole circle is divided into twenty. All the observer has to say is in which quadrant and in which subdivision of the quadrant the star appears, to say in which twentieth of the second (or other brief cycle) it emerged.

The reticule I have just described is fixed in the focus of the eye-piece and does not revolve. What does revolve is a minute double prism of total reflection just before the reticule, the middle of whose reflecting face lies in the optical axis, and by whose means the optical axis is twice broken at a right angle, so that when the telescope is directed at a star the image of the star is not seen at the center of the field, but on one side of it. If the prism is revolved, the star must appear to revolve in a circle whose radius is nearly that of the side of the prism.

The little prism is turned by a small piece of watch-work, but it is not at all necessary that this should be exact, since all we demand is that the rate shall be constant during a second or so—a condition easily secured with the most ordinary mechanism.

The sketch and the apparatus exhibited sufficiently indicate, I think, the simple means by which this is brought about.

Figure 1 is a section one-half full size. *A A A* is the outer tube, which can be fitted, if desired, into the eye end of a telescope. *b b* is the inner tube, resting on friction-wheels *f f*, revolved by the clock-work *c* about once a second, and recording the time at which a key in the observer's hand may be pressed to indicate the particular second. This record may be made electrically by the wires *w w* on a chronograph, or more simply and directly on a little attached dial like that of a recording stop-watch.

p is the prism of double total reflection. *r r* is the posi-

tion of the fixed reticule (shown independently as it appears to the observer and of full size in figure 2.)

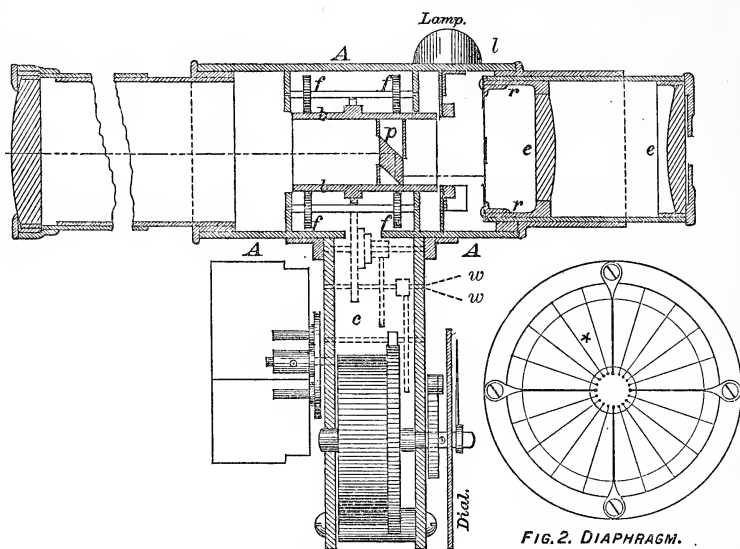

FIG. 1. SECTION.
1/2 FULL SIZE

FIG. 2. DIAPHRAGM.
FULL SIZE.

S. P. LANGLEY. INVT

ee are the lenses of a positive eye-piece. *l* is a lamp for giving wire illumination, if desired, when a telescope is employed.

Field illumination is readily obtained by making the diaphragm in which the prism *p* is set of translucent material.

Finally it should be remarked that on removing the eye piece, events may be observed without using any telescope. In this, its simplest form, the chronograph may also be dispensed with, and the record of the second made on an attached stop-watch dial, and the instrument may thus carry

its own complete recording apparatus and be more portable than an ordinary opera-glass.

I have not found time to use this apparatus on the moon or occultations, but I have, what is possibly more to the purpose now, tried it on an artificial star, the instant of whose appearance and disappearance was independently recorded on a chronograph by an electrical contact. Different observers, entirely unskilled and ignorant in the use of the instrument, were invited to look into it and to determine the quadrant and section in which the star appeared and disappeared.

I have momentarily mislaid my notes containing in full detail the results of four observers, but I can summarize them approximately in saying that after being simply told what to note; the average probable error—(that is, for any single observation)—was rather less than one-twentieth of a second. As far as I can judge from the limited number of instances, the younger the observer the better the observation. The worst of the observers (the oldest), however, had a probable error considerably less than one-tenth of a second; the youngest, a probable error of something like one-fortieth of a second, which implies, as you will observe, that he not only readily noted the quadrant and the subdivisions of the quadrant, but, also as a rule, even the part of the subdivision in which the star was first seen. None of these observers had so much as one hour's practice.

The plan in question is easily adapted to meridian observations, but for these we have numerous plans for correcting personal equation, and the writer may also direct attention to the fact of the existence of a distinct device (*Am. Journal of Science*, July, 1877) which practically eliminates the personal error in the very act of a transit observation. It is more elaborate than the present one, which is so simple that it may be useful even in longitude work with the transit, though its proper field seems to be the observation of sudden events; but, to whatever purpose it is applied, I beg leave to

present it to your attention less for any interest that attaches to the particular mechanism exhibited than as an illustration of a principle which seems to me to have not been employed before in this way, and which I trust may have useful applications.

ON SOME OF THE GREATER PROBLEMS OF PHYSICAL GEOLOGY.

BY

CLARENCE EDWARD DUTTON.

[Read before the Society, April 27, 1889.]

The greatest problems of physical geology I esteem to be: 1st, What is the potential cause of volcanic action? 2d, What is the cause of the elevation and subsidence of restricted areas of the earth's surface? 3d, What is the cause of the foldings, distortions, and fractures of the strata?

The volcanic problem is at present unsolved. Every theory or hypothesis thus far offered to explain it goes to pieces at the touch of criticism. For elevations and subsidences we are also without any satisfactory explanation. But the third problem, the cause of distortions and fractures in the strata, looks much more hopeful, and it is my intention to propose this evening a solution of it, not a new one, let me say, but an old one remodeled. Before proceeding to discuss it, it is proper to advert to a hypothesis which has long been in favor, and which is looked upon by some authorities as affording an explanation. This is sometimes called the contractional hypothesis.

The earth is regarded as being hot within and undergoing secular cooling by conduction of heat through its external shell and its radiation into space. This loss of interior heat is presumed to be accompanied by a corresponding loss of interior volume, thus depriving the cold exterior shell of a part of its support. In a body so large as the earth the tangential strain set up by this loss of interior support is demonstrably so great that the outer shell or crust, as it is usually called, must be crushed or buckled by it and collapse upon

the shrinking nucleus. The objection to this explanation is twofold: In the first place, we cannot, without resorting to violent assumptions, find in this process a sufficient amount of either linear or volume contraction to account for the effects attributed to it. In the second place, the distortions of the strata are not of the kind which could be produced by such a process. As regards the first objection I will confine myself here to a mere reference to the very able analysis of the problem by Rev. Osmond Fisher. I see no satisfactory reply to his argument. As regards the second objection, which, if possible, is more cogent still, it may be remarked that the most striking features in the facts to be explained are the long, narrow tracts occupied by belts of plicated strata and the approximate parallelism of the axes of their folds. These call for the action of some great horizontal force thrusting in one direction. Take, for example, the Appalachian system, stretching from Maine to Georgia. Here is a great belt of parallel synclinals and anticlinals with a persistent trend, and no rational inquirer can doubt that they have been puckered up by some vast force acting horizontally in a northwest and southeast direction. Doubtless it is the most wonderful example of systematic plication in the world. But there are many others which indicate the operation of the same forces with the same broad characteristics. The particular characteristic with which we are here concerned is that in each of these folded belts the horizontal force has acted wholly or almost wholly in one direction. But the forces which would arise from a collapsing crust would act in every direction equally. There would be no determinate direction. In short, the process could not form long, narrow belts of parallel folds. As I have no time to discuss the hypothesis further I dismiss it with the remark that it is quantitatively insufficient and qualitatively inapplicable. It is an explanation which explains nothing which we want to explain.

In proposing another view of the problem we may first turn our attention to those obvious and universally conceded

forces which determine the figure of the earth. That figure we know to be one which a liquid or viscous body of large size will take when subject only to the forces arising from rotation around an axis and to the mutual gravitation of its own parts. This form is an oblate spheroid.

The spherical form, however, is only approximate. We find large portions of its surface protruding into continents and islands, while others are sunken to form oceanic basins. How did these inequalities arise? If the form of the earth is nearly spheroidal why is it not exactly so? It has always been supposed that this nearly spheroidal form implies that the earth, if not liquid, is certainly not rigid enough to maintain any other form against the forces of its own gravitation. Even if the earth were a mass of unbroken steel no great departure from this shape could be maintained for a moment. It would straightway collapse and flow into a spheroidal form. But if gravitation compels it to take a nearly spheroidal shape why should it stop short of making it perfectly so? Perhaps it will be said that while the rigidity of rocks may be insufficient to permit a great deformation of the normal spheroid it may be sufficient to permit a small one. Before discussing this point it will be necessary to introduce a consideration which has seldom been touched upon by geographers or geologists.

If the earth were composed of homogeneous matter its normal figure of equilibrium without strain would be a true spheroid of revolution; but if heterogeneous, if some parts were denser or lighter than others, its normal figure would no longer be spheroidal. Where the lighter matter was accumulated there would be a tendency to bulge, and where the denser matter existed there would be a tendency to flatten or depress the surface. For this condition of equilibrium of figure, to which gravitation tends to reduce a planetary body, irrespective of whether it be homogeneous or not, I propose the name *isostasy*. I would have preferred the word *isobary*, but it is preoccupied. We may also use the corresponding adjective, *isostatic*. An isostatic earth, composed of homoge-

neous matter and without rotation, would be truly spherical. If slowly rotating it would be a spheroid of two axes. If rotating rapidly within a certain limit, it might be a spheroid of three axes.

But if the earth be not homogeneous—if some portions near the surface be lighter than others—then the isostatic figure is no longer a sphere or spheroid of revolution, but a deformed figure, bulged where the matter is light and depressed where it is heavy. The question which I propose is: How nearly does the earth's figure approach to isostasy?

Mathematical statics alone will not enable us to answer this question with a sufficient degree of approximation. It does, indeed, enable us to fix certain limits to the departure from isostasy which cannot be exceeded. This very problem has been treated with great skill by Prof. George Darwin.

But this problem may be approached from another direction with more satisfactory results. Geology furnishes us with certain facts which enable us to draw a much narrower conclusion. There are several categories of fact to which we may turn. One of the most remarkable is the general fact that where great bodies of strata are deposited they progressively settle down or sink seemingly by reason of their gross mechanical weight, just as a railway embankment across a bog sinks into it. The attention of the earlier Appalachian geologists was called, as soon as they had acquired a fair knowledge of their field, to the surprising fact that the paleozoic strata in that wonderful belt, though tens of thousands of feet in thickness, were all deposited in comparatively shallow water. The paleozoic beds of the Appalachian region have a thickness ranging from 15 000 to over 30 000 feet, yet they abound in proofs that when they were deposited their surfaces were the bottom of a shallow sea whose depth could not probably have exceeded a few hundred feet. No conclusion is left us but that sinking went on *pari passu* with the accumulation of the strata. When the geology of the Pacific coast was sufficiently disclosed, the same fact confronted us there. As investigation went on the same fact

presented itself over the western mountain region of the United States. One of the most striking cases is the Plateau Country. This great region, nearly 100 000 square miles in area, lying in the adjacent parts of Colorado, Utah, New Mexico, and Arizona, discloses from 8 000 to 12 000 feet of mesozoic and cenozoic strata. Here the proof is abundant that the surface of the strata was throughout that vast stretch of time never more than a few feet from sea level. Again and again it emerged from the water a little way, only to be submerged. At many horizons grew forests which are now represented by those abundant and beautiful fossil woods which of late have become celebrated. In the cretaceous we find many seams and seamlets of coal or carbonaceous shale; but they are included between sandstones which are cross-bedded and ripple-marked, or between shales and limestones which abound in the remains of marine mollusca. Here the evidence seems conclusive that the whole subsidence went on at about the same rate as the surface was built up by deposition. In short, it may be laid down as a general rule that where great bodies of sediment have been deposited over extensive areas their deposition has been accompanied by a subsidence of the whole mass.

The second class of facts is even more instructive, and stands in a reciprocal relation to those just mentioned. Wherever broad mountain platforms occur and have been subjected to great erosion the loss of altitude by degradation is made good by a rise of the platform. In the western portion of the United States there occur mountain ranges situated upon broad and lofty platforms from 20 to 60 miles wide and from 50 to 200 miles in length. Some of these platforms contain several mountain ridges. All of them have been enormously eroded, and if the matter removed from them could be replaced it would suffice to build them to heights of eight or ten miles; yet it is incredible that these mountains were ever much loftier than now, and may never have been so lofty. The flanks of these platforms, with the upturned edges of the strata reposing against them

or with gigantic faults measuring their immense uplifts, plainly declare to us that they have been slowly pushed upwards as fast as they were degraded by secular erosion.

It seems little doubtful that these subsidences of accumulated deposits and these progressive upward movements of eroded mountain platforms are, in the main, results of gravitation restoring the isostasy which has been disturbed by denudation on the one hand and by sedimentation on the other. The magnitudes of the masses which thus show the isostatic tendency are in some cases no greater than a single mountain platform, less than 100 miles in length, from 20 to 40 miles wide and from 2500 to 3500 feet mean altitude above the surrounding lowlands. From this we may directly infer that in those regions the effective rigidity of the earth is insufficient to uphold a mass so great as one of those platforms if that mass constituted a real deformation of isostasy; and if an equal mass were to be suddenly removed the earth would flow upward from below to fill the hiatus; hence we must look to considerably smaller masses to find a defect of isostasy. It is extremely probable that small or narrow ridges are not isostatic with respect to the country roundabout them. Some volcanic mountains may be expected to be non-isostatic, especially isolated volcanic piles.

Thus the geologic changes which have taken place may be regarded as experiments conducted by Nature herself on a vast scale, and from her experiments we may by suitable working hypotheses draw provisional conclusions, both as to the degree in which the earth approximates to isostasy and also as to the mean effective rigidity of large portions of the subterranean mass. The approach to isostasy is thereby inferred to be very near, while the mean rigidity of the subterranean masses is also inferred to be far less than that of ordinary surface rocks, and even approaching more nearly the rigidity of lead than to that of copper. Pure physics alone would not have enabled us to reach such a conclusion, for the equations employ constants of unknown value. But geologic inquiry may, and I believe does, furnish us with

narrow limits within which those values must be taken. Thus the two sciences must work coöperatively and supplement each other.

There is, however, one other branch of physical inquiry which bears directly on the foregoing questions. This is the investigation of terrestrial gravitation by means of the pendulum. I regret that I have never had time or opportunity to acquaint myself thoroughly with the results thus far reached by this branch of investigation, and can only speak from general knowledge. Pendulum observations are far too few for the wants of geographic or geologic science. So far as they go they are highly suggestive in the present connection. The pendulum, as a rule, does not show any appreciable variation of gravity, such as would be expected if the mean density of all the outer parts of the earth were uniform. It indicates rather that the elevated regions and continents are composed of lighter matter and the depressed regions and ocean basins of denser matter. The exceptions are of a character which prove the general rule, and occur where we should look for them. The results obtained by the India survey upon the Himalayan mass were regarded by Archdeacon Pratt as indicating that the plateau was composed of lighter matter than the lowlands to the southward. A similar result has been obtained in the great bulge which forms the western half of the United States. In other words, the pendulum indicates that those elevated regions are nearly if not quite isostatic.

On the other hand, the observations of Mendenhall on Fujiyama, in Japan, indicated a slight excess of mass, and a similar result would seem to follow from Mr. Preston's work in the Hawaiian Islands. From the nature of the process by which volcanoes are built these results are to be expected.

It would also seem natural to expect that the plumb-line would give some indications upon this subject; but experience has shown that most of the observed deflections of the plumb-line are inexplicable. They occur where we would least expect to find them—upon broad and level plains, where

there is nothing to indicate any cause of deflection. They are found on the tundras of Siberia and the monotonous expanse of British North America, where the surface of the earth is but feebly diversified. In mountain regions they are often conflicting and unintelligible, but along the sea coast the indications are more systematic. On both the Atlantic and Pacific shores the deflection of the plummet is almost invariably towards the ocean, and is often of considerable amount; but it is along the shore that the isostatic theory would lead us to look for just this deflection, for it is along the margins of the continents that great bodies of sediment accumulate; and so long as the earth possesses any noteworthy degree of rigidity, enabling it to sustain in part the resulting deformation of isostasy, so long must we expect to find these sediments constituting an excess of mass whose attraction will make itself felt upon the plummet.

The theory of isostasy thus briefly sketched out is essentially the theory of Babbage and Herschel, propounded nearly a century ago. It is, however, presented in a modified form, in a new dress, and in greater detail. We may now proceed to deduce some important consequences.

A little reflection must satisfy us that the secular erosion of the land and the deposit of sediment along the shore lines constitute a continuous disturbance of isostasy. The land is ever impoverished of material—is continuously unloaded; the littoral is as continuously loaded up. The resultant forces of gravitation tend to elevate the eroded land and to depress the littoral to their respective isostatic levels. Whether these forces shall become kinetic and produce actual movement or flow will depend, first, upon their intensity; second, upon the rigidity of the earth by which such movement is resisted. Let us consider, then, the intensity of the forces.

The littoral belts upon which sediments are thrown down are coextensive in length with shores. Their widths are no doubt variable, but must often reach a hundred miles or more with considerable thickness, and are not wholly unimportant at much greater distances. The thickness of the de-

posits may vary much, but may be proportional to the time of accumulation, and here the time is measured by the geologic standard. The gross weight of such masses of sediment must be vast indeed. If there is any viscous yielding at all the problem becomes essentially that of the flowing solid, which is in a large measure governed by hydrostatic laws. The intensity of the force must have a maximum value proportional to the thickness which lies above the isostatic level and also proportional to its specific gravity. The area covered by the deposit enters as a quantity factor, but not as an intensity factor. The greater the area, the greater is the total potential energy of movement without any necessary increase of the intensity of the force. This intensity, being proportional to the thickness of the sediments, may become almost indefinitely great or it may be small. Indeed, it may, and in fact does, become negative when we apply the same statical theory to the movement or stress of the denuded land areas.

But whether these forces are sufficient to produce actual flow is equally dependent upon the rigidity, or, as we may here term it, the viscosity of the masses involved. We have already seen reason to infer that the mean viscosity is not great, being far less than that of the surface rocks alone. Beyond this rather vague statement I perceive no way of assigning a value to the resistance to be overcome.

It remains to inquire what is the resulting direction of motion. The general answer is, towards the direction of least resistance. The specific answer, which must express the direction of least resistance, will, of course, turn upon the configuration of the deposition on the one hand, and of denudation on the other, and also upon the manner in which the rigidity or viscosity varies from place to place. Taking, then, the case of a land area undergoing denudation, its detritus carried to the sea and deposited in a heavy littoral belt, we may regard the weight of each elementary part of the deposited mass as a statical force acting upon a viscous support below. Assuming that we could find a differential expression applicable to each and every element of the mass

and a corresponding one for the resistance offered by the viscosity, the integration for the entire mass might give us a series of equipotential surfaces within the mass. The resultant force at any point of any equipotential surface would be normal to that surface. A similar construction may be applied to the adjoining denuded area, in which the defect of isostasy may be treated as so much mass with a negative algebraic sign. The resultants normal to the equipotential surfaces would, in this case, also have the negative sign. The effective force tending to produce movement would be the arithmetical sum of the normals or of a single resultant compounded of the two normals. From this construction we may derive a force which tends to push the loaded sea bottoms inward upon the unloaded land horizontally.

This gives us a force of the precise kind that is wanted to explain the origin of systematic plications. Long reflection and considerable analysis have satisfied me that it is sufficient both in intensity and in amount unless we assume for the mean viscosity of the superficial and subterranean masses involved in the movement a much greater value than I am disposed to concede. The result is a true viscous flow of the loaded littoral inward upon the unloaded continent.

There may be in this proposition some degree of violence to a certain mental prejudice against the idea that the rock-ribbed earth, to which all our notions of stability and immovableness are attached, can be made to flow. It may assist our efforts if we reflect upon the motion of the great ice sheet which covers Greenland. Here the masses involved are no greater than some masses of sediment. The specific gravity of ice is only about one-third that of the rock masses. The forces called into play to carry the glacier along horizontally do not seem to differ greatly in intensity or amount from the described forces, and the rigidity of the ice itself may not exceed the mean rigidity of the rock masses beneath the littoral.

We may now proceed to inquire how this theory adjusts itself to the actual facts. And, firstly, where do systematic plications occur?

(1.) It is a remarkable fact that they occur among sedimentary beds of great and variable thickness, which were rather rapidly accumulated. They seldom, and, so far as I now recall, never occur among strata which are of small thickness, slowly accumulated with uniformity over large areas; and the theory requires that they should occur in the heavy deposits or along their margins, and should have their greatest development there, for the forces called into play must be proportional to the masses involved.

(2.) They occur in their systematic form along the ancient shore lines. This is but another way of stating the preceding proposition. It has its uses, however, for in so far as the continents have preserved approximately their old shore lines since the ages in which the plications were formed there is a conspicuous parallelism of the axes of plication to the neighboring coast. This is true of the Pacific coast of the United States. As regards the Appalachian plications, we have the remarkable fact that in paleozoic time the ocean lay to the west of those vast bodies of folded strata instead of to the east of them, as now. We must look to a paleozoic Atlantis for the origin of a great portion of those sediments. The flow of the earth was from west northwest to east southeast.

(3.) The parallelism of the folds and their occurrence in long, narrow belts formed by horizontal forces acting in one direction become a consequence so obvious as to need no comment. It is in strong contrast with the contractional theory, which gives a force without any determinate direction.

(4.) Another important fact is that these systematic flexures were mainly formed at the times the sediments were deposited. This is a fact of geologic observation. The contractional hypothesis gives no determinate time for the formation of these flexures. It holds up to us a process continuous through all geological time, proceeding at a rate which diminishes but slowly as the ages roll by. These plications, according to the isostatic theory, are the results of the disturbance of isostasy, and follow immediately upon that

disturbance or after it has reached a sufficient amount, and cease with it. These folds, however, have been subject since their first formation to great erosion, which is also a disturbance of isostasy, and thus the original plication may have been increased or modified thereby.

The theory may also be applied in a most satisfactory manner to the explanation of subordinate features associated with plication.

(5.) One of the features of plication which has attracted great attention and occasioned great perplexity to geologists is the so-called fan-structure. This is very striking in the Alps, and has its counterpart in the inclined folds of the Appalachians of Pennsylvania, where the northwestern branches of the anticlines are steeper than the southeastern branches. If we assume that as the rocks lie deeper in the earth they are softened somewhat by the increasing heat, it follows that in the flow of the mass the movement would be easier and more rapid below than above. Thus a horizontal force arising from this differential movement acts upon the inverted arches of the synclines and carries their lower vertices forward in the direction of motion.

Thus the general theory here proposed gives an explanation of the origin of plications. It gives us a force acting in the direction required, in the manner required, at the times and places required, and one which has the intensity and amount required and no more. The contractional theory gives us a force having neither direction nor determinate mode of action, nor definite epoch of action. It gives us a force acting with a far greater intensity than we require, but with far less quantity. To provide a place for its action it must have recourse to an arbitrary postulate assuming for no independent reason the existence of areas of weakness in a supposed crust which would have no *raison d'être* except that they are necessary for the salvation of the hypothesis.

Before closing this discussion it will be necessary to advert to another one of the great problems of physical geology, viz., the cause of general elevations and subsidences. I do so,

not with the idea of throwing light upon it, but to guard against a misapprehension which would otherwise be sure to occur.

Geologic history discloses the fact that some great areas of the earth's surface which were in former ages below sea-level are now thousands of feet above it. It also gives us reason to believe that other areas now submerged were in other ages *terra firma*. Our western mountain region at the beginning of cenozoic time was at sea level. It is now, on an average, 6000 feet above it. The great Himalayan plateau contains early cenozoic beds full of marine fossils which now lie at altitudes of 14000 feet or more. The whole North American Continent has, since the close of the paleozoic, gained in altitude. Now, it is sufficiently obvious that the theory of isostasy offers no explanation of these permanent changes of level. On the contrary, the very idea of isostasy means the conservation of profiles against lowering by denudation on the land and by deposition on the sea bottom, provided no other cause intervenes to change those levels. If, then, that theory be true, we must look for some independent principle of causation which can gradually and permanently change the profiles of the land and sea bottom. And I hold this cause to be an independent one. It has been much the habit for geologists to attempt to explain the progressive elevation of plateaus and mountain platforms, and also the foldings of the strata by one and the same process. I hold the two processes to be distinct and having no necessary relation to each other. There are plicated regions which are little or not at all elevated, and there are elevated regions which are not plicated. Plication may go on with little or no elevation in one geologic age and the same region may be elevated without much additional plication in a subsequent age. This is in a large measure true of the Sierra Nevada platform, which was intensely plicated during the paleozoic and early mesozoic, but which received its present altitude in the late cenozoic.

Whatever may have been the cause of these great regional

uplifts it in no manner affects the law of isostasy. What the real nature of the uplifting force may be is, to my mind, an entire mystery; but I think we may discern at least one of its attributes, and that is a gradual expansion, or a diminution of the density, of the subterranean magmas. If the isostatic force is operative at all, this expansion is a rigorous consequence; for whenever a rise of the land has taken place one of two things has happened: the region affected has either gained an accession of mass or a mere increase of volume without increase of mass. We know of no cause which could either add to the mass or diminish the density, yet one of the two must surely have happened. But the difference of the two alternatives in respect to consequences is immense. If the increase of volume of an elevated area be due to an accession of matter, the plateau must be hoisted against its own rigidity and also against the statical weight of its entire mass lying above the isostatic level. But if the increase of volume be due to a decrease of density there is no resistance to be overcome in order to raise the surface. Hence I infer that the cause which elevates the land involves an expansion of the underlying magmas, and the cause which depresses it is a shrinkage of the magmas. The nature of the process is, at present, a complete mystery.

NOTE.—The foregoing paper was written hastily to occupy a vacant half hour of a meeting of the Philosophical Society without the thought of publication. I have yielded however to the kind solicitation of friends to consent to its publication. It contains a rough outline of some thoughts which have worked in my mind for the last fifteen years and which, from time to time, I have discussed at length in unpublished manuscripts and in familiar conversation with my esteemed colleagues.

ON
THE CRYSTALLIZATION
OF
IGNEOUS ROCKS.

BY
JOSEPH PAXSON IDDINGS.



TABLE OF CONTENTS.

	Page.
<i>Introduction</i>	71
PART I. PHENOMENA OF CRYSTALLIZATION	72
<i>Rock structures in general terms</i>	72
(1.) Glassy rocks.....	72
— without porphyritical crystals	73
— with “ “	73
(2.) Holocrystalline (completely crystallized) rocks.....	73
— with porphyritical crystals.....	73
— without “ “	74
(3.) One or more generations of crystals	74
(4.) Special structures	74
<i>Component minerals</i>	74
(1.) Their variety	74
(2.) Chemical character.....	75
(3.) Association in various kinds of rocks.....	75
<i>Character of the minerals as crystals</i>	76
(1.) External characters.....	76
Form and relative age.....	77
— in glassy rocks	77
— in holocrystalline rocks	78
— intergrowths	78
(2.) Internal characters.....	79
Inclusions	79
— kinds: gaseous.....	79
fluid	79
glassy	80
crystallized	80
— mode of occurrence.....	80
abundance.....	80
kind and association.....	81
arrangement.....	81
Zonal structure	81
— isomorphous shells.....	81
<i>Relations between the mineral crystals</i>	82
(a.) Association as inclusions and intergrowths	82
(1.) As inclusions	82
(2.) As intergrowths (synchronous growths)	82
(3.) As parallel growths (successive growths)	83
(b.) Order of crystallization.....	84
(1.) One period.....	84

	Page.
(2.) Two or more periods	85
— interruption and repetition of the series	85
— essential differences between minerals of the 1st and 2d generation	85
— essential identity of minerals of the 1st and 2d generation	86
— extraneous differences between minerals of the 1st and 2d generation, but identity of mineral species	86
<i>Relation of rock structures to geological occurrence</i>	88
(1.) Geological occurrence of glassy rocks	88
— fine-grained porphyritical rocks	88
— coarsely crystalline rocks	88
(2.) Instances in which the geological location of the magma at the time of crystallization can be determined	88
<i>Relation of rock structures to chemical composition</i>	89
(1.) Degree or extent of the crystallization	89
(2.) Character of the structure	90
<i>Relation of mineral composition to chemical composition</i>	90
(1.) For rocks of similar geological occurrence	90
(2.) Exceptional relations	91
<i>Relation of mineral composition to geological occurrence</i>	92
PART II. CAUSES OF CRYSTALLIZATION	93
<i>Artificial production of rocks and minerals</i>	93
Researches of Fouqué and Lévy and others	93
— minerals and rocks produced (basic)	93
— greater tendency of certain minerals to crystallize	94
— minerals and rocks not produced (acid)	94
— certain minerals produced by the use of mineralizers	94
<i>Conclusions based upon analogy</i>	95
— Bunsen's opinion that rock magmas behave like solutions of salts	95
— Lagorio's views on the same	95
— supersaturated solutions	95
— uncertainty regarding the nature of solutions and fusions	96
— Sorby's law applied to rock magmas	96
— changes of temperature and pressure	96
— solubility and saturation	96
— Pelouze's and others' experiments on artificial glasses	97
— relative power of saturation possessed by the chemical compounds existing in rock magmas	97
<i>Application of the foregoing conclusions to rock magmas</i>	98
(a.) <i>Saturation of rock magmas</i>	98
Its degree dependent primarily on temperature and pressure	98
Its character dependent primarily on chemical composition	98
<i>Cooling magmas</i>	98
(1.) Order of crystallization and chemical composition	98
(2.) Crystallization under various physical conditions	99
(3.) Comparison with the phenomena of crystallization in rocks. 100	100

CONTENTS.

69

	Page.
(b.) <i>Consideration of magmas during their eruption</i>	100
(1.) Changes of temperature and pressure	101
(2.) Temperature of the conduit	103
(3.) Size of the conduit.....	103
(4.) Changes in the velocity of eruption.....	104
— acceleration and retardation of crystallization	104
— resorption of crystals.....	104
— order of resorption	105
(c.) <i>Rate of cooling and rock structures</i>	105
<i>Relative influence of the various causes of crystallization</i>	106
(1.) Cooling and time (rate of cooling).....	106
(2.) Chemical composition	107
(3.) Mineralizers.....	107
(4.) Pressure	108
— apparent lack of influence.....	108
— identity of minerals formed under different pressures..	108
— identity of rocks at different altitudes.....	108
— absence of dimorphism among the rock-making minerals, except tridymite (which may be due to mineralizers)	108
— optical anomalies probably due to changes of temperature	108
<i>Condition of rock magmas previous to crystallization</i>	109
— gas bubbles in glass inclusions.....	109
— molten, fluid condition of the magmas.....	109
<i>Résumé</i>	109

ON THE CRYSTALLIZATION OF IGNEOUS ROCKS.

BY

JOSEPH PAXSON IDDINGS.

[Read in abstract before the Society, May 25, 1889.]

INTRODUCTION.

In the search for evidences of the character and composition of the interior of the earth attention has naturally been turned to those rocks which, by their mode of occurrence on the surface of the globe, give ample evidence of having come from greater depths than those once occupied by the lowest upturned sediments or by the great body of crystalline schists and gneisses.

Volcanic lavas that reach the surface in a highly heated, fluid condition, and other crystalline masses that traverse the earth's crust in dikes, sheets, and laccolites, which are of similar origin and are classed with the former as igneous rocks, have evidently been erupted from deep-seated sources in a molten state, and appear to have been the same in the earliest geological ages that we have records of, as now.

They may fairly be considered as the material evidence concerning the greatest depths within our planet of which we can hope to obtain direct knowledge.

How far the phenomena of igneous rocks may contribute to the solution of the problem of the earth's interior, or whether they may, in fact, belong to the superficial portion of the earth's mass, is still an open question, an answer to which will not be found in the present paper.

It is not the purpose of this paper to discuss all the varied phenomena of igneous rocks; nor is it considered that those here treated of are the phenomena which may contribute

most to a conception of the interior of the earth, or even of the possible source of igneous rocks. It is intended rather to prepare the way for the discussion of such phenomena by considering those which lie at the foundation of an understanding of the true nature of the rocks themselves. It will, therefore, attempt to present some of the most prominent and general facts connected with the crystallization of igneous rocks, and to show what conclusions as to the early condition of these rocks may reasonably be drawn.

The student of crystalline rocks should never lose sight of the fact that a great number of the rock-making minerals crystallize from molten magmas and from aqueous solutions without appreciable difference in their characters, and that metamorphic processes set in action by aqueous solutions, by heating, or by the pressure derived from great dynamical movements, may in some instances lead to results easily confounded with the products of the direct crystallization of molten magmas. It is, therefore, necessary to be thoroughly acquainted with the geological occurrence of all rock-bodies concerning whose primary and unmetamorphosed condition there is any doubt.

The present paper deals exclusively with the results of the original crystallization of molten magmas, so far as the writer is able to judge of them, and is, therefore, illustrated very largely from the writer's observations.

PART I.—THE PHENOMENA OF CRYSTALLIZATION.

Rock Structures in General Terms.—It would be impossible in anything less than a treatise to do more than sketch as briefly as possible some of the general features of rock-crystallization as they have been observed by all students of microscopical petrography, dwelling, perhaps, at greater length upon some points that have specially presented themselves to the writer in the course of his regular work.

(1.) Lavas that reach the surface of the earth in a fluid condition consolidate upon cooling rapidly to a more or less

perfect glass. The glass in most cases contains crystals of several minerals scattered uniformly through it. The crystals may be microscopic or they may be large enough to be seen by the unaided eye. Usually both large and small crystals occur in the same glass. The large ones that stand out prominently from the mixture of glass and small crystals are said to be *phenocrysts**; the remainder of the rock is called the *groundmass*. The glassy groundmass may be so filled with minute crystals as to lose the appearance of glass and resemble stone or porcelain, but an examination with the microscope will reveal the presence of a small amount of glass acting as a cement for the multitude of crystals.

(2.) Lavas may also cool in such a manner that the whole mass becomes crystalline and no glass is left. When there are porphyritical minerals (*phenocrysts*), they are scattered through a groundmass wholly made up of crystals, which may be of microscopic dimensions or may be large enough to be recognized without the aid of a lens—that is, macroscopically. But surface lavas seldom attain so high a degree of crystallization. It is oftener reached by those magmas which have consolidated as intrusive bodies within the crust of the earth. In these rocks the crystals composing the groundmass may be so large that the porphyritical crystals

* These prominent crystals in porphyritic rocks are frequently termed *Einsprenglinge* by the Germans, which is a convenient collective term without a good English equivalent. Realizing the advantages of such a word, and the inconvenience of not having an equivalent in English, the writer, after consultation with Prof. J. D. Dana and others, suggests the term *phenocryst*, from φαίνω = *conspicuous* or *eminent*, and κρύσταλλος = *crystal*.

Phenocrysts would, therefore, be all those crystals in a porphyritic rock that stand out conspicuously from the surrounding crystals or glass composing the groundmass. They may be large or small; thus the term can be properly applied to very small crystals, like magnetite, which belong to the category of the large crystals, having been crystallized in the same period, but which are to be distinguished from the more minute crystals of magnetite, which are genetically related to the groundmass. The term is intended to be collective, like microlite, crystallite, spherulite. Its use is indicated throughout the present paper.

(*phenocrysts*) cease to be prominent, and the whole rock appears to be of uniform grain.

Completely crystallized or *holocrystalline* rocks, that carry no porphyritical crystals (*phenocrysts*), always present an evenly granular texture, which appears differently according to the size of the component crystals. The finest-grained varieties resemble porcelain; the coarsest are like granite, diorite, etc.

(3.) Upon studying these various structures under the microscope it is evident that in the case of porphyritic rocks the porphyritical crystals (*phenocrysts*) in most instances were formed before those composing the groundmass, and belong to an earlier generation. This is especially true where the same kind of mineral occurs in porphyritical crystals and in microscopic ones; but it does not hold true for all large crystals when compared with all microscopic ones. It is frequently observed that all the different minerals which occur as porphyritical crystals (*phenocrysts*) in a rock may also occur as microscopic crystals in the groundmass. There are, then, two generations of the same minerals in the rock.

Where there are no porphyritical crystals (*phenocrysts*) and the rock has a uniformly granular texture the crystals of the different minerals composing the rock have a nearly uniform size, and there is no evidence of more than one generation of any one mineral. Professor Rosenbusch has made this the distinguishing characteristic between porphyritic and even-grained rocks.

(4.) There are other structures of widespread occurrence which are specially characteristic of particular kinds of rocks that have consolidated under particular conditions. They will not be included in the present discussion. Among them are the laminated and spherulitic structures of acid rocks.

Component Minerals.—(1.) The crystals that make up the great body of igneous rocks, with all their manifold varieties, belong to a comparatively few mineral species. The essential minerals composing $\frac{9}{10}$ of these rocks are: quartz; the feld-

spars, and the allied species leucite and nepheline; the micas, amphiboles, and pyroxenes; olivine, and the iron oxides. With these are associated small amounts of apatite, zircon, sphene, the spinels, and other minerals less regularly.

The great majority of igneous rocks are made up of three or more of the essential minerals just named, the varying proportions of which give rise to the different kinds of rocks, which are generally classified according to their mineral composition.

(2.) The essential minerals, with the exception of the iron oxides, are silicates of a small number of chemical elements, besides free silica. The chemical composition of the rocks consists mainly of silica, alumina, iron oxides, lime, magnesia, soda, and potash, with small amounts of titanitic and phosphoric acids and traces of a few other compounds. The relative proportions of these compounds vary within comparatively narrow limits.

(3.) The igneous rocks may be arranged according to their chemical composition in series that range from those rich in bases and poor in silica to others rich in silica and poor in bases. The mineral composition of the rocks necessarily corresponds to the chemical composition. Thus basic rocks are mostly composed of minerals low in silica, with more or less iron oxide and little or no free silica or quartz. The acid rocks are largely made up of minerals higher in silica, with much quartz and little or no iron oxide.

But since the mineral constituents are largely composed of the same chemical elements in different combinations, it is possible to have a variety of different mineral combinations that would possess the same chemical composition as a whole—that is to say, it is possible to have a number of different sets of multiples of the same factors that would sum up alike. Hence there is no fixed proportion of certain minerals to correspond to each phase of chemical composition of the rock. Variations in mineral composition, therefore, occur frequently.

Certain combinations of minerals, however, are characteristic of rocks with certain chemical characters, and are those generally observed; but exceptional combinations occur. Thus, of the basic rocks, *basalt* is almost universally composed of augite, olivine, basic plagioclase, and magnetite or ilmenite, with no orthoclase, hornblende, biotite, or quartz; but instances are known where each of these minerals occurs as a primary constituent. *Gabbro* is ordinarily composed of diallage or augite, basic plagioclase, an orthorhombic pyroxene, titaniferous iron oxide, and often olivine, but in exceptional cases it may contain hornblende, biotite, orthoclase, and quartz.

With the acid rocks the reverse order obtains. They are, in the great majority of cases, composed of quartz, orthoclase, alkali-plagioclase, biotite, and hornblende, without the minerals characteristic of the basic rocks, but in a comparatively small number of cases the latter minerals also occur.

The various kinds of rocks, therefore, differ in the relative amounts of the essential minerals, which may belong to a few of the rock-making species or may represent a greater number of them.

Character of the Minerals as Crystals.—The history of the crystallization of each rock is written more or less completely upon the mineral crystals composing it, and may be read from their form, their internal or material character, and also from their relations to one another.

(1.) The outward *form* or shape of a crystal indicates something of the conditions under which it crystallized. In glassy rocks the outlines of thin sections of crystals are almost always straight-edged, and correspond to definite crystal planes or faces. This is especially true of the larger crystals. It indicates that the minerals crystallized freely from a fluid or molten magma. Microscopic crystals often exhibit irregular forms, which are not directly referable to crystallographic planes. They assume fantastic shapes in

many instances. These are generally found in rock glasses, and appear to be the result of very rapid growth.

The porphyritical crystals sometimes occur in angular, irregular fragments, which are parts of a once perfect crystal that has been fractured while the magma was molten. This is particularly characteristic of the quartz and sanidine of many rhyolites. The outline of the porphyritical crystals (*phenocrysts*) is at times rounded, so that no vestige of a crystallographic form is visible. In most of these cases it is evident that the rounding is not the original form of the crystal, but is the result of a partial resorption of the crystal by the magma.

Irregularities of form, however, occur with porphyritical crystals (*phenocrysts*) in glassy rocks, which are undoubtedly produced at the time of growth, so that they are not bounded by crystallographic planes.

When the crystals have started close to one another they have often grown together and have interfered with the development of perfect crystallographic form. Their line of juncture is quite irregular in most cases. This indicates that the two were growing at the same time. When one individual crystal has its perfect crystallographic form along the line of juncture of the two, and the second simply terminates against the faces of the first, it is evident that the first crystal was completed before the second reached it. It is therefore older than the second.

Porphyritical minerals in glassy rocks are frequently found in juxtaposition. When they are, their relative age or time of crystallization can be observed. But when they are not found in contact with one another their relative age remains in doubt. The younger mineral may entirely surround the older one.

The relative size of minerals is no indication of their relative age. Porphyritical minerals are larger than those of the groundmass and are generally older. But there are instances where certain porphyritical minerals are younger than the

small crystals in the groundmass, great quantities of which are enclosed in the porphyritical ones.

In holocrystalline porphyritic rocks the outlines of the porphyritical crystals (*phenocrysts*) are sometimes straight-edged, usually when the groundmass is very fine-grained. But in the coarser-grained varieties the sharp outline of the porphyritical crystals (*phenocrysts*) disappears. The surface of the crystals is then rough, and is bounded by the small crystals of the groundmass, which are more or less irregular. This indicates that the crystallization of the large crystals continued while the multitude of small ones were growing, and continued until they interfered with one another.

In much coarser-grained rocks the form of the component crystals is still more irregular, but generally differs for different mineral species. Some may possess their proper crystallographic form completely; they are *idiomorphic*. Others may have quite irregular forms, which have been imposed upon them by adjacent minerals. These are said to be *alio-triomorphic*. As already remarked, the mineral that possesses its proper form when in conjunction with another that does not is older than the second. Hence the idiomorphism of a mineral is an indication of its age with respect to the minerals contiguous with it. It indicates that the idiomorphic mineral ceased to crystallize before the others reached it.

There are cases, however, where one mineral finished growing before another came in contact with it, but where the first one does not possess a sharp crystal form. The original crystallization appears to have been irregular, as noted in the fine-grained varieties. In these cases the relative age is recognized by the partial enclosure of one of the minerals by the other.

Two minerals that grow together at the same time often penetrate each other irregularly, so that they mutually enclose portions of each other in such a manner that all the scattered parts of one mineral have the same crystallographic orientation, and all the parts of the other mineral have another orientation, which may be parallel to that of the first or not.

(2.) The mineral substance of the crystals differs in different individuals; sometimes in those of the same species in one rock-section. Usually the internal character is the same for all the individuals of the same species in one rock. The substance of a mineral is seldom free from inclusions of other substances. The foreign material may be in a gaseous, fluid, or solid condition. Gases exist in minute cavities in all the minerals to a greater or less extent. Sometimes they appear to be entirely absent. Often they occur so uniformly distributed through particular minerals in certain rocks as to become characteristic of them. The cavities may be irregularly shaped or have the form of negative crystals. The nature of the gases has seldom been investigated chemically.

Fluids exist in cavities similar to those occupied by gases. They usually contain a gas-bubble, the size of which, as compared with the amount of fluid, varies greatly, even in the same crystal. The liquid is generally water, which may contain a variety of substances in solution, some of which crystallize out. Besides water there is often liquid and gaseous carbon-dioxide in the same cavity.

Gaseous and fluid inclusions are occasionally of secondary origin and accompany the decomposition of the rock.

The solid inclusions may be amorphous—that is, glassy—or they may be crystallized.

Glass inclusions are usually found in the minerals of glassy rocks or in those whose groundmass is fine-grained. They are evidently portions of the magma of the rock inclosed during the crystallization of the mineral. They are usually rounded or irregularly shaped, but may occupy negative crystal cavities. This is especially the case in quartz, where they generally have dihexahedral forms. They often contain a gas-bubble, and sometimes carry nine or ten in one inclusion.

Inclusions resembling those of glass in form and manner of occurrence, but consisting of crystalline grains, are evidently inclusions of magma, which, instead of solidifying as glass, crystallized to an aggregate of minerals like those in

the groundmass of the rock. They are more frequent in coarsely crystalline rocks than glass inclusions, and do not occur in fresh glassy rocks. They are genetically the same as glass inclusions, but have passed through different processes of consolidation.

Small crystals or grains of the associated minerals may occur as inclusions in any mineral of younger growth.

The manner of occurrence of inclusions in a mineral throws considerable light upon the history of its crystallization. Abundant inclusions indicate the rapid growth of a crystal, and their absence its slower growth; but this cannot be considered an infallible criterion, for it is evident that some kinds of minerals have a greater tendency to inclose foreign substances than others, and that minerals which crystallize synchronously, and therefore under the same conditions, take up different substances in different amounts. Thus the kind of inclusions found in different minerals in the same rock may not always be used as evidence that different conditions attended the crystallization of these minerals.

For example, it is often observed that in the same rock the quartzes carry numerous glass inclusions and the feldspars few, if any, and more probably gas inclusions. In these cases it would not be correct to assume that the quartzes crystallized when the magma was in a different condition from that in which the feldspars formed; for it has been observed that where quartz and orthoclase crystallized together synchronously and formed a pegmatoid porphyritical crystal, as in one instance in Eureka, Nev., the quartz substance inclosed glass in dihexahedral cavities, and the feldspar substance inclosed gas in irregularly shaped cavities.

Another instance is that of intergrown plagioclase and hypersthene in a glassy andesite from Mt. Hood, Oregon. The plagioclase, in common with other minerals in the rock, carried abundant sharply defined glass inclusions, with some apatite and an occasional grain of magnetite; while the hypersthene carried very few glass inclusions, which were poorly defined, but numerous grains of magnetite and some

apatite. The plagioclase and hypersthene had crystallized at the same time, and therefore under the same conditions; yet one was crowded with glass inclusions and the other was nearly free from them.

When two individuals of the same mineral inclose different kinds of substances or very different amounts of the same substance it probably indicates that they have crystallized under somewhat different conditions.

The *arrangement* of the inclusions in a mineral also throws light upon its crystallization. They may be scattered uniformly or irregularly through it, or be accumulated in the center, or located along planes parallel to crystal faces, or in shells corresponding to the form of the crystal in some of the early stages of its growth. Alternating zones of inclusions indicate successive periods of rapid and slow crystallization.

A concentric *zonal* structure is often noticed in minerals free from inclusions. It may be expressed by changes of color or by changes of optical properties. It indicates differences in the chemical composition of the mineral in successive shells of its substance, and is observed in those minerals that are known to occur in rocks in isomorphous series, particularly the feldspars.

Such minerals record the vicissitudes of their crystallization, when others, like quartz, that do not vary chemically and optically, furnish no similar history of their growth. Thus a zonally built feldspar may exhibit two or more rounded zones that prove that the earlier crystallization was checked at some time and the crystal partly resorbed. Afterwards the growth continued in crystallographic zones until it was again checked. This alternating process may go on, and the crystal be finally left with crystallographic boundaries. Such a series of events might happen to a crystal of quartz without any evidence of it being visible, for the chemical composition and optical properties of the quartz would be uniform throughout the individual.

Relations between the Mineral Crystals. (a.) *Association as Inclusions and Intergrowths.*—(1.) The tendency of certain minerals to inclose particular substances has already been alluded to. It may be well to notice some of the commonest of these associations in igneous rocks. It is to be remarked in general that the nature of the inclusions in minerals changes in different occurrences and with different kinds of rocks. A few examples will be sufficient to show the character of the associations.

Glass inclusions are widely distributed in most all kinds of the rock-making minerals, but are seldom observed in mica and almost never in the iron ores. They often occur in apatite and zircon, even when the latter mineral is found in coarsely crystalline granite. It shows that these minerals, which are among the oldest in igneous rocks, crystallized in molten magmas.

In the greater number of rhyolites studied by the writer glass inclusions are more numerous in the porphyritical quartzes than in the sanidines, and in the majority of glassy andesites glass inclusions occur more abundantly in the plagioclases than in the ferro-magnesian silicates.

Fluid inclusions, which are specially characteristic of coarsely crystalline rocks, are much more abundant in the quartzes than in the feldspars, and occur still less frequently in the ferro-magnesian silicates.

Zircon is very often associated with the micas, and magnetite abounds in the ferro-magnesian silicates, but is rarely met with in the alkali feldspars and quartzes. There are instances, however, where iron oxides in minute particles or in scales are abundant in certain lime-soda feldspars.

Augite microlites form characteristic inclusions in a great majority of leucites.

(2.) In the matter of *intergrowths* it is observed that certain minerals are frequently combined, and others almost never. Thus quartz and orthoclase are more frequently intergrown

than quartz and the plagioclases, while quartz has seldom, if ever, been found intergrown with the ferro-magnesian silicates in igneous rocks.

Orthoclase is commonly interlaminated with albite and other plagioclases.

Hornblende and the pyroxenes (hypersthene and augite) are frequently intergrown both in glassy and in holocrystalline rocks.

Hornblende and biotite are often intergrown in the crystalline rocks.

The intergrowth of the ferro-magnesian minerals with the feldspars is of very rare occurrence.

The intergrowths of quartz and orthoclase with pegmatoid and granophyre structures is particularly common in the medium-grained acid rocks, where they are usually constituents of the groundmass; but they also occur in isolated and porphyritical groups, as in the porphyries at Tryberg, in the Schwarzwald,* and the single occurrence at Eureka, Nev., already alluded to. They also occur in very small groups scattered through the glassy groundmass of many rhyolites in the Western United States and in the obsidian of Obsidian Cliff, Yellowstone National Park.† In these instances they are nearly the oldest secretions from the molten magma. Hence there may be in some magmas an initial tendency to secrete crystals of two different minerals at the same time.

(3.) As already remarked, the intergrowth or interpenetration of two minerals indicates their synchronous crystallization; but *parallel growths* often occur where one mineral has acted as a nucleus for the other, and is evidently older. In the majority of cases there is a regular order of succession. Thus it is frequently observed that the basic plagioclases are surrounded by a parallel growth of more alkaline species,

* George H. Williams. Inaugural Dissertation. "Die Eruptivgesteine der Gegend von Tryberg im Schwarzwald." Stuttgart, 1883, p. 23.

† J. P. Iddings. "Obsidian Cliff, Yellowstone National Park." Seventh Ann. Rep't U. S. Geol. Survey, 1888.

and plagioclase is sometimes surrounded by orthoclase, This order is seldom, if ever, reversed.

Hypersthene is generally the older when it is associated with augite or hornblende in parallel growths.

Augite is generally older than hornblende in the diorites, and acts as the nucleus. It is quite frequently inclosed by hornblende in the andesites, but it is oftener the younger mineral in the glassy rocks.

(b.) *Order of Crystallization of the Different Minerals.*

(1.) Where there has been but one series of crystallizations—that is, where each species of mineral belongs to one uninterrupted act of crystallization—the phenomena are presented in their simplest form. In this case it is generally observed that the oldest minerals are the iron ores, with zircon and apatite, followed in turn by one or more of the ferro-magnesian silicates, and the feldspars, with a feldspar and quartz as the last to crystallize. But when a number of different rocks are studied the order is not found to be the same in all of them; however, it is generally constant in all rocks of one kind.

In certain diorites the order is: iron ores, zircon and apatite, hypersthene, augite, labradorite, hornblende, biotite, oligoclase, and lastly orthoclase with quartz.

In many granites biotite precedes hornblende. In most diabases, and in many gabbros, the feldspars (anorthite or labradorite) crystallize before the augite and diallage. When olivine occurs in these rocks it is almost universally older than the other ferro-magnesian silicates.

Apatite is generally considered one of the oldest, if not the oldest, mineral crystallized in igneous rocks; but in an olivine-leucite-phonolite from Ishawooa Cañon, Wyoming Territory,* this does not appear to be the case. The rock is very rich in porphyritical crystals of olivine and augite in a

* Arnold Hague. "Notes on the occurrence of a new leucite rock, from Ishawooa Cañon, Absaroka Range, Wyoming Territory." To appear in the *Am. Journ. Sci.*, vol. xxxviii, Sept., 1889.

crystalline groundmass of orthoclase and leucite; long slender crystals of apatite occur in great abundance in the feldspathic minerals and are absent from the olivines and augites. The comparatively great length of these apatite needles, one being three hundred times longer than wide; their straightness, together with the total absence of fluidal or other orderly arrangement, indicate that they did not exist in the magma when the olivines and porphyritical augites were formed, nor while the mass was in motion. They must have crystallized after the olivine and augite, and after the magma came to rest, prior to the crystallization of the feldspar and leucite. The manner of occurrence of apatite needles in certain diorites also indicates that they were among the later crystallizations in these rocks.

(2.) In rocks where the same species of mineral occurs as the result of more than one period of crystallization—that is, where the crystallization has been interrupted—it is evident that the interruption may happen when only one or two of the mineral species have commenced to crystallize, or when all have progressed to different extents. In the second period of crystallization several or all of the minerals of the first generation may crystallize again in the groundmass. This is particularly the case with the iron ores, ferromagnesian silicates, feldspars, and quartz.

It is sometimes observed that the minerals belonging to the second generation differ from those of the first generation when they belong to isomorphous series. Thus it frequently happens that the feldspars composing the groundmass are more alkaline than those occurring as porphyritical crystals (*phenocrysts*). A difference is sometimes noticeable between the porphyritical hornblendes or pyroxenes and those taking part in the groundmass; but it often happens that no difference can be detected optically, and many minerals appear to be identical in both modes of occurrence. This is particularly true of magnetite, biotite, leucite, nepheline, and quartz. The porphyritical leucites and the microscopic ones of the

groundmass are often characterized by the same inclusions and the same twin lamination.

The importance of the identity of the minerals of first and second generation rests in the light it throws upon the influence, or the apparent lack of influence, of certain physical conditions on the crystallization of the rock-making minerals. It may be assumed that the large porphyritical crystals (*phenocrysts*) were formed much earlier than the microscopic individuals in the groundmass, and therefore that they were formed at much greater depths and under far greater pressure. But when it is observed that the small crystals in a holocrystalline groundmass, which were probably formed at or near the surface of the earth, possess exactly the same characters as those of crystals assumed to have been formed at very great depths, it becomes evident that in their case, at least, extremely great pressure is not necessary to their crystallization. The point is illustrated by the following occurrence: A holocrystalline dacite in the Yellowstone National Park occurs as a surface flow of lava connected with breccias. Its groundmass crystallized completely to a microcrystalline aggregation of quartz and feldspar, which undoubtedly formed after it came to rest at the surface of the earth. The porphyritical crystals consist of hornblende, biotite, plagioclase, and quartz. Some of these quartzes are idiomorphic; others are rounded. They carry numerous glass inclusions. The microscopic quartzes of the groundmass are nearly all idiomorphic, and exhibit the characteristic dihexahedral forms, interfered with slightly by the individuals of feldspar, which must have crystallized at about the same time. These minute quartzes carry dihexahedral glass inclusions like those in the large quartzes. From this it is evident that quartz with the same extraneous characteristics, such as outline and inclusions, may crystallize under comparatively slight pressure and also under very great pressure.

It oftener happens that the outline or shape of the minerals of second generation differs from that of the porphyritical individuals of the same species. This is because the

smaller ones continued their growth until they mutually interfered and produced the same structure as that of evenly granular rocks, which may be granitic, ophitic, or a combination of the two. The character of the inclusions is sometimes different in the minerals of first and second generation, or in the porphyritical individuals and in the so-called granitic ones of the groundmass. This indicates differences in the manner of crystallization in the two cases; but the identity of the mineral species is not affected by these extraneous differences. This is particularly well illustrated for so simple a mineral as quartz, where the difference between its porphyritical occurrence and its so-called granitic occurrence is confined to its outward form and the nature of its inclusions. For example, in a quartz-porphyrite occurring as an intrusive body near the surface of the cretaceous strata at Electric Peak, Yellowstone National Park, the finest-grained varieties of the rock carry small porphyritical quartzes in an extremely fine-grained groundmass. The quartzes are mostly idiomorphic and dihexahedral. Some are rounded. They carry crystallized inclusions resembling the groundmass, which also penetrates some of the individuals in pockets or bays. In the coarser-grained varieties of the same rock the porphyritical quartzes are larger and their outline more irregular. The inclusions of groundmass are coarser-grained. In the coarsest-grained varieties of the rock the quartzes are still larger. Many of them no longer exhibit even a rude dihexahedral form, but are quite irregularly shaped and inclose grains of feldspar. Some quartzes still exhibit a rude idiomorphic form. They have in many cases inclusions shaped like those in the quartzes of the finest-grained varieties, but the inclusions are coarser-grained and appear to be feldspar for the most part. The outer portion of these quartzes may be called granitic.

In this occurrence it is evident that the crystallization of the porphyritical quartzes in the finest-grained varieties of the rock was suddenly checked, and the groundmass formed as a distinct act of crystallization; but in the coarser-grained

varieties the crystallization of the porphyritical quartz continued uninterruptedly into the period of the crystallization of the groundmass, the substance of the quartz being the same in the outer portions of the individual, which have a granitic habit, and in the central portion, which corresponds to the porphyritical individuals in those parts of the rock where the early crystallization was suddenly checked. The final crystallization of this rock took place beneath the surface of the earth, but still at no very great depth. From such instances as this it is evident that the porphyritical crystals in many rocks were crystallizing while the magma was in motion, and did not cease their growth after it came to rest until the whole magma had crystallized.

Relation of Rock Structures to Geological Occurrence.—(1.) The degree of crystallization of igneous rocks is most intimately related to their geological occurrence. Glassy rocks are found where lavas have flowed out upon the surface of the earth, and also where small bodies have penetrated other rocks, the indications all leading to the conclusion that rock glasses are the result of rapid cooling.

Porphyritic, fine-grained rocks occur in the central portions of surface flows and in intrusive bodies, where the cooling was evidently slower than that which produced the glasses.

Most of the coarsely crystalline rocks are found in large intrusive bodies, or in those small bodies which appear to have been intruded in rocks already heated, where the cooling must have been extremely slow.

(2.) When the variations in the crystallization of a large body of rock are studied in connection with its geological occurrence it is sometimes observed that the variations, which are evidently due to local causes and can be traced to the immediate surroundings, affect the crystallization of all the minerals in the rock, proving that in these cases they were all crystallized in the position now occupied by the rock. Thus, in the case of a diorite that crystallized within a few thousand feet of the surface of the earth in cretaceous

strata, in that portion of it where the grain of the rock varies rapidly within a few feet, and where the crystallization of the coarse-grained portion undoubtedly took place after the magma ceased to move, it is observed that the various modes of crystallization not only affected the magnetite, ferro-magnesian silicates, feldspar, and quartz, but even the apatite and zircon; for it is observed that in the fine-grained varieties apatite occurs in great numbers of minute, idiomorphic crystals. In the coarser-grained varieties it is in fewer and larger crystals, and in the coarsest-grained varieties it occurs in very much fewer individuals, which are irregularly outlined, like all the other minerals in the rock. The zircons also are larger in the coarser-grained varieties of the rock. Hence it is evident that in this instance the oldest minerals in the rock crystallized very near the surface of the earth and under comparatively low pressure. The magma must have been entirely fluid when it came to rest, and was free from all kinds of crystals.

There are cases also where it can be shown that the crystallization set in after the magma reached the surface of the earth. Such is the case in the spherulitic obsidian flow which forms Obsidian Cliff, in the Yellowstone National Park.*

Relation of Rock Structures to Chemical Composition.—(1.) The degree or extent of crystallization of a rock also bears a very marked relation to its chemical composition. The basic rocks have a much greater tendency to crystallize than the acid and alkali rocks. Thus surface flows of basalt are almost always crowded with crystals, and pure basalt glasses are very rare, and are then in small bodies. The size of the individual crystals is generally larger than those of acid and alkali rocks of similar occurrence, and it is even probable that some coarse-grained gabbros may have been very large surface flows.

On the other hand, rhyolitic lavas are often almost entirely glassy; the microscopic crystals in them are very minute,

* Loc. cit., p. 248.

and frequently are ill-shaped, while rhyolitic obsidian occurs in great abundance and sometimes in large bodies.

The andesitic glasses are generally found to be more siliceous than the normal andesites to which they are related.

In the case of intruded rocks, which occur under similar geological conditions, that are about the same sized bodies and appear to have been intruded into rocks having about the same temperatures, it is also observed that the basic ones are more coarsely crystalline than the acidic.

(2.) The character of the structure also is intimately related to the chemical composition of the magma. Thus the ophitic structure is peculiar to certain basic rocks, such as the diabases and the dolerites, and a somewhat similar structure is characteristic of highly feldspathic rocks like syenites and certain diorites, where the feldspars crystallized in advance of some of the other minerals, and are more nearly idiomorphic. The evenly granular or granitic structure is more characteristic of the acid rocks, while a combination of these two extreme structures occurs in rocks of intermediate chemical composition.

Relation of the Mineral Composition to the Chemical Composition.—The relation between the mineral composition and the chemical composition of rocks is found to vary within certain limits, as already stated. The extent of this variation must continue for a long time to be the subject of careful investigation.

(1.) The study of a great number of suites of rocks from a large part of this continent shows that this relation is less variable among rocks of similar geological occurrence. Thus, when the volcanic rocks of a large area are compared, it is observed that the *basalts*, which represent the basic end of the series, in ninety-nine cases out of a hundred, have a uniform mineral composition. Over a very large portion of Western America they consist of lime-soda feldspars, augite, olivine, and iron oxides (magnetite or ilmenite). The less basic members of the series, the *pyroxene-andesites*, consist of

lime-soda feldspar, augite, hypersthene, and iron ores. They carry a variable amount of hornblende in many cases, whose connection with the chemical composition is quite variable, as it is so closely allied to augite chemically. The pyroxene-andesites grade into basalt chemically and mineralogically as they carry more and more olivine and less hypersthene. On the other hand, they grade into more acid andesites by increasing percentages of biotite, which characterizes the *hornblende-mica-andesites*. These rocks are composed of more alkaline lime-soda feldspar, biotite, hornblende, and a variable percentage of pyroxene and less iron ores.

As the chemical composition of the rocks varies toward the more siliceous end of the series, the last-named andesites pass into dacites with the development of quartz and sometimes sanidine, besides the oligoclase and biotite, with less and less hornblende and pyroxene. At the more acid end of the series are the rhyolites, characterized by quartz, sanidine, and a variable amount of lime-soda feldspar, with little or no ferro-magnesian silicates.

These are actual observations for large areas of country. When the mineral character of the rocks varies from this rule it can be traced in the great majority of cases to variations in the chemical composition. Thus the development of leucite at Leucite Hills, Wyo. Ter., can be traced to the large percentage of potash in the rock; the occurrence of nepheline in the Black Hills, Dak., to an increase in the soda. The mineral composition of the trachytes, phonolites, leucite basalts, and other volcanic rocks can be correlated with their chemical composition.

(2.) There are mineralogical variations, however, which do not appear to be connected with variations in the chemical character of the rocks; such as the occurrence of primary quartz in numerous basalts and andesites; of porphyritic crystals of hornblende in the basaltic rocks, or those of olivine in acid andesites and in some dacites, and of fayalite in rhyolitic obsidian. Such occurrences are widespread, but are, nevertheless, exceptional in the sense that they form a very

small portion of the whole number of occurrences. They appear to owe their origin to causes that are not ordinarily in control of the crystallization of these rocks, some of which have been discussed by the writer elsewhere.*

Relation of the Mineral Composition to the Geological Occurrence.—The mineral character of rocks of the same chemical composition is found to vary greatly with their geological occurrence and their mode of crystallization. The variation in the mineral composition of rocks derived from the same chemical magma and its relation to their geological surroundings is a fact to which sufficient attention has not yet been given. It is one of the greatest importance for the proper correlation and classification of rocks.

It is strikingly well illustrated by certain intrusive rocks at several localities in the Yellowstone National Park, which are the equivalents of the surface lavas. The study of these rocks shows that the mineral composition of the coarse-grained forms of the different magmas is quite different from that of the corresponding lava flows, the most noticeable difference being in the development of *biotite* and *quartz* in the coarse-grained varieties of those magmas, which, as glassy rocks, take the form of pyroxene-andesite or of hornblende-pyroxene-andesite.

The study also shows that a regular mineralogical variation among rocks of similar grain is found to accompany chemical variations. The regularity of these variations, however, is modified by the fact that the geological occurrence of a magma and the history of its physical experiences is different for different parts of one magma. This renders the discovery of the laws of rock crystallization the more difficult, and makes clear the necessity of an extremely close geological study of all such occurrences.

* Am. Journ. Sci., vol. xxxiii, Jan., 1887; *ibid.*, vol. xxxvi, Sept., 1888; Seventh Ann. Report U. S. Geol. Survey, 1888; also Bull. U. S. Geol. Survey, "On a group of igneous rocks from the Tewan Mountains, New Mexico." [Not yet issued.]

PART II.—CAUSES OF CRYSTALLIZATION.

Artificial Production of Rocks and Minerals.—Turning from the phenomena of crystallization to the consideration of the causes producing them, it is apparent that the evidence of direct observation is the most important, and should be considered first. The molten condition of volcanic lavas when they reach the surface of the earth testifies to the general condition of all igneous rocks previous to their solidification, and shows that we have to deal with the crystallization of molten magmas.

The experiments of James Hall,* Gregory Watt,† Daubrée,‡ Fouqué, and Michel-Lévy § upon the production of crystalline rocks by artificial processes have demonstrated that certain kinds of rocks can be produced by the simple cooling of fused magmas having the requisite chemical composition.

The synthetical researches of Fouqué and Michel-Lévy are of special importance because of their extent and the identity of the products they obtained to those occurring in nature. They succeeded in producing by purely dry fusion and gradual cooling at ordinary pressures a large number of the rock-making minerals, including anorthite, labradorite, oligoclase, nepheline, leucite, augite, enstatite, olivine, melilite, magnetite, and picotite. They also obtained certain basic rocks, as basalt, diabase, augite-andesite, nephelinite, leucitite, and lherzolite, and thereby proved that these rocks can be formed by the gradual cooling of magmas from a condition of purely igneous fusion at low pressures.

* James Hall. "Experiments on whinstone and lava [1798]." *Trans. Roy. Soc. Edinburgh*, vol. 5, 1805, pp. 43-76.

† Gregory Watt. "Observations on basalt and on the transition from the vitreous to the stony texture which occurs in the gradual refrigeration of melted basalt, with some geological remarks." *Phil. Trans. Royal Soc.*, London, 1804, p. 179.

‡ A. Daubrée. *Études synthétiques de géologie expérimentale*. Paris, 1879, p. 517.

§ F. Fouqué and Michel-Lévy. *Synthèse des minéraux et des roches*. Paris, 1882.

They also observed the great tendency of augite and enstatite to crystallize out of a cooling magma, and remarked that the magma must be cooled very rapidly to prevent their partial separation from it.* Nepheline crystallizes rather easily, and the feldspars less so, while a certain group of the rock-making minerals fail to crystallize at all under the conditions of purely igneous fusion at ordinary pressures. These minerals are quartz, orthoclase, albite, mica, and hornblende.

It is to be observed that the last-named minerals are those that characterize the more acid rocks, which it has been remarked more frequently occur in a glassy condition than the basic ones, the latter exhibiting a greater tendency to crystallize than the former when subjected to the same physical conditions.

On the other hand, quartz, orthoclase, and albite† have been produced artificially at high temperatures in the presence of water vapor and other gases under high pressure, and mica has been produced by the simple fusion of silicates with fluorides.‡ This has led many investigators to the conclusion that the crystallization of rocks composed of these minerals requires the assistance of a mineralizing agent in the condition of an absorbed vapor. The influence of absorbed vapors to promote crystallization has been observed in the production of artificial glasses, where it is found necessary to free the molten glass from gas bubbles to prevent its devitrification upon cooling.

The results of experimentation are far from the solution of the problem before us. They have not as yet succeeded in producing the minerals—quartz, orthoclase, mica, and hornblende—in the manner in which they occur either in

* Loc. cit., p. 49.

† Friedel and Sarasin. Bull. Soc. Mineral. France, vol. 2, 1879, p. 158; *ibid.*, vol. 3, 1880, p. 171; Comptes rendus Acad. Sci., Paris, vol. 92, 1881, p. 1374; *ibid.*, vol. 97, 1883, pp. 290-294; K. von Chrustschoff. Am. Chemist, 1873; Tschermak's min. pet. Mittheil, vol. 4, 1882, p. 536.

‡ Hautefeuille. Comptes rendus Acad. Sci., Paris, vol. 104, 1887, p. 508; K. von Chrustschoff. Tschermak's min. pet. Mittheil, vol. 9, 1883, p. 55. C. Doelter. Tschermak's min. pet. Mittheil, vol. 10, 1889, p. 67.

volcanic rocks or in the coarsely crystalline ones; nor have they produced the feldspars in those isomorphous series so common to eruptive rocks. In this respect they have only suggested the possible necessity of a mineralizing agent, and have indicated the lines upon which further research should be made.

Conclusions Based upon Analogy.—Leaving the firm ground of direct experimentation for the uncertain footing of speculation, we come to the consideration of the probable nature of molten rock magmas.

In 1861 Bunsen pointed out the correspondence between rock magmas and solutions of salts. Calling attention to the fact that the order of crystallization of the essential minerals in granite was not in accord with their fusibility, and that their order of separation from the magma upon its cooling was not that which should be expected if they existed in it simply as fused substances, it corresponded to what would happen if they were in solution in one another and obeyed the laws governing the solution of salts. He remarks that "no chemist would think of assuming that a solution ceases to be a solution when it is heated to 200, 300, 400 degrees, or when it reaches a temperature at which it begins to glow, or to be a *molten* fluid. Thus, for example, he would not think of assuming that a mixture of ice and crystallized calcium chloride, which has become fluid, is indeed a solution, but that a fluid mixture of quartz and feldspar is not, because it becomes fluid at a red heat. No one can longer entertain the slightest doubt that that which holds good for solutions at lower temperatures must also *hold good for solutions at higher temperatures.*"*

Schott† considered glasses as supersaturated solutions analogous to salt solutions, and Lagorio,‡ in 1887, assumes that

* R. Bunsen. *Zeitschr. deutsch. geol. Gesell.*, vol. 13, 1861, p. 62.

† Schott. *Poggendorff, Annalen*, vol. 154, p. 422.

‡ A. Lagorio. "Ueber die Natur der Glasbasis, sowie der Krystallisationsvorgänge im eruptiven Magma." *Tschermak's min. pet. Mitth.*, vol. 8, 1887, p. 437.

a molten rock magma is nothing more than a supersaturated solution of different silicates, which only need a slight incentive, according to the degree of saturation of each compound, in order to crystallize out as rock constituents. He discusses at length the crystallization of magmas from a chemical standpoint, and the influence of his views upon the present paper may be recognized in many places.

In the light of our present knowledge, or in the absence of any knowledge to the contrary, this seems the most reasonable hypothesis as to the nature of rock magmas.

It is to be remarked that in considering these magmas with respect to their crystallization we have only to deal with them near their point of solidification, and therefore have no need of considering their possible condition at excessive temperatures.

It is also to be remembered that the actual chemical status of solutions and the physical conceptions of fusion and solidification are as yet unsolved problems of the most essential nature. Nevertheless, some of the laws governing the crystallization of solutions have been investigated to a certain extent, and have been formulated by Sorby.* He found that the crystallization of those salts that condense upon crystallization from a fluid condition is aided by an increase of pressure, and that the reverse is true for those which expand upon crystallization. The silicate rock-making minerals are found to belong to the former class, for their crystallized condition is denser than their amorphous or glassy modification, and these glasses are denser than the molten substance at the same temperature. Hence it is assumed that when they exist in a fluid magma a diminution of pressure would lower the point of temperature at which they would crystallize out of the magma; or, expressed differently, if a magma were on the point of crystallizing under a particular pressure and temperature, a diminution of the pressure would prevent the crystallization by decreasing the degree of saturation, and

* Proc. Roy. Soc., London, vol. 12, 1863, p. 538.

would make it necessary for the temperature to be lowered before the proper degree of saturation was reached.

The effects of temperature and pressure on such solutions near their point of crystallization are consequently the reverse of one another. An increase of temperature hinders crystallization; a decrease of temperature induces it. An increase of pressure induces crystallization; a decrease of pressure hinders it.

It is well known that salts differ greatly in their solubility and in the tendency they possess to saturate a solution; or, in other words, that a solvent may take up different amounts of various substances before becoming saturated. The amount is generally greater as the temperature is higher. A solution that is saturated at a certain high temperature becomes supersaturated as the temperature is lowered and parts with the excess of the dissolved substance, which crystallizes out. It is possible to render a solution highly supersaturated by cooling it very gradually and quietly.

The relative tendency of various chemical compounds that occur in rocks to saturate siliceous magmas has been investigated by Pelouze* and others, who experimented on artificial glass to discover what amount of these compounds could be introduced into the glass without producing devitrification or crystallization. The results of these experiments are summed up by Lagorio,† in the paper already cited, as follows: "Potash silicates saturate molten silicate solutions with great difficulty, the same is true of alumina; soda silicates more easily, then follows CaO, MgO, as well as the oxides of the heavier metals (FeO more difficultly than Fe₂O₃), as well as titanium and zirconium. SiO₂ saturates silicate solutions with difficulty." Hence the order in which these compounds tend to saturate silicate solutions, commencing with that having the strongest tendency, is as follows: Ti and Zr, Fe₂O₃, FeO, MgO, CaO, Na₂O, SiO₂, Al₂O₃, K₂O, the position of silica not being definitely stated.

* Comptes rendus Acad. Sci., Paris, vol. 64, 1867, p. 53.

† Loc. cit., p. 501.

Application of the Foregoing Conclusions to Rock Magmas.

Saturation of Rock Magmas.—From the foregoing observations we may reasonably conclude that the *degree* of saturation of natural molten glasses or rock magmas will depend on the temperature and pressure at which they exist. In a perfectly molten state the relation between the temperature and pressure is such that all of the compounds remain in solution. The *character* of the saturation will depend primarily on the relative amounts of these chemical compounds, which are present in all rock-magmas in variable proportions.

In a *cooling* magma which originally was perfectly molten we may imagine the rate of cooling such that crystallization is possible; then as the temperature decreases a point will be reached where some one or more of the chemical compounds supersaturates the solution and begins to crystallize out. At a lower temperature a point is reached where another combination must crystallize out, and so on until the whole mixture has solidified—it may be to a complete mass of crystallized compounds or to a mixture of crystals and amorphous, uncrystallized glass.

(1.) The nature of the compound that crystallizes first will depend primarily on the chemical make-up of the magma, and will vary accordingly. From the order already given of the ability possessed by the chemical compounds in question to saturate such a solution, it appears that it requires a smaller amount of the iron oxides and magnesia than of lime, and a still smaller amount of these than of the alkalis and alumina to saturate the magma. Hence, if they occurred in nearly equal quantities, the first compounds to separate out would be the ferro-magnesian silicates, followed by those bearing lime and alumina, with more or less of the alkalis, while the last to separate would be the alkali-aluminous silicates and free silica. This order would be maintained if the proportion of the first-named compounds increased, but

would not obtain if the amount of the silica and alkalies passed a certain limit. In the latter case it should happen that the alkali-aluminous compounds and free silica crystallize before the ferro-magnesian compounds.

It is to be remarked that in a cooling solution of various compounds, when a point is reached where certain of the compounds are in excess of what the solution is then capable of holding dissolved, this excess is crystallized out and the relative proportions of the various compounds is changed. In a subsequent phase of the cooling another compound may reach the point of excess and it may start to crystallize. In this manner a number of crystallizations may take place beside one another, though they started to crystallize at successive periods of the cooling.

In the case of magmas highly charged with silica and the alkalies it is probable that the early separations would consist of these compounds, and that the ferro-magnesian compounds would crystallize later and would finish their separation before the alkali compounds and the free silica did.

(2.) The exact chemical nature of compounds when in solution is as yet little known; their mutual relations when in a mixed solution is still less understood. The influence of the temperature and pressure upon their crystallization from mixed solutions has not been determined for a sufficient number of substances to lead to general conclusions; but enough has been observed to indicate that the resulting crystallizations vary within certain limits according to the physical conditions under which they separate from mixed solutions.

Hence it should happen that chemically similar magmas that cool under similar physical conditions should crystallize alike, and that differences in the nature of the crystallization of such magmas should indicate differences in the physical conditions attending their cooling. Further, that chemically different magmas which cool under similar physical conditions should differ in the nature of their crystallization according to their chemical variations; and, finally, that if one

magma cools under a variety of physical conditions which obtain for different portions of its mass the resulting crystallization should vary with the changes of physical conditions.

If the variations in the physical conditions which attend the crystallization of the great majority of magmas are confined to a certain range the corresponding differences in the crystallization will also be limited, and will be recognized as of frequent occurrence. Greater variations in the physical conditions would lead to less frequent variations in the crystallization, both of which would be considered exceptional. By crystallization is to be understood both the kind of minerals developed and the structure they assume.

(3.) These theoretical conclusions agree with the general observations already stated, that among rocks of similar geological occurrence—that is, where the physical history of the crystallization has been similar—the mineral composition of the different kinds of rocks varies according to the chemical composition; that among rocks of different geological occurrence—that is, where the physical history has been different—the mineral composition of rocks of similar chemical character varies according to the geological occurrence.

To these rules there are many apparent exceptions; but it must be remembered that only a portion of the physical history of the crystallization of any rock can be discovered by observation, and that the greater part of it must be derived by indirect methods, if at all. Thus it is possible to judge in many cases of the conditions under which crystallization took place after a magma came to rest from the geological environment in which we find it afterwards; but there is no direct means of observing what conditions it passed through before coming to rest.

Consideration of Magmas during Their Eruption.—The general nature of the physical changes experienced by a magma previous to its coming to rest can be understood if we consider the act of eruption of igneous magmas.

In this consideration we shall start with a molten, fluid

magma about to rise from a great depth through its conduit toward the surface of the earth. Whether it contains any crystal secretions at this stage we have no means of judging, for it has been observed that all of the rock-making minerals are capable of crystallizing at or near the surface of the earth, and none demand an unusual depth for their formation. On the contrary, it has been observed that molten magmas frequently reach the surface or to near the surface without having commenced the crystallization which often leads to their complete separation into minerals.

(1.) As the magma rises through its conduit the *pressure* will diminish in proportion to the vertical distance traversed. The *temperature* will also diminish, but according to the loss of heat by conduction through the walls of the conduit. This loss will be more variable than that of the pressure, and will proceed at a different ratio to the distance traversed. As it depends primarily on the temperature of the walls of the conduit and on their conductivity, it is readily seen that the rate of decrease of temperature will be much less at first, when the hotter rocks near the original seat of the magma are being traversed, than when the cooler rocks near the surface of the earth are passed through. Hence the loss of heat will be slow at first and more rapid toward the end of the eruption, while the decrease of pressure will be more nearly uniform.

Now, since the effects of heat and of pressure upon fluid rock magmas have been assumed to be the opposite of one another, though not necessarily in a directly inverse ratio, it is seen that a rapid decrease of pressure might more than offset a slower loss of heat, and the result would be equivalent to an increase of heat. Thus the magma might at first become more fluid and farther from the point of saturation and crystallization than before its eruption.

If we assume that the *rate of ascension* in the conduit is *uniform*, it is apparent that the ratio between the loss of heat and the decrease of pressure will increase as the magma

approaches the surface. At some particular moment the ratio between them may be such that the rate of loss of the heat exceeds that of the decrease of pressure, and the magma reaches a degree of saturation that necessitates the crystallization of certain of the compounds in solution. As long as the changes in the heat and pressure continue in the same direction the crystallization of the magma will progress.

When the magma reaches the end of its eruption the pressure will remain very nearly constant, while the heat will continue to decrease, but at a different rate, which will depend on the environment of the magma. It may decrease more slowly or more rapidly, and with it the character of the crystallization will vary.

When a column of magma has come to rest and fills its conduit the pressure at various places in the column will remain nearly constant, but will be greater from point to point downward. The temperature will continue to decrease by conduction through the walls of the conduit, but from what has already been said it is probable that the temperature of the conduit's walls will be greater downward, and the actual temperature of the magma will also be greater downward. The rate of the loss of heat by conduction will probably decrease as the distance below the surface of the earth increases; hence the magma should cool much more slowly at great depths than near the surface; but the effect of the increased pressure upon deeper and deeper portions of the magma would be to increase the degree of saturation for any given temperature or to raise the point of temperature at which supersaturation and crystallization sets in. It would consequently tend to counteract the effect of the increase of temperature in the deeper portions of the magma and the slower rate of cooling, and would produce greater uniformity in the crystallization which takes place at various points in a vertical column of magma.

From the study of volcanic phenomena we know that the act of eruption is not always a uniform movement of a magma from great depths to its final place of rest; that its

conduit is not a regularly shaped orifice, but a very irregular one, constantly changing in width and cross-section, and that the experience of various magmas which traverse the same conduit must be very different.

(2.) Thus the later of a series of eruptions may pass through a conduit whose walls have been heated by the magmas that previously passed through it. Indeed, the latter end of a large body of magma will pass through hotter rocks than the advance end of the magma encountered. Consequently the rate of cooling will be different in the later and earlier magmas, and even in the ends of the same magma. It may therefore happen that the crystallization of the first part of a great body of magma will start earlier in the eruption and lower in the conduit than the last part of the same body, and the character of the crystallization may differ greatly in these parts of the magma.

(3.) It is also probable, in the case of a large conduit permitting the passage of a broad body of magma, that the rate of cooling at the sides of the body near the walls of the conduit will be greater than the rate of cooling at the center of the mass. Consequently the crystallization may commence at the sides before it does in the center, and the nature of the crystallization vary from the sides towards the center. This is illustrated by large intrusive bodies which have stopped in their conduits and which exhibit distinct differences of crystallization at the sides and center. The sides of such bodies often exhibit a porphyritic structure with medium-grained groundmass and porphyritical crystals (*phenocrysts*) of quartz, feldspar, or other minerals, according to the rock, while at the center the structure is granitoid or coarse-grained, with no porphyritical crystals (*phenocrysts*). The compounds which crystallized from the magma at the sides of the body with the character of porphyritical minerals crystallized from the magma at the center of the body with the characters of allotriomorphic or granitic minerals. In some of these cases it is apparent that the porphyritical crystals (*phenocrysts*) de-

veloped before the magma came to rest, for the groundmass exhibits flow structure, while it may be equally evident that all of the minerals at the center of the mass developed after the magma came to rest.

(4.) The progress of a magma through its conduit may not be at a uniform rate. In fact, it could not be uniform if the shape and size of the conduit varied. It must travel faster through the narrower portions than through the broader. Moreover, its progress is often spasmodic, rising a certain distance and discharging the advance portion out at the surface, or into gaps in the superficial crust where planes of weakness divide the rock; then standing, or even sinking, in the conduit until another combination of forces causes it to rise still farther.

The effect of a rapid increase in the rate of ascension in the conduit would relieve the pressure at a faster rate, which might gain on the rate of cooling to such an extent as to destroy the previous ratio between them. Its effect would be equivalent to an increase of temperature. If this ratio had previously been that which caused the supersaturation of the magma and induced crystallization, the newly diminished ratio would have the effect of reducing the degree of saturation and of hindering further crystallization, or might even lead to the dissolving of the minerals already separated out—that is, of resorbing them.

Thus it may happen that the porphyritical crystals (*phenocrysts*) in a magma may be partially resorbed during the ascension of the magma, not by an increase of temperature, but during its actual decrease, the cause of the resorption being the rapid diminution of the pressure.

When the balance between the temperature and pressure oscillated about the point of saturation of the magma the development and retardation of crystallization might be often repeated, as it appears to have been in certain zonally built minerals with irregular, rounded zones of resorption.

Before leaving the subject of the resorption of crystals it

may be well to consider how the re-resolution of minerals would take place when several kinds existed in the same magma.

If the magma, upon cooling under decreasing pressure, reaches a point where the molecules of one kind of mineral can no longer remain in solution, they crystallize out; and at a subsequent point the molecules of a second kind of mineral can no longer remain in solution, and they crystallize out; and so on until three or four kinds of minerals have crystallized out of the magma. If, now, the ratio between the temperature and pressure diminishes, so that the result is a greater capacity of the magma to contain matter in solution, then the mineral molecules should be resorbed in the reversed order to that in which they were excluded from solution; for the tendency of a substance to saturate a solution is in a measure inversely proportioned to its solubility in the solvent. Hence the relative solubility of minerals in the solution out of which they have crystallized should be inversely as their power to saturate it. Thus the mineral which crystallized last would be the first to be resorbed. Consequently the *youngest* mineral should exhibit the greatest amount of resorption.

Rate of Cooling and Rock Structures.—It appears to be unquestionably the rule that the crystallization due to slow cooling proceeds from a comparatively few centers, while that due to rapid cooling proceeds from a much greater number of centers closer together. Hence the slower rate of cooling which a magma may experience in the earlier stages of its eruption will lead to the crystallization of a comparatively few individuals of any mineral. These may grow to considerable size before the rate of cooling is sufficiently increased to set up crystallization from a greater number of centers. Such a change would start other individuals of the same mineral that would not reach the size of those started earlier, which may continue growing. In this manner there may be produced a porphyritic structure in which there is a grada-

tion in the size of the crystals of one or more of the essential minerals, from the largest porphyritical individual to the smallest, which occur in far greater numbers in the groundmass. Such structures are common among the andesites.

It is evident that a sudden increase in the rate of cooling would produce a fine-grained groundmass with distinct porphyritical crystals (*phenocrysts*).

Where the magma retained sufficient heat during its eruption to prevent the separation of crystals early in its history it would reach its stopping place without porphyritical crystals (*phenocrysts*). The structure would then result from a nearly uniform rate of cooling, and would become comparatively even-grained if the magma was homogeneous. The rate of cooling would affect the size of the grain, which might be extremely fine or very coarse.

Extremely rapid cooling would prevent all crystallization and would solidify the mass as glass.

Relative Influence of the Various Causes of Crystallization in Rock Magmas.—(1.) When we consider the relative importance of the causes leading to the crystallization of rock magmas we conclude that of the various factors treated of in the foregoing discussion the most evident and essential is the loss of heat, or *cooling*. All igneous rocks have solidified as cooling bodies from a fluid state, and so long as their original temperature existed they would not have crystallized under the conditions existing near the surface of the earth.

It is also evident that the element of *time* is almost as essential as that of cooling; for it is known that a certain amount of time is necessary for the development of crystals, and that very rapid cooling may solidify any rock magma in the form of glass. The *rate of cooling*, therefore, becomes the compound factor whose influence is to be compared with that of the *chemical composition*, *mineralizers*, and *pressure*.

The relative efficiency of these factors, which have taken part in the crystallization of most if not of all rocks, can be

ascertained to a certain extent by comparing occurrences where the relations of two or more of them are known.

To judge of the influence of the *rate of cooling* we must compare instances where similar magmas or parts of one magma have crystallized under the same or similar pressures, and where the mineralizer, if present, has been uniformly disseminated through the mass. These conditions are often realized, and may be found between neighboring points in a chemically homogeneous body, as in a horizontal plane across a broad dike. The crystallization often varies very decidedly in a rock body in such connection with its sides or cooling surfaces that it plainly indicates the great influence of the rate of cooling. It is more strongly marked where bodies of different sizes have crystallized under essentially the same pressure.

(2.) The influence of the *chemical composition* of the magma upon the extent or degree of crystallization appears to stand next in importance. It is very clearly recognized when bodies are compared that have crystallized under similar geological conditions, which indicate very nearly the same rates of cooling and degrees of pressure, the basic magmas exhibiting a much greater tendency to crystallize than the highly siliceous or alkaline ones.

(3.) The influence of a *mineralizer* is very apparent in some instances, and can be appreciated by studying a portion of a rock body which has solidified under a uniform pressure and rate of cooling, but in which the mineralizing agent has been irregularly distributed. It is then observed that the crystallization varies conspicuously with the mineralizer. Such cases have been noted in spherulitic and laminated obsidian and rhyolite and in those with lithophysæ.

The cases in which the influence of a mineralizer can be recognized are very much fewer than those in which the effect of cooling or of the essential chemical composition is observed. Hence it appears to be a much less important factor than either of these. If a mineralizer be uniformly

distributed through a magma, however, its influence may be overlooked.

(4.) The influence of *pressure* upon the crystallization of magmas, judged by the evidence presented by the phenomena of crystallization, appears to be slight; for it has been observed that all of the rock-making minerals, including the earliest to crystallize, may form under very great pressure, and also under comparatively slight pressure, being developed in some instances on or near the surface of the earth, and it is not possible to determine from the character of the crystals themselves whether in a particular case they were formed near the surface or thousands of feet below it.

Portions of the same magma that have crystallized a thousand or more feet from one another vertically exhibit the same minerals and structure where the rate of cooling was about the same.

But it has already been remarked that the influence of greater pressure on deeper portions of a magma may offset the influence of slower cooling and equalize the crystallization at different depths in a column of magma. In this case the influence of pressure on the crystallization of rocks at different depths may easily be miscalculated, as the rate of cooling in any case is entirely conjectural.

With the exception of tridymite, which is almost exclusively confined to surface lavas, and whose development is probably due to mineralizing agencies and is often accompanied by the crystallization of quartz, there is no dimorphism among the rock-making minerals. Their essential crystallographic characters are the same, whether they were formed early in the history of the magma or late.

There are optical anomalies in certain minerals, such as leucite, which indicate that the crystal form or character assumed at the time of crystallization is not that which is stable under present conditions; but this is equally true of those crystals that were formed at great depths as of those that were formed much nearer the surface of the earth, and appears to arise from the change in the temperature under

which it has existed; for it has been found*, in the case of leucite, that simple heating obliterates the optical anomalies and twin lamination, and restores the mineral to what was undoubtedly its original crystal character. Hence the range of physical conditions under which igneous rocks have crystallized does not appear to have been great enough to have produced dimorphism, with the exception of the often contemporaneous production of quartz and tridymite.

Condition of Rock Magmas Previous to Crystallization.—Finally, when it is remembered that most of the porphyritical or older minerals in glassy rocks carry glass inclusions with comparatively large gas bubbles, the diameter of the bubble being half that of the whole inclusion in some instances, which is often the case with quartz; and when it is considered that these bubbles indicate either that the glass has contracted upon solidification and has become so much denser than when first inclosed in the mineral at some great depth, or else that gas actually existed in the magma at the time of the inclosure as a gas with the volume of the bubble, and has not condensed to a liquid state, we may reasonably conclude that the ordinary phenomena of the crystallization of igneous rocks do not indicate the existence of extraordinary physical conditions at the commencement of the crystallization of their magma, and that they throw no light on the possible condition of these magmas previous to the molten fluid state in which crystallization began.

Conceptions of such previous conditions, if they are to be gotten at all, must be derived from the consideration of other phenomena than those exhibited by the ordinary crystallization of igneous rocks.

Résumé.

There are numerous facts concerning the crystallization of igneous rocks that are familiar to all students of petrography,

* C. Klein. Neues Jahrb. Min., etc., 1884, II, p. 50; S. L. Penfield, *ibid.*, 1884, II, p. 224; H. Rosenbusch, *ibid.*, 1885, II, p. 59.

which have not been discussed in this paper. Some of them may have a direct bearing on the points here raised. Many of them are more closely connected with certain phenomena which belong to another phase of the question which has been intentionally left for another paper, the purpose of the present paper being to present only the essential facts which seem to contribute to an understanding of the act of crystallization and of the nature of rock magmas. The facts concerning the phenomena of crystallization have been arranged so as to show:—

The general structure of different igneous rocks and the manner in which the mineral crystals occur in them.

The various kinds of minerals composing the rocks, their chemical nature and association in different rocks.

The character of these minerals as crystals and the means of distinguishing their relative age in glassy and in holocrystalline rocks.

The nature of the inclusions in these minerals, their kinds, mode of occurrence, associations, and their significance.

The zonal structure of certain minerals and its significance.

The tendency of certain minerals to include certain other substances and minerals; to crystallize together as synchronous intergrowths or as successive parallel growths.

The crystallization of the constituent minerals in one continuous period or in two or more interrupted periods.

The order in which these minerals crystallize and its variability for different kinds of rocks.

The essential difference between minerals of different generations in some cases.

The essential identity of minerals of different generations in other cases and its important bearing on the apparent influence or lack of influence of the pressure under which these generations took place upon the nature of the minerals crystallized.

The extraneous differences between minerals of different generations in one rock combined with identity of mineral substance.

The relation of rock structures to the geological occurrence of glassy fine-grained and coarse-grained rocks.

The instances where all of the crystallization took place after the magma reached to within a short distance of the surface of the earth.

The relation of rock structures to the chemical composition of the rock, showing its effect on the extent of crystallization and the character of the structure.

The relation of the mineral composition of rocks to their chemical composition for rocks of like geological occurrence, with a notice of certain exceptions.

The relation of the mineral composition of rocks to their geological occurrence, and the consequent variation of the mineral composition of rocks having like chemical composition.

In discussing the probable causes that have led to the crystallization of these rocks attention was first turned to the results of direct experimentation, which show—

That certain basic rocks and their component minerals can be produced by the gradual cooling of their fused material under slight pressures.

That the pyroxenes have a great tendency to crystallize under such conditions, and that nepheline and lime-soda feldspars crystallize less easily.

That certain minerals characteristic of the acid rocks have not yet been produced in this way.

That the latter minerals have been produced with the aid of mineralizing agents.

From analogy with the crystallization of saturated solutions of salts it seems highly probable that molten rock magmas are saturated solutions of silicate compounds and certain oxides.

The exact laws governing the crystallization of salts from mixed solutions have not been determined, and nothing is known regarding the actual behavior of rock magmas under different physical conditions. It is assumed that Sorby's

law holds for solutions at high temperatures and great pressures.

The results of the experiments of Pelouze and others upon the saturation of artificial glasses are applied to the saturation of natural glasses, and the conclusions drawn—

That the degree of saturation of rock magmas depends primarily on the temperature and pressure.

That the character of the saturation depends primarily on their chemical composition.

That in cooling magmas the order of crystallization will depend primarily on their chemical composition.

That the nature of the crystallization should vary with the physical conditions attending solidification.

The consideration of magmas during their eruption takes account of—

The uniform decrease of pressure accompanying the ascension of the magma in its conduit.

The accelerated decrease of temperature as it approaches the surface of the earth, and its resultant influence on the saturation of the magma.

The changes in the temperature of the walls of the conduit, which may become highly heated and permit the magma to reach the surface of the earth before crystallization sets in.

The effects of large conduits in producing different rates of cooling at the sides and in the center of large bodies of magma.

The variability in the velocity of eruption and the retardation of crystallization, or the resorption of crystals.

It appears that the order of resorption should be according to the solubility of the minerals, which is inversely as their power to saturate the solution. Consequently the last mineral crystallized should exhibit the greatest amount of resorption.

The rate of cooling affects the grain of the rock—slow cooling producing fewer and larger crystals; rapid cooling,

more abundant smaller crystals; and extremely rapid cooling preventing all crystallization.

The order of importance of the factors bringing about crystallization appears to be as follows:

Cooling and a certain amount of

Time, or the *rate of cooling*;

Chemical composition of the magma;

Mineralizing agents;

Pressure, its direct effect not having as yet been recognized.

The phenomena of the crystallization of igneous rocks indicate that they were fluid molten magmas previous to crystallization, and throw no light on the previous condition of these fluid magmas. /

REDUCTION OF PENDULUM OBSERVATIONS.

BY

ERASMUS DARWIN PRESTON.

[Read before the Society by permission of the Superintendent of the U. S. Coast and Geodetic Survey, May 25, 1889.]

Every physical investigation involves certain determinable quantities. The accuracy attainable in the measurement of these quantities depends on various external conditions, to a certain extent beyond our control, but which, from the very fact that they bear on some one final result, have a certain degree of correlation. If from reciprocally imposed relations between the quantities sought and the data bearing on the solution of the problem the accuracy of the result is limited, all auxiliary quantities should be determined with especial reference to this degree of accuracy. In the process of finding chronometer corrections from star observations the refinement in the determination of any one of the auxiliary quantities—*i. e.*, in the correction for aberration, level, azimuth, and collimation—should not be pushed beyond that possible in the final result. When a time-piece, from the nature of its mechanism, cannot be expected to indicate true time—that is, to run uniformly with an error less than one-tenth of a second—the application of the correction for diurnal aberration becomes superfluous. This same principle, namely, that the strength of any investigation in physics is the strength of its weakest part, is everywhere applicable, and it is proposed in the present paper to examine recent work with the pendulum with reference to the degree of accuracy attainable or desirable in the determination of the corrections usually applied to the observed period of oscillation.

The time of vibration is subject to a number of corrections, of which the most important are: *First*, for the rate of the time-piece to which the period is referred; *second*, the reduction to an infinitely small arc; *third*, the correction for temperature, and *fourth*, the atmospheric correction. This last is usually divided into two parts, one of which is statical and depends on buoyancy alone, and the other is dynamical and results from the influence of the air which is set in motion by the pendulum. The first part, being merely a question of the relative densities of the oscillating body and the fluid by which it is surrounded, can easily be found by calculation. The second part, depending on the viscosity and humidity of the air and on the form of the pendulum, can only be computed for certain simple geometrical forms. It is now customary, however, to determine them together, by making observations under widely different atmospheric pressures. The temperature correction is susceptible of two independent determinations: either by measuring the coefficient of linear expansion of the metal composing the pendulum, and by computation, deducing the correction for one oscillation, or by swinging at very different temperatures and noting the change in the period due to a given change in the temperature. Of the other corrections to the observed period of oscillation—that is, for the slip and wear of the knives, the flexure of the support, and the stretching of the pendulum by its own weight—we shall not speak in the present paper, merely remarking that in relative determinations of gravity they may in general be dismissed from consideration, except in so far as is necessary to assure ourselves that their amounts do not change from station to station enough to vitiate the results of the observations, considered now purely as differential work.

In the first place, let us see what has been the general experience by modern observers in the measurement of the time of oscillation of a seconds pendulum. Whether we examine the results of the invariable, reversible, or convertible instrument, the discrepancies in the separate observa-

tions, reduced of course to the same conditions, are not widely different. This supposes the conditions to be not abnormal ones; because if the observations are made in an extremely rarefied atmosphere, or at a very high temperature, or through a wide amplitude for the purpose of studying these conditions, manifestly discrepancies found here should not be taken as a criterion by which to judge this class of work in general, and at ordinary conditions. For swings that have a duration of four or five hours, and in a series having half a dozen sets, we get a range between extreme values of slightly more than a second per day. This is equivalent to differences between the independent measures of the period of one hundred thousandth part. We may therefore assume this to be a standard of accuracy, with reference to which the auxiliary quantities should be determined.

The accuracy of any determination of time, as given by a chronometer or clock, varies with the mechanism of the time-piece and the conditions under which it is running. The modern custom of making pendulum observations extend through the entire 24 hours, eliminates to a great extent the variations of rate; and when stars are obtained every night, the values given each swing are almost—and those given for each day are entirely—independent of the clock. But since, when the pendulum swings in the air, we are confronted with independent values extending over only a small fraction of the day, any variations of the clock rate are made apparent, and it becomes necessary to know to what extent the apparent discrepancies may be attributed to the imperfection of the time-piece; and the shorter the swing, the more pronounced becomes these discrepancies. The unit chosen for discrepancies will be one in the sixth place of decimals—that is, one-millionth of a second. The Kater pendulums, beginning with an arc of vibration of 1° , will swing six hours before falling to an arc of $10'$. Peirce's pendulums will swing $4\frac{1}{2}$ hours with the heavy end down, and $1\frac{1}{2}$ hours with the heavy end up. The Repsold pendu-

lum swings but little over one-third as long. Now it is well known that the best made clocks give variations from the mean daily rate of one or two tenths of a second for different hours when the temperature changes more than a few degrees. Admit one and one half tenths for 15,000 oscillations and we have a discrepancy of 20 between different swings. This is slightly greater than those usually found, but we have supposed the variations on each side of the 15,000 oscillation period to be equal and in opposite directions, which is an exceptional case. At the greatest elevation in India, the English had variations of temperature of 26° daily, and a two-hourly rate variation of the clock from the mean that would amount to 24 seconds per day, which would give a range in the discrepancies for a 15,000 oscillation period of about 70.

The extreme range of temperature at a Coast Survey station during a period of eleven days, 10,000 feet above sea level, was 16° centigrade, and we have a range of about 40 in the observed discrepancies. This range of temperature of 16° was not that to which the pendulums were subjected during the experiments; it is that of the air surrounding the chronometers. The variation in the pendulum house was about 11° centigrade. On the other hand, experiments made by the same observer and with the same pendulums only show a range of 4 in the discrepancies at the Lick observatory. Here however every condition with regard to the time determination was of the most favorable. The Dent clock, which was on the chronograph most of the time for the pendulum work, in a seven-day period only varied from its mean rate two-tenths of a second. The variation of one of the Dutch clocks, which was afterwards substituted for the Dent, was even less. Mr. Keeler gives as the probable error of a clock correction $0^{\circ}.02$. At the mountain station the chronometer varied a second from a uniform rate in a seven-day period, and as the star observations show that a change of nearly two seconds has occurred between the rates of consecutive days we may expect discrepancies of 20 in the separate

swings, and as a matter of fact consecutive swings show just this difference. Therefore the discrepancies are explained by the variations of the time-piece, both at elevated stations, where they amount to 20, and at normal ones, where they are as low as 4. The conclusion would then seem to be that swinging through the entire 24 hours is necessary, unless time can be obtained from a fixed observatory, where the clocks are well protected from changes of temperature, and even when the swinging is done in observatories, with the good temperature conditions that usually exist, the discrepancies from the clock seem to be equal, if they do not overshadow, those arising from the other variable conditions.

The method of reducing the time of a vibration to what it would be were the oscillating body to move in a very small arc involves purely geometrical considerations, and is given in all works on mechanics. Some modifications in the application of the formula have been introduced by modern experimenters, but the influence of these modifications on determinations of relative gravity is probably without material significance. The law of decrement of the arc is that of a geometrical progression, or at least such a progression represents the descent with sufficient accuracy. Of the different transformations of the formula for the purpose of systemizing the computations and making the work more expeditious, it is unnecessary to speak. They all come within the requisite degree of accuracy, both for absolute and relative work. Prof. Peirce however assumes a different law of descent, and corrects each set of swings with quantities that are derived from observations of the decrements of arc from these same swings. His method is to express the differential coefficient of the arc with respect to the time as the independent variable in terms of constants and ascending powers of the arcs. These constants, determined either graphically or algebraically, being substituted in the integral formula which represents the sum of all the arc corrections, gives the correction for the whole swing. This method, which certainly answers most thoroughly the

mathematical and physical conditions of the case, leaves nothing to be desired in point of accuracy. Its use, however, in differential measurements of gravity is hardly necessary, as the accuracy attained in the final result is far from being commensurate with the additional labor entailed. In fact, for differences of gravity, and where the descent of arc is not abnormal, the results are practically identical by the two methods. This is especially true for modern observations, because the accuracy in the construction of the instruments makes it possible to swing in arcs whose half amplitude does not much exceed one degree; so that the second term of the development is almost insensible. In order to compare the different methods, some observations made in 1887 at the Lick observatory have been reduced in four ways, and it will be seen that the corrected time of one oscillation is practically the same for all. Any method is accurate enough for differential gravity until we can better control the temperature and clock rates.

The following are the four ways:

I (Borda). Assuming the arcs to decrease in a geometrical ratio, the quantity to be added to n oscillations in order to get the number made in an infinitely small arc, during the same time, is given by—

$$\frac{Mn \sin(\varphi + \varphi') \sin(\varphi - \varphi')}{32 \log \sin \varphi - \log \sin \varphi'}$$

where φ and φ' are the initial and final arcs, and M the modulus of the common logarithmic system. When the arc falls from about $40'$ to $5'$ this is equivalent to a correction of $0^{\circ}.00000177$ for one oscillation.

II (Peirce). Taking the equation

$$\frac{d\varphi}{dt} = -b\varphi - c\varphi^2$$

to represent the relation between the arc and time, the constants are first determined, and then the correction for arc, by integrating the expression $\frac{1}{16} \int \varphi^2 dt$. By limiting the differential equation at the second power of the arc, the

constants may be determined graphically and approximately by dividing by the arc and thus reducing the equation to that of a straight line. Then plotting the equation

$$b + c \varphi_m = n,$$

b will be the value of the ordinate where the line cuts the axis of y , and c will be the tangent of the angle made with the axis of x . This method is so simple that a great many values of the arc may easily be introduced, and the straight line best satisfying all the values taken to determine the constants; but a few values at the beginning, middle, and end of the swing give all necessary accuracy. The constants being found and substituted in the definite integral equation

$$\frac{1}{16} \int_a^b \varphi^2 dt = \frac{b}{16c^2} \left[\text{Nap. log} \left(1 + \frac{c\varphi}{b} \right) - \frac{c\varphi}{b} \right]$$

taken between the limiting values of the arc gives the quantity to be subtracted from the interval given by observations to obtain that required to make the same number of oscillations in an infinitely small arc. The correction for one oscillation in the swing just referred to would be by this method $.00000173$, differing from the preceding by only 4 units in the eighth place.

III (Weddle).*

Here the decrement of arc is plotted, and the curve divided into equal parts. Letting u represent the ordinates, and n the number of parts, we have to find the integral

$$\int_0^n u_x dx.$$

This from the ordinary interpolation formula is equal to

$$u_0 \int_0^n dx + \Delta u_0 \int_0^n x dx + \frac{\Delta^2 u_0}{1.2} \int_0^n x(x-1) dx,$$

* Boole (Geo.) A. Treatise on the calculus of finite differences. 12° London, 1860, pp. 38-39.

and after integration

$$n u_0 + \frac{n^2}{2} \Delta u_0 + \left(\frac{n^3}{3} - \frac{n^2}{2} \right) \frac{\Delta^2 u_0}{1.2}, \text{ \&c.}$$

The data permit us to calculate the successive differences of u_0 up to $\Delta^n u_0$. When the curve is divided into six parts, Weddle noticed that by changing the coefficient of the sixth difference by the $\frac{1}{140}$ th part of itself, all the coefficients were rendered a common multiple; and since the sixth differences are from the nature of the approximation considered small, this introduces a very slight error, and we have

$$\int_0^{6h} u_x dx = \frac{3h}{10} \left[u_0 + u_2 + u_4 + u_6 + 5(u_1 + u_5) + 6u_3 \right]$$

where dx of the original equation is replaced by h . To apply this to the corrections for arc in pendulum work, the arc is read at the beginning, end, and at five equidistant intermediate points, dividing the swing into six equal parts. These are the values of u . The value of h being converted into seconds of time and the whole quantity being divided by 16, we get the sum of all the arc corrections. For the same swing already calculated, the correction for one oscillation is $0^{\circ}.00000176$.

IV. The arc is read off when it reaches certain divisions of the amplitude scale—the intervals of time to the nearest tenth of a minute being also noted. These arcs are squared and divided by 16. Then taking successive means, we have arc corrections that apply quite approximately to the whole partial period between the different consecutive divisions of the scale. Weighting these in proportion to the length of the interval and taking the mean gives the final arc correction applicable to the mean oscillation between the initial and final arcs. The introduction of weights depending on the time is nothing more than giving to each interval its requisite number of corrections, each of which is a mean between the initial and final arcs for that part of the curve of descent. This method gives a correction of $0^{\circ}.00000172$

for one oscillation. The following are the results by the different methods :

I.	0. ^s 00000177
II.	173
III.	176
IV.	172

The near agreement of the first with the others is due to the small amplitude of the arc. Now it is evident that when the corrections differ so immaterially as in these four cases that method should be chosen which requires the least labor. The first one, or that of Borda, is therefore to be recommended for differential gravity work.

The coefficient of expansion of brass is about 18 millionths for 1° centigrade, and since the time of oscillation varies as the square root of the length of the pendulum, the time of one oscillation will be changed by 9 millionths per degree. Hence it appears that when the range of temperature is not more than one-tenth of a degree and where therefore we can assume to know the mean temperature of the pendulum within this amount, we should not on account of erroneous temperature expect to find discrepancies of more than one or two units in the sixth place. But an examination of the Lick observatory observations shows that we do actually find differences several times as large where the temperature changes during a swing much less than 0°.1. Then, admitting that the coefficient of expansion (not that derived from linear measures, but that deduced from oscillation); admitting that this is correct to two places, we must turn elsewhere for an explanation of the apparent discrepancies. On one of the mountain stations where the daily range of temperature was 11° in the pendulum house, we found differences of 40. This would require, temperature alone being considered, an uncertainty of at least 2° in the mean temperature of the pendulum for any one swing, which is entirely inadmissible. Therefore we are forced to the conclusion that, although the temperature has usually been

considered the greatest enemy to accuracy in work of this kind, there still remain unexplained differences even where the temperature is all that can be desired. The changes in the atmospheric effect, whether depending on buoyancy or the viscosity of the air, need not be particularly examined, because for any one station the conditions do not vary enough to change the time of oscillation by nearly so much as those produced either by temperature or by the time-piece.

Peirce's treatment of the atmospheric corrections is briefly this: From observations at varying pressures an empirical formula is deduced for the times of oscillation at a given temperature. This formula contains a constant term with two others depending on the pressure and the square root of the pressure. The coefficients are then reduced to make them applicable to one absolute atmosphere and to one absolute unit of temperature, on the supposition that the second term varies directly as the pressure and inversely as the temperature, while the third term varies directly as the square root of the pressure and inversely as the eighth root of the temperature. By one absolute atmosphere is meant one million centimeter gramme second units.* The absolute zero of temperature is taken to be at 273° centigrade below the freezing point. For pendulums No. 3 and No. 4 the following formulæ are given by Professor Peirce:

No. 3:

$$T_a = x + \cdot 0003107 \frac{P}{t} + \cdot 0000349 \frac{\sqrt[8]{\bar{P}}}{\sqrt{t}}$$

$$T_u = y + \cdot 0008821 \frac{P}{t} + \cdot 0001047 \frac{\sqrt[8]{\bar{P}}}{\sqrt{t}}$$

No. 4:

$$T_a = x + \cdot 0003315 \frac{P}{t} + \cdot 0000428 \frac{\sqrt[8]{\bar{P}}}{\sqrt{t}}$$

$$T_u = y + \cdot 0009905 \frac{P}{t} + \cdot 0001247 \frac{\sqrt[8]{\bar{P}}}{\sqrt{t}}$$

* This corresponds to ^{cm.} 74.986 barometric pressure at Paris. See Report . . . Coast Survey . . . for 1876. 4°, *Washington*, 1879. Appendix 15, pp. 265-266.

These apply to Washington, the initial station. For any other station the correction is

$$\left(\sqrt{\frac{g_w}{g}} - \frac{288.1}{t + 273.1} \frac{P}{29.554} \sqrt{\frac{g}{g_w}} \right) K$$

where K is the coefficient for Washington, g_w is gravity at Washington, g is gravity at any other station, t is the temperature centigrade, and P is the barometer in inches.

In the application of these formulæ differential corrections are first applied to reduce to a mean pressure and temperature. The mean swing is then brought to one absolute atmosphere and to 15° centigrade, which corresponds to one absolute unit of temperature. Either of two methods may be employed to refer the time of oscillation to the chronometer or clock. If a clock is used, coincidences are generally observed. With a chronometer, the successive transits of the end of the pendulum across the vertical at the lowest point are registered electrically on the chronograph. Formerly 100 transits were observed at the beginning and end of a swing, besides taking 40, at intervals of an hour, during the swing, in order to count correctly the whole number of oscillations made. This, however, is pushing the observations to a point far beyond the necessary accuracy. The probable error of the mean of 40 transits is for an experienced observer only $^{\circ}002$, as far as observation is concerned. This would give an uncertainty for one oscillation in a swing of 4 or 5 hours of 2 in the seventh place, and for 1½ hours, the shortest swings, with heavy end up, of less than one in the sixth place. In regard to the intermediate transits, inasmuch as the object is only to guard against losing two whole oscillations (since, if transits are always begun with the pendulum moving in the same direction, any miscount must involve the loss of an even number of beats) it is quite sufficient to take one or two transits only. This lessening of the number of observed transits very materially shortens the work of the chronographic method, and no significant error can arise therefrom.

The counting of the oscillations is a comparatively easy matter when the period is known to within less than one ten thousandth of a second, because the uncertainty in that case cannot accumulate to be more than about half a second in a couple of hours, which will always enable us to decide between the two contiguous even numbers. This does not consider the changes arising from changes of temperature; but they are not usually enough to throw doubt on the number of oscillations. At one station, however, which has already been cited, the range of temperature was so great that it was necessary to consider it in making the count. At the Lick observatory, on the contrary, all conditions were so perfect that intermediate transits were unnecessary. The time computed for the duration of a swing of 15,000 oscillations for pendulum No. 3 was $4^{\text{h}} 0^{\text{m}} 33.7^{\text{s}}$, and the observed duration was never more than one-tenth of a second different from this. Here obviously there was no necessity for intermediate transits at all, in order to count the oscillations.

The swings were made to consist of exactly 15,000 oscillations. A sounder near the observer gave the seconds from the clock, which was in another building. The minute was known from a sidereal watch compared daily with the clock. This enabled the observer to terminate the swing at exactly the end of the 15,000th oscillation, the moving pendulum being followed by the eye and the clock-beats by the ear. As before stated, when the calculated time had elapsed, the pendulum was always found within a tenth of its amplitude from the lowest point. The determination of the approximate period of oscillation is accomplished by taking transits at short intervals near the end of a swing. For the first and shortest interval the number of vibrations is actually counted from the chronograph. The first approximation will then be in error by a fractional part of the error committed in the terminal observations, and the error of the deduced period will vary inversely as the number of intermediate oscillations. Then, knowing the uncertainty of a single oscillation, it is easily seen how long the next interval

may be made in order, without actually counting the oscillations, not to miss one. Repeating this operation, the period may be found to any desired degree of accuracy, at least up to the point where the uncertainties from other causes overshadow those from the clock and the pendulum itself.

From two minutes' observations the period of pendulum No. 4 was determined at Pakaoao to be $1^s.007$, with an uncertainty of less than $^s.001$. The pendulum was now allowed to swing 500 oscillations, the uncertainty only accumulating in this time to half a second. From this interval the period was found to be $1^s.0072$, the uncertainty being less than $^s.0001$. With this data an interval of half an hour gives a value of $1^s.00720$ correct to the nearest one hundred thousandth of a second, and this value may be used in counting the oscillations for intervals of several hours. Each new approximation increases the accuracy tenfold and decreases the probable error of the result in an equal ratio. Hence the rule is to take sixty transits, allow ten minutes to elapse, and take forty more; allow thirty minutes more to pass, and take forty additional transits. This gives sufficient data for the determination of the period.

Whether the reductions are made on the principle of the reversible or the invariable pendulum, it becomes necessary to measure the distance of the center of mass from the two knife edges. The accuracy necessary here depends entirely on the relation between the times of oscillation in the two positions of the pendulum. Letting a be the difference in these times and $h_d - h_u$ the difference of the distances, and h_u the distance of the center of mass from the knife edge at the heavy end, the effect on the time of one oscillation will be given by the differential of the fraction

$$\frac{ah_u}{h_d - h_u}.$$

For pendulum No. 4

$$a = -^s.000031;$$

hence for this pendulum an error of one millimeter in the location of the position of the center of mass will introduce

an error of $\cdot 00000012$ in the deduced time of one oscillation. For pendulum No. 3

$$a = - \cdot 00017$$

and T would be changed by $\cdot 00000007$. Admit, now, that the distance $h_a - h_a$ is obtained to the nearest millimeter and we have errors that are absolutely insignificant. For the Peirce pendulums the ratio of the distances h_a and h_a are as three to one. Measures of center of mass have therefore usually been made with an accuracy far beyond that attained in the other quantities bearing on the same result, and, in the writer's opinion, the accuracy has been pushed to an unnecessary extent.

The conclusions are therefore that time may be saved, with no sacrifice of accuracy, by correcting for arc by Borda's method. Observations extending through the entire 24 hours are always to be recommended. Forty transits at the beginning and end of swings and one or two intermediate transits at intervals of two hours suffice when the period is known to the nearest ten-thousandth of a second, and finally the determination of the position of the center of mass to the nearest millimeter is sufficiently accurate when the times of oscillation for the two positions of the pendulum do not differ more than about one six-thousandth part of an oscillation.

The distance between the knives has usually been ascertained by comparing it with a known standard in a vertical position, the illumination being effected for a dark field by throwing the light downward on the edge from a right-angled prism, and for a bright field by letting it enter directly towards the microscope in the line of the axis. Measures were made for edge bright and edge dark, and the mean was taken as the true value. Owing, however, to the construction of the pendulums and the comparator, measures could only be made at the middle of the edge, whereas its whole extent fixes the axis of rotation. Moreover, in order to admit the prism, a part of the supporting plane was cut out, so that however much the knives might wear by use, the difference of length on this account could not be detected.

Two pendulums have recently been measured, using a method of illumination due to Mr. O. H. Tittmann, in charge of the Bureau of Weights and Measures at the Coast Survey Office. Without going into the details of the arrangement, it may be said that the image of the edge was reflected from a surface of polished steel, and the mean of the measures on the direct and reflected image was taken as the reading on the surface of the plane. The space between the two images appeared as a dark band, the width of which depended on the closeness of the contact between the edge and surface. Leaving to one side for the present the question as to what should be considered the defining line of the length of the pendulum, the fact is to be noted that after having made measures on the direct and reflected images the reflecting plane was removed and the illumination introduced behind the knife edge. Readings were then made on the dark edge of the pendulum, and these agree quite satisfactorily with those on the direct and reflected images, corrected for the width of the band; so that it would seem to be sufficiently accurate to measure on the edge directly, having the field bright enough to make the threads visible when projected against the body of the knife.

As to the value to be accepted for the length of the pendulum, it is to be remarked that although the true edge at the point measured is not in perfect contact with the plane, as is made evident by the perceptible thickness of the dark band, yet the middle of this band should be considered as making the line about which the pendulum oscillates. If the steel surface is a perfect plane and the pendulum is resting upon it, certainly the existing conditions are precisely similar to those that obtain when the gravity observations are made, and the best value for the position of the line about which the oscillations take place is that given by the surface of the plane or the mean of the direct and reflected images. The thickness of this band was in one case as much as thirty microns; so that, admitting the plane to be perfect, the edge at the point measured departs from a straight line as much as fifteen microns. The two knife

edges were measured in the same way and the resulting values are thought to be much nearer those that should enter into the gravity computations than those heretofore attained.

The following table of corrected swings for pendulum No. 4, at the Lick observatory, in 1887, shows the degree of accuracy attainable when the conditions are favorable :

HEAVY END DOWN.

NAME OUT.					NAME IN.				
No.	Date.	Epoch.	Obs.	Period.	No.	Date.	Epoch.	Obs.	Period.
		<i>h.</i>		<i>s.</i>			<i>h.</i>		<i>s.</i>
1	Oct. 23....	9.1	P	1.006603	9	Oct. 25...	8.8	P	1.000604
2		13.6	"	2	10		13.1	"	2
3		17.9	"	2	11		17.4	"	3
4		22.2	K	4	12		22.2	K	4
5	Oct. 24....	8.7	P	* —	13	Oct. 26...	8.8	P	1
6		13.2	"	3	14		13.2	"	2
7		17.5	"	1	15		17.7	"	1
8		22.1	K	2	16		22.0	K	5

HEAVY END UP.

NAME OUT.					NAME IN.				
No.	Date.	Epoch.	Obs.	Period.	No.	Date.	Epoch.	Obs.	Period.
		<i>h.</i>		<i>s.</i>			<i>h.</i>		<i>s.</i>
1	Oct. 20....	8.3	P	1.006495	11	Oct. 21...	8.2	P	1.006475
2		9.8	"	5	12		9.7	"	71
3		11.3	"	7	13		11.2	"	73
4		12.8	"	6	14		13.0	"	78
5		14.3	"	4	15		14.5	"	72
6		15.9	"	5	16		15.0	"	67
7		17.3	"	5	17		17.5	"	72
8		18.8	"	8	18		19.0	"	71
9		22.5	K	3	19		22.2	K	79
10		0.1	"	8	20		23.7	"	78

* Rejected on account of defective action of clock "trip." The following swings are by a different time-piece.

THE RELATIVE ABUNDANCE OF THE CHEMICAL ELEMENTS.

BY

FRANK WIGGLESWORTH CLARKE.

[Read before the Society, October 26, 1889.]

In the crust of the earth, with its liquid and gaseous envelopes, about seventy chemical elements are at present recognized. Others, as yet unknown, are indicated by gaps in the periodic system and will probably be discovered in the future. Some of the elements are quite plentiful, some are exceedingly rare, and in any thorough discussion of their nature and relations this comparative abundance or scarcity should be taken into account. Even though the full meaning of the facts may not be discoverable for many years to come, it is worth while to put them into something like systematic order.

In its larger aspects the general problem is at present unsolvable, for the reason that we know nothing of the earth's interior. Its surface only is within our certain reach, and from the composition of that we must draw nearly all our conclusions. For that which lies below the crust we must be content with inferences based upon the scantiest of data. Of the crust itself the average composition is easily computable, and the calculation gives results which are in some respects surprising.

In order to have a definite mass of matter under consideration, we may assume for the earth's *known* crust a thickness of ten miles below sea-level. The volume of that crust, including the mean elevation of the continents above the sea, is 1,935,000,000 cubic miles. Of this amount 302,000,000

cubic miles are ocean and 1,633,000,000 are solid matter. The mass of the atmosphere is equivalent to that of 1,268,000 cubic miles of water, the unit of density. For these data, which cover all the terrestrial matter accessible to us, I am indebted to Mr. R. S. Woodward of the U. S. Geological Survey, and from them the relative masses of solid crust, ocean, and atmosphere can be determined within narrow limits of uncertainty. To sea water we may assign a density of 1.03, which is a trifle too high, and to the solid rocks a specific gravity not lower in average than 2.5, nor much higher than 2.7. With these values we can get the following expression for the percentage composition of the known matter of the globe :

<i>Per cent.</i>	<i>density.</i> <i>of crust 2.5.</i>	<i>density.</i> <i>of crust 2.7.</i>
Atmosphere-----	.03	.03
Ocean -----	7.08	6.58
Solid crust-----	92.89	93.39
	<hr/> 100.00	<hr/> 100.00

In short, we may regard the earth's crust, to a depth of ten miles, as composed essentially of 93 per cent. solid and 7 per cent. liquid matter; treating the atmosphere as a small correction to be applied later. More elaborate estimations are unnecessary. Since the known nitrogen of the earth is mainly in the atmosphere, its relative scarcity as an element is at once curiously manifest. It cannot possibly exceed 25 thousandths of one per cent of the total.

For the composition of the ocean, the data given by Dittmar in the Reports of the Challenger Expedition are perhaps the best available. The maximum salinity he puts at 37.37 grammes of salts in the kilogramme of water, and by taking this figure instead of a lower value we can make an allowance for saline masses enclosed in the solid crust, which would not otherwise appear in the final averages. Combining this datum with Dittmar's statement of the average composition of the ocean salts, we get the second of the subjoined columns. The traces of other elements, not named here,

which have been found by various observers in sea water, are too small to be considered.

<i>Comp. of salts.</i>		<i>Comp. of ocean.</i>	
NaCl-----	77.76	O-----	85.79
MgCl ₂ -----	10.88	H-----	10.67
MgSO ₄ -----	4.74	Cl-----	2.07
CaSO ₄ -----	3.60	Na-----	1.14
K ₂ SO ₄ -----	2.46	Mg-----	.14
MgBr ₂ -----	.22	Ca-----	.05
CaCO ₃ -----	.34	K-----	.04
	<hr/>	S-----	.09
	100.00	Br-----	.008
		C-----	.002
			<hr/>
			100.000

Dissolved gases need not be taken into account, and no other constituent of the ocean can reach 0.001 of one per cent.

In the case of the solid crust of the earth the problem of ascertaining its mean composition is far less simple; for the crust is not an homogeneous body, but is made up, so to speak, of shreds and patches; of old crystalline rocks, of volcanic outflows, and of all manner of deposits of sedimentary origin. It is veined and seamed with diverse minerals, it encloses pockets of various materials, and upon its surface are quantities of organic matter and great bodies of fresh water. At first sight it would seem to be impossible to determine the average composition of such a mass, and yet, upon consideration, the question is not seriously complicated. In a crust ten miles thick a section having the superficial area of the United States represents only about 1.5 per cent. of the total; so that all veins, pockets, patches, organic substances, etc., become insignificant in comparison with the whole mass, and even the lakes and rivers are neglectable quantities. On any attempt to compute their percentages they vanish into the dim recesses of the remoter decimals. Discarding these trivial constituents the question becomes one of the mean composition of the dominant rock material, and in that form it is comparatively simple.

In the first place, we may assume that the volcanic and

crystalline rocks represent pretty closely the general composition of the whole crust; for from them the sedimentary rocks have been formed, and the latter differ from the parent formations only in the carbon which they have taken up from the air and in the loss of saline constituents which have been leached out to the ocean. For this gain and loss respectively, approximate corrections are possible.

In the second place, we must regard the original rock matter, volcanic and crystalline, as being in a large sense fairly homogeneous. However greatly these formations may vary locally, they should average pretty much alike all over the world when sufficiently large areas are considered. This assumption can be tested in the light of evidence, as follows: We may average together great numbers of analyses, grouped in various ways, and so determine whether the results are sensibly constant. This has been done in the subjoined table, minor and occasional constituents being temporarily omitted, to be separately considered later.

A. The mean of 82 analyses of volcanic rocks from the Western Territories of the United States, published in Clarence King's Survey of the Fortieth Parallel.

B. 64 analyses of rocks from the Yellowstone Park, taken from the laboratory records of the U. S. Geological Survey.

C. 54 analyses of volcanic rocks collected in Northern California; also from the Survey records.

D. 39 analyses of eruptive rocks from various localities in the Western United States, taken from the Survey records.

E. 80 crystalline and archæan rocks from all parts of the United States. Of these analyses 50 were taken from the Survey records, 23 from the 40th Parallel Report, and 7 from the report of the New Hampshire Survey, vol. 3.

F. 75 analyses of European volcanic and crystalline rocks, taken at random from five recent volumes of the Neues Jahrbuch.

G. 486 miscellaneous plutonic rocks, analyzed between 1879 and 1883, and collected by Roth in his "Beiträge zur Petrographie der plutonischen Gesteine."

H. The mean of the foregoing 880 analyses.

	A.	B.	C.	D.	E.	F.	G.	H.
SiO ₂ -----	61.89	61.89	60.49	60.66	60.50	59.80	56.75	58.59
Al ₂ O ₃ -----	15.71	15.73	16.08	15.46	14.30	14.65	14.90	15.04
Fe ₂ O ₃ -----	1.81	3.18	2.47	2.74	3.35	4.99	4.58	3.94
FeO-----	3.65	2.40	2.86	2.27	4.31	2.92	3.71	3.48
CaO-----	4.51	4.58	6.15	4.71	3.52	5.19	5.79	5.29
MgO-----	2.40	3.08	4.31	3.35	5.00	3.45	5.22	4.49
K ₂ O-----	3.54	2.70	1.80	3.97	2.52	3.06	2.90	2.90
Na ₂ O-----	3.28	3.70	3.31	3.54	2.49	2.98	3.24	3.20
H ₂ O-----	1.69	1.59	1.12	.97	2.53	2.09	2.12	1.96
	98.48	98.85	98.59	97.67	98.52	99.13	99.21	98.89

That these means are remarkably concordant, especially as regards the columns A to F, is at once evident; but a reduction to elementary form renders the agreement even more striking.

	A.	B.	C.	D.	E.	F.	G.	H.
Si-----	28.88	28.88	28.23	28.31	28.23	27.91	26.50	27.34
Al-----	8.31	8.32	8.51	8.18	7.57	7.75	7.89	7.96
Fe-----	4.11	4.09	3.96	3.68	5.71	5.77	6.09	5.47
Ca-----	3.22	3.27	4.39	3.37	2.51	3.71	4.13	3.78
Mg-----	1.44	1.85	2.58	2.01	3.00	2.07	3.13	2.69
K-----	2.94	2.24	1.49	3.29	2.09	2.54	2.41	2.41
Na-----	2.43	2.74	2.46	2.63	1.85	2.21	2.56	2.37
H-----	.19	.18	.12	.11	.28	.23	.24	.22
O-----	46.96	47.28	46.85	46.09	47.28	46.94	46.26	46.65
	98.48	98.85	98.59	97.67	98.52	99.13	99.21	98.89

The thesis that the crust of the earth is fairly homogeneous in composition is thus sustained by positive evidence. The variations in the foregoing table are as small as could reasonably be expected.

So far, however, only nine of the rock-forming elements are accounted for. The proportions of the others are less easily computable, although in some cases fair estimates can be made. In certain directions very many of the analyses considered, especially in the columns A and G, were incomplete, constituents like titanium, manganese, phosphorus, etc., having been ignored as not essential to the purpose of the analyst. These substances appear in part, therefore, as

impurities in the silica and alumina, rendering the latter a trifle too high.

For several of the less frequently determined elements the laboratory records of the U. S. Geological Survey furnish data. In 211 analyses of volcanic and crystalline rocks there recorded, titanium, manganese, and phosphorus were determined in a great majority of cases, and other elements appear frequently enough to prove something as to their relative abundance. Taking these 211 analyses all together, they show the following mean percentages for the constituents in question :

TiO ₂ -----	0.55
P ₂ O ₅ -----	.22
MnO -----	.10
CO ₂ -----	.37
S-----	.034
Cr ₂ O ₃ -----	.021
BaO -----	.033
SrO-----	.009
Cl-----	.012
Li ₂ O-----	.011

All of these figures, obviously, are *under*-estimates, for the determinations were not made in all cases. Furthermore, the rocks analyzed were varied enough in origin, locality, and character to avoid any cumulative error due to the peculiarities of any one formation or area. The value for titanic oxide includes whatever zirconia may have been present in the various rock samples, but, although the latter base is widely diffused, its proportion cannot be very high. Titanium, therefore, must be regarded as more abundant than phosphorus, manganese, or sulphur—a result hardly to have been expected. This conclusion, however, is borne out by evidence from other sources. Titanium is rarely absent from the older rocks; it is almost universally present in soils and clays, and it is often concentrated in great quantities in beds of iron ore. Having no very striking characteristics and but little commercial importance, it is easily overlooked, and so it has a popular reputation for scarcity which it does not

deserve. Among all the elements it probably ranks tenth or eleventh in point of absolute abundance and is rare only as regards obvious concentrations.

For phosphoric acid and manganese the data given are probably not far out of the way, but in the case of carbon the estimation is more troublesome. The percentage of CO_2 in volcanic and crystalline rocks, 0.37, is doubtless untrustworthy, for the reason that surface rocks are mainly represented, in many of which alteration may have begun. The figure, however, may be used as an offset for the undeterminable carbon existing in coal, shales, petroleum, etc. As regards the limestones, rough estimates of their quantity must suffice, and we may provisionally accept that of T. Mellard Reade as given in his essay on "Chemical Denudation in Relation to Geological Time." According to Reade, the existing bodies of limestone are equivalent to a layer of the rock 528 feet thick and completely enveloping the globe. This is approximately one per cent. of the crust under consideration, and represents 0.44 per cent. of CO_2 . To this we may add the 0.37 per cent. given above, making 0.81 per cent. in all—an estimate which can hardly be too low.

In the case of sulphur, the figure given, 0.034 per cent., is surely much too low; for sulphur is abundant both in sulphates and in sulphides, and iron pyrites especially is widely diffused. The absolute proportion of this element seems to be hardly determinable. It should be at least 0.05 and probably not over 0.10 per cent. For chlorine, chromium, barium, and strontium the figures are minima, but cannot be very largely increased. The value for lithia is probably not far out of the way, for that oxide is almost universally present in minute traces in the older crystalline rocks, although it is rarely estimated in ordinary analyses.

Now, taking the mean of 880 analyses as cited in column H of the table, we may insert in it the additional values so far determined, but with certain qualifications. In about half of the analyses TiO_2 , P_2O_5 , and Cr_2O_3 were not estimated, but their amounts appear in the figures for silica and

alumina. The silica, then, may be reduced by about one-fourth the percentage of the titanite oxide, and the alumina by the other fourth, plus half the values assigned to P_2O_5 and Cr_2O_3 . Making these corrections, reducing to elementary form, and recalculating to 100 per cent., we get a rough approximation to the mean composition of the solid crust of the earth. To this approximation the other unestimated elements may be regarded as future corrections of very small amount. Combining this result with the mean composition of the ocean, and including 0.02 per cent. for the nitrogen of the air, we get the final column to illustrate the abundance of the elements so far as at present known. Quantities less than 0.01 per cent. are left out of consideration.

	<i>Solid crust, 93 %.</i>	<i>Ocean, 7 %.</i>	<i>Mean, incl. air.</i>
Oxygen	47.29	85.79	49.98
Silicon	27.21	----	25.30
Aluminum	7.81	----	7.26
Iron	5.46	----	5.08
Calcium	3.77	.05	3.51
Magnesium	2.68	.14	2.50
Sodium	2.36	1.14	2.28
Potassium	2.40	.04	2.23
Hydrogen21	10.67	.94
Titanium33	----	.30
Carbon22	.002	.21
Chlorine01	2.07	} .15
Bromine	----	.008	
Phosphorus10	----	.09
Manganese08	----	.07
Sulphur03+	.09	.04+
Barium03	----	.03
Nitrogen	----	----	.02
Chromium01	----	.01
	100.00	100.000	100.00

Nineteen of the elements are here provided for with very varying degrees of probability, although their order in the last column is presumably correct. The uncertainty may reach one per cent. in the cases of silicon and iron, one-half as much with aluminum and oxygen, and is proportionally

less for the other elements specified. The remaining elements, more than fifty in number, can hardly aggregate over one per cent. altogether, and not one of them could pass 0.05 per cent. in relative quantity. Some of them may be briefly considered in detail, as follows :

Fluorine.—Abundant in fluor-spar and apatite and present in many rocks as a constituent of topaz or mica. If the phosphorus in the foregoing estimate, 0.09 per cent., represents mainly apatite, the proportional amount of fluorine would be .02 to .03, the minimum assignable value.

Glucinum.—Widely distributed as beryl and easily overlooked in small traces. If determined, it would appear as a correction to the alumina.

Boron.—Comparatively abundant in tourmaline and datolite and conspicuous in certain volcanic waters ; difficult to estimate.

The Cerium Group.—According to Cross and Iddings, allanite is a wide-spread constituent of rocks. The same is true of monazite, as shown by Derby. These elements, together with thorium, zirconium, and the yttrium groups, would appear as corrections to alumina.

Nickel.—Frequent in rocks composed of or derived from olivine. Less than 0.01 per cent.

The Metallic Acids—stannic, molybdic, tungstic, columbic, and tantallic.—These, if determined, would form corrections to silica. The same is true to some extent of barium when present in rocks as sulphate.

The Heavy Metals.—Widely distributed in rocks, according to Sandberger's researches, but very small in quantity.

In the larger items, say from oxygen down to the alkaline metals, the estimates here given do not differ very widely from others which have been long current in chemical and geological literature. They rest, however, upon fuller evidence, and the discussion is, perhaps, more complete. In the smaller items the new results display the greatest novelty, and future modifications are most likely. The comparative rarity of carbon and sulphur is, to say the least, surprising.

On the theoretical side the results attained are not easy to interpret. That nine of the chemical elements should constitute, at the lowest estimate, 98 per cent. of all known terrestrial matter is somewhat startling and difficult to comprehend. Are the other elements concentrated in the interior of our planet? On this point there is a little positive evidence.

The mean density of the earth, 5·5 to 5·6, is more than double that of the rocky crust, and the difference may be accounted for as a result of pressure, or by supposing that as the globe cooled the heavier elements accumulated toward the centre. Both suppositions may be true in part, but less weight is to be placed upon the second, for the following reason: A mixture of the elements in equal proportions, in the free state and as they behave at the earth's surface, would have a specific gravity of about 7·3. In combination the density would be greater because of condensation, and below the surface it would also be increased by pressure. Hence it seems clear, since the density of the earth is only 5·5, that in the planet as a whole the lighter elements must very considerably exceed in quantity the heavier ones. Twenty-nine of the known elements have densities below 5·5, and forty exceed that figure, iron being the only one of the heavier group which is at all abundant. The greater part of the earth's mass is almost certainly to be found among the twenty-nine lighter elements. The others may be more plentiful at the centre of the globe than upon its surface, but few beside iron can be dominant constituents. This evidence seems to be clear, even though it is not proof positive.

An attempt was made in the course of this investigation to represent the relative abundance of the elements by a curve, taking their atomic weights for one set of ordinates. It was hoped that some sort of periodicity might be evident, but no such regularity appeared. No definite connection with the periodic law seemed to be traceable. And yet certain other regularities are worth noticing. All of the abundant elements are low in the scale of atomic weights, reaching a maximum

at 56 in iron. Above 56 the elements are comparatively rare, and only two of them, barium and strontium, appear in my estimates. Below oxygen, hydrogen alone approaches one per cent., while between oxygen and iron only scandium and vanadium are of neglectable rarity. Furthermore, in several elementary groups abundance diminishes with increase of atomic weight. This is plainly seen in the series potassium, rubidium, and caesium; in sulphur, selenium, and tellurium; in chlorine, bromine, and iodine; in arsenic, antimony, bismuth, etc., etc. The regularity is not certainly invariable, but it occurs often enough to be suggestive.

Perhaps a part of the difficulty in tracing relations of this sort arises from the fact that our field of view is limited to the earth and does not include the whole solar system. Indeed, several writers, reasoning on the broader basis of the nebular hypothesis and noting the low densities of the outer planets, have argued that the latter may contain the lighter elements mainly, while the heavier substances are concentrated at the original nucleus, the sun. Along this line, however, close reasoning is impossible, partly because evidence is lacking and partly because the conditions of temperature and pressure differ so widely between the sun and the other heavenly bodies. As thus attacked, the problem becomes one of enormous complexity, and even the solar spectrum gives us no conclusive evidence. That oxygen and silicon are not conspicuous in the sun's atmosphere we may admit, but that non-volatile silica is absent from the solar body is by no means certain. We may assume that compounds can exist nowhere in the sun, but the assumption is unprovable. As to the composition of the outer planets we know practically nothing. How far they may differ from each other, from the earth, and from the sun is as yet a matter of pure conjecture.

If, despite Mendelejeff's recent demurrer, we assume that the elements have been evolved from one primordial form of matter, their relative abundance becomes suggestive. Starting from the original "protyle," as Crookes has called it, the process of evolution seems to have gone on slowly until oxy-

gen was reached. At that point the process exhibited its maximum energy, and beyond it the elements forming stable oxides were the most rapidly developed, and in the largest amounts. On this supposition the scarcity of the elements above iron becomes somewhat intelligible; but the theory does not account for everything and is to be regarded as merely tentative. It is legitimate only so long as its purely speculative character is kept clearly in view. If, however, the evolution of the elements is admitted, it is clear that the later stages of the process must have been seriously conditioned by the chemical affinities developed at first.

ASSUMPTION AND FACT IN THE THEORIES OF
SOLAR AND STELLAR PROPER MOTIONS.

BY

JOHN ROBIE EASTMAN.

ADDRESS AS RETIRING PRESIDENT.

Delivered December 7, 1889.

Since the beginning of the historic period, a comparatively few important general themes have furnished the necessary pabulum for the serious cogitations of mankind; and for many centuries the whole range of human thought was covered by that comprehensive term Philosophy.

The earliest definite systems of Philosophy were born of the speculative and reflective intellects about the eastern limits of the Mediterranean sea, and reached their maturity under the fostering care and the keen criticism of the highest Grecian culture. The study of Philosophy was for successive ages the touchstone that separated the learned from the ignorant, and its masters were believed to hold the keys to all knowledge. Most of the systems set forth boldly the solutions to all the moral, religious and material problems of the universe.

The speculative theories dealing with the moral world had their origin deep in the minds and hearts of men, and were founded on observation, experience and reflection. These theories could be brought at once to a rigid test in the daily life of every human being and, therefore, were adapted to a healthy and normal development.

With the material universe this method was completely changed. The ancient Philosopher found himself confronted with the earth, the sun, the moon, the planets and the almost countless number of the stellar systems; he recognized the unspoken challenge to solve their mysteries, and took refuge in feeble speculation. He had penetrated the depths of the human passions, but the distance to the earth's nearest neighbor was unknown; he had probed the follies and set the bounds to the ambitions of his fellow-men, but he had no conception of the form and motion of the earth or of the order of the universe.

Undaunted by the lack of knowledge, and confident that intellectual acumen, though unsupported by observed facts, was equal to the demands of any problem, he explained the system of the universe on the basis of his crude hypotheses, and felt no need of any criterion by which his speculations could be tested. In all these schools of Philosophy assuming to deal with the problems of the physical world, there was one common element, one peculiar arrangement, that evidently was deemed essential to the stability of every system. In every scheme some member of the system was placed in the center, and represented the immovable nucleus of the universe. It was of little importance what body was given the place of honor; whether it be sun, earth, or fire, immovable stability was the distinguishing attribute of the central figure in all the systems, from the earliest known, down through the Ptolemaic to the Copernican. It was the one fixed idea in the order of the solar system that survived the clashing of rival hypotheses for more than twenty-five centuries, and had apparently passed with success the test which observation mercilessly claims the right to apply to theory.

The idea of an immovable center of the solar system had its origin in vague hypotheses, untrammelled by perplexing facts, and it triumphantly passed all tests of theory and observation down to the beginning of the eighteenth century.

In 1718 Edmund Halley,¹ afterwards Astronomer Royal

¹ Halley, Edmund. *Philosophical Transactions*, 1718; 736.

at Greenwich, read a paper before the Royal Society entitled "Considerations on the Change of the Latitudes of some of the principal fixt Stars." He had been engaged upon an investigation of the precession of the equinoxes, and by comparing the declinations of the stars contained in Ptolemy's *Almagest* with the declinations of the same stars obtained nearly two thousand years later, he had reached a point whence he was enabled, on well considered evidence, to suggest the probability of motions that were destined to overthrow the well worn theories of the immobility of the solar system.

On account of the historical importance of this paper, I venture to give the following leading points in the author's own language.

"But while I was upon this Enquiry, I was surprized to find the Latitudes of three of the principal Stars in Heaven directly to contradict the supposed greater obliquity of the Ecliptick, which seems confirmed by the Latitudes of most of the rest; they being set down in the old Catalogue as if the Plain of the Earth's Orb had changed its Situation, among the fixt Stars about 20' since the time of Hipparchus. Particularly all the Stars in Gemini are put down, those to the Northward of the Ecliptick, with so much less Latitude than we find, and those to the Southward with so much more Southerly Latitude. Yet the three Stars Palilicium or the Bull's Eye, Sirius and Arcturus do contradict this rule directly: for by it, Palilicium being in the days of Hipparchus in about 10 gr. of Taurus ought to be about 15 Min. more Southerly than at present, and Sirius being then in about 15 of Gemini ought to be 20 Min. more Southerly than now; yet, *è contra*, Ptolomy places the first 20 Min. and the other 22 more Northerly in Latitude than we now find them. Nor are these errors of Transcription, but are proved to be right by the declinations of them set down by Ptolomy, as observed by Timocharis, Hipparchus and himself, which shew that those Latitudes are the same as those authors intended. As to Arcturus, he is too near the Equi-

noctial Colure, to argue from him concerning the change of the Obliquity of the Ecliptick, but Ptolomy gives him 33' more North Latitude than he now has; and that greater Latitude is likewise confirmed by the declinations delivered by the abovesaid observers. So then all these three stars are found to be above half a degree more Southerly at this time than the Antients reckoned them. When on the contrary at the same time the bright shoulder of Orion has in Ptolomy almost a degree more Southerly Latitude than at present. What shall we say then? It is scarce credible that the Antients should be deceived in so plain a matter, three Observers confirming each other. Again these stars being the most conspicuous in Heaven are in all probability the nearest to the Earth, and if they have any particular Motion of their own, it is most likely to be perceived in them, which in so long a time as 1800 Years may shew itself by the alteration of their places, though it be utterly imperceptible in the space of a single century of Years."

From the date of this paper begins a new and important epoch in the history of Astronomy.

Foremost among the reasons leading to the choice of a subject for this meeting, was the conviction that the history of this branch of astronomy in all the phases of its evolution illustrates the conflict in every department of science between the Philosophy which rests alone on assumption, and that which is founded on observation. In this view of the subject, each member of the Philosophical Society has an interest, and therefore I bespeak your attention, while I briefly trace the evolution of those theories which have been adopted to explain the peculiar motions of the stars among themselves, and to account for the motion of the Sun in a certain direction among the stars. The first phenomenon is known as "Proper Motion of the Stars," and the second, as "Motion of the Solar System in Space." As the sun itself is only a rather insignificant star, there seems to be no real necessity for two names for the same phenomenon, but custom is sometimes more powerful than reason.

Halley's paper was not only the first, but for twenty years it was the only publication in regard to the new hypothesis. At that time, communication between widely separated astronomers was very tedious, and new departures from the beaten tracks of accepted theories were subject to grave doubts, and frequently to harsh criticisms.

On November 12th 1738, Jacques Cassini² presented a paper to the Royal Academy of Sciences at Paris, on "The variations observed in the situation and motion of several fixed stars." The author announced that the earliest work of the Royal Observatory at Paris was the examination of a number of the stars catalogued by Ptolemy, and especially those cited by Halley, in order to test the hypothesis of stellar proper motion. His comparisons with ancient results proved conclusively to his mind, that certain stars had moved from their former positions, while other stars of equal magnitude gave no evidence of abnormal change. As a result of his investigations, he concluded that the stars with proper motion probably revolved about some center, situated perhaps beyond our perception, and remarked, finally: 'It results from this hypothesis that, following the several positions of these stars in their orbits, some would appear to move in longitude from west to east, others in the opposite direction, others, finally, would appear to approach or to recede from the pole of the ecliptic in accordance with observations. Be that as it may, it must remain certain that although the greater part of the stars maintain the same positions among themselves, there are some that approach or recede from each other, in longitude as well as in latitude, which is, as we have already remarked, very important to recognize for the progress of Astronomy since it is principally to the fixed stars that we refer the movements of the other celestial bodies.'

All the discussions and investigations of proper motion for the next forty years were of the same general character

² Cassini, Jacques. *Histoire de l'Académie Royale des Sciences*. Paris, 1738; 331.

as portrayed in the work of Cassini, just quoted, and while the various publications indicated a growing interest in the subject, its scientific development was scarcely affected.

In 1748, James Bradley,³ in his famous paper before the Royal Society announcing his discovery of the Nutation of the earth's axis, mentions the phenomena of proper motion but adds nothing to the theory or the facts.

In 1750, Thomas Wright in his work "The Universe and the Stars," though sometimes quoted, really adds nothing but confusion to the subject; while J. H. Lambert, in his "Cosmologische Briefe" in 1761, was content to contribute only vague speculations.

Near the end of a paper presented by Tobias Mayer in 1760, to the Academy of Sciences in Göttingen, the author remarks: 'If the sun and with it the planets and the earth which we inhabit, tended to move directly towards some point in the heavens, all the stars scattered in that region would seem to gradually move apart from each other, while those in the opposite quarter would mutually approach each other; in the same manner one who walks in the forest sees the trees which are before him separate, and those that he leaves behind approach each other. Since then the observed motions of the stars are not governed by this common law, as one can be assured by examining our Table, it is clear that these movements are not simply apparent, and that they do not depend upon this or any other common law but belong to the stars themselves. In regard to the true and legitimate cause of these phenomena, we shall still remain ignorant, perhaps for several centuries.'

The Rev. John Michell⁴ in 1767, and J. S. Bailly⁵ in 1775, contributed their speculations to the general fund of knowledge without stimulating its increase; and in 1775, De La

³ Bradley, James. Philosophical Transactions, 1748; 39.

⁴ Michell, Rev. John. Philosophical Transactions, 1767; 234 and foot note p. 252.

⁵ Bailly, J. S. Histoire de l'Astronomie Moderne, Paris 1775-'83; Tome II; 662 et seq.

Lande⁶ infers the displacement of the solar system in the following terms:—"Mais une force quel-conque imprimée à un corps, et capable de le faire tourner autour de son centre, ne peut manquer aussi de déplacer le centre, et l'on ne sauroit concevoir l'un sans l'autre. Il paroît donc très-vraisemblable que le Soliel a un mouvement réel dans l'espace absolu," etc.

For more than sixty years the study of the hypothesis of solar or stellar motion had been devoted simply to testing the reality of the phenomena. The problem of the direction and the magnitude of the translation still remained unsolved; in fact, its solution had not been seriously attempted.

On March 6, 1783, William Herschel⁷ gave in detail before the Royal Society his methods of attacking this problem. He used the most carefully determined proper motions of fourteen well known stars. From an examination of these motions he suspected that they indicated a translation of the Solar system toward the constellation of Hercules. Assuming the point to which this motion tended, to be near the Star λ Herculis he found that more than eighty per cent of the proper motions, of these stars, in right-ascension and in declination, were such as they would be if the assumed point were what he termed the true apex of the solar motion. Regarding the magnitude of the solar motion, he offered only the following hints:—"From the annual parallax of the fixed stars, which, from my own observations, I find much less than it has hitherto been proved to be, we may certainly admit (without entering into a subject which I reserve for a future opportunity) that the diameter of the earth's orbit, at the distance of Sirius or Arcturus, would not nearly subtend an angle of one second; but the apparent motion of Arcturus, if owing to a translation of the solar system amounts to no less than $2''.7$ a year, * * * Hence we may in a gen-

⁶ La Lande, J. Histoire de l'Académie Royale des Sciences. Paris, 1776; 513.

⁷ Herschel, William. Philosophical Transactions, 1783; 247.

eral way estimate, that the solar motion can certainly not be less than that which the earth has in her annual orbit."

In this paper we have the first attempt to determine the direction and amount of Solar motion; and, though the problem was not subjected to any real mathematical analysis, it is remarkable that the concluded direction of motion compares favorably with the later determinations from a rigid mathematical treatment of a far greater amount of data. During the remainder of the eighteenth century nothing of importance was added to the subject.

In 1805, Herschel⁸ resumed the study of the problem, and with wider experience, and more and better data, he was led to believe that he had determined with greater accuracy the position of the solar apex, and gave its right ascension as $245^{\circ} 52' 30''$ and its north polar distance $40^{\circ} 22'$.

In the following year Herschel⁹ presented to the Royal Society the results of an extensive investigation of the "Quantity and Velocity of the Solar Motion," in the following terms:—

"It appears, therefore, that in the present state of our knowledge of the observed proper motions of the stars, we have sufficient reason to fix upon the quantity of the solar motion to be such as by an eye placed at right angles to its direction and at the distance of Sirius from us, would be seen to describe annually an arc of $1''.116992$ of a degree; and its velocity, till we are acquainted with the real distance of this star, can therefore only be expressed by the proportional number of 1116992."

About the beginning of the nineteenth century astronomers began to consider analytical methods of discussing the data at hand, and a new epoch was reached in the progress of the investigation. Klügel¹⁰ had already developed special Trigonometrical formulæ but had not employed them in any computation. In 1809, Burekhardt¹¹ presented an ingenious

⁸ Herschel, William. Philosophical Transactions, 1805; 233.

⁹ Herschel, William. Philosophical Transactions, 1806; 205.

¹⁰ Klügel, G. S. Astronomisches Jahrbuch, 1789; 214.

¹¹ Burekhardt, J. C. Connoissance des Temps, 1809; 377.

analytical method of determining the direction of the solar motion. Employing the same data used by Herschel in 1805, he found the results from the different stars so discordant that he concluded that the material then at hand was insufficient to fix the direction of the solar translation.

In his *Fundamenta Astronomiæ*, published in 1818, Bessel¹² gave a portion of his discussion of alleged proper motions, from which he inferred that the data did not warrant Herschel's conclusions in regard to the position of the apex of the sun's motion. It appeared to him that the variable apparent stellar motions could not be explained by any general law.

In 1837, Argelander¹³ presented to the Imperial Academy of Sciences of St. Petersburg, a very complete mathematical determination of the position of the apex of the solar motion. He used the proper motions derived from a larger number of stars than had been used by any of his predecessors, and divided them into three classes. In the first class he had 21 stars whose observed proper motions were greater than $1''.0$; in the second class 50 stars with proper motions between $0''.5$ and $1''.0$; and in the third class 319 stars with proper motions between $0''.1$ and $0''.5$.

He found the right ascension of the point towards which the solar motion is directed, to be $257^\circ 47'.6$ and its declination $+32^\circ 29'.5$, or very near the sixth magnitude star Piazzini XVII, 143.

This investigation settled beyond all doubt the reality of the motion of the solar system in space, and also attested the accuracy of the adopted direction of that motion. In 1840, Lundahl¹⁴ published the results of his mathematical discussion based upon the proper motions derived from Pond's catalogue of 1112 stars, from which he found the position of the solar apex to be in R. A. $260^\circ 51'$ and in Dec. $+31^\circ 17'$. Combining

¹² Bessel, F. W. *Fundamenta Astronomiæ*, 1818, sect. 12; 308.

¹³ Argelander, F. W. A. *Mémoires présentés à l'Académie Imp. des Sciences de St. Pétersbourg par divers savans. Tome III.*

¹⁴ Lundahl, G. *Astronomische Nachrichten*, 398; 209.

Lundahl's result with those from his three classes, Argelander¹⁵ obtained as the most probable result, for the position of the solar apex, from all the observations, a point whose R. A. was $257^{\circ} 49'.7 \pm 2^{\circ} 49'.2$ and Dec. $+28^{\circ} 49'.7 \pm 1^{\circ} 59'.8$, for the epoch 1792.5.

In 1841, Otto Struve¹⁶ presented to the Imperial Academy of Sciences of St. Petersburg, a very elaborate paper on the determination of the constant of precession, with regard to the proper motion of the solar system. Employing a greater amount of data than any of his predecessors in these investigations, the author essayed to obtain, not only the correction to the assumed constant of precession, but also the angular value of the solar motion, from the same set of about eight hundred equations.

He also employed the residuals from the first set of equations, in a new series of equations to find corrections to Argelander's cöordinates of the solar apex. From this last calculation, he found the right ascension of the point in the heavens, towards which the solar system is moving, to be $261^{\circ} 22' \pm 4^{\circ} 50'$ and the declination $+37^{\circ} 36' \pm 4^{\circ} 12'$, at the epoch 1790. Combining these values with those determined by Argelander he obtained the cöordinates $259^{\circ} 9'.4 \pm 2^{\circ} 57'.5$ and $+34^{\circ} 36'.5 \pm 3^{\circ} 24'.5$ for the epoch 1790. For the annual amount of translation of the solar system, at right angles to the line of sight, as seen from the mean distance of the stars of the first magnitude, he found the value $q = 0''.3392 \pm 0''.0252$.

If the proper motion of any star is due to the action of some remote central body, then, like all bodies moving about a centre under the influence of gravitation, its path would deviate more or less from a straight line, and its apparent motion would not be uniform. In comparing the positions of Sirius and Procyon, depending on Bradley's observations in 1755, and on later observations in 1820 and 1844, Bessel¹⁷

¹⁵ Argelander, F. W. A. *Astronomische Nachrichten*, 398 ; 210.

¹⁶ Struve, Otto. *Mémoires de l'Académie Imp. des Sciences de St. Pétersbourg*, VI^e serie. *Sciences, Math. et Phys.* Tome III ; 17.

¹⁷ Bessel, F. W. *Astronomische Nachrichten*, 514, 145 ; 515, 169 ; 516, 185.

believed that he had detected a lack of uniformity in their proper motions; and in 1844 he completed a very elaborate discussion of all the data at hand, reaching the conclusion that Sirius had a variable proper motion in right-ascension, and Procyon in declination; due in each case to the influence of a not very distant, and possibly an opaque, body of immense mass, around which the stars revolved.

In 1847, Thomas Galloway¹⁸ presented to the R. A. S. an investigation of the position of the solar apex, depending on the observations of southern stars. He employed *seventy-eight* stars from the catalogues of Johnson and Henderson, and compared their places with the positions given by Lacaille and Bradley. The difference of epochs was about eighty years, and he selected all the stars that appeared to have an annual proper motion of more than $0''.1$.

Following the line of investigation adopted by Argelander, Galloway found the most probable position of the solar apex to be in R. A. $260^{\circ} 0'.6 \pm 4^{\circ} 31'.4$ and in Dec. $+34^{\circ} 23'.4 \pm 5^{\circ} 17'.2$.

From 1847 to 1856 but little progress was made in mathematical investigation but a number of catalogues of stars with suspected proper motion were constructed, and several astronomers completed admirable discussions of the suspected irregular motions of Sirius and Procyon.

In Vol. XIV of the Dorpat Observations, J. H. Mädler gives the results of his study of the motion of the solar system in space. He adopted the methods of computation employed by Argelander and divided the 2,163 stars, from which he derived his data, into three classes, according to the amount of proper motion.

Class (a) contained 227 stars with proper motion greater than $0''.25$.

Class (b) contained 663 stars with proper motion between $0''.10$ and $0''.25$.

Class (c) contained 1,273 stars with proper motion between $0''.04$ and $0''.10$.

¹⁸Galloway, Thomas. Philosophical Transactions, 1847; 79.

The cöordinates of the solar apex were found to be—

From class (a)	. . .	262°	8'.8;	+39°	25'.2
“ “ (b)	. . .	261°	14'.4;	+37°	53'.6
“ “ (c)	. . .	261°	32'.2;	+42°	21'.9
Mean =		261°	38'.5;	+39°	53'.6,

allowing equal weight for each class.

Mädler¹⁹ had already discussed, in 1846, the proper motions of a limited number of stars in the constellation Taurus, and arrived at the well known conclusion that the Pleiades was the central group of the fixed stars, and that the star Alcyone was the central sun of that group.

In 1859, G. B. Airy,²⁰ the Astronomer Royal at Greenwich, presented to the Royal Astronomical Society the results of his investigation of the movement of the solar system in space. He adopted a new method of discussing the linear movements of the sun, and of each star, by the use of rectangular cöordinates, a device at once complete and independent, in which no assumption of the values of the quantities sought was necessary.

He formed his equations on two widely different suppositions: First, that the irregularities of proper motions are due wholly to chance-error of observation; second, that they are due entirely to peculiar motions of the stars themselves. He was evidently inclined to believe that the second supposition was nearer the truth. Like most of the previous investigators, he sought such a value of the sun's angular motion in space as would be seen from a star of the first magnitude, and for that purpose was obliged to assume some law of relative distances among the stars. In this he was guided by the elder Struve's work, and, dividing the stars used into seven groups, according to magnitude, he adopted the system in the following table, which is almost identical with that of Struve:

¹⁹ Mädler, J. H. *Astronomische Nachrichten*, 566; 213.

²⁰ Airy, G. B. *Mem. Roy. Ast. Society*, XXVIII; 143.

TABLE I.

Division.	Magnitude.	Distance from sun.
1	1	1.00
2	1.2, 2, 2.3	1.71
3	3.2, 3, 3.4	2.57
4	4.3, 4, 4.5	3.76
5	5.4, 5, 5.6	5.44
6	6.5, 6, 6.7	7.86
7	7.6, 7, 7.8, 8	11.34

Using the proper motions of 113 stars from Main's Catalogue, the author found the cöordinates of the solar apex to be, according to the first supposition, R. A. $256^{\circ} 54'$; Dec. $+39^{\circ} 29'$; according to the second supposition, $261^{\circ} 29'$ and $+24^{\circ} 44'$.

From the equations formed under the first supposition, the angular value of the solar motion was found to be $1''.27$, and from the second supposition $1''.91$.

These values of the solar motion were so much larger than that found by Struve, that the author was disposed to cast grave doubts upon the accuracy of the assumed law of distances for the stars, and observed, 'It may be, therefore, that we have in point of fact been using, as stars at the average distance of stars of the sixth magnitude, stars whose distance is little greater than that of stars of the first magnitude.' This remark emphasizes the weak point in every discussion of the solar motion.

In 1863, Mr. Edwin Dunkin²¹ gave to the R. A. S. the results of a very careful investigation of the direction, and the amount, of the solar motion.

He followed the same methods in his work as those employed by the Astronomer Royal, but used the data from

²¹ Dunkin, Edwin. Mem. Roy. Ast. Society, xxxii; 19.

1167 stars. On the supposition that the irregularities of proper motion were entirely due to accidental errors of observation, he found the cöordinates of the solar apex to be in R. A. $261^{\circ} 14'.0$ and in Dec. $+32^{\circ} 55'.0$. On the supposition that the irregularities were due entirely to the peculiar motions of the stars, he found the cöordinates to be $263^{\circ} 43.9$ and $+25^{\circ} 0'.5$. On the first supposition he found the angular value of the annual solar motion to be $0''.3346$, and on the second supposition $0''.4103$.

In 1863, Mr. E. J. Stone²² using the factors of solar motion computed by Mr. Main, in his Catalogue of proper motion stars, proposed to test the possibility of determining the linear velocity of the solar system, so as to obtain any considerable diminution of the sums of the squares of the corrected proper motion.

Assuming the linear unit to be the mean distance of the group of stars considered, and therefore the distances of all the stars to be equal, he found, using the entire number of factors computed, the sum of the squares of the uncorrected proper motions in R. A. to be $0^{\circ}.525$ and the velocity of solar motion to be $0''.054$. The sum of the squares of proper motions corrected for solar motion was $0^{\circ}.473$. Concluding that the small value of the solar motion was due principally to the inaccurate factors for stars near the pole, he omitted the data for the 13 circumpolar stars and from the remaining 91 stars, he found,

	From R. A.	From Dec.
The sum of the squares of the <i>uncorrected</i> proper motions	$0^{\circ}.464$	48.539
The sum of the squares of the <i>corrected</i> proper motions	$0^{\circ}.381$	44.862
The velocity of solar motion	$0''.434$	$0''.341$

The author remarks in conclusion, 'I think we may fairly conclude that, so long as we confine our attention to large proper motions, we have numerical evidence of a drift such

²² Stone, E. J. Month. Not. Roy. Ast. Society, xxiv, 1864; 83.

as would be produced by the motion of the solar system in space but that the numerical evidence is slight.'

In 1869 and '70, Mr. R. A. Proctor²³ published several papers on the nature, direction and amount of solar and stellar motions. With his well known graphical skill, he constructed charts on which the direction and amount of the proper motions of the principal stars were represented, and from which he was able to show that, in certain limited areas of the heavens, the motion or drift of the stars had an apparent common direction. The motion of the stars in Taurus is towards the south-west; in Gemini and Cancer toward the south-east, and in Leo the drift is toward Cancer. The stars α , β and γ Arietis appear to form a single system; while *five* of the *seven* bright stars in Ursa Major are all drifting in the same direction, and at almost the same rate, *towards* the apex of solar motion, or *away* from the point towards which all stellar motions, due to the Sun's translation in space, should be directed.

In 1877, Dr. De Ball²⁴ discussed the direction of the solar motion from the data derived from the proper motions of 67 southern stars and found the cöordinates of the solar apex to be, in right ascension, $269^{\circ}.0$ and in declination, $+31^{\circ}.9$.

In 1882, Dr. F. Rancken,²⁵ proceeding on the hypothesis that the proper motions of the stars increased with the stellar parallax, discussed the data derived from 106 stars, lying within 30° of the plane of the milky way, and found the position of the solar apex to be in right ascension, $285^{\circ} 8'.3$ and in declination, $+31^{\circ} 52'.1$. He also found the annual linear motion of the solar system to be 9.79 radii of the earth's orbit.

In 1884, Dr. Johann Bischof²⁶ investigated the direction

²³ Proctor, R. A. Proc. Roy. Society of London, xviii; 169. Month. Not. Roy. Ast. Society; xxx; 9. Pop. Science Review, London, viii, 1869; 358.

²⁴ De Ball, L. Inaugural Dissertation, Bonn, 1877.

²⁵ Rancken, Freyvid. Astronomische Nachrichten, 2482; 149.

²⁶ Bischof, Johann. Inaugural Dissertation, Bonn, 1884.

and velocity of the solar motion; using as data the proper motions determined by Argelander for his well known list of 250 stars, and also the proper motions from 95 other telescopic stars which had been observed by Argelander. He divided the 345 stars into four groups, depending upon the amount of proper motion, as follows:

The first group contained 19 stars with proper motions greater than $1''.000$.

The second group contained 24 stars with proper motions between $0''.701$ and $1''.000$.

The third group contained 65 stars with proper motions between $0''.401$ and $0''.700$.

The fourth group contained 237 stars with proper motions between $0''.050$ and $0''.400$.

He found a position of the Solar apex from each group separately, but finally adopted the following values derived from combining the data from all the stars: R. A. = $285^\circ.2$; Dec. = $+48^\circ.5$.

He also found the annual, angular value of the solar motion to be $0''.3367$.

In March, 1887, Ludwig Struve,²⁷ a member of the third generation of Russian astronomers who have borne the name of Struve to the great credit of the empire, presented to the St. Petersburg Academy of Sciences an important paper entitled "Bestimmung der Constante der Praecession und der Eigenen Bewegung des Sonnensystems." He adopted in his computations the method of rectangular cöordinates as used by Airy, and also assumed for the stars the same relation between magnitude and distance. The author used the proper motions of 2509 stars whose earliest positions depend upon Dr. Auwer's late re-reduction of Bradley's observations, while the modern places were taken from the Pulkowa Catalogues for the epochs 1845, 1855 and 1865. From this discussion, the cöordinates of the solar apex, for the epoch 1805,

²⁷ Struve, Ludwig. Mémoires de l'Académie Imp. de St. Pétersbourg. vii^e Serie, Tome xxxv, No. 3.

were ascertained to be, in right ascension, $273^{\circ} 21'$ and in declination, $+27^{\circ} 19'$. At the same time the annual, angular motion of the solar system, as seen from a sixth magnitude star, was found to be $0''.43642$.

The principal results, derived from the laborious computations undertaken during the last hundred years to determine the position of the solar apex, as well as the velocity of the solar motion, are collated in the following table. In some cases, the epoch for which the computation was made, is omitted in the original papers, and in others it is indefinite. Only those are given in the table about which there is no doubt. The date given, is the time of publication.

The values of the solar motion given by Herschel and Airy were considered by the authors themselves as of little weight. Rancken's value is indeterminate. The mean is given of the seven other determinations.

The values found by O. Struve and by Dunkin were for the distance to *first* magnitude stars, that by L. Struve for the distance to *sixth* magnitude stars, while the values given by Stone and Bischof were for the mean distances of the respective groups of stars used by each author.

But little importance is attached to the *means* of the coordinates of the solar apex, for it is impossible to assign proper weights to such data.

It is intended to give each determination as deduced by the author and, in the means, equal weight is given to the separate values.

TABLE II.

Author.	Date.	Number of stars used.	Deduced position of solar apex.		Epoch.	Annual, angular solar motion.
			Right ascension.	Declination.		
Herschel	1783	14	260.6	+26.3		
"	1805	6	245 52.5	49 38		
"	1806	36				1.117
Gauss			259 10	30 50		
Argelander	1838	390	259 51.8	32 29.1	1792.5	
Lundahl	1840	147	252 24.4	14 26.1	1792.5	
O. Struve	1841	392	261 21.8	37 36.0	1790	0.3392
Galloway	1847	78	260 0.6	34 23.4	1790	
Mädler	1848	2,163	261 38.8	39. 53.9	1800	
	1856					
Airy	1859	113	256 54	39 29	1800	1.269
"	1859	113	261 29	24 44	1800	1.912
Dunkin	1863	1,167	261 14.0	32 55.0	1800	0.3246
"	1863	1,167	263 43.9	25 0.5	1800	0.4103
Stone	1863	91				0.434
"	1863	91				0.341
Gyldén ²⁸	1872		274.1			
Gylden ²⁹	1877		260.5		1800	
De Ball	1877	67	269.0	31.9	1860	
Rancken	1882	106	285 8.3	31 52.1		(9.79)
Bischof	1884	480	285.2	48.5	1855	0.3367
Ubaghs ³⁰	1886	464	262.4	26.6		
L. Struve	1887	2,509	273.3	27.3	1805	0.4364
Mean			263° 53'	32° 35'		0''.3760

²⁸ Gyldén, Hugo. Antydningar om lagbundenhet i Stjernornas rörelser (Öfversigt af Kongl. vetens kaps Akademiens Förhandlingar, 1871, No. 8.) Stockholm, 1872.

²⁹ Gyldén, Hugo. Grundlehren der Astronomie. Leipzig, 1877; 388.

³⁰ Ubaghs, P. Astronomische Nachrichten, 2733; 355. Bulletin de l'Académie Royale des Sciences de Belgique, 1887, 3^e series, Tome XIII; 66.

In this incomplete review, altogether too brief for the importance of the subject, but, I fear, long enough to weary your patience and dull your interest, I have endeavored to outline the methods and the results of the labor of a century

in one of the important departments of astronomical science ; and at the same time to indicate the progress of that line of thought which tended to uproot the theory of the immobility of the solar system, and to supplant the speculations of a baseless philosophy with a broader theory of the Universe, resting on the solid foundation of numerous and well observed facts.

The progress of science has often been likened to the march of a grand army, sweeping with a steady but irresistible momentum towards some definite point ; and, again, it has been characterized as the advance of an undisciplined throng, without a leader, but finding its directing impetus in the common impulse of its individual members. In the special investigation considered to-night, the progress seems to me to be more like that of a rising flood invading for the first time the surface of a partially broken but unexplored country. There is no steady, uniform progress in any direction. When the tide overrides the barrier to an unoccupied basin beyond, the rush of the current is not stayed until every nook and indentation in the fresh fields has been searched out, and the new possibilities have been exhausted. Then a period of tranquillity ensues, until a higher level is reached, fresh obstacles are surmounted, and the accumulated energy is diverted into new regions where exploration is again concentrated, until the rising flood is strong enough to break its way into still higher areas, intermittingly repeating the cycle of renewing rest and impulsive effort.

A careful examination of the literature of solar and stellar motions will reveal, in a striking manner, the intermittent character of the numerous investigations undertaken within the past century. New observations and more ingenious methods have revived, at irregular intervals and with fresh energy, the hope that new light might be thrown upon the troublesome problem, and many zealous students have entered the field, at nearly the same, time to search for a more satisfactory solution.

It is now one hundred and seventy years since Halley

called attention to the phenomena, and one hundred and six years since the first serious investigation, by Herschel, of the suspected motion of the stars and the solar system in space, and yet the problem is not completely solved.

It has been proven beyond all doubt that certain phenomena known as stellar proper motions exist. They have been explained by assuming; first, the translation of the solar system through space at a high velocity; second, the motions of the stars themselves; and, third, a combination of both solar and stellar motions.

It has been shown very conclusively that the solar system has a motion of translation through space, and the general direction of this motion is known within narrow limits. But this alone will not explain all the observed phenomena. If the solar system were moving towards some definite point in the heavens, and the stars had no motion of their own, then the angular distances, between the stars about the objective point, would increase as the sun, with the earth, gradually approached them, while the intervals between the stars, in the opposite quarter of the heavens, would correspondingly decrease. At the same time, stars, situated 90° from the line of the solar motion would have an apparent movement directly opposite to the sun's real motion.

These phenomena are observed in the case of some stars, but not in all. It is observed also, that whole groups of stars, as well as isolated ones, in the same portion of the heavens, move in opposite, or, at least, divergent directions, and the inference is unavoidable that the stars, as well as the sun, have their own peculiar motions of translation. If the problem ended here, we could count on having made substantial progress. But for further advance in this research, it is necessary to know the distances of the stars from the solar system. Here, alas! the astronomer is working with the infinitely short arm of the lever. Many assumptions have been made, and many shrewd inferences have been drawn, but still we have almost no actual knowledge of stellar distances. It is certain that some well known stars

have an appreciable parallax, and most of these are of large magnitude. Hence it was inferred that the larger stars were nearer the solar system, and that the apparent brightness was a guide to their relative distances. It was also assumed that if the apparent motion of the stars was caused wholly, or partially, by the motion of the sun, the nearer or larger stars would be affected by the greatest proper motion.

In 1827, the elder Struve³¹ devised an ingenious scheme of relative stellar magnitudes and distances, in which the stars then called the first magnitude, were taken as the unit of magnitude, and the mean distance of these stars from the solar system, was assumed as the unit of distance. This scheme included not only the relative magnitudes and distances, but the relative brightness of the stars, together with the number of stars of each magnitude which would be equal in brilliancy to the adopted standard.

This system, or some modification of it, has been employed in nearly every study of the direction and velocity of the solar motion undertaken since these supposed relations were published. It is apparent that this system was founded on the assumption that all the stars are of the same real magnitude and brilliancy, and that all changes in those characteristics are due to the varying distances from the solar system. If these assumptions be true, then all stars of the same magnitude ought to have the same parallax. Sirius, apparently the largest stellar body known, and theoretically the nearest to the solar system, has an annual parallax of less than $0''.4$, while the 7th magnitude star, Lalande 21185, has an annual parallax of $0''.5$. According to the generally accepted theory the fainter star should be more than *eleven* times as far from the sun as Sirius is, while the observations for parallax show that it is *nearer* than Sirius by the ratio of *five* to *four*. Many comparisons showing similar discrepancies between theory and fact could be easily shown.

If all stars of the same magnitude were at equal distances

³¹Struve, F. G. W. *Catalogus Novus Stellarum Duplicium et Multiplicium*. Dorpat, 1827; XXXV.

from the sun, and the apparent stellar proper motions were caused by the motion of the solar system in space, then the largest stars, or those nearest the sun, in those portions of the heavens 90° from the direction of the sun's motion, would show the greatest proper motion. If, on the other hand, the solar system is fixed in space and the observed change in the positions of the stars is due to an inherent motion of those bodies themselves, then the stars nearest the solar system would have the greatest apparent motion. But, what are the facts?

The annual proper motion of Sirius is about $1''.30$, or less than that of some 9th magnitude stars which theory would place at least twenty-three times as far from the sun. The seventh magnitude star, Groombridge 1830, which, according to theory, would be more than eleven times the distance of Sirius from the sun, has an annual proper motion of $7''.05$ or more than 5.4 times that of Sirius. The cases just cited are isolated phenomena, and, as the inferences drawn from such data are possibly misleading, it has been deemed of the highest importance to undertake a more general investigation in a much broader field.

In the Proceedings of the American Association for the Advancement of Science³², for 1889, is published an abstract of the methods employed in the investigation of the relation between stellar magnitudes and proper motions, together with the results obtained. In this connection it is unnecessary to cite from that paper anything but the data and the results. I first investigated the relations of the magnitudes and proper motions of 345 stars whose proper motions had served as a basis for an Inaugural Dissertation by Dr. Johann Bischof. This list included the well known proper-motion catalogue of 250 stars by Argelander.³³

The magnitudes of these stars range from the 5th to the 9th, inclusive, and the observed motions are determined with

³² Eastman, J. R. Proc. Am. Ass. for Ad. Science, 1889 ; 71.

³³ Argelander, F. W. A. Astronomische Beobachtungen auf der Sternwarte zu Bonn. Siebenter Band ; 109.

very great care. Arranging all the stars in four classes, according to the amount of observed proper motion, and taking the mean of the magnitudes and of the proper motions in each class, the following rather significant result was reached. In class I, which includes the *largest* proper motions, are found the *faintest* stars; in class II, which contains smaller proper motions, there is a slight increase in the size of the stars; and in all the classes as the mean proper motion *decreases*, the mean magnitude *increases*. I then examined the proper motions deduced by Newcomb³⁴ from 307 of Bradley's stars ranging from the largest down to the 5th magnitude. These stars were not so well adapted for this investigation as those of Argelander's list, because many of the deduced proper motions are so minute as to be at least doubtful. They were arranged and treated in the same way as the first list, and in many respects similar results were obtained.

Finally, in order to show definitely the relations between magnitudes and proper motions the whole number of stars, 652, were arranged in *nine* groups, according to magnitudes. Taking the mean of the magnitudes and the mean of the proper motions in each group, certain rather remarkable results were reached. The mean proper motion for the first magnitude stars, $0''.52$, is somewhat anomalous, inasmuch as the number of stars is quite small and there occurs three large proper motions. For the succeeding magnitudes, from the *second* to the *ninth*, inclusive, the mean proper motions are respectively, $0''.16$, $0''.18$, $0''.14$, $0''.17$, $0''.29$, $0''.42$, $0''.46$ and $0''.68$.

These results were so decidedly opposed to the accepted theories that a further examination was considered very desirable. Since the publication of the paper just quoted, another investigation of the proper motions of Bradley's stars has been made on the same general plan as the first. In Argelander's list no star was used whose proper motion

³⁴Newcomb, Simon. *Astronomical Papers of the American Ephemeris*, 1882; 147.

was less than $0''.05$, and, in order to make the data from the two lists more nearly homogeneous, all the stars from Bradley's list, from the *first* to the *fifth* magnitude, inclusive, whose proper motions were less than $0''.05$, were excluded from the second investigation. By this process, one hundred and two stars used in the first paper, were rejected in the second. The remaining five hundred and fifty stars of the two lists were arranged, as in the first investigation, in *nine* groups, according to magnitude. In the *first* group were placed all stars whose magnitudes were greater than 1.5; in the *second* group all magnitudes between 1.6 and 2.5, inclusive, and, by a similar method, each group was arranged until the *ninth*, which contained all stars fainter than the 8.5 magnitude.

Taking the means of the different quantities, as in the first discussion, there are found the results which are arranged in the following table:

TABLE III.

Group.	Number of stars.	Mean magnitude.	Mean proper motion.
1	14	1.13	0.668
2	28	2.15	0.237
3	42	3.08	0.272
4	70	4.02	0.187
5	61	4.89	0.243
6	64	6.12	0.293
7	128	7.04	0.422
8	114	8.08	0.460
9	29	8.78	0.678

In this table we have results similar to those derived from the first investigation, but all tending to disprove the ordinary theories in regard to the relations of magnitudes and proper motions.

The result in the first line, like that in the first discussion, is peculiar by reason of the small number of stars and the occurrence of *three* large proper motions. Neglecting that result, there is found an almost uniformly *increasing* proper motion as the stars grow fainter, until the 9th magnitude stars are found to have a proper motion nearly *three times as great* as those of either the 2d., 3d., 4th. or 5th. magnitudes, and quite as large as the anomalous result for the 1st. magnitudes.

Assumption, which has developed into a quasi theory, and gained general acceptance, asserts that the largest stars are nearest the solar system. Observation plainly shows this theory to be quite untenable.

The following tables exhibit the magnitude, proper motion and parallax of *forty-six* stars or, practically, all those whose parallaxes have been well determined. Most of this data was compiled by Dr. Oudemans³⁵ for a special occasion, and I have used his figures except where additional data have made changes necessary, or where less apparent accuracy was sufficient for my purpose.

The stars in Table IV are arranged in five nearly equal groups, according to magnitude of proper motion.

Table V giving the mean results from each group in Table IV, presents some important features. 1°. The larger proper motions and parallaxes belong to the smaller stars. 2°. The decrease in the numerical value of the parallaxes is accompanied by a corresponding decrease in the proper motions. 3°. The mean magnitude of the first two groups is 5.58 and the mean proper motion is 3''.63. Of the last three groups the mean magnitude is 2.86 and the mean proper motion is 0''.49.

³⁵ Oudemans, J. A. C. *Astronomische Nachrichten* 2915 '6; 193.

TABLE IV.

Name of star.	Magni- tude.	Proper motion.	Annual parallax.
Groombridge 1830	6.5	// 7.05	// 0.07
Lalande 9352	7.5	6.96	0.28
61 Cygni	5.1	5.16	0.40
Lalande 21185	6.9	4.75	0.50
ϵ Indi	5.2	4.60	0.20
Lalande 21258	8.5	4.40	0.26
σ^2 Eridani	4.5	4.05	0.19
μ Cassiopeæ	5.2	3.75	0.19
α Centauri	0.7	3.67	0.75
O. A. N. 11677	9.0	3.04	0.26
ϵ Eridani	4.4	3.03	0.14
Groombridge 34	7.9	2.80	0.29
Σ 2398	8.2	2.40	0.35
α Bootis	0.0	2.28	0.02
B. A. C. 8083	5.5	2.09	0.07
ζ Tucanæ	4.1	2.05	0.06
σ Draconis	4.7	1.84	0.25
Groombridge 1618	+6.5	1.43	0.32
α Canis Majoris	-1.4	1.31	0.39
85 Pegasi	+5.8	1.29	0.05
O. A. N. 17415	9.0	1.27	0.25
α Canis Minoris	0.5	1.25	0.27
η Cassiopeæ	3.6	1.20	0.15
70 Ophiuchi	4.1	1.13	0.15
α Aquilæ	1.0	0.65	0.20
6 (B) Cygni	6.6	0.64	0.23
β Geminorum	1.1	0.64	0.07
β Cassiopeæ	2.4	0.55	0.16
10 Ursæ Majoris	4.2	0.51	0.20
ι Ursæ Majoris	3.2	0.50	0.13
α Aurigæ	0.2	0.43	0.11
Σ 1516	7.0	0.42	0.28
α Lyræ	0.2	0.36	0.16
α Leonis	1.4	0.27	0.09
α Geminorum	1.6	0.21	0.20
α Tauri	1.0	0.19	0.11*
ν^1 Draconis	4.9	0.16	0.32
ν^2 Draconis	4.8	0.16	0.28
η Herculis	3.7	0.08	0.40
α Cassiopeæ	2.2	0.05	0.07
α Ursæ Minoris	1.1	0.04	0.07
π Herculis	3.4	0.04	0.00
α Herculis	3.2	0.04	0.06
γ Draconis	2.4	0.03	0.09
γ Cassiopeæ	2.3	0.02	0.01
α Argus	0.4	0.00	0.03

* Elkin's and Hall's value.

TABLE V.

	Number of stars.	Mean magnitude.	Mean proper motion.	Mean parallax.
First group ---	9	5.57	4.93	0.32
Second " ---	9	5.59	2.33	0.20
Third " ---	9	3.37	1.04	0.20
Fourth " ---	9	2.36	0.38	0.16
Fifth " ---	10	2.84	0.06	0.13

If the stars in Table IV be arranged according to the magnitude of the parallaxes, it will be seen that eighteen of them have a parallax greater than $0''.2$. The mean magnitude of these stars is 5.56 and the mean parallax is $0''.34$. Of the remaining twenty-eight stars the mean magnitude is 2.89 and the mean parallax is $0''.11$.

Hence it would appear that, if any law can be formulated from the observed data, it must be that the *fainter*, rather than the *brighter* stars are nearest the solar system.

A corollary of the theory just discussed avers that, as the largest stars are nearest the solar system, they should be affected by the largest apparent proper motions. This, as is fully shown in the discussions just cited, is not in accordance with the observed phenomena; in fact, the manifest conclusion, from all recent observations and investigations, must be that the assumptions in regard to the relations between stellar magnitudes, distances and proper motions, which have been introduced into the discussions of the direction and of the velocity of motion of the solar system, have little or no foundation in nature, and are now a decided hinderance to true progress in such investigations.

The elder Struve's scheme, formed to express certain assumed relations between stellar magnitudes and distances, was not originally designed to aid the study of stellar proper motions, but was a bold and ingenious assumption which he employed in the investigation of a different class of problems

in stellar astronomy, and in that direction, in the hands of such a master, it served a useful purpose.

The most important obstacle, in all the discussions of solar and stellar motions, is our almost complete ignorance of the distribution and the distances of the stars. While it is true that the parallaxes, and consequently the distances of a very few stars, have been measured with considerable apparent accuracy, the probable error of many of the most trustworthy results, if expressed in miles, would be greater than any known distance in the solar system.

But even if we knew the distance from the solar system of any star of a given magnitude, or of a number of stars of different magnitudes, with as much precision as we know the distance of the earth from the sun, we should only be in possession of a few isolated facts, and would be unable, from such data, and with the knowledge we have thus far attained, to infer the distance of any other star in the universe.

Our knowledge of stellar distances must be obtained by the slow and laborious process of measuring the parallax of each object, trusting that, with the gradually accumulating facts, new light may be thrown upon the problem, and a second Newton may appear, who will solve the riddle, and point out to future astronomers the laws that obtain among the stellar worlds.

It is well, perhaps, to consider at this point, one important fact. If, at this moment, we knew the distance from the solar system of every star visible to the naked eye, with an accuracy equal to the best work ever done in that direction, we should still be unable to solve the problem of the direction and the velocity of the motion of the solar system, with a degree of precision commensurate with the importance of the question.

But we are not yet in possession of the necessary accurate knowledge of the proper motions of the stars.

While many of the earlier observations of right ascensions are fairly trustworthy, it is only about ninety years since Pond's observations, with astronomical instruments of

the proper character, gave declinations with which to begin the discussion, and at least another century must elapse before the necessary data can be obtained for a satisfactory solution of the problem.

Finally, lest, after rehearsing the obstacles that confront our progress in this direction, I be misunderstood, I wish to disclaim most earnestly any pessimistic views in regard to the results of genuine investigation in this field of astronomical research.

For more centuries than we now reckon since the Christian era, a peculiar theory of the immobility of the solar system held undisputed and dominating sway in the minds of those who formulated the philosophy of the physical world, and only yielded, at last, to the accumulated evidence gathered by those patient watchers of the stars who labored not for present gain or future glory, but to learn the secrets of the heavens.

And shall we now grow faint hearted because we may be forced to wait for one or two centuries for the solution of an interesting problem, while the progressive evolution of the result is visibly manifest from year to year? It is, rather, the attractive duty of the astronomer of these later days to strive cheerfully to fix, for his epoch, the evidence of each member of that starry host of witnesses whose cumulative testimony will make clear, sooner or later, the laws that guide their motions through the depths of space.

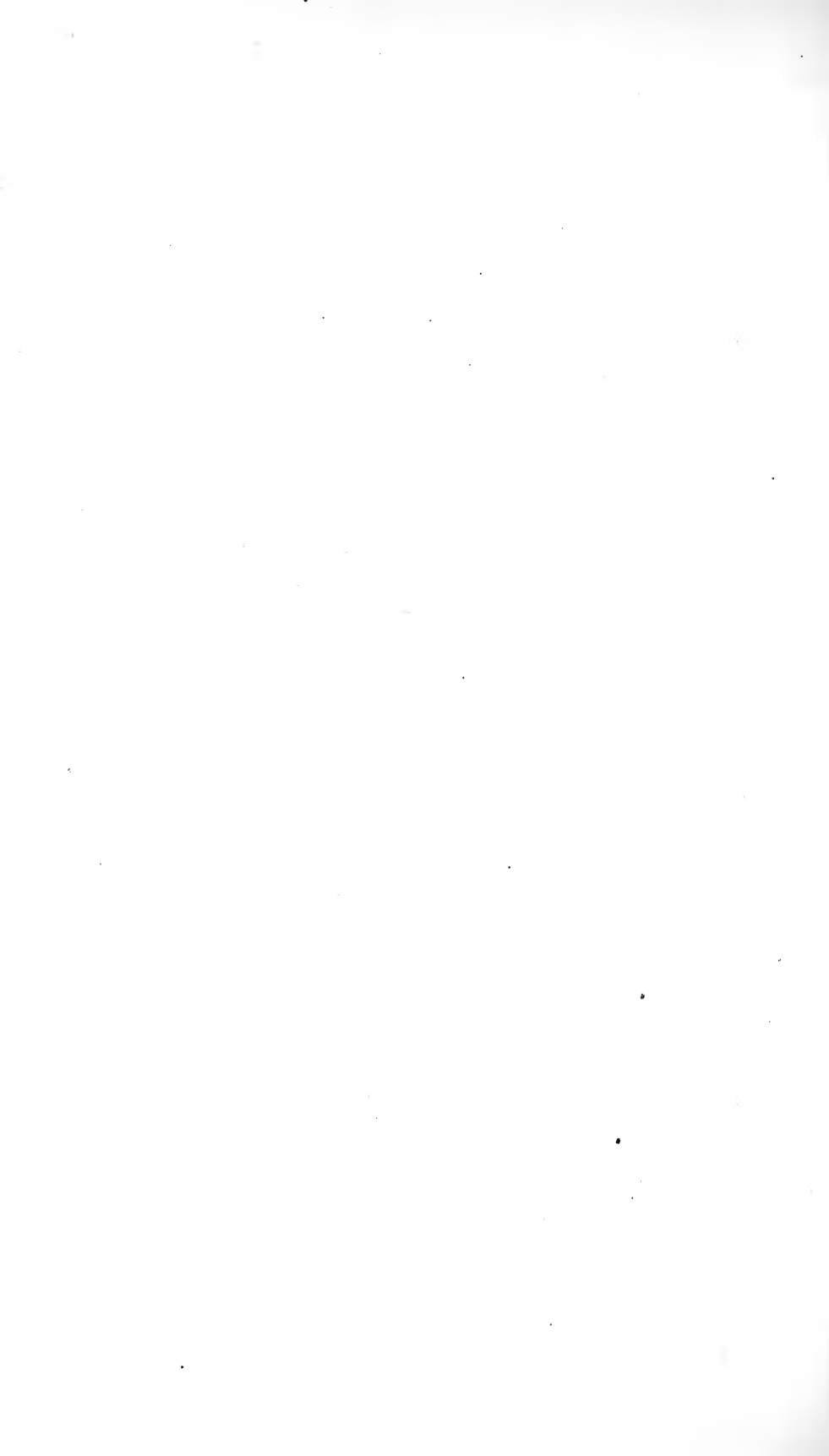

HURRICANES IN THE BAY OF NORTH AMERICA.

BY

EVERETT HAYDEN.

[Read before the Society, October 12, 1889.]

The Bay of North America embraces the entire western part of the North Atlantic between Newfoundland and Venezuela, including the Caribbean Sea and Gulf of Mexico. The term was first used, I believe, by Prof. Alexander Agassiz, and it is so expressive that it should come into more general use. In its general outlines this great body of water bears a certain analogy to the corresponding indentation of the North Pacific into the continent of Asia, and the hurricanes of the Bay of North America are very similar, in all their essential features, to the typhoons of the China seas. The tracks along which they move, however, seem to be far more uniform and regular in character, due, perhaps, to the greater simplicity in the general configuration of land and water and to the fact that the Gulf Stream, a famous breeder of ocean storms, is greater as to temperature, velocity, and volume than the Kuro Siwo, or Black Stream of Japan.

The word "hurricane" comes from a Carib word, meaning simply a violent wind. As used at present it has a double meaning: first, an entire storm system or cyclone, in which the highest force of wind is as high as 12 (Beaufort's scale); secondly, a wind as high as 12. Thus a sailor might say that on a voyage from Havana to New York he encountered a hurricane; here the word would mean a "revolving storm," or a very severe cyclone. Again, in describing the

storm, the shifts of wind, &c., he might say that at 8 a. m. it was blowing a moderate gale from E NE.; at noon, a strong gale from E.; and at 4 p. m., a *hurricane* from SE.

A hurricane, then, in the broader signification of the word, is a cyclone of enormous intensity. This word *cyclone*, as originally coined by Piddington and adopted by Redfield and other early writers, and as still used by leading authorities, does not necessarily convey the idea of a violent storm, but is used as a generic term to refer to a wind system where the circulation is cyclonic (in the Northern hemisphere, *against* watch hands; in the Southern, *with*) and the barometric pressure below the normal. It is, I think, a pity that popular usage is making the meaning of the word too specific, somewhat as it has made the expression "tidal wave" too generic. The following quotation from Redfield is of interest in this connection :

"The term cyclone was first proposed by Mr. Piddington to designate any considerable extent or area of wind which exhibits a turning or revolving motion, without regard to its varying velocity, or to the different names which are often applied to such winds. If used in this sense it may prevent the confusion which often results from other names, more variable or indeterminate in their signification. Thus, all hurricanes or violent storms may, perhaps, be considered as cyclones or revolving winds; but it by no means follows that all cyclones are either hurricanes, gales, or storms. For the word is not designed to express the degree of activity or force, which may be manifested in the moving disk or stratum of rotating atmosphere to which it is applied. It often designates light and feeble winds, as well as those which are strong and violent."

The tracks that have been traversed by storms during each month of the year are valuable indications to the navigator regarding the probable path of a storm that he may encounter during a voyage. For this reason there were plotted upon the Pilot Chart of the North Atlantic Ocean last year

the tracks of all the cyclones on record for August, September, and October, respectively, likely to indicate to the navigator the paths that hurricanes usually follow during these three months—the especially dangerous hurricane months in the Bay of North America. Upon looking at these three charts it will readily be seen that the motion of translation of such storm systems is westward in the tropics, then northward into the temperate zone, and finally northeastward; it will be noticed, also, that the tracks are most numerous off our coast, in the Gulf Stream region. These storm tracks, although valuable as indicating in a general way the region where tropic cyclones are most liable to be encountered and the direction of their tracks, are nevertheless far from satisfactory. Although compiled from all available data, we have had hardly time enough to go into the subject with the thoroughness that it deserves, in order to sift out the tracks that represent the movements of cyclones unaccompanied by winds of any noteworthy violence, to omit everything founded too largely on guess-work, and to verify and correct the tracks of genuine hurricanes. As they stand, we cannot base upon them anything but the weakest and vaguest generalities.

A *hurricane* is an event of enormous importance in the history of atmospheric physics; to use a metaphor from human history, it is a great battle, upon which the fate of nations—of civilization itself—depends, as compared to the desultory and meaningless skirmishes that are so liable to confuse and mislead the historian. The simplicity and breadth of marine meteorology, due to the greater extent and uniformity of the leading meteorologic conditions at sea than on land, would seem to make its study of the very greatest value in arriving at any correct ideas regarding the general laws of atmospheric circulation, and to repay well the increased difficulty in collecting and collating data.

In a general way, then, these tracks illustrate the fact that hurricanes, originating as great whirlwinds in the tropics, move westward, northward, and finally northeastward, along

a parabolic track concave to the east, with a marked tendency to follow the Gulf Stream. Speaking of the origin of these terrific storms, Padre Viñes, the eminent director of the Observatory of Belen College, Havana, says:

“To the east of the Windward Islands and along the Caribbean Sea is planted a cyclonic battery which in certain months of the year aims its death-dealing projectiles at us—projectiles of incalculable destructive power and prodigious range.” He says further, and to this I would call especial attention: “The position and aim of the battery that is planted to fire upon us, the range of its shots, and even the destructive force of its projectiles, all depend upon general causes that vary, more or less, with the seasons; hence the cyclone commonly takes a path that varies with the months.”

Here, then, we have a general law, a key that opens the door to the solution of problems of the greatest interest and importance to the physicist, to the meteorologist, and to the practical navigator. Briefly stated, Viñes' laws regarding the recurvature of West Indian hurricanes are as follows: In June (and October) the vertex of the parabola is in about latitude 20° to 23° north; in July (and September), 27° to 29° , and in August, 30° to 32° . The importance of these laws is so great, both theoretically and practically, and the authority of their discoverer so well established, that they are worthy of the most careful consideration and are not to be denied on the strength of any series of storm tracks that has yet been published.

Let us consider next the conditions that precede the formation of a hurricane. To do this let us imagine ourselves aboard ship in the tropics, near the northern limits of the belt of equatorial rains and calms, and watch the weather. I will quote from “Two Years before the Mast,” by R. H. Dana, Jr., a little book whose interest, truthfulness, and descriptive power are so great that many successive editions have been published since its first appearance, some fifty years ago:

“*Sunday, September 4th*, the trades left us, in latitude 22° north, longitude 51° west, directly under the tropic of Cancer. For several days we lay ‘humbugging about’ in the Horse latitudes, with all sorts of winds and weather, and occasionally, as we were in the latitude of the West Indies, a thunder-storm. It was hurricane month, too, and we were just in the track of the tremendous hurricane of 1830, which swept the North Atlantic, destroying almost everything before it. The first night after the trade-winds left us, while we were in the latitude of the island of Cuba, we had a specimen of a true tropical thunder-storm. A light breeze had been blowing from aft during the first part of the night, which gradually died away, and before midnight it was dead calm, and a heavy black cloud had shrouded the whole sky. When our watch came on deck, at twelve o’clock, it was as black as Erebus; the studding-sails were all taken in and the royals furled; not a breath was stirring; the sails hung heavy and motionless from the yards; and the stillness and darkness, which was almost palpable, were truly appalling. Not a word was spoken, but every one stood as though waiting for something to happen. In a few minutes the mate came forward, and in a low tone, which was almost a whisper, told us to haul down the jib. The fore and mizzen top-gallant sails were taken in in the same silent manner; and we lay motionless upon the water, with an uneasy expectation, which, from the long suspense, became actually painful. We could hear the captain walking the deck, but it was too dark to see anything more than one’s hand before the face. Soon the mate came forward again and gave an order, in a low tone, to clew up the main top-gallant sail; and so infectious was the awe and silence that the clew-lines and buntlines were hauled up without any singing out at the ropes. An English lad and myself went up to furl it, and we had just got the bunt up when the mate called out to us something, we did not hear what,—but, supposing it to be an order to bear-a-hand, we hurried and made all fast, and came down, feeling our way among the rigging. When we got down we

found all hands looking aloft, and there, directly over where we had been standing, upon the main top-gallant mast-head, was a ball of light, which the sailors call a corposant (*corpus sancti*), and which the mate had called out to us to look at. They were all watching it carefully, for sailors have a notion that if the corposant rises in the rigging it is a sign of fair weather, but if it comes lower down there will be a storm. Unfortunately, as an omen, it came down and showed itself on the top-gallant yard-arm. We were off the yard in good season, for it is held a fatal sign to have the pale light of the corposant thrown upon one's face. As it was, the English lad did not feel comfortably at having had it so near him, and directly over his head. In a few minutes it disappeared, and showed itself again on the fore top-gallant yard; and, after playing about for some time, disappeared once more, when the man on the fore-castle pointed to it upon the flying-jib-boom-end. But our attention was drawn from watching this, by the falling of some drops of rain, and by a perceptible increase of the darkness, which seemed suddenly to add a new shade of blackness to the night. In a few minutes, low, grumbling thunder was heard, and some random flashes of lightning came from the southwest. Every sail was taken in but the topsails; still, no squall appeared to be coming. A few puffs lifted the topsails, but they fell again to the mast, and all was as still as ever. A moment more, and a terrific flash and peal broke simultaneously upon us, and a cloud appeared to open directly over our heads, and let down the water in one body, like a falling ocean. We stood motionless and almost stupefied; yet nothing had been struck. Peal after peal rattled over our heads, with a sound which seemed actually to stop the breath in the body, and the 'speedy gleams' kept the whole ocean in a glare of light. The violent fall of rain lasted but a few minutes, and was followed by occasional drops and showers; but the lightning continued incessant for several hours, breaking the midnight darkness with irregular and blinding flashes. During all this time there was not a breath stirring, and we lay motion-

less, like a mark to be shot at, probably the only object on the surface of the ocean for miles and miles. We stood hour after hour, until our watch was out, and we were relieved at four o'clock. During all this time hardly a word was spoken; no bells were struck, and the wheel was silently relieved. The rain fell at intervals in heavy showers, and we stood drenched through and blinded by the flashes, which broke the Egyptian darkness with a brightness that seemed almost malignant; while the thunder rolled in peals, the concussion of which appeared to shake the very ocean. A ship is not often injured by lightning, for the electricity is separated by the great number of points she presents and the quantity of iron which she has scattered in various parts. The electric fluid ran over our anchors, topsail sheets and ties; yet no harm was done to us. We went below at four o'clock, leaving things in the same state. It is not easy to sleep when the very next flash may tear the ship in two, or set her on fire; or where the deathlike calm may be broken by the blast of a hurricane, taking the masts out of the ship. But a man is no sailor if he cannot sleep when he turns-in, and turn out when he's called. And when, at seven bells, the customary 'All the larboard watch, ahoy!' brought us on deck, it was a fine, clear, sunny morning, the ship going leisurely along, with a soft breeze and all sail set."

As a good, brief, scientific statement of the most widely accepted theory regarding the formation of these storms, Abbe's review of Blanford's results in the Bay of Bengal is of interest: "Cyclones are not produced between parallel currents flowing in opposite directions. A calm state of the atmosphere, or one in which the winds are light and variable over the open sea, is a favorable condition, and a second condition is a high or moderately high temperature," resulting "in the production and ascent of a large quantity of vapor, which will be condensed with the liberation of its latent heat over the place of its production. If this state of things last for some days, the slowly inflowing winds acquire by the influence of the motion of the earth a whirl, in consequence

of which, as Mr. Ferrel has shown, the barometric depression must increase. The last step preceding and apparently determining the formation of a well-defined cyclone in the Bay of Bengal is, according to Blanford, the inrush of a saturated stormy current from the southwest or west-southwest. But this last feature may be peculiar to that locality, and those previously enumerated seem to correspond best to the conditions generally observed in the formation of whirlwinds." Abbe says, further, "Concerning the origin and cause of the hurricanes of the Atlantic Ocean comparatively little is positively known." Relative to this statement it can only be said, I think, that it is one of the most remarkable and lamentable facts in the history of meteorology that we have so completely failed to utilize the admirable opportunities that exist for the study of marine meteorology. There is no large body of water in the world that compares with this in availability for such a purpose; it is classic ground for the meteorologist, for it was here that Redfield made his great discoveries; and, finally, very complete and reliable data have been for years past and are now being collected from masters of vessels navigating these waters. In spite of all these advantages, however, no well-directed effort seems to have been made to utilize the data at hand, and we have to go to the Bay of Bengal for light on the subject. The fact is, the interests of agriculture and other great inland industries are really so important in this country that they are of right entitled to every consideration; and yet commerce is a great factor in our success as a nation, and, indeed, the study of the meteorology of the Bay of North America is of the very greatest importance in connection with a knowledge of weather conditions in the entire eastern half of the United States, so intimate is the relation between the two.

Another theory regarding the formation of cyclones is that of the French astronomer, Faye, and this may be called the "descending eddy" theory. Although not supported by the same weight of authority as the generally accepted "aspiration" theory (referred to above), it seems to me to be worthy

of respectful consideration and comment, at least. Its essential feature is the hypothesis that eddies form amongst the rapid upper atmospheric currents and descend toward the surface of the earth, bringing down with them some of the intense energy of motion characteristic of their place of origin. The Edinburg Review for October, 1888, contained an able and favorable review of Faye's theory, going into the whole subject somewhat exhaustively. To one statement, however, I must take decided exception, and as it is rather an essential part of the theory I may as well quote it here. The reviewer says, after speaking of the comparatively clear and calm space at the center of a tropic cyclone: "There can, then, be no doubt that in the calm space of the typical storm of the tropics the air is descending; and if it be descending at the core, it is difficult, if not impossible, to believe that it is mounting in the spires." Relative to this statement I must say that it seems to me incredible that any one who has seen a tropic cyclone, or who has considered the known facts regarding cyclonic circulation, can fail to admit that there *is* an ascending current in the spires of the whirlwind. It is now well known that in a hurricane the winds at the surface blow somewhat spirally inward; the next upper current (bearing the low scud) moves in a circular direction about the center; the next higher (the high cumulus) in an outward spiral, and so on up to the very highest cirrus, which radiates almost directly outward. These features of cyclonic circulation are illustrated by means of this large chart, showing the marked spirally in-blowing character of the circulation in the great hurricane off our coast the 25th of last November, and by the cyclonoscope constructed by Padre Viñes to illustrate the typical and normal relative direction of motion of the various atmospheric currents, as observed by him in hundreds of cyclones. If, then, we are to believe the substantial accuracy of such data, there is no possible alternative but to accept the observed fact (regardless of any theory) that the air moves inward below, and, whirling about the central core, flows outward above.

One of the strongest arguments advanced against the theory of an ascending current has been the fact that all observations regarding the rainfall in a waterspout at sea have seemed to show that the water was *fresh*, and never *salt*, as it should be were any water drawn bodily up from the ocean. A recent and thoroughly reliable report sent to the United States Hydrographic Office from a vessel that passed through a waterspout off the Bahamas states positively that the rainfall was *salt water*, and this observation has been confirmed by careful inquiry regarding the particulars of the case. Admitting, then, that there is an ascending current of air in every cyclone, it does not seem to me that even this is sufficient to disprove the most essential feature of Faye's theory. In fact, if you start with the hypothesis of a descending eddy of cold dry air, the natural and normal result would be that an ascending spiral should be induced by it as soon as it broke through the intervening strata and reached down to the lower warm and saturated layers of the atmosphere. That there is a descending current of dry air at the center seems to be admitted, indeed, by the leading supporters of the "aspiration" theory, and the principal difference of opinion would therefore seem to be as to whether such a descending current or eddy be the *cause* or the *effect*. The following quotation from a late work by Ferrel must be of especial interest in this connection: "The air, charged with moisture, in its vertical circulation, in toward the center below, up in the interior to a given altitude, and outward above in the middle strata, necessarily moves in a path somewhat elliptical; so that it is being deflected outward above and still ascends until at a considerable distance from the center, and so there is little condensation of vapor in the central part, and the cloud stratum is thin and sometimes entirely wanting. And this state is still further promoted by the gyratory motion which is confined mostly to the lower and middle strata, bringing the air down from above, it may be, down pretty low, into the interior central part, where it is carried out horizontally on all sides; and the descending air in the

interior above is of course clear air. The effect under such conditions is a thinning of the cloud and a scantiness of condensation and rainfall in the center, a ring of denser and deeper cloud at some distance from the center, which gradually shades off to the outer limit. Where, however, the conditions give rise to a vertical or cyclonic circulation up to very high altitudes, this phenomenon is perhaps never observed." If the supporters of Faye's theory will only admit that their "descending eddy" must cause and be accompanied by spirally ascending whirls in the lower strata, then, perhaps, the "aspirations" will admit, on their side, that this theory, as well as their own, is competent to explain the facts. It would then remain to decide as to which of the two principles is the more general in its operation, and to discriminate, perhaps, between two classes of storms. There might, for instance, be reasons for believing that great hurricanes, traversing their majestic orbits for thousands of miles with such marked symmetry, individuality, and energy, may have a higher origin than the countless little storms whose more or less erratic tracks on our charts obscure their more regular and systematic paths.

It seems to me that there is one factor that has not received sufficient, if any, attention, namely, the focusing of the sun's rays at the center of a hurricane by reflection from surrounding cloud-masses and by refraction through strata of varying density about the "eye of the storm." Under certain conditions similar action may, perhaps, determine the *origin* of a hurricane, and certainly in the case of a fully developed hurricane, with a clear space at the center surrounded by a ring of piled-up masses of clouds, the reflected and refracted rays of an almost vertical sun must have a very great effect in determining the intensity, and variations in the intensity, of the storm.

What part electricity plays in maintaining the terrific energy of a hurricane is unknown. It is, perhaps, dimly suspected, for the problems of atmospheric electricity are engaging the attention of many of the ablest physicists of the

age, but it certainly has not as yet been announced. It is a striking fact that there is a marked absence of thunder and lightning in a tropic cyclone. The ordinary visible and audible manifestations of this great physical agent are almost wholly wanting in the inner whirls of a hurricane, although its pressure is indicated very decidedly in other ways. On *a priori* reasoning, at least, we must assign it some very important part in the phenomenon.

Certain marked exceptions to the normal tracks of hurricanes in the Bay of North America may next be referred to, and these I have illustrated by a chart upon which are plotted the tracks of two hurricanes of September, 1888, and two of September, 1889. Of the former, the first crossed Cuba from east to west, September 4th, and thence moved along a very abnormal track (about west by south) toward Vera Cruz; it was followed at a distance of about 700 miles by a second hurricane, which recurved about as usual. This notable exception to the usual law called forth an important statement from Padre Viñes, who attributed the deflection of the first hurricane to its *repulsion* by the second. The following extract from this statement may be quoted here: "At the impact of two cyclones the only currents that can and ought to produce a repellent action are the upper ones, which diverge from the center toward the circumference, and which are expelled with great velocity and to great distances in tropic cyclones. Consequently, when two meet, the upper currents of one flow out and strike the upper currents of the other directly. The lower currents, as they are convergent, tend rather to join the two cyclones in one. Furthermore, when two cyclones are brought into contact from a distance, the first meeting and first shock is among the upper currents, which extend much farther outward than the superficial winds. I would say, then, that the contact of the upper currents of the two cyclones could and ought to be proven, and that in fact the struggle was proven and established. We have, therefore, the exceptional case of a storm whose path, instead of curving toward the north, as usual, curved

southward, this rare phenomenon being due to the disturbing action of the upper currents of another simultaneous storm."

It has been observed that one hurricane often succeeds another and follows it at only a few days' interval and along an almost identical track. Probably in this case the relative position and normal motion of each happens to be such that the repellent action is manifested by accelerating the first and retarding the second. In addition to the interest that attaches to this question from the point of view of theory, there is thus a side of great practical importance, since occasion might arise when two tropic cyclones were known to be in existence near each other and it were desired to predict the course each would follow. This chart shows that a second and very severe cyclone was in existence about 800 miles east from St. Thomas, September 3, 1889, the very day that the first of these two September hurricanes passed the island. Now it seems possible, indeed, probable, that the delay of the first hurricane off our coast between Hatteras and Block Island was due to the area of high pressure built up between the two (as they moved north), southward of Newfoundland. Thus, just as in the case of the Cuban hurricane a year previously, the two cyclones modified each other's movements. It is so often the case that two storms of moderate energy unite to form one storm of considerable energy, especially in the temperate zone, that it seems particularly important to put on record the fact that two hurricanes repel each other. That this is not the case where cyclones of moderate or slight energy are concerned, even in the tropics, is evidenced by a recent communication from Maxwell Hall, Jamaica Government Meteorologist, who refers to the union west of that island of two small depressions that passed on either side of Jamaica September 15th. Here, then, is one distinction, at least, between the movements of cyclones of slight and great intensity, and it will serve to illustrate what was said relative to the importance of studying the movements of hurricanes from the tracks of hurri-

canes, and not from the tracks of cyclones of every grade of intensity. The case may be compared to that where the movements of great icebergs south of Newfoundland give correct ideas regarding the sub-surface currents that drag them southward into and through the easterly surface current, which, however, would determine the track of any lighter and less deeply immersed object.

The recent and very severe hurricane that was central off Hatteras September 8th, and that raged off the coast between Hatteras and Block Island for several days, is described briefly by a supplement issued with the October Pilot Chart, entitled "The St. Thomas-Hatteras Hurricane of September 3-12, 1889." The ten synoptic charts of the Bay of North America contained thereon illustrate the general characteristics of the storm for each day, from the time it passed St. Thomas till it died away north of Hatteras. Extracts from St. Thomas and Antigua newspapers illustrate the severity of the storm amongst the Windward Islands, and a chart of telegraph lines and cables shows that it is practicable, with the facilities that already exist, to get very complete telegraphic information regarding such storms, and to watch their progress from day to day as they approach our Atlantic and Gulf coasts. In the present case, indeed, brief telegraphic reports were received by the United States Signal Office, but the importance of early, decided, and definite warnings of such a storm would seem to require that we should receive as full reports as reach Havana, where the dangers of a hurricane are so keenly appreciated that the daily papers publish columns of news about every one that is reported from the Windward Islands. These long clippings from Havana newspapers show exactly what was known in Havana about this particular storm, as compared with the few words that reached Washington. The almost unflinching accuracy with which a skilled observer in the tropics can note the presence and character of a storm while it is still distant is not appreciated at all by those who are accustomed to base their forecasts entirely upon the syn-

chronous data charted on a daily weather map. This subject is so well understood at places like Manilla, Mauritius, and Havana, that a hurricane cannot come within 500 miles without detection by means of observations of the upper clouds, together with various other well-known indications, such as peculiar atmospheric effects, increased ocean swell, etc., although its existence might not even be suspected by the uninitiated. Indeed, a good example is furnished in the present case, where the motions of the storm were clearly traced from Havana when it was central about 900 miles away.

One very important source of information regarding a storm off the coast, generally recognized by meteorologic offices and published on their daily weather maps, in England and France, for instance, is the *state of the sea*. A long rolling swell from the direction of a distant storm is one of the earliest signs of its approach, and perhaps the very best index of its severity. This valuable source of information might well be utilized along our own coast. It will be remembered that it was a marked feature of the recent hurricane, and the enormous seas started by the great whirlwind had overspread almost the entire western half of the Atlantic as early as the 5th, when it was central 750 miles S SE. from Hatteras. At this time there was a heavy northeasterly swell at Jamaica and through the Windward Channel; northeasterly and easterly, all along the Bahama Islands and northern Florida; very heavy surf at Bermuda; long, rolling swell from S SE. off Hatteras, perceptible as early as the 2d and increasing daily; long, low southerly swell off Nantucket, perceptible as early as the 4th, when the storm center was 1,300 miles away, and increasing daily. The more severe the storm, the more important is this source of information. The energy of a hurricane is so concentrated that by the time its presence is indicated on a daily weather map by the increased velocity of the wind and low reading of the barometer the warning is too late to be of much value.

The high tides and floods along the coast between Hatteras

and Nantucket were due to the *storm wave* of the hurricane. This feature is well described in the following quotation from Buchan: "The most dreadful attendant on tropical cyclones is the storm wave, caused by the inflowing winds and the low pressure of the center of the storm. When this wave is unusually high and is hurled forward on a low-lying coast at high water it becomes one of the most destructive agents known. The Bakarganj cyclone of October 31, 1876, was accompanied by a wave which flooded the low grounds to the east of the delta of the Ganges to heights varying from 10 to 45 feet, by which more than 100,000 human beings perished."

In conclusion, permit me to call your attention to the commercial importance of the Bay of North America, the value to navigators and to the inhabitants of its shores and islands of taking advantage of every possible method of obtaining and circulating early and reliable information of approaching storms, and the admirable facilities that exist for the establishment by international co-operation of a weather service that would exhibit clear and intelligible storm warnings and concise general statements of existing weather conditions from every prominent light-house and headland. A cable is about to be laid from Halifax to Bermuda, which will add a very important station, and a line should be extended to Nassau, which is perhaps an equally important point. First and most important of all, however, the enormous value to commerce of a first-order station at Hatteras should be recognized, and this might well be considered in planning the new light-house on the outer Diamond Shoal. The great strategic value of this salient and commanding point in our outer line of defenses against Atlantic storms has never been fully appreciated. It is too often the case that at the first attack of the enemy the wire to Hatteras goes down and communication is severed. In connection with the new light-house there should be a cable that no storm, however severe, could ever interfere with. From a commercial point of view, at least, this is the central and

commanding point in the weather service of the Bay of North America.

Considering, then, what has already been said regarding the distance at which a skilled observer can note the presence and character of an ocean storm, it is interesting to take a map and select a certain number of points along the coast and from each of these points as a center describe a circle with a radius of, say, 300 miles (to be well within the distance assigned for the easy detection of an approaching storm). It will be found that an almost perfect system of interlocking circles can be obtained by selecting the following fifteen points, all of which, with the exception of Bermuda and Nassau, have, already, full telegraphic communication: Cape Race, Halifax, Nantucket, Hatteras, Bermuda, Nassau, Havana, New Orleans, Brownsville, Progreso, Kingston, St. Thomas, Barbados, Curaçao, and Aspinwall. A most important step toward the establishment of such a service has been taken by the formation at Havana of a Marine Meteorologic Service for the Spanish West Indies, under the direction of Captain Carbonell, of the Royal Spanish Navy, who has already rendered valuable assistance to the Signal Office and the Hydrographic Office. He has interested the French, Spanish, and American cable companies to such an extent that they have allowed him the franking privilege for his weather despatches over their lines, and it is hoped that the English company will soon grant the same favor, in consideration of the benefits that must result to commerce and to the people generally. With the growth and extension of this system we may expect to see, within a very few years, a great increase in the safety of navigation in the Bay of North America and a notable addition to our knowledge of every branch of marine meteorology.

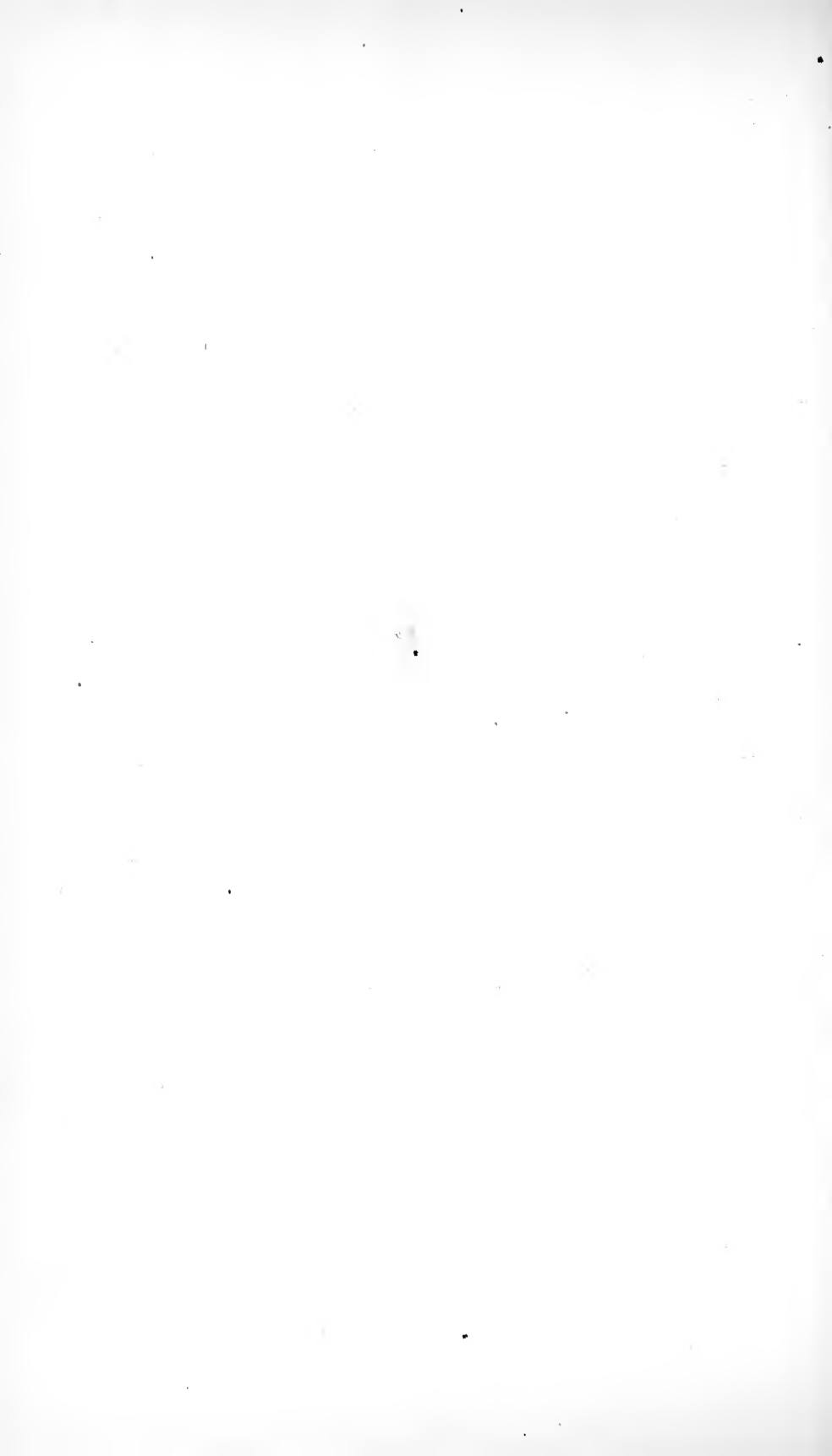

THE MINERAL COMPOSITION AND GEOLOGICAL
OCCURRENCE OF CERTAIN IGNEOUS ROCKS IN
THE YELLOWSTONE NATIONAL PARK.

BY

JOSEPH PAXSON IDDINGS.

[Read before the Society by permission of the Director of the U. S.
Geological Survey, January 18, 1890.]

INTRODUCTION.

That there is a connection between the *geological occurrence* of igneous rocks and their *crystalline structure* is very generally admitted; when by the geological occurrence is meant the mode of occurrence of such rocks as dikes, stocks or necks, laccolites, or irregularly shaped masses of variable dimensions enclosed within other bodies of rock, or as extravasated masses which assume the form of lava-flows, breccias, pumices, and tuffs.

But the term should be extended so as to include the *geological history* of the eruption. For the nature of this relation is not definite or fixed, since the crystalline structure of different rock-masses not only varies with the size and character of the geological bodies in which they occur, but more especially with certain conditions attending the solidification of the magmas, including those connected with the whole history of their eruption.

The extent of these variations in structure is becoming better understood as the geological investigation of igneous

rocks in the field and their petrographical examination advance hand in hand.

The relation, however, between the *geological occurrence* and the *mineral composition* of igneous rocks is less understood, and seems not to have entered sufficiently into the consideration of these rocks as crystallized magmas. This relation is a matter of fundamental importance for the establishment of the proper connection between different varieties of eruptive rocks, which necessarily underlies a natural system of their classification.

The study of the igneous rocks at Electric Peak and Sepulchre Mountain—incidental to the investigation of the Yellowstone National Park under the charge of Mr. Arnold Hague—offers a valuable contribution to our knowledge of these relations. In order to present some of the results of this study it will be necessary to sketch the geology of the region and describe the eruptive rocks occurring in it. After which the variations in their mineral composition and crystalline structure will be discussed.

GEOLOGICAL SKETCH OF THE REGION.

Electric Peak is the highest point of that portion of the Gallatin Mountains lying within the Yellowstone National Park, and reaches an altitude of 11,100 feet. It has been carved out of Cretaceous shales and sandstones, which, with the underlying strata of this range of mountains dip gradually toward the northeast. Occupying a synclinal trough between two bodies of Archæan gneiss, these strata have undergone more or less folding and displacement, which has been accompanied by the eruption of igneous magmas.

The earlier of these eruptions forced sheets and laccolites of intrusive rocks between the strata wherever the nature of the beds offered planes of least resistance to the dynamical forces engaged in their plication. Hence the sheets are more abundant and smaller where the strata were very fissile, and abound in the shales and thinly bedded sandstones of the Cretaceous. The mass of Electric Peak is

traversed by sheets of porphyrite, which have been intruded from a centre of eruption southwest of the mountain.

A subsequent synclinal break along what is now the east side of the mountain, permitted the further eruption of igneous material, which penetrated the nearly vertical fissures caused by this fracture. These vertical dikes traverse the strata and intercalated sheets in the main body of the mountain, but are nearly parallel to them in that portion of the mass east of the synclinal axis where the beds have been turned up on end. The dikes radiate from about the middle of the northeast spur of the mountain through an arc of 45° from south to southwest, and are not more than a mile and a half long. At the centre from which they radiate is a broad stock of intrusive rocks 1,500 feet wide, which lies in the axis of the synclinal. From it branch several apophyses, and around it the sedimentary rocks have been highly metamorphosed.

The eruptive magmas which found their way between the ruptured strata and solidified as intrusive rocks in the form of laccolites, sheets, dikes and stocks, also reached the surface of the earth in places and cooled as effusive bodies. The extravasated rocks were probably erupted from a number of different vents, whose position was governed by the nature and extent of the fissures in the sedimentary rocks. They poured out as flows of lava and were from time to time blown to pieces and thrown into great accumulations of breccia. These in turn were intersected by dikes and stocks of subsequently erupted magmas, that solidified as intrusive bodies within the effusive rocks.

This is the condition of things at Sepulchre Mountain, which is directly east of Electric Peak across the valley of Reese Creek. The mass of this mountain is made up of volcanic breccias and lava-flows and tuffs, which rest upon Cretaceous strata and exhibit little or no evidence of bedding. The western portion of the mass at the base of the mountain is filled with dikes and larger intruded bodies of igneous rocks, which also form the low ridges and hills between

these two mountains. The dikes are later eruptions through the breccia, and trend from the vicinity of Cache Pond in a north and northeast direction, some trending east. In a general way they radiate in the opposite direction to those in Electric Peak.

The mass of Sepulchre Mountain with the body of intrusive rocks at its west base is separated from Electric Peak by a profound fault that trends north and south, and has thrown the higher surface accumulations of Sepulchre Mountain below the level of the Cretaceous strata with their deep-seated bodies of intruded rocks.

The eruptive rocks at the western edge of the Sepulchre Mountain mass, and directly east of the plane of faulting, carry large blocks of black Cretaceous shale, showing that they have broken up through the same strata as those forming Electric Peak. The effect of the faulting on the eruptive rocks along the east side of the fault is plainly seen. The rocks are shattered and fractured into small pieces, held together by the pulverized portion.

PETROGRAPHICAL NOTICE OF THE VARIOUS ROCKS.

An investigation of all of the igneous rocks embraced within this small area reveals a great number of important and interesting facts, which it would be impossible to present at one time to the attention of the society. In the present paper it will be sufficient to notice some of the more general observations before describing those more intimately connected with the subject in hand.

Electric Peak.—The rock-bodies forming the sheets that were intruded into the mass of Electric Peak before the intrusion of the dikes consist of a group of fine grained porphyrites. They are holocrystalline with slight variations in the grain of the groundmass. They form a group of rocks varying in chemical and mineralogical characters within certain limits. Thus they may be arranged under five different divisions, which grade into one another mineralogically, and may be tabulated with reference to the phenocrysts

other than plagioclase, which is common to all the varieties, as in the following table:

TABLE I.

Variation of Phenocrysts in the sheet-rocks at Electric Peak.

(a)	pyroxene			
(b)		hornblende		
(c)		hornblende	biotite	
(d)		HORNBLLENDE	BIOTITE	
(e)		hornblende	biotite	quartz

The variations in the mineral composition are accompanied by changes in the character and amount of the feldspars. Toward the end of the series in the order given the feldspars become less basic and more abundant and are associated with an increasing amount of quartz in the ground-mass of the rock. The proportion of ferromagnesian silicates decreases from the pyroxene end toward the mica end of the series.

The intrusion of these sheet-rocks was not the result of a single eruptive action, but of a succession of eruptions; hence we observe that there was a period of volcanic activity that injected into the mass of Electric Peak a series of magmas which solidified as pyroxene-porphyrite, hornblende-porphyrite, and hornblende-biotite-porphyrite.

Subsequently another period of activity filled the eastern portion of the mountain with dikes and the stock. The magmas forced up at this period solidified as porphyrites and diorites, which grade into one another structurally and mineralogically. The coarse grained rocks, the diorites, occur in the stock and larger apophyses; the porphyrites occupy the dikes and smaller apophyses, and are found along the sides of the stock in places, in contact with the sedimentary rocks.

The great body of diorite varies both in structure and composition; the variations being rapid in some places, and very irregular. It is mostly a dark-colored granular rock,

composed of ferromagnesian silicates and feldspar; parts of it are light-colored with a noticeable percentage of quartz. It is traversed by veins or dikes of light-colored diorites, and shows by brecciated portions that the whole mass is made up of a number of bodies that have followed one another up through the main fissure at short intervals of time.

The minerals composing the diorites are: hypersthene, augite, hornblende, biotite, lime-soda-feldspar (labradorite), orthoclase and quartz. The relative proportions of these vary considerably as already noted. The crystallization of the coarser grained diorites appears to have been a continuous, uninterrupted act; all of the minerals including the accessory ones having come within the influence of the causes producing the granular structure. In the finer grained, porphyritic portions of the diorite mass it is evident that the initial tendency of crystallization led to the formation of hypersthene and augite, and also hornblende in some cases, and that the biotite was a later crystallization connected with the final consolidation of the rock. In the non-porphyritic, granular forms of the diorite, it is also evident that the earlier crystallizations were of hypersthene and augite and of part of the hornblende, while the greater part of the hornblende, and the biotite followed. The labradorite commenced to crystallize early, while the alkali plagioclase, orthoclase and quartz closed the series.

The last eruption through this channel was that of a quite siliceous magma, solidifying as quartz-biotite-diorite-porphyrity, which approaches granite-porphyrity in composition. It is a light-colored, fine grained rock with abundant phenocrysts of plagioclase, biotite and quartz, with a little hornblende in places. It forms a broad body within the diorite, with a few dikes of still finer grained rock traversing the strata to the southwest.

The mineral variation in the rocks within the stock is shown in the accompanying table in which (a) (b), etc., represent different modifications of the rock.

TABLE II.

Mineral variation of the diorites and their facies at Electric Peak.

(a)	pyroxene		biotite	labradorite	OLIGOCLASE		quartz
(b)	pyroxene	hornblende	BIOTITE	labradorite	OLIGOCLASE		quartz
(c)	pyroxene	hornblende	biotite	LABRADORITE	OLIGOCLASE	orthoclase	QUARTZ
(d)		hornblende	biotite	LABRADORITE	OLIGOCLASE	orthoclase	quartz
(e)		HORNBLLENDE	biotite	labradorite	oligoclase	orthoclase	quartz
(f)		hornblende	biotite		oligoclase	orthoclase	quartz
(g)			biotite		oligoclase	ORTHOCLASE	quartz

The porphyrites associated with the diorites vary in mineral composition from those with phenocrysts of pyroxene and some hornblende, through varieties with hornblende and biotite, to those with biotite and quartz, plagioclase being common to them all. The series is represented by the following table :

TABLE III.

Variation of phenocrysts in the porphyrites at Electric Peak.

(a)	pyroxene		
(b)	pyroxene	hornblende	
(c)	PYROXENE	HORNBLLENDE	
(d)	pyroxene	hornblende	
(e)		hornblende	
(f)		hornblende	biotite
(g)		hornblende	BIOTITE
(h)		hornblende	biotite
(i)		hornblende	biotite
(j)			BIOTITE quartz

The variation in the nature and abundance of the porphyritical ferromagnesian silicates is accompanied by a gradual change in the character of the plagioclase, which is more basic at the pyroxene end of the series; besides a

change in the character of the groundmass, which is richer in quartz and assumes a more granular structure toward the mica end of the series.

The course of volcanic events at Electric Peak, then, commenced with successive intrusions between the sedimentary strata of a series of porphyrites. A later series of magmas came up through vertical fissures and a central conduit. These later magmas imparted a great amount of heat to the rocks immediately surrounding the conduit, and highly metamorphosed them. The magmas which followed one another through the conduit broke through those that had previously solidified within it, but had not entirely cooled. They solidified in the outlying, narrow fissures as dikes of porphyrite, while within the heated conduit they consolidated into coarse grained diorites of various kinds; the magmas of this series of eruptions becoming more and more siliceous.

The succession of eruptions may be expressed as in the first half of the table on the opposite page.

Sepulchre Mountain.—The eruptive rocks lying east of the fault line embrace a large body of extravasated breccias with smaller bodies of dikes that have broken through the breccia. The whole group of rocks coming within the generally accepted class of volcanic rocks.

The breccias which form the main mass of Sepulchre Mountain and extend as far west as the fault consist of fragments of various kinds of andesites. The lowest portion is made up of acidic andesites, that are characterized by phenocrysts of biotite, hornblende and plagioclase. They are light-colored rocks, passing in places into fine tuffs. This, the oldest breccia, carries a great amount of Archæan material in fragments, which are not found in the later, overlying breccias. Over the acidic breccia is a dark-colored one of basic andesite with inconspicuous phenocrysts of pyroxene and plagioclase, and a variable amount of hornblende. Higher up the breccia becomes grayer, and carries more hornblende phenocrysts. Some of the dark-colored

TABLE IV.

Succession of Eruptions at Electric Peak.	Succession of Eruptions at Sepulchre Mountain.
A. Intrusion of sheets of porphyrite from the southwest.	A. Extravasation of andesitic breccia from some Archæan area.
B. Intrusion of dike- and stock-rocks in the following order:	B. Eruption of andesitic breccias and dikes in the following order:
pyroxene-porphyrtes, grading into	pyroxene-andesites, breccia and flows passing into
pyroxene- and hornblende-diorites with biotite of final crystallization, with dikes of pyroxene- and hornblende-porphyrtes, grading into	pyroxene-hornblende-andesites, breccia and flows with dikes of similar andesites, grading into
hornblende-biotite-diorites with biotite of early crystallization, with dikes of hornblende-biotite-porphyrtes;	hornblende-biotite-andesites in dikes, grading into
quartz-biotite-diorite-porphyrte with some hornblende, with dikes of quartz-biotite-porphyrte.	dacites with phenocrysts of quartz, biotite and some hornblende.

breccia is quite basaltic looking, while the grayer breccia has an andesitic habit. They are very intimately associated, however, with no line of demarcation between them. The upper breccias are distinguished from the lowest by the presence of pyroxene and the absence of biotite. The bottom breccia is made up of hornblende-mica-andesites, the upper breccias of pyroxene-andesites and hornblende-pyroxene-andesites.

The breccias and flows of massive lava occurring in the upper portion of the mountain, differ among themselves in color and macroscopical habit, that is, in the abundance and proportion of groundmass and phenocrysts. They also differ in the relative abundance of the various essential minerals, and in the chemical composition of the rocks within certain limits.

They have all the petrographical characteristics of volcanic lavas; they are mostly glassy, with a porous or vesicular texture; some are compact, and some, holocrystalline.

The dikes that have broken through these breccias and are consequently of younger age, have furnished a series of rocks that vary among themselves mineralogically and chemically. The earliest of these dikes consist of hornblende-andesite with large hornblende phenocrysts; a few are pyroxene-andesite. They are so closely allied petrographically to the flow-rocks of the uppermost breccia that it is probable that they may be the same magmas which solidified as dikes during the extravasation of the hornblende-pyroxene-andesitic breccias and flows.

Later dikes consist of hornblende-mica-andesite, with abundant small phenocrysts of hornblende, biotite and plagioclase. Between these two varieties of andesite are all possible gradations, caused by the variations in the amount of biotite, and in the general habit of the rocks.

These rocks in turn grade into still more micaceous varieties which carry phenocrysts of quartz, and as the extreme variety present a quartz-mica-plagioclase rock with little hornblende. These dacites were the last to break up, and the

most acid variety appears to have closed the series of eruptions that built up Sepulchre Mountain.

It is evident from a study of these dikes in the field that they were formed by a succession of eruptive actions, which fissured the breccias and filled the cracks with magmas that differed chemically and mineralogically; and that, starting with magmas resembling those of the latest breccias, they became more and more siliceous.

The andesitic breccias and dikes form a continuous petrographical series, which may be divided for convenience into varieties that differ in the nature of the porphyritical minerals as represented in the accompanying table, plagioclase being present in all.

TABLE V.

Variation of phenocrysts in the rocks of Sepulchre Mountain.

(a)	PYROXENE			
(b)	pyroxene	hornblende		
(c)		HORNBLLENDE		
(d)		HORNBLLENDE	biotite	
(e)		hornblende	biotite	quartz
(f)			BIOTITE	QUARTZ

The dike rocks are porous and vesicular in the smaller dikes and are sometimes glassy. In the larger bodies they are more compact and usually quite crystalline.

The course of events at Sepulchre Mountain may be expressed as follows, and as tabulated on the second half of Table IV, page 199: An acidic, andesitic breccia carrying a great amount of Archæan fragments was spread upon the surface of the country. It rests upon Cretaceous strata, and was probably thrown from some neighboring area of Archæan schists and gneisses. Such an area at present exists to the north, across the Yellowstone river.

Upon this were thrown breccias with massive flows of

pyroxene-andesite, followed by those of hornblende-pyroxene-andesite. These were intersected by dikes of the same andesites, followed by hornblende-mica-andesites and dacites, which closed the series. The upper portion of this volcano having been removed, the surface-flows of the later magmas are not known in this region.

COMPARISON OF THE ROCKS AT ELECTRIC PEAK WITH THOSE AT SEPULCHRE MOUNTAIN.

Upon comparing the Tables (No. IV) representing the succession of eruptions at Electric Peak and at Sepulchre Mountain, the correspondence between the two is at once striking, but not more so than the correspondence between the rocks themselves. Leaving out of consideration the eruptions embraced in the divisions A, which evidently emanated from different sources; we observe that the series of magmas that were erupted successively, and solidified within the strata of Electric Peak as porphyrites and diorites, and those that consolidated into the mass of Sepulchre Mountain are similar; that each series commenced with basic magmas and closed with acidic ones. Their division in the table into four groups is not intended to convey the idea that they belong to four distinct periods of eruption. The whole series in each case is more correctly a single, irregularly interrupted succession of outbursts of magma that gradually changed its composition and character.

When we compare the rocks that have resulted from the corresponding phases of these series of eruptions, the similarity of the porphyritic forms is immediately recognized. The nature and distribution of the phenocrysts in the different varieties of andesite and dacite, which determine their macroscopical habit, have their exact counterparts in the different varieties of porphyrites. The microscopical characters of the phenocrysts in the corresponding varieties of porphyrites and of the intruded andesites and dacites are identical. The character of the various groundmasses, however, is differ-

ent in the two groups, being more highly crystalline in the porphyrites—many of the andesites being glassy. Many of the finer grained diorites have a habit, derived from the distribution of the ferromagnesian silicates and larger feldspars, which resembles that of some of the andesites and dacites which correspond to them chemically. But the coarse grained diorites bear no resemblance to the andesites in outward appearance or in mineral composition.

CHEMICAL CHARACTERS OF THE ROCKS.

The chemical investigation of these rocks not only brings out more clearly the similarity between the two groups of rocks under consideration, but establishes their chemical identity, and permits of the comparison of those modifications of the magmas which bear no mineralogical or structural resemblance to one another.

The analyses of the rocks occurring at Electric Peak, together with analyses of two of the sheet-rocks, are given in Table VI, p. 206. They were made by Mr. J. E. Whitfield. With the exception of the two analyses of sheet-rocks, which are introduced for comparison, they have all been made from rocks occurring within the area of the main stock in Electric Peak, and represent the composition of various forms of the diorite and the diorite-porphyrityte. The first three analyses are from the main body of coarse grained diorite, and show its variation between 56 and 58 per cent. of silica, with irregular variations in the other chemical constituents, especially in the alumina and magnesia. The next two analyses are from porphyrites occurring in sheets, which resemble certain of the porphyrites occurring in dikes and have been introduced in the table to show their similarity, and to fill up a gap between Nos. 2692 and 3008; it not being advisable to multiply too largely the chemical work on this particular group of rocks since others of equal importance command their share of attention.

That this insertion is admissible is shown by the accompanying list of silica percentages, determined for different modifications and varieties of this group of rocks.

TABLE VII.

Silica Percentages of the Rocks from Electric Peak.

53.72	58.10	61.50	65.80
55.23	58.11	61.85	65.94
55.64	58.49	63.01	65.97
56.28	58.87	63.78	66.05
56.33	59.64	64.85	67.54
57.12	60.54	65.11	69.24
57.38	60.56	65.48	
58.05	60.89	65.60	

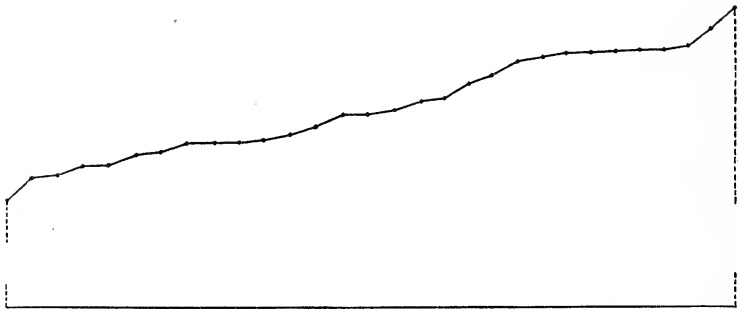

They were intended to supplement the complete analyses in order to demonstrate what is evident from the microscopical study of the thin sections, namely: that the different varieties of porphyrites and diorites pass through all possible gradations from one extreme to the other. The character of this transition is shown by the accompanying diagram, in which each determination is given the same weight, the series being arranged according to the increase of silica, and the silica percentages plotted as ordinates.

The next three analyses of Table VI, Nos. 3008, 2724, 2695, are from the main body of the diorite, No. 3008 being a light colored vein or dike of diorite in the darker mass. Nos. 2668 and 2676 are diorites from the main stock; and Nos. 3001 and 2670 are from the quartz-mica-diorite-porphyrityte, occurring within the main stock. These latter analyses vary from 64.85 to 69.24 per cent. of silica.

The variations of the other chemical constituents are best

comprehended by comparing their molecular proportions. This has been done graphically as in the accompanying diagram Table VIII, in which the molecular proportions of the principal oxides are plotted as ordinates, those of the silica being taken as abscissas. The point of origin of the latter is some distance to the left of the diagram.

The first impression derived from the diagram is that of the irregularity of the variations in all of the oxides besides silica, magnesia being the most erratic. The second impression is that of the apparent independence of the variations of the different oxide molecules. But this independence disappears upon closer study and certain evidences of sympathy become very marked. The most striking evidence of this exists between the ferrous and ferric oxides; they are noticeably inversely proportional to one another, an increase of ferrous oxide being accompanied by a decrease of ferric oxide. The total amount of iron varies irregularly, decreasing from the basic to the acidic end of the series. Each of the iron oxides seems to be quite independent of the magnesia. The most regular variation is that of the lime, which decreases steadily from the basic to the acidic end of the series. The magnesia drops very rapidly at first, and is very irregular in the more siliceous end of the series. The alumina, though quite irregular between certain limits, maintains a uniformly high position, being largely in excess of any one of the other oxides, except silica. The alkalies are most like the alumina in their variations and remain very nearly uniform, increasing slightly toward the siliceous end of the series. The soda molecules are more than twice as numerous as those of the potash. In the basic end of the series the alkalies vary together in the same direction, while in the more siliceous end they vary in opposite directions.

There is a marked accordance between the soda and alumina, both varying in the same direction, with one exception, though not to the same extent. There is an equally marked discordance between the alumina and magnesia, which, with one exception, vary in opposite directions.

TABLE VI.
Chemical analyses of intrusive rocks from Electric Peak.

Specimen number.	2669	2679	2692	2089	154	3008	2724	2695	3001	2668	2676	2670
SiO ₂	56.28	57.38	58.05	58.49	61.50	64.85	65.11	65.60	65.97	66.05	67.54	69.24
TiO ₂84	tr.	1.05	1.71	none	.91	.71	.75	.42	.34	.80	.65
Al ₂ O ₃	14.23	16.86	18.00	16.70	17.42	16.57	16.21	17.61	16.53	16.96	17.02	15.30
Fe ₂ O ₃	4.69	2.49	2.49	3.85	4.66	2.10	1.06	.95	2.59	2.59	2.97	1.72
FeO	4.05	5.17	4.56	2.37	1.09	2.15	3.19	2.76	1.72	1.38	.34	.69
MnO16	tr.	none	.24	tr.	none	none	none	none	none	tr.	tr.
CaO	7.94	7.32	6.17	5.90	5.33	4.01	3.97	3.72	3.37	3.37	2.94	2.98
MgO	6.37	5.51	3.55	3.12	1.26	2.14	2.57	1.49	2.11	2.08	1.51	.95
Li ₂ O01	.39	none	.01	.03	none	.04	.03	.09	none	.03	none
Na ₂ O	2.98	3.33	3.64	3.47	3.99	3.71	4.00	4.36	3.41	4.20	4.62	4.46
K ₂ O	1.23	1.45	2.18	1.59	1.29	3.10	2.51	2.36	2.67	2.53	2.28	2.52
P ₂ O ₅40	tr.	.17	tr.	.60	.14	.02	.16	tr.	tr.	tr.	tr.
SO ₃	tr.	.21	.07	.63	.35	tr.	tr.	tr.	.13	.03	.26	.27
Cl17	.17	tr.	none	none	none	.09	tr.	.15	tr.
H ₂ O93	.42	.86	2.44	2.44	.35	.94	.59	1.23	.69	.55	1.30
Less O for Cl	100.28	100.70	100.79	100.52	99.96	100.03	100.33	100.38	100.33	100.22	101.01	100.08
	.04	.040203	
	100.24	100.66							100.31		100.98	

TABLE VIII.

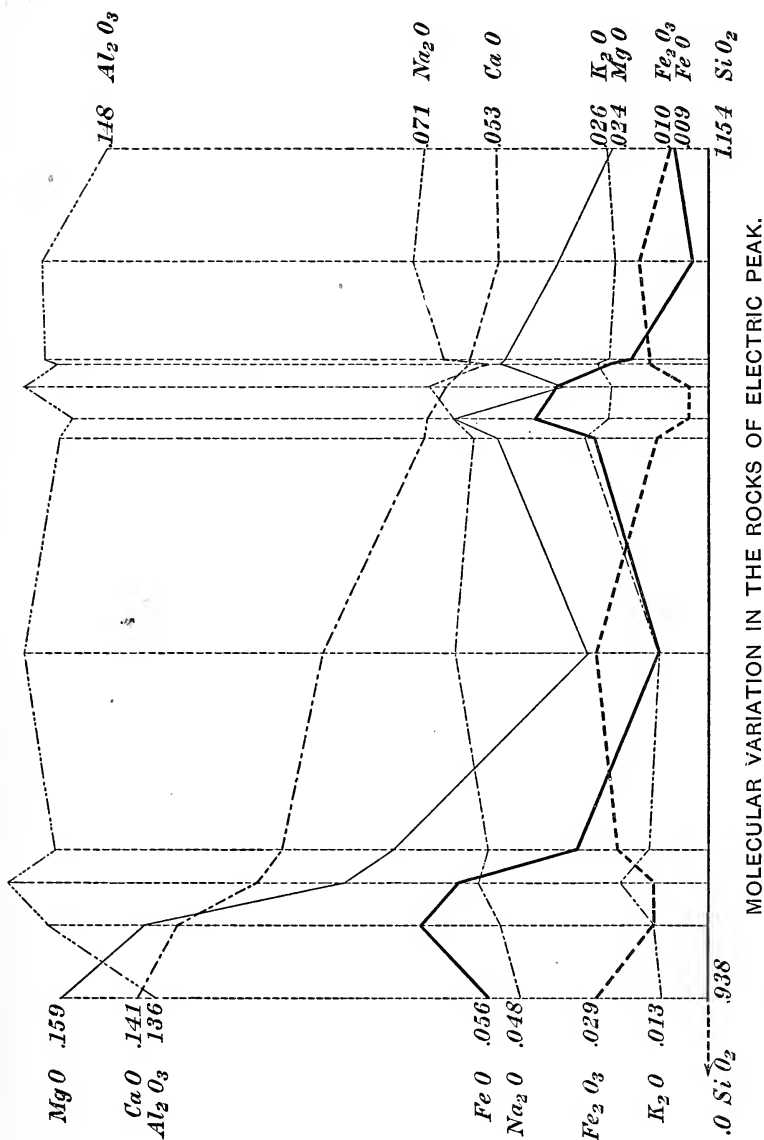

It is to be remembered that these irregular variations take place not only between allied varieties of rocks, but in different parts of the same rock-body, and that they correspond to variations in the relative proportions of the essential minerals. When it is remembered that the essential minerals concerned in this group of rocks are: feldspars, pyroxenes, amphiboles, mica, quartz and magnetite, one or more of which may be absent from a particular form of the rock; and when we consider the number of different complex molecules into which any one of these oxide molecules enters, we begin to realize the interdependence of the variations among the oxide molecules. Thus while most of the alumina enters into the composition of the feldspar, a portion of it enters into the ferromagnesian silicates. The alkalis are mostly found in the feldspars, but the soda takes part in the augites and hornblendes, and the potash in the biotite. The lime is an important factor in both the feldspars and ferromagnesian silicates; it is most abundant in the basic plagioclases, and diminishes as the feldspars become more alkaline; it abounds in augite and to a less extent in hornblende, and is almost absent from hypersthene and biotite. The iron and magnesian molecules, however, have no part in the composition of the feldspars, and are confined to the ferromagnesian minerals.

Corresponding to the extremes of the series of chemical constituents are the simple minerals, magnetite and quartz, consisting of an uncombined oxide or oxides, which act as compensators to regulate the exhaustion of the oxide molecules in the magma; the magnetite expressing the iron oxide in excess of that entering into the complex silicate molecules; the quartz representing the excess of silica molecules.

From these considerations we begin to understand the relative variations expressed by the diagram. The inverse relation between the magnesia and alumina corresponds to variations in the complex molecules of feldspars and of the ferromagnesian silicates; an increase of feldspar molecules is accompanied by a decrease of ferromagnesian molecules.

The independently uniform variation in the lime molecules is consistent with the fact that it enters so largely into both the feldspar and the ferromagnesian molecules. Their steady diminution from the basic to the acidic end of the series is in accord with the decrease in the amount of augite and hornblende, and the increase of alkali feldspars, shown by the increase of soda and potash and silica.

The very noticeable reciprocal relation between the ferrous and ferric oxides indicates the variable oxidation of pre-existing molecules. And it is probable that the ferrous molecules were the original ones; moreover, when all of the iron is reduced to the form of ferrous oxide, its molecules are found to vary in the same direction, and almost to the same extent as those of magnesia. Since the hornblende and biotite are the ferromagnesian minerals, carrying the greatest percentage of ferric oxide, the variation in the oxidation of the iron is naturally in accord with the amount of these minerals in the rock. This is, however, significant from its bearing on the question of the development of hornblende and biotite in the coarser grained varieties of these rocks, and from its possible connection with the work of mineralizing agents.

The chemical composition of different varieties of the Sepulchre Mountain rocks is shown by the accompanying analyses, Table IX. Nos. 219, 694, 221, 2736 and 3680 were analyzed by Mr. J. E. Whitfield; Nos. 214, 217 and 394, by Dr. T. M. Chatard; and No. 3680 by Mr. L. G. Eakins.

The varieties represented are the two forms of breccia: pyroxene-andesite and hornblende-pyroxene-andesite. And the dike rocks including three varieties of andesite and dacite. They range from 55.83 to 67.49 per cent. of silica, very nearly the same as the group from Electric Peak.

The chemical variation of the group is expressed graphically by the diagram, Table X, showing the molecular proportions of the essential oxides, which have been plotted in the same manner as in Table VIII.

An examination of this diagram shows the same relations between the oxides as those observed for the group

TABLE X.

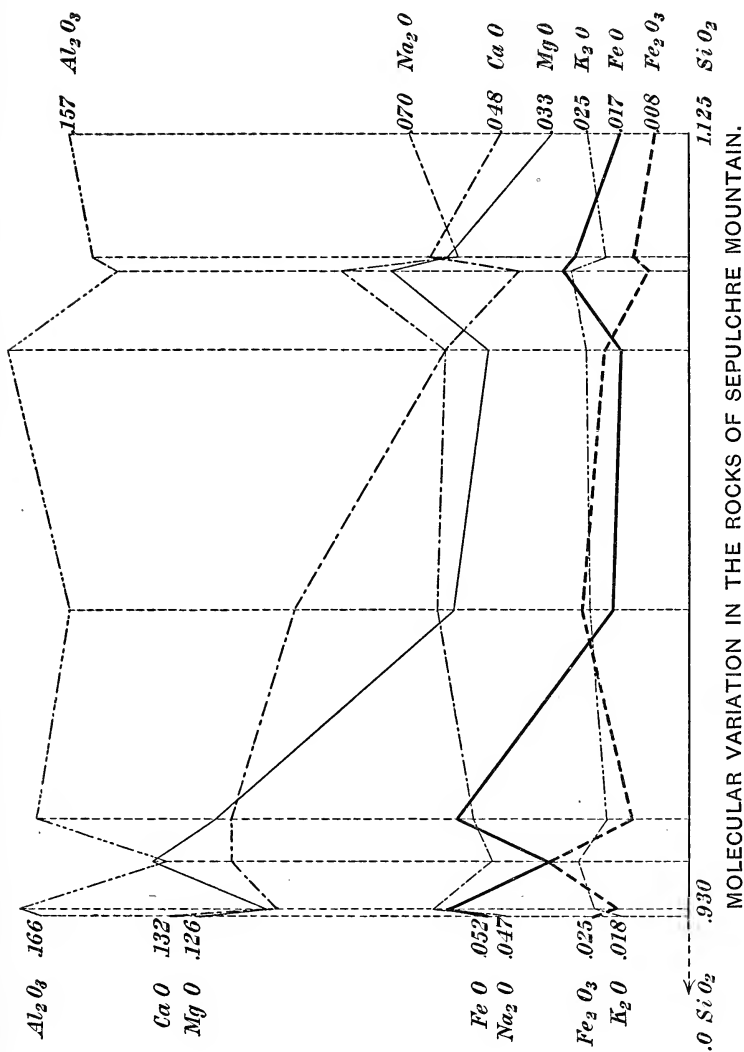

occurring at Electric Peak. They vary quite irregularly for a gradual change in the silica. The alumina varies rapidly and retains a high position. The alkalis gradually increase with the silica, the soda molecules being more than twice as numerous as those of potash. Magnesia experiences the greatest variation which is strikingly opposed to that of the alumina. The lime is less regular than in the Electric Peak group. The two oxides of iron are remarkably uniform in their reciprocal relations. The magnesia, lime and iron diminish with the increase of silica, while the alkalis increase, and the alumina decreases slightly. In this group of rocks also the oxidation of the iron bears a noticeable relation to the presence of hornblende and biotite and magnetite.

It is evident from a study of the analyses that the chemical variations in this group of volcanic rocks are the same in character and extent as those in the intrusive rocks of Electric Peak. Further, it is shown that the variations between similar varieties of andesite—such as those between different pyroxene-andesites—are as great, and in some cases greater than the variations between varieties of andesites which are distinguished mineralogically from one another. Thus 219 and 221 are pyroxene-andesites without hornblende; 214 and 217 are hornblende-pyroxene-andesites, while 694 is a hornblende-andesite. It is not possible to point to any chemical character of these rocks as distinctive of this mineral variation, with the exception of the oxidation of the iron, which, though slight, is an important one; for it undoubtedly relates to forces which did not alter the fundamental relation between the bases in the magma, but simply modified it by changing the oxidation of one of them.

The last four analyses are of hornblende-mica-andesites and dacites. The chemical variations between them are quite as pronounced as those between the more basic members of the series, without there being the corresponding differences between the kinds of ferromagnesian silicates so far as it can be detected microscopically. They all carry horn-

blende and biotite and no pyroxene, the relative proportion of these minerals varying. The character and amount of the feldspars differ in these rocks, and so does the abundance and mode of occurrence of the quartz. In Nos. 3017 and 3680 quartz appears in porphyritical crystals; in the other rocks it is confined to the groundmass.

Comparing the two sets of analyses and the corresponding diagrams it is evident that the intrusive rocks of Electric Peak and the volcanic rocks of Sepulchre Mountain have the same chemical character. In fact, they are chemically identical, for the varieties that have been analyzed are but a few of the many mineralogical and structural modifications assumed by these series of rocks. The analyses serve as indications of the range of the chemical variability of the magma or magmas furnishing these rocks.

Furthermore the comparison demonstrates that the magmas that reached the surface of the earth in this place had exactly the same chemical composition as those which remained enclosed within the sedimentary strata. It proves with equal clearness that the different conditions attending the final consolidation of the extravasated and of the intruded magmas affected not only their *crystalline structure* but their *essential mineral composition*. The most marked illustration of this is in the occurrence of biotite in the two series. In the volcanic rocks of this locality biotite is an essential constituent of the more siliceous varieties, and is only rarely found as an accessory constituent of the varieties with less than 61 per cent. of silica. In the intrusive rocks it is an essential constituent of all the coarse grained varieties, even the most basic. In the finer grained porphyritic forms it is a constituent of the groundmass to a variable extent. The second most noticeable difference is the presence of considerable quartz in the coarse grained forms of the basic magmas, and its absence from the volcanic forms of the same magmas.

CORRELATION OF THE ROCKS ON A CHEMICAL BASIS.

Correlating the two groups of rocks according to their chemical composition as in Table XI, we see that the horn-

blende-mica-andesites, 2736, 394, are the equivalents of the quartz-mica-diorites, 3008, 2724, 2695, 2668, 2676. The dacites, 3017, 3680, are the equivalents of the quartz-mica-diorite-porphyrates, 3001, 2670. The hornblende-pyroxene-andesites and pyroxene-andesites, 219, 694, 214, 221, 217, are the equivalents of the coarse grained diorites, 2669, 2692, and of a fine grained facies, 2679, and they resemble certain porphyrites occurring in sheets, one of which is a hornblende-porphyrite, 2089, and the other a hornblende-mica-porphyrite, 154.

The dacites and hornblende-mica-andesites included within this correlation are intruded bodies within the breccia of Sepulchre Mountain, and have the same mineral composition as the corresponding porphyrites and diorites of Electric Peak. They differ from them in structure and degree of crystallization, the details of which cannot be described in this paper.

The glassy andesites with pyroxene and hornblende phenocrysts, however, present the utmost contrast to the equivalent coarsely crystalline diorites. In the former the hypersthene, augite, hornblende, and plagioclase are sharply defined, idiomorphic crystals of these minerals, scattered through a groundmass of glass, which is crowded with microlites of plagioclase and pyroxene besides grains of magnetite. The hornblende is brown, occasionally red, and the other phenocrysts have all the microscopical characters which distinguish their occurrence in glassy rocks. In the diorite the hornblende is green, in some cases brown; the hypersthene, augite, and hornblende are accompanied by biotite, and are all intergrown in the most intricate manner, with evidence that they commenced to crystallize in the order just given. The labradorite is often clouded with minute opaque particles, which are characteristic of its occurrence in many diorites; it is surrounded by a shell of more alkaline plagioclase, which, with occasional individuals of orthoclase and considerable quartz, closed the crystallization of the magma. Magnetite, apatite, and zircon

SiO ₂ %	No.	VOLCANIC ROCKS OF	
		Name.	
69.24	2670	<i>phenocryst</i> fieldspar.
67.54	2676
67.49	3680	dacite	quartz, biotite, horn
66.05	2668
65.97	3001
65.66	3017	dacite	quartz, biotite, horn
65.60	2695 quartz.
65.50	394	hornblende-mica-andesite .	hornblende, biotite,
65.11	2724 (clase), quartz.
64.85	3008
64.27	2736	hornblende-mica-andesite .	hornblende, biotite,
61.50	154 quartz.
60.30	217	hornblende-pyroxene-andesite	hornblende, augite,
58.49	2089
58.05	2692 clase, (quartz).
57.38	2679
57.17	221	pyroxene-andesite . . .	augite, hypersthene,
56.61	214	hornblende-pyroxene-andesite	hornblende-augite-h
56.28	2669 clase, quartz.
55.92	694	hornblende-andesite . . .	hornblende, plagioc
55.83	219	pyroxene-andesite . . .	augite, hypersthene,

TABLE XI.

Correlation of the two Groups of Rocks upon a Chemical Basis.

SiO ₂ %	No.	VOLCANIC ROCKS OF SEPULCHRE MOUNTAIN.		INTRUSIVE ROCKS OF ELECTRIC PEAK.	
		Name.	Essential Minerals.	Name.	Essential Minerals.
			<i>phenocrysts</i> <i>groundmass</i>		
65.24	2670			diorite-porphyrite . . .	quartz, biotite, plagioclase, hornblende. quartz and alkali feldspar.
67.54	2676			quartz-mica-diorite . . .	biotite, hornblende, plagioclase (orthoclase), quartz.
67.49	3680	dacite	quartz, biotite, hornblende, plagioclase. holocrystalline, quartz and feldspar.	quartz-mica-diorite . . .	biotite, hornblende, plagioclase (orthoclase), quartz.
66.05	2668			diorite-porphyrite . . .	biotite, hornblende, plagioclase (orthoclase), quartz.
65.97	3001			diorite-porphyrite . . .	biotite, hornblende, plagioclase (orthoclase), quartz.
65.66	3017	dacite	quartz, biotite, hornblende, plagioclase. holocrystalline, quartz, feldspar.	quartz-mica-diorite . . .	biotite, hornblende (pyroxene), plagioclase (orthoclase), quartz.
65.60	2695			quartz-mica-diorite . . .	biotite, hornblende (pyroxene), plagioclase (orthoclase), quartz.
65.50	394	hornblende-mica-andesite . . .	hornblende, biotite, plagioclase. holocrystalline, quartz, feldspar.	quartz-mica-diorite . . .	biotite, hornblende, augite, hypersthene, plagioclase (orthoclase), quartz.
65.11	2724			quartz-mica-diorite . . .	biotite, hornblende, augite, hypersthene, plagioclase (orthoclase), quartz.
64.85	3008			quartz-mica-diorite . . .	hornblende, biotite, plagioclase (orthoclase), quartz.
64.27	2736	hornblende-mica-andesite . . .	hornblende, biotite, plagioclase, magnetite. holocrystalline, quartz, feldspar.	hornblende-mica-porphyrite	biotite, hornblende, plagioclase, magnetite. feldspar and quartz.
61.50	154			hornblende-mica-porphyrite	biotite, hornblende, plagioclase, magnetite. feldspar and quartz.
60.30	217	hornblende-pyroxene-andesite	hornblende, augite, hypersthene, plagioclase, magnetite. glassy, microlitic.	hornblende-porphyrite . . .	hornblende, plagioclase, magnetite. feldspar and quartz.
58.49	2089			diorite	biotite, hornblende, augite, hypersthene, magnetite, plagioclase, (quartz).
58.05	2692			pyroxene-porphyrite . . .	augite, hypersthene, biotite, magnetite, plagioclase, quartz.
57.38	2679			pyroxene-porphyrite . . .	augite, hypersthene, biotite, magnetite, plagioclase, quartz.
57.17	221	pyroxene-andesite	augite, hypersthene, plagioclase. brown glass, microlitic.	diorite	biotite, hornblende, augite, hypersthene, magnetite, plagioclase, quartz.
56.61	214	hornblende-pyroxene-andesite	hornblende-augite-hypersthene, plagioclase. glassy, microlitic.		
56.28	2669				
55.92	694	hornblende-andesite	hornblende, plagioclase. microcrystalline.		
55.83	219	pyroxene-andesite	augite, hypersthene, plagioclase. glassy, microlitic.		

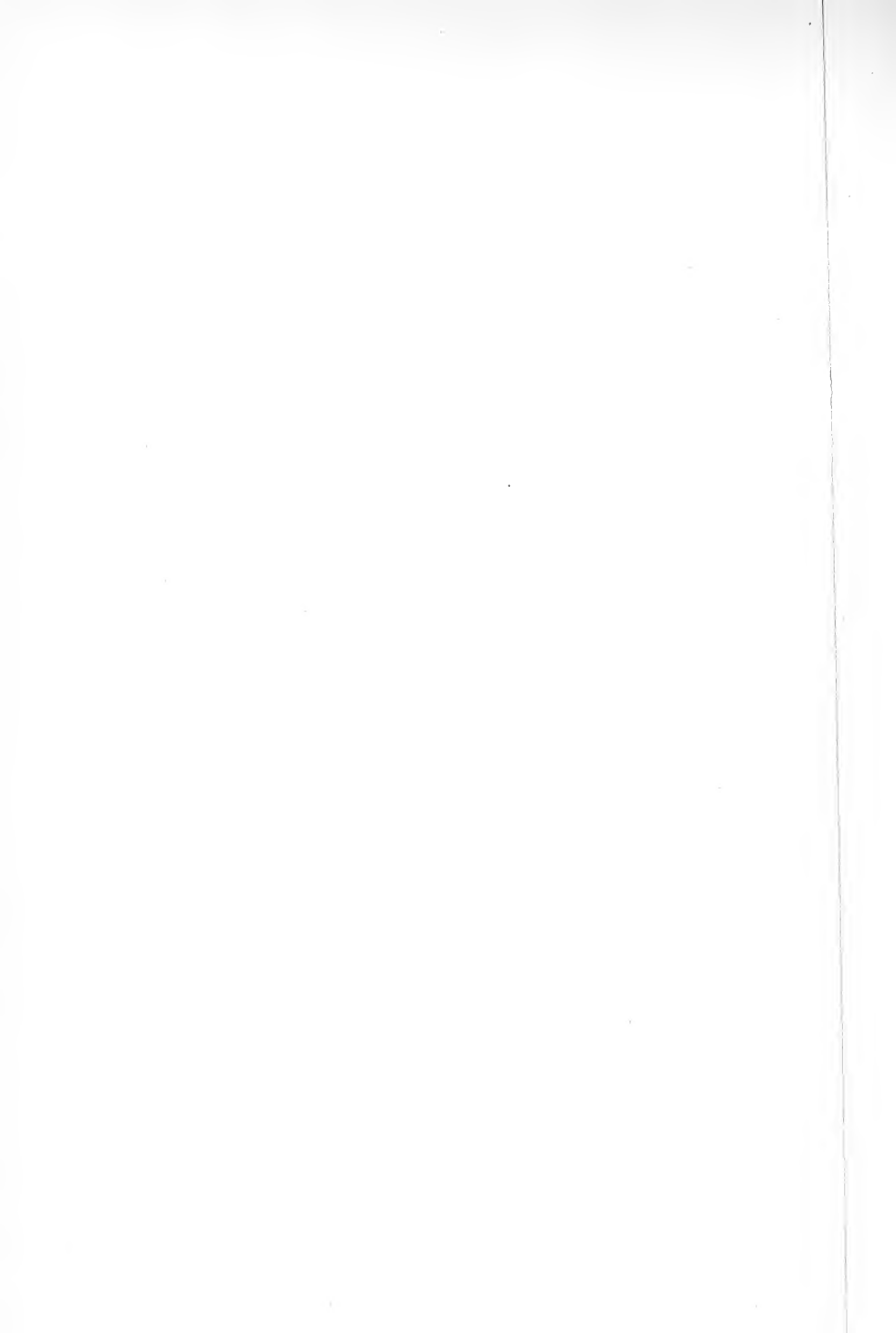

are the accessory minerals. The quartz contains fluid inclusions, which complete the correspondence of this diorite with typical diorites of other regions.

CONCLUSIONS.

When we consider the geological structure of the region; the occurrence at Electric Peak of a broad body of eruptive rocks that have broken up successively through the same general channel, and that have imparted sufficient heat to the surrounding Cretaceous strata to highly metamorphose them for a considerable distance; the existence of a system of fissures filled with dikes of porphyrite that radiate outward toward the south and southwest; and when we observe at Sepulchre Mountain that an accumulation of breccia, resting on the Cretaceous, is traversed by a system of dikes radiating outward toward the north and northeast; the two systems being separated and probably disconnected by a profound fault—

When we further consider the petrographical resemblance between the dike rocks of the two places, the correspondence of habit between the more acid members of both series, and the chemical identity of the magmas involved, we feel justified in concluding that:

- I. The volcanic rocks of Sepulchre Mountain, and the intrusive rocks of Electric Peak were originally continuous geological bodies.
- II. The former were forced through the conduit at Electric Peak during a series of more or less interrupted eruptions.
- III. The great amount of heat imparted to the surrounding rocks was due to the frequent passage of molten lava through this conduit.
- IV. Portions of the different magmas erupted found their way into vertical fissures and took the form of dikes; portions reached the surface and became lava-flows and breccias, while portions remained in the conduit.

V. The various portions of the magmas solidified under a variety of physical conditions, imposed by the different geological environment of each, the most strongly contrasted of which were the rapid cooling of the surface flows under very slight pressure, and the extremely slow cooling of the magmas remaining within the conduit under somewhat greater pressure.

It is to be remarked that the first of a series of eruptions would pass through a colder conduit than the last magmas would, consequently the rate of cooling would be different in each case, and the pressures at which crystallization sets in would also differ. This difference would also obtain between the advance and rear ends of the magma of a single eruption, and should be more marked in the first eruptions of a series than in the last, since the temperature of the conduit increases during the period of eruptions. Hence the first part of a magma may carry porphyritical crystals while the latter portion may be free from them.

VI. We have in this region the remnant of a volcano, which has been fractured across its conduit, has been faulted and considerably eroded; and which presents for investigation, on the one hand, the lower portion of its accumulated débris of lavas, with a part of the upper end of the conduit filled with the final intrusions; and on the other hand a section of the conduit within the sedimentary strata upon which the volcano has been built.

We find that the lower portion of the basic breccia is made up of andesites carrying phenocrysts of augite, hypersthene and plagioclase, and of other basic andesites without macroscopic crystals. The former correspond to a facies of the diorite in the conduit carrying the same kinds of phenocrysts; while the second modification of the andesite corresponds to the greater part of the basic diorite. For it is evident

from a study of this diorite that much of its magma reached its position in the conduit in a completely fused condition, after which it crystallized into hypersthene, augite, hornblende, biotite, labradorite, alkali feldspars and quartz, with accessory magnetite, apatite and zircon. We feel justified, then, in the further conclusions:

- VII. That the molecules in a chemically homogeneous, fluid magma combine in various ways, and form quite different associations of silicate minerals, producing mineralogically different rocks.
- VIII. In this region the greatest mineralogical differences accompany the greatest differences in structure or degree of crystallization; hence, the causes leading to each are coëxistent.
- IX. The causes of these mineralogical and structural differences must be sought in the differences of geological environment, and these affect the rate at which the heat escapes from the magmas, and the pressure they experience during crystallization.

Since it has been demonstrated by synthetical research that water- and other vapors are potent factors in the crystallization of quartz and other minerals that have not been produced artificially without their aid, and as there is ample evidence both in the extravasated lavas and in the coarsely crystallized rocks in the conduit that water-vapor was uniformly and generally distributed through the whole series of molten magmas, and no evidence that there existed in the magmas which stopped within the conduit any more or different vapors than those which existed in the magmas that reached the surface, we may conclude that—

- X. The *efficacy* of these absorbed vapors as mineralizing agents has been *increased* by the conditions attending the solidification of the magmas within the conduit.

For, if it is necessary, as advocated by the French geologists, MM. Michel Lévy,* de Lapparent † and others, to refer the crystallization of certain minerals, as quartz, to the mineralizing influence of absorbed vapors, it is evident that the required mineralizing agent is universally present in sufficient quantities, since there are no instances where a magma of the requisite chemical composition has failed to crystallize completely with the development of quartz when subjected to the proper physical conditions.

However, it is probable that differences in the amount or in the kind of mineralizing agents produce differences in the degree or nature of the crystallization of similar magmas which have solidified with the same geological environment.

It has been suggested by Mr. H. J. Johnston-Lavis ‡ that the nature of the rocks surrounding a conduit, through which molten magmas pass, materially affects the amount and character of the vapors introduced into these magmas, which will vary as the surrounding rocks are more or less porous and are saturated with different kinds of waters. The effect of these vapors on the structure and composition of igneous rocks is also discussed by the same writer.

The effect of differences in the amount of the mineralizer in a single magma is well illustrated in the structure of the obsidian at Obsidian Cliff, Yellowstone National Park, § where the alternating layers of holocrystalline and glassy rock appear to be unquestionably due to the irregular distribution through the magma of vapors, which in the upper portion of the flow have produced alternating layers of pumice and compact glass. The mineralizing agent was present, however, in the alternate glassy layers as well as in the crystallized or in the pumiceous ones, for in the highest

* "Structures et Classification des Roches Éruptives." Paris, 1889. pp. 5 and 12.

† *Revue des questions Scientifiques.* Paris, 1888. 36.

‡ "The Relationship of the Structure of Rocks to the Conditions of their Formation." *Sci. Proc. of the Royal Dublin Soc.* Vol. V (n. s.), part 3, July, 1886, pp. 113 to 155.

§ Obsidian Cliff, Yellowstone National Park, by J. P. Iddings. *Seventh Annual Report of the Director of the U. S. Geological Survey, Washington, 1888, p. 287.*

portion of the flow the whole mass is pumiceous but in different degrees, and the presence of absorbed vapors may be detected chemically and physically in the compact layers. Its amount, however, was not sufficient to produce complete crystallization under the attendant physical conditions. Its effectiveness in this case was controlled by the geological occurrence of the magma.

It is to be observed, in addition, that, whatever the mineralizing vapors in acid magmas may be, there is the same evidence of their existence in intermediate and in basic magmas, whether we investigate them chemically or physically, or study the phenomena of their geological occurrence. There are even indications of their greater abundance in the basic lavas, many of whose glasses contain a high percentage of water, and the highly vesicular character of whose lava-flows is universal. Nor are the geological evidences less conclusive that demonstrate the existence of abundant explosive agents in the basaltic and andesitic magmas that have hurled their shattered masses over broad areas of country, and have piled vast accumulations of basaltic breccia throughout our western territory.

Nevertheless, with all these evidences of the universal presence of mineralizing agents in basic magmas, we do not recognize their influence upon the microstructure or crystallization of basic lavas. We may assume, then, that in the majority of these cases they have no influence.

But when the basic magmas become coarsely crystalline, and separate into minerals, the crystallization of some of which we have already referred to the action of mineralizing vapors, we may logically assume that in these cases the absorbed vapors have influenced the crystallization of the magmas.

If this reasoning is correct, then the action of mineralizers upon basic magmas is controlled by the physical conditions under which they solidify.

Finally, if mineralizing agents are universally present in igneous magmas, and if their action, so far as we can ob-

serve it, is controlled by the physical conditions imposed by the geological history of each eruption, we should not regard the presence or absence of certain minerals, relegated to the influence of mineralizing agents, as evidence of the presence or absence of these agents in the molten magma; but we should see in it the evidence of special conditions controlling the solidification of the magma, and should seek the fundamental causes of the mineralogical and structural variations of a rock in the geological history of its particular eruption.

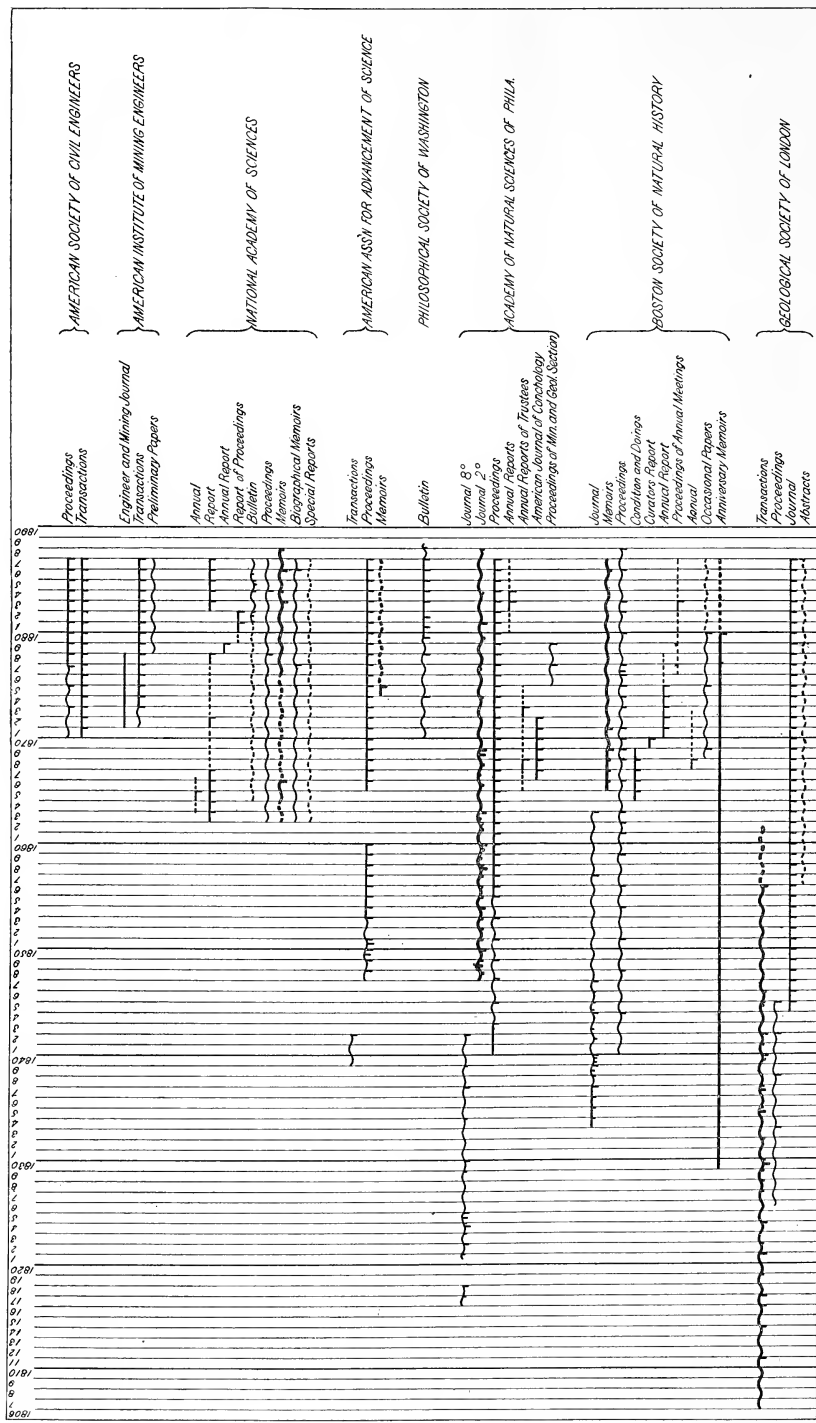

— Periodical issue. ~ Irregular issue. - - - - - Not seen or unknown. — 4°. — 8°. — Dates of issue and volumes.

GRAPHIC CONSPECTUS OF SERIALS PUBLISHED BY SCIENTIFIC SOCIETIES

THE EVOLUTION OF SERIALS PUBLISHED BY SCIENTIFIC SOCIETIES.

BY

W J MCGEE.

[Read before the Society April 13, 1889.]

CONTENTS.

	Page
Introduction.....	221
The Serials studied.....	224
The Evolution of the Serials.....	230
The Causes of Evolution of the Serials.....	235
Methods of fixing Responsibility and their Evolution.....	242

INTRODUCTION.

The study out of which this communication grew was undertaken, and the communication was written, as a basis for a plan for the publications of the Geological Society of America.

The societies whose publications have been examined were selected upon various grounds:

The American Society of Civil Engineers and the American Institute of Mining Engineers were selected for study because these societies are active and energetic, because they comprise the best talent of the country in their specialties, and because, while each has a fixed abode, they stand toward their specialties and toward the country at large much as must the newly organized Geological Society. Moreover, both are comparatively young and may be assumed to have profited by the experience of the older societies in the development of their plans of publication. Another reason for the

selection of these societies was the accessibility of their publications.

The National Academy of Sciences was chosen because it is the most exclusive scientific society of the country, because it comprises the highest scientific talent of the land, because its geographic relations are similar to those of the Geological Society of America, and because its relations to various specialties are much the same as the relations of the last named society to a more restricted group of specialties. It was not selected as a representative scientific society in the matter or manner of its publications, because its relations to the federal government are such that its publications are necessarily unique. Neither was it selected because of accessibility of its publications. Indeed, the publications of the Academy are practically inaccessible; there is no complete set in any public library in Washington; and weeks of labor and inquiry among private libraries and officers of the Academy were insufficient for the preparation of a complete list. There is probably no scientific society in this country whose publications are more inaccessible than those of the National Academy of Sciences.

The American Association for the Advancement of Science was selected partly because the Association began as a national geologic society, and partly because it is a representative scientific society of the migratory class. With its growth the original function of the society has been changed: from a strictly scientific organization, established for the direct advancement of science through investigation, it has become a semi-social body which promotes science by diffusion; it is no longer an organization for investigation, but rather for popularization, and its plan of publication has undergone concurrent modification.

The Philosophical Society of Washington is, despite its inconspicuous place in the conspectus of publications, one of the most active and potent among the local scientific societies of the country. Its small publication record is indeed misleading. While most of its members are actively engaged

in original scientific investigation, many of them have other means of publication; and while their communications are read before and discussed by the society, they are frequently not offered for printing. Moreover, the growth of the Philosophical Society has always taken place through multiplication by fission more than through direct increase in stature, and the Anthropological Society, the Biological Society, the Chemical Society, its own Mathematical Section, and perhaps the National Geographic Society, are its offspring. It is pertinent to add that the change in form of publication by this society was in some degree foreshadowed in the serials issued by some of its subordinate branches—the Anthropological Society recently transformed its organ from a biennial volume of Transactions to the quarterly *American Anthropologist*, and the recently organized National Geographic Society sets out with a Bulletin issued at irregular intervals as a geographic magazine.

The Academy of Natural Sciences of Philadelphia was selected because it is one of the oldest among the scientific societies of the country, because its vicissitudes in membership and financial support have been representative, and because its various publications are fairly accessible. The record of some of its serials as shown in the conspectus may be found defective, (1) because in the absence of original covers (removed in binding) it is sometimes impossible to ascertain the original form of publication; (2) because in the multiplicity of paginations it is sometimes impossible to ascertain whether or not certain matter belonged to a given volume or series; (3) because certain of the minor publications (generally extracted from larger serials) were not found; and perhaps for other reasons.

The Boston Society of Natural History was selected because it is one of the older and more important among the scientific societies of the country, because some of its modifications in plan of publication seem especially significant and at the same time representative, and because its publications are fairly accessible.

The Geological Society of London was selected because, although it has a local habitation, its relations to its country are much the same as those which must obtain between the Geological Society of America and the land of its labors, because it is an old society and its publications represent the outcome of the experience of generations, and because most of its publications are accessible.

The publications of several other scientific societies were examined in greater or less detail, yet they were not included in the final study partly by reason of the labor involved and the space required for their description, but chiefly because their publications seldom exhibit relations not equally well exhibited by those of the societies noted below, and it so became apparent that further extension of the study would be practically fruitless. The generalizations and inductions recorded in the following pages are, however, based in part upon examination of the serials issued by these additional societies.

From the nature of the case, the study was essentially critical, and the supposed defects in plans and methods of publication have been unsparingly recorded, while the features considered good have been strongly brought out. Indeed, each serial and group of serials has been treated as impersonally as would have been a series of formations or a group of rocks, or as species and genera are treated by the biologist.

THE SERIALS STUDIED.

The American Society of Civil Engineers, with a large and practically national membership, a fixed home, and frequent local as well as annual migratory meetings, publishes rather voluminously in two 8vo serials—the first, or Proceedings, being chiefly an administrative record, while the second, or Transactions (accompanied by maps, plates, diagrams, etc.), is a record of research.

The American Institute of Mining Engineers, with a nominal place of abode, a national representation in its member-

ship, and both local and migratory meetings, maintains two serials (or, rather, two editions of the same serial): the first consisting only of a series of preliminary issues of the records of research (printed in the *Engineering and Mining Journal* for some years, but now printed and distributed by the Institute); and the second, or *Transactions*, comprising these records of research in their final form, together with the administrative records of the Institute.

The National Academy of Sciences, with a home office but with a national membership and partly migratory meetings, leads the list in the number of its serials and in the editions in which they appear. Of the seven nominally regular serials and the additional two resulting from inconsistency in nomenclature, the first, or *Annual*, is chiefly an administrative record; the second, or *Report* (including the *Annual Reports* and *Reports of Proceedings*) are also administrative records primarily, but embrace records of research in the appended reports of committees, etc.; the *Bulletin* and the *Proceedings* are essentially records of administration; the *Memoirs* and the special reports are records of research; while the *Biographical Memoirs* stand alone midway between the two classes into which the records of scientific societies may be most conveniently divided. So there are four distinct records of administration (one probably defunct) and two of research, besides a vigorous one of intermediate character. Of this long list of serials, some are published in divers and sometimes enormous and widely distributed editions.

The most completely national scientific society of the country, the American Association for the Advancement of Science, with a large membership and migratory annual meetings, now records its work in a single serial. This serial, the *Proceedings*, comprises moderately full administrative records and greatly condensed records of research, and is issued in annual volumes as soon as may be after meetings. The *Memoirs*, established in 1875 as a vehicle for publishing in extenso the results of elaborate investigations, are practi-

cally discontinued, and the Transactions gave place to the Proceedings with the reorganization of the Association in 1847.

The Philosophical Society of Washington has a fixed place of abode and bi-weekly meetings, and its membership is chiefly local. It has published but a single serial, the Bulletin, comprising records both of administration and research; but the plan of publication of this serial has been repeatedly modified, while in the interests of bibliography the name has been kept unchanged.

The Academy of Natural Sciences of Philadelphia, with a fixed home, frequent meetings, and a predominantly local membership, has generally limited itself to two serials; but that these have not fully met its needs is indicated by the facts (1) that the series have changed in plan from time to time, and (2) that other serials have been issued temporarily. The Society began with the *Svo Journal* as essentially a record of research, and little account was made of the records of administration. About 1840 a need of more detailed administrative records appears to have been felt, and the Proceedings was established principally to meet this need. A few years later the 2^o Journal took the place of the *Svo* record of research and for a generation was vigorously maintained; but as time went on the Proceedings was gradually transformed into a record of research rather than of administration, and so absorbed the energy of the Journal, which now appears decadent. Of late years the original purpose of the Proceedings is in part met by the Annual Reports, as was the case while building was in progress and the Reports of the Trustees were issued annually. The issue of the *American Journal of Conchology* for a few years and the publication of various important works by the Academy represents its partially developed function as a publishing house for trade supply; and the Proceedings of the Mineralogical and Geological section represent sporadic activity in a particular direction, such as led to the birth of new institutions in the Philosophical Society of Washington and in some other cases; but this exceptional activity was short-lived.

The Boston Society of Natural History, like the Philadelphia Academy, has a commodious home, its membership is largely local, and it holds frequent meetings. It leads the National Academy in its list of six regular and four subordinate serials; though it falls far behind in editions and in distribution. In early days it followed the example of the Philadelphia society *first* in setting out with a Journal as a record primarily of research, and *second* in the issue of a substantial serial called Proceedings, chiefly as a record of administration; as in Philadelphia, too, the research record was enlarged (its name being changed to Memoirs); and, again as in Philadelphia, the character of the administrative record gradually changed until it has become principally a record of research and only subordinately an account of administration. Meanwhile, the research record has weakened, and may be regarded as certainly decadent, only one number having appeared in the last 17 years. This loss of vitality may be attributed in part to the initiation of the series of Occasional Papers as a vehicle for research records, and the issue of the semi-centennial volume of Anniversary Memoirs, which gave outlet to the results of several original investigations. The Proceedings, however, seems scarcely to perform the function of an administrative record to the satisfaction of the Society; and the dissatisfaction has found expression in the issue of the Conditions and Doings, the Custodians' Reports, the Annual Reports, the Proceedings of the Annual Meetings, and perhaps the Annual.

The Geological Society of London has a fixed place of abode and frequent meetings, and its large membership is chiefly national, but partly foreign. Like the older American societies, it began with the publication of a research record alone, and this serial, called Transactions, was vigorously maintained for generations; as time went on the desirability of a record of administration appears to have been felt, and another serial, entitled Proceedings, was initiated; the new serial grew and came to absorb part of the vitality of the old,

when a third, designed to combine the functions of the new and part of the old, was initiated as a Quarterly Journal ; but as the years went by this periodical, following the parricidal example of the Proceedings, finally absorbed the entire vitality of the Transactions, and is now a combined record of research and administration of so long standing that it is probably the best known geologic serial in the libraries of the world. But with the growth of the serial its character has undergone modification, and for years it has contained elaborate illustrated papers which can only be published after considerable delay ; and that it has in consequence failed to meet certain of its requirements as an administrative record is indicated by the issue of the little known series of Abstracts, designed for local and temporary use only.

In brief, these eight societies are now regularly issuing nineteen serials (excluding the Memoirs of the A. A. A. S., the Annual Report of the Acad. Nat. Sci. Phil., the Proceedings of the Annual Meetings of the Boston Soc. Nat. Hist. and the Occasional Papers of the same Society, but including the 2^o Journal of the Academy of Nat. Sci. of Phil., the Memoirs of the Boston Soc. Nat. Hist., the Anniversary Memoirs of the same Society, and the Abstracts of the Geol. Soc. of London) ; and they have published in all, for greater or less periods, forty different serials (including the Eng. and Min. Jour., the Annual Reports and Reports of Proceedings of the Nat. Acad. of Sci., the two distinct series of the Journal of the Acad. of Nat. Sci. Phil., the Annual Reports and the Reports of Trustees of the same Society, the sub-reports extracted from the Proceedings of the Boston Soc. Nat. Hist., and the Abstracts of the Geol. Soc. of London), comprising about 315 volumes. These various serials, with the periods covered by each, the regularity or irregularity of issue, their form and size (8vo or smaller, 4to or larger), and the volumes and in some cases the parts issued, are represented in the accompanying diagram. This diagram thus represents salient points in the life-history and the

leading features of each serial, and the relations of all the serials issued by the eight societies, viewed as units or individuals. It is at the same time a graphic representation of the leading bibliographic facts connected with the serials.

THE EVOLUTION OF THE SERIALS.

Even a cursory glance at the diagram or at the publications it represents discovers certain general tendencies toward stability or instability in each serial, and these tendencies become more manifest when the various serials are carefully scrutinized. A few of these may be mentioned :

Perhaps the most obvious tendency is that toward unification in form and functions of serials ; and this tendency is exhibited alike in the history of the various serials issued by any of the older societies, and by comparison of the serials of the old with those of the newer societies. Thus, the Geological Society of London maintained during its youth two or three serials, and even after the abandonment of all but the Quarterly Journal adhered for years to a refined differentiation of matter in each volume expressed by the five, seven, or more paginations. Quite similar is the history of publication by the Academy of Natural Sciences of Philadelphia, which after getting well under way supported distinct serials for the records of research and administration respectively ; and after the latter partly absorbed the former it displayed an analogous differentiation of matter in multiple paginations and in other ways. The tendency is equally shown by the decadence of the 4to serials issued by the American Association for the Advancement of Science, the Academy of Natural Sciences of Philadelphia, and the Boston Society of Natural History. The same tendency also appears when the Philosophical Society of Washington and the American Institute of Mining Engineers, each with a single serial (if the preliminary edition of the papers of the latter Society be disregarded), and the vigorous American Society of Civil Engineers, with its two serials, are compared with the older societies ; for the newer societies appear to have

profited by the experience of the older, and to have adopted only those forms of publication which time has shown to best survive the exigencies and obstacles besetting serial life. True, the National Academy of Sciences and its serials do not exhibit this tendency, but for reasons elsewhere stated this Society is a law unto itself, and inferences concerning it are valueless for other institutions. In short, it would appear that specialized serials do not thrive, and that the most vigorous and long-lived serials (the Proceedings of the American Association for the Advancement of Science, the Bulletin of the Philosophical Society of Washington, the Transactions of the American Institute of Mining Engineers, the Quarterly Journal of the Geological Society of London, and the Proceedings of the Academy of Natural Sciences of Philadelphia and of the Boston Society of Natural History, etc.) comprise records of research and administration combined.

A second tendency is in the direction of prompt publication: An avowed object in the issue of preliminary papers by the American Institute of Mining Engineers is to get the matter into the hands of the public at the earliest possible moment; the present plan of publication of the American Association for the Advancement of Science was expressly adopted to secure prompt issue of the annual volumes; the recent change in plan of publication of the Bulletin of the Philosophical Society of Washington was made for the same purpose; the Proceedings of the Academy of Natural Sciences of Philadelphia was established expressly to permit of prompt publication of results; the Proceedings of the Boston Society of Natural History is issued in signatures for the same reason; the Quarterly Journal of the Geological Society of London was devised to secure more prompt publication than was possible in the Transactions, and the Abstracts are printed to secure still earlier publication. No one can examine the publications of the various scientific societies without finding decided evidences of a prevailing desire to publish promptly, even at considerable sacrifice in other directions.

A third tendency, which is explained in part by the first two, is toward publication in 8vo rather than 4to: The oldest of the eight societies (the Geological Society of London) has completely abandoned the 4to form. The next oldest society (the Academy of Natural Sciences of Philadelphia) nominally maintains a folio, but its importance, both absolute and relative to the 8vo publications, has declined of late, and only two small parts have appeared in eight years; of the leading 4to serial of the Boston Society of Natural History, only one number has appeared in 18 years; the 4to serial of the American Association may be regarded as abandoned after a single issue; and the younger societies, the Philosophical Society of Washington, the American Society of Civil Engineers, and the American Institute of Mining Engineers, have again profited by the experience of the older and have not adopted the 4to form, though the last two frequently introduce plates so large as to require folding. It is evident from inspection of the publications of scientific societies that the quarto serials cannot maintain a leading rank in the race for success, and indeed that, like the great herbivores of the Tertiary ages, they are doomed to extinction save under especially favorable conditions.

A fourth tendency, which is manifestly connected with the second, is toward publication in small units or fractions: This tendency is vigorously opposed by the plans of publication in several societies and evidently by editors and publishing committees generally, and it sometimes fails or even appears to be reversed; but it crops out in the issue of the Abstracts of the Geological Society of London and the advance publication of extracts from the Proceedings of the Boston Society of Natural History and of the Academy of Natural Sciences of Philadelphia under special serial titles, in some of the minor publications of the latter society, in the separate signatures issued by both of these societies, and in the multifarious publications of the National Academy; while it finds full expression in the Bulletin of the Philosophical Society of Washington under its new form, in the prelimi-

nary papers of the American Institute of Mining Engineers, and in the small parts and separate papers of the Transactions of the American Society of Civil Engineers. With a few exceptions, the vigorous and long-lived serials are those appearing in small parts, and the exceptions are mostly explained by another tendency.

A fifth tendency, which is apparently opposed by the last, but which really explains many of the exceptions to it, is against the publication of monthly serials; or, perhaps more properly, against the publication of regular units at short and regular intervals: It finds expression in the transformation of the Journals of the Academy of Natural Sciences of Philadelphia and the Boston Society of Natural History, and of the Proceedings of the former society and of the Geological Society of London from regular monthlies into irregular serials, by the irregularity in appearance of the nominally monthly parts of the Transactions of the American Society of Civil Engineers and of the Quarterly Journal of the Geological Society of London, and by the dearth of monthlies among the publications of the younger societies. All the older societies, save the American Association for the Advancement Science, have tested monthly publication, but none of the societies now issue regular monthlies, and it is evident that this mode of publication does not survive under existing conditions.

There is an evident tendency against the publication of administrative records *per se*: This tendency is exhibited by the decadence of the Proceedings of the Geological Society of London, more decidedly by the combination of the administrative and scientific records of two of the younger societies (the Philosophical Society of Washington and the American Institute of Mining Engineers) and the joint issue of the Proceedings and Transactions of the third (the American Society of Civil Engineers), and still more emphatically and very curiously in the transformation of the Proceedings of the Academy of Natural Sciences of Philadelphia and of the Boston Society of Natural History (and in less measure

the Quarterly Journal of the Geological Society of London and the Proceedings of the American Association for the Advancement of Science), by which they have, contrary not only to the expectation but even to the express plans and purposes of their founders, become changed from almost purely administrative to predominantly scientific records. The purely administrative serial has never held its own for any considerable period, save in the National Academy of Sciences, where the conditions are unique, and in the American Society of Civil Engineers, where the serial is weak and tottering if not decadent; and in the joint records the tendency is decidedly in the direction of condensation of the administrative matter.

Summing these several tendencies, it appears that the general drift of serial publication by scientific societies is toward a combined record of research and administration (the latter condensed) in the form of a single Svo serial, printed promptly in small parts and issued at intervals depending on the accumulation of matter.

No one can scan the serials issued by any considerable number of scientific societies without perceiving that, whatever form and character their founders may impose upon them, they are subject to laws of development more potent than the efforts of editors, publishing committees, or even wealthy and well-organized societies, by which their ultimate success or failure and the qualities which tend toward these ends are determined. Neither can the student fail to perceive that the younger organizations have (perhaps unconsciously) profited by the experience of their elders, and that the modern serials, whether the direct outgrowth of the ancient series of mighty tomes or the offspring of new organizations modelled in part after the old, are the more stable. In short, the serial, like the organism and the institution generally, is a creature of environment, and, whatever its birthright, quickly passes into the troubled sea of mortal strife in which only those survive who both conquer their

adversaries and adjust themselves to the rhythm of the waves. But while the general tendencies of serial publication are more or less obvious, and while modern societies have noted and profited by them, their *raison d'être* appear not to have been sought hitherto. Yet they are not far to seek.

THE CAUSES OF EVOLUTION OF THE SERIALS.

In their relations to the serials published by scientific societies, the people of a country or of the world may be classed as book-makers and book-users; but in order to understand fully the relations of these general classes, a more refined classification must be employed. So the book-makers may be divided into authors and publishers; and the book-users may be separated into librarians, bibliographers, and readers who may be assumed to be students. The requirements and influence of these classes of people control serial publication and the character of the serials. The facts (1) that the student is sometimes his own bibliographer and librarian, (2) that the author may be practically his own publisher, (3) that the functions of the bibliographer are not well differentiated particularly from those of the librarian, and (4) that the society frequently combines various functions, do not run counter to this classification.

Now, it is evident that the requirements of the student are paramount; it is for him that treatises are written; it is for his use that they are printed and bound; and it is to afford access to these treatises that bibliographies are prepared and libraries formed. The student demands not only that books shall be made but that they shall be promptly published while yet their subject matter is new, and so planned that they may be easily handled, conveniently entered in catalogues under intelligible and not misleading titles, and readily found in the library; he needs and is beginning to demand that the author's work shall be carefully and well done, that the text shall be clear and succinct, and that graphic expression shall be used so far as may be expedient;

and he demands with ever increasing emphasis that the responsibility for every published statement shall be definitely fixed. The vehemence of this last demand is not felt by those authors who delude themselves with the notion that the publication of their names is a device for securing credit rather than fixing responsibility. But printed statements are worthless to the student unless vouched for by some individual in person; a thousand anonymous declarations that a meteor has fallen are disproved to the student by the simple utterance of a single reputable individual who backs his utterance with his name; and even the lay reader is coming to regard the author's name as the sign manual of veracity. That the function of the author's name was properly appreciated by students even in the early days of scientific societies is proved by the formula—"The society is not responsible for the facts and opinions expressed by its members"—which has come down from the older organizations just as functionless, vestigean organs are inherited from older organisms.

Second in order of importance are the requirements of the bibliographer: It is he who classifies and catalogues books, not as loosely related units but as sources of information, and so renders their contents accessible to the student for whose use they are designed. At present the place of the bibliographer in the bibliothecal machinery is scarcely recognized, because, while his function is born of books, it is not felt until they become too numerous to be read and remembered; but the work of the bibliographer is represented in subject catalogues, in book lists of all kinds, in annual records of progress in science, in the bibliographic references which careful authors and editors introduce as footnotes, and in the notices and reviews which have occupied a prominent place in scientific literature for years, as well as in the systematic bibliographies of various branches of knowledge which have been published in recent times; and the function of the bibliographer is destined to increase in importance with the increase in volume of the literature

of exact knowledge. The prime requirement of the bibliographer is for systematic arrangement of books and minor publications under expressive, brief, and complete titles; and there are other requirements which the bibliographer holds in common with the student—though certain of the student's requirements are immaterial to the bibliographer.

Third in order of importance are the requirements of the librarian, for it is upon him that the student must depend for access to publications. The requirements of the librarian are that the publications shall be issued in convenient form for arrangement upon shelves and for binding, and that every volume or part-volume shall bear a definite title. Some of the requirements of the librarian are common with those of the student; but his demands are less numerous and exacting, since he deals only with the units and integral parts of publications, while the bibliographer deals with fractions, and the student with the undifferentiated substance of books; and some of his needs are opposed to those of the student—*e. g.*, prompt publication is not a desideratum to the librarian, but rather the opposite, since frequent issue in small parts gives trouble in arranging serials upon shelves and in volumes. But the librarian shares the student's antipathy to multiplication of serials of the same society, and especially to ponderous quartos and limp folios, which he often relegates to bottom shelves and miscellaneous heaps in out of the way corners.

Fourth in order of importance must be placed the requirements of the author; for it is incumbent upon him not only to so prepare his books that they may be conveniently handled by the librarian and readily recorded by the bibliographer and so made accessible to the student for whose use they are written, but to have something to say which is worth the saying; and he must write clearly and illustrate wisely in order that his writings may be comprehensible with a minimum of effort on the part of the student. The just subserviency of the author to the student in this respect is not always understood; but if the author expects to have

300 readers, he ought to realize that it is only fair for him to spend five hours upon a single sentence if he can thereby render it intelligible one minute more quickly. The primary requirement of the author, which is held in common with the student, is prompt publication. The force of this demand on the part of the author cannot well be overestimated; it is the incentive to investigation; it is the spur to subsequent labor at the desk, and it is the stimulus to publication, often at great personal sacrifice. Any plan that prevents prompt publication stifles scientific enthusiasm, and any device that promotes prompt publication vivifies science and enlarges knowledge. Subordinate requirements of the author are (1) publication of his papers in convenient form for the use of the bibliographer and student; (2) publication under his own name that the responsibility and credit may appear *prima facie*; and (3) publication in such form that he may obtain and distribute copies of his own treatises at will. The last of these requirements has led to the development of a form of publication known as the author's separate, which is the bane of the bibliographer and the burden of the librarian, since it commonly involves needless duplication of editions. Emphatic protests on the part of students and bibliographers against re-paging such separates were widely published a few years ago, and the nuisance has been thereby in part abated; but still this form of publication remains an unsightly excrescence on the genealogic tree of scientific serials. There is a fancied requirement of the author for fine printing, heavy paper, broad margins, and sumptuous binding which is antagonistic to the legitimate requirement of wide distribution of his writings, and need not be seriously considered. The author has another interest which is directly antagonistic to the just requirements of the publisher: in seeking to economize time and energy the author may slight his literary and artistic work and prepare his manuscript badly; but since slovenly manuscript costs publishers much more than its improvement would cost the author, and since the

mechanical slovenliness is inevitably accompanied by slovenliness of expression, this illegitimate interest of the author is injurious to the student and so indirectly suicidal.

Last in order of importance, at least as viewed from the standpoint of author, librarian, bibliographer and student, are the requirements of the publisher. He justly demands, first, that his copy shall be carefully prepared; second, that sufficient time shall be permitted for the reproduction of illustrations as well as the composition of the letterpress; and it is generally a convenience to him to keep a considerable amount of copy on hand and to issue the publication in complete volumes or in large parts. The demand of the student and author for prompt publication is immediately antagonistic to his interests; and his disposition is to combine with the librarian, and perhaps also the bibliographer, in delaying publication. The publisher, too, fixes the cost, and thus tangibly represents the condition limiting the volume of the publication; and in this function, too, the interests of the author and publisher are opposed.

On applying these principles to the serials published by the eight representative scientific societies, the reasons for the instability betrayed by some and the stability displayed by others becomes manifest:

Multiplicity of paginations in a volume, of series in a serial, or of serials issued by the same society are all objectionable to the student; the last two conditions impose a burden on the bibliographer; the last condition occasions inconvenience to the librarian, particularly when the serials are unlike in size; and, moreover, the cost of publishing and distributing serials generally increases with the number of serials issued. So the unification of serials represents progress in the direction of economy in labor on the part of students, bibliographers, and librarians and in the monetary cost of publication.

The paramount requirement of student and author alike is prompt publication; and while this requirement

is opposed measurably by the bibliographer and librarian and decidedly by the publisher, its force is such that it has found expression in the publications of almost all the scientific societies. More than half of the changes in form and plan of serials have been made in obedience to the need of prompt issue; and while promptness is opposed by inertia and tends to degrade into sluggishness, the mean interval between regular issues has materially diminished in nearly all of the societies, and is less in the younger than it was in the older at corresponding stages.

The author needs large plates for the illustration of certain subjects; and with this actual need goes the fanciful requirement which leads to publication in sumptuous form. But the need for large plates has diminished with the improvement and reduction in cost of illustrations; wood-cuts in the text are now used where steel or copper-plate engraving was formerly necessary; photo-engravings replace elaborate lithographs; and the art of lithography has been so improved that maps, diagrams, etc., may be published upon smaller scales than formerly. At the same time students have found 4to volumes unwieldy, librarians have found them a source of inconvenience in their libraries, authors have found their issue dilatory and their circulation limited, and publishers have found them expensive. All of these objections to the 4to have had influence, and publication in that form has declined notably, despite the definite plans and sustained efforts of most of the scientific societies.

Publication in large units or fractions involves the accumulation of a considerable volume of matter in the hands of the publisher before the first pages are printed, and this occasions delay; but such delay is inconsistent with the satisfaction of the common need of student and author for prompt issue. So this paramount requirement finds expression also in the small and frequent issues to which nearly all the societies have been forced.

Publishers of regular periodicals of uniform size find it necessary to keep on hand a large amount of copy, upon

which they draw at will in making up each issue; in the literary and popular magazines some articles are so kept on hand for months and sometimes years; and even in scientific journals of the highest grade individual memoirs are often held for weeks or months before they can be fitted into the Procrustean bed provided for each family. Moreover, editorial labor is required in rounding out the various departments into which the periodical is divided, and this involves added expense. These impediments of delay and cost appear to be the rocks upon which the periodicals launched by most of the societies have been wrecked.

The author pursues his researches *con amore*, and on publication of results finds among his fellow-students a large circle of readers who share interest in his problems. So the inspiration of authors and the enthusiasm of students breed special treatises; and it is the chief function of the scientific society to bring the author into communication with the student and to aid the labors of the former and supply the needs of the latter. But except in rare cases there is none of the inspiration of authorship in the preparation of administrative records of scientific societies, and there are few careful readers of such matter save among historians or projectors of new scientific institutions. Such records are indeed necessary for the society and in a less degree for the public, but it is evident *a priori* that the incentives to preparation and the demand for distribution and reading of "proceedings" must be limited, and that such records must ever be parasitic upon the scientific records which it is the special province of the society to maintain. Here, again, deduction from the fundamental principles controlling publication, and induction from the history of scientific serials are coincident; for although nearly all the societies have sought to support separate administrative records, only two are now doing so, and in one of these the serial is unstable while in the second the conditions are unique.

In brief, it appears that the variations and tendencies to vary exhibited by the serial publications of scientific socie-

ties, like those of organisms and of other institutions, result from efforts toward adjustment to environment and represent the survival of the fittest through natural selection; that the variation indicates evolution in a certain definite direction; and that failure on the part of their founders to recognize the conditions of success or failure of serials has never prevented evolution toward the optimum form and character.

METHODS OF FIXING RESPONSIBILITY AND THEIR EVOLUTION.

In all the societies studied, the more important papers are published under the names of authors who thereby assume personal responsibility for statements of fact and expressions of opinion; but the responsibility for the publications does not end here. Every society is in itself or through its committees or other officers a professed censor of the papers read at its meetings or published under its auspices, and therefore assumes a limited responsibility for all its publications, however conspicuous the type of the misleading and obsolescent disclaimer of responsibility displayed upon its title-pages. Moreover, in most societies the administrative records and reports of discussion and the abstracts of oral communications are prepared and arranged in greater or less part by officers of the society, and for all such work the society is responsible through its accredited officers. Again, it is the society, in itself or through its committees or other officers, that deals with printers and engravers, prepares copy, revises proofs, rejects or accepts engravings, and superintends the mechanical part of publication generally; and so in another way the society incurs responsibility for its publications.

Now, it is interesting to note that, concurrently with the change in form and plan of publication, there has been a perceptible movement in the direction of fixing and clearly setting forth the responsibility for the editorial and administrative part of the publications.

In the American Society of Civil Engineers the various

publications are edited by the secretary under the direction of the library committee; and while it is provided that the "Society is not responsible as a body for the facts and opinions advanced in any of its publications," the secretary and library committee are vested with large discretionary powers and practically vouch for the propriety and general scientific or technical value of every published paper. The society thereby incurs a limited responsibility for its publications, and this responsibility is definitely fixed upon the editor and library committee by the frequent publication of their names and official functions.

In the American Institute of Mining Engineers the council (the administrative body of the institute) decide upon the propriety of all communications, and so incur a limited responsibility for them as definite units, though responsibility for statements of fact and opinion contained therein is disclaimed. In this case, too, the secretary is virtually editor of all publications of the society.

In the National Academy of Sciences the standards of membership are high, and large responsibility is thrown upon the authors of communications; but there is a committee on publications who incur limited responsibility (proportionate to the powers with which they are vested) for the records of research; while the administrative records are prepared by the home secretary; and the names and functions of these officers are annually published.

In the American Association for the Advancement of Science the permanent secretary is *ex officio* editor, and all communications are sifted by the sectional committees and by the standing committee, and sometimes the question of publication is decided by vote of a section. So the society at present assumes large responsibility for the character of its publications. But during its early years, when its standards of membership were different, communications were accepted upon their merits and the reputation of their authors, as in the National Academy of Sciences, and there were no statutory provisions for scrutinizing them

nor for determining or fixing the share of responsibility borne by the society.

In the Philosophical Society of Washington every paper offered for publication is submitted to the general committee and by it at once referred to a special committee; this committee reports to the general committee, and it then decides the question of publication. So the general committee assume limited responsibility for matter appearing under the imprint of the society, and this responsibility is vaguely fixed by the publication of the names and functions of the general committee; but it should be pointed out that the large responsibility borne by the secretary and virtual editor is not fixed in the publications.

In the Academy of Natural Sciences of Philadelphia there has long been a committee on publication who not only scrutinize the communications as originally presented but also revise proofs, etc., and thus incur large responsibility for the matter published by the Academy; and in recent years the secretary has come to be editor *ex officio*, and a part of the powers and responsibilities of the more impersonal publication committee have been transferred to him. At first the administrative part of the publication of the society was impersonal.

In the Boston Society of Natural History the names and functions of the officers responsible for the publications were not at first clearly indicated; but there is now a publishing committee who examine and superintend the publication of communications offered by members, and thus vouch for their value though disclaiming responsibility for "any opinion expressed" therein; and the names of this committee appear on most of the publications.

In the Geological Society of London there was originally an indefinite body known as "the Editors" who passed upon all matter offered for publication, though disclaiming responsibility for it; but as time went on the regulations were gradually changed until the communications came to be scrutinized by the council; and now they are not only so examined but edited by the vice-secretary.

Thus, of the four older societies, all of which began without published provision for fixing responsibility upon any individual or individuals on the part of the society, three (the Am. Assn. Adv. Sci., the Acad. Nat. Sci. Phil., and the Geol. Soc. London) now have *ex officio* editors who virtually assume limited responsibility for the publications of the society, while the fourth (the Boston Soc. Nat. Hist.) has a publishing committee whose names appear on every publication issued by the society; and these officers virtually assume limited responsibility proportionate to their powers, and that responsibility is as clearly fixed by the publication of their names as is the larger responsibility of the authors. Thus, too, two or three of the four younger societies (the Am. Soc. Civ. Engrs., the Am. Inst. Min. Engrs., and, perhaps, the Nat. Acad. Sci.) have *ex officio* editors, and only one (the Phil. Soc. Wash., in which the provision for scrutiny of communications by special committees is exceptionally rigorous) now publishes without vouching for the propriety and value of the publication and definitely fixing personal responsibility for the editorial and supervisory work by giving the names and functions of the officers concerned.

The reason for this curious tendency is obscure, but appears to lie at the very foundation of science: Science is preëminently democratic and has ever opposed the secret tribunal and the *ex cathedra* dictum, and so the standing of the scientific institution represents the standing of its members as individuals; the subject matter of science is knowledge, the value of which depends upon its exactitude, and it has been constantly sought to maintain a high standard by holding individuals responsible for their contributions and subject to the penalty of ignominy and public scorn in case of default, and so the recognition of individual responsibility has become more general in science than in those branches of knowledge which are less exact; there is no hierarchy in science, all men stand upon a footing determined by their ability to contribute to human knowledge, and the method

of scientific work renders the collaborator and accessory in even the most trivial detail co-responsible with the principal, and so the editor imbued with the scientific spirit is ready to acknowledge his work and the just author welcomes the acknowledgment. The tendency to fix individual responsibility for censorship and editorship is the outgrowth of the desire to fix responsibility for authorship, and indicates that, whatever be the case in statecraft, in science the executive session is doomed.

ON CERTAIN PECULIAR STRUCTURAL FEATURES
 IN THE FOOT-HILL REGION OF THE ROCKY
 MOUNTAINS NEAR DENVER, COLORADO.

BY

GEORGE HOMANS ELDRIDGE.

[Read before the Society November 23, 1889.]

CONTENTS.

	Page.
Introduction.....	248
Lithological Character of Formations involved. (Table).....	249
General Features of the Affected Area.....	250
Topographical	250
Surface delineations	251
Detailed Geology.....	252
The Formations and their Relations.....	252
The Archæan.....	252
The Trias.....	252
The Jura	253
The Dakota.....	254
The Colorado { Fort Benton	255
{ Niobrara	255
The Montana { Fort Pierre.....	256
{ Fox Hills	257
The Laramie.....	257
The Arapahoe.....	258
The Denver.....	258
Special irregularities.....	258
Structural Features.....	258
Dips	258
The general fold along base of Range.....	259
Faults.....	259
Structural Development of the Area.....	260
Introductory	260

	Page.
Periods in the Development.....	261
First period.....	262
Second period.....	262
Third period.....	263
Fourth period.....	264
Fifth period.....	267
Discussion of Movements producing the present Structure.....	267
1° Hypothesis upon which the argument rests.....	267
2° Faults and folds—the local manifestations of forces involved.....	268
3° Forces have acted with varying direction.....	268
4° Development of the post-Niobrara fold.....	268
5° Readjustment of forces, inducing present structure.....	270
6° Readjustment accounted for.....	270
7° Relation of basalt eruption to the foregoing events.....	271
Earlier Views on the Structure of this Region.....	271
Views of A. R. Marvine.....	271
Views of Lester F. Ward.....	272
Views of others.....	274

NOTE.—The geological map accompanying this paper is an original plat. The profiles are based upon this, and are developed by construction from it and from one another by actual measurements, with the necessary reductions for thickness. The two sketches, towards the close of the text, illustrative of the manner in which the folding occurred and its relations to that of the Main Range, are, however, diagrammatic, although based upon the historical facts developed in the paper.

INTRODUCTION.

The present paper is devoted to the discussion of a type of geological structure recently discovered by the writer in the foot-hill region west of Denver, which upon detailed study may prove of common occurrence along the base of the Rocky Mountains, a recurrence of it in a less developed form having already been observed in the vicinity of Boulder, a few miles north of the area covered by the present instance. The type consists in a succession of non-conformities appearing one after another at various geological horizons, the explanation of which is found in the forces acting in the general uplift of the Colorado Range, from which have been developed certain secondary forces that have from point to point brought about the elevations upon which the non-conformities depend.

Tabular Statement of the Lithological Characteristics of the Formations Involved in the Present Discussion.

Formation name.	Thickness in feet.	Description.
Denver-----	1,400	Upper Half: Coarse conglomerates, with minor clay and sandy beds. Material derived from older sediments and Archean predominates, but is freely mixed with Andestic débris.
Arapahoe-----	800	Lower Half: Conglomerates, grits, sandstones, sandy clays, and nearly pure clays,—all, the débris of Andestic lava-flows. Fossiliferous.
Laramie-----	1,200	Upper Two-thirds: Clays, occasional lenticular sandstones. Fossiliferous.
Montana { Fox Hills Fort Pierre-----	1,000 } 8,700 }	Lower One-third: Conglomerates; pebbles, of all older formations in the field and from Carboniferous beyond. Fossiliferous.
Colorado { Niobrara----- Fort Benton-----	300 } 700 }	Upper Two-thirds: Clays, ironstones, and rarely coal-beds. Fossiliferous.
Dakota-----	300	Lower One-third: Sandstones and coal-beds. Fossiliferous.
Jura-----	200	Sandstone cap, underlain by arenaceous clays. Fossiliferous.
Trias { Upper----- Lower-----	600 } 2,100 }	Clays, drab; limestone concretions, occasional sandstone bands. Fossiliferous.
Archæan-----	?	Two-fifths: calcareo-arenaceous shales, bright buff.
		Two-fifths: gray clays. Fossiliferous.
		One-fifth: light colored, drab, white, limestone. Fossiliferous.
		Black shales, with few limestone bands at top. Fossiliferous.
		Hard sandstones, with conglomerate at base. Fossiliferous.
		Fresh-water clays, with a few sandstone and limestone bands; a noticeable sandstone 60 feet below top. Fossiliferous.
		Upper: Brick-red sandy shales, with occasional interbedded fine-grained sandstones. Heavy sandstone bed at top; thin limestones at base.
		Lower: Red Beds of Rocky Mountain Region,—conglomerates and sandstones. Thickness varies greatly.
		Gneisses, granites, schists, etc.

GENERAL FEATURES OF THE AFFECTED AREA.

The area affected by the phenomena now to be discussed extends along the base of the foot-hills of the Colorado Range west of Denver, from a point about a mile south of Bear creek northward to Coal creek, a distance of 21 miles, with a breadth varying from $2\frac{1}{2}$ to 4 miles, the greater occurring along its northern and southern edges. It involves the hog-backs of the Dakota and the region within to the Archæan, and includes the prairies as far to the east as Mt. Carbon, the western slopes of Green Mountain, the Table Mountains, and the vicinity of the Ralston dyke.

Topography.—Its topography shows a marked variation from that normal for the foot-hills region in general, and its relations with the geology of the tract as displayed from point to point throughout its extent are so close as to warrant the assertion that for every topographical lineament there is to be discovered an equivalent geological incident that has led to its development. The normal foot-hill topography consists of a mountain mass of Archæan rocks, fringed at an average distance of half or three-quarters of a mile by a sharp serrated ridge of Dakota sandstone, the valley between the two being occupied by the formations of the Trias and Jura. Above the Dakota in their geological succession come the Fort Benton, the Niobrara—this generally constituting a second, smaller reef outside the Dakota—the Fort Pierre, Fox Hills, and the Laramie, the basal sandstones of the Laramie, again, forming either a low roll in the ground or an actual comb of rock slightly projecting above the surface of the surrounding prairie. To the east of the Laramie, at a distance of between 600 and 1,200 feet from its basal sandstone, appears in the southern portion of the area yet another comb, formed by the conglomerates at the base of the Arapahoe series. Finally, this is followed at about an equal distance by either an outcrop of the lower members of the Denver formation or a peculiar ribbing of the prairie due to their presence beneath the surface. For mile after mile

along the mountains the above topographical features may be traced with unswerving regularity, but within the area to be described they undergo rapid change, and midway the tract, in the vicinity of the town of Golden, lose all recognition whatsoever. For a distance of over a mile north of the town and an equal one to the south of it, the Dakota hogbacks have completely disappeared; the low Niobrara ridges cease to exist at a point about a mile north of Bear creek, not to again appear until the region of Van Bibber creek, 10 miles to the north, is reached; the Laramie sandstones, with their coal, have gradually approached to within 500 feet of the Archæan at Clear creek, the variation in their strike from that of the Triassic and Dakota outcrops below being apparent to the most casual observer; finally, opposite the center of this great topographical gap, appear the two great basalt-capped sedimentary masses of North and South Table Mountain, originally continuous, but afterwards cut by the waters of Clear creek, which debouches from the main range midway their length.

Surface delineations.—Standing upon any of the more elevated points within this remarkable area, another set of features, second in prominence only to the ones already referred to, at once strike the eye. These are the clearness with which the lines of stratification are delineated upon the surface, and the distinct tendency which they display to group themselves, with respect to direction, into two well marked assemblages: the one embracing the formations of the Colorado and all below, and maintaining for the greater part of their extent the same parallelism to the general trend of the foot-hills which they have held beyond the affected area; the other embracing the Montana and younger formations, and, though maintaining a parallelism of strike within themselves, nevertheless abutting against the older formations at an angle in places as high even as 20° . The latter formations, in fact, approach the range proper in a broad, well marked, and regular, inward sweeping curve, the center of its arch lying a short distance north of Clear creek. The

features just noticed again occur, in a minor degree and in a manner not at first liable to attract attention, in the relations between the Dakota and underlying beds nearer the middle of the area, where the beds of the younger formation lie across the edges of those of the older.

North of the central portion of the area of non-conformity and south of Ralston creek for the distance of about two miles the topographical and geological features are somewhat complicated by the presence of intrusive masses; they are, however, still sufficiently clear to permit interpretation, and with the others in the south and center of the area and in the remainder of the tract to the north form one complete whole.

DETAILED GEOLOGY.

The Formations and their Relations.

The Archæan.—This is but slightly involved in the special geological history of the region. It formed an uneven floor for the deposition of the Trias, across the truncated edges of which the latter formation was deposited.

The Trias.—In their strike and dip the beds of both members of the Trias are conformable *inter se*. Their strike follows approximately the line of the Archæan foot-hills, and their dip is to the east and varies between 35° and 90° , the shallower next the foot-hills and increasing as distance from them is gained.

The lower member of this formation, the Red Beds, maintains its usual appearance, and, with two exceptions, a nearly constant thickness over the entire area under consideration. The two variations in thickness are found, the one near the southern extent of the tract, the other for a mile and a half on either side of Clear creek. The former is of no particular interest in the present discussion. The latter is attributable to two causes: one, non-deposition at the base, due to a rise in the Archæan floor and a consequent shallowing of the sea at this point, the beds of the deeper water abutting against this rise; the other, the disappearance from the top of the

series, of the beds last laid down, including the Creamy sandstone and at least one or two hundred feet of the beds beneath. The linear extent of the disappearance of the Creamy sandstone is probably somewhat under one mile, and is chiefly confined to the region immediately north of Clear creek, reaching to the south of it but slightly, if at all. In this interval the clays of the Fox Hills are found in close proximity to the Red Beds, the former conformable in strike with the Laramie sandstones above, the latter pursuing their usual trend, approximately parallel with the base of the range.

The upper member of the Trias presents nothing anomalous in its occurrence until within a distance of about two miles north and south of Clear creek, when a rapid disappearance of its beds successively from top downward is found to occur as the center of the region is approached, the limestones and associated beds at its base apparently reaching within a short distance of the limits already assigned for the Creamy sandstones below. An extremely important point in this connection is the fact that this disappearance occurs while the overlying Jura is not only still present, but maintains even the greater part of its thickness; it occurs, in fact, between the Jura above and the lower member of the Trias, the Red Beds, beneath. The disappearance of this series of strata is most marked, because more sudden, to the north of Clear creek and Gold run, where within a distance of between a half and three-quarters of a mile it has decreased in thickness from 650 to 270 feet. The diminution in thickness to the south of Clear creek is also rapid, but over this portion of the region the upper Triassic member is not limited altogether by the Jura above, but in part by the Dakota, with a discrepancy of at least 10° in their strike. Farther to the south, where the Jura is present in nearly its full thickness, the variation in thickness of the Upper Trias is more gradual, but still to be associated with the local phenomena of the region.

The Jura.—No extraordinary discrepancy in strike or in general relations between this formation and either the under-

or over-lying one is apparent until upon near approach to the confines of the region presenting the anomalies just described for the Trias. Any decrease in the thickness of the Jura beyond is little more than is usually met with from point to point along the range. From about a mile south and a mile and one-half north of Clear creek, however, the beds of the formation disappear in rapid succession as the center of the region is gained. Their strike is, moreover, at variance with the formations both above and below: in the southern part it is in noticeable contrast with that of the Dakota, being some 10° or 15° to the east of the latter; in the northern portion not only is the same discrepancy probable between these two formations, but an equal one also appears between the beds of the Jura and those of the Trias below. The thinning of the Jura is in part probably due to the absence of some of its lower beds, while the cause of its sudden and final thinning is found in the rapid and successive disappearance of, first, its upper beds, followed in turn by those lying beneath.

The Dakota.—As ascent is gained in the series of formations, the region of anomalies becomes more and more extended in north and south directions. The Dakota begins to display irregularities as far south as the northern end of the high hog-back just south of Coon gulch, and in the north at the southern end of the chain of hog-backs north of Golden. The noticeable points in the behavior of the southern half of the formation are: *first*, the disappearance of the characteristic hog-back; *second*, the gradual decrease in thickness, which the outcrops of the remaining portions show to be both from above and from below, the fireclays in the middle of the formation being the last to disappear, as evidenced at the bluffs of both Clear creek and Gold run; *third*, the discrepancy in strike between this formation and those below and above, its beds in the region of more pronounced irregularity lying across the edges of the former, and abutted from above by the ends of the successive strata

of the Montana group throughout much of their line of contact; *finally*, frequent changes in the strike of its beds over the central portion of the affected area, none of which changes are paralleled by corresponding ones in the prominent sandstones at the base of the Laramie, lying but a short distance to the east. In the northern half these same peculiarities are again met with, but in some particulars are more strongly accented than in the southern: these are the more sudden disappearance of the hog-back; the rapidity with which the formation thins; the marked crumpling, as shown in their strikes, to which its beds have been subjected without the overlying strata being in the least affected. In dip the Dakota varies from 45° in its more normal occurrence to vertical over the more disturbed, middle portion of the field.

The Fort Benton.—This formation completely disappears a short distance north of Coon gulch, and also at a point about opposite the middle of the first hog-back north of Golden. The southern portion has thinned very gradually throughout a distance of three and one-half miles, while for the northern member the disappearance has been completed in a little less than a mile. In strike and dip the Fort Benton conforms to the Dakota, but is overlain, after the disappearance of the Niobrara, by successively higher strata of the Fort Pierre and Fox Hills formations as the center of the disturbed region is approached.

The Niobrara.—This, like the Fort Benton, disappears only from above downward, but its limits are found considerably to the north and south of those of the corresponding members of the older formations. In strike and dip it conforms with the Fort Benton and Dakota, and like them, in passing from without inward, is overlain by successive strata of the Fort Pierre, though nowhere brought in contact with the higher member of the Montana group, the Fox Hills. The disappearance of this formation is especially well shown both in the north and south from the physical

character of its sediments, the upper, bright yellow or buff, sandy measures, which often form a well marked outcrop, first being lost, followed by the destruction of the argillaceous middle part of the series, and finally by the cutting out of the prominent basal limestones themselves. The disappearance occurs in the south only a short distance north of Bear creek, and in the north a quarter mile north of Van Bibber creek.

The Montana.—This group in strike conforms strictly with the overlying Laramie, the basal sandstones of which afford a prominent and reliable key to the relations of these upper formations with the ones already considered. The dip of the component beds of the group, where all are present and in normal occurrence, shows a gradual increase from 45° to 90° as the distance increases from the base towards the summit. Over the middle of the anomalous tract, however, the vertical dip prevails, as in the case of nearly all the formations in this portion of the area.

The fact of chief interest regarding the Montana group is its remarkable and rapid disappearance between Bear and Coal creeks as distance is gained from either of these streams towards the center of the region at Golden. Immediately north of Bear creek its strike relations with the underlying formations are rather more exaggerated than at most other points, and consequently more clearly brought out in the surface exposures there occurring. In this vicinity successive beds of the Fort Pierre may be traced over their general line of strike by means of their lithological characteristics and the general prevalence of certain fossils at particular horizons, from points a thousand feet or more to the east of the Niobrara at the bluffs of Bear creek to others within only two or three hundred feet of the older formation, one or two miles to the north. The angle thus made by the difference in strike between the Niobrara and Fort Pierre is on an average about 15° , but decreases to the north, opposite the middle of the Dakota hog-back, beyond which the strikes are for a considerable distance more nearly parallel.

In the northern part of the region, opposite the first hog-back north of Golden, the exposures of the Montana group are rare, but a half mile north of Van Bibber creek and from this point to Ralston, the discrepancy in strike observable to the south has for a time almost wholly disappeared; beyond Ralston creek, however, a divergence of 20° is still noticed in the general trend of the Laramie and Dakota sandstones, which extends to a line due east from the entrance to the cañon of Coal creek. This area is regarded as corresponding to that in the vicinity of Bear creek in the south, over which a thickness of Montana beds equivalent to that on the southern border of the field is regained, by which the geological symmetry of the region is rendered complete.

Over the middle portion of the region the Montana beds follow closely the behavior of the Laramie, but show frequent variations in thickness and corresponding changes in their strike relations with the beds below. Regarding the individual members of the Montana group, if the general thickness of the Fox Hills is taken at between 800 and 1,000 feet, the Fort Pierre has not been deposited for a long distance in the middle portion of the region, having gradually thinned from the confines of the area towards the center of Golden by successive losses of its lower beds. The Fox Hills alone is of general occurrence, although its thickness, also, over the central portion, varies greatly and often.

The Laramie.—The prominent feature of this formation is its remarkable bend from a course approximately parallel to the foot-hills and to the formations below to a broad sweeping curve, by which it is gradually carried to the westward until at Golden, its point of greatest deviation, it lies between two and three miles to the west of its former course. The general trend is slightly wavy, but with reference to the early Cretaceous and older formations, is of notable steadiness, passing all their individual deviations without the least disturbance of its own. Its dip is vertical or slightly overthrown for the entire length of the area under considera-

tion, and its basal sandstones form along their trend a characteristic series of combs.

Arapahoe and Denver.—The formations above the Laramie, although in reality markedly unconformable with it and with each other throughout the broad area over which they have been deposited, nevertheless in the present tract so closely follow the former in strike and dip that they display no peculiarities worthy of note in the present discussion, and in fact are only incidentally connected with the special geological history here discussed.

Special irregularities.—The two irregularities in the superficial relations of the strata noticed upon the map—the one just south of Ralston creek in the vicinity of the eruptive dike, where a block of strata has been displaced to the eastward, the other immediately north of Coal creek, where the Dakota and formations below have been thrown into the greatest relative confusion—are not connected in any way with the phenomena which form the subject of this paper, and will therefore only be alluded to as occasion demands.

Structural Features.

Dips.—A geological cross-section along Bear creek would present a gradual increase in the dip of the several formations from the Archæan outward at a rate about as follows: 35° E. for the Trias; 38° – 40° for the Dakota, Fort Benton, and Niobrara; 45° for the lower part of the Fort Pierre, increasing to 55° – 65° in the upper part; 65° – 80° from base to summit for the Fox Hills, and 80° – 90° and overthrown for the Laramie, Arapahoe, and lower members of the Denver formation. Three or four miles north of Bear creek, 10° – 15° may be added to the lesser of the foregoing dips, while from Coon gulch to the vicinity of the hog-back first north of Golden the formations of higher dip, having now become vertical or slightly overthrown, remain so, and the Triassic beds alone have an inclination under 80° or 90° . North of this, where regularity in the formations once more prevails,

the dips settle back approximately to their normal amounts as given at Bear creek.

The general fold parallel with the base of the Colorado Range.—The surface exposures of the prominent and sharply defined fold of general occurrence along the base of the Colorado Range and resulting from its uplift are, for the greater part of the area under consideration, to be found within a short distance of the line of union of the Denver and Arapahoe formations. North of Van Bibber creek, however,—where the Denver formation ceases to exist, followed within two or three miles by the disappearance of the Arapahoe,—the bend is almost entirely transferred to the Laramie, the Arapahoe for that part of the distance over which it is present entering into it only in the slightest degree.

Faults.—There are along the line of the older formations in this region four easily recognized fault localities: one near the termination of the Niobrara just north of Bear creek; a second in the isolated Dakota hill two miles south of Clear creek; the third near the southern end of the Dakota hog-back first north of Golden, and a fourth a half mile to the south of the latter, near the line of union of the lower and upper divisions of the Trias. The faults of each region have the present appearance of approximately east and west cross-fractures, along which the ends of the upturned strata are thrown to one side or the other. In the southern half of the field the northern ends of the interfault blocks are carried to the westward, while in the northern half it is the southern ends that are carried to the westward. The fractures in the isolated Dakota hill south of Clear creek are irregular and apparently local in their character. As a rule, the extent of throw of the faults mentioned is slight and confined to the formations in which it has been stated they occur, a single fracture only—one of those in the southern portion of the area—extending beyond one or two hundred feet, this including both Niobrara and Dakota, but of a much less pronounced character in the older formation than in the younger.

STRUCTURAL DEVELOPMENT OF THE AREA.

Introductory.—The abnormal conditions which have been noted in the relations of the several formations to each other are directly traceable to a series of non-conformities that exist at the particular horizons at which these conditions occur. Excluding the higher ones of general occurrence along the base of the mountains in this portion of Colorado—that is, those between the Laramie and Arapahoe, and the latter formation and the Denver beds—there are still to be found four which are in some respects peculiar to this locality: one between the Archæan and Trias, of special development in this area; a second at or near the close of the Trias; a third at the top of the Jura, and a fourth in the Cretaceous at the close of the Colorado.

Entering most prominently into the history of these non-conformities are as many folds, all of which occurred prior to the general uplift of the Rocky Mountains, and hence, with the erosion going on at the time, represented a completely different topography for the region from that of the present day. When the great uplift of the Rocky Mountains brought the beds into the position they now have, all hills, the result of previous folding, were changed in their individual positions from one in which the plane of their bases was horizontal to one in which it became vertical, or at least inclined at a high angle, and parallel to the direction of the mountains. In the subsequent erosion of the region, therefore, what would originally have been a profile section of the strata constituting these folds now appears in plan on the present surface of the ground, all originally north and south dips becoming present north and south strikes—in some cases slightly altered in character by incidental variations in the amount of folding in the general uplift of later times.

The detailed character and the contours of these ancient elevations cannot be determined, the two dimensions given in the profiles being naturally the only ones admitting of obser-

vation. The profiles, however, afford data quite sufficient to furnish a clear insight into the general character of the non-conformities and the movements in the earth's crust which led up to them.

Periods in the Development.

First period.—Taking up now in detail the several events in the geological history of this region by which it has reached its present state of evolution, first: that which brought about the non-conformity between the Archæan and Trias. That there everywhere exists a general non-conformity between the rocks of these two ages is, of course, well known, but within the region in question there is direct evidence of a special development of the non-conformity, which is, furthermore, borne out by the subsequent events which form the successive steps in the geological history of the area. This evidence consists in the observed termination of certain of the lower beds of the Trias against a slightly projecting portion of the Archæan; in the impossibility on structural grounds of the whole amount of thinning which the Triassic beds have undergone being attributable to disappearance from the top and the consequent necessity for its having taken place from below; and in the graphical development of an Archæan eminence, as represented in profile I, by tracing backward from their present positions through the series of figures given, the relative movements of the rocks of the several ages by which they have been brought into these positions. The evidence is found to lead directly to the following conclusions regarding the first of the periods in the special history of this region with which we have to deal.

Prior to the deposition of the Trias there had been developed in the Archæan, partly by erosion and partly, perhaps, by compression, the elevation shown in section in profile I. Its height was probably 800 feet, and it had a linear extent in a north and south direction of nearly four miles. Against the sides of this Archæan elevation were laid down

the coarse sediments of the lower division of the Trias—the Red Beds—which in time completely capped the hill along the line of profile given, and finally buried its summit deep beneath the accumulated material. General subsidence and sedimentation continued uninterruptedly to or nearly to the close of Triassic times, completing the first stage in the history of events here considered.

Second period.—At the close of the Trias the region which embraced the above events a second time yielded in a marked degree to the forces of elevation and developed the gentle arch of Triassic and Archæan strata shown in profile II. The north and south extent of this arch was but slightly greater than that of the one already described in Archæan times, its crown—coincident with that of the earlier one—lying about a half mile to the north of the present position of Clear creek. The rise of the arch, as indicated by its upper beds, was apparently about 420 feet, but subsequent erosion must have planed it down from its original height and shape to approximately the level line drawn across it in the figure as the base of the Jurassic formation.

The evidence for the occurrence of the non-conformity at this horizon and the fold which preceded it is found in the disappearance of most of the upper members of the Trias within the region of its influence, and in the divergence between the present strikes of the formations on either side of the line of unconformity—a divergence in strikes, it being remembered, corresponding to an equivalent discrepancy in the ancient dips, as shown in the profiles.

This line of non-conformity is naturally somewhat wavy, and it is possible, indeed, that at some points along the middle portion of the existing arch, through insufficient erosion, the deposition of a part or even of the whole of the Jura may not have taken place. The weight of the evidence, however, is in favor of nearly complete deposition over the entire section, from the fact that wherever the formation now exists it displays no tendency whatever to a protracted, gradual thinning, as is the case in the disappearance of certain of

the other formations, but, on the contrary, disappears by the sudden truncation of its strata in almost their full normal thickness, clearly the effect of subsequent erosion.

The movement which brought about the elevation of the Triassic strata must be regarded as synchronous with at least a portion of that more prolonged or extensive movement by which the sea was sooner or later shut out from certain areas in the Rocky Mountain region of Colorado, causing either a partial or an entire absence of marine beds, according to circumstances, with a succeeding deposition of fresh-water strata in which a lacustrine life appeared. In the area under discussion the fresh-water Jurassic alone was laid down.

General subsidence of the entire region continued during the deposition of the Jura upon and against the sides of the Triassic eminence, and at its close the second period in the geological development of the area was completed.

Third period.—This opened with still another uplift of all the pre-existing sediments into the fold traced in profile III, the rise of the arch in this case being approximately 1,000 feet. The figure shows the character of the fold on the line of profile given to have been that of a long gentle slope from the confines well towards the center, where, on further yielding to the compressive forces, a clearly defined median ridge was produced. Erosion naturally went on in a more or less irregular manner, but the general position of the hill and its component strata relative to erosive forces was apparently such as to cause the disappearance from the top of the Jura over those parts of the slopes of gentle inclination of only the most insignificant amounts of material, while over the central or sharper portion of the fold the probable effect was the complete removal of the beds of the Jura and Upper Trias together with a partial removal of those of the Lower Trias from the crown of the arch, and from the adjoining flanks the material to the gently sloping line of union shown between these formations and the Dakota lying across their edges. Whether erosion reached an extent sufficient to permit the deposition of the Dakota and the lower part of the

Fort Benton clear across this rise is doubtful, but from the rate of disappearance of the Dakota from below, it is probable that neither this formation nor the lower half of the Fort Benton was here laid down.

The evidence for the conclusions given in the preceding statements is clearly brought out in the strikes (ancient dips) and surface relations of the formations to each other: notably, in the divergence in strike and the truncation of the edges of the Jura by the Dakota on the southern side of the gap (profile III); in the thinning of the Dakota in such a manner as to eventually leave the fire-clay in its upper half in contact with the older sediments at the two points where the formation appears to end, in the south bank of Clear creek and the north one of Gold run; and in the ready reproduction by graphic methods of the structural conditions observed in the field and the natural sequence of events based thereon.

Sedimentation of the Dakota, Fort Benton, and Niobrara continued uninterruptedly to the close of the latter time, subsidence probably keeping pace. With this the third period of development ended.

Fourth period.—The fourth period embraces the time during which the great elevation shown in profile IV was created, and in which the sediments of the Montana and overlying formations were laid down. The uplift of this time was of much greater vertical and areal extent than any of those which preceded it, the rise of the arch on the line of section given reaching at least 9,500 feet, while its lateral extent was not far from 21 miles. It is broadly symmetrical, though there are several sub-flexures of a more or less pronounced curvature. The two of greatest prominence occur midway either flank. The others, of minor development, are confined chiefly to the higher part of the arch, and represent a crumpling of a secondary nature along this portion of the fold. This crumpling is well shown upon the present surface of the region in the changes in strike of the affected beds, which are in strong contrast with the unbroken direction to which the strata of younger age hold. The possi-

bility of the presence of an occasional fault in the place of an unbroken flexure as drawn in the profile is to be remarked, notably, in the vicinity of Gold run and north of Coon gulch at the points x, x of the profile. It so happens that here and there a space intervening between two outcrops of the same bed, lying in an indirect line from each other, is so covered that it is quite impossible to observe the position of the underlying strata; but since in no case a sharp break in the beds of the Archæan and Trias lying below the more affected ones has been discovered, it is preferable to sketch the irregularities as flexures rather than as faults.

Concerning the recognized faults in the northern and southern halves of the arch, described on page 259, their true character now readily appears in profile IV, where, upon the restoration of the beds to their position in pre-Montana times, the fractures are, with the local exception at the south end of the Dakota hog-back north of Coon gulch, all found to be of the normal type, either vertical or hading to the downthrown side and away from the center of the uplift, and similarly developed on either flank of the elevation. The explanation of the normal type of fault under the attendant conditions may possibly be found in the readjustment of the strata brought about by subsidence during a later period.

The profile of this ancient hill, at least on the line given in the figure, is one of structure rather than erosion, the unevenness in its outline being clearly traceable to the flexures underlying, the comparatively little erosion that has taken place over the higher portion of the arch having been regular in distribution, and thus having but slightly altered the original outline of the upheaval. The height of the elevation, however, has been reduced over 1,000 feet—to 8,481—by the removal of the Niobrara, Fort Benton, and Dakota.

The succession of events in the erosion, the transportation of the derived material, the sedimentation in the adjacent Montana seas, and the conditions which led up to each, are

in a degree speculative, but the inferences are: *first*, that soon after the completion of the Niobrara period elevation began, and so much of the hill as is above the altitude indicated in the section by the height upon its flanks reached by the upper layers of the Niobrara was then, sooner or later, brought within the erosive power of waves or currents, and the sediments last laid down, being now brought into a favorable position, and still in a condition sufficiently soft to permit their being easily broken down and comminuted, were removed by the transporting powers of the waters washing them; *secondly*, that the conditions of sedimentation in the immediate seas were the same as those in all mediterranean or large inland seas or along the margins of the continents at the present day—that is, comparatively deep and quiet water at a distance somewhat remote from the nearest coast line, which permitted the quiet settling of the sediments which go to make up the clays of the Montana group, and which correspond to those under which the blue mud of sub-continental areas is now being deposited.

The apparent complete removal over the space originally covered by them of the materials resulting from the breaking down of the early Cretaceous strata is somewhat striking, but it may readily be accounted for in the nature of the formations removed, and in the action of waves and currents and the long time through which the higher parts of the elevation were probably subjected to them. Furthermore, it cannot be positively asserted that the line of non-conformity is as clear of débris as represented, since on the steeper flanks of the arch it is rare that the beds above this line can be traced to actual contact with those below; still further, it is to be remembered that nothing whatever is known of the conditions on other profiles of this ancient hill. During the deposition of the beds of the Montana group gradual subsidence of the area at a generally uniform rate must have taken place, the sedimentation, with two exceptions, being that of quiet and deep water. The exceptions noted—the sandy zone midway the Fort Pierre and the more

arenaceous beds of the Fox Hills—are, however, not confined to the area under consideration, and therefore bear no relation to the phenomena here discussed.

With the general movement at the close of the Laramie and those which produced the non-conformities between the Arapahoe and Denver formations the peculiar structural features here described have nothing to do.

Fifth period.—Upon comparing profile IV with the present surface section of the same beds upon the general map of the region, the early relations between the arched and horizontal strata, as shown in the profile, are observed in later times to have completely interchanged. The once highly arched strata below the line of non-conformity have now assumed a practically direct trend, while the strata above the line of non-conformity, originally horizontal, have at the present time a well-defined inward sweep towards the mountains, reaching their limit of deviation in the vicinity of Golden, or, looking at the latter feature with reference to the profile itself, the Laramie and overlying strata have acquired a downward bend at the center of the area, directly over the crown of the arch of post-Niobrara times. Compare also figures 1 and 2, following.

The final movement which produced the present structural conditions, together with the outpouring of the lavas of Table Mountain midway the period of the Denver formation, are regarded as constituting the fifth and closing stage in the geological development of the area under discussion.

Discussion of Movements producing the present Structure.

1st. Statement of the hypothesis upon which the argument rests.—It is believed from the not infrequent occurrence, either within the present area or in other parts of the Rocky Mountains, of compound folds of the **S** type and of otherwise contorted strata, from the presence of reversed faults, and from the occurrence of the well-known folds “*en échelon*,” that the theory of lateral compression as the means by which

the forces uplifting the range were generated, although not accepted by all scientists, does, nevertheless, more completely and satisfactorily fall in with the observed facts than any other which can be suggested. It is not intended, however, that this shall preclude the acceptance in the future of any other grounds upon which it may be possible to establish a still more satisfactory explanation of the phenomena forming the subject of this paper.

2d. Manner in which the forces of elevation have locally manifested themselves.—At various points along the base of the Colorado Range occur strongly pronounced local peculiarities of structure, either faults, or folds of varying shape and character, both secondary as to the general uplift of the range. It is highly probable that these structural peculiarities are attributable to the general forces of elevation that are acknowledged to have been in action through the several geological periods here represented.

3d. The unequal distribution of, or resistance to, the general force of elevation.—Still further, it may unhesitatingly be granted that the general force of elevation or the resistance opposed to it has been more or less unevenly distributed from point to point, and has acted, not always at an absolutely right angle to the axis of the range, but diagonally to it, in one or more directions at the same time. Its direction has in fact varied according to circumstances.

4th. The development of the post-Niobrara fold.—In the present area the distribution and directions of this force up to immediate post-Niobrara time had been such as to eventually bring into existence the fold of the general character represented in the profiles, and in figure 1 beyond.

An analysis of this distribution and its effects shows that, of the various components of this force, the major, which exceeded all the others combined, was that acting in the general elevation of the range and directly against its axis—that is, for the eastern base, with the arrows A (Fig. 1) westward. This had undoubtedly been in action with probably but little interruption from earliest time. The other com-

ponents, secondary to that just noted, and acting in directions more or less normal to it, B (Fig. 1), were evidently periodical in character. They reasserted themselves with

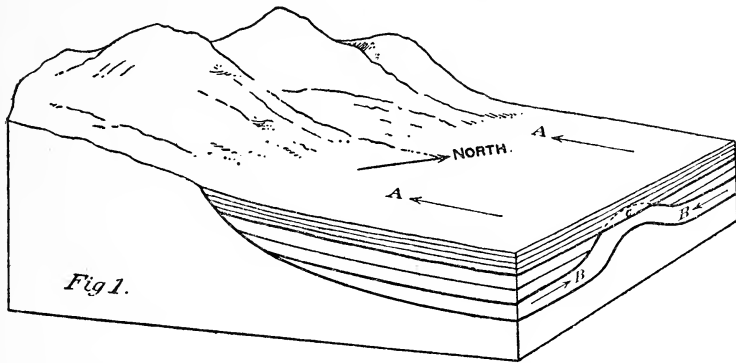

The profiles I-IV, inclusive, may be regarded as transverse (north and south) sections of this secondary fold in the several stages of its development according to the geological time represented by each. Figure 1 is more particularly a diagrammatic representation of the condition of affairs at the close of the Laramie or at a point in time somewhere between this and a stage early in the deposition of the Denver formation.

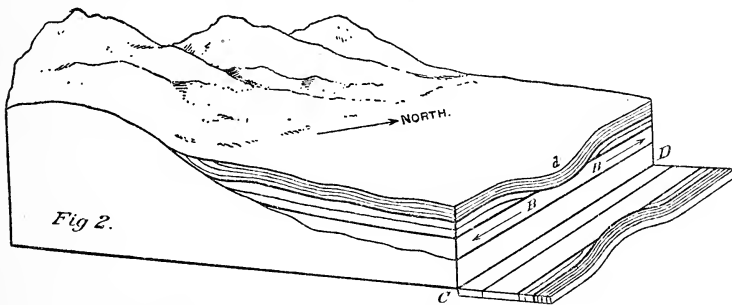

By the post-Laramie movement the strata were bent up against the range nearly at right angles and afterwards truncated by erosion. This effect is produced in the figure by supposing a slice of the block represented, to have been turned down through an angle of 90° , as if hinged along the line C D. The hinged portion is thus a diagrammatic representation of the superficial outlines, as shown in detail by the map.

special intensity at the close of the Niobrara, effecting almost entirely at this time the pronounced elevation under discussion, *c* (Fig. 1), the cross-section of which is that in profile IV. The Montana, Laramie, Arapahoe, and early Denver

beds were then deposited upon this fold, closing the first four periods of history discussed above.

5th. The readjustment of forces by which the structure of post-Niobrara and Laramie times was changed to that of the present day.—At the close of the events detailed in the last paragraph there began a readjustment of the major forces acting against the range, by which the fold of pre-Montana age and its cap of horizontal strata gradually gave way to the structure of later times. The results of this readjustment may have been developed prior to the time of the inclusion of the affected area within the general uplift of the range, but were more probably synchronous with it.

The complex movement which brought about these results may properly be resolved into two chief components. The first of these includes the movement by which the strata composing the pre-Montana fold were brought from their position, as represented in profile IV, to that which they hold in the natural section given by the outlines on the map. The effect of this movement can be seen in diagrammatic representation, shorn of all complicated details, by comparing figure 1, which shows the conditions previous to the movement, with figure 2, which shows those subsequent to it. In this movement the strata resting horizontally upon the pre-Montana fold of necessity followed the recession of the beds beneath, assuming the position of the synclinal depression *d* in Fig. 2, or the highly curved position—the result of the synclinal position—which they hold in the section on the map. The second component is the movement specially involved in the elevation of the range, by which the strata were brought into the highly inclined position they hold along its base at the present time.

6th. Readjustment of the forces accounted for.—The readjustment of the forces effecting such important structural changes can be accounted for by relief from the compression to which the strata had been subjected, brought about beyond the immediate region here considered. The exciting cause may have been elevations in other areas, or even an increase in the force of the general lateral thrust to the north

and south of the field, accompanied by a variation from its normal western direction to directions diagonal to the range and divergent as this is approached, by which the original north and south compressive forces would have been compensated by the components of the later one acting in the reverse direction respectively (B, Fig. 2). Equilibrium having been restored over the area in question, and a portion of the affected region having become involved in the general uplift of the range, which still continued, by subsequent erosion and the formation of the plane surface of the present day the underlying strata became exposed in the superficial section now existing.

7th. Relation of the basalt eruption to the above events.—The eruption of the Table Mountain basalt took place early in the period of the Denver formation, approximately after the deposition of about one-third of the series had been completed and some time before the strata had assumed the extremely high angles they now have. With regard to its relations to the phenomena forming the subject of this paper, it is possible that the subsidence of the Niobrara fold and the horizontal beds capping it may have been, in its later stages, synchronous with the eruption of the basalt masses in Denver times and perhaps in a measure due to it. The fissures through which the pent-up lavas found relief may have been the result of the almost constant bending to which the rocks were subjected, and their appearance may have thus constituted the final event in the history of a place remarkable for its dynamic movements.

THE VIEWS OF OTHERS ON THE STRUCTURE OF THIS REGION.

Before closing this paper it is desirable to notice the views of the late Mr. Marvine and Professor Ward in regard to the structure of this region.

The views of Marvine.—These are given in Vol. VII (1873) of the Hayden Reports, where he has expressed in the briefest possible manner the idea of non-appearance of strata due to

an actual "thinning of the original deposits * * * from conditions naturally attending the laying down of new formations upon the newly prepared and hence uneven surfaces of older rocks." He also mentions, as an alternative, the possibility of a fault accounting for the structural peculiarities, but remarks the limited knowledge of the locality which he then possessed. The unpublished results of his work during the season of 1874 unfortunately cannot be traced, and therefore his final views must remain unknown; but the brief statement given above leads one to believe that he would in the end have reached a solution not far different from the one presented in the foregoing pages.

The views of Ward.—These are to be found in the Sixth Annual Report of the present Geological Survey of the United States, pp. 537-'8, where, referring to the strata in the vicinity of Golden, between Table Mountain and the Cretaceous [Montana group]—which embraces the Denver, Arapahoe, and Laramie formations, but which are all included by him in the Laramie, irrespective of stratigraphical evidence—he remarks as follows: "The strata are conformable, and both the Cretaceous and the Laramie are tilted so as to be approximately vertical. At the base of South Table Mountain the strata are horizontal, and the line dividing the vertical from the horizontal strata could be detected at certain points. A measurement from this line to the base of the coal seam was made at one place and showed 1,700 feet of upturned edges of Laramie strata. It is probable that we here have the very base of the formation.

"The geology of Golden is very complicated, but my observations led me to conclude that during the upheaval of the Front Range a break must have occurred along a line near the western base of Table Mountain, forming a crevice through which issued the matter that forms the basaltic cap of these hills. The eastern edge of a broad strip of land lying to the west of this break dropped down until the entire strip of land assumed a vertical position or was tilted somewhat beyond the perpendicular. This brought the Laramie

on the east side of the Cretaceous, with its upper strata at the extreme eastern, while the coal seam at its base occupied the extreme western side of the displaced rock. The degree of inversion varies slightly at different points, and may have been much greater in some places. This will probably account for the discovery at one time of a certain Cretaceous shell (*Mactra*) *above* a vein of coal in a shaft about four miles north of Golden, and about which considerable has been said in discussing the age of the Laramie group. I visited the spot, but found the strata so covered by wash that I was unable to determine their nature."

In the above views there are four points demanding replies, although one—that regarding a certain Cretaceous shell—is somewhat irrelevant. The first point is the remark as to the conformability of all the strata from the Denver beds to the Montana group. Although no discrepancy in dip or strike is noticed between them in the vicinity of the Table Mountains, a study of the whole region has abundantly proved the existence of several non-conformities, by evidences of erosion, by the areal distribution of the outcrops, and by the character of the component materials of the various formations. The second point is the crevice near the western base of Table Mountain through which issued the basalt of the region. As a matter of fact, no evidence of such a crevice, nor of the dike which would still remain as its filling, exists along the well-exposed base of the hills. Furthermore, the outpouring of the basaltic sheets is entirely accounted for by the great Ralston dike and the irregular eruptive body near its southern end, and hence there is no necessity for assuming a further fracturing of the strata to give it a vent at some other point in the field. The third point, the fault, into which Professor Ward has developed the break, beyond a doubt coincides in locality with the great fold which occurs all along the eastern base of the Colorado Range, by which the beds to the west of it are sharply upturned, often to a vertical or reversed dip, while their continuance to the east of the axis is at a dip of but the slightest amount. This

curve may at times be complete within a distance of fifty feet. A fault is, therefore, unnecessary to explain the abrupt change from the vertical to the horizontal position. Moreover, observations show that the Denver and Arapahoe beds actually take part in this fold at a point directly opposite South Table Mountain. The complicated geology of the region would very naturally lead one to mistaken conclusions unless a thorough knowledge was possessed not only of the area of disturbance here considered, but also of the general structure of the region far beyond. The fourth point in the quoted remarks of Professor Ward relates to the manner in which he accounts for the fossil *Mactra* found, according to prior statements, "over" the coal. As a matter of fact, the fossil does not occur over the coal, but beneath it, in its usual position in the Fort Pierre bed, its apparent position being due to lying within a locally faulted area, the beds of which have been thrown to the eastward of the general trend of the coal in the unaffected area to the south and north.

The views of Others.—In addition to the views of the above gentlemen, others have from time to time been expressed, implying belief in a fault in the vicinity of Golden to account for the peculiarities of structure there displayed. In reply to this it need only be stated that no fault can be conceived which will at once account for the several features in the geology of this region as exposed over the present surface of the area and set forth in the preceding pages of this article.

N. 18 W.



— 1 MILE —

VERTICAL AND HORIZONTAL SCALE THE SAME.

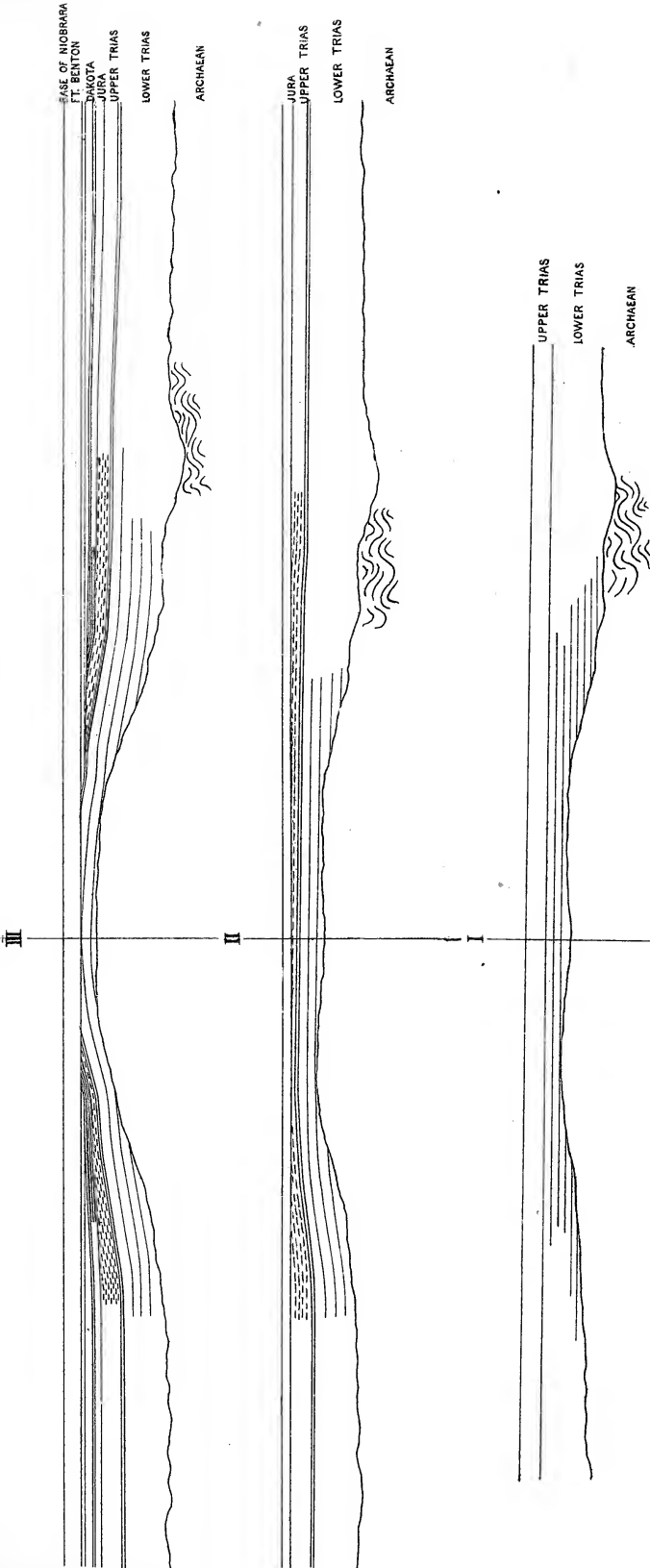

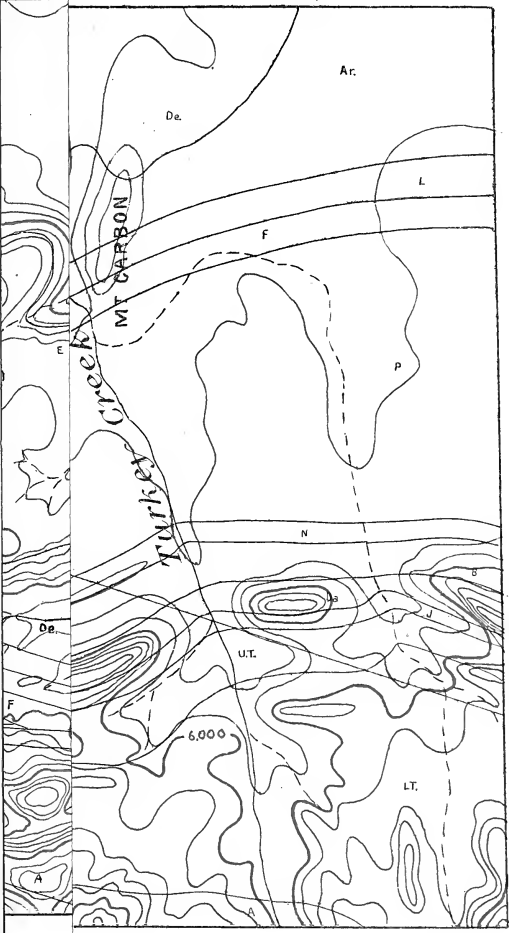

Archaean

E. = Eruptive

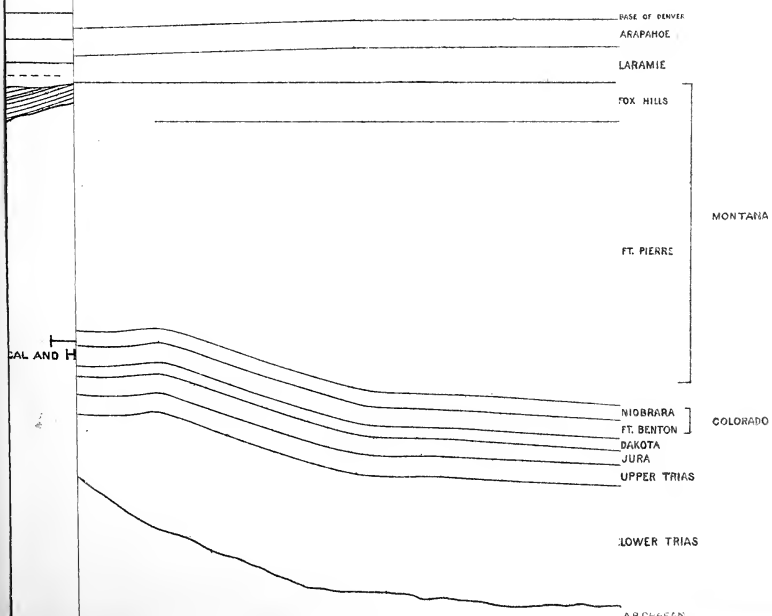

THE PROGRESS OF METEORIC ASTRONOMY IN AMERICA.

BY

JOHN ROBIE EASTMAN.

[Read before the Society April 12, 1890.]

TABLE OF CONTENTS.

	Page.
Introduction.....	276
Abstracts of Theories.....	278
Authors:	
Rev. Thomas Clap.....	278
Dr. W. G. Reynolds.....	278
Prof. Edward Hitchcock.....	279
Prof. D. Olmstead.....	279
E. C. Herrick.....	281
Prof. Benjamin Peirce.....	281
Prof. S. C. Walker.....	281
Prof. Peter A. Browne.....	282
Prof. J. Lawrence Smith.....	283
Dr. B. A. Gould.....	283
Prof. H. A. Newton.....	285
Prof. A. C. Twining.....	285
Prof. H. A. Newton.....	285
Prof. A. C. Twining.....	286
B. V. Marsh.....	286
Prof. H. A. Newton.....	287
Prof. Daniel Kirkwood.....	290
Prof. H. A. Newton.....	290
Prof. S. Newcomb.....	291
Prof. W. Harkness.....	291
Prof. Daniel Kirkwood.....	291
Jacob Ennis.....	291
Prof. Pliny Earle Chase.....	292
Prof. H. A. Newton.....	292
Prof. J. W. Mallet.....	292

	Page.
Authors :	
Prof. A. W. Wright	292
Prof. H. A. Newton	292
Prof. H. A. Newton	297
Examination of Theories	298
Meteors	298
Comets	300
Comets and Meteors	302
Lockyer's Theories	305
Huggins on the Spectra of the Aurora and of Nebulæ	310
Liveing and Dewar on the Spectra of Nebulæ and of Magnesium	310
Conclusions	311
Observations of Meteors	312
Catalogues	313
I. Observed Meteorites	316
II. Discovered Meteorites, date of discovery given	318
III. Discovery of Meteorites, date of discovery unknown	322
IV. Meteor Showers	324
V. Sporadic Meteors	336

INTRODUCTION.

The progress of Meteoric Astronomy through its successive stages of development has been so peculiar in America, especially in the United States, that, unlike almost all the other branches of Astronomy and Physics, its advance may be thoroughly discussed with very little reference to the important growth which it has made in Europe.

From the nature of the phenomena it is evident that the apparition and fall of meteors must have compelled the attention of mankind through all ages, but the earliest records are at least obscure. While there may be some claim to authenticity in the early allusions to what was apparently meteoric phenomena, there seem to be no trustworthy observations until about 600 B. C.

From that time the falls of a great number of meteors and meteorites were recorded with more or less accuracy and detail, but no special attention was attracted to the observation and study of such phenomena until the publication of a paper in 1794, by Chladni, on a mass of meteoric iron

found in Siberia by Dr. Pallas, a well-known naturalist. About this time several noted meteorites fell in Europe, and in 1802 Edward Howard published in the Philosophical Transactions a paper entitled "Experiments and observations on certain stony substances which at different times are said to have fallen on the earth." This paper contains, probably, the account of the first chemical analysis of a meteorite ever made.

Nearly all the publications referring to meteors, both in Europe and America, up to the year 1833 were confined to vague theories and brief speculations with regard to their origin.

The very important meteoric shower on the morning of April 20, 1803, was the first well-defined phenomenon of that class in this country of which there seems to be any record. There is no evidence that it was well observed except at Portsmouth, N. H., and at Richmond, Va., and no recurrence of this shower of any notable magnitude has since been observed. Graphic accounts of this phenomenon were printed in "The New Hampshire Gazette," of Portsmouth, N. H., May 31, 1803, and in "The Virginia Gazette and General Advertiser," of Richmond, Va., May 23, 1803, but apparently no scientific interest or discussion was developed.

The wonderful display of meteors on the morning of November 14, 1833, which was seen throughout the Atlantic coast of the United States, gave a decided impulse to the study of the subject and suddenly brought the principal American observers into prominence.

The serious study of meteoric phenomena in America may be said to date from this epoch.

The earliest studies immediately developed theories, more or less fantastic, to account for the varied but startling display in the heavens.

The first theories, derived from only a few facts, naturally presented the greatest range of speculation.

As phenomena multiplied, the limits of speculation were

notably contracted, and in 1834 the germ of the true theory of meteoric motion was presented, but not developed.

The most accurate idea of the progress of the science of Meteoric Astronomy can be obtained, without doubt, from an examination of the principal theories.

ABSTRACTS OF THEORIES.

The following abstracts of these theories are presented in chronological order, and in each case the language of the author is employed if practicable.

Probably the first paper printed in this country which advances any theory of the nature or the motion of meteors was written by *Rev. Thomas Clap*, ex-president of Yale College, and was printed in Norwich, Connecticut, in 1781. He concluded that "our observations have heretofore been so imperfect as that we cannot easily determine minute circumstances; but the general theory seems highly probable, if not certain, that these superior meteors are solid bodies, half a mile in diameter, revolving around the earth in long ellipses, their least distance being about twenty or thirty miles; that by their friction upon the atmosphere they make a constant rumbling noise and collect electrical fire, and when they come nearest the earth or a little after, being then overcharged, they make an explosion as loud as a large cannon."

In 1819 *W. G. Reynolds, M. D.*, of Middletown Point, N. J., published a paper¹ advocating the theory that "Meteors proceed from the earth. They arise from certain combinations of its elements with solar heat, and meteoric stones are the necessary results of the decomposition of these combinations."

After the shower of 1833 elaborate accounts of the event were written by several scientific observers, and various conclusions and theories were deduced.

Prof. Edward Hitchcock,² of Amherst College, Mass., con-

¹ A. J. S., I, 266.

² A. J. S., XXV, 354.

cluded that "there was a point from which most of the meteors seemed to emanate; that this radiant corresponded to that point in the dome of the heavens to which the magnetic needle would point if left free to move vertically and horizontally, and that meteors are only modifications of the Aurora Borealis."

Prof. D. Olmstead,¹ of Yale College, discussed at length the meteors of November 13, 1833, with the following conclusions:

"1st. The meteors originated beyond the limits of our atmosphere and fell towards the earth, in straight and nearly parallel lines, from a point 2,238 miles above the surface of the earth.

"2d. Their velocity on entering the earth's atmosphere was about four miles per second.

"3d. They consisted of light, transparent, combustible matter, and took fire and were consumed in traversing the atmosphere."

Prof. Olmstead finally concluded that "the meteors of November 13 consisted of portions of the extreme parts of a nebulous body which revolves around the sun in an orbit interior to that of the earth, but little inclined to the plane of the ecliptic, having its aphelion near to the earth's path and having a periodic time of 182 days, nearly."

After discussing the November meteors of 1836, Prof. Olmstead² concluded that "the zodiacal light might be the source of those meteors, and therefore was not a portion of the sun's atmosphere, but a nebulous or cometary body revolving around the sun within the earth's orbit nearly in the plane of the solar equator, approaching at times very near to the earth, and having a periodic time of either one year or half a year, nearly."

On the 28th of April, 1840, *Mr. E. C. Herrick*³ read before the Connecticut Academy of Arts and Sciences a paper on

¹ A. J. S., XXVI, 132.

² A. J. S., XXXI, 386.

³ A. J. S., XL, 349.

“The history of star-showers of former times,” in which he presented a brief account of all the records he had been able to find, together with the following tabular chronological account of star-showers, where the dates are reduced to Gregorian style :

Chronological List of Star-Showers.

Number.	Date.	Number.	Date.
1	B. C. 1768.	21	A. D. 1060.
2	B. C. 686.	22	“ 1090.
3	A. D. 7.	23	“ 1094.
4	“ 532.	24	“ 1095, April 10.
5	“ 558.	25	“ 1096, April 10 (?).
6	“ 585, September 6 (?).	26	“ 1106, February 19.
7	“ 611.	27	“ 1122, April 11.
8	“ 744 or 747.	28	“ 1199, October (?).
9	“ 750.	29	“ 1202, October 26.
10	“ 764 (?), March.	30	“ 1243, August 2.
11	“ 765, January 8.	31	“ 1366, October 30.
12	“ 829.	32	“ 1398.
13	“ 855, October 21.	33	“ 1399, October (?).
14	“ 899, November 18.	34	“ 1635 or 1636.
15	“ 901, November 30.	35	“ 1743, October 15.
16	“ 902, October 30.	36	“ 1799, November 12.
17	“ 912 or 913.	37	“ 1803, April 20.
18	“ 931 or 934, October 19.	38	“ 1832, November 13.
19	“ 935, October (?).	39	“ 1833, November 13.
20	“ 1029, July or August.		

Of the theory of meteors, Mr. Herrick wrote :

“The most probable hypothesis is that there are revolving around the sun millions of small planetary and nebulous bodies of various magnitudes and densities, and that when any of these dart through our atmosphere they become ignited and are seen as shooting-stars.”

In discussing a paper on meteors by Prof. Erman (Schumacher's *Ast. Nach.* No. 385) *Prof. Benjamin Peirce*,¹ after pointing out an error in Erman's work, concludes in these words : “The plane of the meteors cannot differ much from that of the ecliptic, and their relative velocity cannot exceed one-third of the earth's velocity. A ring so nearly in the plane of the earth's orbit must be subject to great perturbations ; and, if there is one, I think that no observations which we can make will enable us to calculate its motions with any degree of accuracy.”

On January 15, 1841, *Prof. S. C. Walker*² read a paper before the American Philosophical Society, “On the periodical meteors of August and November,” in which the following points were discussed :

The relative velocities of meteors ;

The relative directions of meteors in space ;

The periodical or anniversary display of meteors ;

The respective plausibilities of the hypotheses of a single cluster with a half-yearly or yearly period, or that of a continuous ring for the periodical meteors of August and November ;

The theories of aerolites and shooting-stars ;

The variation of the relative velocity and of the convergent point ;

And principally the investigation of formulæ for computing the elliptic elements of the orbit of a meteor from its observed relative velocity and direction.

In 1844 an “*Essay on Solid Meteors and Meteoric Stones*”

¹ *Trans. Am. Phil. Soc.*, VIII₂, 83.

² *Trans. Am. Phil. Soc.*, VIII₂, 87.

was published by *Prof. Peter A. Browne*, of La Fayette College.

The author devoted the first and larger portion of his paper to proving the solidity of meteors.

The latter portion of his essay was confined to the examination and rejection of all the theories previously advanced, which, briefly stated, were :

1st. Dr. Halley's theory that meteors were nothing but a stratum of inflammable vapor, gradually raised from the earth and accumulated in an elevated region, which suddenly took fire at one end and the progress of the flame along the stratum produced the apparent motion of the meteor.

2d. The theory in Luke Howard's Meteorology that hydrogen gas dissolves various bodies, even iron, and that is evolved, mixed with carbon in the gaseous state, from the earth in large quantities, is collected in vast fields in the air, is fired by electric explosions, and, the gasses burning out, they let fall the earthy and metallic contents precipitated and agglutinated as we find them in aerolites.

3d. Prof. Soldani's theory that meteoric stones are generated in the air by a combination of mineral substances which had risen as exhalations from the earth.

4th. Dr. Reynolds' theory, previously given in this paper.

5th. Dr. Blagden's theory that meteors are electrical phenomena.

6th. The theory of Patrick Murray that meteors originate in the local atmosphere of the earth, and their explosions are due to electrical action.

7th. The theories of Brewster and La Grange that meteors are bodies thrown off from the earth by volcanic action.

8th. The theories of Hutton and La Place that meteors are thrown from volcanoes in the moon.

9th. Newton's theory that they proceed from the tail of a comet.

10th. They are terrestrial comets—a theory maintained by Professors Clap and Day and by Carvalho.

11th. The theory that they were solids that have been floating in space from the beginning; advocated by Chladni, Franklin, and Rittenhouse.

12th. The theory of Olbers that they are fragments of an exploded planet.

13th. The theory of Quetelet that they belong to a zone through which the earth passes annually.

14th. The theory of Boubée that they are fragments of an exploded comet.

These theories are all rejected as disproved or absurd; but the author advances no theory as a substitute. He announces, however, that, to his mind, "the most probable supposition yet made is that the solid meteors may possibly emanate from the sun," though no serious attempt is made to prove the proposition.

In a paper read by *Prof. J. Lawrence Smith* before the American Association for the Advancement of Science, in April, 1854, the author¹ advocated the theory of the lunar origin of meteors, which he stated as follows: "The moon is the only large body in space, of which we have any knowledge, possessing the requisite conditions demanded by the physical and chemical properties of meteorites; and they have been thrown off from that body by volcanic action (doubtless long since extinct), and, encountering no gaseous medium of resistance, reached such a distance as that the moon exercised no longer a preponderating attraction, the detached fragment possessing an orbital motion and an orbital velocity which it had in common with all parts of the moon, but now more or less modified by the projectile force and new condition of attraction in which it was placed in reference to the earth, acquired an independent orbit more or less elliptical. This orbit, necessarily subject to great disturbing influences, may sooner or later cross our atmosphere and be intercepted by the body of the globe."

In 1859² *Dr. B. A. Gould* read a paper before the Ameri-

¹ A. J. S., XIX₂, 343.

² Proc. A. A. A. S. 1859, 181.

can Association for the Advancement of Science to disprove the theory that meteors had their origin in lunar volcanoes.

Assuming that a lunar volcano may eject masses of matter with the requisite velocity to pass beyond the region where the lunar gravitation predominates over the terrestrial and the masses become obedient to the earth's attraction, Dr. Gould examines in detail the consequences to which the theory of the lunar origin of meteorites would necessarily lead, and presents his conclusions as follows:

"From the foregoing considerations we are warranted in assuming that for every body expelled from lunar volcanoes with a force adapted for throwing to the earth an aerolite of average dimensions there are, in probability, at the very least one hundred and eighty bodies expelled with forces not thus adapted; that for every mass ejected with the average force of a lunar volcano and striking the earth, there are at least one hundred and eighty masses of inadequate dimensions ejected; and that for any given combination of volcanic force and projected mass, the region of the lunar surface, whence the mass may reach the earth, is exceeded in extent by the tract of the lunar surface whence this would be impossible, in the ratio of fifty to one. Combining these several individual probabilities, it will readily be perceived that not more than

$$\frac{1}{50} \times \frac{1}{180} \times \frac{1}{180} = \frac{1}{1620000}$$

of all the ejected lava masses, or about 3 in 5,000,000 of each possible size, would probably ever reach the earth as aerolites; nor is this an unsafe estimate. It is a very guarded one, and the fraction $\frac{1}{2000000}$ would be more likely to be correct. Now, can we regard it as probable that the moon has parted with so large an amount of matter as nearly, if not quite, two million times the combined mass of all the aerolites which have fallen to the earth? I think not. Even of those known to have fallen there are more than five hundred of various weights, one of them having a mass of thirty thousand pounds. The tokens of such a mass of gravitative matter as this would imply could not fail to be

legibly inscribed in the unerring and enduring records of our system. They would preclude the accordance which is found to exist between the present lunar theory and the ancient observations. They would be found to be inconsistent with the known values of precession and nutation. They might, indeed, almost be said to be incompatible with the present mass of the moon."

From the observations of the meteor of November 15, 1859, *Prof. H. A. Newton*¹, of Yale College, concluded that it must have moved in a hyperbolic orbit, and that we have, therefore, two sources of meteors—the solar system and stellar space.

With regard to the periodic meteors of August, *Mr. A. C. Twining*², of New Haven, concluded that "the radiant is probably capable of a far more exact determination than is ordinarily supposed or than could have been anticipated, and it is apparently subject to a motion of several degrees from day to day, and a motion which exhibits some remarkable points of agreement in the comparison of one year's positions with those of other years."

From a discussion of the peculiar characteristics of the August meteors *Prof. H. A. Newton*³ came to the following conclusions:

- 1st. The individual meteors are cosmical bodies.
- 2d. They are permanent members of the solar system, revolving about the sun in elliptic orbits.
- 3d. The direction and velocity of the relative motion, and therefore of the absolute motion of the individual bodies, are nearly the same.
- 4th. The whole group forms what may be considered a ring or disk around the sun.
- 5th. The periodic time is two hundred and eighty-one days.

¹ A. J. S., XXX₂, 186.

² A. J. S., XXXII₂, 444.

³ A. J. S., XXXII₂, 448.

In the same paper Professor Newton estimates the whole number of meteors in the August ring as 300,000,000,000.

In March, 1862, *A. C. Twining*¹, published a paper entitled "Investigations respecting the phenomena of meteoric rings as affected by the earth," and arrived at the following conclusions: "The position of the node of the ring cannot be shifted by the earth's action more than a degree or two in half a million of years; there is an appreciable change of radiant positions, relative to locality on the earth's surface and to the hour of the day, whose maximum is about $3\frac{3}{4}^{\circ}$ between the extremes and to which the extremes approach; the terrestrial disturbance is sufficient to affect the perihelion distance of the meteors by many millions of miles and to expand the ring to a corresponding breadth at the ascending node; also to collect together in orbits, of similar elements, those meteors which are similarly affected in respect of radiant positions; and terrestrial disturbances do not appear sufficient to draw off meteors into permanently erratic orbits; so that, unless in exceptional instances, meteors are not lost to the ring other than those which the atmosphere absorbs or arrests. If meteors are partially arrested without being dissipated in an excessively tenuous upper medium it may be possible that the ordinary and unconformable meteors are such as have missed a return to the ring under the effect of atmospheric retardation."

Mr. Twining appends the suggestion that, "perhaps comets whose vastly extended atmospheres or heads around the nucleus, although greatly attenuated are perhaps competent to arrest meteors completely, may be found in rare instances to have been disturbed by *impact* with a meteoric ring whose mere attractive influence it would not be possible to detect."

In 1863, *Mr. B. V. Marsh*,² of Philadelphia, published a paper on "The luminosity of meteors as affected by latent heat," in which he arrived at the following results: "The upper regions of the atmosphere, even to its utmost limit,

¹ A. J. S., XXXIII, 244.

² A. J. S., XXXVI, 92.

are grand reservoirs of latent heat most admirably adapted to the protection of the earth from collision with bodies approaching it with planetary velocity from without. The intruder is instantly surrounded with a fiery envelope heated to the greatest conceivable intensity; its surface is burned off or dissipated into vapor; the sudden expansion of the stratum immediately beneath the burning surface tears the body into fragments, each of which, retaining its planetary velocity, is instantly surrounded by a similar envelope, which produces like effects, and so on until, in most cases, the whole is burned up or vaporized." A second paper on the same subject, and of similar import, was published by Mr. Marsh in the Proceedings of the American Philosophical Society, vol. XIV, 114.

From an examination of the list of November meteor showers from A. D. 902 to A. D. 1833 *Prof. H. A. Newton*¹ concluded that "the star-shower has a motion along the siderical year of one day in seventy years, and also that the shower has a period of about a third of a century. This precession seems to imply that the orbit of the body furnishing these meteors has only a small inclination to the ecliptic, and that the motion is retrograde. The small distance of the radiant from the point to which the earth is moving, viz., 7°, confirms this conclusion."

In an article on the peculiarities of the November meteors, *Prof. H. A. Newton*² arrived at the following conclusions: "The length of the annual period as determined from the showers in A. D. 902 and 1833, reckoning 233 leap years, 19 odd days, and adding six hours for difference of longitude, is $365 + \left(\frac{233 + 19.25}{931}\right)$, or 365.271 days. The length of the cycle is 33.25 years.

"The length of the part of a cycle during which showers may be expected may be five or six years or, for extraordinary displays, at least 2.25 years. The supposition of a ring of uniform density throughout its circuit seems improbable.

¹ A. J. S., XXXVI₂, 300.

² A. J. S., XXXVIII₂, 53.

“The elements of the mean of the orbits of the different groups composing the partial ring are:

$$\text{Semi-major axis} = 0.98049,$$

$$\text{Inclination} = 17^\circ,$$

and the ring is nearly circular.

“The velocity with which these bodies enter the earth’s atmosphere is about 20.17 English miles per second.”

The most elaborate American paper on meteors up to the date of its publication was prepared in 1865 by *Prof. H. A. Newton*,¹ who discussed the subject under the following divisions, the conclusions being briefly stated in each case:

“1st. The average altitude of the middle points of the luminous portions of the meteor paths is found to be 59.4 English miles.

“2d. The relative frequency of meteors when the heavens were divided into eight equal parts was about equal in all—perhaps a slight preponderance in the southeast—and the relative frequency in different parts of the visible heavens may be considered a function of the zenith distance only.

“3d. Not quite *one* in fifty of all the meteors seen at any one place should have the middle points of their apparent paths within 10° of the zenith.

“4th. The number of visible meteors that come into the atmosphere every day would be 10,460 times the number visible at one station; or the average number that traverse the atmosphere daily, that are large enough to be seen with the naked eye, if the sun, moon, and clouds would permit, would be $30 \times 24 \times 10,460 = 7,531,000$.

“5th. The number of meteoroids in the space which the earth traverses is discussed at length and formulæ are derived for computing the whole number when the average number is known for a given unit of time.

“6th. The average length of the apparent paths derived from 213 European and 803 American observations is $12^\circ.6$.

“7th. Adopting the theory that for every meteor visible to

¹ Mem. Nat. Acad. Sciences I, 291.

the naked eye there are 52.7 that are visible through a comet-seeker, the whole number of meteoroids coming daily into the air is 400,000,000.

“8th. The mean distance of the meteors from the observer is less than 144 miles.

“9th. The mean foreshortening of the meteor paths by perspective is from 16°.0 to 12°.6.

“10th. The average length of the visible part of meteor paths is between 24 and 40 or 21 and 34 miles; probably nearer 21 and 34 miles.

“11th. The mean duration of flight is not much, if any, greater than half a second of time.”

*Prof. H. A. Newton*¹ discussed the observations of the altitudes of *seventy-eight* meteors observed on November 13–14, 1863, at Washington, Haverford College, Germantown, Philadelphia, and other points, giving diagrams exhibiting the altitudes of these meteors, and also of *thirty-nine* meteors observed in August, 1863, with the following results:

	November meteors.	August me- teors.
Mean altitude at appearance . .	96.2 miles.	69.9 miles.
Mean altitude at disappearance .	60.8 “	56.0 “
Mean altitude of middle point of path	78.5 “	62.9 “

In a paper on “The Theory of Meteors” *Prof. Daniel Kirkwood*² arrived at the following conclusions:

“The zodiacal light is probably a dense meteoric ring, or rather, perhaps, a number of rings.

“Variable and temporary stars are caused by the interposition of meteoric rings.

“Mercury’s mean motion is probably diminished by the action of meteoric matter.

“The transit of a meteoric stream or cloud affords the most probable explanation of the phenomenon known as ‘dark days.’

¹ A. J. S., XL₂, 250.

² Proc. A. A. A. S. 1866, 8.

“It seems probable that a ring of meteor asteroids exists within the orbit of Titan, Saturn’s largest satellite, and causes the annual motion of the apsides of Titan, found by Bessel to be 30’ 28”.

“Saturn’s rings are probably composed of an indefinite number of extremely minute asteroids or meteorites.

“The gaps in the distribution of the mean distances of the asteroids between Mars and Jupiter are analogous to the gaps in Saturn’s rings.”

In May, 1867, *Prof. Daniel Kirkwood* published a book¹ under the title “*Meteoric Astronomy*,” designed by the author to present in a popular form the principal results of observation and study in that branch of Astronomy. It was devoted chiefly to the collection of some of the principal theories and the more important observations, and to presenting them in a brief but popular form without attempting to set forth any new theory.

A paper by *Prof. H. A. Newton*² in 1867, “On certain recent foreign contributions to Astro-meteorology,” was devoted to the discussion of a table comparing the epochs and positions of radiant points of shooting-stars concluded independently by R. P. Greg and Dr. E. Heis; the influence of the August and November meteors on the temperature of the atmosphere; the paths and probable origin of the shooting-stars, by Schiaparelli, and the age of the November group of shooting-stars.

From the data obtained from the observations of the November meteors in 1867 *Prof. H. A. Newton*³ discussed the geographical limits of the shower; the personal equation of observers; the form of the curve of intensity; the breadth of the radiant in latitude; the length of the radiant in longitude, and the distribution in longitude of the perihelia of the orbits of the meteors.

¹ J. B. Lippincott & Co., Phila., 1867, 129 pp.

² A. J. S., XLIII₂, 285.

³ A. J. S., XLV₂, 89.

From data obtained from the observations of the November meteors of 1867 at the U. S. Naval Observatory and at Richmond, Va., *Prof. S. Newcomb*¹, U. S. N., computed the altitude of *nine* meteors, finding the mean altitude at apparition to be 102 miles, and at disappearance 47 miles. From data obtained from observations on the same occasion, *Prof. W. Harkness*², U. S. N., discussed a method of determining the mass of such meteors as are consumed before reaching the earth.

Assuming that the light produced is always proportional to the amount of material consumed, he arrived at the conclusion that "the mass of the ordinary shooting-stars does not differ greatly from one grain."

In 1869 a paper by *Prof. Daniel Kirkwood*³ on "Comets and Meteors" was devoted to exhibiting the probable coincidences between the orbits of comets and periodical meteors.

In 1871 *Mr. Jacob Ennis*⁴ published a paper entitled "The meteors and their long-enduring trails."

The scope and method of this paper are briefly sketched by the author, and are best presented in his own words, as follows:

"Firstly, I will bring forward many facts to prove that some meteors undergo a process of burning or oxidation while passing through the air, and that the trails are the smoke and ashes of such burning.

"Secondly, I will give facts and reasoning which show that some meteors are composed of various simple chemical elements unoxidized, and which are therefore capable of burning in the air.

"Thirdly, I will show the order and process of creation by which such meteors were originally formed and left in an unoxidized condition."

These points are discussed at length, and numerous theories and observations are cited as proof.

¹ A. J. S., XLV₂, 233.

² A. J. S., XLV₂, 237.

³ Proc. Am. Phil. Soc., XI, 215.

⁴ Proc. A. A. A. S. 1871, 122.

In a paper on the "Influence of meteoric showers on auroras" *Prof. Pliny E. Chase*¹ concludes that "there seems therefore good reason to look for an increase of auroral displays soon after every meteoric shower."

In discussing the meteors of November 27, 1872, *Prof. H. A. Newton*² remarked, "With Professor Weis and others, I am inclined to consider them all to have been once connected with periodic comets. The scattering took place apparently at or near the perihelion."

In 1872 *Prof. J. W. Mallet*, of the University of Virginia, read a paper³ on "The occluded gases of meteorites," and another paper⁴ by this author on the same subject appeared in 1875.

In 1875 *Prof. A. W. Wright*, of Yale College, published an account⁵ of some very carefully conducted experiments made to determine the character and quantity of the occluded gases of meteorites.

From these experiments he derived results differing materially from those obtained by other investigators.

This paper was followed by three others⁶ during 1875 and 1876, in which *Professor Wright* reached the conclusion that the spectra of gases from meteorites were identical with the spectra of comets.

In a lecture⁷ at the Sheffield Scientific School of Yale College, on "The relation of Meteorites and Comets," *Prof. H. A. Newton*, exhibiting a fragment from the meteoric stone which fell in Iowa February 12, 1875, very clearly presented his theory of the connection of these bodies.

The principal points in the theory, together with some of the arguments, may be briefly stated as follows:

Between the largest meteorite known and the faintest shooting-star that can be seen on a clear night with a telescope

¹ Proc. Am. Phil. Soc. XII, 401.

² A. J. S., V₃, 62.

³ Proc. Royal Society, XX, 365.

⁴ A. J. S., X₃, 206.

⁵ A. J. S., IX₃, 294.

⁶ A. J. S., X₃, 44; XI₃, 253; XII₃, 165.

⁷ Nature, Vol. XIX, 315, 340.

there is no essential difference as to astronomical character. In all their characteristic phenomena there is a regular gradation of meteors from one end of the line to the other. They differ in bigness, but in their astronomical relations we cannot divide them into groups. They are all similar members of the solar system. In proof of these statements we cite some of the points in which the large and small meteors are alike and unlike:

1st. They are all solid bodies. It is doubtful whether a small gaseous mass could exist permanently as a separate body in the solar system. A liquid would probably freeze and become solid. In any case, neither a gas nor a liquid could for an instant sustain the resisting pressure which a meteor is subjected to in the air, much less could it travel against it with the velocity observed in ordinary meteor flights. In short, every shooting-star must be a solid body.

2d. The large meteors and the small ones are seen at about the same height from the earth's surface. The air is a shield to protect the earth from an otherwise intolerable bombardment by these meteors. Some of the larger masses penetrate this shield, or, at least, are not melted before their final explosion, when the fragments, their velocity all gone, fall quietly to the ground. The small ones burn up altogether or are scattered into dust.

3d. The velocities of the large and the small meteors agree, and, though they are never measured directly very exactly, we are sure that in general they are more than two and less than forty miles per second. Velocities of from ten to forty miles per second imply that these masses are bodies that move about the sun as a center or else move through space. These velocities, as well as other facts, are utterly inconsistent with a permanent motion of such bodies about the earth or with a terrestrial or a lunar origin.

4th. The motions of the large and small meteors as they cross the sky have no special relations to the ecliptic. If either kind had special relations to the planets, in their origin or in their motions, we should have reason to expect them,

if not always, at least in general, to move across the sky *away from* the ecliptic. The fact is otherwise. Both large and small meteors are seen moving *towards* the ecliptic as often as *from* it. Neither class seem, therefore, to have any relation to the planets.

Again, in general character the two classes are alike. They have like varieties of color; they have similar luminous trains behind them. In short, we cannot draw any line dividing the stone or iron producing meteor from the shooting-star, at least in their astronomical relations. They are all astronomically alike. They differ in size; but that has nothing to do with their motion about the sun or in space.

The general connection between comets and meteors may be exhibited in the peculiar relations existing between the meteors of November 13-14 and their accompanying comet. The orbit of these meteors is one that is described in 33.25 years. The meteors go out a little further than the planet Uranus, or about twenty times as far as the earth is from the sun. While they all describe nearly the same orbit they are not collected in one compact group. On the contrary, they take four or five years to pass a given place in the orbit, and are to be thought of as a train several hundred millions of miles long but only a few thousands of miles in thickness.

Along with this train of meteors travels a comet. It passed the place where we meet the meteor stream nearly a year before the great shower of 1866 and two or three years before the quite considerable displays of 1867 and 1868. How came it that this comet and the meteors travel the same road? The plane of the comet's orbit might have cut the earth's orbit to correspond with any other day of the year than November 15; or, cutting it at this place, the comet might have gone nearer to the sun or farther away; or, satisfying these two conditions, it might have made any angle from 0° to 180° instead of 167° ; or, satisfying all these, it might have had any other periodic time than 33.25 years; even then it might have gone off in any other direction of the plane than that in which the meteoroids were

traveling. All these things did not happen by chance; there is something common.

The comet alluded to is not the only one that has an orbit common with meteors, though it is the only case in which the orbit of the meteors is *completely* known, aside from our knowledge of that of the comet. Every August, about the tenth day, we have an unusual number of meteors—a star-sprinkle as it has been called. A comet whose period is about 125 years moves in the plane and probably in a like orbit with these meteors. Near the first of December there have been several star-showers, notably one in 1872, and these meteors are traveling nearly in the orbit of Biela's comet. In April, too, some showers have occurred which are thought to have had something to do with a known comet. Thus much as to the meteors of the star-showers. The sporadic meteors are with good reason presumed to be (and observed facts *prove* some of them to be) the outliers of a large number of meteor streams.

Considering again the November meteor stream and its comet we find that the several bodies move along a common path not at all by reason of a present physical connection. They are too far apart—in general, a thousand times too far apart—to act on each other so much that we may measure the effect. Their connection has been in the past. They must have had some common history. Looking now at the comets, we see that they have been apparently growing smaller at successive returns. Halley's comet was much brighter in its earlier than in its later approaches to the sun. Biela's comet has divided into two or more principal parts, and seems to have entirely gone to pieces. Several comets have had double or multiple nuclei. In the year 1366, in the week after the star-shower, a comet crossed the sky exactly in the track of the meteors. A second comet followed in the same path a week after. Both belonged, no doubt, to the November stream, and one of them may perhaps have been the comet of 1866.

The November meteor stream is a long, thin one. We

have crossed the stream at many places along a length of a thousand millions of miles, sometimes in advance of and sometimes behind the comet, and all along this length have been found fragments—sometimes few, sometimes many. This form of the stream suggests continuous action producing it. A brief, violent action *might* have given this form, but a slowly acting cause seems more natural.

Again, in the history of Biela's comet we have distinct evidence of continued action. The comet divided into two parts not long before 1845, and yet in 1798 fragments of it were met with so far from the comet that they must have left the comet long before, probably many centuries ago.

“Thus we are led to say, *first*, that the periodic meteors of November, of August, of April, &c., are caused by solid fragments of certain known or unknown comets coming into our air; *secondly*, that the sporadic meteors, such as we can see any clear night, are the like fragments of other comets; *thirdly*, that the large fire-balls are only larger fragments of the same kind; and, *finally*, that a portion broken off from one of those large fragments in coming through the air must once have been *a part of a comet*.”

“How came the comet to break up? Perhaps the prior question would be, How came the comet together? In its history there is much that cannot yet be explained, much about which we can only speculate.”

“Thus, how came this meteoric stone to have its curious interior structure? As a mineral it resembles more the deepest fire-rocks than it does the outer crust of the earth. It seems to have been formed in some large mass, possibly in one larger than any of our existing comets. Some facts show that the comets have almost surely come to us from the stellar spaces. Out somewhere in the cold of space a condensing mass furnished heat for the making of this stone. The surrounding atmosphere was unlike ours, since some of these minerals could hardly have been made in the presence of the oxygen of our air. Either in cooling or by some catastrophe the rocky mass may have been broken to pieces,

so as to enter the solar system having little or no cohesion, like a mass of pebbles; or it may have come, and probably did come, a single solid stone.

In either case, as it got near to the sun new and strong forces acted on it.

The same heat and repulsion that develops and drives off from a comet in one direction a tail, sometimes a hundred millions of miles long, may have cracked off and scattered in another direction solid fragments. One of these contained in it this stone, and it wandered in its own orbit about the sun, itself an infinitesimal comet, how many thousands of millions of years we know not, until three years ago it came crashing through the air to the earth in Iowa."

More than ordinary space has been given to the citations from the various statements and arguments and to the concluding speculation of Professor Newton's paper because, better than any preceding American discussion, it presents the status of the modern theories of meteors and comets which are now generally accepted by the scientific world.

The latest formal discussion of this subject was presented by *Professor Newton*¹ in his presidential address before the American Association for the Advancement of Science, at Buffalo, in 1886. This address was devoted wholly to the consideration of the various theories in regard to the motions, character, and origin of meteorites, meteors, and shooting-stars.

The discussion in this address follows the same general lines as in the lecture just cited, while the various arguments are presented with far greater elaboration. No new hypotheses or theories are offered; but the key-note of the address, given in the author's own words, is that "science may be advanced by rejecting bad hypotheses as well as by forming good ones."

¹ Proc. Am. Ass. Ad. Science 1886, 1.

EXAMINATION OF THEORIES.

The abstracts and excerpts just presented are, from the limitations of the method employed, frequently very brief, sometimes disconnected, and generally separated from the various discussions which led to the results cited.

Although they present in themselves insufficient data for an accurate study or a rigorous discussion of the subject, they are quite sufficient to illustrate the evolution of the modern theories as they have been successively developed from the superstitions and the dogmatic assumptions of the last century.

This development is a fair illustration of the growth of most of the sciences, and the sometimes absurd and baseless theories, some of which have been cited, are the usual evidences of an anxious, persistent searching after the truth which is satisfied only by success.

While the modern theories have been slowly evolved from a multitude of observations and discussions, expanding here and there along the lines of least difficulty, it is not improbable that frequently there has been a lack of the nicest discrimination as to what were real and well-established facts.

Keeping in view the precept that no sound theory can be based on doubtful data, it is proposed to examine briefly the accumulated mass of so-called knowledge of Meteors and Comets, with a view to ascertaining what we actually *know* about these bodies; what we *infer*, *assume*, and *assert*, and to some extent, perhaps, what we *do not know* about them.

METEORS.

Those bodies which are usually designated as *meteors*, *meteorites*, and *shooting-stars* are known, to some extent, by every intelligent person. The first name is usually applied to those sporadic bodies which one can see occasionally on any clear night; the second term is applied to iron or stony masses that sometimes fall to the earth, while the last term is used

to designate those bodies which appear in such periodic showers as those of November 13-14, August 6-10, etc., but which, like the first named, are, almost without exception, entirely consumed before they reach the earth.

These bodies have received, at various times, a great variety of names, such as "Fiery Tears of St. Lawrence," "Fire-balls," "Bolides," "Aerolites," "Meteoroids," etc., most of which have been coined to suit the fancy or ambition of some aspiring author. The only definite knowledge we have of this class of bodies before they reach the surface of the earth is obtained with the spectroscope, and the results from observations with that instrument indicate that all these bodies are similar in composition, and their spectra are the same as that obtained from those masses that have reached the surface of the earth before destruction.

There appears to be, therefore, no reason for using but two names—the one, *meteor*, for those bodies that are consumed before they reach the earth; and the other, *meteorite*, for the solid iron or stony substances that succeed in storming our atmospheric barriers, reaching the surface of the earth intact and bringing our only material messages from the depths beyond.

Sporadic meteors as well as meteorites move apparently in all directions. Meteors that appear in showers seem to emanate from pretty well defined points in the heavens, each separate shower having its own radiant, and in most cases the bodies are not condensed in a single compact mass, but are scattered along the orbit in which they move.

This orbit has been determined for several of the showers with considerable accuracy.

From the testimony of the meteors themselves nothing is known of their origin. The theories of a terrestrial or a lunar volcanic origin are easily shown to be absurd, while the so-called theories that place their origin in other portions of the solar system are mere idle speculations.

COMETS.

The whole number of comets, real and suspected, from about 1770 B. C. to the end of 1889 A. D., the elements of whose orbits have *not* been computed, is 472. From 370 B. C. to the end of 1889 A. D. the number of comets the elements of whose orbits have been computed is 309. Of these, 18 are known to have *elliptic* orbits. In the case of 52, the computed elliptic orbits have not been verified by observation.

The computations show that 231 have *parabolic* orbits, and indicate that 7 have *hyperbolic* orbits.

Thus it appears that not more than seven per cent. of the comets whose orbits have been discussed are known to have *elliptic* orbits, while it is almost certain that seventy-five per cent. have *parabolic* orbits. Of course, the periodic comets, whatever their origin, belong now to the solar system.

As it is highly improbable that there are two or more kinds of comets of intrinsically diverse character and of different origin, it follows that all the comets had their genesis beyond the limits of the solar system, and that the few periodic comets are the exception to the general law, and at best are only adopted members of the solar family.

There are only two sources of actual knowledge of the physical constitution of comets :

One is from the use of the spectroscope; the other is the behavior of the light from a star when seen through various portions, but especially the nucleus of a comet.

As is well known, observations with the spectroscope are not always easily interpreted, but in this case the difficulty is not so great as at first it seems to be.

It is a general law that where there is a continuous spectrum containing all the primary colors without gaps, the light is derived from an incandescent solid or liquid body. A discontinuous spectrum containing bands or bright lines indicates that the light comes from luminous gases or vapors.

To these general rules there are some important exceptions or modifications.

If the temperature of certain vapors or gases be raised to a high degree the number and the appearance of the colored band or of the bright lines change rapidly, though not uniformly, and some investigators have asserted that if the temperature be raised to something over 4,500° Fah. the spectrum will become practically continuous. Similar changes in the phenomena are observed if a gas, like hydrogen, is rendered luminous by the electric spark and then subjected to varying pressures. With a pressure amounting to one-twentieth of an inch of mercury the spectrum is discontinuous and consists of several groups of bright lines in the green. As the pressure is gradually increased there appears a temporary spectrum of bands, then a spectrum of three lines, afterwards a more permanent and complete spectrum of bands, and finally, under a pressure of 52 inches of mercury, a complete and pure continuous spectrum.

The spectra of comets, which have been obtained by careful and experienced observers, present a large number of variations and combinations, ranging from one or more faint bands with indistinct or fluted borders against a colorless background to a faint continuous spectrum with bands or lines of a greater or less degree of brightness and definition.

The most obvious interpretation of the spectroscopic observations of comets is that the bands and lines are the true spectra of a gaseous body, varying through a wide range under the effect of changing pressure and temperature, superimposed upon the faint continuous spectrum derived from the sunlight reflected from the nucleus or other parts of the comet.

Such is the information derived from the spectroscope.

In the vast number of observations of comets, made for the determination of their positions or their physical peculiarities, it has sometimes been noted that the comet passed

between the observer and a star without diminishing the apparent brightness of the star or changing its position.

While observing Comet I, 1866, in January, 1866, I saw on one occasion the nucleus of the comet pass directly over a star of the 9.2 magnitude with no more effect on the brightness of the star than would be produced by the close proximity of any object as bright as the comet's nucleus. Similar accounts have been given by other observers, and the phenomenon is too well attested to admit of a reasonable doubt.

The light from a star could not pass unobstructed through a solid body or a dense aggregation of solid bodies; and, considering this phenomenon alone or in connection with the appearance of the nucleus as it approaches and recedes from perihelion, it appears that we are driven to the conclusion that the nucleus of a comet is composed principally, if not entirely, of gaseous matter, which varies in form and in density from the effect of the sun's attraction and repulsion.

COMETS AND METEORS.

The elements of the orbits of *four* meteor streams have been determined with considerable accuracy. These are the streams that produce the showers of November 13-14, November 27, April 20, and August 10.

It has also been found that the orbit of the meteor stream of November 13-14 coincides very closely with the orbit of Comet I, 1866. The orbit of the November 27 stream corresponds to that of Biela's comet, the orbit of the April stream to that of comet I, 1861, and the orbit of the August stream is nearly identical with that of Comet III, 1862.

The identify of these orbits is quite as good as could be expected from the uncertain character of the observations on which the adopted positions of the meteor streams depend.

On these coincidences in the orbits of meteor streams and of certain comets depends principally the modern theory of comets and meteors, which, briefly stated, is as follows :

Sporadic meteors, individual members of meteoric showers,

and meteorites differ in magnitude and appear under widely varying conditions, but from an astronomical standpoint they are all alike.

They are all solid bodies and are fragments of comets.

Assuming that this theory is true, we shall find that some of the inferences drawn from it are of great importance in their bearing on cosmical physics.

1st. As the meteoric masses, both great and small, are derived from comets, they must have originated beyond the limits of the solar system, and they furnish evidence of the existence in space of exactly such minerals, though in different combinations, as are found in the earth's crust.

2d. They arise from the disintegration of comets, which for centuries have furnished the material for the enormous areas of bodies forming the various meteor streams that trail along the orbits of these masses for immense distances.

3d. The meteors forming the shower of November 13-14 have been observed for more than 900 years, and yet the comet whose gradual destruction has produced these bodies was not discovered until 1866. The August meteors have been observed for more than six centuries, but the comet whose disintegration has furnished the material for this vast stream remains intact, and was not discovered until 1862.

The accepted *comet-meteor* theory does not explain clearly the visibility of comets or the changes that occur in the apparent brightness and in the density of the nucleus as these bodies approach and recede from the sun; neither does it explain in a satisfactory manner the position of the comets in their attendant meteor streams. If comets are composed of solid matter or of discrete solid particles, it would seem quite proper to ask why they become visible at such immense distances from the earth and the sun.

The perihelion distance of 26 per cent. of the comets with known orbits is equal to or greater than the mean distance of the earth from the sun.

Many comets when first seen are much farther from the sun than is the earth at aphelion, and the spectroscope only

gives the information that the light is derived from a gas or vapor. From our constant experience with solid masses of stone and iron on the surface of the earth and under the unobstructed influence of the sun, it is impossible to see how the sun's heat alone can produce gas or vapor from such bodies at the observed distances.

As the comet approaches the sun the faint diffused mass of the body begins to contract, and a point in the mass; generally nearer the sun than the center, becomes brighter and denser, frequently, as it rapidly nears the sun, changing its form and brightness in a marked manner from day to day.

It is not improbable that the solid constituents of meteorites would be vaporized if they passed as near the sun as did Comet II, 1882; but it is not probable that this change does occur at distances greater than the radius of the earth's orbit, if it is effected simply by the action of the sun.

If the visibility is caused by the assumed enormous change of temperature experienced by the solid portion of the comet in passing from outer space to the locus of visibility in the solar system, then the entire mass of the comet should be vaporized and solid meteoric bodies would cease to exist.

If, on the other hand, this visibility is brought about by the effect of this change of temperature on the occluded gases stored up in the solid portions of the comet, then during the long period in which these masses are subjected to the solar action these gases would all be expelled and dissipated and none would be found in those meteorites which finally find their way to the surface of the earth and into the chemist's laboratory.

The meteors of the shower of November 27 are scattered along the orbit of that stream for at least 500 millions of miles. If this elongation of the meteor stream is formed, as is highly probable, by the difference in velocity between those meteors on that portion nearest the sun and those on the outside of the mass, then, if the comet is the meteor-producing body, the same action would tend to break it up and destroy it early in its existence as a solar satellite.

If the existence of the comet as a member of the solar system antedates the meteor stream, it is difficult to see how the comet could have remained intact long enough to have been observed, in the presence of forces that for thousands of years have been transforming the figure of the original mass and stretching it out into a stream whose length is measured by hundreds of millions of miles. It is not improbable that comets of large dimensions are destroyed by the action of such forces; but that a body of that character should miraculously survive its own destruction and be found existing in ordinary cometary form in the midst of its own ruins is a proposition that makes large demands on the imagination.

If the brightness of comets is caused by the vaporization of iron or stony matter, it must be produced by collisions between the masses at such velocities that a high temperature is developed, producing an incandescent vapor yielding a distinctive spectrum. It seems difficult to explain how such relative velocities can arise among the individual members of the same stream moving in a common orbit. It is more than probable that the light of a star passing from the extremely low temperature of space through the supposed high temperature of the comet's nucleus, and again into the temperature of space, would suffer so much apparent change of position that it would compel recognition. It is claimed, however, that the individual masses of meteoric matter which form the nucleus are so far separated that the light of a star can pass through the aggregated mass without material change of direction.

But if the masses are vaporized by collisions, then there must be absolute contact, which would to a great extent obstruct the passage of stellar light and would be certain to produce refraction.

Lockyer's Theories.—before leaving the consideration of these points I venture to call attention for a moment to a recent theory which has been set forth with considerable elaboration of detail.

In a paper entitled "Researches on the Spectra of Meteorites," presented to the Royal Society on October 4, 1887, and in the Bakerian lecture on April 12, 1888, followed by an appendix to the same on January 10, 1889, Mr. Lockyer presented in detail his laboratory experiments, combined with the more or less accurate observations of other astronomers and physicists, which led him to certain definite conclusions in regard to the relations of comets and meteors.

The author's conclusions and theories can be most succinctly presented in the following citations from the papers mentioned:

"The existing distinction between stars, comets, and nebulae rests on no physical basis."

"All self-luminous bodies in the celestial spaces are composed of meteorites or masses of meteoric vapor produced by heat brought about by condensation of meteor swarms due to gravity."

"Meteorites are formed by the condensation of vapors thrown off by collisions. The small particles increase by fusion brought about again by collisions, and this increase may go on until the meteorites may be large enough to be smashed by collisions when the heat of impact is not sufficient to produce volatilization of the whole mass."

"Beginning with meteorites of average composition, the extreme forms, iron and stony, would in time be produced as the result of collisions."

"The spectra of all such bodies depend upon the heat of meteorites produced by collisions and the average space between the meteorites in the swarm, or, in the case of consolidated swarms, upon the time which has elapsed since complete vaporization."

"The temperature of vapors produced by collisions in nebulae, stars without C and F, but with other bright lines, and in comets away from perihelion is about that of the Bunsen burner."

"The temperature of the vapors produced by collisions in α Orionis and similar stars is about that of the Bessemer flame."

“The brilliancy of the aggregated masses depends upon the number of the meteorites and not upon the intensity of the light.”

“The bright flutings of carbon in the spectra of some ‘stars,’ taken in conjunction with their absorption phenomena, indicate that widely separated meteorites at a low temperature are involved.”

“New stars are produced by the clash of meteor-swarms, the bright lines seen being low temperature lines of those elements in meteorites the spectra of which are most brilliant at a low stage of heat.”

“A comet is a swarm of meteors in company. Such a swarm finally makes a continuous orbit by virtue of arrested velocities. Impacts will break up large stones and will produce new vapors, which will condense into small meteoroids.”

“When the meteorites are *strongly* heated in a glow-tube the whole tube, when the electric current is passing, gives us the spectrum of carbon. When a meteor-swarm approaches the sun the whole region of space occupied by the meteorites * * * gives us the same spectrum.”

“The first stage in the spectrum of a comet is that in which there is only the radiation of the magnesium. The next is that in which Mg. 500 is replaced wholly or partially by the spectrum of cool carbon. Mg. is then added and cool carbon is replaced by hot carbon. The radiation of manganese 558 and sometimes lead 546 is then added. Absorption phenomena next appears, manganese 558 and lead 546 being indicated by thin masking effect upon the citron band of carbon. The absorption band of iron is also sometimes present at this stage. At this stage also the group of carbon flutings, which I have called carbon B, probably also makes its appearance. As the temperature increases still further, magnesium is represented by *b*, and lines of iron appear. This takes place when the comet is at or near perihelion.”

“The observations on meteorites recorded in the Bakerian

Lecture and the discussion of cometary observations contained in this Appendix show that the vapors which are given out by the meteorites as the sun is approached are in an approximate order: slight hydrogen, slight carbon compounds, magnesium, sodium, manganese, lead, and iron. Now, of these the hydrogen and carbon compounds are alone permanent gases, and the idea is that they have been occluded as such by the meteorites."

"The aurora being a low temperature phenomenon, we should expect to find in its spectrum lines and remnants of flutings seen in the spectra of meteorites at low temperatures. The characteristic line of the aurora is the remnant of the brightest manganese fluting at 558."

"The spectrum of the nebulae, except in some cases, is associated with a certain amount of continuous spectrum, and meteorites glowing at a low temperature would be competent to give the continuous spectrum with its highest intensity in the yellow part of the spectrum."

"Only seven lines in all have been recorded up to the present in the spectra of nebulae, three of which coincide with lines in the spectrum of hydrogen and three correspond to lines in magnesium. The magnesium lines represented are the ultra-violet low-temperature line at 373, the line at 470, and the remnant of the magnesium fluting at 500, the brightest part of the spectrum at the temperature of the Bunsen burner. The hydrogen lines are *h*, F, and H γ . (434). Sometimes the 500 line is seen alone, but it is generally associated with F and a line at 495. The remaining lines do not all appear in one nebulae, but are associated one by one with the other three lines."

"When a tube is used in experiments to determine the spectrum of meteoric dust at the lowest temperature we find that the dust in many cases gives a spectrum containing the magnesium fluting at 500, which is characteristic of the nebulae and is often seen alone in them. If the difference between nebulae and comets is merely of cosmographical position, one being out of the solar system and one being in

it; and, further, if the conditions as regards rest are the same, the spectrum should be the same, and we ought to find this line in the spectrum of comets when the swarm most approaches the undisturbed nebulous condition, the number of collisions being at or near a minimum—*i. e.*, when the comet is near aphelion the fluting should be visible alone.”

After citing the results of the spectroscopic observations of several comets, the author remarks: “This spectroscopic evidence is of the strongest, but it does not stand alone. Comets at aphelion present the telescopic appearance, for the most part, of globular nebulae.”

The comprehensive theory set forth in the quotations just cited assumes that the auroræ, nebulae, meteorites, comets, and most of the stars all have a common origin, and that all the multifarious telescopic and spectroscopic phenomena exhibited by these bodies are due to the varying velocities of the collisions between the meteoric particles and masses of which in some form all these bodies are composed.

We are told that meteorites at a low temperature present in the spectrum a certain line, at 558, due to manganese, and also that this line appears in the nebulae, the aurora, and in comets at considerable distances from perihelion. Hence the identity of all these bodies is inferred and the foundation of the theory is laid.

Meteorites are subjected to laboratory experiments in tubes in which the temperature is gradually raised to a high degree and the varying spectra is noted. Spectroscopic observations of nebulae, comets, and stars are then compiled and classified, until the several groups are so arranged that they present nearly the same sequence of spectra that have been derived from meteoric matter at increasing temperatures in the experiments.

The theory is then extended and we are given to understand that when, in the case of nebulae and stars greater activity of collisions occur, or when a comet approaches the sun, the same phenomena appear and in the same order.

The identity of these bodies is then supposed to be complete and the theory established.

This theory of collisions rests upon a remarkable congeries of experiments, observations, and assumptions. Many of the observations and many of the laboratory experiments, which were made by the author, as well as much of the data quoted throughout his papers are entitled to the highest merit. But, considering much of the data and many of the statements in his conclusions, and especially the extraordinary assertion that "comets at aphelion present the telescopic appearance for the most part of globular nebulae," it is not remarkable to find the author's data, as well as his deductions, vigorously attacked by able physicists.

Huggins.— After a careful study of the spectrum of the aurora *Mr. Huggins*¹ remarks: "After consideration, I think that I ought to point out that *Mr. Lockyer's* recent statement that 'the characteristic line of the aurora is the remnant of the brightest manganese fluting at 558' is clearly inadmissible, considering the evidence we have of the position of this line."

After a very thorough study of the spectra of the nebulae, *Mr. Huggins*² writes: "As, therefore, there seems to be little doubt that the 'remnant of the fluting at 500' is not coincident with the brightest nebular line, and the next most characteristic group of this spectrum, the triplet at 3720, 3724, and 3730, according to *Liveing* and *Dewar*, does not appear to be present in the photographs, we may conclude that the remarkable spectrum of the gaseous nebulae has not been produced by burning magnesium."

*Professor Liveing*³ says in regard to the line denoted by *Lockyer* as 470: "I have never seen the line at λ 4703 in the spectrum of the magnesium flame. As it is a conspicuous line in the arc and spark, we looked for it in the flame, but did not find it."

¹ Proc. Roy. Soc., XLV, 435.

² Proc. Roy. Soc., XLVI, 55.

³ Proc. Roy. Soc., XLVI, 56.

If the testimony of Huggins and of Liveing and Dewar represents the observed phenomena, and their observations have not yet been disproved, then most of the broad theories of Lockyer, which assume a common origin and structure for auroræ, nebulæ, comets, and stars, lacks a basis of observed facts, resting wholly, so far as the aurora and nebulæ are concerned, on approximate coincidences in the spectra, while the assumed telescopic appearance of comets at aphelion is a creation of the imagination.

CONCLUSIONS.

Attention has been called to these various theories relating to comets and meteors simply with a view to emphasizing the fact that none of the systems, whether simple or complex, seems to explain all the observed phenomena.

As a scientific explanation, the direct and simple is always preferable to the indirect and involved method, and this safe precept should be the guide in all investigations of the apparent physical connection between comets and meteors.

It seems to me that the true theory of the origin and the relations of comets and meteors is yet to be discovered.

When asked to give my own theory of these bodies I can only reply that I have none. At the same time I see less objection to the following hypotheses than to any of those now doing duty as theories:

Meteors and meteorites are solid iron or stony bodies and, whatever their origin, are now members of the solar system. Comets are composed chiefly of gaseous matter, and originate outside of the solar system. Some of these bodies on entering the sphere of solar attraction are so far drawn away from their original orbits by the masses of the sun's outer satellites that they become permanent members of the solar system. Of these, at least *four* have become entangled in the immense aggregations known as meteor streams and have adopted the orbits of their captors. The meteors still remain meteors, however, and the comets retain their former identity and peculiar structure.

OBSERVATIONS OF METEORS.

Most of the observers of sporadic meteors and meteorites have been either amateurs or persons entirely deficient in that special training which is so essential in a trustworthy observer of unexpected phenomena. Fortunately, however, most of the important phenomena have been noted by intelligent and skilled observers, whose zeal and care have left little to be desired.

It would be impracticable to mention even the names of all the successful observers, but any sketch of the progress of meteoric astronomy in this country would be notably deficient if some of the prominent names were omitted.

The remarkable meteor shower of November 13, 1833, attracted the attention of many careful observers and zealous students along our Atlantic coast, and for several years the subject was carefully investigated by Prof. Dennison Olmstead and Prof. A. C. Twining, who were the pioneers in the study of this science in the United States.

From 1838 when E. C. Herrick began his work he labored with untiring industry as an observer and a compiler of observations and other data until his death, in 1862, and no one in this country did so much as he in promoting the observation and investigation of the August meteors.

Mr. Herrick also gave considerable attention to the study and observation of the November meteors, but this stream was made a special study by Prof. H. A. Newton, with the best results.

Professor Newton's observations of the November meteors began in 1860 and have been continued to the present time, while his investigations of the motions and character of this stream place him undeniably at the head of American workers in this branch of Astronomy.

Much work of the highest value was done by Prof. C. U. Shepard and by Prof. J. Lawrence Smith in the chemical examination of all classes of meteorites, and excellent in-

vestigations of a similar character have been carried out by other eminent chemists in the country.

The zeal and industry of Professor Shepard was shown in his extensive collection of meteoric specimens, which at the time of his death was the largest in America.

The attempt to bring together all the published observations in this country in one systematic collection is a task beset with grave difficulties.

The reports of these observations are scattered through all the scientific journals, the metropolitan and local newspapers, and the proceedings of all grades of learned societies. Frequently the reports, when found, have but little scientific value from lack of the necessary information. In many instances much time and space are wasted in describing trivial details which have no interest or value in connection with the true meteoric phenomena, while the really essential data are not mentioned.

It sometimes happens that the only available information in regard to a meteorite is derived from the report of its chemical examination, and there can be found no astronomical data whatever to account for its position; it is simply a portion of the earth's surface, and the *how*, *when*, and *whence* of its advent remain unanswered.

It has been impossible, sometimes, to find any trustworthy authority for essential data, and it has been necessary frequently to interpret freely where the observer or writer has given but a slight clue to his meaning.

In nearly all cases marginal references are made to the original papers in order to facilitate further examination, if desired.

THE CATALOGUES.

The catalogues of Sporadic Meteors, Meteoric Showers, Observed Meteorites, and Discovered Meteorites are supposed to contain all observations, accompanied with the necessary data that have been found in the various publications to which the author has had access. It is not assumed, how-

ever, that these lists contain all the good observations that have been made in this country ; in fact, it is quite certain that they do not, and one of the principal aims of this paper will be attained if this fact attracts sufficient attention to bring to light the missing or the unpublished observations.

In all the catalogues the *day* of the observation is the *astronomical* day. It was manifestly impracticable to give every reference to each object in the five catalogues, and only the most important ones have been retained.

Occasionally references are only given to the first page of a paper when it contains several observations of the same phenomenon.

In the reference notes at the bottom of the page the principal abbreviated notation may be explained as follows :

A. J. S., XXV₂, 306, refers to the American Journal of Science, Vol. XXV, *second* series, page 306.

Trans. A. P. S. refers to the American Philosophical Society.

Proc. A. P. S. refers to the American Philosophical Society.

Proc. A. A. A. S. refers to the proceedings of the American Association for the Advancement of Science.

CATALOGUES

I.-V.

CATALOGUE I.—

Number.	DATE.				Locality.	Iron or stone.
	Year.	Month.	Day.	Hour. Min.		
1	1781(?)				Portage Bay, Chiloet Inlet, Alaska	I.
2	1807	December	13	18.5	Weston, Conn.	S.
3	1810	January	30		Caswell, N. C.	S.
4	1823	August	7		Nobleborough, Me.	S.
5	1825	February	10		Nanjemoy, Md.	S.
6	1827	May	9		Sumner Co., Tenn.	S.
7	1828	June	4		Richmond, Va.	S.
8	1829	May	8	3	Forsyth Co., Ga.	S.
9	1829	August	15		Deal, N. J.	S.
10	1835	July	30	2	Charlotte, Dickson Co., Tenn.	I.
11	1837	May	5	3	East Bridgewater, Mass.	S.
12	1839	February	13	3	Little Piney, Pulaski Co., Mo.	S.
13	1840	October			Concord, N. H.	S.
14	1843	March	25		Bishopville, S. C.	S.
15	1844	January			Argentine Republic	I.
16	1846	August	14	3	Cape Girardeau, Mo.	S.
17	1847	February	25	3	Marion, Linn Co., Iowa.	S.
18	1848	May	19	16	Castine, Me.	S.
19	1849	October	31	3	Charlotte, Cabarrus Co., N. C.	S.
20	1855	August	5	3	Lincoln Co., Tenn.	S.
21	1857	April	1		Costa Rica, Central America.	S.
22	1857				Independence Co., Iowa.	S.
23	1859	March	28	4	Harrison Co., Ind.	S.
24	1859	July	4		Crawford Co., Ark.	S.
25	1859	August	11		Bethlehem, N. Y.	S.
26	1860	May	1	1	New Concord, Ohio.	S.
27	1865	March	24	21	Vernon Co., Wis.	S.
28	1868	November	27	5	Danville, Ala.	S.
29	1868	December	5	3	Frankfort, Ala.	S.
30	1869	October	5	23	Stewart Co., Ga.	S.
31	1871	May	20	20	Searsmont, Me.	S.
32	1874	May	14	2.5	Nash Co., N. C.	S.
33	1875	February	12	10.5	Iowa Co., Iowa	S.
34	1876	June	24	21	Kansas City, Mo.	I.
35	1876	December	21	8.75	Rochester, Fulton Co., Ind.	S.
36	1877	January	2		Warrenton, Warren Co., Mo.	S.
37	1877	January	23		Cynthiana, Harrison Co., Ky.	S.
38	1879	May	10	5	Estherville, Emmet Co., Iowa.	S. & I.
39	1879	August			Fomatlan, Jalisco, Mexico.	
40	1883				Calderilla, Chili	I.
41	1885	November	27		Mazapil, Mexico.	I.
42	1886	March	27	3	Johnson Co., Ark.	I.
43	1887	January	21	2	De Cewsville, Haldimand Co., Ontario.	S.
44	1890	May	2	5 15	Winnebago Co., Iowa.	S.

- Cat. State Mining Bureau of Cal., 1888, No. 2925.
- { Trans. Amer. Phil. Soc. VI₁, 323.
{ A. J. S. XXXVII₁, 130; VI₂, 410.
- A. J. S. II₂, 392.
- A. J. S. VII₁, 170; IX₁, 400.
- A. J. S. IX₁, 351; X₁, 131; VI₂, 406.
- A. J. S. XVII₁, 326; XVIII₁, 200, 378.
- A. J. S. XV₁, 195; XVI₁, 191.
- A. J. S. XVII₁, 388.
- Proc. A. A. S., 1851, Vol. II, 188.
- A. J. S. XLIX₁, 336.
- A. J. S. XXXII₁, 395.
- A. J. S. XXXVII₁, 385; XXXIX₁, 254.
- A. J. S. IV₂, 353; VI₂, 416.
- A. J. S. II₂, 392; VI₂, 411.
- Proc. Lit. and Phil. Soc. Liverpool, VII, 1853.
- A. J. S. XXXII₃, 229.
- A. J. S. IV₂, 288, 429.
- A. J. S. VI₂, 251, 406.
- A. J. S. IX₂, 143; X₂, 127.
- A. J. S. XXIV₂, 134; XXXI₂, 264.
- Buchner, 93.
- A. J. S. XXX₂, 208.

Observed Meteorites.

Number.	Weight.	Authority.	Remarks.
1	88 lbs.	Seen to fall by the father of one of the oldest Indians.
2	300 "	Nathan Wheeler.....	Observed by many persons.
3	3 "	Madison.	
4	4 "	A. Dinsmoor.	
5	16.5 "	W. D. Harrison.	
6	11 "		
7	4 "		
8	36 "	Elias Beall.	
9	Weight "rather more than half an ounce."
10	9 lbs.	G. Troost.....	J. L. Smith gives the date as August 1.
11	0.5 lb.		
12	50 lbs.	Mr. Harrison.	
13	Weight 370.5 grains.
14	13 lbs.	C. U. Shepard.	
15	H. E. Symonds.....	Fall witnessed by 1,400 soldiers. About a cubic yard of the mass remained above the surface of the ground.
16	4.5 lbs.	E. S. Dana.	
17	130 lbs.	S. L. Penfield.	
18	0.1 lb.	D. C. Rogers.	
19	19.5 lbs.	Giles Gardner.	
20	3.9 "	H. Bost.	
21	James B. Dooley.	
22	C. U. Shepard.....	Fell in the "summer" of 1857.
23	3.7 lbs.	Several observers.
24	Mr. Scott.	
25	C. U. Shepard.....	"Smaller than a pigeon's egg."
26	460.2 lbs.		
27	J. L. Smith.	
28	4.5 lbs.	W. Brown.	
29	1.7 "	Jas. W. Hooper.	
30	0.8 lb.	Mrs. Buck.	
31	12 lbs.		
32
33	500 lbs.	Many observers.
34	A. J. Morris.	
35	0.8 lb.		
36	100 lbs.		
37	15 "	"Fell in the afternoon."
38	750 "
39	C. U. Shepard.....	Several pieces; the largest weighed about 2 lbs.
40	"Small."	Ward and Howell.....	Not yet described.
41	8.7 lbs.	W. E. Hidden.	
42	107.5 "	G. F. Kunz.	
43	0.75 lb.	E. E. Howell.	
44	184 lbs.	G. F. Kunz.....	Probably more fragments to be discovered.

- 23. A. J. S. XXVIII₂, 409.
- 24. Owens' 2d Geolog. Reconnaissance of Arkansas, 408.
- 25. A. J. S. XXX₆, 206.
- 26. { A. J. S. XXX₂, 103, 207, 296;
- 26. { A. J. S. XXXI₂, 87; XXXII₂, 30.
- 27. A. J. S. XII₃, 207.
- 28. A. J. S. XLIX₂, 90.
- 29. A. J. S. XLVIII₂, 240.
- 30. A. J. S. L₂, 335, 339.
- 31. A. J. S. II₃, 133, 200.
- 32. A. J. S. X₃, 147.
- 33. A. J. S. IX₃, 407, 459; X₃, 44, 357.
- 34. A. J. S. XII₃, 316.
- 35. A. J. S. XIII₃, 207, 243.
- 36. A. J. S. XII₃, 243; XIV₃, 219.
- 37. A. J. S. XIII₃, 243; XIV₃, 219.
- 38. A. J. S. XVIII₃, 77, 186; XIX₃, 459, 495; XX₃, 136.
- 39. A. J. S. XXX₃, 105.
- 40.
- 41. A. J. S. XXXIII₃, 221.
- 42. A. J. S. XXXII₃, 494, 500.
- 43. Science, N. Y., March 7, 1890, 167.
- 44. Science, N. Y., May 16, 1890, 304.

C A T A L O G U E I I . -

Number.	DATE.		Locality.	Iron or stone.
	Year.	Month and day.		
1	1735	Arizona	I.
2	1784	Bahia, Brazil.....	I.
3	1792	Zacatecas, Mexico.....	I.
4	1808	Red River, Texas.....	I.
5	1810	Santa Rosa, New Granada.....	I.
6	1811	Durango, Mexico.....	I.
7	1818	Lockport, N. Y.....	I.
8	1819	Burlington, N. Y.....	I.
9	1820	Guilford Co., N. C.....	I.
10	1822	Randolph Co., N. C.....	I.
11	1826-7	Waterloo, Seneca Co., N. Y.....	I.
12	1828	Bedford Co., Pa.....	I.
13	1832	Walker Co., Ala.....	I.
14	1834	Scriba, Oswego Co., N. Y.....	I.
15	1834	Claiborne, Clark Co., Ala.....	I.
16	1835	Buncombe Co., N. C.....	I.
17	1836	Brazos, Texas.....	I.
18	1839	March	Putnam Co., Ga.....	I.
19	1839	Buncombe Co., N. C.....	I.
20	1840	February 26.....	Chili.....	I.
21	1840	Cooke Co., Tenn.....	I.
22	1840	Smithland, Livingston Co., Ky.....	I.
23	1841	February	Lexington Co., S. C.....	I.
24	1842	Grayson Co., Va.....	I.
25	1842	Roanoke Co., Va.....	I.
26	1842	Carthage, Tenn.....	I.
27	1842	Green Co., Tenn.....	I.
28	1845	DeKalb Co., Tenn.....	I.
29	1845	Otsego Co., N. Y.....	I.
30	1846	Franconia, N. H.....	I.
31	1846	Jackson Co., Tenn.....	I.
32	1847	Chesterville, S. C.....	I.
33	1847-8	Murfreesborough, Tenn.....	I.
34	1849	Pittsburgh, Pa.....	I.
35	1850	Allegheny Co., Pa.....	I.
36	1850	Seneca River, N. Y.....	I.
37	1850	Salt River, Ky.....	I.
38	18'0	Botetourt Co., Va.....	I.
39	1853	Jefferson Co., Tenn.....	I.
40	1853	Union Co., Ga.....	I.
41	1853	July	Campbell Co., Tenn.....	I.
42	1853	August	Tazewell, Claiborne Co., Tenn.....	I.
43	1854	Madoc, Ontario.....	I.
44	1854	Haywood Co., N. C.....	I.
45	1855	Coahuila, Mexico.....	I.
46	1856	Nelson Co., Ky.....	I.
47	1856	Nebraska.....	I.
48	1856	Madison Co., N. C.....	I.
49	1856	Forsyth, Taney Co., Mo.....	I.
50	1856	Marshall Co., Ky.....	I.
51	1856	Denton Co., Texas.....	I.
52	1856	Oktibbeha, Miss.....	I.
53	1857	Laurens Co., S. C.....	I.
54	1858	Washington Co., Wis.....	I.

- { Smithsonian Report 1863, 55, 85.
A. J. S. XVIII₂, 369; XIX₂, 161, 162.
- { A. J. S. XV₂, 12; XXXV₁, 158.
{ Sci. Am. Supp. Oct. 19, 1889.
- A. J. S. XV₂, 11.
- A. J. S. VIII₁, 218; XVI₁, 217; XXVII₁, 382.
- A. J. S. XV₂, 11.
- A. J. S. XV₂, 19.
- A. J. S. XLVIII₁, 388; II₂, 374, 391.
- A. J. S. XLVI₁, 401; II₂, 391; XV₂, 20.
- A. J. S. XVII₁, 140; XI₁, 369.
- A. J. S. XVI₁, 140; II₂, 391; XV₂, 21.
- A. J. S. XI₂, 39; XXXIV₂, 298.
- A. J. S. II₂, 391; XV₂, 21.
- A. J. S. XLIX₁, 344; II₂, 391; XV₂, 21.
- A. J. S. XI₁, 366; II₂, 390; IV₂, 75.

- A. J. S. XXXIV₁, 332; XLVIII₁, 145.
- A. J. S. XXXVI₁, 81; XLIII₁, 359.
- A. J. S. XXXI₂, 459.
- A. J. S. XVI₂, 331.
- A. J. S. IV₂, 82.
- Lon., Ed. and Dublin Phil. Mag. X₄, 12.
- A. J. S. XXXVIII₁, 250; XLII₁, 354.
- A. J. S. II₂, 357; XV₂, 21.
- { A. J. S. X₂, 128; XV₂, 5, 16.
{ Proc. A. A. A. S. 1850, Vol. I, 152; 1851,
Vol. II, 189.
- A. J. S. XLIII₁, 169; II₂, 392.
- A. J. S. XLIII₁, 169; II₂, 392.
- A. J. S. II₂, 356; XV₂, 20.
- A. J. S. XLIX₁, 342; II₂, 391.

Discovered Meteorites..

Number.	Weight.	Authority.	Remarks.
1	1,400 lbs.	Joseph Henry.....	The "Ainsa" or "Tucson" meteorite.
2	11,819 "	The "Bendego" meteorite.
3	2,000 "		
4	1,635 "		
5	1,700 "		
6			Weight 30,000 or 40,000 lbs.
7	36 lbs.	B. Silliman.	
8	150 "	B. Silliman.	
9	28 "	C. U. Shepard.	
10	2 "	C. U. Shepard.	
11	0.1 lb.	C. U. Shepard.....	Rammelsburg thought this was not a meteorite.
12		C. U. Shepard.....	"A few ounces." Dr. Genth thought it was Spiegeleisen.
13	165 lbs.	G. Troost.	
14	8 "	C. U. Shepard.	
15	40 "	C. T. Jackson.	
16	30 "	C. U. Shepard.....	One date given is 1845.
17	324 "	C. U. Shepard.	
18	72 "	J. E. Willett.	
19	1.3 "	C. U. Shepard.	
20	17 "	R. P. Greg.....	Found in the desert of Tarapaca.
21	2,000 "	G. Troost.	
22	9.9 "	G. Troost.	
23	117 "	C. U. Shepard.....	Found on "Ruff's Mountain."
24		J. B. Rogers.....	"Original mass of many pounds' weight."
25		W. B. Rogers.....	No weight given.
26	280 lbs.	G. Troost.	
27	29 "	G. Troost.....	Found near Babb's mill.
28	36 "	G. Troost.	
29		C. U. Shepard.....	Weighed 276 grains.
30		Robert Gilmore...	Weighed "15 or 20 pounds."
31		G. Troost.....	Weighed 15 oz.
32	36 lbs.	C. U. Shepard.	
33	19 "	G. Troost.	
34	0.6 lb.	F. A. Genth.	
35	292 lbs.	B. Silliman.	
36	9 "		Date somewhat doubtful.
37	8 "	B. Silliman.	
38		C. U. Shepard.....	Original mass lost.
39	2.5 lbs.		
40	15 "		
41	0.3 lb.		
42	60 lbs.	C. U. Shepard.....	Also described by J. L. Smith.
43	370 "	T. Sterry Hunt.	
44		C. U. Shepard.....	Weight about 1/4 oz.
45	252 lbs.	J. L. Smith.....	The "Couch" meteorite.
46	0.2 lb.	G. J. Brush.	
47	35 lbs.		
48	0.1 lb.	G. J. Brush.	
49	197 lbs.	C. U. Shepard.	
50	15 "	C. U. Shepard.	
51		C. U. Shepard.....	Weighed 66 grains.
52	0.3 lbs.	W. J. Taylor.....	Found in an Indian mound.
53	4.7 "	W. E. Hidden.	
54	85.8 "	F. Breundecke.	

28. A. J. S. XLIX₁, 341; II₂, 391.
 29. A. J. S. II₂, 391; XV₂, 16.
 30. A. J. S. II₂, 392; IV₂, 87.
 31. A. J. S. II₂, 357; XV₂, 21.
 32. A. J. S. VII₂, 449; XV₂, 21.
 33. A. J. S. V₂, 351; XV₂, 21.
 34. A. J. S. XV₂, 22; XII₃, 72.
 35. A. J. S. XV₂, 7; Proc. A. A. S. 1850, Vol. II, 37.
 36. A. J. S. XIV₂, 439; XV₂, 363.
 37. A. J. S. XV₂, 22; Proc. A. A. S. 1850, 36.
 38. A. J. S. XLI₁, 250.
 39. A. J. S. XVII₂, 329.
 40. A. J. S. XVII₂, 328.
 41. A. J. S. XIX₂, 153.

42. A. J. S. XVII₂, 131, 325; XIX₂, 153.
 43. A. J. S. XIX₂, 417.
 44. A. J. S. XVI₁, 327.
 45. { A. J. S. XIX₂, 160.
 { Smithsonian Report, 1863, 56.
 46. A. J. S. XXX₂, 240; XXXI₂, 459.
 47. A. J. S. XXX₂, 204; XXXII₂, 459.
 48. A. J. S. XXX₂, 240; XXXI₂, 459.
 49. A. J. S. XXX₂, 205; XXXIV₂, 467.
 50. A. J. S. XXX₂, 240; XXXI₂, 459.
 51. { A. J. S. XXXI₂, 459.
 { Trans. St. Louis Acad. Sci. I, 623.
 52. A. J. S. XXIV₂, 293.
 53. A. J. S. XXXI₃, 463.
 54. Smithsonian Report 1869, 417.

CATALOGUE II.—Dis-

Number.	DATE.		Locality.	Iron or stone.
	Year.	Month and day.		
55.	1858-9	Augusta Co., Va.....	I.
56.	1859	Rogue River Mountains, Ore.....	I.
57.	1860	Mountains of East Tennessee.....	I.
58.	1860	Franklin Co., Ky.....	I.
59.	1860	October	La Grange, Oldham Co., Ky.....	I.
60.	1860	December.....	Coopertown, Tenn.	I.
61.	1860	Newton Co., Ark.....	I.
62.	1863	Ren-selaer Co., N. Y.....	S.
63.	1863	February 18	Colorado.....	I.
64.	1863	Tucson, Arizona.....	I.
65.	1863	June 9.....	Dakota.....	I.
66.	1866	Bear Creek, Colo.....	I.
67.	1866	Frankfort, Ky.....	I.
68.	1867	Allen County, Ky.....	I.
69.	1868	April.....	Losttown, Cherokee Co., Ga.....	I.
70.	1868	"Southeastern Missouri"	I.
71.	1868	Auburn, Macon Co., Ala.....	I.
72.	1869	Utah.....	S.
73.	1869	El Dorado Co., Cal.....	I.
74.	1869	Trenton, Wis.....	I.
75.	1870	Howard Co., Ind.....	I.
76.	1873	August.....	Madison Co., N. C.....	I.
77.	1873	Cleburne Co., Ala.....	I.
78.	1874	Waconda, Kan.....	S.
79.	1875	San Francisco, Brazil.....	I.
80.	1877	Whitfield Co., Ga.....	I.
81.	1878	Fayette Co., Texas.....	S.
82.	1879	Whitfield Co., Ga.....	I.
83.	1879	July 19.....	Davidson Co., N. C.....	I.
84.	1879	Ivanpah, Cal.....	I.
85.	1880	Eagle Station, Carroll Co., Ky.....	I.
86.	1880	Lexington Co., S. C.....	I.
87.	1880	Rutherford Co., N. C.....	I.
88.	1882	June 10.....	Maverick Co., Texas.....	I.
89.	1882	Burke Co., N. C.....	I.
90.	1883	May 15.....	Grand Rapids, Mich.....	I.
91.	1883	Little Miami Valley, Ohio.....	I.
92.	1883	Wayne Co., W. Va.....	I.
93.	1884	June.....	Independence Co., Ark.....	I.
94.	1884	Hammond, St. Croix Co., Wis.....	I.
95.	1884	August.....	Santa Fé County, New Mexico.....	I.
96.	1884	Chili.....	I.
97.	1885	Catorze, San Luis Potosi, Mex.....	I.
98.	1887	January	Laramie Co., Wyoming.....	I.
99.	1887	March.....	Claiborne Co., Tenn.....	I.
100.	1887	March.....	Cumberland Co., Tenn.....	S.
101.	1887	March 27.....	Chattooga Co., Ga.....	I.
102.	1888	April 30.....	Weland, Ontario.....	I.
103.	1888	Chili.....	I.
104.	1888	Chili.....	I. & S.
105.	1888	Chili.....	I.
106.	1888	Hamilton Co., Texas.....	I.

55. A. J. S. XV₃, 337.

56. Proc. Boston Soc. Nat. Hist. Vol. 7, 161, 174, 175, 191, 279, 289.

57. { A. J. S., XXXIV₃, 473.

Proc. Acad. Nat. Sci. Phil. 1886, 366.

58. Smith. Report 1868, 343; A. J. S. XLIX, 331.

59. A. J. S. XXXI₂, 151, 265.60. A. J. S. XXXI₂, 151, 266.61. A. J. S. XL₂, 213; XXXIV₃, 471.62. A. J. S. XXXIV₃, 60.63. A. J. S. XLII₂, 218.64. { A. J. S. XXXVI₂, 152.

Proc. Cal. Acad. Sci. III, 30.

65. A. J. S. XXXVI₂, 259.66. A. J. S. XLII₂, 250, 286; XLIII₂, 280.67. A. J. S. XLIX₂, 331.68. A. J. S. XXXIII₃, 500.69. A. J. S. XLVI₃, 257; XLVII₂, 234.70. A. J. S. XLVII₂, 233.71. A. J. S. XLVII₂, 230.72. A. J. S. XXXII₃, 226.73. A. J. S. III₂, 438; VI₃, 18.74. A. J. S. XLVII₂, 271; III₃, 69.75. A. J. S. V₃, 155; VII₃, 391.76. A. J. S. XII₃, 439.77. A. J. S. XIX₃, 370; XX₃, 74.78. A. J. S. XI₃, 473; XIII₃, 211.

79. { Comptes Rendus LXXXIII, 917, 918;

LXXXIV, 478, 482, 1085, 1508.

A. J. S. XXXIII₃, 232; XXIX₃, 33, 496.

covered Meteorites—Cont'd.

Number.	Weight.	Authority.	Remarks.
55	152 lbs.	J. W. Mallet.	Mass above ground, 4.5 x 3.5 feet.
56	254 lbs.	John Evans	
57	0.1 lb.	F. A. Genth.	Found by Wm. Daring.
58	112 lbs.	G. J. Brush.	
59	37 "		Found by D. Crockett.
60		J. L. Smith.....	Specimen weighed 22½ oz.
61	3.3 lbs.	S. C. H. Bailey.	
62	29 "		Found near Central City by Otho Curtice.
63	632 "		
64	10.6 "	Dr. Jackson	Found in the " Dakota Indian country."
65	436 "	J. L. Wilson.	
66	24 "	J. L. Smith.	Six fragments found; the first in 1869.
67	24.3 "	J. E. Whitfield.	
68	6.6 "		In the province of San Catherina.
69	0.8 lb.	C. U. Shepard.	
70	8 lbs.	C. U. Shepard.	In the province of San Catherina.
71	1.9 "	E. S. Dana.	
72	85 "	B. Silliman.	Six fragments found; the first in 1869.
73	143.5 "	J. L. Smith.....	
74	4 "	E. T. Cox.	In the province of San Catherina.
75	25 "	B. S. Burton.	
76	35.8 "	W. E. Hidden.	In the province of San Catherina.
77	116 "	C. U. Shepard.	
78	22,048 "	E. Guignet.....	In the province of San Catherina.
79	13 "	W. E. Hidden.	
80	321 "	Whitfield and Merrill.	Fragments found in mounds by F. W. Putnam; now in the Peabody Museum.
81	117 "	C. U. Shepard.	
82	2.8 "	W. E. Hidden.	Several fragments.
83	128.2 "	C. U. Shepard.	
84	80 "	G. F. Kunz.	Several fragments.
85	10.5 "	C. U. Shepard.	
86	4.8 "	L. G. Eakins.	Found near Piquios. Not yet described.
87	97.25 "	W. E. Hidden.	
88	1 lb.	G. F. Kunz.	Found near Piquios. Not yet described.
89	114 lbs.	J. R. Eastman.	
90		G. F. Kunz.....	Found near Piquios. Not yet described.
91	26 lbs.	G. F. Kunz.....	
92	94 "	W. E. Hidden.	Found near Piquios. Not yet described.
93	53 "	Davenport Fisher.	
94	324.4 "	G. F. Kunz.....	Found near Piquios. Not yet described.
95	14.5 "	Ward and Howell.	
96	92 "	G. F. Kunz.	Found near Piquios. Not yet described.
97	25.06 "	G. F. Kunz.	
98	18 "	G. F. Kunz.	Found near Piquios. Not yet described.
99	94.5 "	J. E. Whitfield.	
100	27 "	G. F. Kunz.	Found near Piquios. Not yet described.
101	17.5 "	E. E. Howell.	
102	16 "	Ward and Howell.	Found near Piquios. Not yet described.
103	27 "	Ward and Howell.	
104		Ward and Howell.	Found near Piquios. Not yet described.
105	179 "	Ward and Howell.	
106		Ward and Howell.	Found five miles south of Carlton. Not yet described.

80. A. J. S. XIV₃, 246; XXI₃, 286.
 81. A. J. S. XXXVI₃, 113.
 82. A. J. S. XXVI₃, 336; XXXIV₃, 473.
 83. A. J. S. XX₃, 324.
 84. A. J. S. XIX₃, 381.
 85. A. J. S. XXXIII₃, 228.
 86. A. J. S. XXI₃, 117.
 87. A. J. S. XXXIX₃, 395.
 88. A. J. S. XXXII₃, 304; XXXIII₃, 115.
 89. A. J. S. XXXV₃, 275.
 90. A. J. S. XXVII₃, 299; XXX₃, 312.
 91. A. J. S. XXXIII₃, 228.
 92. A. J. S. XXXI₃, 145; Proc. A. A. A. S., 1885, 246.

93. A. J. S. XXXI₃, 460; School of Mines Quarterly, Columbia Coll., VII, No. 2, 188.
 94. A. J. S. XXXIV₃, 381.
 95. A. J. S. XXX₃, 235; XXXII₃, 311.
 96.
 97. A. J. S. XXXIII₃, 233.
 98. A. J. S. XXXVI₃, 276.
 99. A. J. S. XXXIV₃, 475.
 100. A. J. S. XXXIV₃, 387, 476.
 101. A. J. S. XXXIV₃, 471.
 102. Science, N. Y., March 7, 1890, 167., 103.
 104.
 105.
 106.

CATALOGUE III.—Discovered

Number.	Locality.	Iron or stone.	Weight.
1	Tucuman, Argentine Republic.....	I.	1 lb.
2	Crawford Co., Arkansas.....	I.	30,000 lbs.
3	British America.....	S.	1.4 "
4	Canyon City, Trinity Co., Cal.	I.	386 "
5	Los Angeles, Cal.	I.	19 "
6	San Bernardino Co., Cal.	I.	80 "
7	Chihuahua.....	S.	
8	Chihuahua.....	I.	3,853 lbs.
9	Atacama, Chili.....	I.	
10	Sierra de Chaco, Chili.....	S. & I.	
11	Durango, Mexico.....	I.	72.75 "
12	Oaxaca, Mexico.....	I.	
13	San Luis Potosi, Mexico.....	I.	
14	Xiquipilco, Mexico.....	I.	108.6 "
15	Mexico.....	I.	192 "
16	Mexico.....	I.	
17	Mexico.....	I.	
18	Mexico.....	I.	2,942 lbs.
19	Mexico.....	I.	0.5 lb.
20	Mexico.....	I.	
21	Mexico.....	I.	5,000 lbs.
22	Bates Co., Missouri.....	I.	90 "
23	Ironton, Missouri.....	I.	
24	Rasgata, New Granada.....	I.	129 lbs.
25	Rockingham Co., N. C.	I.	11 "
26	Green Co., Tenn.....	I.	6 "
27	Green Co., Tenn.....	I.	290 "
28	Jefferson Co., Tenn.....	S.	1.4 "
29	I.	5.5 "
30	Augusta Co., Va.....	I.	3.5 "
31	Augusta Co., Va.....	I.	36 "
32	Augusta Co., Va.....	I.	56 "
33	Augusta Co., Va.....	I.	2.2 "
34	Kiowa Co., Kansas.....	I.	
35	Chili.....	I.	95.5 lbs.
36	Jackson Co., Oregon.....	I.	2 oz.

1. A. J. S. XXXIV₃, 59.
2. A. J. S. XV₂, 12.
3. Owen's 2d Geological Reconnaissance of Ark., 408.
4. Trans. Roy. Soc. Canada, IV, sect. III, 97.
5. A. J. S., XXIX₃, 469.
6. A. J. S. IV₃, 495.
7. A. J. S. XXXV₃, 490.
8. { A. J. S. XIX₂, 163; II₃, 335; III₃, 207.
Proc. A. A. A. S. 1871, 266.
9. Buchner, 127.
10. Buchner, 131.
11. A. J. S. XXXVII₃, 439.
12. A. J. S. XV₂, 21.
13. Buchner, 149.
14. A. J. S. XV₂, 20; XXII₂, 374; XXIV₂, 295.
15. A. J. S. XXIX₃, 232.
16. Proc. A. A. A. S. 1871, 269.
17. Proc. A. A. A. S. 1871, 269.

Meteorites without Date.

Number.	Authority.	Remarks.
1	R. B. Riggs.....	Found in Col. Abert's collection of minerals presented to the National Museum.
2		
3		
4	A. P. Coleman.....	Brought to Coburg, Canada, in 1869.
5	C. U. Shepard.	
6	C. T. Jackson.	Put through an ore-crusher before its character was known.
7	G. P. Merrill.....	
8	J. L. Smith.	
9		
10		Numerous pieces.
11	J. E. Whitfield.	
12		The San Gregorio meteorite, 6.5 feet long, 5.5 wide, 4.0 high.
13		
14	"The largest yet found in that vicinity."
15	N. T. Lupton.	
16	J. L. Smith.....	The "Butcher" meteorites—six, weighing 290, 430, 438, 550, 580, and 654 lbs.
17	J. L. Smith.....	
18	J. L. Smith.....	Found in a collection of minerals from Mexico.
19	J. L. Smith.....	
20	Now in National Museum, Washington, D. C. Estimated weight, 2,500 lbs.
21	W. M. Pierson.	
22	G. C. Brodhead.	Small specimen.
23	
24		Property of the Smithsonian Institution; place of discovery unknown.
25	J. L. Smith.	
26	C. U. Shepard.....	Riggs considers this a doubtful specimen.
27	W. P. Blake.	
28	R. B. Riggs.....	Probably found in Texas.
29	L. G. Eakins.....	
30	J. W. Mallet.	Found by "cowboys" before that portion of Kansas was settled; fragments weighing in the aggregate more than 1,600 lbs. discovered.
31	J. W. Mallet.	
32	J. W. Mallet.	Found about 10 or 12 leagues east of the port of Chañalar; not yet described.
33	G. F. Kunz and J. W. Mallet.	
34	F. H. Snow.....	Piece of a mass found by a miner.
35	Ward and Howell.....	
36	Ward and Howell.....	

- 18. Proc. A. A. S. 1871, 269.
- 19. A. J. S. XLV₂, 77.
- 20.
- 21. Smithsonian Report, 1873, 419.
- 22. A. J. S. X₃, 401; XII₁₃, 213.
- 23.
- 24. A. J. S. XV₂, 11.
- 25. A. J. S. XIII₃, 213.
- 26. A. J. S. XXI₃, 119.
- 27. A. J. S. XXXI₃, 41.
- 28. A. J. S. XXXIV₃, 60.
- 29. A. J. S. XXXIX₃, 59.
- 30. A. J. S. II₃, 10.
- 31. A. J. S. II₃, 10.
- 32. A. J. S. II₃, 10.
- 33. A. J. S. XXXIII₃, 58.
- 34. Science N. Y., Vol. XV, No. 379, 290; No. 384, 359
- 35.
- 36.

CATALOGUE IV.-

Ref. number.	DATE.			TIME OF SHOWER.		Time of max. flight.	Whole number counted.	Max. hourly rate.	Radiant point.	No. of observ's.
	Year.	Month.	Day.	Begin-ning.	End.					
				<i>h. m.</i>	<i>h. m.</i>	<i>h. m.</i>				
1	1803	April...	19	13 0	15 0	800
2	1833	Nov.....	13	9 0	Sunrise	16 0	200,000	"Bend of the Sickle" in Leo
3	1834	" ...	12	14 50	17 25	17 0	18	1
4	1834	" ...	12	Many.	"In Leo"
5	1835	" ...	13
6	1835	" ...	13
7	1835	" ...	13
8	1836	" ...	12	14 0	16 0	248
9	1836	" ...	12	15 0	18 15	253
10	1836	" ...	12	15 30	16 0	15 40	29
11	1836	" ...	12	23	1
12	1836	" ...	12	75
13	1836	" ...	12	500
14	1836	" ...	12	18
15	1837	Aug. ...	9	8 0	15 0	$\alpha = 55^\circ, \delta = +60^\circ$	1
16	1837	Nov.....	12	13 5	Sunrise	16 30	226	Near μ Leonis	8
17	1837	" ...	12	14 0	"	70	In Leo	1
18	1837	" ...	12	14 0	18 0	45	"	1
19	1837	" ...	12	14 45	16 37	74	12
20	1837	" ...	12	15 15	17 15	16 0	34	17	In Leo	1
21	1837	" ...	12	15 45	17 0	52	In Leo	1
22	1838	April...	20	10 0	16 0	154	"	2
23	1838	Aug. ...	8	11 30	12 30	20	$\alpha = 55^\circ, \delta = +60^\circ$	1
24	1838	" ...	9	9 30	16 20	16 15	54	$\alpha = 35^\circ, \delta = +69^\circ$	1
25	1838	" ...	9	15 0	15 45	24	1
26	1838	" ...	10	8 55	10 0	36	In Cassiopeæ	3
27	1838	" ...	10	9 0	11 0	48	2
28	1838	" ...	10	9 30	16 0	122	Near ϵ Cassiopeæ	1
29	1838	" ...	10	14 30	16 0	65	"Sword handle of Perseus"	2
30	1838	Nov.....	11	12 0	18 0	15 30	199	53	In Leo	8
31	1838	" ...	12	12 0	17 0	13 30	131	37	"	8
32	1838	" ...	13	13 0	17 20	15 30	233	80	"	8
33	1838	" ...	22	13 20	15 30	14 30	50	25	"	8
34	1838	Dec.	6	8 0	17 0	113	In Perseus	5
35	1838	" ...	7	8 0	11 0	210	"	5
36	1838	" ...	7	10 0	11 0	78	"Zenith"	3
37	1838	" ...	8	7 15	9 0	59	3
38	1838	" ...	11	8 45	10 0	18	1
39	1838	" ...	12	6 0	13 30	28	3
40	1838	" ...	15	6 0	9 15	9	4
41	1839	April...	18	12 0	15 0	58	$\alpha = 273^\circ, \delta = +45^\circ$	2
42	1839	" ...	18	14 0	16 0	25	2
43	1839	" ...	19	12 15	13 15	19	4
44	1839	" ...	19	14 0	16 0	25	2
45	1839	Aug.	4	9 0	11 0	36	Vicinity of Cassiopeæ	2
46	1839	" ...	9	9 7	14 7	13 30	691	194	Sword handle of Perseus	4
47	1839	" ...	9	12 41	15 36	100	1
48	1839	" ...	10	9 0	16 0	187	66	1
49	1839	" ...	10	9 0	76	2
50	1839	" ...	10	9 30	10 0	33	"Algenib"	1

<p>1. A. J. S. XXXVI₁, 358; Va. Gazette and General Advertiser, April 23, 1803; N. H. Gazette, May 31, 1803; Med. Repository, N. Y., Vol. 1, 1804.</p> <p>2. A. J. S. XXV₁, 354, 363.</p> <p>3. A. J. S. XXVI₁, 335; XXVIII₁, 305.</p> <p>4. A. J. S. XXVII₁, 339.</p> <p>5. A. J. S. XXX₁, 375.</p> <p>6. " " " "</p> <p>7. A. J. S. XXX₁, 376.</p> <p>8. A. J. S. XXXI₁, 390.</p> <p>9. A. J. S. XXXI₁, 388.</p> <p>10. A. J. S. XXXI₁, 390.</p> <p>11. A. J. S. XXXI₁, 389.</p>	<p>12. A. J. S. XXXI₁, 391.</p> <p>13. A. J. S. XXXI₁, 392.</p> <p>14. A. J. S. XXXII₁, 392.</p> <p>15. A. J. S. XXXIII₁, 133.</p> <p>16. A. J. S. XXXIII₁, 379.</p> <p>17. " " " "</p> <p>18. " " " "</p> <p>19. " " " "</p> <p>20. " " " "</p> <p>21. " " " "</p> <p>22. A. J. S. XXXIV₁, 398.</p> <p>23. A. J. S. XXXV₁, 167.</p> <p>24. " " " "</p>
---	--

Meteor Showers.

Ref. number.	Authority.	Place of observation.	Remarks.
1	Richmond, Va., and Portsmouth, N. H.	"Fell too fast to be counted."
2	Prof. D. Olmstead.....	New Haven, Conn.....	Number estimated; seen throughout the Atlantic and Gulf States.
3	Prof. A. D. Bache.....	Philadelphia, Pa.	
4	Prof. A. C. Twining.....	West Point, N. Y.....	Observed on the morning of the 13th.
5	Amenia, N. Y.	"Unusual number;" hourly rate estimated at 40 or 50.
6	Mt. St. Mary's College, Md..	"Unusual number." Observed on the morning of the 14th.
7	Salisbury, N. C.....	"Unusual number."
8	New York, N. Y.....	Many seen that were not recorded.
9	S. Dunster.....	Springvale, Me.	
10	New Haven, Conn.....	Cloudy.
11	Cambridge, Mass.....	Observed one hour.
12	Newark, N. J.....	Whole number estimated at 400.
13	Randolph and Macon College, Va.	
14	J. L. Russell.....	Hingham, Mass.	
15	G. C. Schaeffer.....	New York, N. Y.....	Counted between 200 and 300.
16	Prof. D. Olmstead.....	New Haven, Conn.....	Majority left trains.
17	G. C. Schaeffer.....	New York, N. Y.....	Many trains.
18	Prof. F. A. P. Barnard.	New York, N. Y.	
19	Prof. E. Loomis.....	Hudson, Ohio.	
20	E. Fitch.....	New Haven, Conn.	
21	L. Obermeyer.....	Mt. St. Mary's College, Md.	
22	Prof. Wright.....	Knoxville, Tenn.	
23	G. C. Schaeffer.....	Barren Hill, Pa.	
24	T. R. Dutton.....	Wilmington Island, Ga.	
25	W. A. Sparks.....	Society Hill, S. C.	
26	J. D. Dana.....	Norfolk, Va.	
27	E. C. Herrick.....	New Haven, Conn.	
28	T. R. Dutton.....	Wilmington Island, Ga.	
29	C. G. Forshey.....	Rock Island, Ill.	
30	Prof. J. Lovering.....	Cambridge, Mass.	Only two observers after 17 hours.
31	Prof. J. Lovering.....	Cambridge, Mass.	
32	Prof. J. Lovering.....	Cambridge, Mass.	
33	Prof. J. Lovering.....	Cambridge, Mass.	
34	E. C. Herrick.....	New Haven, Conn.	
35	E. C. Herrick.....	New Haven, Conn.	
36	Prof. A. W. Smith.....	Middletown, Conn.	
37	E. C. Herrick.....	New Haven, Conn.	
38	E. C. Herrick.....	New Haven, Conn.	
39	E. C. Herrick.....	New Haven, Conn.	
40	E. C. Herrick.....	New Haven, Conn.	
41	E. C. Herrick.....	New Haven, Conn.	
42	Prof. E. Loomis.....	Hudson, Ohio.	
43	E. C. Herrick.....	New Haven, Conn.	
44	Prof. E. Loomis.....	Hudson, Ohio.	
45	E. C. Herrick.....	New Haven, Conn.	
46	E. C. Herrick.....	New Haven, Conn.	
47	T. R. Dutton.....	Columbia, Tenn.	
48	L. L. Knox.....	Middletown, Conn.	
49	Charles Baldwin.....	New York, N. Y.	
50	Prof. A. W. Smith.....	Middletown, Conn.	

- 25. A. J. S. XXXV₁, 167.
- 26. " " " "
- 27. " " " "
- 28. " " " "
- 29. Trans. Am. Phil. Soc. VII, 266.
- 30. A. J. S. XXXV₁, 323.
- 31. " " " "
- 32. " " " "
- 33. " " " "
- 34. A. J. S. XXXV₁, 361; XXXVI₁, 355.
- 35. A. J. S. XXXV₁, 361.
- 36. " " " "
- 37. " " " "

- 38. A. J. S. XXXV₁, 361.
- 39. " " " "
- 40. " " " "
- 41. A. J. S. XXXVI₁, 361.
- 42. " " " "
- 43. " " " "
- 44. " " " "
- 45. A. J. S. XXXVII₁, 325.
- 46. A. J. S. XXXVII₁, 325.
- 47. A. J. S. XXXVII₁, 203.
- 48. A. J. S. XXXVI₁, 325.
- 49. " " " "
- 50. " " " "

CATALOGUE IV.-

Ref. number.	DATE.			TIME OF SHOWER.		Time of max. flight.	Whole number counted.	Max. hourly rate.	Radiant point.	No. of observ's.
	Year.	Month.	Day.	Begin-ning.	End.					
51	1839	Aug.	10	h. m. 10 0	h. m. 13 0	h. m. 13 0	491	189	Sword handle of Perseus.....	4
52	1839	"	10	11 20	12 20		50		" " " " " " " "	1
53	1839	"	11	9 0	10 0		28		" " " " " " " "	3
54	1839	"	14	10 0	12 0		72	44	Bet. Cassiopeæ and Perseus..	3
55	1840	"	9	8 0	16 0		171		Sword handle of Perseus.....	1
56	1840	"	9	10 0	15 30	15 0	818	332	" " " " " " " "	4
57	1840	"	9	14 15	15 45		112	76	$\alpha = 30^\circ, \delta = + 63^\circ 30'$	1
58	1840	"	10	15 0	15 35		35		" " " " " " " "	1
59	1841	April..	18	8 30	11 30		60		$\alpha = 198^\circ, \delta = - 8^\circ$	1
60	1841	"	19	11 0	13 9		20		" " " " " " " "	3
61	1841	Aug.	9	12 0	15 0		49		" " " " " " " "	1
62	1841	"	10	9 0	10 0		60		" " " " " " " "	2
63	1842	April..	20	10 20	16 0	15 30	151	55	Corona Borealis	5
64	1842	Aug.	8	9 50	16 0		90		" " " " " " " "	7
65	1842	"	9	10 0	12 0		133	79	" " " " " " " "	7
66	1842	"	10	10 10	11 0		89		Sword handle of Perseus.....	7
67	1842	Nov.	13	15 0	16 0		46		" " " " " " " "	2
68	1844	Aug.	9	11 20	15 0	13 30	367	139	" " " " " " " "	4
69	1844	"	10	8 0	13 0		117		β Cassiopeæ	1
70	1844	"	11	9 50	15 0	14 0	622	152	" " " " " " " "	4
71	1844	"	12	13 50	15 0		46		" " " " " " " "	2
72	1845	"	9	10 0	13 0		81		Sword handle of Perseus.....	1
73	1846	"	10	12 0	14 0		46		" " " " " " " "	4
74	1846	"	11	9 0	10 0		41		" " " " " " " "	2
75	1847	"	10	10 0	12 0		41		Head of Perseus.....	1
76	1847	"	10	12 0	14 0		415		" " " " " " " "	4
77	1847	"	11	9 15	10 0		37		" " " " " " " "	4
78	1848	"	9	13 0	15 30	15 15	475	281	In Perseus	4
79	1848	"	9	13 30	15 30		216		" " " " " " " "	3
80	1848	"	9	15 0	16 45		55		In Perseus	1
81	1849	April..	19	13 0	14 0		54		" " " " " " " "	3
82	1849	Aug.	10	10 0	12 30		260		" " " " " " " "	4
83	1850	"	9	12 40	15 0	13 30	451	216	In Perseus.....	3
84	1850	"	10	10 0	12 0		312		" " " " " " " "	3
85	1850	"	10	12 0	15 0		351		" " " " " " " "	2
86	1852	"	9	14 0	14 40		19		" " " " " " " "	1
87	1853	"	10	11 45	15 25	14 30	408	119	Sword handle of Perseus.....	3
88	1855	"	9	10 25	14 30	13 30	385	110	" " " " " " " "	3
89	1855	"	10	10 30	13 0	13 30	290	136	" " " " " " " "	3
90	1855	"	11	10 0	11 0		37		" " " " " " " "	1
91	1855	"	11	13 55	15 5		58		" " " " " " " "	1
92	1855	"	12	13 30	14 45		36		" " " " " " " "	1
93	1856	"	10	11 5	14 50	12 30	283	100	" " " " " " " "	3
94	1858	"	9	10 45	15 10	14 35	128		" " " " " " " "	1
95	1858	"	9	12 5	14 5		56		" " " " " " " "	1
96	1858	"	10	8 30	9 0		11		" " " " " " " "	1
97	1858	"	10	13 7	13 52		29		" " " " " " " "	1
98	1858	"	11	14 15	15 15		33		" " " " " " " "	1
99	1859	July	29	10 30	11 30		16		" " " " " " " "	1
100	1859	Aug.	5	11 0	12 0		19		" " " " " " " "	1
101	1859	"	9	11 0	13 0		64		" " " " " " " "	3
102	1859	"	9	13 0	15 30	15 15	304	156	Sword handle of Perseus.....	4
103	1859	"	9	14 15	15 30		56		$\alpha = 38^\circ 30', \delta = + 57^\circ 15'$	1
104	1860	"	9	10 0	15 10	14 30	588	155	Sword handle of Perseus.....	7

51. A. J. S. XXXVII₁, 325.
 52. Trans. Am. Phil. Soc. VII, 268.
 53. " " " " " " " "
 54. A. J. S. XXXVII₁, 325.
 55. Trans. Am. Phil. Soc. VII, 270.
 56. A. J. S. XXXIX₁, 328.
 57. " " " " " " " "
 58. " " " " " " " "
 59. A. J. S. XLII₁, 397.
 60. " " " " " " " "
 61. A. J. S. XLI₁, 399.
 62. " " " " " " " "
 63. A. J. S. XLIII₁, 212.
 64. A. J. S. XLIII₁, 377.

65. A. J. S. XLIII₁, 377.
 66. " " " " " " " "
 67. A. J. S. XLIV₁, 209.
 68. A. J. S. XLVIII₁, 316.
 69. A. J. S. XLVIII₁, 320.
 70. A. J. S. XLVIII₁, 316.
 71. " " " " " " " "
 72. A. J. S. I₂, 86.
 73. A. J. S. II₂, 125.
 74. " " " " " " " "
 75. Sidereal Messenger, II, 14.
 76. A. J. S. VI₂, 278.
 77. " " " " " " " "
 78. A. J. S. VI₂, 279.

Meteor Showers—Cont'd.

Ref. number.	Authority.	Place of observation.	Remarks.
51	E. C. Herrick.....	New Haven, Conn.	
52	C. G. Forshey	St. Louis, Mo.	
53	C. G. Forshey	Illinois River.	
54	E. C. Herrick.....	New Haven, Conn.	
55	C. G. Forshey	Philadelphia, Pa.	
56	E. C. Herrick.....	New Haven, Conn.....	Moon set at 14h. 0m.
57	G. C. Schaeffer	Jamaica, L. I.	
58	G. C. Schaeffer	Jamaica, L. I.	
59	C. G. Forshey	Vidalia, La.....	No trains; paths short.
60	E. C. Herrick	New Haven, Conn.	
61	Dr. J. S. Huntington, U. S. N.	Pensacola, Fla.	
62	Dr. John Locke	Cincinnati, Ohio.	
63	E. C. Herrick.....	New Haven, Conn.....	Moon set at 15h. 0m.
64	E. C. Herrick.....	New Haven, Conn.....	Cloudy; actual observing time 1h. 10m.
65	E. C. Herrick.....	New Haven, Conn.....	Cloudy.
66	E. C. Herrick.....	New Haven, Conn.....	Cloudy.
67	E. C. Herrick.....	New Haven, Conn.....	Cloudy after 16h.
68	E. C. Herrick.....	New Haven, Conn.....	Partially cloudy.
69	S. R. Williams.....	Canonsburg, Pa.	
70	E. C. Herrick.....	New Haven, Conn.	
71	E. C. Herrick.....	New Haven, Conn.	
72	E. C. Herrick.....	New Haven, Conn.....	Cloudy.
73	E. C. Herrick.....	New Haven, Conn.	
74	E. C. Herrick.....	New Haven, Conn.	
75	C. G. Forshey	Pass Christian, La.....	33 conformable with the radiant.
76	W. M. Smith	Manlius, N. Y	Cloudy after 14h.
77	E. C. Herrick.....	New Haven, Conn.....	Completely cloudy after 10h.
78	E. C. Herrick.....	New Haven, Conn.	
79	E. C. Herrick.....	"On Mt. Carmel."	
80	C. G. Forshey	Mouth of Miss. river.	
81	E. C. Herrick.....	New Haven, Conn.	
82	S. R. Williams.....	Canonsburg, Pa.	
83	E. C. Herrick.....	New Haven, Conn.	
84	E. C. Herrick.....	New Haven, Conn.	
85	E. C. Herrick.....	New Haven, Conn.	
86	John Edmunds.....	New Haven, Conn.	
87	E. C. Herrick.....	New Haven, Conn.	
88	E. C. Herrick.....	New Haven, Conn.....	306 conformable.
89	E. C. Herrick.....	New Haven, Conn.....	242 conformable.
90	E. C. Herrick.....	New Haven, Conn.....	One-half conformable.
91	E. C. Herrick.....	New Haven, Conn.....	45 conformable.
92	E. C. Herrick.....	New Haven, Conn.....	20 conformable.
93	E. C. Herrick.....	New Haven, Conn.	
94	F. Bradley	Observed on railroad between Davenport and Chicago, Ill.
95	Prof. A. C. Twining ..	Cleveland, Ohio.	
96	Prof. A. C. Twining ..	Cleveland, Ohio.	
97	Prof. A. C. Twining ..	Cleveland, Ohio.	
98	Prof. A. C. Twining ..	Cleveland, Ohio.	
99	F. Bradley	Chicago, Ill	6 conformable to the August radiant.
100	F. Bradley	Chicago, Ill	8 conformable to the August radiant.
101	F. Bradley	Chicago, Ill.	
102	F. Bradley	Chicago, Ill	Only a few unconfirmable meteors.
103	Prof. A. C. Twining ..	Boston, Mass.	
104	E. C. Herrick.....	New Haven, Conn.	

- 79. A. J. S. VI₂, 279.
- 80. A. J. S. XI₂, 133.
- 81. A. J. S. VII₂, 429.
- 82. " " "
- 83. A. J. S. XI₂, 130.
- 84. " " "
- 85. " " "
- 86. A. J. S. XIV₂, 430.
- 87. A. J. S. XVI₂, 288.
- 88. A. J. S. XX₂, 285.
- 89. " " "
- 90. " " "
- 91. A. J. S. XX₂, 285.

- 92. A. J. S. XX₂, 285.
- 93. A. J. S. XXII₂, 290.
- 94. A. J. S. XXVI₂, 435.
- 95. " " "
- 96. " " "
- 97. " " "
- 98. " " "
- 99. A. J. S. XXVIII₂, 446.
- 100. " " "
- 101. " " "
- 102. " " "
- 103. " " "
- 104. A. J. S. XXX₂, 296.

CATALOGUE IV.—

Ref. number.	DATE.			TIME OF SHOWER.		Time of max. flight.	Whole number counted.	Max. hourly rate.	Radiant point.	No. of observ's.
	Year.	Month.	Day.	Begin-ning.	End.					
105	1860	Aug. ...	9	h. m. 11 30	h. m. 13 0	h. m. 12 30	57	Sword handle of Perseus.....	1
106	1860	"	10	11 0	14 0	381	146	$\alpha = 32^\circ, \delta = +61^\circ$	5
107	1860	Nov. ...	7	7 0	9 0	46	N. E. of zenith	3
108	1860	"	12	6 30	17 0	14 30	423	68
109	1860	"	12	10 0	16 0	14 30	381	90	In Leo.....	5
110	1860	"	13	6 15	17 0	13 30	500	83
111	1860	"	13	15 15	16 15	21	In the "Sickle" in Leo	1
112	1860	"	14	15 40	16 25	15	"	1
113	1860	Dec. ...	12	8 20	12 0	11 30	180	60
114	1861	April...	19	14 45	16 0	52	2
115	1861	July ...	3	9 5	10 5	36	4
116	1861	Aug. ...	10	8 0	15 15	13 30	397	75	β Persei	2
117	1861	"	10	10 0	13 0	12 30	289	119	Sword handle of Perseus.....	4
118	1861	"	10	10 25	14 45	12 30	289	85	Between $\eta, \gamma,$ and τ Persei ..	2
119	1861	"	10	10 30	13 0	95	In Perseus	1
120	1861	"	10	12 25	13 0	12 30	160	37	1
121	1861	"	11	8 15	10 15	52	2
122	1861	"	11	9 30	12 0	47	In Perseus	1
123	1861	Nov. ...	10	13 0	15 0	11	$\alpha = 156^\circ 30', \delta = +40^\circ 40'$	1
124	1861	"	11	14 15	16 40	32	Near γ Leonis.....	1
125	1861	"	11	14 15	15 30	32	In Leo.....	2
126	1861	"	11	16 0	17 0	15	"	1
127	1861	"	12	15 0	17 0	16 30	130	72	"	4
128	1861	"	12	15 0	16 30	15	1
129	1861	"	11	15 12	15	11	4
130	1861	"	12	15 20	16 20	27	4
131	1861	"	13	10 0	13 0	15	Zenith.....	1
132	1861	"	13	15 0	17 30	19	1
133	1861	"	13	15 15	17 38	23	1
134	1862	Aug. ...	9	14 0	15 40	90	In Perseus	2
135	1862	"	10	12 30	15 30	51	"	1
136	1862	Nov. ...	13	12 0	15 0	59	In Leo.....	2
137	1862	"	13	15 15	17 5	31	"	1
138	1862	"	13	16 30	17 30	17	1
139	1863	Aug. ...	10	8 30	10 0	41	1
140	1863	"	10	9 0	12 0	399	In Perseus.....	4
141	1863	"	10	9 0	13 0	257	2
142	1863	"	10	9 15	10 15	96	3
143	1863	"	10	10 0	13 50	130	1
144	1863	"	10	12 0	14 0	289	3
145	1863	"	10	13 0	14 0	87	1
146	1863	"	10	15 10	15 40	153	6
147	1863	"	11	9 0	11 0	67	1
148	1863	Nov. ...	11	10 0	15 0	105
149	1863	"	11	11 22	14 52	185
150	1863	"	12	10 0	14 0	129
151	1863	"	12	10 20	15 51	199
152	1863	"	13	8 0	14 0	107	8
153	1863	"	13	9 30	13 30	32
154	1863	"	13	10 10	17 7	15 0	213	46	In Leo.....	6
155	1863	"	13	10 38	17 16	15 30	316	69	In the "Sickle" in Leo.....	7

- 105. A. J. S. XXXI₂, 136.
- 106. " " " " " "
- 107. A. J. S. XXXI₂, 137.
- 108. A. J. S. XXXI₂, 138.
- 109. A. J. S. XXXI₂, 139.
- 110. A. J. S. XXXI₂, 138.
- 111. A. J. S. XXXI₂, 137.
- 112. " " " " " "
- 113. A. J. S. XXXI₂, 138.
- 114. A. J. S. XXXII₂, 294.
- 115. A. J. S. XXXII₂, 296.
- 116. A. J. S. XXXII₂, 294.
- 117. " " " " " "

- 118. A. J. S. XXXII₂, 294.
- 119. A. J. S. XXXII₂, 447.
- 120. A. J. S. XXXII₂, 295.
- 121. A. J. S. XXXIII₂, 148.
- 122. A. J. S. XXXII₂, 447.
- 123. A. J. S. XXXIII₂, 148.
- 124. " " " " " "
- 125. A. J. S. XXXIII₂, 146.
- 126. " " " " " "
- 127. " " " " " "
- 128. A. J. S. XXXIII₂, 147.
- 129. A. J. S. XXXIII₂, 148.
- 130. " " " " " "

Meteor Showers—Cont'd.

Ref. number.	Authority.	Place of observation.	Remarks.
105	F. Bradley	Chicago, Ill.	
106	F. Bradley	Chicago, Ill.	
107	Prof. C. U. Shepard.....	Off Cape Hatteras.	
108	Francis Miller	Montgomery Co., Md.....	Several students assisted in the observations.
109	Prof. D. Kirkwood	Bloomington, Ind.....	Half the number conformable after 13h.
110	Francis Miller	Montgomery Co., Md.....	Several students assisted in the observations.
111	Prof. H. A. Newton.....	New Haven, Conn.	
112	Prof. H. A. Newton.....	New Haven, Conn.	
113	Francis Miller	Montgomery Co., Md.....	Several students assisted in the observations.
114	E. C. Herrick.....	New Haven, Conn.	No decided radiant.
115	E. C. Herrick.....	New Haven, Conn.	
116	F. W. Russell	Natick, Mass.	
117	E. C. Herrick.....	New Haven, Conn.....	A very large meteor at 11h. 30m.
118	B. V. Marsh.....	Burlington, N. J.....	A very large meteor at 11h. 23m.
119	Prof. A. C. Twining ...	New Haven, Conn.	
120	R. M. Gummere	Burlington, N. J.	
121	John Roberts	Madison, Ind.	
122	Prof. A. C. Twining ...	New Haven, Conn.	
123	F. W. Russell	Natick, Mass.	
124	F. W. Russell	Natick, Mass.	
125	Prof. A. C. Twining ...	New Haven, Conn.	
126	E. C. Herrick.....	New Haven, Conn.	
127	Prof. A. C. Twining ...	New Haven, Conn.	
128	S. J. Gummere	Burlington, N. J.	
129	Prof. D. Kirkwood	Bloomington, Ind.	
130	Prof. D. Kirkwood	Bloomington, Ind.	
131	F. W. Russell	Natick, Mass.	
132	S. J. Gummere	Burlington, N. J.	
133	B. V. Marsh	Germantown, Pa.....	Thirteen left trains.
134	F. W. Russell.....	Winchendon, Mass.	
135	B. V. Marsh	Germantown, Pa.	
136	Prof. S. J. Gummere...	Haverford College, Pa.	
137	B. V. Marsh	Germantown, Pa.	
138	Prof. A. C. Twining....	New Haven, Conn.	
139	W. G. Bryant.....	Winchendon, Mass.	
140	F. W. Russell.....	Natick, Mass.	
141	J. G. Pinkham.....	Manchester, Me.	
142	Prof. H. A. New.on.....	New Haven, Conn.	
143	B. V. Marsh.....	Philadelphia, Pa.	
144	F. W. Russell.....	Natick, Mass.	
145	F. Bradley.....	Chicago, Ill.	
146	Prof. H. A. Newton.....	New Haven, Conn.	
147	F. W. Russell.....	Natick, Mass.	
148	Prof. O. N. Stoddard...	Oxford, Ohio.	
149	Prof. H. L. Smith.....	Kenyon College, Ohio.	
150	Prof. O. N. Stoddard...	Oxford, Ohio.	
151	Prof. H. L. Smith.....	Kenyon College, Ohio.	
152	Prof. A. D. Bache.....	Coast Survey Office, Washington, D. C.	More than half the tracks plotted.
153	Prof. H. A. Newton.....	New Haven, Conn.....	Hazy.
154	Capt. J. M. Gilliss, U. S. N.	U. S. Naval Observatory.	Track of each meteor plotted.
155	Prof. S. J. Gummere...	Haverford College, Pa.....	200 tracks plotted.

- 131. A. J. S. XXXIII₂, 148.
- 132. A. J. S. XXXII₂, 147.
- 133. " " " "
- 134. A. J. S. XXXIV₂, 295.
- 135. " " " "
- 136. A. J. S. XXXV₂, 146.
- 137. " " " "
- 138. " " " "
- 139. A. J. S. XXXVI₂, 306.
- 140. A. J. S. XXXVI₂, 305.
- 141. A. J. S. XXXVI₂, 304.
- 142. A. J. S. XXXVI₂, 302.
- 143. A. J. S. XXXVI₂, 304.

- 144. A. J. S. XXXVI₂, 305.
- 145. " " " "
- 146. A. J. S. XXXVI₂, 302.
- 147. A. J. S. XXXVI₂, 305.
- 148. A. J. S. XXXVII₂, 144.
- 149. A. J. S. XXXVII₂, 146.
- 150. A. J. S. XXXVII₂, 144.
- 151. A. J. S. XXXVII₂, 146.
- 152. A. J. S. XXXVII₂, 145.
- 153. A. J. S. XXXVII₂, 143.
- 154. A. J. S. XXXVII₂, 141.
- 155. A. J. S. XXXVII₂, 142.

Meteor Showers—Cont'd.

Ref. number.	Authority.	Place of observation.	Remarks.
156	B. V. Marsh.....	Germantown, Pa.....	Hazy. { *On Nov. 13, 55 tracks were plotted in Phila. by H. D. Vail, 56 tracks were plotted in West Chester by B. Hooper, 27 tracks were plotted in Easton by E. Menline, 23 tracks were plotted in St. Louis by Prof. W. Chauvenet.
157	C. E. Dutton.....	Norfolk, Va.	
158	J. H. Worrall.....	West Chester, Pa.....	
159	H. P. Tuttle.....	Off Charleston, S. C.	
159 ₁	G. Scarborough.....	Riverside, Kan.	
160	H. S. Osborn.....	Belvidere, N. J.	
161	Francis Bradley.....	Chicago, Ill.....	Cloudy in the Middle and N. E. States.
162	W. H. R. Lykins.....	Lawrence, Kan.	
163	B. V. Marsh.....	Philadelphia, Pa.	
163 ₁	Prof. H. A. Newton.....	New Haven, Conn.	
164	G. Scarborough.....	Riverside, Kan.	
165	Francis Bradley.....	Chicago, Ill.	
166	G. Scarborough.....	Riverside, Kan.	
167	R. H. Stretch.....	Virginia City, Nevada.	
168	R. H. Stretch.....	Virginia City, Nevada.	
169	Prof. A. C. Twining.....	Hinsdale, Mass.	
170	Prof. A. C. Twining.....	Hinsdale, Mass.	
171	Prof. H. A. Newton.....	New Haven, Conn.	
172	O. B. Wheeler.....	Detroit, Mich.	
173	O. B. Wheeler.....	Detroit, Mich.	
174	D. Trowbridge.....	Hector, N. Y.	
175	Prof. H. A. Newton.....	Sherburne, N. Y.	
176	D. Trowbridge.....	Hector, N. Y.....	Some left trains lasting 6 or 7 seconds.
177	F. W. Russell.....	Natick, Mass.	
178	Isaac Pierson.....	Vineyard Sound.....	Off Martha's Vineyard, Mass.
179	B. V. Marsh.....	Germantown, Pa.	
180	R. M. Gummere.....	Germantown, Pa.	
181	Prof. H. A. Newton.....	Sherburne, N. Y.	
182	J. H. Worrall.....	West Chester, Pa.	
183	D. Trowbridge.....	Hector, N. Y.	
184	J. H. Worrall.....	West Chester, Pa.	
185	James Ferguson.....	U. S. Naval Observatory.	
186	James Ferguson.....	U. S. Naval Observatory.	
187	F. Bradley.....	Chicago, Ill.	
188	Prof. Hopkins.....	Williamstown, Mass.....	Williams College. No observations from 12h. 45m. to 13h. 0m.
189	C. G. Rockwood.....	Newark, N. J.	
190	James Ferguson.....	U. S. Naval Observatory.	
191	Prof. H. A. Newton.....	New Haven, Conn.	
192	F. Bradley.....	Chicago, Ill.....	F. W. Russell, of Cambridge, Mass., observed several evenings in first half of November, and counted, in all, 875 meteors.
193	C. S. Lyman.....	New Haven, Conn.	
194	Prof. Hinrichs.....	Iowa City, Iowa.	
195	B. V. Marsh.....	Germantown, Pa.	
196	O. B. Wheeler.....	Detroit, Mich.	
197	Prof. H. A. Newton.....	New Haven, Conn.	
198	Prof. D. Kirkwood.....	Canonsburg, Pa.	
199	B. V. Marsh.....	Germantown, Pa.	
200	Maria Mitchell.....	Vassar College, N. Y.....	Observed seven hours. Williams College.
201	Prof. Hopkins.....	Williamstown, Mass.....	
202	Prof. Hinrichs.....	Iowa City, Iowa.	
203	John T. Wheeler.....	Concord, N. H.	
204	Prof. C. S. Lyman.....	New Haven, Conn.	
205	Prof. H. A. Newton.....	New Haven, Conn.	
206	C. G. Rockwood.....	Newark, N. J.	

182. A. J. S. XLII₂, 429.
 183. A. J. S. XLII₂, 286.
 184. A. J. S. XLII₂, 429.
 185. A. J. S. XLIII₂, 78; Nov. Meteors, 1866,
 U. S. N. Obs'y, 8vo.
 186. " " "
 187. A. J. S. XLIII₂, 78.
 188. " " "
 189. " " "
 190. A. J. S. XLIII₂, 78, Nov. Meteors, 1866,
 U. S. N. Obs'y, 8vo.
 191. A. J. S. XLIII₂, 78.
 192. " " "
 193. " " "

194. A. J. S. XLIII₂, 78.
 195. " " "
 196. " " "
 197. " " "
 198. " " "
 199. " " "
 200. " " "
 201. " " "
 202. " " "
 203. Smithsonian Archives (not yet printed).
 204. A. J. S. XLIII₂, 78.
 205. " " "
 206. " " "
 *A. J. S. XXXVII₂, 141.

Meteor Showers—Cont'd.

Ref. number.	Authority.	Place of observation.	Remarks.
207	B. V. Marsh	Germantown, Pa.	
208	Prof. A. C. Twining.....	New Haven, Conn.	
209	The Denver News.....	Denver, Col.	
210	W. A. Anthony.....	Franklin, N. Y.	
211	James Ferguson.....	U. S. Naval Observatory.	
212	Prof. A. C. Twining.....	New Haven, Conn.	
213	Maria Mitchell.....	Vassar College, N. Y.	
214	James Ferguson.....	U. S. Naval Observatory.....	120 tracks plotted on charts from Nov. 9 to Nov. 17, inclusive.
215	James Ferguson.....	U. S. Naval Observatory.	Observations made in the evening.
216	R. Hayes	St. Louis, Mo.....	"Moon two days past the full."
217	F. W. Russell.....	Winchendon, Mass.....	
218	B. V. Marsh	Philadelphia, Pa.	
219	C. H. Darlington.....	Philadelphia, Pa.	
220	Lewis Swift.....	Marathon, N. Y.	
221	F. W. Russell.....	Winchendon, Mass.	
222	Lewis Swift.....	Marathon, N. Y.	
223	F. W. Russell.....	Winchendon, Mass.	
224	Prof. T. C. Wylie.....	Bloomington, Ind.	
225	Prof. H. A. Newton.....	New Haven, Conn.	Cloudy from 12h. 0m. to 15h. 15m.
226	Prof. N. R. Leonard.....	Iowa City, Iowa.....	
227	S. J. Gummere	Haverford College, Pa.	
228	Prof. F. H. Snow.....	Lawrence, Kan.	
229	Prof. C. A. Young.....	Hanover, N. H.....	Dartmouth College.
230	Prof. T. H. Safford.....	Chicago, Ill.....	Number of observers varied from 8 to 30.
231	Francis Bradley.....	Evanston, Ill.	Several observers.
232	James McClure	Philadelphia, Pa.....	
233	San Francisco Times.....	San Francisco, Cal.	
234	Prof. H. A. Newton.....	New Haven, Conn.....	One-third of the sky covered with clouds.
235	G. F. Kingston.....	Toronto, Canada.	
236	Robert B. Taber.....	New Bedford, Mass.	
237	Profs. Newcomb and Eastman.	U. S. N. Observatory	147 tracks mapped.
238	Prof. J. C. Watson.....	Ann Arbor, Mich.	
239	Prof. W. Harkness.....	Richmond, Va.	
240	Mrs. J. H. Trumbull.....	Hartford, Conn.	
241	Prof. G. W. Hough.....	Dudley Observatory	* In Chihuahua, Mexico, the meteors fell so fast they could not be counted; often 20 or 30 visible at once.
242	J. N. Flint.....	Canaseraga, N. Y.	
243	Prof. A. C. Twining.....	New Haven, Conn.	
244	J. D. Parker.....	Topeka, Kan.	
245	Prof. E. Loomis.....	New Haven, Conn.....	Observed one hour.
246	C. G. Rockwood	Durham, Conn.	
247	Robert B. Taber.....	New Bedford, Mass	Actual observing time 4h. 35m.
248	G. T. Kingston.....	Toronto, Canada.	
249	T. A. Wylie.....	Bloomington, Ind.	
250	W. S. Gilman, Jr.....	Palisades, N. Y.....	† Several bright meteors were seen during the Nov. shower in 1868.
251	B. J. Gilman.....	Williamstown, Mass.	
252	Prof. H. A. Newton.....	New Haven, Conn.	
253	S. J. Gummere	Haverford College, Pa.	
254	Prof. J. R. Eastman ..	U. S. N. Observatory.	
255	C. G. Rockwood	Brunswick, Me.	
256	Lewis Swift.....	Marathon, N. Y.....	The time when observations ended not given.
257	P. E. Chase.....	Haverford College, Pa.	
258	W. H. Pratt.....	Davenport, Iowa.....	48 were counted before 13h. 0m.
259	C. G. Berner.....	Vevay, Ind.	

235. A. J. S. XLV₂, 78.
 236. " " " "
 237. A. J. S. XLV₂, 225; Nov. Meteors, 1867, U. S. N. Obs'y, 8vo.
 238. A. J. S. XLV₂, 78.
 239. A. J. S. XLV₂, 225; Nov. Meteors, 1867, U. S. N. Obs'y, 8vo.
 240. A. J. S. XLV₂, 78.
 241. " " " "
 242. " " " "
 243. " " " "
 244. " " " "
 245. " " " "
 246. A. J. S. XLVII₂, 287.
 247. A. J. S. XLVII₂, 118.
 248. " " " "

249. A. J. S. XLVII₂, 118.
 250. " " " "
 251. " " " "
 252. " " " "
 253. " " " "
 254. Nov. Meteors, 1868, U. S. N. Obs'y, 8vo.
 255. A. J. S. XLVII₂, 118.
 256. " " " "
 257. A. J. S. XLVII₂, 118; Proc. Am. Phil. Soc. X, 539.
 258. A. J. S. XLVII₂, 118; Dav. Acad. Nat. Sci. I, 14.
 259. A. J. S. XLVII₂, 118.
 * A. J. S. XLV₂, 78.
 † A. J. S. XLVII₂, 399.

CATALOGUE IV.—

Ref. number.	DATE.			TIME OF SHOWER.		Time of max. flight.		Whole number counted.	Max. hourly rate.	Radiant point.	No. of observ's.
	Year	Month.	Day.	Begin-ning.	End.	h.	m.				
260	1868	Nov.	13	h. m.	h. m.	h.	m.	3,766	900		5
261	1868	"	13	14 20	17 58	14	30	4,278	1,650		4
262	1868	"	13	15 0	17 0			1,780			3
263	1868	"	13	15 7	17 38			455			1
264	1868	"	13	15 30	18 0			711			1
265	1868	"	13	16 0	17 15			250			1
266	1868	"	13	16 30	17 30			833			2
267	1869	"	13	7 0	19 0			830			4
268	1869	"	13	13 18	15 43			556			2
269	1870	"	12	12 30	15 30			31		In Leo.....	3
270	1870	"	13	11 5	15 45			153		"	6
271	1870	"	13	13 20	16 10			82		"	3
272	1870	"	13	13 30	15 0			13		"	1
273	1870	"	13	13 30	15 0			11		"	1
274	1871	Aug.	10	11 40	13 18			283			6
275	1871	Nov.	13					98			4
276	1872	Aug.	9	10 30	15 30			358			1
277	1872	"	9	14 45	15 55			62			2
278	1872	Nov.	24	7 30	12 30			217		2° or 3° N. of γ Andromedæ.....	1
279	1872	"	25	10 25	14 0			80			5
280	1872	"	27	6 5	10 0	6	30	720	300	μ Andromedæ.....	1
281	1872	"	27	6 10	11 45			143		$\alpha = 15^\circ, \delta = +30^\circ$	1
282	1872	"	27	6 38	8 48	6	55	1,750	1,300	$\alpha = 25^\circ, \delta = +43^\circ$	4
283	1875	Aug.	5	13 30	15 30			112		In Perseus	1
284	1876	Oct.	24	11 30	15 30			58		Bet. Orion and the Pleiades..	1
285	1876	Nov.	13	12 0	13 0			12		Bet. Orion	1
286	1877	"	13	13 55	15 45			54		In Leo.....	2
287	1885	"	27	6 0	6 24			44			1
288	1885	"	27	9 0				12		γ Andromedæ.....	3
289	1885	"	27	10 15	10 30			13			1
290	1885	"	27	7 15	7 45			100		2° N. W. of γ Andromedæ.....	1
291	1885	"	27	6 30	7 50			213			3
292	1885	"	27	7 0	9 0			328			4

260. A. J. S. XLVII₂, 118.

261. Nov. Meteors, 1868, U. S. N. Observatory, 8 vo.

262. A. J. S. XLVII₂, 118.

263. " " "

264. " " "

265. " " "

266. " " "

267. A. J. S. XLIX₂, 244.268. A. J. S. XLIX₂, 244.269. A. J. S. I₃, 30.

270. " " "

271. " " "

272. " " "

273. " " "

274. A. J. S. II₃, 227.275. A. J. S. II₃, 470.276. A. J. S. IV₃, 244.

Meteor Showers—Cont'd.

Ref. number.	Authority.	Place of observation.	Remarks.
260	Maria Mitchell	Vassar College, N. Y.	
261	Prof. J. R. Eastman ...	U. S. N. Observatory.....	90 tracks plotted.
262	B. J. Gilman.....	Williamstown, Mass.	
263	C. W. Tuttle.....	Boston, Mass.....	No observations between 16h. 4m. and
264	Robert B. Taber.....	New Bedford, Mass.	16h. 33m.
265	J. E. Hendricks.....	Des Moines, Iowa.	
266	B. F. Mudge.....	Manhattan, Kan.	
267	Frederickton, N. B.....	Reported by Prof. H. A. Newton.
268	George Davidson.....	Santa Barbara, Cal.	
269	Prof. H. A. Newton.....	New Haven, Conn.	
270	Prof. H. A. Newton.....	New Haven, Conn.	
271	C. G. Rockwood	Brunswick, Me.....	6 tracks plotted.
272	B. V. Marsh.....	Burlington, N. J.	
273	J. G. Gummere	Burlington, N. J.	
274	Prof. H. A. Newton.....	Sherburne, N. Y.	
275	Prof. H. A. Newton.....	New Haven, Conn.....	Only a few belonged to the November
276	Prof. C. A. Lyman.....	New Haven, Conn.	system.
277	R. W. McFarland	Oxford, Ohio.	
278	Prof. H. A. Newton.....	New Haven, Conn.	
279	Prof. H. A. Newton.....	New Haven, Conn.	
280	Prof. J. R. Eastman ...	U. S. N. Observatory.	
281	B. V. Marsh.....	Philadelphia, Pa.	
282	Prof. H. A. Newton.....	New Haven, Conn.	
283	Prof. J. R. Eastman ...	U. S. N. Observatory.....	Most of the meteors had short trains.
284	Prof. J. R. Eastman ...	U. S. N. Observatory.....	A few left long trains.
285	Prof. H. A. Newton.....	New Haven, Conn	Night mostly cloudy; 3 conformable to radiant.
286	Prof. D. Kirkwood	Bloomington, Ind	Night mostly cloudy.
287	Robert Brown.....	New Haven, Conn.	
288	H. A. Newton.....	New Haven, Conn	Hourly number estimated for 3 ob- servers, 100.
289	H. A. Newton.....	New Haven, Conn.	
290	C. A. Young	Princeton, N. J.	
291	A. Hall	Georgetown, D. C.	
292	D. Horigan	Georgetown, D. C.	

277. A. J. S. IV₃, 244.

278. A. J. S. V₃, 53.

279. " " "

280. " " "

281. " " "

282. " " "

283. Astron'l and Meteor'l Observ'ns, 1875.

284. Astron'l and Meteor'l Observ'ns, 1876.

285. A. J. S. XII₃, 473.

286. A. J. S. XV₃, 76.

287. A. J. S. XXXI₃, 78.

288. " " "

289. " " "

290. " " "

291. " " "

292. " " "

CATALOGUE V.-Sporadic Meteors.

Ref. number.	DATE.			Place of observation.	Apparent size.	Color.	Duration.	Position, altitude and azimuth.
	Year.	Month.	Hour and minute.					
1	1779	Oct.....	31 6 10 0	Williamsburg, Va.....	Nearly as large as the full moon.	Like the moon.....	s.	Fell and disappeared below the horizon 4° N. of W. Alt., 35°; az., N. 20° E. Alt., 30°; az., N. 45° E.
2	1813	Mar ...	21 10 0 0	New Haven, Conn.....	One-third size of the moon.	White tinged with blue.	5	Alt., 45°; az., N. 45° E.
3	1819	July ...	24	Youngstown, Ohio.	15' in diameter.....	2.5	Alt., 43°; az., S. 12° E. Alt., 23°; az., S. 55° W.
4	1819	Nov. ...	21 Evening ...	Easton, Penn.....	At appearance 7' and at disappearance 28' in diameter.	2	Alt., 60°; az., N. 30° E.
5	1822	Mar. ...	9 10 0 0	New York, N. Y.	Alt., 9° 48'; az., N. 41° 54' E. Alt., 3° 6'; az., N. 28° 57' E.
6	1826	Mar. ...	31 7 30 0	New Haven, Conn.....
7	1826	Apr. ...	1 9 0 0	New Haven, Conn.....
8	1826	Apr. ...	14 11 20 0	Burlington, Vt.....
9	1828	Feb.....	11 11 12 0	On the East river, at New York.	A light shade of "grass green."
10	1836	Aug. ...	20 4 0 0	Eight miles S.W. of Jacksonville, Ill.	Diameter 15'.....	Like a globe of fire.	Alt., 60°; az., N. 15° E. Alt., 40°; az., N. 15° E.
11	1837	July ...	5 7 8 0	Rochester, N. H.....	As large as the sun.....	Like "white-heated iron."	1m.	Appeared in the S. W. at an altitude of 30°.
12	1837	Dec. ...	14 7 39 32	New Haven, Conn.....	From 1/4 to 3/4 the size of the moon.	1.0 or 1.5	Disappeared at altitude of 9°; azimuth, S. 89° W.
13	1838	May ...	18 8 0 0	Throughout the northern United States and part of upper Canada.	One-fourth the diameter of the moon.	7	Alt. at beginning of path, 28.5 miles; at middle of path, 34.8 miles; at end of path, 32.1 miles.
14	1840	May ...	12 15 0 0	Four miles south of Stonington, Conn.	Larger than the full moon.	3m. 30s.	Appeared in the E. S. E. and disappeared in the N. N. E., near the horizon.

1. Trans. Am. Phil. Soc. II (O. S.), 173, 175.

- 2. A. J. S. XLII, 35.
- 3. A. J. S. V, 315.
- 4. A. J. S. VI, 316.
- 5. A. J. S. VI, 318.
- 6. A. J. S. XI, 184.
- 7. " " " " "
- 8. A. J. S. XI, 120.
- 9. A. J. S. XIV, 199.
- 10. A. J. S. XXXIII, 402.
- 11. A. J. S. XXXIII, 200.
- 12. A. J. S. XXXVI, 130.
- 13. A. J. S. XXXV, 223.
- 14. A. S. S. XXXIX, 382.

CATALOGUE V.—Sporadic Meteors—Continued.

Ref. number.	Train, appearance and duration.	Length of path.	Direction of motion.	Remarks.	Observer.
1	Train visible 15m.	0		Seen in Philadelphia by David Rittenhouse.	John Page.
2	Train 12° long		Easterly nearly horizontal.	The light was powerful; cast deep shadows. In 8 or 10 minutes after its disappearance a heavy report, accompanied by a decided jar, was heard.	S. E. Dwight.
3			Moving towards the north.	Disappeared with an explosion, the report of which was heard in about three minutes. At Gustavus, Ohio, the same object was seen and the report heard in about one minute.	Dr. H. Manning.
4			Towards the S. or S. W.	Disappeared at an altitude of 55° with a loud explosion, the report of which was heard in two, three, or four minutes.	Samuel Turney.
5				This meteor was seen in Canada, throughout New England and New York, and in several places in Pennsylvania. At Troy, N. Y., the report of the explosion was heard in 7m. 30s.	
6	Train several degrees long.			Report of explosion heard in 4m. 25s.	
7	Train visible one minute.		Disappeared at the zenith.	Report heard in two minutes; also seen at Arlington, Vt., where it seemed to move from north to south, and vanished at an altitude of 30°. Report heard in 1m. 30s.	
8		20	N. E. from a point 5° below the zenith.	No explosion.	Dr. H. S. Waterhouse.
9	Train of same color as the meteor.		Vertically towards the earth	The meteor seemed to burst into fragments, but no report was heard.	Prof. E. D. Silliman.
10	Left a "cloud of smoky appearance."	20	Course towards the N. N. W. and inclined to the horizon.	Report of explosion at disappearance distinctly heard.	R. Gaylord.
11	Left a greyish train which, after wavering and expanding for several minutes, gradually vanished.				
12	Brilliant train, visible a long time.		Downward at an angle of from 30° to 50° with the vertical.	Seemed to explode, but no report was heard. Position at appearance not well observed.	E. C. Herrick.
13	A brilliant train broken into several sections.		Nearly north and horizontal	Data collected and computations made by Prof. E. Loomis.	Prof. Hubbard, Catlin, and Barrows, and Messrs. R. W. Haskins, E. Brown, and J. and L. Chandler.
14	Brilliant train lasting several seconds after the extinction of the meteor.		Downward at an angle of 30° with the horizon.	Exploded with a loud report, which was heard in ten or fifteen seconds.	J. J. Comstock.

CATALOGUE V.—Sporadic Meteors—Continued.

Ref. number.	DATE.			Place of observation.	Apparent size.	Color.	Duration.	Position, altitude and azimuth.
	Year.	Month.	Day, Hour and minute.					
15	1841	Nov. ...	10 8 0	Boston, Mass.	Preceding portion white; the following blue.	s.	Passed several degrees west of Fomalhaut and disappeared at an altitude of 10°.
16	1841	Nov. ...	10 8 0	New Haven, Conn.	Diameter 3' or 4'	2 or 3	Appeared 30' below the Pleiades and disappeared midway between β and θ Ceti. Alt., 25° 30'.
17	1845	Aug. ...	11 6 5	Cambridge, Mass.	White	1
18	1845	Aug. ...	8 0	Cambridge, Mass.	Estimated diameter less than 5'. Half the diameter of the full moon.	Red and blue.	Alt., 45°; az., S. 10° W.
19	1845	Aug. ...	31 14 20	Fayetteville, N. C.	"As large as the sun."	20	Alt., 10°; az., S. 69° W. Alt., 8°; az., N. 88° W.
20	1845	July ...	13 9 30	York and Lancaster, Pa.	From one-third to two-thirds the size of moon.
21	1846	July ...	20 9 55	Cambridge, Mass.	"Equal to Venus".	Red and yellowish white
22	1846	Aug. ...	11 10 10	Cambridge, Mass.	"Brighter than Venus"	Blue, red, and white	2	Alt., 35°; az., N. 83° W. Alt., 30°; az., N. 63° W.
23	1848	Jan. ...	20 5 0	Rome, N. Y.
24	1848	Mar. ...	5 14 30	Nantucket, Mass.	20' in diameter
25	1848	April ...	15	Whitesville, Miss.
26	1850	June ...	16 6 25	New Haven, Conn.	"As large as Venus"	Brilliant white	Alt., 31°; az., N. 12° E. Alt., 16°; az., N. 12° W.
27	1850	Sept. ...	30 8 54	Boston, Mass.	Exploded and disappeared in α 2h. 30m. and δ + 27°.
28	1850	Sept. ...	30 8 53	Springfield, Mass.	Bluish.
29	1850	Oct. ...	3 8 30	Hartford, Conn.	Orange	From 60 to 90m.	Alt., 60°; az., S. of W.
30	1856	July ...	8 0 0	Thornhill, Hancock Co., Ala.	"6 or 8 inches in diam'r"	First seen at a point midway between the zenith and horizon; az., S. 30° or 35° W.

15. A. J. S. XLIII, 309.
 16. " " " " " "
 17. Proc. Am. Acad. Arts and Sci. I, 21.
 18. A. J. S. XLIX, 408.
 19. A. J. S. XLIX, 347.
 20. A. J. S. XLIX, 347.
 21. Proc. Am. Acad. Arts and Sci. I, 22.
 22. " " " " " "
 23. A. J. S. V, 437.
 24. Proc. Am. Acad. Arts and Sci. I, 329.
 25. A. J. S. VI, 148.
 26. A. J. S. XL, 131.
 27. " " " " " "
 28. " " " " " "
 29. Proc. A. A. S., 1851, 191.
 30. A. J. S. XXII, 448; XXIII, 138, 287.

CATALOGUE V.—Sporadic Meteors—Continued.

Ref. number.	Train, appearance and duration.	Length of path.	Direction of motion.	Remarks.	Observer.
15	Left a train 2° or 3° long near and a little above δ Aquarii, visible more than 90s.	50	Towards the S. W.		W. C. Bond and Son.
16	Train 8° or 10° long and visible 3m.	7	Toward the horizon at an angle of 50°	Same meteor as the preceding.	W. C. Bond.
17		10 or 20	From N. E. to S. E.	Exploded with a very loud report, which was heard in five or six minutes.	W. C. Bond.
19				Seen also at New Haven and many other places.	D. M. Ettinger. W. C. Bond.
20	Train 1° long, seen only at York.		From γ Cygni to near α Cas-		W. C. Bond.
21			slope ⁸⁰ .		
22	A cometary tail of dense white light.		From α Cassiopee to 80 Pe-	Light of train could be seen through light cirrus clouds.	Edward Huntington.
23	Brilliant train, a portion visible 12m. or 13m.		gas ¹ .		William Mitchell.
24				Loud report heard in 92s. after the meteor disappeared over the ocean.	
25	Left a bright train.		From a little W. of N. to-	Disappeared with a loud explosion. Light strong enough to cast deep shadows, even in the moonlight.	George Rice and J. P. Humason.
26	Train 1° long.		wards the E.	At the time of appearance the sun was about 15° above the horizon and unobserved.	W. C. Bond.
27	Left a brilliant train extending from the head of Medusa to 3° below α Arietis, visible more than one hour.			The train was examined with the Cambridge equatorial and it presented the appearance of minute bright clouds resembling cirro-cumuli.	
28	The train was yellowish, and remained stationary for about 4m. It then slowly changed its form and its direction of motion, and at 9h. 18m. it was barely visible as a faint white cloud in the lower portion of Arietis.		Horizontally from E. to W.	Same meteor as the preceding.	J. C. Hoadley.
29	Train 15 or 16 feet long.		From W. to S. E.	Disappeared below S. E. horizon. No explosion. Train swept over the moon's disk.	Gaylord Wells, by Prof. Brocklesby.
30	White train, visible 15m.	35	Nearly vertical.	Seen also at Columbus, Grenada, and Holly Springs, Miss., and at Marion, Ala.	T. M. Peters and B. R. DeGraffenried.

CATALOGUE V. Sporadic Meteors—Continued.

Ref. number.	DATE.			Place of observation.	Apparent size.	Color.	Duration.	Position, altitude and azimuth.
	Year	Month.	Hour and minute.					
31	1857	April...	h. m. 8 50	Near Lake Winnibogishish, Minn.	"Greater than the full moon."	s. 4	Appeared in Hydra and moved W. to within a short distance of the horizon.
32	1859	Aug. ...	7 20	"As large as the sun"	Exploded over the vicinity of Cape May.
33	1859	Nov. ...	21 30	From Petersburg, Mass., to Petersburg, Va.	Nearly as large as the sun.	Red. Like a ball of fire ...	2
34	1860	July...	From Lake Michigan to Nantucket, Mass., and from Maine to Virginia.	Nearly as large as the moon.	Computed altitudes: Over Lake Michigan, 120 miles. " Lake Huron, 85 miles. " Buffalo, N. Y., 62 miles. " Elmira, N. Y., 51 miles. " Long Island Sound, 42 miles.
35	1860	Aug. ...	2	Knoxville, Tenn.	1 or 2	Appeared 1° S.W. of ε Cygni and passed near the Dolphin.
36	1860	Aug. ...	6	New York and New Haven, Conn.
37	1861	Aug. ...	10	New Haven, Conn.
38	1861	Oct. ...	4	New Haven, Conn.
39	1861	Dec. ...	8	Brunswick, Me.
40	1861	Dec. ...	17	Buffalo, N. Y.
41	1861	Dec. ...	25	Southern Connecticut
42	1861	Dec. ...	30	Hartford, Conn.
43	1862	Jan. ...	2	New York, N. Y.
44	1862	Jan. ...	5	Setauket, N. Y.	One-third diam'r of moon.
45	1862	Aug. ...	7	U. S. Naval Observatory
46	1862	Aug. ...	13	U. S. Naval Observatory
47	1862	Sept. ...	3	U. S. Naval Observatory
48	1862	Oct. ...	3	U. S. Naval Observatory
49	1862	Nov. ...	3	U. S. Naval Observatory
49	1862	Dec. ...	7	U. S. Naval Observatory	"Sparkling white."	3 4	Near Pleiades. In the N.

31. A. J. S. XXIV, 158.
 32. A. J. S. XXXVIII, 300.
 32. (A. J. S. XXIX, 137, 298, 447.
 33. { Jour. Frank Inst. XXXIX, 205, 253.
 { A. J. S. XXX, 186.
 34. A. J. S. XXX, 293; Smithsonian Contributions, XVI, 295.
 35. A. J. S. XXX, 295.
 36. A. J. S. XXX, 296; XXXII, 344.
 37. A. J. S. XXXI, 446.
 38. A. J. S. XXXII, 443.
 39. A. J. S. XXXIII, 491.
 40. " " " "
 41. " " " "

CATALOGUE V.-Sporadic Meteors-Continued.

Ref. number.	Train, appearance and duration.	Length of path.	Direction of motion.	Remarks.	Observer.
31	White train lasting 5m. or 10m.....	0	Nearly horizontal.....	Seen in New York, Connecticut, and Vermont. At its disappearance the explosion jarred the buildings in Troy, N. Y. The sun was shining brightly.	B. F. Odell.
32	No luminous train was seen, but a trail of smoke was left in its path.....	15 or 20	Nearly vertical.....	Position computed by Prof. E. Loomis.	
33	In the vicinity of Elmira, N. Y., the meteor separated by explosion into two parts, which continued their course until over Nantucket, when by another explosion they were separated into small fragments, which continued their course as before.	Positions computed by Prof. C. S. Lyman.
34	Seen throughout the southern portion of the United States.	W. C. Kane.
35	Also seen at Burlington, N. J., by B. V. Marsh.....	Prof. A. C. Twining.
36
37	Brilliant train, visible more than 15s.....	29	From E. to W..... From S. to N.....
38	Brilliant train reaching from Cygnus to Cassiopeia. Its slowly assumed a serpentine shape and remained visible 2m.....	Slightly inclined towards the earth. From west to east nearly through the zenith.
39	Left a short train.....	From W. to E.....	Broke into three fragments.
40
41
42	From an altitude of 10° obliquely to horizon.
43	From a Cygni to Delphinus.	Explosion with a report like a pistol.
44	From E. to W.
45	From the N. E.
46	From N. W. to S. E.
47	Train visible 10s.....	From E. to W.
48	From N. E. to N. W.
49	From zenith to S. W.

42. A. J. S. XXXIII, 291.
 43. " " " "
 44. " " " "
 45. Wash'n Ast. & Met. Obs'ns, 1862.
 46. " " " "
 47. " " " "
 48. Wash'n Ast. & Met. Obs'ns, 1862.
 49. " " " "

CATALOGUE V.-Sporadic Meteors-Continued.

Ret number.	DATE.		Place of observation.	Apparent size.	Color.	Duration.	Position, altitude and azimuth.
	Year.	Month.					
50	1862	Dec.	16	h. m.	U. S. Naval Observatory...	5	
51	1862	Dec.	18	13 30	U. S. Naval Observatory...	5	
52	1862	Dec.	20	11 25	U. S. Naval Observatory...	5	
53	1862	Dec.	20	12 35	U. S. Naval Observatory...	5	
54	1863	Jan.	11	18 0	U. S. Naval Observatory...	5	
55	1863	April	2	12 0	U. S. Naval Observatory...	5	
56	1863	April	19	7 50	Philadelphia, Pa.	3 to 6	
57	1864	July	8	9 0	U. S. Naval Observatory...		
58	1864	July	13	10 15	Boston, Mass.		Appeared just below Delphinus.
59	1864	Oct.	29	9 43	U. S. Naval Observatory...		Appeared 8° S. of Mars.
60	1864	Nov.	10	7 0	U. S. Naval Observatory...		Appeared 7° W. of the zenith.
61	1865	Jan.	8	9 0	U. S. Naval Observatory...		In the N. E.
62	1865	Feb.	21	12 0	U. S. Naval Observatory...		In the N.
63	1865	Nov.	25	9 59	U. S. Naval Observatory...		
64	1866	July	26	8 15	Hector, N. Y.		
65	1866	Nov.	5	6 15	Glen Cove, N. Y.	¼ to 1	In Cygnus.
66	1867	Mar.	29	12 0	U. S. Naval Observatory...		Seen to explode in N. N. E. at alt. of 10 or 14°.
67	1867	April	7	9 5	U. S. Naval Observatory...		In the W.
68	1867	July	18	7 30	Salem, Pa.	4 to 5	Appeared in the S. E., disappeared in the N. E.
69	1867	Oct.	15	5 40	Haverford College, Pa.	5	30° above eastern horizon.
70	1868	Feb.	6	11 33	U. S. Naval Observatory...		Appeared 3° N. of Pleiades.
71	1868	June	6	11 40	Manhattan, Kan.		Appeared in W. at alt. 55°, disappeared at alt. 12°.
72	1869	Jan.	20	10 30	U. S. Naval Observatory...		Appeared alt. 25°, az., N. 20° W.
73	1869	May	20	11 20	New York, N. Y.		Appeared in E.; alt., 30°; disappeared N. 60° E.
74	1869	Aug.	24	7 17	U. S. Naval Observatory...	5	From Mizar to 10° below Polaris.
75	1869	Oct.	26	15 0	Patterson, Ky.		

50. Wash'n Ast. & Met. Obs'ns, 1862.
 51. " " " " "
 52. " " " " "
 53. " " " " "
 54. Wash'n Ast. & Met. Obs'ns, 1863.
 55. " " " " "
 56. A. J. S. XXXVI, p. 154.
 57. Wash'n Ast. & Met. Obs'ns, 1864.
 58. A. J. S. XXXVIII, p. 295.
 59. Wash'n Ast. & Met. Obs'ns, 1864.
 60. " " " " "
 61. Wash'n Ast. & Met. Obs'ns, 1865.

CATALOGUE V.—Sporadic Meteors—Continued.

Ref. number.	Train, appearance and duration.	Length of path.	Direction of motion.	Remarks.	Observer.
50	0
51	From zenith to E.
52	From the N. E.
53	Train visible 6s.....	From zenith to N.W.
54	Visible train.....	From N. E. to N.	Disappeared with an explosion.
55	Visible train.....	45	From E. to N.W.....	Seen also at Westtown and at Wilmington and Odessa, Del.
56	From the S. E.
57	Train 15° long.....	From W. to E.
58	Train 3 or 4° degrees long.....	From Delphinus towards Pegasus.	Disappeared with a loud report.....	John Gardner.
59	Visible train.....	40	Obliquely towards horizon.
60	Vertically to horizon.
61	Very large and brilliant.
62	Brilliant.
63	Towards the N.
64	A beautiful blue train.....	30	From E. to W.....	Passed below some cirro-stratus clouds.....	David Trowbridge.
65	Report of explosion heard in 3/4 m.....	Isaac Coles.
66
67
68	Train 3 or 4° long.....	Brilliant.	J. K. Larimore.
69	25	When first seen its altitude was 40°.	Pliny Earle Chase.
70	Vertically to the horizon.....	Disappeared with an explosion.....
71	Train visible 1m.....	Towards horizon at an angle of 75°.	Mag. at appearance = η Tauri, at disappearance = Jupiter.	Prof. B. F. Mudge.
72	Visible less than 1s. Disappeared with a report heard over an area 120 miles in diameter.
73	Brilliant train.....	30	Vertically to horizon.	Burst into fragments with a loud explosion. Seen in many places in New England, New York, and New Jersey.	Described by Prof E. Loomis.
74	Train visible 5m.
75	Train 30 feet long, 3 feet wide.....	Seen by many observers.....	Described by Prof. J. L. Smith.

72. Wash'n Ast. & Met. Obs'ns, 1869.
 73. A. J. S. XLVIII, 145.
 74. Wash'n Ast. & Met. Obs'ns, 1869, 372; Proc. Am. Phil. Soc. XI, 194.
 75. A. J. S. XLIX, 139.

67. Wash'n Ast. & Met. Obs'ns, 1867.
 68. A. J. S. XLIV, 288.
 69. Proc. Am. Phil. Soc. X, 353.
 70. Wash'n Ast. & Met. Obs'ns, 1868.
 71. A. J. S. XLV, 429.

62. Wash'n Ast. & Met. Obs'ns, 1865.
 63. " "
 64. A. J. S. XLII, 286.
 65. Smithsonian archives (not yet printed).
 66. Wash'n Ast. & Met. Obs'ns, 1867.

CATALOGUE V.—Sporadic Meteors—Continued.

Ref. number.	DATE.			Place of observation.	Apparent size.	Color.	Dura- tion.	Position, altitude and azimuth.
	Year.	Month.	Hour and minute.					
76	1869	Nov.	10	U. S. Naval Observatory...	Very bright	White	s.	In the N. W.
77	1869	Dec.	8	U. S. Naval Observatory...	3d magnitude	White	4	In the E.
78	1870	Mar.	23	U. S. Naval Observatory...	4th magnitude	White	0.4	
79	1870	Mar.	25	U. S. Naval Observatory...	3d magnitude	White	0.3	
80	1870	Apr.	19	U. S. Naval Observatory...	3d magnitude	White	2.4	
81	1870	Apr.	19	U. S. Naval Observatory...	4th magnitude	White	0.5	
82	1870	Apr.	19	U. S. Naval Observatory...	3d magnitude	White	0.5	
83	1870	Apr.	19	U. S. Naval Observatory...	4th magnitude	White	0.5	
84	1870	Apr.	19	U. S. Naval Observatory...	5th magnitude	White	0.5	
85	1870	Apr.	25	U. S. Naval Observatory...	4th magnitude	White	0.5	
86	1870	Apr.	27	U. S. Naval Observatory...	5th magnitude	White	0.4	
87	1870	June	19	U. S. Naval Observatory...	4th magnitude	Reddish	0.3	
88	1870	June	21	U. S. Naval Observatory...	2d magnitude	Reddish	2.0	
89	1870	June	21	U. S. Naval Observatory...	6th magnitude	White	0.4	
90	1870	June	24	U. S. Naval Observatory...	1st magnitude	Orange	1.5	
91	1870	June	25	U. S. Naval Observatory...	2d magnitude	White	1.5	
92	1870	June	25	U. S. Naval Observatory...	Size of Jupiter.	Orange and green.	2.5	
93	1870	June	25	U. S. Naval Observatory...	6th magnitude	White	0.3	
94	1870	July	26	U. S. Naval Observatory...	Size of Jupiter.	White	0.2	
95	1870	July	30	U. S. Naval Observatory...	3d magnitude	White	0.2	From 240° + 75° to 195° + 75°.
96	1870	July	30	U. S. Naval Observatory...	Size of Saturn	White	3.0	From 14h. 50m. + 20°.
97	1870	July	30	U. S. Naval Observatory...	3d magnitude	White	1.5	From 17h. 0m. — 25°.
98	1870	July	30	U. S. Naval Observatory...	4th magnitude	White	0.2	From 4° south of Saturn.
99	1870	July	30	U. S. Naval Observatory...	2d magnitude	White	0.5	From α Aquilæ.
100	1870	Aug.	15	U. S. Naval Observatory...	4th magnitude	Orange.	0.5	From α Pegasi.
101	1870	Sept.	4	U. S. Naval Observatory...	5th magnitude	White	0.4	From 10° N. of Arcturus.
102	1870	Sept.	4	U. S. Naval Observatory...	4th magnitude	White	0.3	
103	1870	Sept.	24	U. S. Naval Observatory...	3d magnitude	White	0.4	
104	1870	Oct.	15	U. S. Naval Observatory...	3d magnitude	White	0.3	From 19h. 30m. + 60° directly towards Polaris.

86. Wash'n Ast. & Met. Obs'ns, 1870.
87. " " " " " "
88. " " " " " "
89. " " " " " "
90. " " " " " "

81. Wash'n Ast. & Met. Obs'ns, 1870.
82. " " " " " "
83. " " " " " "
84. " " " " " "
85. " " " " " "

76. Wash'n Ast. & Met. Obs'ns, 1869.
77. " " " " " "
78. Wash'n Ast. & Met. Obs'ns, 1870.
79. " " " " " "
80. " " " " " "

CATALOGUE V.—Sporadic Meteors—Continued.

Ref. number.	Train, appearance and duration.	Length of path.	Direction of motion.	Remarks.	Observer.
76	No train.	0	N. 20° E.	From δ Aquilæ	Prof. J. R. Eastman.
77	No train.	8	S. to N.	Across the "Sickle"	Prof. J. R. Eastman.
79	Short train.	5	S. 5° W.	From a point on the meridian 10° S.	Prof. J. R. Eastman.
80	No train.	10	S. W.	South of α Canis Majoris	Prof. J. R. Eastman.
81	No train.	4		Northerly from near the eastern horizon	N. Cahill.
82	No train.			Northerly from near the eastern horizon	N. Cahill.
83	No train.			Northerly from near the eastern horizon	N. Cahill.
84	No train.			Northerly from near the eastern horizon	N. Cahill.
85	No train.	10	Towards the W.	Across the "Dipper"	N. Cahill.
86	No train.	10	Towards the E.	From 10° south of the zenith	D. Horigan.
87	No train.	8	N. W. from α Cygni		D. Horigan.
88	Long train, lasting 3s.	12	N. from α Bootis.		D. Horigan.
89	No train.	5	South	From ζ Urse Minoris to 5° south of α Bootis.	D. Horigan.
90	No train.	10	Easterly	From alt. 40° through the constellation of the Scorpion	Prof. J. R. Eastman.
91	No train.	8	West	From β Cassiopeæ to 10° below Polaris.	Prof. J. R. Eastman.
92	Train visible 0.8s.	30	West	Exactly across Polaris in a line parallel to the above course.	Prof. J. R. Eastman.
93	No train.	4	East		Prof. W. Harkness.
94	No train.	45	West		Prof. J. R. Eastman.
95	No train.	6	West		Prof. J. R. Eastman.
96	No train.	15	West		Prof. J. R. Eastman.
97	No train.	15	West		Prof. J. R. Eastman.
98	No train.	6	South	Between 9h. and 10h. saw ten other small meteors, all moving westward.	Prof. J. R. Eastman.
99	No train.	8	West		Prof. J. R. Eastman.
100	Train visible 0.6s.	10	Southwest		D. Horigan.
101	No train.	8	Vertically to horizon	"Across the Dipper"	D. Horigan.
102	No train.	8	East	"From Polaris towards the Dipper"	D. Horigan.
103	Train visible 0.3s.	10			D. Horigan.
104	No train.	4			Prof. J. R. Eastman.

91.	Wash'n Ast. & Met. Obs'ns, 1870.	96.	Wash'n Ast. & Met. Obs'ns, 1870.	101.	Wash'n Ast. & Met. Obs'ns, 1870.
92.	" " " "	97.	" " " "	102.	" " " "
93.	" " " "	98.	" " " "	103.	" " " "
94.	" " " "	99.	" " " "	104.	" " " "
95.	" " " "	100.	" " " "		

CATALOGUE V.-Sporadic Meteors-Continued.

Ref. number.	DATE.			Place of observation.	Apparent size.	Color.	Duration.	Position, altitude and azimuth.
	Year.	Month.	Day.					
105	1870	Nov.	3	U. S. Naval Observatory...	3d magnitude	White	s.	From α Andromedæ.
106	1870	Nov.	14	U. S. Naval Observatory...	3d magnitude	White	0.3	From Orion towards Sirius.
107	1870	Nov.	15	U. S. Naval Observatory...	1st magnitude	White	0.5	
108	1870	Nov.	15	U. S. Naval Observatory...	3d magnitude	White	2.0	
109	1870	Nov.	7	U. S. Naval Observatory...	3d magnitude	White	0.5	
110	1870	Dec.	13	U. S. Naval Observatory...	4th magnitude	White	2.0	
111	1870	Dec.	9	U. S. Naval Observatory...	3d magnitude	White	0.2	
112	1870	Dec.	13	U. S. Naval Observatory...	3d magnitude	White		
113	1870	Dec.	12	U. S. Naval Observatory...	1st magnitude	Orange	3.0	From 8° N. of Jupiter.
114	1871	May	23	U. S. Naval Observatory...	1st magnitude	White	3.5	On the meridian, Z. D. S. 55° .
115	1871	July	6	U. S. Naval Observatory...	2d magnitude	White	1.0	8° N. of Antares.
116	1871	July	6	U. S. Naval Observatory...	2d magnitude	White	1.5	
117	1871	July	6	U. S. Naval Observatory...	4th magnitude	White	0.8	15° N. W. of Antares.
118	1871	July	6	U. S. Naval Observatory...	1st magnitude	White	3.0	
119	1871	Aug.	8	Wilmington, N. C.	" Large ball of fire "	Crimson.		
120	1871	Aug.	8	U. S. Naval Observatory...	2d magnitude	White	1.0	4° N. of Algol.
121	1871	Aug.	9	U. S. Naval Observatory...	1st magnitude	White	0.3	Near β Pegasi.
122	1871	Aug.	12	U. S. Naval Observatory...	2d magnitude	White and orange.	1.0	At α Aquilæ.
123	1871	Aug.	16	U. S. Naval Observatory...	As large as Sirius.			At α Bootis.
124	1871	Aug.	16	U. S. Naval Observatory...	Larger than Jupiter.			From Aldebaran passed 5° below the Pleiades.
125	1871	Nov.	16	U. S. Naval Observatory...	1st magnitude	White		
126	1871	Nov.	13	U. S. Naval Observatory...	1st magnitude	White	10m.	
127	1872	Jan.	22	City of Mexico.	1st magnitude	Red, then white.	4	From β Cassiopeæ towards Polaris.
128	1872	July	30	U. S. Naval Observatory...	1st magnitude	Orange.		
129	1872	July	28	U. S. Naval Observatory...	1st magnitude	White	1	
130	1872	July	28	U. S. Naval Observatory...	1st magnitude	White	1	
131	1872	Aug.	3	U. S. Naval Observatory...	2d magnitude	White	1	20° E. of Polaris.
132	1872	Aug.	6	U. S. Naval Observatory...	2d magnitude	White	1	At Polaris.
133	1872	Aug.	9	U. S. Naval Observatory...	2d magnitude	Orange and white.	2	
134	1872	Aug.	9	U. S. Naval Observatory...	3d magnitude	Orange and white.	1.5	
135	1872	Aug.	8	U. S. Naval Observatory...	3d magnitude	White	1	
106.	1870	Wash'n Ast. & Met. Obs'ns,	110.	Wash'n Ast. & Met. Obs'ns,	115.	Wash'n Ast. & Met. Obs'ns,	1871.	
107.	"	"	111.	"	"	"	"	
108.	"	"	112.	"	"	"	"	
109.	"	"	113.	Wash'n Ast. & Met. Obs'ns,	114.	Wash'n Ast. & Met. Obs'ns,	1871.	
			114.	"	"	"	"	

CATALOGUE V.—Sporadic Meteors—Continued.

Ref. number.	Train, appearance and duration.	Length of path.	Direction of motion.	Remarks.	Observer.
105	Train visible 0.4s.....	0	Southwest.....	D. Horigan.
106	Train visible 0.3s.....	5	D. Horigan.
107	Train visible 2.0s.....	8	West.....	Passed south of α Pegasi.....	D. Horigan.
108	No train.....	25	South from α Cygni.....	I. Horigan.
109	No train.....	8	N. Cahill.
110	Train visible 0.3s.....	4	N. Cahill.
111	22	N. Cahill.
112	Short train.....	8	Westerly.....	N. Cahill.
113	11	Prof. J. R. Eastman.
114	15	Westerly.....	Prof. J. R. Eastman.
115	15	Westerly.....	Prof. J. R. Eastman.
116	18	West from Antares.....	Prof. J. R. Eastman.
117	10	South.....	Prof. J. R. Eastman.
118	35	West from ϵ Cassiopeæ.....	Very brilliant.....	Prof. J. R. Eastman.
119	Short train, visible 7s.....	12	From South to North.....	Burst into three fragments with a loud explosion.....	E. S. Martin.
120	8	From α to β Aurigæ.....	D. Horigan.
121	12	South.....	Prof. J. R. Eastman.
122	Train visible 2s.....	15	South.....	D. Horigan.
123	20	South.....	Prof. J. R. Eastman.
124	Train visible 1s.....	35	South.....	Prof. J. R. Eastman.
125	25	South.....	Prof. A. Hall.
126	Train visible 3s.....	20	From West to East.....	Seen at several other cities in Mexico.....	José de la Vega.
127	8	Fell vertically from α Cassiopeæ.....	Motion seemed to be by impulses, but slow.....	D. Horigan.
128	Short train.....	12	D. Horigan.
129	Short train.....	15	D. Horigan.
130	Short train.....	8	South.....	D. Horigan.
131	Long train.....	15	Towards γ Ursa Majoris.....	D. Horigan.
132	Long train.....	20	N. E. from Saturn.....	D. Horigan.
133	Short train.....	10	S. from α Cassiopeæ.....	D. Horigan.
			S. from ζ Ursa Majoris.....	D. Horigan.

120. Wash'n Ast. & Met. Obs'ns, 1871.
 121. " " " " " "
 122. " " " " " "
 123. " " " " " "
 124. " " " " " "
 125. A. J. S. III., 235.
 126. Wash'n Ast. & Met. Obs'ns, 1872.
 127. " " " " " "
 128. " " " " " "
 129. " " " " " "
 130. Wash'n Ast. & Met. Obs'ns, 1872.
 131. " " " " " "
 132. " " " " " "
 133. " " " " " "

CATALOGUE V.—Sporadic Meteors—Continued.

Ref. number.	DATE.			Place of observation.	Apparent size.	Color.	Duration.	Position, altitude and azimuth.
	Year.	Month.	Day.					
134	1872	Aug.	9	U. S. Naval Observatory...	2d magnitude	White	s.	
135	1872	Aug.	9	U. S. Naval Observatory...	2d magnitude	Orange	1	
136	1872	Aug.	11	U. S. Naval Observatory...	2d magnitude	Yellow-red	1	Appeared in the cluster in sword handle of Perseus.
137	1872	Nov.	12	U. S. Naval Observatory...	2d magnitude	Orange	1.5	From 3° E. of α Orionis vertically towards the horizon.
138	1872	Dec.	9	U. S. Naval Observatory...	1st magnitude.	White	1.0	From ζ Urse Minoris towards ζ Draconis.
139	1872	Dec.	12	Bloomington, Ind.	"Large	Red		Altitude 40°, 15° E. of meridian.
140	1872	Dec.	12	Louisville, Ky.	1st magnitude.	White		Appeared in the zenith.
141	1873	Jan.	3	U. S. Naval Observatory...	1st magnitude.	One green; the following yellow.	1	Appeared at γ Orionis.
142	1873	Feb.	14	New Haven, Conn.				
143	1873	April	3	U. S. Naval Observatory...	1st magnitude.	White	1.5	Appeared near α Virginis.
144	1873	May	15	Harbor Grace, Newfoundland.				W. S. W. at an altitude of 40°.
145	1873	June	6	U. S. Naval Observatory...	1st magnitude	Orange	1.5	From Polaris vertically towards horizon.
146	1873	June	6	U. S. Naval Observatory...	1st magnitude.	Orange	2.0	From Polaris 8° towards δ Urse Majoris.
147	1873	Aug.	5	U. S. Naval Observatory...	1st magnitude.	Orange	1.5	From ζ Urse Minoris south at an angle of 30° with the horizon.
148	1873	Aug.	10	U. S. Naval Observatory...	1st magnitude.	Orange	3.0	Appeared at θ Cygni.
149	1873	Nov.	24	U. S. Naval Observatory...	Bright as new moon	Intense white	2.0	Appeared at θ Aquilæ.
150	1873	Dec.	14	U. S. Naval Observatory...	2d magnitude	White	4.0	From 12° E. of Polaris vertically towards the horizon.
151	1873	Dec.	24	Washington, D. C.				Entered the atmosphere over the State of Delaware at a height of 90 miles, and disappeared over Fairfax Co., Va., at a height of from 8 to 20 miles.
152	1874	May	25	U. S. Naval Observatory...	1st magnitude.	Orange and violet	3	Appeared near Polaris.
153	1874	July	18	Louisville, Ky.	One-third diam. of moon.	Greenish white	3	
154	1874	Aug.	10	U. S. Naval Observatory...	15' in diameter	White and orange.	3.5	
155	1875	July	9	U. S. Naval Observatory...	Bright as Mars.			Appeared 5° above Mars and passed 8° W. of Mars.
134.	Wash'n Ast. & Met. Obs'ns, 1872.			138. Wash'n Ast. & Met. Obs'ns, 1872.				
135.	"			139. A. J. S. V. 318.				142. A. J. S. V. 318.
136.	"			140. A. J. S. X. 203.				143. Wash'n Ast. & Met. Obs'ns, 1873.
137.	"			141. Wash'n Ast. & Met. Obs'ns, 1873.				144. A. J. S. V. 154.
								145. Wash'n Ast. & Met. Obs'ns, 1873.

CATALOGUE V.—Sporadic Meteors—Continued.

Ref. number.	Train, appearance and duration.	Length of path.	Direction of motion.	Remarks.	Observer.
134	Short train	15	S. from ϵ Ursa Majoris.....	D. Horigan.
135	15	S. from α Andromedæ.....	D. Horigan.
136	Orange train	15	To 7° E. of Polaris.....	Prof. J. R. Eastman.
137	10	E. of S. making an angle of 60° with the horizon.....	Prof. J. R. Eastman.
138	Towards the horizon in a southerly direction.....	Seen also at several places in Kentucky.	Prof. D. Kirkwood.
139	Seen from several other points, and at some places its disappearance was followed by loud detonations. (Probably same meteor as preceding.)	Prof. J. L. Smith.
140	Left a dense stream of blue smoke, which remained visible several minutes.
141	Short train	10	Vertically towards the horizon. North and down to an alt. of 15° in the direction N. 64° W.	D. Horigan.
142	10	Vertically towards the horizon. To W. N. W. at altitude of 10°	Two meteors close together. Seen also at New Britain, Conn.	Prof. H. A. Newton.
143	8	D. Horigan.
144	Yellow train	8	Burst, leaving a coppery-red cloud visible 30m.	Henry H. Cleft.
145	15	Prof. J. R. Eastman.
146	15	Prof. J. R. Eastman.
147	Short train	45	Across α Aquilæ.....	Prof. J. R. Eastman.
148	Short train	Prof. J. R. Eastman.
149	Train separated into two distinct parts.	A. N. Skinner.
150	No train.....	15	Prof. J. R. Eastman.
151	This meteor was seen by many observers from Delaware to Virginia, and all the available data were collected and discussed by Cleveland Abbe in a report to the Washington Philosophical Society.
152	Long train.....	30	Southeasterly.....	D. Horigan.
153	30	From N. N. W. to S. S. E.	When within 20° of the horizon it burst into three or four fragments, flashing forth red and blue lights.	Prof. J. L. Smith.
154	Continuous train.....	30	Seen through the slit of the great dome from zenith towards S. S. E.	Prof. E. S. Holden.
155	Continuous train.....	15	Fell vertically.....	Separated into two parts, each of which moved 5° before extinction.	D. Horigan.
146.	Wash'n Ast. & Met. Obs'ns, 1873.
147.	" " " " " "
148.	" " " " " "
149.	" " " " " "
153.	Wash'n Ast. & Met. Obs'ns, 1873.
154.	Bull. Wash. Phil. Soc. II, 139.
155.	Wash'n Ast. & Met. Obs'ns, 1874.

CATALOGUE V.-Sporadic Meteors-Continued.

Ref. number.	DATE.			Place of observation.	Apparent size.	Color.	Duration.	Position, altitude and azimuth.
	Year.	Month.	Day.					
156	1875	July	14	U. S. Naval Observatory..	Large as Mars.....	Orange and red	s.	Appeared 10° above Mars and passed 5° E. of Mars.
157	1875	Aug.	5	U. S. Naval Observatory..	2d magnitude	Orange	4	Moved from λ Sazitaril towards λ Scorpii.
158	1875	Sept.	16	U. S. Naval Observatory..	Three times size of Venus.	White	2	Moved from Saturn to λ Aquarii.
159	1875	Oct.	7	U. S. Naval Observatory..	1st magnitude	White and green	3	Appeared near β Aquarii.
160	1875	Nov.	14	U. S. Naval Observatory..	Size of Mars	White	2	Appeared in Cassiopeæ.
161	1875	Nov.	17	U. S. Naval Observatory..	3d magnitude	White	1	Appeared near Polaris.
162	1875	Nov.	17	U. S. Naval Observatory..	1st magnitude	White	0.7	Appeared at ζ Ceti.
163	1875	Nov.	17	U. S. Naval Observatory..	1st magnitude	White	0.7	Appeared at X Ceti.
164	1875	Nov.	17	U. S. Naval Observatory..	1st magnitude	White	0.7	Appeared at X Ceti.
165	1875	Nov.	22	U. S. Naval Observatory..	8' to 1 1/2' in diameter	Violet or pink in front, bright green in center, and pale green following.	6 to 8	Appeared at X Ceti.
166	1875	Dec.	27	Few seeds.	From W. to E. across the northern sky.
167	1876	Jan.	26	U. S. Naval Observatory..	2d magnitude	White	0.7	From γ Canis Majoris to α' Canis Majoris.
168	1876	Jan.	31	Louisville, Ky.....	1/2 diameter of moon.....	White	2 or 3	60° above the N. W. horizon.
169	1876	April.	19	U. S. Naval Observatory..	3d magnitude	Orange and red	1
170	1876	July	8	Appeared at an altitude of 88 miles.
171	1876	Aug.	9	U. S. Naval Observatory..	2d magnitude	White and green	2	S. W. from ε Urs. Min. towards Arcturus.
172	1876	Aug.	9	U. S. Naval Observatory..	2d magnitude	White and green	3	S. W. from midway between Polaris and Cassiopeæ.
173	1876	Aug.	13	U. S. Naval Observatory..	3d magnitude	White	1	Appeared 8° below Polaris.
174	1876	Aug.	14	U. S. Naval Observatory..	3d magnitude	White	1
175	1876	Aug.	15	U. S. Naval Observatory..	3d magnitude	White	1
176	1876	Aug.	15	U. S. Naval Observatory..	3d magnitude	White	1	Appeared 5° below α Cassiopeæ.
177	1876	Aug.	15	U. S. Naval Observatory..	3d magnitude	White	1
178	1876	Aug.	21	U. S. Naval Observatory..	4th magnitude	White	1
179	1876	Aug.	22	U. S. Naval Observatory..	4th magnitude	White	0.5
180	1876	Aug.	27	U. S. Naval Observatory..	3d magnitude	White	1

156. Wash'n Ast. & Met. Obs'ns, 1875.
 157. " " " " "
 158. " " " " "
 159. Wash'n Ast. & Met. Obs'ns, 1875.
 160. " " " " "
 161. " " " " "
 162. Wash'n Ast. & Met. Obs'ns, 1875.
 163. " " " " "
 164. " " " " "

CATALOGUE V.—Sporadic Meteors—Continued.

Ref. number.	Train, appearance and duration.	Length of path.	Direction of motion.	Remarks.	Observer.
156	Continuous train.....	0	Fell vertically.....	D. Horigan.
157	Slight train.....	12	Prof. J. K. Eastman.
158	Slight train.....	15	Exploded and illuminated the small cloud behind which it passed.	D. P. Todd.
159	Train visible 20s.....	18	D. P. Todd.
160	No train.....	25	Fell vertically.....	D. Horigan.
161	Short train.....	32	Fell nearly vertically.....	D. P. Todd.
162	No train.....	10	Fell vertically.....	D. P. Todd.
163	No train.....	Fell vertically.....	D. P. Todd.
164	No train.....	Fell vertically.....	All disappeared at an altitude of 5°.....	D. P. Todd.
165	Faint greenish train.....	Moved vertically through ϵ Cygni and nearly through β Cygni.....	Within 6° or 8° of the horizon it passed behind a bank of clouds.	Prof. E. S. Holden.
166	Seen in Missouri, Kansas, Iowa, Nebraska, and Ohio.....	G. C. Brodhead.
167	Faint train.....	8	D. P. Todd.
168	Train short, green.....	From N. W. to S. E.....	Seen by several other observers in Kentucky.....	Prof. J. L. Smith.
169	Train visible 40m.....	15	From N. 78° W. over N. E. corner of Indiana.....	D. Horigan.
170	Exploded over Lake Michigan at an altitude of 34 miles.....	Prof. D. Kirkwood.
171	Long train.....	20	D. Horigan.
172	Train lasted 13s.....	30	D. Horigan.
173	Long train, visible 2s.....	15	Westward.....	D. Horigan.
174	Short train.....	20	"South from ϵ Andromedæ.....	G. Anderson.
175	Short train.....	15	"South from the Dipper".....	D. Horigan.
176	Short train.....	15	Eastward.....	D. Horigan.
177	Long train.....	20	West across Polaris.....	D. Horigan.
178	Short train.....	15	N. E. from β Pegasi.....	D. Horigan.
179	Short train.....	12	S. W. from Polaris.....	D. Horigan.
180	Short train.....	10	E. S. E. from Saturn.....	D. Horigan.

165. Wash'n Ast. & Met. Obs'n's, 1875.
 166. Trans. St. Louis Acad. Sci. III, 349.
 167. Astron' and Meteor' Observations, 1876.
 168. A. J. S. XIV, 458.
 169. Wash'n Ast. & Met. Obs'n's, 1876.
 170. A. J. S. XIV, 3, 75.
 171. Wash'n Ast. & Met. Obs'n's, 1876.
 172. " " " " " "
 173. " " " " " "
 174. " " " " " "
 175. " " " " " "
 176. Wash'n Ast. & Met. Obs'n's, 1876.
 177. " " " " " "
 178. " " " " " "
 179. " " " " " "
 180. " " " " " "

CATALOGUE V.—Sporadic Meteors—Continued.

Ref. number.	Train, appearance and duration.	Length of path.	Direction of motion.	Remarks.	Observer.
181	Short train.....	0	West from Polaris.....	D. Horgan.
182	Train of short duration.....	10 or 15	From N. towards N. E.....	Prof. E. S. Holden.
183	8	Fell vertically to horizon.....	D. Horgan.
184	8	Fell vertically to horizon.....	D. Horgan.
185	Train 1.5° long, lasted 1s.....	15	Down and north.....	Like the preceding, but 10° further north.....	D. P. Todd.
186	Followed by a great number of small meteors.....	From N. W. to N. E.....	Passed within 30' of moon's south limb; moon nearly full. Seen in Kansas, Missouri, Illinois, Indiana, and Ohio; disappeared with an explosion.	Prof. D. Kirkwood.
187	Train visible several seconds.....	4	Westerly.....	3d magnitude at appearance and three times magnitude of Sirius at disappearances.	J. S. Hunter.
188	15	D. P. Todd.
189	Light train.....	30	Eastward.....	Prof. J. R. Eastman.
191	20	Vertically downwards.....	Disappeared at altitude of 12° or 13°.....	F. M. Parker.
192	Prof. E. S. Holden.
193	A. N. Skinner.
194	10 to 12	Towards the west at an angle of 65° with the vertical.	Observer thought he heard the sound of the explosion.....	Robert C. Hindley.
195	12 to 15	Fell nearly vertical.	Probably same as preceding.....	Dr. F. L. James.
196	To 4° above β Cassiopeæ.	Near α Cassiopeæ it broke into seven or eight fragments.....	E. Colbert.
197	A bright train.....	11+	Across α Cygni.....	G. W. E. Tronvelot.
198	6	E. F. Sawyer.
199	10	Across ε and ζ Aquilæ.....	E. F. Sawyer.
200	18	E. F. Sawyer.
201	21	E. F. Sawyer.
202	9	E. F. Sawyer.
203	Red streak.....	23+	E. F. Sawyer.
204	E. F. Sawyer.
205	E. F. Sawyer.

187. Proc. Am. Phil. Soc. XVI, 596.
 188. Wash'n Ast. & Met. Obs'ns, 1877.
 189. " " " " " "
 190. " " " " " "
 191. A. J. S. XIV, 163.
 192. Wash'n Ast. w Met. Obs'ns, 1877.
 193. " " " " " "
 194. Proc. Am. Phil. Soc. XVII, 340.
 195. " " " " " "
 196. Proc. Am. Phil. Soc. XVIII, 239.
 197. Proc. Am. Phil. Soc. XVIII, 239.
 198. A. J. S. XVI, 348.
 199. " " " " " "
 200. A. J. S. XVI, 348.
 201. " " " " " "
 202. " " " " " "
 203. " " " " " "
 204. " " " " " "
 205. " " " " " "

CATALOGUE V.-Sporadic Meteors-Continued.

Ref. number.	Train, appearance and duration.	Length of path.	Direction of motion.	Remarks.	Observer.
206	0	Between η and β Pegasi.....	Quite rapid.....	E. F. Sawyer.
207	10	Between β and γ Andromede.....	Slow.....	E. F. Sawyer.
208	17	From γ Persel.....	Rapid; a Perselid.....	E. F. Sawyer.
209	3	Northward.....	Supposed to have been seen in Oil City and Titusville, Pa.	J. A. Bower.
210	20 or 25	Slow.....	E. F. Sawyer.
211	5	Seen and mapped also by S. C. Chandler, Jr., at Marlboro, N. H.	E. F. Sawyer.
212	6	E. F. Sawyer.
213	Orange trail.....	15	From γ Herculis.....	Rapid.....	E. F. Sawyer.
214	12	Rather slow; an Aug. Lyriad.....	E. F. Sawyer.
215	15	Rapid; a Lyriad.....	E. F. Sawyer.
216	10	Rapid.....	E. F. Sawyer.
217	6	E. F. Sawyer.
218	6	Near α Bootis.....	Slow.....	E. F. Sawyer.
219	9	Near α Cor. Bor.....	E. F. Sawyer.
220	8	Rapid.....	E. F. Sawyer.
221	Orange streak.....	5	Benjamin Vall.
222	14	From near α Aquari.....	Slow.....	E. F. Sawyer.
223	17	Rapid.....	E. F. Sawyer.
224	No trail.....	5	Vertically near β Ceti.....	Very slow.....	E. F. Sawyer.
225	15	E. F. Sawyer.
226	10	Rapid.....	E. F. Sawyer.
227	Train visible two or three seconds.....	33	E. F. Sawyer.
228	7	Slow.....	E. F. Sawyer.
229	10	Very slow.....	E. F. Sawyer.
230	10	Rapid.....	E. F. Sawyer.
231	8	Westward.....	Rapid.....	E. F. Sawyer.
232	E. F. Sawyer.
233	A small meteor branched off just before it reached Ursa Minor	D. E. Hunter.
234	H. E. Stevens.
235	J. J. Skinner.

232. Science Observer, I, 36.
233. Proc. Am. Phil. Soc. XVIII, 241.
234. Science Observer, II, 30.
235. " " " " " "

CATALOGUE V.-Sporadic Meteors-Continued.

Rel. number.	DATE.			Place of observation.	Apparent size.	Color.	Dura- tion.	Position, altitude and azimuth.
	Year.	Month.	Day. Hour and minute.					
236	1878	Nov. ...	14	Hillside Farm, Mass.....	Very bright	s.	South of observer. From the Crab Nebula to above and to the left of α Ursa Majoris. S. 10° W.; alt., 25°.
237	1878	Dec. ...	19	New Haven, Conn.....	3	
238	1878	Dec. ...	30	Grand Traverse City, Mich.	Brilliant. Larger than moon.	
239	1879	Jan. ...	27	
240	1879	Mar. ...	14	Washington, Ind.....	Pale blue.....	

CATALOGUE V.—Sporadic Meteors—Continued.

Ref. number.	Train, appearance and duration.	Length of path.	Direction of motion.	Remarks.	Observer.
236	o	Seen during bright sunshine	Thomas Whitaker.
237	J. J. Skinner.
238	Seen in Indiana, Pennsylvania, and Ohio	Prof. D. Kirkwood.
239	From S. W. to N. E.	Explosion heard 4m. after disappearance	Thomas T. Bates.
240	Train visible several minutes.	Disappeared with an explosion	Prof. D. Kirkwood.

239. Proc. Am. Phil. Soc. XVIII, 243.
 240. Proc. Am. Phil. Soc. XVIII, 245.

236. Proc. Am. Phil. Soc. XVIII, 241.
 237. Science Observer, II, 35.
 238. Proc. Am. Phil. Soc. XVIII, 241.

MONEY FALLACIES.

BY

CLARENCE EDWARD DUTTON.

ADDRESS AS RETIRING PRESIDENT.

Delivered February 14, 1891.

It is the custom of the retiring president of this Society to offer an address upon an occasion fixed for that purpose by its general committee. Such addresses are expected to embody the understanding of the speaker concerning some scientific or philosophical subject which has specially engaged his study and reflection. In following the examples of my learned predecessors, I selected some months ago a theme in the domain of Political Economy which has been almost a life-long subject of interest to me, but which, apart from its pure philosophic interest, chances to touch, and even to underlie, one of the burning questions of the hour. In view of this coincidence I am reminded how in 1860 the power of political agitation, spreading among all men, so infected even the clergy that much was said about preaching politics in the pulpit. I am not unmindful of the dignity of this occasion, and the Philosophical Society would have lived and flourished in vain if it had not inculcated upon all its members the necessity of calmness and candor in treating all subjects admitted to its deliberations.

I have selected the subject of *Money Fallacies* as the theme for this evening. It is a broader one than its title might at first suggest. Money is an institution as old as human society, and the daily, almost hourly, association of human ideas with its uses and abuses constitutes a force of human

impulses so strong and so constant through successive generations that it seems a fair question whether there be not an evolved and hereditary money instinct in the human mind. Certainly the small child grasps the significance of the money function in a way that suggests as much. But in the progress of society the uses of money have been growing more and more complicated. While the great mass of mankind still use it in the ancient, simple way, with an action which seems instinctive, the financier, the statesman, and the economist find upon inquiry that the growing complications give rise to many phenomena which are unknown and unperceived by those who have not analyzed them. The ordinary individual judges of the properties of money by his own limited experience, and, unless he be more than ordinarily observant, extends his reasoning without limit or qualification to all men and to all money. But the economist, who studies and endeavors to integrate the results of all men's actions in using all the money of a community, quickly discovers that the ordinary reasoning either fails wholly or is radically qualified by the total action of forces and conditions which are imperceptible in one individual transaction. Thus the ordinary person says one dollar will buy me so much and two dollars twice as much. Why may not this reasoning be extended to any practicable limit in the same relative proportions? The economist knows that it cannot be. What is generally true in the individual experiences of men, when it is sought to apply it to all men and to all money fails, and at once fallacies make their appearance.

The fallacy that money and wealth are one and the same thing is the fallacy of antiquity. It has during the last century been for the most part relegated to the same class of delusions as perpetual motion, and though on rare occasions it still raises its head, as does the idea of perpetual motion, yet it is now so nearly eradicated from human reason that no one cares to waste his breath upon it. But as old theorems give birth to new ones, so do old fallacies leave be-

hind them a brood of younger ones, and some of them bear the paternal resemblance so strongly that we are at times doubtful whether we have encountered the parent or the child.

The fallacy which I shall discuss *first* is one which is implied, rather than distinctly stated, in a saying which has become frequent of late: "That it is the government stamp that makes the money." The same fallacy is implied in an equivalent saying, "That money is the creature of the law." There is a sense in which either form of the statement is true. It is true that stamping a piece of paper or metal with certain images and superscriptions converts them into money, or, if you like, makes money; but this statement is so obvious that the only interest in it is the query why anybody should have thought it worth while to state a proposition so self evident. There is, however, an implication in the statement which is not true. People who make it generally intend to convey the belief that it is the government stamp that makes the *value* of money, or that the *value* of money is the creation of the law. Nothing could be further from the truth. The value of money is just what value people will consent to give or receive in exchange for it. Its value is fixed, according to time, place, and circumstances, every time a bargain is made, by an agreement between the two parties who trade.

So long as government action conforms to the real and the right practices of the people who use it, the action may be useful and beneficial in protecting the honest against the dishonest, and in facilitating the payment of obligations and in quieting disputes; but any attempt to contravene the monetary customs of a people or to force them to adopt valuations of money against their will would be wholly ineffectual. A few illustrations will suffice: The colonies of New England, before the revolutionary war, repeatedly stamped money and passed laws fixing the values of the various issues. The people, with almost united voice, demanded these laws. Almost immediately after the money

was issued its value began to diminish rapidly, and at length it had no value at all. Cruel and unusual laws were passed in the effort to sustain its value, and in the outrageous attempts to enforce them society was brought almost to the verge of dissolution. People, however, continued at every bargain to place their own value on the money, which value grew less and less, and finally vanished. Again, during the war, the value of the legal tender notes was implied on their faces to be equal to gold money. The people of most of the northern states accepted them as money, but their value declined until, at one time, it became only about two-fifths of their declared value. In California and Nevada they were not accepted as money at all, and the few that were obliged to receive them had no resource but to sell them to money brokers for what they would fetch, or to the banks, which shipped them east as fast as possible.

On the other hand, a government stamp on money, though useful, is in nowise essential. From the close of the revolutionary war to the war of the rebellion, the principal and almost universal money of larger denomination than half a dollar consisted of the notes of State banks. They were privately printed by the banks and were not a legal tender.

The *next* fallacy which will be discussed is one which is very prevalent in our own country, but which has had its day in other countries also, and still exists elsewhere. It is contained in the widely prevalent belief that more money is needed in the total circulation. In some large portions of the country there is an apparent scarcity of money; people find it difficult to obtain. The local papers and periodicals abound with complaints and are urgent in their demands for an increase of the circulation and "a relief of the stringency in the money market." Interest is 10 or 15 per cent. Real estate is offered as security, but "the money" is not forthcoming. Enterprises believed by the people to be pregnant with extraordinary profits are projected and planned in detail, but "money" cannot be had to carry them out. Towns and cities are springing up, but while rents are

exorbitant, there is not sufficient "money" procurable to build dwellings and offices. Surely if more money could be put in circulation (and the more the better) it could be procured with ease, and prosperity would come with a leap and a bound.

The fallacy which underlies this dismal view of the reality and hopeful view of the possibility may begin to appear if we look at other portions of the country. In any of the great cities of the eastern and central states a merchant or manufacturer of good standing has no difficulty in obtaining all the money he wants at 4 or 5 per cent. The banks are full of it. If we look into the accounts of the New York banks we shall find that there is hardly a southern or western bank, whether national or private, that has not a deposit or credit there. It is no uncommon thing to find this money loaned out in the city, or even outside of it, on call, at 2 or 3 per cent. Here there is no scarcity of money, but rather a seeming redundancy. High interest is not a proof that money is scarce, for any one of many causes may make it high; but low interest is proof positive that money is abundant, for in order that interest may be low all causes must conspire to make it so. Money, therefore, is not scarce in all parts of the country, but only in some parts of it. But why should this be so? Why should money be abundant in the mercantile centers and scarce elsewhere? Because money is the medium of exchange and naturally goes where the exchanges are made. Where the exchanges are, there will the money be also. If the western parts of the country have wheat and corn, pork and beef, gold and silver, wool and hides, to exchange; if the southern parts have cotton and oil, iron and lumber to offer, the whole money supply of the world is open to their drafts, and if they want the cash in gold coin or in paper money they have but to say so and it is on the way to them as fast as steam can carry it.

So, then, it appears that the asserted scarcity of money in some parts of the country is not because of a general or universal scarcity; for all of the money in the world is at their

command, upon the same conditions that prevail everywhere else. An equivalent must be given in exchange for it. But if they have already given all that they are disposed to part with and still have not as much as they want, how are they to be benefited though the money of the world were increased tenfold ?

Here the real nature of the complaint begins to show itself. The economist has no difficulty in perceiving that the complaint involves three fallacies : The first consists in confounding the *desire* for more money with the *demand* for more money. Desire is intelligible enough and needs no explanation, but demand for an article is a very different matter. It is the desire to have, accompanied by the willingness and ability to pay the price required. Whenever I enter Tiffany's store, on Union Square, I want a thousand beautiful and costly things ; but my demand for his stock is pitifully small. The impecunious portions of the country have not, it is true, all the money they want, but it is absolutely certain that they have all that they demand. The same is true of every community and of every individual.

The second fallacy consists in confounding the want of money with the want of capital. Those who call for it would indignantly reject the imputation that they are asking for alms ; they would, if the matter were put to them squarely, admit at once that they want money to build up and improve their portions of the country ; to open mines of coal, ore and precious metal ; to build roads and bridges ; to erect factories and set wheels in motion. This is plainly the function of capital. Money is only the intermediary thing and the incident. The ultimate and substantive thing is capital. Money is desired only to give in exchange for something desired still more. Capital is wanted to keep and to hold and to employ in perpetuity. This is so obvious and so well understood that no further discussion of it is necessary.

The third fallacy consists in attributing to a supposed deficiency of money effects which are produced by other causes and which would operate in substantially the same way

whether the total money be of great amount or small. For instance, take the obvious fact of an abundance of money in the great commercial cities and its apparent scarcity in the rural districts. The cause is obvious and would continue to operate in the same way whether the total volume of the circulation were great or small. Or again, take the apparent scarcity of money, even in great cities, during hard times and its apparent abundance almost everywhere, even in the country, during good times. There is little or no difference in either case as to the actual amount of money in the country; but, in hard times, the money circulates very slowly and with difficulty, while in good times it circulates rapidly and with ease. By far the greater portion of the money function in this country is accomplished by transfers of credits. But, in hard times, credits are neither sought nor offered so abundantly, because there is little promise of profit either to borrower or lender, or in the use of credit by its owner. These and other examples of the same fallacy will be discussed a little more in detail hereafter.

We may also disclose the same fallacy by pointing out the fact that the quantity of money in circulation is only one of several factors which determine its general effectiveness for performing the money function of the country in the best possible manner. The efficiency of the same quantity of currency may vary enormously under varying conditions, and so long as there is any considerable quantity in use the efficiency is governed by economic laws and forces which are independent of the amount. So, too, is the distribution of money throughout the country and throughout the world.

There is a prevailing belief among many people that an increase in the amount of money must increase the available purchasing power of a country and thereby stimulate the demand for produce; that this increased demand must lead to greater production and a more rapid increase and consumption of wealth. If there were more money there would be more to spend and more to lend. This looks very

plausible, but it is very fallacious. The fallacy consists in stating one half of the truth and leaving the other half untold. The sting of the fallacy is in the untold half. It is true that a large amount of money suddenly forced into circulation will be an apparent, though not a real, increase in the purchasing capacity of the circulation, for the available things to be bought remain as they were before; still, for a short period there will perhaps be more buying and selling. It matters little how the money is paid out from the treasury, much the greater part of the money will be deposited in the banks or in loan and trust companies or in some large receptacle of money within a week, and nearly the whole of it within a month, and it is the business of these depositories to find some use for it, generally in the form of loans.

Sooner or later the money may (or may not) find borrowers who put it to use in increased purchases or investments. Demand for goods now increases. It is followed by increased production and by a rise of prices. All things look well; business is active, manufacturers find it difficult to fill orders, and labor is well employed. Profits seem large, credit is easy, and people are pleased with their apparent prosperity. This is the rising side of the wave. It would be a great and general benefit if this were all real and permanent. Increased production and consumption mean a general improvement in the material well-being of a people and a higher and better scale of living; but this kind of wave has a descending as well as an ascending side, and the crest is followed by a trough. A mere increase of money suddenly forced into circulation carries with it at the start no corresponding increase in the other valuable things which constitute the wealth of a nation. It has merely increased the nominal lending capacity without increasing the borrowing capacity, and the nominal power of exchanging valuables without increasing the valuables to be exchanged. Thus debts have been increased without any corresponding increase of real assets out of which they must ultimately be paid.

If instead of more money, which has really added nothing, there had been a well diffused increase of the productive unencumbered capital, there would have been increased production, increased consumption, and a higher scale of living without any drawbacks. And this improved condition might have been permanent. People then would have been prospering by the use of accumulated savings from the past fully realized; but with more money and with consequent expansion of debits and credits there is a momentary spasm of seeming prosperity, for which the future is expected to pay but cannot. Sooner or later there must be a reckoning, and when the future arrives it is sure that debts overrun available assets. Credit must be contracted again, and with it production and consumption and all below the original scale. So, too, must the scale of living be reduced. But an increased scale of living is the easiest thing in the world for people to accept, while a decreased scale of living is the hardest. The increased scale they accepted almost unconsciously and with little or no thanks, as if it were their rightful due from the bounty of nature. The decreased scale is yielded to from hard necessity, with repining and sullen discontent, and with a vague notion that something is wrong somewhere, and that somebody is robbing everybody. Today men have their revel with wine and dance and song; to-morrow brings the racking headache, the soured temper, and the depleted pocket-book.

But there is another fallacy lurking in this call for more money. It is suggested by the following inquiry: How happens it that it always arises when times are hard, when trade is stagnant and exchanges diminished—in fact, when the real demand for money to effect exchanges is apparently smallest? And how happens it that in brisk times, when trade is active and exchanges are greatly increased, the cry is suddenly hushed and nobody seems to have the least idea that any more money is needed in the circulation? Is it because there is less money in the country in hard times than in brisk times? Not at all. There is in every civilized

country and in most half-civilized countries plenty of money at all times; only in the hard times people who want it (badly enough, I grant you) are unable to get hold of it. Naturally they judge the whole supply by the leanness of their own purses; but the strangest part of it all is the large masses of money locked up in the great reservoirs of money anxiously waiting and longing for some one to come armed with the proper documents and release it from its irksome confinement. At such times money is just as anxious to be had as impecunious people are to have it. What is it that keeps these two ardent lovers apart? The usual reply, that it is the want of good collaterals, while it may be true in one sense, is hardly so in the sense of a real and ultimate cause, for in fact good collaterals are as plentiful in hard times as in flush ones; but the people who hold the collaterals are not the ones who want the money. The true proximate cause is that money in its capacity of capital never moves but in the expectation of profit, and in hard times there is little profit in sight. Indeed, hard times mean the scarcity of profits much more than the scarcity of real production; and then capital, in the form of credit, retires into winter quarters and money goes into the strong boxes. But why should there be a general dearth of profit at one time and plenty of it at another? The causes are many, and two periods of depression may have very different causes; nor does it seem possible to embrace them under any one form of statement, unless it be one so general that it is of little or no use. Perhaps the most frequent cause of depressions is the waste of capital and of the surplus of society consequent upon an undue expansion of credit. When the effects of this waste have begun to press upon the community, as in due time it inevitably must, people must go to work repairing damages and restoring the capital to its original efficiency and productive power. What would otherwise have been profits are absorbed in this restoration, and this recuperation is itself hampered and retarded by the crippling and diminished efficiency of the capital whose restoration must be accom-

plished. But while over-expanded credit is possibly a more frequent cause of depression than any other one, it is by no means more frequent than all other causes combined. Of other causes it is perhaps unnecessary to speak at present.

There is another mistake involved in the call for more money to be issued by the Government. Forced issues of money by the Government cannot increase, except temporarily and for a very brief time, the amount of money in use beyond what would have been supplied by the spontaneous action of trade without Government interference. The amount of money in use is governed by the law of demand and supply, and this law is still supreme, whether the Government forces issues of money or not. The only qualification to this action is that a stiffening or relaxation of the relative demand is not instantly followed by a corresponding variation in the supply. It takes a little time to attain the readjustment.

The experience of many countries during the last two centuries has taught us that any great increase of currency beyond the demands of trade first displaces the gold money of the country, and, if still further pressed, results in inflation, in which there is a nominal but not a real increase of money. The process by which the displacement of gold money is thus effected is through a rise of prices, which always follows a large increase of the circulation. More money means a nominal increase of the buying capacity, which leads to increased demand for produce, and a general rise of prices follows; but when prices in general have thus risen, there being no corresponding rise in other countries, the country becomes unfavorable for foreign buyers who seek to purchase lower elsewhere. But it becomes a favorable country for foreign sellers, who urge sales and find ready buyers. In a short time an "unfavorable balance of trade" is thus developed, the balance against the country steadily grows, and the premium on sterling exchange rises until it passes the "shipping point." Then gold flows abroad. If the redundancy of money is not relieved by this outflow of

gold the exportation continues until gold available for shipment becomes scarce and at length commands a premium. This is the beginning of inflation, and if the redundancy still persists, the money (necessarily not convertible into gold at par) depreciates or loses purchasing power, which is equivalent to a diminished quantity, and it continues to depreciate until it becomes adjusted to the real demand for money. Prices being quoted in the inflated currency are now at a maximum, but if they are estimated in gold, at a premium, they will be seen after a time to be no higher than they were before, unless in the mean time some other cause wholly independent of the money supply has affected them.

The reverse is seen when the money supply is deficient or when the real demand for more money has increased. Money being really scarce, the purchasing capacity of the country is curtailed, the home demand for merchandise declines, and prices fall. The country now is favorable for foreign buyers and unfavorable for foreign sellers. More values are bought by foreigners than are sold by them, and a "favorable balance of trade" is at length established which leads to an importation of gold.

Since the close of the war there has been a growing demand for a larger circulation in the United States. This has arisen from the rapid increase of population and the still more rapid increase of wealth and amount of exchanges. This growing demand was met during the first part of the period by an appreciation in the purchasing power of the paper money, which reached a parity with gold in 1879, and also in part by an increase in the volume of national bank notes.

In 1878 the Treasury began the issue of silver dollars and silver certificates, but this was in a great part offset by the retirement of national bank notes, so that the total issues of the Government did not keep pace with the growing demand for money. Gold then poured in upon us rapidly, and within the last twelve years the statistics of the gold supply now in the country show an enormous increase. In

fact, the demands of trade have added more gold to the total money of the country in the last twelve years than all the silver money and Treasury notes added by the Treasury in the same time; and if the Treasury had added nothing the demands of trade would doubtless have added it.

It will probably be suggested here that an importation of a large amount of gold drawn from the world's existing stock to meet the growing demand of the United States for money would cause a general increase of demand for gold without a corresponding increase of supply. It is estimated that at the present time the consumption of gold in the arts does not differ greatly from the output of the mines, and the existing stock has within the last five or six years been but little increased. The increased demand, therefore, would tend to increase the value of gold, and thus cause a general fall of prices. This reasoning is no doubt true, but it takes no account of the constant growth of substitutes for gold and the continued increase in the efficiency of money, whereby less is required as the final basis of money needed to accomplish a given amount of exchanges. Whether the effect of all causes combined is such as to produce an increase in the purchasing power of gold relatively to all commodities is a question which hardly admits of an answer. So many new commodities are being introduced almost daily, the older commodities are so much improved in quality or changed in fashion, the relations of capital to labor are so greatly modified, that exact comparisons are impossible. The general opinion of those who have attempted comparisons of the prices of a considerable number of commodities at different times is that the commodity price of gold has appreciated. But it is clear that none of these comparisons take full account of the effects of innumerable causes which influence prices, nor does it seem possible to do so.

Waiving this question, however, and granting that there may have been an appreciation of the commodity value of gold by reason of increased demand for the world's stock, it remains to inquire whether this appreciation would be an

evil or not. The answer, I think, is that a *sudden* appreciation or depreciation of the standard of value would always be a shock or stress to the economic system, and any violent change of this kind is for a time detrimental; but a slow and steady change in the standard is a matter of such small importance that it exerts no appreciable effect. It is like the effect of the rise and fall of the tide upon a ship, which is unfelt as she tosses and labors in the swell of the ocean. There are numberless causes acting upon prices and tending to disturb them which are incomparably more potent than any possible change in the value of gold could ever be:—a change of freight tariffs or of the rate of discounts, an improved machine, a very favorable or unfavorable crop, and many other causes would exercise a much more powerful influence. The objection to “a change in the standard of value” is proportional to the rapidity of the change.

Hitherto I have spoken of money only in the ordinary sense of the currency or the circulating medium. I have done so to avoid unnecessary complication; but we may now advert to the fact that the exchanges of this country and of some others are in much the greatest part effected by other devices. As nearly as can be estimated, about 4 per cent. of the exchanges of the country are effected by the direct payment of money. The rest is effected by transfers of credit on account. It is not a little interesting to note that in the later evolution of the methods of exchanges the civilized world is reverting more and more to barter—not, indeed, of the simple and primitive form of antiquity, but an elaborate and highly developed form involving the fundamental principle of barter. In fact, the use of money is gradually being narrowed down to those exchanges in which the use of credit is impracticable, and there is a powerful tendency to the use of the minimum amount of money with which it is possible to effect exchanges, and there is an equal tendency to make the efficiency of money as great as possible.

To show how money seeks a minimum of quantity and a

maximum of efficiency we have only to recall the nature and uses of the ordinary bank check. By the increasing uses of this device much the greater part of the exchanges of this country are effected. By means of the promissory note, which may pass from creditor to creditor, another great amount of exchange is accomplished. Foreign exchanges are now settled without the use of money at all, except at long intervals, and even the bullion which is interchanged moves rather in the capacity of a commodity than of money. Many other devices might be mentioned, but these will suffice for illustration.

The causes of this tendency to a minimum use of money are superior convenience, the economy of time, labor, and capital, and greater security, and this is in accordance with all tendencies of the age. Money has been superseded to a wonderful extent by devices which accomplish money purposes far better. Transfers of solid credit have taken its place wherever possible. They all perform the money function in a more speedy and satisfactory manner, and they may very properly be called special kinds of money. By the use of these devices the money function of a great and wealthy country can be multiplied and expanded almost in an instant to an enormous extent. If occasion were to arise, in conformity with the real demands of trade, for an instant increase in the money of this country to the extent of a hundred million dollars it could be effected in less than fifteen minutes by the simple action of tens of thousands of men opening their check books in the morning and making a few scratches of the pen. By night 95 per cent. of these checks would be in the banks and through the clearing-houses, and the same operation could be repeated the next day, and day after day, *ad infinitum*.

And so people think there isn't money enough in the country! Why, Mr. President, the creditors in this country can create in a day more money than all the mints can coin in a year, and every dollar of it would have solid face value under it. More money, forsooth! The world is using

Aladdin's lamp in these days, and coin is but a clumsy relic of antiquity.

The assertion that the filling and signing of a bank check for a specified amount by a depositor creates just so much money may seem an absurd one to many. Undoubtedly it must have its qualifications; but there is no qualification which affects its substantial validity. As Prof. F. A. Walker says, "Money is that money does." A valid check pays debts and buys goods as effectually and completely as a Treasury note. Its uses, however, are much more restricted. But, on the other hand, wherever usable it is generally more convenient, either to the drawer or payee, or both. Its function is a pure money function. Between the time the check is drawn and the time it is honored and cancelled at the depository on which it is drawn it is an addition to the circulation. It may have effected one payment only, or it may have effected many payments.

It is also evident that an increased rapidity of circulation is an increase of the monetary potency of the total currency. In truth, one of the most striking differences between the active times and the dull times of business is the difference in the rapidity of circulation of both statutory money and credit money. While most people would say that more money is paid out and in, during active times, the real truth is that the money of the country changes hands more rapidly, with little or no variation in the amount.

Perhaps the best illustration of the effect of credit money, such as bank checks, upon the volume of currency may be seen in contrasting the money system of France with our own. In France such devices are less commonly used. With a population much smaller than our own, as well as much poorer, and with an aggregate value of total exchanges not much more than one-third as great, the total estimated amount of money in the country is about three times as great *per capita* as in the United States. A very considerable part of this mass, however, is not in circulation.

A great deal of fallacious reasoning results from a want

of definiteness in the language employed when the appreciation or depreciation of the money standard or unit is spoken of. Many people proceed to reason about it as if there were some absolute and invariable standard of value with which the particular standard of a country can be compared to determine whether the latter has fallen or risen. There is no absolute standard of value; there is nothing but relative value. We can compare two values and their ratio is a price. Thus the ratio of the value of a quantity of wheat to the value of the money unit is the money price of wheat. If we invert this ratio we have the wheat price of money; but what the value of the money unit is in itself, apart from such a relation, is beyond the power of the human reason to determine. We can have as many relative valuations of the money unit as there are of exchangeable things to compare it with. We may have the wheat value, the cotton value, the silk, iron, copper, silver, or coal value; but when the value of the money unit, independently of its ratio to the value of other things, is asked for, the question is unanswerable. So, too, if it is asked whether the gold dollar or sovereign has appreciated we can only toss back the question and ask, Relatively to what? If it be asked whether the wheat price of the gold unit has appreciated it can be answered by comparing the present market quotations of wheat with those of any past time. Relatively to most commodities, there has been a slow appreciation of gold, or, reciprocally, there has been a depreciation of the value of most commodities relatively to gold; but whether gold has depreciated or appreciated absolutely no man can say. Relatively to a few commodities, gold has depreciated. But what is of far more importance than any other change of this kind is the fact that, relatively to the value of human labor, gold has depreciated.

Another fallacy is that an appreciation in the commodity price of gold works hardship upon debtors who are required to pay their debts in gold or its equivalent. This fallacy is easily exposed. The hardship of paying any debt must ob-

viously consist in the relative difficulty of obtaining the wherewithal to pay it. There are, of course, thousands of people who would have had much less difficulty in obtaining a thousand dollars in gold one, five, ten, or twenty years ago than at present, but there are also thousands of whom the reverse is true. We can take account only of averages or, at most, of large groups or classes.

The means of paying debts must come from one or more of three sources—wages, profits on capital, and rents. As these terms are understood in political economy, they comprise all possible sources of income. First, as to wages, there can be no question that the amount of gold which an average worker, whether with brain or muscles, can earn in a given time has in this country greatly increased and is continually increasing. The exceptions are extremely few. Hence, measured in terms of labor, pure and simple, the price of gold has greatly diminished, and this measurement of the price of gold is of far greater moment to the nation than its price measured in commodities. Hence, where the means of paying debts are derived from wages alone, it is on the average much easier to pay them now in gold than formerly.

Second, as to profits on capital. Here two considerations arise: first, the rate of profit; second, the amount of capital or principal on which the profit is to be reckoned. The rate of profit during the last twenty or twenty-five years has fluctuated with good and bad times, but, on the whole, has considerably diminished, and hence a person whose capital is unchanged in amount and who depends wholly upon such profits for the means of paying debts finds increased difficulty. On the other hand, the amount of capital has not only increased as a whole very greatly, but the *per capita* amount has also much increased. Whether the aggregate profit (average amount of capital multiplied by the rate of profit) has increased is a difficult matter to settle. The probabilities favor the view that there has been an increase in the aggregate profits of the average individual; but this

average embraces the sum of the widest inequalities in the distribution of ownership of capital, from a fortune of \$100,000,000 or more down to the ownership of a sewing-machine or typewriter.

Third, in respect to rents. Throughout the greater part of the country they have increased. The term rent, of course, is used in its economic sense. The increase of rents has been unequal, being greater in city and town property than in country property. In some farm lands, notably those of New England, rents have greatly fallen; in the Central and Southern States they have generally increased; on the frontier of the agricultural states, Dakotas, Nebraska, and Kansas, they have lately begun to exist at zero, and are steadily increasing. We must, however, distinguish between the profits of farming and the economic rent of farm land. Agricultural profits have during the last ten years greatly fallen all over the world, and the cause is world wide.

As this thought brings me to the real lesson contemplated in my address, I will, as briefly as possible, develop it in its outline, and show what part money fallacies play in the drift of human sentiment and human action. The depression of agriculture, as has been remarked, is world wide. It has of late years been felt not only in Europe and America, but has spread to tropical countries in Asia and, to a less extent, even to the unprogressive states of South America. It has pressed with severe force upon the colonies of Australia and South Africa and the Mohammedan provinces of the Levant. Extremely few countries or districts have escaped. A few have had the good fortune to be shielded from the pressure by reason of some special crop not produced elsewhere or producible on its native soil only in limited quantity, or grown under special conditions of market not common to the rest of the world. The causes have already been alluded to. Proximately, the cause has been the railroad and steamship, by which vast areas of good land has been brought under cultivation, the cost of production cheapened, and the produce brought to market at won-

derfully low rates. The first effect of this was to make farming in the newly opened districts highly profitable. Good profits and unlimited cheap land made more farmers. Improved agricultural machinery made larger crops with a given amount of labor. Our own Government adopted the policy of giving away land at a nominal price to whomsoever would take it and use it, inviting settlers from all quarters of the earth, except China, to come and occupy it. Meantime Australia and the Argentine Republic adopted a public land policy differing in details, but amounting to the same thing in the end. In India the government fostered the opening of wheat lands, and set millions of ryots at work producing wheat for the world's markets. Thus the force of governmental policy and action was added to the forces already powerfully at work, tending to make agriculture less and less profitable. With almost unlimited expauses of the finest agricultural land given away without price, with marvelous improvements of machinery for increasing the produce of agricultural labor, with still more marvelous reduction of the cost of transportation and distribution of the produce, the number of farms has been enormously and disproportionately multiplied, until the markets of the world have been gorged and broken down with a surfeit of the first fruits of the soil. The profits of farming have greatly fallen all over the world, and the cause is excessive production of surplus products. Dakota and California are competing with India, Russia, and Australia in the principal market of the world, Great Britain, where their surplus is most largely taken and where its prices are inevitably determined according to the law of demand and supply. The cotton crop of the South has scarcely any competitor except itself, but so vast has been the increase of product and so greatly has the use of wool and other fibers increased that the supply of cotton has grown more rapidly than the demand. This has been a great blessing to the rest of the world, but has been the cause of diminished profits to the farmer. He feels it keenly, and yet it would seem that he has

failed to recognize what it is that hurts him. When the falling price of his products began to press upon him, his first thought was that it was the railroads. If the railroads, which had made his farm a possibility and without which it could have been no more than Robinson Crusoe's farm, could be persuaded or compelled to haul his produce for less, he would get more profit. He applied the law, and the result was that England and the Eastern States got the whole benefit of the reduced tariffs and he got poorer railroad service and less of it. He had bitten a file and broken his teeth. Still, the pressure upon him grew more and more intense. Surely something is wrong somewhere, and somebody must be robbing him. Looking eastward or northward, he sees wealth rapidly piling up and contrasts it with his own languishing condition. The effect upon his mind is inevitable and is only history repeating itself. Surely that vast wealth must in a great measure have been wrung from him, the toiler of toilers. If justice had been done he would have been at least an equal sharer in it. He would be more than human if he failed to think so. Here are the men who have by black art or by the relentless use of the tyrannical power of capital squeezed or leached out the profits of his noble industry and concentrated them into colossal fortunes. How have they done it, and how can their art be proscribed and their power for oppression broken? Thousands of men are ready to tell them. To the man who is really suffering any kind of a doctor who will look wise, talk sympathetically, and promise him a speedy cure is welcome. He must be careful, however, not to assign as a cause of the malady anything which everybody knows is beyond the reach of physic, or else the patient will have no use for his nostrums. The quacks have told him of many causes of his suffering, and one set of them assure him that something is the matter with the money of the country. Money, the circulating medium, is the life-blood of economic organism; there is not enough of it, and what there is is out of order. Something must be done to

make more of this blood and put it in order. All this is in harmony with popular ideas of economic pathology, and it is not at all surprising that the call for blood-purifiers is urgent.

To diagnose the real cause of the depression of agriculture requires no assumption of peculiar wisdom, but does call for a great deal of candor. Any man has but to open his eyes and it is as plain as the Washington monument from the south windows of the Treasury. The cause is world-wide. Monetary conditions have absolutely nothing to do with it. The industrial revolutions of the last fifty years, having profoundly modified almost every other industry, have at last begun to operate with resistless force upon the oldest, the greatest, and the most deeply rooted of all human occupations—agriculture itself. The old régime of agriculture is doomed and must give way to a new one. To oppose it is as futile and hopeless as the effort to sway the motion of the earth in its orbit. Nearly all other great industries have been compelled to undergo their metamorphosis, and the turn of agriculture has now come. As with the others there has been suffering during the transition epoch, so will there be suffering with the transition of agriculture; as with the others there has at length resulted a general increase of benefits, so will it be in agriculture. It will end in greater comfort and an improved condition for all mankind; but the transition stage will be one of depression to the industry which is transformed. That the change will be resisted and that resistance will aggravate the suffering is to be expected.

But how is it with the rest of the world? It has prospered greatly. And yet most people cannot see it so. The mercantile and some of the manufacturing classes are complaining. Of what? That profits are small. And this is true. Profits are decreasing—not the aggregate profits, perhaps, but certainly the rate of profit. Political economy teaches us that the rate of profit always tends to a minimum, and, though occasional disturbances or upheavals and

wars or other calamities sometimes shake and unsettle the economic foundations of the world, compelling communities to start anew with a higher rate of profit, yet the tendency immediately reappears. After a period of rest and stability or of equable unperturbed motion of the economic machine, profits are seen to have dwindled. But is not this a pessimistic and gloomy view to take of the prospects of society? Is this to be the outcome of our boasted improvement, and is there nothing before us but a diminution of profits until trade is simply a struggle to secure a bare margin against loss? What becomes of those vanishing profits?

My good friend, if you would find the vanished profits, look about you. They have not left the earth nor lapsed into nothingness; they have gone to places where of all others and before all others it is well that they should go. Here they are all around you—better food and more of it, better clothing and more of it, better houses and more of them, better streets and roads and more of them, better furniture and fairer decoration in your houses and more of them, swifter trains and more of comfort in them, better music and paintings and more of them, better schools and colleges and more of them, better comfort, better thought, better art, better living, and, in Heaven's name, let us hope, better men and better women. Your profit of 20 per cent. of 20 years ago, my friend, has dwindled now to 5 per cent., but the world has gotten the other fifteen, and that, too, on a vastly greater capital sum. You may long for the good old times, but the world will, if it is wise, give you little sympathy. It is best as it is. As profits diminish real wages rise. In the division of the produce of land, labor, and capital a decreasing share goes to capital and, for the present, to rent also, and labor has gained what the other two have lost.

Still the world is not happy. Why? Because it is blind to what it has gained and sees only what it has lost. It has gained a better living because it has sacrificed profits, and is moping because it cannot have its cake and eat it, too. Yet

all classes have not fared alike, for some have gained a much greater advantage than others, and some have gained little and perhaps nothing. It is doubtful whether the agricultural class have materially improved their condition in the last ten years, though, on the whole, I am inclined to think they have, but not in nearly the same ratio as other classes. This is a very serious drawback to the general improvement of the people, and it is most deeply to be regretted. No great community can fully prosper or enjoy the full measure of its prosperity unless it be fairly distributed. Even though two-thirds be greatly advanced, a terrible tension will be set up if there be some drag or friction which keeps the other third behind, and the obstruction is sure to react on the whole system.

Under such circumstances history has taught us by many examples that among the depressed or obstructed class the pressure of the discontent manifests itself. People seek for the real cause honestly enough, but seldom apprehend it. It is at such times that money fallacies spring up like mushrooms. All of them are the progeny of the most ancient of all money fallacies, that money and wealth are one and the same thing. And this quickly leads to another fallacy incomparably more dangerous, more destructive, more suicidal. Seeing that vast wealth has accumulated in the hands of comparatively few men, while the rest are grinding away their lives in the hardest toil, with a trifling reward, a sense of injustice is aroused. This monstrous inequality cannot be right. Such a distribution of the good things of this world must be founded in the rottenness of the system and not in right and justice. True, rich men may have broken no statute and, with here and there an exception of some gigantic robber, they may have gained their wealth either by inheritance or by any other method which the law sanctions and upholds. So much the worse, then, for statute law. Let us see if we cannot change it and make it conform a little more nearly to something like justice. Nor is this complaint confined to the languishing classes of the community. It is taken up

and ventilated by men who make a business of finding wrongs and correcting them on paper. Let us inquire into this grave charge in quest of the real guilt of social customs and statute law.

In what does the wealth of the rich men of the world consist? Is it money? No. Shall it be warehouses filled with merchandise? Who eats it, drinks it, wears it? Who builds or adorns his house with it? Shall it be mills and factories? For whose uses are the wheels turned, the iron heated and shaped, the spindles whirled, the fabric woven? Shall it be blocks of city real estate built up with houses? Who dwell in them and find in them the comforts of home and the family fireside? Shall it be stocks and bonds? These are but the evidences of ownership, and the real things owned are undivided portions of railways. For whose benefit are the trains run, whose goods are transported, who are the passengers carried swiftly on their journeys? It appears, then, that while the rich man owns the wealth, the community is using it. The ownership is his, but the usufruct is ours. But if the final use of all this wealth is by the community what matters it who owns it, whether one man or a million? Whoever owns it is under bonds for all he owns to apply it to the most urgent demands of society. Failing to do this, he first loses his profits and then his principal. The economic law is merciless and accepts no excuse. He who owns capital, I say, must apply it to such uses as society demands or it will be taken from him. Good intentions or evil intentions are nothing to the purpose. Only the result is weighed in the balance. The economic law encompasses equally the evil and the good, the just and the unjust, and its mesh is fine enough to catch all the financial minnows and strong enough to hold all the financial whales. So long as a man comes honestly by his wealth, there is no more injustice or injury to society than there is in the fact that the Treasurer of the United States is the custodian of tens or hundreds of millions of public money. Even when dishonestly acquired, the moral sense

of the community is outraged, but not its pocket. If by subtle art one man has been able to gain possession of a railroad system at the expense of the stockholders, he may be an object of moral aversion, but his ill-gotten railroads remain and must carry the public and its goods just the same or he will lose what he has wrongfully gotten. He may have broken the moral law and evaded the statutes, but the economic law still holds him with unshaken grip. If offenses of this kind occur it is an excellent reason for striving to make the statute law as strong and inevitable as the economic; but it is a very bad reason for seeking to make the economic law as weak and as full of holes as the statute.

It is to the latter effort that money fallacies invariably lead. Under the influence of these fallacies the effort is first directed to making money cheap and lowering the value of its unit. Its effect on credit capital is immediate and destructive. Credit capital is the life-blood of industry, the subtle fluid which penetrates and nurtures every part of the economic organism. A lowering of the standard of value does not destroy, at least for a time, the fixed capital of the country. It does not contract the length of a railway nor the size of a machine shop, nor the number, size, or power of the machines that are in it; but it contracts credit capital directly in proportion as the unit of value is contracted. But that is not the worst of it. Not only is a part of the blood drawn from the veins and spilled, but the arrow wilfully shot from the bow of the law always leaves a poisoned wound. A creditor may lose by the honest insolvency of his debtor, and many a creditor will do what he justly can to put the debtor on his feet again. A creditor may be defrauded, but without losing confidence in other men; but when laws are passed whose ultimate effect must be to impair the obligations of contracts, then, indeed, the very ground on which the structure of modern credit stands is undermined.

MOHAWK LAKE BEDS.

BY

HENRY WARD TURNER.

(Read before the Society January 31, 1891, and published by permission of the Director of the U. S. Geological Survey.)

CONTENTS.

	Page.
General remarks	385
Pleistocene Lake Beds	386
Earlier Lake Beds	388
Pliocene Beds	390
Glacial Moraines in relation to the Lake Beds	392
Faulting in the Lake Beds	396
Relation of the Mohawk Valley Fault to the Structure of the Sierra Nevada	396
Résumé	407
Publications referred to	408

GENERAL REMARKS.

The facts presented in this paper were gathered in the course of my regular field-work as assistant of Mr. G. F. Becker, geologist in charge of the California Division of the United States Geological Survey.

For assistance in connection with the publication I am indebted to Mr. Becker, to Mr. J. S. Diller, and to Mr. W J McGee.

The memoirs and papers referred to will be found in a list at the end.

On the accompanying map, Plate No. 4, the areas indicated as Pre-tertiary include all of the rocks known ordinarily

as bed-rock to the miner, on which the late Cretaceous and Tertiary rocks rest unconformably everywhere in the Sierra Nevada. These rocks about Mohawk Valley are granite, diabase, porphyrites, and clastic rocks of Paleozoic or early Mesozoic age.

Mohawk Valley is in Plumas county, California, on the eastern slope of the Sierra Nevada. Its general location may be seen in Figure 1. The geological map of Mohawk Valley and vicinity, Plate No. 4, covers the area included in the rectangle in Figure 1.



FIG. 1.—Outline sketch of central California.

That Mohawk Valley was once the bed of a lake is evident from the deposits of fine stratified material underlying it and from the terraces about it. The elevation of the lower parts of the valley, now occupied by farms, is about 4,500 feet and that of the highest terraces something more than 5,000 feet. There was thus at one time a depth of water of more than 500 feet. We will first consider the certainly Pleistocene deposits.

PLEISTOCENE LAKE BEDS.

The middle fork of the Feather River now flows through the valley, the former lake having been merely a widening

LEGEND

- PLEISTOCENE
- MORAINES
- RIVER GRAVEL
- ANDESITE
- RHYOLITE
- PRE-TERTIARY

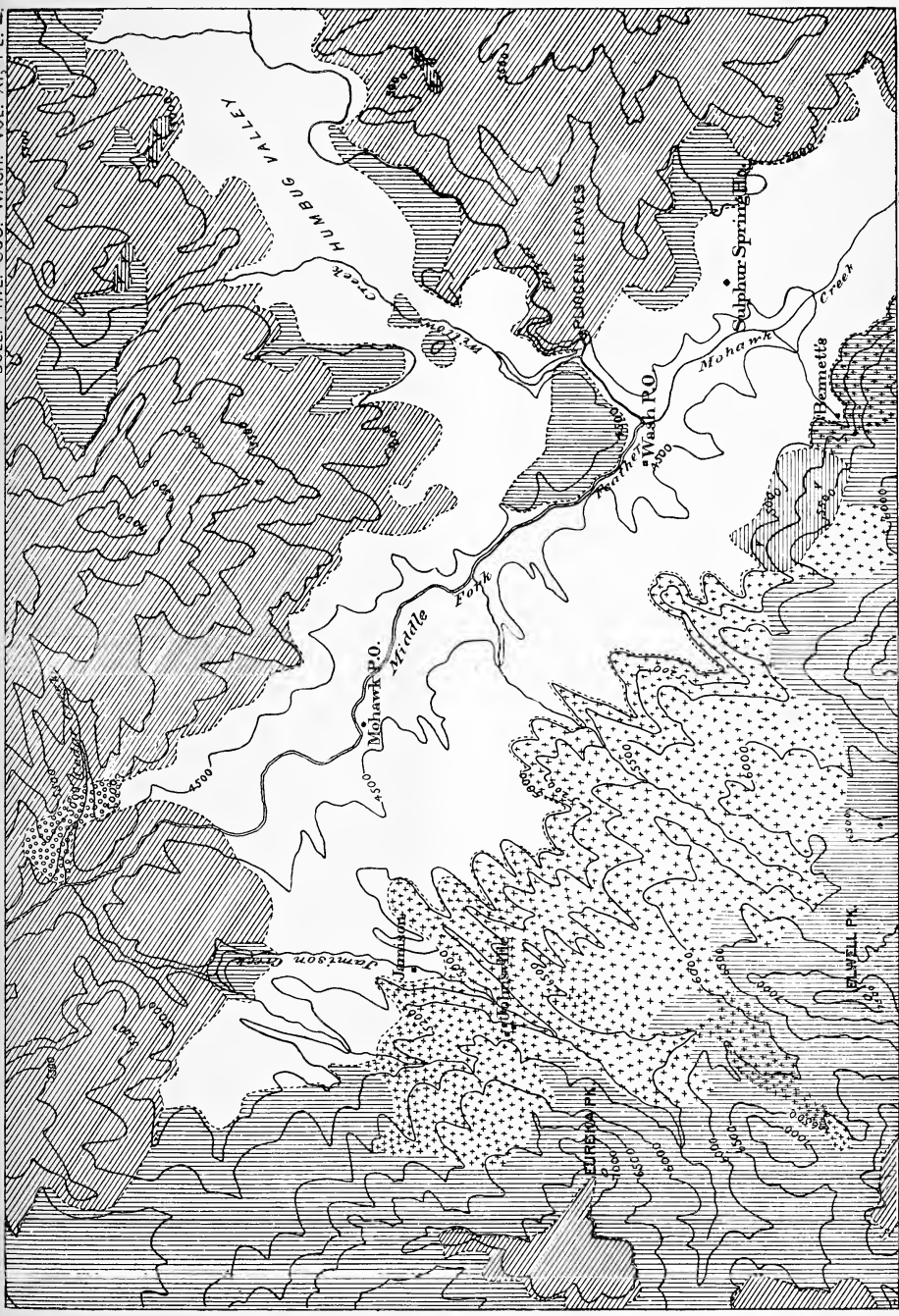

GEOLOGICAL MAP OF MOHAWK VALLEY AND VICINITY



and deepening of this stream. If we seek for the cause of the former existence of the lake it will be found to be connected with volcanic outflows that occurred about the close of the Pliocene or in early Pleistocene time.

Judging from the present contours of the surface of the bed-rock formations (granite and the auriferous slate series), the middle fork of the Feather River at the present time follows approximately an older drainage system, which existed before the volcanic outflows, though perhaps not for a great length of time. These outflows, largely andesitic breccia and tufa, filled up the cañon that then existed, and the waters thus dammed back formed the Pleistocene lake here treated of. Since that time the river has cut through the barrier, and the lake has been drained. For three miles north of the Mohawk lake beds the Feather River at the present time flows through a cañon, the walls and bottom of which are composed entirely of andesitic and some later lavas.

Pebbles of andesite and of rhyolite abound in the lake beds, and, to the north and east of Mohawk Valley, thin patches of lake deposit may be seen at many points to rest upon the andesite. It is therefore certain that the lake attained its maximum development after the andesitic eruptions.

The lake at its highest level not only filled Mohawk Valley, but extended east into Humbug Valley, having a surface of, approximately, thirty-five square miles. The deposits at the highest stage were largely rather fine material, andesitic and morainal detritus, which has since been much eroded, particularly on the east side of Mohawk Valley, where well-defined terraces are not to be found.

But in the northwestern portion of the lake area, at an altitude of about 5,000 feet, the terraces are well preserved. The road from Mohawk Post Office to the mining town of Johnsville passes over some of these terraces. They are now heavily wooded. Exposures of them at various points show them to be composed of loose sand and gravel distinctly stratified, the bedding being approximately horizontal.

Forming a set of terraces about 4,500 feet high about Mohawk Valley and well exposed along the Feather River where it enters the valley from the east, and by the public road just south of Wash Post Office, are beds of coarse gravel and sand containing some pebbles of late olivine basalt, a lava of much later age than the andesite. These beds appear to be the latest of the lake deposits. Lying usually somewhat below the 4,500 foot contour is the alluvium, which will not be considered here as part of the lake beds. The alluvium is of very recent origin.

EARLIER LAKE BEDS.

Underlying the coarser deposits, previously described, is an older series of beds not anywhere found, so far as I know, at a much greater elevation than 4,600 feet. These older beds are usually whitish in color and composed largely of sand and clay, with layers of carbonaceous shale. Since there is some doubt about the age of the beds, exposed at different points, some of them will be described separately.

About one-fourth of a mile down-stream from Mohawk Post Office, on the west bank of the Feather River, and forming also the bed of the river, are beds, largely clay and sand, with a good deal of carbonaceous shale. Distinctly and unconformably overlying the fine material, which is horizontally stratified, is a later gravelly series, with some sand and clay. Vertically above the line of contact in the later material are some angular blocks of carbonaceous shale, only a few feet from the carbonaceous layer from which they came. There must have elapsed between the formation of the earlier fine and the later gravelly deposits sufficient time for some erosion and consolidation of the earlier beds to have taken place. It is also evident that the earlier deposition took place in comparatively still and deep water, while the later gravelly beds could only have been deposited in water moving with some rapidity. The entire exposure is about sixty feet high.

The later beds are correlated with the gravels forming the 4,500 foot terraces previously described.

On Grey Eagle Creek, about one and a half miles nearly south of Mohawk Post Office, at an elevation of about 4,600 feet, is another exposure of beds very similar to the older beds just described, with much clay, sand, and carbonaceous shale.

In addition there was observed a fine white layer, a few inches in thickness, composed almost entirely of volcanic glass in angular fragments with fluted forms, very similar to some material described as volcanic dust by Mr. G. P. Merrill (XV). The most reasonable explanation of the homogeneity of the volcanic layer is to suppose that it was thrown out in its present fine condition, and falling in the water, was deposited as we now find it. It might also be supposed that it was eroded from an area of volcanic ash near by and re-deposited on the lake bottom. In either case it marks approximately the age of the eruption, since, if the result of the erosion, it could hardly fail, after a considerable period had elapsed, to be much mixed with other detrital material. The angular character of the dust is against its having undergone much transportation, though fine thin glass would doubtless be not greatly rounded, but rather broken into finer angular particles. The material presents all the appearance of being rhyolitic glass. This is further substantiated by a silica determination made by Dr. W. H. Melville, of the United States Geological Survey. He found the fine white powder from Grey Eagle Creek to contain 70.64 per cent. of silica, while a rhyolite from near Mohawk Valley contains 71.14 per cent.

Now the rhyolites of the Sierra Nevada in general underlie the andesites. Indeed, in some places, there is proof that they were eroded somewhat before the andesitic eruptions.

Evidence gathered by Mr. Waldemar Lindgren and myself at a great many localities in the Sierra Nevada all points to the rhyolites being older than, at least, the hornblende-andesites which form the great bulk of the andesitic eruptions.

It is therefore likely that the Grey Eagle Creek and Mohawk Post Office beds belong to a lake that existed before the

Pleistocene lake, formed by the damming back of waters by the later andesite. Further evidence on this point will be presented in a succeeding paragraph.

Southeast of the Sulphur Spring House, in the southern part of Mohawk Valley, is some sandstone sufficiently consolidated to be used for chimneys. This hardening of the material has probably been brought about by the cementing action of the waters of the adjacent springs. Some of the sandstone shows plant impressions. The sandstone is bedded nearly horizontally. Just east of the sulphur springs there is a disturbance in the lake beds, the dip being southwest 22° .

About one-fourth mile north of the Sulphur Spring House, on the north bank of a little stream, is an exposure of lake beds, which dip westerly about 13° . The material is rather fine detritus. A microscopical examination of a whitish layer showed sand grains, fragments of volcanic glass, green hornblende, biotite, apatite, and black opaque grains, presumably magnetite. The volcanic glass appears to be rhyolitic; the sand grains, hornblende, biotite, and apatite are probably from granite.

The narrow area of river gravel to the north of the lake beds and directly connecting with them has at first sight the appearance of being the bed of a former outlet of the lake, but as some of this gravel lies at an elevation of 5,500 feet this does not seem likely. There are indications of local disturbances here, in the form of little benches, such as are to be found where land slides have taken place. It is probable that the low position of part of this gravel just to the north of the mouth of Cedar Creek is due to subsidence by a land slide. This river gravel seems, on the map, Plate No. 4, to rest on andesite, but this is not the case, the rock underlying the gravel being of the auriferous slate series.

PLIOCENE BEDS.

There are some beds exposed along the middle fork of the Feather River, a little to the east of Mohawk Valley, on the ranch of Abel Jackson. These beds consist of sandstone

with a little lignite and carbonaceous shale, and at one point where some sulphur springs issue forth the very fine-grained layers contain numerous well-preserved leaves, mostly of deciduous trees. Professor Ward has made a preliminary examination of these leaves and identifies two forms as *Quercus distincta* and *Liquidambar Californica*.^{*} Some of the leaves are probably new. In the summer of 1890 I obtained here impressions of a bunch of pine leaves and of a winged maple seed. Professor Ward considers the plant remains to indicate that the beds are about of the same horizon as the auriferous gravels, apparently meaning the later and more abundant gravels which occur in considerable amount on the western slope of the Sierra Nevada, and which seem to be but little older than the volcanic material that usually covers them. These later and more abundant gravels are generally considered of Pliocene age. The Sierra Nevada has undoubtedly been a land mass since, at least, early Cretaceous time (since the post-Mariposa upheaval). It is therefore extremely probable that some of the river gravels of the Sierra were deposited by streams that flowed in early Tertiary or even late Cretaceous times.

For positive evidence of there being older river channels, which in some cases are intersected by later channels, the reader is referred to R. E. Browne's paper on "Ancient River Beds" (II), which will be again mentioned further on. The beds above described containing the fossil leaves have a westerly dip varying from 5° to 30° and are distinctly overlaid by andesitic breccia.

I am inclined to correlate the horizontal beds containing carbonaceous shale at Mohawk Post Office and Grey Eagle Creek, previously described, with the certainly pre-andesitic beds, but I have been unable to find any barrier that existed before the time of the andesitic eruptions that could have

^{*} In his "Report on the Fossil Plants of the Auriferous Gravels of the Sierra Nevada," *Memoirs Museum Comp. Zool.*, Vol. VI, No. 2, Professor Lesquereux describes these two species from Chalk Bluffs, Nevada county, referring the beds to the Pliocene.

retained sufficient water to deposit beds of the character described. Moreover, the Mohawk Post Office beds seem to continue north and abut against the andesitic barrier. The Grey Eagle Creek beds have an approximate elevation of 4,600 feet, at least 100 feet higher than at Mohawk Post Office, to which they are so similar. It is possible the first-mentioned beds have attained their present position through differential elevation or subsidence, though as the beds at both exposures are approximately horizontal this does not seem likely.

The beds from which the leaves came may simply record a quiet stage of the former Feather River. The river is probably now, in fact, depositing similar material in the numerous nearly quiet stretches between Mohawk and Sierra Valleys.

GLACIAL MORAINES IN RELATION TO THE LAKE BEDS.

All about Johnsville are enormous accumulations of morainal material. Over an area of fifteen square miles none of the underlying formations are exposed, so deep is the morainal detritus. This is largely made up of diabase and quartz, porphyrite boulders, and subangular fragments from the extensive areas of these rocks in the high ridge to the west and southwest, the east and north slopes of which formed the nevé fields of the glaciers. Mounts Elwell, Bunker Hill, and Eureka Peak are prominent northward-trending spurs of this high ridge, and between these spurs the glaciers were nourished.

The moraines merge into the lake deposits, and opposite Jamison, on the east side of Jamison Creek, there is an exposure of the moraine material at the point where the highest lake terrace begins. The underlying coarse gravel and subangular material are roughly stratified. This would suggest that the maximum period of the glaciers and that of the Pleistocene lake occurred at the same time, for if the water had terraced the moraines subsequent to their deposition it seems probable that there would be no internal stratification, but only a surface leveling of the material.

Some of the moraine material poorly exposed on the opposite (west) side of Jamison Creek at the same elevation (about 5,000 feet) shows less evidence of stratification.

In the bed of Jamison Creek just below the bridge at Jamison, a shaft was sunk some years ago to the depth of 270 feet, all in gravel. This shaft is still to be seen. There must therefore be an enormous amount of detrital material here.

The town of Johnsville rests on a terrace-like embankment, the upper part of which shows some stratification. A similar though narrower terrace exists on the east side of Jamison Creek opposite Johnsville. The stratified material could not have been deposited when the cañon was filled with ice and may have been formed by a slight damming up of the waters of the creek after the retreat of the glacier.

On the west side of Mohawk Valley, at an elevation of about 5,000 feet, is Bennett's hydraulic mine. The upper part of the material washed is clay with scratched boulders, traces of a rough stratification being visible, which may have been due to water from melting ice.

A little lower down, however, the material is more arenaceous, shows bedding plainly, and is traversed by normal faults at two points, the down-throw of each being toward the valley at an angle of perhaps 30° from verticality, and the throw in each case being about one foot. This lower material is thought to represent the highest terrace of Mohawk Lake. The inclination of the stratification is toward the valley or easterly, and this may be explained by the steepness of the slope on which it was deposited rather than by any subsequent disturbance. The well-worn gravel at Bennett's hydraulic mine is thought to have come from an old river channel that formerly existed higher up on the slope, remnants of which are still to be seen.

There are frequent large boulders of diabase on the lake beds near the north end of the area, where the outlet of the lake presumably was, and these may have been brought to their present position by floating ice. There is no diabase

in place exposed near them, while the glacial moraines near Johnsville are largely of diabase débris.

Mr. I. C. Russell, in his paper on the Quaternary basin of Lake Mono (XVI), states that the inside as well as the ends of some of the lateral moraines at Lake Mono are terraced, showing that the highest stage of the lake either followed or continued after the retreat of the glaciers, for the inside of the lateral moraines must have been filled with ice at the period of maximum glaciation. Mr. Russell suggests that the melting of the glaciers produced the maximum stage of the lake.

Professor Le Conte (X) considers that the absence of terminal moraines can be accounted for on the hypothesis that the maximum stage of the glacier and that of the ice coincided, for then the loose material that would have formed a terminal moraine would be carried away by floating ice. Professor Le Conte accounts for the presence of large boulders at certain points about Lake Mono by supposing them to have been transported by icebergs.

When at Lake Mono, in 1889, in company with Mr. G. F. Becker, it was observed that a rough stratification existed in the end of the Lundy moraine, the material being well exposed by mining operations; and in the opinion of Mr. Becker this would show that the end of the glacier extended into the water, the morainal material being roughly stratified as it dropped off.

The true explanation may be that the high stage of the water was both contemporaneous with and continued after the retreat of the glaciers. On this hypothesis the internal stratification of the moraines, the terraces on their inner sides, and the stranded boulders would be explained.

It was not till after this paper was read before the Society that I found that Mr. Gilbert had treated the subject of the correlation of glaciers and the Pleistocene lakes of the great basin very fully. On page 314 of his monograph (VI) Mr. Gilbert says:

“With one voice these four localities tell us that Mono Lake occupied its maximum level after the glaciers of the

Sierra had retreated from their most advanced position ; but their testimony goes no farther. The narrow range of levels common to the two may have been occupied first by ice and afterward by the water, or it may have been occupied by both together. We can only say that the ice was first to retreat.

“Combining this result with that afforded by the moraines of the Bonneville basin, we conclude that the epoch of greatest glaciers fell within the second period of lake expansion, but did not coincide with the epoch of greatest water supply. It occurred somewhat earlier. If the two sets of phenomena were consequent upon the same series of climatic changes, then the lacustral changes lagged behind the glacial.

“That such a lagging admits of plausible explanation may readily be shown. The névé and glaciers of the Mono district occupied a portion of the catchment basin of the lake. The precipitation which they accumulated during their growth was subtracted from the precipitation tributary to the lake, and the same was afterward returned to the lake when they were finally melted. Their mass of ice may therefore be regarded as a portion of the water supply of the lake, arrested in its progress. When the climatic conditions were favorable for the growth of lake and glaciers the growth of the glaciers antagonized and delayed the growth of the lake. When the climatic conditions favored the wasting of lake and glaciers the waste of the glaciers fed the lake and thus antagonized its depletion. The ascending and descending phases of the lake thus fell behind the corresponding phases of the glaciers, and the maxima and minima or turning points were correspondingly displaced.

“It is to be observed that this explanation is quite distinct from the theory, alluded to by Whitney (XVIII, page 185), that the Pleistocene lakes were the sequel of the Pleistocene glaciers, being created by their melting. Such a relation is quantitatively impossible. In the Mono basin, indeed, the mass of snow and ice upon the mountains may have been equal to the volume of water in the valley, but in the Lahontan and Bonneville basins it was far too small.”

FAULTING IN THE LAKE BEDS.

Besides the local faulting at Bennett's mine previously referred to, and which would be expected with any not thoroughly consolidated material on a steep slope, there is evidence of a line of faulting on the east side of Mohawk Valley.

The lake beds on the east side of the Feather River opposite Wash Post Office are plainly faulted. A very evident fault exists in the lake beds on the south bank of the river about one mile up-stream from Wash Post Office. About one-fourth mile still further east, at the locality where I obtained the fossil leaves, a fissure was formed in the tufa and breccia beds overlying the fossiliferous series at the time of an earthquake shock some years ago (about 1876).

This fissure was about two feet wide, and at the time warm air came out of it. The locality was formerly the resort of numerous rattlesnakes, attracted, no doubt, by the warmth. At the time of my visit, in 1889, slightly warm, moist air still issued from holes near the former fissure. A little east of the fissure is a warm sulphur spring. Near this is another spring which, according to Abel Jackson, who lived here at the time, was so warm that at the time of the earthquake the hands could not be held in the water.

The lake beds are flexed just east of the springs at the Sulphur Spring House, showing disturbance. The springs have now a uniform temperature of about 75° as tested in 1890.

Artesian wells sunk along the west side of Sierra Valley in some cases strike flows of hot water. The land slides noted in connection with the river gravel by Cedar Creek may be connected with faulting.

RELATION OF THE MOHAWK VALLEY FAULT TO THE
STRUCTURE OF THE SIERRA NEVADA.

The different localities above mentioned, together with the hot artesian wells in Sierra Valley, are approximately in line, which coincides very well with the general line of

faulting which Mr. J. S. Diller (III) has laid down as having formed the east escarpment of a huge orographic block. This block as outlined constitutes the main mass of the Sierra Nevada. Mr. Diller presumably bases his general scheme of faulting upon the previous work of Professor Le Conte and Mr. Gilbert, to whose papers he refers. This main escarpment forms the steep east slope of the Sierra Nevada, and is best seen west of Lakes Owen and Mono. For the extension of this great line of faulting which seems well substantiated by all geologists who have visited the above places, to the northward through Mohawk and American Valleys, we are, I think, indebted alone to Mr. Diller. My own observations substantiate the hypothesis of Mr. Diller so far as they relate to the existence of a line of faulting in Mohawk Valley. The existence of the hot springs seems to point to a fissure of some depth.

Mr. Diller establishes, in the publication just referred to, two other lines of faulting to the east of the main fracture. (See also IV.) The smaller of these, which is intermediate in position between the other two, all three being approximately parallel, extends along Little Grizzly Creek northwesterly to near Taylorville, in Indian Valley. The Grizzly Mountains lie between it and the main fracture to the west, and constitute another smaller orographic block. The other line of faulting is west of Honey Lake, the escarpment being best seen on the east side of Thompson Peak. The region between the Little Grizzly Creek fault and the fault west of Honey Lake constitutes Mr. Diller's third and most eastern block of the Sierra Nevada.

In Figure 1 these three lines of faulting are shown by black lines. Between Mohawk Valley and Mono Lake Valley the line of the main fault is indicated only by a dotted line, since positive evidence of faulting in this part of the Sierra Nevada has not, so far as I know, thus far been presented.

To well understand the basis for Mr. Diller's division of the Sierras into orographic blocks it will be necessary to take a brief review of the papers of Professor Le Conte and Mr. Gilbert, giving their important conclusions only.

In 1872, in his paper on the "Formation of the Great Features of the Earth's Surface" (VIII, page 355), Professor Le Conte says :

"I think, therefore, I am justified in asserting that the phenomena of plication and slaty cleavage demonstrate a crushing together horizontally and an upswelling of the whole mass of sediments, and that slaty cleavage demonstrates in addition that the upswelling produced by this cause alone is sufficient to account for the elevation of the greatest mountain chains."

On page 463 of the same article he further says :

"Mountain chains are formed by the mashing together and the upswelling of sea bottoms where immense thicknesses of sediments have accumulated, and, as the greatest accumulations usually take place off the shores of continents, mountains are usually formed by the uppressing of marginal sea bottoms. We will make this plainer by some illustrations taken from the history of mountain chains in North America.

* * * * *

"During the whole Triassic and Jurassic periods the region now occupied by the Sierras was a marginal sea bottom, receiving abundant sediment from a continental mass to the east. At the end of the Jurassic, this line of enormously thick, off-shore deposits yielded to the horizontal thrust and the sediments were crushed together and swelled upward into the Sierra range. All the ridges, peaks, and cañons—all that constitutes the grand scenery of these mountains—has been the result of an almost inconceivable subsequent erosion."

In 1874 Professor Le Conte writes (IX, page 180) :

"The *Sierra range* was first formed at the *end of the Jurassic* by mashing together and up-swelling only, while its subsequent slight increase at the *end of the Tertiary* was attended with great fissure-eruptions."

In 1878, in his article on the "Structure and Origin of Mountains," (XIX, pages 100-101), Professor Le Conte says:

"The Sierra Nevada may be taken as a typical example, both in form and in structure, of a monogenetic upheaval, or what I have called a range. * * * So simple appears the structure of this mountain that we might imagine that it consists of only one grand fold, eroded along its crest until the granite is exposed. * * * But this is probably not so, because forty miles of slates and schists outcropping at high angle would give an incredible thickness of sediments if we regard them as a single unrepeatable series. It is probable, therefore, that these flanking slates really consist of several closely appressed folds, afterward deeply eroded so as to simulate a single series. * * *

"Again, the Sierra range is an admirable example of a fold passing gradually into a fault. In the northern portion of Lake Tahoe the slates occupy a broad area on *both slopes*, though largely covered on the eastern slope by volcanic ejections. The two slopes are more equal, and the height of the crest is moderate—only about 9,000 to 10,000 feet. The great wave [referring to the largest supposed fold forming the crest of the range] *is more normal*.

"In the middle portion, about Lake Mono, the eastern slate area is far narrower, the two slopes more unequal, and the crest higher, viz., 13,000 feet. The great wave *is ready to break*. In the southern portion, about Lake Owen, the eastern slope is still more abrupt, the eastern slates have entirely disappeared, granite alone forming the summit and the whole eastern wall, and the crest here reaches its highest point, near 15,000 feet. The great wave has *at last broken with the formation of a prodigious fault*. Remembering that the escarpment is here 10,000 to 11,000 feet, and that the whole thickness of the slates has been removed by erosion from its summit, and that their eastern continuation lies buried beneath the soils of the plains below, we cannot estimate this slip as less than 15,000 feet. It is probably much

more. It is almost certain that it was a slight readjustment of this slip which caused the Inyo earthquake of March, 1872.

* * * * *

“Marginal sea-bottom sediments are thickest near shore, and thin out very gradually seaward. Such sediments, therefore, even before yielding, form a lenticular mass, with the thickest part near the shore edge, and therefore asymmetric. Now, this already thickest part is precisely the line of greatest yielding and therefore of greatest upswelling, and thus the mountain wave becomes very asymmetric, with its steeper slope landward. Finally, the already asymmetric mountain is pushed over against the stiffened land crust, making a still steeper slope, which may even break on that side.

“Now, the Sierra is again an admirable illustration of this law. The oldest portion of the western half of the American continent is probably the basin region, especially its southern portion, running down into Mexico. During much of the Paleozoic and all the Mesozoic times until the end of the Jurassic this was a continental mass with its western shore near the eastern margin of the Sierra region. The Sierra region, as I have elsewhere shown, was then a marginal sea bottom, receiving sediments from the basin-region continent, until an enormous thickness had accumulated. When these thick sediments began to yield from the aqueo-igneous softening of their floor they would first swell up asymmetrically, and then be pushed over against the stiffened Basin region land crust, forming a steep slope, or even a fault and escarpment, on that side.”

Professor Le Conte, in the same paper, ascribes a similar origin to the Wahsatch Mountains, which he regards as made up of sediments, on the eastern shore of the basin-region land mass, while their steep western and landward escarpment was formed in the same way that the steep eastern and landward escarpment of the Sierra Nevada was formed.

In 1880 Professor Le Conte wrote an important article on

the "Old River Beds of California" (XII). His conclusions in brief are that the enormous deposits of coarse sediments (the auriferous gravels) were caused by overloaded waters, which resulted from the melting of snow and ice, from the heat of the approaching interior lava which soon after was erupted, completely filling up the old river beds and causing their streams to seek new channels.

Glacial conditions are presumed to have commenced before the lava flows and to have reached their maximum after the lava flows. It is thought probable that the gradual elevation and the attendant glacial conditions commenced and advanced until the former culminated in the fracture and outflow of lava. He considers that there is a certain definite relation between slope and the amount of detritus which determines the depth of cañons.

If this relation be disturbed by increase of slope the stream will strive to re-establish it. Thus it has been with the great cañons of the plateau region, and thus it must have been with the cañons of the Sierra Nevada. Professor Le Conte says:

"It is difficult to imagine that the Tertiary river channels should have remained so shallow after the erosion of the whole Cretaceous and Tertiary times if the general Sierra slope were as high *then* as it is *now*, viz., 100 to 200 feet per mile. * * *

"The elevation which I suppose took place in the Sierra range at the time of the lava flow was evidently of a gentle kind, unaccompanied with crumbings and dislocations of the strata, and therefore undetectable except by the work of cañon cutting."

In reviewing Whitney's "Climatic Changes" (XVIII), in 1883, Mr. Gilbert (V, page 194) writes:

"If the inclination of the western flank of the Sierra was exceedingly gentle in Pliocene time, it would be natural for its streams to form deposits on the lower slopes; and if afterward an elevation occurred, increasing this inclination, the

habit of the streams would be reversed, and the cañons we see would result. That such a change in inclination has taken place is rendered probable by other considerations. In the first place, the western face, which is far broader than the eastern, is, as described by Whitney and others, an inclined plane, interrupted only by the narrow cañons of the modern streams. Its plateau character is not given by a continuous stratum of hard rock parallel to the general surface, but has been produced by the uniform erosion of a system of plicated strata. Such uniform erosion could only have been accomplished by streams flowing at a low angle. Second, the eastern boundary of the range or plateau is a line of faulting; and the orographic movement producing the range consisted of a displacement along this fault line, and a consequent inclination of a plateau-like mass to the westward."

In 1886 Professor Le Conte wrote a paper on the "Post-Tertiary Elevation of the Sierra Nevada" (XIII). On page 173 he says:

"The old river beds were probably established at the beginning of the Cretaceous, when the Sierra range was born from the sea and were being cut and shaped throughout the whole Cretaceous and Tertiary. By the end of that time * * * the rivers seem to have reached their base level and had ceased to deepen their channels, but rain erosion still continued to widen the valleys and cut down the divides. The river system had therefore assumed the form characteristic of old topography. Then came the lava flood, displacing the rivers, and the contemporaneous elevation changing the base level and enormously increasing the erosive power of the rivers. These, therefore, without loss of time, commenced cutting anew, and in comparatively short time have cut far lower than before. * * * It is impossible to explain this except by supposing a great rise, probably several thousands of feet, with increased slope of the range at the end of the Tertiary."

Professor Le Conte, on the evidence of Gilbert, Howell, and Russell, considers the fault scarps of the great basin to be due to *normal* faulting, which he considers due to *gravitative settling*. He says:

“It is certain that the great normal faults which characterize the basin region, among which must be counted the eastern Sierra fault and the western Wahsatch fault, were produced in this way long after the orogenic crumpling had ceased.”

Professor Le Conte has still further elaborated methods of faulting in a paper “On the Origin of Normal Faults,” published in 1889 (XIV). This may be taken as representing his present views.

Professor Le Conte assumes the earth to have a solid nucleus surrounded by a liquid layer on which the crust floats. He says:

“At the end of the Tertiary the whole region from the Wahsatch to the Sierra, inclusive, was lifted by intumescent lava into a great arch, the abutments of which were the Sierra on the one side and the Wahsatch on the other. * * *

“The arch broke down and the broken parts readjusted themselves by gravity into the ridges and valleys of the basin region, leaving the raw faces of the abutments overlooking the basin and toward one another. It must not be supposed, however, that this took place at once, but *gradually*, the lifting, the breaking down, and the re-adjustment going on *pari passu*.”

“The Sierra Nevada is a great crust-block heaved and slipped on the eastern side, forming there a great fault of 15,000 to 20,000 feet vertical displacement, and this took place at the end of the Tertiary, accompanied by floods of lava.”

It will be observed that Le Conte's views have undergone a marked change since his first articles were published. Supposing his assumption of a liquid substratum to be cor-

rect, his explanation of the formation of the basin ranges by gravitative settling finds confirmation in a paper by William Hopkins, in 1842 (VII), who demonstrated that a series of wedge-shaped blocks, formed by a system of normal faults cutting a given area of crust resting on a molten magma, would be differentially displaced, and that the blocks with the base of the wedge downward would be elevated relatively, and those with the apex of the wedge downward would settle. The relatively elevated blocks would form a system of flat-topped ridges with steep sides, the intervening blocks forming the floor of valleys.

This would not, however, account for the monoclinical ridges, which Professor Le Conte supposes to have been rhomboidal blocks, the overhanging side of which would tip, heaving up the other side.

It will be seen from Le Conte's earlier writings that he considered the Sierra to have attained nearly its present elevation at the time of its upheaval, and that at about that time a fault was formed west of Owen's Lake, which ran into a fold at about Lake Mono; also that the elevation of the range at the close of the Tertiary was a very slight affair.

He now evidently considers the range to have attained its present elevation by a considerable elevation at the close of the Tertiary, with the formation of a line of normal faulting along the base of the steep eastern scarp of the range.

We will here assume Mr. Diller's extension of this line of faulting through Mohawk and American Valleys to be correct. It will follow that the amount of faulting in recent times has not been great. Since the highest lake deposits occur on both sides of the line of fracture at an approximate elevation of 5,000 feet, it is evident that the amount of faulting since the existence of the highest stage of the lake must be measured in tens and not hundreds of feet.

On the supposition that the Pliocene beds containing the fossil leaves and the Mohawk Post Office beds are approximately of the same strata, these also being on opposite sides of the line of fracture and nearly of the same elevation, the

main faulting must have occurred before the existence of the so-called Pliocene lake, which, on the grounds before given, may be supposed to have existed.

Professor Le Conte studied the main fault scarp where it is at its maximum—that is, from Lake Mono south—but, so far as I know, has given no proof of so great a displacement as he indicates. The Sierra Nevada is thought to have been reduced to a base level of erosion during Tertiary time, and to have had an elevation not much, if any, greater than that of the great basin at the time of the displacement along Lake Mono and Owen's Lake. But while there is evidence of the river channels having had a very moderate grade during Tertiary time in the more northern part of the Sierra, so far as I know no evidence has been adduced to show that the Sierra Nevada did not constitute a mountain range during all of Tertiary time in the region where it is now highest, viz., to the west of Owen's Lake. No extensive gravel deposits, showing ancient rivers flowing at a moderate grade, have, to my knowledge, been found there, and it remains for the future geological explorer in that region to get evidence that may decide the question.

The general topography of the country indicates that the amount of displacement along the main fault scarp is much less in the region to the north of Lake Tahoe than from there south. Bearing on this point are some facts which I will now present. Referring again to Mr. Diller's orographic blocks as set forth in Bull. No. 33, U. S. G. S., there is evidence of an old river channel that originated as far south, at least, as Haskell Peak, which is south of Mohawk Valley, and flowed in a course a little west of north across all three of these blocks. If future investigations substantiate the course of this river as above it can be certainly shown that a differential elevation or subsidence of the land on opposite sides of the fault line of the Mohawk Valley of perhaps a thousand feet has taken place, but it will be equally certain that this displacement took place previous to the deposit of the Mohawk lake beds, even the oldest, and after the deposit

of the river gravels which now give evidence of the former existence of the river above mentioned. It could be also shown that the amount of faulting between the middle block, having its eastern escarpment along Little Grizzly Creek, and the eastern block, with its escarpment east of Thompson Peak, has been comparatively slight at the place where the river crossed the fault line.

The highest gravel area observed which is ascribed to the ancient river lies about one mile north of Haskell Peak at an elevation of 7,000 feet. The most northern area observed lies to the east of Little Grizzly Creek and north of the fortieth parallel at an elevation of about 5,800 feet. The gravel deposits of this old river are well exposed by hydraulic washings at several points, particularly at the Cascade gravel mine. The river probably existed in Eocene and Miocene times.

Mr. Diller informs me that he has traced the same channel still further north, and that he believes the river to have had a northerly course. During a subsequent season I hope to get positive evidence as to the course of this ancient river and its bearing on the question of faulting.

Professor Whitney believes the Sierra Nevada to have had substantially the same elevation in Tertiary times as now. (XVII, page 342.)

He accounts for the large accumulations of auriferous gravels in Tertiary times by supposing the precipitation, and consequently the volume, of water in the rivers to have been far greater at that time, and thinks that the present narrow and deep cañons were cut by streams constantly diminishing in volume.

In an excellent paper on "The Ancient River Beds of the Forest Hill Divide" (II, page 435) Mr. R. E. Browne gives the results of his investigations of certain channels in Placer county, California, which have been pretty thoroughly exposed by mining operations. He has been able to show that there are several channels of different ages, and has been able to map with absolute certainty portions of the courses

of these ancient streams. One very remarkable thing noted is the finding of fossil trees standing upright on the banks of one of these channels, having been overwhelmed by a mud flow of lava, such as many of the flows of breccia and tufa undoubtedly were, without being displaced.

On page 445 Mr. Browne says:

“If Professor Le Conte’s view is correct, and the bearing of the axis of upheaval is north and south and the tilt to the west, one should expect to find in following the sinuous course of the tilted channel, first, the original grade maintained wherever the course is north or south; second, a greatly increased grade wherever the course is west; third, little or no grade wherever the course is east, * * * more data are wanted to settle the question of tilting. However, it may be said that the evidence, as far as it goes, is against any considerable increase in the slope of the Sierra flank—decidedly against an increase large enough to account *per se* for the two-thousand-feet-deeper cutting of the modern river.”

The most decisive grade would be an easterly one. Unfortunately, none of these channels appear to have such a course, even for a few miles.

The last important paper is by Mr. Becker, “The Structure of a portion of the Sierra Nevada” (I). Mr. Becker accounts for the late elevation of the Sierra Nevada by means of distributed faults, of which he has found evidence during the past season. His explanation of how this occurred is somewhat elaborate, and the reader is referred to the original.

RÉSUMÉ.

Mohawk Valley is the bed of a Pleistocene lake caused by the damming up of the cañon of the Feather River by a flow of andesitic lava.

Glaciers existed contemporaneously with the lake.

A line of recent faulting extends across the lake beds in a northwesterly direction. This line of faulting appears to

coincide with the east fault scarp of the Sierra Nevada as outlined by Le Conte and Gilbert and extended by Diller.

The amount of faulting since the deposit of the lake beds is to be measured in tens and not hundreds of feet.

If the course of an ancient river as described be later substantiated, the amount of faulting since perhaps Eocene times may be approximately measured.

The literature bearing on the elevation of the Sierra is briefly reviewed. Gilbert, Le Conte, Diller, and Russell regard the Sierra Nevada as being a tilted block of late origin, while Whitney, Becker, and Ross E. Browne believe the range to have had nearly its present elevation since the post-Mariposa upheaval.

PUBLICATIONS REFERRED TO.

- I. BECKER, G. F. "The Structure of a Portion of the Sierra Nevada of California." *Bull. Geol. Soc. Am.*, vol. 2, pp. 49-74, Jan., 1891.
- II. BROWNE, ROSS E. "The Ancient River Beds of the Forest Hill Divide." *Tenth Ann. Rep. State Mineralogist of California*, 1890, pp. 435-465, with a map in two sheets.
- III. DILLER, J. S. "Notes on the Geology of Northern California." *Bull. No. 33, U. S. Geol. Survey*, 1886.
- IV. DILLER, J. S. "Geology of the Lassen Peak District." *Eighth Ann. Rep. Director U. S. Geol. Survey*, pp. 395-432, with a geological map.
- V. GILBERT, G. K. Review of "Whitney's Climatic Changes." *Science*, vol. I, 1883, pp. 141-142, 169-173, and 192-195.
- VI. GILBERT, G. K. *Lake Bonneville. Monograph I, U. S. Geol. Survey*, 1890.
- VII. HOPKINS, WILLIAM. "Researches in Physical Geology." *Phil. Trans. Roy. Soc., London*, 1842, p. 43.
- VIII. LE CONTE, JOSEPH. "A Theory of the Formation of the Great Features of the Earth's Surface." *Am. Jour. Sci., Third Series*, vol. IV, 1872, pp. 345-355 and 460-472.
- IX. LE CONTE, JOSEPH. "On the Great Lava Floods of the West, and on the Structure and Age of the Cascade Mountains." *Am. Jour. Sci., Third Series*, vol. VII, 1874, pp. 167-180 and 257-267.

- X. LE CONTE, JOSEPH. "On some Ancient Glaciers of the Sierra Nevada." *Am. Jour. Sci., Third Series*, vol. X, 1875, pp. 126-139.
- XI. LE CONTE, JOSEPH. "On the Structure and Origin of Mountains with special reference to recent objections to the Contractual Theory." *Am. Jour. Sci., Third Series*, vol. XVI, 1878, pp. 95-112.
- XII. LE CONTE, JOSEPH. "Old River Beds of California." *Am. Jour. Sci., Third Series*, vol. XIX, 1880, pp. 176-190.
- XIII. LE CONTE, JOSEPH. "A Post-Tertiary Elevation of the Sierra Nevada shown by the River Beds." *Am. Jour. Sci., Third Series*, vol. XXXII, 1886, pp. 167-181.
- XIV. LE CONTE, JOSEPH. "On the Origin of Normal Faults, and on the Structure of the Basin Region." *Am. Jour. Sci., Third Series*, vol. XXXVIII, 1889, pp. 257-263.
- XV. MERRILL, G. P. "On Deposits of Volcanic Dust and Sand in Southwestern Nebraska." *Proc. U. S. Nat. Museum*, 1885, pp. 99-100.
- XVI. RUSSELL, I. C. "Quaternary History of Mono Valley, California." *Eighth Ann. Rep. Director U. S. Geol. Survey*, Part I, pp. 269-394, illustrated with maps and photo-engravings.
- XVII. WHITNEY, J. D. "The Auriferous Gravels of the Sierra Nevada of California." *Memoirs of the Museum Comp. Zool.*, vol. VI, No. 1, 1880.
- XVIII. WHITNEY, J. D. "The Climatic Changes of Later Geological Times." *Memoirs Museum Comp. Zool.*, vol. VII, No. 2, Part II, 1882.
- XIX. LE CONTE, JOSEPH. "On the Structure and Origin of Mountains." *Amer. Jour. Sci., Third Series*, vol. XVI, 1878, pp. 100-101.

CONSTITUTION AND ORIGIN OF SPHERULITES IN ACID ERUPTIVE ROCKS.

BY

WHITMAN CROSS.

[Read before the Society, April 25, 1891.]

In the course of geological investigations in Colorado, extending through several years, the writer has observed a number of occurrences of rhyolitic rocks containing the interesting bodies known as spherulites and lithophysæ. Some of these occurrences have furnished material remarkable for its variety and degree of development, and exhibiting in unusual clearness certain important characteristics of these structural forms. The author began the study of these spherulites without having had previous experience with such objects, and he naturally sought to apply to them the classificatory scheme and the descriptive terms of the leading authorities of the day; but, whether he turned to the German, to the French, or to the English school of petrography, he found that the current views regarding spherulites were in large measure inapplicable to the case in hand, and that the schemes of classification were unsatisfactory.

A full description of the spherulitic rocks collected in Colorado is being prepared for publication by the U. S. Geological Survey, and it is the intention to give at the present time only such results of the investigation as have a general bearing upon the subject and tend to correct certain inaccurate or fallacious beliefs concerning spherulites which are current in text-books and in general literature. Preliminary to this discussion it will be necessary to review in brief the origin of the prevailing ideas.

HISTORICAL REVIEW.

The term spherulite is one of many in the nomenclature of petrography to which no satisfactory and consistent definition has as yet been given, for the evident reason that knowledge concerning the essential character of the objects to which the term has been applied is inadequate for the establishment of such a definition. A round or spherical form is implied by the word, and a radiate or concentric inner structure has been found to be a seldom-failing characteristic of the bodies in question; yet, in spite of these purely structural conceptions, which are prominent in all discussions of the subject, the term has usually been limited in its application to masses found in the acid eruptive rocks and assumed to be peculiar forms of consolidation of a molten magma.

It is not necessary for present purposes to go far back into the literature of petrography, for the views entertained concerning spherulites before the microscope was applied to their examination are naturally vague and in a large measure incorrect. But, although the microscope dispelled certain illusions, it brought out a host of new problems to be explained, and in the latest presentations of the subject by acknowledged authorities some important features of spherulites are still surrounded by a veil of mystery.

In 1866 Zirkel states* that spherulites may be considered to represent an intermediate stage in the development of the crystalline state, between the knotted trichites or crystallites of many obsidians and the perfect crystals of the same rock.

* Zirkel (F.). Lehrbuch der Petrographie. 8°. Bonn, 1866, vol. II, p. 253.

“Die Sphärolithe scheinen eine ähnliche Bildung zu sein, wie die sogenannten Krystalliten in den langsam abgekühlten Gläsern, dem Réaumur-schen Porzellan; sie dürften eine Mittelstufe in der Entwicklung des krystallinischen Zustandes darstellen, einerseits zwischen jenen Knötchen, welche sich mitunter in den Obsidianen finden, und welche als die unvollkommensten Producte gelten können, die eine rasch erkaltende Masse in ihrem Bestreben Krystalle auszuscheiden, hervorzubringen vermag, und andererseits den vollkommen ausgebildeten Krystallen in der Glasgrundmasse.”

This view is probably based upon the earlier investigations of Vogelsang on slags, and upon the resulting theories of crystallogenesis. Vogelsang himself elaborated this idea in his celebrated work, "Die Krystalliten," issued in 1875, which contained an application of the result of his synthetic experiments to the explanation and classification of spherulites in rocks. It is not necessary to review the classic observations of Vogelsang in the field of crystallogenesis, and it is no part of the present writer's purpose to discuss the theories of crystal growth which arose from those observations. He does wish to question their application to a large share of spherulitic forms in rocks; and in this connection it may be well to point out that Vogelsang himself seems to have appreciated the dangers of this application much more clearly than most of his followers have done.*

The idea that spherulites are not made up of known minerals, and that their essential elements are indefinite substances, has proven very attractive, both to superficial observers and to those whose material would not allow of accurate diagnosis. It has therefore been widely adopted, and many descriptions of spherulites have been published which contain no mention of a definite mineral component, although the statements made clearly indicate the presence of feldspar or quartz.

In 1887 Lagorio† speaks of spherulites in terms very similar to those used by Zirkel in 1866.

The views concerning the structure and composition of spherulites, found in the petrographical literature of today, are naturally the views of the leaders in the respective schools

* Vogelsang (H.). Die Krystalliten. 8°. Bonn, 1875, p. 107. "Es ist nicht zu verkennen, dass die Gefahr dabei sehr nahe liegt, zu weit zu gehen, und der Idee zu Liebe dem krystallitischen Aggregatzustand ein grösseres Feld einzuräumen als er beanspruchen darf; . . ."

† "Ueber die Natur der Glasbasis, sowie der Krystallizationsvorgänge im eruptiven Magma." Tschermak (G.). Min. und petrog. Mittheilungen. 8°. Wien, 1887; vol. 8, p. 440. "Diese letzteren [Spherulites] sind als Anfänge der Krystallization zu betrachten, die in einem gegebenen Augenblick zum Stillstande kam, sei es, weil das Gestein erstarrte, sei es, weil das Magma überhaupt keine Tendenz besass, die gelösten Silicate auszuscheiden."

of petrography. A large part of the descriptions to be found are based upon the statements and follow the classification presented by Professor Rosenbusch in his "Physiographie der massigen Gesteine." Messrs. Fouqué and Michel-Lévy are followed even more closely by French writers, and current English literature of this subject has in a certain measure an individual tone.

The classification of spherulites presented by Professor Rosenbusch* is a modification of that proposed by Vogelsang. It establishes six divisions, namely: 1st, Cumulites; 2nd, Globospherulites; 3rd, Granospherulites; 4th, "Sphærokrytalle;" 5th, Pseudospherulites; 6th, Felsospherulites, or spherulites proper. Cumulites and globospherulites are almost wholly of theoretical importance. They consist of primitive globulites—unindividualized matter—a radial arrangement of these particles distinguishing the second group from the first. Granospherulites are composed of distinct mineral grains without any regular arrangement. A spherulite consisting of but a single mineral and exhibiting a radiate structure is a "Sphærokrytall." A radiate aggregate of chlorite leaves is mentioned by Rosenbusch as an illustration of this group of spherulites. It is clear that these first four classes of spherulites include but comparatively few of the bodies found in rocks, and only those of minute size.

For the more abundant, more complex, and as prominent rock constituents, more important, spherulites, but two groups are provided by Rosenbusch, the pseudospherulites and the felsospherulites, between which he draws what must be characterized as a very remarkable distinction. If a complex spherulite of radiate structure consists only of identifiable minerals it is a *pseudo*-spherulite, while if there is an undetermined element, in addition to the known substances, we have before us a *true* spherulite. This distinction illustrates another phase of the idea that spherulites proper cannot consist of definite minerals; for while the presence of crystallites is not essential to the felsospherulites, Rosenbusch

* Rosenbusch (H.). Mik. Phys. der mass. Gesteine. 2d ed. 8°. Stuttgart, 1887, pp. 392-3.

sees in many of them the even more mysterious substance called *microfelsite*, which appears to be abundant in the rocks studied by certain petrographers, is never mentioned by other good observers, and has certainly never been found by any one in such development that its right to recognition as a definite substance could be established.

“Mikrofelsit” is a term proposed by Zirkel for the microscopically felsitic, *i. e.*, unresolved and apparently unindividualized, yet not glassy, base of acid porphyries and rhyolites. Whether desirable at the time of its proposal, or not, the term soon fell into disrepute, because used as a mere “confession of ignorance” by careless observers. The latest definition of microfelsite, and that with which we are here concerned, is given by Rosenbusch in his already cited work. The definition is scattered through the descriptions of several rocks, but when the parts are put together it is seen that Rosenbusch gives to microfelsite the properties of a distinct mineral species. It is averred to have a stoichiometric chemical composition and a homogeneous crystalline structure. It occurs in scales and fibers which normally do not have any effect upon polarized light, and the radiate spherulitic form is characteristically assumed. Through strain of some kind such spherulites give a negative black cross between crossed nicols, and even superposed scales in a groundmass may acquire the power of polarizing light.

The chemical composition assigned to microfelsite by Rosenbusch is that of a silicate of alumina and the alkalis. The bases have the ratio 1 : 1, as in feldspar, but there is more silica than in any feldspar. The ratio of silica to bases is not given, and is apparently not constant. How can the substance, then, be asserted to have a stoichiometric composition?

There are obviously many reasons for doubting the correctness of the position taken by Rosenbusch in regard to microfelsite. Teall* and Brögger,† among others, have defi-

* Teall (J. J. Harris). *British Petrography*. 4°. London, 1888, p. 402.

† Brögger (W. C.). *Die Mineralien der Syenitpegmatitgänge, etc.*, being *Zeitschrift für Krystallographie und Mineralogie etc.* von P. Groth. 8°. Leipzig, 1890, vol. 16, p. 402.

nately expressed the opinion that microfelsite is simply a "submicroscopic" intergrowth of orthoclase and quartz. As will be seen later, the writer has been led to the same conclusion for the microspherulites thought by Rosenbusch to represent microfelsite in its purest state and most characteristic development. As for scales and fibers of the supposed substance occurring in the groundmass of porphyries and rhyolites, it will be extremely difficult to prove that they are not simply minute particles of known minerals, as feldspar, whose properties cannot be accurately determined by existing means under the circumstances of their development.

Turning now to the classification of spherulites recently presented by Michel-Lévy* and compared by him with that of the German author, we find here, too, a great confusion resulting from the introduction of the vaguely characterized element, *pétrosilex*. The present writer has searched in vain through the publications of Fouqué, Michel-Lévy, and other French authors for a definition of *pétrosilex* which should cover and explain the various usages of the term. In the pamphlet last cited, Michel-Lévy states that *pétrosilex* is the same thing as microfelsite, to which Rosenbusch gave the definition above mentioned, but then refers to it as "a partially amorphous magma impregnated with silica already individualized in the state of opal or chalcedony," a phrase which admirably illustrates the indefinite way in which the term is used. One finds in descriptions of spherulitic rocks such expressions as: "la matière pétrosiliceuse," "le substance pétrosiliceux," "la structure pétrosiliceuse," "l'aspect pétrosiliceux," "la cassure pétrosiliceuse," "globules pétrosiliceux à extinction," "globules pétrosiliceux promorphiques," etc., etc. It is seldom that a French writer describes a dense, obscure groundmass of an acid eruptive rock, or a spherulitic growth, without applying this favorite adjective. The various uses of the term logically imply that *pétrosilex* may possess either the properties of an amorphous, of a crystallitic, or of a fully crystalline substance.

* Michel Lévy (A.). Structures et classification des roches éruptives. 8°. Paris, 1889, pp. 20-24.

In the "Tableaux des Minéraux des Roches" by Michel-Lévy and Lacroix, issued in 1889, pétrosilex is mentioned under quartz, and summarily defined as a "mélange de quartz sphérolitique dominant et de feldspath." Its chemical composition is given as " Si O_2 + un peu d'alumine et d'alkalis;" its characteristic form as "Sphérolites à fibres surtout positives," and its color is said to be "brunâtre." This definition is precise, but it by no means covers the usages to which the term is put in petrographical literature, and is directly opposed to many statements of the properties of the substance—as, for example, the one above cited. One of the results of the present investigation seems to explain in a measure the confusion of properties attributed to pétrosilex, as will appear later on.

Michel-Lévy divides spherulites into five groups, which he designates as follows: 1st, "Étoilements des micropegmatites;" 2d, "Sphérolites à quartz globulaire;" 3d, "Sphérolites pétrosiliceux à croix noire;" 4th, "Sphérolites d'orthose;" 5th, the spheres of perlite. The last group is excluded from present consideration, the second includes peculiar and usually secondary forms of a single rock constituent of minor importance. The fourth group is said to represent the "Sphærokrytalle" of Rosenbusch. The classification of Michel-Lévy has no place for spherulites composed of known minerals, unless they be quartz and feldspar intergrown in the manner of micropegmatite. His third group corresponds to the felsospherulites of Rosenbusch, and as a matter of fact the great majority of spherulites are referred to this division, pétrosilex, like microfelsite, being readily assumed to be present where the spherulite is very dense, or when it is clouded by decomposition products, or when the sections are too thick for microscopical analysis.

It is to be noted that the French author does not recognize among spherulitic bodies of rocks any representatives of Vogelsang's cumulites and globospherulites; at least he does not provide for them in his classification.

Existing literature concerning spherulites is almost exclu-

sively the product of European writers. The only important contribution to the subject which has been made by an American is contained in the description by J. P. Iddings* of the wonderful material of Obsidian Cliff, in the Yellowstone National Park. In beauty, freshness, variety, and degree of development, the spherulitic rhyolite of this locality seems to surpass any previously described occurrence in the world. Spherulites of several types are here associated, from extremely minute microscopic forms to those several inches in diameter, and the relationship between solid spherulites and the hollow variety termed lithophysæ is very plainly shown.

The publications of Iddings regarding this excellent material contrast very markedly with those of European writers, in that he does not mention in his description of any variety of spherulites a crystallitic or otherwise indefinite substance, such as microfelsite or pétrosilex. He interprets all spherulites studied by him as made up of known minerals, which are not different in kind from the constituents of the rhyolite formed from the same magma under other conditions. In other words, he treats these spherulites as produced by the crystallization of a magma under special conditions causing the peculiar structure, and not as mere consolidation products, caught in a certain transition stage between the molten fluid and the normal crystalline state. As shown by mineral and chemical composition and geological relationships these spherulitic masses are simply primary structural modifications of a rhyolitic lava.

The investigations of the present writer upon a large collection of spherulitic rocks, showing many modifications not exhibited at Obsidian Cliff, have led him to the same conclusion regarding his own material. He must not be understood to deny the existence of crystallitic aggregates, cumulates, or globospherulites, in glassy rocks, but he has seen no reason to believe that they are developed in the material he

*The nature and origin of lithophysæ and the lamination of acid lavas. Amer. Jour. of Science. 8°. New Haven, 1887, Jan., vol. 33, p. 46.

Obsidian Cliff, Yellowstone National Park. Seventh Ann. Rep. Director U. S. Geological Survey. 8°. Washington, 1888, pp. 249-296.

has studied. On the other hand, certain facts to be brought out show conclusively that in very many interpretations of spherulitic bodies the presence of indefinite substances—crystallites, pétrosilex, or microfelsite—has been unnecessarily and unjustifiably assumed under the influence of preconceived ideas.

DESCRIPTION OF SPHERULITES FROM COLORADO.

The spherulitic rocks examined by the writer come mainly from the Silver Cliff-Rosita mining district, in Custer county, Colorado, where, on the western slopes of the Wet Mountain range, there is a small group of hills made up of a series of andesites, rhyolites, and trachytes from a single volcanic center. The rhyolite was poured out through numerous fissures and ejected from explosive vents, the products intermingling in a complex manner. The rock is now found in dikes, in remnants of flows, and in breccia or agglomerate masses, almost all of which are characterized by an abundance of spherulitic growths. In many cases the entire mass is spherulitic, in a number of generations, the conditions favorable to such crystallization having been repeatedly interrupted, to be renewed with distinct, though minor, changes in the character of the successive products.

In these various rock masses spherulites occur of all sizes between those of microscopic dimensions and complex bodies more than ten feet in diameter. In form they vary from the perfect sphere through almost the whole series of modifications so easily produced by this kind of crystalline growth. These multitudinous forms are visible in many relationships to each other, to glassy rocks, and to banded lithoidal rhyolite. They are sometimes found in fresh condition in pitchstone, and in other cases occur in masses which have been subject to decomposition in several ways. The material is therefore adapted to show the original relationships of the bodies to the consolidation of the magma, different kinds of internal structure and mineral constitution, and also changes due to entirely secondary processes.

Excepting purely silicious forms of secondary origin, all the spherulitic bodies of these rocks are products of the consolidation of a cooling magma. As an aid in appreciating some of the subsequent statements, it is thought advisable to give in the outset quantitative analyses of two typical pitchstones, both in almost perfectly fresh condition, and representing, as nearly as can be ascertained, the composition of two magmas in which spherulites were locally developed. Analysis I is of the pitchstone at Silver Cliff, in which occur the large compound spherulites to be described, while II represents a small lava flow in the Rosita Hills. The analyses were made by L. G. Eakins.

	I.	II.
Si O ₂	71.56	73.11
Al ₂ O ₃	13.10	13.16
Fe ₂ O ₃	0.66	0.62
Fe O.....	0.28	0.23
Mn O.....	0.16	0.14
Ca O.....	0.74	0.54
Mg O.....	0.14	0.19
K ₂ O.....	4.06	5.10
Na ₂ O.....	3.77	2.85
H ₂ O.....	5.52	4.05
	<hr/>	<hr/>
	99.99	99.99

Other analyses confirm these in showing the very simple constitution of the rhyolitic magmas of this district, each of which on complete crystallization must consist of nearly two-thirds alkali feldspar and a little more than one-third free silica. All other possible constituents are quite subordinate in amount, and it is to be noted that prior to the spherulitic period the lime, magnesia, and much of the iron oxides had been separated out in phenocrysts of plagioclase, leaves of biotite, microlites of augite, and in grains or trichites of magnetite. When the spherulites began to form in these lavas the molecular ratio of potash + soda to alumina in the still fluid part was almost exactly 1 : 1, and the only other important constituents were silica and an abundance of water.

All substances older than the spherulites are arranged to bring out the fluidal structure of the viscous magma. Here, as elsewhere, this structure traverses the spherulites without change in course, but the earlier mineral particles have been more or less attacked by the agencies active in the spherulitic periods. This action reaches a maximum when the microlitic crystals are wholly resorbed and the fluidal structure is thus obliterated.

Extremely minute microscopic spherulites were the first to form, although also developed in later periods, and several varieties may be distinguished among them. Some are clearly micropegmatite groups; others are too dense to show any definite intergrowth of minerals. The early ones are usually colored brownish, but often have an outer colorless zone, plainly contemporaneous with adjoining spherulites which are colorless throughout. Dense cores are occasionally surrounded by an outer zone of later date, composed of distinct feldspar rays, and, rarely, microspherulites of apparently pure feldspar are found.

Globules of opal or chalcedony are sometimes present in these rocks, chiefly in certain bands of lithoidal rhyolite, in druses, or in veins. They seem referable in all cases to the last period of spherulitic growth, or to a definitely secondary period. No reason has been found to suppose that purely silicious spherulites formed here in any period when the magma yet contained the components of feldspar in considerable amount.

Further description of these minutest spherulites is unnecessary, as they seem to correspond to varieties developed in unusual perfection in the lava of Obsidian Cliff, which have been described by Iddings in the publications already cited and in an article read before the Philosophical Society at the same meeting with the present one. Iddings shows conclusively that a very large share of those dense microspherulites affording a distinct, negative interference cross must be supposed to consist of micropegmatite. This is a most natural product of crystallization of such magmas, and

it seems both unnecessary and unwise to suppose that indistinguishable bodies may occur in the same association and of the same condition of origin which are either made up of a wholly hypothetical substance, such as pétrosilex or microfelsite, or of a known mineral, as chalcedony, whose formation in such circumstances is chemically unlikely. The assumption for other cases, that the optical properties are due to tension in an amorphous substance, should have some special basis to rest upon.

Dismissing from further consideration these very dense and very minute spherulitic forms, the main part of the following descriptions will have reference to a distinctly different class of spherulites, the nature of whose growth permits them to reach a size and assume forms scarcely possible for the others. The spherulites in question occur in several generations of growth in the rocks of Custer county, and each growth possesses characteristics suggesting some local name for use in study and description. In using these convenient terms in this article the writer must not be understood to suggest that similar types, developed in other lavas under somewhat different conditions, are likely to appear in the same order of formation, or in the same formal relationships. A perfect coincidence in products of two occurrences would imply a perfect coincidence in numerous varying conditions, something very improbable for the entire series though it might be partially realized in many cases.

The first spherulites of this series are commonly characterized by internal cavities, large with reference to the whole spherulite and of very irregular shape. Movements of the stiff viscous mass soon after these *hollow* spherulites were formed crushed many of them and the cavities were filled by liquid matter. Fig. 1, Plate 5, shows in natural size a rock in which the hollow spherulites are abundant. Most of them have been crushed, but the dislocation of fragments was evidently slight.

The solid shells of hollow spherulites are chiefly made up of colorless needles of feldspar radiating from many different

centers on the surface of the cavity, but in the outer zone they have all come into position normal to the circumference. These needles branch or fork at low angles in the manner well illustrated by Iddings and others, and which is quite common in large spherulitic growths. Between the feldspar needles is the silica, often in amorphous form, probably opal, and colored light yellowish brown by ferritic pigment. But a portion of the silica has usually become anhydrous and is developed in minute balls of tridymite, scattered wholly irregularly through the mass. The ferritic matter is excluded from these tridymite aggregates and is gathered in the amorphous material about them, or, if the silica is all developed in such aggregates, the pigment becomes concentrated in larger particles and the whole spherulite is thereby clarified. The feldspar needles are naturally most plainly seen when the silica is thus developed. In some cases irregular quartz grains develop instead of tridymite, and then the optical action of the feldspar needles is more or less obscured by the mineral of stronger double refraction. It is characteristic of hollow spherulites that magnetite should be formed in distinct grains scattered evenly through the fibrous mass and in no way accentuating the radial structure.

The second spherulitic growth, or the first where the hollow ones are missing, has been termed the *trichitic* type. In form these growths are most variable, the tendency being to develop in bushy shapes or peculiarly lobed modifications of the round form. This variability is due to the fact that the conditions attending the growth caused the extremely delicate feldspar fibers to curve and branch to an unusual degree, and this influence was so strong that the magnetic iron assumed a trichitic form, and, starting from the same centers with the feldspars, branched and curved about with all the eccentricities of the silicate mineral. While in actually small amounts, the delicate black lines of these trichites are, when fresh, the most striking element of these spherulites. The feldspars are very thin indeed, averaging only 0.004^{mm} in diameter. In trichitic spherulites the silica is developed as in the hollow ones, though less frequently as tridymite.

Trichitic spherulites do not as a rule form extensions of the earlier hollow variety, but spring from independent centers. While in spherical form they may reach a diameter of two or three inches, they are much more commonly developed in fox-tail-like arms of a few millimeters diameter. In Fig. 1 of Plate 5 the arborescent forms between hollow spherulites are trichitic growths.

Both hollow and trichitic spherulites are often surrounded by a zone of *supplemental* spherulitic growth. In this the force of crystallization has been weak. Probably only a small part of the feldspathic material crystallized out, and it appears in very thin delicate fibers which are prevailingly oriented as extensions of the needles of the interior growth. Often the optical action of these fibers is so slight as to require special care in observation, in order to detect it. Further individualization of minerals in these supplemental areas is rare. A pigment of almost unresolvable fineness usually produces a very even yellowish-brown coloration, which sharply defines the spherulite from the surrounding glass. Occasionally the pigment develops in distinct flakes which by concentration on certain planes emphasize a wavy concentric structure. Supplemental spherulitic zones may be very narrow, or they may be even wider than the diameter of the enclosed spherulite. Their outer boundary is a sharply defined curved surface. Secondary grains of quartz sometimes develop from the silica in the amorphous base.

The three spherulitic generations which have been described locally make up the entire rock. Usually, however, there is more or less residual space between them that may be occupied by glass, by a fourth radiate growth, or by the two together. This *residual* spherulitic growth exhibits a regular outer form only where bounded by glass or by a somewhat later crystallization of the same kind. The forces acting in this last period favored the development of larger individuals of feldspar, quartz, and ore than in the preceding groups.

Where the first three spherulitic growths were subordinate in development the fourth generation was able to acquire a

regular outer form, and as the action of this period seems to have been very energetic, complex spherulites several inches in diameter have frequently resulted. In such a spherulite the early forms are simply surrounded as so many foreign bodies, and the type may be termed the *enveloping* spherulite. Such bodies are comparatively coarse in texture and have practically the same characteristics as the more limited residual growths.

What may be termed *compound* spherulites result from a regular orientation of successive growths. A most remarkable instance of this type is found at Silver Cliff, where a large lava flow several hundred feet in thickness was poured into a lake basin. The lower part is pitchstone (see analysis I above), the upper, banded lithoidal rhyolite, and between the two is a zone, locally fifty feet thick, largely made up of gigantic compound spherulites. These bodies vary from a few inches to more than ten feet in diameter. They are built up by two or three successive growths about a common center and in several ways. In the largest ones the first growth took the form of very dense finely fibrous arms branching as they extended out from the center, often for a distance of several feet. After an interval the matter between these arms crystallized in a coarser growth, the feldspars of which are oriented in accordance with the fibers of the earlier development. This crystallization does not extend far beyond the limits of the first, but an outer zone is frequently present of a third type, which may in itself build up certain other compound spherulites. Fig. 1, Plate 6, represents the structure of the compound type, to which reference will again be made in considering conditions of spherulitic development.

DISCUSSION OF THE MINERALOGICAL CONSTITUTION OF SPHERULITES.

It has been shown many times that the larger and more important spherulites of acid lavas have practically the same chemical composition as the rock in which they lie. This

composition renders it inevitable that the spherulite, if holocrystalline, will contain alkali feldspar as its chief constituent and free silica in some form as the only other quantitatively important element; yet many spherulites, seemingly like some forms developed in lavas of the Rosita Hills, have been described as quartz spherulites, without reference to the implied absence of feldspar, which would certainly be remarkable. Such descriptions are often, if not always, based upon the erroneous assumption that optically positive fibers or needles of spherulites cannot be feldspar, and are therefore probably quartz. This assumption seems to be merely an unwarranted extension of the rule, now commonly recognized, that free microlites of alkali feldspar in vitreous acid rocks are characteristically elongated parallel to the clinaxis, and thus have the negative optical character of the prismatic zone. It has been found true of the spherulites above described that their feldspar needles are in some cases negative, and in others positive, in character. This observation, if substantiated, casts doubt upon all determinations of quartz needles in spherulites, which rest alone upon the optical character displayed, and throws light upon the origin of some important misconceptions in regard to spherulites.

As far as the coarser crystalline spherulites of the Rosita Hills are concerned, the determination of the branching needles as feldspar is justified by the observations that the extinction is not always parallel to the length axis, but varies from 0° to more than 15° , and that cross-sections show the mineral to be biaxial, while what appears to be a normal quantity of free silica is developed in quartz grains or tridymite scales between fibers. By using the quartz plate *à teinte sensible* in the well-known manner, the application of which to the study of spherulites has been specially recommended by Michel-Lévy in "Les Minéraux des roches," the greater number of feldspar fibers are found to be optically positive in character, while a lesser proportion are negative. In the hollow, the trichitic, and the supplemental spherulitic growths the feldspar fibers are all positive; in the dense

bushy growth of the compound spherulites represented by Fig. 1, Plate 6, they are uniformly negative, but those of the second, coarser growth between these arms are all positive. The feldspars of the residual and enveloping forms are variable in character, being positive in some cases and negative in others. In certain enveloping spherulites the needles of one portion are all negative, and of other parts all positive, the change from one character to the other taking place most frequently on some concentric zone of growth. Again, positive and negative fibers are mingled so intimately as to show that for these the optical sign is probably \pm .

All of these characters are explainable on the assumption that the needles of positive optical character are feldspar elongated parallel to the vertical axis, and that they possess the so-called abnormal optical orientation, the optic axes lying in the plane of symmetry. The needles whose character is \pm are elongated parallel to the vertical axis, but possess the usual optical orientation, and those of constant negative character are doubtless parallel to the clinoaxis and may have either optical orientation. The so-called abnormal position of the axes of elasticity is found most frequently in sanidines of acid lavas, and that these needles of somewhat peculiar conditions of growth should be thus different from the free microlites is nothing strange.

The cross sections of positive needles are sometimes rhombic, the angles corresponding to those of the feldspar prism, and in other cases they are apparently hexagonal through probable development of the clinopinacoid; but in many growths the faces of the prismatic zones are curved or otherwise irregular in development. Cross sections of positive needles polarize much more strongly than those of negative fibers, the latter being sometimes sensibly isotropic, a difference which is a natural consequence of the optical orientation. The larger negative fibers are frequently Manebach twins, and there are reasons to suppose that they grow characteristically with the reëntrant angle $\infty P \overline{\infty} \wedge \infty P \overline{\infty}$ outwards. They fork at larger angles than the positive needles,

and the diverging twigs are in some cases apparently parallel to the vertical axes of the two halves of the twin. A beautiful instance of this forking of negative feldspar fibers occurring in a spherulite of Obsidian Cliff is described and illustrated by Mr. Iddings in his article in this volume on spherulitic crystallization. It may be added that Iddings has found positive feldspar prisms characteristic of many spherulites in the Yellowstone Park.

The first and most important result of this error, in regarding all positive fibers of spherulites as quartz, has been a fundamental misconception as to the character of many spherulitic bodies, so that their true relationship to the rock masses of which they are a part has not been appreciated.

The observations made upon the spherulites of the Rosita Hills show that the amorphous base holding the feldspar needles is mainly hydrous silica. It is a curious fact that Michel-Lévy, of all petrographers, has emphasized the importance of colloidal silica in influencing spherulitic growth; but so long as the positive fibers of spherulites were regarded as quartz the amorphous material between them had to be considered as a kind of feldspathic paste, with a probable excess of silica. By regarding the needles as the silicate and the base as colloidal silica, the importance of the latter is by no means diminished, and it is made to appear in a natural rôle. Many references to *pétrosilex* as a partially amorphous base impregnated with quartz or chalcedony, such as that cited on page 416, seem to be fully explained by these considerations.

The delicate branching trichites described above as characteristic of certain growths are beyond question primary. They correspond to magnetite in some growths and to trichites of other forms in residual or enveloping spherulites. It is plain from the literature of the subject that the small amount of iron oxide usually present in spherulites has greatly obscured certain occurrences, and the manner in which it has been accomplished seems clearly indicated in some partially decomposed rocks of the Rosita Hills.

When branching trichites are first attacked they disintegrate, the particles are hydrated and become brown, but the radial arrangement is still very clear. If solvents carry off a large part of the hydrous oxide, the place of the original trichite is often indicated by most delicate, faintly brownish lines. The hydration sometimes produces a flocculent matter which materially obscures the feldspar needles. Each of these secondary conditions of the iron oxide corresponds exactly to what has at times been described as the essential characteristic of certain spherulites. The various secondary forms of iron oxide have even been the only constituents described in a spherulite said to show a distinct black cross in polarized light.

The brownish color of the amorphous base between feldspar needles is sometimes not referable to individualized particles; but if tridymite or quartz crystallizes out of that base the iron oxide is excluded and forms distinct particles. This brownish color is often mentioned as a property of pétrosilex, and it is noteworthy that Michel-Lévy and Lacroix retain this feature in their late definition, cited above, which makes spherulitic quartz and feldspar the components of the substance.

There are various other features of the mineral constitution of spherulites well illustrated in the material which has been studied, but only those of greatest importance can be discussed in the limits of this article.

ORIGIN OF SPHERULITES.

It is the writer's desire to discuss, briefly and in a preliminary way, the bearing of some of the observations made upon the question as to the origin of spherulites produced during the consolidation of a rock magma, the agencies involved and the conditions directing their activity to the end specified. At present it seems impossible to harmonize all the known facts with any theory suggested, but this is doubtless because some one of the important agents is unknown or

unappreciated, or because the physical laws controlling some recognized agent are too imperfectly understood.

Among the spherulites studied by the writer there are two prominent classes: The first class embraces the distinct micropegmatite or "granophyre"* groups and the dense forms which may be considered their equivalent. It has been observed by various petrographers that between coarse micropegmatite and microspherulites of most delicate radiate structure there exist all intermediate stages. Iddings † has illustrated very beautifully the structure of certain spherulites formed by the interpenetration of feldspar crystals, each of which has quartz fibers regularly intergrown, and the manner in which these distinct groups grade into the very dense spherulites. He also calls attention to the occurrence of single crystals or simple groups of orthoclase crystals with quartz thus intergrown among the phenocrysts of crystalline and vitreous rhyolites. While spherulites of micropegmatite seem to form most characteristically in the early stages of consolidation, they are not thus limited, and occur at Silver Cliff as products of the last period. Viewing micropegmatitic spherulites as manifold interpenetrations of quartz-bearing feldspar crystals, it is evident that their size will be limited by the same general conditions which limit the development of single crystals in magmas.

Micropegmatitic spherulites are composed of the two principal constituents of rhyolite, but it does not seem probable that the feldspar and quartz are necessarily present in the proportion in which they occur in the rock. The amount

*Granophyre is a term appropriately applied by Vogelsang (p. 160 of work before cited) to a porphyry with a granular crystalline groundmass, as a companion to felsophyre and vitrophyre. Under the idea, now abandoned, that some glassy residue was essential to a porphyry, Rosenbusch (p. 31 of work before cited) diverted the term from its original use and inappropriately applied it to what is called micropegmatite by the French and by many English authors. It seems to the present writer that the usage of the term in the sense advocated by Rosenbusch is to be deprecated both on historical and on etymological grounds.

† Obsidian Cliff, Yellowstone National Park. Seventh Annual Report Dir. U. S. Geol. Survey. 8°. Washington, 1888, Plate XV.

of quartz may presumably sink to nothing, and in fact in one of the Silver Cliff rocks there are spherulites made up of interpenetrating crystals of apparently pure feldspar. Other rock constituents are but accidentally included in spherulites of this type.

The second class of spherulites to be considered differs widely from the first in several essential characters. In the first place, they represent the consolidation of the whole magma for a certain space, excepting only what had crystallized out in the early microlites and phenocrysts. The nature of the crystallization which produced them allows of large dimensions and various modifications of the spherical form. Under this class are two primary divisions, the one characterized by radiating branching feldspar crystals, the other by a more marked concentric structure, though the two are connected by all manner of intermediate stages. Concerning this important class of spherulites the study of the material from Colorado has brought out or emphasized a number of points to be discussed. Let us first consider the arborescent growth of the feldspathic constituent.

It is well known that many substances crystallize out of solutions in curved and branching forms, and a host of observations upon the synthetic products of chemical laboratories has made clear certain of the conditions essential to this growth. It is plainly a study in molecular physics, and has been so treated by Dr. O. Lehmann,* among others, who has also observed and discussed the relationships between these artificial products and the similar bodies met with in glassy rocks. Briefly stated, the cause of the curving of a growing needle or trichite is supposed by Lehmann to be a tension unequally distributed over the outer surface. If the tension increases the needle may break or simply crack, and in the latter case a forking of the stem is a frequently observed

* Lehmann (O.). *Molekular Physik*. 2 vols. 8°. Leipzig, 1888. In this work are described and illustrated many branching crystallizations, with data concerning the conditions under which they were formed. See vol. I, pp. 378-390.

result. If this forking is continued arborescent growths are produced. While the physics of these curving growths are as yet imperfectly understood, it seems that a certain degree of viscosity of the medium in which the crystallization proceeds and a great rapidity in the process are essential factors. Lehmann expresses the belief that most substances crystallizing out of solutions can be made to form branching growths under proper conditions.

Applying this idea to crystallizations met with in glassy lavas, we find that certain forms are almost completely analogous to some that have been observed in synthetic experiments, as, for instance, the curling or knotted bunches of trichites, forked microlites, and the beautiful feathery shapes assumed by augite in the pitchstone of Arran, or in the basalt of the Sandwich Islands described by E. S. Dana.* But these crystallizations are not complete spherulites; they are simply branching crystals, and correspond to but one element in a spherulite of the type under discussion. In no spherulite examined by the writer can all of the branching feldspars be assumed to spring from a single original crystal. They start from many such centers, so that the feldspathic part of each spherulite is a complex of many arborescent individuals. A single branching individual that acquires a spherical form by curving about until the primary crystal grain is in the center of the body is called a "Sphærokrystall" by Lehmann, who compares such a growth with the spherulite thus designated by Rosenbusch. But the radiate aggregate consisting of a single mineral to which Rosenbusch gives the name can seldom, if ever, be an individual such as the Sphærokrystall of Lehmann. The criticism of Cohen† that a radiate aggregate of crystals should not be called a Sphærokrystall will undoubtedly hold good for nearly all cases coming under Rosenbusch's definition.

The question as to what has caused the branching feld-

* Contributions to the petrography of the Sandwich Islands. Amer. Journ. of Science. 8°. New Haven, 1889, June, vol. 37, pp. 441-467.

† Göttingische gelehrten Anzeigen, 1886, p. 915.

spathic growth in the spherulites studied by the writer seems inseparable from that regarding the meaning of the concentric structure and the regularity of the outer form. In considering these problems we must take into account all available data as to the condition of the magma at the time of the spherulitic formation. We know that the lava had come to rest, for the fluidal structure caused by the movement of the magma during eruption traverses the spherulites undisturbed as to course. The mass must have been nearly solid, yet capable of being locally softened or rendered viscous again, by the agencies involved in the formation of spherulites. The heat liberated during rapid crystallization and the influence of superheated water and steam are factors which were doubtless potent in producing this result. A very remarkable occurrence at Silver Cliff is full of significance in this connection, though its full meaning is not yet clear.

In some of the enormous compound spherulites of the type represented by figure 1, Plate 6, there is a very marked breccia structure. The fragments are sharply angular, of various sizes up to two or three inches in diameter, and are defined as fragments by the dislocation of the fluidal structure, and by a slight brownish color in the more finely brecciated parts. The first idea is that the spherulite has been fractured, but the outer surface shows no dislocation of parts, and closer examination proves that both generations of spherulitic growth traverse these fragments without change in course. The symmetry of the spherulite is not affected by the interior breccia structure, which is thus clearly of older date. The same breccia structure is, however, found locally in the perfectly fresh pitchstone of the same flow. Here the fragments seem almost welded together, so perfect is the union of surfaces on which a sharp dislocation of the fluidal structure takes place. It appears that the lava must have been in a very stiff viscous state, just prior to final consolidation, when by some sudden and violent volcanic shocks it was broken into pieces, which still possessed plasticity enough to perfectly coalesce again under the pressure upon them.

That the brecciated mass, whatever its condition when fractured, became plastic to a certain degree during the subsequent spherulitic growth, is clear. In the first place, the symmetry of these huge spherulites, several feet in diameter, cannot be explained on the assumption that they are entirely secondary devitrification products of a solid glass. Some force was able to control the growth of the delicate branching arms of the earlier crystallization and limit it to a certain relationship to the outer form. That these arms were produced by rapid crystallization in a viscous medium seems an irresistible conclusion from the synthetic experiments mentioned. In harmony with this idea is the fact that microlites and minute garnet crystals of an earlier formation are strongly resorbed in the denser spherulitic growth, and less so in the succeeding coarser one; but perhaps the strongest evidence of a plasticity within the area of crystallization is afforded by a feature of certain spherulites which will now be described.

Fractured faces normal to the circumference of large spherulites often show what appear to be veins, a centimeter or less in width, cutting sharply through the fragments of the breccia. Examination shows that these vein-like spaces extend into the spherulite for varying distances from the circumference to which they are nearly at right-angles; that they curve and branch laterally, and generally die out toward the center. They are filled with a mixture of micropegmatite spherulites and an irregular aggregate of quartz and feldspar grains. Some of them contain very minute and delicate lithophysal cavities, with several concentric shells. Further, these apparent veins do not cut across the fibrous growths, and it seems even clear that, in some way, these spaces were marked out and occupied by plastic matter when the adjoining fibrous parts of the spherulite were formed. This is indicated by the fact that the smooth surface bounding the radiate growths against the vein area is beautifully fluted, the undulations corresponding to concentric zones of the spherulite. Figure 2, Plate 6, represents

such a surface on a specimen from a large spherulite. A portion of the vein against which this undulating surface was developed is shown resting on it, in the left central area of the figure. The fractured surface of the lower part of the specimen shows the delicate development of the early growth, here subordinate to the latter one. It is evident that the vein-like space whose walls are thus moulded cannot be thought of as a fissure cutting into solid rock. An explanation is suggested below.

Further evidence that the agencies active during the periods of spherulitic growth were able to soften or even liquefy the viscous mass is found in many places. In certain rocks of the Rosita Hills where there are three or four generations of spherulites the residual growth is characterized by large curving trichites, which form a heavy fringe about the earlier crystallizations, and in other cases large knots of trichites have developed in the residual space, exactly like those of some obsidians and quite unlike the earlier trichites of this magma. In such cases the original fluidal structure of the magma is seen traversing the earlier spherulites up to the boundaries of the residual space, but cut sharply off on that line, the augite and feldspar microlites and the small primary trichites having been completely resorbed, while a fluidal structure pertaining to the residual period has resulted from minor movements which drew out and deformed the new trichitic knots in the narrower spaces between the spherulites. Residual spherulites develop in a part of the area characterized by these trichitic knots.

In order to explain the phenomena above described the writer wishes to advance an hypothesis as to the conditions favorable to or causing spherulitic growth in the cases which have been specially considered. It is an attempt to explain the close and seemingly interdependent relationships existing between the outer form, the concentric zones of growth, and the branching character of the feldspathic constituent. The fact that such spherulites are especially characteristic of lavas rich in silica and containing some water, together with

the frequent development of opalline silica with the spherulites, has led to the idea that this amorphous substance plays an important rôle in the formation of these bodies. Michel-Lévy* has expressed the same belief, founded on the observed facts, first, that opal characteristically assumes the globular form; second, that chalcedony is often developed in spherulitic form, and on the erroneous supposition discussed above, that all positive rays of spherulites are quartz.

The hypothesis to be presented has been suggested by numerous observations tending to show that the crystallization of the feldspars in radiating branching forms was but one act in the history of the spherulite, and that it was preceded by another more important act, which provided the conditions necessary to that peculiar growth and directed and limited it. This precedent act is conceived to be a local change in the character of the magma, in that, within the area of each spherulite, there first developed a colloidal substance. There are several ways in which this general idea can be elaborated and applied to different phases of the problem in hand.

The simplest conception is to suppose that the magma splits into its two chief components, hydrous silica and feldspar, through the separation of the former in its characteristic globular form, and that the individualization of the latter takes place simultaneously. Starting with the initial globule of opalline or colloidal silica, containing in it the elements of feldspar, the idea is that the degree of viscosity and the tension which must be assumed induce and direct the arborescent feldspathic growth. Such a globule once formed might serve as a nucleus for successive secretions from the surrounding magma. If this secretion proceeded at a uniform rate the structure of the resulting spherulite would be simple. But if the opalline matter were added in distinct periods a concentric zonal structure might be emphasized by slight variations in the development of the feldspars, or in other ways actually observed in spherulites. Where the

* Michel Lévy (A.). Structures et classification des roches éruptives. 8°. Paris, 1889, p. 22.

surrounding magma is not perfectly homogeneous the secretion of the colloidal substance will probably not proceed uniformly and the common hemispherical or otherwise laterally developed forms are a natural result. If a lateral growth is once started by some primarily trivial cause, its continuation in that direction may be attributed to the thus localized influence of some factor, such as the heat liberated in rapid crystallization, which may promote further secretion of the colloidal matter in the adjacent portion of the magma. In this way bushy spherulites extending in all directions through a homogeneous magma may be explained.

Many irregularities of growth to be observed in spherulites seem to be natural results of such a process as that outlined above. For example, it is common to find spherulites of regular form whose radiate crystallizations spring from several points not symmetrically related to that form. There is often a concentric zonal structure about each point of origin and the growths meet on sharply defined planes, but gradually a controlling force brings all into harmony and the outer zones are regular shells of the sphere. Such a structure may be explained by supposing that the secretion of the colloidal substance began simultaneously at several neighboring points. As the spheres came into contact they would at first be separated by planes such as those between drops of viscous liquid, and the accompanying crystallization would be limited by those planes. Gradually these additional zones would become concentric to a common point and might coalesce. The manner in which a spherulitic growth regains its symmetrical relationship to the outer form after curving around a foreign body is directly analogous to the case just considered.

That the colloidal substance formed prior to the crystallization of the feldspar needles cannot in all cases have been simply hydrous silica is indicated by several observations, three of which will be mentioned :

1st. In the supplemental spherulitic growth which has been described (p. 424) and is illustrated by Fig. 2, Plate 5,

the development of the feldspar seems to be so slight that one can hardly avoid concluding that the amorphous base must contain the elements of feldspar in addition to hydrous silica.

2d. The hollow spherulites illustrated by Figs. 1 and 2, Plate 5, bear evidence of another character. It is found that the arborescent feldspar groups spring from many points on the surface of the cavity, and all the indications are that the cavity was formed prior to the crystallization. One can imagine the cavity to be a result of contraction in a sphere of colloidal matter. They are not found in glass, but are common in spherulites; hence the contraction seems to have taken place in a substance, not glass, occupying the spherulitic area.

3d. The huge compound spherulites of Silver Cliff represent several peculiarities which seem explainable only on the hypothesis that a colloidal mass having practically the chemical composition of the magma separated out in the spherulitic areas. The vein-like spaces described above may then be looked upon as radial fissures of contraction in such a sphere; and the two feldspathic crystallizations which took place after the formation of these fissures may be thought of as separations of the colloidal mixture into its two parts under the directing influence of the tension existing in the large sphere.

In considering the further application of this hypothesis, that the separation of a colloidal substance precedes the formation of branching feldspar needles, it will at once occur to many observers that a large number of spherulites are holocrystalline and present no evidence as to the former existence of an amorphous constituent of any kind; but this undoubted fact may possibly be explained by the very simple idea that an individualization of the silica as tridymite or quartz will effectually destroy all evidence of this early stage in the history of the spherulite; and this change may take place at once, before the rock has completely solidified, or in a much later period as a decidedly secondary process. It

seems probable that the amount of water present in the magma may have much to do with this question. In the spherulites of Obsidian Cliff no amorphous matter is described by Mr. Iddings, but the fresh obsidian carries less than one per cent. of water, while the pitchstones of Silver Cliff contain four or five per cent.

In conclusion, it may be well to briefly review the reasons for advancing a hypothesis which once more introduces an element of unknown character into the discussion as to the essential nature of spherulites. The idea that a radiate crystallization is the direct and primary cause of the peculiar forms assumed by spherulites cannot be accepted for all cases, because there are instances, mentioned above, in which the crystalline growth is very subordinate to an amorphous matter that in its development brings out the same characteristics of form, as opposed to the surrounding glass. In certain spherulites one finds indications that the form was outlined by the amorphous substance before crystallization began. Further, there are many minor peculiarities in the spherulites of Custer county which, in the author's judgment, are best explained by the assumption of some force tending to produce the spherical form, other than that of radiate crystallization.

If one accepts the idea of the formation of a colloid, preceding the crystallization in the spherulitic area, for any case, one must necessarily extend the application to some instances of apparently holocrystalline spherulites, because it has been observed that evidence of the former amorphous material may be entirely destroyed by crystallization of tridymite, quartz, or feldspar in its place. The question is, how many holocrystalline spherulites are to be thus explained?

The branching arborescent growths of feldspar are results of certain conditions. If those conditions are realized in the viscous glass, the growths in question will undoubtedly form. In the rocks studied by the writer it does not appear that they ever did form except in the complete spherulites. The

single arborescent individuals should be found in glass, and also the intermediate stages between the individual and the regular complex of such forms observed in spherulites, if it is to be argued that the latter are wholly due to the crystallization. Between spherulites due to radiate crystallization alone and those whose structure seems to demand the assumption of another nearly contemporaneous agency, there are many forms whose relationships are not yet perfectly clear.

It is the writer's hope that the foregoing descriptions may contribute somewhat to our knowledge of the constitution of spherulites, and that the speculative portion may also prove to be of some value.



Fig. 1.

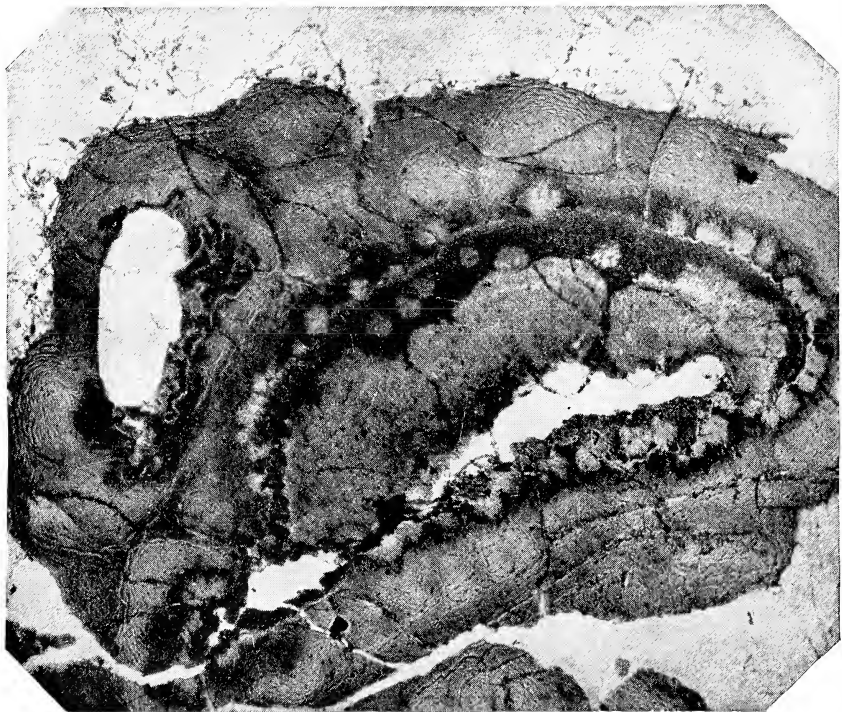

Fig. 2

EXPLANATION OF PLATE 5.

FIGURE 1.—From photograph of hand specimen, nearly natural size; represents a rock of three generations of spherulitic growths. 1st. "Hollow" spherulites (p. 422), many of them crushed by movements of the viscous mass. 2d. "Trichitic" spherulites (p. 423); the small white arms often in bunches or groups; cross-sections of these arms shown in center of specimen. The dark central part contains fresh trichites, the white color of the outer zone being due to decomposition of the trichites. 3d. "Supplemental" spherulitic zones (p. 424), comprising in this rock almost the entire mass between the earlier growths. This part has a dull brown color, subconchoidal fracture, and opalline luster.

FIGURE 2.—Photomicrograph, $\times 25$, ordinary light. In center a "hollow" spherulite of botryoidal form. Branching feldspar needles radiate from several centers and run to circumference, but are obscured by ferritic flakes. The development of tridymite is shown by the lighter parts of the spherulite, and the consequent exclusion of ferritic matter caused the outer zone to be very dark. Several small balls of tridymite are seen in this outer zone.

On surface of the hollow spherulite are numerous balls of tridymite, surrounded by dark zones filled with ferritic matter. Each of these tridymite balls is a center for the development of a wavy concentric structure and of a delicate radiate growth of feldspar needles. Compare with descriptions, page 423. This "supplemental" spherulitic development also surrounds the sanidine crystal on the left of the hollow spherulite. This rock contains no trichitic spherulites, and the crystalline parts above described are surrounded by fresh colorless glass, shown on the upper edge of the figure.

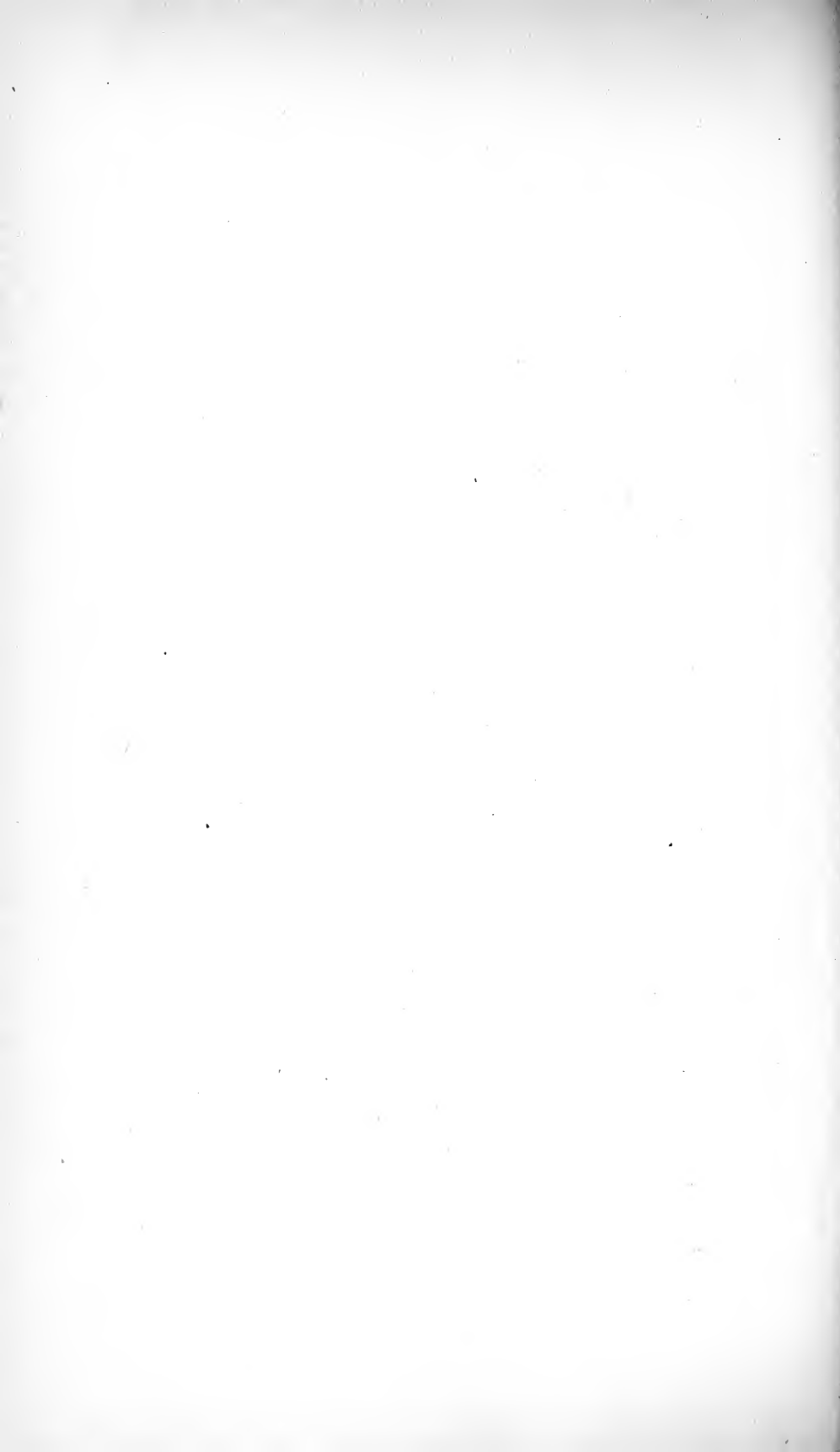

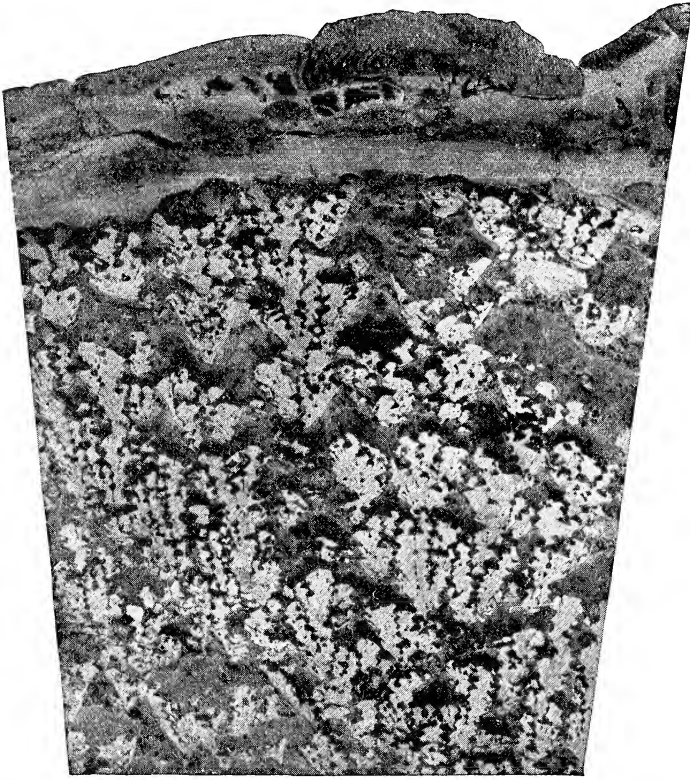

Fig. 1.

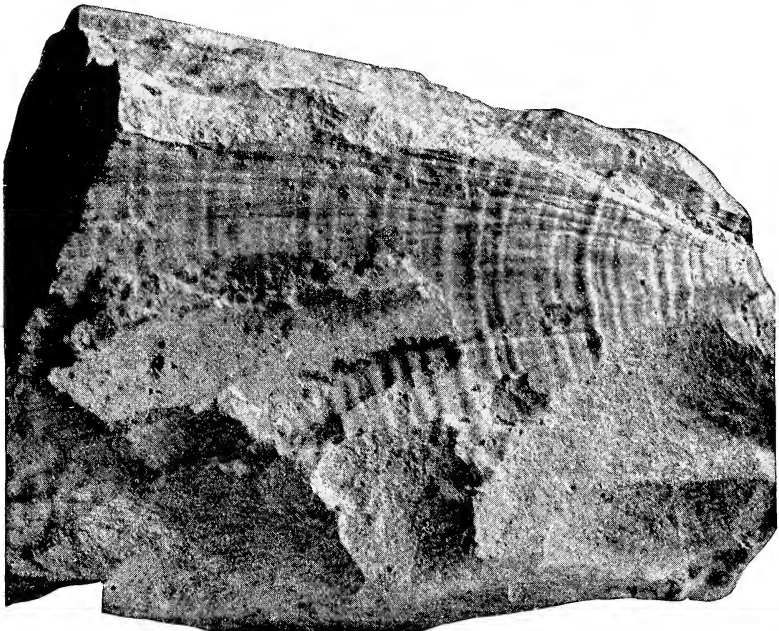

Fig. 2.

EXPLANATION OF PLATE 6.

FIGURE 1.—From a photograph; illustrates structure of the “compound” spherulites of Silver Cliff (p. 425), $\frac{4}{5}$ natural size, from section of a spherulite 3 feet in diameter. The white branching arms represent the earliest spherulitic development; they consist mainly of a dense bundle of feldspar fibers lying in a base of amorphous hydrated silica. The darker, mottled part between these arms consists of feldspar and quartz, the former in fibers more or less regularly oriented with reference to the earlier crystallization.

The outer zone consists of a dense microspherulitic band and of added spherulites of pronounced zonal structure, some of them being very distinct lithophysæ.

FIGURE 2.—From a photograph, $\frac{4}{5}$ natural size; illustrates features of a compound spherulite from Silver Cliff, described in detail on page 434.

SPHERULITIC CRYSTALLIZATION.

BY

JOSEPH PAXSON IDDINGS.

[Read before the Society, April 25, 1891.]

Having had occasion recently to study a new series of thin sections of the lithoidite of Obsidian Cliff, Yellowstone National Park, which were prepared for the educational series of rocks to be distributed by the U. S. Geological Survey, the writer has been led to review his previous work on the spherulites of the glassy and lithoidal rhyolite of this locality. The new thin sections present 26 examples of one phase of the rock, whereas the previous 50 or 60 thin sections represented its great variability, with more or less duplication.

In the new thin sections the microscopic spherulites attain a degree of crystallization that permits their structure in many cases to be clearly observed. The use of the quartz plate, giving the purple color (*teinte sensible*) between crossed nicols, for determining the relative values of the axes of elasticity throws additional light upon the character of these radially fibrous intergrowths.

The results of the recent study corroborate the conclusions already reached, and extend our knowledge of the subject by making it more definite. The investigation also adds to the list of primary minerals in this rock three not previously observed, one of which is rarely, if ever, found as a constituent of volcanic rocks, and its presence in this one is a further indication of the part played by mineralizing agents in the original crystallization of the rock. The minerals are tourmaline and mica, with an occasional zircon.

The general conclusion arrived at by the former study was summed up in an article published in 1887, and is briefly as follows: "It seems highly probable that the differences in consistency and in the phases of crystallization" (lithophysae, spherulites, and allied structures) "producing the lamination of this rock were directly due to the amount of vapors absorbed in various layers of the lava and to their mineralizing influence."*

The writer's conception of the action of an absorbed vapor, like that of water, upon the crystallization of a molten siliceous magma is derived from the following consideration. Since the water-vapor does not enter into the chemical composition of the resulting minerals in most cases, though it may affect the oxidation of the iron in some instances and lead to the formation of mica and hornblende,† its action is most probably physical rather than chemical; but in the case of other vapors, as fluorine, the action may also be chemical. The occurrence of a completely crystallized portion of magma, such as a spherulite, within a wholly glassy rock indicates that while the greater part of the molten magma cooled and consolidated so rapidly that it formed amorphous glass, a certain portion of it passed through different conditions, which permitted it to crystallize completely. It is evident from the nature of the case that any considerable mass of the magma within the body of the rock must have cooled at a uniform rate, and therefore the portions forming the spherulites must have cooled at the same rate as the magma immediately surrounding them, which solidified as glass. The crystallization of minerals in a molten magma requires a certain amount of molecular mobility within the fluid at the proper temperature—that is, between the point of fusion of the minerals developed

* Iddings (J. P.). The nature and origin of lithophysae and the lamination of acid lavas. *In Amer. Journ. Science.* 8°. New Haven, 1887, Jan. vol. 33, p. 45.

† Iddings (J. P.). The mineral composition and geological occurrence of certain igneous rocks, etc. *In Bulletin Phil. Soc. Washington.* 8°. 1890, Vol. XI., p. 209.

and the point of solidification of the magma. In the portion of the magma which solidified as glass the requisite mobility was wanting. In that which formed crystalline spherulites it must have been present. It is easily demonstrated that absorbed water-vapor makes molten glasses more fluid, and also lowers their melting point or point of solidification. Hence we may conclude that the influence of the absorbed water-vapor is to render the molecular mobility of the molten magma greater at a given temperature in proportion to the amount of hydration, thus permitting the crystalline arrangement of the molecules in places of greater hydration while the surrounding less hydrated portions are becoming too viscous.

In this connection the writer wishes to call attention to the speculations of Charles Darwin* on the lamination of volcanic rocks of the "trachytic series." After considering the different degrees of crystallization in the various layers of laminated obsidian and of what was then termed "trachyte," but which is mostly lithoidal rhyolite, and correlating them with the parallel layers of gas pores in pumice and obsidian, with a remark that "numerous facts, as in the case of geodes, and of cavities in silicified wood, in primary rocks, and in veins, show that crystallization is much favored by space," he concludes: "That, if in a mass of cooling volcanic rock, any cause produced in parallel planes a number of minute fissures or zones of less tension (which from the pent-up vapors would often be expanded into crenulated air-cavities), the crystallization of the constituent parts, and probably the formation of concretions, would be superinduced or much favored in such places, and thus a laminated structure of the kind we are here considering would be generated." As a possible cause for the production of parallel zones of less tension in volcanic rocks he cites Forbes' theory as to the lamination of glacier ice and suggests a possible parallelism between the two groups of phenomena.

* Darwin (Charles). *Geological observations, etc.* 8°. London, 1851, Part II (on volcanic islands), pp. 65-72.

The investigation of the spherulitic forms of crystallization already alluded to showed that there are two different kinds, one of which is compact and radially fibrous, the shape of the individual fibers not being determinable. The second kind is composed of jointed fibers, sometimes branching, made up of microscopic feldspar crystals; between these fibers are tridymite scales and often gas cavities.*

The compact and radially fibrous spherulites range in size from those which are a centimeter in diameter to microscopic ones, .05^{mm} in diameter. Between crossed nicols the larger ones exhibit numerous dark arms, a characteristic of the so-called pseudospherulites. The smallest ones exhibit a more or less well-defined dark cross, the arms of which alternately contract and spread, and split into branches near their ends when rotated, a characteristic of the so-called true spherulites when highly magnified. It was stated in the paper published in January, 1887, that "These spherulites have been traced through gradations of microstructure to groups of granophyre feldspars of extreme minuteness, which appear to be composed of intergrown quartz and acid feldspar, and enclose trichites and microlites which also occur in the spherulites, so that the mineral composition of the spherulites is most probably quartz, acid feldspar, and trichites of magnetite with augitic microlites. Chemical analyses of the spherulites and the obsidian in which they occur show that the two are identical, and that a spherulite is only a particular form of crystallization of the once molten glass." The evidence on which this conclusion was based has been described and illustrated with considerable detail in the article on Obsidian Cliff, in which the writer was led to conclude "that the spherulites are composed of feldspar and quartz that have crystallized from the molten glass at one and the same time and have intergrown with each other."

In his work entitled "British Petrography," published in

*Amer. Journ. Science. 8°. New Haven, 1887, Jan. vol. 33, pp. 36-37. Also fuller article by same author on Obsidian Cliff, Yellowstone National Park, in Seventh Annual Report of the U. S. Geological Survey. 8°. Washington, 1888, pp. 276-278.

1888, Mr. J. J. Harris Teall says, on page 402: "The spherulites in many of the acid rocks probably answer in composition to micropegmatite. * * * The present writer is inclined to regard these spherulites as due to the simultaneous crystallization of quartz and feldspar. * * * If this be correct, then the spherulites in question are simply special modifications of the pseudospherulites and micropegmatite." To which might have been appended a foot-note similar to that numbered (2) on page 338 of the same memoir. Brögger has expressed the same view in his great work on the minerals of the syenite-pegmatite dikes of Southern Norway.* He considers microfelsite a submicroscopic intergrowth of orthoclase and quartz, basing his argument on the optical and chemical characters of microfelsitic spherulites, and states that if one approaches the subject from a study of the pseudospherulites of granophyre the conviction is more quickly reached that microfelsite is the crystallitic equivalent of granophyric pseudospherulites; and it is not difficult to find all transitions between the two in the proper thin sections.

In the articles on Obsidian Cliff by the present writer the term microfelsite was not used, as there seemed to be no occasion for introducing this ambiguous term into the description of a rock whose manifold microstructures could be explained without it. The minutest spherulites appeared to be nothing more than very small forms of larger ones, whose structure and composition could be observed, and they were so considered.

It may seem that after the definite statements already quoted as to the transition of microspherulites to micropegmatite or granophyric intergrowths it would be unnecessary to pursue the subject further; but there remains sufficient uncertainty regarding the exact nature of these microscopic crystallizations to warrant a careful investigation of them

* Brögger (W. C.). Die Mineralien der Syenitpegmatit-gänge, etc., being *Zeitschrift für Kryst. u. Min. von P. Groth.* 8°. Bonn, 1890, vol. 16, pp. 552-553.

whenever the undertaking promises to furnish additional evidence of their mineralogical and crystallographic character. Such have been the grounds for recording the following observations:

The lithoidite from which the new thin sections were prepared is the same as that described in the papers on Obsidian Cliff already referred to. It forms the thinly laminated lithoidal portion of the obsidian flow a short distance north of the columnar glassy portion immediately on the road near the bridge. It is light, purplish gray, delicately banded by layers of different degrees of crystallization, the most highly crystalline being white, and the more or less glassy layers the darkest colored. It is filled with lithophysae of great beauty, which are very open and cavernous, the volume of the cavities frequently exceeding that of the solid portion of the lithophysae proper.

In thin sections the rock is irregularly banded or mottled according as the sections have been ground across or parallel to the layers of lamination. The most crystalline parts are colorless, the dark gray portions are mottled with minute spots, and with a low magnifying power these dark portions are seen to be minutely spherulitic, exhibiting characteristic black crosses. The transparent parts are quite crystalline aggregations of tridymite or quartz and feldspar, often with numerous irregular cavities between the crystals. Occasionally these places contain irregular grains of fayalite, and still more rarely brown mica, besides scattered spherulites, which also border these more crystalline portions.

The thin sections show a few of the larger spherulites which are porous, and in some places branching, arborescent or feather-like growths of feldspar—in fact, all of the modifications of spherulitic crystallization described in the paper on Obsidian Cliff.

Studied with higher magnifying power, it is seen that the finely spherulitic portions are crowded with trichites, which are more perfect as the spherulitic structure is more minute, but which lose their form and uniformly fluidal arrange-

ment when the spherulites are more developed, sometimes being crowded out toward the margin of the spherulites and aggregated in opaque lines between the spherulite individuals. The finely spherulitic parts of the rock-section also exhibit an extremely minute granulation by transmitted light and appear brown; but by incident light this granulated portion is white, evidently in consequence of the reflection of the light from innumerable small surfaces or cracks. In the small spherulites that lie isolated in and also bordering on the more crystalline portions of the rock the centers of the spherulites are granulated and brown while the margins are often colorless and transparent. In some cases the centers of the spherulites are colorless, and the brown color is confined to an outer zone. In such spherulites the fibers of the outer zone are more delicate than those of the central portion, showing a lower degree of crystallization.

These small spherulites when investigated with the quartz plate prove to be optically negative—that is, the axis of greatest elasticity, μ , lies approximately parallel to the direction of the radial fibers. This is also true of the most minute colorless spherulites which occur in the glass of the obsidian and are represented by fig. 1, Plate 7. In the lithoidite the spherulites have formed in juxtaposition, so that they adjoin one another with more or less polygonal boundaries. Occasionally there is a small space between several spherulites where the magma has crystallized differently. These spaces may attain a considerable size, relatively, or may constitute layers of the rock. The spherulites bordering such spaces frequently continue their crystallization a short distance into them, and exhibit distinct prismatic rays that project beyond the apparent periphery of the spherule, and resemble the teeth of a cog-wheel. Sometimes the projecting rays assume a comparatively great size. These forms are illustrated by figs. 3 and 5, Plate 7. In such cases the mineral character of the rays is clearly determinable. The projecting rays are prisms with parallel sides and crystallographic

terminations. They extend with uniform optical orientation toward the center of the spherulite. They exhibit in a few instances distinct cleavage parallel to the sides of the prism. The angle of extinction ranges from 0° to 10° or 12° , being usually low. The prisms are invariably optically negative, and are therefore orthoclase crystals elongated in the direction of the clinoaxis. The high limit of the extinction angles, as well as the chemical composition of the rock and the spherulites, since there is no evidence of the presence of more than one species of feldspar, indicates that the orthoclase is rich in soda, the molecular ratio of the potash to soda in the rock being 1 to 1.

There is a difference between the end of the projecting prisms of feldspar and the part of the ray within the spherulite. The former is transparent and clear, without inclusions; the part within the spherulite proper is clouded and granulated, as already stated. In some instances the granulation assumes a more definite character and has a radiating feather-like structure, which at once suggests the granophyric arrangement of quartz in feldspar. This is unquestionably its true character, although the quartz does not appear to affect the optical behavior of the feldspar rays.

An examination of the microscopic granophyre groups of feldspar and quartz which occur in the same thin sections and which have been described in the article on Obsidian Cliff (p. 274) shows the same optical characters and feather-like structure. Such an intergrowth is represented in fig. 2, Plate 7. It is made up of feldspar crystals, which cross one another at a common point, or which radiate from a common center. These feldspars invariably have the axis of greatest elasticity, α , approximately parallel to the direction of radiation. They have the same crystallographic orientation as the feldspar rays of the spherulites. The intergrown quartz does not alter perceptibly the optical orientation; therefore it must be either so oriented as to have its axis of greatest elasticity more or less coincident with that of the feldspar, or it is not present in sufficient amount to

influence the interference phenomena appreciably. The latter is most probably the case, for in a large granophyric group with the same structure, which was studied for comparison; it was observed that the quartz, though appearing to be present in considerable amount, was not sufficient to change the character of the double refraction of the feldspar, which was the predominant mineral. It modified it, however, to a variable extent; and in places where quartz was more abundant its optical character was predominant.

The small spherulites of this rock are unquestionably composed of orthoclase prisms or needles elongated in the direction of the clinoaxis, which radiate from a center and are intergrown with quartz after the manner of granophyre or micropegmatite; and it is this microscopic intergrowth which gives them the granulated or feather-like structure.

In the case of the spherulites with projecting rays of pure feldspar it is evident that the free silica ceased to crystallize as quartz in intimate connection with the orthoclase and allowed the latter to continue alone and project into a highly siliceous residual paste, which finally crystallized as tridymite in most instances.

In certain cases the zone of clear feldspar does not occur on the margin of the spherulite, but forms a crescent-shaped transparent belt within it, as shown in fig. 4, Plate 7. In ordinary light this belt appears to be a gaping circular crack, though its definition is lost at one end. Between crossed nicols it is found to consist of pure feldspar, oriented in accord with the radiating prisms, and producing no disturbance of the dark cross which passes regularly through it. At the lower end, fig. 4, it is seen to be part of the same crystallization as the purer feldspar rays of that part of the spherulite; and in the upper part it differs from the rest of the spherulite simply by being free from the granulated or micropegmatitic structure. There can be no doubt that it is a part of the original crystallization of the spherulite, and that from some cause the free silica ceased to crystallize for a short space and then continued in other portions of the spherulite. This is in har-

mony with the observation that the micropegmatitic structure and the other phases of crystallization in this part of the rock are irregularly scattered in patches, so that adjoining parts of adjacent spherulites are micropegmatitic, while other portions of them are free from this structure. Such crescent-shaped spaces in the spherulites of this rock have undoubtedly been produced at the time of the crystallization of the feldspar rays by conditions which affected the quantity or distribution of the free silica or of the mineralizing agencies engaged in its crystallization.

In parts of the rock the small feathery spherulites bordering an area of tridymite do not terminate in well-defined feldspar prisms, but pass out into irregularly shaped feldspars and send out acicular rays of extreme delicacy. These transparent needles also lie in various directions in the tridymite area. They have apparently the same double refraction as orthoclase, and have the axis of greatest elasticity, λ , parallel to their length. A transverse parting is slightly developed. Their mineralogical character cannot be made out with any degree of satisfaction from the smallest needles, but they can be traced to stouter ones which are undoubtedly orthoclase; so that there would seem to be no question that the delicate acicular rays of these spherulites are needles of orthoclase elongated parallel to the clinaxis. They are then the same as the stouter prismatic rays, but have probably developed an acicular form because of some slight difference in the conditions under which they crystallized.

The spaces between the spherulites already mentioned are in most instances occupied by tridymite in comparatively large crystals, often twinned and carrying numerous gas cavities. These patches may be completely filled with tridymite, or may be but partially filled, there being open spaces between the crystals which cross one another in all directions, and in extreme cases the tridymite may simply coat the walls of a hollow cavity. In most instances the area is completely occupied, when the free silica is sometimes in the form of quartz. There are always other minerals

present in variable amounts, including orthoclase, and magnetite, with less regularly tourmaline, mica, and fayalite. The fayalite occurs in relatively large irregular individuals, with an opaque border, which at times entirely replaces the original mineral.

The tourmaline and mica occur in minute crystals about .025^{mm} long and .01^{mm} thick. They are abundant in places and lie scattered through the tridymite or quartz and also in the margin of the bordering spherulites. They occur sometimes together, but usually one is present to the exclusion of the other. The tourmaline is recognized by its decided pleochroism, the strong absorption being across the prisms, $O > E$. Its color is brownish green; colorless parallel to E . The double refraction is strong and negative. Transverse sections exhibit a uniaxial cross and are bounded by six sides, alternately three short and three long. It also occurs in the tridymite coating the walls of the hollow cavities in some cases.

The mica is green and also yellowish brown to reddish. It forms stout tablets with six sides, and exhibits strong absorption, from colorless to almost opaque, which is of course in the opposite direction from that of the tourmaline, the axes of elasticity also in the long and narrow sections being reversed in the two minerals. The dark-green mica may be easily mistaken for the tourmaline.

The tourmaline and mica are idiomorphic and must have crystallized just before the outer portion of the small spherulites and the tridymite and quartz in which they lie. They are confined to the region of these interspherulitic spaces, and are not found scattered indiscriminately through the compactly spherulitic portion of the rock. Their period of crystallization is therefore later than that in which the small spherulites began to crystallize and earlier than the final crystallization of the residual magma or paste. Their separation from the magma was preceded by that of quartz and orthoclase, and was also followed by the same. Their crystallization in such a siliceous lava is abnormal, for they

are locally abundant in very small spaces within the body of the rock, and not along a contact face of it. The crystallization of the tourmaline at least involves the presence of a small amount of boron and fluorine within the magma before its final solidification; but they were probably present in extremely small amounts and only locally.

While the occurrence of the tourmaline like that of the fayalite may be referred to the category of "fumarole action," still this is only correct when the term is so defined as to include any mineralizing influence which heated vapors may have upon crystallization. It would thus include their primary action within fused magmas, as well as their secondary action on solidified ones. The effect of heated vapors which permeate the rocks in many places in the Yellowstone National Park is distinctly a destructive or metamorphosing process; and all such fumarole action is plainly secondary in the sense that it affects changes in the crystalline character of rocks already solidified. It would seem advisable, therefore, in order to avoid confusion, to use some other term for the primary mineralizing influence of absorbed vapors upon the crystallization of molten magmas.

The second kind of spherulites occurring in this rock, which were described in the paper on Obsidian Cliff under the head of *porous spherulites* (p. 278), are distinguished by being composed of more or less distinct rays of feldspar, which are generally branched, and a cementing material of tridymite, with numerous hollow spaces or gas cavities. The branching feldspars may also lie in an isotropic base, which appears to be glass. The arborescent feldspar growth may form a complete sphere or only a plume-shaped growth, or it may even resemble the stem and branches of a shrub. The optical investigation of these feldspar rays shows them in some cases to consist of many small stout prisms of feldspar grown together with their longer axes parallel and forming long crooked rods in the direction of this axis.

In thin section these rods or rays are partly positive and partly negative—that is, the axis of elasticity, which is

approximately parallel to their length, is sometimes less and sometimes greater than that at right angles to this direction. The prisms have a small extinction angle of variable size, and it is observed that the negative rays exhibit less double refraction than the positive ones and have a lower extinction angle. From these characters it is evident that the rays are prisms of orthoclase elongated parallel to the vertical axis, c , and that the plane of the optic axes is normal to the plane of symmetry. In spherulites of this sort the positive and negative rays are generally uniformly mixed throughout the whole. Such a spherulite sometimes has an outer zone or border of compact, finely fibrous structure, which is negative and is the same growth as the small granophyric spherulites. Tridymite is scattered through these spherulites, besides small grains of magnetite, and sometimes a few grains of fayalite and a little mica.

In other cases the branching rays are all positive. This indicates that the feldspar prisms have the same development—that is, parallel to the axis c —but that the plane of the optic axes is in the plane of symmetry, which is frequently observed to be the case in prisms of orthoclase which have crystallized independently in the tridymite in other parts of the rock.

The distinctly arborescent growths of feldspar in which the long slender rays branch off from a stouter stalk is shown in the figure on Plate 8. The prisms become thinner and more crowded together as they grow outward, and terminate in broad fronds like leaves. The stems are usually twinned throughout their length, as are also the fronds, which are sometimes found as isolated growths. These are twinned in the same manner, the composition plane dividing the crystal in two in the direction of its length. These twinned prisms of orthoclase are always negative, and the inclination to the twinning plane of the axis of greatest elasticity is about 7° or 8° . These characteristics could only be found in orthoclase prisms elongated parallel to the clinoaxis, a , and twinned according to the Manebach law, which is the

orientation already given for this form of feldspar in the article on Obsidian Cliff (p. 278).

In the large porous spherulites several forms of feldspar growths occur together. In one instance the center consists of an aggregation of partial spherulites of small size and positive character. This is surrounded by a narrow zone of cloudy material, but slightly doubly refracting, and with a positive character. Outside of this zone the porous portion of the spherulite begins. It is made up of nearly straight radiating fibers of feldspar, with weak double refraction, which are all positive. From points at various distances from the center of the whole spherulite, within these positive fibers, there start stouter fibers of feldspar with stronger double refraction and negative character. These branch out into radiating bunches, which unite to form the outer zone of the spherulite, where the fibers are partly negative and partly positive. In this outer zone it is observed, on closer inspection, that the negative feldspars form stems from which thinner positive feldspar fibers branch like the needles of a pine twig. These needles curve to a position parallel to the stem and to the radii of the sphere. All of the porous portion of the spherulite is thickly spotted with pellets of tridymite. The structure is very crudely represented by figs. 6 and 7, Plate 7, the actual structure being extremely complex, formed as it is by innumerable delicate crystals. The first porous zone of weakly refracting rays of feldspar, all of which are positive, must be composed of prisms elongated in the direction of the vertical axis, c , with the plane of the optic axes in the plane of symmetry. The branching groups of strongly refracting feldspars, which are all negative, must be prisms parallel to the clinoaxis, a ; they are twinned according to the Manebach law. In the outer zone these latter prisms send out thinner ones in the direction of the vertical axis, c , which are positive. These thinner needles branch forward from both sides of the twinned stem; consequently the crystallization of the twinned prism must have advanced out from the angle 2β made by the c -axes of the twinned halves of the crystal.

The synchronous growth of crystals of the same mineral with two distinct habits is a natural consequence of crystallographic branching as distinguished from that due to the splitting or cracking of microlites.* Its occurrence in this rock indicates how slight may be the difference in the conditions under which either form of crystal is induced. This accords with the fact that we find no fixed order in which positive and negative spherulitic growths have been developed. In the rock of Obsidian Cliff they alternate with each other, sometimes one having started first and sometimes the other.

THE ESSENTIAL CHARACTERISTICS OF SPHERULITIC GROWTHS.

In expressing what seems to the writer to constitute the essential nature of spherulitic crystallization, there will be no attempt made to suggest a cause for its initiation. It is simply a statement of conclusions which have probably forced themselves upon all who have made a careful study of these kinds of microstructures.

Just as the earliest definition of a crystal was confined to the outward form of the body, and rested upon its being bounded by plane surfaces, so the conception and derivation of the term spherulite rested on its spherical form. In both cases the definitions would not now be limited to a statement of the outward form of the bodies. It is, of course, understood that a spherulite differs from a crystal in being a complex intergrowth of minute crystals of one or more species. The essential character of the spherulite must be sought in the internal arrangement of this intergrowth; for we should not consider the essential character of the crystallization which produced a spherical body as having changed because in one instance the sphere had a smooth surface and in another a roughened one. In the latter case the composite crystals may have been larger. Nor is it necessary that a complete sphere should have been formed.

* Lehman (O.). *Molekular Physik*. 8°. Leipzig, 1888, p. 378.

It would require the same kind of growth to form the segment of a sphere. Furthermore, the character of the growth which would produce a sphere would not be altered by changing the curvature of the spherical surface from which it was advancing at any moment of its growth; consequently it is not essentially different when it proceeds from the surface of a sphere whose radius is infinity—that is, from a plane; or even when the sign of the radius is minus—that is, when the surface is concave. These conclusions are substantiated by the study of the various forms of growth associated with spherulites. It is therefore logically correct to embrace all manner of crystalline growths which have the same internal structure as crystalline spherulites under the general designation of *spherulitic growths or crystallizations*, whether their cross-sections be circular, elliptical, or in sectors, plume-like or irregularly excentric; or whether they appear as straight or curving bands.

The necessity of basing the general definition of spherulitic structures on some other character than their outward form is well illustrated by the microscopic spherulites of a typical spherulitic groundmass such as occurs in the rock under investigation. The absence of a spherical boundary to the majority of the spherulites and the frequency with which excentric and irregularly polygonal forms occur forces one to the conclusion that the fundamental characteristic of these typical spherulites must exist in their *mode of crystallization*. It is to be remarked that the proof of their being definitely crystallized bodies and not amorphous material under an internal strain, which might produce double refraction, lies in the fact that the dark crosses which show themselves between crossed nicols do not bear that relation to the shape of the excentric and polygonal spherulites which they should if they resulted from a contraction or irregular compression of globules which had assumed corresponding shapes. If the latter were the case they should behave like the dark hyperbolas of pearlite grains. The dark crosses retain their form with slight modifications corresponding to

those in larger crystalline spherulites, their arms shortening and lengthening out according to the distance of the boundary from the center of crystallization, which may be quite excentric.

We should therefore consider the essential characteristic of spherulitic growths to consist in the formation of *radiating* or *diverging groups of crystals*, which commenced to crystallize from one or more points. Thus it may be from a single center or from a number of different ones more or less distant from one another. The component crystals are usually prismatic and form delicate rays or fibers, with which may be associated other forms of minerals with or without definite orientation; but an arrangement of plate-like crystals or grains that are oriented with reference to a center of crystallization may also constitute a spherulitic growth.

A diverging fibrous crystallization which has started from innumerable points close together over a plane would produce a growth of fibers which would lie approximately parallel to one another. Such structures appear in thin section like bands or fringes of almost parallel fibers, and constitute a special form of spherulitic crystallization.

SUMMARY.

The chief facts brought out by this study may be stated as follows:

The occurrence of tourmaline as a primary constituent of the rock in small amounts and sporadically, with the similar occurrence of mica.

The compact granophyric spherulites are composed of prisms of orthoclase elongated in the direction of the clin-axis, which radiate from a center of crystallization. With the feldspar is quartz, intergrown as in granophyre or micropegmatite.

The branching growths of feldspar needles which form the rays of the porous spherulites, and which also occur alone, are formed of prisms of orthoclase, sometimes elongated par-

allel to the vertical axis, c , and sometimes parallel to the clin-axis, a . In the latter case they are generally twinned according to the Manebach law. In the former they exhibit, in some instances, the normal position of the optic axes and at others the abnormal position.

The crystallization of orthoclase prisms of these two types may take place at the same time or may follow one another alternately.

The essential characteristic of spherulitic growths is the crystallization of minerals from one or more points with a radiating or diverging arrangement.

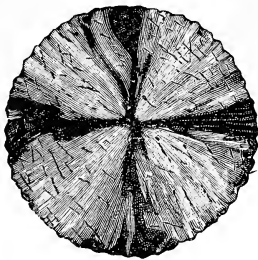

1

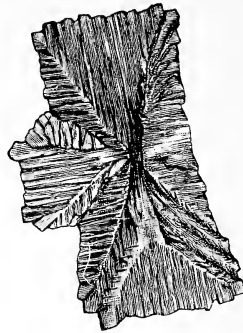

2

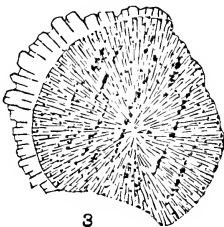

3

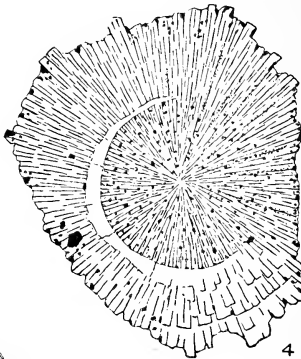

4



7

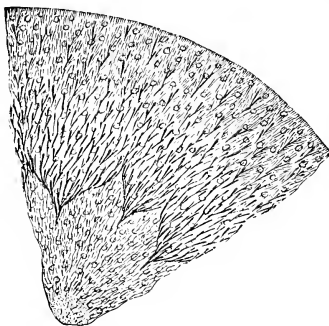

6

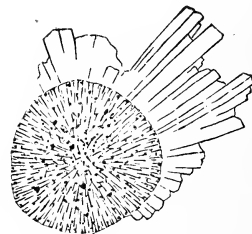

5

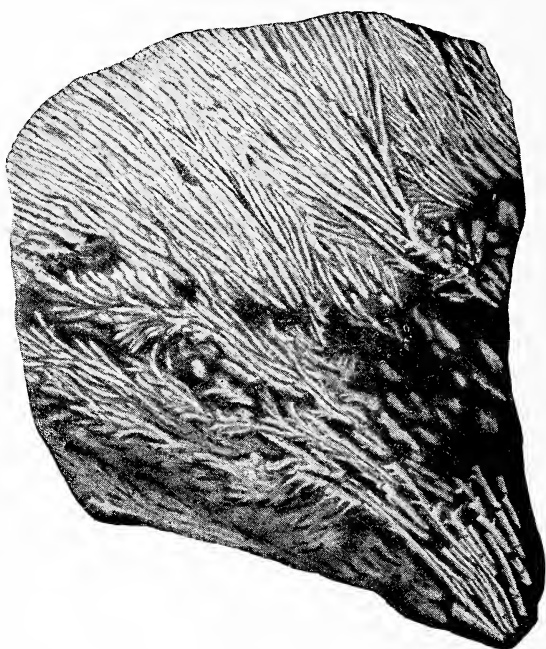

EXPLANATION OF PLATES.

PLATE 7.—*Sections of spherulites.*

FIGURE 1.—Colorless microscopic spherulite, showing irregular dark cross between crossed nicols, enlarged 153 diameters.

FIGURE 2.—Simple form of granophyre group of quartz and feldspar between crossed nicols, enlarged 235 diameters.

FIGURE 3.—Microscopic spherulite with projecting rays of orthoclase, enlarged 120 diameters.

FIGURE 4.—Like figure 3, with crescent-shaped area of pure feldspar substance, enlarged 130 diameters.

FIGURE 5.—The same as figure 3, enlarged 120 diameters.

FIGURE 6.—Portion of large spherulite, showing different forms of feldspar needles.

FIGURE 7.—Branching group of orthoclase needles occurring in the outer portion of the spherulite of figure 6.

PLATE 8.—*Branching crystals of orthoclase.*

Mannebach twins, enlarged 43 diameters.

OBITUARY NOTICES.

EMIL BESSELS.

EMIL BESSELS was born in Heidelberg, June 2, 1847. Educated at the University, and securing the degree of Doctor in Medicine, he was more disposed toward science and belles-lettres than to the practice of his profession. Being in easy circumstances, he was enabled to follow his natural bent, and for a time was a student in zoology under Van Beneden, and an assistant of Krauss at the Naturalien Cabinet or Royal Museum of Würtemberg, in Stuttgart. He became interested in Arctic discovery, and his first essay in that direction, under the encouragement of Petermann of Gotha, was the well-known voyage of 1869 into the sea between Spitzbergen and Nova Zembla. By his observations on this journey he traced the influence of the Gulf Stream water east of Spitzbergen, and added much to the scanty knowledge of this region then available. In 1870 he was called to the field as military surgeon, rendering service in the hospitals which brought him a public commendation from the Grand Duke of Baden. In 1871 he came to America, at Petermann's suggestion, to join Hall's polar expedition as naturalist and surgeon. Most of the scientific results of this voyage were the fruit of his personal efforts. After the rescue of the survivors he returned to America, where for some years he was busy at the Smithsonian Institution in preparing for publication the scientific results of the voyage, one of the most striking of which was the proof, first brought out by him, of the insularity of Greenland, which he deduced from the tidal observations secured on the expedition. In 1876 his work was printed in quarto, under the title of "Report on the Scientific Results of the Polaris

Expedition." Three years later he published, through Engelmann, at Leipzig, a German narrative of the expedition, illustrated largely from his own very artistic sketches. He projected a work on the Eskimo, to which he devoted much labor. An ethnological voyage, undertaken on the U. S. S. Saranac to the northwest coast of America, was prematurely terminated by the wreck of that vessel in Seymour narrows, British Columbia. He returned to Washington, where he prepared several contributions to arctic and zoological literature. Through an unfortunate fire at his residence he lost his library, manuscripts, and collections in 1885, and subsequently returned to Germany, where he settled, at Stuttgart. There he was engaged in literary pursuits, the study of art, and in geographical instruction. He died, after a short illness, March 30, 1888, and his remains were interred in the Friedhoff cemetery at Heidelberg.

Doctor Bessels was short and slight, of dark complexion, and highly nervous temperament. His brilliant, dark eyes, flowing hair, and aquiline nose gave him a striking and attractive physiognomy. Versatile, lively, and open-hearted to a fault, his social qualities inspired warm affection among his intimates, while his restless energy and undoubted ability secured for science results—valuable, if not profuse—which will serve to perpetuate his memory.

WM. H. DALL.

CHARLES OTIS BOUTELLE.

When the history of the United States in the nineteenth century comes to be written, as doubtless it will be written by some Bancroft or Adams one or two hundred years hence, it is not improbable that one of its most valuable chapters will relate to the influence that has been exerted upon the course of events by the scientific organizations that have been founded and fostered by this Government.

The life and work of a man who was for nearly half

a century an efficient and prominent officer of the oldest and one of the most important of these organizations must have had share enough in shaping the movement of affairs to warrant a memorial of him more complete than the necessarily brief one now presented and intended to form a part of the records of this Society.

CHARLES OTIS BOUTELLE was born in Lexington, Massachusetts, August 4, 1813. His grandfather was an officer who served honorably throughout the Revolutionary War. His father, a skillful physician and a man of brave and earnest temperament, was a surgeon in the navy during the war of 1812. His mother, a daughter of General Nathaniel Goodwin, of Plymouth, who served also during that war, was a woman loved and revered by all who knew her. She lived to nearly the age of one hundred, and her son never ceased to mourn her loss.

With such ancestry, many features of Mr. Boutelle's character can be traced to their source. Having while yet at an early age lost his father, he was educated by his uncle, the Reverend Ezra Shaw Goodwin, of Sandwich, Massachusetts, and received from him a thorough training in both the classics and mathematics. It soon became necessary for him to earn his own living; so he taught school, studied surveying, and one day, having heard that a friend who owned a work on that subject was willing to lend it to him, he walked twenty miles to get it. His skill in practical surveying soon became known, and a place was given to him on the survey of his native State by its director, Simeon Borden.

Having served creditably as Mr. Borden's chief assistant, he was appointed by Alexander Dallas Bache, Superintendent of the U. S. Coast Survey, to a position upon that work in January, 1844. His service was at first in the office, but his active temperament and robust physique demanded less sedentary occupation, and his special capabilities for the field were quickly recognized by his distinguished chief. His advancement was rapid. In 1846 he was made an as-

sistant in the Survey, and from that time forward gained steadily in standing on the work, being intrusted with the charge of important operations, which he conducted with his accustomed energy and with the professional skill and fertility of resource always at his command.

For some years he carried on the reconnoissance for the primary triangulation upon the coast of Maine. He made the reconnoissance and selection of sites for three primary base-lines, and had personal charge of the measurement of a primary base-line (the Atlanta base) in Georgia. This measurement was three times repeated as a test of accuracy, the line being measured twice in winter and once in summer, with an accordance of results so close that the greatest divergence did not exceed a millionth part of the whole length of nearly six miles. He conducted the primary triangulation which was carried from the Atlanta base northward and northwestward along the Blue Ridge to connect with the primary triangulation which was advancing southward and southwestward from the Kent Island base, and had charge of the surveys upon the coasts of South Carolina and Georgia.

During this period the bent of his mind was shown by the improvements he introduced into the methods and processes of the work; among these may be mentioned the form of preliminary base apparatus described in the Coast Survey Report for 1855; his form of tripod and scaffold observing signal, 1855; his experiments with lights for geodetic night signals, carried on for several years, and brought to a successful termination in 1880 by the adoption of the magnesium lights and the student-lamp reflectors.

In 1884 the charge of the Coast and Geodetic Survey office was assigned to him, and after his relief from that duty he was placed in immediate supervision of geodetic operations in the States which had organized their own geological and topographical surveys.

For a number of years he was a member of the board of commissioners for the improvement of the harbor of Norfolk.

On February 16, 1884, soon after taking up his residence in this city, he was elected a member of the Philosophical Society of Washington.

No notice of Mr. Boutelle's life would be complete that should omit reference to the important services which he rendered to his country at a critical period of its history. In common with the great majority of his brother officers assigned to duty with the military and naval forces, he participated in the hardships and dangers of the civil war. Soon after the outbreak of hostilities he was assigned to the command of the steamer *Vixen* and schooner *Arago*, as hydrographic officer of the South Atlantic squadron, serving under Admirals Dupont and Dahlgren, and Commodore Lanman, U. S. N. This duty lasted throughout the war, and it devolved upon him the responsibility for the safety of navigation of the squadron along its entire cruising ground. With what patriotic devotion and professional ability this service was rendered, the records of the civil war amply attest.

Admiral Dupont, in his report to the Navy Department of the capture of Port Royal, refers to the fact that all aids to navigation had been removed by order of the Confederate authorities and acknowledges the able assistance of Captain Boutelle in sounding out and buoying the channel, and thus enabling the squadron to advance to the attack.

General W. T. Sherman, U. S. Army, commanding the land expeditionary force, concludes a report, dated November 8, 1861, as follows:

"It is my duty to report the valuable services of Mr. Boutelle, assistant in the Coast Survey. * * * His services are invaluable to the army as well as to the navy, and I earnestly recommend that important notice be taken of this very able and scientific officer by the War Department."

Personally, Captain Boutelle (as he was known to his friends after the civil war) was a man of varied reading and a most retentive memory, genial and witty in conversation,

of uniform kindness of heart, and of a generous and hospitable nature, always assuming that others were guided by motives as unselfish as his own.

He combated manfully the advances of age and the inroads of disease, and it was not until the approach of his seventy-eighth year that, yielding to the solicitations of his family and friends, he sought relief from active duty. He died on the 22d of June, 1890, at the home of his son, Dr. Boutelle, in Hampton, Virginia.

EDWARD GOODFELLOW.

EZEKIEL BROWN ELLIOTT.

EZEKIEL BROWN ELLIOTT was born on July 16, 1823, in the village of Sweden, Monroe county, New York, and died of heart failure, on May 24, 1888, at Washington, D. C., after only a few hours' illness.

He was the second child of John Brown Elliott, M. D., and Joanna Balch. In his boyhood he attended the high school at Waterloo, N. Y., and the academy at Geneva, N. Y., and subsequently entered Hamilton College, whence he was graduated in 1844. Immediately upon graduation he engaged in teaching, first at Grand Rapids, Mich., and subsequently at Macedon, N. Y.; Lyons, N. Y.; Lubec, Me., and Eastport, Me. From the latter place he removed to Boston, Mass., in 1849, and there became an actuary and electrician. Late in the last-mentioned year he aided in opening the House printing telegraph line between New York and Boston and took charge of the Boston office, having previously spent a few weeks in Providence, R. I., where he made himself familiar with the necessary routine. Subsequently he and Mr. W. O. Lewis, of Hartford, Conn., became for a short time joint proprietors of the line, and still later they were joint superintendents. Finally he became superintendent of the Boston, Troy and Albany (House) printing

telegraph line. During these years he made several inventions, among which may be mentioned a white-flint telegraph insulator, for which he received a bronze medal from the Massachusetts Charitable Mechanics' Association in 1853. In 1854 he gave up telegraphy in order to undertake for the New England Mutual Life Insurance Company the preparation of tables of two-life survivorships, which comprised, when finished, about eighteen thousand logarithmic values, computed on the basis of the London actuaries' life table, at four per cent. Later on he was engaged in computing annuity, survivorship, and other tables, and in 1860 he prepared a set of official "instructions concerning the registration of births, marriages, and deaths in Massachusetts," the latter work being done under the direction of Hon. Oliver Warner, then secretary of the Commonwealth. While in Boston he united with the late Uriah A. Boyden and others in investigating the claims of spiritualism, hypnotism, etc., and, failing to find satisfactory evidence of the truth of these claims, he was ever after their emphatic opponent.

Upon the breaking out of the civil war in 1861 he came to Washington as actuary of the United States Sanitary Commission, and of his work relating to the first battle of Bull Run it has been said that probably "there is no instance in history in which the causes of the loss of any considerable battle have been so thoroughly sifted and examined on the spot, and within a week after the disaster, and in which the minutest details affecting the result have been so carefully preserved and their influence so accurately noted." Statistical work respecting the personnel and condition of the United States armies occupied him till 1863, when, as a delegate from the American Statistical Association, he attended the International Statistical Congress at Berlin. After the close of the congress he visited the German and Danish armies engaged in the Schleswig-Holstein war, which was then virtually over, and was afforded unusual opportunities for inspecting the hospitals and becoming

acquainted with the methods adopted in caring for the sick and wounded.

In 1865 he was made secretary to the commission, consisting of Messrs. Wells, Colwell, and Hays, for revising the United States revenue laws; and subsequently he continued in a similar relation with Mr. Wells when that gentleman became special commissioner of the revenue, in the office of the Secretary of the Treasury. After the expiration of Mr. Wells' official term, Mr. Elliott remained in the office of the Secretary of the Treasury until September, 1870, when he was made chief clerk of the U. S. Bureau of Statistics. He was transferred to the Bureau of the Mint about 1878, and in July, 1881, he was appointed to the newly created office of government actuary, which he held till his death. Notwithstanding the nominal changes in his official position, from 1867 to 1888 Mr. Elliott's duties were always substantially the same, namely, those of an actuary employed in the office of the Secretary of the Treasury, and as such he bore a large part in the operations connected with the refunding of the United States war debt. In addition to the offices already mentioned, he was appointed by General Grant, in June, 1871, a member of the first Civil Service Commission, which place he held until the close of the active operations of the commission, in March, 1875.

Mr. Elliott was elected a member both of the American Association for the Advancement of Science and of the American Statistical Association in 1856, of the American Academy of Arts and Sciences in 1857, of the British Association for the Advancement of Science in 1864, and subsequently of the American Horological Society. He was one of the founders of the Washington Philosophical Society in 1871, of the American Metrological Society in 1873, and of the Cosmos Club in 1878.

Both in the American Association for the Advancement of Science and in the Washington Philosophical Society Mr. Elliott was very prominent, contributing many papers to their proceedings; he was vice-president of the former

association and chairman of its economic section in 1882, and a member of the governing body of the Philosophical Society almost continuously from its foundation to the time of his death. The titles of his numerous papers may be found in the publications of the societies to which he belonged, in the documents both of the United States Sanitary Commission and of the Treasury Department, in the Report on the Ninth Census of the United States (1870), in Hunt's Merchants' Magazine, and in other places. It will suffice to mention here his paper "On the Military Statistics of the United States of America," which was read before the International Statistical Congress in Berlin in September, 1863, and in recognition of which he received a letter from the Crown Prince Frederick, afterward Emperor of Germany; and his "Tables of money, weights, and measures of the principal commercial countries of the world, with their equivalents as used in the United States and as known in the metric system," which was published in 1869 in Webster's Counting House Dictionary.

One of Mr. Elliott's most notable achievements was the discovery of a method by which the labor of computing life tables was enormously reduced. The mathematical theory of this method was communicated by him to the American Association for the Advancement of Science in August, 1866, but no abstract was furnished for publication, and probably the only accessible account of the method is that contained in his "Remarks upon the statistics of mortality," in volume 2 of the Ninth Census of the United States (June 1, 1870), pages ix to xvi.

In person Mr. Elliott was portly and slightly below the medium height. Although not a fluent speaker, his address was agreeable and his manner such as to indicate clearly the sturdy honesty and straightforwardness of his character. To these sterling qualities he united a kindliness of disposition and a keen sense of honor, which gave him a high place in the estimation of all who knew him.

WILLIAM HARKNESS.

THOMAS HAMPSON.

THOMAS HAMPSON was born in New York city in 1849. His early life was passed in the town of Newberg, N. Y., where he adopted the avocation of a printer. Having prepared himself by study after his day's work was done, he entered Cornell College in 1869. Notwithstanding that he had to provide his own maintenance and, in addition, to keep up with his studies, he took a high position in his class. To relieve the heavy tax upon his strength and by the advice of President White, always his warm friend, he left college in the third year of his course to accept a position in the Government Printing Office at Washington. In 1874 he was graduated from Cornell and returned to Washington to resume his place. His marked ability in this position becoming known, in 1875 he was offered and accepted a clerkship in the Bureau of Education, with the duties of editor of its publications. In 1882 he entered the Law Department of Georgetown University, where he was graduated as Bachelor of Laws in 1884. In 1885 he left the Bureau of Education to accept a similar position, though with enlarged duties, in the United States Geological Survey, where he remained until his death, which occurred April 23, 1888.

In addition to being a member of this Society, he belonged to the Cosmos Club and to the Anthropological Society of Washington. A few months before his death, in connection with the last-named society, he became one of the editors of the "American Anthropologist."

Mr. Hampson belonged to the Philosophical Society, not because he cultivated a special branch of science in which his word was authority, but because he possessed a broad education and an enlightened culture which was in full harmony and sympathy with its spirit and aims. Strictly speaking, Mr. Hampson was not a scientific man. He neither professed nor coveted the title of scientist. Naturally of a

bright and receptive mind, education served to store it with a rich harvest of facts and well-digested opinions. During recent years he was brought daily into close personal and professional intimacy with scientific specialists, and as editor of the publications of a large and important scientific bureau annually producing many volumes, the product of scholarly minds, it was requisite that he should possess a general and comprehensive knowledge of the subjects treated as well as a thorough literary ability. How well equipped he was for his work and how complete his mastery of its details is best known to the men whose privilege it was to consult him daily and who had learned to welcome his advice and criticism.

It was in the exercise of his daily functions as a critic that the kindness of Hampson's nature was most apparent. Criticism of an author's work is at best but a thankless task and only too apt to hurt pride and arouse opposition. Hampson's ready tact and generous sympathy robbed criticism of its sting without in the least blunting its force or weakening its effect.

While not himself a producer of scientific works, Mr. Hampson's death was a distinct loss to science, most deeply felt by those who received his criticism and suggestions in the line of his duty.

Mr. Hampson was of fair complexion, medium height, and of robust frame. His eyes were bright and sparkling, the expression of his face singularly frank and pleasing, and his manner and address such as to inspire immediate confidence. His kindness of heart and genial disposition were constantly bubbling over in open mirth, and perhaps his most marked characteristic was a certain enthusiasm and boyishness of manner which was peculiarly attractive.

H. W. HENSHAW.

FERDINAND VANDIVEER HAYDEN.

FERDINAND VANDIVEER HAYDEN, who died in Philadelphia December 22, 1887, in his 59th year, was the tenth name among those appended to the call asking Prof. Joseph Henry to preside at the meeting on March 13, 1871, for the formation of the Philosophical Society of Washington. He was not only one of the founders of the Society, but had previously been a member of the Saturday Night Club, from which the Philosophical Society was evolved.

He was born at Westfield, Mass., September 7, 1829. He was the son of Asa Hayden and Melinda Hawley, the latter of Middletown, Conn. Both of his grandfathers were in the Continental Army during the Revolutionary War, and both fought at Bunker Hill. His father died when he was about ten years of age, and about two years later he went to live with an uncle at Rochester, in Lorain county, Ohio, where he remained for six years. He taught in the country district schools of the neighborhood during his sixteenth and seventeenth years, and at the age of eighteen went to Oberlin College, where he was graduated in 1850. The united testimony of those members of his class who survive him is that he was shy and modest in demeanor, of an excitable temperament, frank and unconcealing, with an intense and self-absorbed air; enthusiastic and persistent in whatever he undertook, a good student, well read in general literature, and particularly fond of poetry. The subject of his graduating address was, "The Benefits of a Refined Taste."

He studied medicine with Dr. J. S. Newberry, at Cleveland, and at Albany was graduated Doctor of Medicine in the early part of 1853. After his graduation he was sent by Prof. James Hall, of New York, to the Bad Lands of White river, in Dakota. The years 1854 and 1855 he spent exploring and collecting fossils in the upper Missouri country, mainly at his own expense. From 1856 until 1859 he was connected as geologist with the expeditions of Lieuten-

ant Warren, engaged in explorations in Nebraska and Dakota. From 1859 until 1862 he was surgeon, naturalist, and geologist with Capt. W. F. Reynolds, in the exploration of the Yellowstone and Missouri rivers. In October, 1862, he was appointed acting assistant surgeon of volunteers, and was connected with the army as assistant surgeon and assistant medical inspector until June, 1865, when he resigned, and was brevetted lieutenant colonel for meritorious services during the war. He then resumed his scientific work, and in 1866 made another trip to the Bad Lands of Dakota, this time in the interest of the Academy of Natural Sciences of Philadelphia. In 1865 he was elected professor of mineralogy and geology in the University of Pennsylvania, which position he resigned in 1872. From 1867 to 1879 his history is that of the organization of which he had charge, which began as a geological survey of Nebraska and became finally the Geological Survey of the Territories. In the winter of 1871-'72 he succeeded in having the Yellowstone National Park made a Government reservation, the bill setting it apart having been chiefly written by himself. From 1879 until December, 1886, he was connected with the United States Geological Survey as geologist. His health began to fail soon after his connection with this organization, and gradually became worse, and he lived only a year after his resignation.

In 1876 the degree of LL. D. was conferred upon him by the University of Rochester, and in June, 1886, he received the same degree from the University of Pennsylvania. He was a member of seventeen scientific societies in the United States, among them the National Academy of Sciences, and was honorary and corresponding member of some seventy foreign societies. A bibliography of his writings includes 158 titles.

Dr. Hayden was one of the pioneers in the geological investigations of the West, among whom, as the Director of the Geological Survey of Great Britain has said, his name will always hold a high and honored place. He made the

first complete sections of the cretaceous and tertiary formations of the West, and the names he applied to them have long been known and widely used. He was the first to demonstrate the fact that the Rocky mountains and adjacent regions were covered during tertiary times with fresh-water lakes, and he also recognized as long ago as 1862 the fact that the elevation of the Rocky mountains began in Laramie times, and continued throughout the tertiary period, and is still going on at the present time.

The gentleness and diffidence, approaching even timidity, which impressed his fellow students at Oberlin characterized Dr. Hayden throughout his life, and rendered it somewhat difficult for those who did not know him intimately to understand the reasons for his success, which was undoubtedly due to his energy and perseverance, qualities which were equally characteristic of him as a boy and student and in later life. His desire to forward the cause of science was sincere and enthusiastic, and he was always ready to modify his views upon the presentation of evidence. He was intensely nervous, frequently impulsive, but ever generous, and his honesty and integrity undoubted. The greater part of his work for the Government and for science was a labor of love.

A. C. PEALE.

ROLAND DUER IRVING.

ROLAND DUER IRVING was born in New York city April 29, 1847, and died at Madison, Wis., May 30, 1888.

His father was Rev. Pierre P. Irving, nephew of Washington Irving, and a clergyman of the Episcopal church. His mother was a daughter of Judge Duer, an eminent lawyer, and at one time chief justice of the supreme court of the city of New York.

In 1849 Dr. Irving removed his residence to New Brighton, Staten Island, where he was rector of Christ church.

Young Roland there passed his boyhood days, and in his rambles over the island first exhibited a taste for geological studies. His education was conducted by his father and his sisters until his twelfth year, when he attended a classical school near his home. In 1863 he entered the freshman class at Columbia College, but owing to a disorder of the eyes he was obliged to suspend his studies during his sophomore year. Six months of this enforced interval of rest was passed in England. Returning in 1866, he resumed his studies and was graduated as a mining engineer from the School of Mines in 1869, and as a master of arts from the collegiate department of Columbia College in 1870. Ten years later the same institution conferred upon him the degree of Doctor of Philosophy.

While a student at the School of Mines he was engaged during the summer of 1867 as an assistant engineer in the Lykens Valley colliery, Pa., and during the following summer as assistant geologist on the Geological Survey of Ohio.

Soon after his graduation he accepted the position of metallurgist in the Gold Smelting Works of Greenville, N. J., where he was employed until the summer of 1870, when he was called to the chair of geology, mining, and metallurgy—changed to the chair of geology and mineralogy in 1880—in the University of Wisconsin, a position which he held until his death.

He was assistant State geologist of Wisconsin between the years 1873 and 1879, and expert special agent of the 10th Census, in charge of explorations on Lake Superior in 1880 and 1881. For several years he was president of the Wisconsin Academy of Sciences.

In 1882 he became connected with the United States Geological Survey and assumed the direction of the Lake Superior division, a position which occupied a large share of his time and thought until his death. His reports in this capacity are among his most enduring contributions to science.

On August 8, 1872, Professor Irving was married to Abby

McCullough, daughter of John McCullough, of Glencoe, Maryland.

Professor Irving's work as a teacher and as an investigator were carried on side by side with equal success in each direction. His ability as a teacher has been highly commended both by his colleagues in the University of Wisconsin and by the students who received the benefits of his instruction. The results of his geological investigations are known to all who are interested in the earth's history, and have been a credit to himself, to the Geological Survey, and to American science.

Professor Irving became a member of this Society in 1886, but owing to the distance of his residence he was seldom able to attend its meetings. In March, 1886, he read an important paper on "The Enlargement of Mineral Fragments as a Factor in Rock Alteration," the only scientific communication that he made to the Society.

JEROME HENRY KIDDER.

JEROME HENRY KIDDER, whose untimely death has deprived this Society of one of its most active and respected members, was born October 26, 1842, in Baltimore county, Maryland, and there his boyhood days were spent. Entering Harvard College as a freshman at the age of sixteen years, he was graduated Bachelor of Arts in 1862, and shortly after, having tendered his services for the war, he was placed by General Saxton in charge of the Sea Island plantations, near Beaufort, S. C. There contracting yellow fever, he was obliged to return north early in 1863, but, upon recovery, he enlisted in the Tenth Maryland infantry, in which regiment he served as private and non-commissioned officer for about a year. He was then appointed a medical cadet, and in that capacity was employed in the hospitals near the capital until after the war had closed. The study of medi-

cine, begun at that time, was continued in Baltimore, and in 1866 he received the degree of Doctor of Medicine from the University of Maryland. The degree of Master of Arts, in regular course, was also conferred upon him by Harvard College in 1865.

On June 18, 1866, a few months after completing his medical education, Dr. Kidder was commissioned an assistant surgeon in the United States Navy, in which he served for eighteen years with much distinction. He was promoted to passed assistant surgeon April 5, 1871, and to surgeon May 19, 1876, and resigned his commission June 18, 1884.

His first detail was to the Naval Asylum at Philadelphia, where he remained a little over a year. From 1867 to 1870 he was attached as assistant medical officer to the United States ship *Idaho*, then stationed off Nagasaki, Japan, as the general hospital for the Asiatic squadron. While on this station he received from the King of Portugal the decoration of the Military Order of Christ, in recognition of gracious professional services to a distressed vessel of His Majesty's navy; and during the memorable typhoon of September 21, 1868, he displayed his faculty for accurate observation by making a careful plotting of the storm's track. In 1874 and 1875 he served, in connection with the United States steamer *Swatara*, as surgeon and naturalist of the Transit of Venus expedition to Kerguelen island, and in 1877 and 1878 as surgeon of the United States steamer *Alliance* in the Mediterranean. On the latter cruise he was married, at Constantinople, September 18, 1878, to Anne Mary, daughter of the Honorable Horace Maynard, Minister of the United States to Turkey. During the summers of 1875 and 1879 he was assigned to special duty with the small naval steamers *Bluelight* and *Speedwell*, engaged in fishery investigations on the New England coast, and in December, 1882, became the first surgeon of the Fish Commission steamer *Albatross*, on which he remained until the following April. His shore service was performed mainly at the Naval Hospital and

Laboratory, Brooklyn, from 1871 to 1874, and at the Bureau of Medicine and Surgery, Washington, from 1879 to 1882.

Dr. Kidder was recognized as one of the most accomplished and efficient surgeons in his corps, and his frank and genial disposition gained him hosts of friends. The advantages of the naval laboratory at Brooklyn, where he served as an assistant from 1871 to 1874, probably led to the chemical and physical inquiries which afterward became his favorite studies, and in all probability they determined the character of his principal future work. The Brooklyn laboratory was then the only one under the Navy Department equipped for general chemical investigations, and it was also the naval depot for medical supplies. In addition to the customary analyses of drugs, Dr. Kidder was assigned many special problems, and while at this place he also prepared a chemical test case and manual of instructions for the use of medical officers on board ship, which, slightly modified, is still issued to naval vessels.

It was from Brooklyn that Dr. Kidder was ordered to join the scientific party sent out by the United States Government to observe the transit of Venus at Kerguelen island in 1874. Four months were spent in the desolate and inclement spot selected for the station, and during that period Dr. Kidder was indefatigable in his study of the natural history, geology and climatology of the island. No group of animals or plants was neglected, and notwithstanding the comparative scantiness of the field, his labors were well rewarded. After his return to Washington he remained about a year at the Smithsonian Institution studying, with the coöperation of several specialists, the material which he had obtained. The results were published by the National Museum in two bulletins—one descriptive of the birds, the other covering the remaining subjects, with a special monograph on *Chionis minor*, which has been regarded as his most valuable contribution to zoology. The outcome of this single expedition was sufficient to demonstrate Dr. Kidder's ability and fitness as a naturalist, and

to prove that he might readily have attained eminence in that pursuit had he chosen it as a profession. Appreciating the importance of observing every detail which could elucidate the habits or distribution of a species, his descriptions are replete with interesting notes, which add greatly to their value, and he was equally successful in discussing structure and relations.

This brief sojourn at the Smithsonian Institution was fruitful in many ways, and the relations then established with Professor Baird, soon ripening into a warm and lasting friendship, were instrumental in finally severing his connection with the navy. In fact, a career in natural history seems at that time to have been seriously considered by him, if we may judge from the elaborate plans prepared for an expedition to the Antarctic regions, under the auspices of the Institution, which was to have been in his charge. Circumstances, however, delayed the execution of this project, and it was finally abandoned.

The first published record indicating Dr. Kidder's interest in hygiene is contained in his report as surgeon of the steamer *Alliance* during 1878. This paper states in forcible terms the requirements for a healthy ship, and closes with a "Memorandum of a partial examination of the impurities of the air on board the *Alliance*," and contains also a description of the apparatus improvised for the occasion. The simplicity of these methods of obtaining condensed moisture and of securing the impurities of the air on small glass slips and watch-crystals led the author to suggest the propriety of supplying similar outfits, with some additional appliances, to all naval vessels—a recommendation which was soon adopted and carried out.

In 1879 there was started in Washington, under the charge of Dr. Kidder, a small naval laboratory, consisting in the beginning of only a single room, and intended primarily for the special examinations which he had recently proposed. The limited amount of money available for the purpose made it necessary to resort to very crude appliances, but in

no way checked the ardor with which the work was carried on. Under the liberal and energetic policy of Surgeon General Wales, by whom the laboratory had been founded, the facilities for study were rapidly increased, larger appropriations were obtained, and in the course of two or three years the young establishment was converted into the Museum of Hygiene, as it is known to-day. The principal investigations conducted by Dr. Kidder during his three years' assignment to this duty consisted in the chemical and microscopical analysis of the air with respect to the amount and character of the influences exerted in the production of disease by its organic and inorganic impurities, while among his other duties were the examination of pathological specimens and the consolidation of meteorological reports derived from naval sources.

The zeal and earnestness displayed in all this work, his untiring devotion to the cause of hygiene, and, above all, his strength and breadth of mind, especially fitted him for leadership in this important movement, with which he would undoubtedly have continued to be identified under more stable conditions of environment. His several reports upon this subject indicate most careful and painstaking observations, and exhibit marked success in the development of ingenious though, for the most part, exceedingly simple methods of experiment.

His earlier inquiries in hygiene had reference mainly to the surroundings of the laboratory, but prior to his detachment he was detailed to assist in two special investigations.

The first and more important of these was an inquiry into the cause of the recurrent epidemic of yellow fever on board the United States Steamship Plymouth, in conjunction with Medical Inspector Dean and Naval Constructor Wilson, and was executed in 1880. The report submitted by this board was published in the report of the Surgeon General of the Navy for 1880. The following year Dr. Kidder, with Medical Director Browne and Passed Assistant Surgeon Griffiths, examined with unusual care the sanitary

condition of the proposed site for the new naval observatory at Washington, and upon their favorable decision depended in great part the acceptance of the property. While on this duty Dr. Kidder also suggested several changes in the American naval rations, based upon a study of their physiological value. Subsequent to his resignation from the navy, he was called upon to investigate the purity of the air in the Hall of Representatives at the Capitol and its approaches, and in the lecture hall of the National Museum, in both instances securing practical results of great benefit.

As before mentioned, Dr. Kidder was on special service with the United States Fish Commission during the summers of 1875 and 1879, and in the latter year he made an interesting series of experiments on the animal heat of fishes. He was detailed to the Albatross in 1882 as a naval surgeon, but after holding that position for only a few months his active connection with the navy ceased, and he was appointed a civilian assistant on the Fish Commission. This change was determined mainly by the recent death of his father, of whose estate he was an administrator, and by his desire for occupation that would retain him near his family. His specific duties were those of physicist and chemist, but as the trusted adviser of Professor Baird, who had the highest regard for his ability and judgment, he contributed in many ways to the general welfare of the Commission. In the building of the marine station at Wood's Holl, Mass., begun in 1883, he took a deep personal interest, placing at the service of Professor Baird an adjoining piece of land which he had acquired for that purpose. A physical laboratory, suitably equipped for fishery investigations, was established at that place, and another of the same character in the Smithsonian Institution at Washington, Dr. Kidder's time being divided between the two. His work related chiefly to water temperatures, densities, and analyses, to the purchase and testing of all physical apparatus, to experiments upon the preservation of fresh fish, and to such other kindred subjects as came within the province of the Fish Commission. His unwillingness to publish

until the volume of results would seem to warrant their being placed before the public has left us with only a few printed records of his fishery studies, but it is due to him to state that the high perfection attained in the methods of physical research employed by the Commission has resulted largely from his intelligent supervision.

In the autumn of 1887, upon the death of Professor Baird and the appointment of Dr. G. Brown Goode as Commissioner of Fish and Fisheries, Dr. Kidder became the Assistant Commissioner, for which position he was well qualified by his administrative ability and his intimate acquaintance with the affairs of the Commission. Resigning that office, however, early in the following year, he was appointed, in March, 1888, Curator of Laboratory and Exchanges in the Smithsonian Institution, which post he held until his death, rendering most efficient service and becoming greatly endeared to his associates. His surroundings were, moreover, entirely suited to his tastes, and his future seemed full of promise, with the prospect of again returning to the study of many early problems which his frequent change of duty had interrupted but not banished from his mind. His attachment for the Smithsonian Institution and appreciation of its objects were manifested in his will, by which the sum of \$5,000 was bequeathed for the promotion of physical research.

Dr. Kidder was a contributor to the National Medical Dictionary, compiled under the editorial supervision of Dr. John S. Billings, United States Army. His principal scientific papers have appeared as follows: Those relating to sanitary and kindred subjects, in the reports of the Surgeon General of the Navy from 1879 to 1882, the Proceedings of the Naval Medical Society for 1884, the reports of the Forty-eighth Congress, and the report of the Smithsonian Institution for 1884; on the natural history of Kerguelen island, in Bulletins Nos. 2 and 3 of the National Museum, published in 1875 and 1876; on fishery matters, in the reports and bulletins of the Fish Commission subsequent to 1883, and on chemistry and physics, in the publications of various scientific societies.

In the social, scientific, and literary circles of Washington, Dr. Kidder was especially prominent and influential, having been a member of the Cosmos, Metropolitan, Harvard, and Rover Clubs, and of the Philosophical, Biological, and Chemical Societies. He joined the Philosophical Society in 1880, was one of its secretaries in 1887, and a member of the general council during 1888 and 1889. He was faithful in attendance at the meetings of the Society and active in the promotion of its interests, contributing papers on deep-sea temperature observations and on the gilding of thermometer bulbs. A founder in both the Biological and Chemical Societies, he took a prominent part in their proceedings, and was an officer in each, having served as president of the latter in 1888. He had been a companion for over twenty years of the New York Commandery of the Military Order of the Loyal Legion, and was also a zealous member of the Masonic fraternity.

Dr. Kidder was an able writer and a fluent speaker, using clear and vigorous language, and always presenting his subject in a simple and attractive manner. While not entirely at home before a formal audience, he was ready, even brilliant, in conversation, and among the "Rovers," a few well-chosen friends, whose meetings were given over to the familiar discussion of interesting topics, he never failed to take a leading part. His proficiency in writing was gained, to some extent, from an early experience with the New York journals, to which he contributed on literary and other matters during a number of years. He was an accomplished linguist, and being passionately fond of books, a choice collection that had been left to him was made the nucleus of a large and valuable library. His residence in Washington also bore evidences of his taste in art and of the opportunities in that direction afforded by his distant travel.

His final illness was of short duration and scarcely known beyond his household. In perfect health, he was stricken with pneumonia on a Friday and died on the following Monday, the 8th of April, 1889, in his forty-seventh year.

In their sad bereavement the devoted wife and children had the heartfelt sympathy of every one to whom his name had become familiar, whether through personal contact or through a knowledge of his good works and sterling qualities. His loss was widely felt and his place will long be vacant.

RICHARD RATHBUN.

EDWARD BROWN LEFAVOUR.

EDWARD BROWN LEFAVOUR, eldest son of Issachar and Lydia A. Lefavour, was born in Beverly, Mass., November 25, 1854. His whole course as a student was a brilliant one. Entering the high school of his native town at the age of twelve, he graduated in his fifteenth year, in June, 1870, with the rank of valedictorian of his class. After pursuing an advanced course for one more year at Beverly, he went to Salem and spent a year in its high school, from which he was graduated, at the head of his class, in 1872.

Thus prepared, he entered Harvard College in 1872, at about the beginning of his eighteenth year, taking the course in mathematics and physics, and in 1876 again graduated at the head of his class, this rank being determined by the record of his four years of undergraduate work. He took honors in both physics and philosophy, a thing of rare occurrence, and received an oration at commencement, having previously taken honors in mathematics in his junior and in classics in his sophomore year. He was also during his junior year elected to membership in the Harvard chapter of the Phi Beta Kappa Society.

After graduation he returned to Cambridge and spent a year in post-graduate work and as tutor at the university.

From September, 1877, to near the end of January, 1878, he served as a substitute teacher in the Jamaica Plain high school, during the illness of the principal, and the following April accepted the position of principal of the high school at Holbrook, Mass., a position which he filled till July, 1880.

At the close of the summer vacation of 1880 he came again to the university as special student and private tutor, but only for a brief interval. In January, 1881, he came to Washington and entered the Bureau of Weights and Measures, in the office of the Coast and Geodetic Survey. In this work as verifier of weights and measures, for which his talent and training so well fitted him, he remained nearly five years, resigning his place December 1, 1885. It was during this interval that he became known to and a member of the Philosophical Society, which he joined December 16, 1882. An occasional participant in the discussions in the Society, his chief activity was, however, manifested in the mathematical section, in the work of which he was more especially interested. While employed in the Bureau of Weights and Measures he also undertook, beginning June 1, 1883, the measurement of the star photographs made by Dr. B. A. Gould at the Argentine National Observatory, at Cordoba, South America. This work he continued to prosecute after leaving the Weights and Measures Bureau, and brought it to a successful conclusion a few months before his death. For facilitating these measures he devised and had partially completed an instrument, which his sudden death has left incomplete.

After leaving Washington he returned to Cambridge, and continued his work upon the star photographs of Dr. Gould. At the same time he entered the Theological Department of Boston University with a view to entering the ministry, for which he had always evinced a strong liking. For some time it had been his wish and his purpose to enter the Andover Theological Seminary. Indeed, for a number of years he had been privately pursuing his theological studies in connection with his other work. In 1887, after pursuing theological studies for a year in Boston University, he appears to have finally decided the question as to whether theology or science should be his vocation by giving up his theological studies and devoting his energies to scientific work. He became a member of the Mathematical and Phys-

ical Society of Cambridge, and in October, 1888, he was made an assistant in physics in Harvard College, which position he held to the date of his death.

In May, 1889, he was attacked by rheumatic fever, which rapidly developed into typhoid, from which he died on May 18, 1889.

Never physically strong, he succumbed to an illness which a more robust constitution might easily have withstood.

Through training and inheritance he was of a strongly religious temperament. He was always an active worker in the church, and in the Sunday school he acted both as teacher and superintendent. With this strong tendency towards both science and religion, the question of his vocation was long an open one, and it was not until his thirty-second year that the question appears to have been finally decided in favor of science.

Without being shy, he was reserved in his manner, and appeared formal to those not intimately acquainted with him. To his intimate friends, however, he was a most genial and instructive companion.

His logic was keen and his conclusions came faultlessly from the assumptions based on his philosophy and religion. He was a thinker rather than an actor, and his thinking a compound of clear, cold, mathematical reasoning conjoined with metaphysical speculation.

In person he was of medium or slightly less than medium height, neither spare nor stout. He had a clear, hazel eye, and his black, curly hair heightened the whiteness of a clean-shaven face, suggestive of the churchman. A slightly bent form, and the head thrown forward, showed the man of thought rather than the man of action. Most faithful and diligent in all he undertook, exceedingly conscientious, kindly and considerate to all, he had no enemies, and his friends were only limited by the number of his acquaintances.

MARCUS BAKER.

PETER PARKER.

PETER PARKER, who had attained some distinction in the two different professions of divinity and medicine, was one of the original founders of the Philosophical Society of Washington, in 1871. He was born in Framingham, Mass., June 18, 1804. He was educated at Yale College, where he was graduated in 1831; and he was a graduate of the medical department in 1834. He was at the same time a student in theology, and a few years later was ordained and sent to China as a missionary by the American Board of Foreign Missions. He made a diligent study of the Chinese language, and established at Canton a hospital for the treatment of diseases of the eye, which he found to be quite frequent in that city. Other classes of disease were soon admitted into the hospital, and in the first year he had received and cared for 2,000 patients suffering with various afflictions. His skill and success as a surgeon made his hospital quite famous, and he trained several natives in medicine and surgery to act as his assistants. During this time he was as diligent in the care of the spiritual as of the corporeal requirements of the people around him, and practiced his function of preacher no less zealously.

In consequence of the disturbed condition of affairs in China during England's memorable "opium war" with that country, Dr. Parker returned to the United States in 1840. Two years later he revisited Canton and reopened his hospital. In 1845 he resigned his position under the American Board of Missions in order to give uninterrupted attention to his very large clientage of patients. Having acquired a good practical acquaintance with the Chinese language, he was selected as secretary and interpreter to the United States legation in that place, and in the absence of the United States minister, he also acted as *chargé d'affaires ad interim*.

In 1855, to obtain a needed rest and recuperation for his overtaxed strength, he again returned to his native country,

but, from his familiarity with the manners and language of the Chinese, he was soon appointed a special commissioner to again visit the country, with powers to rearrange a commercial treaty with the nation. This important and responsible mission accomplished, in 1857 he for the last time left the country and the people with whom for more than twenty years he had been so intimately and so honorably associated.

Having made his residence at the city of Washington, Dr. Parker was on January 11, 1868, appointed by resolution of Congress a regent of the Smithsonian Institution, and at the meeting of the board held January 22 he was elected to the executive committee of the regents, to fill the vacancy occasioned by the death of Prof. A. D. Bache. This position he held till induced by failing health to offer his resignation, April 7, 1884, as member of the committee and of the board.

He died at his residence in this city (Washington) January 10, 1888, universally respected for his integrity and admired for his geniality and sympathetic disposition. His remains were buried at Oak Hill cemetery, in West Washington.

HENRY FRANCIS WALLING.

HENRY FRANCIS WALLING was born in Burrillville, R. I., June 11, 1825. He was the son of a well-known man of sterling integrity. Both father and mother were members of the Baptist church. His maternal grandfather was a Baptist deacon, while his grandmother belonged to the Society of Friends. From her he inherited the gentleness of manner which distinguished him and which is so marked a characteristic of that peaceful people.

Early in Mr. Walling's life his father removed to Providence, where young Walling was first educated in the pub-

lic school, leaving it for Lyons and Friese's classical school, where he was fitted for college; but he did not enter college, having married at the early age of twenty-two.

At that time his attention had already been turned toward his future field of labor. While studying surveying and civil engineering he had assisted in making and publishing a map of Northbridge, Worcester county, Massachusetts. At the same time he also taught an evening drawing school in Providence with marked success. Previous to this time he had been assistant librarian of the Providence Atheneum.

He formed a partnership about 1849 with Barrett Cushing, a civil engineer of Providence, with whom he was associated in making the map of Northbridge before referred to. This partnership did not last long, for in the next year he alone engaged in surveys in Bristol county, Massachusetts, resulting in the production of maps of five considerable towns, all bearing the date of 1850. From that time forward map-making and surveying for that object became the business of his life. Between 1850 and 1860 fifty-two maps of towns and twelve maps of counties, all in Massachusetts, bear his name.

In 1858 he set up in New York an establishment for the making and publishing of maps of all kinds upon a large scale. Here he employed surveyors, whose work he carefully superintended, while watching the reductions and publication with thoughtful care. This establishment he had brought into successful and profitable operation, when, in 1861-'62, the war supervened and nearly ruined him. The class of men in his employ were precisely those most needed in the country's service and most ready to give both service and life to the country when called upon.

Early in 1868 he accepted an appointment to the chair of civil and topographical engineering at the Pardee Scientific School of Lafayette College, Pennsylvania, at the same time carrying on to some extent the publication of maps. He held this position about three years, and then, returning to

the east, took up his old business of map-making at Boston. Here he was again engaged for several years under the auspices of the State of Massachusetts in correcting and adding new data to the State map of Massachusetts, originally published in 1842. The result was an imperial quarto atlas of the State published in 1871 by H. F. Walling and A. O. Gray, which was very creditable to them and a decided step forward. But it did not satisfy Mr. Walling; none knew better than he its many imperfections. Resting as it did upon a practically perfect basis in the triangulation, executed between 1834 and 1841, under the direction of Mr. Simeon Borden, upon which the State of Massachusetts had expended over \$70,000, Mr. Walling knew that the topographical details were by no means of the same order of precision.

Mr. Walling had been brought much into contact with Mr. Borden between 1850 and 1856, while he was engaged in making and publishing the town maps of Massachusetts. He was in the habit of consulting him and coming to him for information, as he did to the writer of this notice, especially after Mr. Borden's death, in 1856. [It was in these years, from 1853 to 1862, that I saw most of him and learned to value rightly his many excellent qualities. The events of the war and subsequent duty south of New England for many years deprived me of opportunities of personal intercourse with him until my removal to Washington in 1884.]

He had made many surveys and maps in the meantime. Among his plans was one for a general map of the United States. To this end he had made a very elaborate collection of all obtainable atlas maps of every part of our country. This very useful and valuable collection is now the property of the Coast and Geodetic Survey, purchased from Mr. Walling in 1884.

At that time he had been several years in the service of the Coast and Geodetic Survey, where he had rendered faithful service, as he did everywhere.

In 1884 he entered the service of the Geological Survey. He had always wished to see a really accurate map of the State of Massachusetts, in which he had spent so much of his life upon patchwork. It is not too much to say that the inception and execution of the work now approaching completion was largely due to his persistent efforts.

He was employed upon it from the time of his entering the Geological Survey, in 1884, until his death, in April last. His widow writes that "he was devoted to his work, putting his whole soul into it, and giving himself up to it until the last hour of his life. The book from which he was computing lay open before him when he could no longer see it. He was an earnest seeker after the truth; an honest, sincere, and upright man."

In the report of the Commissioners of the Massachusetts State Topographical Survey for 1888, the commissioners, Messrs. Walker, Whiting, and Shaler, say of him:

"Mr. Walling has been identified with the State survey from its inception to the time of his death; in fact, it was mainly due to his personal efforts that the survey was inaugurated. He was at the time a member of the Geological Survey, which he finally left for the exclusive service of the Commonwealth. His personal knowledge of the geography of the State and his long experience in map-making gave him a special fitness for the work of the new survey.

"Although always a sufferer from grave bodily ills, Mr. Walling, by dint of patience and a masterful will, succeeded in accomplishing a remarkable body of work. To him more than to any one else is due the appreciation of good maps which is now bearing fruit in the National Survey."

Mr. Walling was married at Providence, in 1847, to Miss Maria Fowler Wheeler, who survives him, as do two daughters. Two sons died—one in infancy; the other, a fine, promising youth, died in 1867, while in his sophomore year at Yale College. His father never entirely recovered from this severe blow, but his "masterful will" kept him up to the

end, which came in the form of a heart disease and was sudden.

Obituary notices of the following members of the Society who have died during the period covered by this Bulletin have not yet been prepared for publication :

GEORGE BANCROFT, died January 17, 1891.

JOHN HUNTINGTON CRANE COFFIN, died January 8, 1890.

CHARLES HENRY NICHOLS, died December 16, 1889.

CHARLES CHRISTOPHER PARRY, died February 20, 1890.

PROCEEDINGS

OF THE

PHILOSOPHICAL SOCIETY OF WASHINGTON

AND OF ITS

MATHEMATICAL SECTION.

1888-1891.

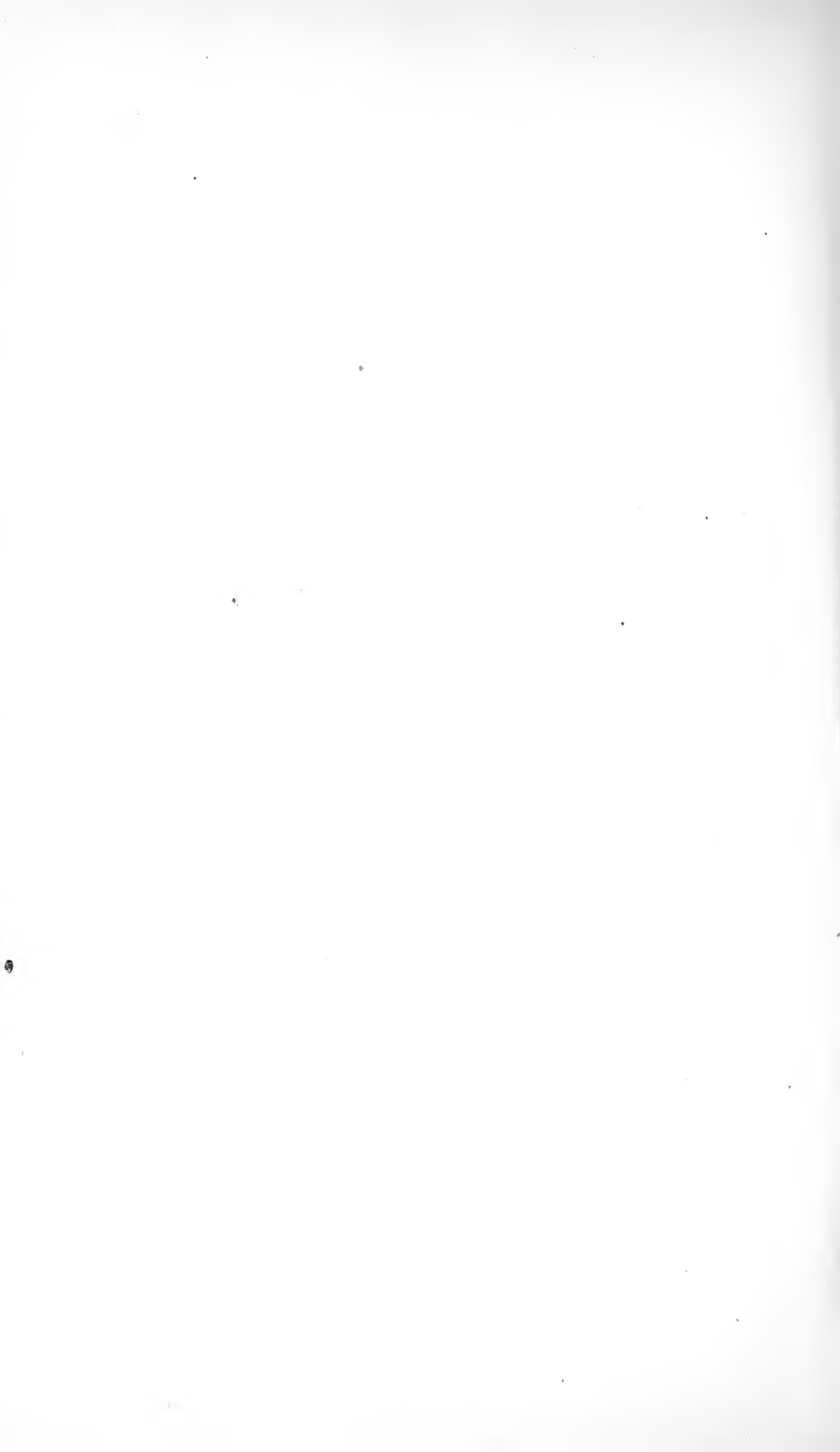

PROCEEDINGS
AT THE
GENERAL MEETINGS OF THE SOCIETY.

1888 TO 1891.

FROM THE MINUTES.

311th Meeting.

January 7, 1888.

The President, Mr. GARRICK MALLERY, in the chair.

Thirty members and guests present.

The President announced the death, on December 22, 1887, of FERDINAND VANDIVEER HAYDEN, a founder of the Society.

Announcement was also made of the appointment of the following Standing Committees:

On Communications:

G. K. GILBERT, *Chairman.* J. R. EASTMAN. G. BROWN GOODE.

On Publications:

MARCUS BAKER, *Chairman.* ROBERT FLETCHER.
W. C. WINLOCK. S. P. LANGLEY.

The report of the committee appointed to audit the Treasurer's accounts was read, accepted, and ordered to be entered upon the minutes. The report is as follows:

JANUARY 6, 1888.

The undersigned, a committee appointed at the Annual Meeting of the Philosophical Society of Washington, December 21,

1887, for the purpose of auditing the accounts of the Treasurer, respectfully report as follows :

We have examined the statement of receipts, including dues, sales, and interest, and find the same to be correct.

We have examined the statement of disbursements, compared it with the vouchers, and find that they agree.

We have examined the returned checks, which agree with the bank book, the balance of which, as reported by Riggs & Co. on December 28, was \$942.05, agreeing with the Treasurer's report.

We have examined the United States and other bonds belonging to the Society, and find them to be in amount and character as represented in the Treasurer's report, aggregating \$3,100.

JOHN S. BILLINGS.

C. O. BOUTELLE.

JAMES C. WELLING.

Mr. GEORGE F. BECKER presented a communication on the Rounding of Rock Masses by External Attack.

Mr. J. W. SPENCER read a paper on the Iroquois Beach—a Chapter in the Geological History of Lake Ontario. [Abstract published in *Science*, vol. 11, p. 49.]

312th Meeting.

January 21, 1888.

The President in the chair.

Thirty-seven members and guests present.

The following communications were presented :

Determination of Fault Hades, by Mr. Bailey Willis.

[Abstract.]

Mr. Willis suggested the application of methods of descriptive geometry to the determination of hade, and illustrated by statement of results obtained in East Tennessee.

The method rests on the assumption that the fault surface is a plane for short distances, and under this assumption the strike and hade may be found after ascertaining by survey the relative positions of three points of the fault outcrop. A check is afforded by using a large number of points in adjacent sets of three each, and a conception of the fault surface may be obtained by extending adjacent plane facets thus determined, either

graphically or in a model, to their intersections; care is, however, necessary not to be misled by the development of theoretical planes beyond reasonable limits.

As a result of many determinations of hade, it is found that faults in southwestern Virginia and northeastern Tennessee hade to the upthrow at angles ranging from forty-five to seventy degrees from the vertical.

The Neozoic Formations in Arkansas, by Mr. R. T. Hill.

[Abstract.]

The Neozoic formations of the Southern Gulf States have been studied mostly from long range, from which only the hard rock material and conspicuous fossils, both exceptional features, were visible and from which no ideas whatever of their relation, differentiation, and stratigraphic paleontology are conceivable. Southwest Arkansas, notwithstanding the obscurement of the stratigraphy by the dense forest growth and débris, afforded a fair cross-section of the Neozoic formations and the method in which they were deposited one upon the other and upon the older Paleozoic continental area.

During the past year, under the direction of Dr. John C. Branner, State geologist of Arkansas, Dr. Hill commenced a systematic investigation of the economic questions of the region, to facilitate which he was under the necessity of making a thorough study of the stratigraphy, from the basal Mesozoic to the basal Tertiary, inclusive.

Mr. Hill found that the lower Tertiary and uppermost Cretaceous formations were continuations of nearly similar formations from the adjoining States, as has been previously supposed, but in addition to those he found the lower Cretaceous and probably uppermost Jurassic strata of the central Texas region to extend into the State, disappearing near the Indian Territory line beneath the later strata of the Mississippi embayment.

The lowest of the Mesozoic strata he found resting directly upon the highly disturbed Carboniferous rocks, and extending from near Antoine P. O., Arkansas, to the Brazos river in Texas. Owing to the undoubted stratigraphic position of these beneath the lowest marine Cretaceous of the Comanche series, and the great resemblance of the fossils therefrom to those of the transitional Wealdan and Purbeck beds of Europe, he provisionally referred these to the upper Jurassic.*

The detail of these beds, together with those of all the overlying strata herein mentioned, are in process of publication by the Arkansas State Geological Survey.

Throughout the whole series of strata there were found several non-conformities and breaks in faunal continuity, contrary to preconceived ideas, indicating many oscillations in depth of the waters in which the formations were deposited.

*Science, Jan. 13, 1888.

Upon inquiry by Mr. Gilbert Thompson, Mr. Hill said that he had made careful observations of the fall lines of the rivers in this portion of Arkansas and Texas, and that Dr. Branner was having topographic maps made that would give valuable data upon this question.

A paper by Mr. Romyn Hitchcock—Notes on Eclipse-Photography in Japan—was read by the Secretary in the absence of the author.

Mr. GILBERT made a communication on the Flat Rock Channel.

313th Meeting.

February 4, 1888.

The President in the chair.

Fifty members and guests present.

Announcement was made of the death, on January 10, 1888, of PETER PARKER, a founder of the Society.

Announcement was also made of the election to membership of ROBERT THAXTER EDES and OTTO HILGARD TITTMANN.

Mr. C. F. MARVIN described A New Self-recording Rain-Gauge, and developed the formula for its various adjustments or corrections. [Abstract, *Science*, vol. 11, p. 97, Feb. 24, 1888.]

Mr. J. S. BILLINGS exhibited a form of Galton's Apparatus for Testing Muscular Sense.

The President announced the presence of Dr. GEORGE M. DAWSON, Assistant Director of the Geological Survey of Canada, and requested him to favor the Society with an account of his explorations in the extreme northern part of British Columbia, and the head-waters of the Yukon river.

Following is an abstract of Dr. Dawson's remarks:

[Abstract.]

The route followed was by the Stikine river to the head of navigation at Telegraph creek, and thence overland to Dease lake, the center of the Cassiar gold mining district of British Columbia. Here boats were built, and the Dease, Liard, and Frances rivers followed to the head of the last named in Frances lake. At Frances lake the boats were abandoned, and a difficult portage of about fifty miles made across the height of land between Frances and Liard rivers and the Pelly branch of the Yukon. This route had been used many years ago by the Hudson Bay Co., but

had been abandoned since 1852. A canvas boat was made on the Pelly, and that river was descended to the mouth of the Lewis, where another wooden boat was built for the ascent of the Lewis, and the coast finally reached on September 20th by crossing the Chilkoot or Perrier Pass to the head of Lynn canal. Two parties still remain in the district for the purpose of continuing explorations next spring—one under Mr. R. G. McConnell on the Mackenzie river, the other under Mr. W. Ogilvie on the Pelly (Yukon).

An outline was given of the geological results obtained on the route above described. The general character of the rocks and the formations represented are very similar to those characterizing the Sani Cordillera belt in the more southern part of British Columbia, embracing deposits referable to the Carboniferous, Cretaceous, Laramie (probably), and Miocene. The coast ranges preserve an almost identical character from the Fraser river to Lynn canal, a distance of about 900 miles. They are chiefly composed of gray granites and granitoid rocks, with associated crystalline schists.

Evidences were found of the glaciation of the upper Yukon basin by working in a northern and northwestern direction.

Mention was also made of a wide-spread deposit of volcanic ash, of comparatively recent date, in the region, and of the discovery of rolled fragments of jade in the bed of the Lewis river.

Dr. Dawson regretted that he was unprovided with specimens and photographs obtained during the exploration, which would have illustrated his remarks.

[A full account of these explorations has been published by the author as Part B to the Annual Report for 1887 of the Director of the Geological and Natural History Survey of Canada.]

314th Meeting.

February 18, 1888.

The President in the chair.

Forty-two members and guests present.

The following communications were presented :

Increasing Industrial Employment of the Rarer Metals, by Mr. Henry H. Bates.

[Abstract.]

The metals particularly referred to were, first, aluminium. Its valuable properties were mentioned and outlines of some of the leading processes for obtaining it were given. Its most valuable alloys were enumerated,

viz., 1, aluminium bronze, a 10 per cent. alloy of aluminium and copper; 2, tiers argent, a $66\frac{2}{3}$ per cent. alloy of aluminium and silver, and, 3, the "mitis" casting, an alloy of cast iron with a minute proportion of aluminium ($\frac{1}{30}$ of one per cent.) to improve fluidity in the mold and solidity in the casting. The Cowles incandescent electrical furnace for the smelting of refractory ores, including those of aluminium, was described from the patents; also the electrical furnace of Bradley and Crocker for the procurement of sodium. The sodium process of Frishmuth of Philadelphia for obtaining aluminium was also described from the patents. Specimens of pure aluminium and aluminium bronze were shown.

Sodium.—Its uses in metallurgy were referred to and the mode of its production on a commercial scale indicated.

Potassium.—An industrial use in the manufacture of fuses to ignite and burn on contact with water was described.

Magnesium.—Several modes of utilizing this metal in the production of artificial actinic light for instantaneous photography were described.

Cadmium.—The use of this metal as a component of fusible alloys for dental and other purposes was described and its use for the preparation of artist's colors referred to.

Iridium.—The mode of utilizing this metal in the arts by melting and casting it as a phosphide was described. Its principal industrial uses are, for tubular points in fountain pens, as a hard facing for burnishers, etc., as draw-plates for wire drawing, and as indestructible bearings for fine machinery in lieu of jewels, for which its great hardness and unchangeableness recommend it. As a phosphide, it is also useful for anodes in the electro-deposition of iridium. A specimen of the electro-deposited metal was shown.

Palladium.—This metal finds a valuable use in the hairsprings, compensation balances, and other quick-moving parts of watches to be used near dynamo-electro generators, where ordinary watches with steel balances are rendered useless by magnetic influences. Palladium is recommended for these purposes by its unchangeableness, elasticity, and low coefficient of expansion.

Strontium.—The industrial uses of this metal arise out of the magnificent crimson light of its spectrum, which qualifies it for coloring rocket signals for military and naval purposes.

Tungsten.—This metal has recently been found valuable for military projectiles on account of its high specific gravity conjoined with sufficient hardness, giving it superiority over either lead or steel, neither of which unites these two qualities. Specimens of such proposed projectiles were exhibited.

Yttrium, Lanthanum, Zirconium, and Thorium.—The great refractory qualities of the oxides of these metals qualify them for incandescents in gas-lighting with non-carburetted gas, a novel way of utilizing them having recently been introduced and patented in Europe by saturating web-like cylinders of textile fabric with aqueous solutions of the salts of said

oxides, singly or in combination, and then burning away the fabric, leaving the shell of refractory matter as the incandescent, which is illuminated by burning gas within the same by means of a small Bunsen cylinder. A specimen lamp was operated and exhibited.

Trans-Mississippi Rainfall, by Mr. A. W. Greely.

Note on the Formation of Alloys, by Mr. William Hallock.

[Abstract.]

In the *Berichte der Chemischen Gesellschaft*, vol. XV, 1882, pp. 595-7, W. Spring describes the formation of alloys by submitting the filings of the constituent metals to high pressure without appreciable rise in temperature. Wood's alloy of cadmium, tin, lead, and bismuth he produced by mixing the proper weights of the filings of these metals and subjecting them to 7,000 atmospheres pressure. The block thus obtained was again filed up and subjected to the same pressure. In this way a block of metal was produced which possessed the physical properties of ordinary Wood's alloy formed by melting the mixed constituents.

W. Chandler Roberts repeated this experiment [*Chemical News*, vol. XLV, 1882, p. 231] and verified Mr. Spring's results.

In seeking an explanation of the above phenomenon satisfactory to myself, I reasoned that if at any time during the first compression, the subsequent filing, or the second compression, anywhere throughout the mass the constituent metals were in contact, that at that point there would be a minute globule of the alloy—a molecule of the alloy, as it were. If now the temperature of the block, either during compression or subsequently, be raised to 70° C., then that molecule of alloy will fuse and act as a solvent upon the surrounding metals till the whole mass is fused.

If my idea was correct I concluded that perhaps I could produce the result without pressure, giving more time and an appropriate temperature to the substance. The filed metals in the proper proportions (1 Sn, 1 Cd, 2 Pb, 4 Bi.) were mixed and packed into the bottom of a "sealed tube," such as is used in blowpipe work, using no greater pressure than could be conveniently exerted with a piece of wire $\frac{1}{8}$ -inch diameter held between the thumb and finger. This tube was hung in the water bath of the laboratory over night (eighteen hours), thus maintaining it at a temperature of 98° C. or 100° C. On examination the filings had settled down considerably; the tube was then struck upon the table, jarring them down still more, and in an hour or two the whole was a molten globule.

The experiment was repeated, using larger quantities, packed in with a lead pencil, and occasionally pressing the mass together with the pencil, producing 20 or 30 grains of alloy. Since then tin and lead have been fused together at 200° C., tin melting only at 230° C.; also sodium and potassium at ordinary temperatures (20° C.), the first melting at about 90° C., and the latter at about 60° C.

Thus I propose the law that *an alloy can be formed out of the constituents at a temperature above the melting point of the alloy, although it be far below that of any constituent, with no (appreciable) pressure.*

The extended verification of this law, as well as the electrical and thermal phenomena associated therewith, will be the subject of a work which I hope soon to undertake and carry through.

An abstract of this paper was also published in *Science*, vol. 11, pp. 99, 100, Mar. 2, 1888.

315th Meeting.

March 3, 1888.

The President in the chair.

Thirty-two members and guests present.

Announcement was made of the election to membership of ANDREW BRAID and ARTHUR KEITH.

The following papers were read :

On the Determination of Atomic Weights, by Mr. F. W. Clarke.

Notes on the Drift north of Lake Ontario, by Mr. J. W. Spencer.

[Abstract.]

Amongst the deposits of the later Pleistocene period there is a well-stratified, hardened brown clay, charged with pebbles which are more or less glaciated, resting upon the typical blue bowlder clay north of Toronto. In the Canadian classification of the Pleistocene deposits there is no place for this deposit. Indeed, all of the stratified deposits of this region need revision, in the light of the progress that has been made in surface geology during the last twenty years. Thus, the Saugeen clay is resolvable into three series. The relation of all the clays to the older beaches require special study, as some of them may represent the deep-water deposits of the Beach epoch, while some of the later beaches rest upon such clays. Around the head of Georgian bay there are ridges in the form of moraines, similar to those about the other great lakes, reaching to the height of 1,300 to 1,400 feet above the sea. From the face of the Niagara escarpment—between Georgian bay and Lake Ontario—there extends for over a hundred miles, to near Belleville, a broad zone of from eight to twenty miles in width, covered with drift ridges, composed of stony clay below and frequently stratified clay or sand above, having an elevation of 1,100 to 1,200 feet above the sea, with occasional reductions to only 900 feet. These "Oak Hills or Ridges" rise from 300 to 500 feet above the flat Paleozoic country to the north. The stones in the clay are often glaciated fragments of limestone, with only a small proportion of crystalline pebbles

or boulders. In the deposits of the ridge native copper has been found; consequently the drift-carrying agent moved southeastward down Georgian bay to the western end of the Oak Ridge and probably throughout its whole length. North and east of Belleville there are many lower and fragmentary ridges, having a trend somewhat across that of the Oak Ridge. The glaciation of the region adds great difficulties to the explanation of the phenomena. The striation in the Ottawa valley, from Lake Tamiscamang to near the junction with the St. Lawrence, is to the southeastward with very rare local exceptions. On the Niagara escarpment, between Georgian bay and Lake Ontario, from 1,600 down to 700 feet above the sea, the striæ are also to the southeast; but between these widely separated regions the surface markings of the rocks to the south and west are obscured to the west and south by drift, and to the north and east absent or rarely seen, although the crystalline rocks are commonly rounded or very rarely polished—an absence that can only in part be accounted for by subsequent atmospheric erosion. About the St. Lawrence and Lake Ontario the striations are to the west and more particularly to the southwest. Between the Ottawa river and Georgian bay there is a high prominence which divided the drift-bearing currents; but north of Lake Huron the glaciation is very strongly marked and to the southwest, with very rare local variations.

All the lobes of glaciation about the lakes, from Superior to the Ottawa valley, radiate backward to the broad and open but low basin of James (Hudson's) bay. The watershed between the lakes and Hudson's bay during the epoch of the formation of the drift was several hundred feet lower than now—it is about 1,600 feet at present—as shown by the differential elevation of the beaches. For these conflicting phenomena of the drift no explanation was offered, but one was rather sought for.

Mr. C. A. Kenaston presented a paper on the Physical Features of a Portion of the British Northwest.

316th Meeting.

March 17, 1888.

The President in the chair.

Fifty members and guests present.

Mr. JOHN MURDOCH presented a communication on An Arch of Ice Formed by Horizontal Pressure.

[Abstract.]

On February 17, 1883, the heavy ice-pack off Point Barrow moved in with great violence before a westerly gale, which blew with a velocity of sixty miles an hour, and by forcing the grounder "lava flow" against the

edge of the level shore-ice produced at one point, half a mile west of the International Polar Station, a permanent arch of ice. This arch was a regular anticlinal uplift, with the ridge of the anticlinal at right angles to the direction of the pressure, and, as was to be expected, was steeper on the side toward the pressure and arched along the ridge. The span of the arch was about 45 feet and its height in the clear 6 feet. The strip of ice was 20 feet wide and 4 feet thick. The temperature at the time was about 0° F.

Such arches must frequently be formed during heavy ice-pressure, but it is apparently very rare for the pressure to stop in time to leave the arch intact. A similar arch is mentioned by Dr. Kane ("First Grinnell Expedition," p. 286), which was probably formed in the same way and not, as he believed, by the bending over of an erect cake of ice.

Mr. H. G. OGDEN read a paper on Distortion in Plane Table Sheets.

[Abstract.]

A brief reference was made to the difficulties experienced in all classes of precise work arising from the hygrometric properties of paper, and the method employed by draughtsmen of shrinking paper on a board was cited as the most ready means of overcoming them. The same devices have been resorted to by topographers using the plane table, where they had not the check afforded by the points of a triangulation previously plotted. A general knowledge of the change in the form of the sheet, it was asserted, however, permits a determination of the change that takes place in the relations of all the fixed points marked upon it. The percentage of expansion, it was stated, is less in the direction of the grain of the paper than at right angles to that direction, or across the grain, and the difference between these percentages is practically the "distortion." If the per cent. of increase should be the same in both directions there would result only a change of scale. The change that takes place was said to be uniform in each direction throughout the sheet, provided the paper had been carefully made and subjected to equal exposure, and it was this fact that permitted an analysis of the disturbance in the relations of the fixed points previously marked upon it, and the determination of rules to guide the operator in the selection of points, or to eliminate the error of points not well conditioned.

The general result of changes that take place is a permanent contraction that varies little except on exposure to excessive moisture. All sheets do not change alike. In some no change is apparent, and in others the percentage is so nearly the same in both directions that the "distortion" is not appreciable. Experiments conducted at the Coast Survey office some years ago, with strips of hand-made antiquarian paper backed on muslin, were then cited, showing a "permanent distortion" in the strips that was quite appreciable in a foot of paper, with a maximum distortion about twice as large, but Mr. Ogden stated that he had frequently found a

distortion much larger than these experiments indicated, in his experience in the field.

A simple diagram with eight points marked upon it in the form of a parallelogram, with an included figure showing the relations of the points after the sheet had become distorted, was then referred to in illustration, and the following rules announced :

1st. A station made with three points that are on the lines of contraction, the resecting lines forming nearly right-angles at their intersection, will give the true position in relation to all the points on the sheet.

2d. A similar condition of right-angle intersection at the station, but the lines of resection forming diagonals to the lines of contraction, will give the worst possible position for the station.

3d. A station made with three points on one of the "lines of contraction" will give the correct orientation of the table.

4th. In eliminating errors of the points due to distortion, those situated on the lines of contraction require no allowance, however distant.

The errors liable to arise in conducting an extensive plane-table triangulation were then referred to, and a method of correcting distances measured on a distorted sheet was briefly explained, and the advisability of constructing squares on all sheets before taking them into the field was recommended.

Mr. WILLIAM HALLOCK read a paper on The Flow of Solids.

[Abstract.]

The question whether solids possess any of the properties of liquids, or what conditions will impart such properties to them, is one of ever-increasing interest and importance, alike to the student of molecular physics in general or of the earth's crust in particular.

The temperature rises as we penetrate the earth ; hence, if no other influences affect the substances, the earth has a liquid center with this solid crust.

Astronomical and mechanical facts seem to demand a considerable rigidity.

Thompson has even demanded a rigidity equal to that of glass or steel. Geological phenomena require a considerable liquid-like motion. With rising temperature as we penetrate the earth's crust, we also have rising pressure, which probably increases the rigidity of the materials. Can we not satisfy the demands of both geology and astronomy or mechanics?

In the glaciers we have the grandest examples of the flow of solids. Henri Tresca proved that lead and some other substances would flow and follow the laws of flowing liquids. W. Spring has extended the list. Mousson actually liquefied ice. These observations have led many to advocate the idea of a liquefaction by pressure. Others, having in view the results of Bunsen, Hopkins, Amagat, and others, maintain that the melting-point is raised by pressure, the rigidity increased. Solids can be made to flow ; hence that property cannot be used to characterize them.

The essential difference between a solid and a liquid is the relative ease of rearrangement of the molecules. In liquids the change is very easy; in solids, very difficult. Rigidity may briefly be defined as the difficulty of rearranging the molecules of the body in question. Can rigidity be reduced by pressure? *A priori*, it seems scarcely likely that forcing the molecules nearer together can give them greater freedom of motion. Generally rigidity is inversely as the intermolecular distances. Ice is abnormal and cannot be taken as evidence *pro* or *con*. Lead, copper, and iron are all hardened by compression. All metals are harder, more rigid, in the rolled or hammered state than when cast or annealed. The rigidity of a steel pin was raised from 95,000 pounds to 110,000 pounds per square inch by that pressure. Two experiments bear directly upon the question and are convincing, although they gave unwelcome results. The first was made under the Ordnance Department, and will be found fully given in their report on "*Tests of Metals, etc., for 1884.*" A mixture of four parts wax and one part tallow was used as a "straining liquid" in "tangential tests." It was demonstrated that such a mixture would not transmit pressure through a hole $\frac{3}{16}$ inch in diameter and $2\frac{1}{2}$ inches long when the pressure at one end was 100,000 pounds per square inch and at the other 30,000 pounds or less, whereas 2,000 pounds was sufficient to overcome all friction and force it through when there was no back pressure—that is, the wax and tallow were rigid enough under pressure to maintain a difference of 70,000 pounds per square inch (100,000 — 30,000) at the two ends of that hole. The second experiment was also made with the testing machine of the Ordnance Department at Watertown arsenal, Mass. (See *Am. Jour. Sci.* (3), XXXIV, 1887, p. 280.) In that experiment silver coins on top of beeswax and paraffine in the holder, instead of sinking through a liquid under 6,000 atmospheres, were pressed so hard against the *top* of the holder that their impression in the steel was easily seen and felt. The paraffine and wax were rigid enough to impress silver into steel.

Such facts lead us to believe that pressure increases rigidity; and when we remember that the pressure at the center of the earth is millions of atmospheres, a demand for the rigidity of steel seems trifling. What is the rigidity of steel? Simply a rigidity capable of resisting a deforming force of 80,000 to 100,000 pounds per square inch. But distinguished geologists have made the fatal mistake of using "rigidity of steel" and "absolute rigidity" as synonymous and equivalent terms. Nothing is more misleading.

Upheavals and depressions and other geological phenomena are most beautiful examples of the viscous flow of solids. The forces causing a glacier to flow are trifling as compared with those generated in the earth's crust by shrinking, and undoubtedly to cause any body to flow we only need sufficient force and *time*.

Can pressure impart to solids the ability to change crystallographically, mineralogically, or chemically? Prismatic sulphur naturally changes to octahedral, and in many other cases changes take place under ordinary conditions of pressure and temperature. We would scarcely expect press-

ure, pure and simple, to cause a re-orientation of the axes of two crystal fragments, even if it could perfectly weld them together; nor would we expect pressure without heat to impart the ability to complete the fusion of a lump of barium sulphate in sodium carbonate, even after the reaction had been well started by heat. Under these extremely complex conditions it is difficult to generalize. A welding together is not only theoretically but practically possible between two chemically clean surfaces that *fit*, but any operation which requires an increase of freedom of the molecules would scarcely be assisted by pressure. Cohesion and adhesion I believe to be identical, and molecular rather than molar.

The bearing of these ideas, if good, upon geological phenomena is somewhat thus: By the action of pressure and *time* a sandstone or such material might be rendered compact and coherent, and even continuous, the most plastic constituent yielding most, and the most viscous retaining their shape most perfectly. Some constituents might even appear to have been fused and filled in between the rest; certain crystallographic changes might take place, but more than the slightest chemical effect of the constituents upon each other is not to be expected. The case becomes infinitely complex, and the subject for conjecture only, if the temperature is high. An indisputable fact in this connection is that many more experiments are needed, and such that each effect can be ascribed to its proper cause, and not, as at present, causes and effects treated collectively.

See, also, Science, vol. 11, p. 152; *also*, Am. J. Sci., vol. 34 (3. s.), p. 277; *also, ibid.*, vol. 36 (3. s.), p. 59.

317th Meeting.

March 31, 1888.

The President in the chair.

Thirty-five members and guests present.

Mr. C. V. RILEY presented a communication on Some Recent Entomological Matters of International Concern. [This paper has been published by the U. S. Department of Agriculture in the Periodical Bulletin of the Division of Entomology for November, 1888, vol. 1, No. 5, p. 126.]

Mr. H. A. HAZEN presented a paper on "Two Balloon Voyages."

[Abstract.]

It was shown that with modern safety appliances ballooning was by no means the dangerous pastime it was generally thought to be. Most of the fatal accidents were due to the use of hot-air balloons or to carelessness on the part of the aeronaut. The first voyage was from St. Louis, in the "World" balloon, on June 16, 1887—a balloon of 160,000 cubic feet

capacity. It was intended to make the longest trip on record. After a delay of 10 days, during which the currents were all from the east, the start was made at 4.26 p. m. A probable eddy or back current in the air caused a sudden drop of the balloon near the starting point, and nearly 400 pounds of ballast were thrown over. This caused the balloon to rise to 15,700 feet, though it was not intended to go much above 1,500 feet.

Results Obtained During the "World" and "Great North West" Balloon Voyages.

Height.	Temperature.		Rel. Hum.		Dew-point.		$p \div p_o$.*		Hann.
	W.	G. N.W.	W.	G. N.W.	W.	G. N.W.	W.	G. N.W.	
Feet.	W.	G. N.W.	W.	G. N.W.	W.	G. N.W.	W.	G. N.W.	
500	91°	71°	39%	56%	62°	53°	100	98	
1,000	89	68	40	53	61	50	97	93	87
1,500	87	67	41	56	60	49	96	85	
2,000	85	65	42	51	58	47	86	80	80
2,500	82	60	43	58	57	46	84	78	
3,000	81	61	45	54	58	45	87	73	73
3,500	79	60	47	57	57	45	85	74	
4,000	77	56	50	66	56	46	84	73	64
4,500	75	55	53	69	56	44	83	72	
5,000	73	53	56	53	56	36	81	53	56
5,500	72	51	58	24	55	12	80	26	
6,000	70	53	60	13	54	2	79	13	52
6,500	69	54	62	11	53	1	77	12	
7,000	67	54	64	11	52	2	76	12	48
7,500	65		66		52		71		
8,000	64		65		50		65		42
8,500	63		63		47		58		
9,000	61		62		45		51		38
9,500	58		63		45		50		
10,000	55		70		45		49		34
10,500	51		80		44		48		
11,000	48		82		43		47		31
11,500	47		84		42		46		
12,000	46		86		41		45		27
12,500	45		84		39		40		
13,000	45		56		32		30		25
13,500	43		52		27		25		
14,000	41		45		21		19		23
14,500	40		31		10		14		
15,000	40		35		14		15		21
15,500	37		33		10		13		

* p_o = vapor tension at ground.

p = vapor tension at each height.

At the height of 12,000 feet the neck of the balloon opened and large quantities of gas flowed out, so that the sudden rise was immediately followed by a more sudden fall, and to check the impetus and avoid striking the ground, much more ballast was thrown out. This carried the balloon up over 1,000 feet, and as the ballast was now exhausted a landing was made at Hoffman, Illinois, 54 miles from St. Louis.

The second voyage was made in the "Great Northwest," on August 13, 1887, from Philadelphia, to a height of 7,070 feet. Both of these voyages showed a remarkable adaptability of the sling psychrometer for balloons. In the most rapid ascent or descent the temperature was obtained within about 1° F., while in other voyages errors of 15° have been noted, owing to the sluggishness of the still thermometer. The scientific results were of the highest interest, and show what may be hoped for meteorology in the future of ballooning. The preceding table exhibits the more important determinations.

Mr. THOMAS RUSSELL made a communication on Baudin's Vertical Minimum Thermometer à Marteau.

318th Meeting.

April 14, 1888.

The President, Mr. MALLERY, in the chair.

Forty-eight members and guests present.

Mr. C. O. BOUTELLE read a paper on Geodetic Azimuths.

[Abstract.]

1. Account of difficulties found in use of glass roofs for protection of mercurial horizons, owing to unequal surfaces, densities, and other imperfections shown by the best French plate glass while observing for azimuth at Seaton station, in Washington, in December, 1868.

2. They were overcome in 1870 by the substitution of thin semi-transparent gauze for glass in all the more delicate class of observations where a reflecting surface of mercury is used.

3. Geodetic observers have, as a rule, settled upon observations of close circumpolar stars as the best method of obtaining good azimuths. The simplest method is that of observations of Polaris in any part of its orbit. Polaris is chosen because its place is best determined and because its size and brilliancy make it peculiarly available for accurate pointing with field telescopes.

4. A comparison was made between the results of observations made upon Polaris for azimuth, in Spain, in 1879, where a striding-level was

used to insure verticality of the telescope, and similar observations made in Wisconsin, in 1887, using a mercurial horizon protected by a gauze cover.

5. A comparison was also made between the results of observations made in the great Franco-Spanish quadrilateral of 1879, connecting the European geodetic system with that of Africa, and the "Davidson" quadrilateral of the U. S. Coast and Geodetic Survey in California.

6. In both instances, while the observing skill might be considered equal, superior methods and better atmospheric conditions gave somewhat greater precision to the American results.

7. In conclusion, American observers were urged to supreme exertion to keep pace with equally earnest brother-workers abroad, both in theory and practice—educating the hand to become the skilled servant of the head.

Mr. SIMON NEWCOMB then presented a communication on the Fundamental Concepts of Physics.

[Abstract.]

The subject was introduced with a twofold objection to the maxim that a body cannot act where it is not. In the first place, the question how and where a body can act can be determined only by observation, and if we find by observation that it does act where it is not, that settles the question; but, secondly and mainly, we do not know where a body is except by its action. When the hand comes in contact with a material object we infer that the object is there solely from the fact that the resisting force is exercised against the motion of the hand. It is commonly supposed that this resisting force is the effect of a repulsion exerted by all bodies upon others which come sufficiently near them. If we admit that such a repulsive force can be exerted through a space a millionth of a millimeter, we may with equal force conclude that it may extend through the celestial spaces.

The remainder of the paper was principally devoted to the discussion of the probability of forming a satisfactory theory of the constitution of matter and of the nature of such physical agents as light, heat, and electricity. The suggestion was thrown out that it might be forever impossible to form a rational theory of these things, owing to the fact that our senses afford no means of seeing what is going on in the ultimate parts of matter. We cannot conceive of any physical change which does not imply a change of something in space, but we may have to admit that changes may take place in the chemical qualities of bodies without any such change.

319th Meeting.

April 28, 1888.

President MALLERY in the chair.

Twenty-five members and guests present.

The President announced to the Society the death of THOMAS HAMPSON, on April 28, and that of EMIL BESSELS, on March 30, 1888. He also announced the election and acceptance to membership of ROBERT BOWNE WARDER.

The following communications were presented :

On the Origin of Primary Quartz in Basalt, by Mr. J. P. Iddings. [Published in the Am. Jour. Sci., vol. 36 (3. s.), p. 208.]

Some Peculiarities in Personal Equation, by Mr. J. R. Eastman.

[Abstract.]

In general, transit observers who use the chronograph may be divided into two classes: First, those who make their record an appreciable time after the phenomena, and, second, those who intend to have their record effected at the instant the transit takes place, and therefore necessarily begin the process of making the record before the star reaches the transit thread. In the case of the first class the observer waits until he sees the star bisected by the thread and then makes his record, which occurs *always later* than the time of actual transit. The magnitude of this error depends upon the times required by the brain, nerves, and muscles and by the recording apparatus to act. For the same recording instrument the instrumental time is the same for all observers. The variability is due to the brain, nerves, and muscles. For all stars except very faint ones the error of the first class of observers does not seem to vary. So far as investigations have been carried, it is found that the errors of the second class of observers vary with the magnitude of the star. Large stars are observed earlier than small ones; so that if a large star precedes a small one, the observed interval is *too great*; if the order is reversed, the interval is *too small*.

Such work introduced into a fundamental catalogue would vitiate the results, and it would be impossible to determine the ultimate effect of such work without knowing the exact amount of error introduced by each observer. A discussion of the grouping of the large stars in every fundamental catalogue leads to the conclusion that it is more than probable that a large portion of the catalogue errors, whose elimination is attempted by

corrections obtained from the formula $m \cos a + n \sin a$, were introduced by observers whose records were made too early.

Another peculiar form of personal equation arises in the observation of very faint stars, such as can be seen only in a dark field and observed with bright threads.

Abnormal personal equations in such cases have been suspected for some time, and an investigation, lately undertaken but not yet completed, shows that all classes of observers have a personal equation for such stars different from their ordinary errors and one that cannot be inferred from those obtained from the work on ordinary stars.

A communication was also presented on Cambrian Rocks in Tennessee, by Mr. Cooper Curtice.

320th Meeting.**May 12, 1888.**

President MALLERY in the chair.

Seventy-five members and guests present.

The President announced the death of H. F. WALLING, at Cambridge, Massachusetts, on April 8, 1888.

It was also announced that the meeting of May 24 would be the last meeting of the Society before the customary summer recess.

Mr. W. A. CROFFUT, upon the invitation of the Society, gave a series of Experiments in Hypnotism.

Dr. G. STANLEY HALL, who was also present by invitation, followed Mr. Croffut with some remarks and experiments upon the same subject.

321st Meeting.**May 26, 1888.**

President MALLERY in the chair.

Thirty members and guests present.

The Chair announced the death, on May 24, of EZEKIEL BROWN ELLIOTT, a founder of the Society, and stated that the General Committee desired to refer appropriate action to the full meeting of the Society.

On motion of Mr. HARKNESS, it was *Voted* that a committee of three be appointed by the Chair to draft suitable resolutions and present them at the first meeting of the next session.

The Chair appointed Messrs. HARKNESS, TAYLOR, and WOODWARD.

The following communications were presented :

The Sphygmograph, by Mr. R. T. Edes. [The substance of this paper has been published under the title "A New Clinical Sphygmograph," in the Journal of the American Medical Association, August 18, 1888.]

The Recent Mount Vernon, Ill., Tornado, by Mr. H. A. Hazen.

[Abstract.]

This tornado was unusually interesting, in that it possessed in a marked degree most of the characteristics of a typical tornado, and in that it occurred at a very early date (February 19) for this latitude. A chart was presented giving the distribution of the meteorological elements just preceding the tornado, which occurred at about 4.50 p. m. (central). A low area had moved at a velocity of about thirty miles per hour from the north of Texas, and at 2 p. m. was central at the point of meeting of the boundaries of Iowa, Missouri, and Illinois. About 300 miles to the southeast of this point, in the region of uniform and fresh southerly winds, with southerly upper currents, was a region of narrow width, but nearly 300 miles long, in which a large number of very destructive storms raged. The earliest was at Houston, Missouri, and the latest at Russellville, Illinois. An approximate velocity of 70 miles per hour was determined.

A little later another tornado started about 200 miles to the southeast of the first and with its path parallel to it. The destruction at Mt. Vernon was very great; 35 people killed and over \$500,000 in property destroyed. The following is a brief *résumé* of the characteristics of this tornado :

1st. It occurred about 300 miles to the southeast of an area of low pressure and in a region of rather brisk uniform southerly winds.

2d. The temperature was abnormally high for this region.

3d. Its motion was about 70 miles per hour, while that of the low area was only 30.

4th. There were intense electrical disturbances all along its path.

5th. The upper currents in all this region continued from the south or from a southerly direction.

6th. It seemed to be an independent formation suddenly thrust in upon the southeast border of the low area.

Mr. MERWIN-MARIE SNELL presented a communication—Observations on Certain Hypnotic Experiments of the Comte de Maricourt.

Mr. E. D. COPE presented a communication on The Relation of Consciousness to Animal Motion.

322d Meeting.

October 13, 1888.

The President in the chair.

Thirty-five members and guests present.

The President announced the election to membership of LELAND OSSIAN HOWARD and LOUIS AGRICOLA BAUER.

The following amendment to the constitution was offered by Mr. ASAPH HALL: In Rule 3 strike out the words "the ex-Presidents of the Society."

In accordance with the constitution, this was laid over for discussion and action at the annual meeting.

The following communications were presented:

On the Solar Parallax and its Related Constants, by Mr. William Harkness. [Published in Washington Observations for 1885, Appendix III.]

Chemical Action between Solids, by Mr. William Hallock.

Note on Certain Surfaces Feebly Sensitive to Light, by Mr. J. W. Osborne. (Read by Mr. Hallock.)

323d Meeting.

October 27, 1888.

The President in the chair.

Thirty-nine members and guests present.

The special committee appointed on May 26, 1888, to draft resolutions commemorative of the late E. B. Elliott, presented,

through its chairman, Mr. William Harkness, the following report, which was adopted and the committee discharged :

“ The committee appointed to take suitable action respecting the death of our late member, Mr. E. B. Elliott, beg leave to report that on account of the trite and perfunctory character of the resolutions usually passed on such occasions they are of opinion that it would be better to omit them entirely, and to substitute in their stead a suitable biographical notice of Mr. Elliott, to be published in the Bulletin of the Society.

“ The committee are further of the opinion that in the future such biographical notices should be published in the case of all deceased members of the Society, and for that reason the committee offer the following resolution :

“ *Resolved*, That in the future suitable biographical notices of all deceased members of this Society shall be published in our Bulletin, and it shall be the duty of the President in each case to appoint a member of the Society to prepare such notice.

“(Signed)

WM. HARKNESS.

“(Signed)

R. S. WOODWARD.

“ OCTOBER 27, 1888.”

Mr. J. W. POWELL then read a paper entitled The Laws of Corrasion. [Abstract published in *Science*, vol. 12, p. 229.]

Remarks on this communication were made by Messrs. WARD, KENASTON, and GREELY.

[Abstract.]

Mr. Ward said that while making the descent of the Missouri river in the summer of 1883, from Fort Benton to Bismarck, he had been interested in studying the phenomena of lateral corrasion, and had observed that this was the only influence at work at that season of the year in causing the well-known turbidity of the water of that river. The river consists of a succession of curves or “bends,” in which, on one side or the other, it is perpetually wearing away the flood plain. The lateral corrasion takes place only on one side at a time, namely, on the side of maximum curvature. On the other side deposition is going on and bars are formed. The current is most rapid on the corradng side and regularly diminishes in velocity from one bank to the other. This fact, Mr. Ward said, did not seem in harmony with the law laid down by Major Powell,

that corrasion and deposition could not occur at the same part of a stream at the same time. The valley of the Missouri consists of a flood plain which has been many times eroded and deposited, and this work of simultaneous erosion and deposition of the same material is still going on, not merely at different parts of the river, but on opposite sides of it at the same point.

In reply to further remarks by Major Powell, Mr. Ward stated that at the season of the year of which he was speaking there were no other influences whatever operating to produce the result, as all the streams were so nearly dry that only clear alkaline water flowed in them.

Mr. B. E. FERNOW then read a paper entitled *Methods Used in Determining the Influence of Forests upon Quantity and Frequency of Rains.*

324th Meeting.

November 10, 1888.

The President in the chair.

Fifty members and guests present.

The President announced the election and acceptance of membership of ERASMUS DARWIN PRESTON.

In accordance with the resolution presented at the 323d meeting the following gentlemen were appointed to prepare biographical sketches of members who have died during the year:

Mr. Wm. B. Taylor, notice of Dr. Peter Parker, died January 10, 1888.

Mr. W. H. Dall, notice of Dr. Emil Bessels, died March 30, 1888.

Capt. C. O. Boutelle, notice of Mr. Henry F. Walling, died April 8, 1888.

Mr. H. W. Henshaw, notice of Mr. Thomas Hampson, died April 22, 1888.

Prof. Wm. Harkness, notice of Mr. E. B. Elliott, died May 24, 1888.

Mr. I. C. Russell, notice of Prof. R. D. Irving, died May 30, 1888.

The programme for the evening consisted of a symposium, participated in by MESSRS. GANNETT, GREELY, and FERNOW, upon the question, *Do Forests Influence Rainfall?*

325th Meeting.

November 24, 1888.

The President in the chair.

Thirty members and guests present.

Messrs. HAZEN and ABBE presented communications upon the Influence of Forests upon Rainfall.

The following is an abstract of Mr. Hazen's communication :

[Abstract.]

This question, discussed at the last meeting of the Society, is of vast economic importance and should be thoroughly investigated. The crucial test would be to take an extended forest region and carefully determine the difference in precipitation within and without the forest. Such an investigation as presented to the Society shows a tendency to an increase of about ten per cent. in the forest. It is very evident that fogs tend to linger much longer over a forest than a plain, and this increase of moisture must give more rain. The forest cannot attract rain, but it often prevents the evaporation of moisture and a desiccation of the air, such as takes place over a desert, and in consequence the rain-drops when formed are not dried up as they descend.

An attempt has been made to determine this influence by a comparison of total annual rainfall at a large number of stations, on the supposition that the forest has gradually increased, and hence there should be an increase of rain in the last half of a series of years, even if these years did not embrace the same period. At Augusta, Illinois, for example, the records extended from 1843 to 1860, while at Davenport, Iowa, they were from 1861 to 1885, and so on. If forests have increased steadily from 1843 on, and if no other influences have affected the rain, this discussion might be accepted as showing a purely *negative* effect from forests. We find, however, that there is a regular secular variation, which is far greater than the influence of the forest. Suppose a minimum epoch about the year 1860; then by the two series above we would have had a decided decrease by the first and just as decided increase from the second, neither of which, however, would be due to the forest. Taking the fluctuations at a station (St. Louis) having a long series of years, it was possible to predict, from the intervals of time at each of the twenty and more stations discussed by Mr. Gannett, which station would give an increase and which the reverse.

It should be noted that vegetation and a deciduous forest can, in general, influence rain only during the growing season, and if the other seasons are taken they will serve to mask the effect sought. We have several stations which have a record of about forty-eight years. Taking the observations during May, June, July, August, and September, a table

was presented showing that each station gave a diminution of rainfall during the latter half of the long period. This was due to the fact that the secular variation reached a minimum about 1877 and the forest had little or no influence. The forestry reports from Illinois show, in the region covered by their records, about three trees to the acre, which indicates plainly that they had no effect on the precipitation one way or the other. We may consider that forests keep back the precipitation from rivers, increase the humidity and the number of springs, and by actual observation augment the rainfall slightly, and hence should be carefully conserved all over the country.

Mr. GILBERT read a paper upon the Problem of the Soaring of Birds. [Abstract published in *Science*, vol. 12, p. 267, December 7, 1888.]

326th Meeting.

December 8, 1888.

By courtesy of the trustees of the Columbian University the meeting was held in the lecture-room of the University building. About 200 ladies and gentlemen were present, including, by special invitation, members of the various scientific societies of Washington and members of the Cosmos Club.

Vice-President EASTMAN presided.

The retiring President of the Society, Colonel GARRICK MALLERY, presented an address bearing the title Philosophy and Specialties. [Printed in full upon pages 3-40 of this volume.]

327th Meeting.

December 22, 1888.

EIGHTEENTH ANNUAL MEETING.

The President, Mr. MALLERY, in the chair.

Thirty-five members present.

The minutes of the 310th, 325th, and 326th meetings were read and approved.

The Chair announced the election and acceptance of membership of DANIEL CURRIER CHAPMAN.

The report of the Secretaries was read and accepted.

ANNUAL REPORT OF THE SECRETARIES.

WASHINGTON, D. C., *December 22, 1888.*

To the Philosophical Society of Washington :

We have the honor to present the following report for 1888 :

The last annual report brought the record of membership down to December 21, 1887, at which date the number of active members was 189

This number has been increased by the addition of 11 new members and by the return of 1 absent member. It has been diminished by the departure of 3 members, by the resignation of 2, by the dropping of 6 for non-payment of dues, and by the death of 5 members. There has thus been a net decrease of..... 4

And the active membership is now..... 185

The roll of new members is :

L. A. BAUER.	G. H. ELDRIDGE.	E. D. PRESTON.
ANDREW BRAID.	B. E. FERNOW.	O. H. TITTMANN.
D. C. CHAPMAN.	L. O. HOWARD.	R. B. WARDER.
R. T. EDES.	ARTHUR KEITH.	

The roll of deceased members is :

F. V. HAYDEN, died December 22, 1887.
 PETER PARKER, died January 10, 1888.
 EMIL BESSELS, died March 30, 1888.
 THOMAS HAMPSON, died April 22, 1888.
 H. F. WALLING, died April 8, 1888.
 E. B. ELLIOTT, died May 24, 1888.
 R. D. IRVING, died May 30, 1888.

Of these five were, on the active list and two, Messrs. Hayden and Walling, on the absent list.

There have been 17 meetings, of which 15 have been for the presentation and discussion of papers, one for the President's annual address, and one for the annual reports and election of officers. The average attendance (at the 15 meetings for the presentation of papers) has been 40. Also the Philosophical

Society, in conjunction with the Anthropological and Biological Societies, held on January 11 a joint meeting commemorative of the life and scientific work^o of Professor S. F. Baird. This meeting, as well as that for the annual address of the retiring President, was held in the lecture-room of the Columbian University; all other meetings in the assembly hall of the Cosmos Club.

There have been 12 meetings of the Mathematical Section; average attendance, 14. All meetings of the section were held in the Columbian University.

In the general meetings 43 communications have been presented by 30 members and 5 guests; in the Mathematical Section, 27 communications by 16 members. Altogether 70 communications have been made by 44 members and 5 guests. The number of members and guests who have participated in the discussions is 45. The total number who have contributed to the proceedings is 62, or 30 per cent. of the present active membership.

The General Committee has held 16 meetings; average attendance, 14; the smallest attendance at any meeting being 11 and the largest 22.

When the place of meeting of the Society was changed last year from the Army Medical Museum to the assembly hall of the Cosmos Club, the rules respecting attendance of guests were modified to the extent of tendering a general invitation to all members of the Club to attend the meetings of the Society. This invitation has affected the average attendance by increasing the number of guests.

To its small stock of furniture the Society has added during the year a magic lantern of good quality and all its accompanying appliances.

There has also been formed this year a Joint Commission of the Scientific Societies of Washington to consider matters of common interest. The initiative in organizing such commission was taken in the General Committee early in the year. As organized, the commission consists of three delegates each from the Anthropological, Biological, Chemical, National Geographic, and Philosophical Societies.

The General Committee of the Society has agreed to unite in the preparation and publication of a joint directory of the five named Scientific Societies. It has also decided to make impor-

tant changes in the publications of the Society, and for this purpose has adopted a complete new set of rules respecting publication.

Respectfully submitted :

MARCUS BAKER,
WILLIAM C. WINLOCK,
Secretaries.

The report of the Treasurer was read, accepted, and referred to an auditing committee consisting of Messrs. H. G. OGDEN, G. W. HILL and W J McGEE.

REPORT OF THE TREASURER.

The report which I shall presently have the honor to submit to you exhibits the total receipts and disbursements for the fiscal year which ends with this meeting.

The assets of the Society consist of—

Two Government bonds, \$1,000 and \$500, at 4 per cent.....	\$1,500 00
One Government bond, \$1,000, at 4½ per cent.....	1,000 00
Six Cosmos Club mortgage bonds, at 5 per cent.....	600 00
Cash with Riggs & Co.....	956 26
Unpaid dues.....	230 00
	<hr/>
Total.....	\$4,286.26

The expense of printing the Bulletin this year was materially increased, owing to the publication of the complete and valuable index of the entire series of volumes which accompanied it. This volume of the Bulletin, being volume X, was promptly issued upon publication to all members who were entitled to receive it, and to such Societies and scientific journals as are on the exchange list of the Philosophical Society.

ROBERT FLETCHER,
Treasurer.

Dr.

The Treasurer in Account with The Philosophical Society of Washington.

Cr.

1888. Dec. 22	To balance, cash on hand, Dec. 21, 1887.. To cash received for dues of 1886. \$25 00 " " " 1887. 105 00 " " " 1888. 735 00 " " " 1889. 10 00 " " for interest on bonds: On \$1,500 @ 4% \$60 00 " " 1,000 @ 4½% 45 00 " " 600 @ 5% 30 00 To cash received for sales of Bulletin....	\$942 05		
1888. Mar. 12	By cash paid for expenses of the Baird Memorial Meeting, including invitations and 700 portraits.....			\$52 25
May 29	By cash paid Judd & Detweiler for printing, binding, and wrapping Vol. X of the Bulletin	875 00		572 79
Dec. 22	By cash paid for postage, etc., for distributing the same..... By cash paid for lantern and sundry fixtures..... By cash paid for miscellaneous printing, postal cards, circulars, etc..... By cash paid for miscellaneous expenses of Treasurer and Secretaries for postage, stationery, clerk hire, etc..... By cash paid janitor for attendance on meetings of the Society and of the Mathematical Section..... Balance with Riggs & Co.....			19 43 120 16 120 85 82 06 29 00 956 26
		\$1,952 80		\$1,952 80

WASHINGTON, December 22, 1888.

ROBERT FLETCHER, *Treasurer.*

GENERAL MEETINGS.

1889.

328th Meeting.

January 5, 1889.

President EASTMAN in the chair.

Forty-one members present.

The Chair announced the following standing committees :

*On Communications :*G. K. GILBERT, *Chairman.* G. BROWN GOODE. HENRY H. BATES.*On Publications :*ROBERT FLETCHER, *Chairman.* MARCUS BAKER. W. C. WINLOCK.

The Auditing Committee reported, through its chairman, Mr. Ogden, as follows :

WASHINGTON, *January 2, 1889.**To the Philosophical Society of Washington :*

The undersigned, a committee appointed at the annual meeting of the Philosophical Society of Washington, December 22, 1888, for the purpose of auditing the accounts of the Treasurer, respectfully report as follows :

We have examined the statement of receipts, including dues, sales, and interest, and find the same to be correct and satisfactory. We have examined the statement of disbursements, compared it with the vouchers, and found that they agree. We have examined the returned checks, which agree with the vouchers and with the bank book, the balance of which, as reported by Riggs & Co. on December 27, 1888, was \$956.26, agreeing with the Treasurer's report. We have examined the United States and other bonds belonging to the Society and find them to be in amount and character as represented in the Treasurer's report, aggregating \$3,100.

HERBERT G. OGDEN.

G. W. HILL.

W J MCGEE.

By appointment, the following obituary notices were prepared and read :

Of Peter Parker, by W. B. Taylor, published in this volume, pages 491-492.

Of E. B. Elliott, by Wm. Harkness, published in this volume, pages 470-473.

Of F. V. Hayden, by A. C. Peale, published in this volume, pages 476-478.

Of Roland D. Irving, by I. C. Russell, published in this volume, pages 478-480.

Of Thomas Hampson, by H. W. Henshaw, published in this volume, pages 474-475.

Of Emil Bessels, by W. H. Dall, published in this volume, pages 465-466.

Mr. BAILEY WILLIS made a communication on The Mechanism of the Overthrust Fault.

[Abstract.]

Mr. Willis referred briefly to the views of Professor H. D. Rogers, published in 1842, and to those of Professor Heim, of Zürich, published in 1878 and again in 1888, concerning the formation of faults intimately related to folds, which frequently arise in the steeper side of an anticlinal, and which may be termed overthrust faults. Professor Heim's explanation of phenomena of this nature rests upon the fact observed in the Alps, that the inverted limb of an anticlinal is stretched or is even crushed between the anticlinal and synclinal cores of an overturned fold moving in opposite directions. This explanation fails to account for faults in the Appalachians, because the essential fact of squeezed beds has not been found.

The Appalachian sedimentary series from Cambrian upwards is composed of strata differing greatly in their capacity for resistance to horizontal thrust. These variations of rigidity occur in the same stratum originally in the same horizontal plane, and also in different strata superimposed one on the other. It follows that a rigid stratum may not fold at the place where a vertically adjacent flexible stratum does fold; the rigid stratum may ride forward on its lowest bedding plane until it reaches an axis, anticlinal or synclinal, in which both beds have suffered flexure. The forward movement will then shear across the beds on the opposite dip, producing a fault.

The facts relating to this hypothesis were illustrated by photographs of folded strata and of models; the latter showed differential folding and faulting produced in layers of wax by horizontal thrust.

329th Meeting.**January 19, 1889.**

President EASTMAN in the chair.

Fifty-one members and guests present.

Mr. W. O. ATWATER, by invitation, made a communication on American and European Food Consumption, compared from physiological and economic standpoints.

This paper has not been published in full. Its principal data as to statistics of dietaries are given under the title "Tables of Foods and Dietaries," by Professor W. O. Atwater, in the National Medical Dictionary, edited by Dr. J. S. Billings, and published by Lea Brothers & Co., Philadelphia, 1890; vol. 1, pp. xxxv-xL, with two charts.

330th Meeting.**February 2, 1889.**

President EASTMAN in the chair.

Thirty-seven members and guests present.

The Chair announced the election to membership of CHARLES WILLIAM HAYES; also the action of the General Committee with reference to the minutes of the general meetings of the Society, as follows: "It is the sense of the General Committee that it is not desirable that the Secretary should be required to make abstracts of the remarks upon and discussion of papers."

Mr. C. R. VAN HISE, by invitation, made a communication on The Penokee Iron-Bearing Series of Rocks.

The paper will be published in full as part of United States Geological Survey Monograph, entitled "The Penokee Iron-Bearing Series of Northern Wisconsin and Michigan," by R. D. Irving and C. R. Van Hise. 4to, 1890. Washington: Government Printing Office.

Mr. W J MCGEE read a paper on Rock Gas and related Bitumens.

The paper will be published in full as an introduction to United States Geological Survey Bulletin No. 63, Natural Gas Districts of Indiana, by Arthur John Phinney. Published also in part in *The Forum* (8vo, New York, July, 1889, vol. 7, No. 5, pp. 553-566) under the title of "The World's Supply of Fuel."

331st Meeting.**February 16, 1889.**

President EASTMAN in the chair.

Thirty-three members present.

The Chair announced the election to membership of Messrs. COSMOS MINDELEFF and VICTOR MINDELEFF.

Mr. C. O. BOUTELLE read an obituary notice of Mr. H. F. WALLING, published in full in this volume, pp. 466-470.

Mr. I. C. RUSSELL made a communication on Sub-Aërial Deposits of the Arid Region of North America, published in full in the Geological Magazine, 8vo, London, 1889, July and August, vol. 6, No. 7, pp. 289-295; No. 8, pp. 342-350.

Mr. SWAN M. BURNETT made a communication entitled Exhibition of Models Showing Refraction by Cylinders with their Axes Crossed at Various Angles.

332d Meeting.**March 2, 1889.**

President EASTMAN in the chair.

Forty-eight members and guests present.

Mr. H. V. WÜRDEMAN read a paper on Color Perception.

Mr. S. P. LANGLEY read a paper on the Observation of Sudden Phenomena.

Published in full in this volume, pp. 41-50; also in: American Journal of Science, 8vo, New Haven, 1889, August, vol. 38, No. 224, pp. 93-100.

333d Meeting.**March 16, 1889.**

President EASTMAN in the chair.

Twenty-seven members and guests present.

The Chair announced the election to membership of Mr. JOHN GEORGE HAGEN.

Mr. J. S. DILLER made a communication on The History of Porphyritic Quartz in Eruptive Rocks.

Mr. C. D. WALCOTT made a communication on The Stratigraphic Position of the Olenellus Fauna in North America and Europe.

Published in full in the American Journal of Science, 8vo, New Haven, 1889, May and July, vol. 37, No. 221, pp. 374-392; vol. 38, No. 223, pp. 29-42.

334th Meeting.

March 30, 1889.

President EASTMAN in the chair.

Fifty-two members and guests present.

The Chair announced the election to membership of Mr. JOHN ELFRETH WATKINS.

Mr. R. S. WOODWARD presented a communication entitled "Some Mechanical Conditions of the Earth's Mass."

[Abstract.]

It was the object of this communication to adduce the grounds for the opinion that the earth is a viscous body, whose mass behaves under the action of long-continued forces essentially as if it were fluid, and is therefore subject to internal pressures which differ little from hydrostatic pressures.

It was first explained that, independently of any hypothesis as to the actual arrangement of the earth's mass, five important properties dependent on that arrangement are accurately known. These properties are the surface shape, the surface density, the mean density, the relation of the moments of inertia expressed by the constant of precession, and the relation of the moments of inertia derivable from the moon's motion. Collectively these properties require a peculiar symmetry of distribution in the mass and a marked increase in density with depth below the surface; they are so many conditions which must be satisfied by any hypothesis concerning the arrangement of the constituents of the mass.

Turning, then, to the question of pressures to which the earth's crust would be subject if it were self-supporting like a dome, it was shown that such pressures would be thirty times the crushing strength of the finest cast steel, or six hundred to one thousand times the crushing strength of granite and limestone. The conclusion drawn from these figures was that the upper strata rest with their full weight, substantially, upon those below, producing perfect continuity of matter (probably in the amorphous state) at no great distance from the surface, and generating pressures throughout all but the superficial portions of the mass which differ in no material degree from hydrostatic or fluid pressures.

It was shown that numerical estimates of the magnitudes of these internal pressures require an hypothesis as to the increase of density with depth or as to the relation of density to pressure, but that any hypothesis not inconsistent with the above-named conditions will give pressures increasing rapidly with the depth to about two or three million atmospheres per square inch at the earth's center. Of the various hypotheses which have been made, the so-called Laplacian law was instanced as of special interest, and a table showing the corresponding variation of density, gravity, and pressure with depth from the earth's surface was exhibited.

Mr. J. ELFRETH WATKINS made a communication on The Origin of the Railway Systems of England and America, and the Causes of their Differences.

Published in part under the title "Development of the American Rail and Track." Trans. Am. Soc. Civil Eng., 8vo, New York, April, 1890, vol. 22.

335th Meeting.

April 13, 1899.

President EASTMAN in the chair.

Forty-six members and guests present.

The Chair announced the death, on April 8, of Dr. J. H. KIDDER, and remarked upon the great loss to the Society, as Dr. KIDDER was ever active in furthering its best interests.

Mr. DAVID P. TODD made a communication on Results of the Total Solar Eclipse of January 1, 1889.

Mr. W J MCGEE made a communication on The Evolution of Serials Published by Scientific Societies.

Published in this volume, pp. 221-246.

Mr. ABBE made the following remarks upon the paper presented by Mr. Woodward at the last meeting :

[Abstract.]

As I was not present at the last meeting, I take the liberty now of saying that I do not see how we can decline to accept the figures and statements which have just been given us by Mr. Woodward.

Similar statements have been made by several other eminent and able students of the subject during the past ten years, and it remains only for us to follow these results up to their logical conclusions.

Absolute rigidity, limpidity, and elasticity do not exist in nature.

The matter we have to deal with is all of it plastic and viscous. The pressure of a quick blow makes a glass rod give out a musical ring, and a harder, quicker blow may break it to fragments; but the same pressure long continued will produce neither sound nor fragments, but will mold the glass into any shape we please.

It is evident that every form of matter as we know it on this earth becomes viscous fluid under the influence of either temperature or pressure, and the pressures within the earth's surface at a comparatively short depth are sufficient to make all known rocks behave like viscous fluids, without any special increase of temperature.

It is therefore evident that our earth, under the influence of the centrifugal force due to its diurnal rotation, would assume its present spheroidal shape without the necessity of being any more truly a fluid than it is at the present moment.

We thus remove what to me has always seemed a great difficulty, both from geological and from thermo-dynamic considerations, namely, the assumption that the earth was at one time a molten globe. There is evidently no longer any need of making such assumption, and in fact still other considerations that I need not now enumerate have of late made me feel the propriety of wholly rejecting this idea as a necessity in any cosmogony.

It is now evident that any irregular meteoric mass that is a mixture of materials like those of our earth, and as large as it, must under the influence of its own gravitation, assume a spherical form and have a greater density at its center than its circumference, owing not only to the presence there of denser forms of matter, but especially to the general compression due to pressure. On the other hand, irregularities would continue to exist on the surface, but to such an extent only as is allowed by the fact that the pressures there are less, and consequently the relative rigidity greater.

Again, such a viscous, but rough-surfaced, globe entering the solar system and acquiring a rotation would, under the long-continued influence of its own axial rotation, assume a spheroidal shape.

In doing this the change of shape from sphere to spheroid would, through internal friction and stress, produce considerable internal heat, which I would designate as its initial heat. The diurnal rotation of such a globe in the presence of the sun and moon also gives rise to the bodily tides recently investigated by Mr. G. H. Darwin and Sir William Thomson. Sea water is so limpid that it can have an appreciable diurnal tide, but the diurnal bodily tides are too rapid to produce large deformations in the very viscous, dense body of our earth; however, they can produce temporary strains, whose effect I will explain at some future date. On the other hand, the fortnightly lunar tide, however, can produce a continual deformation of the viscous and plastic mass of our earth, and give rise to an internal friction such as occurs in every fluid when the molecules move past each other. This friction we recognize in another form as internal heat, so that in fact lunar gravitation (and possibly solar gravita-

tion to a slight extent), acting upon the earth to produce internal tidal friction, are converted into heat, and thus we have a steady development of heat in the interior of the earth to supply what is lost by radiation.

I do not suppose this heat sufficient to melt the rocks, nor do we in fact need to assume any high temperature in the interior of the earth. We have at present all the fluidity we need in the central portion of our planet. In the lower portion of our outer crust any breaks in the rocks are quickly healed by a welding process; it is in the quasi-viscous outer portion of the crust where pressures are less and rigidity slightly greater, and where innumerable faults break up the solid strata into fragments that slide on each other like the molecules of the small masses that we experiment on in our laboratories, that a steady tidal action produces the strains that continually cause new faults and crumples with their accompanying earthquakes, and is therefore most efficient in producing sensible heat.

Our observed earth temperatures show an increase of one degree Fahrenheit for fifty feet of descent, but it is a very violent hypothesis that assumes this increase to continue at this rate for many miles in depth.

The hardest materials that we know of would become plastic at ordinary surface temperatures and under the pressures prevailing at a depth of fifty miles; but with a slowly increasing temperature, they would become very plastic at a temperature of 1,000° Fahrenheit and the pressure prevailing at a less depth, say of twenty miles; so that the latter is the greatest thickness we need assume for our so-called solid crust.

Now, it is only in this crust that by means of crushing earthquakes, tidal friction, viscous tides, faulting, chemical action, and perhaps other causes, there takes place a continued evolution of internal heat. This heat has been conducted inward for ages, until the central sphere has attained a nearly uniform temperature; it has also been conducted outwardly for ages to the radiating surface of our globe. As the evolution of heat still continues, we have on the continents attained a pretty stable rate of temperature decrease of 100 degrees to the mile (and rather less, I suppose, under the oceans), but I do not suppose that at any time the hottest stratum within the earth has had an average temperature so high as a thousand degrees Fahrenheit (except in lava pockets).

Of course I accept the view that the specially high temperatures attending the formation of lava have been due to the local chemical action between warm rocks and water penetrating to them under great pressure through crevices in the crust.

The study of Geological Climate during and since the formation of Azoic metamorphic strata has led me to adopt the conclusion that surface geology, like volcanic, does not demand excessive temperatures; it seems to me most reasonable to assume that the surface was never much warmer than 250 degrees Fahrenheit, but to allow that this temperature may have prevailed at the close of the Archæic epoch.

At this temperature all the water of the ocean would exist only as vapor

and clouds in the atmosphere. The steady hot rain from the atmosphere would rapidly disintegrate the surface rocks. Small seas and lakes of water saturated with alkalis and salts would at once begin to form the rocks that we know as metamorphic and archæan. The covering thus formed would contribute to diminish the rate of cooling of the interior mass, thus allowing the atmosphere to cool down to its present condition and deposit the most of its moisture.

The systematic changes in the contours of the continents and the mountain ranges that have taken place since the Azoic period, like those that took place before that, have therefore not been due to any great extent to strains of contraction consequent on the general cooling of the molten nucleus of our globe, but must have been due mostly to strain produced by solar and lunar bodily tides, and to similar strains produced by the gradual slowing down of the earth's rotation, which abatement produces a tendency to return from the spheroidal back to the spherical shape; and thirdly, but to a less degree, to strains produced by the unequal cooling of those portions that have for a long time been continental and oceanic respectively.

It will thus be seen that from our present point of view the physical questions involved in dynamic geology differ from those that were the subject of discussion a few years ago, and I should hardly have dared to express myself so decidedly to-night if it were not that the study of some problems in meteorology had forced me to go over the question as to what we know about the earth's surface and its relation to our atmosphere.

336th Meeting.

April 27, 1889.

President EASTMAN in the chair.

Thirty-six members and guests present.

Mr. C. E. DUTTON read a paper on Some of the Greater Problems of Physical Geology.

Published in full in this volume, pp. 51-64.

Remarks were made upon Mr. Dutton's paper by Messrs. WOODWARD, GILBERT and DUTTON, who have prepared the following abstracts:

[Abstract.]

Mr. Gilbert found difficulty in understanding the particular way in which the crumpling of the surface layers is produced.

Assume a portion of the terrestrial surface sloping seaward and partly covered by the sea; assume that the material near the surface is homogeneous and sharply separated from the heavier material, also homogeneous, beneath: then under isostasy the surface of separation between the

lighter matter above and the heavier beneath must slope toward the land. When isostasy is disturbed by degradation on the land side or deposition under the water, the tendency to flow landward in restoration of equilibrium cannot reside in the superficial portion, because it would there be opposed by gravitation. It must be in the deeper, denser material, so deep that it is difficult to understand its crumpling effect on the surface layers.

In response to Mr. Gilbert, Captain Dutton said that there is no limit in depth to the flow. Owing to the higher rigidity of the surface rocks, the flow would be greatest at great depths, but would extend to near the surface, and by the adhesion of the parts of the viscous mass the surface portion would be carried along and crumpled in much the same manner as the rough surfaces of certain lava flows. He cited the case of the wrinkles on the surface of "pahoehoe" in the Hawaiian lavas as examples and illustrations on a small scale of the effect of a more rigid surface in a less rigid flowing mass beneath.

Remarks were also made by Mr. Woodward, who opposed the view that secular contraction plays an unimportant part in crumpling the earth's crust. While not unmindful of the difficulties of the contraction hypothesis, he considered it an essential basis for the hypothesis of isostasy. The process of isostasy tends at a relatively rapid rate toward equilibrium; it ought, apparently, to run down in a comparatively brief geologic age. The process of contraction goes on at a relatively slow rate and is continually opposing the equilibrium to which isostasy leads. Both processes tend to produce crumpling along lines of weakness, and though that of isostasy may have been the more effective of the two, it appears to require secular contraction for its maintenance.

Mr. Woodward called attention also to Dr. Helmert's recent memoir on plumb-line deflections, in which it is shown that the observed deflections in the vicinity of the Appalachians are on the whole toward the mountains rather than from them.

Mr. WALTER HARVEY WEED read a paper on The Formation of Deposits of Lime, Iron, and Silica by Plant Life.

[Abstract.]

It is a little strange that the chemical and geological work performed by plant life has not been recognized by naturalists who have studied so carefully the analogous work of the mollusks, corals, and other forms of animal life. It has long been known that certain marine algæ build stony structures of carbonate of lime, and more recently that certain mosses and fresh-water algæ are lime-encrusted because of the vital activity of the plants. My own observations upon the subject convince me that the importance of the subject is not realized, and that the deposits formed in this way are not only sometimes of great magnitude, as is the case at Tivoli and Carlsbad, and more especially in our own

Yellowstone Park, but are more common than is generally supposed, and embrace a variety of mineral deposits.

In point of magnitude and frequency of occurrence, deposits of carbonate of lime undoubtedly take first rank. The travertine deposits just alluded to, the limestones on the coast of Florida, described by Agassiz, and a host of other cases too numerous to mention, make it unnecessary to dwell upon deposits of this character further than to state that they sometimes result from a direct secretion of carbonate of lime to form the cell-wall of the plants, and sometimes from the precipitation of the carbonate of lime because of the withdrawal of carbonic-acid gas from the water by the living plants—a sufficient explanation of the chemistry of the process in either case.

It is not so well known that deposits of oxide of iron, as bog iron ore or as a silicious ocher, are also formed by living plants. This is probably because a simple oxidation resulting from exposure to the atmosphere will explain the deposition of the ferric oxide; yet it is well known to botanists that the algæ, *Leptothrix ochrocea*, secretes ferric oxide in the algæ sheaths, and that several species of diatoms form their tests of both silica and oxide of iron, and microscopic examinations of many bog ores prove them to consist very largely of these organic structures. In the Yellowstone mounds of silicious iron ocher have been found formed of the remains of a *Hypnum* in situ, with the living moss at the surface, whose green stems were formed very largely of iron.

Both algæ and mosses secrete silica and form strata of silicious sinter, and of what may be called moss sinter. As in the case of the diatoms forming the well-known deposits of diatomaceous earth, the secretion of silica by the plants seems to be due to some physiological need of the plants being first secreted as a silicious jelly by the algæ, and in sandy, gritty grains by the moss *Hypnum*. Both varieties of silicious deposits are common in the Yellowstone Park, where they are of considerable magnitude.

The strangest case of all is the formation of gypsum by the vegetation of sulphur waters. The slimy, white masses of algæ that live in sulphur springs have been found to secrete sulphur which they oxidize to sulphuric acid, the latter immediately forming sulphate of lime with the carbonate of lime in the water.

Examples of all these deposits due to plant life may be found in the Yellowstone Park, where they have been studied by the writer.

Also Published in part under the title of The Formation of Silicious Sinter by the Vegetation of Thermal Springs. Am. Jour. of Science, 8vo, New Haven, May, 1889, vol. 37, No. 221, pp. 351–359; also in The Ninth Annual Report (1887–88) of the Director of the U. S. Geological Survey (4to, Washington, 1890, pp. 613–676), under the title The Formation of Travertine and of Silicious Sinter by the Vegetation of Hot Springs.

Mr. J. C. GORDON made a communication entitled Notes on the Discovery and Development of Hearing in Certain Deaf-Mutes.

[Abstract.]

The pupils in our schools for deaf-mutes have been, before admission, with rare exceptions, under the care of physicians and aural surgeons, who have pronounced them incurably and hopelessly deaf. Instructors, until recently, have acquiesced in the diagnosis furnished, and have referred phenomena indicative of partial hearing, either to acuteness of tactile sensation or to sense-impressions, too rudimentary for use or improvement.

Experiments by the writer years ago convinced him that the prevalent opinion was a generalization too sweeping, and that a large percentage of so-called deaf-mutes were fit subjects for auricular training and development.

The honor of initiating experiments leading to important results belongs to Mr. J. A. Gillespie, of Omaha, who began in the Nebraska Institution, with selected pupils in 1880, progressive exercises in auricular development, which were carried to a successful conclusion. This led to the consideration of the subject by conventions of instructors of the deaf and to the appointment in 1884 of Professors A. G. Bell, F. D. Clark, and the writer as a committee to make thorough investigation of tests of hearing and other phases of the subject. This committee presented in 1885, through the *American Annals of the Deaf*, a preliminary report, and its members still hold in reserve much interesting matter for further investigation and study.

The writer here gave an account of the auditory apparatus, with reasons for thinking that a standard test for hearing, approaching to a standard test of vision in scientific exactness, is not attainable. After referring to various acoumeters, and to the tests and methods of expressing results approved by the American Otological Society, the telephonic audiometer devised by Professors Clark and Bell was described. This apparatus consists of a Bell receiver in circuit with the movable coil of an "induction balance," the fixed coil of which is connected with an ordinary magneto-electric machine. The rapid revolution of the armature produces a very loud sound in the telephone when the coils are together, which diminishes as the induced current becomes weaker by separating the coils, until it is finally inaudible. Provision is made for cutting off the sound at will without the knowledge of the subject tested. The vanishing point of the sound, or the initial point as the coils approach, as read on a centimeter scale measuring the separation of the coils, is taken as the measure of audition. This vanishing point in persons whose hearing is good ranges, say, from 55 to 87 centimeters, and is rarely the same for both ears. Though this apparatus was suggested by Hughes' sonometer, important modifications are apparent which make it simpler

and efficient. Comparative constancy, wide range, compactness and portability adapt it to testing the hearing of large numbers of persons at different times and places, and it has been used in testing the hearing of about fifteen hundred deaf-mutes in New York, Washington, New Jersey, Illinois, and Arkansas. Comparative tests and subsequent training demonstrate that not less than 15 per cent. of these possess utilizable hearing, requiring systematic education and the judicious use of special appliances for satisfactory results.

Sexton's binaural conversation tube, Currier's duplex tube, Maloney's otaphone, an audiphone, and an English conical tube were exhibited.

In 1888 twenty-four American schools reported 261 pupils under auricular training. Certain cases present interesting and novel phenomena for the psychologist and many throw light upon problems in physiology.

The writer's notes briefly discussed hypnotic experiments with a view to the alleviation of deafness; also European experiments in auricular development.

In certain cases the evidence of improvement in the auditory apparatus appears to be conclusive. In the majority of cases the improvement may be in sense-perception. It is not claimed that hearing is restored, nor that hearing is supplied where none existed, but simply that in certain cases rudimentary or dormant hearing may be detected and developed to a useful extent, thus giving to a large percentage of "deaf-mutes" much of the profit and pleasure gained through what is to them practically, if not scientifically, a new sense.

337th Meeting.

May 11, 1889.

President EASTMAN in the chair.

Twenty-nine members present.

The Chair announced the election to membership of Mr. WILBUR OLIN ATWATER.

Mr. ARTHUR KEITH read a paper on The Rocks of the Great Smokies and Their Age.

Mr. D. C. CHAPMAN made a communication on A New Form of Galvanometer.

[Abstract.]

This instrument was devised and constructed in response to a demand for a cheap and convenient means of comparing heavy currents with a fair degree of accuracy.

Its coil consists of a number of heavy copper rods or bars placed parallel to each other and secured by transverse bars or blocks of copper into

which their ends project, making good electrical contact with these blocks and thus with each other. This gridiron arrangement, the length of which is about six times its width, is then bent in the middle, so that one half lies above and parallel to the other, their planes being separated by about one inch.

When a current is led into one end of one of the end blocks it divides nearly equally among the parallel rods and returns to the opposite end of the other, producing an approximately uniform magnetic field in the inclosed space, as well as in the space immediately above. A needle of proper dimensions may be placed in either of these positions and a large range of sensibility is the result. The instrument may be calibrated by any of the ordinary methods.

338th Meeting.

May 25, 1889.

President EASTMAN in the chair.

Thirty-four members present.

The Chair announced the death of Mr. E. B. LEFAVOUR, a member of the Society.

Mr. E. D. PRESTON read a paper on The Reduction of Pendulum Observations.

Published in full in this volume, pp. 115-130.

Mr. J. P. IDDINGS read a paper on The Crystallization of Igneous Rocks.

Published in this volume, pp. 65-113.

Mr. W. H. DALL made a communication on Some Forms of the Gill in Pelecypod Mollusca.

The facts of this paper are incorporated in Mr. Dall's report on The Gasteropoda and Scaphopoda: Bulletin Museum of Comparative Zoology, Cambridge, vol. 18, June, 1889.

339th Meeting.

October 12, 1889.

President EASTMAN in the chair.

Forty members present.

The Chair announced the election to membership of Mr. OLIVER LANARD FASSIG.

Mr. EVERETT HAYDEN made a communication on The Hurricanes of the Bay of North America.

Published in full in this volume, pp. 173-189.

Mr. FRANK BAKER made a communication on Work of the Life-Saving Crews during the Recent Hurricane.

340th Meeting.

October 26, 1889.

President EASTMAN in the chair.

Twenty-four members present.

Mr. ROMYN HITCHCOCK read a paper on The Action of Light on Silver Chloride.

Published in full in Anthony's Photographic Bulletin, 8vo, New York, December, 1889, vol. 20, pp. 748-754; also in American Chemical Journal, 8vo, Baltimore, October, 1889, vol. 11, pp. 474-480.

Mr. F. W. CLARKE made a communication on The Relative Abundance of Chemical Elements.

Published in full in this volume, pp. 131-142.

Mr. WILLIAM HALLOCK made a communication entitled Chemical Action Between Solids.

Published in full in the American Journal of Science, 8vo, New Haven, 1889, May, vol. 37, No. 221, pp. 402-406.

341st Meeting.

November 9, 1889.

President EASTMAN in the chair.

Sixty members present.

Mr. ASAPH HALL made a communication on Saturn and its Ring.

Published in full as Appendix II of Washington Observations for 1885, 4to, Washington, Government Printing Office.

Mr. C. E. DUTTON made a communication entitled Remarks on Irrigation in the Arid Region.

342d Meeting.**November 23, 1889.**

President EASTMAN in the chair.

Forty-two members present.

Mr. GEORGE H. ELDRIDGE read a paper on Certain Structural Features near Denver, Colorado.

Published in this volume, pp. 247-274.

Mr. J. S. DILLER made a communication on The Sandstone Dikes of Northern California.

Published in Bulletin of the Geological Society of America, 8vo, Washington, April 1890, vol. 1, pp. 411-442.

343d Meeting.**December 7, 1889.**

Vice-President DUTTON presided.

About two hundred members and guests present.

By courtesy of the trustees of the Columbian University, the meeting was held in the law lecture-room of the University building. Members of the other scientific societies in Washington and their friends were invited to be present.

President EASTMAN delivered the annual address, entitled The Association of Assumption and Fact in the Theories of Solar and Stellar Proper Motions.

Published in full in this volume, pp. 143-172.

344th Meeting.**December 21, 1889.**

NINETEENTH ANNUAL MEETING.

President EASTMAN in the chair.

Thirty-one members present.

The chair announced the election to membership of Messrs. GEORGE WASHINGTON LITTLEHALES and of JOHN FILLMORE HAYFORD.

The annual report of the Secretaries was read as follows, and accepted:

ANNUAL REPORT OF THE SECRETARIES.

WASHINGTON, D. C., *December 21, 1889.*

To the Philosophical Society of Washington :

We have the honor to present the following report, containing the usual statistics, for the year from December 22, 1888, to December 21, 1889—that is, from the 327th to the 343d meeting (inclusive) of the Society.

At the date of the last annual report, December 22, 1888, there were 185 active members upon the rolls. This number has been increased by the addition of 10 new members and by the return of 1 absent member. It has been decreased by 3 who have been transferred to the absent list, 1 who has resigned, 2 who have been dropped for non-payment of dues, and 2 who have died, 1 upon the active list and 1 absent. There has thus been a net increase of 4 in the active membership, which now numbers 189.

Invitations to attend the meetings of the Society for a period of 3 months have been extended to 2 gentlemen.

The roll of new members is :

C. WILLARD HAYES.
COSMOS MINDELEFF.
VICTOR MINDELEFF.
C. WHITMAN CROSS.
J. G. HAGEN, S. J.

J. E. WATKINS.
W. O. ATWATER.
O. L. FASSIG.
G. W. LITTLEHALES.
J. F. HAYFORD.

The deceased members are Jerome H. Kidder, who died April 6, 1889, and Edward B. Lefavour, who died at Beverly, Massachusetts, May 18, 1889. Dr. Kidder was, at the time of his death, a member of the General Committee of the Society and a regular and interested attendant at its meetings. For two years he served with marked ability as general secretary.

The Society has held 17 regular meetings; 15 of these have been devoted to the presentation and discussion of papers; one to the address of the retiring President, and one to the annual reports and the election of officers. The average attendance at the 15 meetings for the presentation of papers has been 40. Thirty-eight communications have been presented, 35 of which

have been by members, and 3 by guests; 54 members and guests have taken part in the proceedings.

The Society is indebted to the courtesy of the authorities of the Columbian University for the use of their large lecture-room on December 7, when the President presented his annual address, and for the use of a smaller room in which the meetings of the Mathematical Section have been held. All other meetings of the Society have been held in the hall of the Cosmos Club, the Society paying a small amount to defray a portion of the expense of lighting and heating.

In the Mathematical Section 7 meetings have been held, with an average attendance of 14; 14 communications have been presented, 22 members and guests have participated in the discussions, and an aggregate of 23 members and guests in the scientific proceedings of the section.

The General Committee has held 15 regular meetings and 1 special meeting; the average attendance has been 13, the least number at any meeting being 8, and the greatest, 17.

The new rules for the publication of the Bulletin, which were adopted December 22, 1888, were first applied to the address of the retiring President for that year, Mr. GARRICK MALLERY. The paper was printed in February, 1889, and was at once distributed to the members of the Society. Seven papers have now been published, including the address of the President for 1889, and we believe that the new method of publication has added materially to the value of our Bulletin.

Very respectfully,

J. S. DILLER,
W. C. WINLOCK,
Secretaries.

The annual report of the Treasurer was read, accepted, and referred to an Auditing Committee, consisting of C. D. Walcott, W. A. De Caindry, and W. Eimbeck.

REPORT OF THE TREASURER.

The report which I shall have the honor to submit to you exhibits the total receipts and disbursements for the fiscal year ending with this meeting. In the receipts are included amounts received for outstanding dues of previous years and for dues paid in advance for 1890 and 1891. The precise income for the year 1889 was \$871.79, and the total expenditures \$604.47, leaving a balance in favor of the Society, upon the year's transactions, of \$267.32.

The change in the form of the Bulletin from a single volume, published complete, to separate fasciculi, printed at different times, has added somewhat to the expense of printing and distributing, but this is more than compensated for by the advantages to members from prompt publication of their papers.

The assets of the Society consist of—

One Government bond, at 4 per cent., No. 64,596 . . .	\$500 00
One Government bond, at 4 per cent., No. 135,639 . .	1,000 00
One Government bond, at 4½ per cent., No. 41,719 . .	1,000 00
Six mortgage bonds of the Cosmos Club, at 5 per cent., Nos. 16 to 21, for \$100 each	600 00
Cash with Riggs & Co.	1,408 58
Unpaid dues	200 00
	<hr/>
Total	\$4,708 58

ROBERT FLETCHER,
Treasurer.

WASHINGTON, D. C., *December 21, 1889.*

DR. *The Treasurer in Account with The Philosophical Society of Washington.* CR.

1889. Dec. 21	To balance, cash on hand, Dec. 22, 1888... To cash received for dues of 1887. \$30 00 " " " " 1888. 140 00 " " " " 1889. 735 00 " " " " 1890. 10 00 " " " " 1891. 5 00	\$956 26	1889. Dec. 21	By cash paid Judd & Detweiler for printing fasciculi of Bulletin..... By cash paid for miscellaneous printing, postal cards, bills, circulars, etc..... By cash paid janitor for attendance at meetings of Mathematical Section..... By cash paid miscellaneous expenses of Secretaries, Treasurer, and committees for stationery, postage, and clerk hire... By cash paid miscellaneous expenses, for lighting hall, etc..... Balance with Riggs & Co.....	\$337 53 100 98 9 00 99 96 57 00 1,408 58
	On \$1,500 Gov't bonds, @ 4%. \$60 00 " 1,000 " " @ 4½%. 45 00 " 600 m't'ge bonds, @ 5%. 30 00	135 00			
	To cash received for sales of Bulletin....	1 79			
		\$2,013 05			\$2,013 05

WASHINGTON, December 21, 1889.

ROBERT FLETCHER, *Treasurer.*

The election of officers for the year 1890 was then held, with the following result:

President.....C. E. DUTTON.

Vice-Presidents..... { G. K. GILBERT. H. H. BATES.
G. B. GOODE. T. C. MENDENHALL.

Treasurer.....ROBERT FLETCHER.

Secretaries.....W. C. WINLOCK. J. S. DILLER.

MEMBERS-AT-LARGE OF THE GENERAL COMMITTEE.

MARCUS BAKER.

H. M. PAUL.

F. W. CLARKE.

C. V. RILEY.

W. H. DALL.

O. H. TITTMANN.

G. W. HILL.

LESTER F. WARD.

R. S. WOODWARD.

PAST PRESIDENTS, EX-OFFICIO MEMBERS OF THE GENERAL COMMITTEE.

J. S. BILLINGS, 1886.

GARRICK MALLERY, 1888.

J. R. EASTMAN, 1889.

SIMON NEWCOMB, 1879, 1880.

ASAPH HALL, 1885.

J. W. POWELL, 1883.

WM. HARKNESS, 1887.

W. B. TAYLOR, 1883.

J. C. WELLING, 1884.

STANDING COMMITTEES.

On Communications:

T. C. MENDENHALL, *Chairman*. G. BROWN GOODE. C. V. RILEY.

On Publications:

ROBERT FLETCHER, *Chairman*. MARCUS BAKER. W. C. WINLOCK.

GENERAL MEETINGS.

1890.

345th Meeting.

January 4, 1890.

President DUTTON in the chair.

Thirty members present.

The report of the committee appointed to audit the accounts of the Treasurer was read and adopted.

REPORT OF AUDITING COMMITTEE.

WASHINGTON, *December 31, 1889.**To the Philosophical Society of Washington :*

The undersigned, a committee appointed at the annual meeting of the Philosophical Society of Washington, December 21, 1889, for the purpose of auditing the accounts of the Treasurer, respectfully report as follows :

We have examined the account of receipts, including dues, sales, and interest, and find the same to be correct and satisfactory. We have examined the statement of disbursements, compared it with the vouchers, and find that they agree. We have examined the returned checks, which agree with the vouchers and with the bank book, the balance of which, as reported by Riggs & Co. on December 24, 1889, was \$1,408.58, agreeing with the Treasurer's report. We have examined the United States and other bonds belonging to the Society and find them to be in amount and character as represented in the Treasurer's report, aggregating \$3,100.

CHAS. D. WALCOTT.
WM. A. DE CAINDRY.
WILLIAM EIMBECK.

Read, adopted, and the committee discharged January 4, 1890.

J. S. DILLER,
Secretary.

Mr. H. A. HAZEN made a communication on The Brocken Spectre.

Published in *Science*, vol. 14, p. 224, September 27, 1889.

Mr. W J McGEE made a communication on The Southern Extension of the Columbian Formation.

Published in abstract in *Proceedings of the American Association for the Advancement of Science*, vol. 39, p. 244, 1890.

346th Meeting.

January 18, 1890.

President DUTTON in the chair.

Fifty members present.

The President announced the death of Professor J. H. C. COFFIN, who was one of the founders of the Society, and died January 8, 1890.

The two standing subcommittees for 1890 were then announced as follows:

On Communications:

T. C. MENDENHALL.

C. V. RILEY.

G. B. GOODE.

On Publications:

ROBERT FLETCHER.

W. C. WINLOCK.

MARCUS BAKER.

Hon. EDWIN WILLETS made a communication on The Scientific Work of the Department of Agriculture.

Published as a special report, included in the Report of the Secretary of Agriculture for 1890, pp. 59-73.

Mr. J. P. IDDINGS read a paper on The Relation Between the Mineral Composition and Geologic Occurrence of Certain Igneous Rocks of the Yellowstone National Park.

Published in this volume, pp. 191-220.

347th Meeting.**February 1, 1890.**

Vice-President GILBERT in the chair.

Forty members present.

Mr. C. HART MERRIAM read a paper on The General Results of a Biological Survey of the San Francisco Mountain Region of Arizona.

Published in U. S. Department of Agriculture, Division of Ornithology and Mammalogy, North American Fauna, No. 3, pp. 1-136, pl. 13, maps 5.

348th Meeting.**February 15, 1890.**

President DUTTON in the chair.

Seventy-five members and guests present.

The President announced the election of JOSEPH STANLEY-BROWN and LINCOLN GRANT EAKINS as members of the Society.

Mr. GARDINER G. HUBBARD gave An Account of Stanley's Discoveries in Africa.

Not published.

Mr. C. D. WALCOTT read a paper entitled A Study in Structural Geology.

Published under the title "Study of a Line of Displacement in the Grand Cañon of the Colorado in Northern Arizona," Bulletin of the Geological Society of America, vol. 1, pp. 48-64, 8vo, Washington, 1890.

349th Meeting.**March 1, 1890.**

President DUTTON in the chair.

Forty members present.

Mr. G. BROWN GOODE made a communication on The Origin of our National Scientific Institutions.

Published in Papers of the American Historical Association, 8vo, New York, 1890.

Mr. C. R. VAN HISE made a communication on the Pre-Cambrian Rocks of the Black Hills of Dakota.

Published in Bulletin of the Geological Society of America, vol. 1, pp. 203-244, 8vo, Washington, 1890.

350th Meeting.

March 15, 1890.

Vice-President GILBERT in the chair.

Thirty members present.

Mr. B. E. FERNOW read a paper on The Relation of Forests to Water Supplies.

Published by U. S. Department of Agriculture, Report of the Chief of the Forestry Division for 1889, pp. 297-330.

Mr. G. E. CURTIS made a communication on The Relation of Surface and Climatic Conditions to the Flow of Water-Courses.

Not published.

351st Meeting.

March 29, 1890.

President DUTTON in the chair.

Thirty-four members present.

The President announced the election to membership of JOSEPH FRANCIS JAMES and GEORGE MARIE SEARLE.

The Secretary read a letter from the University of Toronto, Canada, giving an account of the losses to the university on February 14, 1890, by fire and soliciting donations of publications for a new library.

Mr. MARCUS BAKER read an obituary notice of Edward Brown Lefavour.

Published in this volume, pp. 488-490.

Mr. O. H. TITTMANN read A Note on the Length of Kater's Pendulum.

Published in Nature April 10, 1891, vol. 41, No. 1067, p. 538.

Mr. HERMAN HOLLERITH exhibited and described a new electrical tabulating machine.

Description published in U. S. letters patent Nos. 395781, 395782, 395783, January 8, 1889.

352d Meeting.

April 12, 1890.

President DUTTON in the chair.

Forty-five members and guests present.

Announcement was made of the election to membership of CHARLES RICHARD VAN HISE, ERNEST GEORGE FISCHER, and ALFRED CHARLES TRUE.

Mr. J. R. EASTMAN read a paper on The Progress of Meteoric Astronomy.

Published in this volume, pp. 275-358.

By invitation, Prof. B. G. WILDER made a communication on The Comparative Anatomy of the Simian and Human Brain.

Not published.

353d Meeting.

April 26, 1890.

President DUTTON in the chair.

Forty-five members present.

Mr. G. W. LITTLEHALES read a paper on A New Method of Recording and Reproducing Articulate Speech.

Published in U. S. letters patent No. 404,850.

Mr. WILLIAM EIMBECK read a paper on A New Method of Determining Astronomical Differences of Longitude.

Not published.

Mr. ROMYN HITCHCOCK read a paper on The Burial Mounds of Japan.

Published in the Smithsonian Institution Annual Report for 1891.

354th Meeting.**May 10, 1890.**

President DUTTON in the chair.

Thirty-four members present.

Mr. J. ELFRETH WATKINS read a paper on Early Dividing Engines, with special reference to that constructed by Ramsden in 1775.

Published in the Report of the National Museum, 1888-'89.

Mr. W J MCGEE read a paper on Recent Geographic Changes on the Atlantic and Gulf Coasts.

Published, under the title "Encroachments of the Sea," in The Forum, 8vo, New York, June, 1890, vol. 9, No. 4, pp. 437-449.

355th Meeting.**May 24, 1890.**

Vice-President GILBERT in the chair.

Thirty-five members present.

The election to membership of Dr. FRANK BAKER and Mr. A. W. HARRIS was announced.

Mr. H. G. OGDEN read a paper on Chart-Making.

Not published.

Mr. FREDERICK W. TRUE read a paper entitled An Epitome of the Natural History of the Puma.

Published in the Report of the National Museum, 1888-'89, pp. 591-608.

356th Meeting.**October 11, 1890.**

Vice-President GILBERT in the chair.

Forty-five members and guests present.

The Chair announced the death of Capt. C. O. BOUTELLE, who died June 22, 1890. He announced also the election to

membership of Messrs. B. A. COLONNA, HERMAN HOLLERITH, W. P. JENNEY, W. R. ATKINSON, WALDEMAR LINDGREN, and H. W. TURNER.

Mr. CLEVELAND ABBE gave a General Account of the Eclipse Expedition to Africa, especially as to its results in the study of meteorology.

This will be published in Professor Abbe's contribution to Professor D. P. Todd's preliminary report to the Secretary of the Navy on the U. S. Scientific Expedition to the West Coast of Africa.

Mr. H. S. REID, of the Case School of Science, Cleveland, Ohio, presented by request a Note on the Muir Glacier of Alaska.

Published in Johns Hopkins Circular No. 84, December, 1890.

357th Meeting.

October 25, 1890.

Vice-President BATES in the chair.

Thirty-six members present.

Mr. WILLIAM HARKNESS made a communication On the Determination of the Mass of the Moon from the Tides.

Published by the U. S. Naval Observatory, in 1891, under the title The Solar Parallax and its Related Constants, pp. 112-121, Washington Observations for 1885, Appendix III.

Mr. F. H. BIGELOW made Some Suggestions on Eclipse Photography and Eclipse Apparatus.

The substance of the suggestions will be published in the report to the Secretary of the Navy on the Scientific Expedition to the West Coast of Africa in 1889.

358th Meeting.

November 9, 1890.

Vice-President GILBERT in the chair.

Forty-two members present.

The Chair announced the election to membership of Dr. JOSEPH POHLE.

Mr. J. ELFRETH WATKINS read a paper on The Beginnings of Engineering.

Published in the proceedings of the American Society of Civil Engineers, May, 1891.

Mr. J. HOWARD GORE read a paper on The Decimal System of the Seventeenth Century.

Published in the American Journal of Science, January, 1891, 3d ser., vol. 41, pp. 22-27.

359th Meeting.

November 22, 1890.

Vice-President GILBERT in the chair.

Thirty-four members present.

Mr. CHARLES F. MARVIN read a paper on Wind Pressures and the Measurement of Wind Velocities.

Substance published in the Engineering Journal December 13, 1890, p. 520; also in American Meteorological Journal for February, 1891, p. 487.

Mr. WILLIAM HALLOCK made a communication on The Coefficient of Expansion of Some Rocks.

Published in U. S. Geological Survey Bulletin No. 78, pp. 109-116.

360th Meeting.

December 6, 1890.

Vice-President GILBERT in the chair.

Forty-nine members present.

Mr. E. G. FISCHER read a paper on Standard Screws and Threads.

Not published.

Mr. GILBERT THOMPSON communicated An Example of Work in Barometric Hypsometry.

Not published.

Mr. B. E. FERNOW read a paper on The Artificial Production of Rainfall.

Published by the U. S. Department of Agriculture, Report of the Chief of the Forestry Division for the year 1890, pp. 227-235.

361st Meeting.

December 20, 1890.

TWENTIETH ANNUAL MEETING.

President DUTTON in the chair.

Thirty-nine members present.

After the reading and approval of the minutes of the nineteenth annual meeting, the annual report of the Secretaries was read and accepted.

ANNUAL REPORT OF THE SECRETARIES

WASHINGTON, D. C., *December 20, 1890.*

To the Philosophical Society of Washington:

We have the honor to present the following annual report for 1890:

At the beginning of the year the Society numbered 189 active members. During the year this number has been increased by the addition of 18 new members. Four members have been transferred to the absent list, 1 has been dropped for the non-payment of dues, 2 have resigned, and 2 have died. The total decrease in the membership of last year has been 9; but, as the increase has been 18, the active membership of the Society has risen to 198.

An invitation to attend the meetings of the Society for a period of 3 months was extended to one gentleman.

The roll of new members is:

J. F. DAWSON.	J. STANLEY-BROWN.	L. G. EAKINS.
G. M. SEARLE.	A. W. HARRIS.	C. R. VAN HISE.
E. G. FISCHER.	A. C. TRUE.	FRANK BAKER.
B. A. COLONNA.	HERMAN HOLLERITH.	W. P. JENNEY.
W. R. ATKINSON.	WALDEMAR LINDGREN.	H. W. TURNER.
JOSEPH POHLE.	F. H. BIGELOW.	J. F. JAMES.

The roll of the deceased members is :

J. H. C. Coffin, one of the founders of the Society, died January 8, 1890. C. O. Boutelle died June 22, 1890.

The Society has held 17 meetings—16 for the presentation of papers and one for the annual reports and election of officers.

All the meetings were held in the assembly hall of the Cosmos Club.

The average attendance at the meetings for the reading of papers has been forty-one and one-half, an increase of one and one-half upon the average attendance of last year.

Thirty-four communications have been presented to the Society by 28 members and 4 guests.

Two members have presented two papers each.

Sixty-seven remarks were made by 39 members.

In all, 52 members, which is over 25 per cent. of the active membership of the Society, have taken part in its proceedings.

It has been the custom of the Society to set apart the meeting next preceding the annual meeting for the delivery of the President's annual address, but the President found it to be impossible for him, on account of his other official duties, to deliver the address at the appointed time.

The address was postponed and a program for the meeting furnished by the Committee on Communications.

The Mathematical Section has held 7 meetings, with an average attendance of 11. Nine communications were presented to the section and an aggregate of 12 members participated in its proceedings.

The General Committee has held 17 regular meetings and one special meeting, with an average attendance of 13.

The least number at any meeting was 11 and the greatest 16.

Last year 38 communications were presented to the Society.

Of these, 9, including the annual address of the President, have been published by the Society. During the year just closed, as already stated, 34 communications were presented, and of these only 3 have been offered to the Society for publication; 2 have already been published and 1 is in course of publication.

It should be noted, however, that the annual address of the President has not yet been communicated, and that the two papers published this year are above the average length. The 9

published of those read last year contained an aggregate of 220 pages.

They average twenty-four and one-half pages each, while the two published this year average 49 pages each.

Concerning the remaining 31 communications presented to the Society, but not offered to it for publication, the following information has been obtained :

4 have been or will be published in the Reports of the Department of Agriculture.

4 in reports of the Smithsonian Institution or National Museum.

2 in the bulletins of the Geological Society of America.

1 in a bulletin of the U. S. Geological Survey.

1 in the American Journal of Science.

1 in the publications of the Naval Observatory.

1 in the report of the Secretary of the Navy.

1 in the proceedings of the American Society of Civil Engineers.

1 in the papers of the American Historical Association.

1 in Nature.

1 in The Forum.

1 in Science.

1 in School of Mines Quarterly.

1 in Johns Hopkins University circulars.

1 in letters patent.

7 have not been published ; 2 have not been heard from.

Very respectfully,

W. C. WINLOCK,

J. S. DILLER,

Secretaries.

The report of the Treasurer was then read.

REPORT OF THE TREASURER.

The report which I have the honor to submit to you exhibits the total receipts and disbursements for the fiscal year ending with this meeting. In the receipts are included some amounts received for outstanding dues for previous years, and in the disbursements are included amounts paid in purchase of bonds.

The precise income for the year 1890 was \$988.88, and the expenditures for the same period \$784.88, leaving a balance in favor of the Society upon the year's transactions of \$204.00.

The Society possessed a Government bond, No. 41,719, for \$1,000.00, bearing interest at 4½ per cent., which was sold in December under the offer of the Secretary of the Treasury to purchase these bonds at face value with a year's interest in advance. It is difficult to find a satisfactory investment for a small sum of money, but the amount in question was used for the purchase of ten Cosmos Club second-mortgage bonds, which fortunately happened to be for sale to close an estate. The Society already owned 12 of these bonds, purchased from surplus funds. Upon February 1, 1891, these bonds will become first-mortgage bonds, and as the total amount of the loan is \$20,000, secured by mortgage upon property valued at four times that sum, the security cannot be excelled.

The assets of the Society consist of—

1 Government bond, at 4 per cent., No. 64,596.....	\$500 00
1 Government bond, at 4 per cent., No. 135,639.....	1,000 00
22 bonds of the Cosmos Club, at 5 per cent., Nos.	
16-21, 119-132, 135 and 136.....	2,200 00
Cash with Riggs & Co.....	1,133 40
Unpaid dues.....	245 00
	<hr/>
Total.....	\$5,078 40

ROBERT FLETCHER,
Treasurer.

WASHINGTON, D. C., *December 20, 1890.*

GENERAL MEETINGS.

1891.

362d Meeting.

January 3, 1891.

President MENDENHALL in the chair.

Forty-eight members and guests present.

The report of the committee appointed to audit the accounts of the Treasurer was read, accepted, and placed on file.

REPORT OF AUDITING COMMITTEE.

WASHINGTON, D. C., *December 31, 1890.*

To the Philosophical Society, Washington, D. C. :

The undersigned, a committee appointed at the annual meeting of the Philosophical Society of Washington, December 20, 1890, for the purpose of auditing the accounts of the Treasurer, respectfully report as follows :

We have examined the statement of receipts, including dues, sales, and interest, and find the same to be correct. We have examined the statement of disbursements, compared it with the vouchers, and found that they agree. We have examined the returned checks, which agree with the bank book and with the vouchers.

The balance of cash on hand, reported by the Treasurer as \$1,133.40, is accounted for by the receipt of W. A. De Caidry, the newly elected Treasurer. The other assets of the Society, as reported by the Treasurer, are also accounted for by the receipt of W. A. De Caidry. They are as follows :

1 Government bond, at 4 per cent., No. 64,596.....	\$500 00
1 Government bond, at 4 per cent., No. 135,639.....	1,000 00
22 bonds of the Cosmos Club, at 5 per cent., Nos. 16-21, 119-132, 135 and 136.....	2,200 00
Total.....	<u>\$3,700 00</u>

EDWARD FARQUHAR.
GEORGE E. CURTIS.

Mr. G. E. CURTIS read a paper on The Hot Winds of the Plains. Published in the Seventh Triennial Report of the Kansas State Board of Agriculture, part 2, 1891, pp. 162-183.

Remarks were made by Messrs. BIGELOW and HAZEN.

Mr. O. T. MASON read a paper on The Study of Religions by the Methods of Natural History.

Not published.

Remarks were made by Messrs. E. FARQUHAR, MUSSEY, and MASON.

Mr. J. E. WATKINS read a paper entitled The Log of the Savannah, a Pioneer Transatlantic Steamship.

363d Meeting.

January 17, 1891.

President MENDENHALL in the chair.

Thirty-four members present.

The following standing committees were announced :

On Communications :

G. BROWN GOODE.

F. W. CLARKE.

H. M. PAUL.

On Publications :

ROBERT FLETCHER.

MARCUS BAKER.

W. C. WINLOCK.

W. A. DE CAINDRY.

The Chair announced the death of the oldest and one of the most eminent members of the Society, Mr. GEORGE BANCROFT, the great historian, who died January 17 in this city.

Mr. H. A. HAZEN read a paper on The Lawrence (Massachusetts) Tornado of July 26, 1890.

Published in the Monthly Weather Review, July, 1890.

Remarks were made by Messrs. CURTIS, GREEN, PAUL, HAZEN, EASTMAN, and BIGELOW.

Mr. ASAPH HALL made a communication entitled Note on ζ Cancri.

Not published.

Remarks were made by Messrs. BATES, ^{H.}FARQUHAR, PAUL, GILBERT, CHAPMAN, and HALL.

364th Meeting.

January 31, 1891.

President MENDENHALL in the chair.

Thirty-eight members and guests present.

The Chair announced the election and qualification for membership of Mr. THOMAS WILLIAM SMILLIE.

Mr. C. V. RILEY read a paper on Bacteriology in Applied Entomology.

Not published.

Mr. H. W. TURNER made a communication on An Extinct Lake of Pleistocene Times in the Sierra Nevada, California.

Published in this volume, pp. 385-410.

Remarks were made by Messrs. GILBERT and DILLER.

Mr. W J McGEE read a paper on The Flood Plains of Rivers.

Published in The Forum for April, 1891, pp. 221-234.

365th Meeting.

February 14, 1891.

By the courtesy of the authorities of Columbian University the meeting was held in the lecture-room of that institution to listen to the address of the retiring president, Major C. E. DUTTON, on the subject "Money Fallacies."

Published in this volume, pp. 359-384.

The President, T. C. MENDENHALL, occupied the chair and there were about 150 members and invited guests present.

366th Meeting.**February 28, 1891.**

President MENDENHALL in the chair.

Fifty-five members present.

The Chair announced the death of CHARLES CHRISTOPHER PARRY, which occurred at his residence, in Davenport, Iowa, February 20, 1890.

Mr. EDWARD GOODFELLOW read a biographical notice of the late Capt. C. O. BOUTELLE.

Published in this volume, pp. 466-471.

Vice-President GILBERT was called to the chair and Mr. MENDENHALL exhibited and described a new pendulum apparatus.

Not published.

Remarks were made by Messrs. PAUL, HARKNESS, ABBE, BAKER, LANGLEY, BIGELOW, PRESTON, and MENDENHALL.

Mr. A. C. TRUE read a paper On the Status and Tendencies of the Agricultural Experiment Stations.

The substance of this paper is published in the annual reports of the Secretary of Agriculture for 1889, pp. 485-544, and 1890, pp. 489-555.

367th Meeting.**March 14, 1891.**

President MENDENHALL in the chair.

Forty members present.

The election and qualification of the following individuals for membership in the Society was announced :

HENRY NEWLIN STOKES, JOSEPH KAY McCAMMON, ROLLIN ARTHUR HARRIS.

Mr. SWAN M. BURNETT made a communication on A New Metric System of Numbering Prisms, and exhibited apparatus for applying the system.

The substance of the paper is published in "Ophthalmic Review," London, January, 1891; also in "Medical News," Philadelphia, May 2, 1891.

Mr. E. D. PRESTON read a paper on The Study of the Earth's Figure by Means of the Pendulum.

Not published.

Remarks were made by Messrs. WOODWARD and PRESTON.

Mr. J. HOWARD GORE read a paper on The Geodetic Operations in Russia.

Published in the Smithsonian Report for 1890.

The final paper of the evening was by Mr. J. STANLEY-BROWN on Bernardinite: Is it a Mineral or a Fungus?

Published in the American Journal of Science, July, 1891, vol. 42, pp. 46-50.

368th Meeting.

March 28, 1891.

Vice-President R. S. WOODWARD presided.

Forty members present.

Mr. HENRY FARQUHAR made a communication on The Commercial Growth and Import Duties of the United States. Illustrated by curves.

Published in chapter III of a work entitled "Economic Delusions," by A. B. and H. Farquhar. Published by G. P. Putnam's Sons, New York.

Mr. W J MCGEE read a paper on The Mississippi Bad Lands. Not yet published.

Remarks were made by Messrs. VAN HISE and MCGEE.

Mr. R. W. SHUFELDT read a paper on Indian Types of Beauty, and illustrated the subject by a series of lantern slides.

Not yet published.

369th Meeting.

April 11, 1891.

Vice-President GILBERT in the chair.

Eleven members present.

On motion of Mr. GOODE, it was voted that on account of the

small attendance, due to the inclemency of the weather, the reading of the papers upon the program be deferred until the next meeting.

370th Meeting.**April 25, 1891.**

Vice-President GILBERT in the chair.

Thirty-three members present.

The election and qualification of Mr. W. K. CARR as a member of the Society was announced.

Two papers, illustrated by a series of specimens, were read On the Characteristic Radiate Growth in Acid Lavas, the first by Mr. W. CROSS, entitled Constitution and Origin of Spherulites (published in this volume, pp. 411-444), and the second by Mr. J. P. IDDINGS, entitled Spherulitic Crystallization in Obsidian (published in this volume, pp. 445-464).

Remarks were made by MESSRS. ABBE, GILBERT, LITTLEHALES, IDDINGS, and CROSS.

Mr. R. S. WOODWARD gave a review of Tisserands *Traité de Mécanique Céleste*.

Published in the *Annals of Mathematics*, vol. 6, No. 1.

Remarks were made by MESSRS. KUMMEL and WOODWARD.

371st Meeting.**May 9, 1891.**

Vice-President GILBERT in the chair.

Twenty-one members present.

The death of Prof. JULIUS E. HILGARD, one of the founders of the Society, was announced. It occurred at his residence in this city on May 8.

Mr. F. W. CLARKE made a communication on A Theory of the Mica and Chlorite Groups.

To be published in the *American Journal of Science* early in 1892.

Mr. J. W. POWELL read a paper on Evolution of Industry.
Not yet published.

372d Meeting.

May 23, 1891.

Vice-President GILBERT in the chair.

Eighteen members and one guest present.

Mr. R. T. HILL made a communication on Some Recent Geographical and Geological Explorations in the Southwest.

Published in the American Journal of Science, July, 1891; also in the Report of the U. S. Artesian Inquiry for 1891.

Remarks were made by MESSRS. WARD and HILL.

Mr. F. H. NEWELL read a paper on Stream Measurements in the Western States.

To be published under the head of Hydrography, in the Twelfth Annual Report of the Director of the U. S. Geological Survey.

Mr. D. E. SALMON read a paper On the Objects and Methods of the System of National Cattle and Meat Inspection.

Not published.

373d Meeting.

October 10, 1891.

President MENDENHALL in the chair.

Fifty members and guests present.

The President announced the election and qualification for membership of Dr. ALBERT L. GIHON U. S. N.; also the death, since the last meeting, of ASA OWEN ALDIS, June 24, 1891, and WILLIAM FERREL, September 18, 1891.

Mr. CLEVELAND ABBE made a communication on Meteorology in Europe and America.

Not published.

Remarks on Mr. Abbe's paper were made by Messrs. HARKNESS, HAYDEN, MUZZEY, and FERNOW.

Mr. G. E. CURTIS made a communication on The Rain-making Experiments in Texas.

Published in *Nature*, vol. 44, October 22, 1891, p. 594.

A general discussion followed, participated in by Messrs. FERNOW, CLARKE, HALLOCK, RILEY, MCGEE, and ABBE.

Mr. F. W. CLARKE made a communication on The Gem Localities of Maine, with exhibition of specimens.

Not published.

374th Meeting.

October 24, 1891.

President MENDENHALL in the chair.

Thirty members and guests present.

Mr. FRANK H. BIGELOW presented An Account of the Experiments for Eliminating the Error of Personal Equation from Stellar Transits by Photography, with exhibition of instruments and photographic negatives.

Published in the January number of the *New Sidereal Messenger and Astrophysical Journal*.

Remarks on this communication were made by Messrs. HARNESSESS, PAUL, and WINLOCK.

Governor JOHN W. HOYT (of Wyoming) gave An Account of the Present Status and Prospects of the Project for a National University.

Remarks upon this communication were made by Mr. F. W. CLARKE.

Mr. THOMAS WILSON read a paper on The National Postal and School Savings Bank System of Belgium. Not published.

Remarks were made by Messrs. HILL and MANN.

375th Meeting.

November 7, 1891.

President MENDENHALL in the chair.

Thirty-four members and guests present.

The first paper of the evening was read by Mr. E. M. GALLAUDET on Values in the Education of the Deaf.

Published in the Educational Review of New York, January —, 1892.

Remarks were made by Messrs. WELLING and GALLAUDET.

Mr. J. C. GORDON made a communication on The New Departure at Kendall Green.

376th Meeting.**November 21, 1891.**

Vice-President FLETCHER in the chair.

Thirty-four members and guests present.

Mr. WILLIAM HALLOCK made a communication on The Deep Well at Wheeling.

Published in the Proceedings of the American Association for the Advancement of Science for 1891.

Remarks were made by Messrs. ABBE, WOODWARD, and HALLOCK.

Mr. ROBERT T. HILL read a paper on The Occurrence and Availability of Underground Water in Texas and New Mexico.

Published under the same title in the Report of the Artesian Well Investigation of the U. S. Department of Agriculture, 1892.

The paper was discussed by Messrs. ABBE, MCGEE, ELDRIDGE, and FOLLETT.

377th Meeting.**December 5, 1891.**

President MENDENHALL in the chair.

Forty members and guests present.

The President announced the election and qualification of MARK W. HARRINGTON and JOSEPH NELSON JAMES.

Mr. R. S. WOODWARD read a paper on Maxwell's Theory of Electrostatics.

Published in the Annals of Mathematics.

This paper was discussed by Messrs. BIGELOW, HARKNESS, HILL, and WOODWARD.

Mr. J. F. HAYFORD read two papers; the first, entitled The Detection by Azimuth Observations of Variations in the Pole or the Vertical, was discussed by Messrs. BAUER, PAUL, KUMMEL, HARKNESS, and HAYFORD; the second was entitled A Recent Check on the Relation Between the Metric Units of Length and Mass.

Not published.

378th Meeting.

December 19, 1891.

TWENTY-FIRST ANNUAL MEETING.

President MENDENHALL in the chair.

Thirty-three members present.

On motion of Mr. HARKNESS, it was voted that the officers of the Society shall serve to the end of the annual meeting.

The annual report of the Secretaries was read and accepted.

ANNUAL REPORT OF THE SECRETARIES.

WASHINGTON, D. C., *December 19, 1891.*

To the Philosophical Society of Washington:

The Secretaries have the honor to submit the following annual report for the year 1891:

The number of active members in the Society at the close of last year was 198. Since that time 3 members have died: Mr. George Bancroft died January 17; Hon. Asa Owen Aldis, June 24, and Professor William Ferrel, September 18, 1891.

During the year 10 new members have been added to the list. The roll of new members is as follows:

THOMAS W. SMILLIE.

JOSEPH KAY McCAMMON.

WILLIAM K. CARR.

ISAAC WINSTON.

JOHN NELSON JAMES.

HENRY NEWLIN STOKES.

ROLLIN ARTHUR HARRIS.

ALBERT L. GIBON.

MARK W. HARRINGTON.

G. L. MORTON.

Upon request, 3 members have been transferred to the absent list, 3 have resigned, and 5 have been dropped for the non-payment of dues. There has thus been a decrease of 11 in the number of active members from last year, but the addition of 10 new members brings the active membership of the Society at the present time to 197.

Besides the annual meeting and the one at which the address of the retiring President was delivered, the Society has held 15 regular meetings, with an average attendance of 36 members and guests. At these meetings 38 communications were presented by 32 members and 1 guest, and 44 members participated in the discussions.

The General Committee has held 15 regular meetings, with an average attendance of 13. The least number at any meeting was 9 and the greatest 17.

The Mathematical Section has held 2 meetings, with an average attendance of 8. Two communications were presented, and one of them has been published in the *Mathematical Magazine* of this city.

During the year the Society has published four papers, including the annual address of the President, besides a series of obituary notices of deceased members. The final brochures of volume XI of the *Bulletin* are now in press. They contain the minutes of the general meetings of the Society and the Mathematical Section from 1888 to 1891, inclusive.

Concerning the publication of communications presented to the Philosophical Society during the year the following information has been obtained from the authors. As already stated, 4 have been published by the Society.

3 have been published in the *American Journal of Science*.

2 in *Nature*.

2 in *The Forum*.

3 in the reports of the U. S. Geological Survey.

2 in the *Annals of Mathematics*.

1 in the *Weather Review*.

2 in the Reports of the Department of Agriculture.

1 in the *Medical News*.

1 in the *Smithsonian Report*.

1 in the *New Sidereal Messenger*.

1 in the *Educational Review*.

1 in the Proceedings of the American Association for the Advancement of Science.

14 have not been published.

Very respectfully,

W. C. WINLOCK,
J. S. DILLER,
Secretaries.

The annual report of the Treasurer was then read.

ANNUAL REPORT OF THE TREASURER.

The Philosophical Society of Washington, D. C. :

The Treasurer submits herewith his annual financial statement, covering the period from December 23, 1890, to December 19, 1891.

The income of the Society derivable from the dues of members for the year 1891 alone, and from interest accruing on investments received during the same period, was as follows :

From dues of 1891 received in 1891.....	\$780 00
From receipts in 1891 of interest on investments....	170 00
	<hr/>
Total income derivable from 1891.....	950 00
The disbursements made during the year were all chargeable to the transactions of the year 1891 and amounted to.....	598 54
	<hr/>
Leaving balance in favor of the Society on the year's transactions of.....	\$351 46

In addition to the receipts above mentioned, there were received on account of dues of 1889, \$40; dues of 1890, \$110; dues of 1892, \$20.

In May last, with the consent of the General Committee, the Treasurer rented a lock-box at the National Safe Deposit Company, Washington, D. C., in which to keep the securities owned by the Society. There are now on deposit in the Treasurer's box in the vaults of that company the following securities, the property of the Society, viz :

One U. S. 4 per cent. bond, No. 64,596.....	\$500 00
One U. S. 4 per cent. bond, No. 135,639.....	1,000 00
Twenty-two Cosmos Club 5 per cent. 5-20 bonds, Nos. 16 to 21, 119 to 132, 135 and 136 (these bonds have now become first-mortgage bonds).....	2,200 00
Total	<u>\$3,700 00</u>

A committee from the General Committee of the Society is now seeking an investment for a portion of the cash balance to the credit of the Treasurer at Riggs & Co.

There are several pieces of movable property owned by the Society which should be taken into account in any statement of assets. It is not known to the Treasurer in whose charge this property is now placed. It is believed to consist of a fine mahogany table and chair, a large blackboard, a microscope, and a magic lantern. Omitting it from consideration, the money assets of the Society may be stated as follows :

The securities on deposit at the National Safe Deposit	
Co., as above.....	\$3,700 00
Cash with Riggs & Co.....	1,655 61
Unpaid dues.....	205 00
Total	<u>\$5,560 00</u>

The Society has no outstanding liabilities.

Respectfully submitted.

WM. A. DE CAINDRY,
Treasurer.

DECEMBER 19, 1891.

Dr.

The Treasurer in Account with The Philosophical Society of Washington, D. C.

Cr.

1890. Dec. 23	To cash received from Dr. Rob't Fletcher, late Treasurer.....	\$1,133 40	1891. Dec. 19	By cash paid during the year 1891 on the following accounts, viz:	\$241 39
	To cash received during the year 1891 for dues, as follows:			For printing Bulletins.....	77 00
	Dues for 1889.....	\$40 00		For printing postal cards, circulars, &c., and distributing Bulletins....	86 80
	Dues for 1890.....	110 00		For miscellaneous expenses of Sec- retary and of committees.....	50 77
	Dues for 1891.....	780 00		For stationery, postage, and clerical work.....	53 73
	Dues for 1892.....	20 00		For sundries for Mathematical Sec- tion.....	4 65
	To cash received as interest on invest- ments, viz:	950 00		For Directory of Scientific Societies. For rent of box at National Safe Deposit Co.....	34 20
	On \$1,500 U. S. 4 per cent. bonds.....			For use of assembly hall, Cosmos Club.....	5 00
	On \$2,200 Cosmos Club 5-20 bonds.....	110 00			45 00
	To cash received from sale of Bulletin...	170 00			598 54
			1891. Dec. 19	By cash balance on deposit at Riggs & Co.	1,655 61
					\$2,254 15

Respectfully submitted.

DECEMBER 19, 1891.

W. M. A. DE CAINDRY, *Treasurer.*

The report of the Treasurer was accepted and referred to an Auditing Committee, consisting of THOMAS RUSSELL, G. E. CURTIS, and B. R. GREEN.

The Society then proceeded to the election of officers, with the following results :

President G. K. GILBERT.
Vice-Presidents { G. BROWN GOODE. R. S. WOODWARD.
 { ROBERT FLETCHER. W. H. DALL.
Treasurer W. A. DE CAINDRY.
Secretaries W. C. WINLOCK. J. S. DILLER.

MEMBERS-AT-LARGE OF THE GENERAL COMMITTEE.

MARCUS BAKER.	G. W. HILL.
H. H. BATES.	H. M. PAUL.
F. H. BIGELOW.	C. V. RILEY.
F. W. CLARKE.	O. H. TITTMANN.
L. F. WARD.	

The following standing committees were appointed by the President for 1892 :

On Communications :

R. S. WOODWARD.	J. S. DILLER.	F. H. BIGELOW.
-----------------	---------------	----------------

On Publications :

ROBERT FLETCHER.	W. C. WINLOCK.	MARCUS BAKER.
------------------	----------------	---------------

PROCEEDINGS
OF THE
MATHEMATICAL SECTION.

1888 TO 1891.

36th Meeting.

January 25, 1888.

The Chairman presided.

Present, thirteen members.

The minutes of the 35th meeting were read and approved.

An election of officers of the Section was held, resulting in the choice of Mr. H. M. DOOLITTLE for Chairman and Mr. R. S. WOODWARD for Secretary. Thereupon Mr. DOOLITTLE was called to the chair and presided during the subsequent proceedings of the evening.

Mr. A. S. CHRISTIE presented a communication on What is a Quaternion?

[Abstract.]

A quaternion, according to the point of view from which it is regarded, is either, 1st, The *product* of a tensor and a versor; or, 2d, The *sum* of a scalar and a vector; or, 3d, A *power* or a *root* of a vector; or, 4th, Any combination by *sum*, *difference*, *product*, *quotient*, *power*, or *root* of tensors, versors, scalars, vectors, or quaternions—where the underscored words must be taken in the peculiar but not perverted sense assigned them by Hamilton.

Tensors, versors, scalars, vectors, and quaternions are reals, easily comprehensible and combined by methods always rationally explicable. It is a mistake to suppose that either the ideas or the methods of the quaternion calculus are based upon or are affected by any "curious quasi-metaphysical speculation." Tait's employment of that phrase (North British Review, September, 1866, page —; Quaternions, 2d edition, § 64)

is unfortunate and does injustice to the luminous and unimpeachable character of Hamilton's mathematical reasoning. It is equally a mistake to suppose that the quaternion calculus is merely an "abridged notation." It is a calculus *sui generis*, its novelty consisting, not in a notation, but in new ideas requiring a new notation for their expression.

37th Meeting.

February 8, 1888.

The Chairman presided.

Present, seventeen members.

The minutes of the 36th meeting were read and approved.

Mr. R. S. WOODWARD presented the principal features of a paper on The Variation of Terrestrial Density, Gravity, and Pressure, according to the Laplacian Law.

Starting from the law assumed by Laplace, namely, that at any point within the earth's surface the increment of pressure is proportional to the increment of the square of the density, the steps involved in the derivation of formulas expressing the density, gravity, and pressure in terms of the distance of the point from the earth's center were briefly indicated. A set of formulas adapted to the numerical computation of the density, gravity, and pressure was given, and a table of numerical values derived by means of these formulas was exhibited. Attention was called to the fact that, according to the law in question, gravity increases with the depth below the earth's surface to a maximum which corresponds to a depth of about 610 miles, and then decreases to nothing at the earth's center.

Some examples of other laws connecting pressure and density but not applicable to the earth were briefly considered.

An outline was given of a proposed extension of the Laplacian law, or rather of an investigation whose object is the discovery of all possible laws of arrangement of density applicable to the earth, provided those laws are continuous functions of distance from the earth's center.

Mr. ARTEMAS MARTIN read a paper on Square Numbers whose Sum is a Square Number.

Mr. Martin gave a proof of the proposition that a series of n squares whose sum is a square can always be found. The application of the formulas expressing this proof was illustrated for the cases in which $n = 2$ and $n = 3$, and the geometrical constructions corresponding to these and the general case were pointed out.

When the number of squares to be found is large, the tentative process explained by Mr. Martin in his communication on n th-power numbers whose sum is an n th power, at the 35th meeting of the Section, is found to be more convenient. By this process many series were derived. A few of these are as follows :

1. The sum of the squares of the natural numbers from 1 to 24, both inclusive, is 70^2 . This result is of historical interest in being the only known series of squares of consecutive natural numbers, from 1 upward, whose sum is a square. It is the solution of a prize problem proposed in the Ladies' Diary in 1792.

2. Several series of 50 squares whose sum is 231^2 .

3. Several series of 1,000 squares whose sum is a square.

4. One series of 999,995 squares whose sum is a square.

5. Two series of 1,000,000 squares whose sum is a square.

6. Several series of squares of consecutive numbers whose sum is a square.

38th Meeting.

February 22, 1888.

The Chairman presided.

Present, nineteen members and guests.

The minutes of the 37th meeting were read and approved.

Mr. G. W. HILL read a paper on The Interior Constitution of the Earth as Respects Density.

This paper was published *in extenso* in vol. iv, No. 1, of Annals of Mathematics, University of Virginia, Va., 1888.

Mr. H. A. HAZEN presented a paper on A Failure in the Application of the Law of Probabilities.

39th Meeting.**March 7, 1888.**

In the absence of the Chairman of the Section, Mr. W. B. TAYLOR was called to the chair and presided during this meeting.

There were present eleven members and guests.

The minutes of the 38th meeting were read and approved.

Mr. C. H. KUMMELL presented a communication entitled Remarks on Some Recent Discussions of Target-Shooting. The recent discussions to which he referred are those of J. Bertrand, published in the Comptes Rendus, Nos. 3, 4, 6, and 8 of vol. CVI, 1888, and those of Mr. E. L. De Forest, published in the Transactions of the Connecticut Academy, vol. VII, 1885. These authors reject Poisson's hypothesis that the departure of a shot from the center of the target is the resultant simply of the independent errors of alignment in azimuth and altitude, and maintain that the law of arrangement of shots in any target can only be determined by examining the target itself.

Mr. Kummell referred to his own investigations on target-shooting, published in the Bulletin of the Philosophical Society for 1883, vol. VI, p. 138, which proceed from Poisson's hypothesis, and affirmed the correctness of his published views and results.

Mr. Kummell gave also a solution of the problem of conditioned maxima or minima from a new point of view.

This solution consisted in the introduction of certain factors or correlates in a manner similar to that followed in the treatment of conditioned observations in least squares, by which the problem is changed in form to that of unconditioned maxima and minima.

Mr. G. K. Gilbert proposed a new problem relative to the estimation of skill in making predictions. He stated that Messrs. Finley and Doolittle and himself had considered in their investigations only absolute success and failure. Some weight, he thought, should be attributed to a near approach to success, or there ought to be considered degrees of success and failure. In short, the problem he hoped some of the mathematicians of the Section would solve is, "What is the proper mathematical expression for a close miss?"

40th Meeting.**March 21, 1888.**

The Chairman presided.

Present, fifteen members and guests.

The minutes of the 39th meeting were read and approved.

Mr. M. H. DOOLITTLE presented a communication on Probabilities.

Mr. Doolittle read an extract from the chapter on the Calculation of Chances in the eighth edition of Mill's System of Logic, in which Mill accedes to Laplace's definition of the term *probability*, as implied in his statement of requisites for mathematical calculation, after having controverted it in an earlier edition.

While Mr. D. regarded Laplace's definition and statement as eminently proper for adoption by mathematicians in order to a comprehensive and correct understanding of the subject, he maintained that a signification is very extensively attached to the term when used without qualification, not only in popular usage, but also among scientific men, such as largely to justify the position at first taken by Mr. Mill.

41st Meeting.**April 4, 1888.**

The Chairman presided.

The Secretary being absent, Mr. G. K. GILBERT was appointed Secretary *pro tem*.

Present, eleven members.

The minutes of the fortieth meeting were read and approved, subject to revision by Mr. DOOLITTLE, of his remarks.

The subject for discussion was, What is Force?

The following paper by Mr. A. HALL was read by the Chairman :

When a man comes to intellectual consciousness he finds himself in a wonderful and interesting world, full of change and motion on earth and in the heavens. Perhaps the most striking of these phenomena are the rising and setting of the sun and moon and the grand procession of the

planets and the stars. Men are so constituted that theories for the explanation of these motions and changes will soon be formed. Thus we find in the oldest books that have come down to us very complete and dogmatic accounts of the construction of the universe. The slow growth of science has overturned one after another of these explanations until we have come to look with distrust upon elaborate theories that cannot be tested by observation or reduced to truths that may be considered axiomatic. The history of astronomy gives a good example of such changes of opinion. The study of this science presents to observers the motions of bodies in a manner that cannot fail to excite their curiosity. From the study of the motions of bodies has come the science of rational mechanics. It deals with questions in a purely mathematical form, and its fundamental conceptions are matter, space, and time. It is not necessary to undertake the definition of these conceptions. The only satisfactory method seems to be that every one shall determine them for himself. We assume that they are quantities that can be measured, and proceed to consider the motions of a body. Among the first things we notice are differences in the rates of motion; this gives us the idea of velocity. Our first step in such investigation is always to simplify the conditions, and here we begin by considering motions that are uniform and rectilinear. In this case we measure velocity by comparing the ratio of the observed spaces to that of the observed times. Thus we have

$$v : V :: \frac{s}{t} : \frac{S}{T}$$

$$v = V \times \frac{s}{t} \times \frac{T}{S}$$

In order to make measurements we must adopt units of space, time, and velocity. If we make

$$S = 1, \quad T = 1, \quad V = 1,$$

we have for uniform motion

$$v = \frac{s}{t}.$$

If the motion be variable we have for the instant t , by the usual method of proceeding to the limit,

$$v = \frac{ds}{dt}.$$

Observation shows that the same body has different velocities at different times, and we infer a cause for this change. We notice that a large

body has two kinds of motion ; a motion of translation and a whirling motion. We also see bodies change their forms while moving, and this occurs even among the heavenly bodies, as is shown when a comet approaches the sun and recedes from it. Again, in order to make the question simple, we leave out of consideration the whirling motions of bodies and their changes of form, and to do this we imagine the moving body to be infinitely small, and call it a particle. This particle we adopt as the unit of matter. Assuming this simple body to be uniformly changing its velocity under the action of causes which we designate as forces, we have the proportion,

$$\varphi : F :: \frac{v}{t} : \frac{V}{T}.$$

Let F be the unit of force, or a force which acting on a unit of matter during the unit of time produces a unit of velocity ; then for a uniform force we have

$$\varphi = \frac{v}{t}.$$

If the force be variable we have

$$\varphi = \frac{dv}{dt} = \frac{d^2s}{dt^2}.$$

Force appears, therefore, as a secondary idea, or as a function of the three fundamental conceptions of matter, space, and time. It is true that this process teaches us nothing concerning the nature of force, and I know of no method that does ; but from the preceding simple equations can be deduced the whole theory of rational mechanics. We are able to study the modes under which forces act, and in some cases to deduce the laws of their action, but all these results are to be controlled by accurate observation and measurement. Thus it is very natural to extend the Newtonian law of gravitation to the stellar universe, but such an extension should be tested by observation, and the reasons for the universal extension of the simple law that controls our solar system should be carefully examined.

The notion of force is one that we acquire from our earliest experiences, such as lifting bodies, putting them in motion, or resisting their motions. Let us examine some of the phrases that are in common use ; and first the "centrifugal force." The equations of motion of a particle for rectangular coördinates are

$$\frac{d^2x}{dt^2} = X, \quad \frac{d^2y}{dt^2} = Y, \quad \frac{d^2z}{dt^2} = Z, \quad (a)$$

in which t is the independent variable. The phrase "centrifugal force"

came from considering motion in a curve; and since the radius of curvature ρ for the point xyz has the expression

$$\frac{1}{\rho^2} = \left(\frac{d^2x}{ds^2}\right)^2 + \left(\frac{d^2y}{ds^2}\right)^2 + \left(\frac{d^2z}{ds^2}\right)^2,$$

where s is the independent variable, we transform the expressions for the forces into others which have a more general form. Thus

$$\begin{aligned} X &= \frac{d^2x}{dt^2} = \frac{d}{dt} \cdot \left(\frac{dx}{ds} \cdot \frac{ds}{dt}\right) \\ &= \frac{d^2x}{ds^2} \cdot \frac{ds^2}{dt^2} + \frac{d^2s}{dt^2} \cdot \frac{dx}{ds} \\ &= v^2 \cdot \frac{d^2x}{ds^2} + \frac{dx}{ds} \cdot \frac{d^2s}{dt^2}, \end{aligned}$$

with similar values for the components Y and Z . Squaring these values and adding, we have for the resultant,

$$\begin{aligned} R^2 &= v^4 \cdot \left\{ \left(\frac{d^2x}{ds^2}\right)^2 + \left(\frac{d^2y}{ds^2}\right)^2 + \left(\frac{d^2z}{ds^2}\right)^2 \right\} \\ &+ 2 v^2 \cdot \frac{d^2s}{dt^2} \cdot \left\{ \frac{dx}{ds} \cdot \frac{d^2x}{ds^2} + \frac{dy}{ds} \cdot \frac{d^2y}{ds^2} + \frac{dz}{ds} \cdot \frac{d^2z}{ds^2} \right\} \\ &+ \left(\frac{d^2s}{dt^2}\right)^2 \cdot \left\{ \frac{dx^2}{ds^2} + \frac{dy^2}{ds^2} + \frac{dz^2}{ds^2} \right\}. \end{aligned}$$

From analytical geometry we have

$$dx^2 + dy^2 + dz^2 = ds^2.$$

From this equation the second term in the values of R^2 is zero, and the coefficient of $\left(\frac{d^2s}{dt^2}\right)^2$ is unity; so that we have

$$R^2 = \left(\frac{v^2}{\rho}\right)^2 + \left(\frac{d^2s}{dt^2}\right)^2.$$

If we differentiate the equation

$$dx^2 + dy^2 + dz^2 = ds^2,$$

making t the independent variable, and divide by $2 ds dt^2$, we have

$$\frac{dx}{ds} \cdot \frac{d^2x}{dt^2} + \frac{dy}{ds} \cdot \frac{d^2y}{dt^2} + \frac{dz}{ds} \cdot \frac{d^2z}{dt^2} = \frac{d^2s}{dt^2}.$$

Since $\frac{dx}{ds}$, $\frac{dy}{ds}$, $\frac{dz}{ds}$ are the direction cosines of the tangent at the point xyz , we see that $\frac{d^2s}{dt^2}$ is the accelerating force along the tangent to the curve. The other component of R acts at a right angle to the tangent and contributes nothing to the velocity of the particle, but changes the direction of its motion. This component is called the "centrifugal force." Since it does not change the velocity of the particle, and would not even if its connection with the center of motion were severed, it is common to speak of it as a fiction; but it is a component of R that must be considered in many questions, and the old nomenclature of Huygens is convenient. At the equator of the earth centrifugal force diminishes gravity by $\frac{1}{289}$ th part of its value. The effect varies as the square of the cosine of the latitude, the general expression being

$$g = G \cdot \left(1 - \frac{\cos^2 \varphi}{289}\right).$$

G is the value of gravity if the earth had no rotation, and φ is the latitude.

Another expression which is disputed, and which indeed seems to be unfortunate, is the "force of inertia." Correctly speaking, there does not appear to be a force of this kind, and we mean by this phrase the reaction we experience when we attempt to put a body in motion or to resist a moving body. If a mass be placed on a smooth surface where there is no friction, and if it be acted on by a force however small, it will begin to move with a certain velocity. If the mass be increased, the force must also be increased in order to obtain the same velocity; and if we could accurately compare the forces we could in this way determine the masses of bodies. But it does not follow that matter opposes a resistance to the action of force.

Still another expression which seems to me incorrect is that of "specific gravity." Gravity is a general force and does not depend on the nature of bodies; but so delightfully inconsistent are we that writers who strain at the term "centrifugal force" have no trouble with "specific gravity."

The preceding examples are sufficient to convince me that the only safe way in such matters is first to obtain the general equations of motions (α), and then to deduce results by the proper analytical transformations. This method has the great advantage of starting from grounds that are fundamentally correct; so that a slip in the use of a word or phrase need not make our result wrong.

After the reading of Mr. Hall's paper Mr. H. H. BATES said:

In the paper to which we have just had the pleasure of listening Professor Hall states some well-known mathematical truths with his accustomed accuracy and ability. His presentation has no flaw as a

mathematical statement. I had doubted, on receiving the notice for this evening's discussion, whether the subject announced strictly came within the province of the mathematical section. The question, "What is force?" seemed more properly to belong to physics, and to involve one of the fundamental definitions of Philosophy; yet I recognize that the subject is in a sense a mathematical one. Mathematicians find in their analytical processes certain constants and also variables, representing a rate of acceleration in dynamic problems, and this they conveniently term force, throwing causes out of view; to which there is no objection. This, however, affords no answer to the question, "What is force?" Mathematics is purely a science of abstract relations, dealing with such relativities as number, quantity, extension, position, dimension, and time, and their variations, by deductive methods, and hence is incapable of replying to primary questions of ontology. Many mathematicians, therefore, finding the question irrelevant to their science, throw it out and deny that force has any existence other than as a mathematical expression. Perhaps the question cannot be answered. The word "force," however, exists in our language, as in others, as a symbol of a reality of nature, though still with an ambiguity of usage proportional to the abstruseness of the subject. It is a fact in language, as in all other evolutionary products, that function precedes structure and is the prime cause of the evolution of structure. Thus both organs and words exist at first in a generalized and rudimentary state, the organ or word becoming specialized as the function becomes differentiated. The terms of physics and mechanics have become more specialized within the last twenty-five years. About a quarter of a century ago a distinguished English physicist published a work which he called "The Correlation of the Physical Forces," a title not particularly incorrect at that time, but which now would be written "The correlation of the various modes of energy;" energy being the well-understood dynamic term for the manifestations of matter in motion and capable of doing work by transference of motion. Heat, although a form of *vis impressa*, being a mode of motion capable of impressing itself by transference, has been differentiated as a form of energy, as much so as *vis viva*.

Force is the proximate cause of motion, while energy is the product or resultant compounded of mass and the variable factor motion, itself a function of space and time. Energy is therefore variable and transferable, while force is persistent and inexhaustible, and manifest as well under static as under dynamic conditions. A magnet or a planet draws a million neighboring bodies with the same power as one. Force in its centripetal aspect appears to exist as a universal stress and is not separately apparent. There is an intermolecular stress which takes the names of cohesion and affinity. In its aspect of mass, force is manifest under the various forms of "*vis*" as used by Newton, the basis of which is inertia or persistence of condition. In this aspect it is also a cause of motion by transference or by conservation of condition. I hold, then, that in the necessary imperfection of language we may with propriety use the term force in either

of its recognized senses: as a physical term to express a fundamental concept of philosophy, and a basic fact of observation, as the force of gravity, the force of cohesion, the force of elasticity, the force of magnetism, the force of affinity, the force of inertia, or as a mathematical term to express mere kinetic relations. In the vernacular, it is the mere synonym of power.

Mr. M. H. Doolittle had previously defined a force as "that which does anything whatever;" but this definition may require interpretation. A chord subtends an arc, though there may be difference of opinion as to whether the chord can properly be said to do anything. It is supposed that no one regards a mathematical line as a force; but perhaps every possible definition would itself need to be defined, and he would not now attempt to improve the definition which he had given. The word should be so understood as to adapt it for use in fundamental propositions, such as that of the "parallelogram of forces," and the definition should therefore be broad enough to cover every case. He read an extract from Newton's Principia (Book I, sec. II, prop. 1), in which the parallelogram of forces is made to cover the case in which *vis insita* (inertia) is one of the forces. He read another extract from the same work (Scholium between definitions and axioms), in which Newton speaks of "the forces which are the causes and effects of the true motions." A body may be conceived as voluntarily endeavoring to move in one direction while impelled by an external force in another direction. In order to bring this case under the general proposition, voluntary effort must be regarded as a force. Some writers on physics define *force* as "that which changes or tends to change a body's condition of rest or of uniform motion in a right line," maintaining that a body left to itself perseveres in such a condition, and that no force is required for such perseverance; but it may well be doubted, if not denied, that any one knows what matter does when left to itself. The uneducated usually think that force is necessary to keep a body from falling, but not to make it fall. There are those who maintain that matter is always left to itself and produces all the phenomena of the universe without foreign assistance or intervention; others hold that matter is never left to itself, and that divine or other external force is always required to keep it in any state of motion or even of existence; between these extremes there may be a great variety of opinions, and all are unscientific. There is a conservative force which always tends to preserve an existing condition of rest or of uniform motion in a right line, and there are various mutative forces which in various ways permanently or transiently tend to change such conditions. Whether any or all of these forces consist of matter itself, are inherent in it, or are impressed upon it, are metaphysical speculations which should not be imbedded in the significations of terms employed in physical science. We need broad terms for broad propositions as well as narrow terms for narrow propositions; it is much easier to introduce a new narrow term when it is wanted than to replace a broad term that has been spoiled; and those who give

a narrow meaning to such a word as *force* may believe that they are improving our terminology by rendering it, as they say, more definite; but they are really threatening an irreparable injury to our language.

Mr. ELLIOTT exhibited a notation for various fundamental terms in physics and electricity, force being designated by $m a$, the symbols for mass and acceleration.

After Mr. Elliott's remarks, and in response to the President's comments on the parallelogram of forces, so called, Mr. BATES said :

I regard the use of the term force in the parallelogram of forces as coming under Newton's "*vis impressa*" and relating to the manifestation of mass under the first law of motion. The resultant is the expression of the second law of motion, exemplifying the relativity of motion and the independence of *vires impressæ*. The parallelogram is a purely intellectual notion—a sort of mental scaffold by which we aid conception, having no real existence.

42d Meeting.

May 2, 1888.

The Chairman presided.

Present ten members and guests.

The minutes of the 41st meeting were read and approved.

Mr. W. B. TAYLOR read a paper on A Question in Mathematical Nomenclature, of which the following is an abstract :

[Abstract.]

Mr. Taylor in criticising the terms "square" and "cube," commonly used to designate algebraic second and third powers—a usage probably due to the convenient conciseness of the expressions, and probably also to a latent sentiment of their greater definiteness—thought that the evils of such mis-nomer were twofold: First, the vague suggestion of some geometrical significance in such expressions as "the squares of the disturbing forces," employed in discussions of planetary perturbations; "mass multiplied by the square of the velocity," in dynamical problems, and "the product of the masses divided by the square of the radius," in celestial mechanics. In the latter case the general use of the symbol r^2 suggested the further error that a radial emanation is involved, and it was contended that the symbol d for distance simply should always be used in preference to the customary r for radius. And the second evil was the false induc-

tion (actually drawn by some writers of repute) that since the first three terms in a series of algebraic powers may have a geometrical import, the succeeding terms should also in some way have the same. Of course, as an exercise of pure logic, such discussions may be as instructive as the developments of any other imaginary values of a variable; but when the products of such pure or abstract logic are supposed to have a real concrete existence they evidence fatuity and illustrate absurdity. If logic be the science of "necessary conclusions," it must as certainly conduct us to necessary falsehood as to necessary truth, accordingly as our postulates are faulty or sound.

Reference was made in this connection to the somewhat astounding statement of Professor Peter G. Tait (in his "Lectures on Recent Advances in Physical Science," published in 1876) that our Solar system might be gradually passing into "curvature of space," where a fourth-dimension change of form will be necessarily evolved. Such arrant nonsense could be accounted for only on the supposition that the incongruous *algebraic* square and cube naturally suggested cubic contents of the fourth degree and even of still higher powers in grandly ascending orders, and that the abstract and imaginary had been hopelessly confounded with the concrete and the real. While it is true that algebraic analysis may be successfully applied to geometrical relations, the converse is utterly false; and the two departments of mathematical logic are as radically distinct as is the science of space dimension from the "science of pure time." The speaker insisted, in conclusion, that mathematicians, above all others, should cultivate not only the finest perspicacity of concept, but the most vigorous accuracy of expression.

[Mr. Taylor added that after writing out his present criticism he had just discovered (almost accidentally) that Judge Stallo, in his "Concepts and Theories of Modern Physics," published in 1882, incidentally remarked in a foot-note to chapter 14 (on Riemann's Dissertation) that such an expression as x square or x cube assumes *algebraic* quantity to have an inherent *geometrical* import.]

Mr. MARCUS BAKER made a communication on Averages.

43d Meeting.

May 16, 1888.

The Chairman presided.

Present, thirteen members and guests.

The minutes of the 42d meeting were read and approved.

MR. ARTEMUS MARTIN presented a paper on An Error in Barlow's Theory of Numbers. The following is an abstract:

[Abstract.]

It is stated on page 299 of Barlow's "Theory of Numbers" that "the equation

$$x^2 - 5658 y^2 = 1$$

has the least values of x and y as follows, viz:

$$\begin{aligned} x &= 166100725257977318398207998462201324702014613503, \\ y &= 698253616416770487157775940222021002391003072. \end{aligned}$$

But I have found the least values of x and y satisfying this equation to be—

$$\begin{aligned} x &= 1284836351, \\ y &= 17081120. \end{aligned}$$

As Barlow's value of x contains three more figures than his value of y , it is plain that the coefficient of y^2 should contain *five* figures, and that he (or some one else) left out one of them. Our problem is to determine and locate the missing digit.

From $x^2 - Ny^2 = 1$ we easily obtain

$$N = \frac{x^2 - 1}{y^2}, = \frac{x^2}{y^2}$$

very nearly when x and y are large numbers;

$$\therefore \frac{x}{y} = \sqrt{N} \text{ very nearly.}$$

In the example under consideration I find

$$\frac{x}{y} = 237.8802219 +, = \sqrt{56587}.$$

Hence it appears that the last figure, 7, of the coefficient of y^2 was left out, probably by the compositor, possibly by the writer of the "copy."

I have computed the least values of x and y in the equation

$$x^2 - 56587 y^2 = 1,$$

and find them to be correctly given by Barlow.

Mr. H. FARQUHAR read a paper entitled Systematic Differences of Proper Motions in Declination Catalogues. The following is an abstract :

[Abstract.]

The "Fundamental-Catalog" of the Berlin Jahrbuch (Astr. Gesellsch. Pubs. 14 and 17, Dr. A. Auwers) and that of the American Ephemeris (Report of Northern Boundary Commission, Appx. H, Prof. L. Boss) contain 303 stars in common. Boss gives, along with his proper motion in declination, an estimate of its probable error; and the probable error-square of the difference between his proper motion and Auwers' is taken proportional to the square of this estimate plus a constant ($\epsilon_B^2 + .000008$), the differences being weighted accordingly from 1 to 4. The stars were first taken in zones between parallels 5° apart, then within limits of an hour of right ascension. The former only of these comparisons is shown in the table. Though the differences in order of right ascension show some uniformities of sign, they are not well satisfied by a formula in sine and cosine of α , while the smallness of the means and the wide range of the individual residuals throw doubt on their significance.

The first column of the table gives the declination, the next two the number of + and - residuals within the zone in the direction Boss-Auwers, the fourth the sum of the weights, as just explained; the fifth the mean difference of proper motion in declination in seconds per century; the sixth the same difference, smoothed by taking five times the means of successive values. This is adopted as the systematic difference of the two catalogues in proper motion. It is so applied to the next column, five times the reduction of the Pulkowa '45 to the Pulkowa '65 catalogue or the systematic difference between Auwers' system of proper motions and those to be obtained from a comparison of these two, column 8 giving the same difference for Boss. The uniformity of sign is significant. If this column, 8, were corrected by the rate of change of latitude, $\frac{2}{3}''$ per century, deduced from observations of Polaris at Pulkowa, but not included in the declinations, the residuals, except near the southern limit, would all become very small. Column 10 gives the systematic difference between the proper motions of Boss and those to be deduced from comparison of six Greenwich catalogues, 1840 to 1872, all reduced to the same refractions. It is derived from the table of systematic corrections to each of these catalogues. Column 9 = No. 10 - 6 gives a similar difference for Auwers. Considering northern stars only, the closer agreement of the Boss system is noteworthy, but the effect of those south of the equator is materially to weaken the argument from these catalogues. Column 11 is from the Berliner Jahrbuch for 1884, and shows the systematic difference in declination between the Jahrbuch and the American Ephemeris for 1883 as found by Dr. Auwers. No. 13 gives the difference of the fundamental catalogues themselves (Epoch 1875) found by me in 1886 [see Bull.

Phil. Soc.; also Proceedings Amer. Assn., Buffalo meeting]. This difference, corrected by $+\frac{8}{100} - \frac{10}{100}$, etc., of column 6, gives Nos. 12, 14, 15, 16, and 17, the differences between the two systems for 1883, 1865, 1838, 1809, and 1755. Columns 12 and 11 are closely alike, as they should be; the only differences, of a tenth of a second, are about the pole and about declination 45° , and are probably due to the asterisked stars of the Ephemeris, whose declinations do not depend on Boss [see B. J., 1884, p. —, 86 —]. As column 14 gives the reduction to Boss of the later Pulkowa declinations at their own epoch, it may be of interest to examine it. No. 18 gives the residuals of this column, after subtracting the simple correction $\frac{1}{38}$ ($54^\circ - 8$); the difference thus practically disappears, except close to the pole and within 15° of the Pulkowa horizon. This is a striking demonstration of the equable character of the later Pulkowa scale, and if the corrections are taken as showing an error in it, this error is naturally to be ascribed to the adoption at Pulkowa of two large refractions, a correction which may possibly be smaller south than north of their zenith. Column 19 gives the difference between Auwers' system of Publication 14 and that of Astron. Nachr., vol. 64 (see Pub. 14). No. 20 = No. 19 + No. 15 shows the reduction to Boss of Dr. Auwers' former system. The best epoch of this system differs from that of the Fundamental Catalog by 27 years, about a fourth of the interval from Bradley's observations (1755–1865); hence if the places of Auwers for 1838 have 16 times the weight of Bradley's places they are as suitable as his for the deduction of proper motions. Dr. Auwers, in fact, forms them from a mean of fourteen observation catalogues, each having weight 1, while he allows to Bradley but half weight, and since $14 : \frac{1}{2} > 16$, it seems to follow from his very rule of procedure that the proper motions of the Astron. Gesellsch. Fundamental Catalog would have been better had he based them exclusively on comparison with this earlier system, making no use at all of Bradley. As Professor Boss proceeds upon this very theory, his close agreement with Auwers' earlier system is not surprising; it would be closer still but for his inclusion of some catalogues (as the Pulkowa, 1845) not then accessible to Auwers. Column 22 gives Boss' correction to Piazzini, and No. 21 = No. 22 — No. 16 that of the Publication 14 system. The difference in size between these columns is noteworthy, though no considerable systematic weight is generally allowed to Piazzini. Column 23 gives the correction to "Greenwich 1861" in the fundamental system, which, as Dr. Auwers derives proper motions from comparison of this with his reduction of Bradley, is taken as his systematic correction of Bradley. No. 24 = No. 23 + No. 17 is therefore Boss' correction to Auwers' Bradley. A careful direct comparison of the two is desirable. Professor Newcomb has published one ("Standard Clock and Zodiacal Stars") for the neighborhood of the ecliptic. Treating the corrections found by him as a function of declination and smoothing them, column 25 is derived, furnishing a rough check on No. 24. The next two columns contain Boss' correction to Bessel's Bradley for stars about the ecliptic and between $+15^\circ$ and -15° ,

1	2	3	4	5	6	7	8	9	10	11	12	13	14	15	16	17	18	19	20	21	22	23	24	25	26	27	28					
No. res.		Diff.		Mean Sm.		Pulk. '45		Grw. '45		AE-		Reduction		Answers to Boss.		P. '65		Cor. A ₁		Cor. A ₂		Cor. A ₁		Cor. A ₂		Cor. B. B. on ecliptic.						
δ	+	-	Σ	±	Σ	A ₂	B	A ₂	B	A ₂	Bj(A)	83	75	65	38	00	55	rem.	A ₂	B	A ₂	B	A ₂	B	A ₂	B	A ₂	B	N. 0h.	12h.	0	
90	5	0	16	+97	+78	-8	0	0	-8	0	-14	+01	-05	-13	-34	-63	-39	+13	+19	-15	+63	00	+19	-80								
85	3	0	7	30	.66	9	-2	.6	+1	1.0	-02	.07	.14	.32	.57	.87	.08	.37	+05	.73	+16	.23	.64									
80	4	4	16	.18	.41	1.0	.4	.4	1	.06	.07	.11	.15	.28	.46	.08	.04	.54	.26	.76	.30	.26	.42									
75	10	5	31	.54	.38	1.2	.9	.4	0	.03	.05	.08	.12	.22	.37	.54	.00	.49	.27	.89	.52	.27	.27									
70	7	5	23	.42	.25	1.4	1.2	.4	-1	.03	.06	.08	.10	.17	.27	.38	-02	.35	.18	.79	.52	.22	-16									
65	7	4	28	+26	+02	1.4	1.4	.4	.4	.04	.08	.08	.08	.09	-09	-10	.04	.21	.12	.57	.48	.12	+02									
60	12	12	46	-21	-20	1.1	1.3	-2	.4	.06	.07	-05	-03	+02	+10	+18	-02	+04	.06	+25	.35	+01	.19									
55	3	10	33	.28	.40	.8	1.1	+2	-2	1.1	.03	.00	+04	.14	.29	.46	+01	-11	.03	-19	+10	-06	.40									
50	8	14	47	.44	.67	-3	1.0	.7	.0	.15	.01	+04	.10	.28	.54	.81	.03	.26	.02	.84	-30	.13	.68									
45	9	11	41	.59	1.05	+1	.9	1.1	+1	1.5	.04	.05	.15	.44	.84	1.31	.05	.42	+02	1.64	.80	.16	1.15									
40	2	16	35	1.61	1.32	.4	.9	1.4	.1	1.4	.06	.05	.18	.53	1.03	1.63	+04	.54	-01	2.06	1.03	.17	1.46									
35	1	17	35	1.81	1.33	.3	1.0	1.5	.2	.09	.06	.04	.17	.53	1.04	1.63	.00	.51	+02	2.14	1.10	.13	1.50									
30	2	22	48	.81	1.26	.1	1.1	1.5	.2	-01	-04	.06	.19	.53	1.01	1.58	-02	.45	.08	2.37	1.36	.04	1.54	+1.2								
25	1	14	35	1.57	1.27	.1	1.2	1.6	.3	+06	+02	.12	.25	.59	1.07	1.64	.00	.49	.10	2.69	1.62	.04	1.60	1.3								
20	3	13	37	1.24	1.31	.1	1.2	1.5	+2	1.0	.07	.17	.30	.66	1.06	1.74	+02	.57	.09	2.68	1.62	.07	1.67	1.6	+51	+94	+56					
15	2	13	43	1.10	1.34	.2	1.1	1.1	-3	.05	.07	.18	.32	.68	1.19	1.79	.00	.54	.14	2.56	1.35	.13	1.66	1.9	.60	1.34	.74					
10	0	17	46	1.74	1.27	.3	.9	+3	1.0	1.0	.08	.18	.31	.65	1.14	1.71	-05	.50	.15	2.43	1.29	.23	1.48	2.0	.64	1.69	.90					
+5	1	10	29	1.08	1.15	.6	.6	-3	1.5	.20	.12	.21	.32	.63	1.07	1.59	.07	.56	+07	2.63	1.56	.37	1.22	1.8	.66	1.96	1.54					
0	1 1/2	7 1/2	23	.61	1.19	.9	.3	.7	1.9	.25	.16	.26	.37	.69	1.15	1.68	-06	.74	-05	3.01	1.86	.50	1.18	1.7	.66	2.15	.40					
-5	0	8	23	1.50	1.31	1.0	.3	.9	2.2	.30	.23	.34	.47	.82	1.32	1.91	+01	-99	-17	3.28	1.96	.60	1.31	1.7	.67	2.25	.50					
10	0	5	14	1.70	1.29	+4	.9	1.0	2.3	.37	.36	.46	.59	.94	1.43	2.01	.09															
15	0	4	11	.92	1.17	-8	2.0	1.3	2.5	.52	.49	.58	.70	1.01	1.46	1.98	.16															
20	0	4	8	1.14	1.09	-2.1	-3.2	1.3	2.4	.61	.57	.66	.77	1.06	1.48	1.97	.20															
25	1	3	5	1.10	-1.08	-1.2	-2.3	+66	+59	+68	+79	+108	+149	+198	+18																	
-30	0	2	2	-96																												

No. 26 for those near 0^h , and No. 27 near 12^h of right ascension. These apply to Bessel's reduction, unaffected by a correction derived from Bradley's observations of the sun and introduced by Bessel between $+14^\circ$ and -14° ; the value of which correction, smoothed by repeatedly taking means of successive values, gives column 28. It is of the same sign as the Boss correction, and agrees more nearly with column 26 than with a mean of Nos. 26 and 27.

It may be worth while to summarize the reasons for believing that Bradley's observations, even in the elaborate and skillful reduction of them made by Dr. Auwers, are open to a large correction in the direction of the Boss system, the first of which is furnished by that system itself, which is for 1820-'30 practically a mean of Bessel's, Struve's, and Argelander's independent and carefully determined places. (2) The evidence of Piazz's results (see columns 21, 22). (3) Evidence of the same kind from contemporary work by Mayer in Göttinger and La Caille in Paris, both of whom put their southern stars considerably northward of Bradley. (4) The similarity of Boss' correction to that adopted by Bessel, represented in column 28. For a correction to Bradley of opposite sign there is one reason: that the Boss system requires us to adopt for Greenwich in 1755 a latitude considerably higher than is now used. Auwers adopts a latitude for Bradley's epoch $0''.88$ smaller than Bessel's value, though $0''.56$ larger than the one suiting recent observations, while Boss is satisfied with Bessel's latitude. Though the change of a second or more is quite possible, and agrees with observations elsewhere, there is no independent reason for suspecting it, and the series of catalogues under Airy's long direction of this observatory shows no sign of its continuance. This consideration, together with the uncontested high superiority of Bradley over Mayer or Piazz as an observer, may be held sufficient to keep the question for the present doubtful.

Professor W. A. Rogers (Memoirs Amer. Acad., n. s. vol. 10) has already made a comparison between these two declination systems, and has paid attention to the important difference of proper motions used in their formation. The present paper is, however, entirely independent of the researches of Professor Rogers.

Mr. M. H. DOOLITTLE presented a communication on Means and Averages, of which the following is an abstract:

[Abstract.]

Such problems as require the determination of the average value of a variable may be divided into two classes.

In the first class there is a locus within which points, lines, or surfaces are equally distributed. In the solution the equirescent variable grows but is otherwise stationary, and its definite integral is the locus of equal distribution. For illustration, let it be required to determine the average value of a right triangle inscribed in a given semicircle, the vertices of the

right angle being equally distributed in the semi-circumference, or each set of legs being equally distributed in a right angle having the hypotenuse for one of its sides.

In the second class there is no locus of equal distribution, and the variable whose average value is required is a function of an equicrescent variable which moves while it grows. For illustration, let it be required to determine the average area of a right triangle with a given hypotenuse and one of the legs equicrescent.

In the published works on the subject nearly all, if not all, the problems belong to the first class, and the locus of equal distribution is frequently a given constant. When only one such constant is mentioned it has not always been thought necessary to state that this constant is the locus of equal distribution.

If it be required to determine the average area of a right triangle having a given hypotenuse, with no other conditions given, the problem is confessedly obscure; but the solution best conforming to any system of interpretation is that which makes the altitude divide the hypotenuse into equicrescent segments.

44th Meeting.

May 30, 1888.

In the absence of the Chairman, Mr. H. H. BATES presided.

Present, fourteen members.

The minutes of the 43d meeting were read and approved.

On motion of Mr. W. B. TAYLOR the following resolutions were adopted :

Whereas we have learned of the sudden death of our esteemed fellow-member E. B. Elliott, which occurred on last Thursday, May 24th; and whereas Mr. Elliott has been one of the most earnest and faithful members of this Section, presiding over the meeting which organized it, attending almost every session, contributing frequently to its proceedings, and always appreciatively following the discussions of others :

Be it resolved by the Mathematical Section of the Philosophical Society of Washington, at a session held May 30th, 1888, That we, the members of the Section, feel it to be our duty to unite in a warm expression of our high appreciation of the intellectual and social qualities of our departed friend, of our strong admiration of the courtesy and fidelity manifested by him in all his relations with others, and of our deep grief at the loss we realize in having no longer the pleasure and the benefit of his familiar presence among us.

Be it resolved, That the Secretary of the Mathematical Section be requested to present a copy of this minute of its proceedings to his relatives, with

the assurance of our sincere condolence with them in the affliction they have suffered.

Mr. G. W. HILL read a paper on The Disputed Mass of Titan.

This paper was published in full in No. 176 of the Astronomical Journal, Boston, July, 1888, under the title The Motion of Hyperion and the Mass of Titan.

Mr. ORMOND STONE also made a communication on the same general subject, the title of his paper being The Orbit of Hyperion. The following is an abstract of this paper:

[Abstract.]

A pure ellipse having a mean longitude equal to three times the mean angular distance of the radius vector of Hyperion from that of Titan was taken as an intermediate orbit. The difference between the equations of motion for the intermediate orbit and those for the disturbed orbit gave new equations, which were solved by indeterminate coefficients. An approximate solution gave for the mass of Titan $\frac{1}{4617}$ times that of Saturn.

The following paper on Problem-Solving was read by Mr. A. HALL:

Every one who has a taste for mathematical studies must have had some experience in solving problems. That this is a good exercise for a beginner no one can doubt. Such practice serves to clear his ideas, to show the power of theory, and to give confidence. Two centuries ago, when the differential calculus was coming into use, it was common among mathematicians of the first rank to propose questions to each other, and these questions or challenges had an important influence on the progress of mathematics. Thus the modern theory of probabilities had its origin in a question proposed to Pascal by one of his friends, the Chevalier de Méré, who having failed to solve a question in gaming declared with a high tone that arithmetic was crazy and lied. "He has," says Pascal, "a very good mind, but he is not a geometer, which is a great defect." The questions proposed were nearly always such as involved the consideration of a principle, and thus the study of them was fruitful. Another example is that of the pendulum. The simple pendulum having been discovered by Galileo, Huygens undertook to solve the problem of the compound pendulum. He obtained a correct result, but his assumptions and arguments were doubted and criticised. At length James Bernoulli gave the correct formal solution, which afterwards led to a great extension of the theory of dynamics. Such questions are worthy the labor of the ablest men. There are still questions of this nature that are under discussion, and the followers and representatives of the former investigators of the higher problems are our present writers on applied mathematics.

But with the growth of the science mathematicians separate into classes, and different nations produce various methods for teaching and cultivating the science. The English school teaches largely by working examples, and lays much stress on the solving of problems. I think there is much that is good in this method, since it is well to bring one's knowledge to the test of trial. But when we look over the lists of wranglers at Cambridge and consider the great amount of reading and hard work that is done, we feel that for some reason this method does not furnish the best results. Apparently it gives too much weight to memory and the training for a special trial. The prizes offered in the shape of honors and fellowships are so great that men with money employ experienced coaches and tutors, and it is not certain that the ablest mathematicians win. The successful coach will not only be a good mathematician, but he must also be a man of the world. He will invite the examiners to dinner, gauge them, and find out what kind of questions they are likely to set. Having done this, he can prepare his students for the contest with a confidence of success. Here is a good field for skillful management, and one is not surprised to be told that during the last twenty years more than half the first ten wranglers of each year at Cambridge have come from one famous coach. These successful men become the examiners of after years, and of course this old coach knows the caliber of every one of them. In these contests, as described by one of their best men, the main thing is to solve a question in twenty minutes, for this is all the time the contestant will have at his disposal. To do such work a man must be well drilled in all analytical transformations, he must have a great deal of practice in solving problems, and, furthermore, he must be quick with his pen and write a plain hand. But the real questions of a science cannot be dealt with in this manner, and experience teaches us that a man's ability does not depend on his penmanship; and although the drill in analysis is valuable I think the habits a man gets from such a course are apt to make him for life merely a solver of conundrums and book-questions, or he becomes dead scientifically as soon as he is stamped A. B. It has a strange sound to be told that to get honors in the great mathematical university of England it is a waste of time to read Lagrange, Laplace, and Gauss. But after all we must acknowledge that this system does produce some able men.

Turning now to the continent of Europe we see many men in France and Germany who spend their lives in the study of pure mathematics. These are the men who support the great mathematical journals and who are the real pioneers of the science. It is a wonder how they live and find time to do so much work. The only answer I can think of is that they are content with small salaries and are willing to lead simple lives. These men are not problem-solvers as the term is now used.

In our own country we have only begun scientific work, and in mathematics we have done very little. The tone of our society is opposed to such work. Religion and politics, politics and religion, have been and still are the subjects which attract the attention of men and furnish the

rewards of life. So long as we assume that an act of Congress can regulate everything it seems impossible for us to understand that we are placed in a world where universal laws have been established which we ought to learn and to which we should conform our conduct. No wonder we are told that mathematics should be studied only to "discipline the mind"—that is, to make us sharp and cunning in the affairs of life. Perhaps it is the influence of this sentiment that makes so much of the mathematical learning that we have tend to become quibbling and intolerant. The best corrective for this condition is the study of the real questions of nature. Whenever we undertake to solve a question of this kind we are sure to find things so different from the questions of the books that our eyes are opened to a wider world. If we call a thing by a different name, or represent it by a new symbol, it does not help much. The real difficulty must be met.

From my own experience I find that solving a few problems now and then is a good exercise. Even if they are mere book-questions, the practice serves to keep one's knowledge bright; but if a question be thoroughly worked it will generally give some instruction, and can be used to illustrate a theory. In this respect mathematics has a great advantage over most of the natural sciences, in which the investigator seems like a boy picking up stones on a New England farm—the work must be repeated every time the land is plowed.

45th Meeting.

October 17, 1888.

The Chairman presided.

Present, eleven members and guests.

In the absence of the Secretary, Mr. A. S. FLINT was elected secretary *pro tem*.

Mr. C. H. KUMMELL read a paper on Some Fundamental Theorems in Mensuration in One, Two, and Three Dimensions.

This paper was published in full in No. 4, vol. iv, of the Annals of Mathematics, University of Virginia, Va., 1888.

The remainder of the evening was devoted to a discussion of the paper of Mr. A. Hall on Problem-Solving, read at the 44th meeting.

46th Meeting.**October 31, 1888.**

The Chairman presided.

Present, fourteen members and guests.

The minutes of the 44th and 45th meetings were read and, after amendment, approved.

On motion, the Section voted to offer for publication *in extenso* the paper by Mr. A. Hall on Problem-Solving, read at the 44th meeting.

Mr. R. S. WOODWARD presented a communication on The Summation of Certain Complex Series.

The details of the analysis involved in this summation are given in full in a paper on The Diffusion of Heat in Homogeneous Rectangular Masses, with Special Reference to Bars used as Standards of Length, in No. 4, vol. iv, of the Annals of Mathematics, University of Virginia, Va., 1888.

Mr. G. W. HILL read a paper on the Application of Infinite Determinants to the Integration of Differential Equations.

47th Meeting.**December 12, 1888.**

The Chairman presided.

Present, fourteen members and guests.

Minutes of the 46th meeting read and approved.

Mr. W. C. WINLOCK presented a communication on Comet 1888 (*f*) V (Barnard, Oct. 30).

The substance of this communication was published in the Astronomical Journal, vol. 8, p. 136 and p. 148, Boston, 1889.

Mr. A. HALL presented a note on a method of deducing the right ascension and declination of an object observed to be at the intersection of the diagonals of a quadrilateral of the celestial sphere, from the right ascensions and declinations of the four vertices of the quadrilateral.

Mr. M. H. DOOLITTLE discussed A Problem in Probabilities, which may be stated as follows: Two persons, A and B, agree in their testimony concerning the occurrence of an event. The veracity of A is known, of B unknown. What is the probability that the event did occur when the testimony is affirmative? Mr. Doolittle considered the answer to this question concurred in by several mathematicians, whom he cited, erroneous. He indicated the error which led to the erroneous answer and gave the steps of the reasoning involved in what he thought the correct solution of the problem. In brief, the veracities of A and B being denoted by p and x respectively, the probability sought, if x were known, would be

$$\frac{px}{px + (1-p)(1-x)}.$$

But x being unknown, though confined within the limits 0 and +1, the correct answer according to Mr. Doolittle is the ratio of the average values of the numerator and denominator of this fraction, or p ; while the erroneous answer is the average value of the fraction, or

$$\frac{p}{2p-1} \left[1 - \frac{1-p}{2p-1} \log_e \frac{p}{1-p} \right].$$

During the discussion which followed Mr. A. S. CHRISTIE presided.

Mr. ARTEMAS MARTIN read a brief paper maintaining the correctness of the expression last given above and gave a demonstration leading thereto.

48th Meeting.

December 26, 1888.

The Chairman presided.

Present, seventeen members and guests.

Minutes of the 47th meeting read and approved.

Mr. R. S. WOODWARD presented a Statement of the Mathematical Theory of the Stratum of no Strain and its Application to the Earth. The object of this communication was to explain the

physical conditions under which an unstrained stratum may exist in a cooling sphere, to define its position mathematically, and to indicate the bearing of the theory on geological phenomena.

Mr. ARTEMAS MARTIN read a paper written by Professor FLORIAN CAJORI, of Denver, Colorado, on the Difference Between Napier's and Natural Logarithms.

This paper is published in full in No. 1, vol. II, of *The Mathematical Magazine*, Washington, D. C., January, 1890.

Mr. M. H. DOOLITTLE presented a communication on Symbols of Non-Existence, of which the following is an abstract:

[Abstract.]

After a brief allusion to 0 as a symbol of non-existence, Mr. Doolittle dwelt chiefly on probability-equations as symbols of the non-existence of knowledge, either real or assumed. In the first edition of his *Logic*, Mill complained that mathematicians were attempting to coin ignorance into knowledge. In the last edition he acknowledged the injustice of this complaint. The mathematician merely analyzes an alloy of ignorance and knowledge and properly stamps it. In making this analysis probability-equations are appropriate expressions for the ignorance involved. For example, the equation $p = \frac{1}{2}$, when denoting the probability of an event, merely signifies the non-existence of knowledge (real or assumed) of any reason for expecting the occurrence rather than the non-occurrence of the event or the reverse. The equation requires no assumption and implies no existence of any knowledge whatever, unless it be (as Mr. Hill suggested) the mere knowledge that the event must either happen or fail to happen. If the mathematician has any knowledge or assumption of knowledge to express, there are appropriate symbols, and he should not confuse his analysis by attaching to probability-equations a meaning beyond their proper scope. To illustrate more definitely, if the event be the random drawing of a white ball from a box containing balls of no other colors than black and white, the equation neither implies nor denies that the balls are equally divided in color; it is perfectly consistent with certain knowledge that they are all of the same color, if we do not know which; and it is amply justified by complete ignorance of the proportions in which the colors are mingled.

49th Meeting.**January 23, 1889.**

The Chairman, Mr. DOOLITTLE, presided.

Present, fifteen members and guests.

The annual election of officers of the Section was held and resulted in the choice of Mr. R. S. WOODWARD for Chairman and of Mr. A. S. FLINT for Secretary.

Mr. A. S. FLINT presented a paper on, A Brief Control for General Solutions of Normal Equations.

Published in full in the Annals of Mathematics, 4to, University of Virginia, Va., Dec., 1888, vol. 4, No. 6., pp. 182-185.

Mr. ARTEMAS MARTIN read a paper on Napier's Logarithms.

Published in full in the Mathematical Magazine, edited and published by Artemas Martin, 4to, Washington, vol. II, No. 1, Jan., 1890, pp. 4-6.

Mr. W. F. MCK. RITTER made a communication on General Perturbations of the Minor Planets.

50th Meeting.**February 6, 1889.**

The Chairman, Mr. WOODWARD, presided.

Present, thirteen members and guests.

Mr. C. H. KUMMELL made a communication on An Error of Delaunay which has Passed into Text-Books and Encyclopedias.

Mr. J. H. GORE made a communication on The Scope and Character of a Bibliography of Geodesy now Completed.

The bibliography referred to is published as Appendix No. 16 of report of U. S. Coast and Geodetic Survey for 1887, 4to, Washington, Government Printing Office, 1889.

Mr. M. H. DOOLITTLE made a few remarks on The Applications of a Formula for the Probability of an Event Resting on the Concurrent Testimony of Two Witnesses.

51st Meeting.**February 20, 1889.**

The Chairman, Mr. WOODWARD, presided.

Present, thirteen members and guests.

Mr. M. H. DOOLITTLE discussed briefly Two Problems in Probabilities.

Mr. R. S. WOODWARD stated and briefly discussed A Problem in Dynamics.

52d Meeting.**April 3, 1889.**

The Chairman, Mr. WOODWARD, presided.

Present, sixteen members and guests.

Mr. G. W. HILL read a paper on The Combination of Observations into Normal Positions.

Mr. C. H. KUMMELL read a paper on Warped Polyhedra in General, with Special Application to the Road-Cutting Solid.

Mr. A. HALL made a brief communication on the problem: Given a chord drawn at random within a given circle, what is the probability that its length will be greater than the side of the inscribed equilateral triangle?

53d Meeting.**May 29, 1889.**

The Chairman, Mr. WOODWARD, presided.

Present, twelve members.

Mr. R. S. WOODWARD made a communication entitled Notes on Problems in Averages.

54th Meeting.**October 16, 1889.**

The Chairman, Mr. WOODWARD, presided.

Present, eighteen members and guests.

The Chairman announced that both himself and the Secretary would soon depart for a prolonged absence from the city and suggested that the Section elect officers to serve for the remainder of the year.

Accordingly Mr. G. W. HILL was elected Chairman and ALEX. S. CHRISTIE, Secretary.

Mr. G. W. HILL read a paper on A Reported Occultation of α Tauri by Saturn in 1679.

Mr. A. HALL made a communication on The Resisting Medium in Space.

Published in full in the Siderial Messenger, 8vo, Northfield, Minn., Dec., 1889, vol. 8, No. 10, pp. 433-442.

55th Meeting.**October 30, 1889.**

The Chairman, Mr. HILL, presided.

Present, ten members and one guest.

Mr. G. K. GILBERT made a communication on The Geometry of Shrinkage Cracks.

Mr. ARTEMAS MARTIN made a communication on A Method of Extracting the Square Root.

Published in the Mathematical Magazine, vol. II, 1890, p. 33-38.

56th Meeting.**January 8, 1890.**

The Chairman, Mr. HILL, presided.

Present, seven members.

The annual election of officers of the Section was held, and resulted in the choice of Mr. J. H. GORE for Chairman and of Mr. G. E. CURTIS for Secretary.

57th Meeting.**February 5, 1890.**

The Chairman, Mr. GORE, presided.

Present, nine members.

Mr. C. H. KUMMELL began a communication on The Method of Continued Identity in its Application to the Solution of Equations and Expressing Functions in Highly Convergent Forms.

Published in full in the Annals of Mathematics, 4to, University of Virginia, Va., vol. v, 1890, pp. 85en 98.

58th Meeting.**February 19, 1890.**

The Chairman, Mr. GORE, presided.

Present, seven members and one guest.

Mr. C. H. KUMMELL continued his presentation of the communication begun at the previous meeting.

59th Meeting.**March 19, 1890.**

The Chairman, Mr. GORE, presided.

Present, sixteen members and guests.

By invitation Mr. G. N. SAEGMULLER exhibited the drawings of the new telescope now in process of construction for the Chamberlain Observatory, at Denver, and explained the novel features that he has introduced in its mounting.

Mr. C. E. DUTTON made a communication on Some Remarkable Transcendental Equations.

60th Meeting.**April 2, 1890.**

Mr. G. W. HILL presided.

Present, fifteen members.

Mr. R. S. WOODWARD made a communication on Some Special Laws of the Diffusion of Heat in Homogeneous Spheres, in which

he discussed the application of the laws of cooling of a sphere under various assumptions as to the initial distribution of temperature.

Mr. C. H. KUMMELL made a communication on A Short, Rough Method of Computing the Probable Error.

61st Meeting.**April 30, 1890.**

The Chairman, Mr. GORE, presided.

Present, ten members.

Mr. G. W. HILL made a communication on The Secular Perturbations of Two Planets Moving in the Same Plane, with Application to Jupiter and Saturn.

62d Meeting.**May 14, 1890.**

The Chairman, Mr. GORE, presided.

Present, ten members.

Mr. MARCUS BAKER made a communication on The Published Writings of Mr. E. B. Elliott, in which he presented a bibliography of Mr. Elliott's publications, accompanied by remarks upon their scope and character.

Mr. ARTEMAS MARTIN made a communication on The Curve of Pursuit.

Mr. J. F. HAYFORD made a communication on A Modification of the Ferrel Tide-Predicting Machine, which enables hourly readings of the tidal heights to be made in addition to the heights and times of high and low water, which latter the instrument has heretofore given.

63d Meeting.**January 7, 1891.**

The Chairman, Mr. GORE, presided.

Present, ten members and guests.

The first business transacted was the annual election of officers for the ensuing year.

Professor J. H. GORE was re-elected Chairman and Mr. G. E. CURTIS Secretary.

Mr. C. H. KUMMELL made a communication on A New, Simple, and Symmetrical Solution of the Quartic.

64th Meeting.

April 1, 1891.

The Chairman, Mr. GORE, presided.

Present, six members.

Mr. ARTEMAS MARTIN made a communication entitled The Sum of Two Biquadrate Numbers Cannot be a Biquadrate Number.

Mr. C. H. KUMMELL completed his communication, begun at the preceding meeting, on A New Solution of the Quartic.

Published in full in the Mathematical Magazine, 4to, Washington, D. C., vol. II, 1890, pp. 49-55.

Mr. MARTIN pointed out that of all known solutions of the quartic Mr. Kummell's is the only one which does not employ more than one auxiliary unknown quantity.

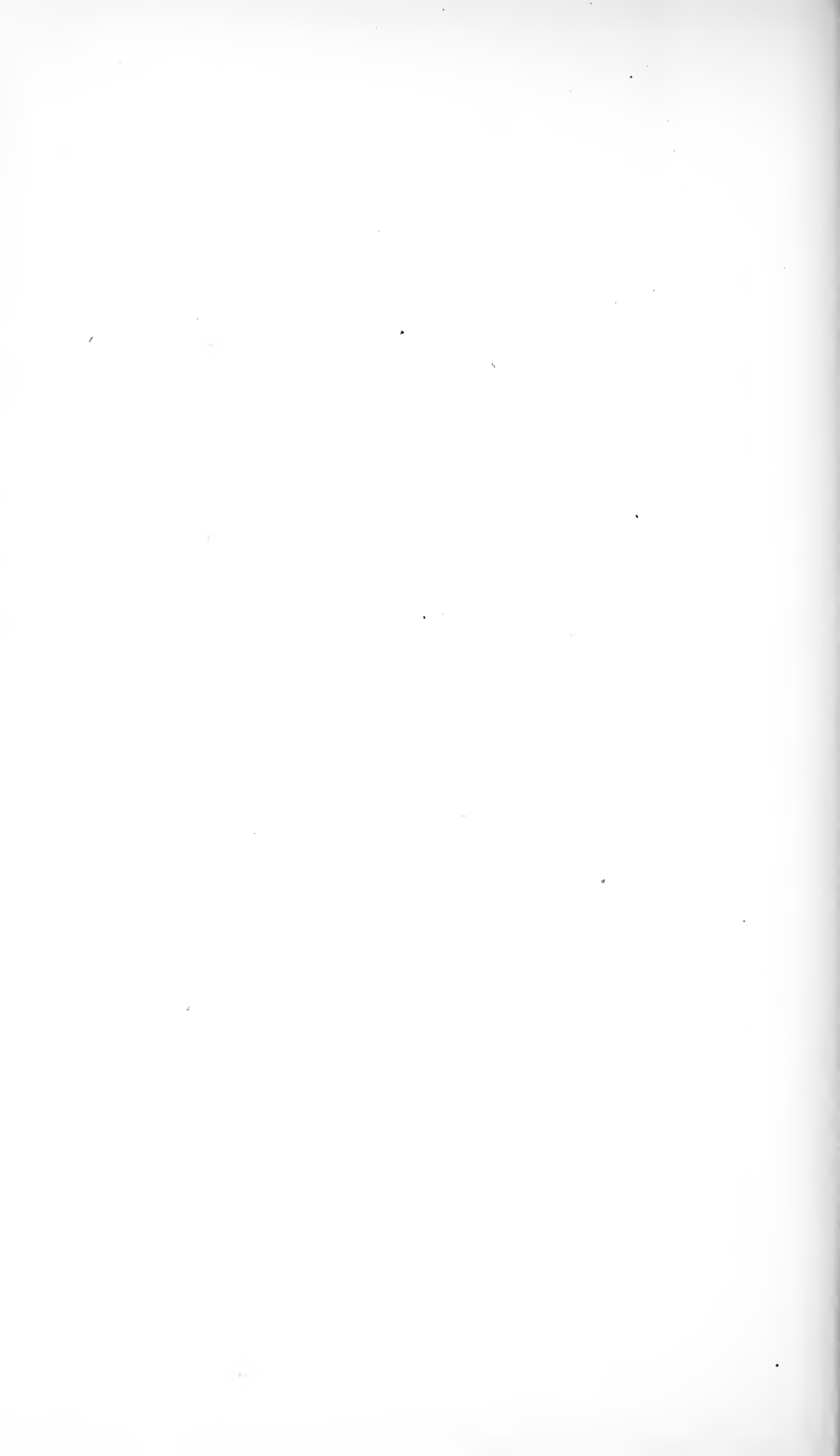

INDEX.

	Page.		Page.
Abbe, C.: Account of the eclipse expedition to Africa.....	555	Azimuth observations for the detection of variations in the pole or vertical. J. F. Hayford.....	572
— Influence of forests upon rainfall.....	521	Bacteriology in applied entomology. C. V. Riley.....	565
— Mechanical conditions of the earth's mass.....	533	Baker, F., elected member	554
— Meteorology in Europe and America.....	569	— Work of the life-saving crews during the recent hurricane.....	542
Address of President Dutton, 1890 [1891].....	359	Baker, M.: Averages.....	591
— — President Eastman, 1889.....	143	— Obituary notice of É. B. Lefavour.....	488
— — President Mallery, 1888.....	1	— Published writings of E. B. Elliott.....	608
Africa, Stanley's discoveries in. G. G. Hubbard	551	— Report of the Secretaries, 1888	523
Agricultural Department, Scientific work of. E. Willits	550	Balloon voyages, Two. H. A. Hazen.....	511
— experiment stations, Status and tendencies of. A. C. True.....	566	Bancroft, G., Death of.....	564
Aldis, A. O., Death of.....	569	Bates, H. H.: Force.....	587
Alloys, Formation of. W. Hallock.....	505	— Increasing industrial employment of the rarer metals.	503
Anatomy, Comparative, of the simian and human brain. B. G. Wilder	553	Bauer, L. A., elected member	518
Annual Meeting, 1888	522	Becker, G. F.: Rounding of rock masses by external attack.....	500
— — 1889.....	543	Belgium, National postal and savings bank system of. T. Wilson.....	570
— — 1890.....	557	Bernardinite. J. Stanley-Brown.....	567
— — 1891.....	572	Bessels, E., Death of.....	515
Arid region of North America, Subaërial deposits of. I. C. Russell.....	531	— Obituary notice of, by W. H. Dall.....	465
Arkansas, Neozoic formations in. R. T. Hill.	501	Bigelow, F. H.: Experiments for eliminating the error of personal equation from stellar transits by photography.....	570
Astronomy, Meteoric, Progress of, in America. J. R. Eastman.....	275	— Suggestions on eclipse photography and eclipse apparatus.....	555
— Spherical, Problem in. A. Hall.....	601	Billings, J. S.: Galton's apparatus for testing muscular sense.....	502
— Tisserand's <i>Traité de mécanique céleste</i> . R. S. Woodward.....	568	Biological survey of the San Francisco mountain range of Arizona. C. H. Merriam ...	551
Atkinson, W. R., elected member	555	Birds, Soaring of. G. K. Gilbert.....	522
Atlantic and Gulf coasts, Recent geographic changes on. W J McGee.....	554	Black Hills, Pre-Cambrian rocks of the. C. R. Van Hise	552
Atomic weights, Determination of. F. W. Clarke.....	506	Boutelle, C. O.: Geodetic azimuths	513
Atwater, W. O., elected member.....	540	— Obituary notice of H. F. Walling.....	492
— American and European food consumption	530	— Death of.....	554
Auditing committee, Report on Treasurer's accounts for 1887	499	— Obituary notice of, by E. Goodfellow.....	466
— — — — — 1888	528	Braid, A., elected member	506
— — — — — 1889.....	649	Brain, Comparative anatomy of the simian and human. B. G. Wilder	553
— — — — — 1890.....	563	British Columbia, Explorations in. G. M. Dawson.....	502
Averages. M. Baker.....	591		
— Notes on problems in. R. S. Woodward..	605		
— and means. M. H. Doolittle	596		

Page.	Page.		
British northwest, Physical features of a por- tion of. C. A. Kenaston.....	507	Dall, W. H.: Some forms of the gill in pe- lecypod mollusca	541
Brocken spectre. H. A. Hazen.....	550	— Obituary notice of Emil Bessels.....	465
Burial mounds of Japan. R. Hitchcock	553	Dawson, G. M.: [Explorations in northern part of British Columbia and head-waters of the Yukon]	502
Burnett, S. M.: Models showing refraction by cylinders with their axes crossed at vari- ous angles.....	531	Deaf, Education of the. E. M. Gallaudet.....	570
— New metric system of numbering prisms..		— New Departure at Kendall Green. J. C. Gordon	571
Cajori, F.: Difference between Napier's and natural logarithms.....	603	Deaf-mutes, Discovery and development of hearing in. J. C. Gordon	539
Carr, W. K., elected member	568	De Caindry, W. A.: Treasurer's report, 1891.	574
Cattle and meat inspection, Objects and methods of. D. E. Salmon.....	569	Decimal system of the 17th century. J. H. Gore.....	556
Chapman, D. C., elected member	522	Delaunay, Error in. C. H. Kummell.....	604
— New form of galvanometer	540	Differential equations, Application of infinite determinants to the integration of. G. W. Hill.....	601
Chart-making. H. G. Ogden.....	554	Diller, J. S.: History of porphyritic quartz in eruptive rocks.....	531
Chemical action between solids. W. Hal- lock.....	542	— Sandstone dikes of northern California... 543	
Chemical elements, Relative abundance of. F. W. Clarke.....	131, 542	— Secretaries' report, 1889	544
Christie, A. S.: What is a Quaternion?.....	579	— — — 1890.....	557
Clarke, F. W.: Determination of atomic weights.....	506	— — — 1891.....	572
— Gem localities of Maine.....	570	Dividing engines. J. E. Watkins.....	554
— Relative abundance of the chemical ele- ments.....	131, 542	Doolittle, M. H.: Applications of a formula for the probability of an event resting on concurrent testimony of two witnesses..	604
— Theory of the mica and chlorite groups... 568		— Means and averages.....	596
Coffin, J. H. C., Death of.....	550	— Probabilities	583
Colonna, B. A., elected member.....	555	— Problem in probabilities	602
Color perception. H. V. Würdemann.....	531	— Symbols of non-existence	603
Columbian formation, Southern extension of. W J McGee	550	— Two problems in probabilities.....	605
Comet 1888 V. W. C. Winlock	601	— What is force?.....	589
Committee on communications, 1888	499	Dutton, C. E.: Irrigation in the arid region.	542
— — — 1889.....	528	— Money fallacies. President's address, 1890 [1891].....	359
— — — 1890.....	550	— Remarkable transcendental equations.....	607
— — — 1891.....	564	— Some of the greater problems of physical geology	51, 536
— on publications, 1888.....	499	Dynamics, Problem in. R. S. Woodward.....	605
— — — 1889.....	528	Eakins, L. G., elected member.....	551
— — — 1890.....	550	Earth, Interior constitution of, as respects density. G. W. Hill	581
— — — 1891.....	564	— Figure of Study of, by means of the pen- dulum. E. D. Preston	567
Constitution, Amendment to, proposed.. 518, 527		— Mass of, mechanical conditions of. C. Abbe	533
Cope, E. D.: Relation of consciousness to animal motion.....	518	— Mass of, mechanical conditions of. R. S. Woodward	532
Corrasion, Laws of. J. W. Powell.....	519	— Mathematical theory of the stratum of no strain. R. S. Woodward.....	602
— Remarks on the laws of. L. F. Ward.....	519	— Variation of terrestrial density, gravity, and pressure. R. S. Woodward	580
Croffut, W. A.: Experiments in hypnotism... 516		Eastman, J. R.: Assumption and fact in the theories of solar and stellar proper mo- tions. President's address, 1889.....	143, 543
Cross, W.: Constitution and origin of spher- ulites.....	411, 568		
Crystallization of igneous rocks. J. P. Id- dings.....	65, 541		
Curtice, C.: Cambrian rocks in Tennessee... 516			
Curtis, G. E.: Hot winds of the Plains	564		
— Rain-making experiments in Texas.....	570		
— Relation of surface and climatic condi- tions to the flow of water-courses.....	552		
Curve of pursuit. A. Martin.....	608		

	Page.		Page.
Eastman, J. R.: Progress of meteoric astronomy in America.....	275, 553	Flint, A. S.: Brief control for general solutions of normal equations.....	604
— Some peculiarities in personal equation.....	515	Food consumption, American and European, compared. W. O. Atwater.....	530
Eclipse expedition to Africa. C. Abbe.....	555	Force, What is. A. Hall.....	583
Eclipse photography and eclipse apparatus.		— — — H. H. Bates.....	587
F. H. Bigelow.....	555	— — — M. H. Doolittle.....	589
— — in Japan. Romyn Hitchcock.....	502	Forests, Relation of, to water supplies. B. E. Fernow.....	552
— Solar, January 1, 1889. D. P. Todd.....	533	Gallaudet, E. M.: Values in the education of the deaf.....	570
Edes, R. T., elected member.....	502	Galvanometer, New form of. D. C. Chapman.....	540
— The Sphygmograph.....	517	Gannett, H.: Do forests influence rainfall?... ..	520
Einbeck, W.: New method of determining astronomical differences of longitude... ..	553	Gem localities of Maine. F. W. Clarke.....	570
Eldridge, G. H.: Peculiar structural features in the foot-hill region of the Rocky mountains near Denver, Col.....	247, 543	Geodesy, Scope and character of a bibliography of. J. H. Gore.....	604
Electrostatics, Maxwell's theory of. R. S. Woodward.....	571	Geodetic azimuths. C. O. Boutelle.....	513
Elements, Chemical, Relative abundance of the. F. W. Clarke.....	131	— operations in Russia. J. H. Gore.....	567
Elliott, E. B.: Notation in physics and electricity.....	590	Geology, Physical, Some of the greater problems of. C. E. Dutton.....	51, 536
— Death of.....	516	— — — — — G. K. Gilbert.....	536
— Bibliography of. M. Baker.....	608	— — — — — R. S. Woodward.....	537
— Obituary notice of, by W. Harkness.....	470	— Study in structural. C. D. Walcott.....	551
— Resolutions upon the death of.....	597	Gihon, A. L., elected member.....	569
Engineering, Beginnings of. J. E. Watkins.....	556	Gilbert, G. K.: Estimation of skill in making predictions.....	582
Entomological matters of international concern. C. V. Riley.....	511	— Flat Rock channel.....	502
Equations, Remarkable transcendental. C. E. Dutton.....	607	— Geometry of shrinkage cracks.....	606
Equatorial telescope, Denver, Drawings of. G. N. Saegmuller.....	607	— Soaring of birds.....	522
Evolution of serials published by scientific societies. W J McGee.....	221	— Some of the greater problems of physical geology.....	536
Explorations, Recent geographical and geological, in the southwest. R. T. Hill.....	569	Goode, G. B.: Origin of our national scientific institutions.....	551
Farquhar, H.: Commercial growth and import duties of the United States.....	567	Goodfellow, E.: Obituary notice of. C. O. Boutelle.....	566
— Systematic differences of proper motions in declination catalogues.....	593	Gordon, J. C.: Discovery and development of hearing in certain deaf-mutes.....	539
Fassig, O. L., elected member.....	541	— New departure at Kendall Green.....	571
Fault hades. Bailey Willis.....	500	Gore, J. H.: Decimal system of the 17th century.....	556
Fault, Mechanism of the overthrust. Bailey Willis.....	529	— Geodetic operations in Russia.....	567
Fernow, B. E.: Artificial production of rainfall.....	557	— Scope and character of a bibliography of geodesy.....	604
— Influence of forests upon quantity and frequency of rains.....	520	Great Smokies, Rocks of the, and their age. A. Keith.....	540
— Relation of forests to water supplies.....	552	Greely, A. W.: Do forests influence rainfall?	520
Ferrel, W., Death of.....	569	— Trans-Mississippi rainfall.....	505
Fischer, E. G., elected member.....	553	Hagen, J. G., elected member.....	531
— Standard screws and threads.....	556	Hall, A.: Note on ζ Cancri.....	565
Flat Rock channel. G. K. Gilbert.....	502	— Problem in probabilities.....	605
Fletcher, R.: Treasurer's report, 1888.....	525	— — — spherical astronomy.....	601
— — — 1889.....	546	— Problem-solving.....	598
— — — 1890.....	559	— Resisting medium in space.....	606
		— Saturn and its ring.....	542
		— What is force?.....	583
		Hall, G. S.: Experiments in hypnotism.....	516

	Page.		Page.
Hallock, W.: Chemical action between solids	518, 542	Hitchcock, R.: Action of light on silver chloride.....	542
— Coefficient of expansion of some rocks.....	556	— Burial mounds of Japan.....	553
— Deep well at Wheeling.....	571	— Notes on eclipse-photography in Japan....	502
— Flow of solids	509	Hollerith, H., elected member.....	555
— Formation of alloys	505	— Electrical tabulating machine.....	553
Hampson, T., Death of	515	Howard, L. O., elected member.....	518
— Obituary notice of, by H. W. Henshaw	474	Hoyt, J. W.: Account of the present status and prospects of the project for a national university	570
Harkness, W.: Determination of the mass of the moon from the tides	555	Hubbard, G. G.: Stanley's discoveries in Africa	551
— Obituary notice of E. B. Elliott	470	Hurricane, Work of the life-saving crews during the recent. F. Baker.....	542
— Solar parallax and related constants	518	Hurricanes in the bay of North America. E. Hayden	173, 542
Harrington, M. W., elected member.....	571	Hyperion, Orbit of. O. Stone	598
Harris, A. W., elected member	554	Hypnotic experiments of the Comte de Maricourt. M. M. Snell.....	518
Harris, R. A., elected member.....	566	Hypnotism, Experiments in. W. A. Croffut and G. Stanley Hall	516
Hayden, E.: Hurricanes in the bay of North America	173, 542	Hypsometry, Barometric example of work in. G. Thompson.....	556
Hayden, F. V., Death of	499	Ice-arch formed by horizontal pressure. J. Murdoch	507
— Obituary notice of, by A. C. Peale	476	Iddings, J. P.: Crystallization of igneous rocks.....	65, 541
Hayes, C. W., elected member.....	530	— Mineral composition and geological occurrence of certain igneous rocks in the Yellowstone National Park.....	191, 550
Hayford, J. F., elected member.....	543	— Origin of primary quartz in basalt.....	515
— Check on the relation between the metric units of length and mass.....	572	— Spherulitic crystallization in obsidian.....	445, 568
— Detection by azimuth observations of variations in the pole or vertical	572	Identity, Continued, in its application to the solution of equations, and expressing functions in highly convergent forms. C. H. Kummell.....	607
— Modification of the Ferrel tide-predicting machine	608	Indian types of beauty. R. W. Shufeldt.....	567
Hazen, H. A.: Brocken spectre	550	Industry, Evolution of.....	569
— Failure in the application of the law of probabilities	581	Iroquois beach. J. W. Spencer.....	500
— Influence of forests upon rainfall	521	Irrigation in the arid region. C. E. Dutton..	542
— Lawrence tornado, July 26, 1890	564	Irving, R. D.: Obituary notice of, by I. C. Russell.....	478
— Recent Mount Vernon, Ill., tornado.....	517	James, J. F., elected member.....	552
— Two balloon voyages	511	James, J. N., elected member	571
Heat, Special laws of the diffusion of, in homogeneous spheres. R. S. Woodward..	607	Japan, Burial mounds of. R. Hitchcock	553
Henshaw, H. W.: Obituary notice of Thomas Hampson	474	Jenney, W. P., elected member.....	555
Hilgard, J. E., Death of	568	Keith, A., elected member.....	506
Hill, G. W.: Application of infinite determinants to the integration of differential equations	601	— Rocks of the Great Smokies and their age. 540	
— Combination of observations into normal positions	605	Kenaston, C. A.: Physical features of a portion of the British northwest.....	507
— Interior constitution of the earth as respects density.....	581	Kendall Green, New departure at. J. C. Gordon	571
— Mass of Titan.....	598	Kidder, J. H., Death of.....	533
— Reported occultation of α Tauri by Saturn in 1679	606	— Obituary notice of, by R. Rathbun.....	480
— Secular perturbations of two planets moving in the same plane, with application to Jupiter and Saturn	608	Kummell, C. H.: An error of Delannay.....	604
Hill, R. T.: Neozoic formations in Arkansas. 501		— Fundamental theorems in mensuration in one, two, or three dimensions.....	600
— Occurrence and availability of underground water in Texas and New Mexico. 571			
— Recent geographical and geological explorations in the southwest.....	569		

	Page.		Page.
Kummell, C. H.: Method of continued identity in its application to the solution of equations, and expressing functions in highly convergent forms.....	607	McGee, W J: Flood plains of rivers.....	565
— New simple and symmetrical solution of the quartic	609	— Mississippi bad lands.....	567
— Remarks on some recent discussions of target-shooting	582	— Recent geographic changes on the Atlantic and Gulf coasts.....	554
— Short, rough method of computing the probable error.....	608	— Rock gas and related bitumens.....	530
— Warped polyhedra, with special application to the road-cutting solid.....	605	— Southern extension of the Columbian formation.....	550
Lake, Extinct, of Pleistocene times in the Sierra Nevada. H. W. Turner.....	565	Members elected in 1888.....	523
Lake Ontario, Drift north of. J. W. Spencer.	506	— — — 1889.....	544
Langley, S. P.: On the observation of sudden phenomena	41, 531	— — — 1890.....	557
Lavas, Characteristic, radiate growth in acid. W. Cross.....	568	— — — 1891.....	572
Lefavour, E. B., Death of.....	541	Mendenhall, T. C.: New pendulum apparatus.....	566
— Obituary notice of, by M. Baker	488, 552	Mensuration, Fundamental theorems in. C. H. Kummell	600
Life-saving crews, Work of during the recent hurricane. F. Baker.....	542	Metals, Increasing industrial employment of rarer. Henry H. Bates	503
Lindgren, W., elected member	555	Meteoric astronomy in America, Progress of. J. R. Eastman	275
Littlehales, G. W., elected member.....	543	Meteorology in Europe and America. C. Abbe.....	569
— New method of recording and reproducing articulate speech.....	553	Metric units of length and mass, Check on the relation between. J. F. Hayford....	572
Logarithms, Difference between Napier's and natural. F. Cajori	603	Merriam, C. H.: Biological survey of the San Francisco mountain range of Arizona ...	551
— Napier's. A. Martin.....	604	Mica and chlorite groups. F. W. Clarke.....	568
Longitude, Determination of. W. Eimbeck.	553	Mindeleff, C., elected member	531
Mallery, G.: Philosophy and specialties. President's address, 1888.....	1	Mindeleff, V., elected member.....	531
Martin, A.: Curve of pursuit.....	608	Mineral composition and geological occurrence of certain igneous rocks in the Yellowstone National Park. J. P. Idings	191
— Error in Barlow's theory of numbers.....	592	Mississippi bad lands. W J McGee.....	567
— Method of extracting the square root.....	606	Minutes of general meetings, Resolution in relation thereto.....	530
— Napier's and natural logarithms	603, 604	Mohawk Lake beds. H. W. Turner	385
— Probabilities.....	602	Mollusca, Pelecypod, Some forms of gill in. W. H. Dall	541
— Square numbers whose sum is a square... ..	580	Money fallacies, President's address, 1890. C. E. Dutton.....	359
— Sum of two biquadrate numbers cannot be a biquadrate number.....	609	Moon, Mass of, from the tides. W. Harkness.....	555
Marvin, C. F.: New self-recording rain-gauge.	502	Muir glacier of Alaska. H. S. Reid.....	555
— Wind pressures and the measurement of wind velocities.....	556	Murdoch, J.: Ice-arch formed by horizontal pressure.....	507
Mason, O. T.: Study of religions by the methods of natural history.....	564	Muscular sense, Galton's apparatus for testing. J. S. Billings.....	502
Mathematical nomenclature, A question in. W. B. Taylor.....	590	Newcomb, S.: Fundamental concepts of physics.....	514
Mathematical Section, Officers for 1888	579	Newell, F. H.: Stream measurements in the western states.....	569
— — — 1889.....	604	Normal equations, Brief control for general solutions of. A. S. Flint.....	604
— — — (<i>pro tem.</i>) 1889.....	606	— positions, Combination of observations into. G. W. Hill.....	605
— — — for 1890.....	606	Numbers, Error in Barlow's theory of. A. Martin	592
— — — for 1891.....	609		
— — Proceedings of, 1888 to 1891	579-609		
McCammon, J. K., elected member.....	566		
McGee, W J: Evolution of serials published by scientific societies.....	221, 533		

	Page.		Page.
Numbers, Square, whose sum is a square.....	580	Preston, E. D., elected member	520
— Sum of two biquadrate, cannot be a biquadrate number. A. Martin.....	609	— Reduction of pendulum observations 115, 541	541
Obituary notices	465, 520, 529	— Study of the earth's figure by means of the pendulum.....	567
— Report of committee relative to.....	518	Prisms, New metric system of numbering. S. M. Burnett.....	566
Observation of sudden phenomena. S. P. Langley	41, 531	Probabilities, Failure of the apparent law of. H. A. Hazen.....	581
Obsidian, Spherulitic crystallization in. J. P. Iddings.....	508	— A. Martin.....	602
Occultation, Reported, of α Tauri by Saturn in 1679. G. W. Hill.....	606	— M. H. Doolittle.....	583
Officers of the Mathematical Section. See Mathematical Section.		— Problem in. A. Hall.....	605
Officers for 1889.....	527	— — — M. H. Doolittle.....	602
— — 1890	548	— Two problems in. M. H. Doolittle.....	605
— — 1891	562	Probability equations. M. H. Doolittle.....	603
— — 1892	xvii	— of an event resting on the concurrent testimony of two witnesses, Application of a formula for. M. H. Doolittle.....	604
Ogden, H. G.: Chart-making	554	Probable error, Short, rough method of computing. C. H. Kummell.....	608
— Distortion in plane-table sheets.....	508	Problem-solving. A. Hall.....	598
Osborne, J. W.: Surfaces feebly sensitive to light.....	518	Proper motions, Assumption and fact in the theories of solar and stellar. J. R. Eastman	143
Parker, Peter, Death of.....	502	Puma, Epitome of the natural history of. F. W. True	554
— Obituary notice of, by W. B. Taylor.....	491	Quaternion, What is a? A. S. Christie.....	579
Parry, C. C., Death of.....	566	Quartic, New simple and symmetrical solution of. C. H. Kummell.....	609
Peale, A. C.: Obituary notice of F. V. Hayden. 476		Quartz, Origin of primary, in basalt. J. P. Iddings	515
Pendulum apparatus. T. C. Mendenhall.....	566	— Porphyritic, in eruptive rocks. J. S. Diller.....	531
— Length of Kater's. O. H. Tittmann.....	553	Railway systems of England and America, Origin of	533
— observations, Reduction of. E. D. Preston	115, 541	Rainfall, Trans-Mississippi. A. W. Greely ..	505
— Study of earth's figure by. E. D. Preston. 567		— Artificial production of. B. E. Fernow ...	557
Penokee iron-bearing series of rocks. C. R. Van Hise.....	530	— Influence of forests upon. C. Abbe	521
Personal equation, Elimination of, from stellar transits by photography. F. H. Bigelow	570	— — — — —. B. E. Fernow	520, 552
— — Observation of sudden phenomena. S. P. Langley	41, 531	Rain-gauge, New self-recording. C. F. Marvin	502
— — Some peculiarities in. J. R. Eastman. 515		Rain-making experiments in Texas. G. E. Curtis	570
Perturbations of the minor planets. W. F. McK. Ritter.....	604	Ramsden's dividing engine. J. E. Watkins..	554
— Secular, of two planets moving in the same plane, with application to Jupiter and Saturn	608	Rathbun, R.: Obituary notice of J. H. Kidder. 480	
Philosophy and specialties. President Malley's address	1	Reduction of pendulum observations. E. D. Preston	115, 541
Physics, Fundamental, Concepts of. S. Newcomb	514	Refraction by cylinders with axes crossed at various angles. S. M. Burnett.....	531
Plane-table sheets, Distortion in. H. G. Ogden	508	Reid, H. S.: Note on the Muir glacier of Alaska	555
Plant life, Formation of deposits of lime, iron, and silica by. W. H. Weed.....	537	Relative abundance of the chemical elements. F. W. Clarke.....	131
Pohle, J., elected member	555	Religions, Study of, by the methods of natural history. O. T. Mason.....	564
Powell, J. W.: Evolution of industry	569	Resisting medium in space. A. Hall.....	606
— Laws of corrosion	519	Riley, C. V.: Bacteriology in applied entomology	565
Predictions, Estimation of skill in making. G. K. Gilbert.....	582		
President's address. See Address.			

Page.	Page.		
Riley, C. V.: Some recent entomological matters of international concern.....	511	Spherulites, Constitution and origin of. W. Cross.....	568
Ritter, W. F. McK.: Perturbations of the minor planets	604	Sphygmograph. R. T. Edes	517
Rivers, Flood plains of. W J McGee	565	Stanley-Brown, J., elected member	551
Rock gas and related bitumens	530	— Bernardinite	567
— masses, Rounding of, by external attack. G. F. Becker	500	Star-catalogues, Systematic differences of proper motions in declination. H. Farquhar.....	593
Rocks, Coefficient of expansion of some. W. Hallock	556	Star, Multiple, ζ Cancri. A. Hall.....	565
Rocky mountains, Peculiar structural features in the foot-hill region near Denver. G. H. Eldridge	247-274	Steamship Savannah, Log of. J. E. Watkins..	564
Russell, I. C.: Subaërial deposits of the arid region of North America.....	531	Stokes, H. N., elected member.....	566
— Obituary notice of R. D. Irving	478	Stone, O: Orbit of Hyperion.....	598
Russell, T.: Baudin's vertical minimum thermometer à Marteau.....	513	Stratigraphic position of the olenellus fauna in North America and Europe.....	532
Saegmuller, G. N.: Drawings of Denver equatorial telescope.....	607	Stream measurements in the western states. F. H. Newell	569
Salmon, D. E.: National cattle and meat inspection	569	Tabulating machine, Electrical. H. Hollerith.....	553
Saturn and its ring. A. Hall.....	542	Target-shooting, Recent discussions of. C. H. Kummell.....	582
Savings-bank system of Belgium, Postal and school. T. Wilson	570	Taylor, W. B.: A question in mathematical nomenclature	590
Scientific institutions, Origin of our national. G. B. Goode	551	— Obituary notice of Peter Parker.....	491
Screws, Standard. E. G. Fischer.....	556	Tennessee, Cambrian rocks in. C. Curtice..	516
Searle, G. M., elected member.....	552	Thermometer, Baudin's vertical minimum thermometer à Marteau.....	513
Secretaries' report for 1888.....	523	Thompson, G.: Example of work in barometric hypsometry.....	556
— — — 1889.....	514	Tide-predicting machine, Modification of the Ferrel. J F. Hayford.....	608
— — — 1890.....	557	Titan, Disputed mass of. G. W. Hill.....	598
— — — 1891.....	572	Tittmann, O. H., elected member.....	502
Series, Summation of certain. R. S. Woodward	601	— Length of Kater's pendulum.....	552
Shrinkage cracks, Geometry of. G. K. Gilbert	606	Todd, D. P.: Results of the total solar eclipse of January 1, 1889.....	533
Shufeldt, R. W.. Indian types of beauty.....	567	Tornado at Mount Vernon, Ill. H. A. Hazen..	517
Silverchloride, Action of light on. R. Hitchcock.....	542	— — Lawrence, July 26, 1890. H. A. Hazen..	504
Smillie, T. W., elected member.....	565	Treasurer's accounts for 1887, Report of auditing committee on	499
Snell, M. M.: Hypnotic experiments of the Comte de Maricourt	518	— — 1888, Report of auditing committee on..	528
Societies, Scientific, Evolution of serials published by. W J McGee	221, 533	— — Report of auditing committee on, for 1889.....	549
Solar parallax. W. Harkness.....	518	— — for 1890, Report of auditing committee on.....	563
Solids, Chemical action between. W. Hallock.....	518, 542	— report, 1888.....	525
— Flow of. W. Hallock.....	509	— — 1889.....	546
Square root, Method of extracting. A. Martin.....	606	— — 1890	559
Speech, New method of recording and reproducing articulate. G. W. Littlehales..	553	— — 1891.....	574
Spencer, J. W.: Drift north of Lake Ontario.....	506	True, A. C., elected member.....	553
— Iroquois beach—a chapter in the geological history of Lake Ontario.....	500	— Status and tendencies of the agricultural experiment stations	566
		True, F. W.: Epitome of the natural history of the puma.....	554
		Turner, H. W., elected member.....	555
		— Extinct lake of pleistocene times in the Sierra Nevada	565
		— Mohawk Lake beds	385

	Page.		Page.
United States, Commercial growth and im- port duties of. H. Farquhar.....	567	Well, Deep, at Wheeling. W. Hallock.....	571
University, National, Present status and prospects for a. J. W. Hoyt.....	570	Wilder, B. G.: Comparative anatomy of the simian and human brain.....	553
Van Hise, C. R., elected member.....	553	Willis, Bailey: Fault hades.....	500
— Penokee iron-bearing series of rocks.....	530	— Mechanism of the overthrust fault.....	529
— Pre-Cambrian rocks of the Black Hills of Dakota.....	552	Willits, E.: Scientific work of the Depart- ment of Agriculture.....	550
Walcott, C. D.: Stratigraphic position of the olenellus fauna in North America and Europe.....	532	Wilson, T.: National postal and school sav- ings-bank system of Belgium.....	570
— Study in structural geology.....	551	Wind pressures and the measurement of wind velocities. C. F. Marvin.....	556
Walling, H. F., Death of.....	516, 531	Winds, Hot, of the plains. G. E. Curtis.....	564
— Obituary notice of, by C. O. Boutelle.....	492	Winlock, W. C.: Comet 1888 V.....	601
Ward, L. F.: Remarks on the laws of corra- sion.....	519	— Secretaries' report, 1888.....	523
Warder, R. B., elected member.....	515	— — — 1889.....	544
Warped polyhedra, with special application to the road-cutting solid. C. H. Kum- mell.....	605	— — — 1890.....	557
Water-courses, Relation of surface and cli- matic conditions to the flow of.....	552	— — — 1891.....	572
Water supplies, Relation of forests to. B. E. Fernow.....	552	Woodward, R. S.: Mathematical theory of the stratum of no strain and its applica- tion to the earth.....	602
— Underground, in Texas and New Mexico. R. T. Hill.....	571	— Maxwell's theory of electrostatics.....	571
Watkins, J. E., elected member.....	532	— Mechanical conditions of the earth's mass.....	532
— Beginnings of engineering.....	556	— Notes on problems in averages.....	605
— Early dividing engines.....	554	— Problem in dynamics.....	605
— Log of the Savannah.....	564	— Some of the greater problems of physical geology.....	537
— Origin of the railway systems of England and America.....	533	— — special laws of the diffusion of heat in homogeneous spheres.....	607
Weed, W. H.: Formation of deposits of lime, iron, and silica by plant life.....	537	— Summation of certain complex series.....	601
		— Tisserand's <i>Traité de mécanique céleste</i> ..	568
		— Variation of terrestrial density, gravity, and pressure.....	580
		Würdemann, H. V.: Color perception.....	531

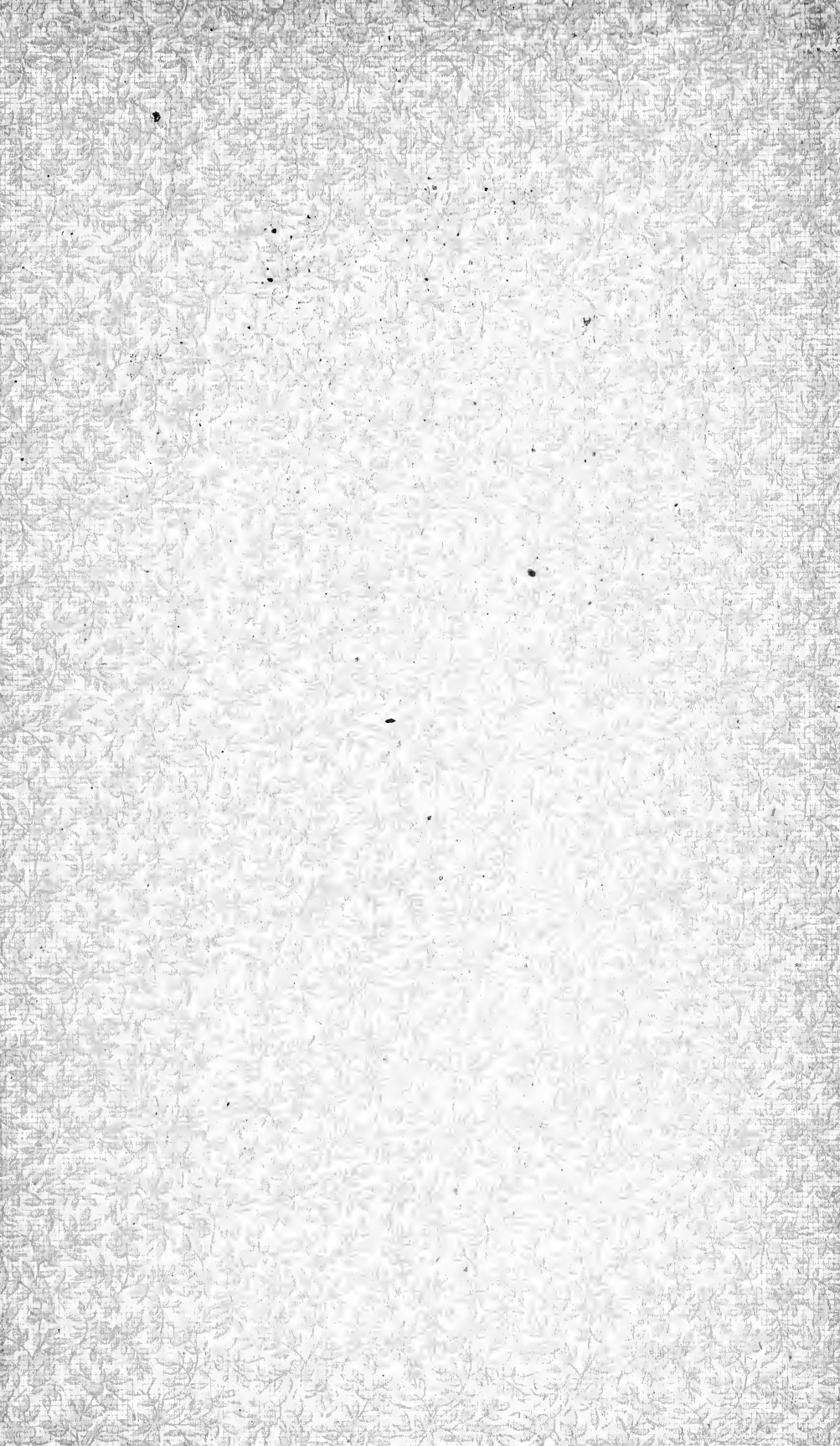

SMITHSONIAN LIBRARIES



3 9088 01871 8049