

Volume 36 Number 4 April 1974



Marine Fisheries

National Oceanic and Atmospheric Administration • National Marine Fisheries Service



SPECIAL NUMBER

THE CALIFORNIA GRAY WHALE

QL
737
.C425
C35



Marine Fisheries

National Oceanic and Atmospheric Administration • National Marine Fisheries Service



SPECIAL NUMBER

THE CALIFORNIA GRAY WHALE

QL
737
.C425
C35

Marine Fisheries Review

Vol. 36, No. 4
April 1974

CONTENTS

Articles

- 1 Preface, W. E. Evans
- 2 Introductory Remarks, Brian J. Rothschild
- 3 Respiration and Metabolism in Two Baleen Whale Calves, Eric A. Wahrenbrock, Gary F. Maruschak, Robert Elsner, and David W. Kenney
- 9 Ballistocardiography as a Technique for Comparative Physiology, N. Ty Smith and Eric A. Wahrenbrock
- 15 Investigation of Blubber Thickness in a Gray Whale Using Ultrasonography, Michael P. Curran and William M. Asher
- 20 Surgical Attachment of a Telemetry Device to the Dorsal Ridge of a Yearling California Gray Whale, *Eschrichtius robustus*, John C. Sweeney and Joel L. Mattsson
- 22 Some Hematologic Observations on the California Gray Whale, Alfred Zettner
- 24 Some Coagulation Factors in Plasma from a California Gray Whale, *Eschrichtius robustus*, W. Medway
- 25 Fluorescent Karyotype of the California Gray Whale, Deborah A. Duffield
- 28 Some Physiological Parameters of the Blood of the California Gray Whale, William G. Gilmartin, Richard W. Pierce, and George A. Antonelis, Jr.
- 31 Feeding of a Captive Gray Whale, G. Carleton Ray and William E. Schevill
- 38 Sounds Produced by the Gray Whale, *Eschrichtius robustus*, James F. Fish, James L. Sumich, and George L. Lingle
- 45 Aerial Observations of Migrating Gray Whales, *Eschrichtius robustus*, off Southern California, 1969-72, J. S. Leatherwood
- 50 A Note on Gray Whale Behavioral Interactions with Other Marine Mammals, J. S. Leatherwood
- 51 Aerial Observations of Gray Whales During 1973, Paul N. Sund and John L. O'Connor
- 52 Telemetering of Temperature and Depth Data from a Free Ranging Yearling California Gray Whale, *Eschrichtius robustus*, W. E. Evans
- 58 Capture and Harnessing of Young California Gray Whales, *Eschrichtius robustus*, Kenneth S. Norris and Roger L. Gentry

Cover.—After almost a year in captivity, the California gray whale, Gigi II, is carried in a special cradle aboard ship to the site where she will later be released. Photograph, courtesy of Audio Visual Prod. Div., Naval Undersea Center, San Diego, Calif.

U.S. DEPARTMENT OF COMMERCE
Frederick B. Dent, Secretary

NATIONAL OCEANIC AND
ATMOSPHERIC ADMINISTRATION
Robert M. White, Administrator

National Marine Fisheries Service
Robert W. Schoning, Director



Address correspondence to: Marine Fisheries Review, NMFS Scientific Publications Staff, Room 450, 1107 N.E. 45th St., Seattle, WA 98105.

Publication of material from sources outside the Service is not an endorsement. The Service is not responsible for the accuracy of facts, views, or opinions of these sources.

Although the contents have not been copyrighted and may be reprinted freely, reference to source is appreciated.

The Secretary of Commerce has determined that the publication of this periodical is necessary in the transaction of public business required by law of this Department. Use of funds for printing this periodical has been approved by the Director, Office of Management and Budget, May 10, 1973.

Editor: Thomas A. Manar

Managing Editor: Willis L. Hobart

For sale by the Superintendent of Documents, U.S. Government Printing Office, Washington, DC 20402. Price \$1.25 (single copy). Subscription price: \$12.50 a year, \$15.75 a year for foreign mailing.

Marine Fisheries Review

Vol. 36, No. 4
April 1974

CONTENTS

Articles

- 1 Preface. W. E. Evans
- 2 Introductory Remarks. Brian J. Rothschild
- 3 Respiration and Metabolism in Two Baleen Whale Calves. Eric A. Wahrenbrock, Gary F. Maruschak, Robert Elsner, and David W. Kenney
- 9 Ballistocardiography as a Technique for Comparative Physiology. N. Ty Smith and Eric A. Wahrenbrock
- 15 Investigation of Blubber Thickness in a Gray Whale Using Ultrasonography. Michael P. Curran and William M. Asher
- 20 Surgical Attachment of a Telemetry Device to the Dorsal Ridge of a Yearling California Gray Whale, *Eschrichtius robustus*. John C. Sweeney and Joel L. Mattsson
- 22 Some Hematologic Observations on the California Gray Whale. Alfred Zettner
- 24 Some Coagulation Factors in Plasma from a California Gray Whale, *Eschrichtius robustus*. W. Medway
- 25 Fluorescent Karyotype of the California Gray Whale. Deborah A. Duffield
- 28 Some Physiological Parameters of the Blood of the California Gray Whale. William G. Gilmartin, Richard W. Pierce, and George A. Antonelis, Jr.
- 31 Feeding of a Captive Gray Whale. G. Carleton Ray and William E. Schevill
- 38 Sounds Produced by the Gray Whale, *Eschrichtius robustus*. James F. Fish, James L. Sumich, and George L. Lingle
- 45 Aerial Observations of Migrating Gray Whales, *Eschrichtius robustus*, off Southern California, 1969-72. J. S. Leatherwood
- 50 A Note on Gray Whale Behavioral Interactions with Other Marine Mammals. J. S. Leatherwood
- 51 Aerial Observations of Gray Whales During 1973. Paul N. Sund and John L. O'Connor
- 52 Telemetering of Temperature and Depth Data from a Free Ranging Yearling California Gray Whale, *Eschrichtius robustus*. W. E. Evans
- 58 Capture and Harnessing of Young California Gray Whales, *Eschrichtius robustus*. Kenneth S. Norris and Roger L. Gentry

Cover.—After almost a year in captivity, the California gray whale, Gigi II, is carried in a special cradle aboard ship to the site where she will later be released. Photograph, courtesy of Audio Visual Prod. Div., Naval Undersea Center, San Diego, Calif.

U.S. DEPARTMENT OF COMMERCE
Frederick B. Dent, Secretary

NATIONAL OCEANIC AND
ATMOSPHERIC ADMINISTRATION
Robert M. White, Administrator

National Marine Fisheries Service
Robert W. Schoning, Director



Address correspondence to: Marine Fisheries Review, NMFS Scientific Publications Staff, Room 450, 1107 N.E. 45th St., Seattle, WA 98105.

Publication of material from sources outside the Service is not an endorsement. The Service is not responsible for the accuracy of facts, views, or opinions of these sources.

Although the contents have not been copyrighted and may be reprinted freely, reference to source is appreciated.

The Secretary of Commerce has determined that the publication of this periodical is necessary in the transaction of public business required by law of this Department. Use of funds for printing this periodical has been approved by the Director, Office of Management and Budget, May 10, 1973.

Editor: Thomas A. Manar

Managing Editor: Willis L. Hobart

For sale by the Superintendent of Documents, U.S. Government Printing Office, Washington, DC 20402. Price \$1.25 (single copy). Subscription price: \$12.50 a year, \$15.75 a year for foreign mailing.

The California Gray Whale

PREFACE

In early March 1971 an expedition sponsored by Sea World, Inc. of San Diego, under the direction of David W. Kenney with scientific support from the University of California, San Diego, captured a newborn female California gray whale (*Eschrichtius robustus*) in Scammon's Lagoon, Baja California Sur, Mexico. This whale, 5.84 meters long and weighing 1,952 kilograms, arrived at Sea World in San Diego on 17 March 1971.

Although not the first successful capture of an immature California gray whale, this was however the beginning of a successful year of maintenance in captivity and the subsequent release into the wild, the first time for any species of baleen whale. The results of the scientific studies conducted during this year of captivity and the later field observations which were stimulated by the release of this unique whale, are the subject of this publication.

Many important contributors to our overall understanding of the complexities of the biology of the California gray whale are not formally represented in this report as contributors. The impact of the work of Carl L. Hubbs, Scripps Institution of Oceanography, University of California, San Diego, La Jolla; Raymond Gilmore, Museum of Natural History, San Diego; and Dale Rice, National Marine Fisheries Service, Northwest

*Papers presented at the
California Gray Whale Workshop,
University of California,
San Diego, Scripps Institution
of Oceanography,
21-22 August 1972.*

Sponsored by

*Southwest Fisheries Center,
La Jolla Laboratory, National
Marine Fisheries Service, NOAA*

and

*U.S. Department of the Navy's
Naval Undersea Center,
San Diego.*

CARL L. HUBBS, Chairman.

W. E. EVANS, Editor.



Fisheries Center, Seattle, Wash., as pioneers in establishing the basis for our present knowledge of the status of the gray whale population cannot be overstated.

Special acknowledgement is also due David W. Kenney, of Poway, Calif. for his efforts in successfully capturing and maintaining in good health the immature gray whale named Gigi II, the subject of most of the research reported here. Dr. Kenney should be applauded for his persistence in overcoming seemingly insurmountable opposition. Many of Dr. Kenney's colleagues were doubtful that a newly born gray whale could be successfully maintained alive in captivity for more than a few months, let alone one year. Yet, this

goal was achieved with overwhelming success. From predictions of normal growth, Gigi should have reached a total weight of 5,946 kilograms and a length of 8.30 meters by 20 March 1972. During her last week in captivity (6-13 March 1972), Gigi II was weighed three or four times. Due to the use of three different scales and two different conditions of weighing (i.e., animal fasting and animal fed prior to weighing), her final weights ranged from 5,364 kg to 6,350 kg. This weight range remarkably brackets the predicted weight previously mentioned. Her final overall length on 13 March 1972 was 8.15 meters, also significantly close to the predicted length of 8.30 meters based on normal growth. W.E.E.

indiscriminate interpretations which often accompany events of high publicity value, inadequate data collection, and difficulties in interpreting the sparse marine mammal data. Further complications arise from conflicting and contradictory views of special interest groups that influence resource decisions. A case in point is, of course, the blue whale.

Because this is also a time when significant policy and conservation decisions are being made on marine mammals, it is particularly important to concentrate on the generation of factual information. The conservation of our resources is essentially a decision-making process; this process can only be effective if decision-makers are supplied with appropriate facts. Workshops such as this California Gray Whale Workshop will do much to contribute to our understanding and knowledge of marine mammals and assist in making better resource decisions which hopefully will preserve these Leviathans for the education and enjoyment of future generations.

I think Herman Melville had a premonition that all of this would come to pass; that status of marine mammal stocks would be of world concern and as a small part of this concern we would be holding our workshop. In fact he could be before you now saying, as he did in *Moby Dick*:

"Already we are boldly launched upon the deep; but soon we shall be lost in its unshored, harborless immensities. Ere that come to pass; ere the Pequod's weedy hull rolls side by side with the barnacled hulls of the Leviathan; at the outset it is but well to attend to a matter almost indispensable to a thorough appreciative understanding of the more special leviathanic revelations and allusions of all sorts which are to follow.

It is some systematized exhibition of the whale in his broad genera, that I would now fain put before you. Yet is it no easy task. The classification of the constituents of a chaos, nothing less is here essayed. Listen to what the best and latest authorities have laid down . . ."

INTRODUCTORY REMARKS

BRIAN J. ROTHSCHILD

It is a great pleasure to welcome you to the California Gray Whale Workshop. The Workshop is being held in a significant location and at a particularly appropriate time.

The location, La Jolla, is of course, quite near the area surveyed as part of the well-known California gray whale census and is also a focal region for other studies on the dynamics and life history of the California gray whale. Some of this research will be presented at this Workshop where you will hear about such diverse topics as husbandry, respiration and metabolism, cardiovascular physiology and blood studies and behavior and physiology — all related to the California gray whale.

In addition to being a region where many contemporary studies on the gray whale have been undertaken, it was also in this general area of the North American coast that Charles M. Scammon, whaler and sometime

captain in the U.S. Revenue Marine, undertook his early studies of the natural history of the gray whale. His studies "The Marine Mammals of the North-Western Coast of North America," were published in 1874. Many of Captain Scammon's observations on the gray whale were made in the mid-1850's when he discovered a major nursery ground of the California gray whale in a Baja California embayment, Laguna Ojo de Liebre, now frequently called Scammon's Lagoon. Scammon was also involved in the early, intensive harvest of this species, an activity that was terminated in 1946 when the International Whaling Commission declared the gray whale a protected species.

The timing of this symposium is also appropriate. There is now an unprecedented interest in marine mammals. TV, radio, motion pictures, newspapers and magazines have all contributed to a growing public awareness and concern with these fascinating animals. Unfortunately, this deluge of publicity has resulted in a mixture of fact and fiction. The fiction has been further fed by various

Brian J. Rothschild is Director, Southwest Fisheries Center, National Marine Fisheries Service, NOAA, La Jolla, CA 92037.

Respiration and Metabolism in Two Baleen Whale Calves

ERIC A. WAHRENBROCK, GARY F. MARUSCHAK,
ROBERT ELSNER, and DAVID W. KENNEY

ABSTRACT

We performed respiratory and metabolic studies on two female gray whale calves. Although one died 2 months after capture, the other thrived during a year's captivity, permitting serial observations while growing, and weighed in excess of 6,350 kg when released. They appeared to be of normal size and weight compared to whales in the wild. Relative increases in body length and weight, lung volume, minute ventilation, and metabolic rate were similar to those in terrestrial mammals, as was the growth efficiency. Lung volume and metabolic rate could be predicted with only partial success from the relationships of those variables to body weight proposed by Tenney and Kleiber, perhaps due to immaturity in the whales.

Compared to terrestrial mammals, the ratio of tidal volume to resting lung volume in the whale was large, while the ratio of wasted ventilation to tidal volume was small. We measured respiratory excursions of arterial O₂ and CO₂ tensions of 36 and 16 mm Hg, respectively, consonant with the relationships between respiratory rate, lung volume, tidal volume, and metabolic rate.

INTRODUCTION

Although the physiology of toothed whales, particularly porpoises, has been studied at some length (Irving, Scholander, and Grinnell, 1941; Olsen, Elsner, Hale, and Kenney, 1969; Olsen, Hale, and Elsner, 1969; Scholander, 1940), the study of living baleen whales has been particularly elusive. The size and dietary habits of these large mammals present formidable obstacles to their maintenance in captivity, and these obstacles are compounded by ignorance of the whales' growth rate, dietary requirements, metabolism, and hematologic and cardiorespiratory physiology.

However, these and other aspects of the biology of baleen whales are, in many respects, unique among mammals: research would therefore be

doubly rewarding. This line of reasoning led to the capture and study of the two animals reported herein, and to this workshop.

We were naturally inclined toward studies of especial personal interest, and recognize their limited scope and serious omissions (cardiac output, for example). We are here reporting observations on growth, respiratory function, and metabolic rate; additional reports of detailed nutritional, metabolic, biochemical and hemotologic studies; inert and anesthetic gas uptake; and respiratory mechanics will follow.

METHODS

The first gray whale calf (Gigi I) was captured in Scammon's Lagoon, Baja California, Mexico in February

Eric A. Wahrenbrock and Gary F. Maruschak are members of the staff of the Anesthesia Laboratory of the School of Medicine, University of California, San Diego, La Jolla, CA 92037. Robert Elsner is a member of the staff of the Physiological Research Laboratory of Scripps Institution of Oceanography, University of California, San Diego, P.O. Box 109, La Jolla, CA 92037. David W. Kenney was formerly a member of the staff of Sea World, Inc., San Diego, Calif.; his present address is 14220 Poway Rd., Poway, CA 92064.

1965 and brought to San Diego, where a number of respiratory and metabolic studies were performed. Although the whale at first seemed to thrive, it died of an uncontrollable infection about 2 months after it was captured.

The second calf, Gigi II, was captured in March 1971, again in Scammon's Lagoon, and was again kept in (increasingly larger) pools at an oceanarium in San Diego. Gigi II thrived indeed: gained in size, was weaned, was studied intensively, and was reluctantly (but inevitably) released almost exactly a year after her capture.

Two of the authors were members of each of the expeditions (DWK and RE on the first, and DWK and EAW on the second) and one of us (DWK) was responsible for the medical care of both animals while in captivity.

For most of the studies reported here, the water level in the tank was lowered so as to nearly immobilize the whale, leaving about 12 inches of dorsal body surface above the water level, and the blowhole barely awash. A few of the studies were performed with the whale completely stranded on the bottom of the empty tank.

The respiratory pattern in whales and other marine mammals consists of an expiration followed by an immediate inspiration, followed by an interrespiratory pause during which

the airway is closed. The duration of the pause in Gigi II was about 1 minute, and inspiration and expiration together required about 2 seconds. Two observations can be made from this respiratory pattern (commonly called "apneustic"): 1) a valve would be needed in order to separate inspiration from expiration, and 2) resting lung volume is different from that in terrestrial mammals, because in cetaceans it includes the tidal volume.

Accordingly, we fabricated nonbreathing valves: first of approximately 5 inches diameter, and later (for Gigi II) of 8 inch stovepipe (Figure 1), thus permitting us to collect uncontaminated exhaled gas. For Gigi I a large, calibrated, counterbalanced, bellows-type spirometer was used; and for Gigi II, expired gas was collected in 900 liter meteorological balloons. The volume of exhaled gas was then measured by emptying the balloons through a calibrated dry gas meter (Wright Spirometer or American Meter Co.)¹ at a constant, known flowrate. Aliquots of mixed expired gas from Gigi I were analyzed for O₂ and CO₂ with a Scholander apparatus, and for Gigi II with a modified Haldane apparatus (Lloyd-Gallenkamp), as were samples of end-tidal gas, obtained from a port just beyond the expiratory valve leaflet of the nonbreathing device.

Resting lung volume was measured in Gigi II by injecting 1.50 liters of pure helium into the inspiratory port of the nonbreathing valve during inspiration. The subsequent expiration was captured, and mixed expired gas analyzed for helium with a sensitive, calibrated katharometer (W. E. Collins).

Arterial blood was drawn from Gigi II by percutaneous puncture of the digital artery in a flipper with an 18 gauge 3 inch needle, and arterial placement ensured by observing pulsations of blood through the needle. Because of the configuration of the

arterial and venular system, it is possible that arterial blood was contaminated at times with venous blood. Some of the gas samples from Gigi II, and all of her blood samples, were analyzed for O₂ and CO₂ tensions (P_{O_2} and P_{CO_2}) with a blood gas analyzer (Radiometer BMS-3), with which blood pH could also be determined.

From timed gas collections during which the number of breaths was also counted, respiratory rate, minute ventilation, tidal volume, oxygen consumption, and wasted ventilation (or "dead space" fraction, V_d/V_t) could thus be determined by suitable analysis.

RESULTS

In the first few weeks of captivity, each whale lost weight, but gained thereafter (Figure 2). The rate of gain during the first 8 months was about 200 kg/mo in Gigi II.² She was weaned at about 7 months of age, as are calves in the wild (Rice and Wolman, 1971). At age 10 months, she entered a very rapid growth phase during which her food intake increased from about 1,200 to about 1,800 pounds of squid/day, and her rate of gain in weight increased almost 5 fold, to 970 kg/mo or (for those of us who enjoy such reductions) approximately 3 pounds/hour. Each whale gained in length regularly; although Gigi I was smaller than Gigi II when captured, their increases in body size were similar (Figure 3). This suggests that the infection did not seriously impede her growth.

Respiratory rate (f) was counted on many occasions; it varied with the whales' activity. It averaged 2/min for Gigi I at first, and increased to 4 or 5/min after age 2 months. However, this whale had atelectasis and pneumonia secondary to a harpoon wound,

² Both calves were first fed by gavage, and in both the liquid diet was gradually changed from mainly whipping cream to a mixture of ground squid, ground bonito calcium caseinate yeast and corn oil. For Gigi II, the proportion of squid in the diet was gradually increased until the time of weaning.



Figure 1.—Nonbreathing valve for Gigi II, constructed of 8 inch stovepipe and containing one quarter inch neoprene foam rubber valve leaflets. Inspiration was from the side-arm, and the inspiratory valve leaf and its supporting ring were slanted so that closure was assisted by gravity.

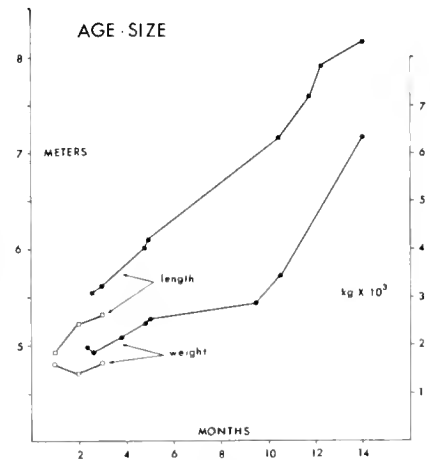

Figure 2.—The whale was weighed with an industrial heavy duty scale (Dynamometer) by lifting her from the water with a crane while supported on a canvas and pipe stretcher, and subtracting the tare weight. Body length was measured on a straight line from lips to notch in fluke. Data from Gigi I are represented by open circles and squares, and for Gigi II by solid symbols. Length in meters on left hand scale; weight in thousands of kilograms on right hand scale.

leaving the meaning of this observation somewhat uncertain. When Gigi II was motionless, or nearly so, f averaged 1/min, irrespective of age. Accordingly, tidal volume (V_t) and minute ventilation were nearly equal (Figures 4, 5). Each value for V_t is an average of three or more measurements, as we observed that V_t varied

¹ Reference to name of firm does not imply endorsement by the National Marine Fisheries Services, NOAA

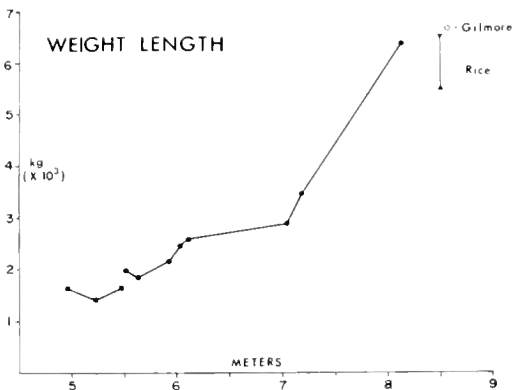

Figure 3.—Weight plotted as a function of length in the two gray whale calves. Data from Gigi I is represented by squares, and from Gigi II by circles. At the time of the rapid weight increase Gigi II was approximately 9.5 months old. Gilmore (1961) reported data from one calf which died after being stranded in San Francisco Bay. Data from Rice and Wolman (1971) represent north and southbound calves (lower and upper points respectively); the difference supports the hypothesis that gray whales fast during the southern migration.

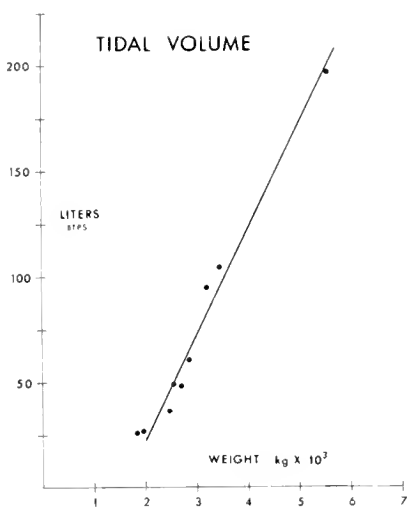

Figure 4.—Tidal volume (V_t) in a gray whale calf during the first year of life. The regression equation for the line is: $V_t = (47 \times \text{body weight in metric tons}) - 70$. The correlation coefficient $r = 0.99$.

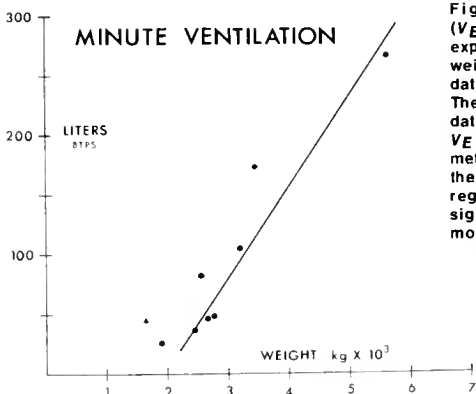

Figure 5.—Minute ventilation (V_E) in two gray whale calves, expressed as a function of body weight. The triangle represents data from observations in Gigi I. The regression equation for the data from Gigi II (circles) is: $V_E = (70 \times \text{body weight in metric tons}) - 117$. Although the $r = 0.94$ for this rectilinear regression, it is apparent that a sigmoid curve could be even more closely fitted to the data.

markedly from one breath to the next, sometimes by 50 percent.

Resting lung volume, (Figure 6) necessarily varied from breath to breath also, and in addition, the measurement was technically difficult because of the difference between in-spired and expired V_T . Nevertheless, five measurements were felt to be adequate. Two measurements were made at weight = 6,150 kg, one when awash and one when stranded on the bottom of the completely drained tank. Lung volume was reduced by about 20 percent by stranding, although that value was determined only once.

From time collections of mixed expired gas, oxygen consumption was computed (Figure 7). The composition of end tidal gas from Gigi II was determined on several occasions, and did not vary systematically with age. End tidal P_{O_2} varied from 54

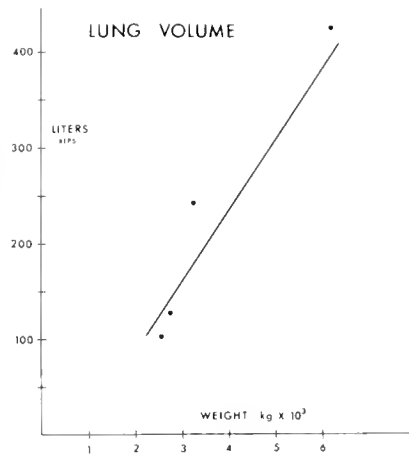

Figure 6.—Resting lung volume in a gray whale calf (Gigi II), expressed as a function of body weight. Resting lung volume includes tidal volume, and is the volume of gas in the lungs during the intervals between breaths. The equation for the line is: lung volume = $(70 \times \text{body weight in metric tons}) - 44$; for which $r = 0.94$.

Table 1.—Arterial blood gas tensions and pH, drawn at random during the respiratory cycle.

Item	Age, months		
	2.5	3.0	10
PaO ₂ , mm Hg	55	62	60
P _a CO ₂ , mm Hg	56	69	41
pH	7.23	7.32	7.35

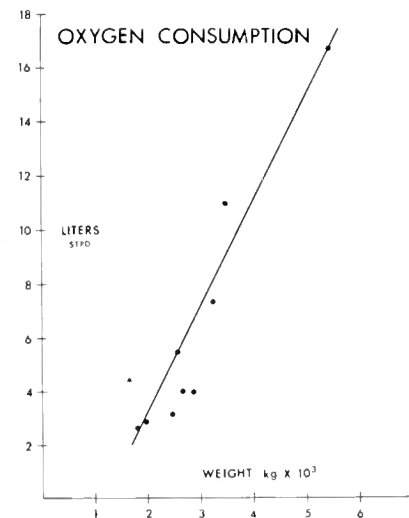

Figure 7.—Oxygen consumption in liters/min (V_{O_2}) in two gray whale calves, expressed as a function of body weight. The triangle represents data from observations in Gigi I. The regression equation for the data from Gigi II (circles) is: $V_{O_2} = (4.1 \times \text{body weight in metric tons}) - 5.7$; for which $r = 0.96$.

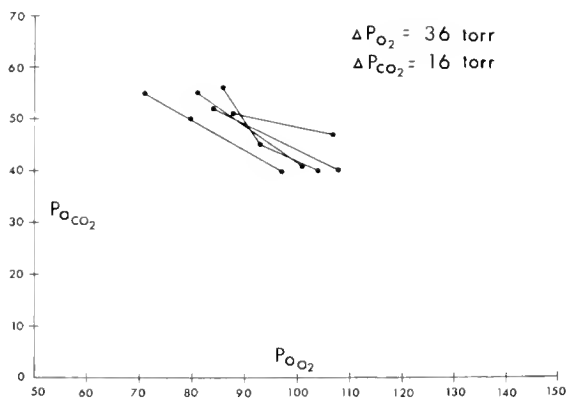

Figure 8.—Arterial O_2 and CO_2 tensions (PaO_2 and $PaCO_2$) in a gray whale calf, from sequential blood samples drawn about every 15 sec during five respiratory cycles.

to 85 mm Hg, and the corresponding P_{CO_2} varied from 75 to 54 mm Hg. We computed wasted ventilation from the difference between end tidal and mixed expired P_{CO_2} . It equalled 13.0 percent of V_t at age 3 months and 13.5 percent at age 13 months.

Arterial P_{O_2} , P_{CO_2} , and pH were measured on three occasions in samples drawn at random during the respiratory cycle. (Table 1). Those values also varied considerably: the differences between arterial and alveolar P_{O_2} and P_{CO_2} were difficult to interpret, and were sometimes negative. Therefore, we measured blood gases and pH in arterial blood drawn sequentially during the respiratory cycle (about every 15 sec): the values then varied systematically (Figure 8).

DISCUSSION

As we are presenting data concerning the respiratory and metabolic changes in growing whales, we should examine the hypothesis that their size and rate of growth were normal. There is ample reason to raise the question, for confined animals fed contrived diets should always be suspected of exhibiting biological values which would be abnormal for the population in nature. There are two methods of examining this question: to make comparisons with other gray whales; and to look for internal evidence of abnormal growth and development.

Data from Gilmore (1961) and

Rice and Wolman (1971) comprise the first method, for they have examined gray whale calves similar in age and size to Gigi II. Her weight and length at the time of release compare favorably to the other data on calves thought to be yearlings (Figure 3). As gray whales in the wild are thought to fast during the southern migration (Rice and Wolman, 1971), the observation that Gigi II was slightly heavy for her length should be interpreted with caution.

The internal evidence relating to the question consists of the observation that Gigi II sustained an increase in body length which preceded any considerable growth in body weight, mitigating against an argument that she was grossly overweight or overfed, and which is consistent with the pattern of early growth in other mammals (i.e., exponential for weight and linear for length) (Christian, 1972; Carlander and Ricker, 1962; Brody, 1964).

Although there is some disagreement (Gilmore, 1961, and pers. comm.), newborn gray whales are estimated to be 4.9 meters in length at birth (Rice and Wolman, 1971). Their birthweight is less certain, although Rice proposes the weight of the products of conception at term to be between 1,000 and 2,000 kg. Our estimates of the birthweight of the two whales at about 1,500 kg, and the birthlength at just under 5 meters are therefore consistent, and permit extrapolation of their ages at capture to 4 weeks for

Gigi I and 10 weeks for Gigi II. At age 1 year, Gigi II had increased her birthweight by about 3.5 fold, and her birthlength by a little less than 1.5 fold.

Comparison of growth rates between species may be deceptive due to species differences in longevity, newborn maturity, and adult body size. However, since humans and gray whales (Rice and Wolman, 1971) have similar life spans, and are both large mammals, it is of interest to consider their relative growth rates in body weight, respiration, and metabolism.

If mature female gray whales are 13 meters in length (Rice and Wolman, 1971; Scammon, 1874), and 30 to 35 thousand kg in weight, then the newborn whale must increase its birthweight by about 20 fold and its birthlength by about 2.5 fold. The fractional annual and ultimate increases in weight of the whales are similar to those in man, but the fractional increase in length is greater (Benedict and Talbot, 1921).

Lung volume in human infants increases as a cubic function of body length (Cook and Hamann, 1961), a satisfying observation considering the geometry involved. The regression onto body weight is not very reliable; the regression onto length is approximately: Total Lung Capacity (liters) = body length (meters) cubed. Although we have insufficient data for the whale to make firm conclusions (and have arbitrarily linearized the data against body weight in Figure 6), calculation of resting lung volume against body length suggests that an equation of Lung Volume = $0.62 \times \text{length}^3$ also fits the data. This relationship seems reasonable, as resting lung volume in the whale is probably less than total lung capacity.

Tidal volume and minute ventilation increased during the year's growth, and as a first approximation, we have again linearized the data (Figures 4,5). We recognize that changes in respiratory function and metabolic rate are probably not rectilinear functions

of body weight, but we also recognize that the data available to us represent only a small portion of the full curves. Tidal volume increased about 8 fold as body weight tripled; the corresponding value for minute ventilation was 10 or 12 fold. Comparison of this growth rate with that of terrestrial mammals is awkward, because of marked changes in their respiratory rate during growth (Watson and Lowrey, 1962), while respiratory rate in the whale was constant. In terrestrial mammals, tidal volume changes as a function of lung volume (which in turn varies as a cubic function of length), while minute ventilation changes as a function of metabolic rate (Tenney and Kemmers, 1963); a more complex function of growth, which is not linear on any convenient parameter of body size because of growth spurts during early and late childhood (Benedict and Talbot, 1921).

The increase in the metabolic rate of Gigi II corresponded to the increase in her ventilation, and for a tripling of weight, increased about 10 fold. This increase is of the same order as the increase in human metabolic rate during the first year (about 8 fold) (Benedict and Talbot, 1921), and is consistent with our general impression that growth in the whale, whether of body weight, lung volume, or metabolic rate, proceeded in parallel with, or only slightly more rapidly than, human growth.

Observation of animals at the extremes of body size invites interspecies comparisons of biological phenomena. The existing data for two such correlations: of lung volume with body size (Tenney and Remmers, 1963), and of metabolic rate with body size (Kleiber, 1961), are particularly well organized. Tenney has shown that lung volume is closely related to body mass (over a range of body mass of 5 orders of magnitude) by the equation: $\log \text{lung vol} = 1.02 \log \text{body weight} - 1.25$, with volume in liters and weight in kg. This yields a predicted lung volume

in Gigi II of 410 liters at 6,150 kg, which corresponds closely to our measurement of 428 liters, but which diverges widely from values obtained early in her growth. Tenney measured total lung capacity (TLC) of excised lungs, and we measured resting lung volume; this ordinarily considerable difference is fortuitously minimized by the fact that resting lung volume in the whale is a larger fraction of TLC than is the case for terrestrial mammals. This measurement permits considerable extension of Tenney's data, for his largest animal, also a cetacean, weighed only 1,750 kg.

Kleiber studied the metabolic rates of animals also differing in body size by about 5 orders of magnitude, and concluded that metabolic rate was best related to the 0.75 power of weight, by the equation: $\log M = 1.83 + (0.756 \log W) \pm 0.05$, with M in kcal/day and W in kg. Using the conversion factor of 4.8 kcal = 1 liter of O_2 , the whales' metabolic rates compare favorably with that regression line up to a body weight of 3,000 kg, but diverge significantly thereafter. The last metabolic rate measured was 16.8 l/min, while the calculated value from Kleiber's equation is 6.8 l/min. It is notable that metabolism in Gigi II, Benedict's elephant, and Irving's whale all differ from Kleiber's prediction, thereby raising the question of whether large mammals do indeed follow the 0.75 power rule. However, the value for the 70,000 kg fin whale was extrapolated from a measurement in a porpoise (Irving, Scholander, and Grinnell, 1941), and neither the elephant nor our whales were studied under conditions meeting Kleiber's criteria of ambient temperature neutrality, adulthood, and basal postabsorptive state. The resulting errors would be in the direction of the observed differences. Divergence from the 0.75 power rule may also be seen in growing cattle, horses, children, and rodents (Brody, 1964).

During the phase of rapid weight gain, Gigi II ate from about 1,200 to

about 1,800 pounds of squid per day, and gained weight at the rate of about 980 kg/mo. If we assume that squid are about 80 percent water and the dry weight is equivalent to 5 kcal/gm (R. Lasker, pers. comm.), and make the further assumption that growing whale tissue contains the same energy (1,720 kcal/kg wet weight) as other growing mammalian tissue (Mayer, 1949), it is possible to calculate the gross efficiencies for growth of a baleen whale calf of 10.3 percent and 6.9 percent. Correcting for metabolic rates of 11.0 and 16.8 liters O_2 /min yields net efficiencies for growth of 12.0 percent and 8.0 percent (Brody, 1964). In general, growth efficiency is independent of body size (Kleiber, 1947), but is a diminishing function of metabolic age; the calculated values are within the expected range for terrestrial mammals beyond the first doubling of body weight (Brody, 1964).

Tidal volume equalled about 50 percent of resting lung volume, irrespective of age or size. This is a smaller ratio than that reported for other diving mammals (Irving et al., 1941; Olsen et al., 1969; Scholander, 1940), although they were mature. The ratio of wasted ventilation to tidal volume (V_d/V_t) in Gigi II was about 13 percent, irrespective of age. This value is consistent with observations in mature diving mammals (Irving et al., 1941; Scholander, 1940, and Kooyman, pers. comm.), and is considerably smaller than the ratio in terrestrial mammals. However, V_d/V_t diminishes with increasing V_t in humans and dogs (Bouhays, 1964), a pertinent observation in view of the relatively large V_t in the divers.

Fluctuations in arterial P_{O_2} and P_{CO_2} with respiration have been predicted in man and terrestrial animals (Otis, 1964; Suwa and Bendizen, 1972) and diving animals (Irving et al., 1941). Those fluctuations are influenced by: 1) the relative sizes of the tidal and resting lung volumes; 2) the relationship between resting lung volume and metabolic rate; 3) the relationship

between the fluctuating pulmonary blood flow and the fluctuating alveolar gas composition (Otis, 1964); and 4) the solubility of respiratory gases in pulmonary tissue. The greatest differences we observed were $\Delta P_{O_2} = 36$ mm Hg and $\Delta P_{CO_2} = 16$ mm Hg (Figure 8): These considerable excursions follow from the ratio of resting lung volume to tidal volume, which in the whale is about 2 and in man about 5; the ratio of resting lung volume to metabolic rate, which in the whale is about 20 and in man is about 10; and the very large difference between human and whale respiratory rates. Taken together, these relationships suggest that apneustic breathing in the whale is just as it seems: each breath interrupts a respiratory pause which actually represents a period of breathholding, during which appropriate changes occur in arterial blood gas tensions. Although tempting, approaches toward cardiac output computation are hampered by ignorance of the composition of mixed venous blood. Calculations of the "mean" alveolar gas or arterial blood composition are similarly hampered, and by imprecision in the sample collection timing as well.

CONCLUSIONS

1. These two gray whale calves have provided the first opportunity for the collection of physiologic data from living baleen whales. The growth-rate in one of them was such that she became the world's largest captive animal.

2. Comparison of their size with that of whales in nature, and of their growthrate with one another and with other animals, strongly suggests that their size and growthrate were normal.

3. We observed increases in respiratory function and metabolism during growth similar to the increases in terrestrial mammals. In particular: relative increases in body weight; and of lung volume, minute ventilation, and metabolic rate as functions of body weight, proceeded in approxi-

mate parallel to the relative increases observed in man.

4. Interspecies comparisons of absolute lung volume and metabolic rate can also be based on body weight. Where the gray whale calves differed from correlations drawn between mammals including those at the extremes of body size, the departure could be explained by the whales' immaturity.

5. One of the whales entered a rapid growth phase, during which it gained approximately 1,000 kg/mo. Its gross efficiency for growth, calculated from the amount it ate and weighed, diminished from about 10 percent at a body weight of about 3,000 kg to about 7 percent at a body weight of 6,350 kg.

6. The relationships between tidal volume, resting lung volume, and wasted ventilation are similar in the gray whale calf to these in other diving mammals: although those relationships are different from the ones in terrestrial animals, they follow from the apneustic respiratory pattern (of infrequent but very large breaths interrupting long periods of breathholding at high lung volume).

7. The apneustic pattern of breathing also results in respiratory excursions in arterial oxygen and carbon dioxide tensions much larger than those predicted in terrestrial mammals.

ACKNOWLEDGMENTS

Both whales were kept in pools at Sea World, Inc., an oceanarium in San Diego, Calif. The staff and administration extended to investigators courtesies and facilities both large and small, ranging from hot showers and coffee to underwriting the expeditions and the subsequent upkeep of the whales; and thereby made these studies both possible and enjoyable. In particular, Bud Donahoo and Sue Bailey provided Gigi II and her investigators with understanding and with expert assistance. We acknowledge with thanks the support of Robert Peterson and the crew of the *Falcon* involved in the capture,

transport, and maintenance of Gigi I. We are also grateful for the considerable assistance of Jack Schultz, Ken Hamai, James Wright, Brian D' Aoust, and Morgan Wells. Finally, we are grateful to the two Gigis, for they, by patiently enduring our several insults, made possible observations new to the largest and least accessible sub-order of living mammals.

LITERATURE CITED

- Benedict, F. G., and F. B. Talbot. 1921. Metabolism and growth from birth to puberty. Carnegie Inst. Wash., Publ. No. 302, Wash., D. C.
- Bouhays, A. 1964. Respiratory dead space. In W. O. Fenn and H. Rahn (editors), Handbook of physiology. Respiration, Sect. 3, Vol. 1, p. 699-714. Am. Physiol. Soc., Wash., D. C.
- Brody, S. 1964. Bioenergetics and growth. Hafner, New York.
- Carlander, K. D., and W. E. Ricker. 1962. Postnatal vertebrate development. In P. L. Altman and D. S. Dittmer (editors), Growth, p. 333-378. Fed. Am. Soc. Exp. Biol., Wash., D. C.
- Christian, L. L., L. N. Hazel, J. P. Scott, M. Shelton, G. M. Sidwell, N. R. Ellis, W. W. Swett, G. S. Templeton, and G. Van Wagener. 1972. Growth: Mammals other than man. In P. L. Altman and D. S. Dittmer (editors), Biol. data book, p. 207-216. Fed. Am. Soc. Exp. Biol., Bethesda, Md.
- Cook, C. D., and J. F. Hamann. 1961. Relation of lung volumes to height in healthy persons between the ages of 5 and 38 years. J. Ped. 59:710-714.
- Gilmore, R. M. 1961. The story of the gray whale. 2nd ed. Privately publ., San Diego, 16 p.
- Irving, L., P. F. Scholander, and S. W. Grinnell. 1941. The respiration of the porpoise, *Tursiops truncatus*. J. Cell. Comp. Physiol. 17:145-168.
- Kleiber, M. 1947. Body size and metabolic rate. Physiol. Rev. 27:511-541.
- . 1961. The fire of life. An introduction to animal energetics. John Wiley & Sons, Inc., New York, 454 p.
- Mayer, J. 1949. Gross efficiency of growth of the rat as a simple mathematical function of time. Yale J. Biol. Med. 21:415-419.
- Olsen, C. R., R. Elsner, F. C. Hale, and D. W. Kenney. 1969. "Blow" of the pilot whale. Science 163:953-955.
- Olsen, C. R., F. C. Hale, and R. Elsner. 1969. Mechanics of ventilation in the pilot whale. Resp. Physiol. 7:137-149.
- Otis, A. B. 1964. Quantitative relationships in steady-state gas exchange. In W. O. Fenn and H. Rahn (editors), Handbook of physiology. Respiration, Sect. 4, Vol. 1, p. 681-698. Am. Physiol. Soc., Wash., D. C.
- Rice, D. W., and A. A. Wolman. 1971. The life history and ecology of the gray whale (*Eschrichtius robustus*). Am. Soc. Mammal., 142 p.
- Scammon, C. M. 1874. The marine mammals of the North-western coast of North America. John H. Carmany and Co., San Francisco, 319 p.
- Scholander, P. F. 1940. Experimental investigation of the respiratory function in dividing mammals and birds. Hvalrad. Skr. 22:1-131.

Suwa, K., and H. H. Bendixen. 1972. Pulmonary gas exchange in a tidally ventilated single alveolus model. *J. Appl. Physiol.* 32:834-841.

Tenney, S. M., and J. E. Remmers. 1963. Comparative quantitative morphology of the mammalian lung: diffusion area. *Nature* 197:54-56.

Watson, E. H., and G. H. Lowrey. 1962. Growth and development of children. 4th ed., Year Book Medical Publishers, Inc., Chicago, 384 p.

MFR Paper 1045. From Marine Fisheries Review, Vol. 36, No. 4, April 1974. Copies of this paper, in limited numbers, are available from D83, Technical Information Division, Environmental Science Information Center, NOAA, Washington, DC 20235.

MFR PAPER 1046

Ballistocardiography as a Technique for Comparative Physiology

N. TY SMITH and ERIC A. WAHRENBROCK

ABSTRACT

The ultra low-frequency ballistocardiogram was recorded on a young California gray whale. The tracing is remarkably similar to those obtained from man and mouse, both in amplitude and in form. The IJ amplitudes for mouse, man, and whale were 2.6, 4.3, and 4.6 cm/sec². We conclude that greater differences are caused by poor recording technique or by disease than by species differences. The major interspecies differences were seen in the timing of cardiac events, such as pre-ejection or ejection time. These differences could be caused by differences in heart size.

The ballistocardiograph (Beg) is a device for evaluating the mechanical function of the heart. It has been recorded in an incredible array of animals, ranging from egg embryos to cattle. One of the more interesting facts to arise from these recordings is that the tracings are remarkably similar among species, particularly mammals. This similarity holds both in form and in amplitude. It was therefore an excellent opportunity to

extend these observations to Gigi, an animal with an entirely different mass and configuration from other mammals previously used.

The Beg records the movements of the body caused by movements of blood in the body. First recorded in 1887, the Beg has undergone a series of ups and downs in its attempts to become a useful tool for measuring cardiovascular function noninvasively. Not until the 1950's when physicists and engineers entered the field, did the Beg finally re-emerge as an accurate, relatively simple technique.

Essentially, the Beg works on the principle that an attempted shift in the center of mass of a floating body is compensated for by a movement of the body in the opposite direction, so that the center of mass remains constant in

relation to a fixed point. Thus, if blood moves in one direction after ejection by the left ventricle, the body will move in the opposite direction. These movements are quite small, but the reader has certainly noticed a slight bodily movement as he lies quietly on a bed or a slight movement of the pointer on a weighing scale, each movement synchronous with the heart beat. This minute body movement can be recorded as displacement, velocity, or acceleration. Figure 1 shows examples of normal tracings in man. The important fact to note is that the major components of the Beg occur during ejection of blood, particularly during the early portion.

METHODS

When the physical scientists entered the field, they laid down certain standards for recording the Beg, standards which were to convert ballistocardiography from a haphazard technique to a precise one. The first requirement is that a very light bed is necessary, in contrast to the heavy ones formerly used. A ratio of 10:1 for subject:bed is minimal. Second, coupling, or binding, of subject to bed must be as tight as possible. Third, coupling to ground must be minimal, so that ambient vibrations can be attenuated. The Beg is an extremely sensitive instrument. Peak displacement is about 100 μ , peak acceleration, a few millig's, g being the acceleration of gravity. With older instruments, vibrations from a truck outside the building were able to destroy a bal-

N. Ty Smith is an Associate Professor of Anesthesia at the University of California at San Diego, Veterans Administration Hospital, San Diego, CA 92161, and Eric A. Wahrenbrock is an Assistant Professor of Anesthesia at the University of California, San Diego.

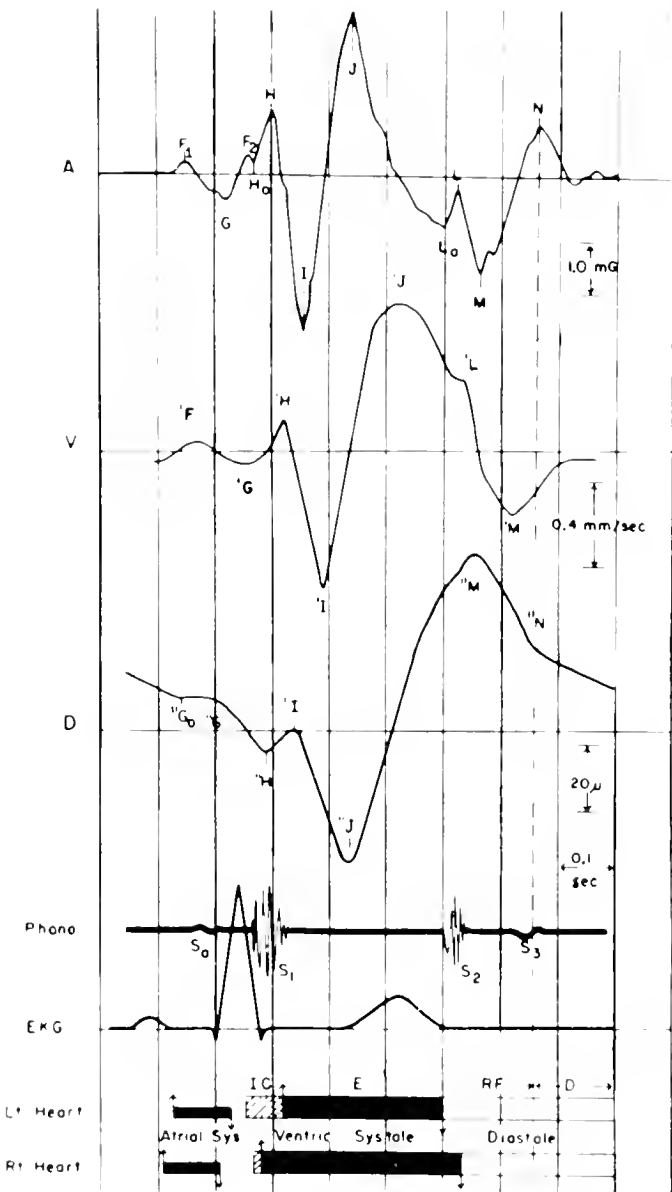

Figure 1. — Examples of normal ballistocardiographic tracings in man. From top to bottom are recorded acceleration (A), velocity (V), and displacement (D). In addition, the EKG and the major events of the cardiac cycle are given as reference points. (From Scarborough et al., *Am. J. Cardiol.* 2:613-641, 1958.)

bed ratio of 20:1 was more than adequate. Six ropes supported the poles, four at the ends, each 13 feet in length, and two in the middle. A board inserted between the two middle ropes prevented injury to the animal. The six ropes were suspended by a single cable from a crane. During the recording the cable was 7½ meters from pulley to hook, giving a natural frequency of about 0.18 Hz. The crane was part of a truck hoist, which was ideal for isolation from ground because of the pneumatic lift and the rubber tires.

Most of the water was drained from Gigi's tank to reduce her mobility and to enhance our own. She was reluctant to lie on the bed, and had to be coaxed. The coaxing process took 45 minutes. Once on the bed, she became surprisingly quiet, which was fortunate, since she could easily have demolished our fragile accelerometer. One re-adjustment of the relative position of whale and bed was required to level the bed.

Acceleration was transduced in the head-foot direction with an Endevco¹ piezo-resistive accelerometer clamped to one of the steel poles with a large C clamp. The accelerometer was calibrated with a pendulum, according to the method of Moss (1961). Lead two of the ECG was recorded using 4 inch 18 g spinal needles. All electrical cables were supported by a rope stretched across the tank. A 60 Hz passive notch filter and a 50 Hz low pass Butterworth filter were used on both the ECG and Beg to eliminate unwanted noise and at the same time preserve timing relations. Data were recorded on a Hewlett-Packard oscilloscope and an Ampex FM tape recorder.

listocardiographic recording. Finally, the natural frequency of the entire system should be as low as possible—0.3 Hz or less is mandatory. These four requirements imply that the ideal Beg system is one in which subject and bed float as a unit in space.

Several ingenious systems, some simple, some complex, have been assembled to accomplish the above requirements. Beds have been constructed from aluminum and canvas, styrofoam, balsa, or aluminum honey-

comb, and suspended by wires or floated on mercury or air. The simplest and original bed is based on the pendulum, and was the type used in this study. The Beg bed was the same stretcher used to weigh Gigi (Figure 2). The stretcher was constructed from canvas and two 20-foot heavy wall, galvanized steel pipes 3 inches in diameter. The total weight of 227 kg may seem large to most ballistocardiographers, but Gigi's weight at the time was 4,500 kg, and the whale:

¹Use of trade names in this publication does not imply endorsement of commercial products by the National Marine Fisheries Service

RESULTS

Figure 3 shows the Beg recorded from Gigi. In amplitude and form, it is similar to that seen in man. Figure 4 demonstrates that the influence of ventilation on the tracing is profound. In fact, during expiration and inspiration reading the Beg is impossible.

Figure 5 displays the Beg's of three animals—a mouse, a man, and a whale. Their similarities are more striking than their differences. This similarity holds in spite of differences in body mass and form, amount and distribution of fat, and natural environment.

Table 1 lists some measurements derived from the Beg's of the mouse, man, and a whale. It also gives some fundamental values which are helpful in comparing the species.

The Beg has been used to estimate cardiac output and stroke volume in several species. By using the Starr formula (Starr and Noordergraaf, 1967, p.177-180) we estimated Gigi's stroke volume to be 7.2 l, and the cardiac output as 308 l/min (Table 1).

DISCUSSION

One of the major postulated objections to the Beg is that the amount and distribution of body fat can considerably alter the recording. This did not seem to be the case in Gigi, in spite of a $3\frac{1}{2}$ inch layer of blubber. It is true that the old direct-body Beg used in the 1950's was subject to influence by body fat. However, the ultra low-frequency bed, by virtue of its light weight and strong coupling between subject and bed, has eliminated most of this inaccuracy. The fundamental natural frequency of the body ("bowl of jelly" phenomenon alluded to by some in reference to the Beg) does not depend on body mass, amount of fat, or age (Burger, Noordergraaf, and Verhagen, 1953; Burger and Noordergraaf, 1956; Talbot and Harrison, 1955; Tannenbaum, Vessell, and Schack, 1956; Weissback, 1960a, 1960b; Tischenko, 1963). Some of

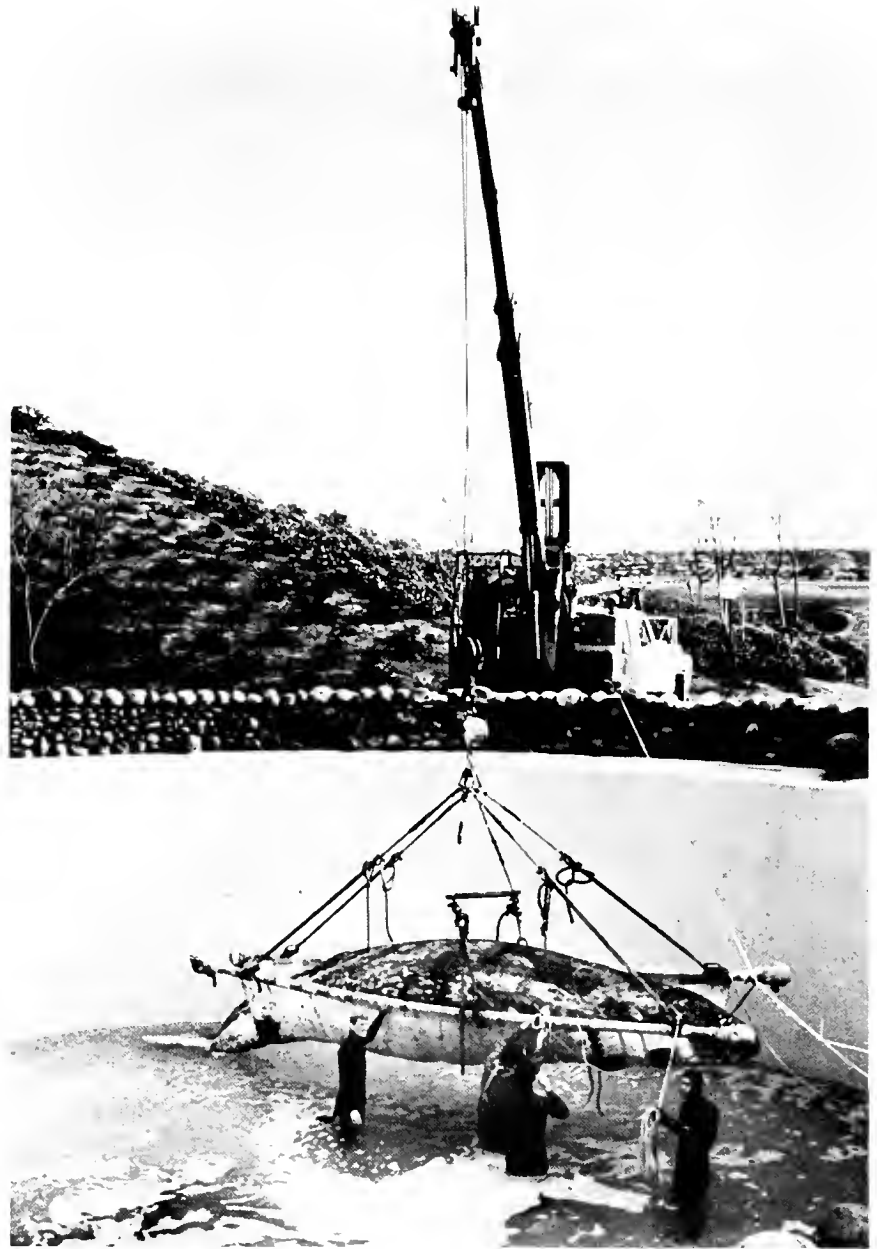

Figure 2. — Gigi, Beg bed, man, and hoist. The accelerometer is being attached to the right side of the proximal pole. The truck was jammed against the retaining wall of the lank. A white rope strung across the tank supports the cables.

the higher mode frequencies may depend on the amount and distribution of body fat.

A crucial factor in ballistocardiography is the orientation of the aorta in relation to the body. This is so because usually complexities have forced ballistocardiographers to

record the Beg in one dimension, the head-foot direction, instead of the possible three dimensions and six degrees of freedom. Thus if the direction of ejection and runoff is different in different species, the comparison would be difficult. The orientation of the aorta seems to be no

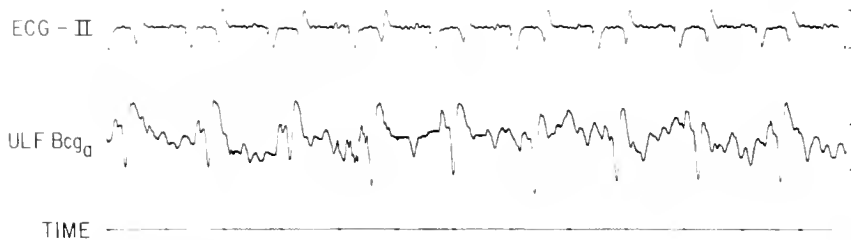

Figure 3. — ECG lead two and acceleration Bcg in a California gray whale. Paper speed = 50 mm/sec. The Bcg calibration of 3 cm/sec² is shown in the lower right.

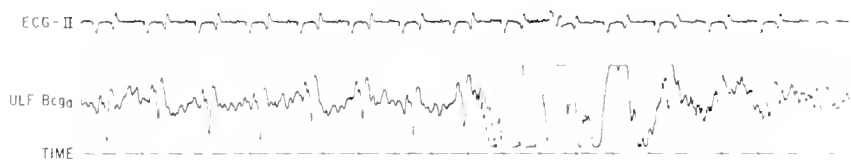

Figure 4. — The Bcg with Gigi during one breath. Paper speed = 25 mm/sec. The respiratory influence on the Bcg is considerably greater in the whale than other species. This is probably due to the necessarily rapid and large tidal exchange.

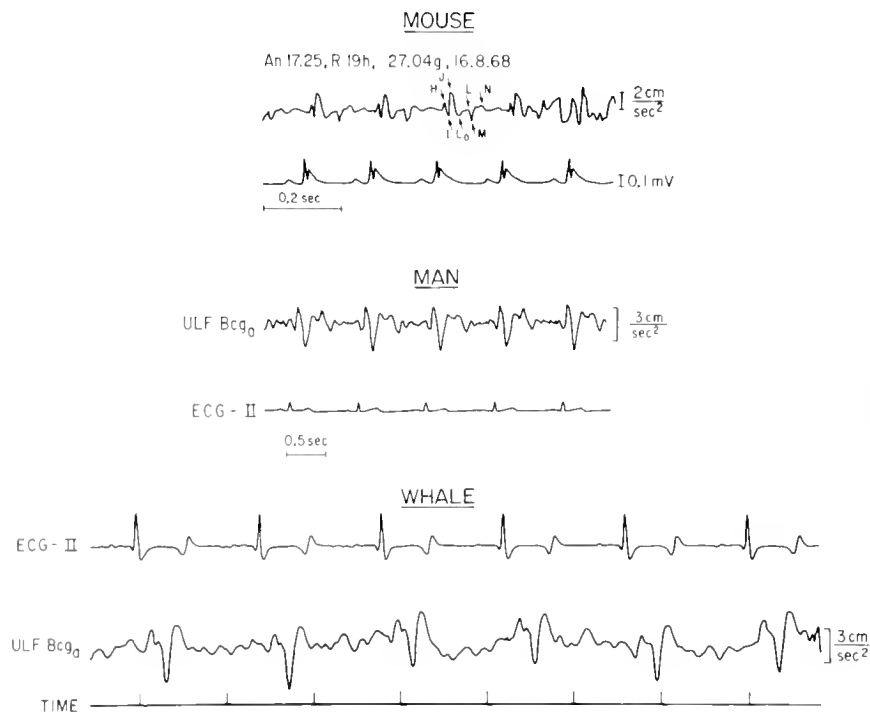

Figure 5. — The ultra low-frequency acceleration Bcg's in a 27-gm mouse (top record), a 73,000-gm man (middle record), and a 4,500,000-gm whale (lower record). The ECG's are also shown. Note the more rapid paper speed in the mouse Bcg. Considering the 167,000-fold difference in body mass, as well as the differences in body shape, amount and distribution of fat, and instrumentation, the records are remarkably similar. The mouse Bcg is from Juznic, G., *Bibl. Cardiol.* 26:281-291, 1970. The human Bcg is courtesy of Dr. Aaron G. Dinaburg.

different in the whale from other mammals. Green (1971) describes the course and relations thus: "Leaving the left ventricle, the aorta makes the characteristic left arch before passing superficially and caudally to lie just under the center of the thoracic cavity to pass through the diaphragm."

Body acceleration, which is closely related to blood acceleration, is a constant factor among various mammalian species. A peak-to-peak body acceleration of 2.5-5 cm/sec² (about 2.5-5 millig) seems to be optimum. If the acceleration is greater, as with severe aortic insufficiency, the slight motion now becomes quite noticeable. If the whale's body acceleration were proportionately large in relation to its mass, the motion could become uncomfortable. Why a smaller normal acceleration would not be feasible, or indeed why an initial ventricular impulse is necessary at all, is difficult to guess.

Other constants occur among mammals. For example, with rare exceptions such as the giraffe, arterial blood pressure is very similar in different species (Altman and Dittmer, 1971, p. 405-408). One could speculate why these values are so appropriate. If normal arterial pressure were higher, either the vessel walls would have to be of considerably stiffer material, or they would have to be so thick that the ratio of wall thickness to lumen would be impractical. If normal pressure were lower, perfusion through the necessarily small capillary vessels would be difficult. Perhaps even more pertinent a constant involves the relative masses of the heart and body in different mammals (Table 1). Apparently there is more variation within species than among species.

The general form of Gigi's Beg is very similar to that given for normal man by Scarborough et al. (1958). One can certainly recognize an HIJ complex and an LMN complex. It seems that greater differences in amplitude and form are caused by faulty technique, such as a heavy bed and poor

coupling, or by disease states, than by differences in species. Figure 6 gives an example of this. It compares a virtually normal Bcg in a dog with the Bcg in a dog at the terminal stages of rejection. The latter tracing is obviously grossly abnormal and demonstrates the extreme in Bcg abnormality. Other conditions which can cause a greater ballistocardiographic variation within than among species include anginal attacks, severe coronary artery disease, hyperthyroidism, aortic valvular insufficiency, and congestive heart failure (Starr and Noordergraaf, 1967). Even a program of physical conditioning over several months can alter an individual's Bcg to as great an extent as the differences seen among species (Elsbach et al., 1970, Holloszy et al., 1964).

The major difference among the Bcg's of various mammals seems to be one of timing of the systolic wave forms. As body size increases, the onset of the systolic complex is delayed (QH interval) and the complex spreads out (HJ and HL intervals, Table 1). If we consider the tip of the H wave as the onset of ejection, we shall at worst slightly underestimate the cardiac pre-ejection period. Certainly the relative values among species can be estimated by the QH interval. Similarly, ejection time can be estimated by the HL interval. This interval did not seem to be so relatively prolonged in Gigi as the QH. The contribution of prolonged conduction time in hearts of different sizes to the interspecies differences in systolic time intervals is probably considerable, as is shown by the PR and QRS intervals in Table 1.

In general, heart rate and ejection time are inversely related. Thus part of the differences in systolic time intervals is due to heart rate differences. But heart rate cannot explain all of the differences. Gigi's heart rate of 43 beats/min was not as slow as expected and occurred presumably because she was excited. An athlete with a heart rate of 40-45 beats/min does not show the prolonged pre-

Table 1.—Some comparative values among mouse, man, and whale.

	Mouse	Man	Whale	Ratio Whale/Mouse
Weight (gm)	27	73,000	4,500,000	167,000
Length (cm)	6.5-9.5 (12.5-20) + (1)	180	760	38-117
Heart/body mass (gm/100 gm)	0.41-0.51 (2)	0.44-0.57(3)	0.32-0.50(4)	0.78-0.98
Heart rate (beats/min)	300-700 (5)	60-80	43	0.13
Bcg IJ amplitude (cm/sec ²)	2.6 (6)	4.3(6)	4.8	1.8
Bcg IJ amplitude (corrected, cm/sec ²)	3.4*	4.7*	5.0*	1.5
Bcg IJ amplitude (dynes)	73.0	250 × 10 ³ (7,8)	2.27 × 10 ⁷	311,000
Cardiac output (l/min)	—	5.0-8.0	308	—
Cardiac index (l/min/kg)	—	70-90 (9,10)	68.4	—
Stroke volume (ml)	—	70-90 (9,10)	7150	—
Stroke index (ml/kg)	—	0.9-1.2 (9,10)	1.6	—
PR interval (msec)	42 (11)	180-200	294 [#] (320) (11)	7.0
QRS interval (msec)	22 (11)	80-100	103 [#] (90-120) (11)	12.9
QH interval (msec)	27	90-110 (7,8)	320	11.9
"Pre-ejection period"				
HJ interval (msec)	43	140 (7,8)	205	4.8
HL interval (msec)	64	320 (7,8)	490	7.7
"Ejection time"				

+ With tail

* Corrected for mass of bed $IJ \left(\frac{\text{Total Mass}}{\text{Body Mass}} \right)$

[#] Measured in Gigi

¹ Walker, et al., 1968

² Altman and Dittmer, 1971, p. 240

³ Altman and Dittmer, 1971, p. 236-7

⁴ Altman and Dittmer, 1971, p. 239

⁵ Altman and Dittmer, 1971, p. 340

⁶ Juznič, 1970

⁷ Starr and Noordergraaf, 1967

⁸ Moss, 1961

⁹ Cullen, et al., 1970

¹⁰ Altman and Dittmer, 1971, p. 323-4

¹¹ Altman and Dittmer, 1971, p. 278

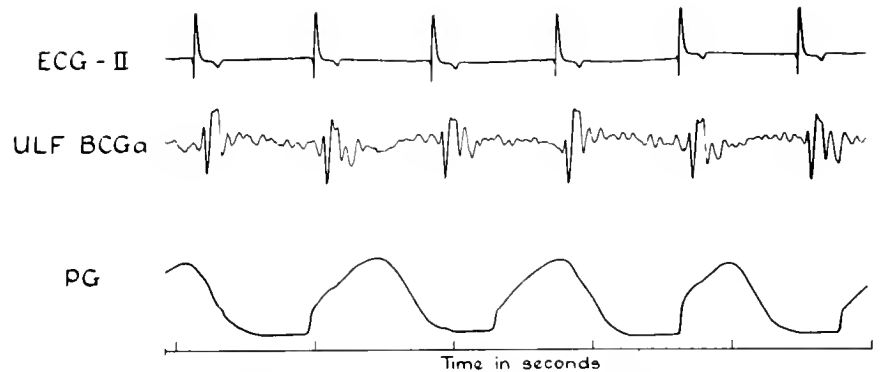

Figure 6a. — These two tracings are from a conscious dog after cardiac autotransplantation. The Bcg is essentially normal. PG = Pneumogram (Whitney gauge).

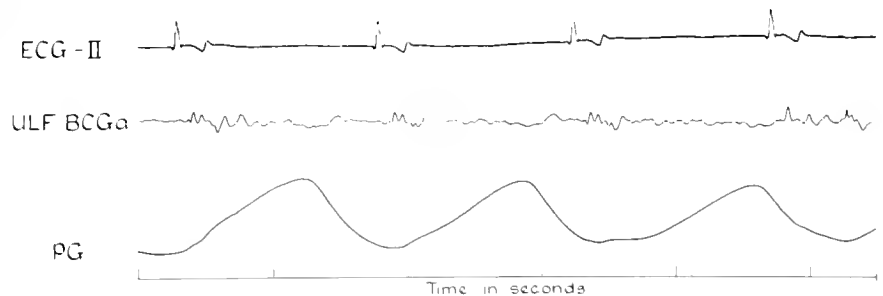

Figure 6b. — These tracings are from a dog in the terminal stages of rejection after cardiac autotransplantation. The difference between the ballistocardiographic records from the two dogs is obviously greater than that between the tracings from a whale and mouse (Figure 5).

ejection period and ejection time that Gigi does (Weissler et al., 1960; Leighton et al., 1971).

We said that the Beg is used to estimate cardiac function. This is possible because of the close relationship between the acceleration Beg and the acceleration of blood out of the left ventricle into the aorta (Winter et al., 1966, 1967; Smith, Van Citters, and Verdouw, 1970; Deuchar, 1966). The latter is a proven sensitive indicator of cardiac function (Noble, Trenchard, and Guz, 1966; Noble, Gabe, and Trenchard, 1967; Rushmer, 1964, 1970).

Gigi's stroke index of 1.6 ml/kg is somewhat greater than that of man, about 1 ml/kg. However, since the heart rate was slower in Gigi, the cardiac index was closer to that of man (Table 1). Again, in comparing several species, we note that when cardiac output is plotted against body weight on a log-log scale, a straight line is obtained (Altman and Dittmer, 1971, p. 320). It does seem reasonable that stroke index is roughly equivalent in different mammals, since the heart/body mass ratios are similar.

Although the measurement of acceleration, as opposed to displacement or velocity, minimizes the influence of ventilation, any movement or muscular activity can disturb the recording. Since whales must expire and inspire rapidly between dives, the muscular activity is relatively violent. As Wahrenbrock has measured, Gigi's peak instantaneous flow rate was 285 l/sec. Thus ventilation demolished Gigi's Beg recording. Fortunately, ventilatory rate was extremely slow so that the Beg had sufficient time to recover between breaths.

The Beg has now been recorded in a wider range of masses in animals than any other physiologic test. The mass ratio is 1.6,000,000, egg embryo, whale. This points out the versatility of the Beg and suggests its importance as a technique for comparative physiological and pharmacological studies.

ACKNOWLEDGMENTS

The authors wish to acknowledge the invaluable assistance of Gary Maruschak. They also thank the staff of Sea World who participated in this study. Without their enthusiastic cooperation, these studies would have been impossible.

LITERATURE CITED

- Altman, P. L., and D. S. Dittmer (editors). 1971. Respiration and circulation. Fed. Am. Soc. Exp. Biol., Bethesda, 930 p.
- Burger, H. C., and A. Noordergraaf. 1956. Physical basis of ballistocardiography. II. The quantities that can be measured with different types of ballistocardiographs and their mutual relations. *Am. Heart J.* 51:127-139.
- Burger, H. C., A. Noordergraaf, and A. M. W. Verhagen. 1953. Physical basis of the low-frequency ballistocardiograph. *Am. Heart J.* 46:71-83.
- Cullen, B. F., E. I. Eger, II, N. T. Smith, D. C. Sawyer, G. A. Gregory, and T. A. Joas. 1970. Cardiovascular effects of fluorene in man. *Anesthesiology* 32:218-230.
- Deuchar, D. C. 1966. The relations of ballistocardiography to other methods of studying the cardiovascular system in man. In A. A. Knoop (editor), *Ballistocardiography and cardiovascular dynamics*, p. 225-236. William & Wilkins Co., Baltimore.
- Elsbach, H., F. A. Rodrigo, H. W. H. Weeda, and J. Pool. 1970. The ballistocardiogram in selection for and assessment of physical conditioning in patients with ischemic heart disease. *Bibl. Cardiol.* 26:49-51.
- Green, R. F. 1971. Observations on the anatomy of some cetaceans and pinnipeds. In S. H. Ridgway (editor), *Mammals of the sea. Biology and medicine*. C. C. Thomas, Springfield, p. 269.
- Holloszy, J. O., J. S. Skinner, A. J. Barry, and T. K. Cureton. 1964. Effect of physical conditioning on cardiovascular function. *Am. J. Cardiol.* 14:761-770.
- Juznic, G. 1970. The ultra-low frequency ballistocardiogram of the mouse. *Bibl. Cardiol.* 26:280-291.
- Leighton, R. F., A. M. Weissler, P. B. Weinstein, and C. E. Wooley. 1971. Right and left ventricular systolic time intervals. *Am. J. Cardiol.* 27:66-72.
- Moss, A. J. 1961. Ballistocardiographic evaluation of the cardiovascular aging process. *Circulation* 23:434-451.
- Noble, M. I. M., I. T. Gabe, and D. Trenchard. 1967. Blood pressure and flow in the ascending aorta of conscious dogs. *Cardiovasc. Res.* 1:9-20.
- Noble, M. I. M., D. Trenchard, and A. Guz. 1966. Studies of the maximum acceleration of blood in the ascending aorta of conscious dogs. In A. A. Knoop (editor),

- Ballistocardiography and cardiovascular dynamics, p. 243-247. William & Wilkins Co., Baltimore.
- Rushmer, R. F. 1964. Initial ventricular impulse. A potential key to cardiac evaluation. *Circulation* 29:268-283.
- _____. 1970. Cardiovascular dynamics. 3rd ed. W. B. Saunders Co., Philadelphia, p. 110.
- Scarborough, W. R., E. F. Folk, III, P. M. Smith, and J. H. Condon. 1958. The nature of records from ultra-low frequency ballistocardiographic systems and their relation to circulatory events. *Am. J. Cardiol.* 2:613-641.
- Smith, N. T. In press. Ballistocardiography. In A. M. Weissler (editor), *Noninvasive methods in cardiac evaluation*. Grune and Stratton, New York.
- Smith, N. T., R. L. Van Citters, and P. D. Verdouw. 1970. The relation between the ultra-low frequency ballistocardiogram, the acceleration pneumocardiogram, and ascending aortic flow acceleration in the baboon. *Bibl. Cardiol.* 26:198-205.
- Starr, I., and A. Noordergraaf. 1967. Ballistocardiography in cardiovascular research. J. B. Lippincott Co., Phila., 438 p.
- Talbot, S. A., and W. K. Harrison, Jr. 1955. Dynamic comparison of current ballistocardiographic methods. Part I: Artefacts in the dynamically simple ballistocardiographic methods. *Circulation* 12:577-587.
- Tannenbaum, O., H. Vessell, and J. A. Schack. 1956. Relationship of the natural body damping and body frequency to the ballistocardiogram. *Circulation* 13:404-409.
- Tischenko, M. I. 1963. The significance of natural vibrations of the human body in shaping the ballistocardiogram. *Biophysics* 8:311-319.
- Walker, E. P. 1968. Mammals of the world. Vol. II. Johns Hopkins Press, Baltimore, p. 921.
- Weissbach, G. H.-J. 1960a. Die Rolle der Tischmasse und der Wert einer zusätzlichen Dämpfung beim Elongationsballistokardiographen. [In Ger.] *Pflügers Arch. ges. Physiol.* 270:529-535.
- _____. 1960b. Die registrier-technischen Eigenschaften des direkten ballistokardiographen. *Z. Kreislaufforsch.* 49:626-630.
- Weissler, A. M., R. G. Peeler, W. H. Roehll, Jr., and N. C. Durham. 1960. Relationships between left ventricular ejection time, stroke volume, and heart rate in normal individuals and patients with cardiovascular disease. *Am. Heart J.* 62:367-378.
- Winter, P. J., D. C. Deuchar, M. N. Noble, and A. Guz. 1966. The ballistocardiogram and left ventricular ejection in the dog. In A. A. Knoop (editor), *Ballistocardiography and cardiovascular dynamics*, p. 248-254. William & Wilkins Co., Baltimore.
- Winter, P. J., D. C. Deuchar, N. I. M. Noble, et al. 1967. Relationship between the ballistocardiogram and the movement of blood from the left ventricle in the dog. *Cardiovasc. Res.* 1:194-200.

MFR Paper 1046. From Marine Fisheries Review, Vol. 36, No. 4, April 1974. Copies of this paper, in limited numbers, are available from D83, Technical Information Division, Environmental Science Information Center, NOAA, Washington, DC 20235.

Investigation of Blubber Thickness in a Gray Whale Using Ultrasonography

MICHAEL P. CURRAN and WILLIAM M. ASHER

ABSTRACT

A captive juvenile gray whale, Eschrichtius robustus, was studied with ultrasound using A-mode technique. Measurements of blubber and fat thickness by means of selected tissue interfaces were made. Suture implantation depths were also measured. Ultrasound would be a reliable method for measuring blubber and fat thicknesses to give insight to a marine mammal's nutritional status.

PROBLEM

A captive yearling gray whale was considered for ultrasound study 1) to measure blubber and fat thickness to reflect on nutritional status, and 2) to measure depth of polyethylene suture implantations being used for an attachment of a radio transmitter device on the animal's dorsal surface.

PROPOSAL

Using an ultrasound beam with A-mode technique, it was proposed to measure skin, blubber, fat, and muscle depth. Tissues of varying density will reflect ultrasound echoes from their respective interfaces. A porpoise, *Tursiops truncatus*, model was proposed for correlation.

BACKGROUND

Ultrasound is a relatively new science which is meeting with intense interest and enthusiasm for medical diagnostic and research purposes. It has proven effective in detecting brain midline shifts with the echoencephalogram. Examinations of the heart to predict cardiac output, mitral valve activity, and presence or absence of pericardial effusions are made. B-scan examination of the abdomen to localize and characterize various masses and organs in the peritoneal cavity and retroperitoneal space is accepted prac-

tice. Obstetrics has found valuable use for ultrasound in evaluating gestational age, placental location, and pelvic masses.

In the field of veterinary medicine this technique has made it possible to select breeding stock by determination of the fat and muscle interfaces, allowing identification of those animals with the best commercial potential. This latter application suggested measurements for marine animals to evaluate nutrition.

MATERIALS AND METHODS

Utilizing commercially available pulsed ultrasound equipment designed for medical application, multiple measurements of the echo interfaces of the gray whale were obtained at selected positions along the dorsal-lateral aspect and axilla. Additional measurements were obtained over the polyethylene sutures to determine the

Lt. Comdr. Michael P. Curran, MC, USNR, and Lt. Comdr. William M. Asher, MC, USN, are both from the Department of Ultrasound and the Clinical Investigation Center, Naval Hospital, San Diego, CA 92134. The opinions or assertions contained herein are those of the authors and are not to be construed as official nor as reflecting the views of the Navy Department.

suture depth. All of this material was displayed on a cathode ray oscilloscope with a linear scale divided into millimeter increments. As an in vitro correlation to provide information as to which structures were providing the echo interfaces observed in the live mammal, a porpoise model with necropsy section was obtained. Using a direct visual placement of the transducer in similar areas to that of the gray whale, the echo interfaces were photographed on the oscilloscope. Direct linear measurements and anatomical identification of the structures traversed were performed. These echo patterns correlated highly with the similar patterns obtained from the gray whale and indicated which structures were providing these echoes. Thin section radiographs were obtained of the porpoise model, further demonstrating the density differences of tissue between the skin lines, blubber, areolar fat, muscle, and fascial surfaces. In all cases the measurements corresponded exactly to the visual interpretation of the fascial, fat, bone, and skin interfaces.

DISCUSSION

Elementary Ultrasound Physics

Although ultrasonic technology in medicine is relatively new, the earliest experiments date back to the 1800's when attempts to produce high frequency sounds were performed. In 1883 Galton developed an ultrasound whistle which was capable of producing vibrations as high as 25,000 cycles per second. In modern terminology, the frequency of vibrations is assigned the term "Hertz" and 25,000 cycles per second is abbreviated as 25 kilohertz (25 kHz). In 1929 Sokolov described an ultrasonic method for detecting flaws in metals. Following this, in 1947, this new modality was utilized in medical diagnosis when early workers such as Keksell, in Sweden, demonstrated the ability to detect the midline of intracerebral structures.

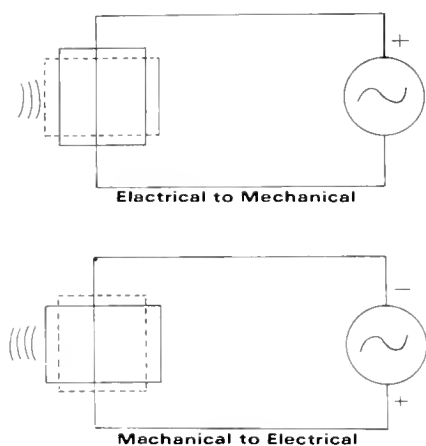

Figure 1.—Piezoelectric effect.

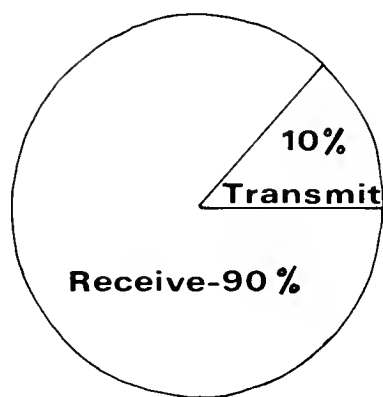

Figure 2.—Split function concept. Pulsed ultrasound from transducer is transmitted 10% of the time and received 90% at 400 pulses/sec.

Ultrasonics, the technology of high frequency sound waves, deals with the transmission of sound or pressure waves through a medium. Sound waves, unlike electromagnetic waves, cannot be transmitted through a vacuum. The generation of sound waves from a transducer depends on a phenomenon known as piezoelectric effect. This effect is produced when electrical energy is applied to a crystal which, when distorted by this electrical energy, will produce a mechanical pressure wave. In reverse, the piezoelectric effect occurs when mechanical energy distorts the crystal, producing an electrical potential which can be measured. The technique of recording reflected ultrasound results

from this reversible behavior. (See Figures 1 and 2.) Sound waves travel through various materials with characteristic velocities. The product of the density of the material and the velocity of sound through the given material is called "characteristic acoustic impedance" (Z). When the two substances adjacent to each other transmit sound at a different velocity, the ultrasonic reflection (R) at the boundary is determined by the ratio of the two acoustic impedances as described in the formula

$$R = \left(\frac{Z_2 - Z_1}{Z_2 + Z_1} \right)^2$$

If the two substances have the same acoustic impedance, the numerator becomes zero and there is no reflection. On the other hand, if there is a large difference between the acoustic impedances, the result approaches unity, and almost all of the energy is reflected. In between these two extremes some of the sound energy is reflected while that remaining passes through the interface. Since most soft tissues have acoustic impedances that are quite similar, there are relatively weak reflections at the boundaries. The air-tissue interface is the strongest biological reflector. The bone-tissue interface, likewise, produces a very strong reflection. As most reflections are relatively weak, sensitive equipment is required to detect those boundaries and interfaces such as fat-muscle.

What is the resolution of the system? The frequency of sound determines its wavelength. The resolution is likewise dependent on the wavelength in the axial direction. The higher the frequency, the smaller the wavelength; thus, we have a better resolution capability as determined by the formula $v = \lambda f$ where v is the velocity of the sound in the medium, λ is the wavelength, and f is the frequency. We assume that the minimum distance between two objects for dis-

$$v = \lambda f$$

$$\lambda = \frac{v}{f} = \frac{1500 \frac{\text{m}}{\text{sec}}}{5,000,000 \frac{\text{cyc}}{\text{sec}}}$$

$$= 3 \times 10^{-4}$$

$$= 0.3 \text{ mm} = \lambda$$

$\lambda \times 1.5 = \text{Minimum Distance}$
Between Two Objects
for Discrimination.

$$= 0.45 \text{ mm For } 5 \text{ mhz}$$

Figure 3.—Formula for resolution.

crimination must be equal to at least $1\frac{1}{2}$ wavelengths. (See Figure 3.) By going to higher frequencies, however, we lose penetration in tissue due to sound attenuation; therefore, a compromise must be made and the frequency selected which gives adequate axial resolution, yet adequate penetration through the tissue thickness. For the mammalian models studied the frequency varied between 1 and 2 megahertz, which was adequate for penetration through the structure studied.

Findings

Although the size difference between the 28 foot captive gray whale and the captive Atlantic bottlenosed dolphin (*Tursiops truncatus*) necropsy model is somewhat different, the anatomical structures of the mammals are known to be similar.

During periods of illness or malnutrition, marine mammals of these species are noted to develop a depression in the dorsal contour posterior to the axilla. It is thought that this depression is due to catabolism of blubber, areolar fat, and/or muscle mass loss.

Presuming that areolar fat diminishes in volume prior to muscle loss,

Figure 4.—Radiograph of *Tursiops* cross section demonstrating (1) blubber, (2) areolar fat, (3) muscle group to fascial layer, and (4) second deep muscle group to dorsal spinous process.

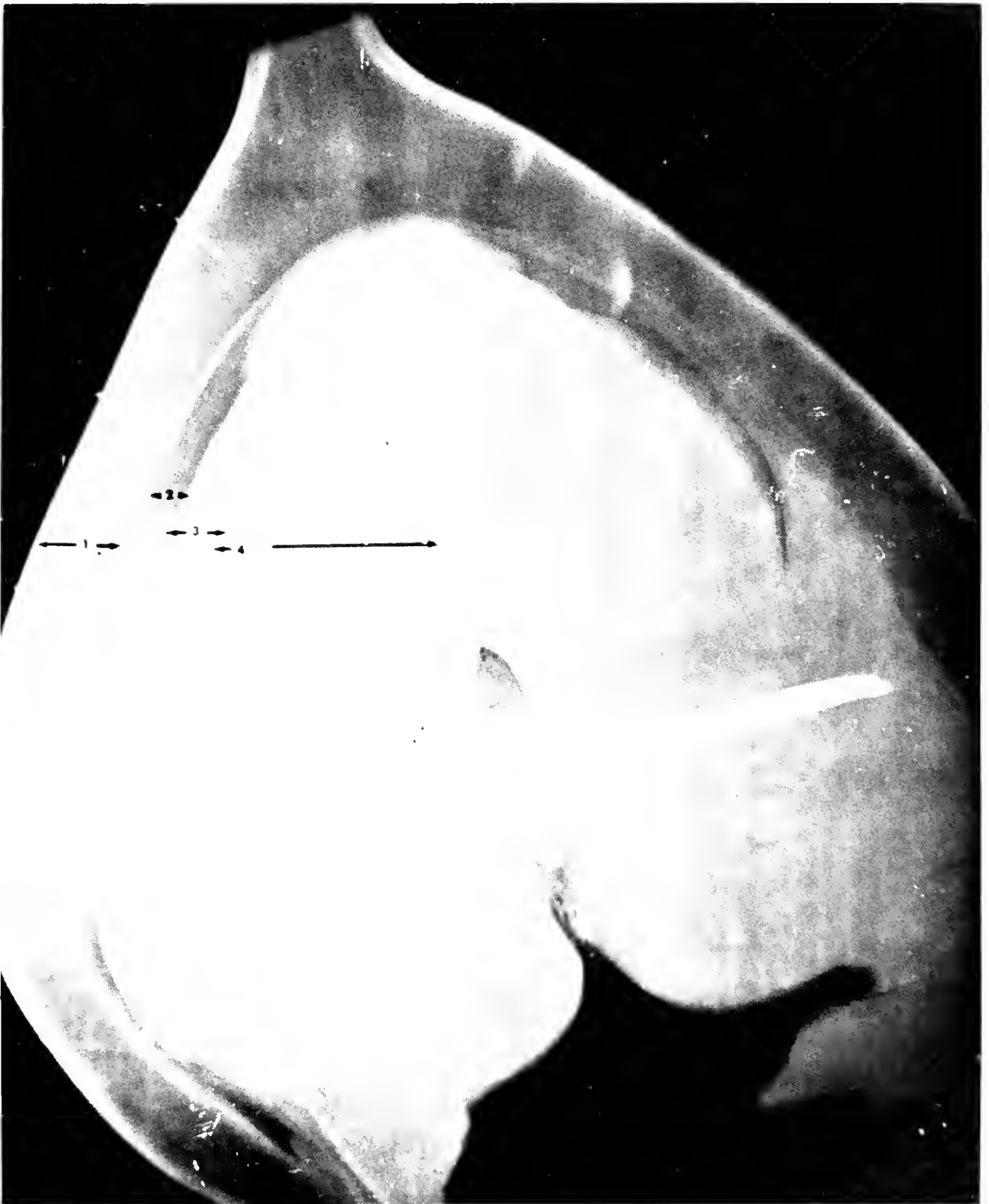



one could measure the normal thickness in healthy mammals and compare with abnormal animals and any available necropsy specimens.

As a pilot program, echographic measurements were made in both the gray whale, *E. robustus*, and the porpoise, *T. truncatus*. Necropsy correlation in *Tursiops* showed that the measurements were easy to perform and were highly accurate. (Figures 4-8.)

Applications

Ideally, to make this method most useful, measurements should be made and necropsy correlation measurements obtained whenever these mammals are found deceased. Due to the expense and shortage of the species, flying a small team to the animal site with the easily portable battery or generator operated scanning equipment should be the most effective means of collecting this invaluable data.

Further observations on the nutritional status during development comparing captive and free animals, as well as disease effects, should prove to be a new approach to the study of marine mammals. Such research data, if accumulated, may be of great benefit in the protection and treatment of valuable, trained marine mammals and their free swimming counterparts.

CONCLUSION

A-mode echography is an effective means of measurement of tissue layers and should be an effective tool in the study of marine mammal nutrition and health status.

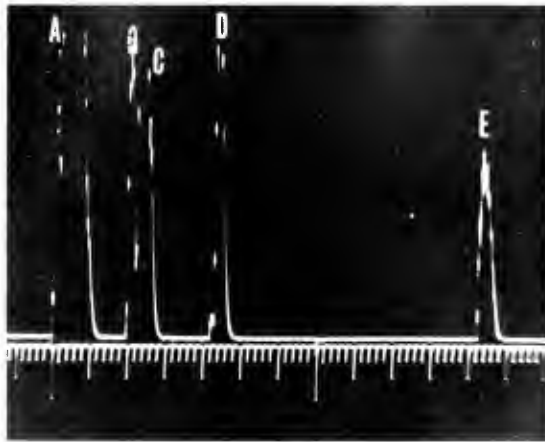

Figure 6.—A-scan of *Tursiops* cross section. Lettered spikes conform to radiographs and tissue boundaries as measured in necropsy section: (A-B) blubber thickness = 2 cm, (C-D) fat thickness = 1 cm, and (D-E) muscle thickness = 8.2 cm.

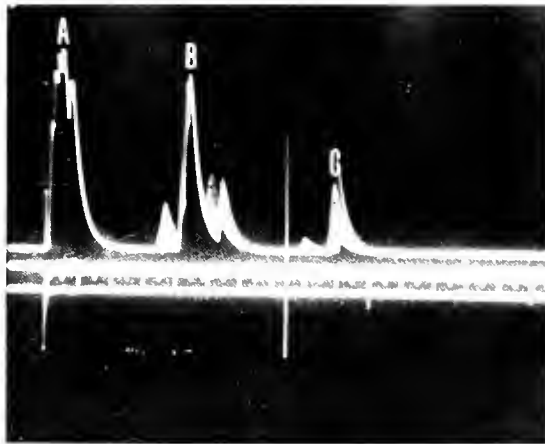

Figure 7.—A-scan of gray whale dorsal-lateral surface posterior to axilla demonstrating blubber thickness of 4.1 cm (A-B) and fat thickness of 4.6 cm (B-C). C represents fat-muscle interface.

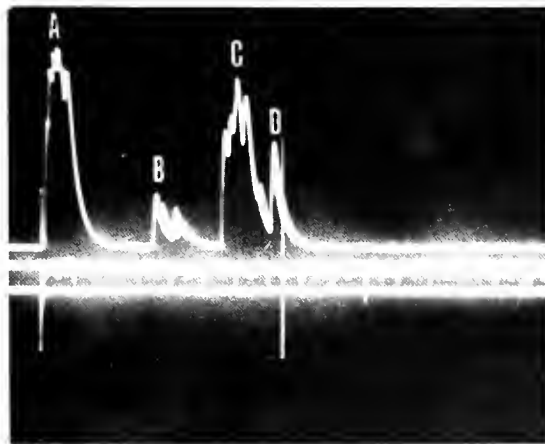

Figure 8.—A-scan of gray whale for polyethylene suture localization. (A) Skin. (B) Blubber-fat interface at 3.5 cm. (C) Polyethylene suture at 5.5 cm. (D) Fat-muscle interface at 7 cm.

Figure 5.—Radiograph of *Tursiops* cross section demonstrating (A) skin-blubber interface, (B) blubber-fat interface, (C) fat-muscle interface, (D) muscle-fascial layer interface, and (E) reflective bone (dorsal spinous process).

REFERENCES

- Asher, W. M., and A. K. Freimanis. 1969. Echographic diagnosis of retroperitoneal lymph node enlargement. Ultrasound scanning technique and diagnostic findings. *Am. J. Roentgenol. Radium Ther. Nucl. Med.* 105:438-445.
- Freimanis, A. K., and W. M. Asher. 1970. Development of diagnostic criteria in echographic study of abdominal lesions. *Am. J. Roentgenol. Radium Ther. Nucl. Med.* 108:747-755.
- Grossman, C. C., J. E. Holmes, C. Joyner, and E. W. Purnell (editors). 1966. Diagnostic ultrasound. *Proc. First Int. Conf. Univ. Pittsburgh*, 1965. Plenum Press, New York, 519 p.
- Lehman, J. S. 1969. Ultrasonography. *Delaware Med. J.* 40:24-25.
- Okasawa, A., and L. Hakkinen. 1969. Comparative experiments on the attenuation of ultrasound in muscular and fat tissue. *Acta Aphthal (Kobenhavn)* 47:735.
- Straková, M., and J. Marková. 1971. Ultrasound use for measuring subcutaneous fat. *Rev. Czech. Med.* 17:66-73.

MFR Paper 1047. From Marine Fisheries Review, Vol. 36, No. 4, April 1974. Copies of this paper, in limited numbers, are available from D83, Technical Information Division, Environmental Science Information Center, NOAA, Washington, DC 20235.

MFR PAPER 1048

Surgical Attachment of a Telemetry Device to the Dorsal Ridge of a Yearling California Gray Whale, *Eschrichtius robustus*

JOHN C. SWEENEY and JOEL L. MATTSSON

ABSTRACT

Surgical attachment of an instrument package mounting device onto the dorsal ridge of a yearling female California gray whale, Eschrichtius robustus, was accomplished through the utilization of four large polypropylene sutures. Use of polypropylene and polyester fabric meshes to induce tissue growth around the sutures was not successful. Post-operative therapy was beneficial in insuring adequate healing at the suture sites. The original polypropylene sutures were replaced the day before release by polyvinyl chloride coated stainless steel.

INTRODUCTION

In March 1971, an infant female gray whale was captured within Scammon's Lagoon, Baja California, and subsequently transported by boat to Sea World, Inc. in San Diego, Calif. The animal was captured for research purposes, and for the year following her capture, various studies were undertaken.

As the animal approached 1 year of age, the financial burden to Sea World in holding facilities, personnel, and food made it necessary to design a plan for her release. At that time, W. E. Evans, of the Naval Undersea Center, San Diego, proposed (with the support of the National Oceanic and

Atmospheric Administration) that the whale be released carrying a telemetry device for tracking and recording.

Evans (1971) has reported the use of radiotelemetry devices attached to the dorsal fin of dolphin, using a bolt placed through the fin. Martin, Evans, and Bowers (1971) have utilized a harness for the fixation of a device onto a pilot whale. A gray whale has no dorsal fin for bolt fixations, and the growth rate of this animal left the harness method undesirable. Therefore, a surgical fixation was considered the method of choice.

John C. Sweeney and Joel L. Mattsson are associated with the Naval Undersea Center, San Diego, CA 91132.

MATERIALS AND METHODS

Sutures composed of 3 mm diameter polypropylene were swaged onto a stainless steel needle made from 3 mm diameter rod shaped into a 10 cm diameter half circle. Polypropylene was chosen because of its inert nature in mammalian tissues (Usher et al., 1962) and because of its availability in the dimensions required. Two types of prosthetic mesh were used in conjunction with the sutures, polypropylene (Marlex^{®1}) mesh and polyester fiber (Mersilene^{®2}).

Five weeks before the scheduled release, an attempt was made to place polypropylene mesh pads (2 cm × 2 cm) subdermally at the entrance and exit sites of the four proposed sutures at positions on a longitudinal plane 10 cm to either side of the dorsal ridge and 10 cm apart. The intention was to induce collagen fiber infiltration within the fabric to add strength to the skin and to prevent infiltration of water once the sutures were in place. The skin was closed with simple interrupted nylon sutures.

Four weeks before release the four polypropylene sutures, each having had a sheet of polyester fabric attached to it using Eastman 9-10 adhesive,³ were placed at the proposed sites. Depth of penetration of the sutures was later confirmed by ultrasonography to be from 4 to 6 cm (Curran

¹Cavol, Inc., Providence, RI Reference to trade names does not imply endorsement by the National Marine Fisheries Service, NOAA

²Ethicon, Inc., Somerville, N.J.

³Eastman Chemical Products, Kingsport, Tenn

and Asher, 1974) all lying within the fatty tissue between blubber and muscle. Once in position, the suture ends were temporarily fused, each suture forming a ring enclosing the dorsal ridge (Figure 1). Each surgical procedure was done under local anesthesia, using 2 percent Xylocaine.

RESULTS

Both attempts to utilize mesh fabrics were unsuccessful. Because no fascial interface is present between epidermis and dermis, or dermis and hypodermis, in cetaceans, placement of mesh pads under the skin was not accomplished. After attempts were made at two of the operative sites, it became apparent that it would be too difficult to embed the pads properly. In addition, the sutures cut through the epidermis when even light tension was applied, preventing adequate closure of the incision. Because of these problems, the procedure was not completed. Within 5 days, each of the mesh pads had been sloughed.

The mesh coated sutures did not induce tissue infiltration, but rather, acted as an irritant with a consequent tissue inflammatory response.

Some drainage from the suture holes was observed on the third postoperative day, and at this time, all four sutures were easily moved back and forth within their tissue bed. The exudate was composed of clear, non-viscous fluid containing tags of white coagulated matter dispersed throughout. Cellular composition was 70 percent mature neutrophils and 30 percent lymphocytes. Swabs were taken on the third postoperative day and on two subsequent occasions. No bacteria were found. Daily flushing of each suture site with normal saline and nitrofurazone solution was done for the next three postoperative weeks. At no time did the animal appear sick, nor was there any indication in her blood tests to suggest that an infection



Figure 1.—Polypropylene sutures in position with ends fused, forming a ring enclosing the dorsal ridge.



Figure 2.—Normal healing around polypropylene sutures.

was present. By the end of the 3 week postoperative period, normal healing was considered well underway (Figure 2), and there was, by then, no drainage from any of the suture sites, though the sutures were still freely movable.

One week before the scheduled release, the instrument package saddle was mounted onto the sutures to allow the animal time to adjust to it before adding the somewhat heavier (approximately 6 kg) instrument package itself. The animal occasionally rubbed the saddle against the side of the tank until the attachment was tightened to reduce free-play of the saddle as the animal swam. On the day before release, cracking of the polypropylene sutures was noticed, requiring their replacement with sutures of the same

diameter composed of polyvinyl chloride coated stainless steel. These were found to be more pliable and stronger than the polypropylene.

At the last visual sighting of the animal on 7 April 1972, the instrument package was still securely attached despite the fact that, on several occasions, kelp had been seen trailing from it (J. S. Leatherwood, pers. comm.). At this time, we have no indication that this procedure has, in any way, compromised the ability of this animal to survive.

MFR Paper 1048. From Marine Fisheries Review, Vol. 36, No. 4, April 1974. Copies of this paper, in limited numbers, are available from D83, Technical Information Division, Environmental Science Information Center, NOAA, Washington, DC 20235.

MFR PAPER 1049

Some Hematologic Observations on the California Gray Whale

ALFRED ZETTNER

ABSTRACT

Examination of the blood of the California gray whale, obtained shortly after its arrival at Sea World, San Diego revealed the following data: WBC- 13.9×10^3 /cubic mm; RBC- 2.4×10^6 /cubic mm; hemoglobin-10.0 g/100 ml; hematocrit-31 percent; MCV-128 μ^3 ; MCH-42.8 $\mu\mu\text{g}$; MCHC-32.4 percent. Hemoglobin electrophoresis showed a single hemoglobin band with a mobility similar to that of human hemoglobin F. The whale hemoglobin was 100 percent alkali resistant. No changes of this hemoglobin were seen on repeated analyses over the course of 12 months.

The capture of a young, female California gray whale, *Eschrichtius robustus*, in Seammon's Lagoon, and its maintenance in captivity at Sea World, San Diego for 12 months pro-

vided the opportunity for some hematologic studies which are to be reported here.

ROUTINE BLOOD EXAMINATION

A heparinized blood sample obtained on 18 March 1971, one day after the arrival of the whale at Sea World, was brought to the Clinical

LITERATURE CITED

- Curran, M. P., and W. M. Asher, 1974. Investigation of blubber thickness in a gray whale using ultrasonography. *Mar. Fish. Rev.* 36(4):15-20.
- Evans, W. E. 1971. Orientation behavior of dolphins: radio telemetric studies. *Ann. N.Y. Acad. Sci.* 188:142-160.
- Martin, H., W. E. Evans, and C. A. Bowers, 1971. Methods for Radio Tracking Marine Mammals in the open sea. *IEEE Eng. in the Ocean Environ. Conf.* p. 44-49.
- Usher, F. C., J. E. Allen, Jr., R. W. Crosthwait, and J. E. Cogan, 1962. Polypropylene monofilament. A new biologically inert suture for closing contaminated wounds. *Am. Med. Assoc.* 179:780-782.

Laboratories of University Hospital, University of California, San Diego. The blood was analyzed on a Coulter Counter,¹ Model "S", which allows the automatic simultaneous determination of cell counts, mean corpuscular volume (MCV), and hemoglobin content. The hematocrit, mean corpuscular hemoglobin (MCH), and the mean corpuscular hemoglobin concentration (MCHC) are automatically computed from the three parameters measured (Pinkerton et al., 1970). The instrument is standardized twice daily and performs approximately 200 analyses per day for clinical purposes. The results were the following:

WBC- 13.9×10^3 /cubic mm
RBC- 2.4×10^6 /cubic mm
Hemoglobin-10.0 g/100 ml
HCT-31 percent
MCV-128 μ^3
MCH-42.8 $\mu\mu\text{g}$
MCHC-32.4 percent

A blood smear was prepared and stained by the automatic HEMA-TFK² technique, which employs a

¹Coulter Electronics, Inc., Hialeah, Fla. References to trade names does not imply endorsement by the National Marine Fisheries Service, NOAA.

²Ames Company, Division of Miles Laboratories, Inc. Elkhart Ind.

Alfred Zettner is a physician with the Division of Clinical Pathology, Department of Pathology, School of Medicine, University of California, San Diego, CA 92103.

modified Wright-Giemsa stain, and examined by oil immersion microscopy.

The red cells were round, moderately anisocytotic ranging from 7.5-9.5 μ in diameter, and appeared well hemoglobinated with only occasional slight central pallor. An occasional red cell displayed polychromasia, and some rare Howell-Jolly bodies were seen. No nucleated red cells were encountered.

A white cell differential count was as follows:

Segmented neutrophils	63 percent
Band forms	19 percent
Metamyelocytes	< 1 percent
Monocytes	9 percent
Lymphocytes	8 percent

No eosinophils nor basophils were encountered. The lymphocytes were all of the large type. No small lymphocytes with the typically scant cytoplasm and dark staining nuclei were present. Twenty-one percent of the nuclei of the mature, segmented neutrophils had distinct "drumstick" appendages.

The thrombocytes appeared as round platelets, with diameters approximately one-third to one-half of those of the red cells. Their number, estimated from their frequency distribution on the smear in relation to the erythrocytes, was in the range of 300,000-350,000/cubic mm.

HEMOGLOBIN ELECTROPHORESIS

Hemoglobin electrophoresis was performed by the vertical acrylamide gel technique as described in detail elsewhere (Bierman and Zettner, 1967) (Nakamichi and Raymond, 1963). Briefly, a toluene hemolysate of the washed red cells is prepared and electrophoresed in Tris-buffer of pH 9.0 for 3½ hours at 120 ma. The acrylamide gel slabs are then stained with amido black and destained electrophoretically in 5 percent acetic acid.

The results are shown in Figure 1. The whale hemoglobin (Slots Nos. 1 and 7) migrated slightly slower than human hemoglobin A. The position

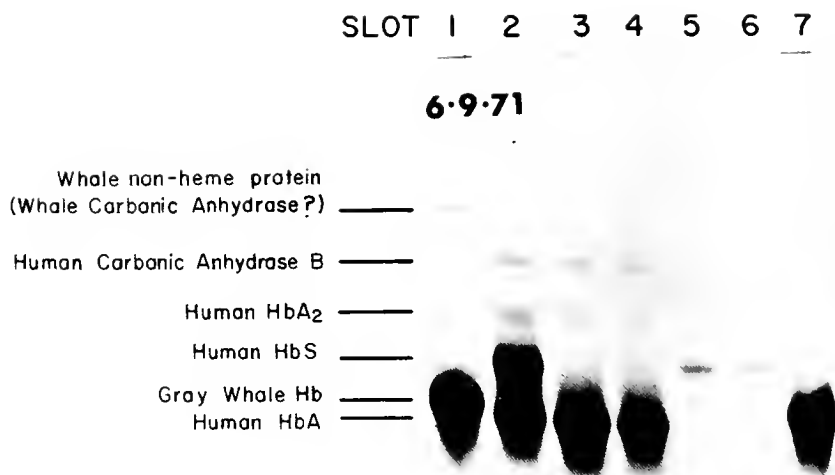

Figure 1.—Vertical acrylamide gel hemoglobin electrophoresis. Tris-buffer, pH 9.0. The gel contains the toluene hemolysates of the following: Slots No. 1-gray whale; No. 2-human with A-S trait; No. 3, 4-normal humans; No. 5,6-standards; No. 7-gray whale (same as slot No. 1). Original (sample application slots) at top. Cathode-top; anode-bottom.

of the band of the whale hemoglobin was indistinguishable from that where human hemoglobin F would be expected. No minor hemoglobin components equivalent to those found in human blood could be detected. The weakly stained band of much slower mobility, as shown in Figure 1, is a non-heme protein, as indicated by the failure of this protein band to react with benzidine when a freshly electrophoresed, unstained strip of the gel containing the whale sample was submerged in a benzidine and peroxide solution.

The pattern of hemoglobin electrophoresis performed on blood samples obtained on 17 March and 27 April 1971, and 13 March 1972 was identical to that demonstrated here.

ALKALI DENATURATION

A quantitative alkali denaturation test performed on the toluene hemolysate by the method of Singer, Chernoff, and Singer (1951) revealed the whale's hemoglobin to be 100 percent alkali resistant. The alkali resistance of the hemoglobin was the same in all samples obtained over the course of 1 year, as listed above.

DISCUSSION

The values of the various red cell parameters, as reported here, are in fair agreement with those published by Lenfant (1969). Relative to most terrestrial mammals, the California gray whale appears to have lower red cell counts, hemoglobin concentrations, and hematocrits, although the MCV is considerably in excess of 100 μ^3 . A proportional increase of the MCV of red cells with total body length of marine mammals of different species has been shown (Lenfant, 1969). Of interest is the finding of Lenfant (1969) of a high proportion of nucleated red cells in the gray whale. This is in distinct contrast to the complete absence of nucleated red cells in the blood samples examined here. It should be considered that the previous observations were apparently made on sick, wounded, dying, or dead animals; and that under these abnormal conditions, immature red cells may have been released into the circulation. The only indication of young red cells in our samples were the rare Howell-Jolly bodies and occasional polychromasia.

The white cells were remarkable in that no small lymphocytes, eosinophils, or basophils were seen. Otherwise, their numbers and percentages appear to be near the normal limits. Of interest is the occurrence of "drumstick" appendages in 21 percent of the mature segmented neutrophils. These were described by Davidson and Smith (1954) in human blood as a genetic sex indicator for females. They occur in 1-17 percent of the segmented neutrophils of all human females and are thought to represent the inactivated X-chromosome, analogous to the Barr body observed in most somatic cells. It can be reasonably assumed that also in the whale, drumsticks in the neutrophils are indicators for the female sex.

The uniform electrophoretic mobility of this gray whale's hemoglobin, characteristic of human hemoglobin F, is in accordance with the finding of others (Lenfant, 1969). Of further interest was the hemoglobin's resistance to alkali denaturation. However, no conclusions can be drawn from this coincidental sharing of two physical properties with human hemoglobin F as to functional or structural similarities between these two hemoglobins. The reasons for the alkali resistance of certain hemoglobin variants are poorly understood. In the human this is related not only to the presence of gamma chains in the hemoglobin molecule, but also to the structural relationships of the various chains to each other. For instance, Bart's hemoglobin, composed of four gamma chains, is only half as alkali resistant as hemoglobin F, which is a tetramer of two alpha and two gamma chains. The elucidation of the structure of the gray whale's hemoglobin depends on the full analysis of its amino acid sequence. Such an undertaking can also be expected to provide some evolutionary clues for the California gray whale.

From the evidence presented here, it appears that this species possesses only one type of structurally uniform hemoglobin, although the possibility

that we are dealing with two or more hemoglobins of identical electrophoretic mobility and alkali resistance cannot be entirely excluded.

The band of non-heme protein appears to be analogous to a similar band which is consistently seen in the electrophoretograms of human bloods. In the latter, this is known to represent carbonic anhydrase B, a red cell constituent persistently extracted with the toluene hemolysates.

LITERATURE CITED

Bierman, A. H., and A. Zettner. 1967. A simple electrophoretic method for the

quantitative determination of hemoglobin A₂. *Am. J. Clin. Pathol.* 48:139-146.
Davidson, W. M., and D. R. Smith. 1954. A morphological sex difference in the polymorphonuclear neutrophil leukocytes. *Brit. Med. J.* 2:6-7.
Lenfant, C. 1969. Physiological properties of blood of marine mammals. In H. T. Andersen (editor), *The biology of marine mammals*, p. 95-116. Academic Press, N.Y.
Nakamichi, M., and S. Raymond. 1963. Acrylamide-gel electrophoresis of hemoglobins. *Clin. Chem.* 9:135-145.
Pinkerton, P. H., I. Spence, J. C. Ogilvie, W. A. Ronald, P. Marchant, and P. K. Ray. 1970. An assessment of the Coulter counter model S. *J. Clin. Pathol.* 23:68-76.
Singer, K., A. I. Chernoff, and L. Singer. 1951. Studies on abnormal hemoglobins. I. Their demonstration in sickle cell anemia and other hematological disorders by means of alkali denaturation. *Blood J. Hematol.* 6:413-428.

MFR Paper 1049, From Marine Fisheries Review, Vol. 36, No. 4, April 1974. Copies of this paper, in limited numbers, are available from D83, Technical Information Division, Environmental Science Information Center, NOAA, Washington, DC 20235.

MFR PAPER 1050

Some Coagulation Factors in Plasma from a California Gray Whale, *Eschrichtius robustus*

W. MEDWAY

ABSTRACT

A citrated plasma sample was assayed for some coagulation factors. The levels obtained were compared with those from some of the small toothed whales. Factor XII activity was very low in the gray whale sample, whereas toothed whales have none.

INTRODUCTION

Many people working with small odontocete whales in captivity have made the observation that whale blood has a prolonged clotting time. Since this observation was made two reports have described the lack of clotting Factor XII in blood in some of the smaller whales (Lewis, Bayer,

and Szeto, 1969; Robinson, Kropatkin, and Aggeler, 1969). Another publication reports a prolonged clotting time of blood from other small whales; however, assays for Factor XII were not made (Ridgway, 1972). There were no reports of similar studies on blood from any baleen whale; hence this report on some studies on a plasma sample from a captive California gray whale, *Eschrichtius robustus*.

MATERIALS AND METHODS

A citrated plasma sample was obtained from a young (1-2 years) female California gray whale kept in captivity in San Diego, Calif. The sample was deep-frozen and shipped via air express to Philadelphia where the assays were made. The plasma sample was slightly lipemic. The prothrombin time, partial thromboplastin time, Factor V, Factor XI, and Factor XII assays were made in the Coagulation Laboratory at the Hospital of the University of Pennsylvania. It was not possible to do a fibrinogen assay on the sample.

Standard laboratory procedures employing commercial reagents were used to conduct the assays, with the exception of Factor XII where dolphin, *Tursiops truncatus*, plasma was used as the substrate. Plasma reagent from Factor XI deficient cattle was used for the Factor XI assay.

RESULTS AND DISCUSSION

The results of the assays on the gray whale plasma and some results on a few odontocete whales, from the literature, are shown in Table 1.

The divergence of our results on the gray whale plasma for prothrombin time, partial thromboplastin time, Factor V, and Factor XI assays from those of the two species of odontocete whales can be explained perhaps on the elapsed time between sampling and assay. The presence of a low level of Factor XII in the gray whale plasma to the non-existence in odontocete plasma warrants some consideration. The significance of this difference teleologically is not known. One of the problems encountered by deep diving humans is decompression sickness. This sickness is attributed to the formation of microclots (disseminated

Table 1.—A comparison of some clotting factors between odontocete whales and a baleen whale. The numbers in parentheses indicate the number of samples.

	<i>Tursiops truncatus</i> ^{1,2,3}	<i>Orcinus orca</i> ²	<i>Eschrichtius robustus</i>
Prothrombin time (sec)	17 0(14)	15 6(3)	26 5(1)
Partial thromboplastin time (ptt) (sec)	346 (15)	216 (3)	107 (1)
Factor V(%)	136 (14)	239 (3)	17 sec (1)
Factor XI (%)	92 7(14)	146 (3)	24 6(1)
Factor XII (%)	0 (15)	0 (3)	3 4(1)

¹ Lewis, Bayer, and Szeto (1969).

² Robinson, Kropatkin, and Aggeler (1969).

³ Ridgway (1972).

intravascular coagulation) with resulting consequences. It is known that slow-moving acid blood has a propensity to clot faster. This property has been attributed to activation of Factor XII and subsequent clot formation.

Whales dive deeply and are not believed to suffer from decompression sickness. Perhaps the lack of Factor XII or low levels of it is nature's way of protecting the animals.

ACKNOWLEDGMENTS

The author wishes to express appreciation to H. A. Wurzel, Director,

Coagulation Laboratory, Hospital of the University of Pennsylvania, and his staff as well as to J. C. Sweeney, Naval Undersea Center, San Diego, Calif. for providing the opportunity to make this study on the gray whale.

LITERATURE CITED

- Lewis, J. H., W. L. Bayer, and J. L. F. Szeto. 1969. Coagulation factor XII deficiency in the porpoise, *Tursiops truncatus*. *Comp. Biochem. Physiol.* 31:667-670.
- Robinson, A. J., M. Kropatkin, and P. M. Aggeler. 1969. Hageman factor (factor XII) deficiency in marine mammals. *Science (Wash., D. C.)* 166:1420-1422.
- Ridgway, S. H. 1972. Homeostasis in the aquatic environment. *In* S. H. Ridgway (editor), *Mammals of the Sea*, p. 655. Charles C. Thomas, Springfield.

MFR Paper 1050. From Marine Fisheries Review, Vol. 36, No. 4, April 1974. Copies of this paper, in limited numbers, are available from D83, Technical Information Division, Environmental Science Information Center, NOAA, Washington, DC 20235.

MFR PAPER 1051

Fluorescent Karyotype of the California Gray Whale

DEBORAH A. DUFFIELD

ABSTRACT

The fluorescent karyotype of the California gray whale, Eschrichtius robustus, is presented and the use of the fluorescent banding technique for distinguishing between various cetacean karyotypes is discussed.

The California gray whale, *Eschrichtius robustus* (Gibbosus) has a diploid chromosome number of 44

(Benirschke's unpublished data cited in Kulu, 1972; Arnason, 1972). Since reporting of the gray whale karyotype,

W. Medway is associated with the Department of Clinical Studies, School of Veterinary Medicine, University of Pennsylvania, Philadelphia, PA 19104.



Figure 1.—Karyotype of the California gray whale, Gigi. The autosomes are arranged into four groups based on centromere position and relative size. The provisional X chromosomes are indicated.

prepared by standard homogeneous staining techniques, advances in the differential staining of chromosomes have added another dimension to karyotypic analysis by making it now possible to individually characterize each chromosome of the complement. Consequently, and as part of a larger cytotaxonomic study of marine mammals, evaluation of the gray whale karyotype by quinaerine mustard fluorescent banding was undertaken on Gigi, a captive female gray whale.

MATERIALS AND METHODS

Chromosome preparations were obtained by blood culture (Kulu, Veomett, and Sparkes, 1971). Exposure of the cells to 0.075 M KCl for 8 minutes was the preferred hypotonic treatment and cold, rather than flame-dried, slides were made. The slides were stained with Giemsa for normal karyotyping or with quinaerine mustard (50 micrograms/ml buffer for 30-40 minutes) for fluorescent karyotyping. Photographs of fluorescent metaphases were taken on Kodak¹ Tri-X film with an exposure time of 45-50 seconds. Ten Giemsa and eight fluorescent karyotypes were analyzed.

¹ Use of trade names in this publication does not imply endorsement of commercial products by the National Marine Fisheries Service

RESULTS

Gigi's karyotype (Giemsa) is illustrated in Figure 1. The autosomes are provisionally arranged into four groups (designated A, B, C, and D). Group A is composed of five pairs of large submetacentric chromosomes, Group B of five pairs of medium-sized submetacentric chromosomes, Group C of six pairs of metacentrics, and Group D of five pairs of acrocentric chromosomes. Within each group the chromosome pairs are arranged by decreasing size. The presumptive X chromosomes are indicated in the karyotype.

The fluorescent karyotype of *Eschrichtius robustus* is presented in Figure 2. The arrangement of the chromosomes follows that of the standard karyotype. The banding pattern of each chromosome pair is distinctive and in addition to allowing positive identification of the homologues makes it possible to characterize each pair of the complement in order to facilitate karyotypic comparison with other species. The fluorescent banding pattern of the presumptive X chromo-

Deborah A. Duffield is with the Department of Biology at the University of California at Los Angeles, Los Angeles, CA 90024.

some is the same as that exhibited by the X chromosome of another of the baleen whales, the sei whale, *Balaenoptera borealis*², and a number of the smaller odontocete cetacean species (personal observation).

DISCUSSION

The karyotype of the California gray whale appears to be very similar in number and gross morphology to that of a number of other cetaceans, both mysticete and odontocete³ (Kulu, 1972; Arnason, 1972). The fluorescent karyotype of the gray whale was examined in the hope that the resolution of chromosome structure afforded by fluorescent banding would indicate differences between its karyotype and that of other cetaceans not obvious by regular staining methods. In order to illustrate the level of karyotypic comparison made possible by fluorescent banding, the larger submetacentrics which comprise Group A (pairs 1-5) in two mysticete and two odontocete species are shown in Figure 3. While there are certain similarities between the banding patterns of all four species, it is clearly possible to distinguish between the overall banding pattern of the mysticete (gray whale, sei whale) chromosomes and that of the odontocetes (*Tursiops truncatus*, *Lagenorhynchus obliquidens*). Less obvious differences are also present which further distinguish gray whale from sei whale and *Tursiops* from *Lagenorhynchus*. A detailed comparison of the fluorescent karyotypes of these cetaceans is beyond the scope of this report; however, it can be concluded

² Arnason (1972) has reported that the X chromosome of *B. borealis* is one of the larger chromosomes of the complement, such as found in other of the balaenopteran whales. However, both standard and fluorescent karyotypes of a male sei whale, tissue from which was made available to this author by the Richmond whaling station in California, indicate that the X chromosome of *B. borealis* is of medium size and similar both in relative size and banding pattern to the provisional X chromosome of the odontocetes (Kulu, 1972).

³ Of all cetaceans studied to date, only the sperm, pigmy sperm, and killer whales are karyotypically distinct by standard staining techniques



Figure 2.—The fluorescent karyotype of the California gray whale. Note that the members of each pair have identical bands while one pair can be distinguished from any other by its characteristic banding pattern.

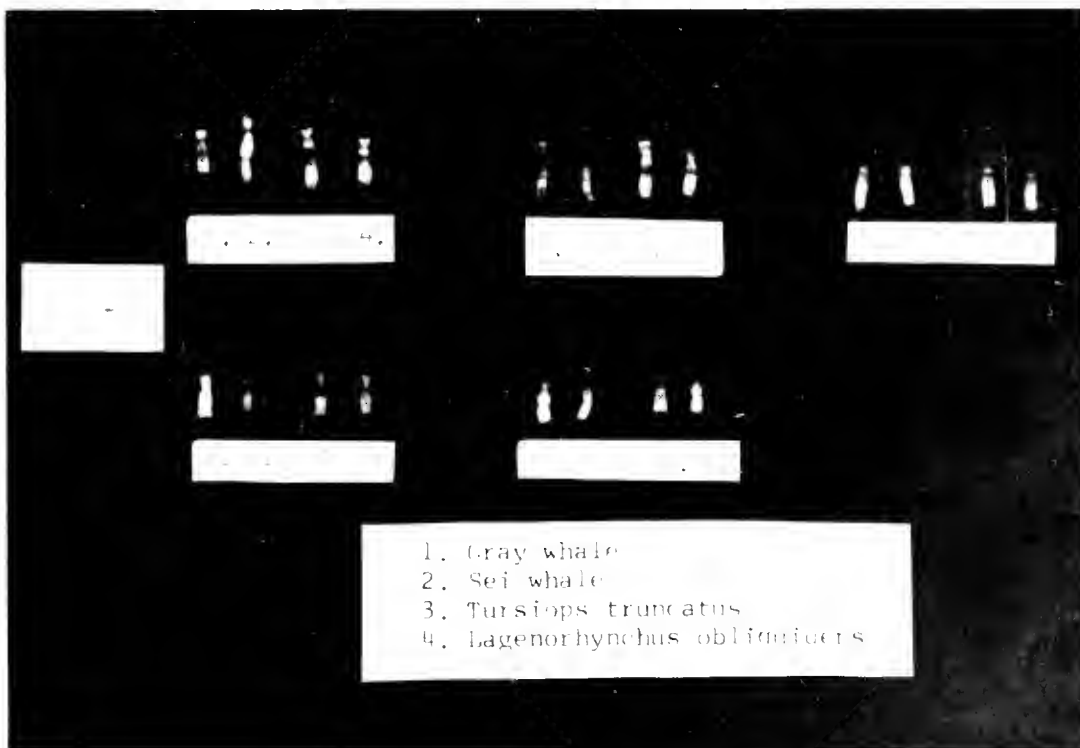

Figure 3.—Comparison of the banding patterns of four species. Only group A chromosomes are shown and only one chromosome from each pair per species. Species 1 and 2 are mysticetes, 3 and 4 are odontocetes.

from these initial observations that the comparison of fluorescent banded karyotypes will significantly enhance the potential contribution which karyotypic analyses can make to the resolution of the phyletic interrelationships of the modern Cetacea.

ACKNOWLEDGMENTS

My thanks to Sea World and Jay Sweeney of the Naval Undersea Cen-

ter, San Diego, Calif. for making the gray whale samples available to me. The fluorescent technique followed in the preparation of the karyotypes is that of Helga Muller, UCLA Medical Genetics Unit, Los Angeles, California. This work was supported by a Mental Retardation Training Grant from the Departments of Psychiatry and Medicine, UCLA Medical School, Los Angeles, California.

LITERATURE CITED

- Arnason, U. 1972. The role of chromosomal rearrangement in mammalian speciation with special reference to Cetacea and Pinnipedia. *Hereditas* 70: 113-118.
- Kulu, D. D. 1972. Evolution and cytogenetics. In S. H. Ridgway (editor), *Mammals of the sea. Biology and medicine*, p. 503-527. Charles C. Thomas, Springfield.
- Kulu, D. D., I. Veomett, and R. S. Sparkes. 1971. Cytogenetic comparison of four species of cetaceans. *J. Mammal.* 52: 828-832.

MFR Paper 1051. From Marine Fisheries Review, Vol. 36, No. 4, April 1974. Copies of this paper, in limited numbers, are available from D83, Technical Information Division, Environmental Science Information Center, NOAA, Washington, DC 20235.

MFR PAPER 1052

Some Physiological Parameters of the Blood of the California Gray Whale

WILLIAM G. GILMARTIN, RICHARD W. PIERCE,
and GEORGE A. ANTONELIS, JR.

ABSTRACT

Hematocrit, a O₂-Hb dissociation curve, and blood volume have been determined for a California gray whale, Eschrichtius robustus, and the results are compared to some physiological blood properties of other cetaceans. The E. robustus has a blood volume that is similar to values estimated for large whales by other authors. This is the first time isotopic techniques have been used to determine a large cetacean's blood volume.

Large cetaceans do not appear to follow the trend of most terrestrial mammals when the body size and P₅₀ are compared. The P₅₀ for the E. robustus was 36.5 mm Hg and is the highest reported for any cetacean.

The determination of the physiological properties of the blood of large cetaceans has been confined primarily to animals that are stranded or have been dead for many hours before blood samples can be drawn. Lentant (1969) has summarized most of the data available on marine mammals. The capture and maintenance of Gigi, a California gray whale, *Eschrichtius robustus*, has given us the

opportunity, for the first time, to study a large cetacean under definable conditions and to determine its blood volume and oxygen-hemoglobin dissociation curves.

METHODS

On two separate occasions the whale was given 10 μ Ci of radioiodin-

Both William G. Gilmartin and George A. Antonelis, Jr. are with the Naval Undersea Center Bio-Systems Program, San Diego, CA 92132. Richard W. Pierce is with the Coastal Marine Laboratory, Division of Natural Science, University of California, Santa Cruz, CA 95060.

ated human serum albumin (Risa)¹. The labeled compound was administered to the animal in one of the brachial vessels in the right pectoral fin. Two blood specimens were taken following each determination to insure that mixing was complete and the albumin was not being eliminated rapidly from the serum. In the first test (27 December 1971) blood volume determination samples were taken at 14 and 20 minute intervals and in the second test (6 March 1972) were collected at 10 and 18 minute intervals after administration of the labeled compound. The blood samples removed for counting were taken from one of the brachial vessels of the left pectoral fin and put into well-heparinized tubes. Three ml of the heparinized whole blood was added to 3 ml of 1

¹ Abbott Laboratories, Chicago, Illinois. Use of trade names in this publication does not imply endorsement of commercial products by the National Marine Fisheries Service.

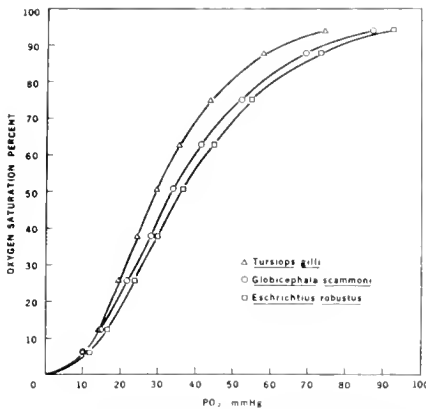

Figure 1.—Oxyhemoglobin dissociation curves for three cetaceans (*T. gilli*, *G. scammoni*, *E. robustus*). All curves have been corrected for pH = 7.4 and determined at 37°C.

percent acetic acid to lyse the red cells to permit counting of a uniform suspension without the problems associated with cells settling while being counted. A standard solution was prepared by adding a fraction of a milliliter of the same solution injected into the animal to saline in a total volume of 1 liter. The standard was prepared for counting by the same procedure as the blood specimens.

All samples were counted for 100 minutes in a 3-inch well TII crystal attached to a Packard Model 2001 Spectrometer Scaler-timer. Counts of the paired blood specimens were very close, within 5 percent in December and 3 percent in March. The reported blood volumes are the mean values of the respective paired samples. The oxyhemoglobin dissociation curve was determined on 21 January 1972. A 20 ml blood sample was secured from a puncture of a distal brachial vein the the pectoral fin. The blood was immediately placed into well-heparinized (250 units heparin per 10 ml blood) plastic test tubes, inverted 4 or 5 times, and then placed in an ice bath.

Less than 4 hours after collection the dissociation curve was completed by a Dissociation Curve Analyzer (DCA-1, Radiometer, Copenhagen). Duvelleroy et al. (1970) have explained in detail the methodology involved in the operation and construc-

tion of the O₂-Hb dissociation curves by the DCA-1. Slight changes in pH were monitored for every point on the dissociation curve. Because P_{O₂} changes with pH variation, corrections were made to a pH of 7.4 with the equation

$$\frac{\Delta \log P_{O_2}}{\Delta \text{pH}} = \text{Bohr effect.}$$

The value for the Bohr effect was obtained from Lenfant (1969).

The hematocrit (Hct) was obtained in the usual manner. A Clay-Adams Autocrit Centrifuge was the instrument used.

RESULTS

The hematocrit, blood volume, and P₅₀ of the *E. robustus* as well as certain physiological blood parameters of other cetaceans are presented in Table 1. The blood volume was determined on two occasions and the oxygen binding capacity was determined with one blood sample. Typical sigmoid O₂-Hb dissociation curves are shown in Figure 1. Curves for two other cetaceans, *Globicephala scammoni* and *Tursiops gilli*, determined by the same methods (Antonelis, 1972)² are included.

DISCUSSION

The hematocrit of Gigi is not unlike that measured in other mammals. While Lenfant (1969) asserts that this is true for all marine mammals, Ridgway and Johnston (1966), Horvath et al. (1968), and Ridgway et al. (1970), have demonstrated an increased packed cell volume in some of the small cetacea. Lenfant (1969) attributes such results to differences in technique or in physical condition. However, the animals who showed high hematocrits were maintained in captivity. Had they followed the normal pat-

tern of captive animals, the values would have been even higher if sampled in their natural environment. It has been amply demonstrated that animals brought into a captive situation soon show a reduction in both hematocrit and hemoglobin content (Gilmartin and Ridgway, 1969,³ Lenfant, 1969).

The first blood volume for a large cetacean using isotopic methods is reported. Although ¹³¹I labeled human serum albumin was used in the analysis, the similarity of the paired blood specimens taken at each test date indicates not only that mixing was complete, but also that this foreign protein was not being eliminated so rapidly that a meaningful blood volume determination could not be made. Unpublished data on the killer whale are included also. Both animals have blood volumes (*E. robustus*: 6.1 and 8.1 percent; *O. orca*: 8.2 percent) within the range reported for other species of large cetaceans; Laurie (1933) reported a large blue whale's blood volume as 6.6 percent. Smith and Pace (1971) estimate that the blood and body fluids of large cetaceans to be between 10 and 15 percent of the body mass.

Lawson (1962) and Sjöstrand (1953, 1962) have reviewed the many factors which affect blood volume and one should be aware of them when evaluating blood volume data. Since the animal is placed under highly stressful conditions as well as the imposition of unaccustomed gravitational forces as a result of removal from the water, the picture for marine mammals is complicated.

Nutrition and electrolyte balance also affect blood volume. To our knowledge neither the freezing point depression nor the osmolality of the urine were determined. Osmolality can be calculated, however, using the formulas of Wolf (1958). Gigi's exclusive squid diet must have produced a urine whose minimum osmotic con-

² Antonelis, G. A. 1972. O₂-Hb dissociation curves of the pilot whale, *Globicephala scammoni*, and Pacific bottlenose porpoise, *Tursiops gilli*. (Unpubl. manuscr.)

³ Gilmartin, W. G., and S. H. Ridgway. 1969. Some physiological properties of the blood of the killer whale, *Orcinus orca*. (Unpubl. manuscr.)

Table 1.—Some physiological properties of the blood of cetaceans.

Species	Sex and reference	Body weight (kg)	Hemato- crit (%)	Hemo- globin (g/100 ml)	Mean cell Hb content (%)	Derived O ₂ capacity (ml/100 ml)(8)	Derived O ₂ capacity (ml/kg)	Blood volume (ml/kg)	Measured P ₅₀ (mm Hg)	Calculated P ₅₀ (mm Hg)(9)	Bohr effect
Gray Whale <i>Eschrichtius robustus</i>	Immature ♀	(6) 4.409	40.0	14.1	30.5	19.2	1,553	61	36.5	21.8	
	Adult	(7) 5.364	42.6	12.8	33.3	17.4		81	30.0		0.456
	Fetus	(2)	44.6	13.9	32.1		18.9		19.0		0.538
Pilot whale <i>Globicephala scammoni</i>	Immature ♀	(1)	39.7	15.1	38.0	20.5			34.0		0.622
	(2)								31.2		
Killer whale <i>Orcinus orca</i>	Immature ♂	(5)	48.0	17.8	37.0	24.2	1,985	82	30.7	22.7	0.738
	(2)	2.525	43.9	16.0	36.4	22.5					
Sperm whale <i>Physeter catodon</i>	(2)		42.0	14.7	35.0	20.0			26.5		0.478
	(1)										
Pacific bottlenosed dolphin <i>Tursiops truncatus gilli</i>	(1)		50.5	18.2	36.0	24.8			29.8		0.712
	(2)								26.0		
Atlantic bottlenosed dolphin <i>Tursiops truncatus</i>	(2)		43.0	15.9	37.0	21.6			26.8		0.664
	(3)		45.0	14.4	32.0	19.6	1,390	71	24.6	26.4	
	(4)	(10) 159	41.7								
	(4)	(10) 43	46.7						21.6	28.3	
Common dolphin <i>Delphinus delphis</i>	(2)		51.2	18.7	36.5	25.4			24.8		0.717
	(3)		53.0	17.0	32.0	23.1	2,497	108	20.2	27.2	
	(4)	(10) 88	48.9								
	(3)		57.0	20.3	35.6	27.6	3,948	143	19.1	26.6	
Dall porpoise <i>Phocoenoides dalli</i>	(4)	(10) 133	53.6								
	(1) Antonellis (1972)										
(2) Lentant (1970)											
(3) Ridgway and Johnston (1966)											
(4) Horvath, et al. (1968)											
(5) Gilmarin and Ridgway (1969)											
(6) Weight on 12/28/71											
(7) Weight on 3/6/72											
(8) Derived by Hb concentration × 1.36 Bernhart and Skeggs (1943)											
(9) Calculated by P ₅₀ = 50.34W ^{-0.054} Schmidt-Neilsen											
(10) Average											

centration was 1,670 milliOsmols/liter. The effect of such a diet, which is isoosmotic with sea water, is unknown.

The P_{50} , the partial pressure (mm Hg) of oxygen at which hemoglobin is 50 percent saturated, is a measure of the blood's affinity for oxygen—the higher the P_{50} , the lower the affinity. The P_{50} for Gigi was 36.5 mm Hg and is the highest reported for any cetacean. In a list of fifty mammalian species in which the P_{50} has been determined, only four animals exhibited a higher P_{50} (Bartels, 1971).

Horvath et al. (1968) compared the dissociation curves of several small cetacea and found that a shift to the left, or increased affinity for oxygen, relates to individual species behavior and feeding habits. Apparently this pattern does not hold for the larger cetaceans.

In looking at such parameters as hematocrit, oxygen capacity, and particularly the P_{50} , a pattern emerges and one is tempted to ascribe this to some behavioral characteristic of the animal. However, one should proceed with caution.

Oxygen dissociation curves are determined by several methods. The method used by Horvath et al. (1968) was to treat the blood with varying levels of oxygen and sufficient CO₂ to maintain a pH of 7.4. Lenfant (1969) and Schmidt-Neilsen and Larimer (1958) maintained a P_{CO_2} of 40 mm Hg in determination of their curves. Schmidt-Neilsen and Larimer (1958) observed that in terrestrial animals the blood of the larger animals has the higher affinity for oxygen (low P_{50}). Lenfant (1969) pointed out that this does not hold for marine mammals and the calculated P_{50} 's using their formula supports this.

Steen (1971) has pointed out that a P_{CO_2} of 40 mm Hg may not represent the true arterial P_{CO_2} of the animal, e.g., a cat is about 28 mm Hg. Since the P_{CO_2} has a profound effect on the P_{50} and the magnitude of the Bohr shift, one is hard put to make meaningful comparisons in marine

mammals when different methods are used. To complicate the picture further, Riggs (1960), using a buffered system at a pH of 7.4, observed that animals of varying size had identical P_{50} 's at that pH.

In order to make meaningful evaluations of the dissociation curves in marine mammals, the *in vivo* P_{CO_2} and pH need to be determined. Rieu and Hamar (1968) point out the difficulties of drawing a representative arterial blood sample although these arterial data have been collected from one species, *Tursiops truncatus*, by Ridgway (1968). In short, more work needs to be done.

ACKNOWLEDGMENTS

We thank K. Suwa and E. Wahrenbrock of the Anesthesia Department, University Hospital, San Diego, California, for making the Dissociation Curve Analyzer available for our use, and the staff of Sea World for their cooperation.

This study was supported in parts by grants from the Oceanography Section of the National Science Foundation (Grant #GA-31297) and the Bureau of Medicine (Project #MF-12524014).

LITERATURE CITED

- Bartels, H. 1971. Blood oxygen dissociation curves: mammals. *In* P. L. Altman and D. S. Dittmer (editors), *Respiration and circulation*, p. 196-197. Biological Handbook, Fed. Am. Soc. Exp. Biol., Bethesda.
- Bernhart, F. W., and L. Skeggs. 1943. The iron content of crystalline human hemoglobin. *J. Biol. Chem.* 147:19-22.
- Duvelleroy, M. A., R. G. Buckles, S. Rosenkaimer, C. Tung, and M. B. Laver. 1970. An oxyhemoglobin dissociation analyzer. *J. Appl. Physiol.* 28:227-233.
- Horvath, S. M., H. Chiodi, S. H. Ridgway, and S. Azar, Jr. 1968. Respiratory and electrophoretic characteristics of hemoglobin of porpoises and sea lion. *Comp. Biochem. Physiol.* 24:1027-1033.
- Laurie, A. H. 1933. Some aspects of respiration in blue and fin whales. *Discovery Rep.* 7:363-406.
- Lawson, H. C. 1962. The volume of blood—a critical examination of methods for its measurement. *In* W. F. Hamilton (editor), *Handbook of physiology, Circulation, Sect. 2, Vol. 1*, p. 23-49. Am. Physiol. Soc., Wash., D.C.
- Lenfant, C. 1969. Physiological properties of blood. *In* H. T. Andersen (editor), *The biology of marine mammals*, p. 95-116. Academic Press, New York.

- Ridgway, S. H. 1968. The bottlenose dolphin in biomedical research. *In* W. I. Gay (editor), *Methods of animal experimentation*, Vol. 3, p. 387-446. Academic Press, New York.
- Ridgway, S. H., and D. G. Johnston. 1966. Blood oxygen and ecology of porpoises of three genera. *Science (Wash., D.C.)* 151:456-458.
- Ridgway, S. H., J. G. Simpson, G. S. Patton, and W. G. Gilmartin. 1970. Hematologic findings in certain small cetaceans. *J. Am. Vet. Med. Assoc.* 157:566-575.
- Rieu, M., and M. Hamar. 1968. Preliminary results concerning the gas of arterial and venous blood in *Delphinus delphis* and *Stenella styx*. Report for ONR, Contract NF610527 00063.
- Riggs, A. 1960. The nature and significance of the Bohr effect in mammalian hemoglobins. *J. Gen. Physiol.* 43:737-752.
- Schmidt-Neilsen, K., and J. L. Larmer. 1958. Oxygen dissociation curves of mammalian blood in relation to body size. *Am. J. Physiol.* 195:424-428.
- Sjostrand, T. 1953. Volume and distribution of blood and their significance in regulating the circulation. *Physiol. Rev.* 33:202-228.
- . 1962. Blood volume. *In* W. F. Hamilton (editor), *Handbook of physiology, Circulation, Sect. 2, Vol. 1*, p. 51-62. Am. Physiol. Soc., Wash., D.C.
- Smith, A. H., and N. Pace. 1971. Differential component and organ size relationships among whales. *Environ. Physiol.* 1:122-136.
- Steen, J. B. 1971. Comparative physiology of respiratory mechanisms. Academic Press, Lond., p. 109-112.
- Wolf, A. V. 1958. Thirst - physiology of the urge to drink and problems of water lack. Charles C. Thomas, Springfield, p. 344-355.

MFR Paper 1052. From Marine Fisheries Review, Vol. 36, No. 4, April 1974. Copies of this paper, in limited numbers, are available from D83, Technical Information Division, Environmental Science Information Center, NOAA, Washington, DC 20235.

MFR PAPER 1053

Feeding of a Captive Gray Whale, *Eschrichtius robustus*

G. CARLETON RAY and WILLIAM E. SCHEVILL

ABSTRACT

The feeding of a captive yearling female Eschrichtius robustus was observed while diving with her as well as from the surface. She sucked food off the bottom while swimming tipped over about 120° so that her cheek was nearly parallel to the bottom. An increase in mouth volume is apparently caused by action of the tongue, resulting in strong suction, during which the lower lip is opened and food enters the mouth. How food is separated from water and mud or detritus is not known. The observed behavior is probably natural and illuminates earlier records of stomach contents, external markings, and asymmetrical baleen. Clearly, much needs to be learned about the mechanism of feeding of baleen whales. This species' feeding habits may be unique among them.

INTRODUCTION

Observations on the food of *Eschrichtius robustus* (Lilljeborg, 1861), the gray whale, have been summarized by Zimushko and Lenskaya (1970) and Rice and Wolman (1971), indicating that the diet consists predom-

inantly of benthic animals, mostly amphipods and a few other crustaceans; incidental items include polychaete worm tubes, shells, gastropod opercula, feathers, kelp, bits of wood, sand, mud, and gravel. Tomilin (1957, p. 346-347) suggests that *Eschrichtius*



Figure 1.—*Eschrichtius robustus* calf, Gigi, in Sea World tank, tilted to her right, with water (and some squid near rear end) pouring into her mouth. One block of frozen squid is over the forward end of her mouth. Note open blowholes. Photograph by W. E. Schevill.

G. Carleton Ray is with The Johns Hopkins University, Baltimore, MD 21205. His work was partly supported by contracts to the University from the Office of Naval Research (Oceanic Biology), contract Nonr N00014-67-A-0163-0010 03. William E. Schevill is with the Museum of Comparative Zoology, Harvard University, and the Woods Hole Oceanographic Institution, Woods Hole, MA 02543. This is Contribution No. 3069 from the Woods Hole Oceanographic Institution. His work was partly supported by the Office of Naval Research (Oceanic Biology), contract Nonr N00014-66-0241.

is to some extent vegetarian (which would make it a most exceptional cetacean), supposing that seaweed found in the stomach is food and not merely incidentally swallowed. Howell and Huey (1930) found the planktonic *Euphausia pacifica* in the baleen of a gray whale taken off northern California on 21 July 1926. Gilmore (1961, p. 11) gives a winter observation of presumed feeding by gray whales, "criss-crossing thru a dense school of small fish, like anchovies, off San Diego," and Ken Balcomb (pers. comm.) informs us that a gray whale beached 15 miles north of Grays Harbor, Wash., in April, had a gullet packed with several gallons of *Osmerus mordax* (rainbow smelt). It would appear that *Eschrichtius* is not limited to eating small benthic crustaceans, but will also eat a variety of other food as opportunity offers.

Gray whales seem to do most of their feeding in the Bering and Chukchi Seas (Pike, 1962, p. 831-832). Rice and Wolman (1971, p. 24-25) conclude that all organisms found in the stomachs of gray whales killed on the Arctic summer grounds are "infaunal benthic species." They state that 95 percent of the food species found in one Bering Sea sample were gammaridean amphipods 6 to 25 mm long, and that the predominant species from this sample, *Ampelisca macrocephala*, "occurs mainly on

sandy bottoms at depths of 5 to 300 meters" (italics ours). Zimushko and Lenskaya (1970) say that gray whales feed on nectobenthos, some 70 species in all, but that only six species of amphipods are of primary importance. We assume that though such active creatures as amphipods may be infaunal at times, their well-known tendency, when disturbed, to move just off the bottom, would make them readily available to a sweeping whale. One of us (Ray) observed this amphipod behavior from a submersible in the Bering Sea in 1972. Nemoto (1959) has discussed probable feeding behavior of whales in the light of mouth shape and baleen characteristics. During the last century many authors have alluded to gray whales surfacing with mud visible on the beak or other dorso-lateral parts. Pike (1962, p. 823) cites a particularly illuminating communication from Dr. F. H. Fay, who mentions a gray whale supposed to be feeding in 5 fathoms: "As this whale surfaced close to the vessel, mud was seen washing from its back." Although Tomilin (1957, p. 347) supposes that these whales may actually dig their mouths into the bottom, scooping and plowing, it seems to us (see below) that their behavior and anatomy are better adapted to sweeping the bottom than for digging; this accords well with the evidence of asymmetrical barnacle infestation and baleen wear reported by Kasuya and Rice (1970).

The gray whale calf, Gigi, which was captured in March 1971 and kept by Sea World, San Diego, was initially fed an artificial diet, but was soon taught to eat full-grown squid, *Loligo opalescens*. By the time of our observations (28 January-1 February and 11 March 1972), her daily diet was 900 kg of squid, dropped frozen into her tank in 9 kg blocks, and her weight gain was almost 40 kg a day. Our behavioral observations were made both from the water's surface and by scuba-diving with Gigi. We also used underwater motion pictures made by John Seeker of Sea World

when Gigi was about 6 months old. To aid in our interpretation, we have consulted her trainers (Bud Donahoo and Susan Bailey), and we have solicited observations on Gigi and on other gray whales from several of our colleagues. To them, who are mentioned below, to the Naval Undersea Center, and to the management of Sea World, we are grateful.

BEHAVIORAL OBSERVATIONS

Before detailing our observations, we remind the reader that a gray whale's head is roughly triangular in cross section, the gular region being the base while the cheeks form the sides, sloping inwards at about 60° towards the narrow beak-like upper jaw. The curved mouth is at about the middle of the cheeks. The mouth has effectively only lower lips; the upper lips are represented by the rabbit-like recess above the gum line into which the lower lips fit snugly.

In the course of teaching Gigi to eat squid, trainers Donahoo and Bailey taught her to relax the edge of the left lower lip and turn it outward in response to light taps on the head. Food was placed by hand in the opening thus created, passing into the throat either through or under the baleen. This was in contrast to the feeding of the artificial liquid diet, when the jaws were opened while accepting the feeding tube; during the hand-feeding of squid, the jaws remained closed and the lip was opened, as was also the case later on when one of us thrust an arm down her pharynx. Training Gigi to move her lip voluntarily was critical, for normally the lip was held so tightly shut that a man could not forcibly pry it open. This training was done while she was grounded in the tank almost empty of water; it was not long before she would thus accept food while swimming. Soon thereafter she was feeding freely without the aid of her trainers. Gigi was always fed from the left side (Donahoo has mentioned having been



Figure 2 —Gigi, tilted to her right, jetting water upward as she makes noisy pulses while nibbling at a block of frozen squid (near end of mouth). Photograph by W. E. Schevill.



Figure 3.—*Eschrichtius robustus* calf, Gigi, in Sea World tank, tilted on her left side (top of head toward viewer), sweeping over bottom in general direction of arrow. Note open right lip and shut jaws. Photograph by G. C. Ray.



Figure 4.—Gigi, tilted on her left side (throat toward viewer), sweeping over the bottom of her tank in the direction of the arrow. Note expanded gular region indicated by the gular grooves. Photograph by G. C. Ray.

a horseman before becoming acquainted with whales), which may account for the left-sided sweeping behavior described below; Kasuya and Rice (1970) reported that of 34 gray whales that they investigated, 31 were right-sided.

We observed that the edges of the lips could be turned out and down through about 60°, either one or both sides at a time. Motion pictures further show a fluttering of the posterior part of this edge during hand-feeding, especially near the major flexure.

Voluntary feeding was as follows: The frozen blocks of squid floated at the surface and, as they thawed, the squid mostly sank slowly to the bottom. Gigi often "nibbled" at the thawing corners of the blocks, using the left side of her mouth and usually, but not always, holding the block at about the place where the fluttering had been noted. The nibbling was occasionally accompanied by a noisy pulsation called "earthquaking" by the trainers, and splashing or jetting of water and air for nearly half a meter (Figures 1 and 2). The jet was usually at this same place near the after end of the mouth, but it sometimes ran nearly the entire length of the baleen (not quite to the forward end of the mouth). Often the jetting was on both sides of the mouth. When Gigi's mouth was at the surface, air was involved in the jetting, but not always when her mouth was completely submerged, and not at all when she was on the bottom of the tank. We assume that this air was adventitiously taken in, as in eating soup.

After most of the squid had fallen to the bottom of the tank, Gigi's behavior altered markedly. As she approached them, she would roll over toward her back some 120°, so that her cheek was nearly parallel to the bottom and about 10-20 cm above it. As she swam over the squid, she left a clean swath 30-50 cm wide. It was apparent that the squid were being sucked up in a sort of pulsation, as some squid briefly reappeared after

their first disappearance into her mouth. It is presumed that she could easily see the squid lying in her path. In the cylindrical tank she described a track slightly dorsad of straight ahead, so that she swept over the squid at about a 30° angle to the mouth (Figures 3 and 4). Then three separate actions were seen: (1) an opening of the edge of the mid to posterior part of the left lip so as to fold it away from the baleen, (2) a swelling of the gular region and expansion of the gular grooves (Figure 4), and (3) an opening of the right side of the mouth, during which squid were sometimes jetted out. The third item may merely mean that it is easier to open both sides of the mouth symmetrically, though Gigi had showed us that she could flex her lips one side at a time. Since we could not see all these parts of the whale at once, we can only infer the presumable sequence of these related events. Then Gigi righted herself and swam away; sometimes turbid jets could be seen pulsing from both sides of her mouth.

ANATOMICAL INTERPRETATION

Our understanding of the mechanisms involved is hampered by our ignorance of the myology and other soft anatomy of this species. We have been able to find only osteological anatomical descriptions and have had no carcass available for even rough dissection. W. C. Cummings and J. Sweeney made, on our account, some exploratory sections of the lower lips of dead neonates found on the beaches of Laguna Ojo de Liebre, Baja California, and found them to be well muscled. D. W. Rice reminds us that the tongue is also well muscled, much more so than in *Balaenoptera*; it is well figured and described by Andrews (1914, p. 254, pl. 21, fig. 4, and pl. 22, fig. 6).

All this, as well as observations of behavior, strongly indicates that the gray whale's oral anatomy is adapted for suction and that motion of the

lips is voluntary. We had but limited opportunity to manipulate Gigi's mouth ourselves; one of us (Schevill) had his arm in her mouth several times while she was "earthquaking" and could feel no motion at all of the tongue and only a slight agitation near the larynx. But W. E. Evans (in litt.) states that "the tongue cannot be pulled back and forth very easily; however, it can be raised high, displacing a reasonably good percentage of the volume of the mouth cavity". Donahoo had his hand in Gigi's mouth repeatedly; both he and Evans have emphasized the tongue's strength and mobility. Donahoo asserts that it moves so as virtually to vacate the oral cavity and that this involves a shape change. He further asserts that the shape change travels rearward and that this movement of the "ball" of the tongue can be seen from outside, as the gular grooves expand. This posteriorly moving expansion of the gular region was also seen by one of us (Ray) underwater. Further, Donahoo said that as the tongue moves back, a strong inflow appears at the out-folded lip. He added that Gigi's feeding was not simply accepting, but quite selective. When presented a mixture of squid, "Pacific mackerel" (chub mackerel, *Scomber japonicus*), and "whitebait" (probably jacksmelt, *Atherinopsis californiensis*, or top-smelt, *Atherinops affinis*), all three were sucked from the bottom, but only squid were retained, the others being rejected.

CONCLUSIONS

Nothing benthic of the size of squid has been reported in the diet of *Eschrichtius*, so we should be cautious in interpreting this captive's feeding style as indicative of natural behavior of the species, bearing in mind that Gigi was completely isolated from her kind throughout captivity. Nevertheless, her bottom-sweeping habit we suppose may be natural, since it appears appropriate for catching the animals that comprise the recorded

natural food of this species of whale. Our captive's habit of sweeping a few centimeters off the smooth tank bottom does not deny the probability that sweeping a soft or irregular bottom at sea could get mud on the sweeper's back (cf. Fay in Pike, 1962, p. 823), especially if the prey is actually benthic.

Cetological literature is full of poorly supported conjecture, and we hesitate to add more. Although we have learned a number of things from the captive Gigi, there is still much unknown. For one thing, her jetting water in pulses from a particular restricted part of her mouth seems to imply, perhaps, a special activity of the tongue. Furthermore, we do not understand the mechanics of the hydraulics that bring the food-bearing water into the mouth. This is no mystery in whales that swim along with the mouth wide open, but it is not so obvious in a whale which swims along rather slowly with only a narrow slit open, as did our *Eschrichtius*. Here it seems necessary to increase the volume of the mouth to cause useful inflow of water. We are handicapped by our imperfect understanding of the functions of the muscular tongue. W. E. Evans (pers. comm.) has told us that Gigi's tongue once pressed his hand painfully hard against her palate. Such pressure might serve to push the gular region downward, enlarging the mouth cavity, and this idea fits with the observations of Donahoo and Ray of the migrating tongue-bulge visible from beneath.

Thus we suppose, from the assorted evidence, the following concatenation of events in feeding: First the whale rolls over far enough so that the cheek is about parallel with the bottom, and the lip is opened as the tongue, pressing against the palate, pushes the gular region away so that it expands, producing an inflow which brings in the epibenthic food. Then the tongue relaxes and the gular musculature tightens, reducing the size of the mouth cavity and expelling water; the food is trapped in the baleen

fringes. We do not know exactly what happens next; perhaps a slight renewed suction of water removes the food from the baleen fringes, and swallowing presumably follows.

LITERATURE CITED

- Andrews, R. C. 1914. Monographs of the Pacific cetacea. I. The California gray whale (*Rhachiumectes glaucus* Cope). Mem. Am. Mus. Nat. Hist. (New Series) 1:227-287.
- Gilmore, R. M. 1961. The story of the gray whale, 2nd ed. Privately published, San Diego, 17 p.
- Howell, A. B., and L. M. Huey. 1930. Food of the gray and other whales. J. Mammal. 11:321-322.
- Kasuya, T., and D. W. Rice. 1970. Notes on baleen plates and on arrangement of

- parasitic barnacles of gray whale. Sci. Rep. Whales Res. Inst. 22:39-43.
- Nemoto, T. 1959. Food of baleen whales with reference to whale movements. Sci. Rep. Whales Res. Inst. 14:149-290.
- Pike, G. C. 1962. Migration and feeding of the gray whale (*Eschrichtius gibbosus*). J. Fish. Res. Board Can. 19:815-838.
- Rice, D. W., and A. A. Wolman. 1971. The life history and ecology of the gray whale (*Eschrichtius robustus*). Am. Soc. Mammal., Spec. Publ. No. 3, 142 p., 18 tables, 38 text figs.
- Tomilin, A. G. 1957. Kitoobraznye Zveri SSSR i prilozhashchikh stran (Cetacea, Mammals of the USSR and adjacent countries.) 9, 756 p. (Engl. transl. Smithsonian, 1967, 9, 717 p.)
- Zamushko, V. V., and S. A. Lenskaya. 1970. O pitanii serogo kita (*Eschrichtius gibbosus* Erx.) na mestakh nagula (Feeding of the gray whale (*Eschrichtius gibbosus* Erx.) at foraging grounds). Ekologiya Akad. Nauk SSSR 1(3):26-35. (Engl. transl. Consultants Bureau, Plenum Publ. Corp., 1971, Ekologiya 1(3):205-212.)

MFR Paper 1053. From Marine Fisheries Review, Vol. 36, No. 4, April 1974. Copies of this paper, in limited numbers, are available from D83, Technical Information Division, Environmental Science Information Center, NOAA, Washington, DC 20235.

MFR PAPER 1054

Sounds Produced by the Gray Whale, *Eschrichtius robustus*

JAMES F. FISH, JAMES L. SUMICH, and GEORGE L. LINGLE

ABSTRACT

Underwater sounds produced by a young captive gray whale are described. A "metallic-sounding pulsed signal," consisting of 8 to 14 pulses in bursts lasting up to 2 sec was the most common vocalization. Other sounds included a low-frequency "growl" or "moan," similar to a sound recorded from gray whales at sea; a short, broadband, "gruntlike" sound; a low-pitched "blowhole rumble"; and a long "metallic-sounding pulse train" that merged into a low-frequency "groan." The sounds could not be correlated with specific behaviors. Also described are "clicks" recorded in the presence of the whale when she was returned to sea and similar "clicks" recorded from gray whales in Wickaninnish Bay, Vancouver Island, Canada.

This report describes a variety of sounds recorded from Gigi, a young gray whale, *Eschrichtius robustus*, while she was in captivity at Sea World, a marine park in San Diego, Calif., and sounds recorded in the

vicinity of the whale when she was returned to the ocean nearly a year later. Also described are the sounds recorded in the presence of gray whales in Wickaninnish Bay, Vancouver Island, Canada.

Table 1.—Summary of previously published data on gray whale sounds.

Reference	Signal type	Duration (sec)	Frequency (Hz)	Pulses per burst	Pulse Repetition rate (per sec)	Pulse duration (msec)	Peak energy (Hz)
Eberhardt & Evans, 1962	"Croaker-like grunts"		40-700				80-300
	"Low-frequency rumbles"		40-700				80-300
Painter, 1963	"Pulses" "Low-pitched grunting"			4-6 4-9 pulses per grunt	Approx 33	100 11	
¹ Wenz, 1964	"Clicks"		<200- >3,000		10		
Rasmussen & Head, 1965	No sounds						
² Gales, 1966	"Clicks"		<200- >3,000		10		
Hubbs, 1966	No sounds						
Asa-Dorian & Perkins, 1967	"Echolocation-like pulses" "Variable whistles"		70-3,000	5-22	3-7	1-15	400-800
Cummings et al., 1968	"Moans"	1.5	20-200				
	"Underwater blow"	Approx 1	15-175				<100
	"Bubble-type sounds"	0.7	15-305				
	"Knocks"		to 350				
Poulter, 1968	"Croak-like grunts"						
	"Rumbles"						
	"Cries"						
	"Grunting"						
	"Rasping"	1 to several					
	"Pulses"				5-18		
	"Chirps"	2-5			8		
	"Bong" "Clicks"			to 12,000	3-5		

^{1,2} Both references show data on sounds recorded by Asa-Dorian in 1955

Vocalizations have been recorded from migrating gray whales off the southern California coast (Wenz, 1964, and Gales, 1966, both reporting on recordings made by P. V. Asa-Dorian in 1955; Asa-Dorian and Perkins, 1967; Cummings, Thompson, and Cook, 1968) and from gray whales in the lagoons of Baja California, Mexico, where the whales breed (Eberhardt and Evans, 1962; Painter, 1963; Poulter, 1968). Unsuccessful attempts to obtain sounds from gray whales off southern California and in the lagoons have been made by Rasmussen and Head (1965) and by Hubbs (1966). The published data on gray whale sounds are summarized here in Table 1.

Gigi had already been in captivity at Sea World and hand-fed by her trainer for about 2 months before the tank recordings were made. Although

she seemed quite content in her unnatural surroundings, her behavior was certainly not representative of a free-ranging gray whale of the same age. Hence, the sounds may or may not be similar to sounds emitted by a young gray whale in its natural environment. A second problem with any tank recording is the effect of tank resonance and reverberation on the physical characteristics of the sounds. Certain frequencies were probably accentuated in amplitude and extended in time. Nevertheless, the data at least represent the general

frequency range and variety of a young captive gray whale's sound emissions.

SOUNDS OF GIGI AT SEA WORLD

Sounds were recorded simultaneously in water and in air on a 2-track tape recorder (Uher 4200)¹ at 19 cm/sec. The hydrophone (Wilcoxon M-H90-A), connected to one channel of the recorder, was suspended 1 m above the bottom of the circular concrete tank (11 m wide × 4 m deep). The frequency response of the underwater recording system was 40 Hz to 16 kHz, ±3 dB. The microphone, connected to the other channel, was lowered over the lip of the tank

¹ Use of trade names in this publication does not imply endorsement of commercial products by the National Marine Fisheries Service.

James F. Fish is with the Naval Undersea Center, San Diego, CA 92132. James L. Sumich is with Grossmont College, El Cajon, CA 92020. George L. Lingle is with SEACO, Inc. at the Naval Undersea Center, San Diego, CA 92132.

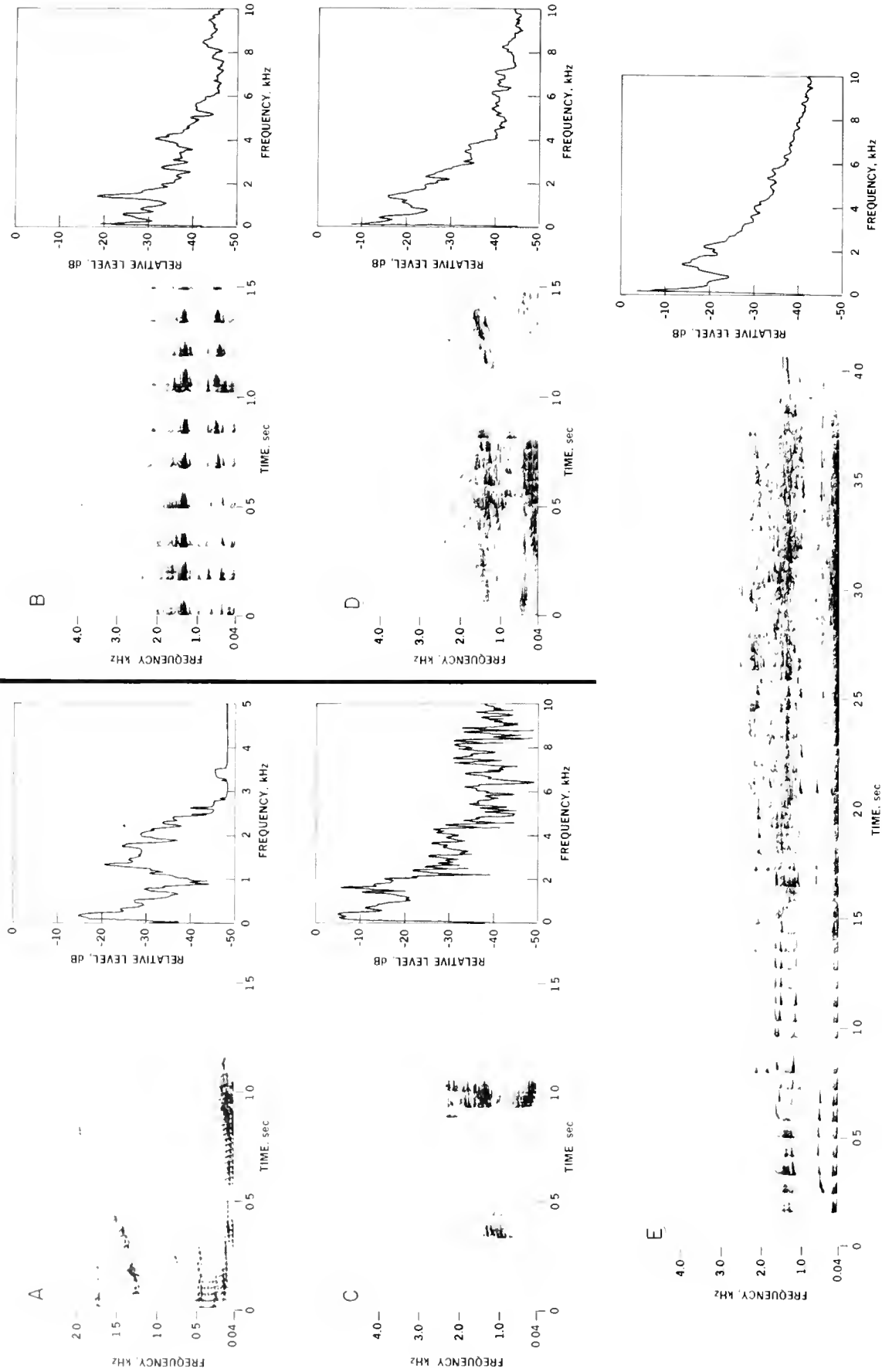

Figure 1.—Spectrograms (left) and spectral displays (right) of: A. Low-frequency "growl" or "moan"; B. "Metallic-sounding pulsed signal"; C. "Gruntlike" sound; D. Low-pitched "blow-hole rumble"; E. "Metallic-sounding pulse train". Effective analyzing filter bandwidth was 20 Hz for all spectrograms, 30 Hz for spectral display A, and 60 Hz for spectral displays B, C, D, and E. Spectral plots were generated with the spectrum analyzer in the Peak Hold mode for the entire duration of sounds shown in spectrograms. Data in each of the 250 filter locations were updated, but only in a positive direction, every memory period (50 msec for A, 25 msec for B, C, D, and E).

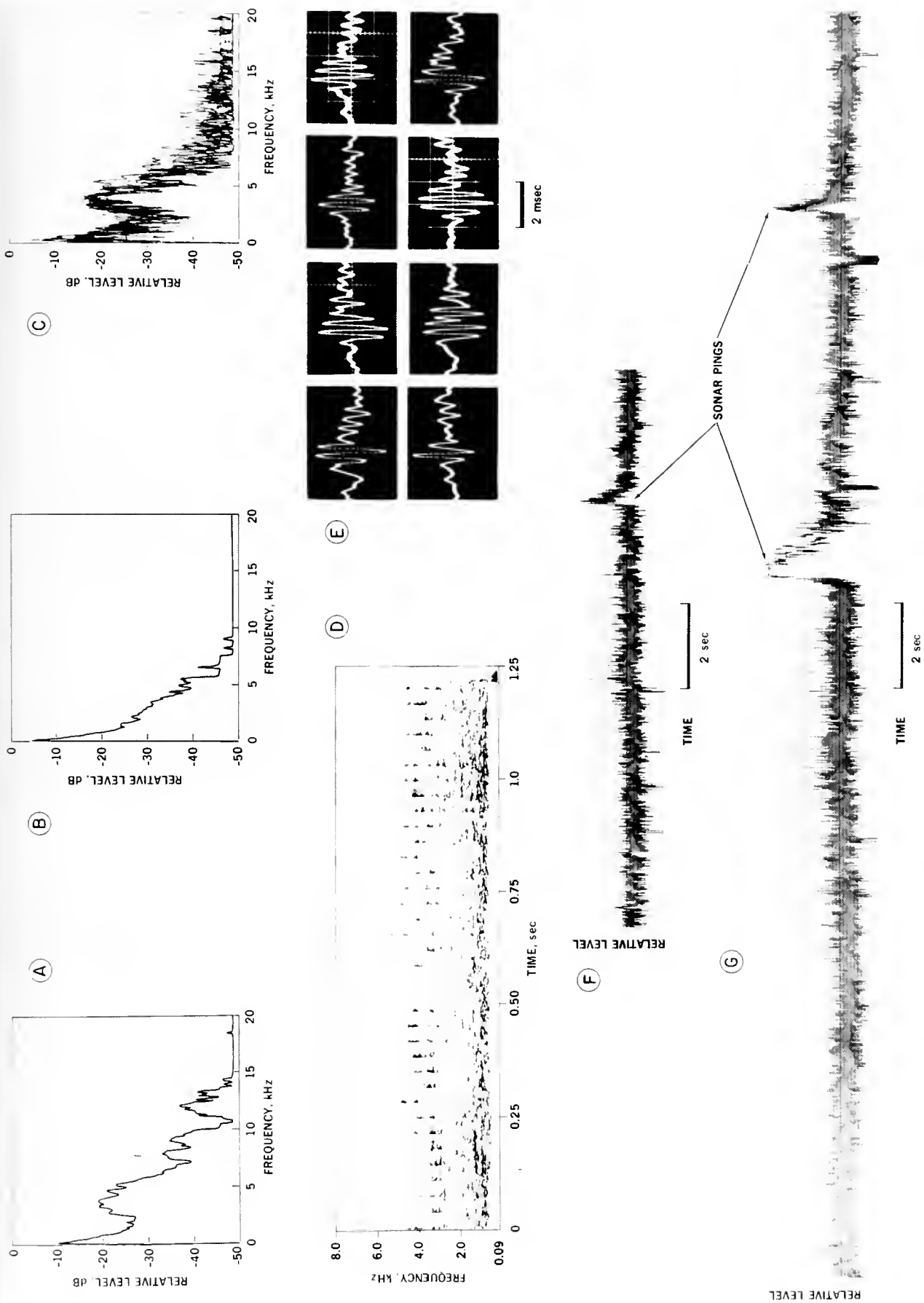

Figure 2.—A. Spectral display of clicks recorded during release of Gigi. Spectrum analyzer set in Peak Hold mode for a 9-sec sample of clicks (about 200 clicks). B. Spectrum of ambient noise during preceding 9 sec. For A and B, data in each of 250 litter locations updated, but only in a positive direction, every 0.0125 sec. Analyzing bandwidth 120 Hz. C. Overlapping spectra of the eight individual clicks, shown in E below. Spectrum analyzer set in Transient Capture mode. D. Spectrogram of a typical click train. E. Oscilloscope photographs of typical clicks. F and G. Bruel and Kjaer level recordings of two different repetition rate click trains.

to record the commentary of the trainer in the tank with the whale. The 3-hr recording session began about 1 hour before a feeding period and lasted until the water level, which initially was about 1 m above the whale's back, was too low to make useful underwater recordings.

Spectrographic analyses were made in the laboratory with a "Vibralyzer" (Kay Electric Company) to determine frequency vs. time, and a real-time spectrum analyzer (Spectral Dynamics SD330) connected to an X-Y recorder (Hewlett Packard 7035B) to portray the relative amplitude vs. frequency. The waveforms were monitored with either the spectrum analyzer in the Scope Time mode or an external oscilloscope. All of the sounds described below were recorded from the hydrophone output.

The whale was very inactive and emitted no sounds until the water was lowered enough for the trainer to stand in the tank and touch her back. None of the sounds could be consistently associated with a particular behavior. However, one type, a "metallic-sounding pulsed signal," was emitted nearly every time the trainer tapped the whale lightly on the back.

A low-frequency "growl" or "moan," similar to one type of sound recorded from gray whales off San Diego, Calif., by Cummings et al. (1968), was produced twice during the recording session. The principal energy of this signal recorded from the captive animal was in a band from 100 to 200 Hz, with a secondary peak around 1.5 kHz (Figure 1A). The duration of the sound was just over 1 sec. There was no obvious movement of the blowholes or expulsion of air associated with this vocalization.

The most common sound was the "metallic-sounding pulsed signal" which consisted of 8 to 14 pulses in bursts lasting up to 2 sec (Figure 1B). The pulses had sharp fronts (fast rise times) with energy extending from below 100 Hz to over 10 kHz, and several resonant peaks, the strongest being at 1.4 kHz. This sound occurred

as often as five times a minute, even when not incited by the trainer. Only occasionally did it appear to be correlated with exhalation and movement of the blowholes.

Three times during the recording session, a short (0.2 sec), broadband, "gruntlike" sound (Figure 1C) was emitted, without movement of the blowholes. Its peak energy was centered at 200-400 Hz and 1.6 kHz.

Figure 1D shows the underwater sounds of an exhalation followed by a low-pitched, "blowhole rumble." This combination occurred several times.

Twice, a long "metallic-sounding pulse train" with a repetition rate of about 14 pulses/sec merged into a long, low-frequency "groan" after about 1.5 sec (Figure 1E). Except for the much faster pulse repetition rate, the first part of this vocalization was similar to the sound shown in Figure 1B.

Numerous other sounds produced by Gigi during the 3-hr recording session essentially were variations of one of the five types discussed above.

SOUNDS RECORDED DURING RELEASE OF GIGI

Unfortunately, we did not record again in the presence of Gigi until she was released on 13 March 1972. The recording and analysis system used for these data was the same as used at Sea World. Shortly after Gigi was lowered into the water from the barge that carried her out to sea, long trains of "clicks" were heard. Although at the time there was no way to determine if these sounds, which were unlike any recorded from Gigi at Sea World, actually came from the whale or from another unseen biological source in the area, we now believe they were emitted by Gigi. The clicks were nearly identical to the clicks we have recently recorded in the presence of gray whales in Wickaninnish Bay, Vancouver Island, Canada.

The clicks recorded in the presence of Gigi are shown in Figure 2. Their principal energy occupied a band from about 2 to 6 kHz, centered at 3.4 to 4.0 kHz. Click duration was 1 to 2 msec. Eight minutes and 15 sec after the whale entered the water most boats in the area shut down their engines for our recording. The first burst of 29 clicks was recorded 6 sec later. Three minutes and 49 sec later the boats started their engines and we had to terminate our final recording of Gigi. During the 3 min and 55 sec of quiet-ship conditions we recorded 1,304 clicks. The number of clicks per burst (or train) varied from 1 to 833 and the click repetition rate from 9.5 to 36.0/sec. The longest click train, containing 833 clicks at an average repetition rate of 19/sec, began about 1 min after the boats had shut down their engines. Although the amplitude of the signals varied with time, we could not correlate signal level with the location of Gigi because the animal was not seen during the entire time of the recording.

SOUNDS RECORDED FROM GRAY WHALES OFF VANCOUVER ISLAND

The system used to record sounds in the presence of gray whales in Wickaninnish Bay on the west coast of Vancouver Island, Canada, consisted of a cassette recorder (Sony Model TC-126) and a portable underwater listening set (InterOcean Model 90A Bio-Acustik). The useable frequency range of the system was 100 Hz to 10 kHz. The hydrophone arrangement shown in Figure 3 resulted in good quality recordings with the small boat system.

Since 1967, as many as seven gray whales have been sighted at one time in Wickaninnish Bay. However, all of the recordings described here were from single whales or pairs. At 1725 hr on 10 August 1973, several click trains were recorded from a single feeding gray whale in 10 m of water, 1,200 m from shore. Very little wind

and calm seas made recording conditions ideal. The first clicks, shown in Figure 4F, began 1 min after the whale started a 3-min-35-sec-long dive, at a distance of 50 to 70 m from the hydrophone. Additional click trains (Figure 4G) occurred simultaneously with the first exhalation after the dive. Twenty sec later, noise from an unseen boat began and continued for 95 sec. A third click train was emitted 50 sec after the boat noises ceased and 50 sec prior to the next blow. By then, the whale was 80 to 100 m from the hydrophone and the received level of the clicks was 5 to 7 dB lower than the level of the clicks recorded when the whale was half that distance from the hydrophone.

On 18 August 1973, the click train shown in Figure 4H was recorded from a single feeding gray whale at 0900 hr. The whale was about 600 m from shore in 4 m of water. The surface was calm with about a 1m swell. At the time the click train was emitted, the whale was 100 to 150 m from the hydrophone. Twenty min later a single harbor porpoise, *Phocoena phocoena*, was observed in the area.

About 5 hr of recordings were made in the presence of the gray whales in Wickaninnish Bay and much additional monitoring was done without recording. Although at times nearly continuous very faint clicking could be heard, only about 250 of the recorded clicks had good signal-to-noise ratios. The number of clicks per train varied from 1 to 96 with repetition rates of 8 to 40/sec. The principal energy of these clicks occupied a band from about 2 to 6 kHz, centered at 3.5 to 4.0 kHz. The average click duration was a little under 2 msec.

DISCUSSION

We do not know how any of the sounds discussed in this paper were actually produced by the gray whales. The "metallic-sounding pulsed signal" produced by Gigi at Sea World sounded like air bubbles escaping from an area of high pressure through a con-

striction (similar to the sound of air escaping from a scuba regulator underwater). Since this whale sound generally was not associated with exhalation or blowhole movement, if it were, in fact, generated by escaping air, the air must have passed from one internal chamber to another. No bubbles were observed coming from the mouth or blowholes.

Although the possibility exists that another species of marine mammal could have produced the clicks recorded when Gigi was released off San Diego and the clicks recorded in the presence of gray whales in Wickaninnish Bay, we think the evidence indicates that the clicks did come from the gray whales. The acoustic parameters of the clicks recorded from the geographic areas are nearly identical. The only marine mammals, other than gray whales, observed in either recording area was the single *Phocoena phocoena* observed a half hour after the recording was made on 18 August 1973 in Wickaninnish Bay and a small group of *Delphinus delphis*, about 2 km away from the site of Gigi's release a half hour before she was released. *Phocoena phocoena*,

however, has not been observed off San Diego, and clicks of *Delphinus* have a much higher frequency content than described in this report. Also, the level of the clicks recorded in the presence of Gigi was too high for the sounds to have come from the *Delphinus* as the clicks appeared to originate from a single source rather than from a group of animals.

We have no evidence that the clicks recorded in the presence of gray whales have an echolocation function, but if they do, their frequency range (2 to 6 kHz) probably would be too low for the sounds to be useful for locating small individual food organisms. However, they could be helpful for finding dense concentrations of organisms or for ranging off the bottom to feed or navigate. Despite four seasons of recording in the presence of hundreds of migrating gray whales off San Diego, Naval Undersea Center personnel have never recorded similar clicks from the whales. But, according to most authorities, gray whales do not feed on their long migrations (Rice and Wolman, 1971). If the clicks were associated with feeding, we consequently should not expect to

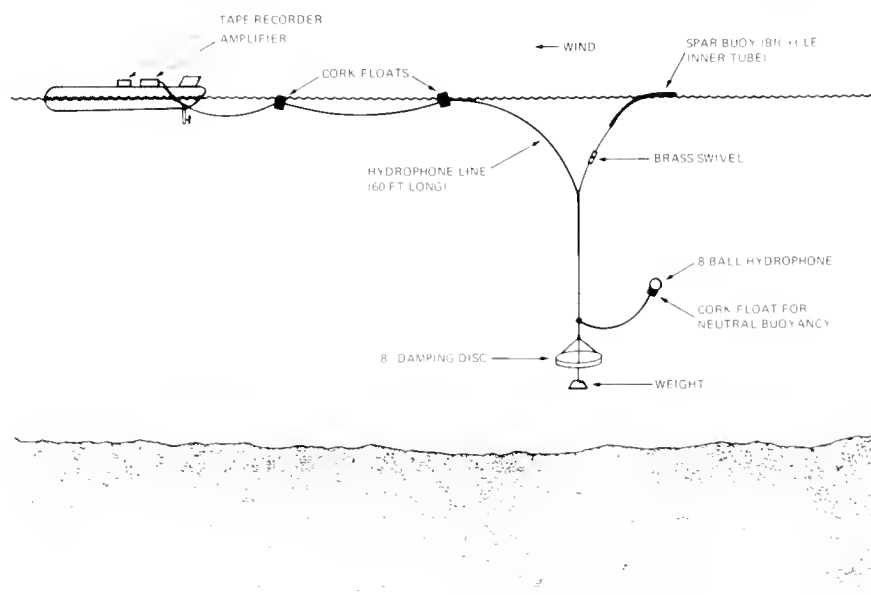

Figure 3.—Hydrophone suspension system used to record underwater sounds in Wickaninnish Bay, Vancouver Island, Canada.

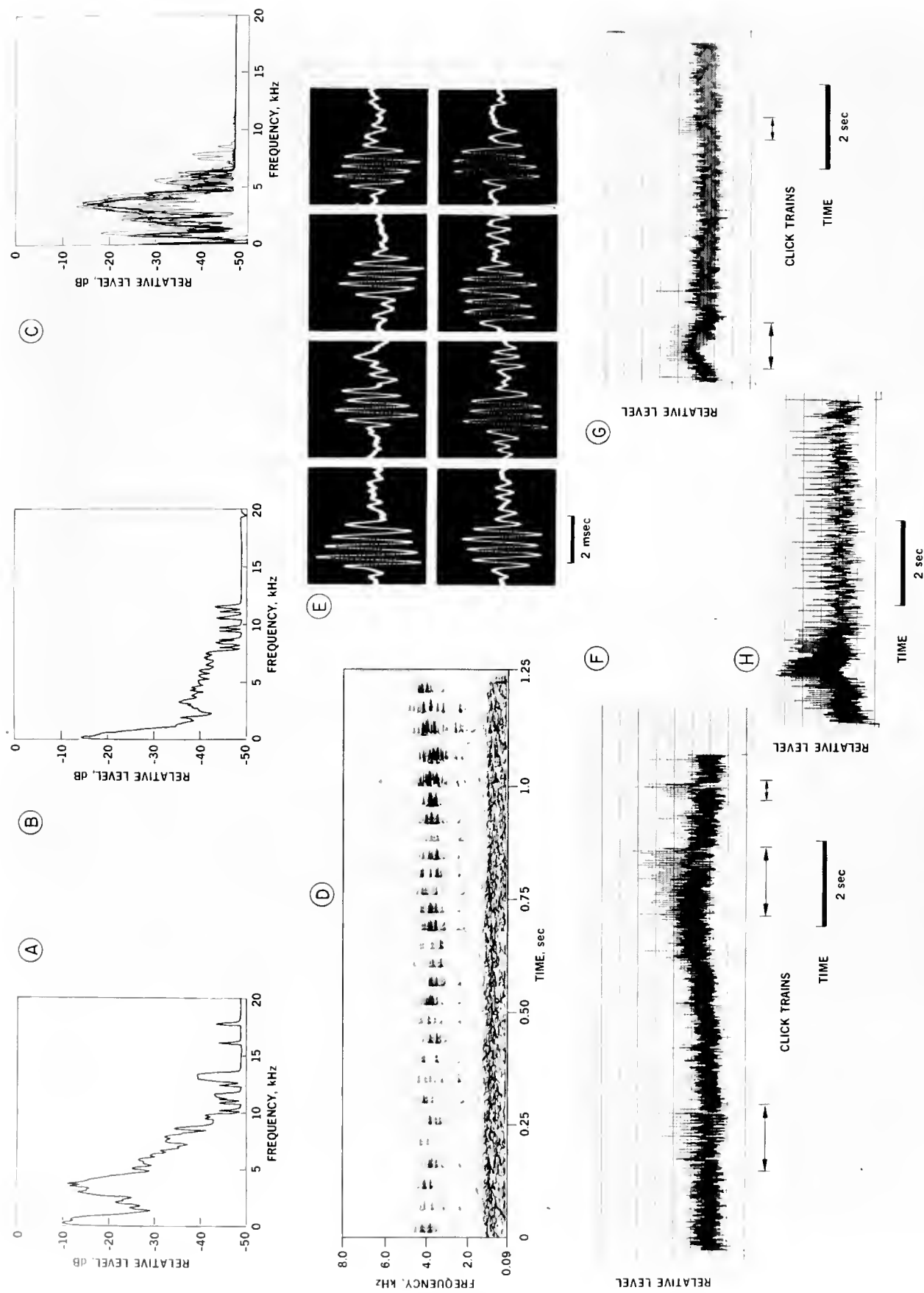

Figure 4.—A. Spectral display of clicks recorded in the presence of a gray whale in Wickinnish Bay. Spectrum analyzer set in Peak Hold mode for a 6-sec sample of clicks (about 90 clicks). B. Spectrum of ambient noise during preceding 6 sec. For A and B, data in each of 250 filter locations updated, but only in a positive direction, every 0.0125 sec. Analyzing bandwidth 120 Hz. C. Overlapping spectra of the eight individual clicks shown in E below. Spectrum analyzer set in Transient Capture mode. D. Spectrogram of a typical click train. E. Oscilloscope photographs of typical clicks. F, G, and H. Bruel and Kjaer level recordings of several click trains. Note changing repetition rate in H.

encounter them in this area of migrating whales. When the clicks were recorded in Wickaninnish Bay, the gray whales were feeding. Why Gigi emitted clicks when released is unknown. In this case, their function could have been orientation since it is unlikely that she was looking for food so soon after being placed in a new environment. The clicks discussed here are only slightly like those recorded by Asa-Dorian in 1955 (see Wenz, 1964). They are not similar to any other reported gray whale sounds.

Other recent evidence for mysticetes producing click-type sounds has been reported by Beamish and Mitchell (1971). Their recordings in the presence of blue whales included clicks with peak energy in a band from 21 to 31 kHz.

ACKNOWLEDGMENTS

We are grateful to Wilburn G. ("Bud") Donahoo for his help at Sea World during the recording session; to William C. Cummings for his advice and assistance in the recordings of Gigi at sea, and to William E. Evans and Fay Wolfson for their suggestions on the manuscript.

This work was supported by the Naval Undersea Center, Independent Research funding, and the Office of Naval Research, Oceanic Biology Branch, Grant No. NR 104-123.

LITERATURE CITED

- Asa-Dorian, P. V., and P. J. Perkins. 1967. The controversial production of sound by the California gray whale, *Eschrichtius gibbosus*. Nor. Hvalfangst-Tid. (Norwegian Whaling Gazette) 56:74-77.
- Beamish, P., and E. Mitchell. 1971. Ultrasonic sounds recorded in the presence of a blue whale, *Balaenoptera musculus*. Deep-Sea Res. 18:803-809.
- Cummings, W. C., P. O. Thompson, and R. Cook. 1968. Underwater sounds of migrating gray whales, *Eschrichtius glaucus* (Cope). J. Acoust. Soc. Am. 44:1278-1281.
- Eberhardt, R. L., and W. E. Evans. 1962. Sound activity of the California gray whale, *Eschrichtius glaucus*. J. Aud. Eng. Soc. 10:324-328.
- Gales, R. S. 1966. Pickup, analysis, and interpretation of underwater acoustic data. In K. S. Norris (editor), Whales, dolphins, and porpoises, p. 435-444. Univ. Calif. Press, Berkeley and Los Angeles.

- Hubbs, C. L. 1966. Comments. In K. S. Norris (editor), Whales, dolphins, and porpoises, p. 444. Univ. Calif. Press, Berkeley and Los Angeles.
- Painter, D. W., II. 1963. Ambient noise in a coastal lagoon. J. Acoust. Soc. Am. 35:1458-1459(L).
- Poulter, T. C. 1968. Vocalization of the gray whales in Laguna Ojo de Liebre (Scammon's Lagoon) Baja California, Mexico. Nor. Hvalfangst-Tid. (Norwegian Whaling Gazette) 57:53-62.

- Rasmussen, R. A., and N. E. Head. 1965. The quiet gray whale (*Eschrichtius glaucus*). Deep-Sea Res. 12:869-877.
- Rice, D. W., and A. A. Wolman. 1971. The life history and ecology of the gray whale (*Eschrichtius robustus*). Spec. Publ. 3, Am. Soc. Mammal., 142 p.
- Wenz, G. M. 1964. Curious noises and the sonic environment in the ocean. In W. N. Tavolga (editor), Marine bioacoustics, p. 101-123. Pergamon Press, New York.

MFR Paper 1054. From Marine Fisheries Review, Vol. 36, No. 4, April 1974. Copies of this paper, in limited numbers, are available from DB3, Technical Information Division, Environmental Science Information Center, NOAA, Washington, DC 20235.

MFR PAPER 1055

Aerial Observations of Migrating Gray Whales, *Eschrichtius robustus*, off Southern California, 1969-72

J. S. LEATHERWOOD

ABSTRACT

Migrating gray whales were observed from helicopter and fixed-wing aircraft from central California south to Cedros and Guadalupe Islands, Baja California, Mexico, with the primary sighting effort off southern California. Peak numbers were observed off southern California in January for the southward migration and in March for the northward migration. Individuals were observed with the same relative frequency 80-160 km offshore as they were within 80 km of shore. Cows with calves were seen from February through May, primarily inshore, and tended to be alone or with other cows with calves. Yearling whales were seen inshore from February through April and also tended to be solitary or with other yearlings. Average speed of movement for northward migrants was 2.8 km/hour.

Results of aerial surveys compare favorably with published summaries of the timing of migration based on shore and ship samples and support the value of aerial surveys as a tool in cetacean population studies.

INTRODUCTION

Since shortly after its population began to recover from a second near-extirmination by man in the 1920's and 1930's (Gilmore, 1955), the California gray whale, *Eschrichtius robustus*, has been the subject of more public interest and more scientific research than perhaps any other species of large whale. Because of their

spectacular nature and proximity to shore along much of the route, the migrations of the species have been rather exhaustively described by Scammon (1874), Hubbs (1959), Gilmore (1960a and 1960b), Rice (1961), Pike (1962), Hubbs and Hubbs (1967), Adams (1968), and Rice and Wolman (1971). Observations from shore stations (primarily at Point Loma in

San Diego, and at Yankee Point near Monterey) supplemented with aerial observations and boat surveys, have fixed the timing and described most aspects of that migration in detail.

Even so, several interesting gaps still exist in our knowledge of the migrating animals. For instance, although Gilmore (1969) has discussed movement patterns of yearling whales on the southern migration, there are no reports on the movements of yearlings during the northern migration. Similarly, although Hubbs (1959) reported that "cows with calves seem to take a more offshore path," actual data on

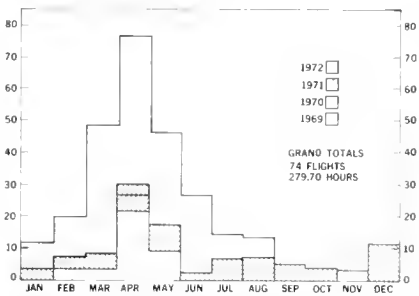

Figure 1.—Flight hours, 1969-72.

the movements of mothers with calves after they leave the breeding lagoons are so scant that Rice and Wolman (1971) simply report that "the route taken by females and calves during the spring migration is unknown." Finally, although average rates of movement for the population have been computed from dates of peak passage at two separate shore stations, there are actual numbers for rates of movement of individual animals to test those averages only for the southward migration (Wyriek, 1954; Cummings, Thompson, and Cook, 1968).

Since February of 1969, the author has been conducting routine aerial surveys of the cetaceans off southern California, primarily in the area from lat. 34°N south to Islas Todos Santos and offshore as far as 280 km. Additional flights have surveyed the

coast from Point Mugu north to Monterey Bay in March and the area from San Diego to Cedros and Guadalupe Islands in January and February.

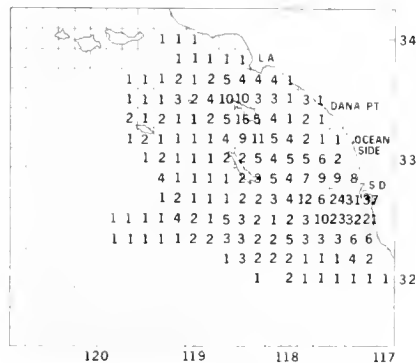

Figure 2.—Survey effort by 10-minute blocks, southern migration, 1 October to 15 February. Each number represents total number of times that area was surveyed during this time period.

METHODS

Flights were made in Navy H-3 helicopters and S-2 reconnaissance aircraft, and in twin-engine rental aircraft. Survey altitudes ranged from 150 to 300 meters depending on weather conditions. Detailed observations were made from as low as 15 meters. Although gray whales were not the exclusive target of the survey, for every gray whale sighting the number and estimated size of individuals, their location, swimming direction and speed, and details of behavior were recorded.

Through 1 July 1972 we made 74 flights totaling 279.7 hours of observation time (Figure 1). Sampling effort was accelerated during March, April, May, and June 1972 in support of the radio track of the gray whale Gigi (Evans, 1972, and this publication) and of a common dolphin, *Delphinus delphis*, subsequently tagged and radio-tracked from aircraft (Evans and Leatherwood, 1972). In general, surveys were more extensive during the period of the northern migration (approximately mid-February through May).

J. S. Leatherwood is a member of the staff of the Bio-Systems Program, Naval Undersea Center, San Diego, CA 92132.

To facilitate data analysis, the study area was divided into 10-minute blocks, and tallies were maintained of the number of times each zone was surveyed for cetaceans whether or not animals were sighted. Zones were not recorded as surveyed if cloud cover, fog, or surface water conditions prevented adequate observation in the area.

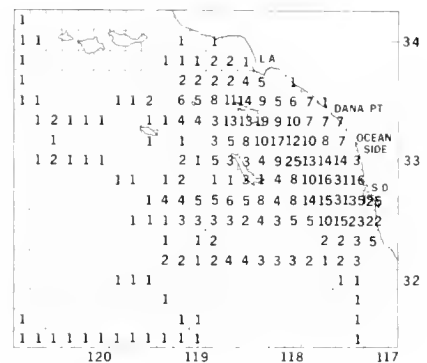

Figure 3.—Survey effort by 10-minute blocks, northern migration, 16 February to 1 June. Each number represents total number of times that area was surveyed during this period.

Figures 2 and 3 summarize the total number of times each zone was surveyed during the periods of the southern migration (1 October to 15 February) and northern migration (16 February to 1 June) of gray whales. Effort was concentrated off San Diego during both periods because all three airfields used are located there. The substantial increase of effort in the southern San Pedro Channel from the southern to the northern migration is the result of the aerial radio-tracking mentioned above.

During the three migratory seasons, gray whale groups were sighted 91 times in the study area. Of these, 23 groups included mothers with calves, 19 included yearling whales, and 8 sightings represented observations of the same animals on successive days.

RESULTS

Migration Peaks and Offshore Movements

The picture of migration peaks obtained from the aerial surveys agrees with the summaries of Hubbs (1959) and Gilmore (1960). The earliest animals were seen in the third week of December and the latest during late May. The largest numbers of animals were seen during the first and second weeks of January and the second and fourth weeks of March. Because the amount of aerial survey effort varied from month to month, indices of apparent abundance were computed for data in blocks of a month by dividing both the number of aerial observations and the number of individuals seen by the amount of survey effort during that time period. These indices (Figure 4) also clearly indicate the periods of greatest abundance off San Diego as January and March.

During both legs of the migration many whales were sighted far offshore. (Figure 5) presumably taking what has been called the "inter-island leg" (Gilmore, 1969). For instance, within the 64 km wide band between lat. $32^{\circ}15'N$ and $32^{\circ}55'N$, southern migrating gray whales were encountered during 4.7 percent of the flights in the first 80 km from shore, 5.0 percent of the flights in the second 80 km, and 1 percent of the flights over the next 48 km. Similarly on the northern migration, grays were sighted 6.4, 9.2, and 3.3 percent respectively of the times the three zones were surveyed. These findings support the contentions of Rice (1965) and Rice and Wolman (1971) that at least since 1965 a rather high percentage of the whales have passed offshore, out of sight of Point Loma.

Though most of the animals taking the offshore route apparently strike for the coast shortly after they pass by the southernmost of the Channel

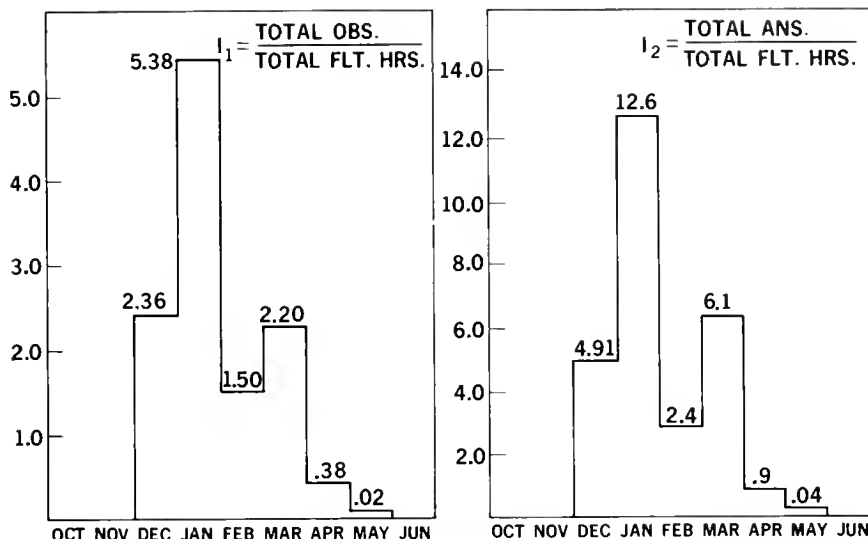

Figure 4.—Indices of apparent abundance (I_1) of gray whales from aerial surveys, 1969-72.

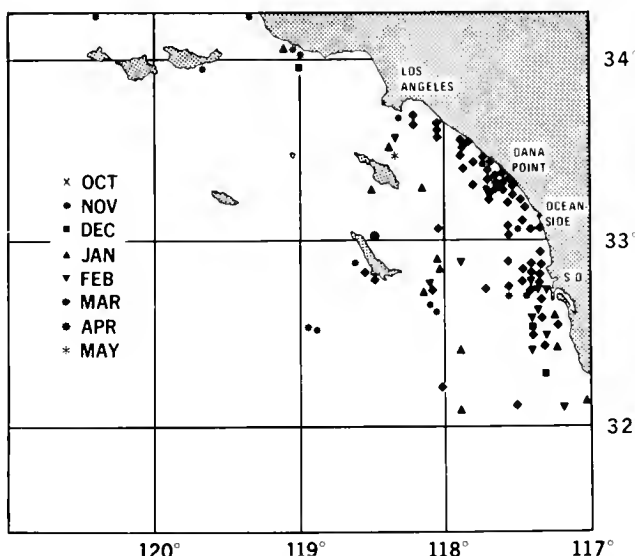

Figure 5.—Aerial survey gray whale sightings, 1969-72.

Islands, some do pass offshore toward Guadalupe Island. Gilmore (1955) reported Hubbs' sighting of three mothers with calves outside Guadalupe in February of 1950. In February 1972, I located two gray whales on the outside of Guadalupe near the southwest tip. A third animal, too close to the cliffs to permit close examination, was also believed to be a gray. The two verified sightings were both adult animals 11 or more meters in length.

Cow-Calf Groups

As was noted earlier, the routes taken by females with calves during the spring migration have been unknown.

Twenty-three northward migrating groups containing mothers with calves were observed during the aerial surveys (Figure 6). The earliest was sighted 18 February, the latest on 18 May. Although the majority of those sightings were well inshore, this may

be a result of the heavy sighting effort inshore in 1972 during the times of the northern migration. The few sightings of mothers with calves late in the season, however, were more offshore.

Of the 23 times mothers with calves have been observed, in 18 mothers and calves have been either by themselves or with other mothers with calves. In only four instances were they in the company of other adults. This observation may be supported in part by the fact that females with calves are not receptive to breeding because a female calves and breeds in alternate years (Scammon, 1874; Gilmore, 1961; Rice and Wolman, 1971).

Yearlings

There is still little information in the literature on the distribution and movements of yearling gray whales. Hubbs (1972 pers. comm.) has observed solitary yearlings migrating south very near shore off La Jolla. Gilmore (1960b) reported that yearlings frequently travel with larger adult animals on the southern migration, presumably learning the migration route, but that solitary individuals are also seen.

Based on the growth curve of gray whales (Rice and Wolman, 1971) and on estimates of size range at time of weaning (Gilmore, 1961), all whales estimated in our surveys to be between about 6 and 9 meters (20-30 feet) long were classified as yearling whales. The opportunity to observe Gigi (8.26 m [27 ft] long) from the air for nearly an hour in early March 1972 verified the accuracy of my previous size estimates and increased confidence in the reliability of the classification in subsequent sightings.

The room for error in this estimate notwithstanding, yearling-sized whales were observed with higher frequency than expected (Figure 7). A total of 21 yearlings or groups of yearlings was observed in the study area. Of those, 16 were observed after the release of Gigi (Evans, 1972) all during

Figure 6.—Locations of sightings of mother-calf groups during aerial surveys, 1969-72.

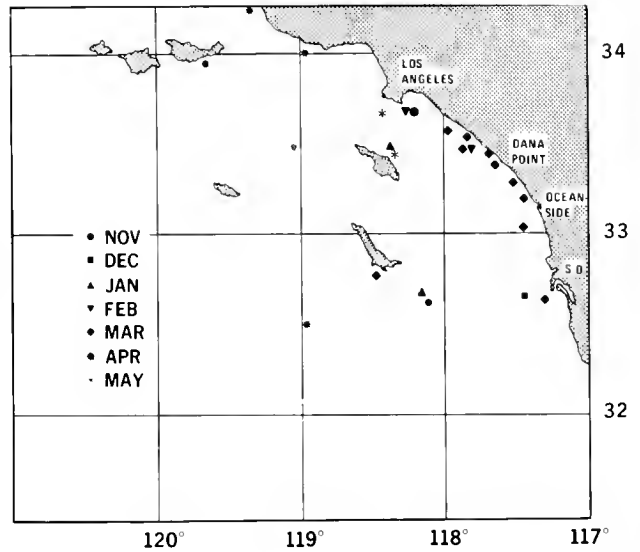
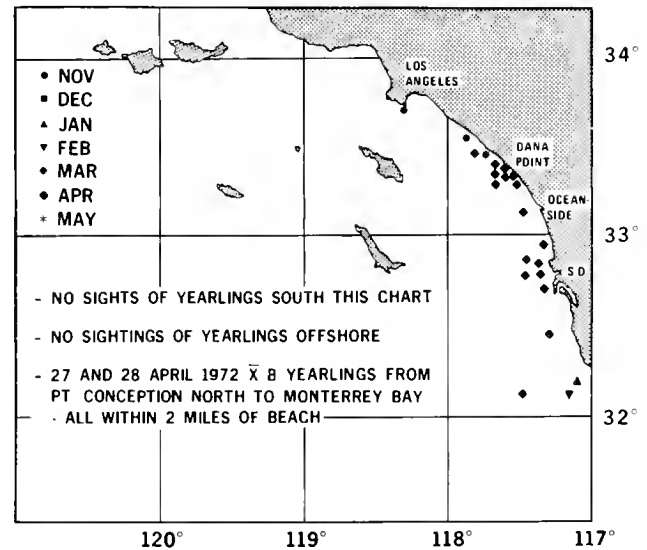

Figure 7.—Locations of sightings of probable yearling gray whales (estimated size, 20 to 30 feet) during aerial surveys, 1969-72.



the period of the northward migration. No yearlings were seen south of the Coronado Islands, but a total of 16 was encountered on a 2-day survey flight north to Monterey Bay in April. All were within 5 km of the beach.

No yearlings were observed in the offshore areas where other whales were seen. Further, like cows and calves, yearlings tended to be either by themselves or with other yearlings. In only 4 of the 21 cases were yearlings accompanying adult animals. This absence of yearlings with adults may be a result of the forced rejection

by the mother at the late summer weaning in the north.

Rates of Movement

Estimates of rates of movement for southward migrating whales have ranged from 7.7 km/hour calculated over the entire migration route (Pike, 1962) to 10.2 km/hour calculated over a small segment of the route (Cummings et al., 1968). Rice and Wolman (1971) used the times of peak passage at two separate shore stations to calculate the average distance trav-

eled in 24 hours as 185 km. Pike (1962) used the same calculations to determine that northward migrants traveled from 56-80 km/day at about $\frac{1}{3}$ - $\frac{1}{2}$ the rate of southern migrants.

During this study, natural markings on three whales observed on successive days permitted the calculation of speeds of movement along two areas of the coastline. Rates of movement of all 3 are comparable to Pike's calculations.

Two 12-13 meter individuals, one distinctly marked with white brush markings on the tail stock and flukes, were seen 11, 12, and 13 April 1972. During the 49.5 hours between the first and third sightings, they moved approximately 129 km from the Coronado Islands to near San Clemente, Calif., an average speed of only 2.6 km/hour.

A 12-meter individual with a nearly all white tail fluke and a wide white band across the tail stock was seen with four other animals off Point La Jolla on 27 March 1972. The same animal was observed again on the 28th just northwest of Newport Beach and on the 29th 13 km southwest of Point Vicente. Net movement in 44 hours was 128 km or 2.9 km/hour.

Finally, an unusually dark yearling observed just south of Point San Luis 27 April 1972 had moved 64 km to the north when it was resighted 23 hours later northwest of Point Estero. It had moved at an average rate of 2.8 km/hour.

SUMMARY

Results of periodic aerial surveys are comparable to those from ship and land-based surveys in defining the timing of migration of gray whale populations past southern California. Peak densities were observed in January for the southward and in March for the northward migration. Over half the population observed passed more than 64 km offshore from San Diego. Cows with calves were seen from February through May primarily inshore and tended to be alone or with other cows with calves. Yearling whales were seen inshore from February through April and tended to be solitary or with other yearlings. Finally, average speeds observed for three individuals over small segments of the northward migration route were comparable to estimates based on peak movements past shore stations.

ACKNOWLEDGMENTS

I am indebted to many people for help with this project. John Hall and Larry Tsunoda each flew some of the survey flights. George Lingle and John Moore helped summarize the data. Raymond Gilmore, Dale W. Rice, and William F. Perrin read the manuscript and made useful suggestions. Marita Doerflein, Marty Allen, and Shirlee Preis typed the manuscript.

Finally, I am indebted to the officers and men of Carrier Antisubmarine Air Groups 53 and 59 for their skill, patience and helpful spirit, and to LCDR Al Zollers for scheduling aircraft.

This research was part of NUC IR Project 150550 "Marine Mammal Populations," W. E. Evans principal investigator.

LITERATURE CITED

- Adams, L. 1968. Census of the gray whale, 1966-67. *Nor. Hvalfangst-Tid.* 57:41-43.
- Cummings, W. C., P. O. Thompson, and R. Cook. 1968. Underwater sounds of migrating gray whales, *Eschrichtius glaucus* (Cope). *J. Acoust. Soc. Am.* 44:1278-1281.
- Evans, W. E. 1972. A mobile marine environmental survey vehicle. NUC TN No. 758.
- Evans, W. E., and J. S. Leatherwood. 1972. The use of an instrumented marine mammal as an oceanographic survey platform. NUC TP No. 311, 11 p.
- Gilmore, R. M. 1955. The return of the gray whale. *Sci. Am.* 192(1):62-74.
- . 1960a. A census of the California gray whale. U.S. Fish Wildl. Serv., Spec. Sci. Rep. Fish. 342, 30 p.
- . 1960b. Census and migration of the California gray whale. [In Engl. and Norw.] *Nor. Hvalfangst-Tid.* 49:409-431.
- . 1961. The story of the gray whale, 2nd ed. Privately published, San Diego, 16 p.
- . 1969. The gray whale. *Oceans* 1:9-20.
- Gilmore, R. M., and G. Ewing. 1954. Calving of the California grays. *Pac. Discovery* 7(3):13-15.
- Hubbs, C. L. 1959. Natural history of the gray whale. *Proc. XVth Int. Congr. Zool., Sect. III, Pap.* 46, 3 p.
- Hubbs, C. L., and L. C. Hubbs. 1967. Gray whale censuses by airplane in Mexico. *Calif. Fish Game* 53:23-27.
- Pike, G. C. 1962. Migration and feeding of the gray whale (*Eschrichtius gibbosus*). *J. Fish Res. Board Can.* 19:815-838.
- Rice, D. W. 1961. Census of the California gray whale, 1959-60. [In Engl. and Norw.] *Nor. Hvalfangst-Tid.* 50:219-225.
- . 1965. Offshore southward migration of gray whales off southern California. *J. Mammal.* 46:504-505.
- Rice, D. W., and A. A. Wolman. 1971. The life history and ecology of the gray whale (*Eschrichtius robustus*). *Am. Soc. Mammal. Spec. Publ. No. 3*, 142 p.
- Scammon, C. M. 1874. The marine mammals of the north-western coast of North America. John H. Carmany and Co., San Francisco, 319 p.
- Wyrick, R. F. 1954. Observations on the movements of the Pacific gray whale, *Eschrichtius glaucus* (Cope). *J. Mammal.* 35:596-598.

MFR Paper 1055. From Marine Fisheries Review, Vol. 36, No. 4, April 1974. Copies of this paper, in limited numbers, are available from D83, Technical Information Division, Environmental Science Information Center, NOAA, Washington, DC 20235.

A Note on Gray Whale Behavioral Interactions with Other Marine Mammals

J. S. LEATHERWOOD

With the exception of reports of killer whales, *Orcinus orca*, attacking gray whales, *Eschrichtius robustus*, (Seammon, 1874; Andrews, 1914; Gilmore, 1961; Burrage, 1964; Morejohn, 1968; and Baldrige, 1972) there are no accounts in the literature on the behavioral interactions between gray whales and other marine mammals. During aerial surveys of southern California cetaceans, (Leatherwood, 1974), I often observed gray whales in close association with other marine mammals (Figure 1). Though the abundance of all these species in the area during the winter and spring makes coincidental association likely, the following incidents represent behavioral interaction:

Four days after her release, when she was first relocated by aircraft, the gray whale Gigi (Evans, 1974) was swimming with a small group of Pacific bottlenose dolphins *Tursiops* sp. in the surf zone just north of the San Clemente, Calif. pier. Though the dolphins left the whale shortly after the aircraft began to circle the area, when first seen they were closely clustered about the head of the gray whale as if riding its pressure wave. Since Gigi was housed during almost her entire internment at Sea World with an Atlantic bottlenose dolphin, *Tursiops truncatus*, this association in the wild may have been a result of the captivity. However, I have observed gray whales swimming with bottlenose dolphins in the wild in six other instances, in three of which the porpoises were also riding the whales' pressure waves. Further, bottlenose dolphins are common along the Baja California portion of the gray whales'

migration route and in the breeding lagoons and have been reported moving freely among California gray whales (Evans and Dreher, 1962).

On 19 January 1972, three adult gray whales were observed heading southwest over Sixty-Mile Bank (lat. 32°05'N, long. 118°10'W). The entire area was rich with birds and the surface action of many schools of small fishes and a large aggregation of odontocetes (including over 1,000 northern right-whale dolphins, *Lissodelphis borealis*, approximately 500 Pacific common dolphins, *Delphinus delphis*, approximately 500 North Pacific white-sided dolphins, *Lagenorhynchus obliquidens*, and at least 3 Dall porpoises, *Phocoenoides dalli*) was present. The whales were observed at close range from a helicopter for nearly 45 minutes and dolphins and porpoises were observed riding the pressure waves of the whales for the entire

J. S. Leatherwood is with the Naval Undersea Center Bio-Systems Program, San Diego, CA 92132.

time. All species were involved in the interaction.

In addition, during this same period gray whales were observed riding the large glassy swells which moved through the area. This behavior is common among small dolphins (e.g., *Tursiops*, *Delphinus*, *Lagenorhynchus*, *Lissodelphis*) and is perhaps not surprising for the gray whale in the light of its reported surf-riding (Caldwell and Caldwell, 1963).

In March 1971, several gray whales were observed along the west side of Catalina Island where an estimated 200 pilot whales, *Globicephala* sp., were distributed in small groups from Ben Wesson Point to the northwest tip of the island. One gray whale was turned belly up in the midst of a pod of 12 or 15 pilot whales, and an adult pilot whale was swimming over the belly of the inverted gray whale. Both were alarmed by the aircraft and sounded on our approach.

In the other instances (Figure 1) the animals were simply swimming close to each other. With one exception, that of Gigi, all the observed associations between gray whales and other cetaceans involved adult whales,

Figure 1.—Locations of sightings of gray whales associated with other marine mammals (1969-1972).

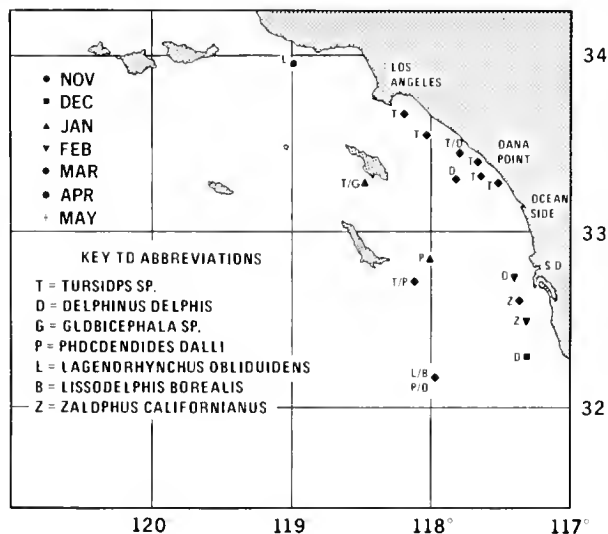

all greater than 30 feet in length. Furthermore, in all cases the gray whales have appeared to be passive participants in the interaction.

LITERATURE CITED

- Andrews, R. C. 1914. Monographs of the Pacific Cetacea. I. The California gray whale (*Rhachianectes glaucus* Cope). Its history, habits, external anatomy, osteology and relationship. Mem. Am. Mus. Nat. Hist. (New Ser.) 1:227-287.
- Baldrige, A. 1972. Killer whales attack and eat a gray whale. *J. Mammal.* 53:898-900.
- Burridge, B. R. 1964. An observation regarding gray whales and killer whales. *Trans. Kansas Acad. Sci.* 67:550-551.
- Caldwell, D. K., and M. C. Caldwell. 1963. Surf-riding by the California gray whale. *Bull. South. Calif. Acad. Sci.* 62(2):99.
- Evans, W. E. 1974. Telemetry of temperature and depth data from a free ranging yearling California gray whale, *Eschrichtius robustus*. *Mar. Fish. Rev.* 36(4): 52-58.
- Evans, W. E., and J. J. Dreher. 1962. Observations on scouting behavior and the associated sound production by the Pacific bottlenosed porpoise (*Tuostoops tilli* Dall). *Bull. South. Calif. Acad. Sci.* 61:217-226.
- Gilmore, R. M. 1961. The story of the gray whale, 2nd ed. Privately published, San Diego, 16 p.
- Leatherwood, J. S. 1974. Aerial observations of migrating gray whales, *Eschrichtius robustus*, off southern California (1969-1972). *Mar. Fish. Rev.* 36(4):45-49.
- Morejohn, G. V. 1968. A killer whale—gray whale encounter. *J. Mammal.* 49: 327-328.
- Scammon, C. M. 1874. The marine mammals of the North-western coast of North America. John H. Carmany and Co., San Francisco, 319 p.

MFR Paper 1056. From Marine Fisheries Review, Vol. 36, No. 4, April 1974. Copies of this paper, in limited numbers, are available from D83, Technical Information Division, Environmental Science Information Center, NOAA, Washington, DC 20235.

MFR PAPER 1057

Aerial Observations of Gray Whales During 1973

PAUL N. SUND and JOHN L. O'CONNOR

During their annual southward migration California gray whales, *Eschrichtius robustus*, were observed between Monterey Bay and Point Sur, Calif. (Figure 1) from an aircraft during the period 15-23 January 1973. An aerial survey was initiated in response to recommendations of the Joint Naval Undersea Center—National Marine Fisheries Service (NMFS), Southwest Fisheries Center Gray Whale Workshop (held in La Jolla, California in August 1972), that the accuracy of the annual NMFS shore census taken near Yankee Point be checked. The survey was designed to compare shore observers' estimates of numbers with those of aerial observers; to test the estimate that 95 percent of the gray whales migrating

by Yankee Point pass within 1.9 km (1.2 miles) of the shore (Rice and Wolman, 1971); and to provide observations of gray whale behavior and associations with other marine mammal species. The utility of aerial surveys in cetacean research has been demonstrated by Levenson (1968) and Leatherwood (1974a,b). This paper reports on simultaneous shore and aircraft observations and discusses the problems inherent in each method.

METHODS

Five flights, totaling 13.6 hours, were made between Monterey Bay and Point Sur, Calif. (Figure 1) in a Cessna 172 flown by a professional spotter-pilot at altitudes ranging from 150 m (500 ft) to 900 m (3,000 ft).

Radio communications with shore observers permitted coordination of observational efforts. Time, location, numbers of whales, and behavior observations were noted for the sightings and photographs were attempted on occasion.

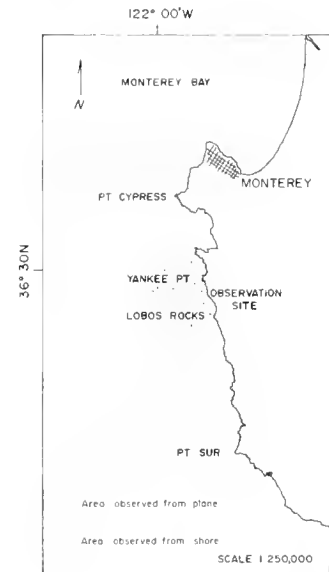

Figure 1.—The area off California observed for gray whales, 15-23 January 1973.

RESULTS AND CONCLUSIONS

From the aerial observations made in the sector scanned by shore observers, the following points were determined. Of 24 paired observations (individuals or groups observed by both air and ground personnel), initial visual contact was made by a ground observer in eight instances and by an airborne observer in ten instances. Hence, ground and aircraft observers apparently were equally adept at initially sighting whales. Of the 24 paired sightings, the aerial observers were able to correct the

Paul N. Sund is with the Pacific Environmental Group, National Marine Fisheries Service, NOAA, Monterey, CA 93940. John L. O'Connor, P.O. Box 1942, Newport Beach, CA 92660.

numbers recorded by the shore observers six times. In three instances of poor (white caps and 4-6 foot swells) sea state conditions, on the other hand, the aerial observers were unable to confirm groups or individuals sighted by the shore observers. These data suggest that, although aerial observations may be more directly limited by sea conditions, they are useful in quantifying the number of whales in groups. Further, resolution of numbers present is faster from the air than from shore. (It often takes the shore observers up to 30 minutes to determine their count for a given group—during which time the individuals in the group may dissociate or join with others.)

Resolution of numbers of whales in groups is more rapid and apparently more accurate from the air than from shore. With a professional spotter pilot working a limited area—such as that scanned by the shore observers—in good sea state conditions, essentially no whales will pass unnoticed. "Misses" by the aerial observers were due to leaving the area prematurely in order to accomplish other tasks; had the aircraft been consistently in the shore observers' area (and immediately outside to prevent unnoticed passage of individuals offshore) none would have gone unrecorded.

The aerial observers made 50 observations of whales involving 149 animals. All these observations occurred within 7 miles of the shoreline, even though the area surveyed extended to 25 miles seaward. Of these sightings, 98 percent were within 5 miles of shore, 96 percent within 3 miles, and 94 percent within 1 mile. Distances were estimated by making timed runs at constant speed from positions offshore to the coastline. The observations of this study tend to confirm Rice and Wolman's statement that 95 percent of the whales pass within 1.9 km (1.2 miles) of the shore near the Yankee Point site.

Gray whales have been reported interacting with other marine mammals by Leatherwood (1974b), but

during this study no other marine mammals were observed "associating" directly with gray whales. Feeding behavior was observed on two occasions. A calf was seen accompanied by an adult. These two latter observations are of particular note and the senior author intends to publish the details elsewhere.¹

¹Sund, P. N. Manuscript. Evidence of feeding during migration and of an early birth of the California gray whale.

MFR Paper 1057. From Marine Fisheries Review, Vol. 36, No. 4, April 1974. Copies of this paper, in limited numbers, are available from D83, Technical Information Division, Environmental Science Information Center, NOAA, Washington, DC 20235.

MFR PAPER 1058

Telemetry of Temperature and Depth Data From a Free Ranging Yearling California Gray Whale, *Eschrichtius robustus*

W. E. EVANS

ABSTRACT

In 1968 the author initiated a series of studies using radio transmitters to follow the movements and study the diving behavior of small toothed whales. This paper describes the modifications of this equipment necessary to use this technique on larger whales, in this case a yearling California gray whale, Eschrichtius robustus. In addition to the transmission of positional data, i.e. azimuth and depth of dive, the instrumentation package used in this study was designed to transmit environmental data (temperature-at-depth). The animal used in this study, a female E. robustus, was captured on 13 March 1971, in Scammon's Lagoon, Baja California Sur, Mexico, by Sea World, Inc., San Diego, and released on 13 March 1972, at lat. 32° 41.5' N, long. 117° 20.5' W (off Point Loma, San Diego, Calif.) by the Naval Undersea Center (NUC), San Diego. Radio contact was maintained with the animal until 5 May 1972. Depth of dive and temperature-at-depth data were continuously monitored for a 24-hour period.

INTRODUCTION

The present study is an extension of a 6-year research program designed to evaluate the feasibility of using medium-sized to large cetaceans, instrumented with a combination data collection and transmission system,

LITERATURE CITED

- Leatherwood, J. S. 1974a. Aerial observations of migrating gray whales, *Eschrichtius robustus*, off southern California (1969-1972). *Mar. Fish. Rev.* 36(4):45-49.
 ———. 1974b. A note on gray whale behavioral interactions with other marine mammals. *Mar. Fish. Rev.* 36(4):49-50.
 Levenson, C. 1968. Factors affecting biological observations from the ASWEPS aircraft. U.S. Naval Oceanogr. Off., Informal Rep. No. 68-102, 6 p.
 Rice, D. W., and A. A. Wolman. 1971. The life history and ecology of the gray whale (*Eschrichtius robustus*). *Am. Soc. Mammal. Spec. Publ. No. 3*, 142 p.

to measure physical oceanographic parameters at various depths, and to evaluate the relationship of these parameters to cetaceans' movement patterns and secondary productivity (Evans, 1970, 1971, in press).

Because of the impending release of a yearling California gray whale

W. E. Evans is with the Naval Undersea Center, San Diego, CA 92132.

(Gigi II) captured by Sea World, Inc., San Diego, on 13 March 1971, in Scammon's Lagoon, Baja California, Mexico, and the timing of the northern migration of California gray whales (March-April), the program was accelerated to take advantage of this opportunity. The prototype data transmission/acquisition system had been designed and bench-tested in anticipation of tests on a Pacific pilot whale, *Globicephala* cf. *scammoni*, in mid-summer 1972. The unit was repackaged and the test dates subsequently moved up to coincide with the planned release of the Sea World captive yearling gray whale which was scheduled for 13 March 1972. It was then field tested attached to the Sea World gray whale when she was released at 0905 hours at lat. 32°41.5'N, long. 117°20.5'W into a group of four to five California gray whales moving north.

DATA PARAMETERS

Since one of our primary purposes for using a data system attached to a cetacean was to measure environmental parameters associated with the animal's movements below the air-sea interface, the instrumentation used must indicate the depth at which the measurement was made. The following parameters were considered as potential indicators of productivity and important correlates of cetacean movement:

1. Temperature at depth.
2. Ocean current speed at surface and at depth.
3. Salinity-derived from conductivity measurements.
4. Dissolved gases:
 - a. O₂;
 - b. N₂;
 - c. Free CO₂.
5. Light:
 - a. Absorption loss due to molecular absorption, particulate matter;

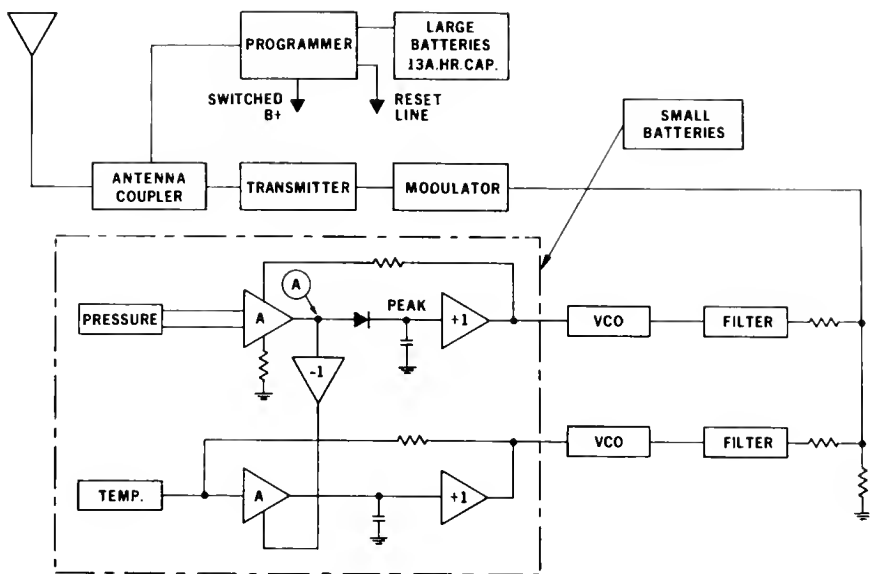

Figure 1.—Block diagram of telemetry transmitter attached to yearling California gray whale (Gigi).

- b. Backscattering from particulate matter;
- c. Light level at depth.

After consideration of all these parameters, temperature was selected as the most desirable for this phase of the program because: 1) methods of measurement are straightforward electronically, 2) considerable bathythermal data exist for the California Current region, 3) data transmitted from the instrumented animal could be easily checked by use of currently available expendable bathythermographs, and 4) a great deal of data relating the thermal structure of the water columns to primary and secondary productivity are available in the scientific literature (e.g. Eckman, 1953).

INSTRUMENTATION

Data Transmission System

The data acquisition system mounted on the yearling gray whale provided measurement of the depth of each dive and the water temperature at that depth, and served as a radio beacon for tracking. Data measured was telemetered by an 11 meter transmitter (27.585 megaHertz) to either a surface vessel, shore station, or air-

craft-based receiving set which would also demodulate the data being transmitted. Directional information for tracking was obtained by a special fast response automatic direction finder developed several years ago specifically for this type of application (Ocean Applied Research Corporation, San Diego, Model ADF210).¹

A block diagram of the telemetry transmitter is shown in Figure 1. Function and operation are as follows:

Pressure is measured by a semiconductor strain-gauge bridge excited with constant current. The output voltage is amplified by three operational amplifiers connected in an "instrumentation amplifier" configuration and the peak pressure reading stored (remembered) on a capacitor which is followed by an insulated-gate field-effect transistor (FET). This peak detector is inside the feedback loop of the amplifier which maintains accuracy and also yields a digital zero at point A when pressure is decreasing from the peak depth. This level is used to hold the temperature reading.

¹ Use of trade names in this publication does not imply endorsement of commercial products by the National Marine Fisheries Service.

Temperature is measured by a thermistor composite which is pressure protected in a thin-wall stainless steel tube. The thermistors' conductance is measured by an "operational trans-conductance amplifier" (OTA) whose output is gated by the digital signal from the pressure sensor. The output of the OTA drives a capacitor which serves as a temperature-reading memory. It is also followed by an insulated-gate FET whose high input impedance prevents memory discharge.

These two voltage analogs are converted to frequency analogs by voltage controlled oscillators (VCO). The filtered outputs of the VCO's are summed and the resulting composite fed to the amplitude modulator of the 3-watt peak transmitter.

A programmer is also included to provide a 4-second data transmission time when the animal first surfaces followed by a series of short pulses which are adequate for the tracking system. A seawater connection between the antenna tip and the instrument case generates a delayed reset for all capacitor memories and the programmer.

In the package used on the yearling gray whale two batteries were included



Figure 2.—Photograph of the Ocean Applied Research Corporation data transmitter Model WDT-920 attached to the Sea World yearling gray whale (Gigi) just prior to release. (Photo courtesy of J. S. Leatherwood.)



Figure 3.—Aerial photograph of test animal taken on 16 March 1972, as she was swimming through kelp beds off San Clemente, California. (Note kelp trailing behind the transmitter package.) (Photo courtesy of J. S. Leatherwood.)

in the system. One had a capacity of 13 ampere hours and was used to power all electronics which were on when the animal was at the surface. The second, smaller, battery, which had a 1.2 ampere hours capacity, powered the depth and temperature instrumentation continuously. The expected life of the smaller battery was approximately 1 month while the larger battery with its greater capacity and reduced duty cycle should continue to provide tracking transmissions for as much as 9 months. The entire system packaged and attached to the whale is shown in Figure 2.

During the first month of operation,

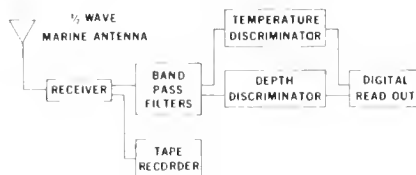

Figure 4.—Block diagram of the telemetry data receiving and recording system.

performance of the Instrument/Beacon package was satisfactory with the notable exception of transmission range which was initially more than 25 miles. Subsequent tests indicate that the antenna, which is a top loaded stainless steel whip antenna, had sustained some damage. The animal was, on two occasions, observed swimming through kelp and kelp was seen hanging on the antenna. Figure 3. California gray whales are also known to rub on the bottom, a behavior which could have abraded or even severed the loading coil from the antenna, drastically reducing its radiation efficiency. The estimated useful range of the damaged system was on the order of 10 miles.

The original antenna design employed on beacon transmitters for marine mammals (specifically porpoises) was an adaptation from a design which had been in use for some time on radio beacons used for the recovery of oceanographic instruments. It con-

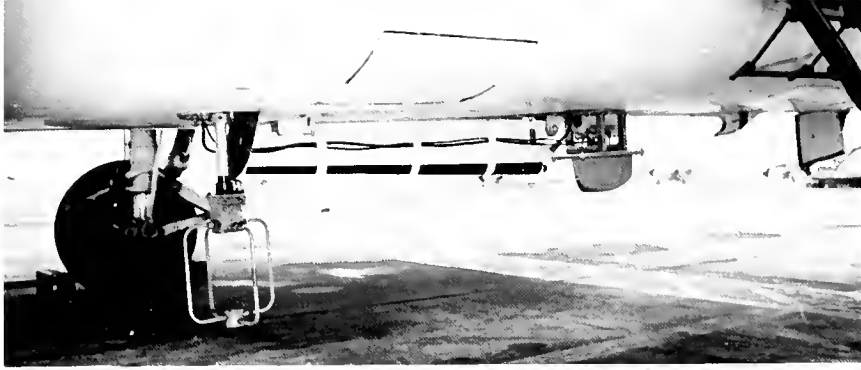

Figure 5.—Automatic direction finding antenna (loops) and data acquisition antenna (whip) attached to the belly of a U.S. Navy S-2 tracker aircraft. (Photo courtesy of J. S. Leatherwood.)

sisted of a solid fiberglass tapered rod onto which was wound a conductor and loading coil. An aluminum tip served both as a seawater contact and as a section whose length could be trimmed for peak field strength. A proprietary coating protected the conductor and coil from seawater. The antenna was entirely successful on *Delphinus* species (Evans, 1971), but problems were encountered when a similar design was used on captive whales such as pilot whales and killer whales. The captive whales invariably broke the antennas by rubbing on structures or boats and in the instance of the release of a pilot whale into the wild, the antenna was broken by seaweed. Subsequently, a spring-wire antenna was designed which could be severely bent without catastrophic damage and has been used successfully on the aforementioned whales (Martin, Evans, and Bowers, 1971). This type of antenna was used on the gray whale pack. Subsequent simulations of various types of damage to this antenna indicate that modifications would be in order before employing this type of antenna again. Specifically, the arrangement of the spring at the base should be changed to allow the antenna to be bent double against the transmitter case without damage. The antenna should be lengthened somewhat to reduce the variation in impedance for a given variation in the relative position of the ground plane (sea surface) and the loading coil should be fully encapsulated in the nonmetallic antenna's structure to completely eliminate the abrasion damage potential.

Data Receiving System

The data receiving and recording system illustrated in Figure 4 was originally tested on board the NUC RV *Cape*. Subsequent to the initial tracking and data acquisition attempts

following the release of the whale on 13 March 1972, the system was placed on board a U.S. Navy S-2 tracker aircraft. The antenna mounting configuration used on this type of aircraft is shown in Figure 5. The whip antenna is shown in the retracted mode. The loop antenna used in conjunction with the automatic direction finding system is adjustable and was aligned prior to every flight by using a shore-based radio beacon.

Several relocations of the animal were made using this system. The short transmission range of the damaged transmitter system attached to the whale seriously limited the acquisition of temperature and depth data from the aircraft-mounted system. Tests

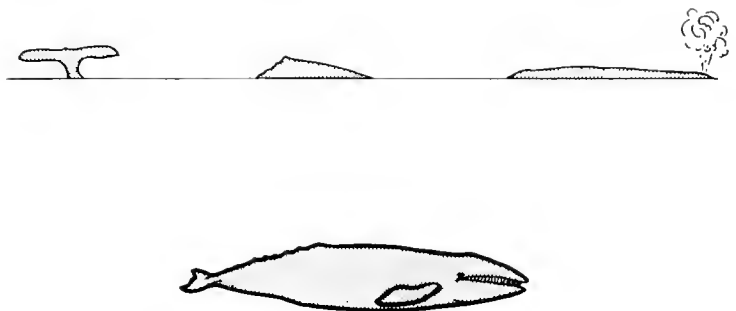

Figure 6.—California gray whale breaking the surface exposing only the head and fore-part of the back. The normal sequence of a blow is shown right to left at the bottom of the figure, note exposure of the dorsal ridge. (Photo courtesy of J. S. Leatherwood.)

Gray Whale Relocation Records

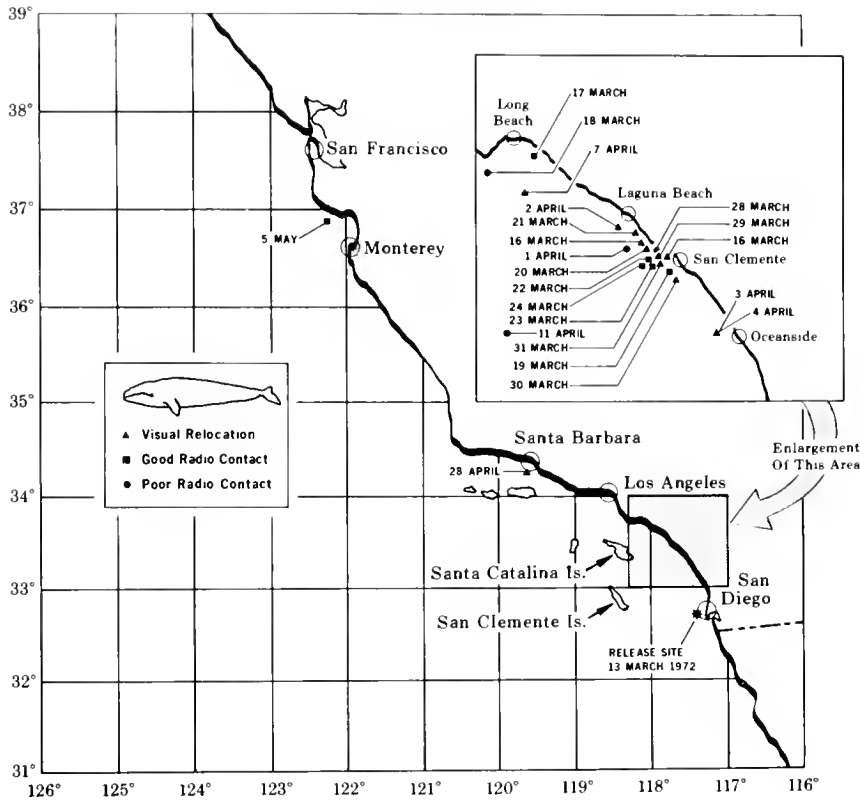

Figure 7.—Map of California coastline showing locations of the Sea World yearling gray whale (Gigi) 13 March-5 May 1972.

conducted following the release of the whale using a similar data transmitter with one-third the power of the system used on the test animal and a modified antenna have yielded data acquisition ranges up to 40 nautical miles.

RESULTS

During the initial 2 hours after release of the test animal, signals were very intermittent and seldom longer than 2 seconds in duration. Observations lead us to believe this was a behavioral problem since the animal frequently broke the surface of the water showing only her blow hole and mid-portion of her back as illustrated in Figure 6. Since the data transmitter was mounted on the dorsal ridge (on the last half of the body) the antenna either did not break the surface of the water, thus no transmission, or only the tip of the antenna broke the surface, resulting in a very short duration transmission.

This resulted in limited data reception during the first 2 hours after release and subsequent loss of the animal's location and movement pattern. Those signals over 2 seconds in duration that were received during this time period did indicate temperature-at-depth values reasonable for the location and time of year (e.g., above 20 meters temperatures of 13°-14°C and below 20 meters a temperature of 7.4°C). A 20-meter isothermal layer is not uncommon at this location. Since the quality of radio signal acquisition was quite poor, the search from the RV *Cape* was abandoned in favor of an aerial search. The animal was relocated on 15 March between 1300 and 1500 hours on a bearing of 320° south of Oceanside. The animal was relocated again on 16 March close inshore off San Clemente, Calif., working slowly north. The photograph shown in Figure 6 was taken at this time. On this flight and those that followed, although the animal could

be easily located, acquisition of useable temperature-at-depth data was limited 1) by the long time interval between adequate exposure of the antenna, and 2) by the apparent short range of the transmissions received. Areas of visual relocation and radio contact from 16 March 1972 to 5 May 1972, are illustrated in Figure 7.

After a period of 5 to 6 days, the animal's swimming pattern changed and longer and more frequent transmissions were being received. In order to verify these observations and, if possible, to collect temperature-at-depth data over a 24-hour period, the RV *Cape* left San Diego at approximately 1600 hours on 20 March 1972 for the Dana Point-San Clemente, Calif. area. At 1840 hours, 35 nautical miles from San Clemente, Calif., we acquired weak signals from the animal bearing 340°T. At 2300 hours, signal level had increased and we were receiving bearing and temperature-at-depth data. Initial data indicated temperatures of 12°-14°C at depths of 15-20 meters. At 2350 hours the animal's diving behavior changed and indicated some dives to depths of 170 meters. Triangulation placed the animal at a location approximately on the 100 fathom curve, 1.7 nautical miles off Laguna Beach, Calif. (Aliso Canyon). Although the depths recorded at this location were realistic if the animal was diving to the bottom, the water temperatures at those depths appeared to be anomalous. At this

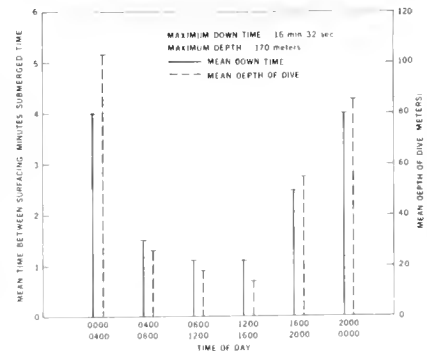

Figure 8.—Mean down times and depths of dive as a function of time of day recorded 20-21 March 1972.

time of the year one would expect surface temperatures between 12° and 14°C, and temperatures at 170 meters of 7°-8°C or less. Data from the animal, however, indicated temperatures-at-depths of 100-170 meters ranging from 10° to 14°C. If these levels were indeed accurate, a significant temperature inversion layer was present. This cruise was terminated at 2100 hours on 21 March 1972, after having recorded data for approximately 24 hours. In addition to the temperature-at-depth data, the following observations were made:

1. The animal was offshore 1-2 nautical miles after sunset, moved inshore 100-200 meters from the beach post-sunrise.

2. The diving pattern at night was regular, as compared to an erratic pattern during daylight hours.

3. The animal was observed in Dana Cove along with three other gray whales of a similar size range. All four animals left the Cove in late afternoon.

4. The mean time between transmissions was significantly longer from 1600 to 0400 hours than during the remainder of the day (Figure 8).

Since transmissions were more predictable after sunset, our aircraft data acquisition flights were scheduled at night. Under this plan, data were collected on 28 and 29 March from the S-2 tracker aircraft in the vicinity of Dana Point, Calif. The recorded data from these flights indicated dives of 50-80 meters and temperatures of 12°-14°C. The observations that the animal moved offshore (1-4 miles) at night were verified.

No readily apparent explanation was available for the relatively high temperatures recorded at depth on 20-21 March. To check on these measurements, the RV *Sea Sec* was sent to the Dana Point area to work from 6 April 1972 through 10 April 1972, equipped with an expendable bathythermograph (XBT) system capable of measuring temperature versus depth over a range of 0°C-30°C to depths of 450 meters. During the

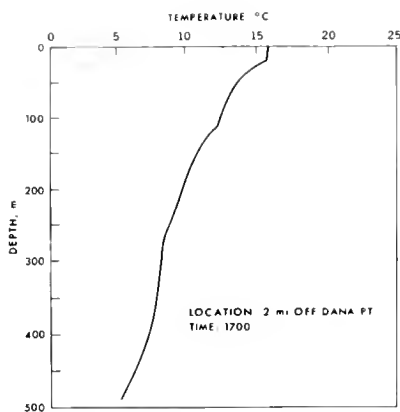

Figure 9.—A composite of three expendable bathythermograph plots collected 2 miles off Dana Point, California, at 1700 hours on 10 April 1972.

period 6-7 April, the area south of Dana Point was searched and no contact was made with the animal, although one small 7-8 meter whale was sighted. The XBT data, however, indicated surface temperatures of approximately 13°C which dropped to 6°C at 300 meters, with no obvious thermocline or temperature inversion. Late on 7 April, a search was made north of the Dana Point area by automobile and signal acquisition was made from the Huntington Beach pier at 1600 hours. Observers on the pier claimed to have sighted a small California gray whale with a radio pack swimming north 100 meters off the end of the pier at 1000 hours on that same day. Our signal acquisition was on a bearing of 280°T which would

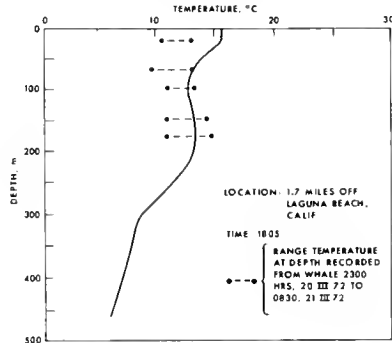

Figure 10.—A composite of three expendable bathythermograph plots collected 1.7 miles off Laguna Beach, California, at 1800 hours on 10 April 1972, compared to temperature versus depth data collected from Gigi on 20 March 1972.

place the animal between Seal Beach and Santa Catalina Island.

On 10 April 1972, the RV *Sea Sec* started a search north of Dana Point at 1600 hours. The first XBT station was at 1700 hours, 2 miles off Dana Point. A plot of temperature versus depth representative of the three measurements taken at this location is presented in Figure 9. The vessel moved north to approximately the same location where the temperature-at-depth data were collected from the whale on 20 March. Of major interest here is indication from the XBT data that a rather significant temperature inversion did exist in this area. A plot of the XBT station taken at 1800 hours on 10 April, 2 miles off Laguna Beach compared to the temperature-at-depth data transmitted from the whale is illustrated in Figure 10. It should be noted that although the relationship between the XBT and whale data appears to be comparable at depths of 100-200 meters, these are preliminary data. Conclusion should not be made without further verification of the thermal inversion shown in Figure 10. It is possible that the outfall of the San Onofre nuclear power plant north of this location is dumping warm water back into the sea. It has also been shown that at this time of year the mean geostrophic flow at 200 meters has northbound components (Wyllie, 1966). Depending on the temperature, volume, and depth of the San Onofre effluent it is not inconceivable that inversions such as that shown in Figure 9 could result. This, however, is pure speculation at this point.

ACKNOWLEDGMENTS

This study was accomplished under funding from NASA, Defense Purchase request A-70496A, RTOP 160-75-81, Task 01, Ames Research Center, Moffett Field, California. Additional funding support was received from the Naval Undersea Center, San Diego, California, Independent Research project R000-01. All of the electronic equipment used to instru-

ment the whale and subsequently track and obtain data from it was designed and manufactured by Ocean Applied Research Corporation, San Diego, California. Hugh Martin and Romaine Maiefski, both from this organization, actively participated in the attachment of the instrumentation to the animal and the initial stages of tracking. J. S. Leatherwood, J. Hall, Bruce Parks, and L. McKinley, of the Naval Undersea Center, San Diego, California, and the Commanding Officer of the RV *Cape* and his crew were directly instrumental in the success of this project. The radio contact with the instrumented whale on 5 May 1972 was accomplished by Paul Sebesta, NASA Ames Research Center, Moffett Field, Calif., using equipment supplied by the author.

POSTSCRIPT

During the period 2 January 1973-21 March 1973, the author investigated 37 reported resightings of Gigi. Although most of these reports did not check out, on 5-6 January, a Captain Paul Roth, USN, and a Mr. and Mrs. Sherwood of San Diego independently described behavior of a 9-10 meter California gray whale sighted inside the kelp off the Sunset Cliffs area of Point Loma, San Diego, California. In both cases the whale, light in color, approached close to small vessels less than 10 meters, rolled, and frolicked around. On 15 March we received a report from the MV *Long Beach Prince* that a whale of similar size and with white tail flukes (see Figure 3) and a 60 cm \times 60 cm square white scar behind the blow hole was sighted frolicking around the vessel by 178 whale watchers. The location of this sighting was 3-4 miles off Point Fermin. This latter sighting is especially interesting since on 6 March 1972, one week prior to release, Gigi II was branded using cryogenics with a 60 cm \times 60 cm mark, midline on the back just posterior to the blow hole. This form of marking, called "freeze branding," results in a white scarring

due to the destruction or displacement of melanin in the epidermis of the area treated.

LITERATURE CITED

- Eckman, S. 1953. Zoogeography of the sea. Sidgwick and Jackson Ltd., Lond., 417 p.
- Evans, W. E. 1970. Uses of advanced space technology and upgrading the future study of oceanology. AIAA 7th Annual Mtg. and Tech. Display, Houston, Tex., Pap. No. 70-1273, p. 1-3.

_____. 1971. Orientation behavior of delphinids: Radio telemetric studies. *Ann. N.Y. Acad. Sci.* 188:142-160.

_____. In press. Radio telemetric studies of two species of small odontocete cetaceans. In W. E. Schevill (editor), *The Whale Problem*. Harvard Press, Cambridge, pp. 385-394.

Martin, H., W. E. Evans, and C. A. Bowers. 1971. Methods for radio tracking marine mammals in the open sea. *IEEE Eng. in the Ocean Environ. Conf.*, p. 44-49.

Wyllie, J. G. 1966. Geostrophic flow of the California Current at the surface and at 200 meters. *Calif. Coop. Oceanic Fish. Invest. Atlas No. 4*, xiii + 288 charts.

MFR Paper 1058. From Marine Fisheries Review, Vol. 36, No. 4, April 1974. Copies of this paper, in limited numbers, are available from D83, Technical Information Division, Environmental Science Information Center, NOAA, Washington, DC 20235.

MFR PAPER 1059

Capture and Harnessing of Young California Gray Whales, *Eschrichtius robustus*

KENNETH S. NORRIS and ROGER L. GENTRY

ABSTRACT

This paper reports on the details of capture, harnessing, tracking, and harness release for three suckling gray whales. These tests are the first steps in a program to develop new means of data acquisition and recovery from whales during their migrations. It is hoped by these means to develop new information about population routes and hence population numbers to assist management. Capture was by tail noosing and head netting from a fishing vessel equipped with a swordfish plank. The harness, placed on the captive ashore, was held in place over the pectoral fins and back by means of a pair of metal plates held together by a soluble magnesium bolt. Tracking was by radio.

INTRODUCTION

Informed whale management requires adequate knowledge of population numbers. Uncertainty about migratory pathways and population mixing makes determination of such numbers uncertain for some whales such as the humpback (*Megaptera novaeangliae*), the blue whale (*Balaenoptera musculus*), the fin whale (*Balaenoptera physalus*), and the minke whale

(*Balaenoptera actorostrata*). Thus precise information on migration routes of these and other marine mammals would materially assist in the development of sound management practice (Anonymous, in press).

In spite of decades of work with Discovery and other tagging methods (Clarke, 1957) our knowledge of whale migration remains highly incomplete. Because such information is needed for some protected species, new tag-

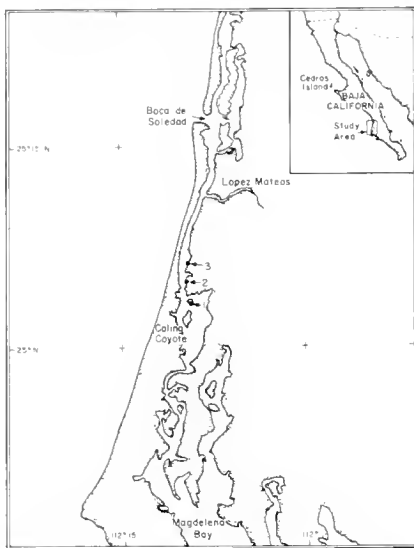

Figure 1.—Map of capture locality. Numbers indicate the capture sites for the three harnessed animals.

ging methods that do not require killing are now required. These methods seem to fall into two categories: (1) those involving the capture of whales, placement of harnesses and equipment on them, tracking along the whale's route, and subsequent release and recovery of data packages; and (2) those involving placement of data or telemetering packages on whales without capture, followed by tracking.

The first method will allow data collection from a few animals, while the latter will presumably allow less complete data collection from more animals and from those species that cannot be captured. The tests described here are of the first sort; that is, they involve capture and harnessing. The experiments of Evans (this number of *Marine Fisheries Review*) with Gigi are also of this sort, though surgical attachment rather than harnessing was used.

We chose our subject, the California gray whale, because large numbers of suckling calves are available in their Mexican breeding lagoon during January and February of each year and because the calm working conditions in the lagoon would assist these preliminary tests. We expect that the

majority of results obtained on this relatively well-known animal will be applicable to more oceanic species. Our tests were restricted to capture, harnessing, and very short term tracking, since we expected that our results would require harness redesign prior to long-term tracking. This proved to be the case.

We attempted to capture suckling animals only because of the obvious dangers and seamanship problems presented by adult whales. The rationale supporting this choice is that a suckling calf, harnessed and instrumented, should keep station with its mother and, hence, give a true migratory route.

To our knowledge five baby gray whale captures or handlings have been reported. Eberhardt and Norris (1964) report working with a stranded baby gray whale in Scammon's Lagoon. Robert Elsner (pers. comm.) detailed a capture of a baby gray whale in Scammon's Lagoon from a small catamaran by use of a superficial harpoon followed by netting. David Kenney (pers. comm.) directed the capture of Elsner's animal and the capture and transportation of Gigi, the gray whale calf caught in Scammon's Lagoon and held for 12 months in Sea World. The latter whale was captured with a tail noose from a small fishing vessel equipped with a bow plank. The ship was reportedly damaged slightly by the mother when the baby was brought alongside. Theodore Walker (Couteau, 1972) is shown manipulating a stranded baby gray whale in circumstances much like those discussed by Eberhardt and Norris (1964). Spencer (1973) reported on the drug-assisted capture of adult whales in Scammon's Lagoon.

THE STUDY SITE

We chose northern Magdalena Bay, Baja California Sur, Mexico, near Boca de Soledad for our work because of an abundance of whales living in a system of shallow bays and rather narrow channels and because

Kenneth S. Norris and Roger L. Gentry are associated with the Coastal Marine Laboratory, University of California, Santa Cruz, Santa Cruz, CA 95064.

the Mexican government has recently declared the better known Scammon's Lagoon (Laguna Ojo de Liebre) a whale reserve. Headquarters were established in the small government cannery town of Lopez Mateos, which fronts on the main lagoon channel 8 km southeast of Boca de Soledad (Figure 1).

In this region the channel is about 800 m wide and averages 11 m deep in mid-channel. To the west a low ridge of dunes separates the lagoon from the sea. The shore along the dunes drops precipitously into deep water. The eastern bank is typically bordered with dense mangrove thickets often cut by shallow bays and channels. The shore along the mangrove coast usually shelves gradually over a broad tidal flat to the main channel. This difference in bottom contour proved crucial to capture and harnessing.

While whales were found throughout the deeper parts of the channel, one concentration occurred just inside Boca de Soledad and another occurred at a broad expanse of water just north of Colina Coyote (see Figure 1). It was here, or somewhat closer to Lopez Mateos, that our captures took place. Our counts showed approximately 86 whales in residence in the entire channel system. Most were mothers and young, but a few males were present, as indicated by copulations observed inside the channel.

WHALE CAPTURE AND HARNESSING

Capture of suckling gray whales proved to be rather simple, once the basic techniques were established. Four whales were netted in 3 days (27-29 January 1973). One was released because it was clearly too large for our

harnesses. The other three were successfully harnessed, released to their mothers, and tracked. Capture was performed from the swordfish boat *Louison*, a 15-m vessel equipped with a 11.5 m welded aluminum pipe pulpit projecting from its bow. During capture Captain Tim Houshar occupied the basket at the end of the pulpit, while the helmsman steered from a remote station atop the crow's nest. The vessel was maneuvered behind a whale pair, attempting to place the netman in the pulpit over the animals as they surfaced to breathe. At the same time another crewman in a speedboat zigzagged around and in front of the animals in an attempt to direct and distract them. This attempt succeeded often enough that surfacing whales rather regularly allowed the pulpit to pass over them. The tendency to surface beneath the pulpit varied rather widely from pair to pair and seemed most consistent in mothers with small young.

Once a pair surfaced under the pul-

pit a noose of 1.25 cm nylon line was placed over the small animal's head by means of a large metal hoop cut through at its outer margin and held together inside a piece of plastic tubing (Figure 2). The rather slow speed of the whales (usually less than 7 knots) and the relatively long time they spend at the surface during respiration make this a reasonably simple process.

At this point the nylon noose which was tied to the metal hoop with light twine was pulled loose. The hoop separated over the animal and was pulled away, leaving the noose to slip back to the tail stock of the little whale. Another crewman on the pulpit pulled the noose tight over the tail stock. The nosed young took out a modest amount of line, usually less than 100 m, before the line was belayed around a Samson post. The young did not dive for extended periods (less than 1 minute) but towed the vessel for a time in this position. The mother always stayed in close attendance,

often sliding over the line or coming up underneath it. At times she lifted the young on her snout or back, and occasionally she thrashed at the restraining line with her flukes.

Once the young animal began to slow somewhat, it was brought back under the pulpit by bringing in line. The mother came with it and swam under the pulpit or slightly off to the side. Never did a female attempt to hit the boat or the pulpit, though our small sample may not be representative. A head net bag of 5 cm nylon mesh, also containing a noose of 1.25 cm nylon line and similarly positioned on a hoop frame, was placed over the baby's head. Optimally this net was deep enough to extend from the tip of the snout to just posterior to the pectoral flippers. In practice our nets were too small for all but one animal and placed the noose anterior to the pectorals. Even so, the noose did not slip loose.

With lines fore and aft the young animal was severely hampered and could be pulled in rather easily by hand. During this time the boat and skiff had been maneuvering the pair toward the east bank and its shallow shelf.

Two plastic trash barrels containing the coiled head and tail lines were lifted into a waiting skiff and payed out to the restrained whale until the shallow shelf was reached. Then the lines were taken ashore and the men, usually four to six, pulled the baby sideways onto the shelf. Usually the mother's efforts were strenuous at this time, and occasionally she looped the line over her body or tail giving an irresistible pull, but always she rapidly slipped free and the baby could be towed in again. The baby was beached in about 0.7 m of water, 10 m or so from the shelf edge. The mother was unable to enter such shallow water, though she did patrol the shelf edge, and in one case partially stranded herself, seemingly in an attempt to reach the baby. Thus protected from the obvious ire of the mother, it was rather simple to



Figure 2.—Capture of the baby whale. Note hoop and noose being placed over the baby. Note also the swordfish plank which is maneuvered over the mother-young pair.

place the harness on the baby. The danger from the mother was made clear when a crewman began working within a few meters of one. The female whale lifted her tail, bent it back and thrashed the flukes around in a semi-circle, horizontal to the water surface. She missed the man by quite a distance but the force of the blow was enough to send a sheet of water over everyone nearby.

The baby remained rather quiet during the harnessing process. The harness was usually slipped on under the snout and worked posteriorly to the pectorals which were then inserted through the harness. The harness was then tightened in place until snug over the baby's body. At this point, timing for harness release began as a corrosible magnesium bolt which held the release mechanism began to corrode away in salt water.

Three or four men pushed the baby back into deep water over the shelf taking care to avoid the mother. In all but one case she was nearby and quickly took up station with her offspring. In one case the mother left before the baby was launched and was a kilometer or so down the bay shore when the baby began to swim in deep water. This baby cruised quietly for a short time and then, when about 300 m from the mother, turned as if on a signal and raced toward her. The mother did the same, turning toward the baby and beginning to swim rapidly. Once they were near the mother circled the baby, thrashing the water with her flukes. It was probable that an acoustic recognition signal was involved. This young animal had been emitting short low frequency signals while stranded. Even if the young did become separated from the mother by some distance, chances for reunion remained excellent because of the restricted channels available for swimming.

In all cases the presence of the harness had no visible effect on the behavior of the mother-young pair.

HARNESS DESIGN

The harness was constructed of four layers of one-way stretch Lino 241,¹ commonly used in fabricating girdles and corsets, that permitted expansion and contraction around the whale's circumference. The two legs of each harness half (Figure 3) were attached together ventrally by "D" rings to a timed-release mechanism. Dorsally they were bolted to a curved metal plate holding the radio transmitter. Horizontal rows of grommets 5 cm apart in the heavy plastic-impregnated nylon reinforcing band at the dorsal ends of the harness legs allowed adjustments to animals of different circumferences and allowed the harness to be secured under different degrees of tension. We pulled the harnesses snug on our animals, which prevented flutter from water passing around the swimming animal and kept the harness in place during dives (the harness was 40 cm wide and 112 cm long).

The strength feature of the harness was a 2.5 cm wide by 0.6 cm thick woven nylon strap in the leading and trailing edge of each harness half. These straps, held in sewn folds of the harness, were sewn to the harness only near the ventral "D" rings, thus permitting harness and straps to be adjusted independently to the whale's circumference. The grommets ends of both the harness itself and the strengthening straps were attached to bolts on the dorsal plate by means of knurled nuts.

A plastic cup on each side by mid-body simulated an instrument housing, and a polyvinyl chloride rod sewn across the harness above the pectorals acted as a batten, preventing bunching of the harness in the anterior-posterior direction.

The timed-release mechanism consisted to two aluminum plates held together by a central spring-loaded

¹ Reference to trade names does not imply endorsement by the National Marine Fisheries Service, NOAA

magnesium bolt. One plate had four tapered corner posts that fit into four receptacles on the other plate. The "D" rings of the harness legs slipped over the posts and over four strong springs that assisted in forcing the plates apart during jettisoning. All tensions of the harness and nylon straps were exerted against these posts. The magnesium bolt bore only the vertical strain of a spring between the two plates.

The wall thickness of the magnesium bolt determined the interval between submergence in seawater and the time of breakage. When the bolt broke the springs forced the two plates apart and released the "D" rings from their posts. Corrosion of the bolts was insured by a central copper sleeve that promoted rapid electrolysis.

The dorsal plate to which the harness attached was constructed of 5 mm curved aluminum, designed to fit over the body contour of a baby whale. An Ocean Applied Research Model PT-202 radio transmitter was secured to the center of this plate, and a painted yellow cap moulded of high density polyurethan foam was fitted over the transmitter for flotation. Foam neoprene sheeting was glued to the ventral surface of this plate to prevent chafing the whale's skin.

To fasten the harness around the animal, the two halves, connected ventrally to the timed-release mechanism, were slid under the animal and the pectoral flippers inserted through the harness. The radio, float, and plate were placed on the dorsal midline, and each harness half was pulled tight; the appropriate rows of grommets in the harness were fitted over bolts in the dorsal plate and the nuts tightened down. Then the excess rows of grommets were cut off with a knife and the heavy nylon straps secured in place and similarly trimmed. Finally straps from the float were attached, and the calf was ready to be launched to its mother. Figure 4 shows the harness and radio in place as the released calf joins its mother.

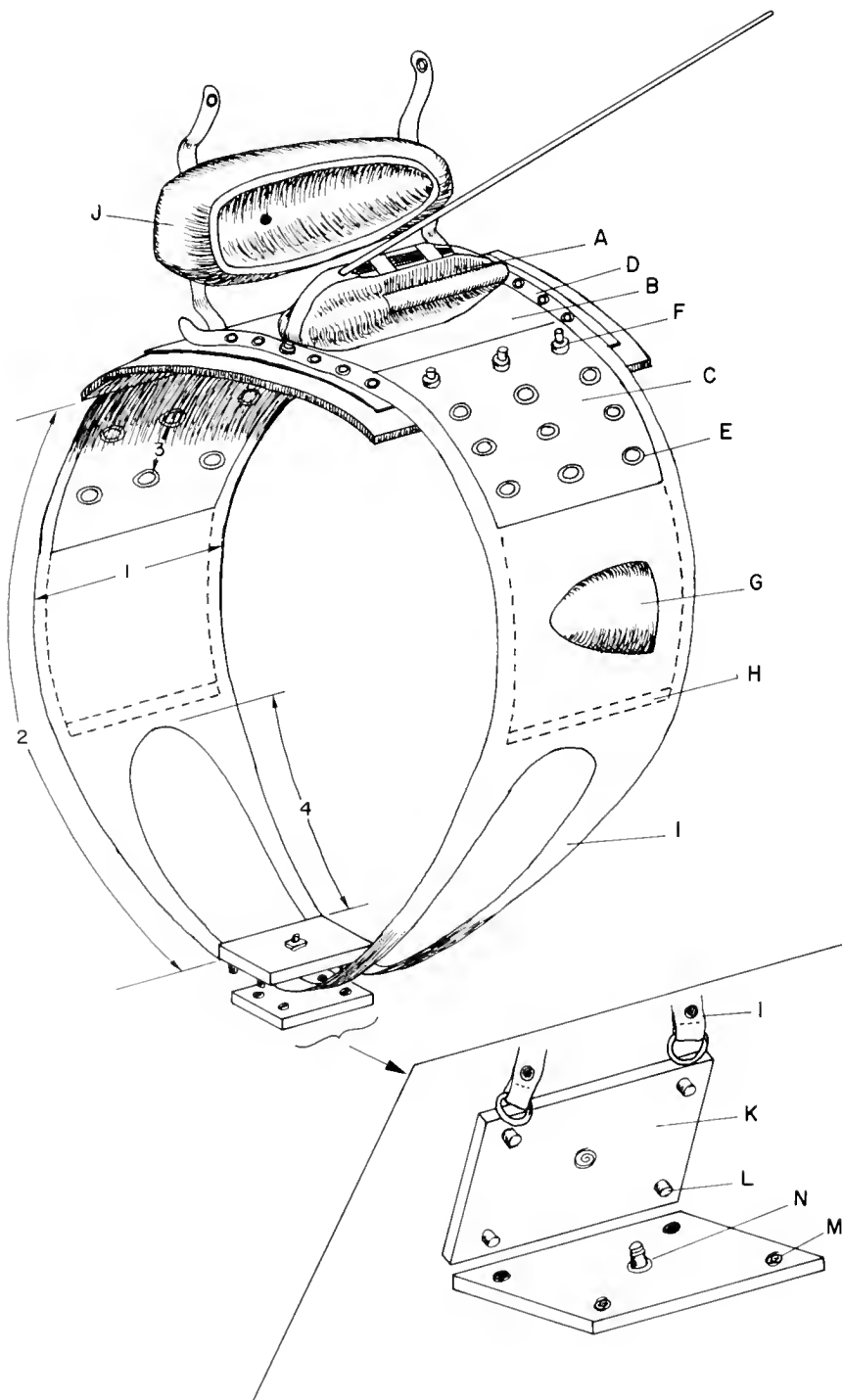

Figure 3.—The harness, radio transmitter and timed release mechanism: (A) OAR PT-202 radio transmitter (B) 5 mm curved aluminum dorsal plate (C) Plastic-impregnated nylon reinforcing sewn into harness of Lino # 241 material (D) Nylon reinforcing strap sewn into harness and bolted to dorsal plate (E) Rows of grommets (F) Knurled nuts holding harness to dorsal plate (G) Instrument housing (H) Polyvinyl chloride bal-tan (I) Harness legs with "D" rings (J) Polyurethan flotation device attached by straps to dorsal plate (K) Timed-release mechanism (L) Aluminum corner posts to which "D" rings of harness legs attach (M) Receptacles for above posts—spring loaded (N) Magnesium bolt passes through spring loaded hole in top plate and secured with a nut.

Dimensions: (1) Harness width 40 cm (2) Harness length 112 cm from timed—release mechanism to first row of grommets (3) Distance between each of five rows of grommets = 5 cm (4) Length of harness legs 40 cm (5) Timed release mechanism 10 × 15 cm.

TRACKING AND HARNESS RECOVERY

The three harnessed whales remained within a few hundred meters of their release points (see Figure 1). Visual tracking in daylight was greatly assisted by the bright yellow float and upper harness which were visible even a foot or two underwater.

In the first release, after some time in the water, the calf swam purposefully toward the *Louson*, turned on her side, and rubbed the harness against the hull and keel of the boat—breaking the float partly loose, releasing one "D" ring, and snapping the fiberglass radio antenna. Transmission of radio signals immediately ceased. This damage could have been prevented by our maintaining a greater distance from the harnessed animal. The timed-release mechanism contained a 5-hour bolt which had not released by the time darkness fell. The harness was recovered 2 days later in vegetation along the channel edge, about 2 km from the release point.

The second release, timed for somewhat less than 5 hours, went flawlessly, including radio tracking and harness release.

The third release was planned for 20 hours, with tracking overnight from the *Louson*. To assist after dark should the radio malfunction, a waterproof lifejacket light was fixed to the float. Though both radio and light functioned at release, they failed before



Figure 4.—Mother and young swimming with harness and radio in place.

dark, and the animal was lost during the night. However, shortly after dawn the released harness was found floating within 60 m of the vessel. Details of these releases and trackings are presented in Table 1.

DISCUSSION

The capture methods described here for suckling gray whales are remarkably effective and simple. Except when the mother is under the pulpit or at the edge of shallow water, the methods seem relatively safe. Given enough shipboard power the noosing methods would work with larger animals, though the sheer bulk of an adult would make any movement by the whale, purposive or not, dangerous. This would certainly be a prime consideration in any attempt to affix a harness on an adult.

The harness described here would, with minor modifications, serve nicely for short-term tracking and instrumentation of small gray whales. Because a whale attains 66-72 percent of its adult size in the first year (Rice and Wolman, 1971), growth during the first months is extremely rapid. Harnesses for periods of more than a week must therefore include a device that allows for growth but also keeps a constant tension and locks if the

Table 1.—Harnessing and tracking of gray whale calves.

Date	Animal number and name	Sex	Girth (m)	Length (m)	Planned bolt life (hr)	Netting to beaching (min)	Beaching to release (min)	Tracking
1/27/73	(1) Carl(a)	F	2.41	4.80	5 ±	30 ±	37 ±	4 hr, 45 min track, release time uncertain
1/28/73	(2) Lee	M	2.17	4.20	5 ±	18 ±	14 ±	3 hr, 16 min
1/29/73	(3) Baja	F	2.51	5.16	20 ±	28 ±	8 ±	17 hr, 23 min to harness recovery. Time to release uncertain.

animal rubs the harness against underwater obstructions.

Another concern on any long-term track is abrasion of the harness. The purposive rubbing of whale No. 1 against the capture ship and its mother caused damage to the radio antenna and serious abrasion to the lower harness legs. On whale No. 2 the abdominal legs of the harness were abraded through the girdle fabric and into the flat nylon strap in several places, even though the animal wore the harness for only 3 hours, 16 minutes. Behavioral observations suggest that much harness wear results when the baby rubs against the barnacle-covered back of the mother and slides to one side as she surfaces. None of these problems was more than very minor in these tests. But clearly long-term tracking with increased exposure to obstacles along the migratory path

will exacerbate these problems greatly. More durable materials, such as metal or the strongest fabric, and more resilient radio antennae will be needed for successful long-term tracking.

The release mechanism dependent upon magnesium bolt corrosion worked adequately, but variations in water temperature and salinity could unpredictably alter release time. Long release times (more than a week) may require a new system, such as the use of electroexplosive or electronic release mechanisms that might allow an operator to release the harness upon command.

Harnessing is probably the least injurious means of attaching instruments to cetaceans, and harness placement around the pectoral flipper area is probably optimal. Pectoral placement insures maximum exposure of the antenna, minimal body movement

during swimming, and relatively little change in girth during diving. Further, when physiological data are to be taken, most important vital areas (lungs, heart, brain) are nearby.

In our opinion package volume could be relatively high, providing it is weight compensated until nearly isotatic. A baby whale might well carry 15-20 kg of instruments properly housed and shaped to reduce drag. Instrument placement is probably best just above or between pectorals where it would cause the least disequilibrium. In these positions it would be most difficult for the whale to rub the instruments loose. Any such package, of course, would have to be strongly protected from impact and abrasion.

The harness used here was designed with a float at the top to suspend the antenna with the harness hanging below so that when cast off it rode easily with the antenna in the vertical position for good transmission.

In conclusion, the first steps of whale capture and instrumentation have been taken, but much remains to be done to transfer the methods to (1) long term trackings, (2) other species which must be caught and handled at sea, and (3) adult whales.

ACKNOWLEDGMENTS

Permission to study the gray whale came from both the Mexican and United States governments, and many people helped. Prominent were Carl L. Hubbs of Scripps Institution of Oceanography; George Gross, U.S. Fisheries Attaché, U.S. Embassy, Mexico City; and Philip Roedel and Robert Miller of National Oceanic and Atmospheric Administration, U.S. Department of Commerce. We thank our willing and skillful field crew: Captain Tim Houshar and the crew of the *Louison*, Richard Pierce, Kenneth Balcomb, and Thomas P. Dohl of the University of California, Santa Cruz; Gerald Kooyman of Scripps Institution of Oceanography; Robert Gibson of the Franklin Institute Research Laboratories, Philadelphia;

José Castelló of the Consejo Nacional Ciencias y Tecnología, Mexico City; and Jaime Domínguez and Mario Camparán of the Escuela Superior de Ciencias Marinas, Ensenada, Baja California Norte, Mexico.

We thank Frank Brocato for consultation on whale capture and for constructing much of our gear.

We are especially grateful to Edwin Janss and Richard Wheeler of the Janss Foundation for support of the field study. A National Aeronautics and Space Administration subcontract No. 23196 (NASA NAS2-6860) allowed harness preparation.

LITERATURE CITED

- Anonymous. In press. Report of Working Group on Bio. and Nat'l. Hist. In W. E. Schevill (editor), *The Whale Problem*. Harvard Press, Cambridge, pp 5-10.
- Clarke, R. 1957. Migrations of marine mammals. [In Engl. and Norw.] *Nor. Hvalfangst-Tid.* 46:609-630.
- Coastal, J. Y. 1972. *The whale, Mighty monarch of the sea*. Doubleday & Co., Garden City, 304 p.
- Eberhardt, R. L., and K. S. Norris. 1964. Observations of newborn Pacific gray whales on Mexican calving grounds. *J. Mammal.* 45(1):88-95.
- Rice, D. W., and A. A. Wolman. 1971. The life history and ecology of the gray whale (*Eschrichtius robustus*). *Am. Soc. Mammal. Spec. Publ.* No. 3, 142 p.
- Spencer, M. P. 1973. Scientific studies on the gray whales of Laguna Ojo de liebre (Scammon's Lagoon), Baja California, Mexico. *Natl. Geogr. Soc. Res. Rep.*, 1966 projects, p. 235-253.

MFR Paper 1059. From Marine Fisheries Review, Vol. 36, No. 4, April, 1974. Copies of this paper, in limited numbers, are available from D83, Technical Information Division, Environmental Science Information Center, NOAA, Washington, DC 20235.

Opposite.—Gigi II, with transmitter affixed to back, awaits release at sea off San Diego. Photo by J. S. Leatherwood, courtesy of Naval Undersea Center, San Diego, Calif.



UNITED STATES
DEPARTMENT OF COMMERCE
NATIONAL OCEANIC AND ATMOSPHERIC ADMINISTRATION
NATIONAL MARINE FISHERIES SERVICE
SCIENTIFIC PUBLICATIONS STAFF
ROOM 450
1107 N E 45TH ST
SEATTLE WA 98105
OFFICIAL BUSINESS

FOURTH CLASS

POSTAGE AND FEES PAID
U S DEPARTMENT OF COMMERCE
COM-210

